



HAL
open science

Bases comportementales, physiologiques et génétiques du succès reproducteur d'un hyménoptère parasitoïde

Romain Benoist

► **To cite this version:**

Romain Benoist. Bases comportementales, physiologiques et génétiques du succès reproducteur d'un hyménoptère parasitoïde. Sciences du Vivant [q-bio]. Sorbonne University UPMC; Sciences de la Nature et de l'Homme: Évolution et Écologie, 2019. Français. NNT: . tel-03006621v1

HAL Id: tel-03006621

<https://hal.science/tel-03006621v1>

Submitted on 16 Nov 2020 (v1), last revised 7 Sep 2021 (v2)

HAL is a multi-disciplinary open access archive for the deposit and dissemination of scientific research documents, whether they are published or not. The documents may come from teaching and research institutions in France or abroad, or from public or private research centers.

L'archive ouverte pluridisciplinaire **HAL**, est destinée au dépôt et à la diffusion de documents scientifiques de niveau recherche, publiés ou non, émanant des établissements d'enseignement et de recherche français ou étrangers, des laboratoires publics ou privés.

THÈSE DE DOCTORAT DE Sorbonne Université

École doctorale « Sciences de la Nature et de l'Homme : Évolution et Écologie »

Laboratoire : Évolution, Génomes, Comportement et Écologie

**Bases comportementales, physiologiques et génétiques du
succès reproducteur d'un hyménoptère parasitoïde**

Présentée par Romain Benoist

Pour obtenir le grade de
DOCTEUR

Discipline : Biologie

Présentée et soutenue publiquement le 16/12/2019

Devant un jury composé de :

Mme. Hélène Gilbert	Directrice de recherche	Rapporteur
Mme. Geneviève Prévost	Professeur	Rapporteur
M. Thierry Robert	Maître de conférence	Examineur
M. Emmanuel Desouhant	Directeur de recherche	Examineur
M. Bruno Le Ru	Directeur de recherche	Directeur de thèse
Mme. Laure Kaiser-Arnauld	Directrice de recherche	Co-directrice
Mme. Florence Mougél-Imbert	Maître de conférence	Co-encadrante

“On continue quand même, peut-être parce qu'on sait qu'il faut continuer, même si on ne comprend plus pourquoi.”

Bernard Moitessier, La longue route

Remerciements

J'arrive maintenant au bout de ce voyage mouvementé qui s'appelle la thèse, et il est temps pour moi de regarder en arrière et de remercier l'ensemble des personnes qui ont rendu ce travail possible.

Dans un premier temps je souhaiterais remercier les membres de mon jury de thèse, Hélène Gilbert et Geneviève Prévost pour avoir accepté d'être rapporteurs de cette thèse et ainsi d'avoir la lourde tâche de relire mes divagations, Emmanuel Desouhant et Thierry Robert pour avoir accepté d'être examinateurs.

Il me tient à cœur de remercier mes encadrants, Laure Kaiser-Arnauld, Florence Mougel et Bruno le Ru. À défaut d'avoir été un doctorant exemplaire, je peux au moins me targuer d'avoir eu une équipe de direction formidable sans laquelle je n'aurais tout simplement pas fini ma thèse, notamment Laure et Florence qui m'ont poussé jusqu'à la dernière seconde. Laure, merci de m'avoir toujours fait confiance malgré mon infatigable pessimisme. Florence, merci de ta patience à toute épreuve avec moi, je pense qu'on peut te donner une médaille pour ça. Bruno, je ne suis peut-être pas allé au Kenya au cours de ma thèse mais grâce à toi c'est tout comme. Je vais m'arrêter là car si je devais d'écrire tout ce que je vous dois les remerciements seraient plus long que la thèse alors je conclurai simplement par un merci pour tous.

Je tiens tout particulièrement à remercier les nombreuses personnes avec qui j'ai travaillé au cours de ma thèse : Claire Capdevielle-Dulac avec qui j'ai adoré commérer et qui est à la biologie moléculaire ce que je suis à la maniaquerie (comprendra qui pourra). Je la remercie pour m'avoir (re)formé à la BM et pour son avis qui m'a été très utile tout au long de ma thèse, même si elle dira sûrement que je ne le prends pas en compte ; Taiadjana Fortuna pour sa jovialité en toutes circonstances, toujours là pour me donner un coup de main et grâce à qui j'ai pu me concentrer sur la rédaction de ma thèse. Je sais qu'avec elle, l'élevage est entre de bonnes mains ; Paul-André Calatayud grâce à qui nous avons pu avoir nos souches et avec qui il est toujours extrêmement agréable de discuter et j'aurais aimé plus collaborer ; Rémi Jeannette et Odile Giraudier sans qui il n'y aurait pas eu d'élevage et donc tout simplement pas de thèse ; François Rebaudo avec qui je suis sur la même longueur d'onde pour beaucoup de choses. Ce fut un grand plaisir de travailler avec lui sur ce système de détection de la température ; Stéphane Dupas avec qui j'aurais aimé plus échanger tant ses remarques sont pertinentes ; Mon armée de petits stagiaires formée d'Aurore Vedel, Nicolas Leblanc, Jérémy Guez et notamment Sarah Paquet et Florian Decourcelle qui ont travaillé avec moi pendant près de 6 mois chacun et sans lesquels le contenu de cette thèse serait bien vide. J'espère avoir été un encadrant à la hauteur. Je remercie également Yves Carton pour tous les conseils qu'il m'a prodigués.

Je remercie bien entendu mes chers non-permanents : Mes « gars sûrs », Cécile Courret, Julia Mariette et Andréas Odorico avec qui j'ai perdu la tête au cours de cette dernière année de thèse, zbili ; Arnaud Becheler dont la présence réconfortante dans le bureau me manque beaucoup ; Perrine ma fidèle partenaire de ping-pong ; Céline Chantre qui m'a tout appris ou presque sur les Cotesia ; Damien Delalande mon partenaire de crime ; Florian Bastien le doctorant émérite parti beaucoup trop tôt ; Joseph Guilliet grâce à qui je peux continuer de vivre comme un vampire dans le bureau ; Je remercie également Vincent, Inoussa, Marwa, Claudia, Marie et tous les autres qui m'ont accompagné autour d'une petite bière. J'espère qu'après cette année la jeune génération va reprendre le flambeau pour mettre de l'ambiance dans ce labo !

Plus généralement, je souhaite remercier l'ensemble des membres du laboratoire. J'ai eu la chance de pouvoir interagir avec beaucoup d'entre vous lors de ma thèse et je n'ai jamais trouvé de porte fermée. Ce fut un vrai plaisir d'être membre de l'EGCE que je vais quitter avec regret.

Je tiens également à remercier nos collaborateurs de l'IRBI, Jean-Michel Drezen, Christophe Bressac, Jérémy Gauthier et Elisabeth Huguet et ceux de l'icipe au Kenya, notamment Julius Obonyo.

Je remercie aussi mes amis, Raphaëlle et Arnaud pour leur soutien. Pauline qui m'accompagne depuis quelques mois maintenant et qui a continué de me soutenir jusqu'au bout.

Enfin, je ne remercierais jamais assez les membres de ma petite famille qui ont toujours cru en moi et notamment mes parents pour les nombreux sacrifices qu'ils ont fait et grâce auxquels je peux écrire ces mots aujourd'hui.

Enfin, je remercie toutes les personnes que j'ai oublié de remercier avant (et il y en a forcément). J'espère que vous me pardonneriez.

Encore merci à tous, cette thèse est un peu la vôtre aussi.

Résumé

Etudier l'aptitude d'insectes parasitoïdes à se reproduire dans de nouveaux hôtes est important pour comprendre les mécanismes d'adaptation dans un contexte de lutte biologique. *Cotesia typhae* est un parasitoïde africain spécialisé sur le lépidoptère *Sesamia nonagrioides* et est un agent de lutte biologique potentiel contre ce ravageur du maïs. *C. typhae* appartient à un groupe d'espèces possédant un virus endosymbiotique injecté dans l'hôte lors de la ponte et contribuant à la virulence du parasitoïde. J'ai pu montrer que deux souches de *C. typhae* diffèrent par leur nombre de descendants et par leur virulence envers une population française de *S. nonagrioides*, représentant un nouvel hôte. Afin d'identifier les gènes responsables de ces variations une recherche de QTL a été entreprise (Quantitative Trait Loci). Nous avons établi une carte génétique de *C. typhae*, identifié quatre QTL et dressé une liste de gènes candidats. Pour expliquer la différence de virulence et du nombre de descendants, les quantités d'œufs et de virus injectés au cours de pontes successives ont été estimées. Ces expériences ont montré 1/ que les deux souches ne répartissent pas leurs œufs de la même manière entre les hôtes, 2/ que la quantité de virus injectés n'est pas corrélée à la virulence. Pour comprendre l'origine évolutive de la différence de virulence, ce trait a été estimé sur les populations hôtes naturelles. Les résultats suggèrent que l'adaptation locale pourrait être à l'origine de la pré-adaptation d'une des souches à l'hôte français. Ce travail a permis également de bien caractériser le succès reproducteur de *C. typhae*, essentiel pour son utilisation en lutte biologique.

Abstract

Studying the ability of insect parasitoids to reproduce in novel hosts is important to understand adaptive mechanisms at play when they are used for biological control. *Cotesia typhae* is an African parasitoid specialized on the Lepidoptera *Sesamia nonagrioides* and it is a potential biological control agent against this maize pest. *C. typhae* belongs to a group of species harboring a symbiotic virus which is injected in the host during oviposition and which contributes to the parasitoid virulence. I have found out that two strains of *C. typhae* differed in their offspring number and in their virulence against a French population of *S. nonagrioides*, which represents a new host. A QTL analysis (Quantitative Trait Loci) has been done to identify genes involved in these variations. We have built a genetic map of *C. typhae*, identified four QTL and listed candidate genes. To explain the difference of virulence and offspring number, numbers of eggs and viral particles injected during successive ovipositions have been estimated. These experiments have shown that 1/ the two strains have different patterns of egg allocation among the successive hosts parasitized, 2/ the quantity of injected viral particles is not correlated to virulence. To understand the evolutionary origin of the virulence variation, this trait has been estimated for the natural host populations. The results suggest that local adaptation could explain the better pre-adaptation of one *C. typhae* strain to the French host population. This work also allowed an in-depth characterization of the parasitoid reproductive success, essential for its use in biological control.

Avant-propos

Ce manuscrit est structuré autour des trois articles que j'ai écrits lors de ma thèse et qui présentent la majorité des travaux que j'ai menés, au cours de celle-ci. L'article n°1 est publié dans *Genetica*, le n°2 est actuellement à resoumettre à *Journal of Insect Physiology* après réponse aux reviewers et le n°3 est en cours de finalisation pour soumission, suite à la relecture des co-auteurs (la version présentée dans ce manuscrit n'est donc pas définitive) et sera soumis à *Molecular Ecology*. Afin d'éviter des redondances et pour une question de lisibilité, les listes des références de ces articles en ont été retirées et ont été incluses dans la partie bibliographie du manuscrit.

Sont présents en annexe trois articles auxquels j'ai participé au cours de ma thèse. Les n°4 et 5 apportent des informations complémentaires sur le modèle d'étude et sont respectivement publiés dans *Genetica* et *ZooKeys*. L'article n°6, publié dans *MethodsX* est un article méthodologique portant sur un système permettant de contrôler la température dans les incubateurs d'élevage et d'alerter en cas d'anomalie.

Article n° 1 : Benoist, R., Chantre, C., Capdevielle-Dulac, C., Bodet, M., Mougél, F., Calatayud, P.A., Dupas, S., Huguet, E., Jeannette, R., Obonyo, J., Odorico, C., Silvain, J.F., Le Ru, B., Kaiser, L., 2017. Relationship between oviposition, virulence gene expression and parasitism success in *Cotesia typhae* nov. sp. parasitoid strains. *Genetica*. <https://doi.org/10.1007/s10709-017-9987-5>

Article n°2 : Benoist R., Paquet S., Decourcelle F., Guez J., Jeannette R., Calatayud P.-A., Le Ru B., Mougél F. and Kaiser L. Role of egg-laying behavior, virulence and local adaptation in a parasitoid's chances of reproducing in a new host. *Journal of Insect Physiology* (under review)

Article n°3 : Benoist R., Capdevielle-Dulac C., Chantre C., Jeannette R., Moreau L., Le Rouzic A., Calatayud P.-A., Van Dijk E., Dupas S., Drezen J.-M., Le Ru B., Kaiser L., Mougél L. Quantitative Trait Loci involved in the reproductive success of the parasitoid *Cotesia typhae*. Sera soumis à *Molecular Ecology*.

Article n°4 : Kaiser, L., Dupas, S., Branca, A., Herniou, E.A., Clarke, C.W., Capdevielle Dulac, C., Obonyo, J., **Benoist, R.**, Gauthier, J., Calatayud, P.A., Silvain, J.F., Le Ru, B.P., 2017a. The *Cotesia sesamiae* story: insight into host-range evolution in a Hymenoptera parasitoid and implication for its use in biological control programs. *Genetica*. <https://doi.org/10.1007/s10709-017-9989-3>

Article n°5 : Kaiser, L., Fernandez-Triana, J., Capdevielle-Dulac, C., Chantre, C., Bodet, M., Kaoula, F., **Benoist, R.**, Calatayud, P.-A., Dupas, S., Herniou, E.A., Jeannette, R., Obonyo, J., Silvain, J.-F., Le Ru, B., 2017b. Systematics and biology of *Cotesia typhae* sp. n. (Hymenoptera, Braconidae, Microgastrinae), a potential biological control agent against the noctuid Mediterranean corn borer, *Sesamia nonagrioides*. *ZooKeys* 682, 105–136. <https://doi.org/10.3897/zookeys.682.13016>

Article n°6 : Rebaudo, F., **Benoist, R.**, 2019. Low-cost automatic temperature monitoring system with alerts for laboratory rearing units. *MethodsX*. <https://doi.org/10.1016/j.mex.2019.09.013>

Sommaire

CHAPITRE I – INTRODUCTION GENERALE	13
I) LES PARASITOÏDES.....	14
a. <i>Définition</i>	14
b. <i>Diversité et classification des parasitoïdes</i>	14
c. <i>Succès reproducteur des parasitoïdes</i>	17
1. <i>Stratégie de ponte</i>	17
2. <i>Sexe-ratio et déterminisme du sexe</i>	20
3. <i>Contournement du système immunitaire de l'hôte</i>	22
d. <i>Parasitoïdes et lutte biologique</i>	27
II) MODELE BIOLOGIQUE : <i>COTESIA TYPHAE – SESAMIA NONAGRIOIDES</i>	29
a. <i>Les parasitoïdes du genre Cotesia</i>	29
b. <i>De Cotesia sesamiae à Cotesia typhae</i>	30
c. <i>C. typhae</i>	33
d. <i>S. nonagrioides</i>	36
III) CONTEXTE ET OBJECTIFS DE LA THESE.....	38
CHAPITRE II – BASES COMPORTEMENTALES ET PHYSIOLOGIQUES DU SUCCES REPRODUCTEUR DE C. TYPHAE	41
I) ARTICLE N°1: RELATIONSHIP BETWEEN OVIPOSITION, VIRULENCE GENE EXPRESSION AND PARASITISM SUCCESS IN <i>COTESIA TYPHAE NOV. SP.</i> PARASITOID STRAINS.....	42
II) ARTICLE N°2: ROLE OF EGG-LAYING BEHAVIOR, VIRULENCE AND LOCAL ADAPTATION IN A PARASITOID'S CHANCES OF REPRODUCING IN A NEW HOST	58
III) DONNEES COMPLEMENTAIRES	76
CHAPITRE III – BASES GENETIQUES DU SUCCES REPRODUCTEUR DE C. TYPHAE ..	79
I) ARTICLE N°3: QUANTITATIVE TRAIT LOCI INVOLVED IN THE REPRODUCTIVE SUCCESS OF THE PARASITOID <i>COTESIA TYPHAE</i>	80
CHAPITRE IV – DETERMINISME DU SEXE CHEZ C. TYPHAE	99
I) INTRODUCTION.....	100
II) MATERIEL ET METHODES.....	100
III) RESULTATS.....	101
IV) DISCUSSION.....	102
CHAPITRE V – DISCUSSION ET PERSPECTIVES	105
I) COMPORTEMENT DE PONTE.....	107

II) SEXE-RATIO ET DETERMINISME DU SEXE	108
III) VIRULENCE.....	110
IV) RESISTANCE CHEZ <i>S. NONAGRIOIDES</i>	113
V) ADAPTATION A L'HOTE	114
a. Déterminisme génétique.....	114
b. Facteurs biogéographiques.....	115
VI) LUTTE BIOLOGIQUE	117
VII) CONCLUSION	118
BIBLIOGRAPHIE	121
ANNEXES.....	141
I) ARTICLE N°4: THE <i>COTESIA SESAMIAE</i> STORY: INSIGHT INTO HOST-RANGE EVOLUTION IN A HYMENOPTERA PARASITOID AND IMPLICATION FOR ITS USE IN BIOLOGICAL CONTROL.....	142
II) ARTICLE N°5: SYSTEMATICS AND BIOLOGY OF <i>COTESIA TYPHAE SP. N.</i> (HYMENOPTERA, BRACONIDAE, MICROGASTRINAE), A POTENTIAL BIOLOGICAL CONTROL AGENT AGAINST THE NOCTUID MEDITERRANEAN CORN BORER, <i>SESAMIA NONAGRIOIDES</i>	156
III) ARTICLE N°6: LOW-COST AUTOMATIC TEMPERATURE MONITORING SYSTEM WITH ALERTS FOR LABORATORY REARING UNITS.....	188

Chapitre I – Introduction générale

I) Les parasitoïdes

a. Définition

Au sens large, un parasitoïde est un organisme qui se développe au dépend d'un autre appelé hôte et qui le tue à un moment de son développement. De par leur mode de vie on peut considérer les parasitoïdes comme des intermédiaires entre parasites et prédateurs. L'utilisation du terme parasitoïde a par le passé été soumise à débat. En effet, depuis son premier emploi par Reuter en 1913 (Reuter, 1913, d'après Godfray, 1994) le mot parasitoïde est communément restreint aux insectes parasitant d'autres d'arthropodes. Certains auteurs comme Eggleton et Gaston (1990) ont proposé de l'élargir à d'autres taxons mais dans l'usage le terme reste consacré aux insectes et c'est cette définition qui sera utilisée dans la suite du texte.

On peut diviser le cycle de vie des parasitoïdes en deux phases. Une première phase « libre » au stade adulte, dans le sens où leur survie ne dépend pas directement d'un autre organisme, et une phase « parasite » qui concernent les stades immatures. Au stade adulte, le seul rôle des mâles est de s'accoupler avec les femelles qui elles devront également trouver un ou plusieurs hôtes pour y déposer leurs œufs. Après éclosion des œufs les larves vont se développer en consommant les tissus de l'hôte ce qui dans la plupart des cas, s'il n'est pas tué au moment de la ponte par la femelle, conduira à sa mort (Godfray, 1994).

b. Diversité et classification des parasitoïdes

Les parasitoïdes forment un très large groupe polyphylétique présent dans six des 30 ordres d'insectes : Hymenoptera, Diptera, Coleoptera, Lepidoptera, Neuroptera, Trichoptera (Lecointre et al., 2017; Quicke, 2014). La majorité des parasitoïdes appartient aux ordres des Diptères et des Hyménoptères. Au sein de ce dernier le mode de vie parasitoïde est le plus commun (Quicke, 2014). D'après Eggleton et Belshaw (1992) dans les années 90 on comptait environ 87 000 espèces de parasitoïdes décrites réparties de la façon suivante : Hyménoptère 67 000 espèces, Diptère 15 600 espèces, Coléoptère 4 000 espèces, Névroptère 50 espèces, Lépidoptère 10 espèces et Trichoptère 1 espèce. En se basant sur des estimations contemporaines du nombre d'espèces d'insectes décrits (Gaston, 1991), les parasitoïdes représenteraient environ 10 % des espèces d'insectes. Même si ces chiffres ne sont pas forcément précis et plus forcément encore à jour, ils révèlent néanmoins l'immense richesse spécifique des parasitoïdes.

La diversité des parasitoïdes se manifeste à de nombreux niveaux (Figure 1). Par exemple d'un point de vue morphologique on compte chez les parasitoïdes des espèces très différentes allant de *Dicopomorpha echmepterygis* (Mymaridae), qui est la plus petite espèce d'insecte connue (le mâle fait entre 139-240

µM de long), aux Ichneumonidae géants dont la taille de l'ovipositeur peut atteindre 14 cm de long (Le Lannic et Nénon, 1999; Mockford, 1997). Cette diversité se retrouve également au niveau de leurs hôtes. Ceux-ci appartiennent majoritairement à la classe des insectes, on estime d'ailleurs que toutes les grandes familles d'insectes peuvent être la cible de parasitoïdes. Ils sont essentiellement attaqués aux stades juvéniles (œufs, larves, nymphes) mais peuvent également l'être au stade adulte, à l'image de la punaise *Nezara viridula* parasitée par le diptère *Trichopoda giacomelli* (Godfray, 1994; Porta, 1990). Cependant, certaines espèces s'attaquent aussi à d'autres arthropodes. L'exemple le plus connu étant très certainement les représentants de la famille des Pompilidés qui sont des parasitoïdes spécialisés sur les araignées notamment de grandes tailles comme les mygales et les tarentules (Costa et al., 2004). Certains modes de vie permettent de classer les parasitoïdes en différentes catégories ce qui permet de mieux aborder leur diversité.

La distinction la plus courante est celle entre endo et ecto parasitoïdes. Les larves des endoparasitoïdes se développent dans l'hôte et le consomment de l'intérieur alors que celles des ectoparasitoïdes se développent en restant fixées à l'extérieur de l'hôte.

Une seconde distinction est souvent faite entre les parasitoïdes idiobiontes et koïnobiontes. La différence est basée sur le développement ou non de l'hôte après parasitage. Chez les parasitoïdes idiobiontes, la femelle tue ou arrête le développement de l'hôte au moment de la ponte. A l'inverse chez les koïnobiontes, l'hôte va continuer à se développer après parasitage, au moins pendant une partie du développement du parasitoïde. Contrairement à la distinction endo/ecto, la distinction koïnobionte/idiobionte n'est pas toujours évidente notamment pour les parasitoïdes s'attaquant aux stades immobiles (œufs, chrysalide, pupe, etc ...). La grande majorité des koïnobiontes sont des endoparasitoïdes, cependant les idiobiontes peuvent être soit des endo soit des ecto parasitoïdes (Quicke, 2014).

On peut également classer les parasitoïdes en solitaire ou grégaire en fonction du nombre de larves qui vont compléter leur développement au dépend de l'hôte, une pour les solitaires et plusieurs pour les grégaires. Il est important de noter que la classification en solitaire ou grégaire ne dépend pas du nombre d'œufs injectés dans l'hôte. Par exemple, chez les parasitoïdes poly-embryonnaires, qui sont les parasitoïdes produisant le plus de descendants, la femelle peut pondre un seul œuf qui va par division cellulaire engendrer plusieurs embryons (Segoli et al., 2010). Le nombre de descendants produits de cette manière peut être très élevé, jusqu'à près de 3000 descendants par hôte à partir d'un seul œuf pour *Copidosoma floridanum* (Encyrtidae, Ode and Strand, 1995). Aussi chez de nombreuses espèces de parasitoïdes solitaires, la femelle dépose plusieurs œufs mais un seul adulte sera produit en raison de la compétition, directe ou indirecte, entre larves. Contrairement aux larves de parasitoïdes grégaires, celles des solitaires sont souvent équipées de mandibules leur permettant d'attaquer les autres compétiteurs (Godfray, 1994). Cela leur permet également de mieux se défendre en cas de superparasitisme (l'hôte

est parasité plusieurs fois, soit par la même femelle soit par plusieurs individus de la même espèce) ou de multiparasitisme (l'hôte est parasité plusieurs fois par des individus d'espèces différentes). La grande majorité des parasitoïdes sont solitaires (Godfray, 1994).

Une dernière distinction peut être faite entre les parasitoïdes généralistes qui s'attaquent à une large gamme d'hôtes pouvant aller jusqu'à plusieurs dizaines d'espèces et les spécialistes qui ont une gamme d'hôtes beaucoup plus réduite, tout un continuum existant entre les deux. Les espèces koinobiontes sont généralement plus spécialisées que les espèces idiobiontes en raison du grand nombre d'adaptations à l'hôte nécessaires pour le maintenir en vie lors du développement du parasitoïde (Hawkins, 1994).

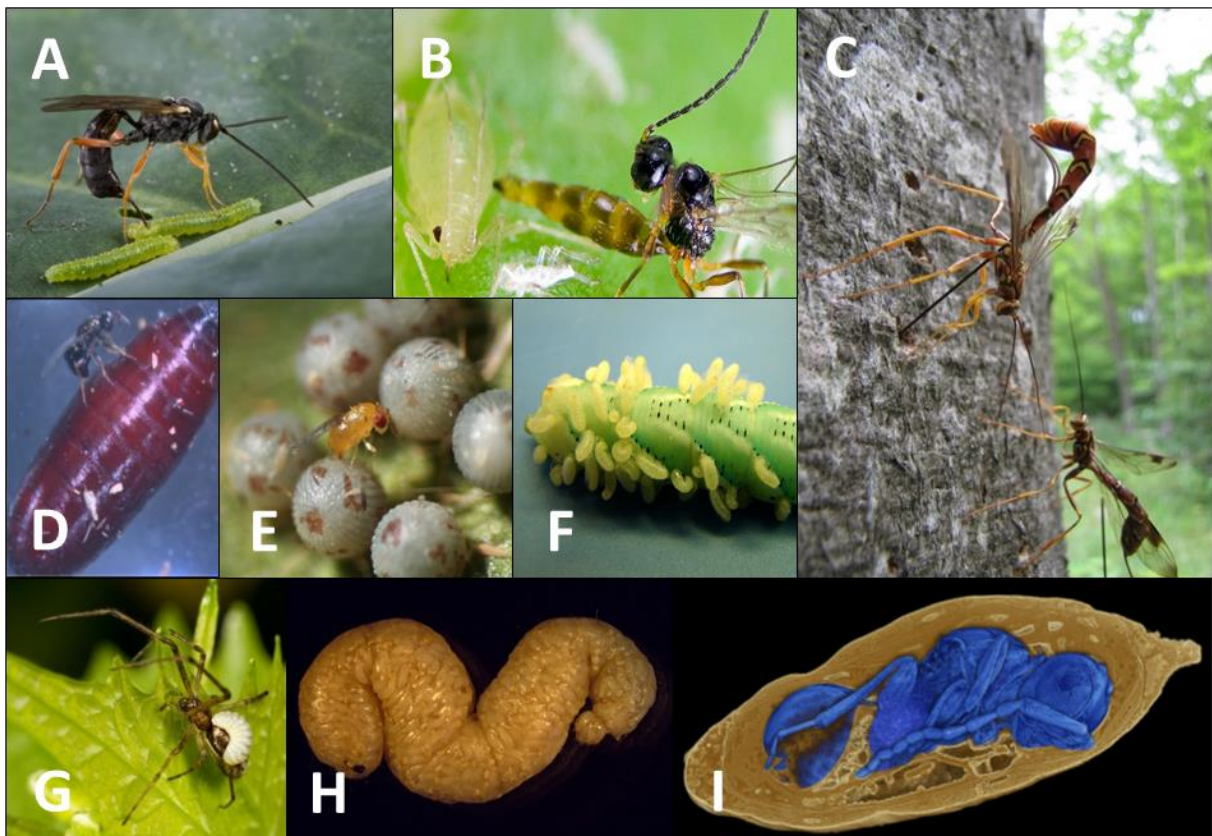

Figure 1 - Diversité des parasitoïdes. (A) Femelle *Hyposoter ebeninus* parasitant une chenille de stade L2 de Piéride de la rave (*Pieris rapae*). (B) Femelle *Aphidius colemani* s'attaquant à un puceron vert. (C) Les femelles *Megarhyssa macrurus* possèdent un long ovipositeur leur permettant d'atteindre leurs hôtes dans les tunnels creusés dans le bois. (D) Femelle *Nasonia vitripennis* parasitant une pupa de la mouche bleue (*Calliphora vomitoria*). (E) *Trichogramma dendrolimi* femelle en train de pondre dans l'œuf d'un Noctuidae. (F) Larves de *Cotesia congregata* sortant d'une chenille *Manduca sexta*. (G) Larve d'un ectoparasitoïde de la famille des Pompilidae accrochée à une araignée. (H) Chenille Fausse-arpenteuse du chou (*Trichoplusi ni*) remplie de larves d'un parasitoïde polyembryonnaire du genre *Copidosoma*. (I) Fossile datant du Paléogène (66 à 23 millions d'années) d'un endoparasitoïde solitaire à l'intérieur d'une pupa vue aux rayons X. Crédits photo : A, Harvey et al., 2010 ; B, Bioplanet ; C, Seney Natural History Association ; D, Danneels et al., 2010 ; E, Victor Fursov ; F, Justin Bredlau ; H, MJ Hatfield ; I, van de Kamp et al., 2018.

c. Succès reproducteur des parasitoïdes

Le succès reproducteur des parasitoïdes est directement lié à leur capacité à parasiter efficacement leur hôte. Pour cela un grand nombre d'adaptations vis-à-vis de l'hôte a été sélectionné, d'autant que celui-ci va également s'adapter de manière à échapper au parasitisme. Dans le cadre de la relation hôte-parasitoïde on a véritablement affaire à une coévolution de type courses aux armements tel que représentée par la théorie de la reine rouge (Van Valen, 1973). Du fait de cette course aux armements et de la dépendance des parasitoïdes envers leur hôtes, les parasitoïdes sont soumis à une très forte pression de sélection qui peut expliquer leur immense diversité qui est la norme chez les espèces parasites (Thompson, 2009). Le parasitisme peut être décomposé en plusieurs étapes comprenant la détection de l'hôte, la ponte, le contournement de son système immunitaire et la manipulation de son métabolisme au profit du parasitoïde. Chacune de ces étapes peut être soumise à sélection et conduit au développement de mécanismes comportementaux et physiologiques complexes chez les parasitoïdes et également chez leurs hôtes. Par exemple, l'ectoparasite *Reclinervellus nielseni* (Ichneumonidae) modifie le comportement de son araignée hôte *Cyclosa argenteoalba* de manière à ce qu'elle tisse sa toile en forme de cocon pour la protection du parasitoïde lors de la nymphose (Takasuka et al., 2015). Un exemple de pression exercée par les parasitoïdes se répercutant sur l'hôte mais aussi sur les espèces avec lesquelles il interagit est le cas des espèces de punaises comme *Catenauliella rugosa* qui produisent un miellat qui va servir à nourrir des fourmis qui en échange leurs apporteront une défense contre leurs parasitoïdes (Gibernau and Dejean, 2001; Gross, 1993).

Dans cette partie du manuscrit je vais me focaliser sur plusieurs points liés au succès reproducteur, que j'ai pu développer pendant ma thèse et qui portent sur la stratégie de ponte, le déterminisme du sexe et le sexe-ratio ainsi que sur les stratégies développées par les parasitoïdes pour contourner le système immunitaire de l'hôte et ce majoritairement chez les hyménoptères.

1. Stratégie de ponte

Une fois qu'un hôte approprié est localisé par une femelle parasitoïde, une série de choix vont devoir être faits par cette dernière. La première est pondre ou non dans l'hôte. Ensuite si l'hôte est accepté, combien d'œufs pondre et comment répartir les œufs entre mâles et femelles. Ce dernier point sera discuté dans la partie suivante.

La taille de la ponte est un sujet classique en écologie comportementale qui a été étudié en particulier chez les oiseaux et les insectes. Historiquement les travaux fondateurs sur l'étude de la taille de la ponte sont ceux réalisés dans les années 40 par Lack (1947) qui le premier postula que les oiseaux pondent un nombre d'œufs qui maximise leur descendance à chaque ponte. Ce postulat a servi de point de départ à de nombreuses études dans différents groupes notamment chez les parasitoïdes. Ces derniers sont particulièrement intéressants pour l'étude de la taille de ponte du fait de la grande diversité des

comportements de ponte qu'ils présentent (synthèse dans Godfray, 1994; Waage et Greathead, 1986). La question de la taille de la ponte est importante chez ces espèces d'un point de vue évolutif, notamment dans le cadre de l'évolution du grégarisme, et aussi d'un point de vue appliqué dans la perspective de leur utilisation en lutte biologique (voir point 3)

Du fait de la sélection naturelle, la taille de la ponte des parasitoïdes tend vers une certaine optimalité. Cela se traduit par des variations interspécifiques de la taille de la ponte mais aussi par la capacité des individus à ajuster la taille de leur ponte en fonction d'un grand nombre de facteurs environnementaux. Ces facteurs influencent d'une part le nombre d'œufs pondus dans un seul organisme hôte (un acte de ponte) et d'autre part le comportement d'allocation des œufs entre plusieurs hôtes.

L'hôte représente une ressource nutritive limitée, qui détermine le nombre de larves parasitoïdes pouvant s'y développer. Ainsi déposer un nombre trop important d'œufs engendre un risque de compétition. Celle-ci peut entraîner une diminution du nombre de descendants ou de leur taille, souvent associée à une diminution de fitness (Gao et al., 2016; Godfray, 1994). Dans le cas des espèces grégaires la compétition entre larves est souvent limitée à la seule compétition par exploitation (compétition pour la ressource). En revanche, chez les espèces solitaires, on observe également de la compétition par interférence ; les larves de parasitoïdes solitaires sont généralement équipées de larges mandibules leur permettant d'attaquer directement les autres compétiteurs et certaines espèces sont également capables de sécréter des toxines (Godfray, 1994; Mackauer, 1986; Salt, 1961). Pour les espèces solitaires, on pourrait imaginer, du fait qu'un seul individu se développe, que la sélection aurait dû favoriser la ponte d'un seul œuf dans l'hôte. Pour autant dans un grand nombre d'espèces de parasitoïdes solitaires, on observe des pontes de plusieurs œufs (Godfray, 1994). Ce comportement peut être favorisé dans plusieurs cas. Par exemple si le risque de super- ou multi-parasitisme est important, pondre plusieurs œufs par hôte peut augmenter les chances qu'un de ses descendants remporte la compétition. Ce comportement peut aussi être un moyen de saturer le système immunitaire de l'hôte afin d'assurer le développement d'au moins un descendant (Blumberg and Luck, 1990; Kapranas et al., 2012; Ode and Rosenheim, 1998; Rosenheim and Hongkham, 1996). Ce type de comportement chez les espèces solitaires pourrait être une voie de transition vers le grégarisme, qui est un caractère dérivé au sein des parasitoïdes, et est apparu de nombreuses fois au cours de leur évolution (Mayhew, 1998; Pexton et al., 2009; Pexton and Mayhew, 2005; Rosenheim and Hongkham, 1996).

La qualité de l'hôte est un facteur ayant un fort impact sur la taille de la ponte des parasitoïdes. En effet, de très nombreuses études montrent que les parasitoïdes sont capables d'évaluer la qualité de l'hôte via une grande variété de stimuli (visuels, tactiles, olfactifs) et ainsi d'adapter leur ponte (Godfray, 1994; Waage and Greathead, 1986). L'évaluation de la qualité de l'hôte se fait sur plusieurs critères variables. Le plus étudié est la taille de l'hôte du fait qu'elle détermine la quantité de ressources disponibles. Par exemple, Kapranas et al., (2008) ont montré chez cinq espèces de parasitoïdes parasitant la cochenille

Coccus hesperidum, que la taille de la ponte est positivement corrélée à la taille de l'hôte. Le même type de corrélation se retrouve chez de nombreuses espèces (Godfray, 1994; Klomp and Teerink, 1966; Le Masurier, 1987). Indépendamment de la taille de l'hôte, l'espèce d'hôte et son âge jouent également sur la taille de la ponte. En effet chez l'ectoparasite *Hyssopus pallidus* (Eulophidae) on observe que les femelles déposent en moyenne le même nombre d'œufs sur des chenilles de *Cydia molesta* que sur des chenilles plus grandes de *Cydia pomonella* (Häckermann et al., 2007). Pour les espèces de Trichogramme qui parasitent des œufs, la taille de la ponte diminue généralement avec l'âge de l'hôte (Pak et al., 1986; Pak et Oatman, 1982). Le fait que l'hôte soit déjà parasité ou non au moment de la ponte influence également la taille celle-ci, généralement de manière négative même s'il existe des contre-exemples (Rosenheim et Hongkham, 1996; van Alphen et Visser, 1990). Un dernier facteur que l'on peut évoquer est la qualité de la nutrition de l'hôte. Ainsi, Cicero et al. (2011) ont montré que le nombre d'œufs déposés par plusieurs parasitoïdes dans *Anastrepha ludens* (Tephritidae) varie en fonction du fruit sur lequel ce dernier est élevé.

Les femelles ne maximisent pas leur fitness en optimisant uniquement le nombre d'œufs déposés dans un seul hôte. Les parasitoïdes ont généralement une fécondité élevée et distribuent leurs œufs dans plusieurs hôtes. De ce fait, la taille de la ponte est également influencée par les facteurs jouant sur la probabilité de parasiter plusieurs hôtes. Par exemple, chez les hyménoptères parasitoïdes grégaires *Cotesia glomerata* et *Mastrus ridibundus*, le nombre d'œufs déposé par hôte diminue en fonction de la fréquence de rencontre de l'hôte (Bezemer and Mills, 2003; Ikawa and Okabe, 1985). Le risque de se faire tuer au cours d'une ponte va également influencer la répartition des œufs entre différents hôtes. En plus de ces contraintes liées à l'hôte, des contraintes intrinsèques au parasitoïde vont aussi influencer la manière dont il répartira ses œufs. Ces contraintes comprennent notamment sa durée de vie, sa fécondité, le fait que l'espèce soit proovogénique (la femelle naît avec un stock limité d'ovocytes matures) ou synovogénique (la femelle produit de nouveaux œufs matures tout au long de sa vie) (Godfray, 1994). Ainsi une espèce n'étant pas limitée par son nombre d'ovocytes et ayant une longue durée de vie associée à une faible mortalité aura une stratégie de ponte très différente d'une espèce ayant un stock d'ovocytes limité, une courte durée de vie et courant un fort risque de se faire tuer lors de la ponte.

D'autres facteurs, comme le statut d'accouplement (Tagawa et al., 1987), peuvent également jouer sur le nombre d'œufs pondus ; il apparaît toutefois difficile de dresser une liste exhaustive. Un cas qu'il est intéressant de relever est celui de *Leptopilina boulardi* (Figitidae). En effet chez ce parasitoïde solitaire un virus infectieux nommé LbFV, pouvant changer le comportement de ponte, a été mis en évidence. Ce virus induit un comportement non optimal chez les femelles infectées qui vont pondre dans des hôtes déjà parasités, favorisant la transmission du virus (Varaldi, 2003; Varaldi et al., 2009).

Chez les parasitoïdes le comportement de ponte a été très étudié au cours de la deuxième moitié du 20^{ème} siècle via de nombreuses approches de modélisation (voir notamment Charnov and Skinner, 1985;

Godfray, 2004, 1987; Mangel, 1989; Skinner, 1985) et expérimentales (voir paragraphes précédents). Bien que la diversité génétique soit à l'origine de l'évolution du comportement de ponte (passage de solitaire à grégaire, aptitude des individus à ajuster leur comportement pour maximiser leur fitness, etc) il y a un manque évident de travaux sur les bases génétiques du comportement de ponte. Ce manque d'intérêt, peut sûrement s'expliquer du fait qu'on s'attend à ce qu'un grand nombre de gènes soit impliqué compte-tenu du grand nombre de facteurs influençant le comportement de ponte, ce qui rend complexe les approches de génétique.

2. Sexe-ratio et déterminisme du sexe

Chez les hyménoptères parasitoïdes, le sexe-ratio de la descendance est également déterminé au moment de la ponte. En effet, les hyménoptères sont pour la plupart caractérisés par un déterminisme du sexe de type haplo-diploïde où les femelles sont diploïdes, issues d'œufs fécondés et les mâles haploïdes, issus d'œufs non fécondés. Chez ces espèces, le déterminisme du sexe dépend donc de la fécondation (sauf dans le cas des espèces faisant de la parthénogénèse thélytoque, voir plus loin). Le sexe-ratio est lié à la probabilité et au succès de l'accouplement, et de nombreuses études suggèrent que le sexe-ratio est sous le contrôle de la femelle qui peut ajuster la fécondation de ses ovocytes au moment de la ponte. Cela est possible car les spermatozoïdes sont stockés dans un organe appelé spermathèque, qui s'ouvre dans l'oviducte et permet donc la fécondation des ovocytes juste avant leur ponte (Godfray, 1994; Quicke, 2014).

Ce type de déterminisme rend plus facile la production de sexe-ratios biaisés en faveur d'un sexe que pour les espèces diploïdes où le déterminisme du sexe est principalement soumis à la ségrégation des chromosomes (Godfray, 1994; Waage and Greathead, 1986). De nombreuses études montrent l'aspect adaptatif et plastique du sexe-ratio. Par exemple chez beaucoup d'espèces de parasitoïdes, notamment grégaires, les accouplements se font dès l'émergence des adultes, sont consanguins et le sexe-ratio est biaisé en faveur des femelles. Une explication de ce phénomène est donnée par Hamilton via la théorie de la « Local Mate Competition » selon laquelle la femelle réduit le nombre de fils dans sa descendance de manière à limiter la compétition entre eux pour l'accès aux femelles qui sont limitantes (un mâle pouvant s'accoupler avec plusieurs femelles) (Godfray, 1994; Hamilton, 1967). Un exemple de plasticité est illustré par Waage et Ming (1984) avec l'espèce de parasitoïde oophage *Trichogramma evanescens*. Chez cette espèce, une femelle qui s'attaque à un œuf isolé pondra un mâle pour deux à trois femelles alors qu'une femelle s'attaquant à un patch d'œufs produira plusieurs descendance composées uniquement de femelles après avoir pondu un mâle dans le premier œuf.

Bien que le sexe-ratio soit très étudié chez les hyménoptères, les mécanismes moléculaires à l'origine du déterminisme du sexe ne sont connus que dans un nombre très limité d'espèces.

Le mécanisme le plus documenté est le *sl-CSD* (Single Locus Complementary Sex Determination) mis en évidence pour la première fois chez le parasitoïde *Habrobracon hebetor* (Whiting, 1943) et dont les bases moléculaires ont été caractérisées chez l'abeille domestique *Apis mellifera* (Heimpel and de Boer, 2008). Le sexe est déterminé par l'état allélique au locus sexuel. Un individu possédant un seul allèle se développera en mâle alors qu'un individu avec deux copies différentes se développera en femelle. D'autres espèces comme *Cotesia vestalis* (de Boer et al., 2008) possèderaient un mécanisme proche, appelé *ml-CSD* (Multi Locus Complementary Sex Determination) qui diffère du précédent du fait qu'il y a cette fois plusieurs locus sexuels indépendants (Heimpel and de Boer, 2008). Chez les espèces possédant un mécanisme de type CSD (*sl* ou *ml*), un individu haploïde (issu d'un ovocyte non fécondé) se développera en mâle mais il est également possible que des individus diploïdes se développent en mâles (à partir d'ovocytes fécondés) en cas d'homozygotie au(x) locus sexuel(s). Une conséquence du CSD est que les espèces sont très sensibles à la consanguinité qui va entraîner une augmentation de la production de mâles diploïdes. Dans la majorité des cas les mâles diploïdes sont soit non-viables, soit stériles. Au sein des parasitoïdes, ce mécanisme n'a été mis en évidence que chez quelques espèces appartenant à la superfamille des Ichneumonoidea (Boulton et al., 2015; Cook, 1993). Pour les nombreuses espèces qui conservent un sexe-ratio très biaisé en faveur des femelles malgré une forte consanguinité, un mécanisme de type CSD ne peut vraisemblablement pas expliquer le déterminisme du sexe.

D'autres mécanismes ont été mis en évidence chez quelques rares espèces (Heimpel and de Boer, 2008). Le plus documenté est de type empreinte génétique identifié pour le moment uniquement chez le parasitoïde solitaire *Nasonia vitripennis* (Pteromalidae). Les femelles de *N. vitripennis* déposent une empreinte génétique masculinisante sur leurs gamètes, qui inhibe l'élément activateur du gène TRA, gène nécessaire au développement en femelle. Ainsi, les ovocytes non fécondés donneront des mâles. Le spermatozoïde porte une copie fonctionnelle de l'activateur du gène TRA, induisant le développement des œufs fécondés en femelles (Beukeboom and Perrin, 2015; Verhulst et al., 2010).

Enfin il est intéressant de noter que de nombreuses espèces d'hyménoptères parasitoïdes peuvent se reproduire par parthénogénèse thélytoque. Les femelles thélytoques produisent des œufs diploïdes soit par mitose, soit par fusion des gamètes après la méiose, et vont ainsi générer des descendance uniquement composées de femelles. Chez certaines espèces la parthénogénèse thélytoque peut être induite pas des bactéries endosymbiotiques comme *Wolbachia* et *Cardinium* (Heimpel and de Boer, 2008; Leach et al., 2009).

3. Contournement du système immunitaire de l'hôte

Afin d'assurer leur développement les parasitoïdes doivent faire face aux réponses immunitaires de leurs hôtes. La manière dont les parasitoïdes sont confrontés au système immunitaire de leurs hôtes varie beaucoup en fonction des types de parasitoïdes (Quicke, 2014). En effet un endoparasitoïde ne rencontrera pas les mêmes types de réponses immunitaires qu'un ectoparasitoïde. De même, un parasitoïde s'attaquant à des œufs dont le système immunitaire est peu ou pas développé ne rencontrera pas les mêmes défenses qu'un parasitoïde s'attaquant à un stade plus tardif avec un système immunitaire mature. Dans cette partie je vais principalement m'intéresser aux endoparasitoïdes car c'est chez ces derniers que les stratégies mises en place pour contourner le système immunitaire de l'hôte sont les plus variées.

Chez les insectes la réponse immunitaire innée est subdivisée en deux catégories : la réponse humorale et la réponse cellulaire. La première comprend des processus variés allant de la production de peptides antimicrobiens ou de dérivés réactifs de l'oxygène, à la coagulation et la mélanisation de l'hémolymphe. La seconde correspond aux réponses faisant intervenir les cellules immunitaires appelées hémocytes contenues dans l'hémolymphe, et comprend la phagocytose, la nodulation et l'encapsulation (Lavine and Strand, 2002). La principale réponse mise en œuvre contre les corps étrangers de grosse taille comme les œufs et larves des parasitoïdes est l'encapsulation (Quicke, 2014; Salt, 1970). La réaction d'encapsulation consiste en la formation d'une capsule constituée par le dépôt de plusieurs couches d'hémocytes autour du corps étranger. La capsule isole généralement les œufs ou larves des parasitoïdes dans l'hémocoèle de l'insecte hôte, provoquant leur mort par suffocation, privation de nourriture ou par la prévention physique de leur développement (Blumberg, 1997; Carton, 1977).

Le contournement du système immunitaire de l'hôte peut se faire de manière passive par exemple en déposant les œufs dans un tissu auquel les hémocytes n'ont pas accès (Moreau et al., 2003) ou en les recouvrant d'une membrane empêchant leur encapsulation (Hu et al., 2003), mais également de manière active en entraînant son inactivation et en perturbant la physiologie de l'hôte via des facteurs de virulence. Cette dernière stratégie, que je vais développer ici, est la plus commune chez les endoparasitoïdes (Beckage and Drezen, 2012).

Afin d'inactiver le système immunitaire de l'hôte et de modifier sa physiologie, les parasitoïdes sont dotés d'un large arsenal de facteurs de virulence qui vont varier en fonction des espèces. Parmi ceux-ci on compte généralement le venin, les protéines ovariennes, les tératocytes, les polydnavirus et les *virus-like particles*. Comme nous allons le voir ces facteurs ont des rôles multiples et souvent redondants.

Le venin correspond au fluide produit par la glande éponyme. C'est le facteur de virulence le plus commun du fait que la plupart, si ce ne sont toutes les espèces de parasitoïdes possèdent cette glande. Elle est reliée au tractus génital femelle ce qui permet l'injection du venin lors de la ponte (Asgari,

2012). L'étude de la composition du venin n'est qu'assez récente et a été permise par les progrès des méthodes de transcriptomique et protéomique. Sa composition est assez complexe du fait du grand nombre de protéines le constituant. Par exemple chez *Nasonia vitripennis* pas moins de 79 peptides différents ont pu être identifiés (de Graaf et al., 2010). Bien que certaines protéines du venin soient conservées, sa composition semble très variable d'une espèce à l'autre, et même entre individus d'une même espèce (Colinet et al., 2013; Moreau and Asgari, 2015). Le venin des parasitoïdes est intéressant car contrairement à celui des autres animaux venimeux, il n'est pas utilisé pour capturer une proie ou pour se défendre mais pour permettre le développement de la descendance (Mrinalini and Werren, 2016). A l'image de sa composition, le rôle joué par le venin est très variable. En général chez les ectoparasitoïdes le venin est plutôt impliqué dans la paralysie de l'hôte alors que chez les endoparasitoïdes il est plutôt impliqué dans la perturbation du développement de l'hôte et dans l'inactivation de son système immunitaire. Il peut agir en synergie avec d'autres facteurs comme les polydnavirus (Moreau and Asgari, 2015; Tanaka, 1987). Bien que les rôles du venin soient bien documentés, la fonction de la majorité des protéines le constituant est inconnue.

Rentrent dans la catégorie des protéines ovariennes, les protéines sécrétées par les ovaires et injectées dans l'hôte au moment de la ponte. De tous les facteurs de virulence, les protéines ovariennes sont très certainement les moins étudiées. A ma connaissance aucune étude ne faisant l'inventaire de ces protéines n'est disponible si bien qu'il est difficile de donner un ordre de grandeur du nombre de protéines ovariennes injectées lors de la ponte. Cependant leur implication dans le contournement du système immunitaire de l'hôte et notamment dans son inactivation a été montré chez de nombreuses espèces (Li et al., 2007; Webb and Luckhart, 1994).

Dans la famille des Braconidae et dans la super-famille des Platygastroidea les femelles de certaines espèces pondent des œufs qui vont produire des tératocytes. Ces dernières sont des cellules géantes qui dérivent de la membrane formée lors de l'embryogenèse autour de l'embryon. Au moment de l'éclosion de l'œuf, les cellules de cette membrane se dissocient en tératocytes qui vont persister jusqu'à plusieurs jours dans l'hôte mais sans se diviser. Ces cellules sont capables de sécréter un grand nombre de protéines et, à l'image des autres facteurs de virulence, sont impliquées dans de nombreux mécanismes (Quicke, 2014; Strand, 2014). Par exemple chez *Cotesia plutellae*, elles ont un effet immunosuppresseur et sécrètent des protéines qui préviennent la métamorphose de l'hôte (Ali et al., 2013; Andrew et al., 2006).

Le facteur de virulence sur lequel j'ai le plus travaillé lors de ma thèse et que je vais plus développer ici sont les PDV (PolyDnaViruses). Les PDV sont des virus endosymbiotiques domestiqués par des parasitoïdes. Ces derniers sont injectés dans l'hôte au moment de la ponte sous la forme de particules virales contenant des cercles d'ADN double-brin portant des gènes de virulence. L'expression des gènes de virulence dans l'hôte perturbe son développement et inactive son système immunitaire pour permettre

le développement du parasitoïde (Beckage and Drezen, 2012; Drezen et al., 2017; Gauthier et al., 2017). Ces virus sont présents chez des dizaines de milliers d'espèces d'hyménoptère parasitoïdes et sont regroupés dans la famille des Polydnaviridae comprenant deux genres distincts (Figure 2) : Les Bracovirus (BV) associés à 6 sous-familles de Braconidae regroupées dans le complexe monophylétique des microgastroïdes, et les Ichnovirus (IV) associés aux sous-familles des Banchinae et des Campopleginae (Drezen et al., 2017; Herniou et al., 2013). Bien que regroupés dans la même famille de virus, BV et IV n'ont pas une origine commune et représentent un cas de convergence évolutive. Les BV des microgastroïdes sont issus de l'intégration du génome chez l'ancêtre commun de ce complexe d'un betanudivirus, de larges virus à ADN infectant les arthropodes et proches des baculovirus (Bézier et al., 2009a, 2009b; Burke and Strand, 2012). Les IV sont quant à eux issus de la domestication d'un ou plusieurs virus d'origine inconnue (Béliveau et al., 2015; Volkoff et al., 2010). Comme les IV sont présents dans deux sous-familles séparées phylogénétiquement par des sous-familles ne produisant pas d'IV, cela pose la question du nombre d'événements de domestication ayant eu lieu : une domestication ancestrale suivie de pertes, ou deux domestications indépendantes. Cette question est pour le moment toujours en suspens (Drezen et al., 2017). Dans la suite je vais me focaliser uniquement sur les BV, pour autant le fonctionnement des IV est comparable à celui des BV.

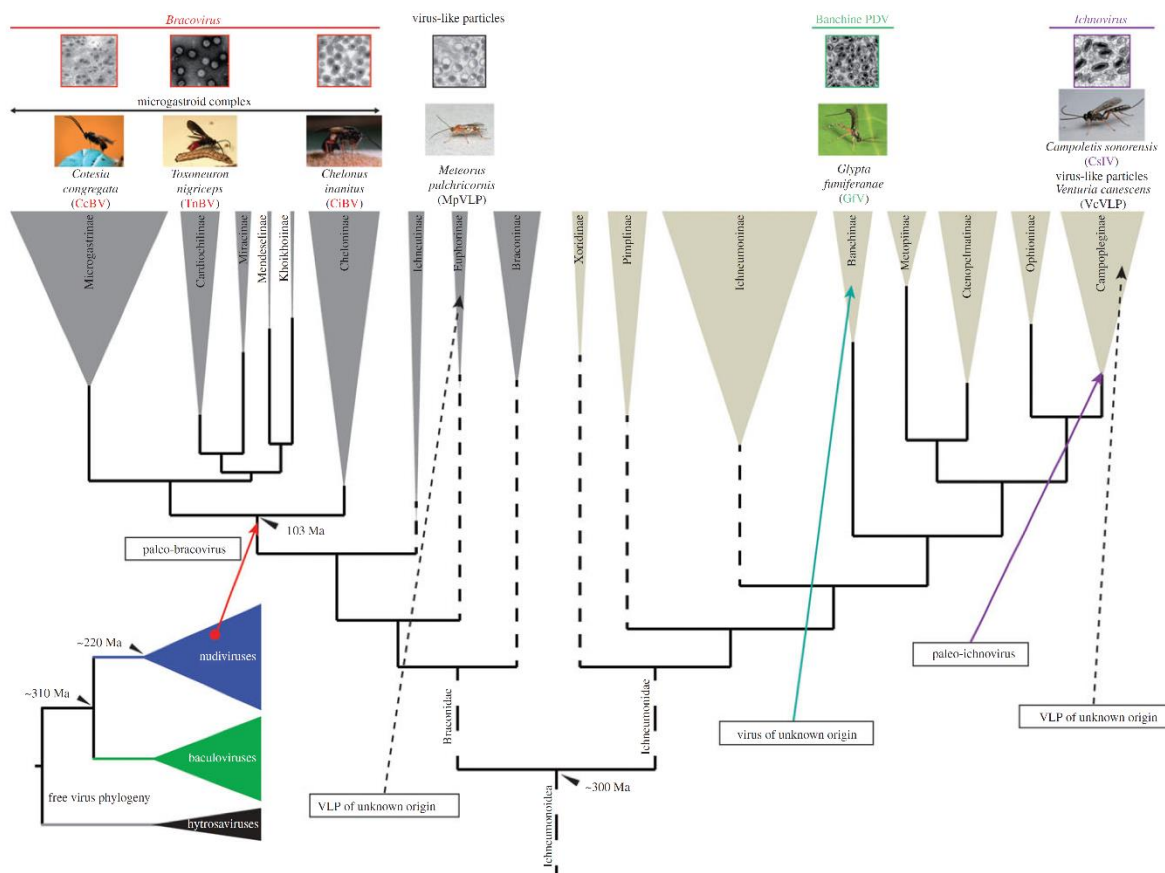

Figure 2- Symbioses avec des virus chez les Ichneumonoidea (Herniou et al, 2013)

La majorité des connaissances sur l'organisation des BV nous viennent des travaux menés sur *Microplitis demolitor* et *Cotesia congregata* (Figure 3). Dans le génome, les BV sont organisés en deux types de régions. La première correspond aux gènes d'origine nudivirale, impliqués dans la production des particules virales. Certains gènes nudiviraux sont regroupés dans une région appelée « nudiviral cluster » mais la majorité de ces gènes est dispersée dans le génome (Beck et al., 2011; Bézier et al., 2009a, 2009b). Le deuxième type de région correspond aux segments proviraux servant à la production des cercles viraux contenus dans les particules virales et portant les gènes de virulence. Le nombre de cercles viraux produits varie en fonction des espèces, par exemple on en compte 26 pour *M. demolitor* et 35 pour *C. congregata* (Bézier et al., 2013; Burke et al., 2014). Chez *C. congregata* les 35 segments proviraux sont organisés en 9 loci proviraux (PL). Les deux tiers des segments sont localisés dans la même région génomique appelée macrolocus, qui regroupe les PL1 et 2, et les autres sont dispersés dans le génome (Bézier et al., 2013).

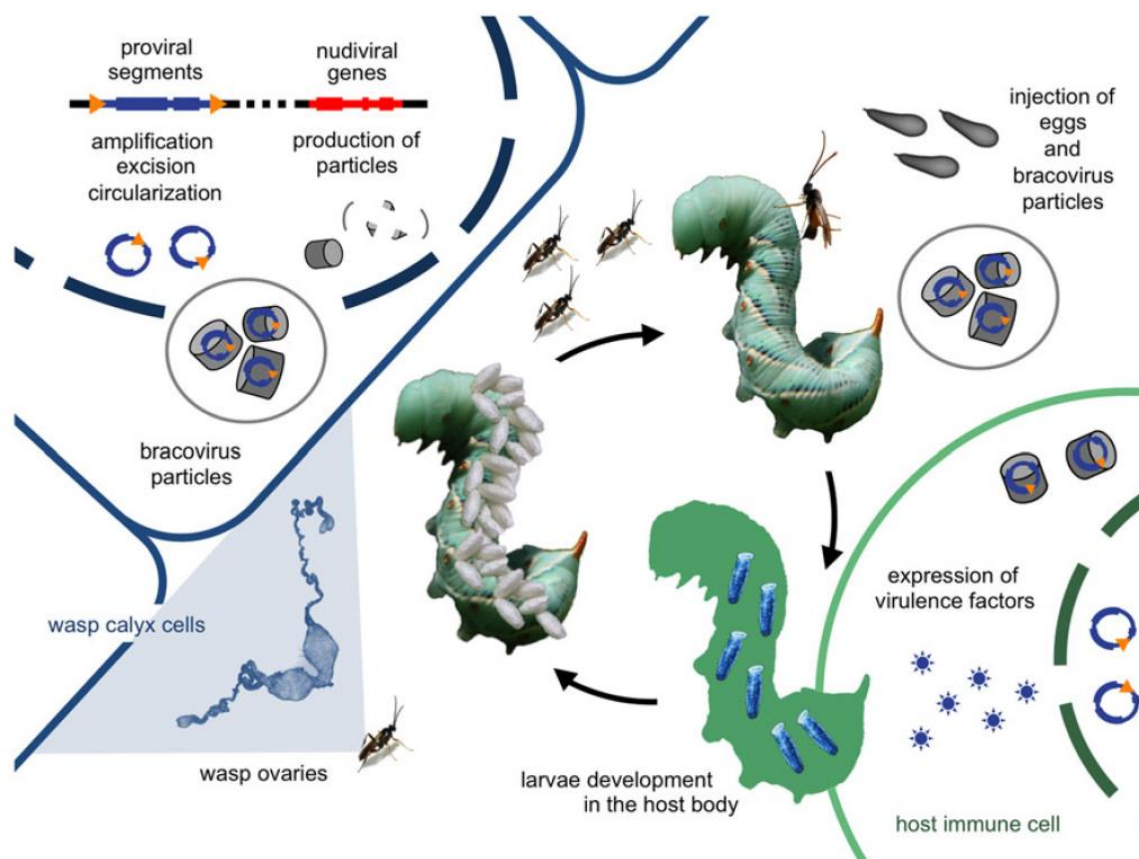

Figure 3- Cycle de vie *C. congregata* et de son bracovirus (Gauthier et al., 2017). Au sein des ovaires, dans les noyaux des cellules du calice (i) les loci proviraux (en bleu) sont amplifiés, excisés et circularisés, (ii) les gènes nudiviraux (en rouge) sont exprimés pour produire les particules virales (iii) et les cercles viraux sont encapsulés dans les particules virales de bracovirus qui acquièrent une enveloppe en sortant du noyau. (iv) Les particules virales sont injectées dans la chenille de *Manduca sexta* au moment de la ponte avec les œufs. (v) Les particules virales rentrent dans les cellules de l'hôte où les gènes de virulence (en bleu) sont exprimés pour produire des facteurs de virulence. (vi) Les facteurs de virulence induisent des modifications de la physiologie de l'hôte permettant le développement de la descendance du parasitoïde jusqu'à moment où les larves sortent de l'hôte.

Chez les parasitoïdes qui possèdent un PDV, la production de particules virales n'a lieu que dans des cellules spécialisées situées dans une région à la base des oviductes latéraux appelés calice (Marti, 2003; Wyler and Lanzrein, 2003). Les particules virales sont ensuite sécrétées dans les oviductes latéraux là où sont stockés les œufs matures et forment le composant majeur du fluide injecté dans l'hôte lors de la ponte. Une fois injectées, les particules virales vont infecter les cellules de différents tissus de l'hôte, ce qui permettra l'expression des gènes de virulence présents sur les cercles viraux. Du fait de l'absence de gènes codant pour la répllication et la production de particules virales dans les cercles viraux, les PDV ne se répliquent pas dans l'hôte, mais certains fragments peuvent s'intégrer dans son génome (Gasmı et al., 2015). Pour une espèce donnée, le nombre de gènes sur les cercles viraux peut être assez important : chez *C. congregata* les cercles viraux portent au total *a minima* 229 gènes (Chevignon et al., 2014). De plus, la nature des gènes peut être très variable d'une espèce à l'autre. Par exemple le BV du parasitoïde oophage *Chelonus inanitus* possède des gènes très différents de ceux des parasitoïdes s'attaquant à des larves, ce qui suggère que la nature des gènes varie en fonction des interactions hôte-parasitoïde (Gauthier et al., 2017; Weber et al., 2007). L'implication des gènes de virulence dans l'évolution de la gamme d'hôtes et dans la spéciation des parasitoïdes a été étudiée notamment dans le genre *Cotesia* (Branca et al., 2011; Gauthier et al., 2018; Jancek et al., 2013). L'exemple de *C. sesamiae* illustrant cette implication est développé dans la partie II de l'introduction.

Le dernier facteur de virulence correspond à des particules présentant une analogie avec des particules virales et appelées VLP (*Virus-Like Particles*). Ces particules se distinguent des PDV car contrairement à ces dernières elles ne contiennent pas d'acides nucléiques mais des protéines de virulences produites par le parasitoïde (Gauthier et al., 2017). De plus alors que les PDV sont produits exclusivement dans les ovaires, les VLP peuvent également être produites dans la glande à venin (Gatti et al., 2012). Les VLP ont été décrites chez une dizaine d'espèces appartenant aux familles des Braconidae, Ichneumonidae et Figitidae (Burke, 2019; Dubuffet, 2005; Gatti et al., 2012). La question de l'origine des VLP est soumise à débat chez de nombreuses espèces ; origine virale indépendante des PDV, évolution de ces derniers avec perte de la capacité d'encapsuler les acides nucléiques, ou aucun lien avec les virus ? Néanmoins, il a pu être montré chez le Braconidae *Venturia canescens* et l'Ichneumonidae *Fopius arisanus* que leurs VLP dérivent de nudivirus comme c'est le cas pour le bracovirus (Burke et al., 2018; Pichon et al., 2015). Encore une fois, le rôle des VLP est varié. Chez le parasitoïde *Meteorus pulchricornis* les VLP sont impliquées dans la suppression de l'immunité de l'hôte *Pseudaletia separata* alors que chez le parasitoïde *V. canescens*, elles sont impliquées dans la protection des œufs sur lesquels elles sont déposées (Gatti et al., 2012; Rotheram, 1967).

d. Parasitoïdes et lutte biologique

La lutte biologique peut être définie comme l'utilisation d'organismes vivants pour diminuer la densité de populations d'autres organismes considérés comme nuisibles. Même si tous les auteurs ne s'accordent pas sur le nombre et la définition des types de lutte biologique, on en distingue généralement trois : (i) La lutte biologique par acclimatation (souvent appelée lutte biologique « classique »), dont le principe est l'utilisation, contre un ravageur d'origine exotique, d'un ennemi naturel importé de la zone de provenance du ravageur et visant son installation pérenne dans l'environnement. (ii) La lutte biologique inondative, qui consiste à réaliser des lâchers d'un ennemi naturel de manière à augmenter sa population. (iii) La lutte biologique par conservation, qui consiste cette fois à modifier l'environnement dans le but de favoriser la multiplication d'un ennemi naturel (Bale et al., 2008). La lutte biologique est souvent considérée comme la meilleure alternative aux méthodes de lutte chimique notamment du fait que l'apparition de résistances chez les ravageurs est moins fréquente en lutte biologique sans doute en raison de la coévolution qui s'opère entre agents de lutte biologique et ravageurs (Holt and Hochberg, 1997).

Bien que l'impact des parasitoïdes sur certaines espèces soit limité, ils jouent souvent un rôle important dans la régulation de la dynamique des populations de leurs hôtes (Hawkins, 1994). En témoigne l'étude de Hawkins et al. (1997) réalisée sur 78 insectes holométaboles, qui montre que les parasitoïdes sont le groupe d'espèces causant la plus forte mortalité loin devant les prédateurs et les pathogènes. De ce fait ils font partie des organismes les plus utilisés en lutte biologique, d'autant qu'ils sont généralement plus spécifiques que les prédateurs (Boivin, 2001). Un bon exemple d'utilisation de parasitoïdes en lutte biologique est le cas de *Cotesia flavipes*. En effet, cet endoparasitoïde originaire du sous-continent indien a été introduit dans au moins 40 pays depuis les années 50 pour lutter contre des ravageurs des cultures des genres *Chilo* et *Diatraea* (Polaszek, 1991). Au Brésil (Figure 4), il est produit en masse (plus de 18 millions d'individus relâchés par an) afin de contrôler les populations du ravageur de la canne à sucre *Diatraea saccharalis* sur plus de 3 millions d'hectares de cultures (soit l'équivalent de la surface totale de maïs cultivé en France). Ceci en fait une des espèces les plus utilisées en terme de surface couverte (Parra, 2014; Vacari et al., 2012).

A l'image de cette thèse, beaucoup de projets de recherche sur les parasitoïdes sont liés de près ou de loin à la lutte biologique. Afin de garantir le succès des programmes de lutte biologique utilisant des parasitoïdes, il est nécessaire de bien connaître les mécanismes d'adaptation à l'hôte et à l'environnement chez ces espèces, de manière à sélectionner les espèces et populations les plus efficaces et présentant le moins de risques pour des espèces non cibles.

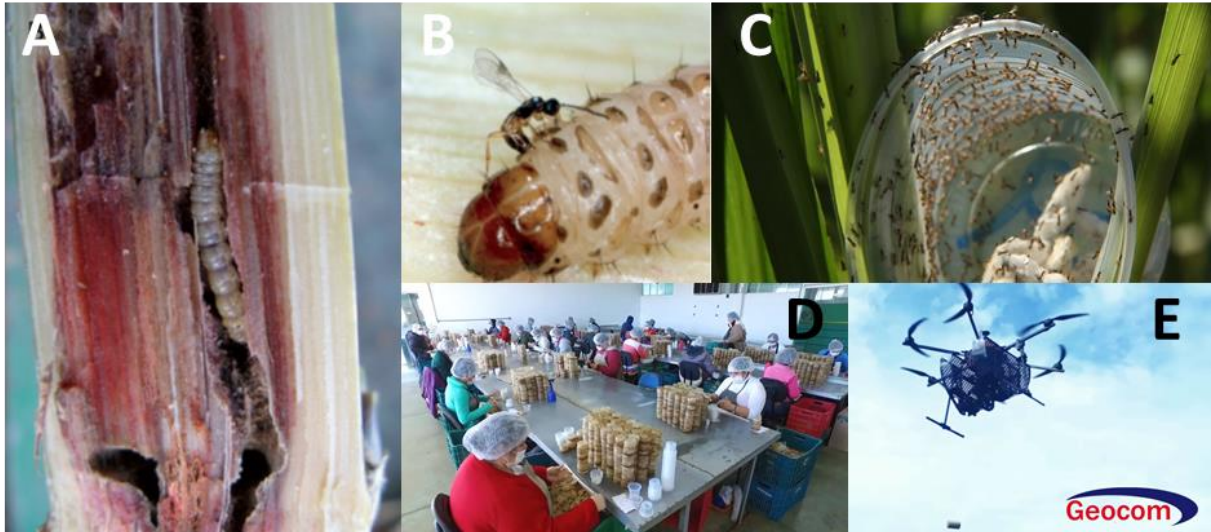

Figure 4- Utilisation de *C. flavipes* contre *D. saccharalis* en lutte biologique au Brésil. (A) Exemple de dégâts occasionnés par *D. saccharalis* sur une tige de cage à sucre. (B) Femelle *C. flavipes* parasitant une chenille de *D. saccharalis*. (D) Usine de production de *C. flavipes*. La lutte biologique se fait par introduction de masses de cocons de *C. flavipes* dans les parcelles par les agriculteurs (C) ou par drone (E). Crédits photos : A, Vargas et al., 2015 ; B, Parra 2014 ; C et D, MCP Controle Biológico ; E, Geocom

II) Modèle biologique : *Cotesia typhae* – *Sesamia nonagrioides*

a. Les parasitoïdes du genre *Cotesia*

Le genre *Cotesia* appartient à la sous-famille des Microgastrinae qui est une des 6 sous-familles de Braconidae possédant un bracovirus (Herniou et al., 2013). Comme l'ensemble des Microgastrinae les guêpes du genre *Cotesia* sont des endoparasitoïdes koïnobiontes de larves de Lépidoptères (Whitfield et al., 2018). Au sein de cette sous-famille, *Cotesia* est un des genres les plus diversifié (Whitfield, 1995). À ce jour pas moins de 400 espèces ont été décrites et selon les estimations il devrait y en avoir environ 1 000 à travers le monde (Mason, 1981; Shaw and Huddleston, 1991). *Cotesia* a été érigé en tant que genre par Cameron au cours du 19^{ème} siècle mais il faudra attendre la grande reclassification des Microgastrinae par Mason en 1981 pour qu'il soit définitivement différencié du genre *Apanteles* dont les espèces ont été reclassées dans 36 genres différents (Mason, 1981; Whitfield et al., 2002). En dépit de l'importance du genre *Cotesia* (voir paragraphe en ci-dessous), sa systématique n'est pas bien connue. La phylogénie la plus complète disponible à ce jour (Figure 6) est celle réalisée par Michel-Salzat et Whitfield (2004) à partir de 35 espèces, et qui a permis de distinguer 5 groupes d'espèces différents.

Les espèces du genre *Cotesia* sont très étudiées au sein des parasitoïdes et ce dans de très nombreux domaines : détection et reconnaissance de l'hôte, évolution et mécanismes de la virulence, apprentissage, comportement, lutte biologique, etc. (Bichang'a et al., 2018; Bredlau and Kester, 2019; Godfray, 1994; Herniou et al., 2013; Kaiser et al., 2017a; Kester and Barbosa, 1991; Quicke, 2014). La recherche sur les espèces du genre *Cotesia* s'articule globalement autour de 3 grands axes (Figure 5). Le plus important (en vert) porte majoritairement sur l'étude des facteurs de virulence des parasitoïdes et de résistance des hôtes notamment au niveau moléculaire. Le deuxième porte lui principalement sur les interactions tri-trophiques (plantes-hôtes-parasitoïdes, en rouge). Enfin, le dernier porte sur la lutte biologique (en bleu) avec *Cotesia flavipes* comme espèce modèle.

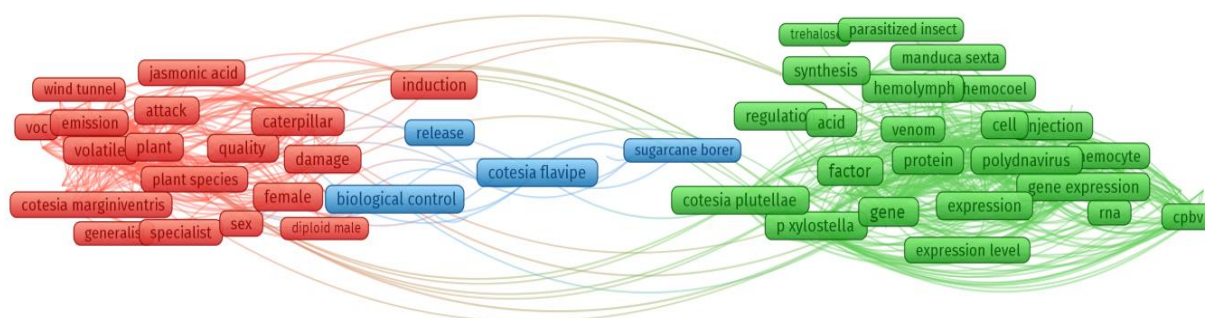

Figure 5 - Organisation des principaux mots-clés relatifs au genre *Cotesia*. Les mots clefs ont été organisés en fonction de leurs taux d'association à l'aide du logiciel VOSviewer (van Eck and Waltman, 2014) à partir des titres et abstract de l'ensemble des articles portant sur le genre *Cotesia* disponibles dans la base de données MEDLINE (en date du 09/09/2019).

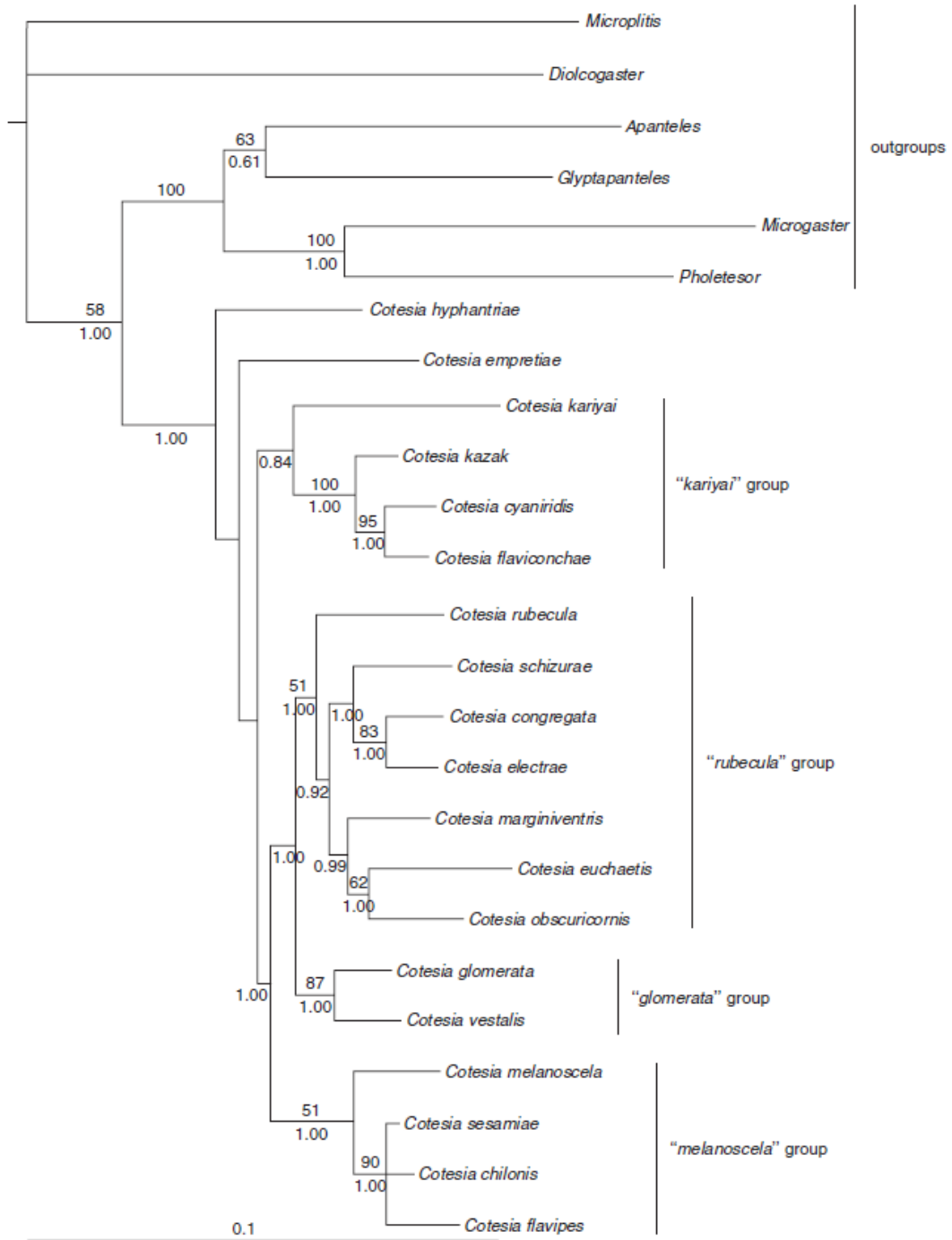

Figure 6 - Phylogénie du genre *Cotesia*. La phylogénie est basée sur quatre gènes (*16S*, *ND1*, *28S* et *LW opsin*) et a été obtenue par la méthode du maximum de vraisemblance (Michel-Salzat et Whitfield 2004).

b. De *Cotesia sesamiae* à *Cotesia typhae*

Afin de comprendre le contexte d'étude dans lequel s'insère cette thèse portant sur *Cotesia typhae* il est nécessaire de revenir sur l'histoire de sa découverte et de sa distinction de *Cotesia sesamiae*. Pour un historique plus complet voir (Kaiser et al., 2017a) en annexe.

Cotesia sesamiae est un parasitoïde généraliste de chenilles de lépidoptères foreurs de tiges de graminées. Il est retrouvé sur plus de 20 espèces d'hôtes différentes. Son aire de répartition naturelle s'étend sur une grande partie de l'Afrique Sub-saharienne (Branca et al., 2011). Cette espèce est également présente à Madagascar et à l'île Maurice où elle a été introduite pour lutter contre les populations de *Sesamia calamistis* et *Chilo partellus*, deux insectes ravageurs du maïs (Polaszek and Delvare, 2000). Elle appartient avec *C. flavipes* (sous-continent Indien) et *C. chilonis* (Asie de l'Est), qui sont morphologiquement proches, au complexe d'espèces monophylétique *flavipes* (Kimani-Njogu and Overholt, 1997; Michel-Salzat and Whitfield, 2004). A ce complexe initialement constitué de trois espèces se sont récemment ajoutées, *C. nonagrioides* (distingué de *C. flavipes*, endémique à l'Australie, Muirhead et al., 2008, 2012) et *C. typhae* distinguée de *C. sesamiae* (Kenya, Ethiopie et Tanzanie, Kaiser et al., 2017b). De par leur distribution on peut imaginer que la plupart des espèces du complexe ont évolué à partir d'événements de spéciations allopatriques. La difficulté à différencier morphologiquement ces espèces illustre bien la notion de complexe d'espèces cryptiques très présente chez les parasitoïdes et la nécessité de compléter les approches morphologiques par des études génétiques et écologiques pour pouvoir explorer leur diversité (Quicke, 2014).

Cotesia sesamiae est une espèce modèle dans l'étude de la variation intra-spécifique de la gamme d'hôte et du rôle joué par le bracovirus dans cette dernière. Dans les années 90, Ngi-Song et al. (1995, 1998) ont mis en évidence que deux populations de *C. sesamiae* variaient dans leurs capacités à parasiter *Busseola fusca* une noctuelle africaine du maïs. En effet, les individus issus de la côte du Kenya, où *B. fusca* est rare, n'arrivent pas à se développer dans cet hôte contrairement aux individus provenant de l'arrière-pays Kenyan, où *B. fusca* est abondant. L'absence de développement dans le premier cas s'explique par l'encapsulation des œufs après parasitage. Plus tard, Mochiah et al. (2002) ont montré qu'il était possible d'induire le développement des individus avirulents dans *B. fusca* en injectant dans l'hôte le fluide du calice (principalement composée de particules virales) de femelles virulentes suggérant l'implication du bracovirus dans l'adaptation à l'hôte.

Suite à ces travaux, plusieurs études se sont ensuite intéressées au rôle du bracovirus dans l'évolution de la gamme d'hôte chez *C. sesamiae* et notamment au rôle du gène de virulence *CrVI*. Ce gène, alors récemment identifié chez *Cotesia rubecula* et dont un homologue est présent chez *C. sesamiae*, code pour une glycoprotéine impliquée dans la dépolymérisation des filaments d'actine des hémocytes de l'hôte entraînant l'inactivation de son système immunitaire (Asgari et al., 1997, 1996; Whitfield, 2000). Il a ainsi pu être montré que les deux populations de *C. sesamiae* précédemment identifiées possédaient des allèles différents du gène *CrVI*, nommés Coast et Inland d'après les régions d'échantillonnage et que la variation de virulence envers *B. fusca* était associée à l'expression ou non de ce gène (Dupas et al., 2008; Gitau et al., 2007).

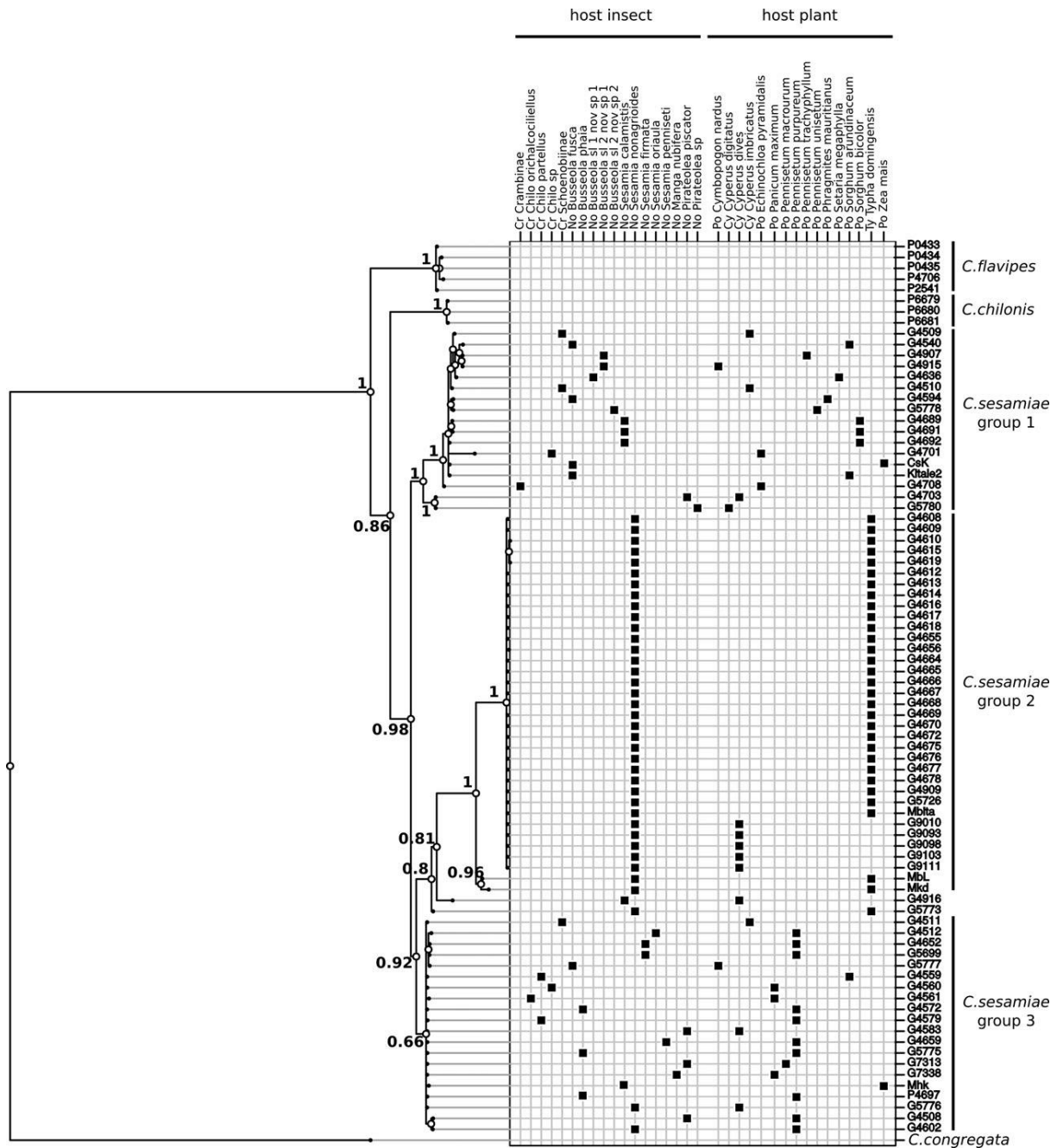

Figure 7 - Phylogénie d'individus de *C. sesamiae* et *C. typhae*. La phylogénie est basée sur 3 gènes mitochondriaux (*COI*, *16S*, *NADH*) et 3 gènes nucléaires (2 gènes viraux : *EP2*, *Histone 4* et un non viral : *LWRH*). Pour chaque individu (lignes horizontales) sont indiquées l'espèce d'hôte (colonne de gauche) et la plante sur laquelle ils ont été échantillonnés (colonne de droite). Le groupe 2 correspond aux échantillons identifiés par la suite comme *C. typhae* (Kaiser et al. 2015).

Afin de tester l'hypothèse selon laquelle il pourrait y avoir d'autres populations adaptées à différents hôtes au sein de *C. sesamiae*, Branca et al. (2011) ont réalisé un très large échantillonnage en Afrique. Pour chaque échantillon le gène *CrVI* a été séquencé et différents paramètres biotiques (espèce d'hôte, plante de l'insecte hôte, souche de *Wolbachia* infectant *C. sesamiae*) et abiotiques (altitude et 19 paramètres climatiques) ont été mesurés. Ces travaux ont montré l'existence de 5 nouveaux allèles du

gène *CrVI* et conclu que l'espèce d'hôte était le facteur expliquant le mieux la variation allélique, suggérant l'implication du bracovirus dans la spécialisation à l'hôte. Parmi les différents allèles identifiés, l'allèle CsNona se distinguait par une divergence importante par rapport aux autres allèles. De plus, les individus échantillonnés portant cet allèle étaient systématiquement retrouvés sur un seul hôte, *Sesamia nonagrioides* presque exclusivement associés à une espèce de plante, *Typha domingensis* ; *S. nonagrioides* est rarement parasité par des *C. sesamiae* ne portant pas l'allèle CsNona. Kaiser et al. (2015) ont réalisé ensuite une phylogénie basée sur 3 gènes mitochondriaux et 3 gènes nucléaires sur un sous-échantillonnage des individus analysés dans Branca et al. (2011) ainsi que sur de nouveaux échantillons issus du terrain (Figure 7). Ils ont ainsi mis en évidence 3 lignées au sein de *C. sesamiae*, dont une rassemblant les individus portant l'allèles CsNona. En réalisant des croisements ils ont montré un isolement reproducteur entre ces individus et ceux des deux autres lignées et ont proposé le statut d'espèce à part entière pour la lignée CsNona. Le statut d'espèce à part entière fut par la suite confirmé par identification morphologique (Kaiser et al., 2017b, en annexe) et le nom de *C. typhae* a été donné à cette nouvelle espèce.

Sachant que *S. nonagrioides* est l'espèce d'hôte la plus abondante dans les localités où *C. typhae* a été retrouvée, le phénomène de spéciation de *C. typhae* peut être interprété comme une conséquence de l'adaptation locale à cet hôte potentiellement médiée par le bracovirus.

c. *C. typhae*

Cotesia typhae (Fernández-Triana) (Hymenoptera, Braconidae) est un endoparasitoïde koinobionte grégaire s'attaquant uniquement au foreur *S. nonagrioides*. Ce parasitoïde a pour le moment été retrouvé au Kenya, en Ethiopie et en Tanzanie (Branca et al., 2011; Kaiser et al., 2015). Son cycle de vie est détaillé Figure 8.

Au stade adulte les femelles du genre *Cotesia* sont attirées à distance par l'émission de volatiles des plantes attaquées par les chenilles hôtes (Ngi-Song et al., 1996). Elles vont ensuite pénétrer dans la galerie creusée par les chenilles et les parasiter à l'intérieur de la plante. Chez *C. sesamiae* et *C. flavipes*, on sait que les femelles sont attirées de manière non spécifique par les graminées infestées par des foreurs de tige et que c'est au contact de la chenille qu'elles l'identifient à partir de ses sécrétions et qu'elles décident ou non d'y pondre (Bichang'a et al., 2018; Ngi-Song et al., 1996; Obonyo et al., 2010a). Lorsque la femelle pénètre dans la galerie il existe un fort risque qu'elle n'en ressorte pas vivante, estimé à 30-40% par Potting et al. (1997) chez *C. flavipes*. En effet la chenille peut se défendre, notamment avec ses mandibules, et tuer la femelle. Du fait du mode de vie similaire et de la proximité génétique, il est vraisemblable que ces caractéristiques s'appliquent à *C. typhae*.

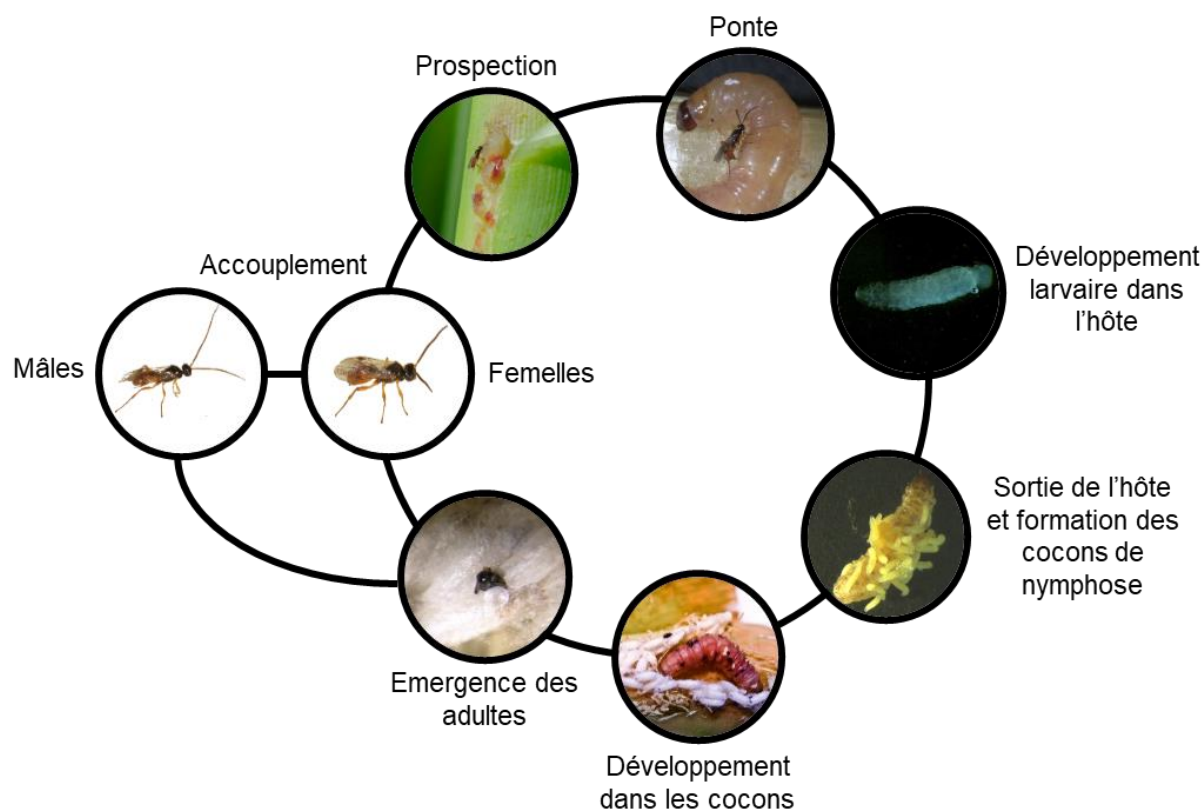

Figure 8 - Cycle de vie de *C. typhae*.

Chez *C. typhae*, la ponte est rapide et dure en moyenne 9 secondes. Au cours de celle-ci la femelle va injecter plusieurs dizaine d’œufs à la fois dans l’hôte. Sur le terrain le pourcentage de chenilles parasitées par *C. typhae* est très variable en fonction des localités d’échantillonnage et des périodes de l’année où ont été faites les collectes. En effet, ce pourcentage peut aller de 3% à 72% (Kaiser et al., 2017b, en annexe). En conditions naturelles on ne sait pas combien de fois les femelles pondent en moyenne. Cependant comme leur durée de vie est très courte et que la mortalité à l’intérieur des galeries est élevée on peut imaginer que la probabilité de pondre plus de deux fois est très limitée. Le superparasitisme chez *C. typhae* est probable sur le terrain sachant qu’il est possible en laboratoire.

Les œufs de *C. typhae* éclosent quelques jours après avoir été injectés et les larves vont ensuite se nourrir de l’hémolymphe de l’hôte. Au terme du développement larvaire qui comprend trois stades, elles vont perforer l’épiderme de l’hôte pour sortir et tisser leur cocon de nymphose dans lequel elles vont finir leur développement. Toutes les larves sortent de l’hôte et tissent leur cocon dans la galerie de manière synchrone formant ainsi une masse de cocons compacte maintenue par des fils de soie. La chenille meure généralement quelques jours après la sortie des larves de *C. typhae*. Dans nos conditions de laboratoire (voir chapitre suivant), le développement dure en moyenne 20 jours : 14 jours à l’intérieur de la chenille et 6 jours à l’intérieur du cocon de nymphose. La sortie de l’hôte et le tissage des cocons se font en quelques heures.

L'émergence des adultes est également plus ou moins synchrone au sein de la masse de cocons. Les mâles émergent un peu avant les femelles et attendent leur émergence pour s'accoupler. Chez *C. flavipes* et *C. sesamiae* il a ainsi été montré que les accouplements sont consanguins dans la majorité des cas (Arakaki and Ganaha, 1986; Ulyyett, 1935). Cependant l'impact de la dépression de consanguinité est largement limité du fait de l'haplodiploïdie qui induit vraisemblablement une purge des allèles délétères via les mâles haploïdes. Les femelles accouplées engendrent des descendance avec un sexe-ratio généralement biaisé en faveur des femelles. Les femelles non-accouplées acceptent également de pondre mais donneront des descendance uniquement composées de mâles (mais voir chapitre IV).

En présence d'eau et d'une source de nourriture sucrée les adultes vivent en moyenne 3 jours à 21°C, les mâles vivant sensiblement plus longtemps. Ces derniers peuvent être différenciés visuellement des femelles car ils ont des antennes environ deux fois plus longues et n'ont pas d'ovipositeur (voir Figure 8 et Kaiser et al., 2017b en annexe).

Le tractus génital femelle est détaillé sur la Figure 9. Les femelles adultes émergent avec la majorité de leur stock d'ovocytes matures constitué (dans les oviductes latéraux) et peuvent pondre donc immédiatement après l'émergence. *C. typhae* peut être qualifiée d'espèce prosynovogénique (intermédiaire entre pro- et synovogénique) car les femelles vont mûrir quelques œufs (dans les réservoirs) à l'âge adulte.

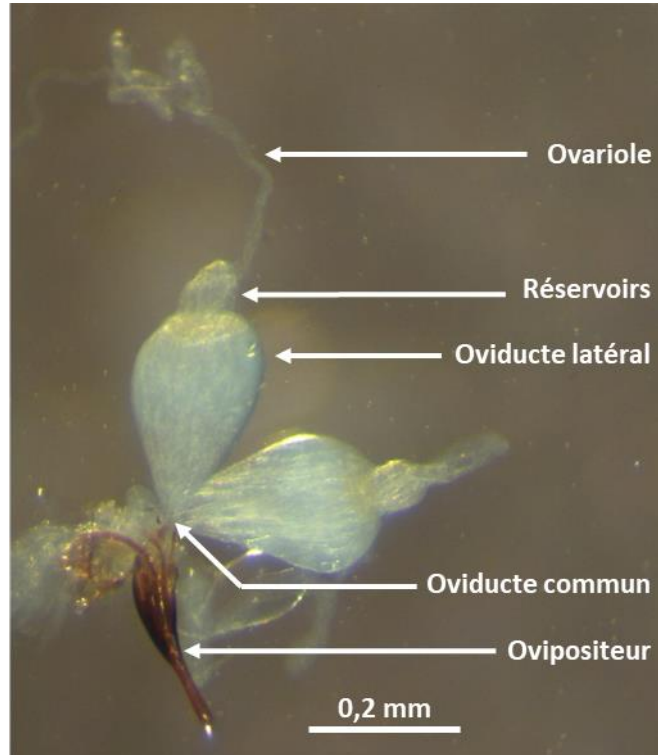

Figure 9 - Tractus génital femelle de *C. typhae*. Les ovocytes sont produits dans les ovarioles débouchant sur les réservoirs où ils seront stockés jusqu'à maturation complète. Les ovocytes matures sont ensuite stockés dans les oviductes latéraux jusqu'au moment de la ponte.

d. *S. nonagrioides*

Sesamia nonagrioides (Lefèbvre) (Lepidoptera, Noctuidae), également appelée sésamie du maïs, est une noctuelle dont les larves se développent en forant les tiges de graminées. Comparée à d'autres espèces de foreurs c'est une espèce polyphage qui a été retrouvée sur une quarantaine d'espèces de plantes de trois familles différentes : Cyperaceae, Poaceae et Typhaceae (Le Rü et al., 2006).

Elle est présente en Afrique sub-saharienne de l'ouest de la Côte d'Ivoire à l'est du Kenya et jusqu'au Botswana au sud. Dans la région paléarctique on la retrouve tout autour du bassin méditerranéen notamment en Europe et également au Moyen-Orient jusqu'en Iran (Cheraghali et al., 2015; Moyal et al., 2011). Des études de génétique des populations réalisées sur toute cette aire de présence ont montré que *S. nonagrioides* est structurée en 4 grandes populations distinctes : ouest-africaine ; centre-africaine ; est-africaine et paléarctique. Selon le scénario le plus probable l'espèce serait originaire du centre de l'Afrique et la colonisation de la région paléarctique serait issue de la migration d'individus de la population est-Africaine il y a environ 178 000 ans (Kergoat et al., 2015; Moyal et al., 2011). Une certaine structuration génétique semble également exister au sein de la population européenne allant de l'Espagne à la Grèce. Cependant, en fonction des études réalisées, les niveaux de différenciation sont variables, la seule constante étant une proximité entre les populations du sud de la France et du nord de l'Espagne (Buès et al., 1996; de la Poza et al., 2008; Kourti, 2006; Margaritopoulos et al., 2007).

Les femelles adultes ont une activité nocturne et pondent leurs œufs en « grappe » sous la gaine foliaire de la plante hôte assurant leur protection. Chaque ponte est constituée de plusieurs dizaines d'œufs. Rapidement après éclosion des œufs, les chenilles s'alimentent à partir du parenchyme de la gaine foliaire. Elles adoptent dans un premier temps un comportement grégaire et coopèrent pour pénétrer à l'intérieur de la tige. A partir du 3^{ème} stade larvaire elles se dispersent et vont forer d'autres plantes ce qui minimise la compétition pour la ressource (Eizaguirre et al., 2004). Les différents stades de développement sont présentés Figure 10.



Figure 10 – Les différents stades de développement de *S. nonagrioides*. Mâles et femelles sont discernables au stade adulte à grâce à leurs antennes (♀ antennes lisses, ♂ antennes bipectinées) et au stade chrysalide à partir de leur orifice génitale (♀ une valve, ♂ deux valves). Œufs déposés en grappes sur un épis de maïs (Crédit : Philippe Mothiron). Chenille au dernier stade larvaire

Le nombre de générations par an est variable selon les zones géographiques : 2 à 3 en France, Espagne et Portugal, 3 à 4 en Grèce, 4 à 5 en Iran, 5 à 6 en Afrique (Eizaguirre and Fantinou, 2012; Polaszek and Delvare, 2000). En Europe, la sésamie passe l'hiver sous forme de chenille en diapause, celle-ci étant induite par la diminution de la durée du jour (Galichet et al., 1982).

La sésamie du maïs est un ravageur des cultures de maïs dans de nombreux pays d'Europe et d'Afrique de l'ouest, et de la canne à sucre en Iran (Buadu et al., 2002; Cheraghali et al., 2015; Eizaguirre and Fantinou, 2012). De manière intéressante, elle n'est pas un ravageur du maïs en Afrique de l'Est. Dans cette région on la retrouve principalement sur des plantes sauvages dans des zones humides et les dégâts causés sur les cultures semblent limités à de récentes attaques reportées sur des cultures de canne à sucre (Goftishu et al., 2019; Moyal et al., 2011).

Les méthodes de lutte sont multiples : broyage des résidus de maïs où les sésamies passent l'hiver ; insecticides ; maïs *Bt* ; pièges à phéromones (Albajes et al., 2002; Castañera et al., 2016; Rousseau, 2009). Cependant leur efficacité semble limitée et/ou leur utilisation soumise à controverse, notamment pour le maïs *Bt* et les pesticides. En France la population de sésamie du maïs est en expansion vers le nord (Rousseau, 2009). A l'heure actuelle il n'existe pas en Europe d'agent de lutte biologique contre la sésamie du maïs bien que l'utilisation du parasitoïde *Telenomus busseolae* ait été envisagée dans les années 90 (Colazza and Rosi, 2001). De par sa spécificité envers la sésamie du maïs, *C. typhae* est un agent de lutte biologique potentiellement intéressant pour lutter contre ce ravageur en Europe.

III) Contexte et objectifs de la thèse

Ce travail de thèse s'inscrit dans la continuité des travaux de l'équipe sur les mécanismes d'adaptation à l'hôte dans le complexe *C. flavipes* et dans la perspective d'une utilisation de *C. typhae* en lutte biologique en France.

Après que *C. typhae* ait été différenciée de *C. sesamiae*, il a été entrepris d'étudier son potentiel de parasitisme contre une population française de *S. nonagrioides* (nouvel hôte pour *C. typhae* qui est originaire d'Afrique). Ainsi, le succès reproducteur de quatre souches kényanes de *C. typhae* sur la sésamie française a été mesuré par le biais de l'analyse de traits d'histoire de vie. Ces travaux, présentés dans la première partie de l'article n°1, ont permis de mettre en évidence des variations importantes du succès reproducteur entre les souches de *C. typhae* sur ce nouvel hôte. Parmi les souches testées, les souches Kobodo et Makindu étant les plus contrastées, nous les avons retenues pour notre étude (voir Figure 11). Les différences initialement mises en évidence entre ces deux souches portent sur la probabilité que leur ponte se développe dans la chenille hôte (succès de parasitisme) et sur leur nombre de descendants (quand il y a développement). En effet la souche Makindu est caractérisée par un succès de parasitisme plus faible sur la souche française et par un nombre de descendants moins important que la souche Kobodo.

L'objectif de ma thèse était d'identifier les mécanismes à l'origine de cette différence du succès reproducteur entre les souches Kobodo et Makindu afin d'améliorer notre compréhension des mécanismes d'adaptation à l'hôte chez les parasitoïdes. Dans cette optique j'ai développé une approche intégrative portant sur les bases comportementales, physiologiques et génétiques du succès reproducteur de *C. typhae*.

Les résultats obtenus sont présentés dans les trois chapitres suivants. Le chapitre II sur les bases comportementales et physiologiques comprend l'identification des souches de *C. typhae* et porte principalement sur l'étude du comportement de ponte et sur ses potentielles répercussions sur le succès de parasitisme et le nombre de descendants. Dans ce chapitre nous avons caractérisé la dynamique de répartition des œufs injectés dans l'hôte par les femelles Kobodo et Makindu. Sachant que les particules virales sont injectées en même temps que les œufs nous avons cherché à savoir s'il y avait un lien entre la quantité d'œufs injectés, la quantité de particules virales injectées, l'expression des gènes viraux et le succès de parasitisme afin d'expliquer la différence observée entre les deux souches. Le chapitre III porte quant à lui sur l'étude des bases génétiques du succès reproducteur. Afin de chercher des gènes impliqués dans la variation du succès de parasitisme et du nombre de descendants, des croisements ont été entrepris entre les souches Kobodo et Makindu et une recherche de QTL (Quantitative Trait Loci) a été mise en place. Enfin, l'analyse d'un grand nombre de descendances a permis de mettre en lumière

des anomalies dans la détermination du sexe chez *C. typhae*. Une analyse préliminaire a été menée sur ce sujet et est présentée brièvement dans le chapitre IV.

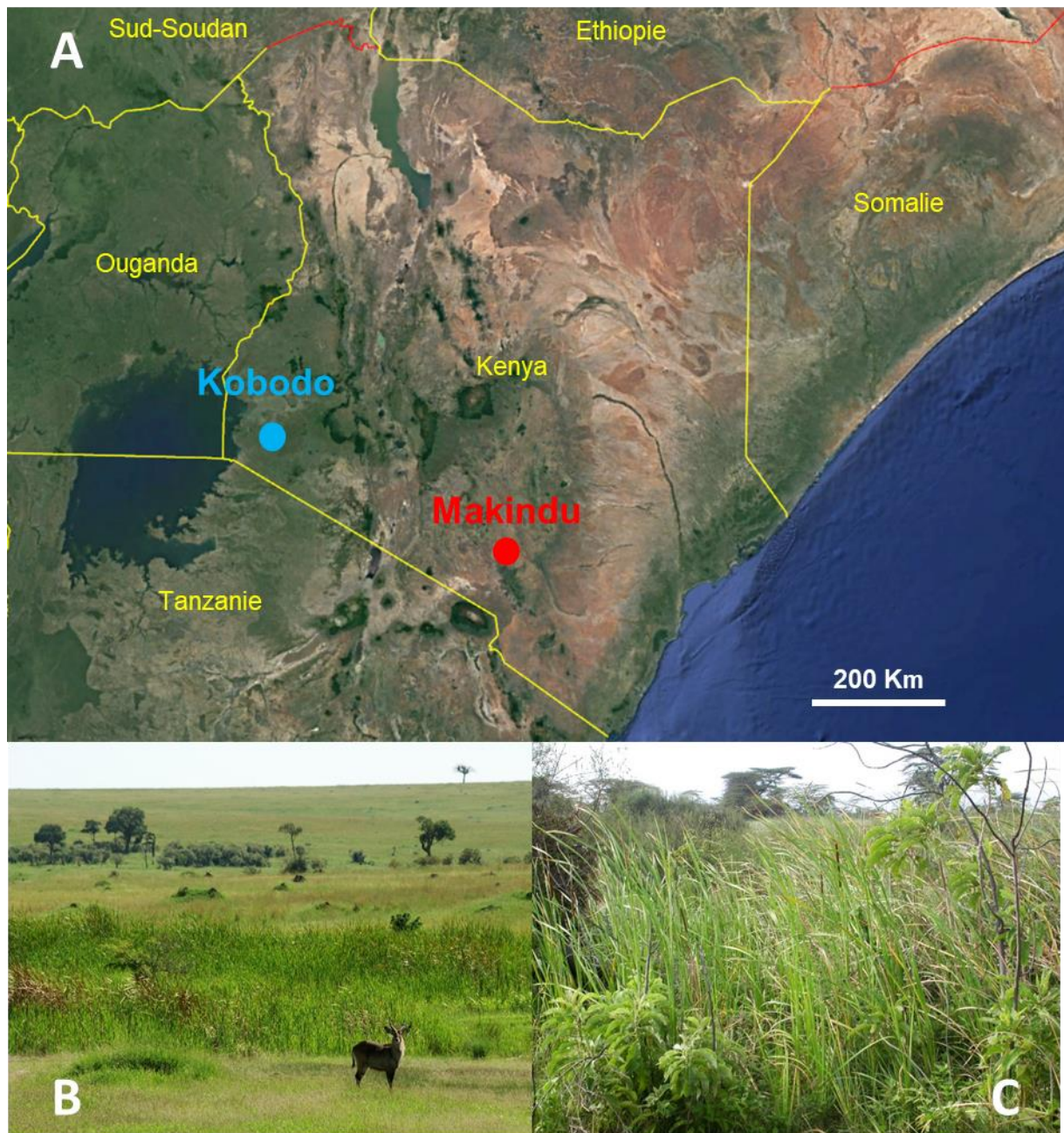

Figure 11 - Localités d'échantillonnage des souches de *C. typhae*. (A) Vue satellite centrée sur le Kenya (source : Google Earth). Les localités d'échantillonnage des souches de *C. typhae* sont séparées par la vallée du rift africain. (B) Photo prise dans le parc de Nairobi avec un peuplement de *Typhae* typique des régions de moyenne altitude (± 1100 m) comme on peut en retrouver à Kobodo. (C) Photo d'un peuplement de *Typhae* à côté de Kibwezi à 20 Km au sud-est de Makindu. Crédit photos : B et C, Bruno Le Ru.

**Chapitre II – Bases
comportementales et
physiologiques du succès
reproducteur de *C. typhae***

I) Article n°1: Relationship between oviposition, virulence gene expression and parasitism success in *Cotesia typhae* nov. sp. parasitoid strains

Ce premier article contient les résultats à l'origine de mon travail de thèse. Les expérimentations ont été réalisées en amont de cette dernière par les membres de l'équipe et par moi-même à l'occasion de mon stage de Master 2. J'ai réalisé l'analyse complète des résultats et la rédaction de l'article au début de ma thèse. Afin d'étudier les mécanismes de l'adaptation à un nouvel hôte, il était initialement prévu de lancer un programme de sélection bidirectionnelle sur *C. typhae* pour générer des souches présentant un fort et un faible potentiel de parasitisme, en terme de succès de parasitisme (probabilité de se développer dans l'hôte) et de nombre de descendants produits par hôte, sur une population allopatrique de *S. nonagrioides* originaire de France. Cependant en caractérisant les quatre souches de *C. typhae* qui devaient être utilisées pour la sélection (résultats présentés dans la première partie de l'article), nous avons mis en évidence que deux de ces souches présentaient déjà des contrastes importants dans leur potentiel de parasitisme.

Nous avons donc décidé de nous focaliser sur ces souches appelées Kobodo et Makindu (d'après leurs localité d'origine) qui sont respectivement celle avec le plus fort et celle avec le plus faible potentiel de parasitisme sur la population française de *S. nonagrioides*. Afin d'expliquer la différence de nombre de descendants observée entre les deux souches nous avons estimé la fécondité et le nombre d'œufs injectés au moment de la ponte. Nous avons ainsi pu montrer que bien que les femelles des deux souches possèdent un stock d'ovocyte équivalent, elles n'injectent pas la même quantité d'œufs dans le premier hôte rencontré ce qui suggère un comportement de ponte différent et explique l'écart observé entre leur nombre de descendants. Aussi nous avons pu montrer que les femelles de la souche Kobodo induisent une plus forte expression dans l'hôte de deux gènes de virulence (*CrVI* et *Cystatin*) portés par le Bracovirus que celles de la souche Makindu, ce qui pourrait expliquer leur plus fort succès de parasitisme. La caractérisation des hybrides obtenus en croisant les deux souches suggèrent une dominance des allèles Kobodo pour ces traits.

Sachant que les particules virales sont injectées dans l'hôte avec les œufs, nous avons émis l'hypothèse que les femelles Kobodo devraient injecter plus de particules virales dans l'hôte que les femelles Makindu car elles injectent plus d'œufs. Une plus forte quantité de particules virales injectées pourrait expliquer la plus forte expression des gènes de virulence et le meilleur succès de parasitisme de cette souche. Pour tester cette hypothèse nous avons interrompu la ponte des femelles Kobodo de manière à diminuer le nombre d'œufs injectés et regardé l'effet de cette interruption sur l'expression des gènes de virulence et le succès de parasitisme. Les résultats montrent que l'interruption de la ponte induit une diminution de l'expression des gènes mais pas forcément une diminution du succès de parasitisme.

Relationship between oviposition, virulence gene expression and parasitism success in *Cotesia typhae* nov. sp. parasitoid strains

Benoist R.¹, Chantre C.¹, Capdevielle-Dulac C.¹, Bodet M.¹, Mougel F.¹, Calatayud P.A.^{1,2}, Dupas S.¹, Huguet E.³, Jeannette R.¹, Obonyo J.², Odorico C.¹, Silvain J.F.¹, Le Ru B.^{1,2} & Kaiser L.¹

¹ *Laboratoire Evolution, Génome, Comportement et Ecologie (UMR CNRS-Univ. Paris-Sud-IRD ; Univ. Paris-Saclay) ; 1 Avenue de la Terrasse, 91198 Gif-sur-Yvette Cedex, France.*

² *icipe: African Insect Science for Food and Health; Duduville Campus, Kasarani, P.O. Box 30772 - 00100, Nairobi, Kenya.*

³ *Institut de Recherche sur la Biologie de l'Insecte, CNRS UMR 7261, Université François-Rabelais, UFR Sciences et Techniques, Parc Grandmont, Avenue Monge, 37200 Tours, France.*

Correspondence author: Laure Kaiser; email: laure.kaiser-arnauld@egce.cnrs-gif.fr; Tel: (33) 1 69 82 37 04

Keywords: Parasitoid, reproductive success, oviposition behaviour, polydnavirus, new host, biological control.

Abstract

Studying mechanisms that drive host adaptation in parasitoids is crucial for the efficient use of parasitoids in biocontrol programs. *Cotesia typhae* nov. sp. (Fernández-Triana) (Hymenoptera: Braconidae) is a newly described parasitoid of the Mediterranean corn borer *Sesamia nonagrioides* (Lefebvre) (Lepidoptera: Noctuidae). Braconidae are known for their domesticated bracovirus, which is injected with eggs in the host larva to overcome its resistance. In this context, we compared reproductive success traits of four Kenyan strains of *C. typhae* on a French and a Kenyan populations of its host. Differences were found between the four strains and the two most contrasted ones were studied more thoroughly on the French host population. Parasitoid offspring size was correlated with parasitism success and the expression of bracovirus virulence genes (*CrV1* and *Cystatin*) in the host larva after parasitism. Hybrids between these two parasitoid strains showed phenotype and gene expression profiles similar to the most successful parental strain, suggesting the involvement of dominant alleles in the reproductive traits. Ovary dissections revealed that the most successful strain injected more eggs in a single host larva than the less successful one, despite an equal initial ovocyte number in ovaries. It can be expected that the amount of viral particles increases with the number of eggs injected. The ability to bypass the resistance of the allopatric host may in consequence be related to the oviposition behaviour (eggs allocation). The influence of the number of injected eggs on parasitism success and on virulence gene expression was evaluated by oviposition interruption experiments.

Introduction

Insect parasitoids are organisms that require only one host to complete development. They are often considered as intermediate between predators and parasites because they finally kill their host (Godfray, 1994). Parasitoid species are under strong selective pressure due to the arms race process that occurs with their host. The resulting co-evolutionary process is responsible for the high specialisation and species richness that can be observed in parasitoids (Smith et al., 2008). Indeed various estimates suggest that 10 % to 20 % of all insects are parasitoids, the majority belonging to the Hymenoptera order (Godfray, 1994; Quicke, 1997). Parasitism is made up of several steps, including recognition of the host, oviposition behaviour and inactivation of its immune response. Because each step is directly linked to parasitoid fitness, elaborate behavioural and physiological mechanisms can often be observed ensuring parasitism success (Wajnberg et al., 2008)

One of the most remarkable examples of such a mechanism is the domestication within the hymenoptera order of two unrelated viruses by the Braconidae and Ichneumonidae wasp families. The viruses associated with these two families respectively belong to the Bracovirus and the Ichnovirus genera, that form the Polydnavirus (PDV) family (Herniou et al., 2013). PDVs are integrated into the genomes of their wasps and therefore vertically transmitted (Fleming and Summers, 1991). PDV particle production occurs only in particular cells located in wasp ovaries, the calyx cells (Webb, 1998). PDV viral particles are secreted into the oviduct and forming the main components of the calyx fluid. During oviposition, they are injected along with the wasp eggs into the host where they will infest host tissues. The expression of PDV virulence genes in the host will inactivate its immune response by preventing the encapsulation of the parasitoids eggs and larvae (Edson et al., 1981; Glatz et al., 2004). Later, viral expression can disturb host development and prevent pupation (Soller and Lanzrein, 1996).

Cotesia typhae nov. sp. (Fernández-Triana) (Hymenoptera: Braconidae) is a newly described parasitoid wasp (Kaiser et al., submitted). Until recently, this species was considered as a population of the generalist African species *Cotesia sesamiae* (Cameron) composed of several populations more or less specialised on different lepidopteran hosts. These populations were identified by their different alleles of the PDV virulence gene *CrV1* (Branca et al., 2011; Dupas et al., 2008), known to be involved in the inactivation of the host immune response (Asgari and Schmidt, 2002). Kaiser et al. (2015) performed a phylogenetic analysis of 74 individuals from different populations of *C. sesamiae* based on six mitochondrial as well as nuclear genes and revealed the existence of three distinct lineages. The authors identified one of these lineages, corresponding to *C. typhae*, as a cryptic species. This species was shown to be reproductively isolated from the two other lineages and was the only one to be specialised on *Sesamia nonagrioides* (Lefebvre) (Lepidoptera, Noctuidae). The speciation of *C. typhae* was therefore interpreted as a consequence of a divergent selection due to a local adaptation to *S. nonagrioides*, the most abundant host in the localities where *C. typhae* individuals were sampled. The distinct species status of *C. typhae* was confirmed by morphological identification (Kaiser et al., submitted). Thus, it be considered as the fifth species of the *Cotesia flavipes* monophyletic complex, formerly composed of four allopatric sister species: *C. flavipes* (Cameron, 1891), *C. chilonis* (Munakata, 1912), *C. nonagriae* (Olliff, 1893) and *C. sesamiae* (Cameron, 1906) (Muirhead et al., 2012). All species of the complex are gregarious endoparasitoids of lepidopteran stem borers and are major biocontrol agents of cereal and sugarcane stem borer pests in various countries (Kfir et al., 2002; Polaszek, 1991; Trevisan et al., 2016).

S. nonagrioides is an important pest of maize in the Mediterranean region (Cordero et al., 1998; Eizaguirre and Fantinou, 2012) and in the north it had progressed to the Loire valley in France (Rousseau, 2009). At present, the only efficient way to prevent its proliferation in Europe seems to be the use of highly controversial *Bt* transgenic maize (Castañera et al., 2016). The alternative of using egg parasitoid *Telenomus busseolae* to control *S. nonagrioides* was explored in the 90's but without success (Colazza and Rosi, 2001) and presently no promising biological agent is actually available in Europe. *C.*

typhae presents several interesting properties making it a good candidate to be used in a biological control programs against *S. nonagrioides*. It appears to be strictly specialised on this single host, so risks for non-target hosts are low (Kaiser et al., 2015). Furthermore, *C. typhae* is known to be able to develop in European populations of *S. nonagrioides* (Kaiser et al., 2017b) which are genetically differentiated from African ones (Kergoat et al., 2015) and represent thus a new host population.

The success of biological control programs depends on the understanding of adaptive mechanisms that occur between target pests and biological control agents. In, this context, the purpose of this study was therefore to explore the ability of *C. typhae* to reproduce in a new host population. We compared the reproductive success of four Kenyan strains of *C. typhae* on a French and a Kenyan population of *S. nonagrioides*, and found differences between these strains on the following traits: parasitism success (proportion of hosts successfully parasitized), viable offspring number, sex ratio and pupal mortality. To explain these differences, we focused on the two most contrasting strains using the French host and characterized the previous traits in F1 hybrids. We performed ovarian dissections and measured by RT-qPCR the expression levels of two highly expressed bracovirus genes, *CrV1* and *Cystatin*, in the fat body of parasitized larvae. Both are involved in immune response inactivation (Asgari and Schmidt, 2002; Serbielle et al., 2008) and are known to be under adaptive selection in the *Cotesia* genus (Jancek et al., 2013). We found that the parasitism success in the French host was associated with both expression of virulence genes and viable offspring number. We hypothesised that the strain that produced more offspring had also oviposited more eggs in a single host larva, together with a higher number of viral particles, thereby inducing higher expression of virulence genes. To test this hypothesis, we artificially reduced the number of eggs laid by the most prolific strain by interrupting the oviposition behaviour and measured both parasitism success and expression of bracovirus genes in the parasitized host.

Materials and Methods

Biological Material

The *C. typhae* laboratory strains are named after the locations in Kenya from where they originate: Kisumu-Rabuor (0.110S, 34.775E); Kobodo (0.679S, 34.412E); Luanda (0.483S, 34.297E); Makindu (2.278S, 37.825E). A strain was established from each locality at the International Centre of Insect Physiology and Ecology (icipe, Nairobi) from adults emerged from naturally parasitized *S. nonagrioides* caterpillars collected in the field during 2011-2013. The number of founder females was 7 for Luanda strain, 3 for Kobodo strain, 4 for Kisumu-Rabuor strain and 10 for Makindu strain. These strains were also reared at the laboratory Evolution, Génome, Comportement et Ecologie (EGCE, Gif-sur-Yvette) and provided all wasps used in this study.

A French and a Kenyan strain of *S. nonagrioides*, were used for the experiments. The French strain originated from Haute-Garonne (maize fields in the Longage-Berat area, 43.368N, 1.192E and within a 10 km distance) whereas the Kenyan strain was collected at Makindu. To prevent any selection process that may occur during parasitoids reared on a new host (French strain), only the Kenyan host strain was used for *C. typhae* rearing.

Insects rearing and parasitism

The host caterpillars were fed on an artificial diet (adapted from Overholt et al. 1994) at 26°C, c.a. 60% RH under a photoperiod of 16:8 (L:D). Host larvae for parasitism were taken from maintenance rearing three weeks post-hatching when most were in their 5th larval stage; smaller larvae as well as pre-pupae were discarded. The larvae were placed on fresh pieces of maize stem at least 24 h before parasitism to ensure acceptance by the parasitoid. They were parasitized individually by a single one-day old *C. typhae* female, a duration allowing for mating in the emergence cages. However, mating was not observed. Two methods of exposure were performed (i) Host in maize stem, whereby one female wasp was placed in a petri dish with one host larva in a piece of bored maize stem, where parasitism could not be observed, (ii) Naked larva where the larva was removed from the maize stem and placed under a small plastic top with one female wasp until ovipositor insertion took place.

Depending on the treatment, parasitized larvae were kept individually in their piece of maize in a Petri dish together with the female parasitoid or placed in a Petri dish with artificial diet under rearing conditions until observation of either (i) the formation of parasitoid cocoons, (ii) death of the host larvae, without cocoon formation, or (iii) formation of host pupa.

For the experiment of oviposition interruption, a timer was triggered when sting was observed and the female wasp was carefully removed from the larva with forceps 1-2 or 3-4 seconds after the ovipositor was inserted (referred in what follow as 1 second and 3 seconds respectively). In this experiment, the control condition corresponded to females which oviposited without interruption.

Under our laboratory conditions, the average duration of *C. typhae* development is 21 days, i.e. 14 days of endoparasitic larval development and 7 days of nymphal development. Each cocoon mass was placed in an emergence cage made of a disposable plastic box (500 ml) at 26°C and c.a. 60% RH under a photoperiod of 16:8 (L:D). Emerging adults were provided with honey droplets and water imbibed cotton wool that increased the relative humidity to 80% inside cages.

For crosses between individuals from Kobodo and Makindu strains, cocoons were isolated when turning grey and the blackish adults became visible through the cocoon silk. They were placed in 2 ml perforated eppendorf tubes with cotton wool imbibed with water and honey droplets under the same conditions as in the emergence cages. At emergence, each couple was enclosed in a small plastic vial (1 cm diameter 2 cm height) until mating was observed. Mated females were kept in the eppendorf tube for 24 h before used the experiments.

The proportion of exposed/stung larvae that produced cocoons, pupated or died prior to parasitoid emergence was recorded for each treatment. The proportion of larvae that produced cocoons was considered as estimators of the parasitism success. For each cocoon mass, the number of viable offspring, the number of parasitoids that died inside cocoons and the sex ratio when females were present was recorded (progenies composed only of males were discarded because they likely stemmed from unmated females). The pupal mortality was calculated as the number of parasitoids that died inside cocoons divided by the number of viable offspring plus number of parasitoids that died inside the cocoons. The sex ratio was calculated as the number of females divided by the viable offspring number.

Ovaries dissection

C. typhae females from Kobodo and Makindu strains were dissected either before or after having they had oviposited once in the French host. Alive females were placed at -20°C and stored until dissection. Their abdomen was separated from the thorax and placed in a drop of phosphate buffered saline (PBS). Thereafter the cuticle was removed to free the ovaries. Both ovaries were dissected because the number of ovocytes varies between ovaries. To individualise the ovocytes and facilitate their counting, the ovaries were dissected in a detergent solution of 5% Triton X100 diluted in PBS. For each parasitoid strain the number of eggs injected was estimated by calculating the difference between the mean number of eggs in the ovaries of females which had not oviposited and the mean number of eggs in the ovaries of females which had oviposited once.

Comparison of *CrV1* and *Cystatin* gene expression in host after parasitism

The quantification cycle (Cq) values were determined based on the single threshold mode. All negative controls had a Cq of 0. The mean Cq standard deviation observed between duplicates was 0.080. The stability of the reference genes was checked with Bestkeeper software (Pfaffl et al., 2004). The differences between the *CrV1* and *Cystatin* transcript concentrations were determined using the $\Delta\Delta Cq$ method [ABI User Bulletin #2 (11-15)].

Data analysis

The experiments were conducted using a completely randomized design. For each treatment each parasitized caterpillar was considered as a replicate. The number of viable offspring, the pupal mortality, the sex ratio, the number of ovocytes in ovaries and gene expression were compared using one or two-way ANOVA followed by Student-Newman-Keul's (SNK) multiple range test when P-value was significant ($P < 0.05$). Before analysis the pupal mortality and sex ratio data were arc-sine square root transformed. The proportion of larvae that produced cocoons, pupated or died were compared using a chi-square test or Fisher-exact test (when sample size are less than 5) followed by multiple comparison test with BH (Benjamini–Hochberg) correction when P-value was significant ($P < 0.05$). All statistical analysis were performed using R Software (R Core Team, 2016) with *fifer*, *NCStats*, *dunn.test* and *agricolae* additional packages.

Results

Experiment one: Larvae exposed in maize

Parasitism success

Parasitism success, estimated as the percentage of host larvae that produced a cocoon mass, ranged from 55 to 76% without significant difference between parasitoid strains and host strains (Table 1). A slight but not significant effect of the parasitoid strain was observed in the French host strain, in which Kobodo and Makindu parasitoid strains exhibited respectively the highest and the lowest success, although they had equivalent success on the Kenyan host (Table 1).

Table 1: Proportion of exposed larvae in which *C. typhae* cocoons developed. n = number of exposed larvae.

<i>C. typhae</i> strain	Host strain	
	French	Kenyan
Kisumu-Rabuor	74 % n=38	59 % n=37
Kobodo	76 % n=38	73 % n=37
Luanda	64 % n=50	74 % n=50
Makindu	55 % n=69	74 % n=58
	Pearson's χ^2 $\chi^2_{3df} = 6.4$; P = 0.09	Pearson's χ^2 $\chi^2_{3df} = 2.95$; P = 0.40

Offspring traits

A first analysis across all parasitoid and host strains revealed that the number of viable offspring varied significantly between mated and unmated females (Wilcoxon sign & rank, $P < 0.001$), with unmated females (i.e. 0 to 17% of the females tested) producing more offspring (100.1 ± 9.0) than mated ones (63.1 ± 1.8). Thus, to prevent bias, only offspring from mated females were considered in the following analyses. Pupal mortalities were below 15% in each treatment. Viable offspring numbers ranged from about 50 to 75 individuals and were female-biased in most cases (Table 2). These three traits varied significantly with *C. typhae* strains but not among host strains. Therefore, for each parasitoid strain, the data from both host strains were pooled for pairwise comparisons. For viable offspring number and sex ratio, pairwise comparisons between *C. typhae* strains (regardless of host strains) showed that the Kobodo strain differed significantly from the other ones; it yielded the highest viable offspring number and the lowest sex ratio (Table 2).

In this experiment, parasitic wasps were individually placed in the presence of one host larva. Because parasitism was not monitored, some females may have performed more than one oviposition or may have not oviposited, which introduced uncontrolled variability. To avoid this, wasps were allowed only a single oviposition in the next experiment. With the aim of developing a biological control program in France, we were primarily interested in the factors of reproductive success on the French host. We therefore focused on the *C. typhae* strains differing the most on this host over the four studied traits (Tables 1, 2), i.e. those from Kobodo and Makindu. To initiate a genetic study of inheritance of these factors we crossed these two strains.

Table 2: Pupal mortality, viable offspring number and sex ratio of four *C. typhae* strains on the French and on the Kenyan host. Means within a column followed by the same letter are not significantly different at $P < 0.05$ (Student-Newman-Keul's test). n = number of cocoon mass.

<i>C. typhae</i> strain	Host strain	n	pupal mortality (%) (mean \pm SE)		viable offspring number (mean \pm SE)		sex ratio (mean \pm SE)	
Kisumu-Rabuor	French	25	7.8 \pm 2.0	ab	57.6 \pm 5.2	b	0.78 \pm 0.03	a
	Kenyan	21	12.0 \pm 3.3		49.7 \pm 4.3		0.77 \pm 0.03	
Kobodo	French	23	4.0 \pm 1.1	b	73.0 \pm 3.7	a	0.69 \pm 0.05	b
	Kenyan	21	5.8 \pm 0.9		75.4 \pm 5.7		0.68 \pm 0.06	
Luanda	French	30	6.3 \pm 1.5	ab	70.0 \pm 4.6	b	0.82 \pm 0.02	a
	Kenyan	29	11.9 \pm 2.8		57.0 \pm 4.4		0.75 \pm 0.04	
Makindu	French	34	12.9 \pm 2.5	a	65.1 \pm 5.5	b	0.82 \pm 0.02	a
	Kenyan	41	13.4 \pm 2.4		59.0 \pm 4.2		0.78 \pm 0.03	
Two-Way ANOVA			<i>C. typhae</i> strain :		<i>C. typhae</i> strain :		<i>C. typhae</i> strain :	
			$F_{3,216} = 3.640$		$F_{3,216} = 4.315$		$F_{3,216} = 3.220$	
			P = 0.003**		P = 0.006**		P = 0.024*	
			Host strain :		Host strain :		Host strain :	
$F_{1,216} = 4.782$		$F_{1,216} = 3.358$		$F_{1,216} = 1.581$				
P = 0.058		P = 0.068		P = 0.210				
interaction :		interaction :		interaction :				
$F_{3,216} = 0.335$		$F_{3,216} = 0.693$		$F_{3,216} = 0.294$				
P = 0.614		P = 0.557		P = 0.830				

In this experiment, parasitic wasps were individually placed in the presence of one host larva. Because parasitism was not monitored, some females may have performed more than one oviposition or may have not oviposited, which introduced uncontrolled variability. To avoid this, wasps were allowed only a single oviposition in the next experiment. With the aim of developing a biological control program in France, we were primarily interested in the factors of reproductive success on the French host. We therefore focused on the *C. typhae* strains differing the most on this host over the four studied traits (Tables 1, 2), i.e. those from Kobodo and Makindu. To initiate a genetic study of inheritance of these factors we crossed these two strains.

Experiment two: Larvae exposed “naked”

Parasitism success

The proportion of hosts successfully parasitized differed significantly between Kobodo and Makindu strains, with 79 and 36% parasitism, respectively. In the Makindu strain more than 50% of the parasitized hosts pupated. Hybrids strains whatever the cross direction, had a phenotype similar to Kobodo parental strain with a high parasitism success (~80%) (Fig. 1).

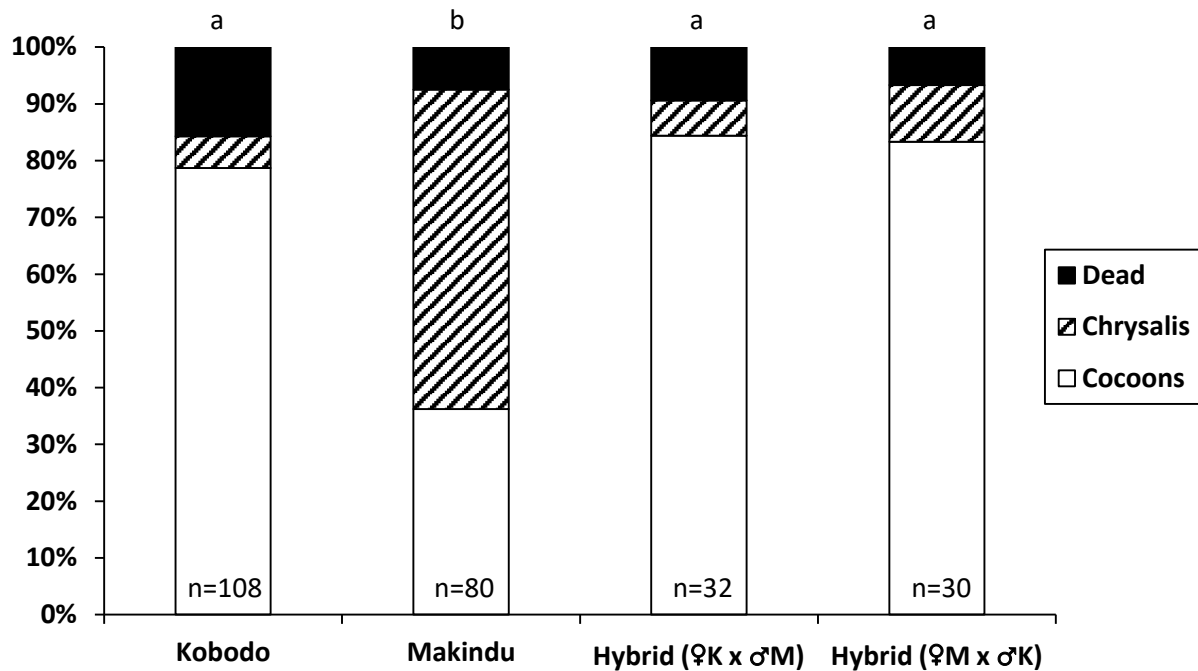

Fig. 1: Fate of the French host exposed to Makindu, Kobodo and hybrids strains. Cocoons, Chrysalis and Dead corresponded to the proportion of hosts that produced cocoons, pupated or died after parasitism. Conditions with the same letter are not significantly different at $P < 0.05$ (Fisher's multiple comparison test). n = number of exposed larvae.

Offspring traits

Like in the first experiment, only mated females were kept to estimate and analyse offspring traits because a significant difference in viable offspring number was found between mated and unmated females (Wilcoxon sign & rank, $P < 0.002$, unmated females representing 0 to 14 % of the samples). Pupal mortality was rather low, ranging from 4 to 11% of cocoons within a mass. No significant difference was observed between *C. typhae* strains when compared pairwise, although the ANOVA indicated a significant in the overall comparison (Table 3). Kobodo mothers produced about twice more viable offspring than Makindu ones. The numbers of viable offspring did not differ between Kobodo and hybrids with a Makindu mother but it differed significantly between Kobodo and hybrids with a Kobodo mother. There was a significant difference in viable offspring number between the two hybrids strains. A female biased sex ratio was observed for Kobodo, Makindu, and hybrids with a Kobodo mother but not for hybrids with a Makindu mother, for which sex ratio was balanced. A single significant difference was only found between Makindu and hybrid with a Makindu mother (Table 3).

With the exception of the viable offspring number for the Makindu strain, observations of parental offspring traits were similar in this experiment and the previous one. However, the differences in pupal mortality and sex ratio were not significant. To attempt to understand the differences in parasitism success and viable offspring number between Kobodo and Makindu strains, females which had or not oviposited were dissected and virulence gene expression in host after parasitism was assessed.

Table 3: Pupal mortality, viable offspring number and sex ratio of Makindu, Kobodo and hybrids strains in the French host. Means within a column followed by the same letter are not significantly different at $P < 0.05$ (SNK test). n = number of cocoon masses.

<i>C. typhae</i> strain	Host strain	n	pupal mortality (%) (mean \pm SE)		viable offspring number (mean \pm SE)		sex ratio (mean \pm SE)	
Kobodo	French	71	4.0 \pm 1.1	a	68.7 \pm 2.8	b	0.69 \pm 0.02	ab
Makindu	French	21	11.0 \pm 3.0	a	33.1 \pm 3.3	c	0.75 \pm 0.04	a
Hybrid (♀K x ♂M)	French	24	6.3 \pm 2.5	a	93.3 \pm 5.4	a	0.64 \pm 0.07	ab
Hybrid (♀M x ♂K)	French	25	4.4 \pm 0.8	a	76.0 \pm 4.0	b	0.50 \pm 0.08	b
One-Way ANOVA			$F_{3,137} = 2.695$ $P = 0.048^*$		$F_{3,137} = 25.18$ $P < 0.001^{***}$		$F_{3,137} = 3.287$ $P = 0.023^*$	

With the exception of the viable offspring number for the Makindu strain, observations of parental offspring traits were similar in this experiment and the previous one. However, the differences in pupal mortality and sex ratio were not significant. To attempt to understand the differences in parasitism success and viable offspring number between Kobodo and Makindu strains, females which had or not oviposited were dissected and virulence gene expression in host after parasitism was assessed.

Ovocytes in ovaries

The initial number of ovocytes in the ovaries before oviposition was not significantly different between Kobodo and Makindu strains (Table 4). However, a significant difference was observed after oviposition, with Kobodo females having fewer eggs remaining in their ovaries than Makindu females. Based on these results, the predicted number of eggs injected by Kobodo females was more than four times higher than that of Makindu females (Table 4).

Table 4: Number of ovocytes in ovaries before and after oviposition in the French host. Means followed by the same letter are not significantly different at $P < 0.05$ (SNK test). n = number of females dissected.

<i>C. typhae</i> strain	oviposition	n	number of ovocytes in ovaries (mean \pm SE)	predicted number of eggs injected
Kobodo	no	40	205.9 \pm 4.2 a	139.2
	yes	20	66.7 \pm 7.0 c	
Makindu	no	43	213.3 \pm 6.7 a	31.3
	yes	18	182.0 \pm 4.0 b	
Two-Way ANOVA			$C. typhae$ strain : $F_{1,117} = 182.42$; $P < 0.001^{***}$ oviposition : $F_{1,117} = 45.91$; $P < 0.001^{***}$ interaction : $F_{1,117} = 67.63$; $P < 0.001^{***}$	

Virulence genes expression

The *C. typhae* strain had a significant effect on *Cystatin* ($P < 0.001^{***}$) and *CrV1* ($P = 0.007^{**}$) expression levels in the host larva, 24h after parasitism. A similar pattern was observed for both genes. Kobodo *CrV1* and *Cystatin* expressions levels were about 3.5-fold and 13.5-fold higher respectively than observed for Makindu. *CrV1* and *Cystatin* expression levels induced by hybrid females, whatever the cross direction, were similar to those induced by Kobodo females and significantly different from those induced by Makindu (Fig. 2a, b).

The higher expression of both virulence genes after parasitism by Kobodo and hybrid wasps matched their higher chances of larval development and their larger viable offspring numbers as a result of a higher number of eggs injected compared to the Makindu strain suggesting that all these traits could be correlated. To test this hypothesis, the egg laying was artificially reduced in the Kobodo strain in order to decrease the progeny size and study its effect on the other traits.

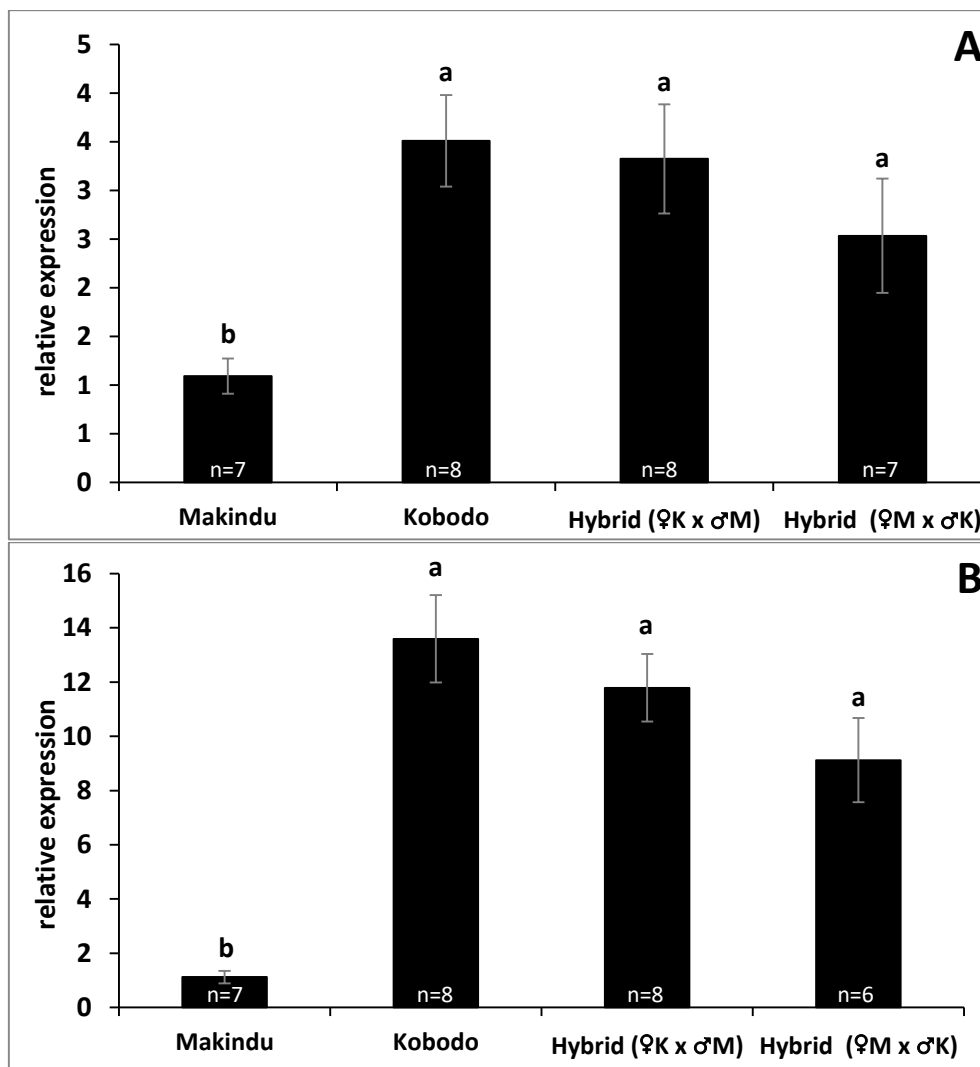

Fig. 2: Expression of *CrV1* (a) and *Cystatin* (b) virulence genes in the French host fat body 24h post-parasitization. For each gene, values were normalized to the Makindu value. Conditions with the same letter are not significantly different at $P < 0.05$ (SNK test).

Experiment three: Interruption of oviposition

The 7 to 20 % of unmated females were not considered in the analyses. The interruptions of oviposition after 1 or 3 seconds decreased significantly the viable offspring number by half, but there no significant differences between the 1 and 3 seconds treatment (Fig. 3a) A similar pattern was observed for the expression of *CrV1* and *Cystatin* genes in the host (Fig. 3c, d). By contrast, parasitism success significantly decreased only in the 1 second treatment (Fig. 3b).

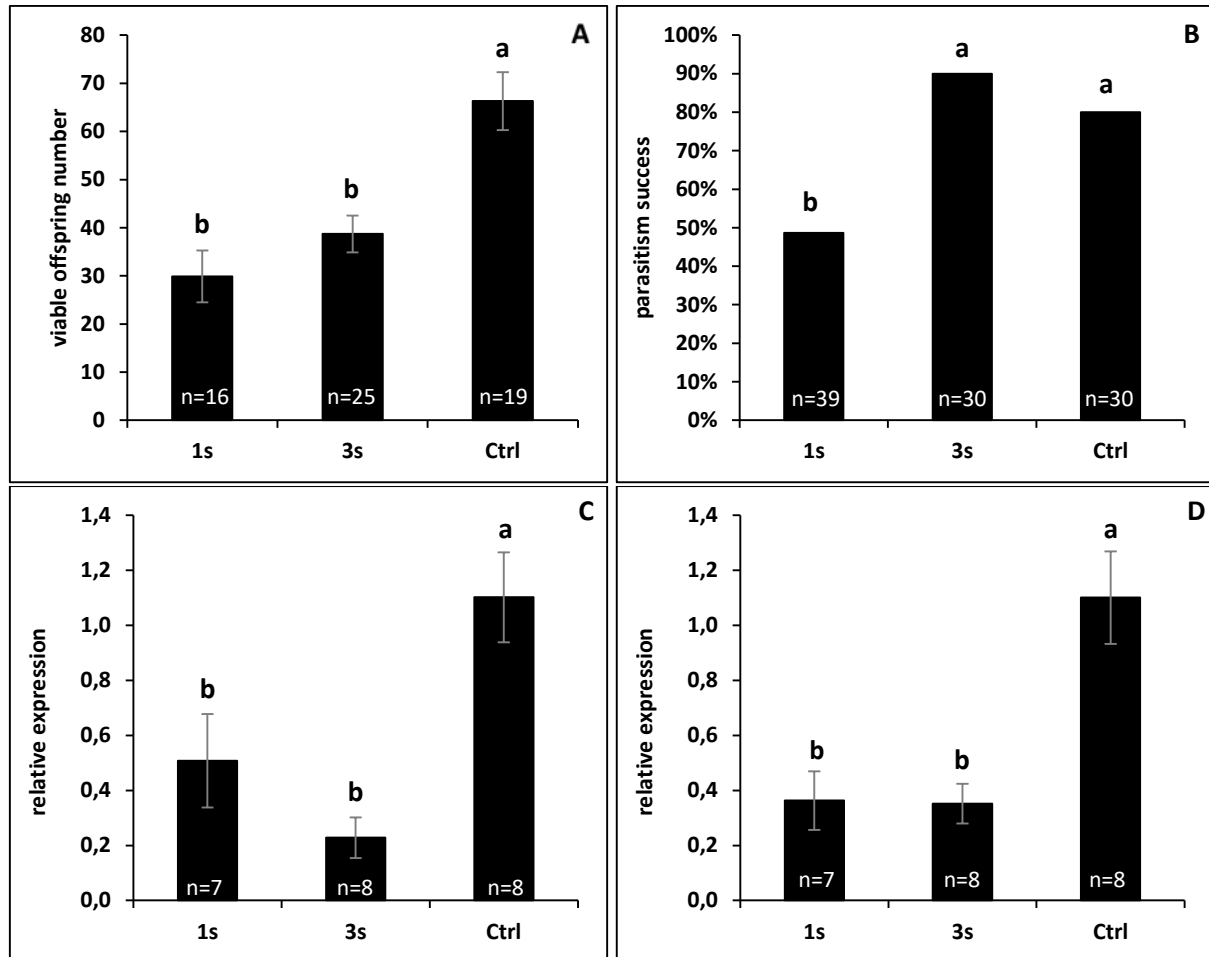

Fig. 3: Effects of oviposition interruption on the viable offspring number (a), the parasitism success (b), the expression of *CrV1* gene (c) and of *Cystatin* gene (d) in the French host after parasitism. Ctrl, 1s and 3s corresponded to females which oviposited without interruption or which oviposited with interruption after 1 or 3 seconds. Conditions with the same letter are not significantly different at $P < 0.05$ (SNK test).

Discussion

The object of this study was to investigate the ability of *C. typhae* to reproduce in a French population of *S. nonagrioides*, which represents a new host population. All *C. typhae* strains used were able to reproduce in this new host population. Among these strains, the Kobodo and Makindu ones showed significant variations for several life history traits and were therefore selected for ongoing study.

Both the parasitism success and the virulence gene expression profiles were similar between hybrids and Kobodo, whatever the cross direction. This strongly suggests the dominance of Kobodo alleles. The determinism seems more complex for the viable offspring number as one hybrid (Makindu mother) was similar to Kobodo strain while the other one (Kobodo mother) shows the highest mean number. This may have been the result of both maternal effects and of dominance or superdominance. These relationships have to be confirmed with larger sample sizes. Moreover, the genetic transmissions of these traits have to be more thoroughly analysed in future experiments through the segregation of F2 progeny.

Focusing on parental strain divergences, two hypotheses are put forward to explain the differences in viable offspring number observed between Kobodo and Makindu strains: (i) Kobodo females injected more eggs in the host than Makindu females and/or (ii) Makindu larvae poorly survived in the host compared to Kobodo. Ovary dissections indicated that Kobodo females injected four times more eggs than Makindu females. Survival percentage estimated by dividing viable offspring numbers by the predicted number of eggs injected was 49.4 % for Kobodo and 105.8% for Makindu. Thus, the difference of viable offspring number does not result from lowest survival rate of Makindu larvae but rather from a lower number of eggs injected in the host by the Makindu strain.

The Makindu survival percentage, slightly superior to 100% was probably the result of an overestimation of the viable offspring number. If a minimal number of eggs laid is required to ensure parasitism success, then only females laying enough eggs would be considered for the estimation of viable offspring number, whereas any females have been considered to estimate the number of eggs laid.

The low survival rate of the Kobodo strain suggests that competition between larvae occurred in hosts parasitized by Kobodo females due to a limitation of the available resources. Conversely, this phenomenon seems to be absent in hosts parasitized by Makindu females, which lay far fewer eggs. It can thus be concluded that a larger number of eggs injected induce a higher competition and therefore a lower survival rate. The progeny size appears therefore to be limited by the carrying capacity of the host, which was, strongly exceeded with the Kobodo strain. Experiments of oviposition interruption are particularly interesting in that perspective: if fewer eggs are injected then a lower competition between larvae is expected. Parasitoids are good models for the study of competition because larvae develop only in/on a single host, which represents a resource of limited size. To date, there are few studies examining the intraspecific competition between gregarious parasitoid species. The majority of studies focus on interspecific competition, especially between solitary parasitoid larvae. Unlike solitary larvae, gregarious parasitoid larvae do not possess fighting mandibles so competition is normally restricted to exploitation of host resources (Godfray, 1994). In that sense, Pexton et al. (2009) dissected hosts double-stung by *C. flavipes* and they did not find wounded or destroyed larvae although competition had been proven to occur. This kind of competition is therefore expected for *C. typhae*.

The number of viable offspring was higher for unmated females than for mated ones, which has never been observed for a *Cotesia* genus. In parasitic wasps, females open their spermatheca during oviposition to fertilize their egg (Godfray, 1994). Thus, unmated females could inject eggs immediately as they do not have to control fecundation. On the other hand, different larval mortalities between

sexes were observed in various gregarious parasitoid species (Van Baaren et al., 1999), which supports potential difference in survival rate in *C. typhae*. Unfortunately, with the experiment used it cannot be determined if the higher number of offspring was due to a higher number of eggs injected or higher survival, and, moreover, the mating status of dissected females was not known.

Since *C. typhae* is a pro-ovigenic species, no oocytes are produced after the emergence and the ovarian egg-load represents the total potential fecundity. Both Kobodo and Makindu females produced around 210 oocytes. This is consistent with the potential fecundity found for other species of the *C. flavipes* complex, which ranged from 150-200 for *C. flavipes* (Potting et al., 1997; Sallam et al., 2002) and *C. nonagriæ* (Muirhead et al., 2010), but only from 120-140 for *C. sesamiae* (Sallam et al., 2002) and *C. chilonis* (Okech and Overholt, 1996). For pro-ovogenic species, increasing the oocyte production would divert resources from other important life-history traits. So for these species it is important to optimise oocyte production to ensure that most of the eggs produced will be laid (Gandon et al., 2009). Despite having the same potential fecundity, the number of eggs injected by Kobodo and Makindu females in the host was very different. Makindu females injected only ~30 eggs compared to ~140 eggs by Kobodo females, which represent, respectively 15 % and 68% of their potential fecundity. To realise their potential fecundity Makindu females should perform at least seven ovipositions, assuming that the number of eggs allocated for each oviposition is constant. Conversely Kobodo females cannot perform a second oviposition equivalent to the first one. This suggests that Kobodo and Makindu strains should have different oviposition strategies. Whereby Makindu females would distribute their eggs more or less equally in several hosts Kobodo females inject the majority of their eggs in the first host encountered. By comparison, *C. nonagriæ* lays more than half of its eggs in the first host (Muirhead et al., 2010), just like Kobodo females, while *C. flavipes* allocate 20-25 % of its eggs in each host (Potting et al., 1997). This suggests that the oviposition behaviour evolved differently between the species in the *C. flavipes* complex. Environmental pressure may explain such differences through selective divergence. Indeed, if the probability to meet several hosts is low, females should benefit by laying most of their eggs in the first host encountered. By contrast, if local host availability is high, eggs distribution among several hosts should maximise female reproductive success, especially if larval competition is high. Many factors such as host density, adult dispersion and lifespan can limit the number of hosts encountered. It will be interesting to identify the selective pressures responsible for the difference in oviposition behaviour between Kobodo and Makindu females.

On the French host, the comparison of the two *C. typhae* strains and their hybrids showed that the expression levels of two virulence genes, *CrV1* and *Cystatin*, varied with parasitism success, which is in agreement with the known involvement of these genes in the inactivation of the host immune response (Edson et al., 1981; Glatz et al., 2004). The low parasitism success of Makindu strain in this new host could be explained by an insufficient induction of virulence gene expression. The French host appears to be more resistant to parasitism than the Kenyan one as demonstrated by the differences in parasitism success on the two hosts.

This strain has been shown to inject more eggs in a single oviposition than Makindu. It may also inject more viral particles, which would explain its higher virulence gene expression and hence its higher parasitism success in the French host. Indeed, in Braconidae wasps mature eggs are stored in the calyx fluid which consists mostly of PDV viral particles. During oviposition, calyx fluid and eggs are introduced through the ovipositor into the body of host insects (Webb, 1998; Wyler and Lanzrein, 2003). Thus it can be expected that the number of viral particles injected is correlated with the number of eggs. If true, it is expected that a minimal number of eggs laid is required to inactivate the host immune system and to ensure parasitism success. In addition, all virulence genes must be more expressed in host after parasitism by Kobodo females than by Makindu females.

The viable offspring number and the expression level of virulence genes in the host increased with the duration of oviposition. Despite the viable offspring number is not the direct measure of the number

of injected eggs, both variables are linked. Therefore, this observation supports our assumption that the amount viral particles increased with the number of eggs injected. However, the relationship is not that clear with parasitism success. While it was obviously reduced when oviposition was interrupted after 1 second, no reduction was observed between the control and 3 seconds treatment. Thus other factors than virulence gene expression play a role to ensure successful parasitism. Venom and teratocytes for example have been shown to also inactivate the host immune response (Asgari and Rivers, 2011; Strand, 2014). Although the expression levels of *CrV1* and *Cystatin* did not vary between 1 and 3 seconds, the quantity of venom injected may be different and could explain the difference of parasitism success.

Conclusion

This study shows that a differentiation of life history traits occurred between geographical different strains of *C. typhae* and particularly between two of them, from Kobodo and Makindu Kenyan locations. This differentiation confers to Kobodo strain a higher parasitism success on a new host population, linked to a higher number of eggs injected and a higher expression of virulence genes in the host. Identification of genes responsible for this differentiation is ongoing, with a quantitative trait loci (QTL) analysis. Furthermore, the assessment of the factors involved in reproductive success is being pursued. A better understanding of mechanisms that drive host adaptation will help to select strains of *C. typhae* for their use in biological control programs.

Acknowledgements

This project was supported by the ANR Bioadapt (ABC Papogen project), and by the authors' operating grants from IRD, CNRS, and icipe. It was realized under the juridical frame of a Material Transfer Agreement signed between IRD, icipe and CNRS (CNRS 072057/IRD 302227/00) and the authorization to import *Cotesia* in France delivered by the DRIAAF of Ile de France (IDF 2017-OI-26-032). We thank Odile Giraudier, Gerphas Ogola and Sylvie Nortier for insect rearing at Gif and the icipe, Boaz Musyoka for field collection, Lionel Saunois, Amandine Dubois and Virginie Héraudet for maize production, Beatrice Denis and the undergraduate students Florian Decourcelle and Maxime Villoing for their contribution to oviposition interruption experiments, and Fritz Schulthess for critical reading of the manuscript and his corrections to the English.

II) Article n°2: Role of egg-laying behavior, virulence and local adaptation in a parasitoid's chances of reproducing in a new host

Dans le premier article, nous avons mis en évidence que les femelles *C. typhae* Kobodo injectent plus d'œufs dans le premier hôte rencontré que les femelles Makindu, et émis l'hypothèse que la différence de succès de parasitisme observée entre ces souches sur la population française de *S. nonagrioides* pourrait s'expliquer par cette différence. Cette hypothèse repose sur l'idée que la quantité de particules virales serait corrélée à la quantité d'œufs injectés, du fait que les deux sont injectés en même temps dans l'hôte lors de la ponte. Ainsi les femelles Kobodo devraient injecter plus de particules virales, ce qui expliquerait la plus forte expression des deux gènes viraux mesurés et la différence de succès de parasitisme.

Pour tester cette hypothèse nous avons cette fois-ci mesuré la quantité d'œufs et de particules virales injectés dans l'hôte par les deux souches et également leur succès de parasitisme lors de pontes successives. Nos résultats montrent que contrairement à l'hypothèse émise précédemment la quantité de particules virales injectées n'explique pas la différence de succès de parasitisme et n'est pas directement proportionnelle à la quantité d'œufs injectés. Au cours de ces expériences de pontes successives, nous avons pu mieux caractériser la stratégie de ponte des deux souches et mesurer d'autres traits d'histoire de vie impliqués dans le succès reproducteur (nombre de descendants et sexe-ratio). Contrairement aux femelles de la souche Kobodo qui injectent la majorité de leurs œufs dans le premier hôte rencontré, les femelles de la souche Makindu les distribuent plus équitablement entre différents hôtes.

Afin de comprendre pourquoi d'un point de vue évolutif les femelles de la souche Kobodo arrivent à parasiter efficacement la population française de *S. nonagrioides* alors que celles de la souche Makindu n'y arrivent que très partiellement, nous avons également mesuré le succès de parasitisme des deux souches sur leurs hôtes naturels. Ces données indiquent que les femelles de la souche Kobodo parasitent efficacement tous les hôtes présentés (*S. nonagrioides* française, de Kobodo et de Makindu) alors que les femelles de la souche Makindu parasitent efficacement uniquement leur hôte local. Ce résultat suggère que la préadaptation de la souche Kobodo à la population française de *S. nonagrioides* pourrait être due à son adaptation à son hôte local potentiellement plus résistant que celui de Makindu.

Role of egg-laying behavior, virulence and local adaptation in a parasitoid's chances of reproducing in a new host

Benoist R.^a, Paquet S.^a, Decourcelle F.^a, Guez J.^a, Jeannette R.^a, Calatayud P.-A.^{a, b}, Le Ru B.^a, Mougél F.^a and Kaiser L.^{a, *}

¹ Laboratory: Evolution, Génomes, Comportement et Ecologie (CNRS, IRD, Université Paris Sud, Université Paris-Saclay), Campus CNRS, Bat. 13, 12 Avenue de la Terrasse, 91198 Gif-sur-Yvette Cedex

² icipe: International Center of Insect Physiology and Ecology, Dugesi Campus, Kasarani, P. O. Box 30772-00100, Nairobi, Kenya

* Author for correspondence: laure.kaiser-arnaud@eqce.cnrs-gif.fr

Abstract

Understanding the ability of parasitoid insects to succeed in new host populations is a relevant question for biological control and adaptive mechanisms. *Cotesia typhae* is an African parasitoid specialized on the moth *Sesamia nonagrioides*, also called the Mediterranean corn borer. Two Kenyan strains of *C. typhae* differ in their virulence against a new host population from France. We explored behavioral and physiological hypotheses about this differentiation. *Cotesia* genus belongs to a group of Hymenoptera in which females inject a domesticated virus in their host to overcome its resistance. Since viral particles are injected along with eggs and since the strain with the higher virulence injects more eggs, we hypothesized that virulence could be explained by the quantity of virus injected. To test this assumption, we measured the injected quantities of eggs and viral particles (estimated by viral DNA circles) of each parasitoid strain along several ovipositions, to vary these quantities. Unexpectedly, results showed that virulence against the French host was not correlated to the injected quantities of eggs or viral circles, indicating that virulence differentiation is explained by other causes. The virulence against the respective natural hosts of the two *C. typhae* strains was also measured, and results suggest that local adaptation to a more resistant natural host may explain the pre-adaptation of one strain to the new host population. We also identified a differentiation of oviposition strategy and subsequent offspring number between the parasitoid strains, which is important in a biocontrol perspective.

Keywords: Parasitoid, *Cotesia typhae*, polydnavirus, oviposition behavior, virulence, biocontrol

1. Introduction

Co-evolution, which occurs when species have a reciprocal effect on each other's evolution, is one of the major processes explaining biodiversity (Thompson, 1999). According to Thompson, 1994, parasites have a special place in the study of co-evolution because theirs is the most prevalent lifestyle and they exhibit the most extreme degree of specialization to other species. Among parasites, parasitoids are particular. Indeed, parasitoid females lay their eggs in or on another arthropod to ensure the development of their progeny, which results in the death of the host, whereas most parasites do not kill their host. Hence parasitoids are considered as intermediate between parasites and predators (Godfray, 1994).

Parasitoid reproductive success lies on a wide spectrum of adaptations to their host. Notably, it depends on many traits, including virulence, which indicates the ability of the parasitoid to overcome host immune response. In endoparasitoids, which inject their eggs in their host haemocoel, the main host immune defense with which they must comply is the cellular response called encapsulation (Lavine and Strand, 2002; Salt, 1968). To avoid or suppress encapsulation, parasitoids have developed a large arsenal of weapons. The most studied are venoms produced by eponymous glands, teratocytes formed from the membranes that envelop parasitoid eggs and polydnavirus (Asgari and Rivers, 2011; Beckage and Drezen, 2012; Strand, 2014). The latter is a nice example of mutualistic viruses. The polydnaviridae family groups viruses from multiple origins which were domesticated and integrated in several lineages of Ichneumonoidea. Due to their integration into parasitoid genomes, polydnavirus are vertically transmitted (Fleming and Summers, 1991). They are produced in the form of viral particles containing double-stranded DNA circles, in specialized cells of the calyx, a tissue located at the basis of the lateral oviducts (Marti, 2003; Wyler and Lanzrein, 2003). These particles are secreted into the lumen of the lateral oviducts and thus injected in the host with the eggs. After oviposition, viral particles infect host cells where virulence genes carried by DNA circle are expressed. Translated virulence proteins disturb host development and suppress its immune responses, allowing the growth of parasitoid eggs (Beckage and Gelman, 2004; Glatz et al., 2004). Polydnavirus differentiation is involved in the evolution of host range (Herniou et al., 2013), as shown in the *Cotesia* genus member of the Microgastrinae family (Braconidae), which harbors the polydnavirus called Bracovirus (Branca et al., 2017, 2011; Jancek et al., 2013).

Like virulence, oviposition strategy can evolve in response to constraints in developmental resources. This is well illustrated by clutch size evolution, a classical topic in ecology, notably in birds (Lack, 1947). Its study is especially relevant in the case of host-parasitoid interactions where host resource is often variable. Many factors such as host size, host quality, host availability, host previous parasitism, parasitoid egg load or experience can influence clutch size, suggesting that females are able to combine information to adjust it (Godfray, 1994; Ikawa and Okabe, 1985; Pexton and Mayhew, 2005; Quicke, 1997; Rosenheim and Rosen, 1991). Beyond the plasticity of this trait, large numbers of injected eggs could also be adaptive, allowing the parasitoid to overcome host resistance by saturating its immune system (Blumberg and Luck, 1990; Kapranas et al., 2012; Rosenheim and Hongkham, 1996; Salt, 1968). The impact of the number of eggs injected on virulence may be addressed. For that purpose, species showing variation in clutch size among individuals is necessary. Such variation was described for *Cotesia typhae* (Fernández-Triana) (Hymenoptera, Braconidae) between two strains from different geographic origins (Benoist et al., 2017).

C. typhae is a gregarious endoparasitoid specialized on caterpillars of *Sesamia nonagrioides* (Lefèbvre) (Lepidoptera, Noctuidae) and was found in Kenya, Tanzania and Ethiopia (Kaiser et al., 2015). This species is proovigenic, which means that females emerge with an ovarian egg-load corresponding to their total potential fecundity and do not produce any more eggs at the adult stage. Thanks to molecular, ecological and morphological analyses, *C. typhae* was recently distinguished from *Cotesia sesamiae*, a generalist species composed of several populations with different host ranges. Local

adaptation to *S. nonagrioides* appears to be the main factor responsible for the speciation of *C. typhae* (Branca et al., 2011; Kaiser et al., 2015, 2017a, 2017b).

In the context of biological control, it is necessary to understand the factors that drive the adaptation of the natural enemy to the targeted host. *C. typhae* is one of the sister species of *Cotesia flavipes* (Cameron), which is used worldwide for biological control against maize and sugarcane Lepidoptera stemborers (Postali Parra and Coelho, 2019). The strict specificity of *C. typhae* for *S. nonagrioides* makes it a good potential biocontrol agent against this important crop pest (Cordero et al., 1998; Eizaguirre and Fantinou, 2012), currently in expansion in France (Rousseau, 2009).

In Benoist et al., 2017, the reproductive success of several strains of *C. typhae* from Kenya in a French population of *S. nonagrioides* was investigated. Among the strains used, those from Kobodo and Makindu localities were respectively the most and the least virulent against this new host population. Females from the Kobodo strain injected more eggs, despite an equal initial egg load, and induced a higher expression of two virulence genes in the first host encountered, in comparison to Makindu females. Given that viral particles are injected along with eggs and that Kobodo females inject more eggs at a time, it was hypothesized that they may also inject more viral particles in the host, which may explain the difference of virulence genes expression and thus the difference of virulence.

The first objective of the present work is thus to test if the difference in parasitism success results from a difference in the number of viral particles injected, and if this number varies together with the number of eggs injected. More globally, the second objective is to characterize the reproductive potential of the parasitoid strains in a biocontrol perspective. The last objective is to investigate if the better pre-adaptation of the Kobodo strain to the French host may come from local adaptation to a more resistant host population.

For these purposes, Kobodo and Makindu parasitoid females were allowed to oviposit in three successive hosts of the French population. At each oviposition rank, host acceptance, number of eggs injected, parasitism success (used as an estimate of the parasitoid virulence), offspring number and sex-ratio were measured. The relative quantity of viral circles injected was measured at the two first ovipositions (parasitism success collapsed at the third oviposition). Finally, egg-laying behavior, parasitism success and offspring traits of both parasitoid strains were measured on their African sympatric and allopatric host populations.

2. Materials and Methods

2.1 Biological Material

The *C. typhae* strains were established from individuals emerging from parasitized larvae collected in two Kenyan field localities: Kobodo (0.679S, 34.412E; West Kenya; collected in 2013) and Makindu (2.278S, 37.825E; South-East Kenya; collected in 2010-2011), which were used to name the strains. They were reared as isofemale lines at the Evolution, Génome, Comportement et Ecologie (EGCE, Gif-sur-Yvette) laboratory from 2015.

Three strains of *S. nonagrioides* were used as host, one from southwest France and two from Kenya. The founder individuals of the two Kenyan strains originated from Kobodo and Makindu, and the founder individuals of the French strain originated from 3 localities in southwest France: Cudos (44.3897N, -2.2183W), Biarotte (43.5640N, 1.2550W) and Longage (43.3680N, 1.1926E).

2.2 Insect rearing and parasitism

The larvae of *S. nonagrioides* were reared on an artificial diet (adapted from Overholt et al., 1994) at 26°C, ca. 60% relative humidity (RH) under a photoperiod of 16:8 (Light:Dark). Three week old larvae from the Makindu host strain were used for the rearing of *C. typhae*, as both parasitoid strains showed similar high reproductive success on this host population. Larvae intended to be parasitized were retrieved and fed for at least 24 hours with fresh maize stems before parasitism to increase their acceptance by the *C. typhae* female. On the day of parasitism, the host larvae were placed individually under a 2 cm diameter plastic top with one *C. typhae* female until the ovipositor insertion was observed, insuring that each larva was parasitized only once. Parasitized larvae were then placed in a Petri dish with artificial diet at 27°C under rearing condition. Once the parasitoid larvae had emerged from the host and spun their cocoons, each parasitoid cocoon mass, corresponding to one progeny, was placed in a disposable plastic box (500 ml) with honey droplets and a water imbibed cotton wool ball under the same rearing conditions. When adults emerged, temperature was decreased to 24°C and the photoperiod changed to 12:12 to lengthen their life expectancy. In the plastic boxes, siblings were free to mate (mating was not controlled). Females were used for parasitism 1 day after emergence to allow time for mating.

Experiments were conducted in the same conditions as parasitoid rearing. When successive ovipositions were performed, each *C. typhae* female was offered one host larva once a day. This was repeated three times at most (the mean life expectancy of *C. typhae* females is 3 days). Females were one-day old when offered their first host. They were kept individually in a plastic tube (height: 9.5cm, diameter: 2cm) with honey droplets and a piece of water-imbibed cotton wool at 21°C between each host exposure (temperature was decreased to lengthen parasitoid life expectancy).

2.3 Phenotypic traits measure

Several phenotypic traits were measured: host acceptance, number of eggs injected, parasitism success, offspring number, sex-ratio, and the quantity of viral circles injected (see next section for this last trait).

Host acceptance is the proportion of females that accepted to oviposit within 3 minutes of host exposure. In order to avoid counting females twice, a female was not considered for further oviposition if it refused to oviposit once. Parasitism success corresponds to the proportion of stung larvae from which parasitoid larvae emerge. The number of eggs injected at each oviposition rank was deduced from the difference between the mean numbers of eggs in the ovaries of females which had not oviposited or oviposited one, two or three times. The ovaries dissection protocol is available in Benoist et al., 2017. The offspring number corresponds to the total number of parasitoid larvae that emerged from one host larva (one progeny). The mean offspring number was estimated only from mixed-sex

progenies. Indeed, in haplo-diploid insects like *Cotesia*, unmated females give all-male progeny and in *C. typhae* offspring number varied significantly between mated and unmated females (Benoist et al., 2017). Similarly, sex-ratio was estimated only on mixed-sex progenies. The sex-ratio of *C. typhae* can be determined only at adult stage, so progenies with more than 20 % of larval mortality (cases where larvae died inside cocoons due to rearing conditions) were not taken into account for the estimation of sex-ratio.

2.4 Comparison of the quantity of viral circles injected in the host

To compare the quantity of viral circles injected in the French host between each treatment (*C. typhae* strain x oviposition rank) we developed a relative qPCR assay. The *S. nonagrioides* larvae were weighed before parasitism. Only larvae with a weight comprised between 260 and 290 mg were kept to ensure that the quantities of hemolymph retrieved were homogeneous between samples. The larvae were dissected 2h post-parasitism. They were anesthetized by cold exposure (-20°C) for 20 minutes. Pro and true legs were cut to collect as much hemolymph as possible. Hemolymph samples were stored at -20°C until DNA extraction. Before DNA extraction, PBS (Phosphate-Buffered Saline) was added to samples to a final volume of 200 µl. DNA extractions were performed with the NucleoSpin Tissue kit (Macherey-Nagel) following the manufacturer protocol. A RNase (DNase free, Roche) treatment (20 min, 37°C) was included.

In *Cotesia congregata* and *Cotesia vestalis*, the bracovirus is organized in 35 viral circles (Jancek et al., 2013). A similar number is expected in *C. typhae*. We decided to quantify 15 viral circles, representing about half the putative circle number. The circle-specific primer pairs were designed for qPCR, based on the sequence of *C. sesamiae* Kitale bracovirus segments published in Jancek et al., 2013 and available in GenBank (accession numbers: HF562906 to HF562931). The *S. nonagrioides* ribosomal protein gene *rps3* and mitochondrial gene *col* were used as references for normalization. The primers' efficiencies were calculated using a calibration curve with four 5-fold successive dilution points using a pool of DNA samples and were close to 100%. The primer sequences are presented in Table 1. PCR reactions were run on a CFX96 (Bio-Rad) in 10 µl comprising: 2.4 µl of water, 5 µl of 2X FastStart Universal SYBR Green Master (Roche), 0.3 µM of each primer, and 2 µl of sample DNA (3 µg/µl). A negative control was included for each primer pair and all samples were amplified in duplicate. The amplification protocol was the same for all primer pairs: 10 min of denaturation at 95°C, followed by 45 cycles of 10 sec of denaturation at 95°C and 30 sec of annealing/elongation at 60°C followed by a melting curve step.

For each primer pair a single peak was observed for all melting curves, indicating specificity and homogeneity of the amplifications. A single threshold mode was used to determine the quantification cycle (C_q) values. If the maximum C_q standard deviation observed between duplicates was higher than 0.4 then the samples were removed. Relative quantities of viral circles were compared using the $\Delta\Delta C_q$ method [ABI User Bulletin #2 (11-15)].

2.5 Data analysis

All statistical analyses were performed using R Software (R Core Team, 2018) with *agricolae*, *fifer* and *emmeans* additional packages. The significance threshold was set at 0.05 p-value. Except for the viral circles' relative quantities, all phenotypic traits were analysed using generalized linear model (GLM) to test the effect of each factor (*C. typhae* strain, oviposition/presentation rank, *S. nonagrioides* strain). The error family used in GLM was: binomial for the acceptance and the parasitism success; quasi-poisson for the number of eggs remaining in ovaries and the offspring number; quasi-binomial for the sex-ratio. When a significant effect was observed, a multiple comparison using Tukey's HSD test was performed on the GLM data. The viral circles' relative quantities were analysed using the Kruskal-Wallis test, followed by multiple comparison with Holm correction.

Table 1: Sequence of the circle-specific and reference genes primers used for qPCR. The circle numbers correspond to those from *Cotesia sesamiae* Kitale in Jancek et al., 2013.

Target	Orientation	Sequence
Circle 1	Forward	5'-ACGGAAGCACAGAAAGAACCT-3'
	Reverse	5'-ACCGAAGCTTTCAGGACACA-3'
Circle 2	Forward	5'-GTTTCGGGTGCGTTTCTGTC-3'
	Reverse	5'-ACTTTGCCATCACGCGTTTG-3'
Circle 4	Forward	5'-TCCGCTGCTGTCTCACTTTT-3'
	Reverse	5'-GCCGGGTCCAATTGTTGTTCC-3'
Circle 13	Forward	5'-AGAACCGATTTGCTCCCCTT-3'
	Reverse	5'-ACTGCTTTCTAGGTGCTTCAGA-3'
Circle 14	Forward	5'-AGCGTAGTTGATGGCGTTCA-3'
	Reverse	5'-TGCTTCTGAATATGGGCGC-3'
Circle 24	Forward	5'-TCGTCGTAAGCTTTCGGAA-3'
	Reverse	5'-CCGATCTCACTTGCGAACCT-3'
Circle 26	Forward	5'-TTGATGAGGGAGACGGGGAT-3'
	Reverse	5'-CCCAGGTGTCTTCTATCGGC-3'
Circle 28	Forward	5'-CGCAGGGTATGAAGAGTCCG-3'
	Reverse	5'-ACAACAGAGAGTCGACCAGC-3'
Circle 30	Forward	5'-CCAGGCTGCTGAACCAAAAC-3'
	Reverse	5'-AGCGTCCTGTGGCATAGAAA-3'
Circle 32	Forward	5'-GCGATTTAGCGTGCCAAGAC-3'
	Reverse	5'-TGACGTCAAGCAGCGAAAAG-3'
Circle 33	Forward	5'-CCCACACTCATTTACCTCCA-3'
	Reverse	5'-GTTCTTACCAGTCGAGCCGG-3'
Circle 35	Forward	5'-TGTACGTCCCAGTAGCACCT-3'
	Reverse	5'-GGAGTGGGAAGAATCTGCCCC-3'
COI	Forward	5'-GGAGCCCCAGATATAGCATTTCC-3'
	Reverse	5'-TCATCCTGTTCCAGCCCCAT-3'
RPS3	Forward	5'-GGGAGCTTGCTGAAGATGGC-3'
	Reverse	5'-AGACTGCTCGGGGATGTTGA-3'

3. Results

3.1 Reproductive success in new host population and correlation between oviposition behavior and virulence

To study the reproductive strategy and the mechanisms behind the parasitism success, females from Kobodo and Makindu *C. typhae* strains were allowed to oviposit several times in the French host. Different phenotypic traits were measured at each oviposition rank.

3.1.1 Host acceptance

Overall, host acceptance varied significantly with the presentation rank (p -value = 5.947×10^{-14}) but not between *C. typhae* strains (p -value = 0.085). Almost all females (>90%) accepted to oviposit at the first host presentation (Table 2). At the second host presentation, the acceptance dropped significantly to around 65 % for both strains. At the third host presentation a significant difference was observed between the two strains. Indeed, while the host acceptance by Kobodo parasitoid did not differ between second and third presentations, host acceptance by Makindu females increased to 78.5 %.

Table 2: French host acceptance by *C. typhae* parasitoid strains. n = number of *C. typhae* tested females. Conditions with the same letter are not significantly different (p -value > 0.05, Tukey's HSD test following binomial GLM).

Presentation rank	<i>C. typhae</i> strain	Host acceptance		
		% accepted	n	Statistical test
First host	Kobodo	91.10	123	ab
	Makindu	94.60	111	a
Second host	Kobodo	64.00	114	c
	Makindu	66.10	115	c
Third host	Kobodo	62.30	61	c
	Makindu	78.46	65	b

3.1.2 Number of eggs injected

Fecundities of the two *C. typhae* strains were not significantly different: females from Kobodo and Makindu strains produced around 200 ovocytes (Table 3). However, the parasitoid strain had a significant effect on the dynamic of egg depletion (p -values = 0.027). At the first oviposition Kobodo females injected around 110 eggs, when Makindu females injected around 72 eggs representing respectively 56% and 34 % of their egg load (Fig. 1). At the second oviposition, the number of eggs injected was reduced by more than half for Kobodo females, whereas only an 11% decrease was observed for Makindu ones. Hence, the number of eggs injected was almost similar for the two strains, around 50-65 eggs. At the third oviposition, Makindu females injected three times more eggs (around 26) than Kobodo ones. This highlighted a difference of oviposition behavior between Kobodo and Makindu females, Kobodo females injecting most eggs in the first host while Makindu females allocated their eggs more equitably along successive ovipositions (Table 3, Figure 1). Despite these different allocation dynamics, the cumulated predicted number of eggs injected was similar between Kobodo and Makindu: Kobodo=167.87; Makindu=162.36.

Table 3: Number of remaining ovocytes in ovaries after each oviposition rank of *C. typhae* parasitoid strains in the French host. n = number of females dissected; se = standard error. Conditions with the same letter are not significantly different (p-value > 0.05, Tukey’s HSD test following quasi-poisson GLM).

Oviposition rank	<i>C. typhae</i> strain	Number of ovocytes in ovaries			Statistical test
		mean	se	n	
No oviposition	Kobodo	194.57	± 3.17	116	a
	Makindu	212.27	± 6.58	44	a
First oviposition	Kobodo	84.91	± 4.3	46	c
	Makindu	139.85	± 4.18	71	b
Second oviposition	Kobodo	34.9	± 2.48	52	e
	Makindu	75.67	± 5.05	36	c
Third oviposition	Kobodo	26.7	± 2.36	38	e
	Makindu	49.91	± 2.97	47	d

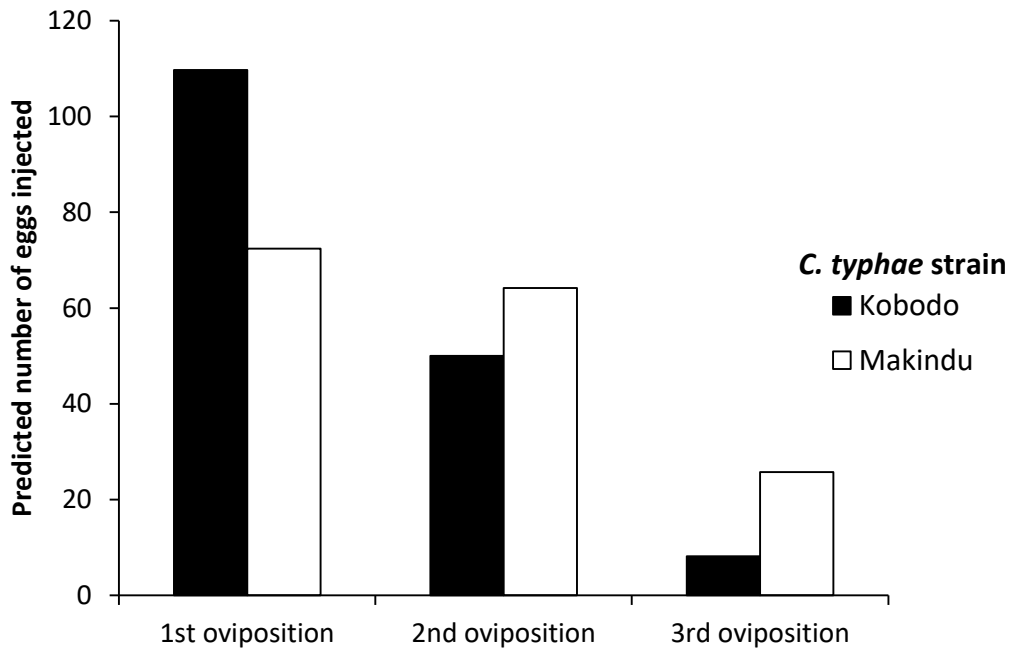

Figure 1: Predicted number of eggs injected at each oviposition rank by *C. typhae* parasitoid strains in the French host. The number of eggs injected is deduced from the difference between the mean numbers of eggs in the ovaries before oviposition or after one, two or three ovipositions (Table 3).

3.1.3 Parasitism success

Cotesia strain and oviposition rank had a significant effect on the parasitism success (respectively p-value $< 2 \times 10^{-16}$ and p-value = 6.744×10^{-8}). A similar pattern was observed at the first and the second oviposition rank: Makindu females had low parasitism success ($< 30\%$), while it was high for Kobodo ones ($\sim 90\%$) (Figure 2). The parasitism success decreased significantly at the third oviposition, to a level of 50% for Kobodo females and to less than 5% for Makindu ones. Globally, the parasitism success decreased along oviposition rank, and the Makindu strain is characterized by its low parasitism success whatever the oviposition rank. Comparison of these results with those from Figure 1 showed that the difference of parasitism success between Kobodo and Makindu parasitoids in the French host could not be explained by a difference in the number of eggs they injected: Despite both strains injecting similar number of eggs at the second oviposition rank, their parasitism success is markedly different.

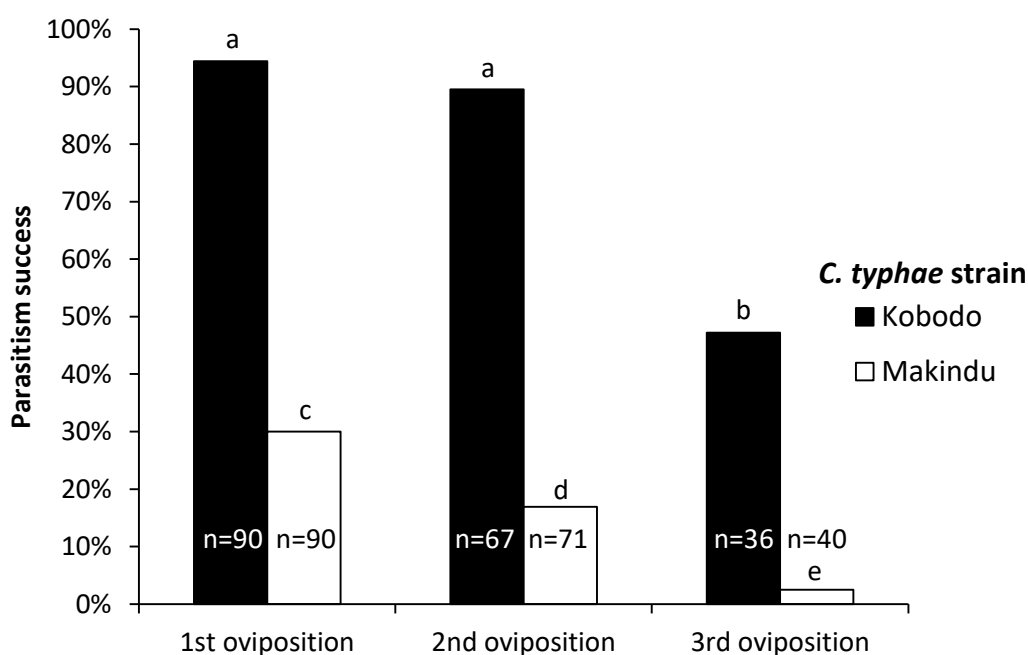

Figure 2: Parasitism success at each oviposition rank of *C. typhae* parasitoid strains in the French host. Parasitism success corresponds to the proportion of stung larvae from which parasitoid larvae emerged. n = number of host parasitized. Conditions with the same letter are not significantly different (p-value > 0.05 , Tukey's HSD test following binomial GLM)

3.1.4 Offspring number

The offspring number decreased significantly along the oviposition rank (p-value $< 2 \times 10^{-16}$) (Figure 3). It followed more or less the same dynamic as the number of injected eggs, with again a significant effect of *C. typhae* strain (p-value = 7.629×10^{-11}). At the first oviposition, Kobodo females had a higher offspring number than Makindu females. The two strains had a similar offspring number, near 40, at the second oviposition. At the third oviposition the offspring number of Kobodo females was low, and that of Makindu could not be estimated due to the lack of progeny development, despite a high rate of host acceptance for oviposition (the only progeny observed in Figure 2 was discarded because only composed of males).

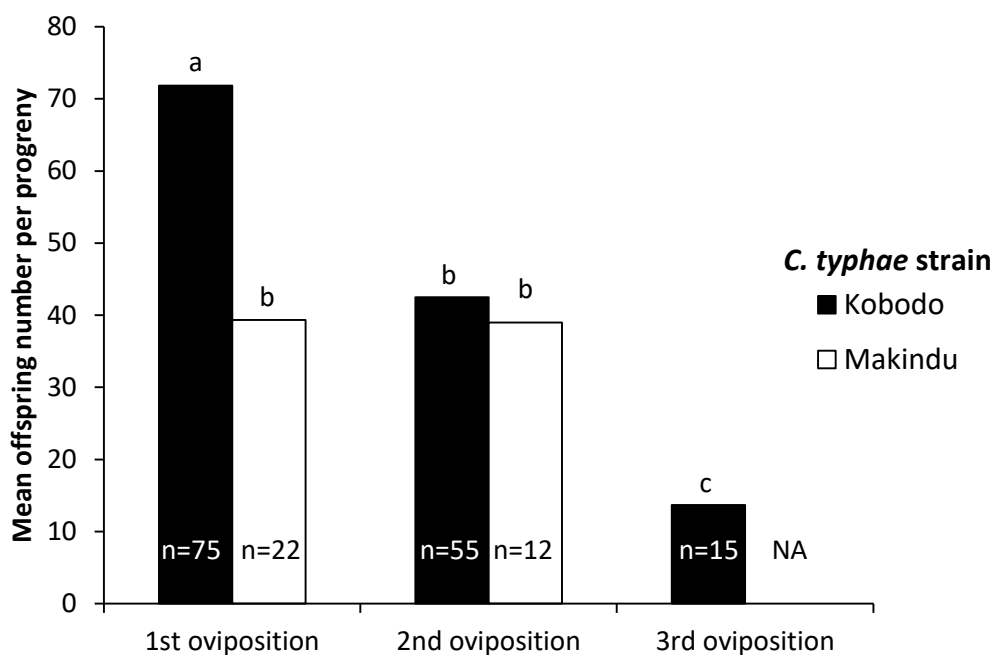

Figure 3: Offspring number at each oviposition rank of *C. typhae* parasitoid strains on the French host. n = number of progenies; error bar = standard error; NA = No progeny in this case. Conditions with the same letter are not significantly different (p -value > 0.05, Tukey's HSD test following negative binomial GLM)

3.1.5 Sex-ratio

The sex-ratio did not vary significantly with the *C. typhae* strains, while a significant effect of oviposition rank was detected (p -value = 0.037×10^{-5}): The proportion of females in the progeny decreased significantly along ovipositions. The sex-ratios of the progeny were female-biased at the two first ovipositions with about two-thirds to three-quarters being females (Table 4). It notably decreased at the third oviposition rank for Kobodo females, for which a balanced sex-ratio was observed. However, pairwise comparisons were not significant, which was explained by the low number of replicates.

Table 4: Sex-ratio at each oviposition rank of *C. typhae* parasitoid strains in the French host. n = number of progenies; se = standard error. Conditions with the same letter are not significantly different (p -value > 0.05, Tukey's HSD test following quasi-binomial GLM).

Oviposition rank	<i>C. typhae</i> strain	Sex-ratio (%females)			
		mean %	se	n	Statistical test
First oviposition	Kobodo	68.41	± 2.15	70	a
	Makindu	76.01	± 3.24	16	a
Second oviposition	Kobodo	62.66	± 3.03	43	a
	Makindu	62.91	± 8.71	8	a
Third oviposition	Kobodo	45.74	± 6.81	8	a
	Makindu	No progeny in this case			

3.1.6 Viral circle quantification

Given that the number of eggs injected in the host caterpillars did not explain the difference of parasitism success between Kobodo and Makindu parasitoids in the French host, a relative quantification of viral DNA circles injected was performed on several circles to see if it could explain this difference.

First of all, as injected quantities of all 15 circles showed a similar pattern (Figure 4), we may assume that it is also the case for the other non-quantified circles. For the two *C. typhae* strains, the quantity of each viral circle injected decreased significantly by a factor of 2 to 3 between the first and at the second ovipositions. Regarding the difference between the parasitoid strains, it appeared that it was not significant when analysing circles independently, except for the viral circle 17. However, when analysing all circles together, it appeared that during the first oviposition, Kobodo females injected significantly more circles than Makindu females.

To investigate the relation between the quantity of viral circles and the number of eggs injected, we normalized these estimates to the values obtained for Kobodo during the first oviposition (Table 5). Both quantities varied similarly according to parasitoid strain and oviposition rank, but with different amplitude. At the first oviposition, Makindu estimates were lower than Kobodo ones, but viral circles decreased by only 1/5 while the number of eggs injected decreased by 1/3. From the first to the second oviposition, the number of circles injected decreased more than the number of eggs; for instance, eggs injected by Kobodo were reduced by 1/2, whereas viral circles were reduced by 2/3.

Table 5: Comparison of the injected quantities of circles and eggs in the French host between *C. typhae* parasitoid strains. For both traits, the medians are given relatively to the Kobodo-First oviposition condition.

Oviposition rank	<i>C. typhae</i> strain	Relative quantity of circles injected (standardized median)	Number of ovocytes injected (standardized median)
First oviposition	Kobodo	1	1
	Makindu	0.789	0.652
Second oviposition	Kobodo	0.359	0.506
	Makindu	0.313	0.562

Most importantly, on average, Makindu females injected more viral circles at the first oviposition than Kobodo females at the second oviposition but parasitism success of Makindu females was lower (Figure 2, Figure 4). Hence, neither the viral circles quantity nor the number of eggs injected in the host explained by itself the difference of parasitism success between Kobodo and Makindu females in the French host.

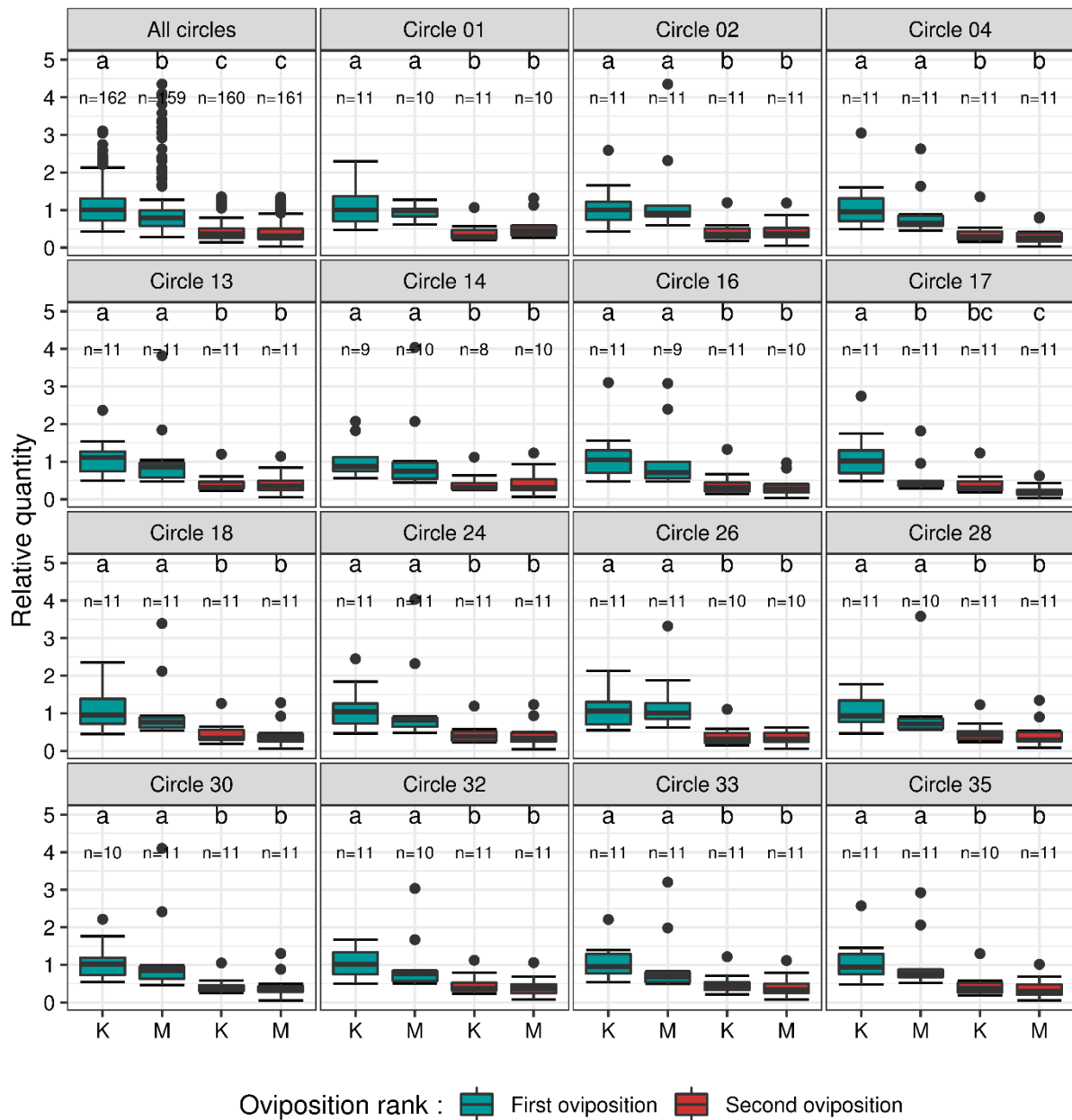

Figure 4: Relative quantification of the viral DNA circles in the French host hemolymph two hours post-parasitism by *C. typhae* parasitoid strains. K = Kobodo; M = Makindu; n = number of host dissected. “All circles” corresponds to data of all circles pooled. For all boxplots the Kobodo-First oviposition condition is used as reference. Conditions with the same letter are not significantly different (p -value > 0.05, Multiple comparison with Holm correction following the Kruskal-Wallis test). Statistical tests were performed independently for each circle, and for the pool of all circles.

3.2 Reproductive success in the natural hosts

In all previous experimentations parasitism was studied in the French host. Higher success of Kobodo parasitoids in this host may originate from adaptation to a local host with a resistance level comparable to the French host. To test this hypothesis, the parasitism success of the two *C. typhae* strains was measured in their natural hosts from their native localities: Kobodo and Makindu (Table 6). The number of eggs injected, the offspring number and the sex-ratio were also estimated on these hosts.

Kobodo females parasitized all the exposed host strains with a high rate of success (~90%), whereas Makindu ones parasitized only their natural host strain with a high success (Table 6). The parasitism success of Makindu females in the Kobodo host corresponded to that observed in the French one. These two *S. nonagrioides* strains displayed a higher resistance to parasitism by the Makindu parasitoid strain than the *S. nonagrioides* strain from Makindu. Unlike females from the Kobodo strain, females from the Makindu strain had a different offspring number depending on the host strain parasitized. Indeed, they had around 63 offspring in the two Kenyan hosts, while their offspring number was around 40 in the French host. The comparison of the number of eggs injected confirmed that Kobodo females laid more eggs in the first host encountered than Makindu ones whatever the host strain considered. The two parasitoid strains injected fewer eggs in the host from Kobodo than in the other ones. The sex-ratio was neither impacted significantly by the parasitoid strain nor by the host strain and varied from 68.41 ± 2.15 to 76.01 ± 3.24 percent of females.

Table 6: Comparison of phenotypic traits between *C. typhae* parasitoid strains in the sympatric and allopatric host populations. n = sample size; \pm = standard error. Conditions in the natural host are in bold. Data in the French host correspond to those presented in previous experiments. Conditions with the same letter are not significantly different (p-value > 0.05, Tukey's HSD test following binomial GLM (Parasitism success) or quasi-poisson GLM (Offspring number)).

Phenotypic trait	<i>C. typhae</i> strain	<i>S. nonagrioides</i> strain		n	
Parasitism success	Kobodo	Kobodo	92.77%	83	a
		Makindu	88.24%	119	a
		French	94.44%	90	a
	Makindu	Kobodo	30.12%	83	b
		Makindu	93.91%	115	a
		French	30.00%	90	b
Offspring number	Kobodo	Kobodo	75.96 ± 2.17	70	a
		Makindu	68.91 ± 1.68	88	a
		French	71.85 ± 1.83	75	a
	Makindu	Kobodo	65.79 ± 4.86	24	ab
		Makindu	60.54 ± 1.83	83	b
		French	39.36 ± 3.87	22	c
Predicted number of eggs injected	Kobodo	Kobodo	87.66		
		Makindu	108.87		
		French	109.66		
	Makindu	Kobodo	68.1		
		Makindu	78.48		
		French	72.42		

4. Discussion

Using the host specific *C. typhae* Braconidae as a biological model, the main objectives of this article were to explore the potential link between parasitoid oviposition behavior and virulence against the host, to investigate if higher parasitism success of one parasitoid strain on a new host originated from its local adaptation to a more resistant host, and to characterize the parasitic potential of two parasitoid strains on the new host population targeted for biological control.

Regarding the link between oviposition behavior and virulence, a previous study on the same species reported differences in the number of eggs injected and in the parasitism success in the French host between Kobodo and Makindu parasitoid strains, when ovipositing once (Benoist et al., 2017). The study showed that the expression of *Cystatin* and *Crv1*, two virulence genes known to inactivate the host immune response (Edson et al., 1981; Glatz et al., 2004), was higher after parasitism by Kobodo, which injected more eggs at a time. Because *C. typhae* females inject eggs and viral particles at the same time in the host, we expected that the quantities of viral circles injected by Kobodo females would be higher than those injected by Makindu ones, which would explain the higher gene expression and thus higher parasitism success.

However, the present study refutes part of this hypothesis. Indeed, although results showed that the injected quantities of viral circles and eggs varied in the same direction (but not proportionally, Table 5), they showed that the quantity of viral particles injected does not explain the level of virulence because at the second oviposition Kobodo had a much higher success than Makindu despite the similar quantities of eggs and viral circles injected (Figures 2 & 4).

To explain the difference of virulence between Kobodo and Makindu we assumed a difference of virulence gene expressions (Benoist et al. 2017). This hypothesis cannot be either validated or rejected as yet. If true, it would imply that the virulence gene expression and the quantity of viral circles injected are not correlated, because we showed that Kobodo females have a higher parasitism success at the second oviposition than Makindu females at the first one (Figure 2), although Kobodo females inject fewer viral circles in this case (Figure 4). This absence of correlation between the quantity of viral circles injected and virulence gene expression was reported for instance in *Microplitis demolitor* and *Cotesia plutellae* (Beck et al., 2007; Kim and Kumar, 2018) and so is likely in our case. As an alternative to the gene expression hypothesis, the difference of virulence between Kobodo and Makindu strains may result from the efficiency of their virulence proteins, due to possible mutations in the coding sequence. Experiments of gene expression on a higher gene number in larvae parasitized at the second rank, and sequencing of virulence genes of both strains will help validate the right hypothesis.

Viral particle production is initiated in wasp ovaries during late pupal development and can continue throughout the adult stage (Beckage and Drezen, 2012; Marti, 2003; Pasquier-Barre et al., 2002). In several solitary parasitoid species the amount of virus present at adult emergence seems to be enough for all ovipositions during female adult life (Beck et al., 2007; Kim and Sanghoon, 2007; Marti, 2003). To our knowledge the quantity of viral circles injected has never been measured along successive ovipositions in a gregarious parasitoid before this work. For both Kobodo and Makindu females the quantity of viral circles injected decreased at the second oviposition, suggesting a depletion of particle stock (Figure 4). So in *C. typhae* viral circles production appears to be insufficient to afford an equal amount of virus for multiple ovipositions, so we can expect that this amount decreases at each new oviposition. At the third oviposition, parasitism success decreased in each experimental combination (Figure 2). The same phenomenon was observed for the very close species *C. flavipes* that parasites *Diatraea saccharalis* (Scaglia et al., 2005). Even if our results show no correlation between the quantity of viral circles injected and parasitism success, a minimum amount of virus could be necessary to allow successful parasitism, and such a threshold would not be reached at the third oviposition of *C. typhae* due to stock depletion.

Inactivating the host immune system is not the only way parasitoids have to ensure the development of their offspring (reviews in Pennacchio and Strand, 2006; Salt, 1968; Vinson, 1990). For example, in the facultative gregarious endoparasitoid *Metaphycus flavus*, laying multiple eggs decreased the encapsulation rate of the host *Coccus hesperidum* and so increased parasitoid larval survival (Kapranas et al., 2012). Since the number of eggs injected differed between Kobodo and Makindu females (Benoist et al., 2017), an alternative hypothesis to explain the difference of parasitism success in the French host, irrespective of the quantity of viral circles, could be that Kobodo females exhausted the host immune system by laying a large amount of eggs. However, successive ovipositions did not support this assumption because the parasitism success of Kobodo females was higher than that of Makindu ones even with fewer eggs injected (Figures 1&2).

Our results also indicated that inactivating the host immune system is not an all or nothing process. Indeed, at the first oviposition, Makindu females got one third less offspring from the French than from its natural host, although they laid almost as many eggs in both hosts. This reveals a lower egg-larval survival rate in the French host. So the difference in offspring number may come from higher encapsulation rate of the eggs and larvae. We observed capsules in this condition, like those described by Gitau et al., 2007, in another noctuid host species parasitized by the sister species *C. sesamiae*, but too few could be observed for reliable counting, due to probable embedding in the host fat body with the same whitish appearance. Thus, even when host larvae allow parasitic development, their immune response is not totally inactivated.

Regarding *C. typhae* behavior, host acceptance by both strains exceeds 90% at the first host exposition, decreases significantly at the second but not at the third (Table 2). Egg load was shown to be an important stimulus for ovipositional activity in several parasitoid species (Collins and Dixon, 1986; Donaldson and Walter, 1988). So, we expected that host acceptance would decrease along ovipositions due to egg depletion. However, no decrease was observed at the third oviposition, suggesting that either the relationship is not linear or other factors drive the motivation to oviposit.

In Benoist et al., 2017 the number of eggs injected was measured only at the first oviposition. On the basis of the observed difference, it was supposed that Kobodo females would inject the majority of their eggs in the first host encountered, while Makindu ones would distribute them more equally. Here, results confirm this hypothesis. Kobodo females lay more than half their eggs in the first host encountered, about 30% in the second and 5 % in the third. In Makindu females, the proportions of egg injected in the first and the second host are close (near 30%) and, unlike Kobodo ones, the proportion at the third oviposition remains high (almost 15%). Finally, after the third oviposition, Makindu females have around two times more remaining eggs in their ovaries (more than 40 eggs) than Kobodo ones (Table 3), suggesting that the behavioral strain difference would also appear upon a fourth oviposition. Thus, the oviposition behavior of Kobodo females differs from that of Makindu ones, despite close initial fecundities. This difference in egg-laying behavior was not an artifact due to the use of a new host population. Indeed, for all hosts tested Kobodo females injected more eggs at the first oviposition rank than Makindu ones (Table 6). Estimating the number of opportunities to oviposit in the field could give information about the causes of this differentiation of oviposition behavior. Indeed, the egg allocation strategy of Makindu females will increase their fitness only if they can oviposit multiple times. Thus, we expect that in the field Makindu females have more opportunities to oviposit than Kobodo, which could have resulted in the differentiation of the oviposition behavior by selection. This is in accordance with accessibility to host resource in their natural habitat.

Indeed, Makindu and Kobodo are located in ecologically contrasted regions (Le Ru et al., 2006). The Makindu field location consists in a well limited and dense settlement of *Typha domingensis* localized on the banks of a small stream (B. Le Ru *personal communication*) and surrounded by dry habitat (Somalia-Masai Acacia-Commiphora deciduous bushland and thicket vegetation mosaic, White, 1983). In this habitat *T. domingensis* hosts *S. nonagrioides* as an almost exclusive stemborer (Kaiser et al.,

2015). In contrast, the Kobodo region consists of a continuum of wetland located in the mosaic of East African evergreen bushland and secondary Acacia wooded grassland vegetation mosaic, White, 1983), with diversified plant-stem-borer species associations (B. Le Ru *personal communication*). So *S. nonagrioides* larvae should be more difficult for the parasitoid to find at the Kobodo locality. Since *C. typhae* are short-lived and thus time-limited, constraints on the probability of finding a host may have favored a higher reproductive investment in the first encountered host.

The reciprocal comparison of the parasitism success of Kobodo and Makindu females in their natural host populations gives information on local host adaptation. While Kobodo females have a high success on both hosts from Kobodo and Makindu, the parasitism success of Makindu females is high only in its sympatric host (Figure 2 & Table 6). Like the French host, the host from Kobodo resists *C. typhae* females from Makindu but does not resist the local *C. typhae*. This suggests that the French host population has a level of resistance equal to that of the Kobodo Kenyan host population. Thus, local adaptation may explain the ability of Kobodo females to parasitize the French host successfully: the higher resistance of the Kobodo host population could have exerted a higher selective pressure on *C. typhae* virulence, which might pre-adapt Kobodo females to the French host.

In southern Europe, *S. nonagrioides* and *Ostrinia nubilalis* are the major pests of maize. Unlike *O. nubilalis* against which *Trichogramma brassicae* are used, no biocontrol agent is available for *S. nonagrioides*. Regarding the potential use of *C. typhae* as a biocontrol agent of *S. nonagrioides* in Europe, this work confirms that Kobodo locality offers an efficient strain against this pest. The performances of this *C. typhae* strain are comparable, for instance, to those of *C. flavipes*, which is used massively in Brazil against the sugarcane pest *Diatraea saccharalis* (Trevisan et al., 2016; Vacari et al., 2012) and are promising for the control of *S. nonagrioides*. The current work shows that Kobodo females could parasitize more than one larvae efficiently. Such data are important for mass rearing and for adjusting parasitoid densities for field release.

5. Conclusions

The *C. typhae* / *S. nonagrioides* system is an attractive system for documenting the mechanisms of adaptation to a host population because it offers differentiation of several reproductive traits between parasitoid strains, and differentiation of resistance between host populations. We addressed mechanisms causing pre-adaptation of a geographical parasitoid strain to an allopatric host pest population targeted for biocontrol. Regarding behavioral and physiological causes, we found that neither the number of eggs injected nor the number of viral particles injected explained the difference of success between strains. Regarding evolutionary causes, our data indicate that pre-adaptation of one strain to the allopatric host population may come from adaptation to its local host. This work also suggests that virulence and oviposition behaviour would have evolved separately, the first in response to the level of host resistance, and the second to environmental variables at play in host availability.

Acknowledgements

We thank Odile Giraudier and Sylvie Nortier for insect rearing at Gif, Julius Obonyo for field collection, Claire Capdevielle-Dulac for her advice for the quantification of viral particles, Matthieu Bodet, Aurore Vedel and Nicolas Leblanc for their contribution to the dissections, Taiadjana Fortuna for her help in the experiments, Lionel Saunois, Amandine Dubois and Virginie Héraudet for maize production and Malcolm Eden for linguistic editing of the manuscript.

Competing interests

The authors declare no competing or financial interests

Author contributions

Conceptualization: K. L, B. R; Methodology: B.R.; Validation: B.R.; Formal analysis: B.R., M.F.; Investigation: B.R., P.S., D.F., G.J., J.R.; Resources: L.R.B., C.P-A., K.L.; Data curation: B.R.; Writing - original draft: B.R.; Writing - review & editing: K.L., M.F., L.R.B., C.P-A.; Supervision: K.L.; Project administration: K.L.; Funding acquisition: K.L.

Funding

This work was supported by the French National Research Agency (project *Cotebio* ANR-17-CE32-0015), and by the authors' operating grants from IRD, CNRS, and icipe. R. Benoist is funded by the « Ecole doctorale 227 MNHN-UPMC Sciences de la Nature et de l'Homme: évolution et écologie ». Sarah Paquet and Florian Decourcelle were funded respectively by the *Cotebio* project and by the *labex* BASC (project *LutteSesa*). The funders had no role in study design, data collection and analysis, decision to publish, or preparation of the manuscript.

Supplementary information

All experimentations were realized under the juridical frame of a Material Transfer Agreement signed between IRD, icipe and CNRS (CNRS 072057/IRD 302227/00) and the authorization to import *Cotesia* in France delivered by the DRIAAF of Ile de France (IDF 2017-OI-26-032)

III) Données complémentaires

Note : Sont présentés ici des résultats n'ayant pas été inclus dans les deux articles précédents.

Tableau 1- Durée des pontes de rang 1 chez les souches Kobodo et Makindu.

Souche <i>C. typhae</i>	Durée de la ponte (seconde)	n	Test de rang de Wilcoxon
Kobodo	8,59 ± 0,4	n=39	W = 1752.5
Makindu	8,33 ± 0,27	n=86	p-value = 0,6871

Tableau 2 - Acceptation de l'hôte par les souches Kobodo et Makindu au cours d'expositions successives. n = nombre de femelles testées. Les conditions avec les mêmes lettres ne sont pas significativement différentes (p-value > 0,05, Test des étendues de Tukey sur un GLM binomial)

Rang d'exposition	Souche de <i>C. typhae</i>	Souche d'hôte	Acceptation de l'hôte	n	lettre
Première exposition	Kobodo	Française	91,10%	n=123	a
		Kenyane (Makindu)	91,80%	n=122	ab
	Makindu	Française	94,60%	n=111	a
		Kenyane (Makindu)	90,80%	n=131	ab
Deuxième exposition	Kobodo	Française	64,00%	n=114	c
		Kenyane (Makindu)	75,00%	n=132	c
	Makindu	Française	66,10%	n=115	c
		Kenyane (Makindu)	61,00%	n=95	c
Troisième exposition	Kobodo	Française	62,30%	n=61	c
		Kenyane (Makindu)	60,00%	n=60	c
	Makindu	Française	78,46%	n=65	cb
		Kenyane (Makindu)	71,40%	n=42	c

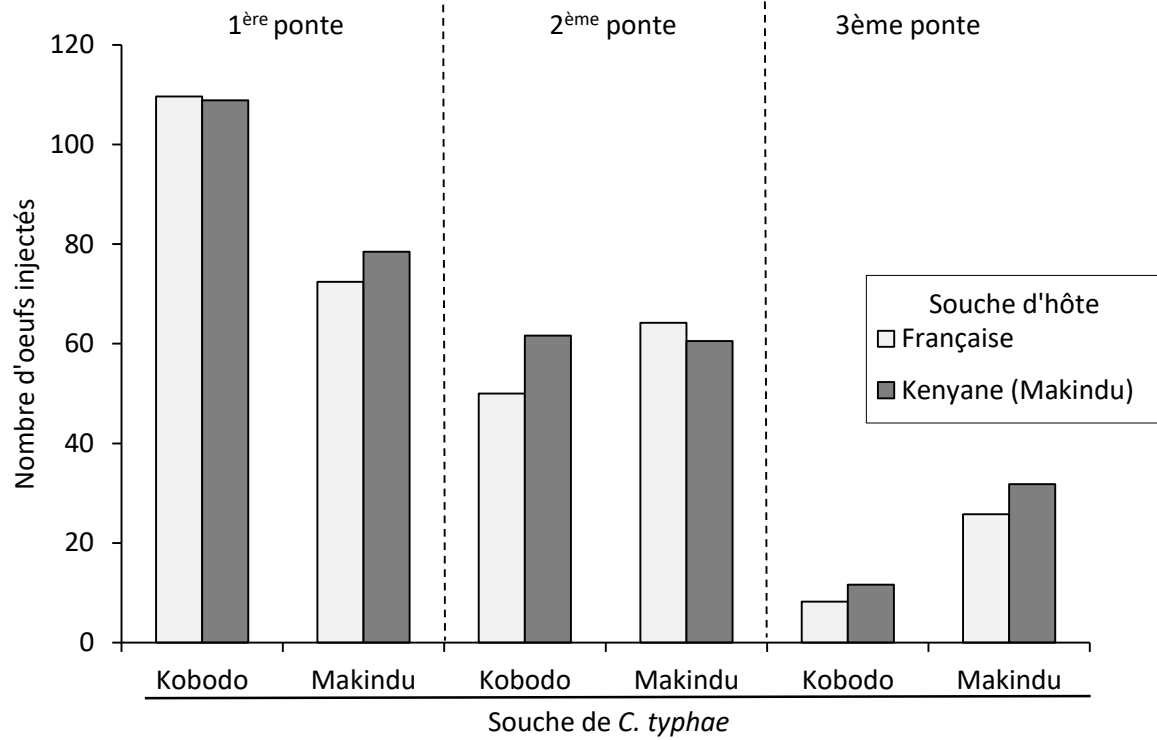

Figure 12 - Nombre d'œufs injectés par les souches Kobodo et Makindu au cours de pontes successives. Le nombre d'œufs injectés est déduit du nombre d'ovocytes restants dans les ovaires après ponte

**Chapitre III – Bases
généétiques du succès
reproducteur de *C. typhae***

I) Article n°3: Quantitative Trait Loci involved in the reproductive success of the parasitoid *Cotesia typhae*

Dans le but d'identifier des régions du génome impliquées dans la variation du succès de parasitisme et du nombre de descendants entre les souches Kobodo et Makindu nous avons mené en parallèle des travaux présentés précédemment une recherche de QTL (Quantitative Trait Loci).

Pour cela nous avons croisé des individus des deux souches de manière à générer des mâles recombinants F2 et F8. Ces mâles ont ensuite été rétro-croisés avec des femelles des souches parentales. Du fait du déterminisme du sexe de type haplodiploïde (les mâles sont haploïdes issus d'ovocytes non fécondés et les femelles sont diploïdes issues d'ovocytes fécondés) et du haut niveau d'homozygotie de nos souches parentales, ce type de croisement permet de générer des fratries de femelles quasiment-clonales appelées CSS (Clonal Sib-Ship). Le fait de disposer de plusieurs femelles clonales permet de réaliser plusieurs mesures du phénotype pour un même génotype et d'avoir suffisamment d'ADN pour faire du séquençage à partir d'un mélange de femelles (voir plus loin). En tout, 181 CSS ont été produites : 42 en croisant des mâles F2 avec des femelles Kobodo, 45 en croisant des mâles F2 avec des femelles Makindu et 89 en croisant des mâles F8 avec des femelles Makindu. Les croisements en F8 n'ont été faits qu'avec des femelles Makindu car la caractérisation des hybrides obtenus en croisant les deux souches suggérait une forte dominance des allèles Kobodo associés aux caractères étudiés (voir article 1).

Des femelles de chaque CSS ont été phénotypées de manière à estimer le succès reproducteur et le nombre de descendants moyen de chaque CSS. Au total, plus de 4000 femelles ont été utilisées et plus de 200 000 descendants comptés. Le génotypage de chaque CSS a été réalisé par séquençage RAD (Restriction site associated DNA markers). Nous avons opté pour cette technique de génotypage par séquençage haut-débit pour deux raisons. La première est qu'il n'y avait pas de marqueurs disponibles pour *C. typhae* et que cette technique permet d'en générer potentiellement des dizaines de milliers répartis sur l'ensemble du génome. La deuxième est que le fait de disposer de la séquence de chaque marqueur rend possible leur localisation sur un génome de référence.

A partir des données de séquençage des CSS F2, une carte génétique de *C. typhae* comprenant 465 marqueurs répartis sur 10 groupes de liaisons a été construite. En recherchant des associations statistiques entre phénotypes et génotypes aux marqueurs des CSS à partir des données des CSS F2 et F8 nous avons identifié plusieurs QTL : Trois QTL impliqués dans la variation du succès reproducteur et deux dans la variation du nombre de descendants, un des QTL étant commun aux deux traits. En positionnant ces QTL sur le génome annoté de *C. congregata* nous avons pu établir une liste de 68 gènes potentiellement impliqués dans la variation de nos traits. Parmi cette liste se trouvent notamment des gènes du Bracovirus et des gènes de composants du venin.

Quantitative Trait Loci involved in the reproductive success of the parasitoid *Cotesia typhae*

Romain Benoist¹, Claire Capdevielle-Dulac¹, Céline Chantre¹, Rémi Jeannette¹, Laurence Moreau², Arnaud Le Rouzic¹, Paul-André Calatayud^{1,3}, Erwin Van Dijk⁴, Stéphane Dupas¹, Jean-Michel Drezen⁵, Bruno Le Ru¹, Laure Kaiser¹, Florence Mougel^{1,*}

¹ Laboratoire Évolution, Génome, Comportement et Écologie, (UMR 9191 CNRS, 247 IRD, Université Paris-Sud, Université Paris-Saclay), Avenue de la Terrasse, 91190 Gif-sur-Yvette, France

² Laboratoire Génétique Quantitative et Évolution – le Moulon (UMR 0320 INRA, CNRS, AgroParisTech, Université Paris-Sud, Université Paris-Saclay), Ferme du Moulon, 91190 Gif-sur-Yvette, France

³ icipe, International Center of Insect Physiology and Ecology, P.O. Box 30772-00100, Nairobi, Kenya

⁴ Institut de Biologie Intégrative de la Cellule (UMR 9198, CNRS, CEA, Université Paris-Sud, Université Paris-Saclay), Avenue de la Terrasse, 9190 Gif-sur-Yvette, France

⁵ Institut de Recherche sur la Biologie de l’Insecte (UMR 7261, CNRS, Université Tours), 37200 Tours, France

* Corresponding author: Florence.mougel-imberty@eqce.cnrs-gif.fr

Running Title: Reproductive success QTL of a parasitoid

Abstract

Life history traits include survival and reproductive traits and are the key components of individual fitness. Their intra-specific variation is essential for the dissection of their genetic basis in the perspective of understanding mechanisms of evolution. Such variations are observed in the African endoparasitoid *Cotesia typhae*, specialized on the crop pest *Sesamia nonagrioides*. Previously, we identified two strains of *C. typhae* that differ significantly for two life history traits (parasitism success and offspring number) on a host population from France. To investigate the genetic bases underlying these phenotypic differences, we developed a Quantitative Trait Locus (QTL) approach based on Restriction site Associated DNA markers (RAD-tags). Taking benefit from the haplo-diploid reproduction of *C. typhae*, crosses between individuals from the two strains were performed to generate F2 and F8 recombinants clonal sibships females. More than 4000 females from 92 F2 and 91 F8 clonal sibships were phenotyped for the mentioned traits and the 183 clonal sibships were genotyped for RAD-tags. Stringent selection of RAD-loci was then conducted to build a high quality genetic map. The 465 selected markers spanning a total length of 1300 cM and are organized in 10 linkage groups which equals to the number of *C. typhae* chromosomes. Three QTLs were detected for parasitism success and two for offspring number. These QTLs explain almost all genetic variation observed and the confidence interval of their location spanned 90 cM. The gene content of these intervals was investigated based on the genome of *C. congregata* and revealed 68 interesting candidates, mainly belonging to bracovirus and venom components.

Keywords: Quantitative Trait Loci, parasitism success, offspring number, RAD-Seq, Linkage map, *Cotesia*

Introduction

Evolution relies on heritable genetic variation that may be neutral or submitted to selection. In this last case, the variation concerns traits directly related to fitness. The study of their genetic basis is thus of prime importance to understand mechanisms of evolution. Fitness related traits, also called life history traits, are tightly linked to survival and reproduction and are involved in adaptation of organisms to their environment. Insect parasitoids represent an interesting case study of environmental adaptation. These species spend their larval stage as parasite and live freely at adult stage and behave in an intermediate way between parasites and predators because they need to kill their host to allow their development. The larval environment is thus mainly biotic and the complete development relies on fine adaptation to the host (Godfray, 1994).

This adaptation encompasses the ability to detect and parasitize efficiently the host. The host detection is based on the location of the host as well as the recognition of its suitability. Once a suitable host is found parasitoids have to optimize their oviposition behavior to maximize their fitness. This is illustrated by the occurrence of different oviposition strategies. Usually, they are classified as solitary or gregarious depending upon the offspring number produced per host, one for solitary (not necessarily implying the injection of only one egg) and several for gregarious. The oviposition behavior is under adaptive constraints and is influenced by numerous factors such as host availability, host quality or larval competition (Godfray, 1994; Pexton et al., 2009; Pexton and Mayhew, 2005; Quicke, 2014). Those environmental factors are also perceived and taken into account by parasitoid females to adjust their clutch size. The resulting offspring number is therefore genetically and plastically determined.

Following oviposition, parasitoid larvae development depends on parasitoid ability to bypass host immune defense and alter its growth to parasitoid benefit. This is especially important for endoparasitoid species which develop in host haemocoel (Quicke, 2014). The virulence arsenal developed by parasitoids to ensure the development of their progeny, defined as parasitism success thereafter, is quite phenomenal and combines factors derived from maternal and embryonic origins. Depending on species, the maternal factors encompass venom, ovarian proteins, polydnavirus and virus-like particles and are injected along with eggs in the host. (Asgari and Rivers, 2011; Pennacchio and Strand, 2006; Strand and Burke, 2015; Webb, 1998). The embryonic factors encompass teratocytes which are cells derived from the membrane surrounding parasitoid embryo and parasitoid larvae itself (Strand, 2014). The most studied factors are probably the venom and polydnavirus. Venom is mainly devoted to host metabolism manipulation insuring parasitoid development (Mrinalini and Werren, 2016). It is produced by a specialized gland connected to female reproductive tract. Within Hymenoptera venom gland is a conserved organ but venom composition seems to be very heterogeneous (Moreau and Asgari, 2015). It comprises proteins that are enzymatic in nature but for which specific function is largely unknown to date. Polydnaviruses are double-stranded DNA viruses associated with Hymenopteran parasitoids (Webb, 1998). Unlike venom, polydnaviruses are harbored by only five subfamilies of Braconidae and one family of Ichneumonidae. The polydnavirus associated with Braconidae are called Bracoviruses, whereas those associated with Ichneumonidae are called Ichnoviruses. They derive from the integration of two unrelated viruses into the genome of two ancestral parasitoids and are now vertically transmitted (Herniou et al., 2013, 2003; Volkoff et al., 2010). In species harboring polydnaviruses, viral particles are produced from calyx cells localized in female ovaries (Marti, 2003; Wyler and Lanzrein, 2003). Those particles contain viral DNA circles bearing virulence genes involved in the inactivation of host immune system and alteration of host growth (Beckage and Drezen, 2012; Beckage and Gelman, 2004; Edson et al., 1981).

The fine description of parasitoid reproductive success components shows that they are multifactorial and highly plastic, demonstrating the influence of many genes and the environment. Quantitative trait

loci (QTL) approaches are optimal to overcome such complex situations and fill the gap between genotype and phenotype and genotype. Quantitative trait loci (QTL) approaches are optimal to overcome such complex situation (Broman and Sen, 2009; Lander and Botstein, 1989; Mackay et al., 2009). These approaches are made easier in organisms with a haplodiploid sex determination such as Hymenopteran. In these species males are haploid and produce spermatozoids all identical. So, when a male is crossed with an inbred female all females produced are genetically identical. This allows repeating phenotypic measure on females with the same genotype reducing effect of environmental variation (Pannebakker et al., 2011; Velthuis et al., 2005). In parasitoids, QTL approach was performed only once on offspring number of *Nasonia vitripennis* (Pannebakker et al., 2011) but was never performed on parasitism success. In this paper we developed a QTL approach to study the genetic basis of these traits in a parasitoid species: *Cotesia typhae* (Fernández-Triana) (Hymenoptera, Braconidae).

Cotesia typhae is an African gregarious endoparasitoid specialized on larvae of the crop pest *Sesamia nonagrioides* (Lefebvre) (Lepidoptera, Noctuidae). It was recently differentiated from the generalist species *Cotesia sesamiae* composed of several populations with different host-ranges (Kaiser et al., 2017a, 2017b, 2015). In a biological control perspective, the ability of *C. typhae* to parasitize a French population of *S. nonagrioides* was studied previously (Benoist et al., 2017). This study highlighted two strains of *C. typhae* named Kobodo and Makindu which differed in their reproductive success on this host. Indeed, Kobodo females had a better parasitism success and produced more offspring than Makindu ones. The natural hosts of these two parasitoid strains also differ in their resistance to parasitism (Benoist et al., submitted). The higher virulence of Kobodo females against the French host could be due to its adaptation to a more resistant host. Due to the difference in reproductive success between strains, this species is valuable to study the genetic basis of these traits. Furthermore, the annotated genome of the close relative species *C. congregata* is available which can be used as a reference for the identification of genes within QTL (Gauthier et al., in prep).

To identify genes involved in reproductive success we developed a QTL approach based on Restriction site Associated DNA markers (RAD-tags), a high throughput marker technique. Crosses between inbred individuals from the two strains Kobodo and Makindu were performed to generate F2 and F8 recombinant males. The production of F2 recombinant individuals was useful to build a genetic map. This dataset was completed by F8 recombinant individuals to increase the number of recombination events for QTL detection. Taking benefit from the haplo-diploid reproduction of *C. typhae*, crosses were designed to produce clonal sibships females from recombinant males. Each clonal sibship was phenotyped for offspring number and parasitism success and genotyped using RAD-tags. Stringent selection of loci was then conducted to build a high quality genetic map. This map was scanned to detect loci showing statistical association between reproductive success phenotype and marker genotype. Then the gene content in the identified QTLs was investigated based on the annotated genome of *C. congregata*.

Materials and Methods

Biological Material

The Kobodo and Makindu *C. typhae* parasitoid strains were initiated from adults emerged from naturally parasitized *S. nonagrioides* caterpillars collected in the field at two Kenyan localities: Kobodo (0.679S, 34.412E; West Kenya; 3 caterpillars collected in 2013) and Makindu (2.278S, 37.825E; South-East Kenya; 10 caterpillars collected in 2010-2011). Until 2015, the two strains were reared separately at the International Centre of Insect Physiology and Ecology (icipe, Nairobi, Kenya). In this rearing, all individuals of each strain were mixed together at each generation. Then the strains were reared as isofemale lines at the laboratory Evolution, Génome, Comportement et Ecologie (EGCE, Gif-sur-Yvette, France) where cross experiments and phenotyping were performed.

Two host strains of *S. nonagrioides* were used: a Kenyan strain initiated from caterpillars collected at Makindu and a French strain initiated from individuals collected in maize fields in Haute-Garonne (Longage-Berat area, 43.368N, 1.192E and within a 10 km distance) which was renewed yearly. The French strain was used for phenotyping whereas the Kenyan one was used for *C. typhae* rearing to prevent any adaptation of the parasitoid to the French host.

The rearing protocol of *C. typhae* and *S. nonagrioides* is detailed in Benoist et al., submitted.

Genetic cross-design

Cotesia typhae is a haplodiploid species, females are produced from fertilized eggs and are diploid while males are produced from unfertilized eggs and are haploid. We combined 2 cross schemes to produce F2 and F8 recombinant individuals (Figure 1). Three generations of sib-mating were first performed for both Kobodo and Makindu parental lines. Virgin males and females from the parental strains were then crossed to generate F1 individuals. Part of the F1 females were isolated and kept virgin (Figure 1a). All other F1 individuals were mixed in a single population which was maintained until F8 generation. At each generation, all adults were stored in the same cage to allow random mating and some randomly chosen females were used to produce the next generation avoiding overlapping between generations. Several F7 females were isolated to be kept virgin as F1 females. Virgin females from F1 or F7 generation were allowed to oviposit to produce respectively F2 and F8 recombinant males. Each recombinant male was backcrossed with a single female from Kobodo or Makindu parental strains for F2 males. For F8 males, only the Makindu strain was used, because previous study suggested a dominance of Kobodo alleles on these traits which was susceptible to mask phenotypic variation. Since no meiosis occurs in males and parental strains are highly inbred, the offspring from one recombinant male and one female from a parental line contain recombinant females with almost the same recombinant genotype at all locus (they were considered as genetically identical). Each female offspring was called a clonal sibship. In total, 187 clonal sibships were produced: 45 from F2 Kobodo backcross, 47 from F2 Makindu backcross, and 91 from F8 Makindu backcross. This experimental design allows replicated phenotyping for each recombinant genotype and thus the measuring of proportion traits like parasitism success (see below) which can only be estimated from several individuals.

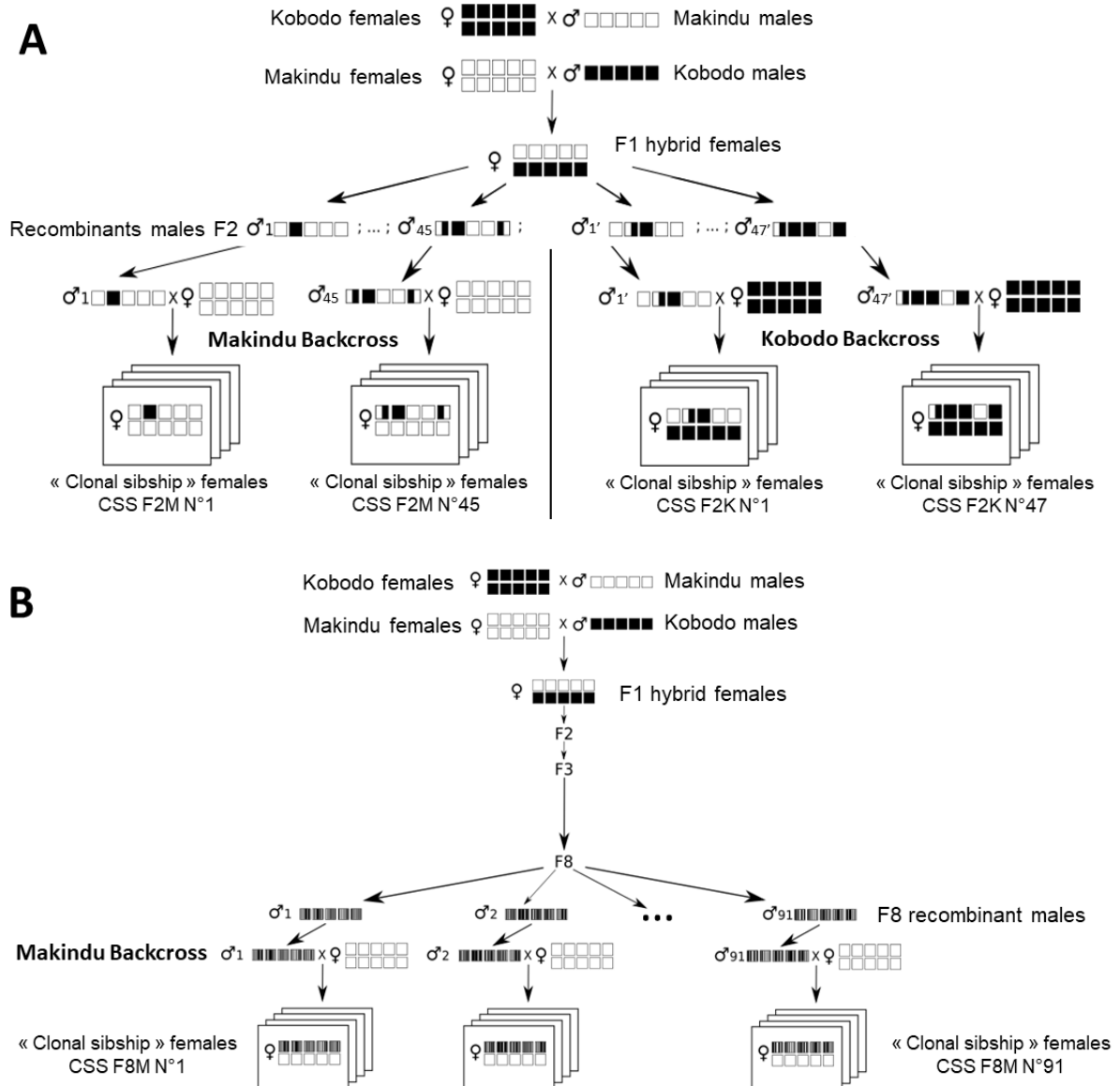

Figure 1: Cross schemes used to generate clonal sibship, adapted from Pannebakker et al., 2011: A: F2 cross scheme; B: F8 cross scheme. *C. typhae* is an haplo-diploid species. Haploid males are represented by 5 squares while diploid females are represented by 10 squares. Kobodo and Makindu alleles are represented in black and white respectively. Inbred parental strains are almost homozygous. Kobodo and Makindu individuals were crossed to generate F1 individuals. A part of F1 hybrids females were kept virgins to produce F2 recombinant males. All other F1 individuals were mixed in a single population which was maintained until F8 generation. F2 (A) and F8 (B) recombinant males were then backcrossed with females from the parental strains to produce clonal sibship females (i.e. females with identical genotype). F8 males were backcrossed only with Makindu females. In total, 187 clonal sibships were produced: 45 from F2 Kobodo backcross, 47 from F2 Makindu backcross, and 91 from F8 Makindu backcross.

Phenotyping

Twenty females were tested for each clonal sibship. In order to allow mating, clonal sibship females were left at least one day with their brothers in the same cage before the experiments (the mating process was not controlled). One caterpillar of the *S. nonagrioides* French strain was provided to each female for oviposition. After exposure, parasitized host caterpillars were kept in rearing conditions

until observation of either the formation of parasitoid cocoon mass (following the emergence of the parasitoid larvae from the host), or the death of the host without parasitoid emergence, or the formation of host pupa. When parasitoid emergence occurred, each cocoon mass was placed in a tube until the emergence of adults. For each clonal sibship, the parasitism success was calculated as the proportion of parasitized hosts from which parasitoid larvae emerged, and the mean offspring number was estimated as the mean number of parasitoid larvae that emerged from the host (only successful parasitisms were taken into account). To avoid bias, progenies of unmated females (containing only males) were discarded because the offspring number varied significantly between mated and unmated females (Benoist et al., 2017). The broad-sense heritability (H^2) could not be estimated for parasitism success due to the lack of repetitions: only one measure is obtained for each clonal sibship based on the number of success and failure of the parasitism. By contrast, each success led to the estimation of an offspring number. Therefore, several measures were available for each clonal sibship genotype allowing the estimation of broad sense heritability. It was calculated using the following formula: $H^2 = Var_G / Var_P$ where Var_P corresponds to the total phenotypic variance and Var_G corresponding to genetic variance deduced from the variance between clonal sibship (broad-sense heritability was calculated independently for each backcross).

RAD-Sequencing

A RAD-seq approach was performed in order to obtain genetic markers widely distributed in the genome. For each clonal sibship DNA was extracted from a pool of females using the NucleoSpin Tissue kit (Macherey-Nagel) and a RNase treatment was performed (Roche). All clonal sibship DNA samples were digested with *PstI* restriction endonuclease. The expected number of restriction sites was around 18,500 based on the *C. sesamiae kitale* genome (Gauthier et al., in prep). A P1 adapter containing and Illumina adapter sequence, a 10 bp barcode (to identify clonal sibships) and a sticky-end extremity corresponding to the *PstI* site, was ligated to the *PstI*-digested fragments. F2 and F8 samples were pooled separately and adapter-ligated fragments were randomly sheared to an average size of 600 bp. The two Illumina libraries were prepared by ligating a P2 adapter with a divergent end to DNA fragments to ensure that only fragments with P1 and P2 adapters will be fully amplified. These libraries were then amplified by PCR with P1 and P2 primers and paired-end sequenced on an Illumina NextSeq 500 instrument. The read length was 75 bp for the F2 samples and 80 for the F8 samples (including 10 bp of the barcode and 6 bp of the restriction site).

Identification of RAD locus and genotypes with Stacks

RAD-seq reads were trimmed to remove adaptors with cutadapt v1.9.1 (Martin, 2011). RAD loci and the associated genotypes were determined using the software package Stacks v1.48 (Catchen et al., 2013; Rochette and Catchen, 2017). The trimmed reads were de-multiplexed and the barcodes were removed from reads using process_radtag, discarding reads with an uncalled base and/or low-quality score. To standardize data between F2 and F8, the last 5 bp of F8 reads were trimmed. F2 and F8 reads were treated separately. F2 and F8 reads were treated separately. For each sample, reads were grouped in “stacks” to build loci using two approaches: *de novo* (ustacks) and reference-based (pstacks, in this case a reference genome is used to build loci). Prior to *de novo* analyses, PCR duplicates were removed with home-made software based on sequence identity. For reference-based analyses, read pairs were mapped to the *C. sesamiae kitale* genome (Gauthier et al., in prep) using BWA v0.7.17 (Li et al., 2009) and PCR duplicates sharing strict identical coordinates were removed with samtools v1.9. The error rate upper bound was fixed to 0.01 for F2 (used to define the locus catalog, see below) and to 0.1 for F8. The deleveraging algorithm was turned on for *de novo* analyses. For all other parameters default settings were used. Two catalogs of loci (*de novo* and reference-based) were generated from all F2 stacks (population option) using cstacks with default parameters. Both F2 and F8 stacks were then matched to these catalogs to infer genotypes using sstacks with default parameters. We thus obtained two sets of genotypes for each clonal sibship from F2 and F8: one from *de novo* and one from reference-based analysis.

Locus selection and genotype correction

Selection of QTL markers from available loci was performed on F2 data. De novo and reference based data were treated separately. Loci respecting the following conditions were selected: (i) diverging at 1 to 3 nucleotide sites between Kobodo and Makindu strains; (ii) showing invariant state in each parental line; (iii) loci found in at least 70 clonal sibships; (iv) showing no segregation distortion. For all retained markers, some genotypes of F2 and F8 clonal sibships were corrected by taking advantage of the backcross design. For each backcross type, only two genotypes are expected among clonal sibship: Homozygous for parental allele or heterozygous. For a clonal sibship from the Makindu backcross, if a genotype was inferred as homozygous for Kobodo alleles it was corrected for heterozygosity, assuming that the second allele was not detected because of low coverage. The same procedure was applied for clonal sibships from the Kobodo backcross. After locus selection and genotype correction, *de novo* and reference-based data were merged as follows. Genotypes were compared for the markers shared between both analyses. If inferred genotypes differed between *de novo* and reference-based analyses, the heterozygous ones were retained: we assumed that it was more likely to miss a second allele than to detect a false positive one.

Linkage map construction and correction

The construction of the linkage map was performed with Carthagen v1.3 (de Givry et al., 2005) using only the F2 data. The *LOD* and genetic distance thresholds used for linkage groups identification were respectively 7 and 0.5 Morgan. Marker ordering was done with the default set of algorithm (Defalco option). For each clonal sibship, genotypes were organized following the linkage map order to visualize recombination events and to correct some genotypes. When crossovers were detected on both sides of a marker, the corresponding genotype was questioned. Markers identified from only one approach (*de novo* or reference-based) and showing several suspicious genotypes were re-sequenced to confirm or infirm genotypic inference. The other suspicious genotypes were encoded as missing values when the coverage was lower than 10. A new map was then generated from corrected data. When several markers were at null genetic distance on F2 and F8 data, the marker with less missing data was retained.

QTL analysis

All QTL analysis was performed using R Software (R Core Team, 2018). For each clonal sibship, the probability of the allelic state at every cM map position was estimated using the package R/qtl v1.44-9 (Broman and Sen, 2009). At each position, additive and dominance indices were determined with the following formulas: *additive index* = $2P_{KK} + P_{KM}$; *dominance index* = P_{KM} , with P_{KK} and P_{KM} corresponding to the probability that the genotype was homozygous for Kobodo alleles or heterozygous.

To identify QTL for each trait, multiple regressions using generalized linear models (GLM) were performed. Due to the cross scheme, data could be classified into 3 cross types which may influence their genotype: F2 backcross with Makindu strain, F2 backcross with Kobodo strain or F8 backcross with Makindu strain. As a consequence, phenotypic variation was analyzed in several steps. In a first step, a GLM was built for each trait taking into account only the cross type. They were based on “quasi-binomial” error family for the parasitism success and on “quasi-poisson” error family for the number of offspring.

In a second step, all positions were scanned with a full GLM using residuals of the first model as response variable and additive and dominance indices of the given position as explanatory variables. Position *LOD* scores ($LOD_{Position}$) were calculated using the formula: $LOD_{Position} = n/2 \times \log_{10}(RSS_{null}/RSS_{full})$, where n is the sample size, RSS_{full} is the residual sum of squares of the full model with additive and dominance indices, and RSS_{null} is the residual sum of squares of the null model (also based on residuals but without explanatory variables). The significant *LOD* score threshold was estimated by performing 2000 permutations between phenotypes and genotypes within cross types and taking the 5 % cut-off of the maximum *LOD* scores obtained as significant threshold value (Churchill and Doerge, 1994).

In the next step, additive and dominance indices at the position with the highest significant *LOD* score were included to build a new null model comprising this fixed position and rescanning the genome for an additional QTL. The process was repeated until no significant position was detected.

To test for interactions between QTLs, interaction terms for all QTL pairs were added to the model including all QTLs detected. Each interaction term was then tested separately by an analysis of deviance performed between the model with and without interaction terms.

For each trait, the final model comprising all fixed QTLs and their significant pairwise interactions will be referred as the complete model in the following. In these models F8 backcross was used as reference.

Additive and dominance coefficients are the estimated coefficients in these complete models. Additive effect corresponds to the variation associated with one Kobodo allele. Estimated coefficients for parasitism success and offspring number are given in logits and log respectively in the final models because we used quasi-binomial and quasi-poisson errors. Parasitism success estimates were turned in proportion (P) using the formula $P=1/(1+1/e^x)$, where x is the logit estimate (Crawley, 2012). Offspring number estimates were turned in count values with exponential transformation. The percentage of total phenotypic variance explained by each QTL was determined from the complete models with the formula SS_{QTL}/TSS where SS_{QTL} is the sum of square associated to QTL and TSS the total sum of square. The confidence interval of each QTL position corresponded to all positions around the QTL for which *LOD* score was above *LOD* score max – 2.

Candidate gene identification

Gene identification was performed by genomic comparison with the available genomes of *C. congregata*. We first assembled RADseq data from all samples with SPAdes v3.11.1 (Nurk et al., 2013). All markers included in the QTL confidence intervals were mapped on the scaffolds obtained using blastn v2.6.0+ (Boratyn et al., 2012). Scaffolds containing markers were then mapped to the annotated genome of *C. congregata* using BLAST to identify genes in QTLs. For this genome, an automatic annotation was performed and refined with manual inspection for some gene families (Bracovirus, Venom, Immunity, Detoxification, Chemodetection, and Memory. Gauthier et al., in prep).

Results

Descriptive Statistics

The two parental strains showed an important difference for the two studied traits (Table 1). The Kobodo strain was the more efficient with a higher parasitism success and a higher offspring number. The parasitism success of the Kobodo clonal sibships (CSS) was equivalent to those of the Kobodo parental strain whereas the parasitism success of F2 and F8 Makindu CSS had an intermediate parasitism success. The offspring number of Kobodo CSS was far higher than the Kobodo parental strain and the offspring number of F2 and F8 Makindu CSS were close to those of the Kobodo parental strain. Data showed a highly significant correlation (Spearman's $\rho = 0.505$, p-value = 5.932×10^{-11} , calculated with all CSS) between the parasitism success and offspring number, suggesting a relationship between both traits. The broad-sense heritability varied between 23 and 36% for offspring number.

Table 1: Phenotypes of the parental strains and the clonal sibships (CSS) from the different backcrosses. \pm Standard deviation; n: number of female progenies analyzed; () number of clonal sibships; H^2 =Broad-sense heritability of offspring number.* Data from Benoist et al., 2017.

Data type	Parasitism Success		Offspring number		
Parental Kobodo*	78.70 %	n=108	71.07 \pm 24.06	n=71	
Parental Makindu*	36.20 %	n=80	36.48 \pm 16.68	n=21	
CSS from Kobodo F2	81.57 \pm 14.80 %	n=789 (47)	91.05 \pm 17.54	n=457 (47)	$H^2=24\%$
CSS from Makindu F2	70.96 \pm 22.55 %	n=900 (45)	74.94 \pm 24.77	n=470 (45)	$H^2=36\%$
CSS from Makindu F8	64.00 \pm 20.24 %	n=1737 (89)	66.83 \pm 19.71	n=801 (88)	$H^2=23\%$

Marker selection and genotype identification

The number of loci identified by *Stack* varied considerably between the two approaches: 119,176 and 33,906 for *de novo* and reference-based respectively (Table 2). However, the number of remaining loci after the first filter step was equivalent between the two approaches, around 30,000, which was close to the 37,000 loci expected (based on the genome of the sister species *C. sesamiae*). This suggests that a large proportion of loci are splitted in different stacks with *de novo* approach. Among these 30,000 only a small fraction was polymorphic suggesting that the two strains are genetically close. The majority of the identified markers were shared between the two approaches, but more than 20% (123/566) were specific to one of them, which highlighted their complementarity. The median coverage was above 30 which is satisfying for reliable genotype inference. Only 4 markers showed segregation distortion. In total, 102,446 genotypes were inferred (181 samples x 566 markers). Among them around 1% were corrected based on *in silico* analysis and on manual resequencing. The comparison of *de novo* and reference-based approaches lead to the detection of 400 genotype discrepancies between the two approaches, which contributed to the improvement of the genotypic data. The final dataset comprised 3143 missing genotypes.

Table 2: Number of retained loci at each step of the loci selection and locus coverage. The locus coverage is given for the 566 markers used for the genetic map construction.

		Analysis	
		<i>De novo</i>	Reference based
Number of loci	Identified by Stacks	119,176	33,906
	Present in at least 70 samples	31,599	29,797
	Fixed in parental strains and polymorphic	541	507
	With at most 3 SNP	524	491
	Without segregation distortion	522	487
	Analysis specific	79	44
	Used for linkage map construction		566
	Retained in final linkage map		465
Marker coverage per sample	Mean	35.55	49.32
	Median	32	34

Linkage map

The final linkage map generated from F2 data after removing redundant loci is presented in Figure 2 and in supplementary data 1. It includes 10 linkage groups, which is consistent with the number of chromosomes identified in *C. typhae* (Christophe Bressac, personal communication) indicating that the map is saturated. In addition, each linkage group matched to one chromosome from *C. congregata*. The linkage map comprises 465 markers spanning a total length of 1300 cM with an average distance of 2.7 cM between two consecutive markers.

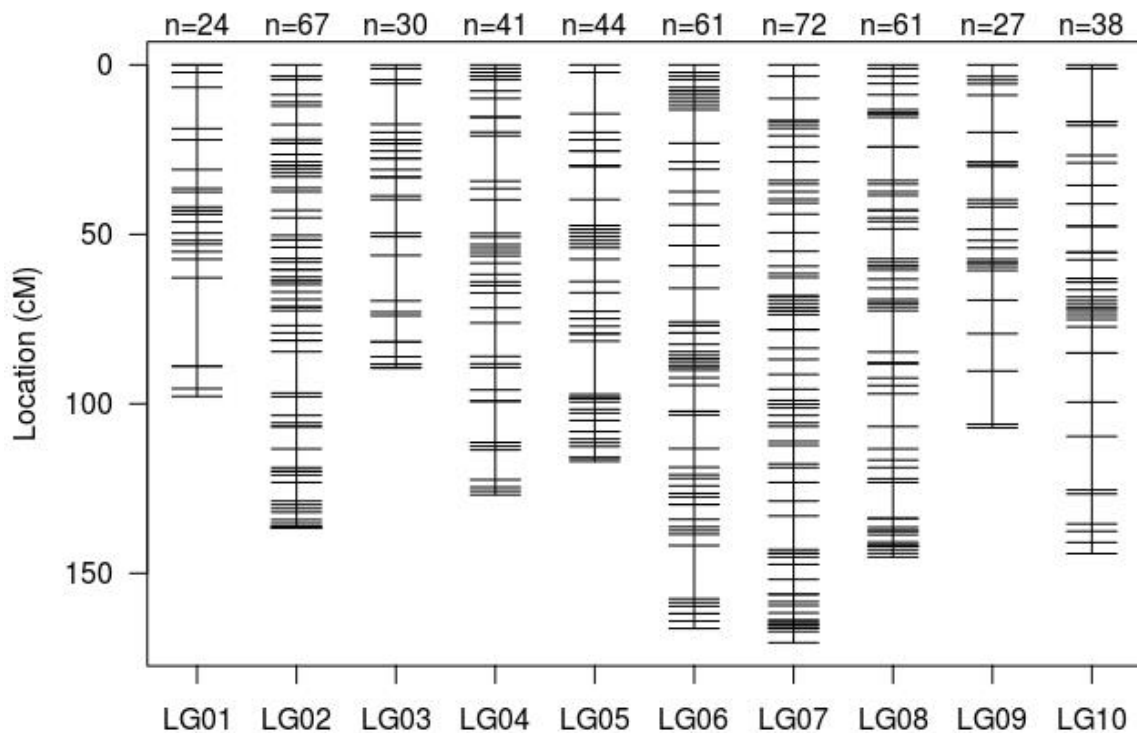

Figure 2: *Cotesia typhae* linkage map based on RAD genotyping of 92 F2 clonal sibships. The linkage map includes 465 markers, n=number of markers by linkage group (LG). Genetic distances are calculated using Kosambi's map function.

QTL mapping for parasitism success and offspring number

Three QTLs were identified for parasitism success (PS) and two for offspring number (ON), localized on linkage groups 4 and 6 and on the linkage groups 4 and 5 respectively (Figure 3). One peak for parasitism success was not retained (linkage group 1, two QTL scan) because it observed in the first scan only and was located in a region with low marker density. The QTL observed on the linkage group 5 was common to the two phenotypic traits. The length of the QTL confidence intervals varied from 9 to 38 cM (Table 3). For both phenotypic traits, the pairwise interactions between observed QTLs were not significant. An overdominance effect is observed for all offspring number QTLs whereas QTL1-PS and QTL3-PS are associated with respectively underdominance and partial dominance of Makindu alleles. The QTL2-PS is strictly additive. The percentage of the phenotypic trait variance explained by each QTL varied between 4 and 14 %. The total phenotypic variance explained reached 27.7 % for parasitism success and 23.9 % for offspring number.

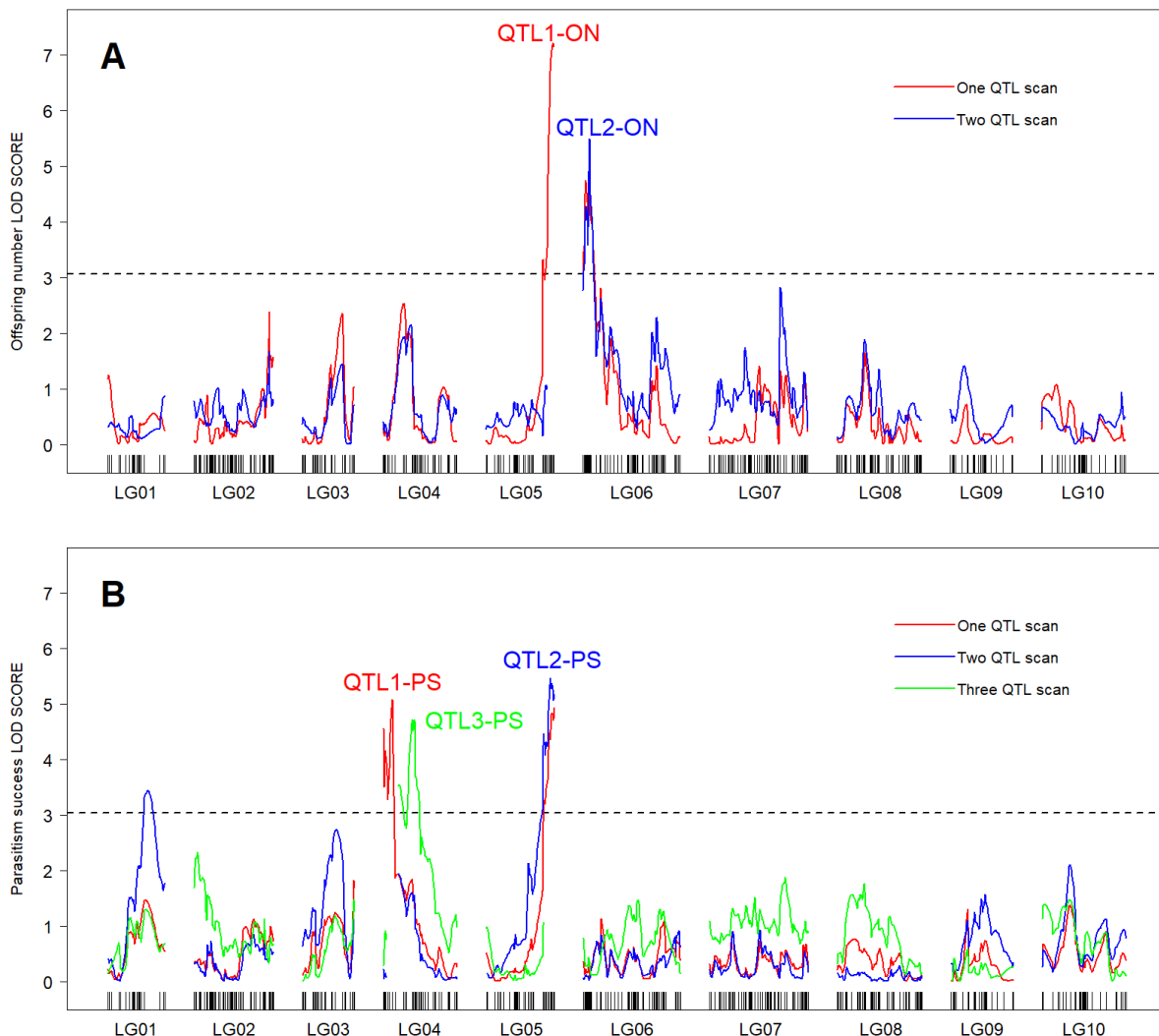

Figure 3: Locations of (A) offspring number and (B) parasitism success quantitative trait loci (QTL) along the *Cotesia typhae* linkage groups (LG). LOD SCORES are calculated from generalized linear models (GLM). The black dotted line corresponds to the QTL threshold calculated by 2000 permutations. Successive scans were performed for each linkage group. In One QTL scan, we hypothesized that only one QTL occurred in the genome. The highest peak was then included in the two QTL scan to search for a second QTL. The process was repeated until no other significant peak was detected. Colored lines correspond to each QTL scans performed where significant peak was detected.

Table 3: Position, confidence interval, coefficient estimates and percentage of the total phenotypic variance explained of each QTL detected. Additive effect corresponds to the effect of one Kobodo allele. *The percentage of the total phenotypic variance explained by the dominance component of the QTL2-PS was not calculated due to the lack of significance of this component in the QTL model.

		Phenotypic trait				
		Offspring number		Parasitism success		
QTL name		QTL1-ON	QTL2-ON	QTL1-PS	QTL2-PS	QTL3-PS
Linkage group		LG05	LG06	LG04	LG05	LG04
Peak position		115 cM	11 cM	15 cM	110 cM	50 cM
Confidence interval		108-117 cM	3-17 cM	0-18 cM	98-117 cM	22-60 cM
Coefficient estimates	Additive effect	6.08	1.53	0.02	0.16	-0.16
	Dominance effect	9.67	10.47	-0.17	-*	0.08
% Total phenotypic variance explained	Additive component	7.57 %	2.53 %	4.68 %	11.15 %	3.50 %
	Dominance component	6.60 %	7.20 %	7.62 %	-*	0.75 %
	Total by QTL	14.17 %	9.73 %	12.30 %	11.15 %	4.25 %
	Total	23.9 %		27.7 %		

Identification of genes within QTL intervals

To identify candidate genes, markers in QTL intervals were mapped on the annotated genome of *C. congregata*. Cumulative length of all QTL intervals represented around 11.7 Mb (Table 4) which corresponds to ~5.9 % of the genome length and comprises 435 genes (Supplementary data 2) with a putative function. This list of genes was inspected based on literature data. We focused on studies (mainly genomic and transcriptomic studies) that identified genes influencing reproductive success in other parasitoid species. From these studies, 68 genes of interest were identified and are listed in Table 5. Among them we found notably Bracovirus genes involved in the production of viral particles and in the inactivation of the host immune system (Gauthier et al., in prep). Some genes producing venom components were also identified (Ali et al., 2015; Arvidson et al., 2019; Burke and Strand, 2014; Colinet et al., 2013; Danneels, 2010; Moreau and Asgari, 2015; Sim and Wheeler, 2016). Finally, we reported genes highly expressed in ovaries of *C. congregata* (Gauthier et al., in prep) and *N. vitripennis* (Sim and Wheeler, 2016) or differentially expressed between resting and ovipositing females of *N. vitripennis* (Pannebakker et al., 2013).

Table 4: Summary of gene identification in quantitative trait loci (QTL) intervals based on the annotated genome of *C. congregata*. Overlapping QTLs (QTL1-ON and QTL2-PS) was considered as a single interval.

QTL name	<i>C. congregata</i> fragment length	Number of genes		
		Automatically annotated	Manually annotated	Total
QTL1-PS	~ 1.3 Mb	47	15	62
QTL3-PS	~ 3.7 Mb	105	37	142
QTL1-ON + QTL2-PS	~ 4.2 Mb	113	25	138
QTL2-ON	~ 2.5Mb	90	3	93

Table 5: Genes of interest in quantitative trait loci (QTL) intervals. Overlapping QTL (QTL1-ON and QTL2-PS) was considered as a single interval. Genes of interest were classified in four categories. Bracovirus (Proviral genes), Bracovirus (Nudiviral genes) and Venom categories refer to parasitoid weapon arsenal. The “other” category comprises genes selected because they are actively transcribed in ovaries of *C. congregata* (Gauthier et al., in prep) and *N. vitripennis* (Sim and Wheeler, 2016) or differentially expressed between resting and ovipositing females of *N. vitripennis* (Pannebakker et al., 2013).

QTL name	Genes of interest
QTL1-PS	Venom: alkaline phosphatase-like; disintegrin and metalloproteinase domain-containing protein 9; Transmembrane protease serine 9-like Other: btb poz domain-containing adapter for cul3-mediated degradation protein 3; 60s ribosomal protein l10; 60s ribosomal protein l23a
QTL3- PS	Bracovirus (Nudiviral genes): 27b; 35a ₁ ; 35a ₂ ; 38K; GbNVorf19; HzNVorf106; HzNVorf9_1; HzNVorf9_2; HzNVorf94; Int ₁ ; K425_438; K425 445; K425 456; K425 459; K425 461; P6.9 ₁ ; P6.9 ₂ ; pif3; pif6; PmNVorf87; PmV; ToNVorf29; ToNVorf54 ₁ ; ToNVorf54 ₂ ; vp39 Other : Putative mediator of RNA polymerase II transcription subunit 12; 40s ribosomal protein s15aa
QTL1-ON + QTL2-PS	Bracovirus (Proviral genes): bv20.1.26.4; bv20.2.26.8; ep1.1.1.3; ep1.2.1.4; ep1.3.1.5; ptp a.26.6; ptp b.1.1; ptp d.1.11 pseudo; ptp delta.26.1; ptp epsilon.26.7 pseudo; ptp i.1.2; ptp k.1.6; ptp l.1.7; ptp m.1.8; ptp p.1.9; ptp q.1.10; vank 5.26.2; vank 6.26.3b; vank 9.26.5 Venom: calcium-independent phospholipase a2; adenosine deaminase-like protein; cysteine-rich with EGF-like domain protein 2; serine protease inhibitor; serpin B4-like; serpin B6-like Other: plasminogen activator inhibitor 1 RNA-binding protein; BTB/POZ domain-containing protein 7; sorting-nexin 24-like; sorting-nexin 6; zinc finger and BTB domain-containing protein 41-like; 60S ribosomal protein l13; 60S ribosomal protein l18a
QTL2-ON	Venom: cysteine-rich secretory protein 2-like Other: guanine nucleotide-binding protein subunit beta-like protein; 60S ribosomal protein l5

Discussion

The aim of this paper was to investigate the genetic basis of the reproductive success of *C. typhae* using Kobodo and Makindu Kenyan strains that diverge for their parasitism success and offspring number from a new host population from France. For this purpose, crosses between these two strains were performed to generate 181 F2 and F8 recombinant clonal sibships which were phenotyped and genotyped using RAD-seq technology. From these data, a linkage map was built and several QTLs involved in the variation of offspring number and parasitism success were identified.

The linkage map obtained is, to our knowledge, the first available for a *Cotesia* species. The high quality of this linkage map is supported by multiple results. First, except one marker, all those used for the linkage map construction were placed on a linkage group. Furthermore, the number of linkage groups corresponds to the number of chromosomes observed in *C. typhae* (Christophe Bressac, personal communication) and a clear correspondence between linkage groups and chromosomes of *C. congregata* was observed (Supplementary data 1). Thus, it is likely that each linkage group corresponds to one chromosome of *C. typhae*. The length of the genetic map is 1300 cM (Figure 2). Dividing the length of the linkage map by the length of the genome, estimated at ~ 200 Mb (Based on the genome sizes of *C. congregata* and the sister species *C. sesamiae*. (Gauthier et al., in prep), the recombination rate of *C. typhae* was estimated at 6.5 cM/Mb. This recombination rate is in line with the average recombination rate of insects (Stapley et al., 2017). The 465 markers in the map were rather well distributed on the linkage groups. On average there is one marker each 2.3 cM, which corresponds to one marker each 400 Kbp on the genome. This is favorable for QTL detection and confirms the interest of using RAD-seq to generate markers. This genetic map will be useful for further studies, for instance for the ongoing assembly of *C. typhae* genome.

Our analysis allowed to detect 4 distinct QTLs (Table 4): two specific to parasitism success on linkage group 4, one specific to offspring number on linkage group 6 and one common to both traits on linkage group 5. In our QTL models the percentage of the phenotypic variation explained by all QTLs was 27.7 % for parasitism success and 23.9 % for offspring number. These values can be compared to the broad-sense heritability. This last parameter could be only estimated for the offspring number and for each backcross type separately. It varied between 23 and 36% indicating that QTL approach succeeded to explain almost all the expected genetic effect. The percentages calculated comprise additive components that may be targeted by selection but also dominance ones. Taking into account only the additive components to calculate a narrow-sense heritability we obtain 10.1% and 19.3% of the total phenotypic variance explained for offspring number and parasitism success respectively. These values are in line with those measured for fitness related traits in other organisms (Gavrus-Ion et al., 2017; Hoffmann et al., 2016; Mousseau and Roff, 1987; Visscher et al., 2008). Heritability estimates presented in these papers range mainly around 10 % and mostly below 20% for life history traits. This result is assumed to arise from strong selective pressure, stronger for traits closely related to fitness, which should have reduced additive genetic variance. This conclusion was questioned because heritability is a ratio between variances and not a direct measure of variability. Low heritability may thus result from high environmental and non-additive variance and not necessarily from low additive genetic one. Houle (1992) proposed another index to better approach the magnitude of additive variance, namely the evolvability index, that is the ratio between the additive genetic variance and the squared mean of the trait studied. This index is difficult to interpret for binominal traits (Hoffmann et al., 2016) such as parasitism success thus it was estimated only for the offspring number to 0.84%. This estimate is also low in agreement with published data (Hansen et al., 2011; Hoffmann et al., 2016) and confirms that reproductive traits are highly constrained and poorly evolvable. The magnitude of the variability for environmental and non-additive genetic components may also be questioned. Many factors like, for instance, host size and quality are known to influence the parasitism success and offspring number of parasitoid species (Godfray, 1994; Quicke, 2014). Even if insects were reared in stable laboratory conditions, using only 3-week-old host, some variation is unavoidable. We calculated

the coefficient of residual variance (residual including all terms apart additive ones) - CVR - for the offspring number and obtained an estimate of 27%. This value is in the upper range of CVR estimated for various traits from livestock (Hoffmann et al., 2016) or natural populations (Houle, 1992) and is common for life history trait. Whether or not this variation is adaptive, it is not deductible from our data.

The detection of a QTL shared between parasitism success and offspring number (Table 4) is consistent with the high correlation detected between both traits (Spearman's $\rho = 0.505$, p -value = 5.932×10^{-11}). In parasitoid species, offspring number depends on (i) the number of oviposition events, which is related to the number of hosts encountered (fixed at one in our experiment), (ii) the number of eggs laid in/on the host by the female and (iii) the parasitoid larval survival rate. This latter component, as parasitism success, is directly connected to parasitoid ability to bypass host immune system. In addition to this natural correlation between parasitoid success and number of offspring, some authors have even suggested that parasitoid females injecting more eggs enhance the survival rate of their larvae (Kapranas et al., 2012).

In a previous study we found that the number of eggs injected in the host varied between Kobodo and Makindu females (Benoist et al., 2017). We also demonstrated that this was the result of a reproducible difference in the behavior strategy of eggs distribution along successive host encountered (Benoist et al., submitted). Thus, we expected to find genes related to the oviposition behavior especially in the QTL specific to offspring number. In QTL1-ON and QTL2-ON we found notably genes (Table 6, other category) which are highly expressed in ovaries of *C. congregata* (Gauthier et al., in prep) or in ovaries of *N. vitripennis* (Sim and Wheeler, 2016) and genes differentially expressed between resting and ovipositing females of *N. vitripennis* (Pannebakker et al., 2013). However, no relationship between these genes and oviposition behavior was reported. The main limitation of this analysis regarding oviposition behavior is that very few genes influencing this trait are known despite the important amount of studies on this topic. It is probably due to the complexity of behavioral traits that involved a huge quantity of genes complicating their study (Flint et al., 2010). A refined annotation of genes in the QTL intervals is therefore required to identify candidate genes.

Genes belonging to the bracovirus were found in the common QTL and in the QTL3-PS (Table 6). Into the wasp genome the bracovirus is organized in two types of regions. The first one corresponds to genes from a nudiviral origin (nudiviral genes) encoding the viral RNA polymerase and proteins involved in the bracovirus particle production. Half of the nudiviral genes are clustered in one region, called nudiviral cluster (Bézier et al., 2009a, 2009b). The second type corresponds to proviral segments used for the production of viral circle contained in viral particles and harboring virulence genes. In *C. congregata*, 35 proviral segments organized in 9 proviral loci (PL) were identified. About two-third of the proviral segments are localized to the same locus called macrolocus comprising PL1 and PL2 while other are dispersed in wasp genome (Bézier et al., 2013).

In the QTL common to both traits we found proviral genes: BV20 genes and genes belonging to EP1-like, PTP and Vank families for which some members are known as virulence factors (Gueguen et al., 2013; Kwon and Kim, 2008; Pruijssers and Strand, 2007). These genes are localized in the PL5 and PL8 producing the circles 1 and 26 respectively. These two circles are of particular interest. It was shown in *Cotesia congregata-Manduca sexta* system that they could integrate into host genome (Chevignon et al., 2018). They are produced in higher amount than others and are particularly active in the host. For instance EP1-like genes and Vank9 are among the most expressed in host haemocytes following parasitism (Chevignon et al., 2014). Genes on these circles are thus good candidates to explain the difference of parasitism success and offspring number between Kobodo and Makindu parasitoid strain. Interestingly, no QTL was detected in the macrolocus region, which concentrates the majority of proviral genes and was shown to encompass genes under positive selection associated with adaptation to the host (Gauthier et al., 2018; Jancek et al., 2013).

Many studies on virulence, with respect to bracovirus, focus on proviral genes but much less focus on nudiviral genes. Interestingly, the QTL3-PS encompasses the nudiviral cluster. Among the genes in this QTL some have a characterized function based on homology with baculovirus genes: Pif3 and Pif6 play a role in virus infection; VP39 and 38K produce major component of viral capsid (Bézier et al., 2009a; Herniou et al., 2003). It was observed in Benoist et al., submitted that the amount of viral particles injected in the host did not explain the difference in parasitism success between Kobodo and Makindu parasitoid strains. The variation of parasitism success induced by this QTL could rather result from a difference in particle infective efficiency between the two *C. typhae* strains. It would be interesting to explore how Kobodo and Makindu bracovirus infect host cells.

In all QTLs, except in the QTL3-PS, we found genes associated to venom component. In polydnavirus-associated parasitoids, polydnavirus is considered as the main virulence factor. However, it was shown in many species harboring polydnavirus that venom is also required for successful parasitism and could synergize the effect of polydnavirus (Asgari, 2012; Kitano, 1986; Moreau and Asgari, 2015; Tanaka, 1987). So far, venom composition and function in parasitism is largely unknown in *C. typhae* and its sister species *C. sesamiae*. The wide presence of venom genes in the QTLs suggests that their role in virulence should be significant and deserves further investigations.

The goal of this analysis was to identify candidate genes. In total 68 genes of interest were retained, which is rather high to study accurately their implication in phenotypic variation in following works. The candidate gene identification was performed using the genome of *C. congregata* as a reference. This strategy may have led to some misidentification in particular due to some synteny losses between the two species (Supplementary data 1). This could be explained by the phylogenetic distance between *C. typhae* and *C. congregata* (Michel-Salzat and Whitfield, 2004). Ongoing genome sequencing and annotation of *C. typhae* will help to improve and maybe reduce the number of candidate genes. Further approaches like, for instance, comparative transcriptomics would also help to select among the list of genes presented here the more interesting candidates genes for functional analyses.

Conclusion

Studying the genetic basis of fitness traits as parasitism success and offspring number is of prime importance to understand parasitoid evolution. Here, we have described for the first time QTLs responsible for parasitism success in parasitoid. Furthermore, this study is only the second one dealing with genetic determinism of offspring number in parasitoids (Pannebakker et al., 2011). This work led to the construction of a genetic map that is now available for the community and will help in the genome assembly of *C. typhae*. It also allowed to identify a list of genes of interest including notably bracovirus and venom genes. The detection of those well-known components of parasitoid virulence gives strong support to the strategy presented here. Despite the number of genes pointed out is quite large, their location is restricted to well-defined genomic regions. It will be interesting in further investigations, such as transcriptomic and detection of signature of selection to focus on these regions to complete the characterization of the two strains. The probable influence of nudiviral genes - and therefore of viral particles infectivity - as well as the influence of venom components in the phenotypic variation between the two strains of *C. typhae* are notably interesting directions for further researches in host adaptation in parasitoids.

Acknowledgements

We thank Odile Giraudier and Sylvie Nortier for insect rearing at Gif, Julius Obonyo for field collection in Kenya, Matthieu Bodet, Florian Decourcelle, Maxime Villoing and Laurence Signon for their contribution to the crosses and phenotyping, Maud Silvain, Claude Thermes, Delphine Naquin and Yan Jaszczyszyn from the I2BC sequencing facility for the RAD-sequencing, Florence Prunier for her methodological advices, Damien Delafoy for his preliminary work on RAD-seq data, Cécile Courret for her help in QTL analysis, Jérémy Gauthier for his advices on sequencing data analysis and his help with the annotated genome of *C. congregata*, Lionel Saunois, Amandine Dubois and Virginie Héraudet for maize production and Malcom Eden for linguistic editing of the manuscript.

Author contributions

Conceptualization: R.B., S.D., F.M.;

Methodology: R.B., C.C-D., L.M, A.L.R., L.K., F.M.;

Software: R.B., C.C-D., F.M.;

Validation: R.B, C.C-D., F.M.;

Formal analysis: R.B., C.C-D., L.M, A.L.R., F.M.;

Investigation: R.B., C.C-D., C.C., R.J., P-A.C., E.V.D., L.K., F.M.;

Resources: B.L.R, P-A.C, J-M.D., L.K.;

Data curation: R.B, C.C-D., F.M.;

Writing - original draft: R.B, F.M.;

Writing - review & editing: [...] A.L.R, P-A.C., E.V.D., S.D., B.L.R, L.K.;

Supervision: L.K., F.M.;

Project administration: L.K.;

Funding acquisition: L.K.

Funding

This work was supported by the French National Research Agency (ABC Papogen project ANR-12-ADAP-0001 and project Cotebio ANR-17-CE32-0015), and by the authors' operating grants from IRD, CNRS, and icipe. R. Benoist is funded by the « Ecole doctorale 227 MNHN-UPMC Sciences de la Nature et de l'Homme: évolution et écologie ». The funders had no role in study design, data collection and analysis, decision to publish, or preparation of the manuscript.

Supplementary information

All experimentations were realized under the juridical frame of a Material Transfer Agreement signed between IRD, icipe and CNRS (CNRS 072057/IRD 302227/00) and the authorization to import Cotesia in France delivered by the DRIAAF of Ile de France (IDF 2017-OI-26-032).

Chapitre IV – Déterminisme du sexe chez *C. typhae*

I) Introduction

Note : Les expérimentations présentées dans ce chapitre ont été menées de manière exploratoire suite à l'obtention de résultats inattendus. Les résultats présentés ici sont préliminaires.

Dans le genre *Cotesia* le déterminisme du sexe a été étudié seulement chez quelques espèces mais montre un pattern intéressant. La présence d'un mécanisme de type CSD (voir chapitre I) a pu être montré pour *C. glomerata* (*sl*-CSD) et *C. vestalis* (*ml*-CSD) (de Boer et al., 2008; Zhou et al., 2006). Chez *C. flavipes* et *C. sesamiae* en revanche ce mécanisme ne semble pas présent (Niyibigira et al., 2004a, 2004b). Ces études montrent que le mécanisme à l'origine de la détermination du sexe est variable dans le genre et peut donc évoluer assez rapidement.

Chez *C. typhae* le mécanisme à l'origine de la détermination du sexe est inconnu. Cependant certaines observations permettent d'exclure un mécanisme de type CSD. En effet, pour *C. typhae* le sexe-ratio, bien que très variable d'une descendance à l'autre, est très stable en moyenne au cours du temps malgré que les souches soient élevées en lignée iso-femelle (chaque génération est générée par une femelle accouplée avec ses frères) depuis de nombreuses générations. Si on compare les sexe-ratios moyens obtenus dans les articles 1 et 2 on n'observe pas de différence bien que les individus soient séparés par plusieurs dizaines de générations de consanguinité. Cette stabilité suggère que le mécanisme impliqué dans le déterminisme du sexe n'est pas de type CSD chez *C. typhae* car si c'était le cas la proportion de mâle devrait augmenter avec la consanguinité dû à l'apparition de mâles diploïdes. (Heimpel and de Boer, 2008)

Lors d'expérimentations conduites au cours de cette thèse nous avons pu mettre en évidence de manière fortuite que chez *C. typhae* les femelles vierges sont capables d'engendrer des femelles. A partir de cette observation nous avons décidé de caractériser la fréquence de ce phénomène et de regarder si les femelles issues de vierges étaient viables et fertiles.

II) Matériel et Méthodes

Les protocoles d'élevage et de parasitage sont les mêmes que ceux décrits dans les articles 1 à 3. Dans cette expérience des chenilles de *S. nonagrioides* (souche Makindu) ont été utilisées comme hôte.

Des femelles *C. typhae* de 1 jour issue des lignées Kobodo et Makindu de 1 jour, préalablement isolées au stade cocon pour être gardées vierges, ont été mises à pondre chacune sur une chenille hôte. Les femelles issues de ces femelles vierges (uniquement pour la souche Makindu) ont été laissées pendant 1 jour avec leurs frères pour pouvoir s'accoupler et ont ensuite été utilisées pour le parasitisme. A chaque

fois que le parasitisme a donné lieu à un développement de *C. typhae*, le nombre de descendants a été compté.

III) Résultats

Dans presque 60 % des descendance de femelles vierges on observe la présence d'au moins une femelle. Sur les 17 descendance, le taux d'apparition des filles (nombre de filles totales / nombre de descendants viables total) est de 1,40 %. Le nombre maximum de filles observées dans une descendance de mère vierge est de 5 (Tableau 3).

Tableau 3 – Nombre de mâles et de femelles dans les descendance de femelles vierges. Chaque femelle a pondu une fois dans un seul hôte.

N° femelle	Souche <i>C. typhae</i>	Nombre de mâles	Nombre de femelles
1	Makindu	80	3
2	Makindu	65	0
3	Makindu	98	1
4	Makindu	91	0
5	Makindu	114	2
6	Makindu	133	1
7	Makindu	89	2
8	Makindu	52	0
9	Makindu	66	0
10	Makindu	82	1
11	Makindu	94	2
12	Makindu	95	5
13	Makindu	108	2
14	Makindu	123	0
1	Kobodo	64	0
2	Kobodo	45	0
3	Kobodo	101	3

Nous avons laissé les filles issues de mères vierges s'accoupler avec leurs frères et elles ont été capables de produire des descendance composées de mâles et de femelles. On peut supposer que les descendance contenant majoritairement des femelles sont issues de femelles s'étant accouplées avec leurs frères et que les autres sont issues de femelles ne s'étant pas accouplées (Tableau 4), indiquant que ces filles issues de vierges sont capables de se reproduire normalement.

Tableau 4 – Nombre de mâles et de femelles dans les descendance de filles issues de mère vierges. Chaque femelle a pondu une fois dans un seul hôte.

N° femelle	Souche <i>C. typhae</i>	Nombre de mâles	Nombre de femelles
1	Makindu	3	28
2	Makindu	98	1
3	Makindu	6	44
4	Makindu	82	0
5	Makindu	6	41
6	Makindu	74	0
7	Makindu	14	15
8	Makindu	24	47
9	Makindu	14	39
10	Makindu	79	0
11	Makindu	55	0

IV) Discussion

Nous avons pu montrer via ces expériences l'existence d'une forme de parthénogénèse chez *C. typhae* permettant la production de femelles viables et fertiles à partir de femelles vierges. Dans le genre *Cotesia* c'est la première fois à notre connaissance que ce phénomène est observé. La production de femelles par des femelles vierges est attestée dans de nombreuses espèces d'hyménoptère (Cole-Clark et al., 2017; Foray et al., 2013; Gadagkar, 2004; Leach et al., 2009). Cependant chez ces espèces, la parthénogénèse est de type thélytoque, c'est-à-dire que les femelles vierges ne produisent que des femelles. Notre système est donc particulier de par la fréquence très faible d'apparition des femelles dans la descendance de femelles vierges. A notre connaissance le seul cas comparable a été observé chez *Nasonia vitripennis*. Beukeboom et al. (2007) ont montré que dans une population canadienne environs 10% des œufs non fécondés se développent en individus gynandromorphe (ayant à la fois des caractéristiques mâles et femelles) haploïdes. Cette population présente un gradient antéro-postérieur de féminisation allant d'individus possédant uniquement des antennes de type femelle à des individus ayant une morphologie complètement de type femelle. Cependant, contrairement à *C. typhae*, moins de 1% des femelles issues de vierges chez *N. vitripennis* sont capables de produire une descendance.

Ces travaux posent la question du mécanisme de détermination du sexe chez *C. typhae*. Afin d'apporter des éléments de réponses à cette question il serait intéressant de regarder le niveau de ploïdie des femelles issues de vierges. Si les femelles sont haploïdes, il faudrait voir à quel point le mécanisme de déterminisme du sexe peut ressembler à celui observé chez *N. vitripennis* de type empreinte génétique (voir chapitre I). Si ces femelles sont diploïdes, leur production pourrait résulter d'une anomalie de ségrégation à la méiose, ou d'une fusion des gamètes comme observé chez les espèces faisant de la parthénogénèse thélytoque (Leach et al., 2009). Une autre approche pourrait être d'étudier ce

phénomène sur des populations naturelles. Cela permettrait de voir notamment si la production de femelles par des vierges est liée à la consanguinité très importante dans nos élevages.

Une autre question soulevée, mais à laquelle il est difficile de répondre pour le moment, est le potentiel rôle adaptatif de ce phénomène. En effet, en cas de fécondation insuffisante le mécanisme de production de filles par des femelles vierges serait avantageux et aurait pu être sélectionné.

D'un point de vue expérimental ces résultats sont également importants. En effet dans nos travaux sur *C. typhae* nous ne traitons pas les femelles non accouplées pour estimer le sexe-ratio et le nombre de descendants (voir articles 1 et 2). Dans l'ensemble des expérimentations réalisées l'accouplement n'a jamais été contrôlé et le statut d'accouplement d'une femelle est défini à partir de la descendance (présence ou non de femelles). Les femelles avec quelques filles dans leur descendance ont donc pu être considérées à tort comme des femelles fécondées et prise en compte dans nos estimations ce qui pose la question du traitement de ces données à l'avenir (Figure 13)

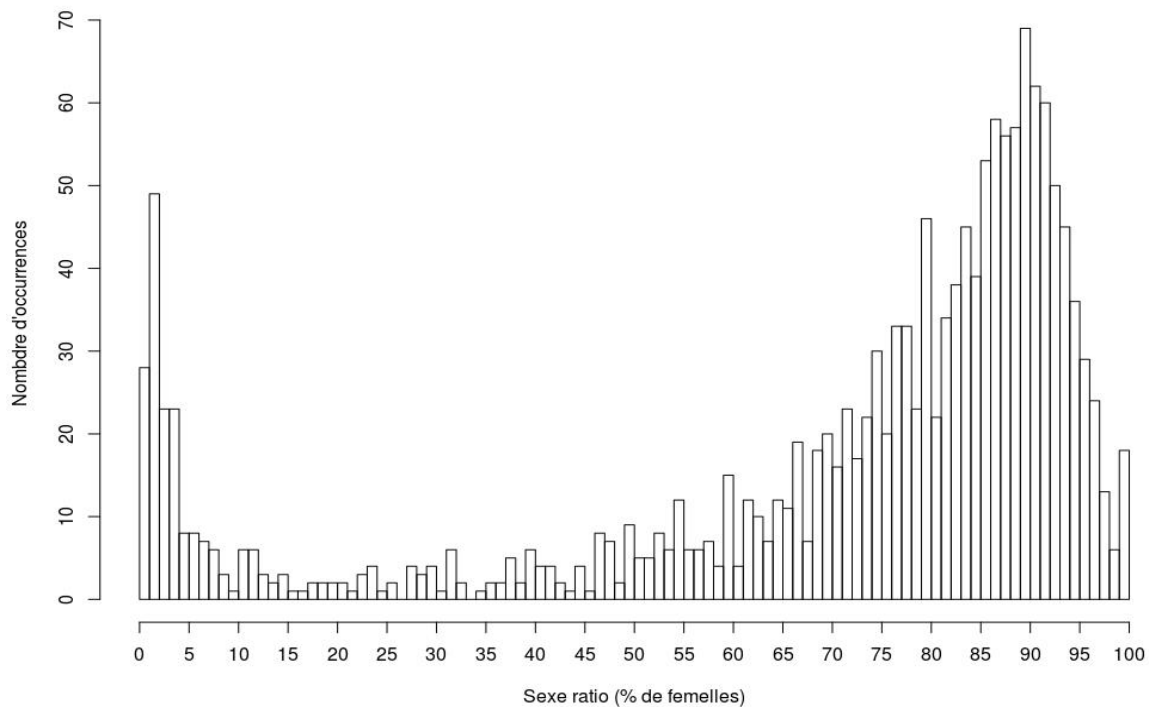

Figure 13 - Distribution du sexe-ratio (% de femelles) chez *C. typhae*. Les données présentées sont issues des descendance des clonal sibships (voir chapitre précédent). Seules les descendance avec au moins une femelle ont été incluses dans cette figure. Le premier pic pourrait correspondre à des descendance de femelles non accouplées.

Enfin ce mécanisme de parthénogénèse a été mis en évidence chez des femelles vierges car on ne s'attend pas à retrouver des femelles dans leurs descendance. Cependant, il est également envisageable qu'une partie des filles de femelles accouplées ai été produite non pas via la fécondation des ovocytes mais par ce mécanisme. Auquel cas toutes les filles produites par une femelle ne seraient pas équivalentes génétiquement. Il serait donc intéressant de voir si ce phénomène a également lieu chez les femelles accouplées.

Chapitre V – Discussion et perspectives

Dans la perspective de mieux comprendre les mécanismes intervenant dans le succès reproducteur des parasitoïdes et dans leur adaptation à l'hôte, je me suis intéressé à l'hyménoptère Africain *Cotesia typhae*. Nous avons pu montrer qu'au sein de cette espèce de parasitoïde, deux souches, appelées Kobodo et Makindu, diffèrent dans leur capacité à parasiter une population française de *S. nonagrioides*, qui constitue un nouvel hôte. En effet, ces deux souches diffèrent sur de nombreux traits impliqués dans le succès reproducteur tels que le nombre d'œufs injectés dans l'hôte, le succès de parasitisme et le nombre de descendants.

L'objectif global de ma thèse était d'identifier les mécanismes comportementaux, physiologiques et génétiques responsables de cette différenciation intra-spécifique du succès reproducteur.

Afin d'identifier les gènes responsables de la variation du succès de parasitisme et du nombre de descendants nous avons entrepris une recherche de QTL (Quantitative Trait Loci). Pour cela, des croisements entre individus Kobodo et Makindu ont été réalisés afin de produire des mâles F2 et F8 recombinants qui ont ensuite été croisés avec des femelles des deux souches pour générer des femelles recombinantes clonales. Ces femelles ont été phénotypées et génotypées par séquençage RAD (Restriction site Associated DNA markers). L'analyse de ces données a permis dans un premier temps d'établir une carte génétique de *C. typhae* et ensuite d'identifier des QTL impliqués dans la variation du succès de parasitisme et du nombre de descendants. À partir du génome annoté de *Cotesia congregata* une liste de gènes candidats sous-jacents a pu être établie.

La comparaison des souches de *C. typhae* sur la population française de *S. nonagrioides* a montré que les femelles Kobodo, qui ont un meilleur succès de parasitisme, injectent dans la première chenille rencontrée plus d'œufs que les femelles Makindu, malgré une même fécondité initiale. Sachant que les particules virales et les œufs sont injectés en même temps dans l'hôte, nous avons émis l'hypothèse que les femelles Kobodo devaient injecter plus de particules virales ce qui expliquerait leur meilleur succès de parasitisme. Afin de vérifier cette hypothèse et de mieux comprendre la stratégie de ponte des deux souches nous avons comparé leur succès reproducteur et la quantité de virus injectés sur plusieurs pontes. Les résultats ont montré que la variation du succès de parasitisme ne dépendait pas de la quantité de virus injectés et que les deux souches ne répartissaient pas leurs œufs de la même manière entre les hôtes. Les femelles Kobodo injectent la majorité de leurs œufs dans le premier hôte, alors que les femelles Makindu les répartissent plus équitablement.

Contrairement aux femelles Makindu, les femelles Kobodo semblent pré-adaptées à la sésamie française en raison de leur haut succès de parasitisme. Dans le but de comprendre l'origine évolutive de cette différence nous avons mesuré le succès de parasitisme des deux souches sur leurs hôtes naturels. Les résultats suggèrent que de l'adaptation locale pourrait être à l'origine de la préadaptation de la souche Kobodo.

Ainsi la différenciation entre ces deux souches nous a permis de tester des hypothèses relatives aux composantes du succès reproducteur. Je discuterai les résultats acquis pour chacune de ces composantes et proposerai des perspectives d'études pour affiner l'identification des mécanismes en jeu.

I) Comportement de ponte

La ponte est précédée par une étape de reconnaissance de la chenille par le parasitoïde, sur la base de composés chimiques. Les femelles du complexe *Cotesia flavipes* sont capables de différencier des espèces propices ou non à leur développement (Obonyo et al., 2010a, 2010b). Cette reconnaissance de l'hôte semble médiée notamment par une enzyme digestive de la chenille, une alpha-amylase, qui déclenche l'examen antennaire, voir la ponte du parasitoïde. Cette protéine pourrait différer entre espèces hôtes et ainsi permettre leur discrimination par les femelles parasitoïdes (Bichang'a et al., 2018, 2018). L'attractivité pour le parasitoïde a été comparée entre espèces d'hôtes mais n'a pas été abordée à l'échelle des populations d'une même espèce hôte. La sésamie du maïs présente des populations plus ou moins propices au développement des deux souches de *Cotesia typhae*, mais ces dernières acceptent indifféremment les populations hôtes que nous leur avons présentées pour pondre. Plusieurs hypothèses peuvent expliquer cela : (i) les populations de chenilles ne seraient pas différenciées pour leurs composés régissant l'acceptation par *C. typhae* ; (ii) elles le seraient mais les femelles *C. typhae* ne percevraient pas cette différenciation, ou n'y répondraient pas ; (iii) les conditions de laboratoires ne permettraient pas de mettre en évidence les capacités de discrimination des femelles notamment parce que les chenilles sont élevées sur le maïs quand leur plante hôte est essentiellement *Typha domingensis* au Kenya. Des analyses biochimiques d'une part, et de choix d'autre part, permettraient de progresser dans ce questionnement.

Les résultats sur le nombre d'œufs pondus corroborent les observations sur les taux d'acceptation des différentes populations de chenille. En effet le comportement de ponte de chacune des deux souches ne semble pas varier en fonction de la population d'hôte présenté : la souche *C. typhae* de Kobodo pond toujours plus d'œufs que celle de Makindu indépendamment de l'origine géographique des populations hôtes. Nous avons également observé que pour chacune des souches de parasitoïdes la dynamique d'allocation des œufs sur des hôtes successifs ne varie pas entre les populations Française et de Makindu. Ce point reste à vérifier sur les chenilles de Kobodo. Lors de ma thèse le nombre d'œufs injectés a été estimé à plusieurs reprises avec des générations successives de *C. typhae* et nous avons toujours observé la même différenciation entre les souches de parasitoïdes. Le mode de répartition des œufs entre différents hôtes serait donc inhérent aux souches géographiques de *C. typhae*. Cette différenciation est également intéressante pour l'étude des mécanismes physiologiques de la ponte. La différence du nombre d'œufs pondus n'est pas simplement liée à la durée de la ponte qui est équivalente entre les deux

souches. La souche Kobodo pondant plus d'œufs, sa fréquence d'injection serait plus grande. Mieux connaître les mécanismes physiologiques et métaboliques de cette différenciation pourrait fournir des guides pour la recherche de gènes impliqués. Plusieurs approches expérimentales peuvent être envisagées, comme l'étude anatomique précise du tractus génital. Par exemple le rythme de ponte pourrait dépendre du diamètre de l'ovipositeur, ou de l'activité neuromusculaire. Des méthodes pour mesurer cette activité ont été développées chez la punaise hématophage *Rhodnius prolixus* (Chiang and O'Donnell, 2009) et le criquet *Schistocerca americana* (Thompson, 2018) et pourraient être mises à profit pour la description physiologique du processus de ponte chez *C. typhae*. Pour mieux caractériser le mécanisme d'injection des œufs, il serait utile d'étudier les mouvements de l'ovipositeur dans la chenille lors du passage des œufs, par une technique d'électrophysiologie, à l'image de l'électropénétrographie utilisée notamment chez les espèces de pucerons pour mesurer les mouvements du stylet dans les tissus de la plante et ainsi analyser leur comportement alimentaire (Garzo et al., 2016).

D'un point de vue évolutif, un autre intérêt de ce travail de thèse est d'avoir mis en évidence une différenciation inter-populationnelle du comportement d'allocation des œufs au fil des pontes. La stabilité de ce comportement comme décrit ci-dessus montre qu'il est vraisemblablement déterminé génétiquement, ouvrant la voie vers l'étude des gènes et fonctions biologiques impliquées. Le caractère adaptatif de cette différence génétique est difficile à dégager du fait du peu d'informations dont nous disposons sur les environnements respectifs des souches de *C. typhae* étudiées. Il faudrait donc pouvoir estimer le nombre moyen de pontes dans chacun des environnements de Kobodo et Makindu, sur la base des densités de populations hôtes, de leur comportement de défense, et de l'importance de la compétition entre parasitoïdes.

II) Sexe-ratio et déterminisme du sexe

Les sexes ratio moyens observés chez *C. typhae*, très biaisés en faveur des femelles, correspondent à ce qui est classiquement observé chez les insectes haplo-diploïdes grégaires, et interprété comme le fruit d'une sélection (Local Mate Competition). Ce trait n'est pas différencié entre les souches de Kobodo et de Makindu, et ne dépend pas non plus de la population hôte. Les moyennes ont été estimées à plusieurs reprises au cours de la thèse et sont reproductibles (voir articles 1 et 2), mais cachent une importante variabilité inter-individuelle. Celle-ci pourrait provenir du fait que les accouplements n'ont pas été contrôlés avant utilisation des femelles pour les expériences. En effet cette utilisation avait lieu 24h après l'émergence, ce qui laisse la possibilité que les femelles aient été accouplées un nombre variable de fois. Nos observations (non publiées) montrent que les femelles *C. typhae* refusent de se ré-accoupler dans un laps de temps d'environ 1h après un premier accouplement. Cependant cela n'exclut pas plusieurs accouplements en 24h. Un argument pour cette hypothèse est le fait que dans une étude de

descendances issues de femelles accouplées une seule fois avec des mâles vierges, des sexe-ratios équilibrés ont été observés pour *C. typhae* (Kaiser et al., 2015). Il est donc possible que la quantité de sperme soit limitante pour la production d'un grand nombre de femelles dans le cas d'un accouplement unique. Une deuxième source de variabilité peut être la quantité de spermatozoïdes transférés par chacun des mâles fécondants. En effet des études chez d'autres Hyménoptères parasitoïdes ont montré que celle-ci diminuait au fil des accouplements du mâle (Boivin, 2013; Bressac et al., 2009, 2008). Ainsi une femelle s'accouplant avec un mâle ayant déjà fécondé plusieurs femelles recevra sans doute moins de spermatozoïdes qu'une femelle s'accouplant avec un mâle vierge. Nous avons aussi très régulièrement observé des descendances de femelles restées vierges malgré la présence de mâles dans leur cage. Dans la perspective d'étudier le sexe-ratio de manière plus précise, il apparaît donc nécessaire de contrôler les accouplements.

Le fait que le nombre de spermatozoïdes stockés dans la spermathèque puisse limiter le nombre de filles dans la descendance est aussi illustré par le fait que la proportion de filles dans les descendances diminue au cours des pontes successives, entre lesquelles les mères n'ont pas eu la possibilité de se ré-accoupler. Ce résultat peut paraître étonnant compte tenu de données récentes sur le nombre de spermatozoïdes retrouvés dans la spermathèque à l'issue d'un accouplement, estimé à 250 (Kifouche et Bressac, données non publiées). Ce nombre suffirait à féconder tous les ovocytes pondus par une femelle. Si la faible proportion de femelles à l'issue d'un accouplement unique reflète un déficit en spermatozoïdes, il y aurait donc une perte de spermatozoïdes dans les voies génitales femelles. Des études sont envisagées pour estimer l'évolution du transfert de spermatozoïdes dans la spermathèque au fil des accouplements successifs.

L'étude de la descendance des femelles vierges chez *C. typhae* a révélé des singularités chez cette espèce. Un résultat très original de cette thèse est la découverte de la capacité des femelles vierges à produire quelques filles au sein d'une descendance essentiellement constituée de mâles, ces filles pouvant s'accoupler et produire une descendance. A notre connaissance cela n'a jamais été observé chez des insectes haplo-diploïdes. En effet, si la production de filles par des femelles vierges existe chez ceux-ci, les descendances sont alors uniquement composées de femelles, et on parle de parthénogénèse thélytoque (Heimpel and de Boer, 2008). Si le mécanisme générant ces rares filles de femelles vierges est inconnu et questionne le déterminisme du sexe chez *C. typhae*, il aurait un intérêt évolutif puisqu'il assurerait la descendance des femelles dans des situations d'absence de mâles, augmenterait la probabilité que leurs gènes soient transmis, et permettrait à des fils de femelles vierges de s'accoupler dès l'émergence avec leurs sœurs. Dans nos conditions d'élevage, ce phénomène a été retrouvé dans environ la moitié des descendances de femelles vierges. Il serait intéressant de pouvoir estimer cette probabilité en conditions naturelles. L'avantage reproducteur conféré par le phénomène dépendrait aussi de la valeur sélective de ces filles de femelle vierges, qui reste à caractériser.

En termes de mécanismes, l'hypothèse la plus probable chez cette espèce haplodiploïde est que les filles de femelles vierges soient diploïdes, par fusion de gamètes ou absence de méiose. Une première étape pour le vérifier est de regarder leur niveau de ploïdie. L'équipe va très prochainement mesurer ce niveau par cytométrie en flux.

Cette découverte nous amène aussi à nous poser la question de la présence de filles produites par parthénogénèse dans les descendance de femelles accouplées. Il serait possible pour le détecter de faire des croisements entre les souches Kobodo et Makindu et de génotyper les filles obtenues, afin de voir si certaines sont homozygotes pour les locus présentant du polymorphisme entre les deux souches.

Une autre caractéristique des femelles vierges de *C. typhae* est leur plus grand nombre de descendants par rapport aux femelles accouplées, résultant d'un plus grand nombre d'œufs injectés dans l'hôte (données non publiées). Ce résultat peut paraître surprenant car les études comparatives faites chez d'autres espèces de *Cotesia* montrent soit une absence d'effet, soit un effet inverse, à savoir une moindre descendance (Scaglia et al., 2005; Tagawa et al., 1987, J. Obonoyo communication personnelle). Nous voyons toutefois deux avantages reproducteurs d'une plus grande descendance des femelles vierges. L'un serait d'augmenter la probabilité de transmettre leurs gènes via l'accouplement de leurs fils, mais cet avantage ne serait pas propre à cette espèce. L'autre avantage, singulier à *C. typhae* à notre connaissance, serait d'augmenter le nombre de femelles produites par parthénogénèse, qui ne représentent qu'un pourcent dans une descendance de femelle vierge, mais lui assurent une descendance.

III) Virulence

Comme détaillé dans l'introduction, les facteurs de virulence des parasitoïdes sont multiples : venin, protéines ovariennes, tératocytes, polydnavirus (bracovirus et ichnovirus), *virus-like particles*, etc. Dans le cas de *C. typhae*, nous nous sommes intéressés en particulier au bracovirus en raison du rôle prépondérant que jouent les polydnavirus dans la perturbation de la physiologie et le contournement du système immunitaire de l'hôte chez les espèces qui en possède un (Beckage and Drezen, 2012), et du fait de l'histoire ayant amené à la découverte de *C. typhae* (voir Kaiser et al., 2017a en annexe).

À partir des résultats présentés dans le premier article nous avons émis l'hypothèse que la plus grande virulence des femelles Kobodo vis-à-vis de la population française de *S. nonagrioides* serait due à une quantité de particules virales injectées plus importante qui entrainerait la plus forte expression des gènes de virulence mesurée. Dans le deuxième article nous avons montré que la quantité de particules virales injectées n'explique pas la différence de virulence entre les souches Kobodo et Makindu. Pour autant, nous avons observé une différence d'expression significative de deux gènes de virulence (*CrVI* et *Cystatin*) par PCR semi-quantitative (qPCR) après parasitisme par les deux souches de *C. typhae*, et qui pourrait expliquer la virulence. Cependant, les expériences d'interruption de ponte semblent indiquer

une dé-corrélation entre le niveau d'expression des gènes de virulence et le succès de parasitisme. Il apparaît nécessaire de compléter les analyses du niveau d'expression des gènes de virulence. Par exemple, il aurait été intéressant de regarder l'expression des gènes de virulence lors des pontes successives. En effet si le niveau d'expression des gènes de virulence explique la virulence, on s'attendrait à observer une corrélation entre expression des gènes de virulence et succès de parasitisme en ponte 2 et 3 comme observée en ponte 1. Néanmoins, la mesure de l'expression de gènes de virulence par qPCR telle que réalisée dans l'article 1 montre plusieurs limites. La première est qu'on ne s'est intéressé qu'à un nombre limité de gènes alors que le bon développement du parasitoïde dans l'hôte repose vraisemblablement sur l'expression de nombreux gènes de virulences. On sait par exemple que *C. congregata* et *C. vestalis* induisent l'expression d'au moins 88 et 147 gènes de virulence respectivement dans l'hôte (Chevignon et al., 2014; Kim and Kumar, 2018). De plus Bredlau et al. (2019) ont montré que deux populations de *C. congregata* n'induisent pas l'expression des mêmes gènes de virulence mais présentent des niveaux de virulence comparables contre *Manduca sexta* et *Ceratonia catalpae*, suggérant qu'un même niveau de virulence peut être atteint via la modulation de l'expression de différents gènes. Cela souligne la nécessité d'étudier l'expression d'un grand nombre de gènes de virulence. Regarder l'expression des gènes de virulence dans l'hôte après parasitisme par transcriptomique serait donc préférable car cela permettrait d'étudier l'expression de l'ensemble des gènes, ce qui a été réalisé avec d'autres espèces de *Cotesia* (Chevignon et al., 2014; Kim and Kumar, 2018). Une deuxième limite est que nous avons mesuré l'expression des deux gènes viraux uniquement dans les corps gras. Or, de nombreux auteurs ont montré que le niveau d'expression des gènes de virulence varie en fonction des tissus (Beck et al., 2007; Chevignon et al., 2014; Galibert et al., 2006; Gundersen-Rindal, 2006). Il serait donc pertinent de regarder l'expression dans différents tissus, notamment dans l'hémolymph qui contient les hémocytes directement impliqués dans la réponse immunitaire de l'hôte. La comparaison des niveaux d'expression pourrait également être améliorée par la prise en compte de la dynamique temporelle d'expression post-parasitisme. En effet, la mesure de l'expression des gènes de virulence n'a été effectuée qu'à un seul moment (24h post-parasitisme) mais on sait qu'elle peut varier au cours du temps (Kim and Kumar, 2018; Weber et al., 2007).

Dans la perspective de comprendre la différence de succès de parasitisme entre les deux souches de *C. typhae*, mesurer l'expression des gènes de virulence n'est pas suffisant car c'est une approche purement corrélative. La cause de la différence de succès de parasitisme peut être un autre facteur influençant également l'expression des gènes de virulence. De plus, le niveau d'expression ne garantit pas l'efficacité des produits d'expression.

L'approche QTL permet d'aborder la question de la virulence sous un angle plus explicatif du fait de la recherche de co-ségrégation entre phénotype et génotype. Dans le cadre de ma thèse elle a permis de mettre en évidence l'implication de plusieurs régions génomiques dans le succès de parasitisme. Deux d'entre elles comprennent des gènes du bracovirus ce qui suggère son implication dans la différence de

virulence entre les souches Kobodo et Makindu. Cependant, ni le gène *CrVI* ni le gène *Cystatin* pour lesquels une différence d'expression a été observée ne sont retrouvés dans les QTL. L'identification des gènes dans les QTL a été réalisée à partir du génome de *C. congregata* (Gauthier et al. non publié). Malgré une bonne conservation de l'organisation du génome entre *C. congregata* et *C. typhae* (chaque chromosome de *C. congregata* a pu être relié à un groupe de liaison de *C. typhae* avec des synthénies comparables) des remaniements génomiques sont envisageables entre les deux espèces. Cela pourrait nous amener à une localisation erronée de certains gènes. Sachant que le macrolocus comprenant les gènes *CrVI* et *Cystatin* est situé dans le génome de *C. congregata* à proximité d'un de nos QTL, on pourrait imaginer qu'il soit en réalité dans le QTL dans le génome de *C. typhae*. Dans le cas où ces deux gènes ne seraient pas présents dans les QTL, cela suggère soit qu'ils ne sont pas du tout impliqués dans la différence de succès de parasitisme, soit qu'un ou plusieurs autres gènes dans les QTL induiraient leur différence d'expression.

La recherche de QTL nous a permis d'identifier des régions génomiques mais la liste de gènes candidats reste importante pour envisager une validation fonctionnelle. Plusieurs méthodes pourraient permettre de compléter cette approche et de potentiellement réduire cette liste. Par exemple nous pourrions mener une étude de transcriptomique à partir de tissus de l'hôte après parasitage comme évoqué précédemment ou à partir de tissus de la guêpe (ovaires, glandes à venin, etc.). Il serait également possible de comparer les séquences des cercles viraux entre les deux souches de parasitoïdes pour rechercher des divergences génétiques. L'étape finale serait la validation fonctionnelle des gènes identifiés. L'extinction de gènes de virulence par RNAi a déjà été mise en œuvre chez des parasitoïdes (Beck and Strand, 2003; Bonvin et al., 2005). Cette méthode permettrait de valider l'implication des gènes dans la virulence mais pas dans la différence de virulence entre les souches. Pour ce faire, il faudrait développer une méthode de type Knock-in, pour remplacer les allèles de Kobodo par les allèles de Makindu et inversement. La difficulté de la transgénèse chez les endoparasitoïdes étant qu'il faudrait arriver à transférer les ovocytes tout en assurant leur injection et leur développement dans l'hôte.

Dans le cas des espèces possédant un polydnavirus celui-ci est souvent considéré comme le facteur de virulence principal du fait qu'il semble indispensable pour assurer le développement dans l'hôte. Chez *Hyposoter didymator*, Dorémus et al. (2013) ont montré que le venin n'est pas nécessaire pour le succès du parasitisme et suggèrent que chez les Campopleginae, auxquels appartient *H. didymator*, la fonction du venin a pu être perdue suite à l'acquisition du polydnavirus. Pour autant, de nombreuses études montrent que le polydnavirus seul n'est pas suffisant pour permettre le développement. Par exemple, pour *Cotesia rubecula* le venin est nécessaire pour permettre l'expression du polydnavirus (Zhang et al., 2004). De la même manière, Tanaka et Wago (1990) ont mis en évidence que les tératocytes sont indispensables pour le développement de *Cotesia kariyai* dans les larves de *Pseudaletia separatu*. Concernant les souches Kobodo et Makindu de *C. typhae*, nous nous sommes concentrés sur le bracovirus mais la différence de succès de parasitisme entre les deux pourrait être due à d'autres facteurs

de virulence, comme le venin dont on retrouve plusieurs gènes dans les QTL. Afin de déterminer quel facteur est impliqué dans cette différence, on pourrait, à l'image de ce qui a été fait par Mochiah et al. (2002) avec *C. sesamiae*, injecter du fluide ovarien (contenant les protéines ovariennes et les particules de polydnavirus) de femelles Kobodo dans des chenilles de *S. nonagrioides* française avant parasitisme par des femelles Makindu et voir si on arrive ainsi à augmenter leur succès de parasitisme. La même démarche pourrait être appliquée en injectant du venin ou des tératocytes de Kobodo. Si l'injection d'un de ces facteurs induit une augmentation du succès de parasitisme on pourrait imaginer que c'est ce facteur-là qui est déficient chez la souche Makindu.

IV) Résistance chez *S. nonagrioides*

Les notions de virulence des parasitoïdes et de résistance des hôtes sont intimement liées. Au cours de cette thèse je me suis principalement concentré sur la différence de virulence entre les souches Kobodo et Makindu de *C. typhae* sur la population française de *S. nonagrioides*. Cependant, le système *C. typhae* / *S. nonagrioides* est également intéressant dans la perspective d'étudier la résistance aux parasitoïdes du fait que l'on dispose de populations de *S. nonagrioides* qui varient dans leur niveau de résistance contre la souche Makindu : faible résistance pour la population kenyane de Makindu ; forte résistance pour les populations française et kenyane de Kobodo. Le mécanisme principal de résistance des insectes aux endoparasitoïdes est l'encapsulation qui consiste en la formation d'une capsule d'hémocytes autour du parasitoïde (Carton et al., 2008). Vu les niveaux de résistance des populations de *S. nonagrioides* on peut se demander s'il n'y aurait pas une différence dans la capacité d'encapsulation entre les chenilles kenyanes de Makindu (faible taux d'encapsulation) et les chenilles françaises et kenyanes de Kobodo (fort taux d'encapsulation).

Chez les espèces du genre *Drosophila* un lien entre quantité d'hémocytes et résistance aux parasitoïdes a pu être mis en évidence à plusieurs reprises (Eslin et Prévost, 1998; Kacsoh and Schlenke, 2012; Wertheim et al., 2011). Il serait intéressant de comparer les quantités d'hémocytes entre nos populations de *S. nonagrioides* pour voir si l'on retrouve le même lien qui pourrait alors expliquer les différences de résistance. Cependant, dans des associations hôtes-parasitoïdes proches de notre système d'étude, la relation entre quantité d'hémocytes et résistance de l'hôte semble plus complexe. Par exemple, Alleyne et Wiedenmann (2001) ont mesuré des quantités d'hémocytes équivalentes entre *Diatraea saccharalis* et *D. grandiosella*. Pour autant ces deux espèces varient dans leur résistance face à *Cotesia sesamiae* et *C. flavipes*.

La résistance via l'encapsulation des parasitoïdes peut se faire à différents moments post-parasitisme. Par exemple, Alleyne and Wiedenmann (2001) ont également montré que *Ostrinia nubilalis* encapsule les œufs de *C. sesamiae* et *C. flavipes* dans les 24 heures suivant le parasitisme alors que pour *D.*

grandiosella l'encapsulation de ces parasitoïdes ne commence pas avant 4 jours et touche principalement les larves. La dynamique temporelle d'encapsulation pourrait être comparée entre les populations de *S. nonagrioides* pour mieux décrire le processus de résistance. L'encapsulation des œufs de *C. typhae* par *S. nonagrioides* a pu être observée. La détection des œufs de *C. typhae* à l'intérieur des chenilles de *S. nonagrioides* est délicate du fait de la difficulté de les distinguer des tissus de l'hôte. Il serait nécessaire d'améliorer notre protocole d'observation pour pouvoir quantifier ce phénomène. Cette dynamique temporelle pourrait être comparée entre populations d'hôtes mais également entre souches de parasitoïdes. Cela pourrait donner des indications sur les facteurs de virulence les plus pertinents à étudier. Par exemple, si la différence d'encapsulation des deux souches de parasitoïdes se fait avant l'éclosion des œufs il est peu vraisemblable que les tératocytes soient impliqués étant donné qu'ils sont produits après l'éclosion des œufs (Strand, 2014). Cela permettrait également de voir au bout de combien de temps post-parasitisme réaliser des expériences de transcriptomique.

La comparaison de transcriptomes de chenilles résistantes et sensibles après parasitisme pourrait nous renseigner sur les gènes impliqués dans la réponse de l'hôte. Une telle approche a déjà été menée avec succès sur différentes espèces et populations de *Drosophila* et a permis d'identifier des gènes surexprimés en lien avec la résistance ainsi que des différences d'épissages entre populations sensibles et résistantes (Salazar-Jaramillo et al., 2017).

V) Adaptation à l'hôte

a. Déterminisme génétique

La notion d'adaptation suppose la sélection de variants génétiques présentant un avantage dans un environnement donné, l'espèce hôte dans le cadre des relations de parasitisme. Comme indiqué en introduction, le succès reproducteur des parasitoïdes repose sur un grand nombre de gènes impliqués dans de nombreux mécanismes. Du fait de cette complexité génétique nous avons décidé de développer une approche QTL. Outre l'identification de segments génomiques impliqués dans la variation d'un phénotype, l'intérêt de cette approche est qu'elle permet de mesurer l'effet de chaque allèle (effet additif) et l'effet d'interaction entre allèles d'un même gène (effet de dominance) ou de gènes différents (effet d'épistasie). Cette dissection génétique permet ainsi de décrire finement la construction du phénotype à partir du génotype. Dans notre cas, nous n'avons pas mis en évidence d'effet d'épistasie pour les deux traits étudiés car aucune interaction significative n'a été détectée entre QTL. Concernant le nombre de descendants nous avons pu observer un effet de superdominance particulièrement sur un des deux QTL. Ce résultat est cohérent avec les résultats obtenus avec les hybrides F1. Ce phénomène de superdominance pourrait être dû à un avantage de l'hétérozygote en tant que tel, lié à une interaction

positive entre allèles d'un même gène. Il est également possible que la superdominance résulte de deux ou plusieurs gènes étroitement liés présentant des allèles favorables en répulsion de phase comme identifié pour le maïs par Larièpe et al. (2012). Dans notre cas cette situation est probable du fait de la taille importante des intervalles de confiance des QTL, et du nombre de gènes présents. Concernant le succès de parasitisme, les hybrides obtenus en croisant les souches Kobodo et Makindu montraient une dominance globale des allèles Kobodo. Or, sur les trois QTL détectés on ne retrouve pas cette dominance. On observe une sous dominance pour le premier, une additivité stricte pour le deuxième et un avantage des allèles Makindu avec dominance partielle de ces derniers pour le troisième. Ce décalage pourrait provenir de plusieurs biais techniques. Nous avons pu observer une importante sur-dispersion dans les données de succès de parasitisme qui pourrait entraîner une mauvaise estimation de nos effets de dominance et d'additivité. De plus, la recherche de QTL a été réalisée à partir de descendants F2 et F8. Les élevages réalisés pour aboutir à la génération F8 ont subi une forte réduction d'effectifs engendrant une dérive importante, caractérisée par une surreprésentation des allèles Makindu dans certains fragments génomiques. Cette distorsion de répartition entre les allèles Kobodo et Makindu entraîne une diminution de la puissance de détection des QTL dans ces régions. Il est donc possible que nous ayons manqué certains QTL d'où une explication incomplète du phénotype. Même si le phénotype pour les deux traits étudiés n'est pas totalement expliqué par nos QTL, l'approche a permis de détecter des gènes d'intérêt qui sont de bons candidats dans l'adaptation à l'hôte.

b. Facteurs biogéographiques

Les localités Kobodo et Makindu d'où sont originaires nos souches de *C. typhae* sont situées à environ 400 km l'une de l'autre, chacune d'un côté de la vallée du rift Africain (Kobodo à l'ouest, Makindu à l'est) connue pour être une barrière aux flux géniques (Freilich et al., 2016; Lehmann et al., 1999; Omondi et al., 2010). Les tests réciproques de parasitisme sur les deux populations kenyanes de *S. nonagrioides* ont montré que les *C. typhae* de Kobodo et Makindu sont adaptées à leur population d'hôte locale, chacune arrivant à parasiter sa population hôte avec un fort succès de parasitisme. Cependant, alors que les femelles Kobodo sont également capables de parasiter efficacement la population Makindu de *S. nonagrioides*, les femelles Makindu ont un faible succès de parasitisme sur la population Kobodo de *S. nonagrioides*. Ce résultat est intéressant car il montre une différenciation à la fois entre souches de *C. typhae*, qui varient dans leur virulence, mais également entre populations de *S. nonagrioides*, qui varient elles dans leur résistance. Pour *S. nonagrioides* cette différenciation se retrouve également au niveau génétique. Il a en effet pu être montré par des membres de l'équipe que les populations de *S. nonagrioides* de l'est et de l'ouest de la vallée du rift africain sont génétiquement différenciées (Naino Jika, données non publiées).

Afin d'expliquer la différence de succès de parasitisme entre *C. typhae* de Kobodo et Makindu nous avons émis l'hypothèse que la souche de Kobodo aurait pu mettre en place des mécanismes de virulence plus importants du fait d'une pression de sélection plus forte due à un hôte plus résistant. Cette plus forte virulence expliquerait son fort succès de parasitisme sur les deux populations kenyanes et également sur la population française de *S. nonagrioides*.

Les différences de virulence et de résistance observées ne sont très certainement pas limitées aux deux localités d'échantillonnages. Il serait intéressant de voir si ce pattern de virulence/résistance se retrouve sur différentes populations naturelles d'hôtes et de parasitoïdes. Cela permettrait dans un premier temps de confirmer que les différenciations observées ne sont pas dues à une dérive génétique de nos souches/populations d'élevages mais correspondent à une différenciation réelle des populations naturelles. On s'attendrait à retrouver une corrélation entre degré de résistance des populations de *S. nonagrioides* et niveau de virulence des populations de *C. typhae* en lien avec une différenciation génétique. Une telle congruence entre structure génétique des populations d'hôtes et de parasitoïdes a été mise en évidence dans le système *C. sesamiae* / *B. fusca* de part et d'autre de la vallée du rift au Kenya (Branca et al., 2019; Dupas et al., 2014). Outre la caractérisation des patrons de virulence, cette approche permettrait également l'identification de gènes impliqués dans l'adaptation à l'hôte via la recherche de traces de sélection dans les génomes. Chez *C. sesamiae* la recherche de trace de sélection a permis d'identifier des gènes potentiellement impliqués dans l'adaptation à l'hôte (Gauthier et al., 2018) et il serait intéressant de voir si on retrouve les mêmes gènes en comparant les populations de *C. typhae*.

Les études reliant la virulence à l'adaptation à l'hôte sont dans la majorité des cas basées sur des analyses réalisées à l'échelle supra-spécifique (Dubuffet et al., 2009). Quelques études ont néanmoins été réalisées à l'échelle populationnelle, qui s'avère pertinente pour aborder l'adaptation à l'hôte et questionner la co-évolution. En effet la mise en évidence de populations plus ou moins adaptées à différentes gammes d'hôtes montre que l'échelle populationnelle est à prendre en compte pour comprendre l'histoire évolutive de l'adaptation à l'hôte. Ainsi chez l'Hyménoptère parasitoïde de larves de drosophiles, *Leptopilina boulardi*, un gène codant pour une protéine de venin a pu être mis en évidence dans la différenciation de la virulence envers des populations de *Drosophila melanogaster* (Colinet et al., 2010). Chez cette espèce, le gène *Rlb* impliqué dans la résistance a pu être identifié également grâce à la différenciation populationnelle (Kim-Jo et al., 2019). L'étude de l'adaptation implique une co-évolution entre virulence et résistance. Le système *C. typhae*/*S. nonagrioides* est intéressant de ce point de vue car les facteurs de virulence de *C. typhae* diffèrent en partie de ceux des parasitoïdes de drosophiles qui n'ont pas de PDV, et car il ouvre la possibilité d'étudier la résistance des lépidoptères aux parasitoïdes, processus mal connu à l'heure actuelle dans ce taxon.

VI) Lutte biologique

La sésamie du maïs, *S. nonagrioides*, est un ravageur en France et dans d'autres pays d'Europe, contre lequel il n'existe pas à ce jour d'agent de lutte biologique disponible. Dans ce contexte l'équipe a lancé, en partenariat avec l'IRBI et des partenaires privés, le programme de recherche CoteBio « Promouvoir une nouvelle espèce de *Cotesia* comme premier agent de lutte biologique contre la sésamie du maïs, un ravageur en recrudescence »¹. Ce programme comprend 4 parties : 1/ Evaluation des risques et bénéfices d'une introduction de *C. typhae* dans l'environnement ; 2/ Etude des mécanismes et facteurs de variation du succès reproducteur de *C. typhae*, du comportement aux gènes ; 3/ Tests de l'efficacité de *C. typhae* contre *S. nonagrioides* en petites parcelles de maïs, sous serres ; 4/ Développement des méthodes de production de l'insecte hôte et du parasitoïde dans la perspective de l'industrialisation et de la commercialisation. Mon travail de thèse s'inscrivait dans la deuxième partie mais apporte également des résultats utiles aux autres parties. En termes d'efficacité, ce travail a permis la caractérisation d'une souche de *C. typhae*, Kobodo, particulièrement virulente contre une population française de la sésamie du maïs. Toutefois l'efficacité de parasitisme dépend aussi d'un grand nombre de facteurs non testés en laboratoire. L'un d'eux est la capacité à localiser les larves hôtes dans le maïs, qui n'est pas la plante naturelle de *S. nonagrioides* au Kenya (Moyal et al., 2011). Cette capacité a pu être vérifiée récemment sous serre, mais seulement pour la souche de Kobodo. J'ai pu grâce aux différentes expérimentations menées estimer le nombre de chenilles que *C. typhae* pouvait parasiter avec succès. Cette donnée est essentielle à la fois pour optimiser l'élevage du parasitoïde mais également pour ajuster le nombre de femelles à lâcher en fonction de la densité de l'hôte. Par ailleurs, compte-tenu de la différence de comportement de ponte mise en évidence au laboratoire, la souche Makindu pourrait être intéressante par le plus grand nombre de chenilles qu'elle peut parasiter, sous réserve de pouvoir augmenter sa virulence par sélection expérimentale.

Une forte virulence pourrait ne pas avoir que des avantages. En effet, un point important de la faisabilité de l'utilisation de *C. typhae* en lutte biologique est son innocuité envers des espèces non-cibles. La très forte virulence de Kobodo a été constatée sur toutes populations hôtes testées, au contraire de Makindu qui n'est très virulente que sur sa population hôte locale. La souche Kobodo pourrait être également plus virulente envers des espèces non-cibles, auquel cas la souche Makindu resterait intéressante.

En termes d'élevage pour la production, mon travail de thèse réalisé sur des lignées maintenues en élevage consanguin (lignées isofemelles) a montré que ces lignées très homozygotes avaient un succès reproducteur stable, indiquant une absence de dépression de consanguinité. Ainsi la production commerciale de *C. typhae* ne nécessiterait pas d'enrichir la souche par des individus collectés au champ.

¹ <https://anr.fr/Projet-ANR-17-CE32-0015#>

Toutefois, garder de la diversité génétique pourrait être intéressant par exemple en cas d'apparition d'une résistance de l'hôte. Le maintien d'un élevage reposant sur plusieurs lignées isofemelles est un moyen de le faire (Delpuech et al., 1993).

VII) Conclusion

La caractérisation de composantes comportementales, physiologiques et génétiques du succès reproducteur de *C. typhae* réalisée au cours de ce travail de thèse a montré tout l'intérêt de ce modèle tant pour l'étude des mécanismes de l'adaptation à l'hôte que pour son utilisation en lutte biologique. Cette thèse a de plus été l'occasion d'une découverte originale, à savoir la capacité des femelles vierges de *C. typhae* à produire à la fois des mâles et des femelles fertiles dans une même descendance. De nombreuses perspectives de recherche découlent de ce travail.

Bibliographie

- Albajes, R., Konstantopoulou, M., Etchepare, O., Eizaguirre, M., Frérot, B., Sans, A., Krokos, F., Améline, A., Mazomenos, B., 2002. Mating disruption of the corn borer *Sesamia nonagrioides* (Lepidoptera: Noctuidae) using sprayable formulations of pheromone. *Crop Prot.* 21, 217–225. [https://doi.org/10.1016/S0261-2194\(01\)00088-6](https://doi.org/10.1016/S0261-2194(01)00088-6)
- Ali, Md.R., Seo, J., Lee, D., Kim, Y., 2013. Teratocyte-secreting proteins of an endoparasitoid wasp, *Cotesia plutellae*, prevent host metamorphosis by altering endocrine signals. *Comp. Biochem. Physiol. A. Mol. Integr. Physiol.* 166, 251–262. <https://doi.org/10.1016/j.cbpa.2013.06.028>
- Ali, M.R., Lim, J., Kim, Y., 2015. Transcriptome of a specialized extra-embryonic cell, teratocyte, and its host immunosuppressive role revealed by *ex vivo* RNA interference: Teratocyte transcriptome. *Insect Mol. Biol.* 24, 13–28. <https://doi.org/10.1111/imb.12132>
- Alleyne, M., Wiedenmann, R.N., 2001. Encapsulation and hemocyte numbers in three lepidopteran stemborers parasitized by *Cotesia flavipes*-complex endoparasitoids. *Entomol. Exp. Appl.* 100, 279–293. <https://doi.org/10.1046/j.1570-7458.2001.00875.x>
- Andrew, N., Basio, M., Kim, Y., 2006. Additive effect of teratocyte and calyx fluid from *Cotesia plutellae* on immunosuppression of *Plutella xylostella*. *Physiol. Entomol.* 31, 341–347. <https://doi.org/10.1111/j.1365-3032.2006.00524.x>
- Arakaki, N., Ganaha, Y., 1986. Emergence Pattern and Mating Behavior of *Apanteles flavipes*(CAMERON)(Hymenoptera : Braconidae). *Appl. Entomol. Zool.* 21, 382–388. <https://doi.org/10.1303/aez.21.382>
- Arvidson, R., Kaiser, M., Lee, S.S., Urenda, J.-P., Dail, C., Mohammed, H., Nolan, C., Pan, S., Stajich, J.E., Libersat, F., Adams, M.E., 2019. Parasitoid Jewel Wasp Mounts Multipronged Neurochemical Attack to Hijack a Host Brain. *Mol. Cell. Proteomics* 18, 99–114. <https://doi.org/10.1074/mcp.RA118.000908>
- Asgari, S., 2012. Venoms from Endoparasitoids, in: *Parasitoid Viruses*. Elsevier, pp. 217–231. <https://doi.org/10.1016/B978-0-12-384858-1.00018-7>
- Asgari, S., Hellers, M., Schmidt, O., 1996. Host haemocyte inactivation by an insect parasitoid: transient expression of a polydnavirus gene. *J. Gen. Virol.* 77, 2653–2662. <https://doi.org/10.1099/0022-1317-77-10-2653>
- Asgari, S., Rivers, D.B., 2011. Venom Proteins from Endoparasitoid Wasps and Their Role in Host-Parasite Interactions. *Annu. Rev. Entomol.* 56, 313–335. <https://doi.org/10.1146/annurev-ento-120709-144849>
- Asgari, S., Schmidt, O., 2002. A coiled-coil region of an insect immune suppressor protein is involved in binding and uptake by hemocytes. *Insect Biochem. Mol. Biol.* 32, 497–504.
- Asgari, S., Schmidt, O., Theopold, U., 1997. A polydnavirus-encoded protein of an endoparasitoid wasp is an immune suppressor. *J. Gen. Virol.* 78 (Pt 11), 3061–3070. <https://doi.org/10.1099/0022-1317-78-11-3061>
- Bale, J.S., van Lenteren, J.C., Bigler, F., 2008. Biological control and sustainable food production. *Philos. Trans. R. Soc. B Biol. Sci.* 363, 761–776. <https://doi.org/10.1098/rstb.2007.2182>
- Beck, M., Strand, M.R., 2003. RNA interference silences *Microplitis demolitor* bracovirus genes and implicates glc1.8 in disruption of adhesion in infected host cells. *Virology* 314, 521–535. [https://doi.org/10.1016/s0042-6822\(03\)00463-x](https://doi.org/10.1016/s0042-6822(03)00463-x)
- Beck, M.H., Inman, R.B., Strand, M.R., 2007. *Microplitis demolitor* bracovirus genome segments vary in abundance and are individually packaged in virions. *Virology* 359, 179–189. <https://doi.org/10.1016/j.virol.2006.09.002>
- Beck, M.H., Zhang, S., Bitra, K., Burke, G.R., Strand, M.R., 2011. The Encapsidated Genome of *Microplitis demolitor* Bracovirus Integrates into the Host *Pseudaletia includens*. *J. Virol.* 85, 11685–11696. <https://doi.org/10.1128/JVI.05726-11>

- Beckage, N.E., Drezen, J.-M. (Eds.), 2012. Parasitoid viruses: symbionts and pathogens, 1st ed. Elsevier/Academic Press, London ; New York.
- Beckage, N.E., Gelman, D.B., 2004. Wasp parasitoid disruption of host development: implications for new biologically based strategies for insect control. *Annu. Rev. Entomol.* 49, 299–330. <https://doi.org/10.1146/annurev.ento.49.061802.123324>
- Béliveau, C., Cohen, A., Stewart, D., Periquet, G., Djoumad, A., Kuhn, L., Stoltz, D., Boyle, B., Volkoff, A.-N., Herniou, E.A., Drezen, J.-M., Cusson, M., 2015. Genomic and Proteomic Analyses Indicate that Banchine and Campoplegine Polydnviruses Have Similar, if Not Identical, Viral Ancestors. *J. Virol.* 89, 8909–8921. <https://doi.org/10.1128/JVI.01001-15>
- Benoist, R., Chantre, C., Capdevielle-Dulac, C., Bodet, M., Mougél, F., Calatayud, P.A., Dupas, S., Huguet, E., Jeannette, R., Obonyo, J., Odorico, C., Silvain, J.F., Le Ru, B., Kaiser, L., 2017. Relationship between oviposition, virulence gene expression and parasitism success in *Cotesia typhae* nov. sp. parasitoid strains. *Genetica*. <https://doi.org/10.1007/s10709-017-9987-5>
- Beukeboom, L., Perrin, N., 2015. The evolution of sex determination. Oxford University Press, Oxford.
- Beukeboom, L.W., Kamping, A., Louter, M., Pijnacker, L.P., Katju, V., Ferree, P.M., Werren, J.H., 2007. Haploid females in the parasitic wasp *Nasonia vitripennis*. *Science* 315, 206. <https://doi.org/10.1126/science.1133388>
- Bezemer, T.M., Mills, N.J., 2003. Clutch size decisions of a gregarious parasitoid under laboratory and field conditions. *Anim. Behav.* 66, 1119–1128. <https://doi.org/10.1006/anbe.2003.2296>
- Bézier, A., Annaheim, M., Herbinière, J., Wetterwald, C., Gyapay, G., Bernard-Samain, S., Wincker, P., Roditi, I., Heller, M., Belghazi, M., Pfister-Wilhem, R., Periquet, G., Dupuy, C., Huguet, E., Volkoff, A.-N., Lanzrein, B., Drezen, J.-M., 2009a. Polydnviruses of braconid wasps derive from an ancestral nudivirus. *Science* 323, 926–930. <https://doi.org/10.1126/science.1166788>
- Bézier, A., Herbinière, J., Lanzrein, B., Drezen, J.-M., 2009b. Polydnvirus hidden face: the genes producing virus particles of parasitic wasps. *J. Invertebr. Pathol.* 101, 194–203. <https://doi.org/10.1016/j.jip.2009.04.006>
- Bézier, A., Louis, F., Jancek, S., Periquet, G., Theze, J., Gyapay, G., Musset, K., Lesobre, J., Lenoble, P., Dupuy, C., Gundersen-Rindal, D., Herniou, E.A., Drezen, J.-M., 2013. Functional endogenous viral elements in the genome of the parasitoid wasp *Cotesia congregata*: insights into the evolutionary dynamics of bracoviruses. *Philos. Trans. R. Soc. B Biol. Sci.* 368, 20130047–20130047. <https://doi.org/10.1098/rstb.2013.0047>
- Bichang'a, G., Da Lage, J.-L., Capdevielle-Dulac, C., Zivy, M., Balliau, T., Sambai, K., Le Ru, B., Kaiser, L., Juma, G., Maina, E.N.M., Calatayud, P.-A., 2018a. α -Amylase Mediates Host Acceptance in the Braconid Parasitoid *Cotesia flavipes*. *J. Chem. Ecol.* 44, 1030–1039. <https://doi.org/10.1007/s10886-018-1002-9>
- Bichang'a, G., Lage, J.-L.D., Sambai, K., Mule, S., Ru, B.L., Kaiser, L., Juma, G., Maina, E.N., Calatayud, P.-A., 2018b. Salivary α -Amylase of Stem Borer Hosts Determines Host Recognition and Acceptance for Oviposition by *Cotesia* spp. (Hymenoptera, Braconidae). *Front. Ecol. Evol.* 6, 228. <https://doi.org/10.3389/fevo.2018.00228>
- Blumberg, D., 1997. 1.3.6 Encapsulation of parasitoids, in: *World Crop Pests*. Elsevier, pp. 375–387. [https://doi.org/10.1016/S1572-4379\(97\)80066-8](https://doi.org/10.1016/S1572-4379(97)80066-8)
- Blumberg, D., Luck, R.F., 1990. Differences in the Rates of Superparasitism Between Two Strains of *Comperiella bifasciata* (Howard) (Hymenoptera: Encyrtidae) Parasitizing California Red Scale (Homoptera: Diaspididae): An Adaptation to Circumvent

- Encapsulation? Ann. Entomol. Soc. Am. 83, 591–597.
<https://doi.org/10.1093/aesa/83.3.591>
- Boivin, G., 2013. Sperm as a limiting factor in mating success in Hymenoptera parasitoids. Entomol. Exp. Appl. 146, 149–155. <https://doi.org/10.1111/j.1570-7458.2012.01291.x>
- Boivin, G., 2001. Parasitoïdes et lutte biologique: paradigme ou panacée? Vertigo. <https://doi.org/10.4000/vertigo.4096>
- Bonvin, M., Marti, D., Wyder, S., Kojic, D., Annaheim, M., Lanzrein, B., 2005. Cloning, characterization and analysis by RNA interference of various genes of the *Chelonus inanitus* polydnavirus. J. Gen. Virol. 86, 973–983. <https://doi.org/10.1099/vir.0.80833-0>
- Boratyn, G.M., Schäffer, A.A., Agarwala, R., Altschul, S.F., Lipman, D.J., Madden, T.L., 2012. Domain enhanced lookup time accelerated BLAST. Biol. Direct 7, 12. <https://doi.org/10.1186/1745-6150-7-12>
- Boulton, R.A., Collins, L.A., Shuker, D.M., 2015. Beyond sex allocation: the role of mating systems in sexual selection in parasitoid wasps: Sexual selection in parasitoid wasps. Biol. Rev. 90, 599–627. <https://doi.org/10.1111/brv.12126>
- Branca, A., Le Ru, B., Calatayud, P.-A., Obonyo, J., Musyoka, B., Capdevielle-Dulac, C., Kaiser-Arnauld, L., Silvain, J.-F., Gauthier, J., Paillusson, C., Gayral, P., Herniou, E.A., Dupas, S., 2019. Relative Influence of Host, *Wolbachia*, Geography and Climate on the Genetic Structure of the Sub-saharan Parasitic Wasp *Cotesia sesamiae*. Front. Ecol. Evol. 7, 309. <https://doi.org/10.3389/fevo.2019.00309>
- Branca, A., Le Ru, B.P., Calatayud, P.-A., Obonyo, J.O., Musyoka, B., Capdevielle-Dulac, C., Kaiser-Arnauld, L., Silvain, J.-F., Gauthier, J., Paillusson, C., Gayral, P., Herniou, E., Dupas, S., 2017. Determinants of genetic structure of the Sub-Saharan parasitic wasp *Cotesia sesamiae* (preprint). Evolutionary Biology. <https://doi.org/10.1101/194084>
- Branca, A., Le Ru, B.P., Vavre, F., Silvain, J.-F., Dupas, S., 2011. Intraspecific specialization of the generalist parasitoid *Cotesia sesamiae* revealed by polyDNAVirus polymorphism and associated with different *Wolbachia* infection. Mol. Ecol. 20, 959–971. <https://doi.org/10.1111/j.1365-294X.2010.04977.x>
- Bredlau, J.P., Kester, K.M., 2019. Evolutionary relationships of courtship songs in the parasitic wasp genus, *Cotesia* (Hymenoptera: Braconidae). PLOS ONE 14, e0210249. <https://doi.org/10.1371/journal.pone.0210249>
- Bredlau, J.P., Kuhar, D., Gundersen-Rindal, D.E., Kester, K.M., 2019. The Parasitic Wasp, *Cotesia congregata* (Say), Consists of Two Incipient Species Isolated by Asymmetric Reproductive Incompatibility and Hybrid Inability to Overcome Host Defenses. Front. Ecol. Evol. 7, 187. <https://doi.org/10.3389/fevo.2019.00187>
- Bressac, C., Damiens, D., Chevrier, C., 2008. Sperm stock and mating of males in a parasitoid wasp. J. Exp. Zool. B Mol. Dev. Evol. 310, 160–166. <https://doi.org/10.1002/jez.b.21168>
- Bressac, C., Thi Khanh, H.D., Chevrier, C., 2009. Effects of age and repeated mating on male sperm supply and paternity in a parasitoid wasp. Entomol. Exp. Appl. 130, 207–213. <https://doi.org/10.1111/j.1570-7458.2008.00810.x>
- Broman, K.W., Sen, S., 2009. A guide to QTL mapping with R/qtl, Statistics for biology and health. Springer, Dordrecht.
- Buadu, E.J., Gounou, S., Cardwell, K.F. (International T.A.I., Mochiah, B., Botchey, M., Darkwa, E., Schulthess, F., 2002. Distribution and relative importance of insect pests and diseases of maize in southern Ghana. Afr. Plant Prot. South Afr.
- Buès, R., Eizaguirre, M., Toubon, J.F., Albages, R., 1996. DIFFÉRENCES ENZYMATIQUES ET ÉCOPHYSIOLOGIQUES ENTRE POPULATIONS DE *SESAMIA NONAGRIOIDES* LEFÈBRE (LÉPIDOPTÈRE: NOCTUIDAE) ORIGINAIRES DE

- L'OUEST DU BASSIN MÉDITERRANÉEN. *Can. Entomol.* 128, 849–858. <https://doi.org/10.4039/Ent128849-5>
- Burke, G.R., 2019. Common themes in three independently derived endogenous nudivirus elements in parasitoid wasps. *Curr. Opin. Insect Sci.* 32, 28–35. <https://doi.org/10.1016/j.cois.2018.10.005>
- Burke, G.R., Simmonds, T.J., Sharanowski, B.J., Geib, S.M., 2018. Rapid Viral Symbiogenesis via Changes in Parasitoid Wasp Genome Architecture. *Mol. Biol. Evol.* 35, 2463–2474. <https://doi.org/10.1093/molbev/msy148>
- Burke, G.R., Strand, M.R., 2014. Systematic analysis of a wasp parasitism arsenal. *Mol. Ecol.* 23, 890–901. <https://doi.org/10.1111/mec.12648>
- Burke, G.R., Strand, M.R., 2012. Deep Sequencing Identifies Viral and Wasp Genes with Potential Roles in Replication of *Microplitis demolitor* Bracovirus. *J. Virol.* 86, 3293–3306. <https://doi.org/10.1128/JVI.06434-11>
- Burke, G.R., Walden, K.K.O., Whitfield, J.B., Robertson, H.M., Strand, M.R., 2014. Widespread Genome Reorganization of an Obligate Virus Mutualist. *PLOS Genet.* 10, e1004660. <https://doi.org/10.1371/journal.pgen.1004660>
- Carton, Y., 1977. La réaction d'immunité cellulaire (capsule hémocytaire) chez un insecte, en fonction de la région du corps. *Ann. Parasitol. Hum. Comparée* 52, 59–62. <https://doi.org/10.1051/parasite/1977521059>
- Carton, Y., Poirié, M., Nappi, A.J., 2008. Insect immune resistance to parasitoids. *Insect Sci.* 15, 67–87. <https://doi.org/10.1111/j.1744-7917.2008.00188.x>
- Castañera, P., Farinós, G.P., Ortego, F., Andow, D.A., 2016. Sixteen Years of *Bt* Maize in the EU Hotspot: Why Has Resistance Not Evolved? *PloS One* 11, e0154200. <https://doi.org/10.1371/journal.pone.0154200>
- Catchen, J., Hohenlohe, P.A., Bassham, S., Amores, A., Cresko, W.A., 2013. Stacks: an analysis tool set for population genomics. *Mol. Ecol.* 22, 3124–3140. <https://doi.org/10.1111/mec.12354>
- Charnov, E.L., Skinner, S.W., 1985. Complementary Approaches to the Understanding of Parasitoid Oviposition Decisions. *Environ. Entomol.* 14, 383–391. <https://doi.org/10.1093/ee/14.4.383>
- Cheraghali, Z., Esfandiari, M., Mossadegh, M.S., Memari, H.R., 2015. Genetic diversity of populations of the stem borer *Sesamia nonagrioides* (Lepidoptera: Noctuidae) in southern and southwestern Iran, using RAPD-PCR.
- Chevignon, G., Periquet, G., Gyapay, G., Vega-Czarny, N., Musset, K., Drezen, J.-M., Huguet, E., 2018. *Cotesia congregata* Bracovirus Circles Encoding *PTP* and *Ankyrin* Genes Integrate into the DNA of Parasitized *Manduca sexta* Hemocytes. *J. Virol.* 92, e00438-18, /jvi/92/15/e00438-18.atom. <https://doi.org/10.1128/JVI.00438-18>
- Chevignon, G., Thézé, J., Cambier, S., Poulain, J., Silva, C.D., Bezier, A., Musset, K., Moreau, S.J.M., Drezen, J.-M., Huguet, E., 2014. Functional annotation of *Cotesia congregata* bracovirus: identification of the viral genes expressed in parasitized host immune tissues. *J. Virol.* JVI.00209-14. <https://doi.org/10.1128/JVI.00209-14>
- Chiang, R.G., O'Donnell, M.J., 2009. Functional anatomy of vagina muscles in the blood-feeding insect, *Rhodnius prolixus*. *Arthropod Struct. Dev.* 38, 499–507. <https://doi.org/10.1016/j.asd.2009.06.002>
- Churchill, G.A., Doerge, R.W., 1994. Empirical threshold values for quantitative trait mapping. *Genetics* 138, 963–971.
- Cicero, L., Sivinski, J., Rull, J., Aluja, M., 2011. Effect of larval host food substrate on egg load dynamics, egg size and adult female size in four species of braconid fruit fly (Diptera: Tephritidae) parasitoids. *J. Insect Physiol.* 57, 1471–1479. <https://doi.org/10.1016/j.jinsphys.2011.07.014>

- Colazza, S. (University of P. (Italy) I. of A.E., Rosi, C., 2001. Differences in the searching behaviour of two strains of the egg parasitoid *Telenomus busseolae* (Hymenoptera: Scelionidae). *Eur. J. Entomol. Czech Repub.* 98, 47–52.
- Cole-Clark, M.P., Barton, D.A., Allsopp, M.H., Beekman, M., Gloag, R.S., Wossler, T.C., Ronai, I., Smith, N., Reid, R.J., Oldroyd, B.P., 2017. Cytogenetic basis of thelytoky in *Apis mellifera capensis*. *Apidologie* 48, 623–634. <https://doi.org/10.1007/s13592-017-0505-7>
- Colinet, D., Mathé-Hubert, H., Allemand, R., Gatti, J.-L., Poirié, M., 2013. Variability of venom components in immune suppressive parasitoid wasps: From a phylogenetic to a population approach. *J. Insect Physiol.* 59, 205–212. <https://doi.org/10.1016/j.jinsphys.2012.10.013>
- Colinet, D., Schmitz, A., Cazes, D., Gatti, J.-L., Poirié, M., 2010. The origin of intraspecific variation of virulence in an eukaryotic immune suppressive parasite. *PLoS Pathog.* 6, e1001206. <https://doi.org/10.1371/journal.ppat.1001206>
- Collins, M.D., Dixon, A.F.G., 1986. The effect of egg depletion on the foraging behaviour of an aphid parasitoid. *J. Appl. Entomol.* 102, 342–352. <https://doi.org/10.1111/j.1439-0418.1986.tb00932.x>
- Cook, J.M., 1993. Sex determination in the Hymenoptera: a review of models and evidence. *Heredity* 71, 421–435. <https://doi.org/10.1038/hdy.1993.157>
- Cordero, A., Butrón Gómez, A.M., Revilla Temiño, P., Malvar Pintos, R.A., Ordás Pérez, A., Velasco Pazos, P., 1998. Population dynamics and life-cycle of corn borers in south Atlantic European coast. *Maydica* 43, 5–12.
- Costa, F.G., Pérez-Miles, F., Mignone, A., 2004. Pompilid Wasp Interactions with Burrowing Tarantulas: *Pepsis cupripennis* versus *Eupalaestrus weijenberghi* and *Acanthoscurria suina* (Araneae, Theraphosidae). *Stud. Neotropical Fauna Environ.* 39, 37–43. <https://doi.org/10.1080/01650520412331270945>
- Crawley, M.J., 2012. *The R Book*, 2nd Edition. ed. Wiley-Blackwell, Chichester, West Sussex, UK.
- Danneels, E.L., 2010. Venom Proteins of the Parasitoid Wasp *Nasonia vitripennis*: Recent Discovery of an Untapped Pharmacopee 23.
- de Boer, J.G., Ode, P.J., Rendahl, A.K., Vet, L.E.M., Whitfield, J.B., Heimpel, G.E., 2008. Experimental Support for *Multiple-Locus* Complementary Sex Determination in the Parasitoid *Cotesia vestalis*. *Genetics* 180, 1525–1535. <https://doi.org/10.1534/genetics.107.083907>
- de Givry, S., Bouchez, M., Chabrier, P., Milan, D., Schiex, T., 2005. CARHTA GENE: multipopulation integrated genetic and radiation hybrid mapping. *Bioinformatics* 21, 1703–1704. <https://doi.org/10.1093/bioinformatics/bti222>
- de Graaf, D.C., Aerts, M., Brunain, M., Desjardins, C.A., Jacobs, F.J., Werren, J.H., Devreese, B., 2010. Insights into the venom composition of the ectoparasitoid wasp *Nasonia vitripennis* from bioinformatic and proteomic studies. *Insect Mol. Biol.* 19, 11–26. <https://doi.org/10.1111/j.1365-2583.2009.00914.x>
- de la Poza, M., Farinós, G.P., Beroiz, B., Ortego, F., Hernández-Crespo, P., Castañera, P., 2008. Genetic structure of *Sesamia nonagrioides* (Lefebvre) populations in the Mediterranean area. *Environ. Entomol.* 37, 1354–1360. [https://doi.org/10.1603/0046-225x\(2008\)37\[1354:gsosnl\]2.0.co;2](https://doi.org/10.1603/0046-225x(2008)37[1354:gsosnl]2.0.co;2)
- Delpuech, J.-M., Carton, Y., Roush, R.T., 1993. Conserving genetic variability of a wild insect population under laboratory conditions. *Entomol. Exp. Appl.* 67, 233–239. <https://doi.org/10.1111/j.1570-7458.1993.tb01673.x>

- Donaldson, J.S., Walter, G.H., 1988. Effects of egg availability and egg maturity on the ovipositional activity of the parasitic wasp, *Coccophagus atratus*. *Physiol. Entomol.* 13, 407–417. <https://doi.org/10.1111/j.1365-3032.1988.tb01124.x>
- Dorémus, T., Urbach, S., Jouan, V., Cousserans, F., Ravallec, M., Demetree, E., Wajnberg, E., Poulain, J., Azéma-Dossat, C., Darboux, I., Escoubas, J.-M., Colinet, D., Gatti, J.-L., Poirié, M., Volkoff, A.-N., 2013. Venom gland extract is not required for successful parasitism in the polydnavirus-associated endoparasitoid *Hyposoter didymator* (Hym. Ichneumonidae) despite the presence of numerous novel and conserved venom proteins. *Insect Biochem. Mol. Biol.* 43, 292–307. <https://doi.org/10.1016/j.ibmb.2012.12.010>
- Drezen, J.-M., Leobold, M., Bézier, A., Huguet, E., Volkoff, A.-N., Herniou, E.A., 2017. Endogenous viruses of parasitic wasps: variations on a common theme. *Curr. Opin. Virol.* 25, 41–48. <https://doi.org/10.1016/j.coviro.2017.07.002>
- Dubuffet, A., 2005. Variation intra spécifique de résistance et de virulence dans un système hôte-parasitoïde: Approche intégrative de la spécificité des interactions.
- Dubuffet, A., Colinet, D., Anselme, C., Dupas, S., Carton, Y., Poirié, M., 2009. Chapter 6 Variation of *Leptopilina boulardi* Success in *Drosophila* Hosts: What is Inside the Black Box?, in: *Advances in Parasitology*, *Advances in Parasitology*. Academic Press, pp. 147–188. [https://doi.org/10.1016/S0065-308X\(09\)70006-5](https://doi.org/10.1016/S0065-308X(09)70006-5)
- Dupas, S., Gitau, C.W., Branca, A., Le Rü, B.P., Silvain, J.-F., 2008. Evolution of a polydnavirus gene in relation to parasitoid-host species immune resistance. *J. Hered.* 99, 491–499. <https://doi.org/10.1093/jhered/esn047>
- Dupas, S., le Ru, B., Branca, A., Faure, N., Gigot, G., Campagne, P., Sezonlin, M., Ndemah, R., Ong'amo, G., Calatayud, P.-A., Silvain, J.-F., 2014. Phylogeography in continuous space: coupling species distribution models and circuit theory to assess the effect of contiguous migration at different climatic periods on genetic differentiation in *Busseola fusca* (Lepidoptera: Noctuidae). *Mol. Ecol.* 23, 2313–2325. <https://doi.org/10.1111/mec.12730>
- Edson, K.M., Vinson, S.B., Stoltz, D.B., Summers, M.D., 1981. Virus in a parasitoid wasp: suppression of the cellular immune response in the parasitoid's host. *Science* 211, 582–583. <https://doi.org/10.1126/science.7455695>
- Eggleton P., Belshaw Robert, 1992. Insect parasitoids: an evolutionary overview. *Philos. Trans. R. Soc. Lond. B. Biol. Sci.* 337, 1–20. <https://doi.org/10.1098/rstb.1992.0079>
- Eggleton, P., Gaston, K.J., 1990. “Parasitoid” Species and Assemblages: Convenient Definitions or Misleading Compromises? *Oikos* 59, 417. <https://doi.org/10.2307/3545155>
- Eizaguirre, M., Fantinou, A.A., 2012. Abundance of *Sesamia nonagrioides* (Lef.) (Lepidoptera: Noctuidae) on the Edges of the Mediterranean Basin. *Psyche J. Entomol.* 2012, 1–7. <https://doi.org/10.1155/2012/854045>
- Eizaguirre, M., Lopez, C., Albajes, R., 2004. Dispersal capacity in the Mediterranean corn borer, *Sesamia nonagrioides*. *Entomol. Exp. Appl.* 113, 25–34. <https://doi.org/10.1111/j.0013-8703.2004.00201.x>
- Eslin, P., Prévost, G., 1998. Hemocyte load and immune resistance to *Asobara tabida* are correlated in species of the *Drosophila melanogaster* subgroup. *J. Insect Physiol.* 44, 807–816. [https://doi.org/10.1016/S0022-1910\(98\)00013-4](https://doi.org/10.1016/S0022-1910(98)00013-4)
- Fleming, J.G., Summers, M.D., 1991. Polydnavirus DNA is integrated in the DNA of its parasitoid wasp host. *Proc. Natl. Acad. Sci.* 88, 9770–9774.
- Flint, J., Greenspan, R.J., Kandler, K.S., 2010. *How Genes Influence Behavior*, 1 edition. ed. Oxford University Press, Oxford ; New York.
- Foray, V., Helene, H., Martinez, S., Gibert, P., Desouhant, E., 2013. Occurrence of arrhenotoky and thelytoky in a parasitic wasp *Venturia canescens* (Hymenoptera: Ichneumonidae):

- Effect of endosymbionts or existence of two distinct reproductive modes? *Eur. J. Entomol.* 110, 103–107. <https://doi.org/10.14411/eje.2013.014>
- Freilich, X., Anadón, J.D., Bukala, J., Calderon, O., Chakraborty, R., Boissinot, S., 2016. Comparative Phylogeography of Ethiopian anurans: impact of the Great Rift Valley and Pleistocene climate change. *BMC Evol. Biol.* 16, 1–19. <https://doi.org/10.1186/s12862-016-0774-1>
- Gadagkar, R., 2004. Sex...Only If Really Necessary in a Feminine Monarchy. *Science* 306, 1694–1695. <https://doi.org/10.1126/science.1106673>
- Galibert, L., Devauchelle, G., Cousserans, F., Rocher, J., Cérutti, P., Barat-Houari, M., Fournier, P., Volkoff, A., 2006. Members of the Hyposoter didymator Ichnovirus repeat element gene family are differentially expressed in *Spodoptera frugiperda*. *Viol. J.* 3, 48. <https://doi.org/10.1186/1743-422X-3-48>
- Galichet, P.-F., Magnin, H., Radisson, A., Tavernier, J., 1982. Hibernation d'une population de *Sesamia nonagrioides* Lef. (Lep., Noctuidae) en France méridionale. *Agronomie* 2, 561–566. <https://doi.org/10.1051/agro:19820609>
- Gandon, S., Varaldi, J., Fleury, F., Rivero, A., 2009. Evolution and manipulation of parasitoid egg load. *Evolution* 63, 2974–2984. <https://doi.org/10.1111/j.1558-5646.2009.00776.x>
- Gao, S., Tang, Y., Wei, K., Wang, X., Yang, Z., Zhang, Y., 2016. Relationships between Body Size and Parasitic Fitness and Offspring Performance of *Sclerodermus pupariae* Yang et Yao (Hymenoptera: Bethyridae). *PLoS ONE* 11. <https://doi.org/10.1371/journal.pone.0156831>
- Garzo, E., Moreno, A., Hernando, S., Mariño, V., Torne, M., Santamaria, E., Díaz, I., Fereres, A., 2016. Electrical penetration graph technique as a tool to monitor the early stages of aphid resistance to insecticides. *Pest Manag. Sci.* 72, 707–718. <https://doi.org/10.1002/ps.4041>
- Gasmi, L., Boulain, H., Gauthier, J., Hua-Van, A., Musset, K., Jakubowska, A.K., Aury, J.-M., Volkoff, A.-N., Huguët, E., Herrero, S., Drezen, J.-M., 2015. Recurrent Domestication by Lepidoptera of Genes from Their Parasites Mediated by Bracoviruses. *PLOS Genet.* 11, e1005470. <https://doi.org/10.1371/journal.pgen.1005470>
- Gaston, K.J., 1991. The Magnitude of Global Insect Species Richness. *Conserv. Biol.* 5, 283–296. <https://doi.org/10.1111/j.1523-1739.1991.tb00140.x>
- Gatti, J., Schmitz, A., Colinet, D., Poirié, M., 2012. Chapter 15 - Diversity of Virus-Like Particles in Parasitoids' Venom: Viral or Cellular Origin?, in: Beckage, N.E., Drezen, J.-M. (Eds.), *Parasitoid Viruses*. Academic Press, San Diego, pp. 181–192. <https://doi.org/10.1016/B978-0-12-384858-1.00015-1>
- Gauthier, J., Drezen, J.-M., Herniou, E.A., 2017. The recurrent domestication of viruses: major evolutionary transitions in parasitic wasps. *Parasitology* 1–13. <https://doi.org/10.1017/S0031182017000725>
- Gauthier, J., Gayral, P., LeRu, B.P., Jancek, S., Dupas, S., Kaiser, L., Gyapay, G., Herniou, E.A., 2018. Genetic footprints of adaptive divergence in the bracovirus of *Cotesia sesamiae* identified by targeted re-sequencing. *Mol. Ecol.* <https://doi.org/10.1111/mec.14574>
- Gavrus-Ion, A., Sjøvold, T., Hernández, M., González-José, R., Esteban Torné, M.E., Martínez-Abadías, N., Esparza, M., 2017. Measuring fitness heritability: Life history traits versus morphological traits in humans. *Am. J. Phys. Anthropol.* 164, 321–330. <https://doi.org/10.1002/ajpa.23271>
- Gibernau, M., Dejean, A., 2001. Ant protection of a Heteropteran trophobiont against a parasitoid wasp. *Oecologia* 126, 53–57. <https://doi.org/10.1007/s004420000479>
- Gitau, C.W., Gundersen-Rindal, D., Pedroni, M., Mbugi, P.J., Dupas, S., 2007. Differential expression of the CrV1 haemocyte inactivation-associated polydnavirus gene in the

- African maize stem borer *Busseola fusca* (Fuller) parasitized by two biotypes of the endoparasitoid *Cotesia sesamiae* (Cameron). *J. Insect Physiol.* 53, 676–684. <https://doi.org/10.1016/j.jinsphys.2007.04.008>
- Glatz, R.V., Asgari, S., Schmidt, O., 2004. Evolution of polydnviruses as insect immune suppressors. *Trends Microbiol.* 12, 545–554. <https://doi.org/10.1016/j.tim.2004.10.004>
- Godfray, H.C.J., 2004. Parasitoids. *Curr. Biol.* 14, R456. <https://doi.org/10.1016/j.cub.2004.06.004>
- Godfray, H.C.J., 1994. Parasitoids: Behavioral and Evolutionary Ecology. Princeton University Press.
- Godfray, H.C.J., 1987. The Evolution of Clutch Size in Parasitic Wasps. *Am. Nat.* 129, 221–233.
- Goftishu, M., Assefa, Y., Niba, A., Fininsa, C., Nyamukondiwa, C., Capdevielle-Dulac, C., Le Ru, B.P., 2019. Phylogeography and Population Structure of the Mediterranean Corn Borer, *Sesamia nonagrioides* (Lepidoptera: Noctuidae), Across Its Geographic Range. *J. Econ. Entomol.* 112, 396–406. <https://doi.org/10.1093/jee/toy323>
- Gross, P., 1993. Insect Behavioral and Morphological Defenses Against Parasitoids. *Annu. Rev. Entomol.* 38, 251–273. <https://doi.org/10.1146/annurev.en.38.010193.001343>
- Gueguen, G., Kalamarz, M.E., Ramroop, J., Uribe, J., Govind, S., 2013. Polydnviral Ankyrin Proteins Aid Parasitic Wasp Survival by Coordinate and Selective Inhibition of Hematopoietic and Immune NF-kappa B Signaling in Insect Hosts. *PLoS Pathog.* 9. <https://doi.org/10.1371/journal.ppat.1003580>
- Gundersen-Rindal, D.E., 2006. Characterization and transcriptional analysis of protein tyrosine phosphatase genes and an ankyrin repeat gene of the parasitoid *Glyptapanteles indiensis* polydnvirus in the parasitized host. *J. Gen. Virol.* 87, 311–322. <https://doi.org/10.1099/vir.0.81326-0>
- Häckermann, J., Rott, A.S., Dorn, S., 2007. How two different host species influence the performance of a gregarious parasitoid: host size is not equal to host quality. *J. Anim. Ecol.* 76, 376–383. <https://doi.org/10.1111/j.1365-2656.2006.01206.x>
- Hamilton, W.D., 1967. Extraordinary Sex Ratios. *Science* 156, 477–488. <https://doi.org/10.1126/science.156.3774.477>
- Hansen, T.F., Pélabon, C., Houle, D., 2011. Heritability is not Evolvability. *Evol. Biol.* 38, 258–277. <https://doi.org/10.1007/s11692-011-9127-6>
- Harvey, J.A., Poelman, E.H., Gols, R., 2010. Development and host utilization in *Hyposoter ebeninus* (Hymenoptera: Ichneumonidae), a solitary endoparasitoid of *Pieris rapae* and *P. brassicae* caterpillars (Lepidoptera: Pieridae). *Biol. Control* 53, 312–318. <https://doi.org/10.1016/j.biocontrol.2010.02.004>
- Hawkins, B.A., 1994. Pattern and process in host-parasitoid interactions. Cambridge University Press, Cambridge [England] ; New York.
- Hawkins, B.A., Cornell, H.V., Hochberg, M.E., 1997. PREDATORS, PARASITIDS, AND PATHOGENS AS MORTALITY AGENTS IN PHYTOPHAGOUS INSECT POPULATIONS. *Ecology* 78, 2145–2152. [https://doi.org/10.1890/0012-9658\(1997\)078\[2145:PPAPAM\]2.0.CO;2](https://doi.org/10.1890/0012-9658(1997)078[2145:PPAPAM]2.0.CO;2)
- Heimpel, G.E., de Boer, J.G., 2008. Sex Determination in the Hymenoptera. *Annu. Rev. Entomol.* 53, 209–230. <https://doi.org/10.1146/annurev.ento.53.103106.093441>
- Herniou, E.A., Hugué, E., Theze, J., Bezier, A., Periquet, G., Drezen, J.-M., 2013. When parasitic wasps hijacked viruses: genomic and functional evolution of polydnviruses. *Philos. Trans. R. Soc. B Biol. Sci.* 368. <https://doi.org/10.1098/rstb.2013.0051>
- Herniou, E.A., Olszewski, J.A., Cory, J.S., O'Reilly, D.R., 2003. The Genome Sequence and Evolution of Baculoviruses. *Annu. Rev. Entomol.* 48, 211–234. <https://doi.org/10.1146/annurev.ento.48.091801.112756>

- Hoffmann, A.A., Merilä, J., Kristensen, T.N., 2016. Heritability and evolvability of fitness and nonfitness traits: Lessons from livestock: HERITABILITY AND EVOLVABILITY IN LIVESTOCK. *Evolution* 70, 1770–1779. <https://doi.org/10.1111/evo.12992>
- Holt, R.D., Hochberg, M.E., 1997. When is biological control evolutionarily stable (or is it)? *Ecology* 78, 1673–1683.
- Houle, D., 1992. Comparing evolvability and variability of quantitative traits. *Genetics* 130, 195–204.
- Hu, J., Zhu, X.-X., Fu, W.-J., 2003. Passive evasion of encapsulation in *Macrocentrus cingulum* Brischke (Hymenoptera: Braconidae), a polyembryonic parasitoid of *Ostrinia furnacalis* Guenée (Lepidoptera: Pyralidae). *J. Insect Physiol.* 49, 367–375. [https://doi.org/10.1016/S0022-1910\(03\)00021-0](https://doi.org/10.1016/S0022-1910(03)00021-0)
- Ikawa, T., Okabe, H., 1985. Regulation of Egg Number per Host to Maximize the Reproductive Success in the Gregarious Parasitoid, *Apanteles glomeratus* L. (Hymenoptera: Braconidae). *Appl. Entomol. Zool.* 20, 331–339. <https://doi.org/10.1303/aez.20.331>
- Jancek, S., Bézier, A., Gayral, P., Paillusson, C., Kaiser, L., Dupas, S., Le Ru, B.P., Barbe, V., Periquet, G., Drezen, J.-M., Herniou, E.A., 2013. Adaptive selection on bracovirus genomes drives the specialization of *Cotesia* parasitoid wasps. *PLoS ONE* 8. <https://doi.org/10.1371/journal.pone.0064432>
- Kacsoh, B.Z., Schlenke, T.A., 2012. High Hemocyte Load Is Associated with Increased Resistance against Parasitoids in *Drosophila suzukii*, a Relative of *D. melanogaster*. *PLoS ONE* 7, e34721. <https://doi.org/10.1371/journal.pone.0034721>
- Kaiser, L., Dupas, S., Branca, A., Herniou, E.A., Clarke, C.W., Capdevielle Dulac, C., Obonyo, J., Benoist, R., Gauthier, J., Calatayud, P.A., Silvain, J.F., Le Ru, B.P., 2017a. The *Cotesia sesamiae* story: insight into host-range evolution in a Hymenoptera parasitoid and implication for its use in biological control programs. *Genetica*. <https://doi.org/10.1007/s10709-017-9989-3>
- Kaiser, L., Fernandez-Triana, J., Capdevielle-Dulac, C., Chantre, C., Bodet, M., Kaoula, F., Benoist, R., Calatayud, P.-A., Dupas, S., Herniou, E.A., Jeannette, R., Obonyo, J., Silvain, J.-F., Le Ru, B., 2017b. Systematics and biology of *Cotesia typhae* sp. n. (Hymenoptera, Braconidae, Microgastrinae), a potential biological control agent against the noctuid Mediterranean corn borer, *Sesamia nonagrioides*. *ZooKeys* 682, 105–136. <https://doi.org/10.3897/zookeys.682.13016>
- Kaiser, L., Le Ru, B.P., Kaoula, F., Paillusson, C., Capdevielle-Dulac, C., Obonyo, J.O., Herniou, E.A., Jancek, S., Branca, A., Calatayud, P.-A., Silvain, J.-F., Dupas, S., 2015. Ongoing ecological speciation in *Cotesia sesamiae*, a biological control agent of cereal stem borers. *Evol. Appl.* 8, 807–820. <https://doi.org/10.1111/eva.12260>
- Kapranas, A., Pacheco, P., Forster, L.D., Morse, J.G., Luck, R.F., 2008. Precise sex ratios manifested by several encyrtid parasitoids (Hymenoptera: Encyrtidae) of brown soft scale, *Coccus hesperidum* L. (Hemiptera: Coccidae). *Behav. Ecol. Sociobiol.* 62, 901–912. <https://doi.org/10.1007/s00265-007-0514-z>
- Kapranas, A., Tena, A., Luck, R.F., 2012. Dynamic virulence in a parasitoid wasp: the influence of clutch size and sequential oviposition on egg encapsulation. *Anim. Behav.* 83, 833–838. <https://doi.org/10.1016/j.anbehav.2012.01.004>
- Kergoat, G.J., Toussaint, E.F.A., Capdevielle-Dulac, C., Clamens, A.-L., Ong'amo, G., Conlong, D., van Den Berg, J., Cugala, D., Pallangyo, B., Mubenga, O., Chipabika, G., Ndemah, R., Sezonlin, M., Bani, G., Molo, R., Ali, A., Calatayud, P.-A., Kaiser, L., Silvain, J.-F., Le Ru, B., 2015. Integrative taxonomy reveals six new species related to the Mediterranean corn stalk borer *Sesamia nonagrioides* (Lefèbvre) (Lepidoptera, Noctuidae, Sesamiina). *Zool. J. Linn. Soc.* 175, 244–270. <https://doi.org/10.1111/zoj.12275>

- Kester, K.M., Barbosa, P., 1991. Postemergence learning in the insect parasitoid, *Cotesia congregata* (Say) (Hymenoptera: Braconidae). *J. Insect Behav.* 4, 727–742. <https://doi.org/10.1007/BF01052227>
- Kfir, R., Overholt, W.A., Khan, Z.R., Polaszek, A., 2002. Biology and management of economically important lepidopteran cereal stem borers in Africa. *Annu. Rev. Entomol.* 47, 701–731. <https://doi.org/10.1146/annurev.ento.47.091201.145254>
- Kim, Y., Kumar, S., 2018. Persistent expression of *Cotesia plutellae* bracovirus genes in parasitized host, *Plutella xylostella*. *PLOS ONE* 13, e0200663. <https://doi.org/10.1371/journal.pone.0200663>
- Kim, Y., Sanghoon, R., 2007. Ultrastructure of *Cotesia plutellae* Bracovirus in its replication at wasp avarian calyx. *J. Asia-Pac. Entomol.* 10, 357–361. [https://doi.org/10.1016/S1226-8615\(08\)60376-3](https://doi.org/10.1016/S1226-8615(08)60376-3)
- Kimani-Njogu, S.W., Overholt, W.A., 1997. Biosystematics of the *Cotesia flavipes* species complex (Hymenoptera: Braconidae), parasitoids of the gramineous stemborers. *Int. J. Trop. Insect Sci.* 17, 119–130.
- Kim-Jo, C., Gatti, J.-L., Poirié, M., 2019. *Drosophila* Cellular Immunity Against Parasitoid Wasps: A Complex and Time-Dependent Process. *Front. Physiol.* 10, 603. <https://doi.org/10.3389/fphys.2019.00603>
- Kitano, H., 1986. The role of *Apanteles glomeratus* venom in the defensive response of its host, *Pieris rapae crucivora*. *J. Insect Physiol., Physiological Interactions between Endoparasitic Insects and their Hosts* 32, 369–375. [https://doi.org/10.1016/0022-1910\(86\)90050-8](https://doi.org/10.1016/0022-1910(86)90050-8)
- Klomp, H., Teerink, B.J., 1966. The Significance of Oviposition Rates in the Egg Parasite, *Trichogramma Embryophagum* Htg. *Arch. Néerl. Zool.* 17, 350–375. <https://doi.org/10.1163/036551667X00065>
- Kourti, A., 2006. Mitochondrial DNA Restriction Map and Cytochrome c Oxidase Subunits I and II Sequence Divergence of Corn Stalk Borer *Sesamia nonagrioides* (Lepidoptera: Noctuidae). *Biochem. Genet.* 44, 320–331. <https://doi.org/10.1007/s10528-006-9032-3>
- Kwon, B., Kim, Y., 2008. Transient expression of an EP1-like gene encoded in *Cotesia plutellae* bracovirus suppresses the hemocyte population in the diamondback moth, *Plutella xylostella*. *Dev. Comp. Immunol.* 32, 932–942. <https://doi.org/10.1016/j.dci.2008.01.005>
- Lack, D., 1947. The Significance of Clutch-size. *Ibis* 89, 302–352. <https://doi.org/10.1111/j.1474-919X.1947.tb04155.x>
- Lander, E.S., Botstein, D., 1989. Mapping mendelian factors underlying quantitative traits using RFLP linkage maps. *Genetics* 121, 185–199.
- Larièpe, A., Mangin, B., Jasson, S., Combes, V., Dumas, F., Jamin, P., Lariagon, C., Jolivot, D., Madur, D., Fiévet, J., Gallais, A., Dubreuil, P., Charcosset, A., Moreau, L., 2012. The Genetic Basis of Heterosis: Multiparental Quantitative Trait Loci Mapping Reveals Contrasted Levels of Apparent Overdominance Among Traits of Agronomical Interest in Maize (*Zea mays* L.). *Genetics* 190, 795–811. <https://doi.org/10.1534/genetics.111.133447>
- Lavine, M.D., Strand, M.R., 2002. Insect hemocytes and their role in immunity. *Insect Biochem. Mol. Biol.* 32, 1295–1309.
- Le Lannic, J., Nénon, J.-P., 1999. Functional morphology of the ovipositor in *Megarhyssa atrata* (Hymenoptera, Ichneumonidae) and its penetration into wood. *Zoomorphology* 119, 73–79. <https://doi.org/10.1007/s004350050082>
- Le Masurier, A.D., 1987. A comparative study of the relationship between host size and brood size in *Apanteles* spp. (Hymenoptera: Braconidae). *Ecol. Entomol.* 12, 383–393. <https://doi.org/10.1111/j.1365-2311.1987.tb01019.x>

- Le Rü, B.P., Ong'amo, G.O., Moyal, P., Muchugu, E., Ngala, L., Musyoka, B., Abdullah, Z., Matama-Kauma, T., Lada, V.Y., Pallangyo, B., Omwega, C.O., Schulthess, F., Calatayud, P.-A., Silvain, J.-F., 2006. Geographic distribution and host plant ranges of East African noctuid stem borers. *Ann. Société Entomol. Fr. NS* 42, 353–361. <https://doi.org/10.1080/00379271.2006.10697467>
- Leach, I.M., Pannebakker, B.A., Schneider, M.V., Driessen, G., van de Zande, L., Beukeboom, L.W., 2009. Thelytoky in Hymenoptera with *Venturia canescens* and *Leptopilina clavipes* as Case Studies, in: Schön, I., Martens, K., Dijk, P. (Eds.), *Lost Sex*. Springer Netherlands, Dordrecht, pp. 347–375. https://doi.org/10.1007/978-90-481-2770-2_17
- Lecointre, G., Le Guyader, H., Visset, D., Bosquet, G., Charrier, D., Dejouannet, J.-F., Haessig, T., Norwood, J., 2017. *Classification phylogénétique du vivant*. 4e Edition. Tome 2.
- Lehmann, T., Hawley, W.A., Grebert, H., Danga, M., Atieli, F., Collins, F.H., 1999. The Rift Valley complex as a barrier to gene flow for *Anopheles gambiae* in Kenya. *J. Hered.* 90, 613–621. <https://doi.org/10.1093/jhered/90.6.613>
- Li, H., Handsaker, B., Wysoker, A., Fennell, T., Ruan, J., Homer, N., Marth, G., Abecasis, G., Durbin, R., 1000 Genome Project Data Processing Subgroup, 2009. The Sequence Alignment/Map format and SAMtools. *Bioinformatics* 25, 2078–2079. <https://doi.org/10.1093/bioinformatics/btp352>
- Li, Y., Lu, J.-F., Feng, C.-J., Ke, X., Fu, W.-J., 2007. Role of venom and ovarian proteins in immune suppression of *Ostrinia furnacalis* (Lepidoptera: Pyralidae) larvae parasitized by *Macrocentrus cingulum* (Hymenoptera: Braconidae), a polyembryonic parasitoid. *Insect Sci.* 14, 93–100. <https://doi.org/10.1111/j.1744-7917.2007.00130.x>
- Mackauer, M., 1986. Growth and developmental interactions in some aphids and their hymenopterous parasites. *J. Insect Physiol.* 32, 275–280. [https://doi.org/10.1016/0022-1910\(86\)90039-9](https://doi.org/10.1016/0022-1910(86)90039-9)
- Mackay, T.F.C., Stone, E.A., Ayroles, J.F., 2009. The genetics of quantitative traits: challenges and prospects. *Nat. Rev. Genet.* 10, 565–577. <https://doi.org/10.1038/nrg2612>
- Mangel, M., 1989. An evolutionary interpretation of the “motivation to oviposit.” *J. Evol. Biol.* 2, 157–172. <https://doi.org/10.1046/j.1420-9101.1989.2030157.x>
- Margaritopoulos, J.T., Gotosopoulos, B., Mamuris, Z., Skouras, P.J., Voudouris, K.C., Bacandritsos, N., Fantinou, A.A., Tsitsipis, J.A., 2007. Genetic variation among Mediterranean populations of *Sesamia nonagrioides* (Lepidoptera: Noctuidae) as revealed by RFLP mtDNA analysis. *Bull. Entomol. Res.* 97, 299–308. <https://doi.org/10.1017/S000748530700507X>
- Marti, D., 2003. Ovary development and polydnavirus morphogenesis in the parasitic wasp *Chelonus inanitus*. I. Ovary morphogenesis, amplification of viral DNA and ecdysteroid titres. *J. Gen. Virol.* 84, 1141–1150. <https://doi.org/10.1099/vir.0.18832-0>
- Martin, M., 2011. Cutadapt removes adapter sequences from high-throughput sequencing reads. *EMBnet.journal* 17, 10. <https://doi.org/10.14806/ej.17.1.200>
- Mason, W.R.M., 1981. The polyphyletic nature of *Apanteles foerster* (Hymenoptera: Braconidae): a phylogeny and reclassification of microgastrinae. *Mem. Entomol. Soc. Can.* 113, 1–147. <https://doi.org/10.4039/entm113115fv>
- Mayhew, P.J., 1998. The evolution of gregariousness in parasitoid wasps. *Proc. R. Soc. Lond. B Biol. Sci.* 265, 383–389. <https://doi.org/10.1098/rspb.1998.0306>
- Michel-Salzat, A., Whitfield, J.B., 2004. Preliminary evolutionary relationships within the parasitoid wasp genus *Cotesia* (Hymenoptera: Braconidae: Microgastrinae): combined analysis of four genes: Phylogeny of *Cotesia*. *Syst. Entomol.* 29, 371–382. <https://doi.org/10.1111/j.0307-6970.2004.00246.x>
- Mochiah, M.B., Ngi-Song, A.J., Overholt, W.A., Botchey, M., 2002. Effects of calyx fluid from a population of *Cotesia sesamiae* (Cameron) (Hymenoptera: Braconidae) on the

- immune response of its host *Busseola fusca* Fuller (Lepidoptera: Noctuidae). Int. J. Trop. Insect Sci. 22, 81–85. <https://doi.org/10.1017/S1742758400015095>
- Mockford, E.L., 1997. A New Species of *Dicopomorpha* (Hymenoptera: Mymaridae) with Diminutive, Apterous Males. Ann. Entomol. Soc. Am. 90, 115–120. <https://doi.org/10.1093/aesa/90.2.115>
- Moreau, S., Asgari, S., 2015. Venom Proteins from Parasitoid Wasps and Their Biological Functions. Toxins 7, 2385–2412. <https://doi.org/10.3390/toxins7072385>
- Moreau, S.J.M., Eslin, P., Giordanengo, P., Doury, G., 2003. Comparative study of the strategies evolved by two parasitoids of the genus *Asobara* to avoid the immune response of the host, *Drosophila melanogaster*. Dev. Comp. Immunol. 27, 273–282. [https://doi.org/10.1016/S0145-305X\(02\)00101-5](https://doi.org/10.1016/S0145-305X(02)00101-5)
- Mousseau, T.A., Roff, D.A., 1987. Natural selection and the heritability of fitness components. Heredity 59, 181–197. <https://doi.org/10.1038/hdy.1987.113>
- Moyal, P., Tokro, P., Bayram, A., Savopoulou-Soultani, M., Conti, E., Eizaguirre, M., Le Rü, B., Avand-Faghih, A., Frérot, B., Andreadis, S., 2011. Origin and taxonomic status of the Palearctic population of the stem borer *Sesamia nonagrioides* (Lefèbvre) (Lepidoptera: Noctuidae): *SESAMIA NONAGRIOIDES* OUT OF AFRICA. Biol. J. Linn. Soc. 103, 904–922. <https://doi.org/10.1111/j.1095-8312.2011.01666.x>
- Mrinalini, Werren, J.H., 2016. Parasitoid Wasps and Their Venoms, in: Gopalakrishnakone, P., Malhotra, A. (Eds.), Evolution of Venomous Animals and Their Toxins. Springer Netherlands, Dordrecht, pp. 1–26. https://doi.org/10.1007/978-94-007-6727-0_2-2
- Muirhead, K., Austin, A., Sallam, M., 2008. The systematics and biology of *Cotesia nonagriæ* (Olliff) stat. rev. (Hymenoptera: Braconidae: Microgastrinae), a newly recognized member of the *Cotesia flavipes* species complex. Zootaxa 1846, 35–46.
- Muirhead, K.A., Murphy, N.P., Sallam, N., Donnellan, S.C., Austin, A.D., 2012. Phylogenetics and genetic diversity of the *Cotesia flavipes* complex of parasitoid wasps (Hymenoptera: Braconidae), biological control agents of lepidopteran stemborers. Mol. Phylogenet. Evol. 63, 904–914. <https://doi.org/10.1016/j.ympev.2012.03.003>
- Muirhead, K.A., Sallam, N., Austin, A.D., 2010. Life history traits and foraging behaviour of *Cotesia nonagriæ* (Olliff) (Hymenoptera: Braconidae), a newly recognised member of the *Cotesia flavipes* complex of stemborer parasitoids. Aust. J. Entomol. 49, 56–65. <https://doi.org/10.1111/j.1440-6055.2009.00737.x>
- Ngi-Song, A.J., Overholt, W.A., Ayertey, J.N., 1995. Suitability of African gramineous stemborers for development of *Cotesia flavipes* and *C. sesamiae* (Hymenoptera: Braconidae). Environ. Entomol. 24, 978–984.
- Ngi-Song, A.J., Overholt, W.A., Njagi, P.G., Dicke, M., Ayertey, J.N., Lwande, W., 1996. Volatile infochemicals used in host and host habitat location by *Cotesia flavipes* Cameron and *Cotesia sesamiae* (Cameron) (Hymenoptera: Braconidae), larval parasitoids of stemborers on gramineae. J. Chem. Ecol. 22, 307–323. <https://doi.org/10.1007/BF02055101>
- Ngi-Song, A.J. (The I.C. of I.P. and E., Overholt, W.A., Stouthamer, R., 1998. Suitability of *Busseola fusca* and *Sesamia calamistis* (Lepidoptera: Noctuidae) for the development of two populations of *Cotesia sesamiae* (Hymenoptera: Braconidae) in Kenya. Biol. Control Theory Appl. Pest Manag. USA.
- Niyibigira, E.I., Overholt, W.A., Stouthamer, R., 2004a. *Cotesia flavipes* Cameron and *Cotesia sesamiae* (Cameron) (Hymenoptera: Braconidae) do not exhibit complementary sex determination: Evidence from field populations. Appl. Entomol. Zool. 39, 705–715. <https://doi.org/10.1303/aez.2004.705>
- Niyibigira, E.I., Overholt, W.A., Stouthamer, R., 2004b. *Cotesia flavipes* Cameron (Hymenoptera: Braconidae) does not exhibit complementary sex determination (ii)

- Evidence from laboratory experiments. *Appl. Entomol. Zool.* 39, 717–725. <https://doi.org/10.1303/aez.2004.717>
- Nurk, S., Bankevich, A., Antipov, D., Gurevich, A., Korobeynikov, A., Lapidus, A., Prjibelsky, A., Pyshkin, A., Sirotkin, A., Sirotkin, Y., Stepanauskas, R., McLean, J., Lasken, R., Clingenpeel, S.R., Woyke, T., Tesler, G., Alekseyev, M.A., Pevzner, P.A., 2013. Assembling Genomes and Mini-metagenomes from Highly Chimeric Reads, in: Deng, M., Jiang, R., Sun, F., Zhang, X. (Eds.), *Research in Computational Molecular Biology, Lecture Notes in Computer Science*. Springer Berlin Heidelberg, pp. 158–170.
- Obonyo, M., Schulthess, F., Le Ru, B., Van Den Berg, J., Calatayud, P.-A., 2010a. Host recognition and acceptance behaviour in *Cotesia sesamiae* and *C. flavipes* (Hymenoptera: Braconidae), parasitoids of gramineous stemborers in Africa. *Eur. J. Entomol.* 107, 169.
- Obonyo, M., Schulthess, F., Le Ru, B., van den Berg, J., Silvain, J.-F., Calatayud, P.-A., 2010b. Importance of contact chemical cues in host recognition and acceptance by the braconid larval endoparasitoids *Cotesia sesamiae* and *Cotesia flavipes*. *Biol. Control* 54, 270–275. <https://doi.org/10.1016/j.biocontrol.2010.05.015>
- Ode, P.J., Rosenheim, J.A., 1998. Sex Allocation and the Evolutionary Transition between Solitary and Gregarious Parasitoid Development. *Am. Nat.* 152, 757–761. <https://doi.org/10.1086/286206>
- Ode, P.J., Strand, M.R., 1995. Progeny and Sex Allocation Decisions of the Polyembryonic Wasp *Copidosoma floridanum*. *J. Anim. Ecol.* 64, 213. <https://doi.org/10.2307/5756>
- Okech, S.H.O., Overholt, W.A., 1996. Comparative biology of *Cotesia chilonis* Hymenoptera: Braconidae on selected African gramineous stemborers. *Biocontrol Sci. Technol.* 6, 595–602. <https://doi.org/10.1080/09583159631235>
- Omondi, S.F., Kireger, E., Dangasuk, O.G., Chikamai, B., Odee, D.W., Cavers, S., Khasa, D.P., 2010. Genetic Diversity and Population Structure of *Acacia senegal* (L) Willd. in Kenya. *Trop. Plant Biol.* 3, 59–70. <https://doi.org/10.1007/s12042-009-9037-2>
- Overholt, W.A., Ochieng, J.O., Lammers, P., Ogedah, K., 1994. Rearing and field release methods for *Cotesia flavipes* Cameron (Hymenoptera: Braconidae), a parasitoid of tropical gramineous stem borers. *Int. J. Trop. Insect Sci.* 15, 253–259.
- Pak, G.A., Buis, H.C.E.M., Heck, I.C.C., Hermans, M.L.G., 1986. Behavioural variations among strains of *Trichogramma* spp.: Host-age selection. *Entomol. Exp. Appl.* 40, 247–258. <https://doi.org/10.1111/j.1570-7458.1986.tb00508.x>
- Pak, G.A., Oatman, E.R., 1982. Biology of *Trichogramma Brevicapillum*. *Entomol. Exp. Appl.* 32, 61–67. <https://doi.org/10.1111/j.1570-7458.1982.tb03182.x>
- Pannebakker, B.A., Trivedi, U., Blaxter, M.A., Watt, R., Shuker, D.M., 2013. The Transcriptomic Basis of Oviposition Behaviour in the Parasitoid Wasp *Nasonia vitripennis*. *PLoS ONE* 8, e68608. <https://doi.org/10.1371/journal.pone.0068608>
- Pannebakker, B.A., Watt, R., Knott, S.A., West, S.A., Shuker, D.M., 2011. The quantitative genetic basis of sex ratio variation in *Nasonia vitripennis*: a QTL study: *Nasonia* sex ratio QTLs. *J. Evol. Biol.* 24, 12–22. <https://doi.org/10.1111/j.1420-9101.2010.02129.x>
- Parra, J.R.P., 2014. Biological Control in Brazil: an overview. *Sci. Agric.* 71, 420–429. <https://doi.org/10.1590/0103-9016-2014-0167>
- Pasquier-Barre, F., Moreau, A., Huguet, E., Dupuy, C., Drezen, J.-M., Poirié, M., Monteiro, F., 2002. Polydnavirus replication: the EP1 segment of the parasitoid wasp *Cotesia congregata* is amplified within a larger precursor molecule. *J. Gen. Virol.* 83, 2035–2045. <https://doi.org/10.1099/0022-1317-83-8-2035>
- Pennacchio, F., Strand, M.R., 2006. Evolution of developmental strategies in parasitic hymenoptera. *Annu. Rev. Entomol.* 51, 233–258. <https://doi.org/10.1146/annurev.ento.51.110104.151029>

- Pexton, J.J., de Boer, J.G., Heimpel, G.E., Vet, L.E.M., Whitfield, J.B., Ode, P.J., 2009. Competition and brood reduction: testing alternative models of clutch-size evolution in parasitoids. *Behav. Ecol.* 20, 403–409. <https://doi.org/10.1093/beheco/arn147>
- Pexton, J.J., Mayhew, P.J., 2005. Clutch size adjustment, information use and the evolution of gregarious development in parasitoid wasps. *Behav. Ecol. Sociobiol.* 58, 99–110. <https://doi.org/10.1007/s00265-004-0881-7>
- Pichon, A., Bezier, A., Urbach, S., Aury, J.-M., Jouan, V., Ravallec, M., Guy, J., Cousserans, F., Theze, J., Gauthier, J., Demetree, E., Schmieder, S., Wurmser, F., Sibut, V., Poirie, M., Colinet, D., da Silva, C., Couloux, A., Barbe, V., Drezen, J.-M., Volkoff, A.-N., 2015. Recurrent DNA virus domestication leading to different parasite virulence strategies. *Sci. Adv.* 1, e1501150–e1501150. <https://doi.org/10.1126/sciadv.1501150>
- Polaszek, A., 1991. The *Cotesia flavipes* species-complex: parasitoids of cereal stem borers in the tropics. *Proc 4th Eur Workshop Insect Parasit. F Bin Ed Perugia 1991 Redia* 743 Append. 1992 335-341.
- Polaszek, A., Delvare, G., 2000. Les foreurs des tiges de céréales en Afrique : Importance économique, systématique, ennemis naturels et méthodes de lutte. *Cirad*.
- Porta, N.C. la, 1990. Evaluation of field parasitism by *Trichopoda giacomellii* (Blanch.) Guimarães, 1971 (Diptera: Tachinidae) on *Nezara viridula* (L.) 1758 (Hemiptera: Pentatomidae). *Rev. Chil. Entomol.* 18, 83–87.
- Postali Parra, J.R., Coelho, A., 2019. Applied Biological Control in Brazil: From Laboratory Assays to Field Application. *J. Insect Sci.* 19. <https://doi.org/10.1093/jisesa/iey112>
- Potting, R.P.J., Overholt, W.A., Danso, F.O., Takasu, K., 1997. Foraging behavior and life history of the stemborer parasitoid *Cotesia flavipes* (hymenoptera: Braconidae). *J. Insect Behav.* 10, 13.
- Pruijssers, A.J., Strand, M.R., 2007. PTP-H2 and PTP-H3 from *Microplitis demolitor* Bracovirus Localize to Focal Adhesions and Are Antiphagocytic in Insect Immune Cells. *J. Virol.* 81, 1209–1219. <https://doi.org/10.1128/JVI.02189-06>
- Quicke, D.L., 1997. *Parasitic Wasps*. Springer Netherlands.
- Quicke, D.L.J., 2014. *The Braconid and Ichneumonid Parasitoid Wasps: Biology, Systematics, Evolution and Ecology*. John Wiley & Sons, Ltd, Chichester, UK. <https://doi.org/10.1002/9781118907085>
- R Core Team, 2018. *R: A Language and Environment for Statistical Computing*. R Found. Stat. Comput. Vienna Austria URL [HtppswwwR-Project.org](https://www.R-Project.org).
- R Core Team, 2016. *R: A Language and Environment for Statistical Computing*. R Found. Stat. Comput. Vienna Austria.
- Reuter, O.M., 1913. *Lebensgewohnheiten und Instinkte den Insekten bis zurn Erwachen der Sozialaen Instinkte*. Friedlander, Berlin.
- Rochette, N.C., Catchen, J.M., 2017. Deriving genotypes from RAD-seq short-read data using Stacks. *Nat. Protoc.* 12, 2640–2659. <https://doi.org/10.1038/nprot.2017.123>
- Rosenheim, J.A., Hongkham, D., 1996. Clutch size in an obligately siblicidal parasitoid wasp. *Anim. Behav.* 51, 841–852. <https://doi.org/10.1006/anbe.1996.0088>
- Rosenheim, J.A., Rosen, D., 1991. Foraging and Oviposition Decisions in the Parasitoid *Aphytis lingnanensis*: Distinguishing the Influences of Egg Load and Experience. *J. Anim. Ecol.* 60, 873. <https://doi.org/10.2307/5419>
- Rotheram, S., 1967. Immune Surface of Eggs of a Parasitic Insect. *Nature* 214, 700–700. <https://doi.org/10.1038/214700a0>
- Rousseau, D., 2009. Maïs: la sésamie progresse cap au nord, dans l’air marin et la douceur angevine: Progression de la sésamie dans les Pays-de-la-Loire: à gérer dans la région, à méditer ailleurs en France. *Phytoma* 622–23, 38–41.

- Salazar-Jaramillo, L., Jalvingh, K.M., de Haan, A., Kraaijeveld, K., Buermans, H., Wertheim, B., 2017. Inter- and intra-species variation in genome-wide gene expression of *Drosophila* in response to parasitoid wasp attack. *BMC Genomics* 18, 331. <https://doi.org/10.1186/s12864-017-3697-3>
- Sallam, M.N., Overholt, W.A., Kairu, E., 2002. Intraspecific and interspecific competition between *Cotesia flavipes* and *Cotesia sesamiae* (Hymenoptera: Braconidae), gregarious larval endoparasitoids of lepidopteran stemborers. *Biocontrol Sci. Technol.* 12, 493–506. <https://doi.org/10.1080/09583150220146059>
- Salt, G., 1970. *The Cellular Defence Reactions of Insects*. Cambridge University Press, Cambridge. <https://doi.org/10.1017/CBO9780511721960>
- Salt, G., 1968. The resistance of insect parasitoids to the defense reactions of their hosts. *Biol. Rev.* 43, 200–232. <https://doi.org/10.1111/j.1469-185X.1968.tb00959.x>
- Salt, G., 1961. Competition among insect parasitoids. Mechanisms in biological competition. *Symp. Soc. Exp. Biol.* 15, 96–119.
- Scaglia, M., Chaud-Netto, J., Brochetto-Braga, M.R., Ceregato, S.A., Gobbi, N., Rodrigues, A., 2005. Oviposition sequence and offspring of mated and virgin females of *Cotesia flavipes* (Hymenoptera: Braconidae) parasitizing *Diatraea saccharalis* larvae (Lepidoptera: Crambidae). *J. Venom. Anim. Toxins Trop. Dis.* 11, 283–298.
- Segoli, M., Harari, A.R., Rosenheim, J.A., Bouskila, A., Kesar, T., 2010. REVIEW: The evolution of polyembryony in parasitoid wasps: The evolution of polyembryony. *J. Evol. Biol.* 23, 1807–1819. <https://doi.org/10.1111/j.1420-9101.2010.02049.x>
- Serbielle, C., Chowdhury, S., Pichon, S., Dupas, S., Lesobre, J., Purisima, E.O., Drezen, J.-M., Huguet, E., 2008. Viral cystatin evolution and three-dimensional structure modelling: A case of directional selection acting on a viral protein involved in a host-parasitoid interaction. *BMC Biol.* 6, 38. <https://doi.org/10.1186/1741-7007-6-38>
- Shaw, M.R., Huddleston, T., 1991. *Classification and biology of Braconid wasps (Hymenoptera: Braconidae)*. Royal Entomological Society of London.
- Sim, A.D., Wheeler, D., 2016. The venom gland transcriptome of the parasitoid wasp *Nasonia vitripennis* highlights the importance of novel genes in venom function. *BMC Genomics* 17, 571. <https://doi.org/10.1186/s12864-016-2924-7>
- Skinner, S.W., 1985. Clutch size as an optimal foraging problem for insects. *Behav. Ecol. Sociobiol.* 17, 231–238. <https://doi.org/10.1007/BF00300141>
- Smith, M.A., Rodriguez, J.J., Whitfield, J.B., Deans, A.R., Janzen, D.H., Hallwachs, W., Hebert, P.D., 2008. Extreme diversity of tropical parasitoid wasps exposed by iterative integration of natural history, DNA barcoding, morphology, and collections. *Proc. Natl. Acad. Sci.* 105, 12359–12364.
- Soller, M., Lanzrein, B., 1996. Polydnavirus and venom of the egg-larval parasitoid *Chelonus inanitus* (Braconidae) induce developmental arrest in the prepupa of its host *Spodoptera littoralis* (Noctuidae). *J. Insect Physiol.* 42, 471–481.
- Stapley, J., Feulner, P.G.D., Johnston, S.E., Santure, A.W., Smadja, C.M., 2017. Variation in recombination frequency and distribution across eukaryotes: patterns and processes. *Philos. Trans. R. Soc. Lond. B. Biol. Sci.* 372. <https://doi.org/10.1098/rstb.2016.0455>
- Strand, M.R., 2014. Teratocytes and their functions in parasitoids. *Curr. Opin. Insect Sci.* 6, 68–73. <https://doi.org/10.1016/j.cois.2014.09.005>
- Strand, M.R., Burke, G.R., 2015. Polydnaviruses: From discovery to current insights. *Virology* 479–480, 393–402. <https://doi.org/10.1016/j.virol.2015.01.018>
- Tagawa, J., Yoshida, C., Hashimoto, T., Sudare, A., 1987. Effects of mating on the oviposition behaviour of the parasitic wasp, *Apanteles glomeratus* L. (Hymenoptera: Braconidae). *J. Ethol.* 5, 37–41. <https://doi.org/10.1007/BF02347893>

- Takasuka, K., Yasui, T., Ishigami, T., Nakata, K., Matsumoto, R., Ikeda, K., Maeto, K., 2015. Host manipulation by an ichneumonid spider ectoparasitoid that takes advantage of preprogrammed web-building behaviour for its cocoon protection. *J. Exp. Biol.* 218, 2326–2332. <https://doi.org/10.1242/jeb.122739>
- Tanaka, T., 1987. Calyx and Venom Fluids of *Apanteles kariyai* (Hymenoptera: Braconidae) as Factors that Prolong Larval Period of the Host, *Pseudaletia separata* (Lepidoptera: Noctuidae). *Ann. Entomol. Soc. Am.* 80, 530–533. <https://doi.org/10.1093/aesa/80.4.530>
- Tanaka, T., Wago, H., 1990. Ultrastructural and functional maturation of teratocytes of *Apanteles kariyai*. *Arch. Insect Biochem. Physiol.* 13, 187–197. <https://doi.org/10.1002/arch.940130306>
- Thompson, J.N., 2009. *The Coevolutionary Process*. University of Chicago Press.
- Thompson, J.N., 1999. Specific hypotheses on the geographic mosaic of coevolution. *Am. Nat.* 153, S1–S14.
- Thompson, J.N., 1994. *The coevolutionary process*. University of Chicago Press, Chicago.
- Thompson, K.J., 2018. Oviposition-like central pattern generators in pregenital segments of male and female grasshoppers. *J. Comp. Physiol. A* 204, 419–433. <https://doi.org/10.1007/s00359-018-1249-1>
- Trevisan, M., De Bortoli, S.A., Vacari, A.M., Laurentis, V.L., Ramalho, D.G., 2016. Quality of the exotic parasitoid *Cotesia flavipes* (Hymenoptera: Braconidae) does not show deleterious effects after inbreeding for 10 Generations. *PLOS ONE* 11. <https://doi.org/10.1371/journal.pone.0160898>
- Ulyett, G.C., 1935. Notes on *Apanteles sesamiae*, Cam., a Parasite of the Maize Stalk-borer (*Busseola fusca*, Fuller) in South Africa. *Bull. Entomol. Res.* 26, 253–262. <https://doi.org/10.1017/S0007485300038189>
- Vacari, A.M., De Bortoli, S.A., Borba, D.F., Martins, M.I.E.G., 2012. Quality of *Cotesia flavipes* (Hymenoptera: Braconidae) reared at different host densities and the estimated cost of its commercial production. *Biol. Control* 63, 102–106. <https://doi.org/10.1016/j.biocontrol.2012.06.009>
- van Alphen, J.J., Visser, M.E., 1990. Superparasitism as an adaptive strategy for insect parasitoids. *Annu. Rev. Entomol.* 35, 59–79. <https://doi.org/10.1146/annurev.en.35.010190.000423>
- Van Baaren, J., Landry, B.L., Boivin, G., 1999. Sex allocation and larval competition in a superparasitizing solitary egg parasitoid: competing strategies for an optimal sex ratio. *Funct. Ecol.* 13, 66–71.
- van de Kamp, T., Schwermann, A.H., dos Santos Rolo, T., Lösel, P.D., Engler, T., Etter, W., Faragó, T., Göttlicher, J., Heuveline, V., Kopmann, A., Mähler, B., Mörs, T., Odar, J., Rust, J., Tan Jerome, N., Vogelgesang, M., Baumbach, T., Krogmann, L., 2018. Parasitoid biology preserved in mineralized fossils. *Nat. Commun.* 9, 3325. <https://doi.org/10.1038/s41467-018-05654-y>
- Van Valen, L., 1973. A new evolutionary law. *Evol. Theory* 1, 30.
- Varaldi, J., 2003. Infectious Behavior in a Parasitoid. *Science* 302, 1930–1930. <https://doi.org/10.1126/science.1088798>
- Varaldi, J., Patot, S., Nardin, M., Gandon, S., 2009. Chapter 13 A Virus-Shaping Reproductive Strategy in a *Drosophila* Parasitoid, in: *Advances in Parasitology*. Elsevier, pp. 333–363. [https://doi.org/10.1016/S0065-308X\(09\)70013-2](https://doi.org/10.1016/S0065-308X(09)70013-2)
- Vargas, G., Gómez, L.A., Michaud, J.P., 2015. Sugarcane Stem Borers of the Colombian Cauca River Valley: Current Pest Status, Biology, and Control. *Fla. Entomol.* 98, 728–735. <https://doi.org/10.1653/024.098.0249>

- Velthuis, B.-J., Yang, W., Van Opijnen, T., Werren, J.H., 2005. Genetics of female mate discrimination of heterospecific males in *Nasonia* (Hymenoptera, Pteromalidae). *Anim. Behav.* 69, 1107–1120. <https://doi.org/10.1016/j.anbehav.2004.06.032>
- Verhulst, E.C., Beukeboom, L.W., Zande, L. van de, 2010. Maternal Control of Haplodiploid Sex Determination in the Wasp *Nasonia*. *Science* 328, 620–623. <https://doi.org/10.1126/science.1185805>
- Vinson, S.B., 1990. How parasitoids deal with the immune system of their host: An overview. *Arch. Insect Biochem. Physiol.* 13, 3–27. <https://doi.org/10.1002/arch.940130103>
- Visscher, P.M., Hill, W.G., Wray, N.R., 2008. Heritability in the genomics era — concepts and misconceptions. *Nat. Rev. Genet.* 9, 255–266. <https://doi.org/10.1038/nrg2322>
- Volkoff, A.-N., Jouan, V., Urbach, S., Samain, S., Bergoin, M., Wincker, P., Demettre, E., Cousserans, F., Provost, B., Coulibaly, F., Legeai, F., Béliveau, C., Cusson, M., Gyapay, G., Drezen, J.-M., 2010. Analysis of Virion Structural Components Reveals Vestiges of the Ancestral Ichnovirus Genome. *PLOS Pathog.* 6, e1000923. <https://doi.org/10.1371/journal.ppat.1000923>
- Waage, J.K., Greathead, D.J. (Eds.), 1986. *Insect parasitoids*. Academic Press, London ; Orlando.
- Waage, J.K., Ming, N.S., 1984. The Reproductive Strategy of a Parasitic Wasp: I. Optimal Progeny and Sex Allocation in *Trichogramma evanescens*. *J. Anim. Ecol.* 53, 401. <https://doi.org/10.2307/4524>
- Wajnberg, É., Bernstein, C., Van Alphen, J. (Eds.), 2008. *Behavioral Ecology of Insect Parasitoids*. Blackwell Publishing Ltd, Oxford, UK. <https://doi.org/10.1002/9780470696200>
- Webb, B.A., 1998. Polydnavirus biology, genome structure, and evolution, in: Miller, L.K., Ball, L.A. (Eds.), *The Insect Viruses, The Viruses*. Springer US, pp. 105–139. https://doi.org/10.1007/978-1-4615-5341-0_5
- Webb, B.A., Luckhart, S., 1994. Evidence for an early immunosuppressive role for related *campoplex sonorensis* venom and ovarian proteins in *heliiothis virescens*. *Arch. Insect Biochem. Physiol.* 26, 147–163. <https://doi.org/10.1002/arch.940260208>
- Weber, B., Annaheim, M., Lanzrein, B., 2007. Transcriptional analysis of polydnaviral genes in the course of parasitization reveals segment-specific patterns. *Arch. Insect Biochem. Physiol.* 66, 9–22. <https://doi.org/10.1002/arch.20190>
- Wertheim, B., Kraaijeveld, A.R., Hopkins, M.G., Walther Boer, M., Godfray, H.C.J., 2011. Functional genomics of the evolution of increased resistance to parasitism in *Drosophila*: GENOMICS OF RESISTANCE TO PARASITOIDS. *Mol. Ecol.* 20, 932–949. <https://doi.org/10.1111/j.1365-294X.2010.04911.x>
- White, F. (Frank), 1983. *The vegetation of Africa: a descriptive memoir to accompany the Unesco/AETFAT/UNSO vegetation map of Africa, Natural resources research ; 20*. Unesco, Paris.
- Whitfield, J.B., 2000. Phylogeny of microgastrid braconid wasps, and what it tells us about polydnavirus evolution. *Hymenopt. Evol Biodivers Biol Control* 97–105.
- Whitfield, J.B., 1995. Annotated Checklist of the Microgastrinae of North America North of Mexico (Hymenoptera: Braconidae). *J. Kans. Entomol. Soc.* 68, 245–262.
- Whitfield, J.B., Austin, A.D., Fernandez-Triana, J.L., 2018. Systematics, Biology, and Evolution of Microgastrine Parasitoid Wasps. *Annu. Rev. Entomol.* 63, 389–406. <https://doi.org/10.1146/annurev-ento-020117-043405>
- Whitfield, J.B., Mardulyn, P., Austin, A.D., Downton, M., 2002. Phylogenetic relationships among microgastrine braconid wasp genera based on data from the 16S, COI and 28S genes and morphology: Phylogeny of microgastrine braconid wasps. *Syst. Entomol.* 27, 337–359. <https://doi.org/10.1046/j.1365-3113.2002.00183.x>

- Whiting, P.W., 1943. Multiple Alleles in Complementary Sex Determination of *Habrobracon*. *Genetics* 28, 365–382.
- Wyler, T., Lanzrein, B., 2003. Ovary development and polydnavirus morphogenesis in the parasitic wasp *Chelonus inanitus*. II. Ultrastructural analysis of calyx cell development, virion formation and release. *J. Gen. Virol.* 84, 1151–1163. <https://doi.org/10.1099/vir.0.18830-0>
- Zhang, G., Schmidt, O., Asgari, S., 2004. A Novel Venom Peptide from an Endoparasitoid Wasp Is Required for Expression of Polydnavirus Genes in Host Hemocytes. *J. Biol. Chem.* 279, 41580–41585. <https://doi.org/10.1074/jbc.M406865200>
- Zhou, Y., Gu, H., Dorn, S., 2006. Single-locus sex determination in the parasitoid wasp *Cotesia glomerata* (Hymenoptera: Braconidae). *Heredity* 96, 487–492. <https://doi.org/10.1038/sj.hdy.6800829>

Annexes

The *Cotesia sesamiae* story: insight into host-range evolution in a Hymenoptera parasitoid and implication for its use in biological control programs

L. Kaiser¹ · S. Dupas¹ · A. Branca^{1,4} · E. A. Herniou² · C. W. Clarke^{3,5} ·
C. Capdevielle Dulac¹ · J. Obonyo³ · R. Benoist¹ · J. Gauthier^{2,6} · P. A. Calatayud^{1,3} ·
J. F. Silvain¹ · B. P. Le Ru^{1,3}

Received: 17 July 2017 / Accepted: 18 September 2017
© Springer International Publishing AG 2017

Abstract This review covers nearly 20 years of studies on the ecology, physiology and genetics of the Hymenoptera *Cotesia sesamiae*, an African parasitoid of Lepidoptera that reduces populations of common maize borers in East and South Africa. The first part of the review presents studies based on sampling of *C. sesamiae* from maize crops in Kenya. From this agrosystem including one host plant and three main host borer species, studies revealed two genetically differentiated populations of *C. sesamiae* species adapted to their local host community, and showed that their differentiation involved the joint evolution of virulence genes and sensory mechanisms of host acceptance, reinforced by reproductive incompatibility due to *Wolbachia* infection status and natural inbreeding. In the second part,

we consider the larger ecosystem of wild Poales plant species hosting many Lepidoptera stem borer species that are potential hosts for *C. sesamiae*. The hypothesis of other host-adapted *C. sesamiae* populations was investigated based on a large sampling of stem borer larvae on various Poales across sub-Saharan Africa. The sampling provided information on the respective contribution of local hosts, biogeography and *Wolbachia* in the genetic structure of *C. sesamiae* populations. Molecular evolution analyses highlighted that several bracovirus genes were under positive selection, some of them being under different selection pressure in *C. sesamiae* populations adapted to different hosts. This suggests that *C. sesamiae* host races result from co-evolution acting at the local scale on different bracovirus genes. The third part considers the mechanisms driving specialization. *C. sesamiae* host races are more or less host-specialized. This character is crucial for efficient and environmentally-safe use of natural enemies for biological control of pests. One method to get an insight in the evolutionary stability of host-parasite associations is to characterize the phylogenetic relationships between the so-called host-races. Based on the construction of a phylogeny of *C. sesamiae* samples from various host- and plant species, we revealed three main lineages. Mechanisms of differentiation are discussed with regard to the geography and ecology of the samples. One of the lineage presented all the hallmarks of a distinct species, which has been morphologically described and is now studied in the perspective of being used as biological control agent against *Sesamia nonagrioides* Lefèbvre (Lepidoptera: Noctuidae), a major maize pest in West Africa and Mediterranean countries (see Benoist et al. 2017). The fourth part reviews past and present use of *C. sesamiae* in biological control, and points out the interest of such molecular ecology studies to reconcile biodiversity and food security stakes in future biological control.

✉ L. Kaiser
laure.kaiser-arnauld@egce.cnrs-gif.fr

¹ Laboratoire Evolution, Génome, Comportement et Ecologie (UMR CNRS-Univ. Paris-Sud-IRD ; Univ. Paris-Saclay), 1 Avenue de la Terrasse, 91198 Gif-sur-Yvette Cedex, France

² Institut de Recherche sur la Biologie de l’Insecte (UMR CNRS 7261), Université François-Rabelais, UFR Sciences et Techniques, Parc Grandmont, Avenue Monge, 37200 Tours, France

³ icipe: African Insect Science for Food and Health, Duduville Campus, Kasarani, P.O. Box 11, 30772-00100 Nairobi, Kenya

⁴ Present Address: Laboratory Ecology, Systematics and Evolution (UMR CNRS-Univ. Paris Sud-AgroParisTech), Université de Paris-Sud, 91405 Orsay Cedex, France

⁵ Present Address: Department of Economic Development, Jobs & Transport, Victoria State Government, 1, Spring Street, GPO Box 4509, Melbourne, VIC 3001, Australia

⁶ Present Address: Inria - IRISA, GenScale team, Campus de Beaulieu, 35042 Rennes, France

Keywords Parasitic wasp · Stem borer larvae · Specialization · Virulence genes · Maize · Africa

Introduction

Insect parasitoids develop as parasites of other arthropods, mostly insects, causing their death or sterility. All insect families and many spiders are hosts for insect parasitoids (Godfray 1994; Quicke 1997) and are thus, a major natural factor limiting arthropod populations (Hawkins 1994). Many parasitoid species are also used as biological control agents, particularly against crop pests (Bale et al. 2008), and factors determining host range need to be investigated in this context (Brodeur 2012). Parasitoid reproductive success lies in their ability to counter behavioural and immune defenses of their hosts, so these processes are shaped by co-evolution, which may explain changes in host range and the existence of host races within parasitoid species.

Species diversification of parasitoid insects is particularly important in the Hymenoptera order, which contains most parasitoid species (Quicke 1997). About 50,000 Hymenoptera parasitoid species have been described compared with 15,000 Dipteran species and about 3000 in other orders (Quicke 1997). Half of the Hymenoptera parasitoid species belong to the Ichneumonoidea super family composed of Braconidae and Ichneumonidae families (Quicke 2014). Such high species diversity is interpreted as the result of a co-evolution between parasitoids virulence and host resistance (Whitfield 1994). Several Braconidae and Ichneumonidae species, particularly those parasitizing Lepidoptera larvae, have a particularly efficient system of virulence enabling them to develop in host larvae (Quicke 2014). These parasitoids are derived from ancestors that had domesticated pathogenic viruses, from the nudivirus family in the case of the Braconidae lineage (Gauthier et al. 2017; Herniou et al. 2013). Genes from nudiviral origin are integrated to the braconid wasp chromosomes (Bézier et al. 2009, 2013). Their high level of transcription in the wasp ovaries (in specialized cells of the calyx, Fig. 1b) results in the formation of viral capsids. This process co-occurs with the amplification and excision of DNA circles supporting the virulence genes of the wasp (proviral loci, also called bracovirus or ichtnovirus genomes). These circles are then incorporated into the capsids, then called polydnavirus (PDV) particles (Fig. 1c). These PDVs are part of a milky fluid called the calyx fluid that fills the oviduct and is injected with the parasitoid eggs inside the host during oviposition. The PDV particles subsequently infect the host cells, in which virulence proteins are produced. This massive production of virulence proteins results in a rapid inactivation of the host cellular immune response, allowing embryonic and parasitoid larval development (Fig. 1d). In the *Cotesia* genus, suppression of host

Fig. 1 Developmental success or failure of *Cotesia flavipes* spp. complex. **a** The female wasp enters stem tunnels bored by caterpillars and oviposits into the host body upon contact recognition of chemical cues. **b** Species from this complex are pro-ovogenic wasps, i.e. most ovocytes are ready to be oviposited, located in the lateral oviduct also called calyx (*c* calyx, *ov* oviduct, *os* basis of the ovipositor sheath). **c** In the calyx wall, cells are specialized in the production of bracovirus particles (*bv*) that enclose several DNA circles, support of virulence genes; during oviposition, these particles are injected into the host body cavity with the eggs. There the particles infect host cells which synthesize the virulence proteins from the viral DNA. These proteins impair the immune cellular host response and allow hatching of the parasitic larva. **d** Second instar parasitic larvae inside the host body; *av*: anal vesicle. **e** Full-grown third stage larvae egress from the host body and spin their cocoons nearby for pupal development. **f** The host may resist, i.e. its immune cells (haemocytes) may not be susceptible to the virulence proteins, and will aggregate around the parasitic eggs, forming a capsule which will cause egg death. **g** Host larvae will then continue their development up to the adult stage. **a** *C. typhae* ovipositing in its larval host *Sesamia nonagrioides*; credit: R. Benoist. **b** Female *C. typhae* reproductive tract; credit: R. Benoist. **c** Bracovirus particles of *Cotesia congregata*; credit: J.M. Drezen. **d** *C. sesamiae* second stage larvae in the host hemolymph; credit: L. Kaiser. **e** Dead body of *S. nonagrioides* larva surrounded by *C. typhae* cocoons; credit: L. Kaiser. **f** *C. sesamiae* egg encapsulated by haemocytes of *Busseola fusca* host; credit: C. Clarke **g** *Sesamia nonagrioides* adult; credit: B. Le Ru

immune response by PDVs was first reported by Stoltz and Xu (1990) and Asgari et al. (1996).

One way to address the evolution of host range in a parasitoid species is to examine its intra-specific variability. Such study are rare in insect parasitoids (but see Muirhead et al. 2012; Phillips et al. 2008) because they require rearing parasitoids from extensive field sampling of a variety of host species on diverse host plants, on the scale of Dan Janzen work in Costa Rica (Smith et al. 2008). In this article, we review how such challenging tasks have been achieved in *Cotesia sesamiae* Cameron (Hymenoptera, Braconidae) and has enabled a wide array of analytical and experimental approaches, which uncovered processes of host range evolution.

Cotesia sesamiae is an African parasitoid of Lepidoptera stem borers of Poales,¹ which reduces populations of main cereal stem borers in Central, East and South Africa (Kankonda et al. 2017; Kfir and Bell 1993; Mailafiya et al. 2010). It belongs to the *flavipes* complex, which includes three other sister species, *Cotesia flavipes* Cameron (Indian sub-continent), *Cotesia chilonis* Munakata (far-east Asia) and *Cotesia nonagriariae* Viereck (Australia) (Muirhead et al. 2008, 2012). These species are all endoparasitoids of Lepidoptera stem borer larvae, which very likely evolved from allopatric speciation since they live in different continents.

¹ Botanical order including 16 families among which Poaceae (ex Gramineae), Cyperaceae and Typhaceae are the main plant families host for stem borers parasitized by species of the *C. flavipes* complex.

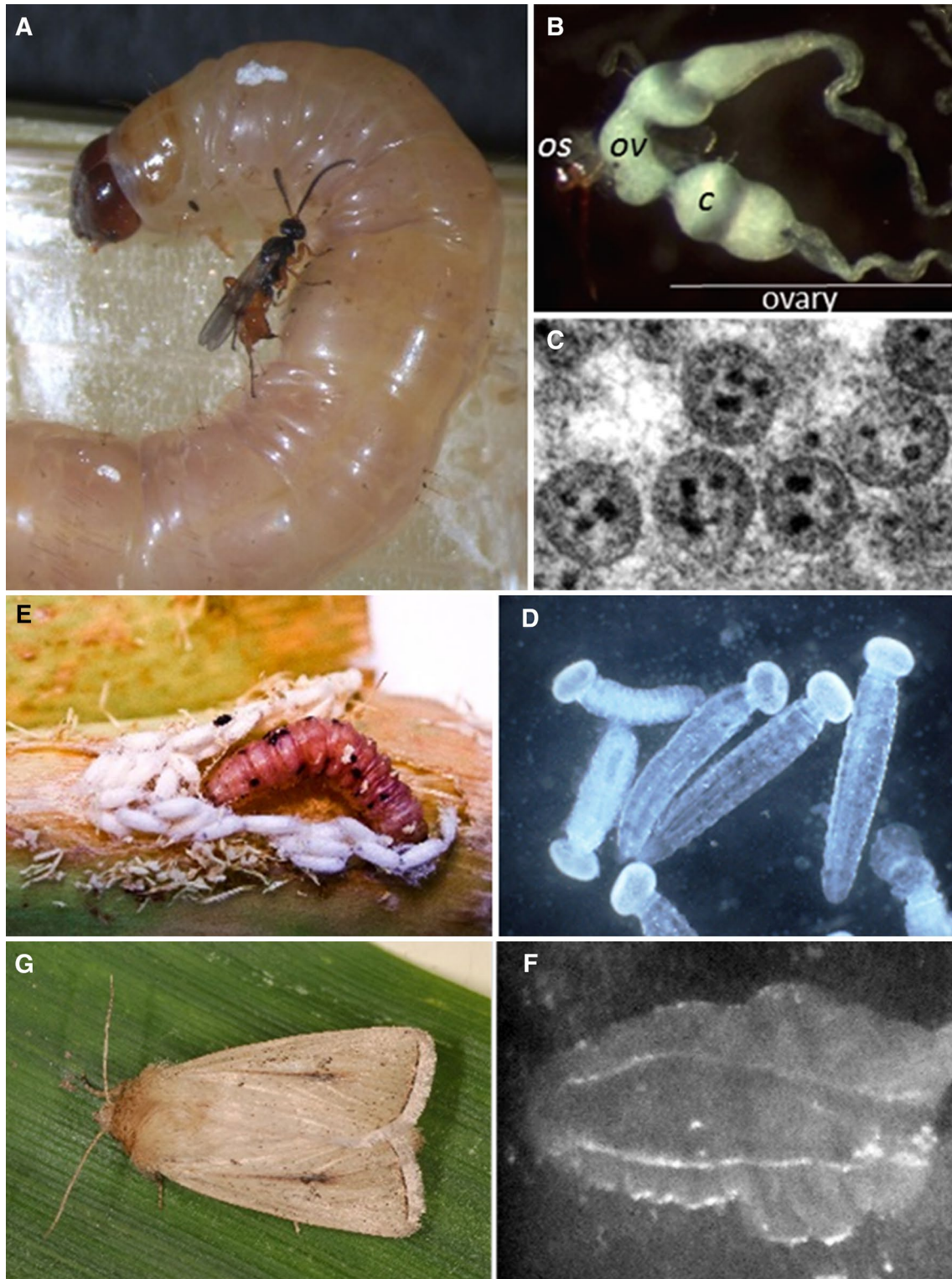

Interest for *C. sesamiae* as biological control agent arose with the rapid increase of maize crop surfaces in Africa, and the damages caused by three main stem borer pests, *Busseola fusca*, *Sesamia calamistis* (Lepidoptera: Noctuidae) and the introduced Asian moth *Chilo partellus* (Lepidoptera:

Crambidae) (Kfir et al. 2002). *B. fusca* commonly causes 25–55% maize yield loss, with peaks of 80% (Chabi-Olaye et al. 2006; Kfir et al. 2002). It is the main pest of maize and sorghum in elevated areas of several countries (like Kenya, South Africa, Cameroon) (Ndemah et al. 2012; Ong'amo



Fig. 2 Main laboratories involved in the *C. sesamiae* studies. Studies on the ecology, physiology and genetics of *C. sesamiae* were conducted at the *icipe* (formerly International Centre for Insect Physiology and Ecology, currently African Insect Science for Food and Health) at Nairobi, Kenya (a), in collaboration with the National agricultural Research Organization (NARO). From 2000, research programs were developed in collaboration with the IRD laboratory BEI (Biodiversity and Evolution of tropical Insects), headed by Jean-François Silvain and hosted by the CNRS at Gif sur Yvette, France (Lab. Evolution, Genetics and Speciation (LEGS), (b), and more recently

with the lab of Jean-Michel Drezen at the IRBI of Tours University (c), in collaboration with France Génomique. Significant knowledge was brought by the work of several PhD students, namely Adele Ngi-Song and Moses Mochiah, at the *icipe* lab of William Overholt; Catherine Clarke (born Gitau) under the supervision of Fritz Schulthess at the *icipe* and Stephane Dupas at BEI; Antoine Branca, under the supervision of Bruno Le Ru at the *icipe* and S. Dupas at BEI; Severine Jancek worked as post-doc at the IRBI with Elisabeth Herniou and Valérie Barbe at France Génomique

et al. 2006). Ngi-Song et al. (1995) showed that *C. flavipes*, which was introduced several times in sub-Saharan Africa, could not develop in *B. fusca*, whereas the native *C. sesamiae* was locally a good biological control agent against this pest (Kfir 1995; Mohyuddin and Greathead 1970).

The 1990s were the starting point of still ongoing studies on the ecology, physiology and genetics of *C. sesamiae* (Fig. 2). This research showed that genetic diversity was explained by local adaptation to host resources, and elucidated some of the associated traits, thereby accompanying the design of biological control operations. We structured this review fairly chronologically to tell a story based on the progression of knowledge on the studied system.

Local host adaptation of *C. sesamiae* in Kenya: study in maize crop

Ngi-Song et al. (1995) found that a *C. sesamiae* strain collected in the inland area of Kenya could develop in *B. fusca*, abundant in this area, whereas a strain collected in the coastal area, where *B. fusca* is rare, could not (Fig. 3). Both strains developed successfully in the noctuid *S. calamistis* (Table 1). Parasitized *B. fusca* larvae were dissected 3 days after parasitism and it appeared that *C. sesamiae* eggs from the coastal strain were encapsulated (Fig. 1f), which explained the developmental failure. The author also observed PDV particles in *C. sesamiae* ovarian fluid. She crossed both strains and characterized a unidirectional incompatibility possibly due to the infection of the coastal strain by the endocellular bacteria *Wolbachia*, while the inland strain was not infected (Table 1). This was soon confirmed by Mochiah et al. (2002) by curing strains from

their *Wolbachia*, using antibiotic treatment. At that time, Ngi-Song et al. (1998) concluded that there were at least two populations of the parasitoid in Kenya which differed in their abilities to develop in *B. fusca*. The authors hypothesized that because *B. fusca* is only sporadically found on the lowland coast (Ong'amo et al. 2006), the *C. sesamiae* population in this area would not have been under selective constrain to evade *B. fusca* immune system. The geographic distribution of virulence against *B. fusca* was confirmed on five other populations of the wasp (Mochiah et al. 2001). Later, Mochiah et al. (2002) showed that the difference in virulence between the two biotypes could be due to PDVs since the injection of the calyx fluid of a virulent wasp in a host infected by an avirulent wasp restored parasitoid development.

This ecological system thus showed great potential to analyze the contribution of PDV genes in local host adaptation. At that time natural variation of PDV genes had rarely been investigated and no studies had been conducted on mechanisms that may explain natural differences in parasitoid virulence. One virulence gene of another *Cotesia* species, *C. rubecula*, had been well characterized for its sequence, as well as the structure and function of the encoded protein (Asgari and Schmidt 2002). This *CrVI* gene, named from *C. rubecula* Virulence gene 1, encodes a secreted glycoprotein implicated in the depolymerization of the actin cytoskeleton of host haemocytes, leading to their inactivation (Asgari et al. 1996, 1997). Homologues of *CrVI* have been found in at least six *Cotesia* species (Whitfield 2000), including *C. flavipes* and *C. sesamiae* (Dupas et al. 2006).

Gitau et al. (2007) investigated if variations of *CrVI* sequence and expression were correlated with variations in *Cotesia* strain virulence. She worked with four Kenyan

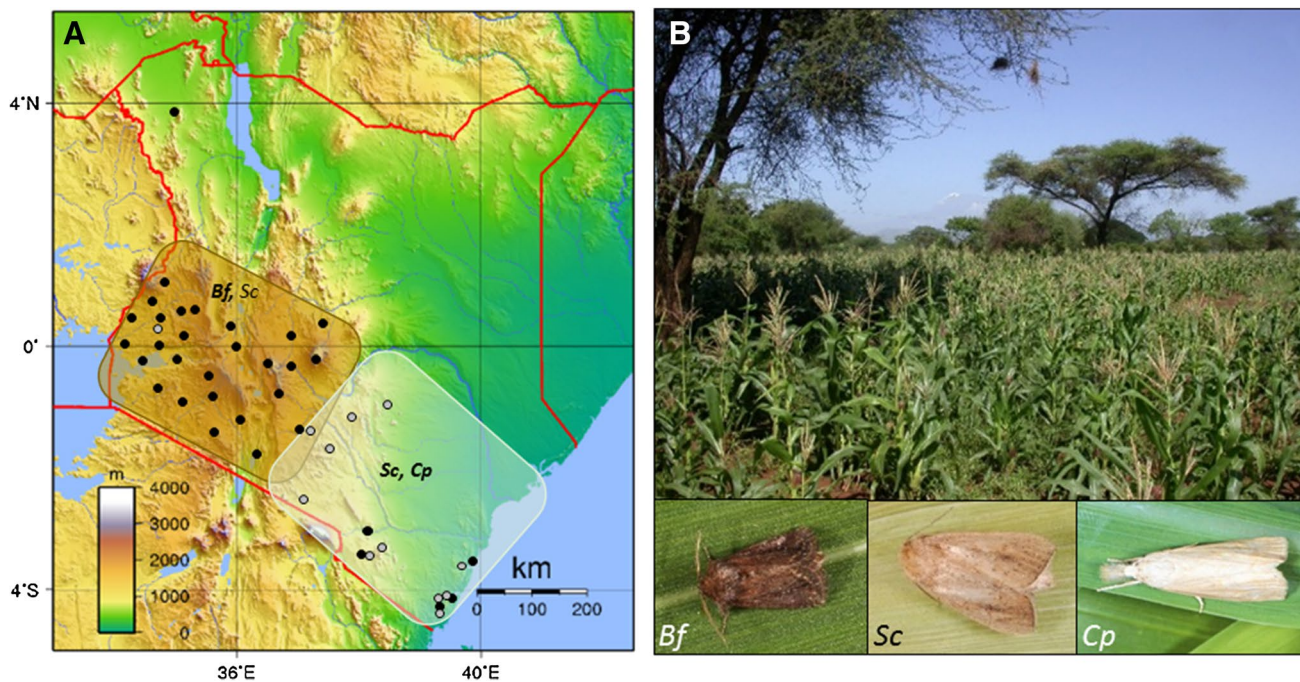

Fig. 3 Distribution of the main maize stem borer pest species in Kenya. **a** Physical map of Kenya showing the prevalence of *B. fusca* (*Bf*) in the mountainous Inland region (light brown area), and its absence in the lowland (light green area) where *Chilo* spp. (*Cp*: *Chilo partellus*) and *S. calamistis* (*Sc*) prevail; the latter is present in both areas but limited by the altitude (found below 2000 m); distribution

from Ngi-Song et al. (1998), and Dupas et al. (2008). In *C. sesamiae*, the distribution of *CrVI* alleles matches that of the hosts: only *CsI* (black dots) in the *Bf* region, and a majority of *CsC* (grey dots) in the *Sc* region (Dupas et al. 2008). **b** A typical landscape in Kenyan lowland maize area, with the associated main stem borer pests. Credit: B. Le Ru

Table 1 Host races in *C. sesamiae* collected on maize in Kenya, evidenced from the traits and data detailed in the left column

	Inland <i>C. sesamiae</i> pop.		Coastal <i>C. sesamiae</i> pop.	References
Acceptance of <i>B. fusca</i>	+		–	Gitau et al. (2010)
Development in <i>B. fusca</i>	+		–	Ngi-Song et al. (1995, 1998) Mochiah et al. (2001)
Acceptance of <i>S. calamistis</i>	+		+	Gitau et al. (2010)
Development in <i>S. calamistis</i>	+		+	Ngi-Song et al. (1995, 1998) Mochiah et al. (2001)
CrVI alleles	<i>CsI</i> and <i>CsI2</i>	between pop. polymorphism: 6 SNPs 5 NS, 1S	<i>CsC</i>	Dupas et al. (2006) Gitau et al. (2007) Dupas et al. (2008)
CrVI expression in <i>B. fusca</i>	+		–	Gitau et al. (2007)
CrVI expression in <i>S. calamistis</i>	+		+	Gitau et al. (2007)
Co-occurrence with <i>B. fusca</i>	Frequent		Rare	Ong’amo et al. (2006) Dupas et al. (2008)
<i>Wolbachia</i> infection	–		+	Mochiah et al. (2002)
Results of crosses between	Male	Normal hybrid progeny	Female	Ngi-Song et al. (1998) Mochiah et al. (2002)
	Female	All male hybrid progeny	Male	Ngi-Song et al. (1998) Mochiah et al. (2002)

SNP single nucleotide polymorphism, NS non-synonymous, S synonymous

C. sesamiae populations, two characterized as virulent and two as avirulent against *B. fusca*, based on egg encapsulation. She visualized the expression of *CrVI* transcripts in the host haemocytes and fat body at different time points (6–24 h) following parasitism by RT-PCR, and sequenced the transcript in one virulent (Inland) and one avirulent (Coast) population, using RACE assays. She found encapsulation occurred when *CrVI* was not expressed. Indeed, expression was faint or absent in fat body and haemolymph samples of *B. fusca* parasitized by the two avirulent *C. sesamiae* strains, the eggs of which became encapsulated. On the contrary, expression was high in the fat body and in haemolymph samples from both *B. fusca* and *S. calamistis* larvae parasitized by the two virulent *C. sesamiae* strains, the eggs of which could develop (Table 1). The *CrVI* transcript sequences had several non-synonymous base substitutions between both *C. sesamiae* strains, which should result in different translated proteins. This result confirmed the hypothesis that immune suppressive ability of the wasp may be due to variations in *CrVI*-haemocyte interactions (Dupas et al. 2006).

Follow up studies investigated if *CrVI* allelic variations were involved in local host adaptation. *B. fusca* is the only host resistant to *C. sesamiae* among the major stem borers present in maize. *CrVI* exon 2 was sequenced for 25 unrelated *C. sesamiae* females, sampled in maize and sorghum of Kenya, Tanzania and French Congo, which represent a large part of the wasp distribution range. Three haplotypes were found (Dupas et al. 2008). Two of them called Inland 1 and 2 (CsI1 and CsI2), were harbored by Inland Kenyan virulent *C. sesamiae*, and were separated by only one non-synonymous nucleotidic substitution. The third haplotype was characteristic of coastal Kenyan avirulent *C. sesamiae*, and differed from its closest haplotype CsI2 by five non-synonymous and one synonymous substitution. Allelic frequencies showed that virulence was correlated to the proportion of *B. fusca* in local stem borers communities.

The ratios of non-synonymous to synonymous substitutions were analyzed among *CrVI* variants and sequences from related species *C. rubecula*, *C. congregata* and *C. pluteellae* attacking leaf-eater Lepidoptera larvae. The results revealed that diversifying positive selection was observed only in branches of the *C. flavipes* complex, except for the Coast allele. Eighth of the nine positively selected sites were located in a 30 amino acid region (Dupas et al. 2008). Functional analyses were realized by designing bacterial constructs of *CrVI* genes lacking or not this region, and transferred into baculovirus. Monolayers of caterpillar haemocytes were then infected by these viruses, but this did not allow to determine any role of the region in preventing haemocytes to spread on foreign bodies (Asgari and Schmidt 2002; Dupas et al. 2008).

To detect selection at the population level, the distribution of *CrVI* alleles was analyzed in 67 localities across all Kenyan regions during a survey conducted several times a year in maize and sorghum fields (Ong'amo et al. 2006). More than one hundred *C. sesamiae* samples were genotyped for *CrVI* by PCR as described by Dupas et al. (2006), to establish relative allelic frequencies in the Kenyan localities. The statistical relationship between *CrVI* allelic distribution and percentage of *B. fusca* in the stem borer community were estimated using logistic regression taking into account other environmental variables as co-factor. It showed that *B. fusca* was the factor having the most significant effect on *CrVI* allelic distribution, the geographic distribution of Inland alleles reflecting that of the resistant host (Fig. 3; Dupas et al. 2008).

Altogether, these results provided evidence that PDV genes evolve in response to host resistance, ensuring local host adaptation. The avirulent Coast *CrVI* allele may be ancestral because phylogenetic analyses showed that it belongs to the same clade as *C. flavipes*. The sites under selection are located in a region of the *CrVI* protein for which functional links to host haemocyte disruption remain unknown (Asgari and Schmidt 2002). The discovery of host-range differentiation within *C. sesamiae* species is of major importance for the use of this species in biological control and was taken into account, as detailed in the last section of this review. Two biotypes or host races of the parasitoid have been evidenced in the maize and sorghum ecosystem, hosting a rather poor community of Lepidopteran stem borers. The existence of dozens of potential host species associated to wild plants suggests that many more host-specific virulence genes may have evolved in *C. sesamiae* and this motivated the studies reported in the second part of this review.

Host selection behavior is also an important trait ensuring parasitism success, especially when errors are costly. Avoiding unsuitable host larvae has strong fitness importance for parasitoids of stem borer larvae because the latter can kill parasitic wasps in about 30% of the parasitism attempts, by grasping them with their mandibles (Potting et al. 1997). Optimal foraging theory predicts that *C. sesamiae* strains avirulent against *B. fusca* would avoid attempting to parasitize larvae of this species. This hypothesis was investigated by Gitau et al. (2010). They observed the approach and acceptance behaviors of *B. fusca* by *C. sesamiae* females of three virulent and three avirulent strains. It appeared that the avirulent strains approached the resistant larvae much less frequently, and almost never parasitized them, whereas they readily approached and parasitized the susceptible *S. calamistis* larvae (Table 1). Studies with hybrids to assess the genetic basis of this differentiation are ongoing, as well as the identification of chemical cues involved in specific host recognition (Calatayud, Personal communication). If local adaptation to *B. fusca* involves the evolution of both

virulence and sensory mechanisms of host acceptance, it would then be interesting to uncover associated genes and their possible genetic linkage to understand the genetic architecture of host specificity, and its role in the evolution of specialization (Via and Hawthorne 2002).

Local host adaptation of *C. sesamiae* in Kenya: study in wild plants

Considering the large number of Lepidoptera stem borer species of Poales that are potential hosts for *C. sesamiae*, the hypothesis of other host-adapted *C. sesamiae* populations was investigated. Most species of Lepidoptera that are stem borer of Poales belong to the Sesamiina sub-tribe of the Apameini tribe, in the Noctuidae family, Noctuidea super family (Polaszek and Delvare 2000). The Sesamiina sub-tribe comprises 12 genera. The number of valid species in only one of these genus illustrates the potential host diversity encountered by *C. sesamiae* when foraging in stem tunnels. There are indeed 30 valid species in the *Sesamia* genus, but new species are being described and the total number may exceed 60 (Kergoat et al. 2015; Le Ru, Personal communication). A few species of Poales stem borers are also found in Crambidae and Pyralidae families, belonging to the Pyraloidea super family. To characterize the ecological diversity of *C. sesamiae*, a large sampling of stem borer larvae on various Poales (Fig. 4a) was undertaken across sub-Saharan Africa, during a 12-year collection campaign led by Bruno Le Ru. He revealed a great diversity of plant-specific Lepidoptera stem borer species (over 53,000 larvae belonging to 150 Sesamiina species of 27 genera, collected on 191 plant species), (Le Rü et al. 2006; Moolman et al. 2014; Ong'amo et al. 2014, 2018; Otieno et al. 2006; Le Ru, Personal communication). Due to the low parasitism rate of stem borer larvae in wild plants by *C. sesamiae* and *C. flavipes* [from 0 to 3.6% parasitized larvae depending on seasons and localities, with an average parasitism rate of 0.5%, Mailafiya et al. (2010)], thousands of collected larvae provided a first collection of 150 *C. sesamiae* samples from more than 20 host borers and host plants species collected in 52 localities in nine countries (Fig. 4b). It has been brought to more than 250 now. Branca et al. (2011) sequenced exon2 of *CrVI* for these samples. As each genotyped sample was characterized by a set of biotic (host species, host plant species, *Wolbachia* infection status of the parasitoid) and abiotic data (altitude and 19 climatic parameters), a multi-factors analysis (AMOVA) pointed out that host species was the main determinant explaining the *CrVI* genotypic polymorphism, followed by the *Wolbachia* strain, and the best model involved an interaction between both factors. Five new alleles were discovered and named after the associated host species (Fig. 4c). Three of them appeared to be host specific

(*CsSci*, *CsSsp9* and *CsSnona*). One of them (*Cs End*) was found only once so its ecology remains undetermined.

This study on the ecology of *C. sesamiae* in wild plants also revealed that parasitoids harbouring *CsI* and *CsI2* alleles (Inland), previously found mostly from *B. fusca* in maize fields, were in fact more generalist because in wild plants, they were recovered from 15 species belonging to six different genera in two families (Crambidae and Noctuidae). It was also the case for parasitoids harboring the *CsC* allele (Coast), recovered from 11 species belonging to five genera in the same two families, whereas collects from maize field evidenced only two host species. The comparison of the host ranges of these *CrVI* haplotypes confirmed that *CsI* and *CsI2* were mostly collected on larvae of the genus *Busseola*, and *CsC* allele on larvae from the genus *Sesamia* (but not on *S. nonagrioides* neither on *Sesamia luy-aensis*). This study also revealed that they shared common host species, showing that their local host adaptation was not characterized by a strict specialization to one host species, whereas this was the case for parasitoids harboring *CsSnona* allele, only recovered from *S. nonagrioides*. Branca et al. (2011) reconstructed a consensus tree genealogy of *CrVI* haplotypes and each allele appeared as a distinct evolutionary lineage with the exception of *CsI* and *CsI2* forming one lineage (Fig. 4c). All these results are additional arguments for the role of virulence gene evolution in the differentiation of host specialized populations of *C. sesamiae*. *Wolbachia* could act as an agent reinforcing host specialization in different populations of *C. sesamiae*, as well as highly inbred reproduction in this species. To better understand the genesis of *C. sesamiae* diversity, a current study investigates the relationship between gene flow assessed with microsatellite markers, host range and reproductive barriers induced by *Wolbachia* (Branca et al. submitted). Regarding the high species diversity within the Sesamiina, future sampling may reveal even more genetic diversity within *C. sesamiae*.

CrVI is one of the numerous genes harbored by the pro-viral loci. Bezier et al. (2013) had sequenced and annotated these loci in *C. congregata*. The authors identified 222 predicted virulence genes present on 35 proviral segments integrated into the wasp genome. They found out that these genes encode a variety of proteins belonging to several families potentially interacting with several cellular pathways of the host immune response. Studying the transcriptome of the host *Manduca sexta* fat body and haemocytes 24 h after parasitism by *C. congregata*, Chevignon et al. (2014) evidenced the expression of 88 of these virulence genes, among which *CrVI* was highly expressed. In order to understand the global role of bracoviruses in the local adaptation or specialization of parasitoid wasps to their hosts, Jancek et al. (2013) first annotated the bracovirus genome of *C. sesamiae* Inland and Coast populations (Kenyan samples from Kitale and Mombasa respectively).

Fig. 4 Ecological and genetic diversity of *C. sesamiae* collected on wild plants in sub-Saharan Africa. **a** From left to right, species from the Poaceae, Cyperaceae and Typhaceae, the main plant families hosting Sesamiina, the main host Noctuidae sub-tribe parasitized by *C. sesamiae*; credit: B. Le Ru. **b** Vegetation map of Africa with the countries where *C. sesamiae* samples have been found. Numbers refers to alleles of the CrV1 virulence gene. **c** Phylogeny of *C. sesamiae* CrV1 alleles (adapted from Branca et al. 2011), with the associated host range, showing that allelic populations vary from polyphagy to monophagy

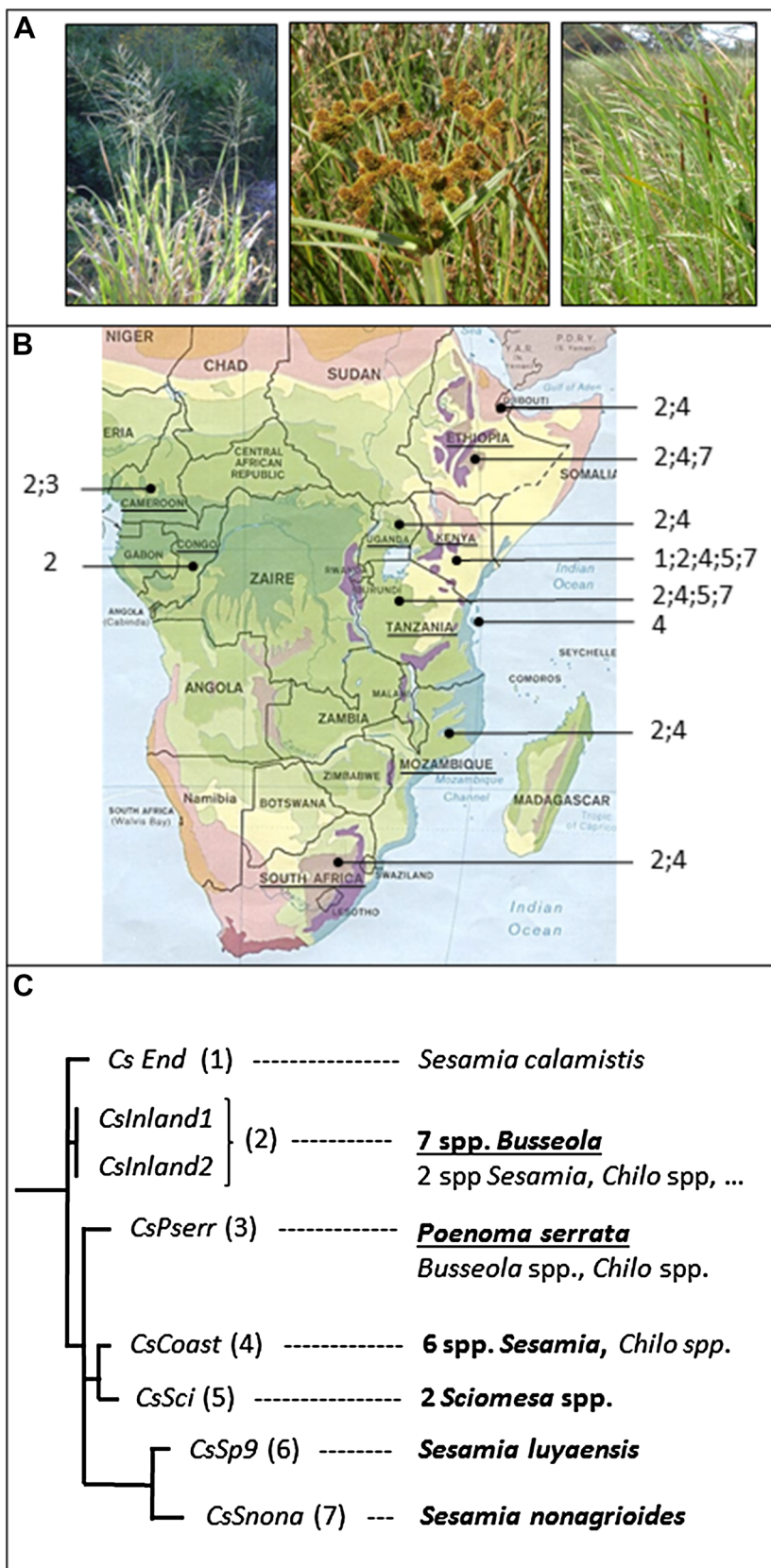
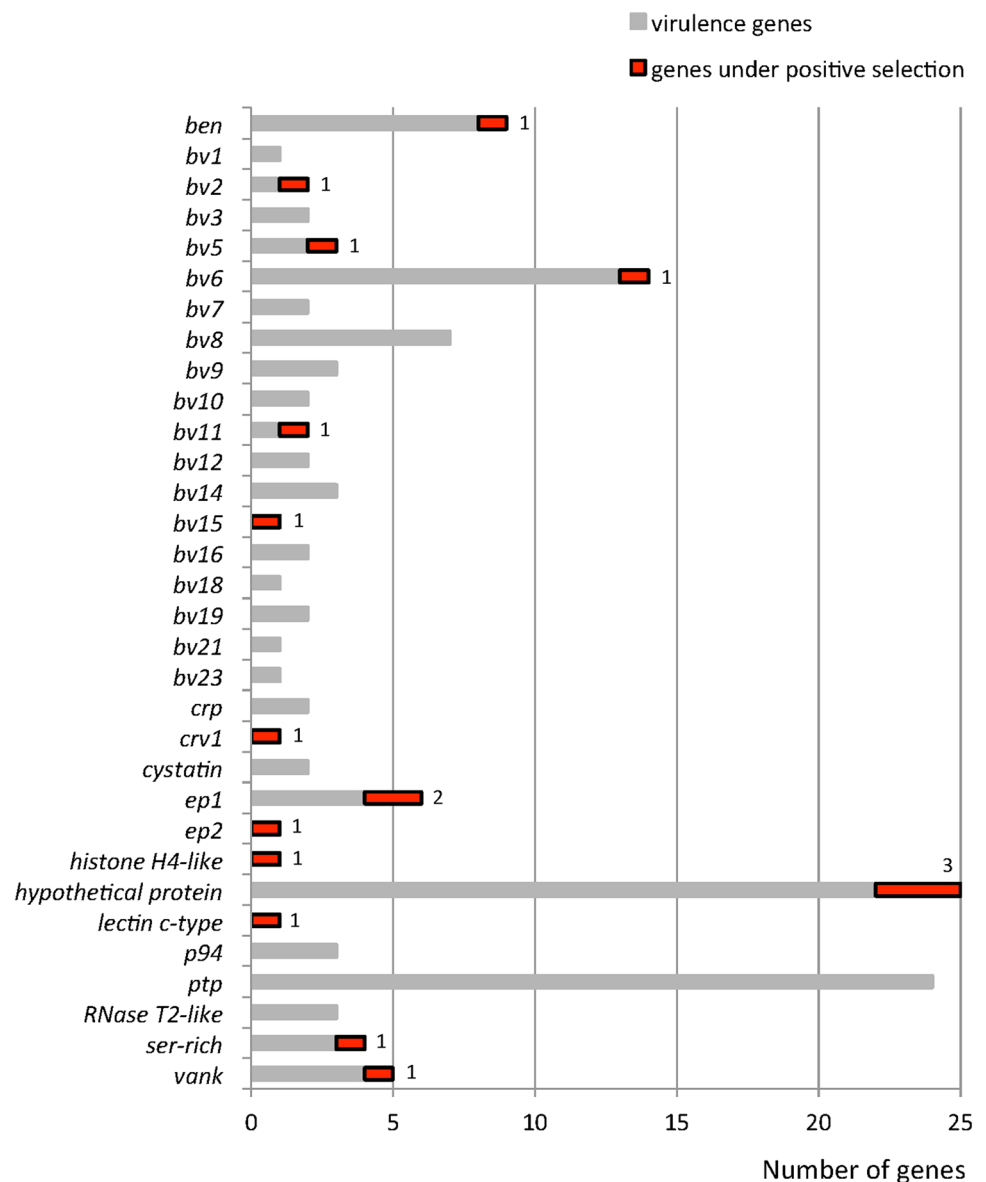

Fig. 5 Bracovirus genes annotated in *C. sesamiae* from Jancek et al. (2013) and organized according to the multigenic families identified by Bézier et al. (2013). In red with associated numbers, the distribution of genes in which signature of selection has been found



Using also the already sequenced and annotated PDV genomes of *C. congregata* and *C. vestalis*, they studied the molecular evolution of these four bracoviruses. Paired orthologues analyses revealed more genes under positive selection when comparing the virulent and avirulent *C. sesamiae* populations, and more genes under strong evolutionary constraint when comparing species. Furthermore molecular evolutionary analyses showed that 17 genes, out of the 54 then available and shared by the four bracoviruses, harbored sites under positive selection including: the *histone H4-like*, a *C-type lectin*, two *ep1-like*, *ep2*, a viral *ankyrin*, *CrVI*, a *ben-domain*, a *Serine rich*, and eight unknown genes (Fig. 5). Jancek et al. (2013) sequenced three of these genes, the *histone*, *ep2* and *CrVI*, in 21 *C. sesamiae* samples from various host and plant species and localities, and performed phylogenetic analyses of the

samples for each of these genes. They showed each gene described differently the individual wasp relationships. In particular recombination had happened between the *ep2* and *CrVI* genes, which are localized only 37.5 kb apart on the wasp chromosomes. This work suggested *C. sesamiae* wasps rely on different bracovirus mediated molecular pathways to overcome local host resistance.

If these studies on few genes point to the potential implication of the bracovirus in wasp adaptation, they only give a restricted view of the wasp genome. Indeed other loci related to other life history traits could bare the hallmarks of selection. Next generation sequencing approaches, such as targeted resequencing, RAD sequencing and whole genome sequencing are being currently carried out (Gauthier 2017) and should bring important insights in the future.

Fig. 6 Phylogeny, ecology and reproductive isolation of *C. sesamiae* populations reveal a new species *Cotesia typhae* sp.n. Fernandez-Triana (Kaiser et al. 2017). Simplified phylogeny from Kaiser et al. 2015. Hybrid with *C. typhae*: traits most precluding the probability of getting a hybrid lineage (from Kaiser et al. 2015); F1: hybrids from parental crosses; BC: progeny of F1 back-crossed with one parental line

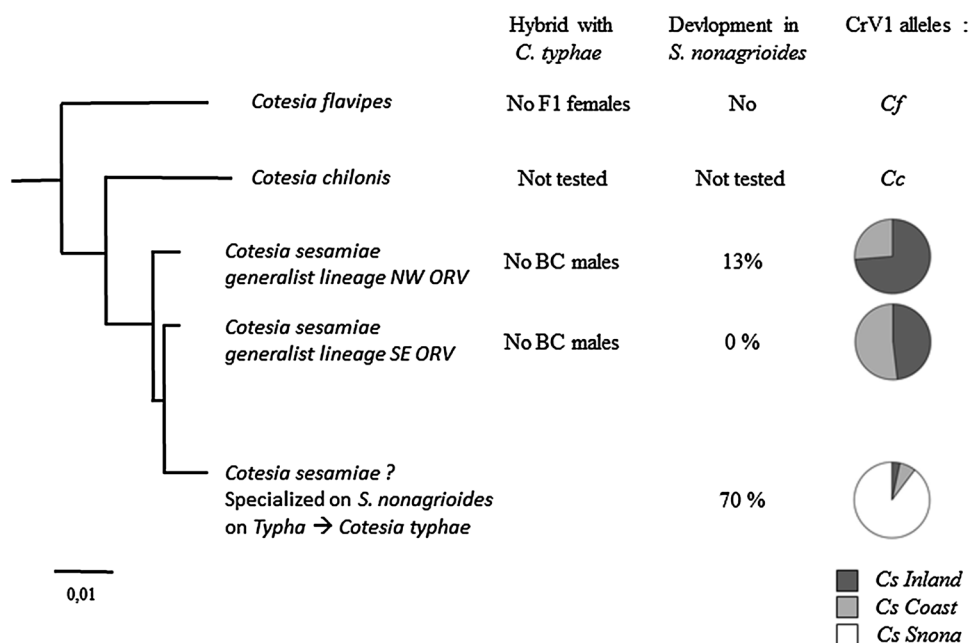

From ecological specialization to speciation

Studying molecular evolution at the genomic scale, as done by Jancek et al. (2013) is restricted to rather small sample size due to sequencing costs. So the study realized by Branca et al. (2011), based on a large sampling, allowed to correlate significantly the sequence polymorphism of one virulence gene, *CrVI*, with the host range of the studied samples. Altogether these studies pointed out that the evolution of bracovirus genes may be a driver of the evolution of host range.

Following the study of Branca, it was decided to explore the evolutionary stability of host range in *C. sesamiae*. Indeed, in biological control, the use of specialized natural enemies is a pre requisite to avoid effects on non-target hosts, but the stability of host range is rarely guaranteed. In insect parasitoids or predators, which include major biological control agents and which limit insect populations in the wild (Hawkins 1994), host preference may be learned by individuals (Davis and Stamps 2004; Kaiser et al. 2009; Kester and Barbosa 1991). Or it may be genetically determined and if so, stability of host preference at the population level will then depend on the gene flow between host specialized populations, sometimes referred to as host races. Stable host preference is expected when gene flow is impossible between host-races, which can be considered as separate species (ecological speciation), (Faria et al. 2014; Rundle and Nosil 2005). Alternatively, depending on ecological conditions, conserved gene flow among specialist populations could maintain their ability to shift to non-preferred hosts, if preferred hosts become scarce (Baer et al. 2004; Mochiah et al. 2002).

One method to get an insight in the evolutionary stability of host-parasitoid associations is thus to characterize the phylogenetic relationships between samples collected from various host and plant species, and based on neutral as well as non-neutral DNA sequences.

This is what we did to investigate if the reported ecological specialization of *C. sesamiae* corresponded to distinct lineages, and if they might be considered as cryptic species. We restricted this analysis to samples of East-Africa, in which we had the highest density and diversity of samples. Seventy-four *C. sesamiae* individuals were sequenced for six genes: three mitochondrial genes (*16S rRNA*, *COI* and *NADHI*), three nuclear genes including two PDVs genes (*Early expressed Protein* or *EP2*, and *Histone4*) and one non-viral gene (*Long-Wavelength Rhodopsin* or *LWRh*). Samples of the sister species *C. flavipes* and *C. chilonis* (Munakata) were also sequenced for the same genes, and *C. congregata* (Say) was added as an outgroup. As expected at the inter-specific level, phylogenetic reconstructions strongly supported the monophyly of the three sister species in the *C. flavipes* complex. Within *C. sesamiae*, the tree revealed the existence of three lineages (Fig. 6) (Kaiser et al. 2015). To understand the mechanisms of this differentiation, the geographic distribution of the identified lineages and their insect and plant hosts in the field was investigated. Two lineages were formed by samples collected from a range of host species, partly shared, and were then considered as generalist lineages. Each included a mix of *CrVI* haplotypes, with mostly *CsI/CsI2* in the first lineage, versus twice more *CsC* than *CsI/CsI2* in the other one. This indicated gene flow between individuals harboring these alleles. We found that a geo-physical factor could explain the differentiation of

these two generalist lineages. Indeed, they were distributed respectively North-west and South-east of the oriental rift valley, a past geographical barrier to gene flow in this area of Africa, known to have influenced genetic differentiation in many taxa (e.g., Danley et al. 2012; Sezonlin et al. 2006).

The third lineage included only samples collected on the noctuid host *Sesamia nonagrioides*, on two riparian plants, *Typha domingensis* and *Cyperus dives*. Some samples were found in the same localities as samples from the other two lineages, but the latter were not collected from *S. nonagrioides*. Almost all samples of the specialized lineage harbored the *CrVI CsSnona* allele. We conducted a reciprocal transfer experiment with laboratory strains initiated for each lineage, and confirmed that the strain from the specialized lineage was the only one able to develop in *S. nonagrioides*. This result indicated that divergent selection for host use had occurred (Kaiser et al. 2015).

The fact that an ecologically specialized population forms a distinct evolutionary lineage suggests that ecological specialization has driven speciation, so absence of gene flow with populations having a different host range should guarantee the stability of the specialization. We then tested reproductive isolation by cross-mating experiments between laboratory strains from each lineage, and with another species of the *flavipes* complex (*C. flavipes*). These experiments revealed pre- and post-mating barriers between the specialized strain and each of the two generalist strains, and between the specialist strain and *C. flavipes*. One trait contributing to pre-mating barrier was the difficulty to terminate copulation, which was presumably due to genitalia differentiation between lineages. Hybrid females were obtained when the specialized lineage was crossed with one of the generalist lineage (the South-east one), but they had lost their virulence against *S. nonagrioides*, and their offspring, obtained from a susceptible species, were all females, indicating genetic incompatibility caused the death of the haploid males. Thus divergent selection for reproductive isolation had occurred in the specialized lineage (Kaiser et al. 2015).

These findings raised the question of when and how a parasitoid population evolves as a specialist entity within a generalist species. Stem borer species parasitized by generalist lineages of *C. sesamiae* are found in communities of Poaceae plants characterized by seasonal availability and harboring a diverse community of stem borer species (Le Rü et al. 2006; Moolman et al. 2014; Ong'amo et al. 2017). The seasonal character of these host species would confer a selective advantage to generalist parasites and counterselect strict host specialization. In contrast, species of Typhaceae are perennial plants which often form large uniform groups on riverbanks and harbor few stem borer species, among which *S. nonagrioides* represent about 90% individuals in the East African localities sampled in this study. Availability

of such insect and host plant resource should confer a reproductive advantage to parasitoids that specialize on it.

Results from phylogenetic analysis, ecological data and observations of reproductive isolation thus converge to the conclusion of an ecological speciation of the lineage of *C. sesamiae* specialized on *S. nonagrioides* on two associated riparian plants, *T. domingensis* and *Cyperus dives*. So far, the *flavipes* complex included four allopatric species. The lineage specialized on *S. nonagrioides* represents a fifth species of the complex, and the first documented case of ecological speciation in this complex. It differed from the other species of the *flavipes* complex by several morphological traits, including genitalia, which is an additional argument for its species status. We named it *Cotesia typhae* Fernandez-Triana and provided barcoding identification, localities of collect, percentage of parasitism, and female reproductive potential (Kaiser et al. 2017).

Cotesia typhae opens a new avenue for the biological control of *S. nonagrioides*, which is a major maize pest in West Africa and in Mediterranean countries, so we studied the reproductive success of several geographic strains of the lineage on a European population of the moth, and some behavioral and physiological factors of the observed variations between strains (Benoist et al. 2017).

Cotesia sesamiae in biological control

Within the *flavipes* complex, *C. flavipes* is the most prominent for biological control of stem borers. It is used worldwide against several stem borer pests, and especially against the sugarcane borer *Diatraea saccharalis* Fabr. (Lepidoptera: Crambidae). In Brasil it is used since the seventies in mass release, in intensive farming system, and this is the only larval parasitoid used at field scale because it can be mass reared. (Dinardo-Miranda et al. 2014; Parisot 2016). In several other sugarcane producing countries (Maurice, La Réunion, Madagascar, Guadeloupe) it has been acclimatized to limit populations of another crambid, *Chilo sacchariphagus* (Overholt 2000). *C. flavipes* is well established in East and Southeastern Africa where it limits populations of the introduced maize crambid *C. partellus* and important socio-economic benefits of its establishment have been recently estimated by the calculation of several indexes (Midingoyi et al. 2016).

Although much less used, *C. sesamiae* develops in several African maize pests. It causes a mean of about 20% of host mortality in maize fields (Mailafiya et al. 2010) and seasonal peaks higher than 70% of host mortality have been reported on *B. fusca* on sorghum in South Africa (Kfir and Bell 1993). This motivated the introduction of the wasp to control *S. calamistis* in different islands of the Indian Ocean and in countries of Africa where it is less abundant

(Overholt 2000). In the fifties, it was introduced in Mauritius, where it established, and from there, in La Réunion Island (Overholt 2000). To our knowledge there are no data about the fate of these introduced populations. In 1994, it was introduced in Benin by the group of F. Schulthess to protect maize against *S. calamistis*, and follow up surveys 2 and 4 years later pointed out that <6% of the pest larvae were parasitized (Gounou et al. 2009). Since then this may have increased as colonization from a small introduced population can take years as observed for *C. flavipes* in East Africa, but no survey has been done in Benin since.

The identification of genetically differentiated populations of *C. sesamiae* in Kenya inspired an original program of introduction of the wasp in Cameroon, to protect maize and sorghum against *B. fusca*, which causes 25–55% yield loss there (Ndemah and Schulthess 2002). In this country *C. sesamiae* is rare in cereal fields but frequently found in wild plant stem borers. In order to control *B. fusca*, Kenyan *C. sesamiae* laboratory strains virulent against *B. fusca* were introduced in maize fields in Cameroon. To limit crosses between introduced and native individuals, Kenyan strains were chosen in order to host a *Wolbachia* strain that is absent from the Cameroonian *C. sesamiae*, so crosses would result in death of fertilized eggs. The suitability of Cameroonian target hosts to Kenyan *C. sesamiae* was checked (Ndemah et al. 2012). Releases were done from 2006 to 2008. *B. fusca* and other stem borer larvae were collected in maize and wild plants up to 2013 to get samples of *C. sesamiae*. Molecular markers (microsatellites) allowing to differentiate introduced and endemic populations are being used to study the colonization process (Ndemah and Dupas, Personal communication).

Conclusion

Phytophagous insects have evolved defenses against parasitoids and parasitism of stem borer larvae is quite low in wild plants. This set of studies is based on a huge sampling effort, associated with the rearing of strains issued from different locally host-adapted populations over two decades. Combined analyses of ecological and genomic polymorphism of wild populations with laboratory behavioral and physiological studies had not been done so far on a single parasitoid species. This allows understanding the evolution of host range at the intra-specific level, a crucial issue for the conservation of biodiversity, which is the cornerstone of biological control.

Acknowledgements The authors thank Geneviève Prevost for inviting them to present this work in this *Thematic issue*, and Rose Ndemah for her info on the use of *Cotesia sesamiae* as biological control agent in west Africa. This review project was supported by the ANR

Bioadapt (ABC Papogen project ANR-12-ADAP-24 0001), and by the authors' operating grants from IRD, CNRS, and ICIPE. R. Benoist is funded by the « école doctorale 227 MNHN-UPMC Sciences de la Nature et de l'Homme: évolution et écologie ».

Compliance with ethical standards

Conflict of interest The authors declare that they have no conflict of interest.

References

- Asgari S, Schmidt O (2002) A coiled-coil region of an insect immune suppressor protein is involved in binding and uptake by hemocytes. *Insect Biochem Mol Biol* 32:497–504
- Asgari S, Hellers M, Schmidt O (1996) Host haemocyte inactivation by an insect parasitoid: transient expression of a polydnavirus gene. *J Gen Virol* 77:2653–2662. doi:10.1099/0022-1317-77-10-2653
- Asgari S, Schmidt O, Theopold U (1997) A polydnavirus-encoded protein of an endoparasitoid wasp is an immune suppressor. *J Gen Virol* 78(Pt 11):3061–3070. doi:10.1099/0022-1317-78-11-3061
- Baer CF, Tripp DW, Bjorksten TA, Antolin MF (2004) Phylogeography of a parasitoid wasp (*Diaeretiella rapae*): no evidence of host-associated lineages. *Mol Ecol* 13:1859–1869. doi:10.1111/j.1365-294X.2004.02196.x
- Bale J, van Lenteren J, Bigler F (2008) Biological control and sustainable food production. *Philos Trans R Soc B* 363:761–776. doi:10.1098/rstb.2007.2182
- Benoist R, Chantre C, Capdevielle-Dulac C, Bodet M, Mougél F, Calatayud PA, Dupas S, Huguet E, Jeannette R, Obonyo J, Odorico C, Silvain JF, Le Ru B, Kaiser L (2017) Relationship between oviposition, virulence gene expression and parasitism success in *Cotesia typhae* nov. sp. parasitoid strains. *Genetica*. doi:10.1007/s10709-017-9987-5 (this issue)
- Bézier A, Annaheim M, Herbinière J, Wetterwald C, Gyapay G, Bernard-Samain S, Wincker P, Roditi I, Heller M, Belghazi M, Pfister-Wilhelm R, Periquet G, Dupuy C, Huguet E, Volkoff A-N, Lanzrein B, Drezen J-M (2009) Polydnaviruses of braconid wasps derive from an ancestral nudivirus. *Science* 323:926–930. doi:10.1126/science.1166788
- Bézier A, Louis F, Jancek S, Periquet G, Theze J, Gyapay G, Musset K, Lesobre J, Lenoble P, Dupuy C, Gundersen-Rindal D, Herniou EA, Drezen J-M (2013) Functional endogenous viral elements in the genome of the parasitoid wasp *Cotesia congregata*: insights into the evolutionary dynamics of bracoviruses. *Philos Trans R Soc B* 368:20130047–20130047. doi:10.1098/rstb.2013.0047
- Branca A, Le Ru BP, Vavre F, Silvain J-F, Dupas S (2011) Intraspecific specialization of the generalist parasitoid *Cotesia sesamiae* revealed by polydnavirus polymorphism and associated with different *Wolbachia* infection. *Mol Ecol* 20:959–971. doi:10.1111/j.1365-294X.2010.04977.x
- Brodeur J (2012) Host specificity in biological control: insights from opportunistic pathogens. *Evol Appl* 5:470–480. doi:10.1111/j.1752-4571.2012.00273.x
- Chabi-Olaye A, Nolte C, Schulthess F, Borgemeister C (2006) Role of inland valleys in the management of stem borers and their natural enemies in upland maize fields in the humid forest zone of Cameroon. *Environ Entomol* 35:282–292
- Chevignon G, Thézé J, Cambier S, Poulain J, Silva CD, Bézier A, Musset K, Moreau SJM, Drezen J-M, Huguet E (2014) Functional annotation of *Cotesia congregata* bracovirus: identification of the

- viral genes expressed in parasitized host immune tissues. *J Virol*. doi:10.1128/JVI.00209-14
- Danley PD, Husemann M, Ding B, DiPietro LM, Beverly EJ, Peppe DJ (2012) The impact of the geologic history and paleoclimate on the diversification of East African cichlids. *Int J Evol Biol* 2012:1–20. doi:10.1155/2012/574851
- Davis J, Stamps J (2004) The effect of natal experience on habitat preferences. *Trends Ecol Evol* 19:411–416. doi:10.1016/j.tree.2004.04.006
- Dinardo-Miranda LL, Fracasso JV, da Costa VP, Lopes DOT (2014) Dispersal of *Cotesia flavipes* in sugarcane field and implications for parasitoid releases. *Bragantia* 73:163–170. doi:10.1590/brag.2014.023
- Dupas S, Gitau C, Le Rü B, Silvain J-F (2006) Single-step PCR differentiation of *Cotesia sesamiae* (Cameron) and *Cotesia flavipes* Cameron (Hymenoptera: Braconidae) using polydnavirus markers. *Ann Soc Entomol Fr* 42:319–323
- Dupas S, Gitau CW, Branca A, Le Rü BP, Silvain J-F (2008) Evolution of a polydnavirus gene in relation to parasitoid-host species immune resistance. *J Hered* 99:491–499. doi:10.1093/jhered/esn047
- Faria R, Renaut S, Galindo J, Pinho C, Melo-Ferreira J, Melo M, Jones F, Salzburger W, Schluter D, Butlin R (2014) Advances in ecological speciation: an integrative approach. *Mol Ecol* 23:513–521. doi:10.1111/mec.12616
- Gauthier J (2017) Génomique de l'adaptation des guêpes parasitoïdes du genre *Cotesia*: rôle du bracovirus. PhD thesis, University François Rabelais, Tours, 267p
- Gauthier J, Drezen J-M, Herniou EA (2017) The recurrent domestication of viruses: major evolutionary transitions in parasitic wasps. *Parasitol*. doi:10.1017/S0031182017000725
- Gitau CW, Gundersen-Rindal D, Pedroni M, Mbugi PJ, Dupas S (2007) Differential expression of the CrV1 haemocyte inactivation-associated polydnavirus gene in the African maize stem borer *Busseola fusca* (Fuller) parasitized by two biotypes of the endoparasitoid *Cotesia sesamiae* (Cameron). *J Insect Physiol* 53:676–684. doi:10.1016/j.jinsphys.2007.04.008
- Gitau CW, Schulthess F, Stéphane D (2010) An association between host acceptance and virulence status of different populations of *Cotesia sesamiae*, a braconid larval parasitoid of lepidopteran cereal stem borers in Kenya. *Biol Control* 54:100–106. doi:10.1016/j.biocontrol.2010.04.010
- Godfray H CJ (1994) Parasitoids: behavioral and evolutionary ecology. Princeton University Press, Princeton
- Gounou S, Jiang N, Schulthess F (2009) Long-term seasonal fluctuations of lepidopteran cereal stem borers and their natural enemies on maize and wild host plants in southern Benin. *Insect Sci* 16:329–341. doi:10.1111/j.1744-7917.2009.01264.x
- Hawkins BA (1994) Pattern and process in host-parasitoid interactions. Cambridge University Press, Cambridge
- Herniou EA, Huguet E, Theze J, Bezier A, Periquet G, Drezen J-M (2013) When parasitic wasps hijacked viruses: genomic and functional evolution of polydnaviruses. *Philos Trans R Soc B*. 368:20130051. doi:10.1098/rstb.2013.0051
- Jancek S, Bézier A, Gayral P, Paillusson C, Kaiser L, Dupas S, Le Rü BP, Barbe V, Periquet G, Drezen J-M, Herniou EA (2013) Adaptive selection on bracovirus genomes drives the specialization of *Cotesia* parasitoid wasps. *PLoS ONE* 8:e64432. doi:10.1371/journal.pone.0064432
- Kaiser L, Couty A, Perez-Maluf R (2009) Dynamic use of fruit odours to locate host larvae: individual learning, physiological state and genetic variability as adaptive mechanisms. *Adv Parasitol* 70: 67–95. doi:10.1016/S0065-308X(09)70003-X
- Kaiser L, Le Rü BP, Kaoula F, Paillusson C, Capdevielle-Dulac C, Obonyo JO, Herniou EA, Jancek S, Branca A, Calatayud P-A, Silvain J-F, Dupas S (2015) Ongoing ecological speciation in *Cotesia sesamiae*, a biological control agent of cereal stem borers. *Evol Appl* 8:807–820. doi:10.1111/eva.12260
- Kaiser L, Fernandez-Triana J, Capdevielle-Dulac C, Chantre C, Bodet M, Kaoula F, Benoist R, Calatayud P-A, Dupas S, Herniou EA, Jeannette R, Obonyo J, Silvain J-F, Le Rü B (2017) Systematics and biology of *Cotesia typhae* sp. n. (Hymenoptera, Braconidae, Microgastrinae), a potential biological control agent against the noctuid Mediterranean corn borer, *Sesamia nonagrioides*. *ZooKeys* 682:105–136. doi:10.3897/zookeys.682.13016
- Kankonda OM, Akaibe BD, Sylvain NM, Le Rü B-P (2017) Response of maize stem borers and associated parasitoids to the spread of grasses in the rainforest zone of Kisangani, DR Congo: effect on stem borers biological control: response of stem borers and parasitoids to grasses spreading. *Agric For Entomol*. doi:10.1111/afe.12238
- Kergoat GJ, Toussaint EFA, Capdevielle-Dulac C, Clamens A-L, Ong'amo G, Conlong D, van Den Berg J, Cugala D, Pallangyo B, Mubenga O, Chipabika G, Ndemah R, Sezonlin M, Bani G, Molo R, Ali A, Calatayud P-A, Kaiser L, Silvain J-F, Le Rü B (2015) Integrative taxonomy reveals six new species related to the Mediterranean corn stalk borer *Sesamia nonagrioides* (Lefèbvre) (Lepidoptera, Noctuidae, Sesamiina). *Zool J Linn Soc* 175:244–270. doi:10.1111/zoj.12275
- Kester KM, Barbosa P (1991) Postemergence learning in the insect parasitoid, *Cotesia congregata* (Say) (Hymenoptera: Braconidae). *J Insect Behav* 4:727–742. doi:10.1007/BF01052227
- Kfir R (1995) Parasitoids of the African stem borer, *Busseola fusca* (Lepidoptera: Noctuidae), in South Africa. *Bull Entomol Res* 85:369. doi:10.1017/S0007485300036105
- Kfir R, Bell RA (1993) Intraseasonal changes in populations of the African stem borer *Busseola fusca* (Fuller) (Lepidoptera: Noctuidae) and its parasitoids in Natal, South Africa. *Rev Zool Afr* 107:543–553
- Kfir R, Overholt WA, Khan ZR, Polaszek A (2002) Biology and management of economically important lepidopteran cereal stem borers in Africa. *Annu Rev Entomol* 47:701–731. doi:10.1146/annurev.ento.47.091201.145254
- Le Rü BP, Ong'amo GO, Moyal P, Muchugu E, Ngala L, Musyoka B, Abdullah Z, Matama-Kauma T, Lada VY, Pallangyo B, Omwega CO, Schulthess F, Calatayud P-A, Silvain J-F (2006) Geographic distribution and host plant ranges of East African noctuid stem borers. *Ann Soc Entomol Fr NS* 42:353–361. doi:10.1080/00379271.2006.10697467
- Mailafiya DM, Ru BPL, Kairu EW, Calatayud P-A, Dupas S (2010) Geographic distribution, host range and perennation of *Cotesia sesamiae* and *Cotesia flavipes* Cameron in cultivated and natural habitats in Kenya. *Biol Control* 54:1–8. doi:10.1016/j.biocontrol.2009.11.008
- Midingoyi SG, Affognon HD, Macharia I, Ong'amo G, Abonyo E, Ogola G, Groote HD, Le Rü B (2016) Assessing the long-term welfare effects of the biological control of cereal stem borer pests in East and Southern Africa: evidence from Kenya, Mozambique and Zambia. *Agric Ecosyst Environ* 230:10–23. doi:10.1016/j.agee.2016.05.026
- Mochiah MB, Ngi-Song AJ, Overholt WA, Botchey M (2001) Host Suitability of Four Cereal Stem Borers (Lepidoptera: Crambidae, Noctuidae) for Different Geographic Populations of *Cotesia sesamiae* (Cameron) (Hymenoptera: Braconidae) in Kenya. *Biol Control* 21:285–292. doi:10.1006/bcon.2001.0941
- Mochiah MB, Ngi-Song AJ, Overholt WA, Stouthamer R (2002) Wolbachia infection in *Cotesia sesamiae* (Hymenoptera: Braconidae) causes cytoplasmic incompatibility: implications for biological control. *Biol Control* 25:74–80
- Mohyuddin A, Greathead D (1970) An annotated list of parasites of graminaceous stem borers in East Africa, with a discussion on their potential in biological control. *Entomophaga* 15:241–274

- Moolman J, Van den Berg J, Conlong D, Cugala D, Siebert S, Le Ru B (2014) Species diversity and distribution of lepidopteran stem borers in South Africa and Mozambique. *J Appl Entomol* 138:52–66. doi:10.1111/jen.12085
- Muirhead K, Austin A, Sallam M (2008) The systematics and biology of *Cotesia nonagriæ* (Olliff) stat. rev. (Hymenoptera: Braconidae: Microgastrinae), a newly recognized member of the *Cotesia flavipes* species complex. *Zootaxa* 1846:35–46
- Muirhead KA, Murphy NP, Sallam N, Donnellan SC, Austin AD (2012) Phylogenetics and genetic diversity of the *Cotesia flavipes* complex of parasitoid wasps (Hymenoptera: Braconidae), biological control agents of lepidopteran stem borers. *Mol Phylogenet Evol* 63:904–914. doi:10.1016/j.ympev.2012.03.003
- Ndemah R, Schulthess F (2002) Yield of maize in relation to natural field infestations and damage by Lepidopteran borers in the forest and forest/savanna transition zones of Cameroon. *Int J Trop Insect Sci* 22:183–192. doi:10.1017/S1742758400012030
- Ndemah R, Schulthess F, Abang A, Ghogomu RT, Ntonifor N, Dupas S, LeRü B (2012) Suitability of cereal stem borers in Cameroon to Kenyan populations of the braconid larval parasitoid *Cotesia sesamiae*: suitability of cereal stem borers. *J Appl Entomol* 136:60–69. doi:10.1111/j.1439-0418.2010.01585.x
- Ngi-Song AJ, Overholt WA, Ayertey JN (1995) Suitability of African gramineous stem borers for development of *Cotesia flavipes* and *C. sesamiae* (Hymenoptera: Braconidae). *Environ Entomol* 24:978–984
- Ngi-Song AJ, Overholt WA, Stouthamer R (1998) Suitability of *Busseola fusca* and *Sesamia calamistis* (Lepidoptera: Noctuidae) for the development of two populations of *Cotesia sesamiae* (Hymenoptera: Braconidae) in Kenya. *Biol Control* 12:208–214
- Ong'amo GO, Rü BPL, Dupas S, Moyal P, Muchugu E, Calatayud P-A, Silvain J-F (2006) The role of wild host plants in the abundance of lepidopteran stem borers along altitudinal gradient in Kenya. *Ann Société Entomol Fr NS* 42:363–370. doi:10.1080/00379271.2006.10697468
- Ong'amo GO, Gall PL, Ndemah R, Ru BPL (2014) Diversity and host range of lepidopteran stem borer species in Cameroon. *Afr Entomol* 22:625–635. doi:10.4001/003.022.0316
- Ong'amo GO, Pallangyo B, Ali A, Njaku M, Musyoka B, Le Ru BP (2018) Diversity and abundance of lepidopteran stem borers and their respective native hosts in different vegetation mosaics in Tanzania. *African Entomologist* (accepted)
- Otieno NA, Rü BPL, Ong'amo GO, Dupas S, Calatayud P-A, Makobe M, Ochora J, Silvain J-F (2006) Diversity and abundance of wild host plants of lepidopteran stem borers in two different agroecological zones of Kenya. *Ann Société Entomol Fr NS* 42:371–380. doi:10.1080/00379271.2006.10697469
- Overholt WA (2000) La lutte biologique. In: Polaszek A, Blary D, Delvare G (eds) Les foreurs des tiges de céréales en Afrique: importance économique, systématique, ennemis naturels et méthodes de lutte. Editions Quae. Cirad, Versailles, pp 351–366
- Parisot C-J (2016) Les nouveaux guerriers des champs. *Arte*. http://boutique.arte.tv/fl1358-nouveaux_guerriers_champs. Accessed 21 Sept 2017
- Phillips CB, Vink CJ, Blanchet A, Hoelmer KA (2008) Hosts are more important than destinations: what genetic variation in *Microctonus aethiopoidea* (Hymenoptera: Braconidae) means for foreign exploration for natural enemies. *Mol Phylogenet Evol* 49:467–476. doi:10.1016/j.ympev.2008.08.005
- Polaszek A, Delvare G (2000) Les foreurs des tiges de céréales en Afrique: Importance économique, systématique, ennemis naturels et méthodes de lutte. Cirad, Versailles
- Potting RPJ, Overholt WA, Danso FO, Takasu K (1997) Foraging behavior and life history of the stem borer parasitoid *Cotesia flavipes* (hymenoptera: Braconidae). *J Insect Behav* 10:13
- Quicke DL (1997) Parasitic wasps. Springer, The Netherlands
- Quicke DLJ (2014) The Braconid and ichneumonid parasitoid wasps: biology, systematics, evolution and ecology. Wiley, Chichester. doi:10.1002/9781118907085
- Rundle HD, Nosil P (2005) Ecological speciation. *Ecol Lett* 8:336–352. doi:10.1111/j.1461-0248.2004.00715.x
- Sezonlin M, Dupas S, Le Rü B, Le Gall P, Moyal P, Calatayud P-A, Giffard I, Faure N, Silvain J-F (2006) Phylogeography and population genetics of the maize stalk borer *Busseola fusca* (Lepidoptera, Noctuidae) in sub-Saharan Africa. *Mol Ecol* 15:407–420. doi:10.1111/j.1365-294X.2005.02761.x
- Smith MA, Rodriguez JJ, Whitfield JB, Deans AR, Janzen DH, Hallwachs W, Hebert PD (2008) Extreme diversity of tropical parasitoid wasps exposed by iterative integration of natural history, DNA barcoding, morphology, and collections. *Proc Natl Acad Sci USA* 105:12359–12364
- Stoltz DB, Xu D (1990) Polymorphism in polydnavirus genomes. *Can J Microbiol* 36:538–543. doi:10.1139/m90-094
- Via S, Hawthorne DJ (2002) The genetic architecture of ecological specialization: correlated gene effects on host use and habitat choice in pea aphids. *Am Nat* 159:S76–S88. doi:10.1086/338374
- Whitfield JB (1994) Mutualistic viruses and the evolution of host ranges in endoparasitoid Hymenoptera. In Hawkins BA, Sheehan W (eds) Parasitoid Community ecology. Oxford Science Publications. Oxford University Press, Oxford, pp 163–176
- Whitfield JB (2000) Phylogeny of microgastroid braconid wasps, and what it tells us about polydnavirus evolution. In: Hymenoptera: evolution, biodiversity and biological control, Canberra, pp 97–105

Systematics and biology of *Cotesia typhae* sp. n. (Hymenoptera, Braconidae, Microgastrinae), a potential biological control agent against the noctuid Mediterranean corn borer, *Sesamia nonagrioides*

Laure Kaiser¹, Jose Fernandez-Triana², Claire Capdevielle-Dulac¹, Céline Chantre¹,
Matthieu Bodet¹, Ferial Kaoula¹, Romain Benoist¹, Paul-André Calatayud^{1,3},
Stéphane Dupas¹, Elisabeth A. Herniou⁴, Rémi Jeannette¹, Julius Obonyo³,
Jean-François Silvain¹, Bruno Le Ru^{1,3}

1 Laboratoire Evolution, Génomes, Comportement et Ecologie, UMR CNRS 9191, IRD 247, Université Paris-Sud, Université Paris-Saclay, 1 Avenue de la Terrasse, 91198 Gif sur Yvette, France **2** Canadian National Collection of Insects, 960 Carling Ave, K1A 0C6, Ottawa, Canada **3** icipe: African Insect Science for Food and Health, Duduville Campus, Kasarani, P.O. Box 30772-00100, Nairobi, Kenya **4** Institut de Recherche sur la Biologie de l'Insecte, UMR CNRS 7261, Université François-Rabelais de Tours, Faculté des Sciences, Parc Grandmont, 37200 Tours, France

Corresponding author: Laure Kaiser (laure.kaiser-arnauld@egce.cnrs-gif.fr)

Academic editor: M. Sharkey | Received 1 April 2017 | Accepted 25 May 2017 | Published 5 July 2017

<http://zoobank.org/E58DDD67-A0FA-41A8-BB09-F854346B98E9>

Citation: Kaiser L, Fernandez-Triana J, Capdevielle-Dulac C, Chantre C, Bodet M, Kaoula F, Benoist R, Calatayud P, Dupas S, Herniou EA, Jeannette R, Obonyo J, Silvain JF, Le Ru B (2017) Systematics and biology of *Cotesia typhae* sp. n. (Hymenoptera, Braconidae, Microgastrinae), a potential biological control agent against the noctuid Mediterranean corn borer, *Sesamia nonagrioides*. ZooKeys 682: 105–136. <https://doi.org/10.3897/zookeys.682.13016>

Abstract

Many parasitoid species are subjected to strong selective pressures from their host, and their adaptive response may result in the formation of genetically differentiated populations, called host races. When environmental factors and reproduction traits prevent gene flow, host races become distinct species. Such a process has recently been documented within the *Cotesia flavipes* species complex, all of which are larval parasitoids of moth species whose larvae are stem borers of Poales. A previous study on the African species *C. sesamiae*, incorporating molecular, ecological and biological data on various samples, showed that a particular population could be considered as a distinct species, because it was specialized at both host (*Sesamia nonagrioides*) and plant (*Typha domingensis*) levels, and reproductively isolated from other *C. sesa-*

miae. Due to its potential for the biological control of *S. nonagrioides*, a serious corn pest in Mediterranean countries and even in Iran, we describe here *Cotesia typhae* Fernandez-Triana **sp. n.** The new species is characterized on the basis of morphological, molecular, ecological and geographical data, which proved to be useful for future collection and rapid identification of the species within the species complex. Fecundity traits and parasitism success on African and European *S. nonagrioides* populations, estimated by laboratory studies, are also included.

Keywords

Cotesia, *Sesamia*, biological control, species complex, Africa, Mediterranean

Introduction

Although the concept of species is questioned in situations characterized by a continuum of genetic differentiation and reproductive isolation between populations (The Marie Curie Speciation Network 2012), well described and identified species are still useful tools in many situations. For instance, in biological control the use of such species, with a defined host range and showing no gene flow with closely related species, limits the risk of confusion and guarantees the stability of its host range. The purpose of this paper is to describe a new species of parasitoid wasp, first considered as a host race of *Cotesia sesamiae* Cameron (Hymenoptera, Braconidae) (Branca et al. 2011; Kaiser et al. 2015). It is a potential candidate for the biological control of the Mediterranean maize stem borer, *Sesamia nonagrioides* (Lefebvre, 1827) (Lepidoptera, Noctuidae).

Cotesia is one of the most diverse genera of the subfamily Microgastrinae (Hymenoptera, Braconidae), with almost 300 species already described (Yu et al. 2016), and probably over 1,000 species worldwide (e.g., Mason 1981). *Cotesia* was originally considered as a genus by Cameron in the 19th century, and definitively split from the genus *Apanteles* by Mason (1981) in his generic reclassification of the Microgastrinae, wherein many *Apanteles* species were transferred to *Cotesia*. Microgastrine wasps are koinobiont endoparasitoids of lepidopteran larvae, and species attacking large larval hosts are often gregarious (Whitfield 1997, Quicke 2015). Females emit sex-pheromones that attract males and can mate upon emergence (Xu 2014). They locate their host at a distance and initiate oviposition upon recognition of chemical cues (Turlings and Fritsche 1999, Jembere et al. 2003, Obonyo et al. 2010). The microgastrine wasps use a domesticated virus (called a bracovirus, Polydnviridae) to inhibit the immune response of host larva. Bracoviruses are produced in the wasps' ovaries by genes integrated in the wasp genome and injected in the host body together with the eggs (Asgari 2006, Gitau et al. 2007, Herniou et al. 2013). Within the host, the viral particles infect the host cells, which produce the viral proteins, which in turn inactivate the host immune cellular response and regulate the host metabolism to the benefit of wasp larvae (Herniou et al. 2013). Fully developed larvae egress from the host body and spin their cocoons to undergo metamorphosis. Host resistance processes can manifest at all these steps of the life cycle, among which encapsulation of the parasitoid eggs has been often reported and well described (Beckage 1998). Evolution of virulence mechanisms

by the parasitoid may have driven the radiation of species within the genus *Cotesia* (Herniou et al. 2013).

The *Cotesia flavipes* species-group is a monophyletic complex made up of (until now) four allopatric sister species, all gregarious endoparasitoids of a few families of lepidopteran stem borers (Crambidae, Pyralidae, and Noctuidae) in monocot Poales (Poaceae, Typhaceae and Cyperaceae). The species-group comprises *Cotesia chilonis* (Munakata, 1912) from eastern Asia, including China, Japan and Indonesia; *Cotesia flavipes* (Cameron, 1891), from the Indian sub-continent, but also released and established in east Africa and the New World for the purpose of biological control; *Cotesia nonagriæ* (Olliff, 1893), an Australian endemic recently removed from synonymy with *C. flavipes* (Muirhead et al. 2008, 2012), and *Cotesia sesamiae* (Cameron, 1906), from sub-Saharan and Southern Africa (Kimani-Njogu and Overholt 1997). Members of this species complex are economically important worldwide as biocontrol agents of cereals and sugarcane stem borer pests (Kfir et al. 2002, Lou et al. 2014, Mindigoyi et al. 2016, Polaszek and Walker 1991, Simões et al. 2012), and their presence in their native settings help regulate populations of important pests (Kfir et al. 2002, Liu et al. 2000).

Additional, cryptic species have been suspected within this complex and several papers have explored this possibility, especially in regard to *C. flavipes* (e.g., Muirhead et al. 2012) and *C. sesamiae*. In the latter species, studies made from samples collected in maize fields on a few pest species showed that local adaptation to host resources and environmental factors were major drivers of intra-species genetic diversity (Dupas et al. 2008, Gitau et al. 2007, 2010). Subsequently, Branca et al. (2011) analysed a large sample of *C. sesamiae* covering most of the species' distribution area and a large range of host and plant species. They provided evidence that variations of host range were associated with sequence variation of a virulence gene, CrV1, which could be used as a marker of host races. Analysis of microsatellite markers revealed gene flow between the host races, except for one population specialized on the noctuid *Sesamia nonagrioides* (Branca et al. in prep.). One method to get an insight into the evolutionary stability of host-parasitoid associations is to characterize phylogenetic relationships between so-called host races. Kaiser et al. (2015) performed a phylogenetic analyses of the *C. sesamiae* samples based on mitochondrial, viral and non-viral nuclear markers, and demonstrated that the samples from the *S. nonagrioides* host race formed a highly supported monophyletic lineage showing all the hallmarks of a cryptic species. The authors confirmed the species status of this lineage by showing that it was reproductively isolated from the other lineages of *C. sesamiae* and from *C. flavipes*. Furthermore they showed that it was the only lineage being virulent against *S. nonagrioides*, and specifically so. Combined evidence for ecological specialization, selection for divergent host adaptation and for reproductive isolation, allowed them to conclude that this lineage was formed by ecological (adaptive) speciation. In addition, some morphological differences were readily identifiable.

Based on a wealth of information – morphological, molecular, biological, and ecological – we describe this new species of *Cotesia* from Africa, the fifth member of the

flavipes complex, and present the first data showing that it is a successful parasitoid of European populations of *S. nonagrioides*, a major maize pest in West Africa and in Mediterranean countries.

Materials and methods

Morphological description

We studied 175 specimens from six different countries, representing ten populations from four out of the five known species within the *flavipes* complex (Table 1). We could not examine specimens of *Cotesia nonagriiae*, but this Australian species has recently been redescribed and illustrated (Muirhead et al. 2008, 2012).

We evaluated a number of morphological characters proposed in previous studies (Kimani-Njogu and Overholt 1997, Muirhead et al. 2008), and others characters are explored for the first time in this species complex. Morphological terms and measurements of structures are mostly those used by Mason (1981), Huber and Sharkey (1993), Whitfield (1997), Karlsson and Ronquist (2012), and Fernandez-Triana et al. (2014). All characters used in this paper are illustrated in Figs 1–8.

In the species description, body ratios and measurement values are presented for the holotype first, followed by the range within the species in parentheses.

Photos were taken with a Keyence VHX-1000 Digital Microscope, using a lens with a range of 10–130 ×. Multiple images were taken of a structure through the focal plane and then combined to produce a single in-focus image using the software associated with the Keyence System. Plates were prepared using Microsoft PowerPoint 2010.

Institution acronyms used:

- CBGP** Centre de Biologie pour la Gestion des Populations, Montpellier, France.
CNC Canadian National Collection of Insects, Ottawa, Canada.

Table 1. Specimens studied for this paper. F- female specimen, M- male specimen.

Species	Country of origin	Collecting year	# of Specimens	Host caterpillar/host plant
<i>C. flavipes</i>	Trinidad	1972 & 1980	4 F, 3 M	<i>Diatraea lineolata</i> /unknown
<i>C. flavipes</i>	Colombia	1978	2 F, 7 M	Unknown/unknown
<i>C. flavipes</i>	Barbados	1977	2 F	Unknown/sugar cane
<i>C. flavipes</i>	India	1954	3 F	Unknown/unknown
<i>C. flavipes</i>	Kenya	2010	25 F, 5 M	<i>Chilo partellus</i> /maize
<i>C. sesamiae</i>	Kenya (Mombasa)	2010	25 F, 5 M	<i>Sesamia calamistis</i> /maize
<i>C. sesamiae</i>	Kenya (Kitale)	2012	25 F, 5 M	<i>Busseola fusca</i> /maize
<i>C. chilo</i>	Japan	2008	2 F, 2 M	Unknown/rice
<i>C. typhae</i> sp. n.	Kenya (Makindu)	2013	25 F, 5 M	<i>Sesamia nonagrioides</i> / <i>Typha domingensis</i>
<i>C. typhae</i> sp. n.	Kenya (Kobodo)	2013	25 F, 5 M	<i>Sesamia nonagrioides</i> / <i>Cyperus dives</i>

Molecular characterization

In order to check the molecular-specific characterization of *Cotesia typhae*, we used the COI (*cytochrome oxidase I*) sequences from Kaiser et al. (2015) (listed in Appendix 1) to calculate the divergence between pairs of *Cotesia* species and populations. The divergence corresponds to the number of nucleotide differences divided by the total number of nucleotides. Since there are several samples for each species and population, the minimum and maximum divergence is given for all pairs.

Distribution, ecology and abundance

Knowing that the new *Cotesia* species was found exclusively on *S. nonagrioides* on two plant families, Typhaceae and Cyperaceae (Kaiser et al. 2015), its distribution, ecology and abundance are characterized here from a collection of *S. nonagrioides* larvae on these two plant families, collected in 13 countries in sub-Saharan Africa between 2004 and 2013. *Sesamia nonagrioides* larvae were sampled from wild plants on banks of streams or rivers and in swamps, the favorite habitat of this species, which is rarely recorded from maize in East Africa. Plants were carefully inspected for stem borer infestations. Symptoms of infestation included scarified leaves, dry leaves and shoots (dead hearts), frass or holes bored. Infested plants were cut and dissected in the field; larvae collected were reared on an artificial diet (Onyango and Ochieng-Odero 1994) until pupation or emergence of parasitoid larvae. *Sesamia nonagrioides* were identified at the adult stage by dissection of the genitalia. After emergence, adult *Cotesia* were stored in absolute ethanol and identified by genotyping CrV1 sequence.

Life history traits and parasitoid success in European host populations

Insect material

The *C. typhae* laboratory-reared strains were collected initially from Kenya localities (Kobodo: 0.68°S; 34.41°E or Luanda: 0.48°S; 34.30°E, depending on the availability of the strains). They were reared on a Kenyan *S. nonagrioides* strain (collected initially from Makindu: 2.28°S; 37.82°E), according to the method described by Overholt et al. (1994). Parasitoid success was tested on this Kenyan strain and on two *S. nonagrioides* European strains collected respectively in France (Longage, 43.37°N; 1.19°E) and Italy (Monterotondo scalo, 42.06°N; 12.60°E). The Kenyan and French strains were reared as described above. The Italian larvae were sent from the University of Perugia.

Longevity experiments

Clusters of cocoons were each placed in a 0.5L disposable plastic box with a 1.5 cm diameter opening clogged with a foam cork. One of the three following food sources was placed in the box to test their effects on longevity: honey droplets and a tap water-

imbibed cotton ball; a cotton ball imbibed with a 2% saccharose solution or a 20% solution. These small cages were placed at 21°C, with internal relative humidity around 75%. Dead insects were counted every day for the 2% sugar solution and at least every two days for the two other food sources, from 24h following emergence.

Realized fecundity

One-day-old wasps were taken from the cages as above and allowed to oviposit in one host larva per day, for four days. Parasitized larvae were kept individually in Petri dishes (2 cm high) with approximately 10cm³ piece of diet, until emergence of the parasitoid larvae or pupation. The diet was replaced by a piece of toilet paper 12 days after parasitism to facilitate cocoon formation.

Parasitoid success

Four weeks after hatching, i.e. when reaching the 5th- 6th stadium, larvae were exposed each to one wasp, then kept fed with the diet, in the conditions described above, until emergence of the parasitoid larvae, or pupation. Recorded traits are specified in Table 8. Individual cocoon weight was calculated by dividing the weight of the cocoon cluster by the number of emerged adults and dead nymphs.

Data analyses

Kaplan Meyer tables from XLSTAT were used to estimate daily mortality and median longevity. The procedure included three tests of equality of the survival curves (Wilcoxon, Log-rank and Tarone-War) that gave identical P-values, so only Wilcoxon's result is given in this study. Comparisons of traits of parasitoid success on the three host strains were performed with the R package. As some of the traits did not follow a normal distribution (Shapiro statistic) or did not fulfill homoscedasticity (Bartlett statistic), the Kruskal-Wallis statistic was used to compare the quantitative traits recorded for the three host strains, followed by the Dunn post-hoc multiple comparison test. Chi-square was used to compare the issue of parasitism. Sample sizes are given in Table 8. The percentage of females in the cluster was not included in the analyses when pupal mortality was equal to or exceeded 30%. This occurred for 11 clusters obtained from the French host strain and two clusters obtained from the Kenyan strain.

Results

Morphological study

***Cotesia typhae* Fernandez-Triana, sp. n.**

<http://zoobank.org/EC4B19D5-9087-4698-A67D-E53EAE5E532E>

Figs 1, 2

Holotype. Female (CBGP).

Type locality. Kenya, Makindu, 2.28°S, 37.82°E.

Holotype label details. Kenya, Makindu, xi.2010, ex *Sesamia nonagrioides* on *Typha domingensis* Pers. Voucher code: CNC634434. Other code on label: F78.

Paratypes. CBGP, Montferrier s/Lez, France; CNC, Canada; International Centre of Insect Physiology and Ecology, Nairobi, Kenya; Natural History Museum London, UK; Smithsonian National Museum of Natural History, Washington DC, USA. 24 female, 5 male specimens, same locality as holotype; 25 female, 5 male specimens from Kenya, Kobodo, 0.41°S, 34.25°E. iii.2013, ex *Sesamia nonagrioides* on *Cyperus dives* Delile.

Previous records. This species has been referred to as the *C. sesamiae* population, harbouring Cs Snona haplotype on CrV1 locus (Branca et al. 2011), as the *C. sesamiae* lineage 2 analysed by Kaiser et al. (2015) and as the sample CsBV G4675 sequenced for 3 viral genes in Jancek et al. (2013).

Diagnosis. The new *Cotesia* is relatively distinct from other members of the *flavipes* complex (Table 2). The most distinctive diagnostic characters are the median projection present between the base of the antennae, the punctures on the anteromesoscutum, the length and shape of the paramere, and the relative length of the antennal flagellomere. The median projection between the base of the antennae is depressed (compared to the rest of the face), usually paler than the rest of the face, and has a strongly excavated median longitudinal sulcus (Figs 1B, 2B); all other species within the *flavipes* complex have a less depressed median projection on the face, usually the same color (or at most slightly lighter) as the rest of the face, and the median sulcus is not defined (*nonagriae*) or is less strongly excavated (Figs 5B, 6B, 7B, 8B). The anteromesoscutum punctures (Figs 1G, 2E) are the largest, densest, and most widely distributed (present near the posterior margin of the anteromesoscutum) among all species within the *flavipes* complex (compare against Figs 5G, 6F, 7G, 8H). The paramere length (Figs 3A, B, 4C, F, G) is intermediate compared to the other species (longer than in *chilonis/sesamiae* and shorter than in *flavipes/nonagriae*; compare Figs 3D, F, H, 4D, E), and its shape seems to be distinctive, with a somewhat widened part near the apex (Fig. 4F, G). The antennal flagellomeres (Figs 1A, D, 2A, B) are the longest among the entire *flavipes* complex (compare versus Figs 5A, B, D, 6A, B, 7A, B, 8A, D). The color of metasoma laterally and ventrally (laterotergites, sternites and hypopygium) is light yellow-orange (Figs 1A, F, 2A, F). This character is useful in recognizing *typhae*, at least in Africa, as all other *Cotesia* species within this complex generally have a much darker metasoma latero-ventrally (e.g. Figs 5A, F, 6A, E, 7A, F, 8G); however, some populations of *C. flavipes* we have examined have a light-colored metasoma, so this character is not absolutely diagnostic.

Description. Head and mesosoma mostly dark brown to black (except for scape, pedicel, wing base and tegula yellow; antennal flagellomeres brown; mandibles and labrums orange-yellow, and face projection between antennal base usually light brown); legs mostly yellow (except for metafemur with brown dorsal tip on posterior 0.1, and metatarsus light brown to brown); metasoma mostly yellow-brown to yellow-orange (except for mediotergites 1 and 2 dark brown to black, and mediotergites 3+ usually

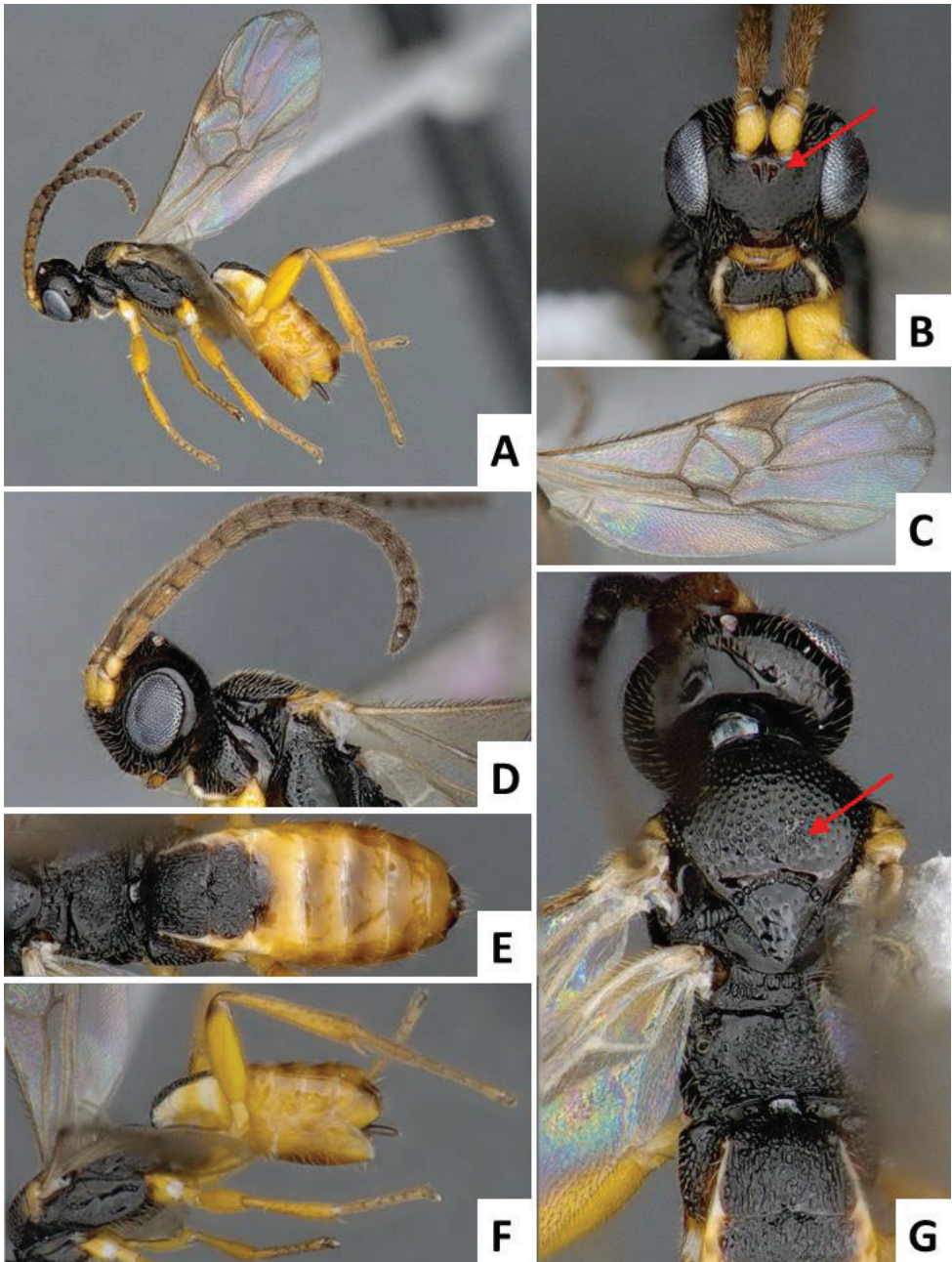

Figure 1. *Cotesia typhae*, holotype, female specimen from Makindu, Kenya. **A** Habitus, lateral view **B** Head, frontal view (arrow shows face projection between antennal base) **C** Wings **D** Head and mesosoma (partially), lateral view **E** Propodeum and metasoma, dorsal view **F** Mesosoma and metasoma, lateral view **G** Head, mesosoma and tergites 1-2, dorsal view (arrow shows anteromesoscutum punctures).

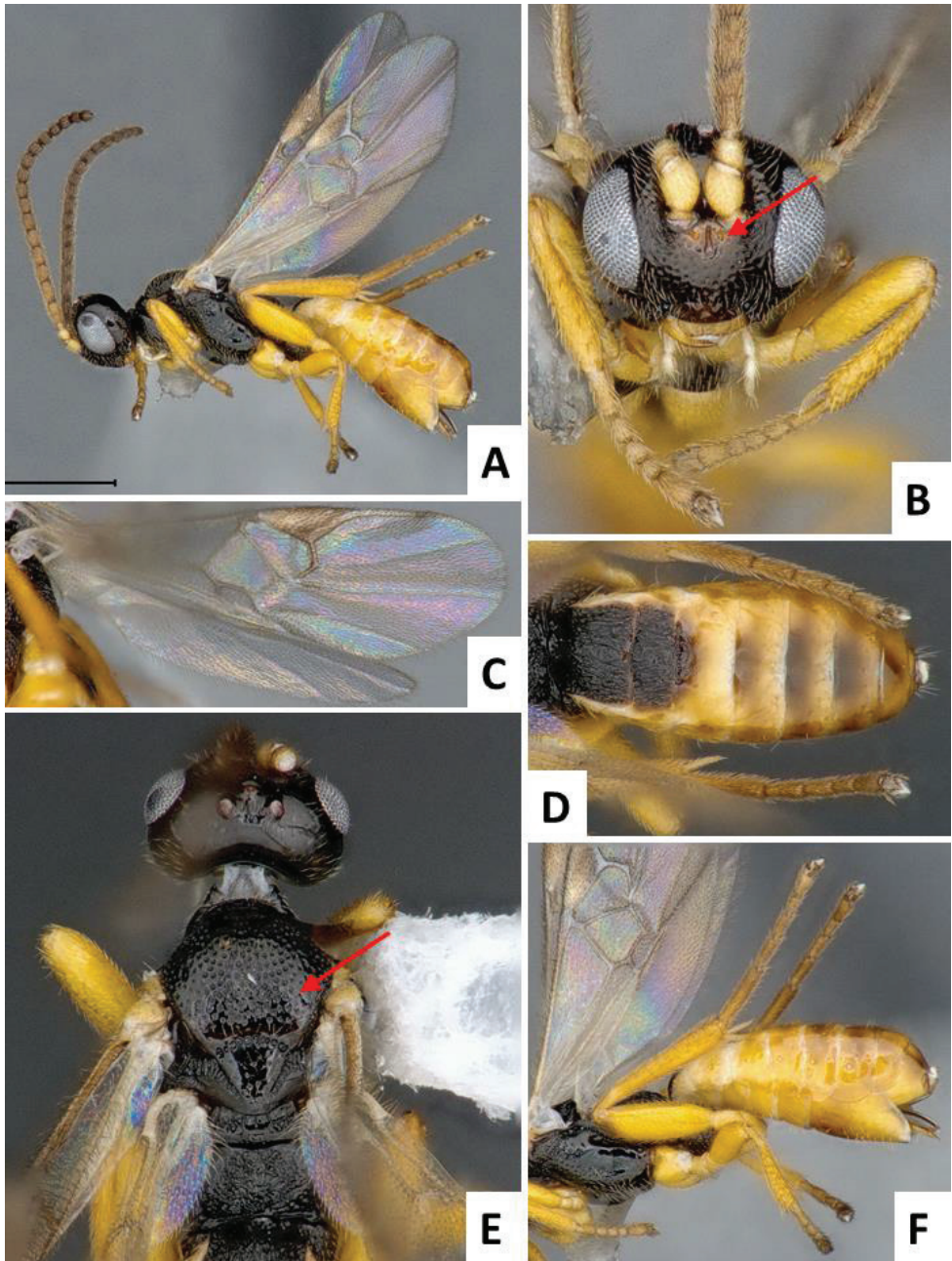

Figure 2. *Cotesia typhae*, paratype, female specimen from Kobodo, Kenya. **A** Habitus, lateral view **B** Head, frontal view (arrow shows face projection between antennal base) **C** Wings **D** Metasoma, dorsal view **E** Head and mesosoma, dorsal view (arrow shows anteromesoscutum punctures) **F** Metasoma, lateral view.

Table 2. Diagnostic characters within the *Cotesia flavipes* complex. Data on host caterpillar species from Branca et al. (2011), Muirhead et al. (2012), Sallam (2006), and Kaiser et al. (2015).

	<i>Cotesia chilonis</i>	<i>Cotesia flavipes</i>	<i>Cotesia nonagrii</i>	<i>Cotesia sesamiae</i>	<i>Cotesia typhae</i>
Scutoscutellar sulcus	Straight (Fig. 8H)	Curved (Fig. 7E)	Curved	Curved (Fig. 5F)	Curved (Figs 1G, 2E)
Antero-mesoscutum (AMS) punctures	Large punctures (diameter larger than distance between punctures) in most of AMS, including most of the posterior half (Fig. 8H)	Relatively small punctures on anterior half of AMS, posterior half almost entirely smooth (Fig. 7E, G)	Relatively small punctures on anterior half of AMS, posterior half almost entirely smooth (Figs 5G, 6F)	Relatively small punctures on anterior half of AMS, posterior half almost entirely smooth (Figs 5G, 6F)	Large punctures (diameter larger than distance between punctures) in most of AMS, including most of the posterior half (Fig. 2G, E)
Face projection between antennal base	Acute, triangular projection with clearly impressed median longitudinal sulcus (Fig. 8B)	Acute projection (sometimes projection less acute, margin almost straight) with clearly impressed median longitudinal sulcus (Fig. 7B)	More or less straight margin, with no clearly impressed median longitudinal sulcus	Acute projection (sometimes projection less acute, margin almost straight) with clearly impressed median longitudinal sulcus (Figs 5B, 6B)	Acute, triangular projection with clearly impressed median longitudinal sulcus (Fig. 1B, B)
Paramere length (observed externally, without removing genitalia from specimen)	Short, around 1.0 × as long as median length of sternite 8 (partially visible in Fig. 3G, H)	Large, clearly more than 1.5 × (usually up to 2.0x) as long as median length of sternite 8 (Fig. 4A, D)	Large, clearly more than 1.5 × (usually up to 2.0x) as long as median length of sternite 8	Short, around 1.0 × as long as median length of sternite 8 (Fig. 4b, E)	Relatively large, around 1.5 × as long as median length of sternite 8 (Fig. 4C)
Paramere shape	Rather uniformly narrowing from base to rounded apex	Rather uniformly narrowing from base to rounded apex (Fig. 4D)	Rather uniformly narrowing from base to rounded apex	Rather uniformly narrowing from base to rounded apex (Fig. 4E)	With a broad, widened area near apex (Fig. 4F, G)
Antennal flagellomeres	Relatively short (3+ about as long as wide)	Relatively short (2+ about as long as wide)	Relatively short (2+ about as long as wide)	Relatively short (3+ about as long as wide)	Relatively long (1–4 much longer than wide)
Natural known hosts	<i>Chilo suppressalis</i> , <i>C. partellus</i> (Crambidae)	More than 7 species (Crambidae & Noctuidae)	<i>Bathytricha truncata</i> (Noctuidae)	More than 34 species (mostly Noctuidae & Crambidae)	<i>Sesamia nonagrioides</i> (Noctuidae)

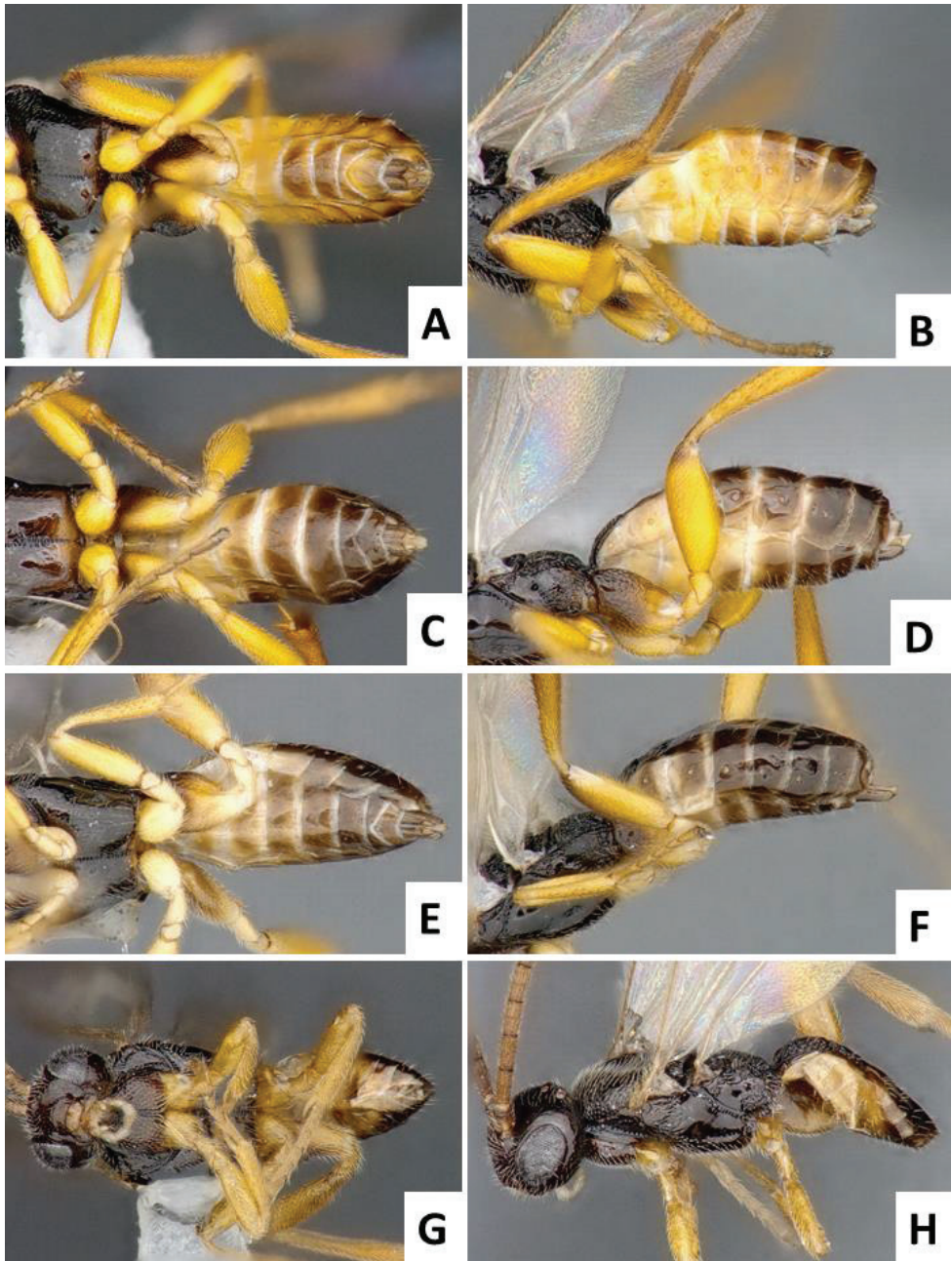

Figure 3. Male metasoma in ventral and lateral view. **A, B** *Cotesia typhae*, paratype specimen from Kenya **C, D** *Cotesia sesamiae*, specimen from Kenya **E, F** *Cotesia flavipes*, specimen from Kenya **G, H** *Cotesia chilonis*, specimen from Japan.

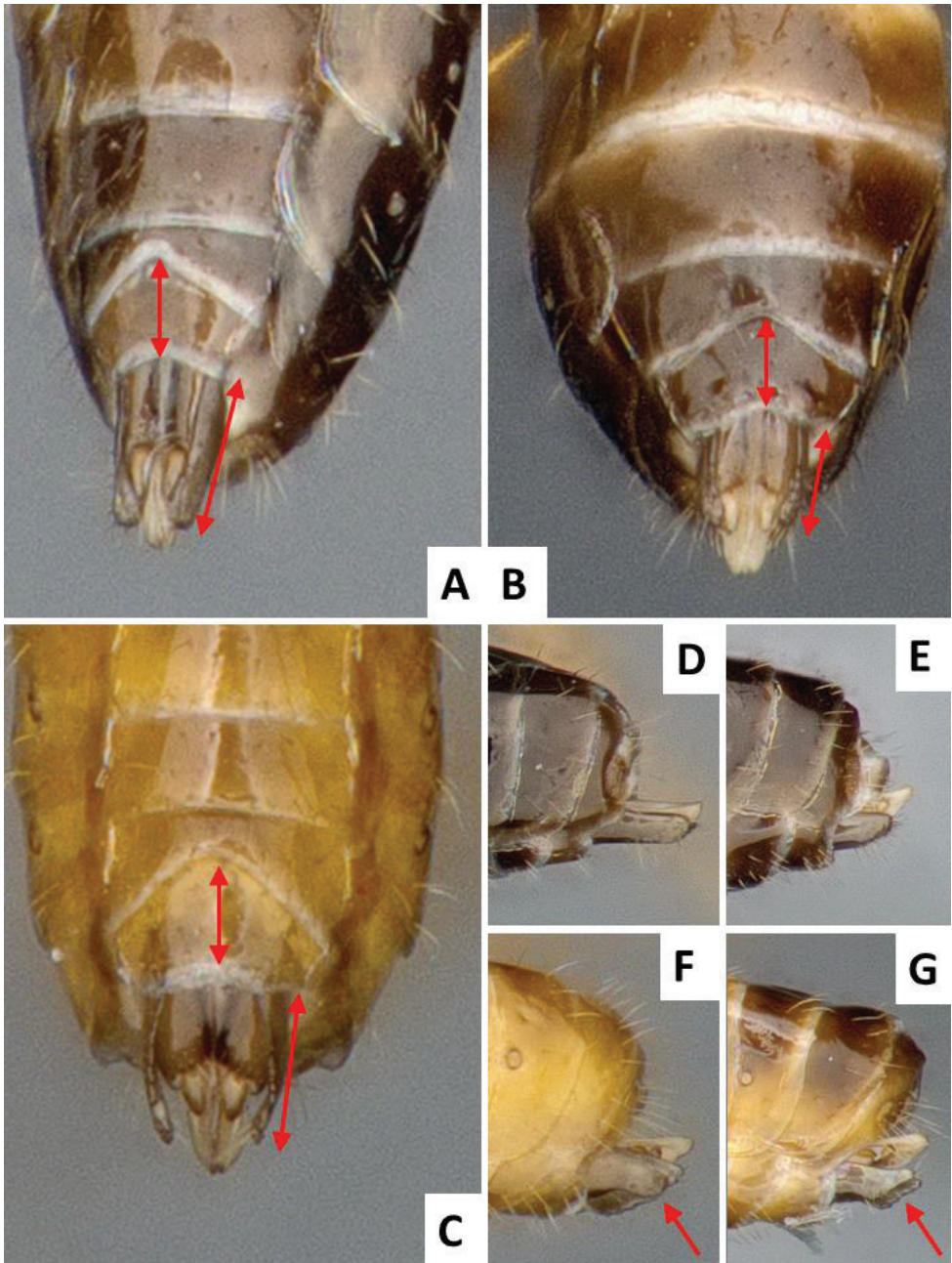

Figure 4. External male genitalia in ventral and lateral view; arrows show length of paramere and sternite 8. **A, D** *Cotesia flavipes* specimen from Kenya **B, E** *Cotesia sesamiae*, specimen from Kenya **C, F, G** *Cotesia typhae*, paratype specimen from Kenya.

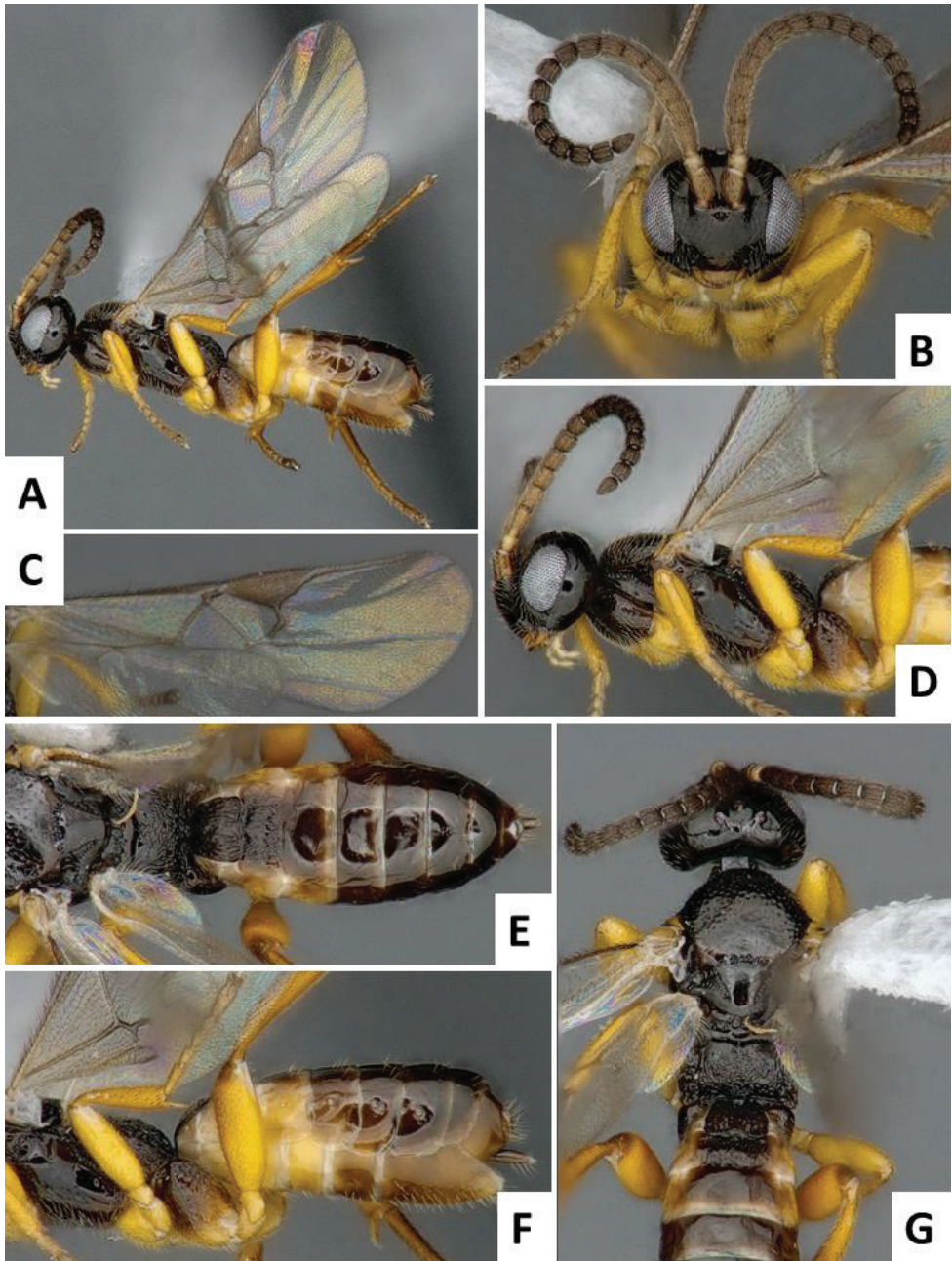

Figure 5. *Cotesia sesamiae*, female specimen from Kitale, Kenya. **A** Habitus, lateral view **B** Head, frontal view **C** Wings **D** Head and mesosoma, lateral view **E** Scutellar disc, propodeum and metasoma, dorsal view **F** Mesosoma and metasoma, lateral view **G** Head, mesosoma and tergites 1-4, dorsal view.

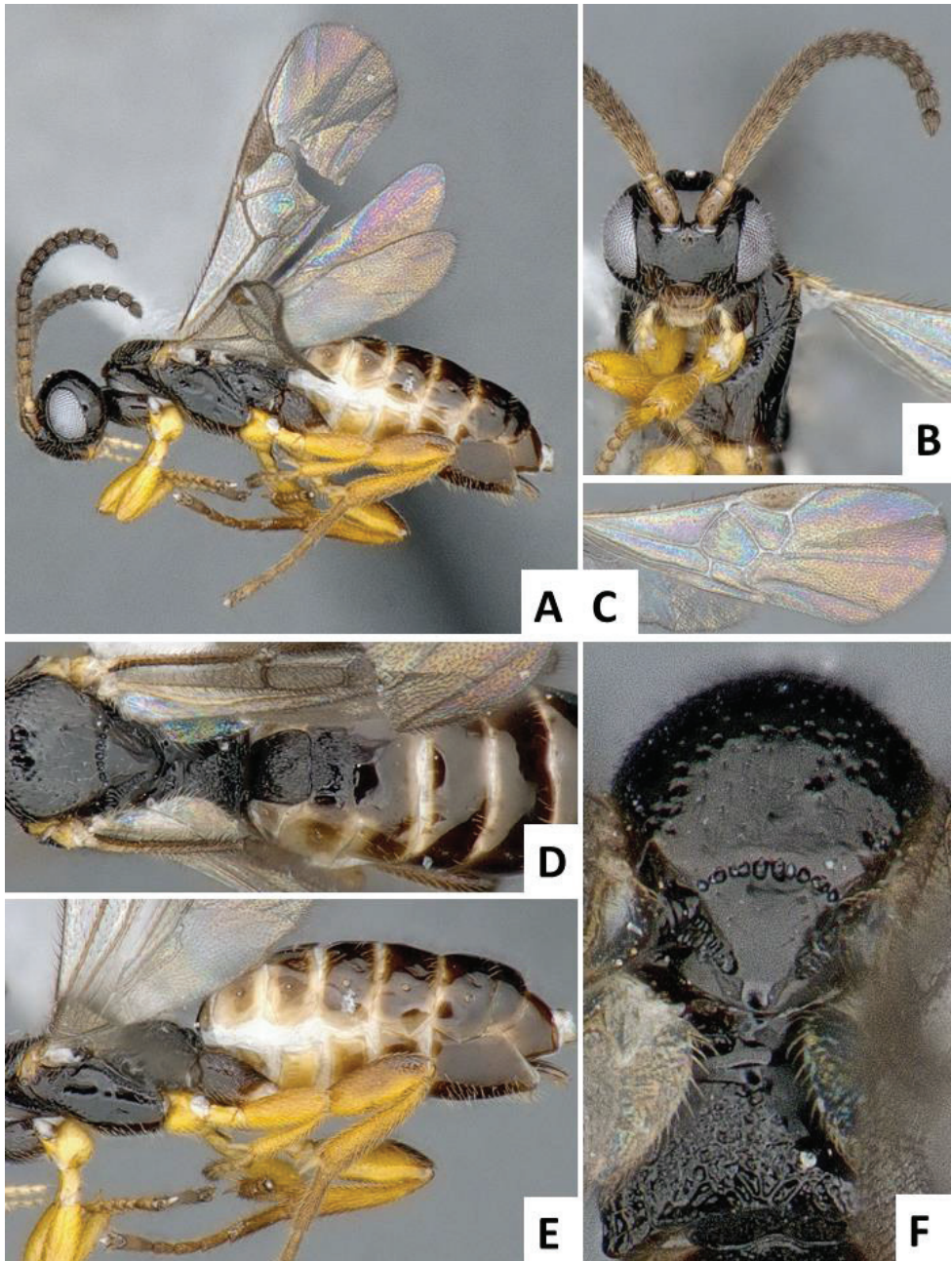

Figure 6. *Cotesia sesamiae*, female specimen from Mombasa, Kenya. **A** Habitus, lateral view **B** Head, frontal view **C** Wings **D** Mesosoma and metasoma (partially), dorsal view **E** Mesosoma and metasoma, lateral view **F** Anteromesoscutum, scutellar disc and propodeum, dorsal view.

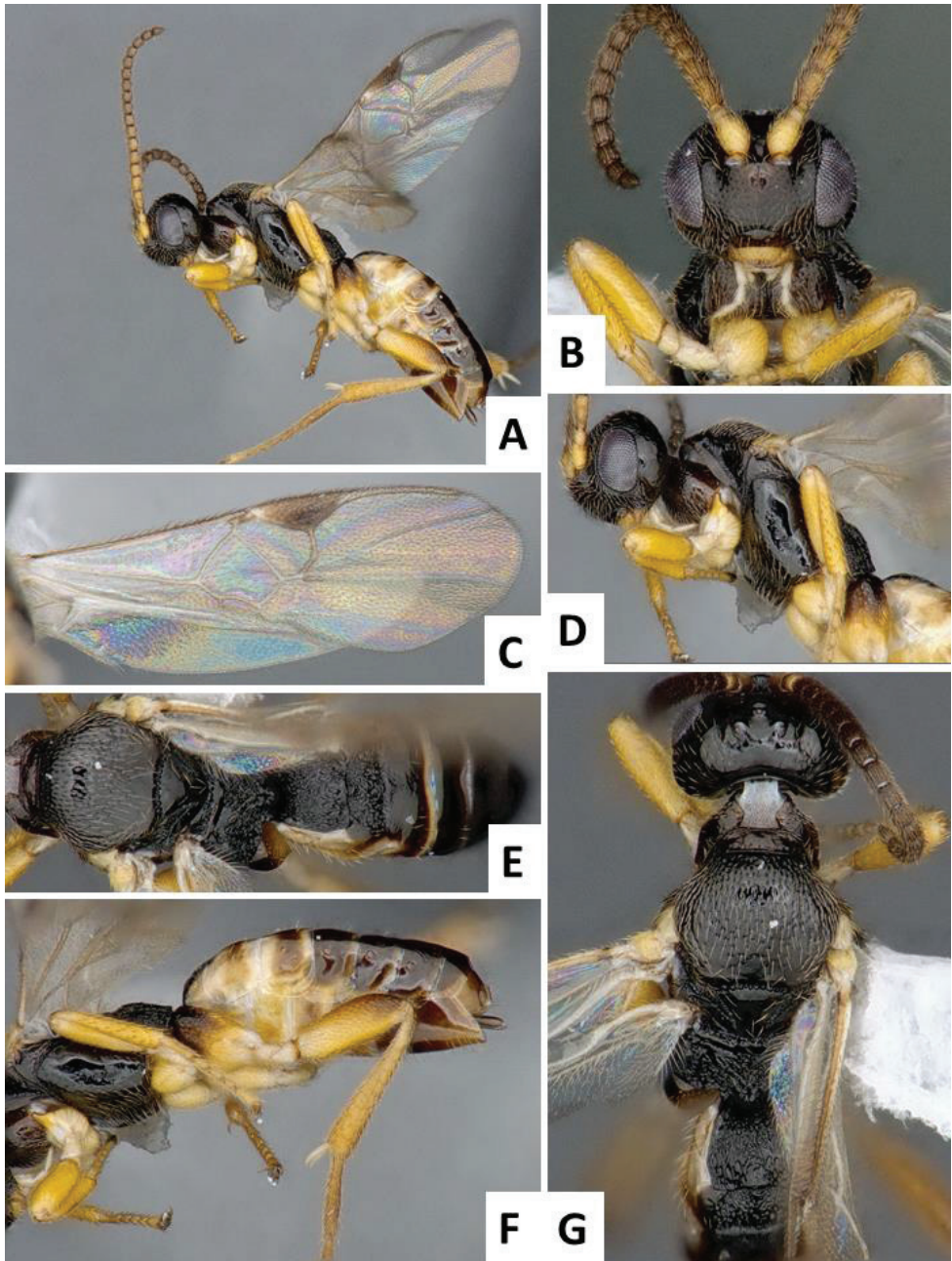

Figure 7. *Cotesia flavipes*, female specimen from Mombasa, Kenya. **A** Habitus, lateral view **B** Head, frontal view **C** Wings **D** Head and mesosoma, lateral view **E** Mesosoma and metasoma, dorsal view **F** Mesosoma and metasoma, lateral view **G** Head, mesosoma and tergites 1-2, dorsal view.

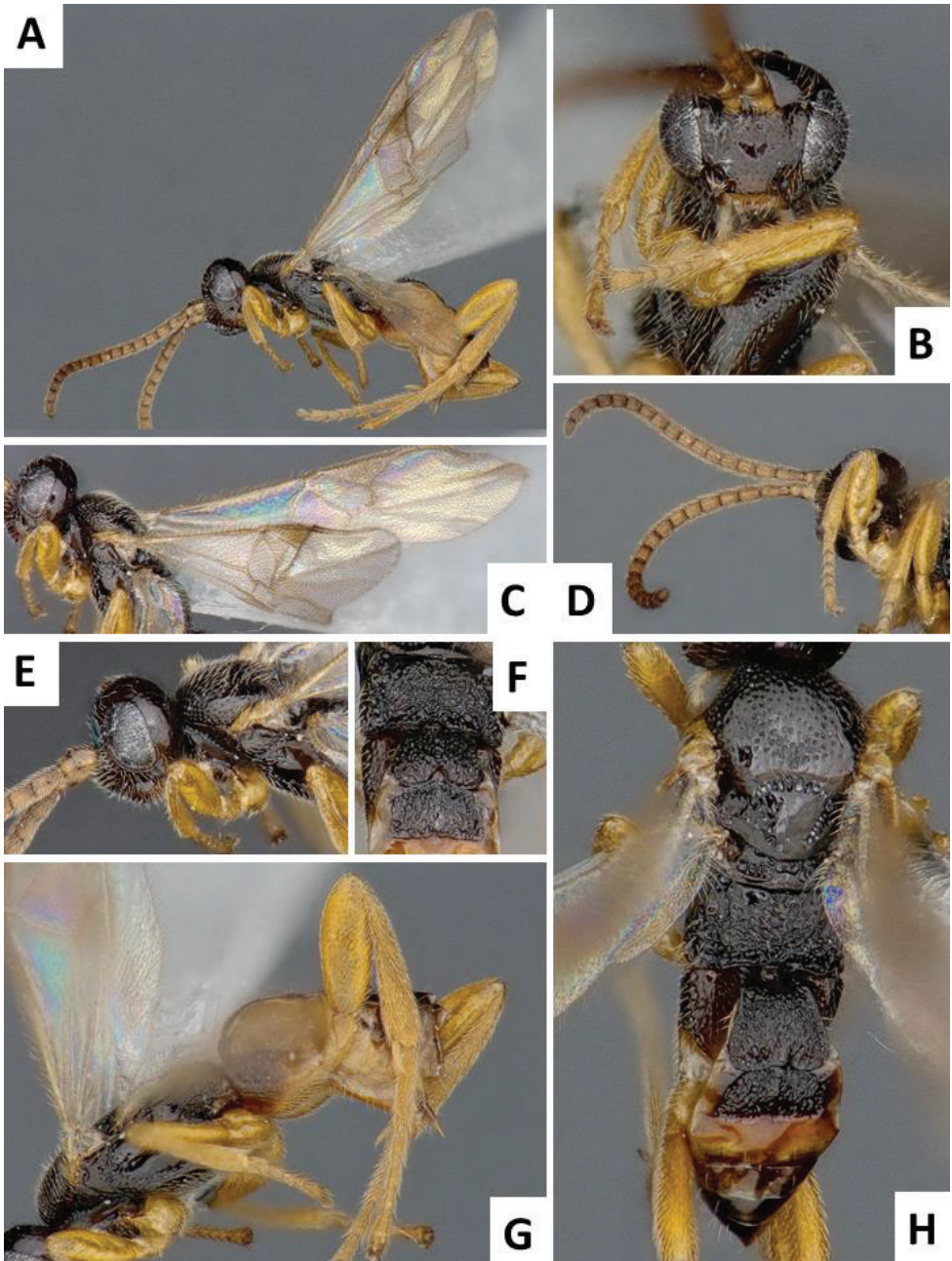

Figure 8. *Cotesia chilonis*, female specimen from Takatsuki, Japan. **A** Habitus, lateral view **B** Head, frontal view **C** Wings **D** Antennae, front and middle legs, lateral view **E** Head, lateral view **F** Propodeum, tergites 1-2, dorsal view **G** Mesosoma and metasoma, lateral view **H** Mesosoma and metasoma, dorsal view.

with brown spot centrally, near anterior margin). Wings with veins mostly brown, pterostigma brown with pale spot on anterior 0.3.

Head wider than high; face with acute, triangular projection between antennal base, the projection with clearly impressed median longitudinal sulcus; head dorsally smooth; gena laterally and dorsally as wide or wider than eye width; anteromesoscutum with relatively deep, coarse and large punctures (puncture diameter larger than distance between punctures), puncture density similar on most of the anteromesoscutum, including posterior half; scutoscuteellar sulcus strongly curved, with 10–12 impressions; scutellar disc mostly smooth, with shallow and sparse punctures; propodeum mostly sculptured with an irregular pattern of strong carinae; mediotergites 1–2 mostly covered by strong longitudinal striae, mediotergites 3+ mostly smooth; hypopygium relatively small, apical tip in lateral view shorter than apical tip of tergites; paramere with broad, widened area near apex; paramere relatively large, around $1.50 \times$ as long as median length of sternite 8.

Body ratios. Length of flagellomere 2/length of flagellomere 14: $1.71 \times (1.50–1.86)$. Metafemur length/width: $3.06 \times (2.92–3.25)$. Length of inner spur of metatibia/length of first segment of metatarsus: $0.48 \times (0.46–0.52)$. Length of inner spur of metatibia/length of outer spur of metatibia: $1.07 \times (1.07–1.18)$. Pterostigma length/width: $2.81 \times (2.61–2.88)$. Length of fore wing vein r/length of fore wing vein 2RS: $0.82 \times (0.82–1.00)$. Mediotergite 1 length/mediotergite width at posterior margin: $1.07 \times (0.93–1.20)$. Length of mediotergite 2/length of mediotergite 3: $0.89 \times (0.83–1.00)$.

Body measurements (all in mm). Body length: 2.40 (2.20–2.50). Fore wing length: 2.10 (2.10–2.20). Length of antennal flagellomere (F), F1: 0.15 (0.14–0.17), F2: 0.12 (0.12–0.13), F3: 0.11 (0.10–0.11), F14: 0.07 (0.06–0.08), F15: 0.07 (0.06–0.08), F16: 0.10 (0.09–0.11). Metafemur length: 0.55 (0.51–0.56). Metafemur width: 0.18 (0.16–0.19). Metatibia length: 0.71 (0.66–0.74). First segment of metatarsus length: 0.31 (0.28–0.31). Length of inner spur of metatibia: 0.15 (0.13–0.16). Length of outer spur of metatibia: 0.14 (0.11–0.14). Ovipositor sheaths length: 0.18 (0.15–0.18). Pterostigma length: 0.45 (0.145–0.49). Pterostigma width: 0.16 (0.16–0.18). Length of fore wing vein r: 0.09 (0.09–0.11). Length of fore wing 2RS: 0.11 (0.10–0.12). Length of mediotergite 1: 0.30 (0.27–0.31). Width at posterior margin of mediotergite 1: 0.28 (0.25–0.32). Length of mediotergite 2: 0.16 (0.14–0.20). Length of mediotergite 3: 0.18 (0.15–0.20).

Etymology. Named after the main host plant on which the wasp parasitizes its host caterpillar, Kaiser et al. (2015).

Notes. *Cotesia typhae* occurs sympatrically with *C. sesamiae* and *C. flavipes* (the latter introduced into Africa). Among these three species, *typhae* is the largest (body and fore wing lengths usually 0.2–0.3 mm longer than the two others), it also has a more sculptured anteromesoscutum and a longer antenna (especially flagellomeres 1–4 which are significantly longer).

Table 3. Minimum and maximum divergence of COI sequences between all pairs of species.

	<i>C. typhae</i>	<i>C. sesamiae</i>	<i>C. flavipes</i>	<i>C. chilonis</i>
<i>C. typhae</i>	0–0.002			
<i>C. sesamiae</i>	0.026–0.035	0–0.028		
<i>C. flavipes</i>	0.033–0.035	0.031–0.042	0	
<i>C. chilonis</i>	0.035	0.030–0.037	0.037	0

Table 4. Minimum and maximum divergence of COI sequences between *C. typhae* and two populations of *C. sesamiae*.

	<i>C. typhae</i>	<i>C. sesamiae</i> Kitale	<i>C. sesamiae</i> Mombasa
<i>C. typhae</i>	0–0.002		
<i>C. sesamiae</i> Kitale	0.03–0.035	0–0.014	
<i>C. sesamiae</i> Mombasa	0.026–0.03	0.019–0.028	0–0.003

Molecular characterization

Between species, pairwise divergence of COI sequences ranged from 2.6% to 4.2%, and distances observed between *C. typhae* and the other *C. sesamiae* species fell in this range (Table 3). Within species, divergence was close to zero for *C. typhae*, *C. chilonis* and *C. flavipes*, and ranged from zero to 2.8% in *C. sesamiae*. The higher within-species values in *C. sesamiae* are explained by the divergence between the Kitale and Mombassa populations, reflecting their affiliation with different lineages, as shown by Kaiser et al. (2015) (Table 4).

Distribution, ecology and abundance

Among the ten sampled countries and 65 sampled localities hosting *S. nonagrioides* on Typhaceae and Cyperaceae, larvae parasitized by *C. typhae* were found in the three most sampled countries (highest numbers of localities and collected larvae), Ethiopia, Kenya and Tanzania (Table 5), in a total of 12 localities (Table 6). This showed that the probability of discovering *C. typhae* depended on the sampling effort, so this species may well be present in other sub-Saharan Africa areas inhabited by *S. nonagrioides* (Kergoat et al. 2015).

We then estimated the percentage of parasitized *S. nonagrioides* in the localities where the parasitoid was present. It varied from less than five to more than 70 % (Table 6), with a mean value of 20.3 % (standard error 4.0 %, n=18). All values, except the highest, ranged between 3.4 and 33.3% of parasitized larvae. Among the 660 parasitized larvae, 5 were parasitized by *Cotesia* other than *C. typhae* (4 *C. sesamiae* and 1 *C. flavipes*). Repeated findings of *C. typhae* in different years in the same locality, as seen in two Kenyan localities (Mbita Lwanda, 4 collections over 9 years; Makindu, 3 collections over 4 years), showed that locality and plant-host combination were good criteria for finding this new species.

Table 5. Presence of *Cotesia typhae* in the sampled countries. Results of collections of *S. nonagrioides* in sub-Saharan Africa from 2004 to 2013. For each country the Table shows the number of localities containing Typhaceae and Cyperaceae plants, the total number of *S. nonagrioides* larvae collected there during the period, and whether some were parasitized by *C. typhae*.

Country	Number of sampled localities with Typhaceae & Cyperaceae	Number of <i>S. nonagrioides</i> larvae	presence of <i>Cotesia typhae</i>
Benin	1	26	no
Botswana	1	2	no
Cameroun	1	1	no
Ethiopia	5	167	YES
Kenya	26	1253	YES
R. Congo	2	38	no
R.D.C.	2	26	no
Rwanda	1	7	no
Tanzania	18	463	YES
Tanzania, Pemba	1	1	no
Tanzania, Zanzibar	3	25	no
Uganda	4	26	no

Life history traits and parasitoid success on different host strains

Adult longevity

The median longevity was close to three days when adults were fed honey, but equal to two days or less when they were fed with 20% or 2% saccharose solution respectively (Fig. 9). The survival curves were significantly different ($W_{2df} = 129.78$; $P < 10^{-4}$). They showed that about 90% adults were dead six days after emergence when fed honey or 20% saccharose, and three days after emergence when fed 2% saccharose (Fig. 9).

Realized fecundity

Females were given the opportunity to parasitize a maximum of four larvae, but they actually parasitized a mean number of only 2.3 larvae (Table 7), either because they died before the end of the experiment (almost half of them were dead on the third day, Fig. 10), or because they refused to oviposit, as observed for a few females on day 3, and for most of the surviving ones on day 4 (Fig. 10). About 2/3 of the stung larvae allowed successful parasitoid development (Table 7). Finally, females produced about 100 offspring during their lifetime, from two host larvae.

In the next experiment, the possibility for *C. typhae* to develop in European populations was estimated by the incidence of the first oviposition, which ensured more than half of the wasp's reproductive success.

Parasitoid success in European host populations

Susceptibility of European *S. nonagrioides* strains to the parasitoid was equal or even higher than that of the Kenyan strain, with for instance almost 90% of successfully

Table 6. Percentage of parasitism of *S. nonagrioides* larvae in the localities where *C. tryphae* was found.

Country	Locality	Latitude	Longitude	EDate	Plant species	Nbr <i>S.n.</i> larvae	% parasitism
ETHIOPIA	Awasa	7.05°N	38.47°E	Nov.-04	<i>T. domingensis</i>	64	6.3%
ETHIOPIA	Chamoleto	5.93°N	37.53°E	Nov.-04	<i>T. domingensis</i>	16	18.8%
ETHIOPIA	Omolante	6.16°N	37.67°E	Nov.-04	<i>T. domingensis</i>	27	22.2%
KENYA	Kabuto	0.35°S	34.96°E	May-12	<i>C. dives</i>	6	33.3%
KENYA	Kobodo	0.86°S	34.57°E	March-13	<i>C. dives</i>	42	7.1%
KENYA	Makindu	2.28°S	37.82°E	Nov.-10	<i>T. domingensis</i>	65	10.8%
KENYA	Makindu	2.28°S	37.82°E	Feb.-11	<i>T. domingensis</i>	64	4.7%
KENYA	Masimba	2.15°S	37.58°E	Dec.-06	<i>T. domingensis</i>	10	30.0%
KENYA	Masimba	2.15°S	37.58°E	Apr.-08	<i>T. domingensis</i>	13	15.4%
KENYA	Mbita Lwanda	0.89°S	34.67°E	Feb.-05	<i>T. domingensis</i>	68	27.9%
KENYA	Mbita Lwanda	0.89°S	34.67°E	Oct.-08	<i>T. domingensis</i>	147	10.2%
KENYA	Mbita Lwanda	0.89°S	34.67°E	June-07	<i>T. domingensis</i>	18	72.2%
KENYA	Mbita Lwanda	0.89°S	34.67°E	March-13	<i>T. domingensis</i>	59	8.5%
KENYA	Rabuor	0.43°S	34.91°E	March-13	<i>C. dives</i>	10	20.0%
KENYA	Rabuor	0.43°S	34.91°E	March-13	<i>T. domingensis</i>	6	33.3%
KENYA	Sori	0.97°S	34.28°E	March-13	<i>T. domingensis</i>	13	7.7%
TANZANIA	Arusha	3.37°S	36.87°E	July-04	<i>T. domingensis</i>	29	3.4%
TANZANIA	Ruvu	6.70°S	38.71°E	March-07	<i>C. exaltatus</i>	3	33.3%



Figure 9. Survival curves of *C. typhae* adults fed honey (number of wasps: n=497), or 20% (n=742) or 2% (n=534) saccharose solutions in collective cages at 21°. Median lifespan is the time value observed at 50% survival.

Table 7. Realized fecundity of *C. typhae* on Kenyan *S. nonagrioides*.

	adult lifetime (days)	stung larvae (nbr)	successfully parasitized larvae (nbr)	Offspring (total nbr)
Mean (N=40)	2.83	2.3	1.63	102.93
Standard error	1.17	0.11	0.11	6.2

parasitized Italian larvae. Several other traits differed between the host strains, with a trend for better performances in the Italian strain, which ranked “a” for the five progeny traits showing significant differences: faster larval and pupal development, resulting in a development time of 20 days; high offspring number per cluster, showing the lowest pupal mortality and highest ratio of females. Highest immature developmental time (22 days) was observed in the Kenyan host strain, and highest pupal mortality and lowest female ratio was observed in the French strain. From these traits, it is possible to estimate a reproductive rate, i.e. the expected number of viable adults per mother, by multiplying the proportion of successful parasitism (probability of host larvae successfully parasitized) by the mean number of produced cocoons and by the proportion of viable adults (1-proportion of pupal mortality). This approach indicated that a female *C. typhae* would produce 56 viable offspring from a host larva of the Italian population, and only 37 from the host larvae of the French or Kenyan populations. As discussed hereafter, most differences could be explained by the effect of rearing conditions on host larvae quality.

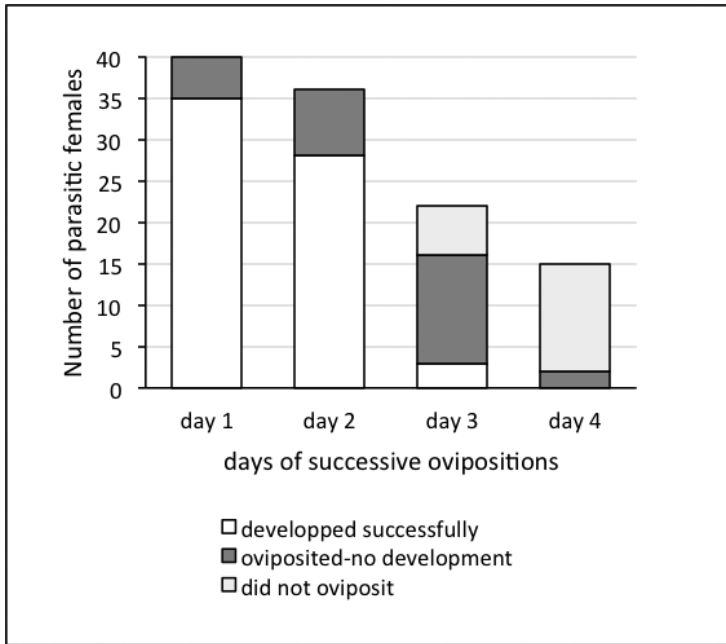

Figure 10. Issue of successive presentations of host larvae to *C. typhae* (one host per day for four days or less for wasps that died).

Table 8. Development of *C. typhae* in Kenyan and European hosts. Bold characters indicate significant differences between host strains.

<i>S. nonagrioides</i> populations:	Kenya	France	Italy	Statistical analyses
<i>N</i> : Nbr parasitized host larvae	58	58	47	–
Host larval weight at time of parasitism (mg)	295 ± 11	272 ± 12	283 ± 12	KW _{2df} = 1.28 <i>P</i> = 0.331
% successful parasitism	69.0 (b)	67.2 (b)	89.4 (a)	χ ² _{2df} = 7.95 <i>P</i> = 0.019
% host pupae	12.1	13.8	2.1	
% host larva mortality	19.0	19.0	8.5	
<i>N</i> : Nbr of cocoon clusters analyzed below	38	32	33	–
<i>Cotesia</i> larval development	14.2 ± 0.4 b	14.4 ± 0.2 b	12.9 ± 7.1 a	KW_{2df} = 18.29 <i>P</i> = 10⁻⁴
<i>Cotesia</i> pupal development (days)	8.2 ± 0.3 b	6.8 ± 0.2 a	7.1 ± 0.1 a	KW_{2df} = 19.60 <i>P</i> < 10⁻⁴
Cocoon number	60.3 ± 4.6 b	75.0 ± 5.5 a	64.6 ± 4.5 ab	KW_{2df} = 7.67 <i>P</i> = 0.022
Individual cocoon weight (mg)	1.3 ± 0.04	1,3 ± 0.05	1,2 ± 0.02	KW _{2df} = 4.20 <i>P</i> = 0.122
% <i>Cotesia</i> pupal mortality	10.4 ± 2.7 a	25.8 ± 4.6 b	3.0 ± 0.7 a	KW_{2df} = 16.54 <i>P</i> < 10⁻³
% females in the cluster	43.9 ± 5.4 c	35.0 ± 8.2 b	72 ± 3.8 a	KW_{2df} = 17.98 <i>P</i> < 10⁻³
Estimated Reproductive Rate (expected viable adults/mother)	37	37	56	–

Discussion

The morphological analysis conducted in this study, as well as the divergence of the CO1 sequences, confirmed the species status of the *C. sesamiae* lineage specialized on the noctuid *S. nonagrioides*. The CO1 divergence fell within the range of values observed between species of the *flavipes* complex. Morphological traits differentiated in this lineage included those used to distinguish species of the *flavipes* complex. This constitutes evidence for the existence of a fifth species in the *flavipes* complex. We named this new species *C. typhae*, based on the main host plant where it is found on its host. Whereas the first four species are allopatric in their endemic range, *C. typhae* is sympatric with *C. sesamiae* and may have differentiated from this species through divergent selection for adaptation on *S. nonagrioides* in Typhaceae and Cyperaceae, a permanent resource, and divergent selection for reproductive isolation (possibly facilitated by *Wolbachia*) (Kaiser et al. 2015).

It is likely that more species may be found in this complex. For instance, a relatively large CO1 divergence was also observed between *C. sesamiae* populations from Kitale (inland Kenya) and Mombassa (coastal Kenya), which are two host races with limited gene flow due to *Wolbachia* infection (Mochiah et al. 2002). Additional studies on the phylogenetic and biological relationships among those lineages, in particular the strength of bidirectional cytoplasmic incompatibilities related to *Wolbachia* strains, may reveal, in the future, the presence of an additional species.

Male genitalia were one of the differentiated morphological traits. This explains mating abnormalities observed by Kaiser et al. (2015) when crossing males of *C. typhae* with females of *C. sesamiae*, i.e. difficulties of males to disengage from females. It is one component of pre-zygotic barriers. In most animal species with internal fertilization, male external genitalia are the most rapidly evolving organs and are usually the first organs to diverge morphologically following speciation (Eberhard 2010; Yassin and Orgogozo 2013). Because of their rapid evolution and species-specificity, their illustration is a common feature in taxonomic literature to discriminate closely related species, particularly in insects (Yassin and Orgogozo 2013), including species of the *flavipes* complex (Kimani-Njogu and Overholt 1997).

The larger size of *C. typhae* relatively to the other species of the *flavipes* complex could result from an adaptation to host size, *S. nonagrioides* being a rather large noctuid relative to other Poales stem borer hosts for the *flavipes* complex. The size of a solitary parasitoid has been often reported as a plastic trait varying with host size; in gregarious parasitoids, the clutch size can be plastic and varies with host size (Godfray 1994). An evolutionary relationship between the size of gregarious parasitoids and the host size can exist if there is a genetic constraint on the clutch size, which is very likely, at least due to limits in the number of mature oocytes. The differentiation of other morphological traits may result from selective sweep or genetic correlation with other adaptive traits exposed to differential selection.

The morphological identification of species of the *flavipes* complex relies on a combination of slight differences, and their observation requires specific expertise, so a

molecular diagnoses using CO1 or the virulence gene CrV1 (Dupas et al. 2006; Branca et al. 2011) remains the easiest identification method.

The geographic distribution and ecology of *C. typhae* have been reported by Kaiser et al. (2015). Here we provide evidence that the probability of collecting *S. nonagrioides* parasitized by *C. typhae* depended on the number of collected larvae. In several visited countries, this number was not sufficient to assess the presence of the wasp, so it may well be present over the sub-Saharan distribution of its noctuid host. The percentage of parasitized larvae was highly variable between localities, and even between periods of sampling in the same locality. Abundance of *C. typhae* within a locality may vary depending on the rainy season. Indeed Mailafiya et al. (2010) found that *C. sesamiae* was more abundant during the rainy season, and here (Table 6), the highest values of *C. typhae* abundance were observed in the middle of the rainy season (December), whereas lower values corresponded to the beginning of the season (Makindu-Masimba area, rainy season from November to January, Mailafiya et al. 2010). Other localities in western Kenya with rainy seasons from March to August and October to December had the highest parasitism observed in June. Regarding mean parasitism rates, about 20% of *S. nonagrioides* larvae were successfully parasitized by *C. typhae*. The same mean value or range of parasitism rates were observed in stem borers parasitized by *C. sesamiae*, and by *C. flavipes*, in maize and sorghum in Kenya (Mailafiya et al. 2010), and by *C. chilonis* in rice in China (Lou et al. 2014), but lower values were also observed (Jiang et al. 2006). This mean value is much lower than that observed in laboratory conditions. One limiting factor of parasitism success in natural conditions may be the behavior of host larvae, which hide inside the stem galleries with entrances that are naturally plugged with residues from boring, and move about mostly during the night, whereas the wasps are diurnal. Larvae also defend themselves by biting to death the wasps attempting to oviposit, killing 30–40% of them (Potting et al. 1997). Dispersion of these small parasitoids may also limit their efficiency, and would explain why mass releases of *C. flavipes* performed in sugarcane fields in Brazil successfully raised the parasitism rate to a range of 40–60% (Botelho and Macedo 2002; Dinardo-Miranda et al. 2014). Our data on *C. typhae* also show that parasitism rates as high as 70% can occur, although this rate was observed only once, and the next closest value was half lower. Even higher seasonal peaks were also reported in the case of the noctuid stem borer *Busseola fusca* parasitized by *C. sesamiae* on sorghum in South Africa (Kfir and Bell 1993), and of the crambid rice stem borer *C. suppressalis* in China (Lou et al. 2014).

Presence of *C. typhae* in different years in the same place showed that locality and plant-host combination was a good criterion for finding this new species. Very rare occurrence of parasitism of *S. nonagrioides* by *C. sesamiae* and *C. flavipes*, observed in less than 1% of the larvae, means that species identity has to be checked systematically.

The longevity of *C. typhae* and reproduction dynamics resemble those observed for the other species of the *flavipes* complex, which are typical short lived pro-ovogenic parasitoid wasps (Quicke 1997), i.e. females emerge with mostly mature oocytes and oviposit shortly after being mated, until egg-depletion. A literature review allows

comparisons with three other species of the complex. *C. typhae* adult longevity was close to that of *C. sesamiae*, i.e. a mean longevity of about three days when fed honey at 25° and 60% RH (Sallam et al. 2002), but shorter than the longevity recorded in similar conditions for *C. flavipes* (about 5-6 days, Potting et al. 1997) and for *C. nonagriiae* (about 12 days, Muirhead et al. 2008). Longevity in outdoor conditions may be longer due to cooler temperatures at night and the opportunity to rest in favorable micro-niches provided by plants. In the *flavipes* complex the dynamic of female reproduction follows their longevity, since most offspring are produced from the first two ovipositions in *C. typhae*, as in *C. sesamiae* (Sallam et al. 2002), and along 4-5 ovipositions in *C. flavipes* (Potting et al. 2007), with the exception of *C. nonagriiae* which produces most offspring during the first two ovipositions, although it can live for several days. This behavior may have been selected in response to the defense behavior of stem borer noctuid larvae, which threatens female survival at each oviposition. With regard to realized fecundity, data available for the species complex were mostly the number of offspring produced from the first oviposition, which can be estimated at 60 offspring in *C. typhae*. This value is intermediate between higher value observed for *C. nonagriiae* (about 90 offspring from one oviposition, Muirhead et al. 2008), and lower value observed for *C. sesamiae* and *C. flavipes* (from 25 to 45, depending on both parasitoid strain and host species, Jiang et al. 2004, Mochiah et al. 2001, Ngisong et al. 1998, Sallam et al. 2002). Altogether, these data indicate an evolution of the reproduction strategy within the *flavipes* complex. Considering longevity and oviposition dynamic, *C. typhae* appeared to be closer to *C. sesamiae* than to *C. flavipes* and *C. nonagriiae*, which is in accordance with the estimated phylogenetic proximity (Muirhead et al. 2012; Kaiser et al. 2015).

The parasitism success of *C. typhae* in European host populations, assessed in the present work, was initially questioned because European *S. nonagrioides* are genetically well differentiated from African populations (Moyal et al. 2011), and they may have evolved immune responses adapted to European parasitoids and pathogens. However, the variation of reproductive success of *C. typhae* in the different host populations did not depend on the continental origin of the host, because *C. typhae* performed globally better in the Italian population than in the French and the Kenyan ones. A genetic differentiation of the Italian host population is unlikely because a recent study based on the analysis of micro-satellite markers showed an absence of genetic structure of *S. nonagrioides* collected in Europe, and in the Near and Middle East (Kader et al., unpublished data). We are more inclined to suspect that the laboratory rearing conditions of the noctuids had an effect on *C. typhae* parasitism success. Indeed, Italian larvae tested in the present work had been reared in a different laboratory than larvae from the French and the Kenyan populations. The Italian laboratory uses a different diet (Giacometti 1995), and larval food is known to influence immune response of Lepidoptera larvae (Smilanich et al. 2009; Vogelweith et al. 2015). Comparison of diets on susceptibility of the three host populations to *C. typhae* will allow this hypothesis to be tested.

In the areas where *C. typhae* have been found, in eastern sub-Saharan Africa, *S. nonagrioides* is rarely seen on maize, sorghum or sugarcane, whereas this is the case in more western parts of Africa and in Europe and the Near and Middle East. However *C. typhae* would probably parasitize *S. nonagrioides* at least on maize, if introduced for biological control, because in laboratory conditions host larvae are readily accepted when fed on maize stem and fecal pellets and eaten stem tissues are highly attractive, triggering intense behavioral examination of the host with antennal tapping.

In conclusion, this study adds a fifth species to the *Cotesia flavipes* complex. Despite the number of individual studies that illustrate the diversity of ecological adaptations in this complex, a comprehensive analysis of the *flavipes* species group is still needed. It will require the joint study of all populations across the geographical and ecological range of the *Cotesia flavipes* complex. The use of an integrative taxonomic approach (combining morphological, molecular, biological and geographical data) will be of paramount importance in recognizing and characterizing this economically important complex of parasitoid wasps. The new *C. typhae* species is an interesting potential biological control agent of the Mediterranean corn borer *S. nonagrioides*, because of its strict host-specificity to that species, at least in its native area, precluding potential negative impact on non-target host species populations.

Acknowledgements

We are very grateful to Antoine Branca, Kate Muirhead and Florence Mougel for fruitful discussions on the project; and to the undergraduate students who contributed to the experiments, namely Louise Trouillaud and Sarah Achibet; to Gianandrea Salerno who sent us the Italian *S. nonagrioides* larvae; to Boaz Musyoka for field collection; to Odile Giraudier, Gerphas Ogola and Sylvie Nortier for insect rearing at Gif and the icipe; to Lionel Saunois, Amandine Dubois and Virginie Héraudet for maize production, to Alice Arnaud de Sartre for editing references; Malcom Eden for linguistic correction. The work of JFT in Canada was supported by project 1558 'Arthropods systematics'. This project was also supported by the ANR Bioadapt (ABC Papogen project), and by the other authors' operating grants from IRD, CNRS, and icipe. It was performed under the juridical frame of a Material Transfer Agreement signed between IRD, icipe and CNRS (CNRS 072057/IRD 302227/00) and the authorization to import *Cotesia* in France delivered by the DRIAAF of Ile de France.

References

- Asgari S (2006) Venom proteins from polydnavirus-producing endoparasitoids: their role in host-parasite interactions. *Archives of Insect Biochemistry and Physiology* 61: 146–156. <https://doi.org/10.1002/arch.20109>

- Beckage NE (1998) Modulation of immune responses to parasitoids by polydnviruses. *Parasitology* 116: S57–S64. <https://doi.org/10.1017/s0031182000084948>
- Botelho PSM, Macedo N (2002) *Cotesia flavipes* para o controle *Diatraea saccharalis*. In: Para JRP, Botelho PSM, Corraferreira BS, Bento JMS (Eds) Controle biológico no Brasil: parasitoides e predadores, São Paulo (Brazil), 2002. Manole, 409–425.
- Branca A, Le Ru B, Vavre F, Silvain J-F, Dupas S (2011) Intraspecific specialization of the generalist parasitoid *Cotesia sesamiae* revealed by polyDNAvirus polymorphism and associated with different *Wolbachia* infections. *Molecular Ecology* 20: 959–971. <https://doi.org/10.1111/j.1365-294X.2010.04977.x>
- Davis RB, Baldauf SL, Mayhew PJ (2010) The origin of species richness in the Hymenoptera: insights from a family-level supertree. *BMC Evolutionary Biology* 10: 109. <https://doi.org/10.1186/1471-2148-10-109>
- Dinardo-Miranda LL, Vilela Fracasso J, Pereira da Costa V, Teixeira Lopes DO (2014) Dispersal of *Cotesia flavipes* in sugarcane field and implications for parasitoid releases. *Bragantia Campinas* 73: 163–170.
- Dupas S, Gitau C, Le Ru B, Silvain JF (2006) Single-stepPCR differentiation of *Cotesia sesamiae* (Cameron) and *Cotesia flavipes* Cameron (Hymenoptera: Braconidae) using polydnvirusmarkers (PCR test). *Annales de la Société Entomologique de France* 42: 319–323. <https://doi.org/10.1080/00379271.2006.10697463>
- Dupas S, Gitau CW, Branca A, Le Ru B, Silvain JF (2008) Evolution of a polydnvirus gene in relation to parasitoid-host species immune resistance. *The Journal of Heredity* 99: 491. <https://doi.org/10.1093/jhered/esn047>
- Eberhard WG (2010) Evolution of genitalia: theories, evidence, and new directions. *Genetica* 138: 5–18. <https://doi.org/10.1007/s10709-009-9358-y>
- Fernandez-Triana J, Whitfield J, Rodriguez J, Smith M, Janzen D, Hajibabaei M, Burns J, Solis A, Brown J, Cardinal S, Goulet H, Hebert P (2014) Review of *Apanteles sensu stricto* (Hymenoptera, Braconidae, Microgastrinae) from Area de Conservación Guanacaste, northwestern Costa Rica, with keys to all described species from Mesoamerica. *ZooKeys* 383: 1–565. <https://doi.org/10.3897/zookeys.383.6418>
- Giacometti R (1995) Rearing of *Sesamia nonagrioides* Lefevre on a meredict diet (Lepidoptera Noctuidae). *Redia* 78: 19–27.
- Gitau CW, Gundersen-Rindal D, Pedroni M, Mbugi PJ, Dupas S (2007) Differential expression of the CrV1 haemocyte inactivation-associated polydnvirus gene in the African maize stem borer *Busseola fusca* (Fuller) parasitized by two biotypes of the endoparasitoid *Cotesia sesamiae* (Cameron). *Journal of Insect Physiology* 53: 676–684. <https://doi.org/10.1016/j.jinsphys.2007.04.008>
- Gitau W, Schulthess F, Dupas S (2010) An association between host acceptance and virulence status of different populations of *Cotesia sesamiae*, a braconid larval parasitoid of lepidopteran cereal stemborers in Kenya. *Biological Control* 54: 100–106. <https://doi.org/10.1016/j.biocontrol.2010.04.010>
- Godfray HCJ (1994) Parasitoids: behavioral and evolutionary ecology. Princeton University Press, Princeton, 488 pp.

- Herniou E, Huguet E, Thézé J, Bézier A, Periquet G, Drezen JM (2013) When parasitic wasps hijacked viruses: genomic and functional evolution of polydnviruses. *Philosophical Transactions of the Royal Society B* 368: 20130051. <https://doi.org/10.101098/rstb20130051>
- Huber J, Sharkey MJ (1993). *Structure. Hymenoptera of the world, an identification guide to families*. Agriculture Canada Research Branch Monograph 1894E, 14–59.
- Jancek S, Bézier A, Gayral P, Paillusson C, Kaiser L, Dupas S, Le Ru BP, Barbe V, Periquet G, Drezen JM, Herniou E (2013) Adaptive selection on bracovirus genomes drives the specialization of *Cotesia* parasitoid wasps. *PLoS ONE* 8(5): 11pp. <https://doi.org/10.1371/journal.pone.0064432>
- Jembere B, Ngi-Song AJ, Overholt W (2003) Olfactory responses of *Cotesia flavipes* (Hymenoptera: Braconidae) to target and non-target Lepidoptera and their host plants. *Biological Control* 28: 360–367. [https://doi.org/10.1016/S1049-9644\(03\)00092-6](https://doi.org/10.1016/S1049-9644(03)00092-6)
- Jiang N, Sétamou M, Ngi-Song AJ, Omwega CO (1994) Performance of *Cotesia flavipes* (Hymenoptera: Braconidae) in parasitizing *Chilo partellus* (Lepidoptera: Crambidae) as affected by temperature and host stage. *Biological Control* 31: 155–164. <https://doi.org/10.1016/j.biocontrol.2004.06.002>
- Jiang ZF, Huang DW, Chen LL, Zhen WQ, Fu YG et al. (2006) Rampant host switching and multiple female body colour transitions in *Philotrypesis* (Hymenoptera: Chalcidoidea: Agaonidae). *Journal of Evolutionary Biology* 19: 1157–1166. <https://doi.org/10.1111/j.1420-9101.2006.01087>
- Kaiser L, Le Ru BP, Kaoula F, Paillusson C, Capdevielle-Dulac C, Obonyo JO, Herniou H, Jancek S, Branca A, Calatayud PA, Silvain JF, Dupas S (2015) Ongoing ecological speciation in *Cotesia sesamiae*, a biological control agent of cereal stem borers. *Evol Applic* 8: 807–820. <https://doi.org/10.1111/eva.12260>
- Kergoat G, Toussaint E, Capdevielle-Dulac C, Clamens A, Ong'Amo G, et al. (2015) Integrative taxonomy reveals six new species related to the mediterranean corn stalk borer *Sesamia nonagrioides* (Lefebvre) (Lepidoptera, Noctuidae, Sesamiina). *Zoological Journal of the Linnean Society* 175: 244–70. <https://doi.org/10.1111/zoj.12275>
- Kfir R, Bell R (1993) Intraseasonal changes in populations of the African stem borer, *Busseola fusca* (Fuller) (Lepidoptera: Noctuidae). *Natal, South Africa (Revue de Zoologie Africaine)* 107: 543–553.
- Kfir R, Overholt WA, Khan RZ, Polaszek A (2002) Biology and management of economically important cereal stem borers in Africa. *Annual Review of Entomology* 47: 701–731. <https://doi.org/10.1146/annurev.ento.47.091201.145254>
- Kimani-Njogu SW, Overholt WA (1997) Biosystematics of the *Cotesia flavipes* species complex (Hymenoptera: Braconidae), parasitoids of the gramineous stemborers. *Insect Science and its Application* 17: 119–130. <https://doi.org/10.1017/s1742758400022232>
- Liu S, Wang X, Guo S, He J, Shi Z (2000) Seasonal abundance of the parasitoid complex associated with the diamondback moth, *Plutella xylostella* (Lepidoptera: Plutellidae) in Hangzhou, China *Bulletin of Entomological Research* 90: 221–31. <https://doi.org/10.1017/S0007485300000341>
- Lou YG, Zhang GR, Zhang WQ, Hu Y, Zhang J (2014) Reprint of: biological control of rice insect pests in China. *Biological Control* 68: 103–116. <https://doi.org/10.1016/j.biocontrol.2013.09.018>

- The Marie Curie Speciation Network (2012) What do we need to know about speciation? *Trends in Ecology and Evolution* 27: 27–39. <https://doi.org/10.1016/j.tree.2011.09.002>
- Mason WRM (1981) The polyphyletic nature of *Apanteles* Foerster (Hymenoptera: Braconidae): a phylogeny and reclassification of Microgastrinae. *Memoirs of the Entomological Society of Canada* 115: 1–147. <https://doi.org/10.4039/entm113115fv>
- Mailafiya DM, Le Ru BP, Kairu EW, Calatayud PA, Dupas S (2010) Geographic distribution, host range and perennation of *Cotesia sesamiae* and *Cotesia flavipes* Cameron in cultivated and natural habitats in Kenya. *Biological Control* 54: 1–8. <https://doi.org/10.1016/j.biocontrol.2009.11.008>
- Mindigoyi S-KG, Affognon HD, Macharia I, Ong'Amo G, Abonyo E, Ogola G, De Groote H, Le Ru BP (2016) Assessing the long-term welfare effects of the biological control of cereal stemborer pests in East and Southern Africa: Evidence from Kenya, Mozambique and Zambia Agriculture. *Ecosystems & Environment* 230: 10–23. <https://doi.org/10.1016/j.agee.2016.05.026>
- Mochiah M, Ngi-Song AJ, Overholt WA, Stouthamer R (2002) *Wolbachia* infection in *Cotesia sesamiae* (Hymenoptera: Braconidae) causes cytoplasmic incompatibility: implications for biological control. *Biological Control* 25: 74–80. [https://doi.org/10.1016/S1049-9644\(02\)00045-2](https://doi.org/10.1016/S1049-9644(02)00045-2)
- Moyal P, Tokro P, Bayram A, Savopoulou-Soultani M, Conti E, Eizaguirre M, Le Ru BP, Avand-Faghih A, Frérot B and Andreadis S (2011) Origin and taxonomic status of the 1244 Palearctic population of the stemborer *Sesamia nonagrioides* (Lefebvre) (Lepidoptera: 1245 Noctuidae). *Biological Journal of the Linnean Society* 103: 904–922. <https://doi.org/10.1111/j.1095-8312.2011.01666.x>
- Muirhead KA, Austin AD, Sallam M (2008) The systematics and biology of *Cotesia nonagriiae* (Olliff) stat rev (Hymenoptera: Braconidae: Microgastrinae), a newly recognized member of the *Cotesia flavipes* species complex. *Zootaxa* 1846: 35–46.
- Muirhead KA, Sallam N, Austin AD (2010) Life history traits and foraging behaviour of *Cotesia nonagriiae* (Olliff) (Hymenoptera: Braconidae), a newly recognized member of the *Cotesia flavipes* complex of stemborer parasitoids. *Australian Journal of Entomology* 49: 56–65. <https://doi.org/10.1111/j.1440-6055.2009.00737.x>
- Muirhead KA, Murphy NP, Sallam N, Donnellan SC, Austin AD (2012) Phylogenetics and genetic diversity of the *Cotesia flavipes* complex of parasitoid wasps (Hymenoptera: Braconidae), biological control agents of lepidopteran stemborers. *Molecular Phylogenetics and Evolution* 63: 904–914. <https://doi.org/10.1016/j.ympev.2012.03.003>
- Ngi-Song AJ, Overholt WA, Stouthamer R (1998) Suitability of *Busseola fusca* and *Sesamia calamistis* (Lepidoptera: Noctuidae) for the development of two populations of *Cotesia sesamiae* (Hymenoptera: Braconidae) in Kenya. *Biological Control* 12: 208–214. <https://doi.org/10.1006/bcon.1998.0628>
- Obonyo M, Schulthess F, Le Ru B, Van der Berg J, Silvain JF, Calatayud PA (2010) Importance of contact chemical cues in host recognition and acceptance by the braconid larval endoparasitoids *Cotesia sesamiae* and *Cotesia flavipes*. *Biological Control* 54: 270–275. <https://doi.org/10.1016/j.biocontrol.2010.05.015>

- Onyango FO, Ochieng-Odero JPR (1994) Continuous rearing of the maize stemborer *Busseola fusca* on an artificial diet. *Entomologia Experimentalis et Applicata* 73: 139–144. <https://doi.org/10.1111/j.1570-7458.1994.tb01848.x>
- Overholt WA, Ochieng JO, Lammers P, Ogedah K (1994) Rearing and field release methods for *Cotesia flavipes* Cameron (Hymenoptera: Braconidae), a parasitoid of tropical graminaceous stemborers. *Insect Science and its Applications* 15: 253–259. <https://doi.org/10.1017/s1742758400017549>
- Polaszek A, Walker AK (1991) The *Cotesia flavipes* species-complex: parasitoids of cereal stemborers in the tropics. *Redia* 74: 335–341.
- Potting RPJ, Overholt WA, Danso FO, Takasu K (1997) Foraging behaviour and life history of the stemborer parasitoid *Cotesia flavipes* (Hymenoptera: Braconidae). *Journal of Insect Behaviour* 10: 13–29. <https://doi.org/10.1007/BF02765472>
- Quicke DLJ (1997) *Parasitic Wasps*. Chapman & Hall, London, 470 pp.
- R Core Team (2016). R: A Language and Environment for Statistical Computing. R Found. Stat. Comput. Vienna Austria.
- Sallam MNS, Overholt WA, Keiru E (2002) Intraspecific and interspecific competition between *Cotesia flavipes* and *Cotesia sesamiae* (Hymenoptera: Braconidae), gregarious larvalendo parasitoids of lepidopteran stemborers. *Biocontrol Science and Technology* 12: 493–506. <https://doi.org/10.1080/09583150220146059>
- Sallam MNS (2006) A review of sugarcane stemborers and their natural enemies in Asia and Indian Ocean Islands: an Australian perspective. *Annales de la Société Entomologique de France* 42: 263–283. <https://doi.org/10.1080/00379271.2006.10697459>
- Shaw MR, Huddleston T (1991) Classification and Biology of Braconid Wasps (Hymenoptera: Braconidae). In: Dolling WR, Askew RR (Eds) *Handbooks for the Identification of British Insects*) Vol 7. Royal Entomological Society of London, London, 1–126.
- Simões RA, Feliciano JR, Solter LF, Delalibera I Jr (2012) Impacts of *Nosema* sp (Microsporidia: Nosematidae) on the sugarcane borer, *Diatraea saccharalis* (Lepidoptera: Crambidae). *Journal of Invertebrate Pathology* 129: 7–12. <https://doi.org/10.1016/j.jip.2015.05.006>
- Smilanich AM, Dyer LA, Chambers JQ, Bowers MD (2009) Immunological cost of chemical defence and the evolution of herbivore diet breadth. *Ecology Letters* 12: 612e621. <https://doi.org/10.1111/j.1461-0248.2009.01309.x>
- Turlings TC, Fritzsche ME (1999) Attraction of parasitic wasps by caterpillar-damaged plants. *Novartis Found Symp* 223: 21–32.
- Vogelweith F, Moreau J, Thiéry D, Moret Y (2015) Food-mediated modulation of immunity in a phytophagous insect: an effect of nutrition rather than parasitic contamination. *Journal of Insect Physiology* 77: 55e61.
- Whitfield JB (1997) Subfamily Microgastrinae. In: Wharton RA, Marsh PM, Sharkey MJ (Eds) *Manual of the New World genera of the family Braconidae (Hymenoptera): Special Publication No. 1*. International Society of Hymenopterists, Washington D.C., 333–364
- Xu H, Veyrat N, Degen T, Turlings TC (2014) Exceptional use of sex pheromones by parasitoids of the genus *cotesia*: males are strongly attracted to virgin females, but are no longer attracted to or even repelled by mated females. *Insects* 5: 499–512. <https://doi.org/10.3390/insects5030499>

Yassin A, Orgogozo V (2013) Coevolution between male and female genitalia in the *Drosophila melanogaster* species subgroup. PLoS One 8(2): e57158. <https://doi.org/10.1371/journal.pone.0057158>

Yu DSK, Van Achterberg C, Horstmann K (2016) Taxapad 2016, Ichneumonoidea 2015. Database on flash-drive. Nepean, Ontario, Canada. doi: <http://www.taxapad.com>

Appendix

Genebank accession numbers of CO1 sequences

Species	Genbank accession nbr	Sample name
<i>Cotesia chilonis</i>	KJ882549	P6679
	KJ882550	P6680
	KJ882551	P6681
<i>Cotesia flavipes</i>	KJ882544	P0433
	KJ882545	P0434
	KJ882546	P0435
	KJ882547	P2541
	KJ882548	P4706
<i>Cotesia sesamiae</i> Kitale	KJ882497	G4540
	KJ882501	G4594
	KJ882512	G4636
	KJ882527	G4701
	KJ882528	G4703
	KJ882529	G4708
	KJ882530	G4907
	KJ882532	G4915
	KJ882537	G5778
<i>Cotesia sesamiae</i> Mombasa	KJ882543	CsK
	KJ882495	G4511
	KJ882496	G4512
	KJ882500	G4572
	KJ882513	G4652
	KJ882533	G5699
	KJ882538	G7338
<i>Cotesia typhae</i>	KJ882541	Mhk
	KJ882502	G4608
	KJ882503	G4609
	KJ882507	G4614
	KJ882508	G4615
	KJ882510	G4618
	KJ882511	G4619
	KJ882514	G4655
KJ882515	G4656	

Species	Genbank accession nbr	Sample name
<i>Cotesia typhae</i>	KJ882516	G4664
	KJ882518	G4666
	KJ882519	G4667
	KJ882521	G4675
	KJ882522	G4676
	KJ882523	G4677
	KJ882531	G4909
	KJ882534	G5726
	KJ882535	G5773
	KJ882539	Mbita
	KJ882540	MbL
	KJ882542	Mkd



ELSEVIER

Contents lists available at ScienceDirect

MethodsX

journal homepage: www.elsevier.com/locate/mex

Method Article

Low-cost automatic temperature monitoring system with alerts for laboratory rearing units



François Rebaudo*, Romain Benoist

UMR 247-9191 EGCE, IRD, CNRS, Univ Paris Saclay, Gif-sur-Yvette, France

A B S T R A C T

Monitoring accurately temperature is a key issue in biological studies involving living experimental material. It is especially true for insects which body temperature is mostly controlled by environmental temperature, with profound consequences of a few degrees variation on most physiological processes such as survival, development, fecundity, and mobility. If programmable rearing units can be purchased, it remains important to monitor and store temperature information acquired inside the rearing unit to ensure that observed phenomena are not the result of unintended and not scarily noticeable changes in temperature, and to account for the effect of temperature variation in statistical analysis. As most laboratories involved in insect rearing dispose of a large number of rearing units, the technical solution should meet the monitoring needs while being affordable and adaptable to various experimental designs. For that purpose, we designed a low cost (below 100€) and open source automatic temperature monitoring system for rearing units in laboratory. Key features providing advantage over pre-existing methods include:

- Highly configurable temperature monitoring and life-time storage capacity
- Email alerts based on configurable user-defined threshold
- Automatic configurable reports in the form of dashboards

© 2019 The Author(s). Published by Elsevier B.V. This is an open access article under the CC BY license (<http://creativecommons.org/licenses/by/4.0/>).

A R T I C L E I N F O

Method name: Automatic system for monitoring temperature in laboratory insect rearing units

Keywords: Raspberry Pi, Temperature, Sensor, Insects

Article history: Received 23 May 2019; Accepted 11 September 2019; Available online 13 September 2019

* Corresponding author.

E-mail addresses: francois.rebaudo@ird.fr (F. Rebaudo), romain.benoist@egce.cnrs-gif.fr (R. Benoist).

<https://doi.org/10.1016/j.mex.2019.09.013>

2215-0161/© 2019 The Author(s). Published by Elsevier B.V. This is an open access article under the CC BY license (<http://creativecommons.org/licenses/by/4.0/>).

Specification Table

Subject Area:	Agricultural and Biological Sciences
More specific subject area:	Insect science (experiments and rearing units in laboratory)
Method name:	Automatic system for monitoring temperature in laboratory insect rearing units
Name and reference of original method:	Lewis AJ, Campbell M, Stavroulakis P (2016) Performance evaluation of a cheap, open source, digital environmental monitor based on the Raspberry Pi. <i>Measurement</i> 87:228–235. doi: 10.1016/j.measurement.2016.03.023
Resource availability:	Hardware: Raspberry Pi 3 model B+ MicroSD card 8 Go (16 Go recommended) DS18B20 temperature sensors Electric cables, tin and soldering iron Software: Linux, Python, R

Method details

Monitoring and recording temperature in rearing units

When designing a scientific experiment under controlled conditions, it is not only necessary to ensure that environmental conditions are actually controlled, but it is also needed to record these environmental conditions so that potential environmental conditions variation can be included in the analysis. In insects, temperature is the key driver of most physiological processes such as temperature-dependent development, which drives the timing of the insect phenological stages [1]. Furthermore, some insect species are very sensitive to variations in temperature, or to fluctuating temperature regimes [3]. Hence, there are many examples on why it is important to monitor and record temperature for experiments in rearing units with insects. If insects of the same population are kept in two different rearing units at the same constant temperature, it is required to be able to separate the effect of intraspecific variability of development in response to temperature [2], from the effect of unintended variations in temperature. If populations are to collapse it is required to quickly identify potential causes and put aside environmentally controlled factors such as temperature. Such monitoring can also be of importance in evaluating the impact of insect manipulation on temperature when opening and closing the rearing unit doors, or to test for the homogeneity of temperature inside the rearing unit. In mentioned examples, the temperature information needs i) to be monitored inside the temperature rearing unit and easily positioned at different places; ii) to be recorded at configurable time steps and stored over the duration of the experiment and beyond.

In case of failure of a rearing unit, it is convenient to dispose of the complete historical data on temperature inside the rearing unit to and an alarm is also needed. Indeed, it can be required to act quickly so as to maintain the biological material, especially in the case of the conservation of an endangered species or a strain. Furthermore, the system should be independent from the rearing unit electrical circuit to avoid a general blackout if the failure is associated with an electric malfunction.

In this article we present the automatic temperature monitoring system that we developed for rearing unit, based on a published temperature monitoring system [4]. This system provides an alarm system and a dashboard html report that allow visualizing the temperature inside rearing units.

Building and deploying the temperature monitoring system

Hardware

The hardware used to collect and analyze the temperature information is a Raspberry Pi 3 model B+ with a 16 Go micro SD card. The Raspberry Pi is a low-cost computer of the size of a credit card (approximately 40€, SD card included). The main advantage is that it operates using Linux, which is a common operating system to the scientific community. The official supported operating system (OS) is

Raspbian which can be installed on a micro SD card from the Raspberry Pi foundation (<https://www.raspberrypi.org/>; using another computer than the Raspberry Pi). Once the OS is installed on micro SD card, the Raspberry Pi can be started. The system should be updated from the terminal using:

```
sudo apt-get update
sudo apt-get upgrade
```

In the configuration menu (sudo raspi-config), from "Interfaces", SSH and 1-wire should be enabled. In "Localization", the time zone and Wi-Fi country (if required) should be updated to correspond to the computer localization. It is also advised to change the default password and reboot the computer so that changes can take effect. Setting a fix IP address is also advised to easily communicate with the computer from SSH protocol (an SSH connection allows to control the Raspberry Pi from any other computer so that it is no longer necessary to have a screen, mouse and keyboard plugged in to the Raspberry Pi). Depending on the network configuration, setting a fix IP address may require the intervention of the IT services. For convenience it is assumed in this article that the fix IP address of the Raspberry Pi is "192.168.0.30". The Raspberry Pi need to be connected to Internet either through the Ethernet port or through Wi-Fi.

For the temperature monitoring, DS18B20 sensors (Maxim Integrated Products, Inc) are used. DS18B20 sensors are digital thermometers (slaves) that communicate with a central microprocessor (master: the Raspberry Pi) over a 1-Wire bus. Each DS18B20 has a unique 64-bit serial code which is practical to connect multiple sensors on the same 1-Wire bus. Temperature measurements range from $-55\text{ }^{\circ}\text{C}$ to $+125\text{ }^{\circ}\text{C}$ with a $\pm 0.5\text{ }^{\circ}\text{C}$ accuracy over a temperature range from $-10\text{ }^{\circ}\text{C}$ to $+85\text{ }^{\circ}\text{C}$. A complete description can be found on the manufacturer web site (<https://www.maximintegrated.com>).

The sensors can be connected in parallel to the Raspberry Pi using the GPIO4, Ground, and 3V3 power pins, with a 4.7 k ohm resistor between the GPIO4 and the 3V3 power (see Fig. 1). DS18B20 sensors can be connected using jumper wires, but it is advised to solder the sensors to wires for long term usage.

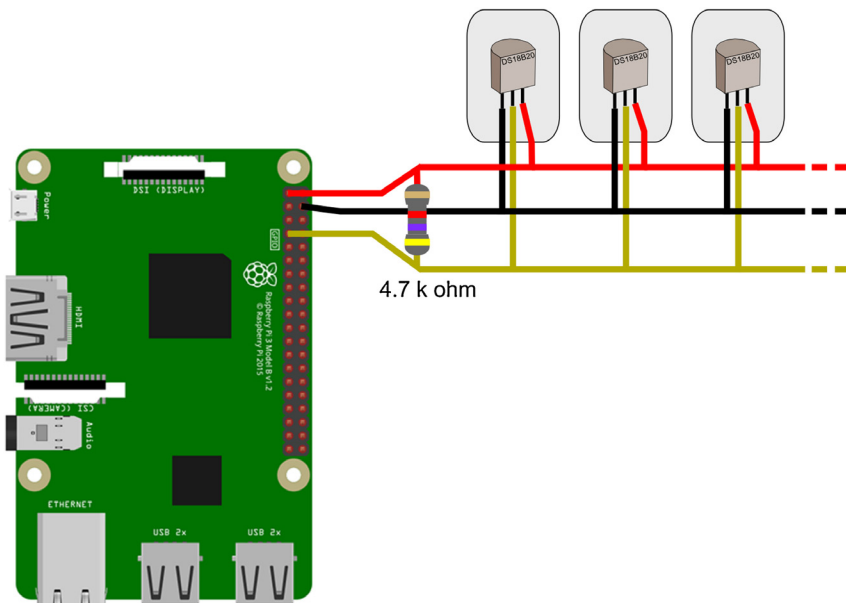

Fig. 1. Schematic representation of the circuit. The Raspberry Pi is connected to Internet using the Ethernet port (note that Raspberry Pi 3 model B+ has a Wi-Fi card).

Software

An overall schematic representation of the monitoring system can be found in Fig. 2.

Reading temperature from the DS18B20 sensors and store information into CSV files. All the procedures to read the temperature and store the information into a CSV file uses Python 3.5.3. The complete script can be found in Supplementary material S1 ("envColTemp_XX.py"). A CSV file is created with the headers corresponding to the data to be stored ("year", "month", "day", "hour", "minute", "second", "sensorId", "temperature"; with sensorId corresponding to the DS18B20 64-bit serial code), and named after the date of initialization.

Temperature reading is contained in the "/sys/bus/w1/devices/" directory of the Raspberry Pi, under directories starting with "28-00". The Python script used to retrieve the temperature information was obtained and adapted from a StackOverflow post by "joan" under a CC-BY-SA license (<https://raspberrypi.stackexchange.com/>).

```
for sensor in glob.glob("/sys/bus/w1/devices/28-
00*/w1_slave"):
    id = sensor.split("/") [5]
    try:
        f = open(sensor, "r")
        data = f.read()
        f.close()
        if "YES" in data:
            (discard, sep, reading) = data.partition(' t=')
            ds18b20t = float(reading) / 1000.0
        else:
            ds18b20t = 9999
    except:
        pass
```

In this article temperature is measured every minute using "time.localtime() [5] == 0" (line 54 in Supplementary material S1). To reduce the number of writing operations on the micro SD card, the temperature information is stored in the RAM with a default number of reading of 40 that can be changed using "RAMReadNumber" variable (line 21). After 40 reads, the data is transferred to the csv file. To reduce the management of large files by the Raspberry Pi, a new file is created once the current file exceeds 10 Mo, configurable with the variable "fileMaxSizeMo" (line 22).

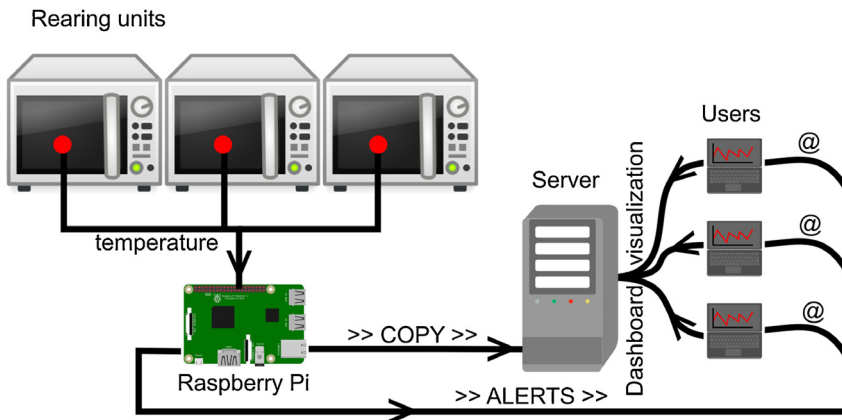

Fig. 2. Schematic representation of the monitoring system.

Once uploaded into the Raspberry Pi (here in the "Documents" directory), from the command line interface of the Raspberry Pi (e.g., through an SSH connection), a bash file can be created to launch automatically the script at each computer startup using a CRON job. This is particularly important in case of power failure or when installing the monitoring system: the monitoring will start automatically and power failure can also be monitored. A separate bash script is used to launch the monitoring system automatically (Supplementary material S2, "launcher.sh"), as it allows to maintain different versions of the Python script without having to change the CRON job.

```
nano launcher.sh # create and edit bash file
chmod 755 launcher.sh
```

A directory "logs" was created under the "Documents" directory for the logs files. CRON job was created using "sudo crontab -e":

```
@reboot sh /home/pi/Documents/launcher.sh >/home/pi/Documents/logs/launcher_log 2 > &1
```

Configuring an alert system with emailing. A simple alert system triggered by a temperature over or below a threshold cannot be used in the case of a rearing unit because variations of temperatures that would trigger the alert are expected when opening the rearing unit for insect manipulation. Thus a more configurable threshold has been developed in which the alert is triggered in case the average temperature over a period of time reach the threshold. A different minimum and maximum threshold can be used for each sensor, like in the case presented here.

A Python script was used and uploaded into the directory "Documents" to be able to send emails automatically with a content defined by arguments passing through the script execution. The Python script can be found in Supplementary material S3 ("emailSender_XX.py").

Then, an R script [5] was made and uploaded into the directory "Documents" to configure the threshold (Supplementary material S4, "envCheckTemp_XX.R"). In this article the monitoring system had 8 DS18B20 sensors connected to the Raspberry Pi. Maximum temperature thresholds for the 8 sensors are stored in the variable "paramMaxTemp" and minimum thresholds in the variable "paramMinTemp". The average temperature for triggering alerts was set to 60 min with the variable "paramDuration". All CSV files are merged into a data frame R object, and sensors renamed from the manufacturer 64-bit serial code to a more human readable name (each sensor can be identifiable by sequentially holding them while recording temperature). If the average temperature over the defined period of time reach a threshold, then the python script is launched from R with arguments corresponding to the average temperature and the name of the sensor. In order to use the script, R must be installed in the Raspberry Pi:

```
sudo apt-get install r-base
```

In order to monitor automatically the temperature and check for potential anomalies, a bash script was used and launched automatically every hour using a CRON job (Supplementary material S5, "checker.sh").

```
nano checker.sh # create and edit bash file
chmod 755 checker.sh
```

CRON job was created using "sudo crontab -e":

```
*** sh /home/pi/Documents/checker.sh >/home/pi/Documents/logs/checker_log 2 > &1
```

The CRON job first five fields correspond to date and time, followed by the command. The date and time fields correspond to minute (0–59), hour (0–23), day of the month (0–31), month (0–12), and day of the week (0–7), respectively. The star symbol "*" represents all available values. Here "0 * * * * *" means that the command will be executed every time the minutes reach 0 (i.e., every hour). The complete documentation on CRON jobs can be found from any Linux terminal using "man crontab".

Additional security measures (optional). A file backup system was used to ensure CSV files security. The backup is triggered from a server and not from the Raspberry Pi using a CRON job every day at 7.00 a.m.:

```
7 * * * python3 /xxx/copyToCommun.py >/xxx/copyFromCommun_log 2 > &1
```

The backup system consists in a Python script (Supplementary material S6, "copyToCommun.py") which lists the files in the Raspberry Pi and locally in the server. If new files or files with a bigger size

are found in the Raspberry Pi, they are automatically copied to the server. It can also be triggered manually from the server at any moment. Using a server to store copies of the Raspberry Pi is useful to ensure long term storage, but also in the case of analyses that require a large amount of RAM or other computer resources not available from the Raspberry Pi.

Dashboard (optional). If the information about the temperature monitoring needs to be revised by several people with graphical visualizations, working with copies of the original files on a server rather than the Raspberry Pi itself is advised (see section 2.3.). In the case presented here, a dashboard in html is created every day at 7.30 a.m. in a server using R [5], with the packages "flexdashboard" [6] and "ggplot2" [7] (Fig. 3). The complete script to build the dashboard and to compile it into html can be found in Supplementary material S7 and S8 ("dashboard_MONTH.Rmd", "renderRMDtoHTML.R").

```
7 * * * Rscript /xxx/renderRMDtoHTML.R >/xxx/dashboard_log 2 > &1
```

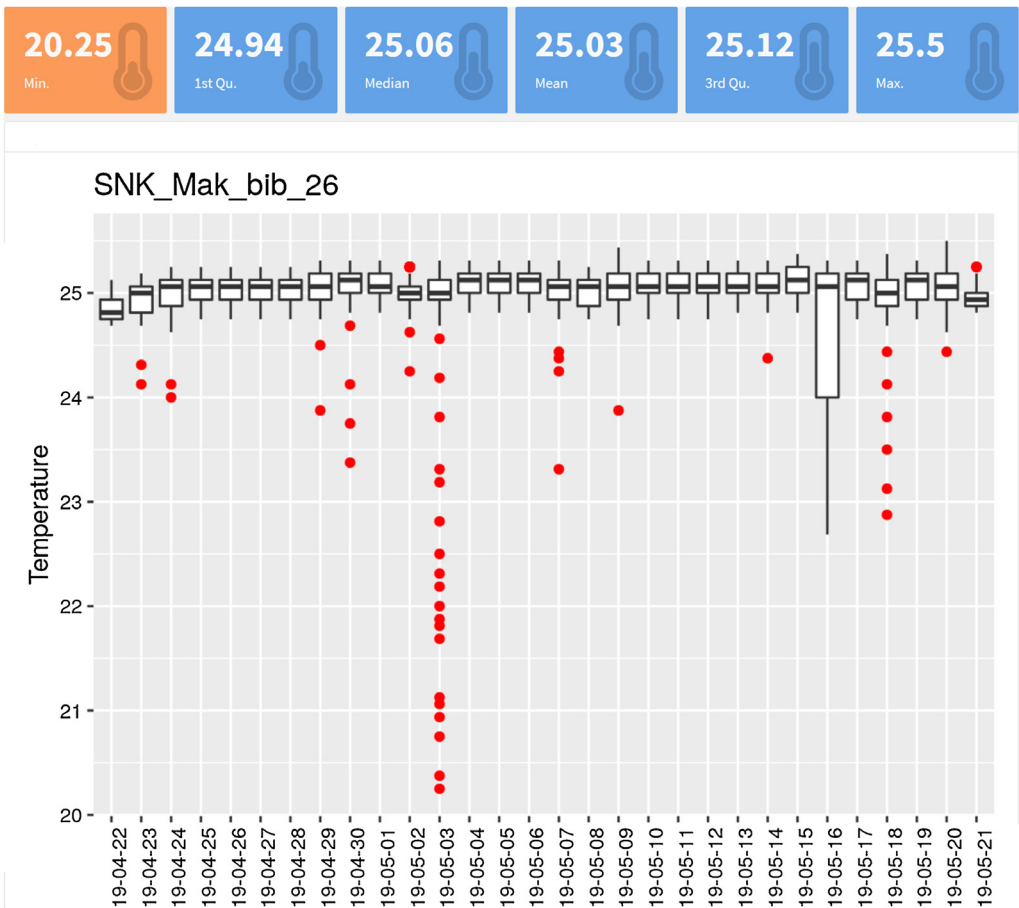

Fig. 3. Example of a simple dashboard for one rearing unit (named "SNK_Mak_bib_26" and set to 25°C) to visualize temperature within the rearing units for the last month. Daily temperatures (yy-mm-dd) are represented as boxplots and red dots represent outliers (they correspond to the times when the door of the rearing unit was opened; the door was opened multiples times on May 3rd and for a long time on May 16th). The dashboard is in HTML format so that it can be accessed from any Internet navigator by any operator with no prior experience in programming, and hosted in a local or distant server.

Conclusion

This method article presents a simple yet powerful system for temperature monitoring at low cost and highly configurable particularly suitable for experiments in laboratory with insect rearing units. It is based on a Raspberry Pi computer and DS18B20 temperature sensors. With eight temperature sensors, the Raspberry Pi, the micro SD card, the power supply, and the wires, the overall cost is below 100€ which makes the system affordable and easy to deploy even in laboratories with a large number of rearing units. Automatic reports and email alerts can easily be configured to ensure full control over your experiments together with long term storage of temperature data, and easy access to the information without programming skills. All the files can be found in GitHub (https://github.com/frareb/raspi_tempMonitor).

Acknowledgements

Thanks to all EGCE laboratory members who have participated during the implementation of this method. R. Benoist is funded by the “école doctorale 227 MNHN-UPMC Sciences de la Nature et de l’Homme: évolution et écologie”. Thanks to Laure Kaiser for the picture in the graphical abstract.

Appendix A. Supplementary data

Supplementary material related to this article can be found, in the online version, at doi:<https://doi.org/10.1016/j.mex.2019.09.013>.

References

- [1] F. Rebaudo, V.-B. Rabhi, Modeling temperature-dependent development rate and phenology in insects: review of major developments, challenges, and future directions, *Entomologia Experimentalis et Applicata* 166 (2018) 607–617, doi:<http://dx.doi.org/10.1111/eea.12693>.
- [2] R. Lamb, Developmental rate of *Acyrtosiphon pisum* (Homoptera: Aphididae) at low temperatures: implications for estimating rate parameters for insects, *Environ. Entomol.* 21 (1992) 10–19, doi:<http://dx.doi.org/10.1093/ee/21.1.10>.
- [3] H. Colinet, B.J. Sinclair, P. Vernon, D. Renault, Insects in fluctuating thermal environments, *Annu. Rev. Entomol.* 60 (2015) 123–140, doi:<http://dx.doi.org/10.1146/annurev-ento-010814-021017>.
- [4] A.J. Lewis, M. Campbell, P. Stavroulakis, Performance evaluation of a cheap, open source, digital environmental monitor based on the Raspberry Pi, *Measurement* 87 (2016) 228–235, doi:<http://dx.doi.org/10.1016/j.measurement.2016.03.023>.
- [5] R Core Team, R: A Language and Environment for Statistical Computing, R Foundation for Statistical Computing, Vienna, Austria, 2018. <http://www.R-project.org>.
- [6] R. Iannone, J.J. Allaire, B. Borges, Flexdashboard: R Markdown Format for Flexible Dashboards, (2018) . <https://CRAN.R-project.org/package=flexdashboard>.
- [7] H. Wickham, ggplot2: Elegant Graphics for Data Analysis, Springer-Verlag, New York, 2016. <http://ggplot2.org>.

Bases comportementales, physiologiques et génétiques du succès reproducteur d'un hyménoptère parasitoïde

Résumé :

Etudier l'aptitude d'insectes parasitoïdes à se reproduire dans de nouveaux hôtes est important pour comprendre les mécanismes d'adaptation dans un contexte de lutte biologique. *Cotesia typhae* est un parasitoïde africain spécialisé sur le lépidoptère *Sesamia nonagrioides* et est un agent de lutte biologique potentiel contre ce ravageur du maïs. *C. typhae* appartient à un groupe d'espèces possédant un virus endosymbiotique injecté dans l'hôte lors de la ponte et contribuant à la virulence du parasitoïde. J'ai pu montrer que deux souches de *C. typhae* diffèrent par leur nombre de descendants et par leur virulence envers une population française de *S. nonagrioides*, représentant un nouvel hôte. Afin d'identifier les gènes responsables de ces variations une recherche de QTL a été entreprise (Quantitative Trait Loci). Nous avons établi une carte génétique de *C. typhae*, identifié quatre QTL et dressé une liste de gènes candidats. Pour expliquer la différence de virulence et du nombre de descendants, les quantités d'œufs et de virus injectés au cours de pontes successives ont été estimées. Ces expériences ont montré 1/ que les deux souches ne répartissent pas leurs œufs de la même manière entre les hôtes, 2/ que la quantité de virus injectés n'est pas corrélée à la virulence. Pour comprendre l'origine évolutive de la différence de virulence, ce trait a été estimé sur les populations hôtes naturelles. Les résultats suggèrent que l'adaptation locale pourrait être à l'origine de la pré-adaptation d'une des souches à l'hôte français. Ce travail a permis également de bien caractériser le succès reproducteur de *C. typhae*, essentiel pour son utilisation en lutte biologique.

Mots clés : Parasitoïde ; succès reproducteur ; virulence ; bracovirus ; QTL ; lutte biologique

Behavioural, physiological and genetic basis of the reproductive success of a hymenopteran parasitoid

Abstract :

Studying the ability of insect parasitoids to reproduce in novel hosts is important to understand adaptive mechanisms at play when they are used for biological control. *Cotesia typhae* is an African parasitoid specialized on the Lepidoptera *Sesamia nonagrioides* and it is a potential biological control agent against this maize pest. *C. typhae* belongs to a group of species harboring a symbiotic virus which is injected in the host during oviposition and which contributes to the parasitoid virulence. I have found out that two strains of *C. typhae* differed in their offspring number and in their virulence against a French population of *S. nonagrioides*, which represents a new host. A QTL analysis (Quantitative Trait Loci) has been done to identify genes involved in these variations. We have built a genetic map of *C. typhae*, identified four QTL and listed candidate genes. To explain the difference of virulence and offspring number, numbers of eggs and viral particles injected during successive ovipositions have been estimated. These experiments have shown that 1/ the two strains have different patterns of egg allocation among the successive hosts parasitized, 2/ the quantity of injected viral particles is not correlated to virulence. To understand to evolutionary origin of the virulence variation, this trait has been estimated for the natural host populations. The results suggest that local adaptation could explain the better pre-adaptation of one *C. typhae* strain to the French host population. This work also allowed an in-depth characterization of the parasitoid reproductive success, essential for its use in biological control.

Keywords: Parasitoid; reproductive success; virulence; bracovirus; QTL; biological control