



HAL
open science

Model-Based Engineering of Critical Large Scale Socio-Technical Systems: Contributions and Future Directions

Célia Martinie

► **To cite this version:**

Célia Martinie. Model-Based Engineering of Critical Large Scale Socio-Technical Systems: Contributions and Future Directions. Human-Computer Interaction [cs.HC]. Université Paul Sabatier (Toulouse 3), 2020. tel-02930976

HAL Id: tel-02930976

<https://hal.science/tel-02930976v1>

Submitted on 4 Sep 2020

HAL is a multi-disciplinary open access archive for the deposit and dissemination of scientific research documents, whether they are published or not. The documents may come from teaching and research institutions in France or abroad, or from public or private research centers.

L'archive ouverte pluridisciplinaire **HAL**, est destinée au dépôt et à la diffusion de documents scientifiques de niveau recherche, publiés ou non, émanant des établissements d'enseignement et de recherche français ou étrangers, des laboratoires publics ou privés.



HABILITATION A DIRIGER DES RECHERCHES

Délivré par *l'Université Toulouse 3 – Paul Sabatier*
Discipline ou spécialité : *Informatique*

Présentée et soutenue publiquement par *Célia Martinie*
Le 1er juillet 2020

Titre :
Model-Based Engineering of Critical Large Scale Socio-Technical Systems:
Contributions and Future Directions

JURY

Caroline Appert, Senior Research Scientist, CNRS-LRI (reviewer)
Carl Gutwin, Professor, University of Saskatchewan, Canada
Philippe Palanque, Professor, Université Paul Sabatier Toulouse III, France
Albrecht Schmidt, Professor, Ludwig Maximilian Universität, München, Germany
Neville Stanton, Professor, University of Southampton, U.K. (reviewer)
Jean Vanderdonckt, Professor, Université Catholique de Louvain, Belgium (reviewer)

Ecole doctorale: *Mathématiques Informatique et Télécommunications de Toulouse (MITT)*

Unité de recherche: *IRIT – UMR 5505*

Parrain de recherche: *Philippe Palanque*

Rapporteurs: *Caroline Appert, Neville Stanton, Jean Vanderdonckt*

Foreword

In France, the habilitation degree is a national degree that confers the formal accreditation to supervise research. The applicant to this degree must demonstrate: an original research path in a scientific domain, the capabilities to manage autonomously a research strategy as well as the ability to supervise PhD students.

In particular, the presented document is expected to be different from a report on scientific activities and has to present original and personal research work. The presented document shall clearly show a reflection on the candidate's scientific progress, its coherence, as well as the autonomous research strategy of the applicant, the capacity of the applicant for synthesis in a scientific field, and the competence of the applicant for the supervision of young researchers. The document shall include a scientific perspective. At last, the document should be completed with publications. The co-publications with doctoral students have to be clearly highlighted.

Acknowledgements

First of all, I thank all the jury members. I am very grateful and honoured to have had the opportunity to present and discuss my work with researchers whose work and contributions have inspired and inspire me. I thank my reviewers, Caroline Appert, Neville Stanton and Jean Vanderdonckt, for their encouraging feedback and insightful comments. I also thank Carl Gutwin and Albrecht Schmidt for having accepted to evaluate my work. Thanks to all of you for sharing your point of view on my research work and for your fascinating questions.

Special thanks to Philippe Palanque who supported my application to the HDR, as well as facilitated its organization. His vision on scientific research, his commitment when leading research activities and the continuous energy that he devotes to build fruitful and sustainable research collaborations makes him a role model for me.

Thanks to the ICS team current and former members (Eric Barboni, David Navarre, Marco Winckler), to the PhD and post-doc students that I have co-supervised (Camille Fayollas, Martina Ragosta, Racim Fahssi, José-Luis Silva) and to the PhD students that I co-supervise (Elodie Bouzekri, Alexandre Canny). Thanks to the master students that I have supervised.

The work presented in this document is the result of several collaborations. I had the opportunity to work with multiple academic and industrial partners (highlighted throughout the document) and I greatly appreciated to work with all of them.

At last, I thank my sister and my parents for their continued support and I thank Adam, Cléopée and Miguel for having allowed me to spend long evenings and weekends working in my home office.

Table of Content

Foreword	3
Acknowledgements	4
Table of Content.....	5
Introduction	8
1. A research strategy for supporting the design and development of critical LSSTS	11
2. Models as a mean to reach our research objectives.....	13
3. Supervision of doctoral students.....	14
4. Presentation of the structure of the document.....	15
Chapter 1 Human, operators and their tasks	17
1. Position statement and list of identified important problems	17
2. Contributions to the identified problems	18
2.1. Increase the expressiveness of task modelling notations.....	18
2.2. Provide support for the customization of a task modelling notation	19
2.3. Provide support for the description and recording of large sets of tasks.....	20
2.4. Provide support for the representation of possible human errors.....	20
2.5. Improve usability of task modelling tools	20
2.6. Provide support for the integration of UX and usability user evaluation results in task models21	
3. Related PhD supervisions and collaborations	21
4. Case studies	24
Chapter 2 Computing systems, command and control systems and interactive systems.....	27
1. Position statement and list of identified important problems	27
2. Contributions to the identified problems	28
2.1. Increase the expressiveness of the ICO notation for describing User Interfaces	28
2.2. Provide support for evaluation of user performance with interactive systems	29
2.3. Provide support for analysing requirements coverage for several design options	30
2.4. Improve usability of system modelling tools.....	31
2.5. Provide support for engineering interactive aircraft cockpits	32
3. Related PhD supervisions and collaborations	35
4. Case studies	37
Chapter 3 Automation.....	39
1. Position statement and list of identified important problems	39
2. Contributions to the identified problems	40
2.1. Provide support to the analysis and design of allocation of task/function and of interactive applications embedding automation	40

2.2.	Provide support for the analysis and design of automation in interaction techniques....	41
2.3.	Provide support to the analysis of allocation of Functions, Authority and Responsibility	43
3.	Related PhD supervisions and collaborations	44
4.	Case studies	46
Chapter 4	Training and operational procedures	47
1.	Position statement and list of identified important problems	47
2.	Contributions to the identified problems	48
2.1.	Provide support for checking the conformance and consistency between user tasks, system behaviour and training program	48
2.2.	Provide support for systematic development of training programs that deal with specific user actions	49
2.3.	Provide support to ensure consistency between artefacts produced during the development of the system and artefacts produced during the development of the training program	50
3.	Related PhD supervisions and collaborations	51
4.	Case studies	51
Chapter 5	Standards and development processes.....	55
1.	Position statement and list of identified important problems	55
2.	Contributions to the identified problems	56
2.1.	Provide support for systematic identification of human errors and for taking into account both human errors and system failures at design time	56
2.2.	Provide support for the systematic integration of the design and development of critical interactive systems with their associated training program.....	58
2.3.	Provide support for the design and development of complex command and control applications	59
2.4.	Provide support for the re-design of partly autonomous interactive systems in critical LSSTS	60
3.	Related PhD supervisions and collaborations	61
4.	Case studies	63
Chapter 6	Synergies between the models of the views on critical LSSTS.....	66
1.	Position statement and list of identified important problems	66
2.	Contributions to the identified problems	67
2.1.	Provide support for ensuring that user goals can be reached with an interactive system	67
2.2.	Provide support for the analysis of the impact of operators' actions and of interactive systems' states on the whole critical LSSTS	70
2.3.	Provide support for automation of usability testing	72
2.4.	Provide support for training and for contextual help at runtime	72
3.	Related PhD supervisions and collaborations	73

4. Case studies	75
Chapter 7 Research directions.....	78
1. Selected perspectives for each view on the design and development of critical LSSTS	78
1.1 Human, operators and their tasks.....	78
1.2 Computing systems, command and control systems and interactive systems.....	79
1.3 Automation.....	80
1.4 Training and operational procedures.....	80
1.5 Standards and development processes	81
1.6 Synergies between the models of the views on critical LSSTS	81
2. Synthesis of the perspectives for the views on critical LSSTS	82
3. Long-term research perspectives	83
References	86
Abstract	107
Annex A – Co-supervised PhD students and post-doctoral students	108
Annex B - Projects	109
Annex C – Curriculum Vitae.....	110

Introduction

The discipline of Human Computer Interaction (HCI) has reached a certain level of maturity with an important portfolio of conferences and an increasing number of laboratories and research teams around the world working on that domain. As an example, one of the most important association of professionals who work in the research and practice of human computer interaction, the ACM SIGCHI, sponsors and co-sponsors over 20 different specialized conferences annually¹. In the industrial sector, growth took longer to start but is now increasing sharply, as shown by the large number of job offers in the field that are explicitly tagged with the keywords “UI” (for User Interface) and “UX” (for User eXperience). In this discipline, most of the contributions are based on the paradigm of User Centred Design (UCD) (Norman & Drapper, User Centred System Design, 1986) arguing that design and development should involve users. The techniques, methods, processes and tools for applying the paradigm of UCD aim to know and to understand the users (analysing their needs, evaluating their ways of using the systems) in order to design and to develop systems that are in line with their behaviours, skills and needs. The main target properties for these systems are the usability property and the user experience (UX) property. Both have been standardized in the ISO standard 9241 part 11. Usability is defined as “*the extent to which a system, product or service can be used by specified users to achieve specified goals with effectiveness, efficiency and satisfaction*” (ISO 9241 part 11, 2018). And user experience is defined as “*user’s perceptions and responses that result from the use and/or anticipated use of a system, product or service*” (ISO 9241 part 11, 2018). “Efficiency” is by far the one that has received and continues to receive the most attention. This is probably due to the fact that it is a factor that is measurable and from which a financial gain can be made as described in detail in the process of return on investment of usability in (Bias & Mayhew, 2005). “Effectiveness” is less considered because innovative consumer interactive systems are often limited to a small and relatively simple number of user tasks (entering a text message, resizing a photograph, changing TV channels...). “Satisfaction” can be seen as a consequence of UX (Hassenzahl, Platz, Burmester, & Lehner, 2000), which receives a lot of attention as systems that generates positive UX are purchased more often (Desmet, Hekkert, & Jacobs, 2000).

Our work targets the application domains of large scale critical interactive systems, such as air traffic management systems, aircrafts cockpits and ground segment applications for managing spacecraft missions (illustrated in Figure 1). Such systems are said critical because a failure of one of their part or function can endanger human life or damage the system and its environment (Palanque & Bastide, 1994) (Sommerville, 2011).



Figure 1. Examples of Interactive Critical Systems

¹ <https://sigchi.org/conferences/conference-history/>

Users, named operators, interact with command and control systems in order to perform multiple usually complex tasks to accomplish their missions. Both “effectiveness” and “efficiency” factors are important because the command and control systems have to enable the operators to perform all of their tasks in an efficient way. As an example, Figure 2 shows an excerpt of the certification specification and acceptable means of compliance for large aeroplanes CS 25 (Amendment 19) (CS 25 EASA, 2017). In this excerpt, it is explicitly stated in the first paragraph that “... *installed equipment must be shown... to be designed so that qualified flight-crew members trained in its use can safely perform their tasks associated with its intended function...*” (related to the effectiveness factor), and in the paragraph (2) that the “*controls and information ... must be accessible and usable by the flight crew in a manner consistent with the urgency, frequency, and duration of their task...*” (related to the efficiency factor).

<p>CS 25.1302 Installed systems and equipment for use by the flight crew (See AMC 25.1302)</p> <p>This paragraph applies to installed equipment intended for flight-crew members' use in the operation of the aeroplane from their normally seated positions on the flight deck. This installed equipment must be shown, individually and in combination with other such equipment, to be designed so that qualified flight-crew members trained in its use can safely perform their tasks associated with its intended function by meeting the following requirements:</p> <p>(a) Flight deck controls must be installed to allow accomplishment of these tasks and information necessary to accomplish these tasks must be provided.</p>	<p>(b) Flight deck controls and information intended for flight crew use must:</p> <p>(1) Be presented in a clear and unambiguous form, at resolution and precision appropriate to the task.</p> <p>(2) Be accessible and usable by the flight crew in a manner consistent with the urgency, frequency, and duration of their tasks, and</p> <p>(3) Enable flight crew awareness, if awareness is required for safe operation, of the effects on the aeroplane or systems resulting from flight crew actions.</p>
---	---

Figure 2. Excerpt from section 1302 of Certification Specification 25 (CS 25 EASA, 2017)

It is important that the operators are able to perform all of their tasks in an effective and efficient way as an error caused by a usability issue may have catastrophic consequences. Then, in addition to recommendations and regulations for the design of command and control applications of critical systems, as for usability, there are recommendations and regulations for the training and qualification of the operators of these systems. For example, the regulation EU 2015/340 (EU 2015/340, 2015) defines the required capabilities and training for the Air Traffic Controllers (ATC). This document encompasses a set of requirements about the training program (for example it specifies a list of basic training performance objectives such as “(k) *detecting potential conflicts between aircraft*” at page L63/31) and about the physical, physiological and mental conditions to get licensed as an ATC (for example it specifies that an ATC should not have a “*symptomatic abnormality of any of the heart valves*” at page L63/113). Dealing with training development and implementation is specific to critical systems and goes beyond the standard usability, as it requires to take into account the “learnability” of the system. Standard usability does not cover learnability of the system to be used, whereas first definitions of usability, such as Nielsen’s one were covering learnability (Nielsen, 1994).

The systems being operated and monitored also have to fulfil properties that aim to avoid that a failure of one of them has catastrophic consequences. One of the main target property is Safety, that is defined as the “*absence of catastrophic consequences on the user(s) and the environment*” (Avizienis, Laprie, Randell, & Landwehr, 2004). Additional properties are also required to be fulfilled by these systems: availability (readiness for correct service), reliability (continuity of correct service), integrity (absence of improper system alterations) and maintainability (ability to undergo modifications and repairs). These properties are gathered under the concept of Dependability: “*the dependability of a system is the ability to avoid service failures that are more frequent and more severe than is acceptable*” (Avizienis, Laprie, Randell, & Landwehr, 2004). Standards and recommendations aim to ensure that an appropriate severity

level (which characterises the consequences of a failure) (Avizienis, Laprie, Randell, & Landwehr, 2004) has been assigned to each component of the system and that, for each component, the development process and the means to apply it are appropriate for this severity level. An example is the “*Software considerations in airborne systems and equipment certification*” (RTCA, 2011) applied in the domain of civil aeronautics for the dependability of the software.

In order to take in to account these properties, the design and development of such systems requires to apply specific techniques, methods, processes and tools (e.g. user centred design, software design, training program development...), each of them explicitly targeting one or several properties (e.g. usability and UX for UCD, dependability for the system and software design, safety of the operations...). However, the design and development of critical interactive systems needs to explicitly take into account all of these properties in an even way (Palanque, et al., 2007). Taking into account those properties requires to understand the potential conflicts between them and to make informed design decisions. For example, to require the operator to input twice the same value for a parameter (to ensure dependability of the input) degrades the efficiency of the operator, and thus degrades usability. In a context where the operator has to input several times the value under a time constraint, the consequences of an operator not being efficient because of too numerous required interactions may also lead to catastrophic consequences and has thus also an impact on safety.

Existing techniques, methods, processes and tools provide support for explicitly taking into account one or several properties for the design and development of one aspect of the critical interactive system. For example, the software design and development is handled by stakeholders who focus on the system, the operators’ tasks are handled by stakeholders who focus on the humans operating the system and the organisation processes are handled by stakeholders who focus on the organisation in which the operators will use the systems. Existing techniques, methods, processes and tools do not provide support for explicitly taking into account all of the properties in an even way along while dealing with technological, human and organisational aspects. In the human factors discipline, the need for having a global perspective on technical, human and organisational aspects for system design has been raised several decades ago and approaches dealing with all of these aspects have been proposed. They are named socio-technical approaches (Hollnagel E. , 1997) (Baxter & Sommerville, 2011) (Boy, 2013). Figure 3 a) presents the socio-technical view on work proposed by (Hollnagel E. , 1997) and Figure 3 b) presents the Technology Organization People (TOP) model proposed by (Boy, 2013) to argue for the integration of human-centred design with system design.

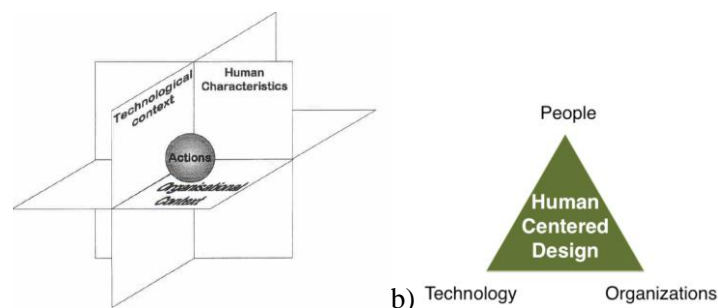

Figure 3. a) Socio-technical view on work (Hollnagel, 1997) b) the TOP model (Boy, 2013)

A Socio-Technical Systems (STS) is defined as a group of entities made of the following three types: system/technology (usually computer-based), human (usually a trained operator with validated qualification for operating the system) and organisation (such a regulatory or hierarchical entities providing high-level rules for the Socio-Technical System) (Emery & Trist, 1960). Socio-technical approaches to the design and development of computing systems explicitly aim to understand and

analyse a whole existing socio-technical system through different high-level perspectives, e.g. Cognitive Work Analysis (Vicente, 1999). Some of these approaches may be suitable to contribute to input design recommendations (Bisantz, et al., 2002), but they provide limited support to system and software engineering (Baxter & Sommerville, 2011).

1. A research strategy for supporting the design and development of critical LSSTS
Our work targets to support the design and development of critical Large Scale Socio-Technical Systems, which we name critical LSSTS. This term encompasses large scale critical interactive systems and their deployment within an organisational context for safe operations. The design and development of critical LSSTS requires to take into account several aspects, that we call views (represented in Figure 4), and that are the refinements of the human, technological, and organisational concepts identified by the socio-technical approaches presented in the previous subsection.

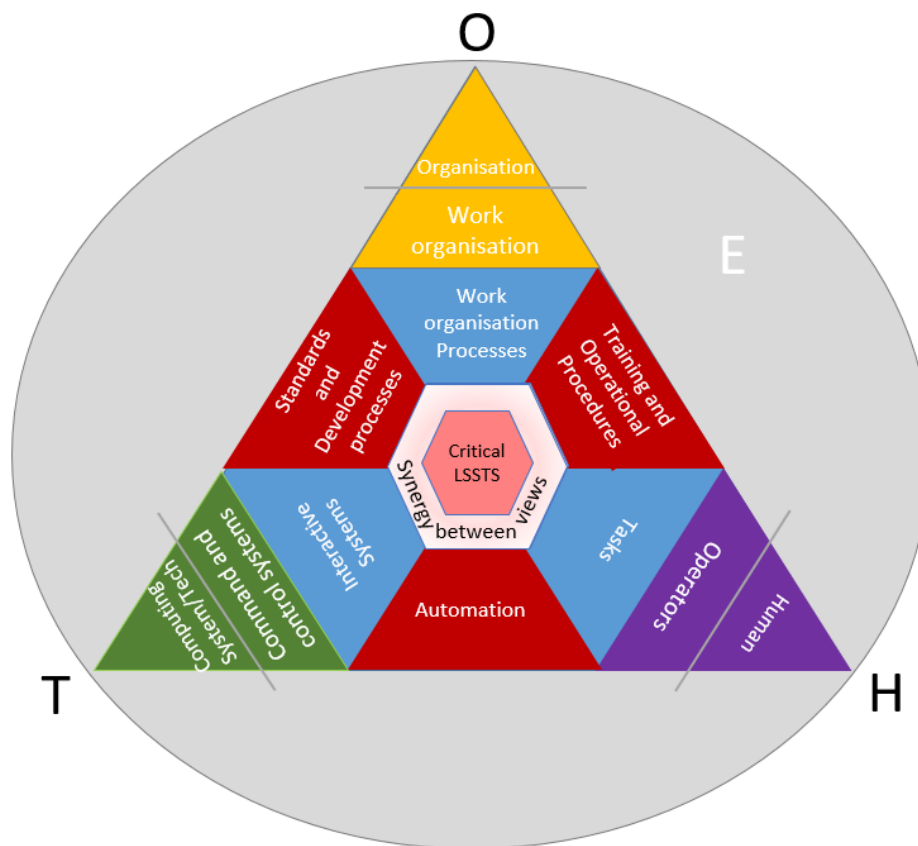

Figure 4. The main views on the design and development of critical LSSTS
adapted from (Ragosta, Martinie, Palanque, Navarre, & Sujan, 2015) and (Palanque P. , 2019)

- Technology
 - Critical LSSTS gather multiple **Computing Systems** (represented in the left corner of the triangle in Figure 4), which in turn embed several components of several types (software, electrical, mechanical...). They are built following a specified architecture and aim to provide services to other components and systems or to their users.
 - Critical LSSTS offer **Command and Control systems** that support the management of the inputs/outputs incoming/outgoing from/to the computing systems (represented in the left corner of the triangle in Figure 4). The computing systems are generally numerous and some of them can be physically and directly (e.g. remote or not safe to directly interact with) inaccessible to their users. Command and control systems thus

provide support to command and control the remote computing systems. They also provide support to help the user in understanding the global states of the systems and of the services they are meant to provide.

- Critical LSSTS offer **Interactive Systems** to provide means for the operators to interact with the command and control applications and more generally to manage the computing systems (represented close to the left corner of the triangle in Figure 4). They aim to take inputs from the users in order to trigger the appropriate command in the relevant command and control or computing system, and to provide outputs to the user. Its behaviour, as well as the information it provides, has to help the user in interpreting correctly its state and the state of the systems.
- Human
 - Critical LSSTS are operated by multiple **Humans** (represented in the right corner of the triangle in Figure 4) who have objectives to reach and work to perform. They may have abilities, disabilities and specific skills. They may make errors and they may behave differently according to their physiological, mental or physical current state.
 - Critical LSSTS require human **Operators** (represented close to the right corner of the triangle in Figure 4) to accomplish the work. They are humans that have been selected, depending on their abilities, trained to learn specific behaviour and to increase the reliability of their behaviour, and qualified to accomplish their work for operating in the context of critical LSSTS.
 - Critical LSSTS require that operators perform specified **Tasks** in order to reach the objectives of the job they have been assigned to (represented close to the right corner of the triangle in Figure 4). These tasks are numerous, usually complex, and require specific knowledge and information for their execution.
- Organisation
 - The deployment and use of the critical LSSTS is supervised by an **Organisation** that gathers a group of human and computing systems together in order to achieve one or more objectives (represented at the top of the triangle in Figure 4).
 - Critical LSSTS are usually managed by one or several **Work Organisations** (represented close to the top corner of the triangle in Figure 4) which structure and plans work to perform by the humans and the means in order to reach the main objectives.
 - Critical LSSTS require **Work organisation processes** (represented close to the top corner of the triangle in Figure 4) to describe necessary workflows between operators to reach the work organisation objectives.
- In between Technology and Human: **Automation**
 - Critical LSSTS embed systems and software applications and some or all of their components implement Automation (i.e. automated functions, represented in between Interactive System and Task in the triangle in Figure 4). Automation makes it possible to reduce overall tasks complexity and effort for operators by allocating to the system tasks that were previously performed by the operator. It also provides support to perform actions that a human is not capable to perform (e.g. long distance physical object detection with radars).
- In between Human and Work organisation processes: **Training and Operational procedures**
 - Critical LSSTS are operated by humans who followed a dedicated Training and have to apply Operational procedures (represented in between Tasks and Work Organisation in the triangle in Figure 4). The design and development of training and of operational procedures takes into account the objectives of the organisation and the organisation processes as well as the tasks that have to be performed by the operators.

- In between Technology and Work organisation processes: Standards and Development processes
 - o **Standards** (represented in between Interactive Systems and Work Organisation in the triangle in Figure 4) rule the design and development of each of the technological components of critical LSSTS, and **Development processes** (in this document, the term development includes the design, production and evaluation of the components of the system) are applied in conformance with them.

Another aspect that has to be taken into account is the **Environment** in which the computing systems, humans and organisation are (represented with a circle tagged “E” around the triangle in Figure 4). The environment has an impact on their behaviour (e.g. an electromagnetic radiation may cause a bit flip in the memory of a computing system, a very noisy environment may cause an operator to badly hear an instruction...).

The centre of the triangle exhibits a hexagon named “Synergy between views”. It aims to highlight the specificity of our research strategy that is to explicitly integrate the different types of views during the design and development of critical LSSTS. With this refined socio-technical framework, we aim to address high level and global aspects (by explicitly taking into account all of the different views on the critical LSSTS) together with low-level and local aspects (by explicitly taking into account the specificities of each view required to design and develop each part of the critical LSSTS).

2. Models as a mean to reach our research objectives

Models aim to represent the characteristics of an element of the real world and, if relevant, the relationships between these characteristics. Our approach requires the use of models to describe the different views on the design and development of a critical LSSTS, this in order to analyse whether the target properties can be reached for each view and for the whole critical LSSTS. For example, for the view on Tasks, task models provide support for usability analysis (Pinelle, Gutwin, & Greenberg, 2003). For the view on computing systems, system behavioural models provide support for reliability analysis (Navarre, Palanque, Ladry, & Barboni, 2009). Models are produced using modelling techniques, which provide guidance to identify and to describe in a complete and unambiguous way the relevant characteristics of the element of the real world that needs to be represented. The selection of the modelling techniques is performed in accordance with the goals of the analysis that have to be done for each view with the models, and thus depends on the properties that need to be analysed. Furthermore, we need modelling techniques that support the analysis of conformance and consistency between the views and that support the analysis of the impact of a design choice made for one view on the other views. For example, a task model that contains the complete set of user goals, sub-goals and tasks provide support for the identification of the actions that will have to be performed by the operator (view on tasks). The association of this task model with a system behavioural model (view on interactive system) provides support to analyse the conformance and consistency between operators’ tasks and system behaviour (synergy between the view on interactive system and the view on tasks), which contributes to the analysis of effectiveness and efficiency – usability property).

The design and development of critical LSSTS requires to deal with a large amount of data of different nature (e.g. information about the users, about the procedures, about the behaviour of the user interfaces, about the computing systems...). The models produced for the design and development of critical LSSTS are numerous and contain an amount of information that cannot be managed without a Computer Aided Software Environment (CASE). Our approach is thus tool supported. The modelling CASE tools have to feature model editing capabilities as well as simulation and analysis capabilities. Beyond the support they have to provide for managing the production and reuse of a large amount of data for each

view, our tool supported modelling approach aims to enable the integration of models of different types (e.g. task models and system models) as well as to enable the mapping between elements in the different types of models. We name this mapping the “synergistic” use of models. Such integration and mapping provides support for the activities of analysing the impact of a design choice (related to a target property) in the other views and on the whole critical LSSTS.

3. Supervision of doctoral students

The contributions presented in this dissertation are the result of the work I have done with my colleagues in the ICS team at IRIT through the co-supervision of 5 PhD students from 2012 to now on (three of them are finished and 2 of them are on-going) and through the co-supervision of 2 post-doctoral students from 2012 to 2017. They are the continuation of the work I have done for the PhD that I defended in December 2011 (Martinie C. , 2011). Table 1 highlights the views that have been target by the work done during the co-supervision PhD and post-doc students as well as the overview of the qualitative coverage of the views by the presented contributions (the related cells are grey shaded). Four views out of six views as well as the synergy between views have started to be covered by the work done during the co-supervision of PhD and post-doc students. The view on training has not been covered by the work done during the cop-supervision of PhD and post-doc students but has started to be covered by the work done during my PhD. The view on work organisation processes has not been covered by the work done during the co-supervision of PhD and post-doc students but has started to be covered indirectly with preliminary work on the engineering of collaborative software applications (the related cell is light grey shaded).

Table 1. Coverage of the views on the design and development of critical LSSTS by the results of the co-supervision of the PhD and Post-Doc students

Co-supervised student View	Martina Ragosta PhD (2011-2015)	Camille Fayollas PhD (2011-2015) Post-doc (2015-2017)	José Luis Silva Post-doc (2012-2013)	Racim Fahssi PhD (2014-2018)	Alexandre Canny PhD (2017-20xx) On-going	Elodie Bouzekri PhD (2017-20xx) On-going
Interactive Systems						
Tasks						
Automation						
Standards and development processes						
Training and operational procedures						
Work Organisation processes						
Synergies between the models of the views						

4. Presentation of the structure of the document

The document is organised in 6 chapters. The first five chapters cover the contributions that address one (or part of a) specific view (“Operators and their tasks”, “Command and Control systems and Interactive systems”, “Automation”, “Training”, “Processes for Systematic Design and development”). The sixth one, named “Synergy between the models of the views on the design and development of critical LSSTS” cover the contributions of the integration of the models representing different types of views during the design and development process of critical interactive systems and of critical LSSTS.

Chapters from two to six are decomposed in five parts that are structured according to the organisation of our research activities and that aim to highlight the main contributions on the important problems we have identified and tackled:

- **First section presents the identified important problems**
Our research strategy relies on the identification of research problems from the analysis of the literature, but also from issues coming from our industrial partners. From these problems, we identify possible relevant research topics that could be investigated through PhD and projects.
- **Second section presents the contributions to the identified problems**
We work on foundations, notations and CASE tools to contribute to the identified research topics. The publications with PhD students and academic colleagues are highlighted in this section.
- **Third section presents the related PhD supervision and collaborations with their supporting projects/funding**
We regularly collaborate with other researchers because our topics require expertise on several scientific domains: HCI, Software engineering, Human Factors, Dependable Computing, Formal methods...
- **Fourth section presents how the contributions have been validated through the application of the contributions to examples from different industrial application domains (Case studies)**
We use illustrative examples for preliminary validation of the concepts and we then use industrial case studies to validate the concepts and to analyse the scalability of the contribution to industrial practices.

Chapter seven presents, for each view, a set of selected perspectives that I believe should be investigated in the near future as they correspond to relevant problems to analyse in order support the design and development of critical LSSTS. Chapter seven also aims to highlight the relationships between the perspectives for each view in order to define the main research directions across views for reaching the target of taking into account altogether the needed properties for the design and development of critical LSSTS.

Chapter 1 Human, operators and their tasks

The design and development of critical LSSTS require to identify and to describe information about the roles and tasks of the operators (or users) of such systems. The identification of operators' roles, operators' tasks and of data required to perform the tasks is achieved through task analysis and the outcome of task analysis is task descriptions (including task models). Task descriptions can be used during several different stages of the design and development process (Benyon, 1992) (e.g. user roles identification, system functions identification, user interface design, training program design...) and by several stakeholders (Paterno, 2002) (e.g. human factor experts, system engineers, software engineers...). Furthermore, task descriptions are central artefacts for several techniques and methods (e.g. User-Centred Design, Human Reliability Assessment...) that are used during the design and development of critical LSSTS. Task descriptions thus have to be as accurate as possible for the analysis targeted by each stakeholder and at the same time, have to enable stakeholders to share a consistent view on users' tasks.

1. Position statement and list of identified important problems

The means for representing and using the outcomes of task analysis has important implications for the value and insight gained from the process, because any omissions cannot be discussed (among the stakeholders) or taken into consideration in later design phases. A systematic and unambiguous description technique is thus required to support effective communication between stakeholders. In addition, each stakeholder needs a notation with a level of expressiveness that matches the objectives of their analysis. The main driver of our contributions is to tackle both of these challenges by enhancing task modelling techniques and by making task models a central artefact for the design and development of critical LSSTS. Moreover, task models produced for the design and development of critical LSSTS are numerous and contain an amount of information that can be hardly managed without computer support. We thus also work on tool support for task modelling in order to provide support to identify and to represent a large number of tasks of different types, to collaboratively work on (share, manage versions) and to reuse tasks models. Each of the sub-sections presented in section "2. Contributions" summarizes the work we performed to investigate the following problems:

- Existing task modelling notations target a specific need for task analysis (e.g. the notation TKS (Johnson, Johnson, & Hamilton, 2000) targets the identification of knowledge required to perform a task, the notation CTT (Paternò, Mancini, & Meniconi, 1997) targets the identification of interactive tasks...). When several objectives are targeted by the task analysis, there is not one notation that can match several objectives and that can be used throughout the whole design and development process. We proposed a task modelling notation that integrates elements from existing task modelling notations as well as several extensions to increase the expressiveness of task models (presented in section 2.1) so that they can match several objectives during the design and development of critical interactive systems and of critical LSSTS.
- To try to integrate every potential useful element of existing task modelling notations into one "supposed complete" task modelling notation that would provide support to the design and development of all types of critical interactive systems and critical LSSTS is not completely possible. The task modelling notation elements to be integrated also depend on the specificities of the application domain and on the technological elements manipulated by the users. Notation elements to identify and describe these specificities may be missing, whatever the task modelling notation. In addition, all of the elements of this "supposed complete" task modelling notation may at least not be useful for every type of task analysis and in the worst case, may degrade the usability of the notation. We proposed a customizable tool supported task modelling notation (presented in

section 2.2) that provides support to tune the notation and its associated tool depending on specific analysis needs.

- Operator tasks with large scale industrial systems are numerous. Existing task modelling notations do not provide explicit support to manage task models containing hundreds of tasks. We proposed structuring mechanisms at notation level and at tool level (presented in section 2.3) to manage the description of large amount of tasks and of task models.
- Task models are not meant to describe human errors whereas humans err. The possibility that human could make errors is taken into account in interactive systems, which often provide means to recover from user errors. Erroneous tasks are then taken into account implicitly at design time. Existing task modelling notations do not propose elements to describe possible human errors in task models, which makes it difficult to systematically identify recuperation actions in task models as well as to assess the cost of errors. We proposed to add elements of notation that would tackle this problem (presented in section 2.4).
- Usability of task modelling tools has to be taken into account carefully in the case of safety-critical applications because the modelling errors may have a negative impact on the artefacts produced using erroneous task models (Vigo, Santoro, & Paterno, 2017). We work on enhancing the usability of our task modelling tool (presented in section 2.5) to better support task modelling activities.
- Task modelling focuses on the objectively measurable criteria of usability (such as effectiveness and efficiency). Beyond effectiveness and efficiency, satisfaction and UX (User eXperience) criteria (e.g. emotions, social relatedness...) are subjective properties that may also have an impact on the performance of users interacting with critical interactive systems (Obriest, Reitberger, Wurhofer, Förster, & Tscheligi, 2011) and on the performance of critical LSSTS. Existing techniques do not provide explicit support to analyse the relationships between user satisfaction or UX and particular identified user actions in task models. We proposed to feedback data from user evaluation into task models to inform the redesign of interactive systems (presented in section 2.6).

2. Contributions to the identified problems

Our work is based on the systematic and unambiguous identification and modelling of user tasks. The presented contributions are focused on the accuracy between the expressiveness of the notation and the task modelling needs for the design and development of critical interactive systems and LSSTS, as well as on the tool support to handle large sets of users' tasks. Each contribution targets to support activities led during the design and development of such systems. Our contributions have been proposed and validated with the HAMSTERS notation and its eponym tool. They can also be applied to other task modelling techniques and tools.

2.1. Increase the expressiveness of task modelling notations

The effectiveness of task analysis and modelling is highly dependent on the expressiveness of the notation for describing the tasks as well as on the tools that are used to produce and work on task descriptions (Caffiau, Scapin, Girard, Baron, & Jambon, 2010). We have proposed several extensions to task modelling notations in order to provide support for specific analysis needs. Table 2 presents the proposed types of extensions. Each entry first describes the problem tackled (column 1), the corresponding proposed extension to task modelling notation (column 2) and the type of analysis it supports (column 3).

Table 2. Extensions to task modelling notations to support the design and development of an interactive critical system or to a critical LSSTS

Problem tackled	Extensions for task modelling notations	Targeted analysis
Existing task modelling notations do not provide support to identify and describe cognitive analysis and cognitive decision tasks	Added elements of notation: Analysis cognitive task type, decision cognitive task type	Identification and description of cognitive decision and analysis user tasks types for the analysis of allocation of function and tasks between system and user (presented in section automation 2.1 in Chapter 3)
	Publications (Martinie C. , et al., 2011) (Martinie C. , Palanque, Barboni, & Ragosta, 2011)	
Existing task modelling notations do not include cognitive tasks refinement as well as elements to describe objects, devices and knowledge	Added elements of notation: Information data type, declarative knowledge data type, physical object data type and device data type	Identification and description of procedural and declarative knowledge (strategic and situational), as well as physical objects and interactive devices: <ul style="list-style-type: none"> - to analyse the impact of dependability policies on user tasks (Fayollas, et al., 2014) - to check the consistency between several types of models (presented in section 2 in chapter 6) - to support training program development (presented in section 2 in chapter 4)
	Publication (Martinie C. , Palanque, Ragosta, & Fahssi, 2013)	
Existing task modelling notations do not include elements to refine cognitive tasks, data and cooperative and group tasks	Added elements of notation: Group, collaborative and computer mediated task types	Identification and description of cooperative tasks and of group tasks for checking the consistency with system models of multi-user and distributed applications (presented in section 2 in chapter 6)
	Publication (Martinie, et al., 2014)	

2.2. Provide support for the customization of a task modelling notation

Each task modelling technique is originally dedicated to the analysis of human tasks with a particular type of interactive system and sometimes for a particular application domain (see Table 3 in (Martinie C. , et al., 2019)). The type of technology manipulated by the user has an impact on the user tasks. For example, from a user motoric action perspective, triggering a command by pressing a mouse button is different from triggering the same command by performing a gesture in the air. The increasing variety and number of interaction techniques and of interactive systems generates an important need of means for precisely refining the descriptions of user actions. We argue that task modelling notations should support the addition of new types of user actions, as well new as of types of devices, data and knowledge that may be required during the performance of tasks with interactive systems. We thus proposed a process and a tool-supported notation based on HAMSTERS and named HAMSTERS-XL that provides support for a stakeholder to customize task types and data types (Martinie C. , et al., 2019) according to the analysis needs. Figure 5 presents an example of task model produced with an extension of the HAMSTERS-XL notation for user tasks in an aircraft cockpit. In this extension, elements of notation have been added to identify and describe: motoric actions with a trackball, finger press motoric actions, sight perceptive actions and touch perceptive actions.

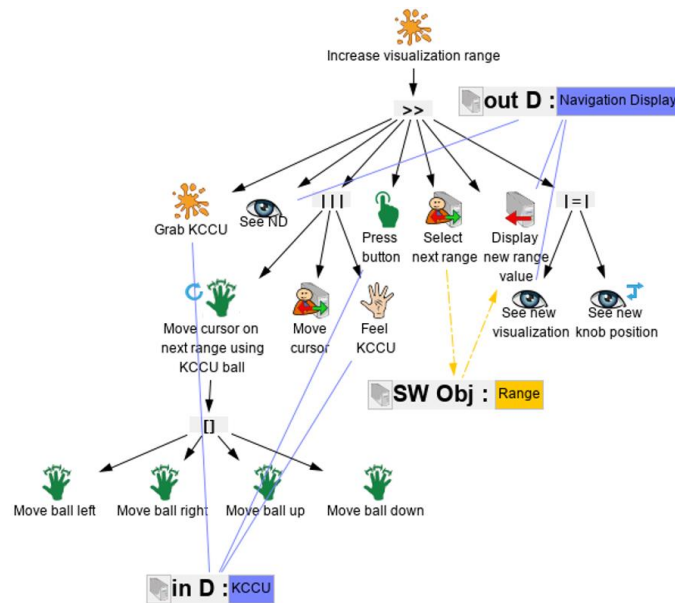

Figure 5. Example of task model produced with HAMSTERS-XL/Cockpit extension

2.3. Provide support for the description and recording of large sets of tasks

When applied to real-life systems, task models end up in very large, hard-to-manage models thus making task modelling a time-consuming and sometimes painful activity (Paterno & Zini, 2004). We practically faced this issue in 2010 when modelling operators' tasks for the command and control of satellite ground segments. We proposed structuring and composition mechanisms to overcome this issue and to enable task modelling and task models reusing for a large number of tasks (Martinie, Palanque, & Winckler, 2011) (Forbrig, Martinie, Palanque, Winckler, & Fahssi, 2014). Since then we regularly apply these mechanisms to model users' tasks with critical interactive systems and within critical LSSTS.

2.4. Provide support for the representation of possible human errors

Task modelling notations focus on providing elements to identify and to describe the expected behaviour of the user. User errors are not part of a user goal and they are thus not part of tasks descriptions. However, understanding the causes of human error and its impact on performance is required to analyse their potential impact on major aspects like the reliability of the operations. In the discipline of Human Factors, Human Reliability Assessment methods relies on task descriptions (including task models) for the analysis of human errors. Several methods (such as HET (Stanton N. , et al., 2010) and CREAM (Hollnagel E. , 1998)) require task models in order to systematically analyse all the potential errors and deviations that may occur. During this systematic analysis, potential human errors are gathered and recorded separately and not connected to the task models. Such non integration brings issues such as completeness (i.e. ensuring that all the potential human errors have been identified) or combined errors identification (i.e. identifying deviations resulting from a combination of errors). We argue that representing human errors explicitly and systematically within task models contributes to the design and evaluation of error-tolerant interactive system. Based on the analysis of existing human error classifications, we proposed several extensions to existing task modelling techniques to represent explicitly all the types of human error and to support their systematic task-based identification (Fahssi, Martinie, & Palanque, 2015) (Fahssi R. , 2018).

2.5. Improve usability of task modelling tools

Modelling tools are interactive applications and poor usability of modelling tools may drastically increase model editing time. We proposed several features in HAMSTERS to support task modelling

activities and in particular we selected several interaction techniques (Fayollas C. , et al., 2017) (Fahssi R. , Systematic identification and representation of human errors in task models, 2018) that aim at limiting the execution and interpretation gulfs, concepts presented in the Norman's Action Theory (Norman D. , 2013). For example, a connection between two elements of a task model is represented by an arc. When the HAMSTERS user tries to connect two elements (with a mouse click and drag from the source task visual object to the target task visual object) the arc is drawn since the user drags the mouse until the target is reached. This interaction technique behaviour helps the user to understand the progression of the connecting task to the goal of connecting the two objects. Other example is that a task cannot be connected directly to another task with the HAMSTERS notation. They have to be connected to a temporal operator (which represent their relative ordering). If a HAMSTERS user tries to connect two tasks, the visual representation of the arc becomes red with an explicative message (instead of green when the connection is possible) so that the user rapidly perceives and interprets the problem.

2.6. Provide support for the integration of UX and usability user evaluation results in task models
 Task modelling focuses on the objectively measurable criteria of usability (such as effectiveness and efficiency). Beyond effectiveness and efficiency, satisfaction and UX (User eXperience) criteria (e.g. emotions, social relatedness...) are subjective properties that may also have an impact on the performance of users interacting with critical interactive systems (Obrist, Reitberger, Wurhofer, Förster, & Tscheligi, 2011) and on the performance of critical LSSTS. These properties are related to the users' tasks but their analysis is not supported by task models. They are assessed using empirical evaluations such as user experiment. Task models can eventually be used to generate and to select scenarios for user evaluation (Winckler, Palanque, & Freitas, 2004). Once the user evaluations are done, usability and/or user experience issues can be identified and can provide some insights for the re-design of part or of all of the interactive system, but this can be done in an informal way. Interactive system designers have to analyse the evaluation results and have to try to make the correspondences between the measures that have been performed and what they know about the user tasks. Existing technique and tools do not provide explicit support to precisely and systematically connect the results and findings from user evaluation studies to each concerned user action. We proposed a tool-supported process to systematically integrate user effectiveness and user experience measures inside task models (Bernhaupt, Palanque, Manciet, & Martinie, 2016), and in particular to systematically attach these measures to the user actions they are related to in the task models (Bernhaupt, Palanque, Drouet, & Martinie, 2018).

3. Related PhD supervisions and collaborations

Figure 6 depicts the timeline for the co-supervision of the students that I have been co-supervising for the contributions on task modelling for engineering critical LSSTS.

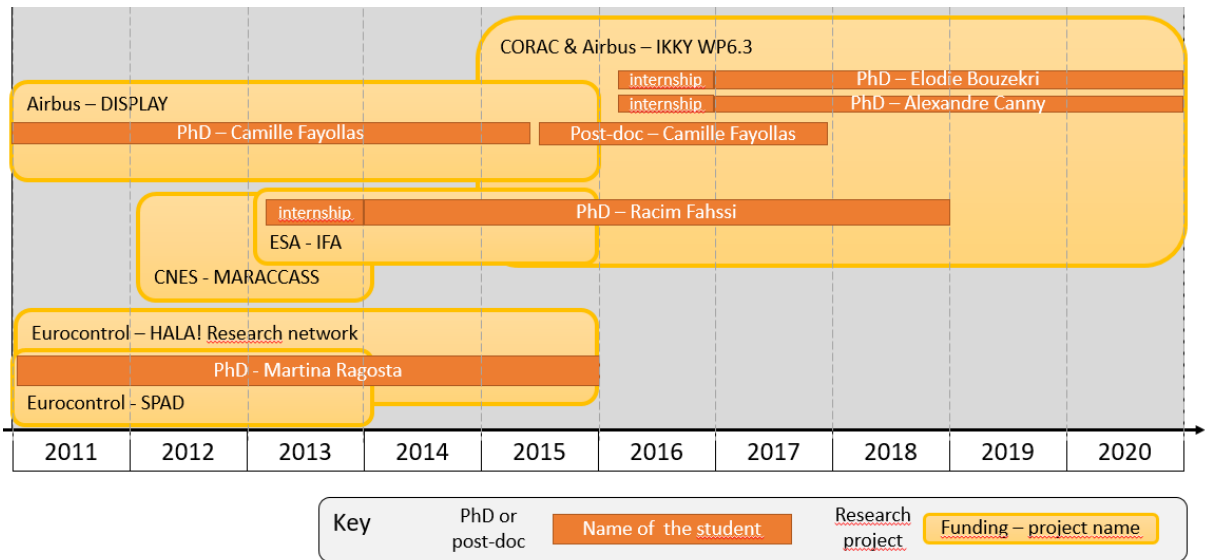

Figure 6. Timeline of supervision of PhD students for the contributions related to operators and their tasks

Table 3 presents the detailed view on the relationships between the contributions, the supervised PhD students and the associated project(s).

Table 3. Contributions on operators and their tasks that result from the co-supervision of PhD students and/or of post-docs

PhD student and/or post-doc	Start and end dates for the PhD	Topic of the PhD or post-doc	Contribution(s) on operators and their tasks issued from the co-supervision of PhD or post-doc	Associated project(s)
Martina Ragosta	2011-2015	Models based approach for the analysis and modelling of usable and resilient partly autonomous interactive systems	Increase the expressiveness of task modelling notations	SPAD (Eurocontrol)
	Associated publications	<ul style="list-style-type: none"> - <i>Martinie, C., Palanque, P., Barboni, E., Winckler, M., Ragosta, M., Pasquini, A., Lanzi, P. 2011. Formal Tasks and Systems Models as a Tool for Specifying and Assessing Automation Designs. International Conference on Application and Theory of Automation in Command and Control Systems, pp. 50-59, ACM.</i> - <i>Martinie, C., Palanque, P., Barboni, E., & Ragosta, M. 2011. Task-Model Based Assessment of Automation Levels: Application to Space Ground Segments. IEEE International Conference on Systems, Man and Cybernetics, pp. 3267-3273, IEEE</i> 		
Camille Fayollas (PhD and post-doc)	2011-2015	Models-based approach for the dependability of critical interactive systems	Task-model based approach to assess the impact of fault-tolerance mechanisms on usability	DISPLAY System (Airbus)
	2015-2017	Specification, verification and evaluation of safe, usable and fault tolerant interactive systems: application to aircrafts' cockpit	Improve usability of modelling tools	IKKY WP6.3 (CORAC and Airbus)
	Associated publications	<ul style="list-style-type: none"> - <i>Fayollas, C., Martinie, C., Palanque, P., Deleris, Y., Fabre, J.-C., Navarre, D. 2014. An approach for assessing the impact of dependability on usability: application to interactive cockpits. European Dependable Computing Conference (EDCC 2014), pp. 198-209, IEEE.</i> - <i>Fayollas, C., Martinie, C., Palanque, P., Barboni, E., Fahssi, R., Hamon, A. 2017. Exploiting Action Theory as a Framework for Analysis and Design of Formal Methods Approaches: Application to the CIRCUS Integrated Development Environment. Handbook of Formal Methods in Human-Computer Interaction, pp. 465-504, Springer.</i> 		
Racim Fahssi	2014-2018	Systematic identification and description of human errors in task models	<p>Increase the expressiveness of task modelling notations</p> <p>Identify and describe human errors</p> <p>Provide support for the description and recording of large sets of tasks</p> <p>Provide support for the identification and representation of possible human errors</p> <p>Improve usability of task modelling tools</p>	MARACASS (CNES), IFA (ESA) IKKY WP6.3 (CORAC and Airbus)
	Associated publications	<ul style="list-style-type: none"> - <i>Forbrig, P., Martinie, C., Palanque, P., Winckler, M. A., & Fahssi, R. M. 2014. Rapid Task-Models Development Using Sub-models, Sub-routines and Generic Components. Human-Centered Software Engineering (HCSE 2014), pp. 144-163, Springer</i> - <i>Martinie, C., Barboni, E., Navarre, D., Palanque, P., Fahssi, R. M., Poupard, E., & Cubero-Castan, E. 2014. Multi-Models-Based Engineering of Collaborative Systems: Application to Collision Avoidance Operations for Spacecrafts. ACM SIGCHI conference Engineering Interactive Computing Systems (EICS 2014), 85-94, ACM.</i> - <i>Fahssi, R. M., Martinie, C., & Palanque, P. 2015. Enhanced Task Modelling for Systematic Identification and Explicit Representation of Human Errors. IFIP TC13 Conference on Human-Computer Interaction (INTERACT 2015), 192-212, Springer</i> 		
Elodie Bouzekri	2017-20xx On-going	Model-based approaches for the description, analysis, and design of automation in command and control systems	Provide support for the customization of a task modelling notation	IKKY WP6.3 (CORAC and Airbus)
	Associated publication	<ul style="list-style-type: none"> - <i>Martinie, C., Palanque, P., Bouzekri, E., Cockburn, A., Canny, A., Barboni, E. 2019. Analysing and Demonstrating Tool-Supported Customizable Task Notations. Proceedings of the ACM on Human-Computer Interaction, 3, 12 (EICS), ACM.</i> 		
Alexandre Canny	2017-20xx On-going	Model-based generation of test cases for validation of interactive systems	Provide support for the customization of a task modelling notation	IKKY WP6.3 (CORAC and Airbus)
	Associated publication	<ul style="list-style-type: none"> - <i>Martinie, C., Palanque, P., Bouzekri, E., Cockburn, A., Canny, A., Barboni, E. 2019. Analysing and Demonstrating Tool-Supported Customizable Task Notations. Proceedings of the ACM on Human-Computer Interaction, 3, 12 (EICS), ACM.</i> 		

We needed the expertise of colleague researchers for specific topics. They worked with us with having in mind the objective of providing support to make task models a reference element in the process of design and development of interactive systems. Table 4 presents the researchers with whom we have collaborated for specific contributions.

Table 4. Contributions on operators and their tasks that results from the collaboration with other researchers

Researcher	Period of the collaboration	Background of the researcher	Contribution issued from the collaboration	Associated publication(s)
Regina Bernhaupt, expert in user evaluation and in UX (Professor, TU Eindhoven, The Netherlands)	2011-today	UX evaluation	Provide support for the Integration of UX and usability user evaluation results in task models	(Bernhaupt, Palanque, Drouet, & Martinie, 2018) (Bernhaupt, Palanque, Manciet, & Martinie, 2016)
Peter Forbrig, expert in the engineering of task models (Professor, Univ. Rostock, Germany)	2013-2014	Task models based engineering	Provide support for the description and recording of large sets of tasks	(Forbrig, Martinie, Palanque, Winckler, & Fahssi, 2014)

4. Case studies

We develop and maintain the HAMSTERS CASE tool, now called HAMSTERS-XLE, which is the new version of the HAMSTERS environment and aims to customise HAMSTERS-XL notation, and at editing and simulating HAMSTERS-XL task models. I am in charge of coordinating and supervising all these developments and the maintenance of the tool.

HAMSTERS-XLE provides support for the editing and simulation of task models created with the HAMSTERS-XL notation, as well as for creating customized versions of the HAMSTERS-XL notation. It is used as teaching support each year for masters' degree in HCI at the Université Paul Sabatier Toulouse III. It is also taught at international level with a course given at Eurocontrol since 2018 (Drogoul & Palanque, 2018) and in many tutorials associated to international conferences: ACM CHI (Palanque & Martinie, 2015) (Palanque & Martinie, 2016), IFIP TC13 INTERACT (Palanque, Martinie, & Winckler, 2017). HAMSTERS-XLE is free and open access², it is based on the Apache Netbeans API³ which provides a set of base features for managing projects of heterogeneous types of files and editing graphical diagrams. Its size is approximatively 40000 lines of code. The main contributors to its code are Eric Barboni (research engineer in the group), myself and the following PhD students: Racim Fahssi, Elodie Bouzekri and Alexandre Canny.

Thanks to this task modelling software environment, each of the presented contributions has been applied to a small example as well as to one industrial case study (see Annex B – Projects), at least. I was in charge of coordinating and supervising the application of the contributions to the small examples and to the industrial case studies. I also participate to the task modelling activities since I have applied the two first extensions presented in Table 2 to model ground segment operators' tasks during the projects Tortuga and Aldabra. Some of the applications of the contributions required the analysis and modelling of a large set of tasks. Table 5 presents a set of case studies that are representative of this work of analysing a large set of information and of modelling the relevant tasks.

² <https://www.irit.fr/recherches/ICS/software/hamsters/>

³ <https://bits.netbeans.org/dev/javadoc/>

Table 5. Application of the contributions on operators and their tasks to case studies

Case study / Project name and period	User type	Main tasks	Number of task models	Number of tasks	Applied contributions	Associated publications
Picard Tortuga (CNES) (2010-2011)	LEOP Ground segment operators	Manage Telemetry failure, manage Sun Array Driver failure	30	440	Provide support for the description and recording of large sets of tasks	(Martinie C. , et al., 2011)
FCU Software (Software version of the Flight Control Unit) Cockpit Display System (Airbus) (2015-2016)	Pilot Flying and Pilot Monitoring	Start descent, manage descent, configure PFD display options	37	451	Provide support for the description and recording of large sets of tasks Increase the expressiveness of task modelling notations	(Martinie, Navarre, Palanque, & Fayollas, 2015) (Fayollas C. , Martinie, Navarre, & Palanque, 2016)
Recommendations for the management of alarms IKKY WP6.3 (CORAC and Airbus) (2016-2018)	Pilot Flying and Pilot Monitoring	Preliminary cockpit preparation, Manage APU failure	55	1937	Provide support for the description and recording of large sets of tasks Increase the expressiveness of task modelling notations Provide support for the customization of a task modelling notation	(Bouzekri E. , et al., 2019a) (Martinie C. , et al., 2019)

Chapter 2 Computing systems, command and control systems and interactive systems

The design and development of critical LSSTS require to set objectives about the functions that have to be performed by the systems and to set objectives in terms of expected behaviour and properties that have to be met (e.g. safety, usability, dependability...). The design and development of critical LSSTS also require to apply techniques and methods that provide support to reach these objectives. Such approaches and techniques involve the collaboration of multiple stakeholders (e.g. project manager, system engineer, software developer...), they are structured and systematic (e.g. software development cannot happen before software design detailed specification for each produced system) and they require the use of software tools (e.g. for the specification of requirements, for the specification of a system element behaviour, for the execution of automated tests...).

1. Position statement and list of identified important problems

Models and abstractions are used since decades in the disciplines of system and software engineering. They provide support to manage and to understand large and complex sets of information concerning the systems' functions, their architecture and their behaviour. We are particularly interested in formal methods and formal models because they provide support for complete and unambiguous description of system behaviour (Palanque & Bastide, 1994) (Johnson C. , 1995). Formal models enable to check if expected properties are verified (Palanque & Bastide, 1994), to foresee the impact of design choices before implementation (Johnson C. , 1995), to make the designer explicit her/his design's choice (Palanque & Bastide,1994), to get rid of natural language ambiguities (Dix, 1995), and to optimize development time (Johnson C. , 1995). ICS team has a long time expertise in formal description techniques for the design and development of interactive systems. The formal description technique named ICO (Interactive Cooperative Object) was coined in the early 1990's by (Palanque & Bastide, 1994) to specify the behaviour of interactive systems. Since then, ICO has been refined and extended with the aim of increasing its support to the engineering of interactive systems ranging from requirements specification (Palanque, Farenc, & Bastide, 1999) to system deployment (Fayollas, et al., 2014). My research work aims to continue along that path to extend the support for engineering interactive systems and more specifically to extend the support for engineering critical LSSTS. Each of the sub-sections presented in section "2. Contributions" in this chapter summarizes the work we performed to investigate the following problems:

- Formal descriptions techniques for interactive systems focus on the behaviour of the system and of the user interactions. They do not provide support to describe the elements that are perceptible by the users, such as the layout of visual widgets on a screen, whereas both perceptible elements and interactive system behaviour are related to user tasks and have an impact on users' performance (and on the whole critical LSSTS). We proposed to integrate user interface layout description techniques with formal description techniques (presented in section 2.1) in order to enable the systematic description of both perceptible and behavioural parts of a graphical interactive application.
- User performance evaluation techniques can be based on the analysis of various measures taken while the user interacts with a system (empirical assessment) or on the computation of mathematical formulas for given parameters that provide indicative values for a set of characteristics of human performance (predictive assessment). These measures and values are design and development artefacts that stand apart from the description of the system behaviour. When it comes to precisely identify the part of the system behaviour that corresponds to a user action for which a performance issue has been detected during user evaluation and/or predicted

using formulas, interactive system designers have no support for this search and identification. To bridge this gap, we proposed a formal high-fidelity prototyping tool-support for connecting interactive system behaviour specification with user evaluation logs. We also proposed a predictive assessment technique based on and connected to the model of the interactive system behaviour (presented in section 2.2).

- Design rationale description techniques (for recording design options and information about the criteria that guided the design decisions) support systematic exploration of design choices but do not provide explicit support for checking which requirements are or not fulfilled by design choices, whereas the traceability of requirements throughout the design and development process of critical systems is explicitly required in several application domains (e.g. civil aircraft cockpits, air traffic management systems...). We proposed to extend a design rationale description technique to enable the traceability of requirements when exploring design options (presented in section 2.3).
- Whether they are used as a mean for describing in a complete and unambiguous way the interactive system or as a means for verifying properties, formal description techniques and their associated tools need to be designed to be usable and not error prone. We proposed several features to improve usability of software environments for formal modelling (presented in section 2.4).
- Since several years, we study the engineering of command and control applications in aircraft cockpits. Engineering such applications requires abstraction of the work to be performed with these applications but also abstraction of the various components that are being monitored and controlled. Given the complexity of these various components, as well as of the possible contexts (e.g. system faults and/or failures) in which they are monitored and controlled, we proposed of several types of representations of the system components and on their possible states (presented in section 2.5) to deal with cockpit engineering issues.

2. Contributions to the identified problems

Our contributions are focused on the use of complete and unambiguous descriptions of the elements that compose critical interactive systems. Each contribution targets to support activities led during the design and development of such systems. Our contributions have been proposed and validated with the ICO notation and its associated PetShop tool, which is a high-fidelity formal model-based prototyping environment (Palanque, Ladry, Navarre, & Barboni, 2009).

2.1. Increase the expressiveness of the ICO notation for describing User Interfaces

ICO stands for Interactive Cooperative Objects and uses concepts borrowed from the object-oriented approach (dynamic instantiation, classification, encapsulation, inheritance, client/server relationship) to describe the structural or static aspects of systems and uses high-level Petri nets to describe their dynamic or behavioural aspects (Navarre, Palanque, Ladry, & Barboni, 2009). The ICO notation provides support to describe every type of interactive systems and interaction techniques' behaviour, even multimodal ones, which are not supported by state machines like notations for example. ICO is associated to a tool named PetShop that supports the editing, execution and analysis of the ICO models. PetShop runs ICO models in the same way that Integrated Development Environments (IDEs) runs interpreted software and in addition provides support to modify the ICO models at runtime (enabling to immediately perceive the impact of a modification of the system behaviour).

ICO did not support the description of visual layout and rendering (e.g. how interactive components are rendered to the users...) and the behavioural descriptions of the user interface were directly connected to the software code for the interactive component rendering. We proposed to integrate the FXML

declarative language for graphical user interface description (which is part of Java FX⁴) to the ICO behavioural models. We also proposed an approach to extend such type of integration by integrating the emergent standard UsiXML (Limbourg, Vanderdonckt, Michotte, Bouillon, & Lopez-Jacquero, 2004) with the ICO notation (Barboni, Martinie, Navarre, Palanque, & Winckler, 2014). UsiXML is a XML-compliant mark-up language that supports the description of UI for multiple contexts such as graphical user interface, auditory user interface and multimodal user interface. This extension allows to cover the description of all the elements of an interactive application, from the perceivable and interactive elements of the user interface to the functional core of the interactive application. This extension enabled to support the development of a model-based approach for generating dynamically user interfaces at runtime and has been applied to a case study in the space ground segment application domain (Martinie, Navarre, & Palanque, 2013). This extension also enabled to support the development of multi-touch applications in the PetShop environment (Hamon, et al., 2014).

2.2. Provide support for evaluation of user performance with interactive systems

User performance is one of the dimensions targeted by the usability evaluations of interactive systems in User Centred Design processes. Moreover, user performance has an impact on the performance of the socio-technical system s/he is operating within. User performance can be assessed with experimental evaluation. During user evaluation sessions, users are observed while using systems or prototypes of systems. The output of such sessions is reports and various materials (e.g. video recording, audio recording, notes...) that will help to raise issues that users may have when using the system. If problems are detected, a new version of the system has to be prepared and it requires to be able to find what modifications have to be performed in the system. Multiple components of the system may be concerned and it then may take time to fix every problem. The use of software logs recorded during user testing sessions can facilitate these modifications. However, the preparation time is proportional to the number of logs to configure, and lines of codes for the logs may be forgotten. We proposed a formal model based approach to systematically and exhaustively log user actions with the system, as well as all of the consecutive flow of event in the system (Palanque, Barboni, Martinie, Navarre, & Winckler, 2011) (Martinie, Palanque, & Fayollas, 2018). It uses the ICO notation and PetShop environment to systematically log each event happening in the ICO models (e.g. transition fired, incoming token in a place). The PetShop environment interprets and runs the formally described interactive system. These fine-grain logs enable to point out all of the places in the description of the system behaviour where are potential problems of consistency between user actions and system behaviour, and save time for the modification of the systems.

Experimental evaluations are time consuming and the usability of the whole system cannot be assessed through user evaluations. Other possibility is then to predict user performance using human models (provided that the relevant human models are available). With the same objective of systematically and exhaustively assess the consistency between user actions and system behaviour, we proposed an approach that integrates human models with system behavioural models (also based on ICO) to predict user performance (Martinie, Palanque, & Fayollas, 2018). We demonstrated how to enrich ICO models with human models to compute time required to complete a given scenario. In that way, it is possible to systematically predict user efficiency for several scenarios. Figure 7 presents an example of such enriched ICO models.

⁴ <https://docs.oracle.com/javase/8/javafx/get-started-tutorial/jfx-overview.htm>

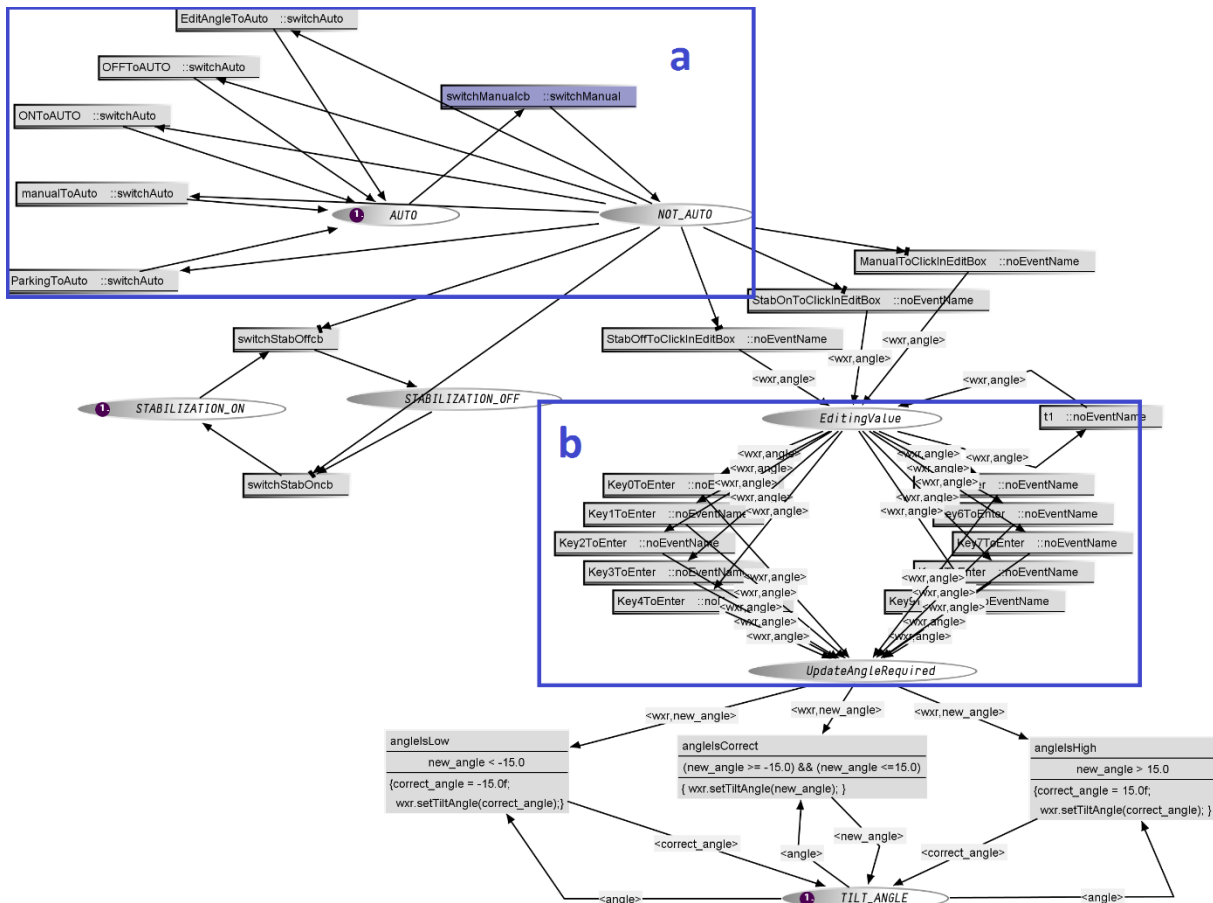

Figure 7. ICO model of the lower part of the control panel of the Weather Radar application enriched with possible user motoric actions (a: mode selection, b: tilt angle edition)

2.3. Provide support for analysing requirements coverage for several design options

Systematic exploration of design options provides support for identifying the most suitable design choices for the system to be developed and then for the traceability of design choices that have been made. Such approach can be used for certification purpose to show evidences that safety requirements for the system are fulfilled by the design choices (Eurocontrol, 2010) (EUROCAE, 2012). We proposed to extend existing design rationale approaches to include the description of requirements and their connection to the representation of design choices (Martinie C. , Palanque, Winckler, & Conversy, 2010). This integration through a tool-supported notation, TEAM and DREAMER, aims to better support the traceability of requirements within the system and software design (an example of a DREAMER diagram is depicted in Figure 8). We have also demonstrated that TEAM and DREAMER can be used to identify conflicting requirements and to make trade-offs when choosing design options (Masip, et al., 2012).



Figure 8. Snapshot of a DREAMER diagram (design of the behavior of the ARINC 661 RadioBox2 widget)

2.4. Improve usability of system modelling tools

Modelling tools are interactive applications and poor usability of modelling tools may drastically increase model editing time. They have to be usable and to avoid to lead the user to make errors (Razali & Garratt, 2010). We proposed several features in PetShop to improve effectiveness and efficiency of users of system modelling tools when performing the tasks of editing, verification and validation of models (Fayollas C. , et al., 2017). We used the Norman’s Action Theory (Norman D. , 2013) to integrate features and interaction technique that aim at limiting the execution and interpretation gulfs. For the interactive system behaviour, we provided functionalities to automate interactive software validation (Brat, Martinie, & Palanque, 2013). We also automated the analysis of high-level Petri nets such as siphon analysis (Silva, et al., 2013), presented in Figure 9 a), and provided a visualisation feature that makes the results of the analysis visually salient in the formal models (Silva, et al., 2013), presented in Figure 9 b). These functionalities provide support to check properties of the user interface and of the user interaction (e.g. ensuring that for every possible system state, a particular user action will always be executable).

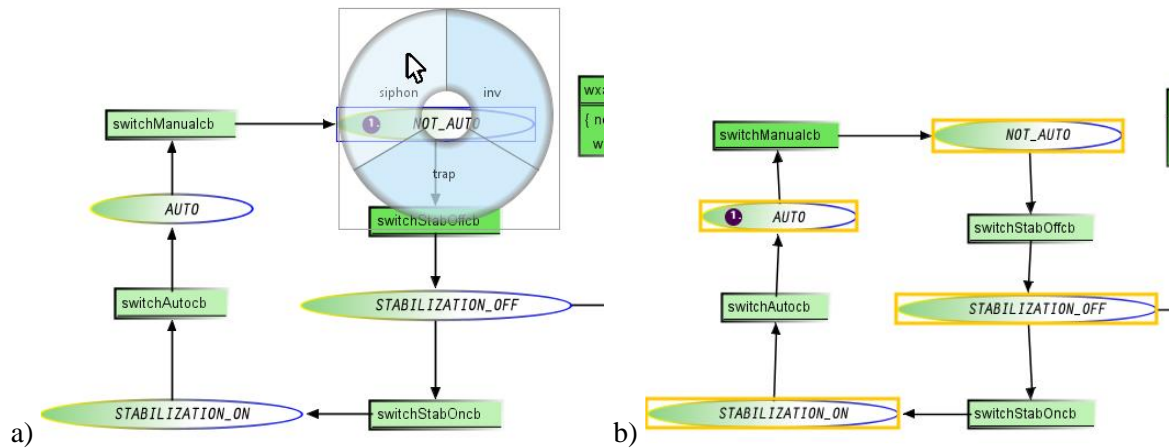

Figure 9. Visualization of a siphon in Petshop – a) pie menu enabling the display of siphons implying “NOT_AUTO” place and b) display of the siphon implying “NOT_AUTO” place

2.5. Provide support for engineering interactive aircraft cockpits

To analyse and to model aircraft cockpits and the interactions between the crew members and the command and control applications require to identify the components of the interactive systems and of the applications composing the command and control application. It also requires to identify the inner systems and components of the aircraft and the relationships between all of these components because all of these systems and their components may be related to the mission of the crew members. We proposed several approaches (architecture based) to identify and model these components of. Each of the approaches provides support for a specific type of engineering issue encountered during the design and development of aircraft cockpits:

- *Dealing with faults through dynamic reconfiguration of interaction techniques*
 We proposed a generic architecture for reconfiguration of interaction techniques (taking into account potential malfunctions/faults in the input/output devices) in interactive aircraft cockpits (Navarre, Palanque, Barboni, Ladry, & Martinie, 2011). It aims to provide a mean to model the interactive system, to model a set of configurations, and to model how configurations evolve according to detected failures.
- *Studying feasibility of the development of recommender systems for critical contexts*
 Recommender systems, widely used in the area of consumer electronics, are a possible option for supporting operations with command and control systems (they can provide support for making a decision when a lot of information has to be dealt with) (Pilarski, 2014). However, existing techniques do not explicitly deal with the design and development of such systems in critical contexts. We identified a set of requirements towards the integration of recommender systems in critical contexts and proposed a generic architecture for the engineering of recommender systems in critical contexts (Bouzekri E. , et al., 2019a). We applied this architecture and built a proof of concept prototype. Figure 10 presents a screenshot of an excerpt of this prototype.

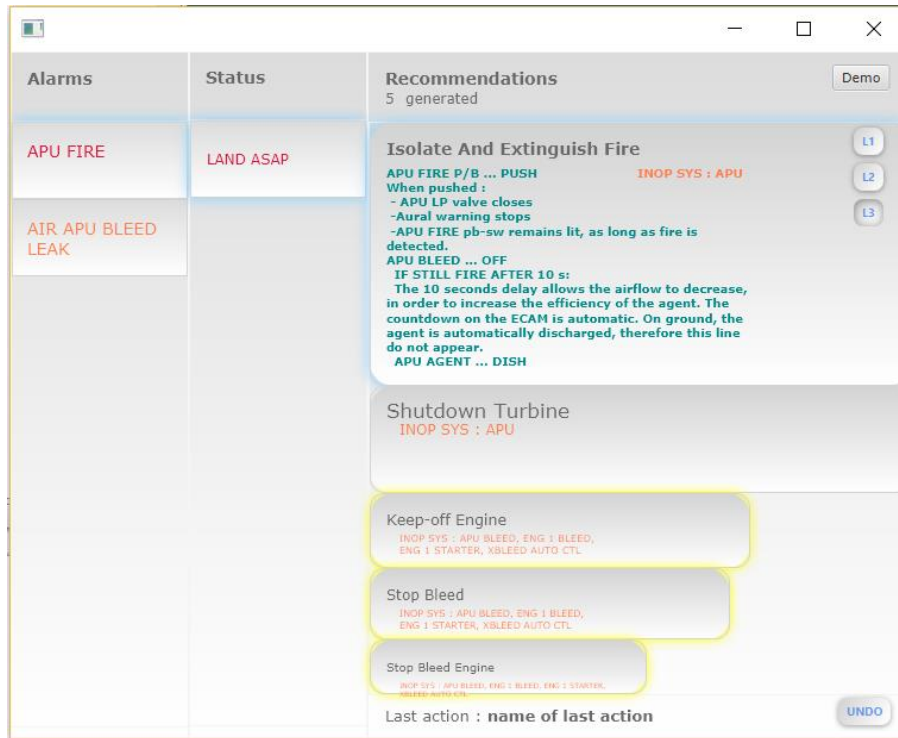

Figure 10. Screenshot of a high-fidelity prototype of application recommending procedures to recover from faults and/or failures

- *Systematic identification of multiple cyber-physical interaction channels*

The systems being monitored have a Cyber-Physical nature (e.g. are composed of software elements, mechanical elements, physical elements...). And the operators may have direct access on (some of) the physical parts of the systems (e.g. connected light bulb in a smart home, Auxiliary Power Unit in a commercial aircraft...). This is a possible interaction channel (e.g. touch the light bulb, perceive smoke incoming from the APU...) that is not explicitly dealt with during the design and development of cyber-physical systems. We proposed a generic architecture to identify the elements composing each Cyber Physical System being operated, their relationships and the possible interaction channels with their users (Canny A. , et al., 2019). Figure 11 depicts an example of the instantiation of this architecture for the Auxiliary Power Unit in a commercial aircraft.

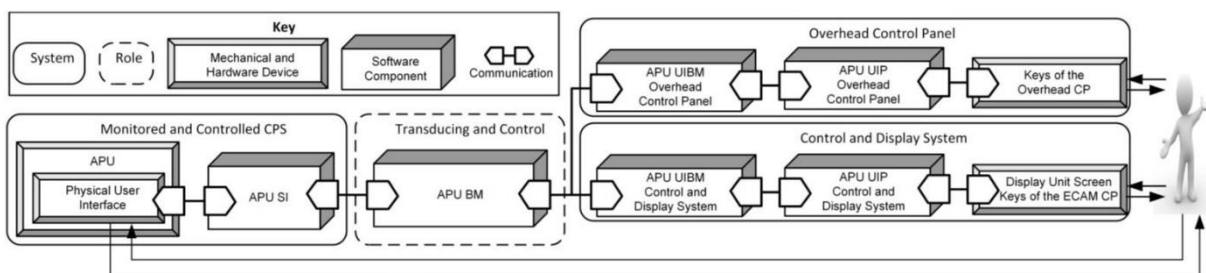

Figure 11. Instantiation of the generic architecture for command and control of the Auxiliary Power Unit in commercial aircrafts

- *Systematic decomposition of services and devices being monitored and controlled*

Command and control systems provide information about the states of several components of the monitored systems (e.g. a warning displayed on the UI) and provide means to act on these systems (e.g. triggering a command with a button). User Centred Design approaches focus on user needs but do not include activities that support to analyse and to explicitly identify the

exhaustive set of system components and information that the users have to monitor and control. The possible states of all the components composing a complex system is out of scope of user interface designers’ knowledge. We proposed an architectural modelling techniques to provide support for the systematic and exhaustive identification of the possible abstract views of the system Devices, system Services, compound Services and User services (DSCU) and of their states (OQCR for Operational state, Qualitative state, Context and Restriction attributes of the state) (Bouzekri E. , et al., 2019b). Figure 12 presents an excerpt of the instantiation of the DSCU architecture for the engines, APU (Auxiliary Power Unit), air conditioned and bleed routing.

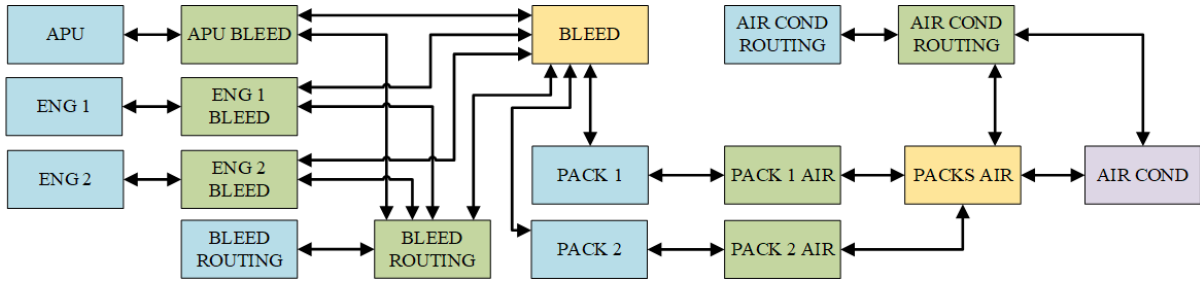

Figure 12. Instantiated architecture for the AIR COND user service from (Bouzekri E. , et al., 2019b)

Figure 13 presents a screenshot of a proof of concept of the presentation of the view on the user services produced using the output from the application of the DSCU and OQCR abstraction and decomposition technique.

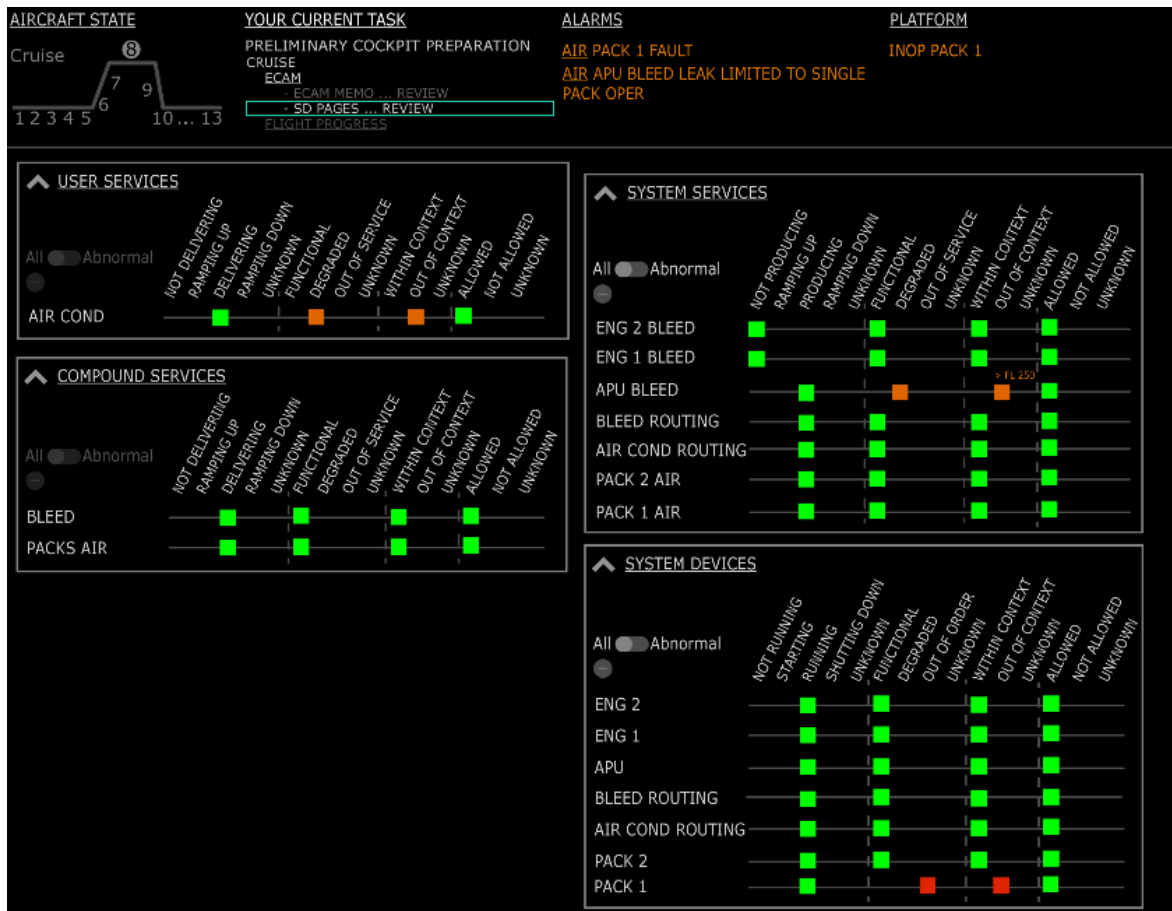

Figure 13. Screenshot of a proof of concept of the presentation of information integrating both DSCU and OQCR from (Bouzekri E. , et al., 2019b)

For all of these presented contributions on engineering aircraft cockpits, modelling techniques have been applied to describe in a complete and unambiguous way the behaviour of each of the components identified in the architecture. The proposed architectures are then also a mean to support the checking of consistency between the components. As each of the components is of different nature, different types of models (e.g. system behavioural models, user task models, physical models) are required to describe all the types of elements in the Cyber-Physical system (Canny A. , et al., 2019) (Bouzekri E. , Canny, Martinie, Palanque, & Gris, 2019).

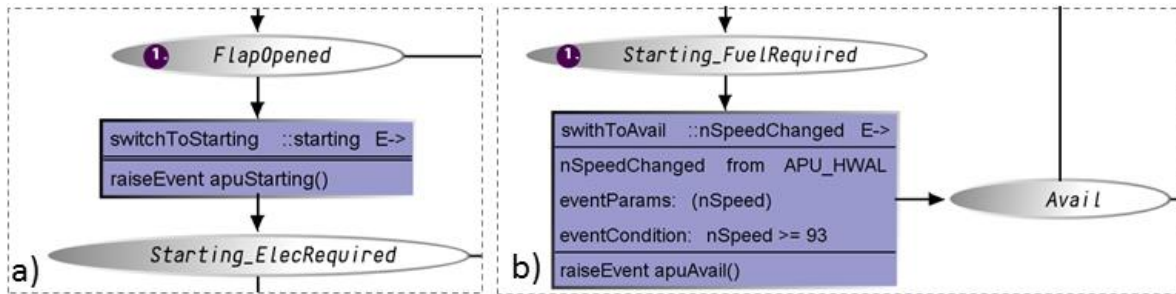

Figure 14. Extract from the ICO model of the APU BM component of the architecture presented in Figure 11

Finally, we also highlighted the potential benefits of using detailed architectures of interactive systems for the development and implementation of interactive system and software testing (Canny A. , Bouzekri, Martinie, & Palanque, 2018).

Our contributions on engineering aircraft cockpits may be applied on command and control systems in other application domains because the proposed level of abstraction is suitable for every kind of system that is composed of several cyber-physical elements that are in relationships together and because the modelling techniques proposed to describe each of these elements have been already applied successfully in other application domains such as satellite ground segment application and air traffic control.

3. Related PhD supervisions and collaborations

Figure 15 depicts the timeline for the co-supervision of the students that I have been co-supervising for the contributions on engineering command and control systems and critical interactive systems.

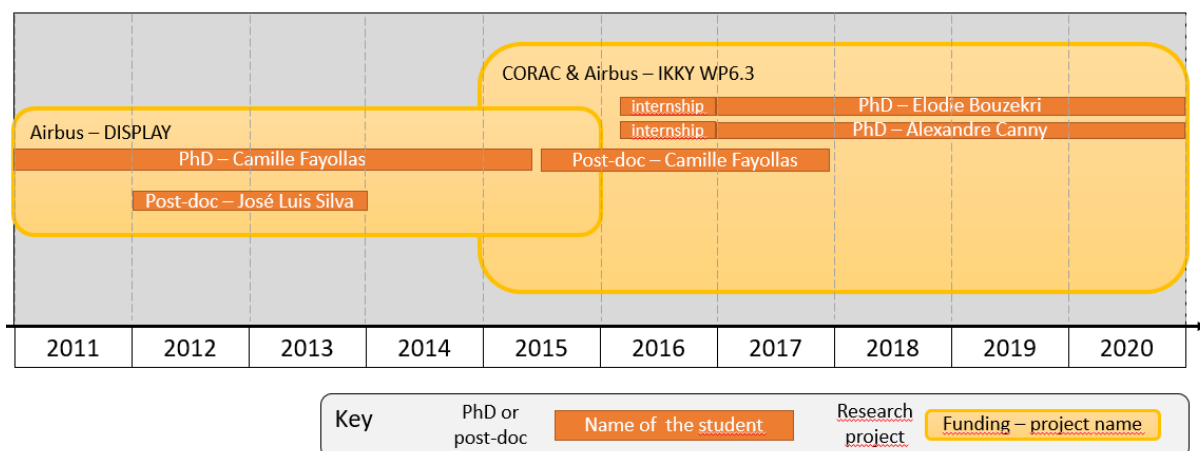

Figure 15. Timeline of supervision of PhD students for the contributions related to command and control systems and interactive systems

Table 6 presents the relationships between the contributions, the supervised PhD students and/or post-doctoral students and the associated project(s).

Table 6. Contributions on command and control systems and on interactive systems that result from the co-supervision of PhD student and/or post-doctoral students

PhD student	Start and end dates for the PhD and/or post-doc	Topic of the PhD or post-doc	Contribution(s) on command and control systems and interactive systems issued from the co-supervision of PhD or post-doc	Associated project(s)
Camille Fayollas (post-doc)	2015-2017	Specification, verification and evaluation of safe, usable and fault tolerant interactive systems: application to aircrafts' cockpit	Improve usability of modelling tools Provide support for evaluation of user performance with interactive systems Provide support for engineering interactive aircraft cockpits	IKKY WP6.3 (CORAC and Airbus)
	Associated publications	<ul style="list-style-type: none"> - <i>Fayollas, C., Martinie, C., Palanque, P., Barboni, E., Fahssi, R., Hamon, A. 2017. Exploiting Action Theory as a Framework for Analysis and Design of Formal Methods Approaches: Application to the CIRCUS Integrated Development Environment. Handbook of Formal Methods in Human-Computer Interaction, pp. 465-504, Springer.</i> - <i>Martinie, C., Palanque, P., & Fayollas, C. 2018. Performance Evaluation of Interactive Systems with Interactive Cooperative Objects Models. In A. Oulasvirta, P. O. Kristensson, X. Bi, A. Howes (Eds.), Computational Interaction, pp. 249-283, Oxford University Press.</i> - <i>Bouzekri, E., Canny, A., Fayollas, C., Martinie, C., Palanque, P., Barboni, E., Deleris, Y. Gris, C. 2019. Engineering Issues Related to the Development of a Recommender System in a Critical Context: Application to Interactive Cockpits. International Journal of Human-Computer Studies, 121, 122-141, Elsevier.</i> - <i>Canny, A., Fayollas, C., Martinie, C., Navarre, D., Palanque, P., Bouzekri, E., Gris, C., Délérís, Y. 2019. Divide to Conquer: Functional Decomposition to Support Model-Based Engineering of Command and Control of Cyber-Physical Systems. IEEE International Conference on Cyber Physical and Social Computing 2019 (CPSCoM), 694-701, IEEE.</i> 		
José Luis Silva (post-doc)	2012-2013	Validation of formal models of interactive systems	Improve usability of modelling tools (tool support for validation of ICO models)	DISPLAY System (Airbus)
	Associated publications	<ul style="list-style-type: none"> - <i>Silva, J. L., Fayollas, C., Hamon, A., Palanque, P., Martinie, C., Barboni, E. 2013. Analysis of WIMP and Post WIMP Interactive Systems based on Formal Specification (regular paper). International Workshop on Formal Methods for Interactive Systems (FMIS 2013), London, Electronic Communications of the EASST.</i> 		
Elodie Bouzekri (PhD student)	2017-20xx On-going	Model-based approaches for the description, analysis, and design of automation in command and control systems	Provide support for engineering interactive aircraft cockpits	IKKY WP6.3 (CORAC and Airbus)
	Associated publications	<ul style="list-style-type: none"> - <i>Bouzekri, E., Canny, A., Fayollas, C., Martinie, C., Palanque, P., Barboni, E., Deleris, Y. Gris, C. 2019. Engineering Issues Related to the Development of a Recommender System in a Critical Context: Application to Interactive Cockpits. International Journal of Human-Computer Studies, 121, 122-141, Elsevier.</i> - <i>Canny, A., Fayollas, C., Martinie, C., Navarre, D., Palanque, P., Bouzekri, E., Gris, C., Délérís, Y. 2019. Divide to Conquer: Functional Decomposition to Support Model-Based Engineering of Command and Control of Cyber-Physical Systems. IEEE International Conference on Cyber Physical and Social Computing 2019 (CPSCoM), 694-701, IEEE.</i> - <i>Bouzekri, E., Canny, A., Martinie, C., Palanque, P., Barboni, E., Navarre, D., Gris, C. Deleris, Y. 2019. Revisiting system's pages in engine indication and alerting system for flight crew using the DSCU architecture and the OQCR system generic state description. INCOSE International Conference on Human System Integration (HSI 2019), INCOSE.</i> - <i>Canny, A., Bouzekri, E., Martinie, C., & Palanque, P. 2018. Rationalizing the Need of Architecture-Driven Testing of Interactive Systems. IFIP TC 13.2 Conference on Human-Centered Software Engineering (HCSE 2018), pp. 164-186, Springer.</i> 		

PhD student	Start and end dates for the PhD and/or post-doc	Topic of the PhD or post-doc	Contribution(s) on command and control systems and interactive systems issued from the co-supervision of PhD or post-doc	Associated project(s)
Alexandre Canny (PhD student)	2017-20xx On-going	Model-based generation of test cases for validation of interactive systems	Provide support for engineering interactive aircraft cockpits	IKKY WP6.3 (CORAC and Airbus)
	Associated publications	<ul style="list-style-type: none"> - Bouzekri, E., Canny, A., Fayollas, C., Martinie, C., Palanque, P., Barboni, E., Deleris, Y. Gris, C. 2019. <i>Engineering Issues Related to the Development of a Recommender System in a Critical Context: Application to Interactive Cockpits</i>. <i>International Journal of Human-Computer Studies</i>, 121, 122-141, Elsevier. - Canny, A., Fayollas, C., Martinie, C., Navarre, D., Palanque, P., Bouzekri, E., Gris, C., Déléris, Y. 2019. <i>Divide to Conquer: Functional Decomposition to Support Model-Based Engineering of Command and Control of Cyber-Physical Systems</i>. <i>IEEE International Conference on Cyber Physical and Social Computing 2019 (CPSCom)</i>, 694-701, IEEE. - Bouzekri, E., Canny, A., Martinie, C., Palanque, P., Barboni, E., Navarre, D., Gris, C. Deleris, Y. 2019. <i>Revisiting system's pages in engine indication and alerting system for flight crew using the DSCU architecture and the OQCR system generic state description</i>. <i>INCOSE International Conference on Human System Integration (HSI 2019)</i>, INCOSE. - Canny, A., Bouzekri, E., Martinie, C., & Palanque, P. 2018. <i>Rationalizing the Need of Architecture-Driven Testing of Interactive Systems</i>. <i>IFIP TC 13.2 Conference on Human-Centered Software Engineering (HCSE 2018)</i>, pp. 164-186, Springer. 		

We needed the expertise of colleague researchers for specific topics. Table 7 presents the researchers with whom we have collaborated for specific contributions.

Table 7. Contributions on command and control systems and on interactive systems that results from the collaboration with other researchers

Researcher	Period of the collaboration	Background of the researcher	Contribution issued from collaboration	Associated publication
Guillaume Brat expert in formal methods, lead of the robust software engineering group, NASA Ames Research Center, USA	2013-2015	Formal methods for software verification	Improve usability of modelling tools	(Brat, Martinie, & Palanque, 2013)
Llucia Masip, Toni Granollers	2011-2012	Usability and UX engineering	Provide support for design rationale	(Masip, et al., 2012)

4. Case studies

Thanks to the PetShop IDE, each of the presented contributions has been applied to a small example as well as to one industrial case study (see Annex B – Projects), at least. For several of these case studies, I have been participating in and/or coordinating the development of interactive applications based on ICO models. Table 8 presents a set of representative case studies I have been involved in the coordination and development.

Table 8. Application of the contributions on command and control systems to case studies

Case study/ Project name and period	Application domain	Interactive application	Produced artefacts	Applied contributions	Associated publication(s)
Dynamic reconfiguration of synoptics and procedure manager Aldabra (CNES) (2011-2012)	LEOP Ground segment applications	Procedure manager	ICO models for dynamic generation of user interface at runtime depending on the procedure to be applied	Increase the expressiveness of the ICO notation for describing User Interfaces	(Martinie, Navarre, & Palanque, 2013)
WXR (Weather radar) Cockpit Display System (Airbus) (2015-2016)	Commercial aircrafts	Weather radar	ICO models enriched with perceptive, motoric an cognitive user actions	Provide support for evaluation of user performance with interactive systems	(Martinie, Palanque, & Fayollas, 2018)
Operational states and Recommendations for the management of alarms IKKY WP6.3 (CORAC and Airbus) (2016-2018)	Commercial aircrafts	Flight warning system	Abstraction and decomposition of devices and services with their associated behavioural models	Provide support for engineering interactive aircraft cockpits	(Bouzekri E. , et al., 2019b) (Bouzekri E. , Canny, Martinie, Palanque, & Gris, 2019)

Chapter 3 Automation

The design and development of automation requires to identify and to understand the human tasks that are relevant to be performed by the computing systems, as well to identify and to understand the tasks that are impossible to be performed by humans in order to cope with it on the computing system side. Dedicated design and development techniques have been proposed for such analysis in the discipline of Human Factors and the contributions presented in this chapter rely on these foundations. In addition, as “*many modern forms of automated (or sometimes: autonomous) machines, such as power plant monitoring devices, automated cars, drones, robots, and chatbots, do involve computers*” (Janssen, Donker, Brumby, & Kun, 2019), the presented contributions also rely on knowledge and techniques from computer science and human computer interaction disciplines as they are also useful to analyse automation, and in particular to understand the behaviour of automated functions.

The number of automated functions increase in every type of computing systems and in a lot of application domains. The argument usually pointed out in favour of automating more functions is that human operators are a source of variation and unpredictability that may decrease the overall socio-technical system performance (Baxter, Rooksby, Wang, & Khajeh-Hosseini, 2012). But when these automations are not adequately designed (or correctly understood by the operator), they may result in so called automation surprises (Palmer, 1995) (Sarter, Woods, & Billings, 1997) that degrade, instead of enhance, the overall performance of the operations. In addition, automated functions may also fail and in cases of failure, human operators are expected to take over and to solve the problems. This paradox is referred as an irony of automation by (Bainbridge, 1983), who explicitly explains (page 778): “*... that one is not by automating necessarily removing the difficulties, and also the possibility that resolving them will require even greater technological ingenuity than does classic automation*”. This paradox is still identified as an issue that requires dedicated design and development practices (Baxter, Rooksby, Wang, & Khajeh-Hosseini, 2012).

1. Position statement and list of identified important problems

Techniques to explicitly and unambiguously model automation are required to enable to exhaustively describe and analyse automation in critical LSSTS, in the same way that they are required to describe user tasks and system behaviour (as presented in Chapter 1 and in Chapter 2). In the discipline of Human Factors, existing techniques of allocation of functions do not provide support to explicitly and precisely the relationships between the user actions and the computing system behaviour. In the disciplines of computer science and human-computer interaction, automation is pervasive and most of the time implicitly taken into account at design time, meaning without dedicated techniques to identify and describe automated behaviours in the systems⁵. We have found few research work dealing with techniques to systematically describe and analyse the allocation of functions. Existing contributions focus on the verification of human automation interaction (Bolton, Bass, & Siminiceanu, 2013), their scope is limited to the description of the allocation of tasks and functions for the explicit interactions between the user and the computing system (i.e. it does not take into account the whole work of the users and the whole behaviour of the system).

Each of the sub-sections presented in section “2. Contributions” in this chapter summarizes the work we performed to investigate the following problems:

- Existing techniques to analyse automation focus on identifying tasks and functions to be performed from a high-level perspective. The outcome of existing techniques is in most of the

⁵ We note that there is an analogous issue with human errors, as some of them are implicitly taken into account at design time but not in a systematic way, as discussed in section 2.4 in Chapter 1.

cases lists of abstract user tasks and of abstract system functions. These lists do not precisely contain neither the refinement of user actions nor the refinement of system actions and are not temporally ordered. As a consequence, the existing techniques provide few support to compare different allocation of tasks and functions in terms of analysing the impact of automation design options on usability and on system behaviour. We proposed a models-based technique to refine the description of the allocation of tasks and function into user actions and system executable instructions (presented in section 2.1).

- Automation design usually focuses on the allocation of the goal-related tasks. The interaction-related tasks also include automation that most of the time embed hidden automations which can prevent users from triggering the commands they want, and also prevent them from perceiving and interpreting correctly evolutions of the underlying controlled system. We proposed a technique to describe, analyse and identify potential automation surprises in interaction-related automation (presented in section 2.2).
- Most of the existing techniques to support automation design focus on allocation of function and tasks, whereas the analysis of the authority and responsibility aspects are very few supported. The analysis of authority is required to define the possible combinations of allocations of tasks and functions, especially in case of dynamic changes of the allocation at runtime. The analysis of responsibility is required to analyse who is liable in case of incident or accident. We proposed a model-based technique to analyse the allocation of authority and of responsibility in addition to the allocation of tasks and functions (presented in section 2.3).

2. Contributions to the identified problems

Our contributions are based on the systematic and unambiguous identification and modelling of user tasks and of computing system functions and behaviour. Systematic and precise descriptions of user tasks and of system behaviour provide support to analyse the allocation of functions in a complete and explicit way. It also provides support to analyse the impact of this allocation on user performance. Systematic and precise descriptions of user tasks and of system behaviour is also a step towards making explicit the design choices concerning the authority sharing and the liability of the users operating the system or of the designers of the system in case of critical incident or accident.

2.1. Provide support to the analysis and design of allocation of task/function and of interactive applications embedding automation

Allocation of function is “... *the process in which members of a design team decide whether to allocate jobs, tasks, system functions, or responsibility to human or automated agents in sociotechnical work environments.*” (page 34-1) (Marsden & Kirby, 2005). The analysis of the allocation of functions is necessary to identify the optimal distribution of both functions and tasks between a system and a user and it provides support for the identification of which tasks are good candidate for automation and which ones should remain performed by the operator (Fitts, 1951). (Fitts, 1951) first proposed to study the allocation of function and provided high-level guidelines for this allocation, known as MABA-MABA, which indicates what kind of tasks would better suit to human and what kind of tasks would better suit to machines. These guidelines are simple and easy to understand which makes them very cited but it is not possible to rely on them to systematically analyse and design automation as they have several drawbacks (Winter & Dodou, 2014) (e.g. they do not take into account individual differences, safety, economic utility, availability, maintainability, the rapid evolution of technology, social values, task complexity, dynamic allocation...).

Later on, (Parasuraman, Sheridan, & Wickens, 2000) proposed a framework, named “Levels of automation” which proposes ten possible levels of automation (from level 0, where all the tasks are allocated to the human, to level 10, where all the functions are allocated to the system) for a system

under design, as well as types of functions that can be performed by the human or by the system (information acquisition, information analysis, decision selection and action implementation) at a specified level of automation. This framework aims to provide support for the analysis of the possible design solutions for the automated parts of a computing system but do not provide specific guidance to describe precisely and in a systematic way the allocation of tasks and functions between the human and the system, i.e. do not provide insights on how to identify and describe the tasks that have to be performed by the human and the functions that have to be performed by the computing system.

The allocation of functions is central to the design of automation because it provides support to migrate user activities to be performed by the system or to migrate system functions to be performed by the user. Existing techniques of allocation of functions can be used to produce lists of tasks to be performed by the user and lists of functions to be performed by the system. But the identified tasks and functions are abstract whereas:

- user tasks are made of perceptive, cognitive, motor and input interactive actions that the user should perform to reach her/his goal,
- system functions are the sets of algorithmic, input and output instructions that the system should execute to support user goal.

Other issue with existing techniques is that although they provide support for the identification of the high-level sequences of tasks and functions to be performed, they do not provide support for precisely describing the temporal ordering and interleaving of user actions and system functions execution.

To overcome these issues, we proposed to use task modelling techniques that embed elements of notations for refining:

- the different types of user tasks (cognitive analysis and cognitive decision tasks according to (Parasuraman, Sheridan, & Wickens, 2000) model of human information processing, and interactive tasks (interactive input and interactive output),
- the description of temporal ordering between user tasks and system tasks

This task-models based approach provides support for:

- the analysis of possible levels of automation and task migratability (Martinie C. , et al., 2011) (Ragosta, 2015)
- the comparison of different design options in terms of task complexity (Martinie C. , et al., 2011) (Fayollas, et al., 2014) (Ragosta, 2015)
- the analysis of the impact of automated dependability mechanisms on usability (Fayollas, et al., 2014)

We also proposed to use system modelling techniques that provide support to describe system behaviour in order to provide support for analysis of consistency and conformance between user actions and system behaviour (Martinie C. , Palanque, Barboni, & Ragosta, 2011).

We demonstrated the feasibility of such approaches using the HAMSTERS and ICO tool-supported notations.

2.2. Provide support for the analysis and design of automation in interaction techniques

Automation design usually focuses on the allocation of the goal-related functions and tasks. However, the interaction-related tasks also include automation that is usually considered outside of the scope of automation design (as they are most of the time dealt with by the window management system of the interactive system). Interaction-directed tasks are performed on interactive systems in order to trigger the goal related tasks. Interaction-related tasks most of the time embed hidden automations that can jeopardize operations by preventing users from triggering the commands they want, and also by

preventing them from perceiving and interpreting correctly evolutions of the underlying controlled system. This problem has for example been highlighted by for the “undo” command which is an automation of the cancelling a sequence of actions that have been done by the user (Appert, Chapuis, & Pietriga, 2012). They argue that the “undo” command is not consistent across platforms, which leads to motor and cognitive costs for the user as the type and number of actions to revert to a previous state are unpredictable for the user. They thus propose a new cross-platform interaction technique to overcome these problems and make automation transparent. This example stands for one interaction technique but there are plenty of existing ones and plenty to be created. Another example is the behaviour of the double-click interaction technique as implemented in Windows 8 OS presented in a state machine in Figure 16. There may be several ways of providing visual rendering feedback, and this for the same set of user actions. Figure 17 a) presents the actual observable rendering in Windows 8 OS. It is interesting to note that there are two identical rendering that are associated to two different internal states of the interaction technique (second and third row in Figure 17 a)). This design may lead to mode confusion, and thus to automation surprises.

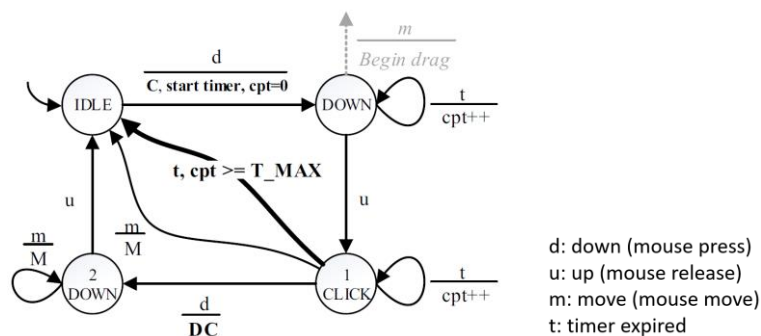

Figure 16. State machine describing the behaviour of the double-click interaction technique in Windows 8 OS

Graphical rendering of state	Description	Graphical Rendering of State	Description
	• IDLE state, the mouse has just entered the icon		• IDLE state, the mouse has just entered the icon.
	• DOWN state after a « d » event from the IDLE state • A « tick » is rendered in the checkbox		• DOWN state after a “d” event from the IDLE state: • A label “+Click” is displayed, indicating that a click event has been fired; • A timer bar is displayed at the top of the icon, indicating the remaining time to perform a double click. This timer bar decreases automatically.
	• 1 CLICK state after a « u » event • No change in rendering		• 1 CLICK state after a “u” event: • The “+Click” label is disappearing (an animation is moving it towards the top of the screen); • The time bar is decreasing.
	• 2 DOWN state after a « d » event in 1 CLICK state • The double click succeeded and a window named « Folder » has appeared		• 2 DOWN state after a “d” event in 1 CLICK state: • A label “+Double-Click” is displayed, indicating that a double-click event has been fired; • The time bar is disappearing; • The double click is succeeded and a window named “Folder” has appeared.

Figure 17. Automation design options for the double-click interaction technique a) state machine (behaviour) of the interaction technique b) Windows 8 rendering c) proposed rendering for transparent automation

We proposed a technique that provides support for systematically identifying potential sources of automation surprises in interaction techniques (Bernhaupt, Cronel, Manciet, Martinie, & Palanque,

2015). It is based on the formal description of the behaviour of the interaction technique and on its analysis in terms of number of states, of events produced and mapping between these states and their rendering. Figure 17 b) presents an outcome of the application of this technique, it depicts a possible solution to solve the ambiguous rendering of the Windows 8 OS double-click interaction technique by adding rendering feedback that correspond to each internal state of the interaction technique.

2.3. Provide support to the analysis of allocation of Functions, Authority and Responsibility
 Miller and Parasuraman (Miller & Parasuraman, 2007) proposed to extend the Level of Automations framework with the concepts of authority and responsibility, in order to provide support to the analysis and design of adaptive automation. Adaptive automation is the dynamic change of automation level at runtime and its design requires to understand who of the user and of the system has the right to trigger a change and who will be liable in case of problem. Existing approaches that argue for taking into account the allocation of authority and of responsibility at design time but do not provide explicit support for identifying precisely which one between the human and the system has the authority to trigger or to perform a particular action, and which one will be responsible in case of a problematic outcome of the planned tasks. We proposed a technique for the identification and description of Allocation of Function, Authority and Responsibility (A-FAR) (Bouzekri E. , Canny, Martinie, Palanque, & Gris, 2018). This technique is based on task modelling and provides extensions for task modelling notations to support the identification and description of the detailed allocation of functions and tasks, as presented in previous section, as well as of:

- orchestration of human tasks and system functions, meaning that it makes it possible to describe possible dynamic changes in levels of automation at runtime (Figure 18 depicts an orchestration model that describes the possible temporal orderings between user goals and system goals),
- tasks or functions on which the human or the system have the authority,
- tasks or functions that have an impact on the outcome when reaching a goal of the couple human-system, expected result when reaching a goal and actual result when the goal has been reached (enabling to identify the responsibilities).

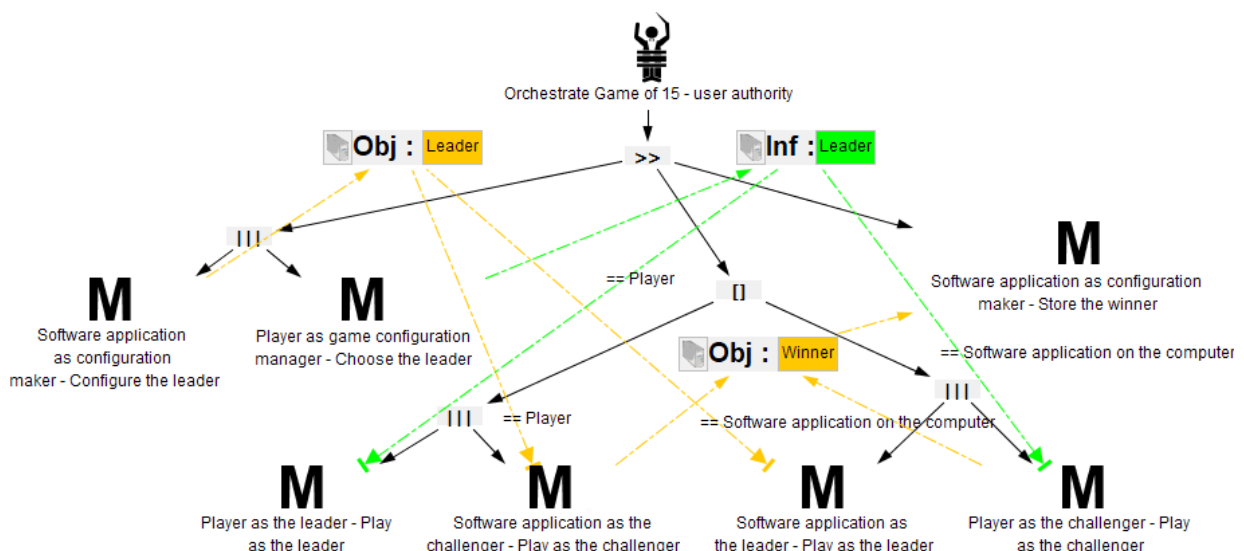

Figure 18. Orchestration model of the computerised version of the Game of Fifteen

With an example from the Air Traffic Control domain, we performed the application of the A-FAR technique on a subset of tasks that are related to the management of the incoming planes in an airport. Figure 19 presents an excerpt from the outcome of the A-FAR analysis for the case study of the Arrival MANager in the Air Traffic Control domain. The Arrival MANager (AMAN) is a computer-based tool

that generates a predefined sequence for the arrival of planes in an airport (Skybrary, 2017). Several possibilities are possible for its usage. The tool may be used as an assistant, and the controllers have the choice to follow the advice or not. But the concept of time-based operations, studied in SESAR JU, may imply that the advisories presented by AMAN have to be followed strictly in order to guarantee the synchronisation of operations in all of the European airports (Regulation 2017/373, 2017). When comparing the A-FAR for both design solutions, we see (Figure 19) that for a same Level of Automation, the allocations of functions, authority and responsibility are different. This example highlights that classifications of levels of automation are not enough to analyse the implications of different designs on the user tasks and on the consequences of potential problems (human error, system failures) occurring during operations.

LOA	Definition	Allocation of Functions	Allocation of Authority	Allocation of Responsibility
...				
5	[The computer] executes that suggestion if the human approves.			
4	[The computer] suggests one alternative	- AMAN produces the sequence of arrivals - Controller applies the plan to manage the arrivals	To AMAN for producing the sequence To the controller for sending the clearances	To AMAN for the produced sequence of arrivals To the controller for the clearances that the s/he sends
4	[The computer] suggests one alternative	- AMAN produces the sequence of arrivals - Controller chooses to follow the proposed sequence or prepares another one , and then applies the plan to manage the arrivals	All to the controller	All to the controller
3	[The computer] narrows the selection down to a few.			

Figure 19. Excerpt from the comparison of allocation of functions, authority and responsibility for different levels of automation for the case study of the Arrival MANager (AMAN) in Air Traffic Control

3. Related PhD supervisions and collaborations

Figure 20 depicts the timeline for the co-supervision of the students that I have been co-supervising for the contributions on engineering command and control systems and critical interactive systems.

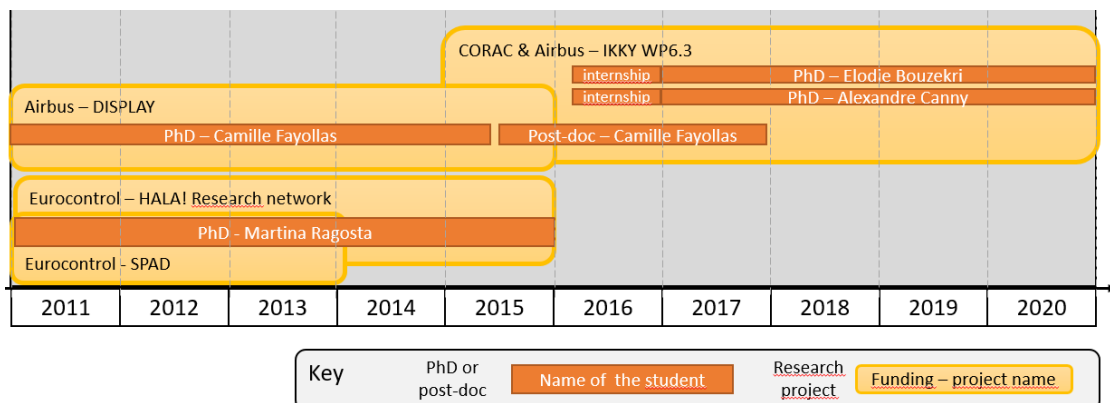

Figure 20. Timeline of supervision of PhD students for the contributions related to the engineering of automation

Table 9 presents the detailed view on the relationships between the contributions, the supervised PhD students and the associated project(s)

Table 9. Contributions on operators and their tasks that result from the co-supervision of PhD students and/or of post-doctoral students

PhD student and/or post-doc	Start and end dates for the PhD	Topic of the PhD or post-doc	Contribution(s) on operators and their tasks issued from the co-supervision of PhD or post-doc	Associated project(s)
Martina Ragosta	2011-2015	Models based approach for the analysis and modelling of usable and resilient partly autonomous interactive systems	Provide support to the analysis and design of task/function allocation and of interactive applications embedding automation	SPAD (Eurocontrol)
	Associated publications	<ul style="list-style-type: none"> - Martinie, C., Palanque, P., Barboni, E., Winckler, M., Ragosta, M., Pasquini, A., Lanzi, P. 2011. <i>Formal Tasks and Systems Models as a Tool for Specifying and Assessing Automation Designs</i>. <i>International Conference on Application and Theory of Automation in Command and Control Systems</i>, pp. 50-59, ACM. - Martinie, C., Palanque, P., Barboni, E., & Ragosta, M. 2011. <i>Task-Model Based Assessment of Automation Levels: Application to Space Ground Segments</i>. <i>IEEE International Conference on Systems, Man and Cybernetics</i>, pp. 3267-3273), IEEE 		
Camille Fayollas (Phd and post-doc)	2011-2015	Models-based approach for the dependability of critical interactive systems	Task-model based approach to assess the impact of fault-tolerance mechanisms (automated versus manual input checking) on usability	DISPLAY System (Airbus)
	2015-2017	Specification, verification and evaluation of safe, usable and fault tolerant interactive systems: application to aircrafts' cockpit	Provide support to the analysis and design of task/function allocation and of interactive applications embedding automation	IKKY WP6.3 (CORAC and Airbus)
	Associated publication(s)	<ul style="list-style-type: none"> - Fayollas, C., Martinie, C., Palanque, P., Deleris, Y., Fabre, J.-C., Navarre, D. 2014. <i>An approach for assessing the impact of dependability on usability: application to interactive cockpits</i>. <i>European Dependable Computing Conference (EDCC 2014)</i>, pp. 198-209, IEEE. - Palanque, P., Martinie, C., Fayollas, C. 2017. <i>Automation: Danger or Opportunity? Designing and Assessing Automation for Interactive Systems</i>. <i>Tutorial at ACM SIGCHI Conference on Human Factors in Computing Systems, CHI 2017</i>, ACM. - Palanque, P., Martinie, C., Fayollas, C. 2018. <i>Automation: Danger or Opportunity? Designing and Assessing Automation for Interactive Systems</i>. <i>Tutorial at ACM SIGCHI Conference on Human Factors in Computing Systems, CHI 2018</i>, ACM. 		
Elodie Bouzekri (PhD student)	2017-20xx On-going	Model-based approaches for the description, analysis, and design of automation in command and control systems	Provide support to the analysis of allocation of Authority and Responsibility (Automation, Tasks and Interactive Systems)	IKKY WP6.3 (CORAC and Airbus)
	Associated publication(s)	<ul style="list-style-type: none"> - Bouzekri, E., Canny, A., Martinie, C., Palanque, P., Gris, C. 2018. <i>Using Task Descriptions with Explicit Representation of Allocation of Functions, Authority and Responsibility to Design and Assess Automation</i>. <i>IFIP TC 13.6 Conference on Human Work Interaction Design (HWID 2018)</i>, Springer. 		
Alexandre Canny (PhD student)	2017-20xx On-going	Model-based approaches for the description, analysis, and design of automation in command and control systems	Provide support to the analysis of allocation of Authority and Responsibility (Automation, Tasks and Interactive Systems)	IKKY WP6.3 (CORAC and Airbus)
	Associated publication(s)	<ul style="list-style-type: none"> - Bouzekri, E., Canny, A., Martinie, C., Palanque, P., Gris, C. 2018. <i>Using Task Descriptions with Explicit Representation of Allocation of Functions, Authority and Responsibility to Design and Assess Automation</i>. <i>IFIP TC 13.6 Conference on Human Work Interaction Design (HWID 2018)</i>, Springer. 		

We needed the expertise of colleague researchers for specific topics. Table 10 presents the researchers with whom we have collaborated for specific contributions.

Table 10. Contributions on command and control systems and on interactive systems that results from the collaboration with other researchers

Researcher	Period of the collaboration	Background of the researcher	Contribution issued from collaboration	Associated publication(s)
Alberto Pasquini, Paola Lanzi DeepBlue srl, Italy	2011 - 2015	Human Factors in Air Traffic Control	Provide support to the analysis and design of task/function allocation and of interactive applications embedding automation	(Ragosta, 2015) (Martinie C. , et al., 2011)

The contributions presented in this section have been disseminated during tutorials at the ACM SIGCHI conference on Computer Human Interaction (CHI) (Palanque, Martinie, & Fayollas, 2017) (Palanque, Martinie, & Fayollas, 2018) and at the IFIP TC 13 International Conference on Human Computer Interaction (INTERACT) (Palanque, Martinie, & Bouzekri, 2019). We have also proposed and run a Special Interest Group (short session workshop) at CHI 2016 with colleagues from different labs in order to share different points of view on engineering automation in different application domains (Feary, Martinie, Palanque, & Tscheligi, 2016).

4. Case studies

Thanks to the HAMSTERS task modelling software environment and to the PetShop IDE, each of the presented contributions has been applied to a small example as well as to one industrial case study (see Annex B – Projects). I was in charge of coordinating and supervising the application of the contributions to the small examples and to the industrial case studies. Table 11 presents a set of representative case studies I have been involved in the coordination and development.

Table 11. Application of the contributions on automation to case studies

Case study / Project name and period	User type / Main task	Automation design options	Applied contributions	Associated publication(s)
Picard Telecommand management Tortuga (CNES) (2010-2011)	Low Earth Orbit (LEO) Ground segment controller / Monitor and control satellite platform	Human sending of telecommands versus system automated sending with human programmed procedures	- Provide support to the analysis and design of task/function allocation and of interactive applications embedding automation - Provide support for the design of interaction techniques	(Martinie C. , et al., 2011) (Bernhaupt, Cronel, Manciet, Martinie, & Palanque, 2015)
Weather radar command and control application SPAD Eurocontrol (2011-2013)	Aircraft pilot / Manage display of weather information	Human test of weather radar device versus system automated test	Provide support to the analysis and design of task/function allocation and of interactive applications embedding automation	(Martinie C. , et al., 2011) (Ragosta, 2015)
Interactive cockpit DISPLAY System (Airbus) (2011-2015)	Aircraft pilot / User input (editing and modification)	Human verification of the input versus automated human programmed verification	Provide support to the analysis and design of task/function allocation and of interactive applications embedding automation	(Fayollas, et al., 2014)
Recommendations for the management of alarms (Flight warning system) IKKY WP6.3 CORAC-Airbus	Aircraft pilot / Manage platform and manage alarms	Human cognitive analysis and/or decision of possible options and of their ordering versus system guided analysis and/or decision of possible options and their ordering	Provide support to the analysis of allocation of Resources, Authority, Responsibility, Functions and Tasks.	On-going

Chapter 4 Training and operational procedures

In the field of critical systems, operators (e.g. pilots, air traffic controllers) are not allowed to take up their duties unless they are qualified and certified by an authority (e.g. Joint Aviation Authorities, EUROCONTROL) or by their employer, depending on the application domain. Operators must learn to apply specific procedures according to specific contexts. Training programs aim to provide operators with a predefined set of skills and knowledge before using the system, this in order to increase operators' performance and to decrease the number of potential human errors when using the system (Salas & Cannon-Bowers, 2001) (Aguinis & Kraiger, 2009). Training programs for critical systems are regulated and systematic. They are described in requirements that precisely identify the different phases of the training and their objectives. They also identify the skills, tasks and knowledge that the trainee must master, as well as the types of teaching materials to be used for each phase (courses, computer-assisted training, simulator training, etc.). Examples of such requirements document is the Flight Crew Licensing requirement document released by the Joint Aviation Authority (JAA, 2006) as well as the EU regulation for training and licensing of Air Traffic Controllers (EU 2015/340, 2015).

The design, development and implementation of training programs is a systematic process that is composed of several phases that take place before, during and after training effectively occurs (Salas, Tannenbaum, Kraiger, & Smith-Jentsch, 2012). The design and development of training program aims to identify the different phases of the training and their objectives, the skills, the tasks and knowledge that the trainee must master, as well as the types of teaching means and materials to be used for each phase.

1. Position statement and list of identified important problems

Systematic approach to training, also referred to as Systems Approach to Training (SAT) (Reiser, 2001), provide guidelines to develop and implement training programs in a systematic manner. They are based on the identification of the tasks that the trainee has to know how to perform after having followed the training. These tasks are identified when analysing training needs, they are then analysed to design and implement the training program and the type of training sessions. And at the end of the training program, they are used to set criteria for trainee performance evaluation. Whereas systematic approach to training are based on the identification and analysis of tasks that the trainee has to learn to be able to accomplish her/his mission, and thus have to deal with the operations and interactions that the user will have to perform with the computing systems within the critical LSSTS, they neither provide explicit support to describe these tasks, nor explicitly address the behaviour of the computing systems that will have to be operated. Moreover, training programs (with associated training devices such as computers or simulators) are developed apart from the development of the computing systems that will be operated within the critical LSSTS, which may lead to inconsistencies between the operators' expectation of the system behaviour and the actual system behaviour. Each of the sub-sections presented in the section "2. Contributions" in this chapter summarizes the work we performed to tackle a particular research problem related to the explicit integration of unambiguous descriptions of tasks and system behaviour during the design and development of training programs for critical interactive systems and critical LSSTS:

- Although systematic approaches to training provides a structured view on the phases to be followed, they do not explicitly refer to techniques for applying the approach. We proposed to associate systematic approaches to training with model-based descriptions of user tasks and of system behaviour (presented in section 2.1) in order to ensure conformance and consistency between them.
- Systematic approaches to training do not provide explicit guidance for the design, development and implementation of training programs that take into account the interaction techniques that

the users will have to master, as well as the specific tasks that the operators have to perform in case of adverse events such as failures or errors. We highlighted how our model-based approach enables to develop training programs with sessions that deal with specific and detailed user actions (presented in section 2.2).

- Systematic approaches to training (and training development in general) do not address the gap between the design and development of critical interactive systems that will be operated and the design and development of the associated training devices (computer-based simulators) implemented for the training program. We proposed to bridge this gap by ensuring consistency between artefacts produced during the critical interactive system design and development (task and system specification), and artefacts produced during the design, development and implementation of the training program (presented in section 2.3).

2. Contributions to the identified problems

Our contributions rely on the ISD approach (which stands for Instructional System Development), which one, among existing systematic approaches to training, is generic and detail the main phases that have to be followed to systematically develop a training program. These main phases are: Analysis, Design, Development, Implementation and Evaluation which forms the acronym ADDIE (Branson, Rayner, Cox, & Furman, 1975) used to refer to it. We used this approach because it synthesizes the main steps of a systematic approach to training and because it can be applied in all application domains.

- 2.1. Provide support for checking the conformance and consistency between user tasks, system behaviour and training program

Systematic approaches to training are particularly well adapted to command and control systems and their operations as the list of operators' tasks are typically complex and involve possible critical consequences. Due to that complexity, model based approaches are particularly well suited as they make it possible to designers to describe in a complete and unambiguous way behavioural and data aspects. In particular, we have shown that task models, operational procedure models and system models provide support for several phases of the ADDIE process and of several steps in these phases (Martinie C. , Palanque, Navarre, & Winckler, 2010) (Martinie C. , Palanque, Navarre, Winckler, & Poupart, 2011). Figure 21 details in what steps and phases task models and system models provide support to training program development. In our contributions, operational procedures models were produced using the ICO notation.

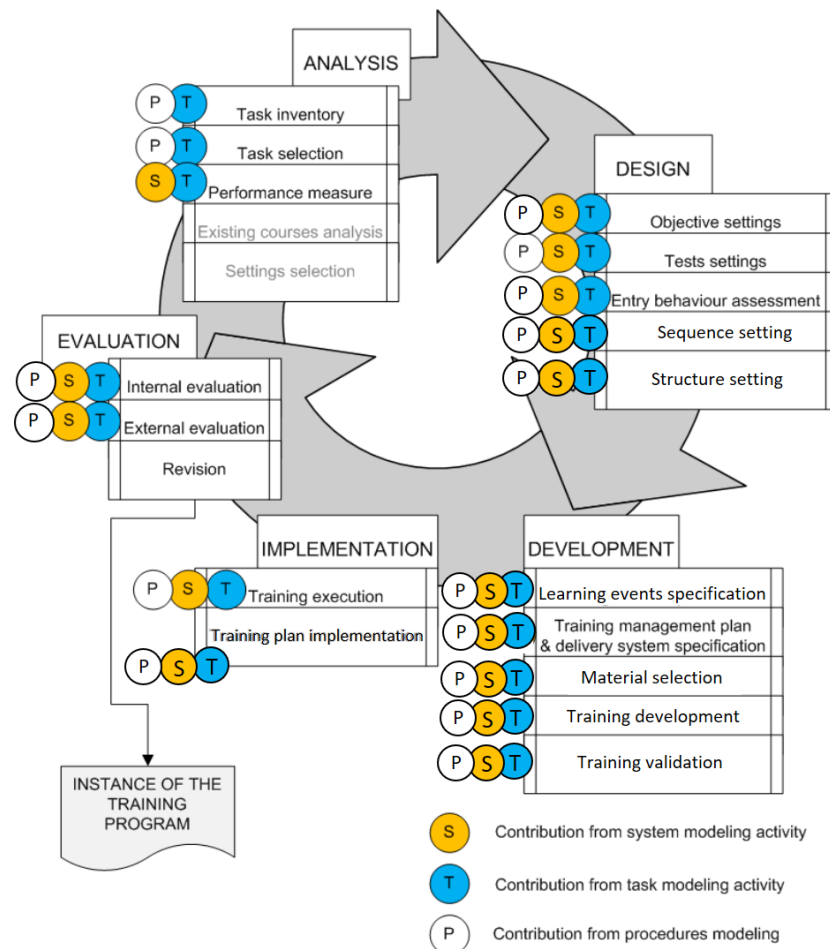

Figure 21. Steps of the ADDIE systematic approach to training supported by the use of task and system models

2.2. Provide support for systematic development of training programs that deal with specific user actions

How operators can be trained to overcome systems failures or human errors that may occur is of prime importance in the area of safety critical systems. We proposed to use task and system models to handle both normative situations (as presented in previous section) together with situations including adverse events (such as failures, operators' errors or environmental variations) (Martinie C., Palanque, Navarre, & Barboni, 2012). This contribution aims to provide support for preparing training sessions that deal with how to recover from system faults or human error and that are based on the exact behaviour of the systems that the users will operate. In particular, we proposed to use the means for attaining dependability (Avizienis, Laprie, Randell, & Landwehr, 2004) as a conceptual background to ensure that the training program takes into account each possible type of recovery procedures that the trainee has to learn.

Training programs development focus on the main goals and tasks that the trainee has to learn. Interaction techniques can be independent from the main goal and can be overlooked during the development of the training program. In the ADDIE approach, there is not explicit reference to the design and development of a part of the training that would be dedicated to the interaction techniques. Interaction techniques are usually designed in order to reduce error rate and to improve operations (by increasing number of commands triggered by the operators and the quantity of information to be presented to the operator by the interactive system). However, if operators are not familiar with these interaction techniques this envisioned improvement might in the end result in performance degradation.

We proposed to use task and system models to prepare training on interaction techniques (Martinie C. , Palanque, Navarre, Barboni, & Poupart, 2012). Figure 22 depicts the main steps to take into account interaction techniques during the design of the training.

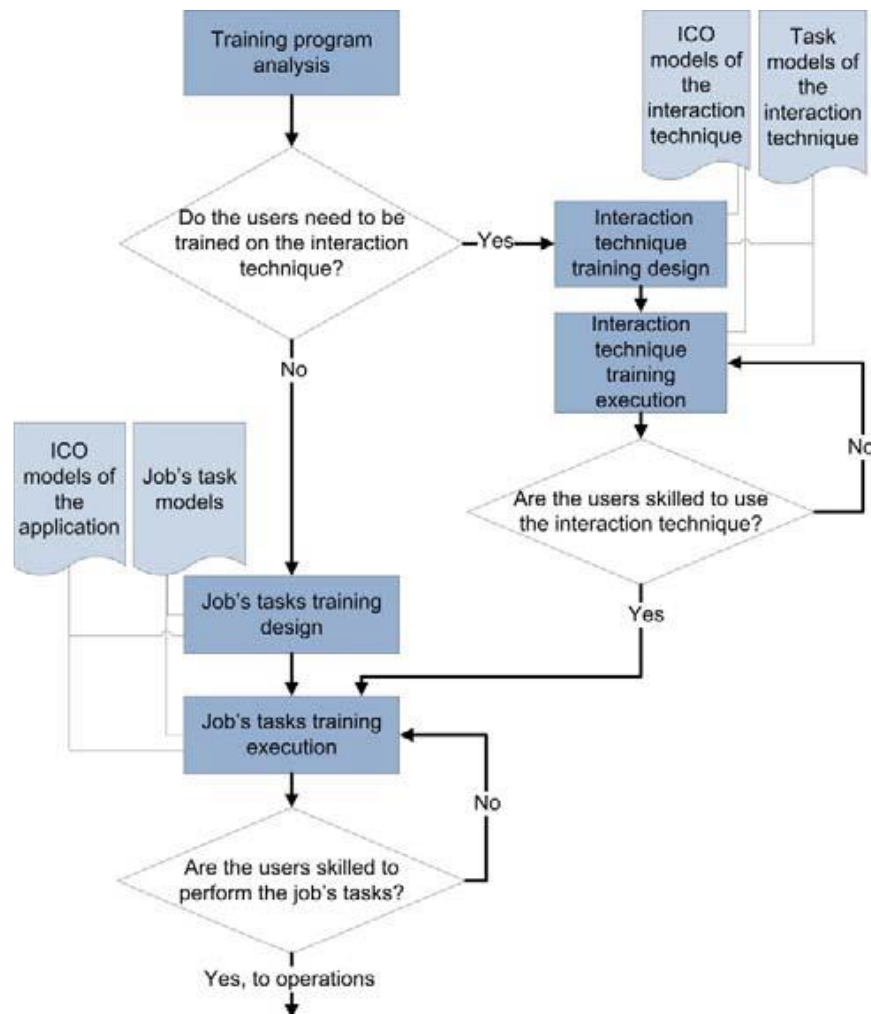

Figure 22. Integration of the development flow of the training for the required interaction techniques (from (Martinie C. , Palanque, Navarre, Barboni, & Poupart, 2012))

- 2.3. Provide support to ensure consistency between artefacts produced during the development of the system and artefacts produced during the development of the training program

On one side, operators of critical systems have not always been trained on the systems they are going to use. In best cases, they have been trained on simulators of real systems that mimic the expected system's behaviour. On the other side, the system development process stands apart from the training program development process. The artefacts produced during the system development process can be meant to be reused for the development of another version of the same system but are not explicitly meant to be used for other development activity. We proposed that models produced during the design and development of the system are an explicit input of the training program development process (Martinie C. , 2011) (Martinie, Palanque, Navarre, & Poupart, 2012). We also proposed that potential issues detected during the development of the training program are an explicit input (return link) to modify the design of the system being built. The integration of the training program development within the systems development process aims to provide a unique opportunity to deliver timely and with an optimal match both a system and its training material.

3. Related PhD supervisions and collaborations

The integration of training program development with design and development of critical interactive systems was one of the main topic of my PhD. We have been continuing this work a few years after the end of my PhD but, after this period, we did not supervise PhD or post-doc students on this topic.

Since 2017, we are collaborating with Lucio Davide Spano, associate professor in HCI at the University of Cagliari in Italy. We study the relevance and feasibility of combining the use of tasks models and augmented reality technologies to support training activities of both trainees and instructors (explained in section 1.4 in Chapter 7).

4. Case studies

Thanks to the Circus IDE (that integrates the HAMSTERS task modelling software environment and the PetShop IDE as well as a software component to support the mapping and co-execution between task models and system models), the presented contributions have been applied to the industrial case studies that are listed in Table 12 (the projects for which these case studies have been implemented are described in Annex B – Projects). I was in charge of coordinating and supervising the application of the contributions to these industrial case studies.

Table 12. Examples of application of the contributions on training to large scale case studies

Case study / Project name and period	User type	Training sessions main tasks	Scenarios	Applied contributions	Associated publication(s)
Weather radar command and control application DISPLAY System (Airbus) (2011-2015)	Aircraft pilot / Manage display of weather information	Manage weather radar	Set weather radar ON, set weather radar OFF, Change tilt angle	- Provide support for checking the conformance and consistency between user tasks, system behaviour and training program	(Martinie C. , 2011)
Picard Tortuga (CNES) (2010-2011)	Low Earth Orbit (LEO) Ground segment operators	Manage Telemetry failure, manage Sun Array Driver failure	Identify Sun Array Driver Failure Switch to redundant Sun Array Driver Abort switching to redundant Sun Array Driver	- Provide support for checking the conformance and consistency between user tasks, system behaviour and training program - Provide support for systematic development of training programs that deal with specific user actions - Provide support to ensure consistency between artefacts produced during the development of the system and artefacts produced during the development of the training program	(Martinie C. , Palanque, Navarre, & Winckler, 2010) (Martinie C. , Palanque, Navarre, Winckler, & Poupard, 2011) (Martinie C. , et al., 2011) (Martinie C. , Palanque, Navarre, & Barboni, 2012)

For the Picard case study, we had to transform existing software that simulates the Picard satellite behaviour and to integrate it within our modelling and development environment. This integration was needed to enable the preparation and setup of computer-based training sessions. The simulator of the Picard satellite has its own control interface that can be manipulated by the instructor at the same time as the trainee is operating the high-fidelity prototype of the ground segment applications. In this way, the instructor can trigger events in the satellite (such as failures), and the trainee has to recognize the issue, remember the procedure to apply and apply it. Figure 23 provides an overview of the setups for

a) the training sessions preparation by the instructor and b) the implementation of a training session with a trainee and the instructor who controls the simulator.

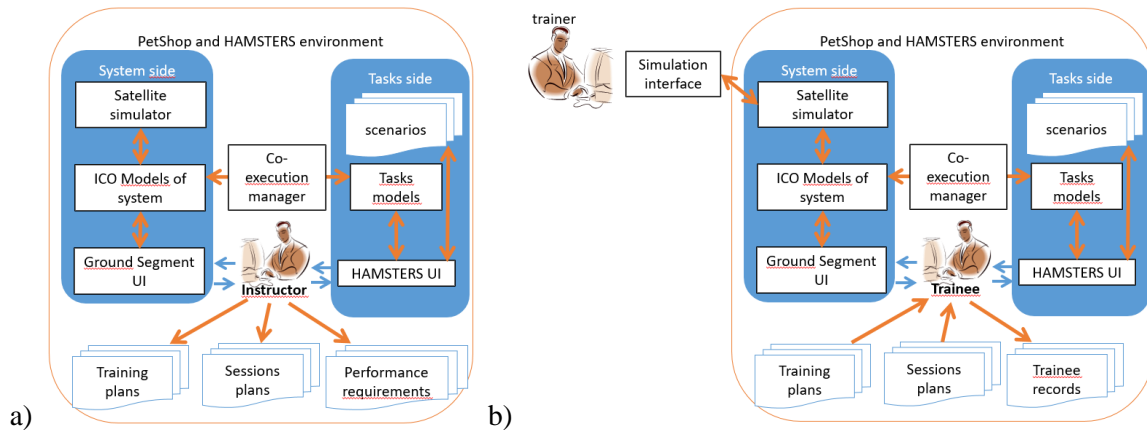

Figure 23. Overview of the a) training preparation setup and of the b) training session implementation with the Petshop and HAMSTERS integrated modelling and development environment

When preparing a training session (summarized in Figure 23 a)), the instructor selects a set of scenarios to be performed by the trainee to reach objectives in term of skills and knowledge to be acquired. Figure 24 presents a screenshot of the module that provides support for preparing a training session.

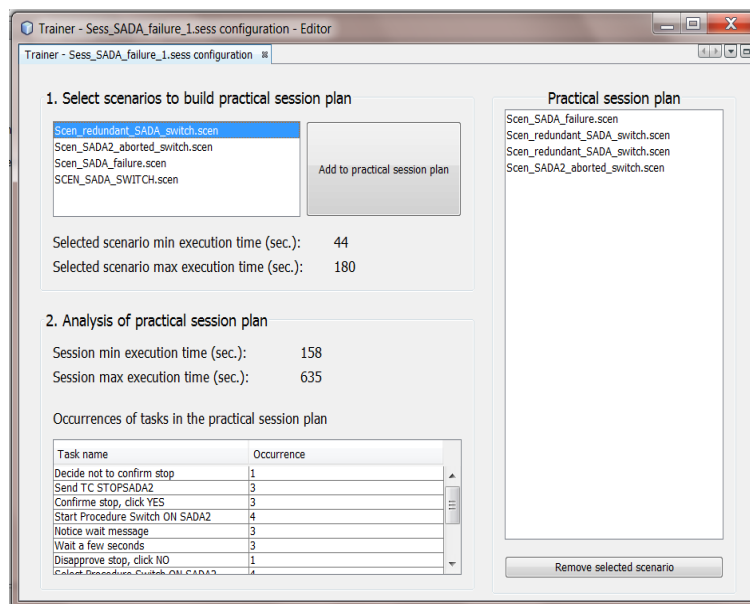

Figure 24. Screenshot of the the instructor module that provide support for preparing the content of a training session

During a training session (summarized in Figure 23 b)), the trainee is guided through an interactive application (depicted in Figure 25) that helps her/him to learn and to perform the tasks.

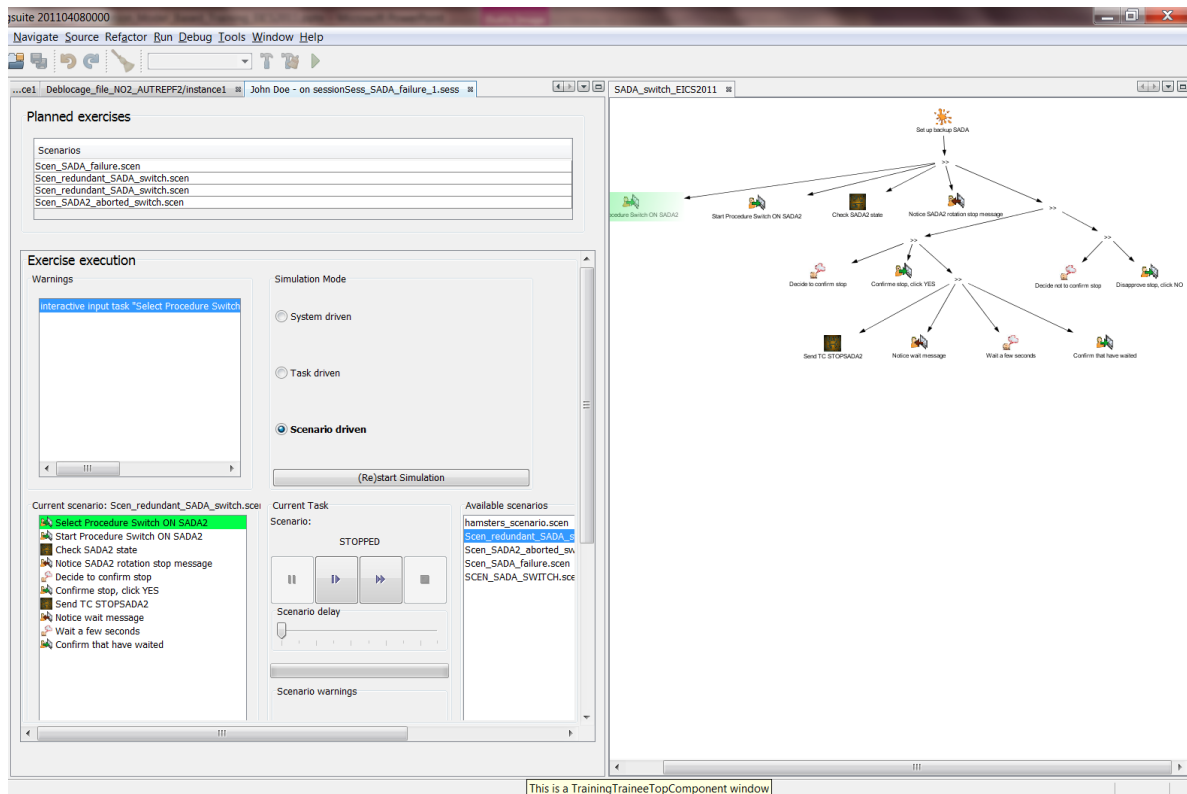

Figure 25. Screenshot of the trainee module that provides guidance to learn and to perform the tasks

Chapter 5 Standards and development processes

Standards aim to guarantee a specified level for target properties (e.g. safety) to be matched by systems, software and by their deployment in operational context. Standards are specifications that may target system and software design and development processes (e.g. Certification Specification 25 for large aeroplanes (CS 25 EASA, 2017)) or that may target their operators (e.g. regulation of required capabilities and training for air traffic controllers (EU 2015/340, 2015)).

Design and development processes are means to reach specified levels for target properties. They are composed of systematic and stepwise activities to engineer the different aspects of the systems and software (e.g. requirements analysis, safety analysis, software design, user interface design, software development, software testing...) and of how they will be operated in the context of critical LSSTS (e.g. human reliability analysis, training design...). For example, development processes such as the waterfall process (Royce, 1970) and the V cycle process (McDermid & Ripken, 1983) provide support to take into account the reliability property as they aim “to build the system right” (Boehm, 1986) but they fail in taking into account the usability property (i.e. “to build the right system”). User Centred Design (UCD) approaches aim to target the usability and user eXperience properties but UCD do not explicitly address the whole development process for an interactive system (Göransson, Gulliksen, & Boivie, 2003).

The design and development of critical LSSTS and their deployment within an organisational context for safe operations actually requires the application of several processes, each one aiming to target one or several properties. In addition, there are a lot of existing stepwise activities to engineer the different aspects of the operating of an interactive critical system in the context of critical LSSTS. Some of them have common steps and common types of manipulated data. For example, one of the first steps of user centred design approaches is to analyse the user and her/his needs. Task analysis is part of this step and will produce task description or task models. Task analysis and its output task descriptions are also required to perform a human reliability assessment during risk assessment processes. And, as explained in previous chapter (Chapter 4), task analysis is one of the first steps of training program development processes as task descriptions are then needed to prepare and execute training sessions.

1. Position statement and list of identified important problems

The design and development of the various elements of critical LSSTS (e.g. critical interactive systems, training, automation...) are partitioned because they target specific properties (e.g. reliability, usability...) and whereas they may have common steps and common types of manipulated data (e.g. operators' tasks). We argue that to integrate these processes could enable to take into account all the properties in an even way. However, the integration of all required processes for the design, development of large scale critical interactive systems and for their deployment in operational context has to be carefully managed as its relevance and feasibility have to be studied too. We have thus started to conduct this research direction by studying the feasibility of integrating sets of processes that we found relevant to integrate according to the problems that could be solved by performing this integration. Each of the sub-sections presented in section “2. Contributions” in this chapter summarizes the work we performed to investigate the following problems:

- Whereas there are on one side human factors techniques to analyse the potential impact of human errors on operations (Bell & Holyroyd, 2009), and on the other side system safety techniques to avoid or to deal with potential system failures (Avizienis, Laprie, Randell, & Landwehr, 2004), there are few existing techniques to take into account the impact of both potential human errors and system failures on operations. Those few techniques do not provide

explicit support to analyse how complex the recovery task might be (Philipart, 2018). We proposed a process for the integrated identification and modelling of potential human errors and system failures as well as of the detailed actions needed to recover from the identified errors and failures (presented in section 2.1).

- Critical interactive systems are developed apart from the training programs for operators that will use these systems to accomplish their mission within a critical LSSTS, whereas they are both centred around operators' activities. We proposed a development process that integrates the design and development of the critical interactive system with the design and development of the associated training program (see section 2.2).
- User Centred Design approaches do not provide explicit support to design and develop command and control applications of complex systems. The gathering of user needs and the evaluation of how the interactive applications fulfil these needs provides support for reaching usability objectives but do not provide support to inform the design and development of the system information that should be presented to the operators (e.g. information about the devices being operated, about their possible states and about the output of their possible combinations). We proposed a design process for command and control applications of complex systems that integrates User Centred Design approaches with a process for the exhaustive identification of the generic information about the systems that are monitored and controlled and their associated possible states (presented in section 2.3).
- Several types of approaches have been proposed to understand socio-technical systems, one of the most advanced being the Cognitive Work Analysis (Vicente, 1999) framework. However, existing approaches do not provide explicit support to analyse the impact of a variation of performance of one element of a critical LSSTS (e.g. system failure, human error) on its global performance. We proposed a model-based process to model and analyse performance, and in particular the resilience property, of a critical LSSTS in order to provide insights for the re-design of partly-autonomous systems within a critical LSSTS (presented in section 2.4).

2. Contributions to the identified problems

We proposed to integrate part of or whole development processes that are relevant for the engineering of critical interactive systems and of critical LSSTS. This would enable to better take into account socio-technical aspects of the use of the produced interactive critical system. In each of the proposed contribution, the models-based aspect of the activities led during the process is very important as it is a mean to integrate the different steps of the process. Furthermore, whereas the contributions may be applied with different modelling notations than the one who have been used to prove the concepts, the expressiveness of the selected notation is a prerequisite to be able to fully apply the proposed processes.

- 2.1. Provide support for systematic identification of human errors and for taking into account both human errors and system failures at design time

During the process of design and development of critical interactive systems, human errors are implicitly taken into account (as discussed in 2.4 in Chapter 1). In the discipline of human factors, many techniques have been proposed for the identification of which human errors may occur in a particular context and what could be their consequences in this given context (Bell & Holyroyd, 2009). Most of the human reliability assessment techniques are based on task analysis and have the common steps of, first, systematically identifying user tasks and then assess for each task if an error could occur. Such techniques are applied on existing systems and the output of their application is recommendations to modify procedures, training and/or system. We proposed to extend the HET technique (Stanton N. , et al., 2006) by replacing task descriptions with HAMSTERS task models and by adding steps of identification of potential errors that are related to the refined types of tasks and of knowledge that are

part of the HAMSTERS notation (Fahssi, Martinie, & Palanque, 2015) (Fahssi R. , 2018). The representation of user errors in task models is also an extension of the HET technique (presented in 2.4 in Chapter 1). Both of these contributions have been integrated in a process named TASSE (Fahssi R. , 2018), that aims to explicitly take into account possible human errors, human task deviations and their severity for the design of interactive systems.

System failures may also occur while a system is in operation. However, system failures and human errors are generally addressed by different communities and analysed in an independent way, even though both contribute to the dependability level of the socio-technical system under consideration. In the fields of dependable computing and system safety, one can find fault taxonomies, methods for identifying system faults, methods to analyse their potential impacts, and techniques to remove them (Avizienis, Laprie, Randell, & Landwehr, 2004). In several application domains (such as aeronautics, aerospace, and automotive industry), these dependable computing techniques are applied using an approach, which is based on Failure Modes, Effects, and Critical Analysis (FMECA) (MIL-STD-1629A, 1980). FMECA is a risk identification technique that focuses on the system components. It is defined as “a procedure or technique to analyze each potential failure in a system to determine the results or effects thereof on the system and classify each potential failure mode depending to its severity.” Depending on the classification of the potential failure modes with their associated severity, different development processes as well as selected means (e.g. fault tolerance, fault removal...) are applied to guarantee a predetermined level of reliability. Fault trees (Salmon, et al., 2011) techniques provide support to describe the combination of system failure and human errors but they do not provide support to analyse how complex the recovery task might be (Philipart, 2018).

In order to taken into account both possible system failures and human errors during the process of design and development of critical interactive systems, we proposed to integrate the analysis of both system failures and human errors in a task model-based stepwise process (depicted in Figure 26) for informing interactive system design about the cost of recovery when human errors and/or system failures occur (Martinie C. , et al., 2016).

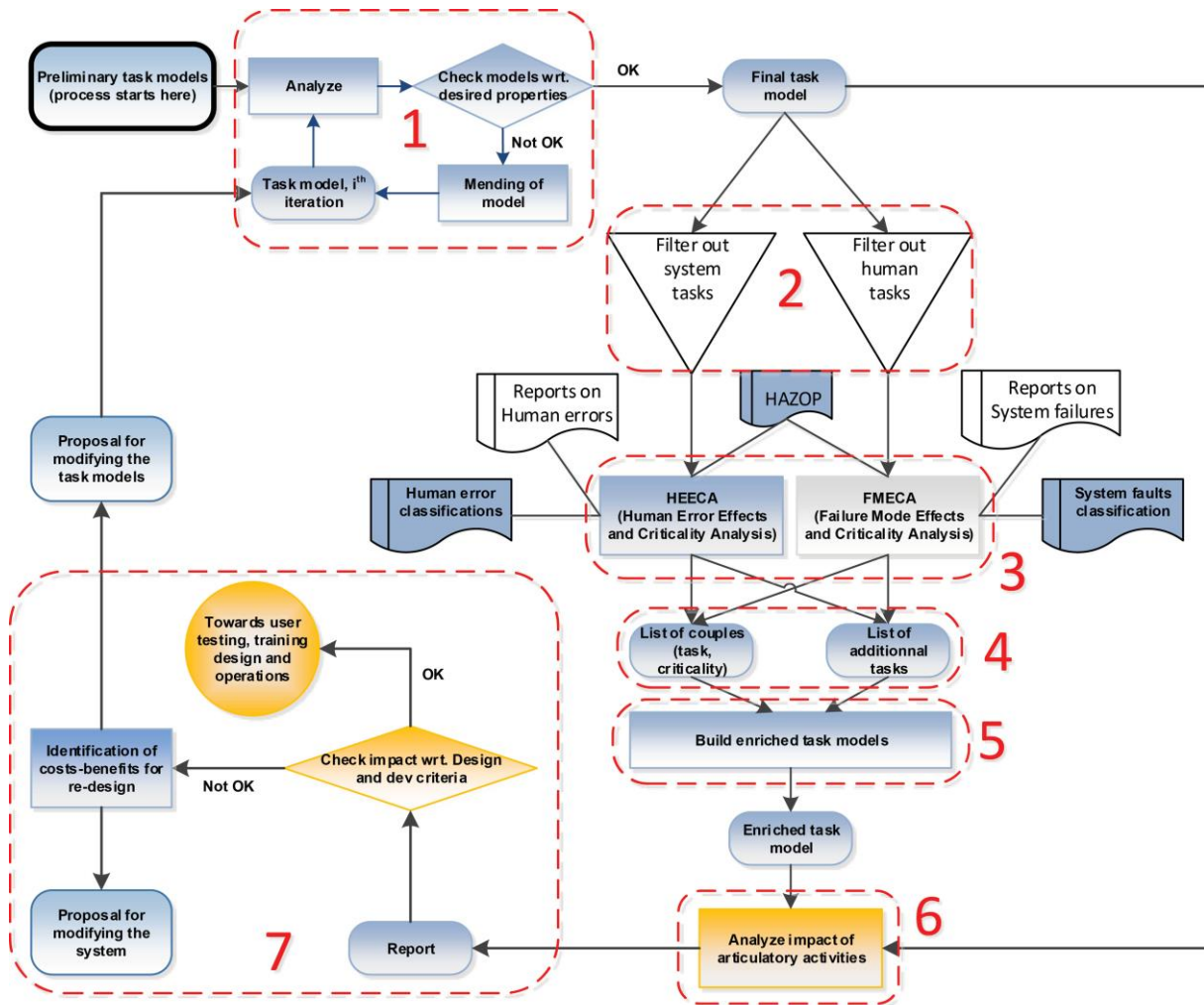

Figure 26. Process to account for system failures and human errors during the design and development of an interactive critical system

2.2. Provide support for the systematic integration of the design and development of critical interactive systems with their associated training program

Training program development is designed independently from the system development. This may lead to operators trained with non-optimal means (e.g. computer-based simulators that do not behave exactly in the same way as the system they will operate or simulators embedding partial sets of existing functions). In addition, interactive system design and training design both require to analyse the tasks the users will perform with the system. We proposed to integrate both interactive system design development process with training development process (depicted in Figure 27) in order to ensure consistency and conformance between the deployed interactive system and the associated training (Martinie C. , 2011) (Martinie C. , Palanque, Navarre, & Barboni, 2012). This development process is independent from the techniques that can be used to perform its steps (e.g. task analysis, prototyping...). However, the use of tool supported model-based techniques presented in the previous chapters enables to take advantage of their benefits, and in particular to ensure consistency between all of the artefacts produced during the development process (presented in section 2.3 in chapter 4).

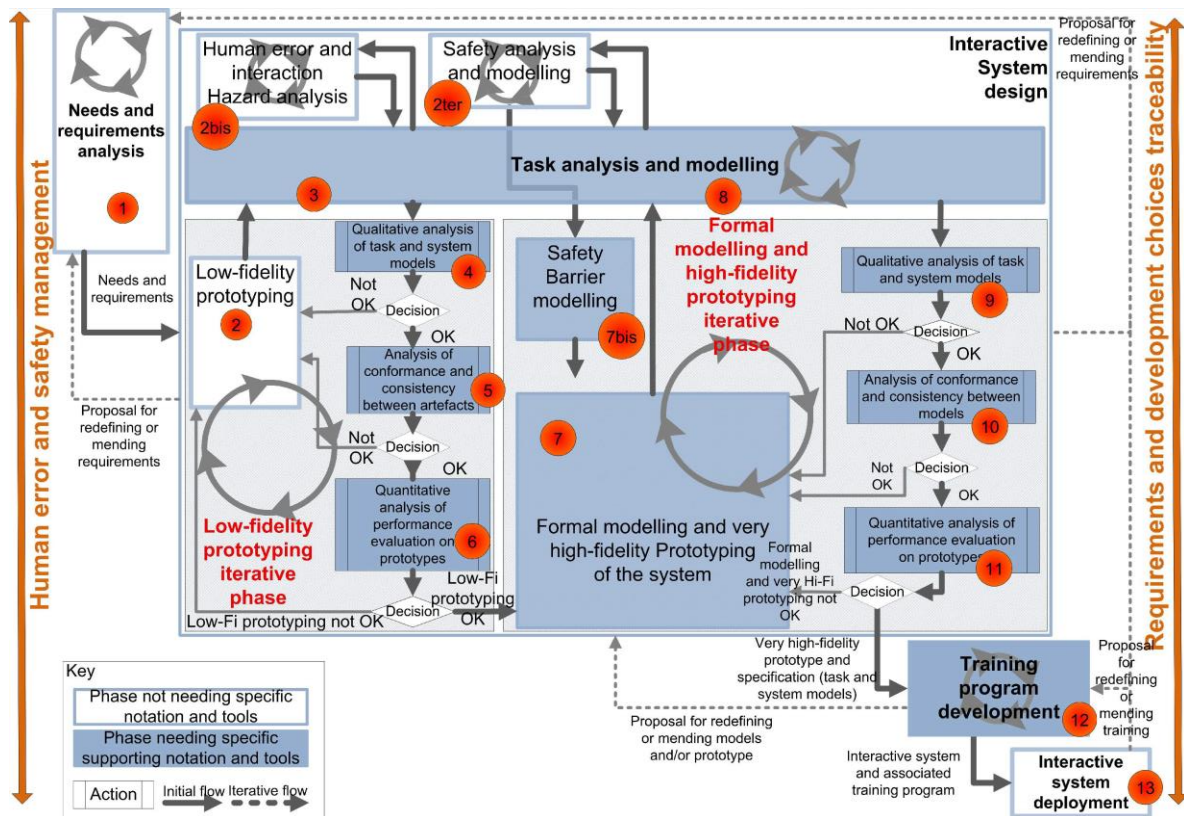

Figure 27. Development process for an interactive critical system and its associated training program

2.3. Provide support for the design and development of complex command and control applications

User Centred Design processes (International Standard Organisation, 2019) target the design of usable interactive systems and promote the inclusion of real users in various development phases from early needs identification and design until evaluation and deployment. UCD approaches are flexible but are still far from being adequate for the design and evaluation of command and control systems in general, and critical ones in particular. For instance, cockpit design by aircraft manufacturers and suppliers is performed jointly with Human Factors experts (with a deep knowledge about operators’ tasks and environmental conditions) and test pilots (with a deep knowledge about missions and platform systems) (Singer, 2001). This is required as command and control systems centralize information from multiple underlying systems to support operators in the performance of their mission. Beyond the mission itself (that may be complex), operators must also ensure the correct functioning of these systems (often called platform). This does not mean engaging repair activities but shutting down a faulty system or starting a redundant one (Singer & Dekker, 2000). However, when dealing with command and control that supports activities dedicated to the management of the platform, those user interfaces need to present and organize information from the underlying complex devices and technological elements. Understanding those devices and abstracting away information about their behaviour in order to allow operators to manage them, requires deep system knowledge, far beyond the average knowledge of UI/UX designers and UCD methods experts’. We proposed a process named the “clover process” that aims to cover the properties required for C&C systems: feasibility, usability, dependability and safety (Bouzekri E. , Canny, Martinie, Palanque, & Gris, 2019). It is composed of three different sub-processes (depicted in Figure 28): The System Centred Design (SCD) process, the User Centred Design (UCD) process and the Regulator Centred Design (RCD) process. The system-centred process (that aims to complement UCD approaches) is dedicated to the design of command and control systems. That process takes as input the detailed functioning of underlying systems and provides abstract and structured

information to inform the UCD of command and control systems. As UCD approaches target at improved usability, our integrated process targets at feasibility as relevant additional and required property. The RCD process aims to set dependability and safety properties and to verify them.

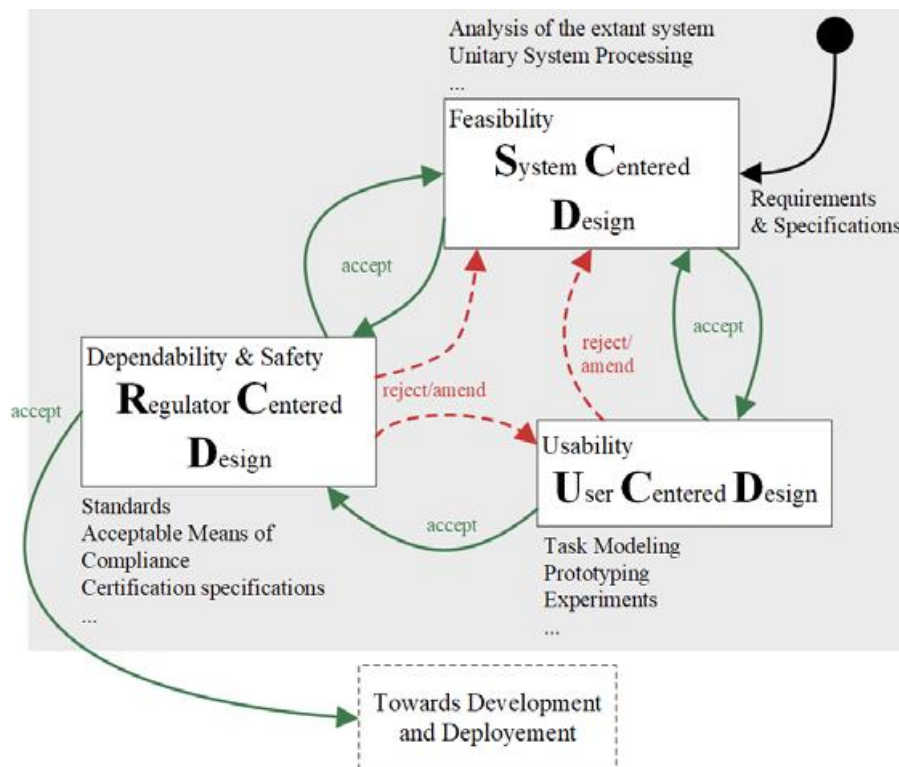

Figure 28. The clover process for the design and development of command and control application for complex systems from (Bouzekri E. , Canny, Martinie, Palanque, & Gris, 2019)

2.4. Provide support for the re-design of partly autonomous interactive systems in critical LSSTS Adverse event including potential automation degradation, interaction problems between their interactive systems and the operators, and human errors may negatively impact the performance of the critical LSSTS in which the issue occurred. These issues may affect several aspects of the performance of critical LSSTS such as resources, time in tasks performance, ability to adjust to environment. The analysis of performance of socio-technical systems requires support for describing (modelling) and structuring a large amount of information, but also be able to address the variability of each of STS elements as well as the variability related to their interrelations.

Existing processes and approaches, such as CWA (Vicente, 1999) and FRAM (Hollnagel E. , 2012), focus on the description of the relationships between the elements composing the socio-technical system. They do not explicitly provide support (neither dedicated steps in the process, nor identified notation) for describing the behaviour of each element composing the socio-technical system. We proposed a process for analysing the impact of a variation of performance of a partly-autonomous interactive systems on a socio-technical system (Ragosta, 2015) (Ragosta, Martinie, Palanque, Navarre, & Sujan, 2015). This process is model-based and integrates the FRAM method with the ICO and HAMSTERS modelling techniques in order to model the actions of the human involved in the STS (using HAMSTERS), the behaviour of the partly-autonomous interactive systems operated by the humans and their functions (using ICO), as well as the relationships between the actions performed by the human and the functions performed by the partly-autonomous interactive systems (using FRAM). The detailed description of human actions and partly-autonomous interactive systems behaviour deepen the analysis of the potential issues that may occur and the FRAM model enables to analyse the consequences of such

potential issues on the whole the socio-technical system. From this analysis, it is possible to propose recommendations for re-design.

3. Related PhD supervisions and collaborations

Figure 29 depicts the timeline for the co-supervision of the students that I have been co-supervising for the contributions on engineering command and control systems and critical interactive systems.

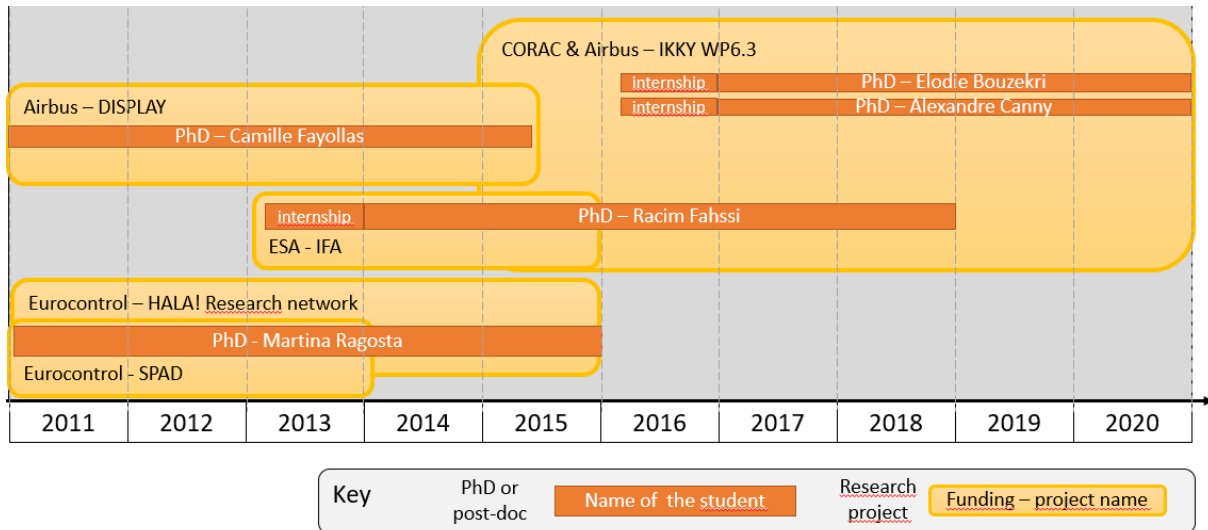

Figure 29. Timeline of supervision of PhD students for the contributions related to the processes for systematic design and development of critical interactive systems

Table 13 presents the detailed view on the relationships between the contributions, the supervised PhD students and the associated project(s).

Table 13. Contributions on operators and their tasks that result from the co-supervision of PhD students and/or of post-doctoral students

PhD student and/or post-doc	Start and end dates for the PhD	Topic of the PhD or post-doc	Contribution(s) on operators and their tasks issued from the co-supervision of PhD or post-doc	Associated project(s)
Martina Ragosta (PhD)	2011-2015	Models based approach for the analysis and modelling of usable and resilient partly autonomous interactive systems	Provide support for the re-design of partly autonomous interactive systems in critical LSSTS	SPAD (Eurocontrol)
	Associated publication	- Ragosta, M., Martinie, C., Palanque, P., Navarre, D., Sujan, M.-A. 2015. <i>Concept Maps as a Glue for Integrating Modeling Techniques for the Analysis and Re-Design of Partly-Autonomous Interactive Systems. International Conference on Application and Theory of Automation in Command and Control Systems (ATACCS 2015)</i> , 41-52, ACM.		
Camille Fayollas (PhD)	2011-2015	Models-based approach for the dependability of critical interactive systems	Provide support for systematic identification of human errors and for taking into account both human errors and system failures at design time	DISPLAY System (Airbus)
	Associated publication	- Martinie, C., Palanque, P., Fahssi, R. M., Blanquart, J.-P., Fayollas, C., Seguin, C. 2016. <i>Task Model-Based Systematic Analysis of Both System Failures and Human Errors. IEEE Transactions on Human-Machine Systems</i> , 46, 243-254, IEEE.		
Racim Fahssi (PhD)	2014-2018	Systematic identification and description of human errors in task models	Provide support for systematic identification of human errors and for taking into account both human errors and system failures at design time	IFA (ESA)
	Associated publication	- Martinie, C., Palanque, P., Fahssi, R. M., Blanquart, J.-P., Fayollas, C., Seguin, C. 2016. <i>Task Model-Based Systematic Analysis of Both System Failures and Human Errors. IEEE Transactions on Human-Machine Systems</i> , 46, 243-254, IEEE.		
Elodie Bouzekri (PhD student)	2017-20xx On-going	Model-based approaches for the description, analysis, and design of automation in command and control systems	Provide support for the design and development of complex command and control applications	IKKY WP6.3 (CORAC and Airbus)
	Associated publication	- Bouzekri, E., Canny, A., Martinie, C., Palanque, P., Gris, C. 2019. <i>Deep System Knowledge Required: Revisiting UCD Contribution in the Design of Complex Command and Control Systems. IFIP TC 13 International Conference on Human Computer Interaction, INTERACT 2019</i> , 699-720, Springer.		
Alexandre Canny (PhD student)	2017-20xx On-going	Model-based generation of test cases for validation of interactive systems	Provide support for the design and development of complex command and control applications	IKKY WP6.3 (CORAC and Airbus)
	Associated publication	- Bouzekri, E., Canny, A., Martinie, C., Palanque, P., Gris, C. 2019. <i>Deep System Knowledge Required: Revisiting UCD Contribution in the Design of Complex Command and Control Systems. IFIP TC 13 International Conference on Human Computer Interaction, INTERACT 2019</i> , 699-720, Springer.		

We needed the expertise of colleague researchers for specific topics. Table 14 presents the researchers with whom we have collaborated for specific contributions.

Table 14. Contributions on command and control systems and on interactive systems that results from the collaboration with other researchers

Researcher	Period of the collaboration	Background of the researcher	Contribution issued from collaboration	Associated publication
Christel Seguin, Research engineer, ONERA	2012-2014	Dependable computing	Provide support for systematic identification of human errors and for taking into account both human errors and system failures at design time	(Martinie C. , et al., 2016)
Jean-Paul Blanquart, Engineer, Airbus Defence and Space	2012-2014	Dependable computing	Provide support for systematic identification of human errors and for taking into account both human errors and system failures at design time	(Martinie C. , et al., 2016)
Mark Suján University of Warwick, Coventry, UK	2011 - 2015	Safety and human factors engineering	Provide support for the re-design of partly autonomous interactive systems in critical LSSTS	(Ragosta, Martinie, Palanque, Navarre, & Suján, 2015)

4. Case studies

Thanks to the Circus IDE (that integrates the HAMSTERS task modelling software environment and the PetShop IDE as well as a software component to support the mapping and co-execution between task models and system models), the presented processes have been applied to the industrial case studies that are listed in Table 15 (the projects for which these case studies have been implemented are described in Annex B – Projects). I was in charge of coordinating and supervising the application of the contributions to these industrial case studies.

Table 15. Application of the contributions on processes for systematic design and development to large scale case studies

Case study / Project name and period	Targeted application / user(s)	Process(es) applied	Produced artefacts	Applied contributions	Associated publication(s)
Picard Tortuga (CNES) (2010-2011)	LEOP Ground segment procedure manager and synoptics/ Controllers	Development process for an interactive critical system and its associated training program	- Task models (“Manage satellite platform”) - High-fidelity prototypes of procedure manager and of synoptics - HEECA tables for the procedure manager - design options using human error avoidance techniques - training sessions for Managing Telemetry failure and for managing Sun Array Driver failure	- Provide support for systematic identification of human errors at design time - Provide support for the systematic integration of the design and development of critical interactive systems with their associated training program	(Martinie C. , et al., 2011) (Martinie C. , Palanque, Navarre, & Barboni, A Tool-Supported Training Framework for Improving Operators: Dependability Confronted with Faults and Errors (regular paper), 2012) (Martinie C. , et al., 2016)
Change route SPAD (Eurocontrol) (2011-2013)	Weather radar configuration/ Cockpit crew members	- HET extended - Process for analysing the impact of a variation of performance of a partly-autonomous interactive systems on a STS	- Task model (“Manage weather radar application”) - Task model enriched with potential human errors - Weather radar application High-fidelity prototype - FRAM model	- Provide support for systematic identification of human errors at design time - Provide support for the re-design of partly autonomous interactive systems in critical LSSTS	(Fahssi, Martinie, & Palanque, 2015) (Fahssi R. , 2018)
Operational states and Recommendations for the management of alarms IKKY WP6.3 (CORAC and Airbus) (2015-2019)	Flight Warning System in commercial aircrafts / Cockpit crew members	System Centred Design	- DSCU and OCQR conceptual representations for APU, FPS, Bleed, Electricity, Engine, Fuel - Behavioural models (ICO) - Presentation layouts	Provide support for the design and development of complex command and control applications	(Bouzekri E. , Canny, Martinie, Palanque, & Gris, 2019)

Figure 30 summarizes the workflow we have been through for the application of the System Centred Design process to the devices APU (Auxiliary Power Unit), FPS (Fire Protection System), Bleed, Electricity, Engines, Fuel of a civil aircraft cockpit. Extracts of the artefacts produced during the application of this process are presented in the last sub-section in section 2.5 in Chapter 2. This process has been applied in collaboration with a Flight Warning System (FWS) expert and with Cockpit Display System (CDS) expert.

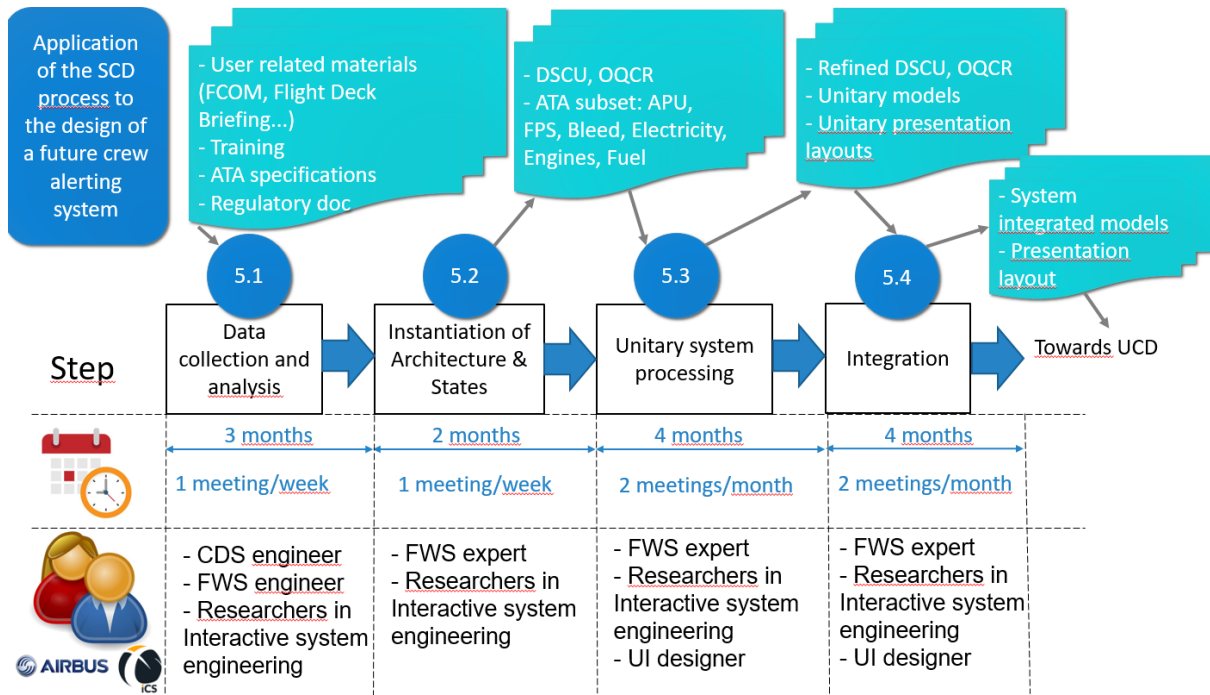

Figure 30. Timeline for the application of the System Centred Design process on the Flight Warning case study

Chapter 6 Synergies between the models of the views on critical LSSTS

The approach to combine views or models offering different perspectives of the system under study and analysing them at different levels of granularity is not new. A widely used approach following this philosophy is UML (Rumbaugh, Jacobson, & Booch, 2004) exploiting nine different models/notations for describing data intensive software. Another one is SysML (Friedenthal, Moore, & Steiner, 2011) that has been designed in order to introduce a broader (system oriented) perspective to UML resulting in the addition of other models (e.g. a model for describing requirements that was not present in UML). This type of approach targets complex system development but are not suitable to the analysis of socio-technical systems as their focus are the technological views on the system. Cognitive Work Analysis (Vicente, 1999) aims to analyse complex socio-technical systems. It provides support to describe and analyse five different views (work domain, control task, strategies, social organisation and cooperation, worker competencies) on a socio-technical system in order to identify constraints on the work and to analyse how to cope with them (e.g. re-design, training...) (Stanton, et al., 2013). This type of approach targets work analysis and socio-technical aspects of the work, but the views on technological aspects (computing systems, interactive systems) are not completely covered. At last, in the discipline of HCI, approaches using several types of models have been proposed. Their main philosophy is that task and context models are the preliminary source of information and that it is possible to generate an interactive application from such information (while adding other ingredients such as UI guidelines for instance). An example of this type of approach is the CAMELEON framework (Calvary, et al., 2003). The highlighted benefits are that it is possible to generate usable user interfaces for different platforms while reducing the development costs. This approach does not suit to critical LSSTS because it does not deal explicitly neither with the dependability of the systems nor with their deployment within an organisational context for safe operations.

1. Position statement and list of identified important problems

Thanks to the descriptions of the views they help to build, existing approaches provide insights on the characteristics of the views composing the critical LSSTS, as well as on the relationships between the individual characteristics of the views. But they do not provide explicit support for analysing in an even way the views on critical LSSTS and their relationships. In particular, in order to analyse the target properties, we need to be able to understand the potential impact of a runtime action of a system or operator in the context of an organisational procedure on the other systems and operators of the socio-technical system. This capability requires to be able to explicitly identify a possible (or not possible) mapping between each type of element in each type of model of the views, i.e. to systematically and unambiguously interconnect models of different types. The two first sub-sections in the section “2. Contributions” in this chapter presents the result of the work we performed to investigate the following problems related to the interconnection and synergistic use of models:

- Ensuring the effectiveness of users performing their tasks with an interactive application requires to verify that each user action is feasible with the interactive application (e.g. being able to click on a button that is enabled at the appropriate time). Task descriptions contain the information about user actions when using an interactive system but do not contain information about the behaviour of the interactive system. Interactive systems behavioural descriptions (such as state machines or Petri nets) contain information about what should be displayed and available to the user for all of the possible states of the application but do not contain information about which actions will be performed, at what time and in which order. We proposed to make a synergistic use of task models with interactive applications (behavioural models and/or

interactive software) both at edition time and at runtime to provide support for ensuring effectiveness of users performing their tasks with an interactive system (presented in section 2.1).

- The coupling of operators' actions, interactive systems' behaviour and operational procedures in critical LSSTS makes it difficult to identify and isolate problems when they occur, and to detect minor malfunctions that may propagate to the whole critical LSSTS. Existing analysis techniques provide support for describing and understanding different views the critical LSSTS (and on some of their characteristics) but do not provide support for explicitly connecting the type of elements that are described inside these views (e.g. operators' actions with an interactive system function or with another operators' action). We proposed to integrate and to connect different types of elements of different views on critical LSSTS to provide support for analysis of the impact of operators' actions and of interactive systems' state on the whole critical LSSTS (presented in section 2.2).

The synergistic use of models can provide support to several phases of the design and development process of a critical LSSTS. The two last sub-sections in the section "2. Contributions" present the results of the work we performed to highlight the relevance of the synergistic use of models for supporting software testing, training and contextual help at runtime as detailed hereafter:

- Existing techniques for testing usability of interactive system mainly rely on the execution of sequences of user actions generated by models of the interactive system behaviour or of sequences of user actions listed in scenarios. Interactive systems testing artefacts are exploited apart from the user task descriptions and from the models of the interactive systems, whereas they are the reference for verifying effectiveness. We proposed to make a synergistic use of task models, scenarios and interactive application to automate scenario based testing of user interfaces (presented in section 2.3).
- Materials used for training and for contextual help are based on user tasks. They are usually build apart from the interactive system that they aim to support, which may lead to imprecise or wrong interpretation of how the system should behave depending on the performed user action, and thus lead to imprecise or wrong training program and contextual help. We proposed to exploit the synergistic use of task models with interactive applications to the preparation and execution of training sessions as well as to the contextual help at runtime for the user of the interactive application (presented in section 2.4).

2. Contributions to the identified problems

The synergistic use of models requires to identify and to explicitly represent the actions and the behaviour of each view, but also to be able to identify and to explicitly describe the actions and events that have an impact on other views or that are impacted by other views.

2.1. Provide support for ensuring that user goals can be reached with an interactive system

Usability testing is typically a craft process involving high-level expertise evaluators involved in very repetitive testing tasks with multiple end users. As detailed in the introduction usability (ISO 9241 part 11, 2018) is decomposed into three factors: efficiency, effectiveness and satisfaction. Efficiency can be (partly) assessed in a predictive way exploiting high-level models such as GOMS (John & Kieras, 1996). Questionnaires such as SUS (Brooke, 1996) provide efficient ways of assessing users' satisfaction. Effectiveness corresponds to the capability of the interactive application to allow users to reach their goals and to perform their activities. Assessing effectiveness requires assessing (in an exhaustive way) that every goal is reachable and that each activity can be performed on the application.

Task models are a mean to check the coverage of the user tasks that will be feasible with the interactive system. When they contain information about the temporal ordering of user tasks, they are also a mean to check that the right function will be available at the right time for the user. This verification activity can be led by manually reviewing task models and executing tasks on prototypes (task-centred walkthrough) (Greenberg, 2004). In order to take advantage of the information contained in task models, the CAMELEON framework (Calvary, et al., 2003) assumes that task models are the preliminary source of information and that it is possible to generate an interactive application from such information (while adding other inputs such as UI guidelines for instance). The main claim is that with such an approach it is possible to generate effective user interfaces for different platforms thus reducing the development costs. The main drawbacks are that it is difficult to integrate design and craft knowledge in such processes. Another way to connect take advantage of task models for ensuring effectiveness of users with an interactive application is to connect task models with models of the application behaviour, which is a fully model-based approaches (Barboni, Ladry, Navarre, Palanque, & Winckler, 2010) We proposed to extend this approach in the way that the software programmer connects the presentation and dialog of the application with the task models and then checks the co-execution of both sides. We proposed to use this task-system models synergistic framework as a support for assessing the impact of interruptions (unexpected or unplanned activities) on users' effectiveness (Palanque, Winckler, & Martinie, 2011). This task-system models synergistic framework has been extended for groupware applications and demonstrated on a case study of collaborative management of management of collision risks between satellites and space objects (Martinie, et al., 2014).

Producing and exploiting system formal models is time consuming for large scale command and control systems, and all of their parts may not require formal modelling. In addition, all of the interactive applications that are operated within a critical LSSTS may not require to be formally verified. We then proposed to apply a task model- interactive application synergistic approach for interactive applications that are programmed without using models (Martinie, Navarre, Palanque, & Fayollas, 2015). This approach provides support to instrument the code of existing application and to put in correspondence interactive tasks in task models with event handlers and rendering functions in interactive applications. Such connections enable to check the coverage of tasks by the functions available in the interactive application, and to verify at runtime that the right controls are available at the right time and that the right rendering occurs as when expected. The mapping and co-execution between interactive application and task models have been demonstrated on Java applications for which user interface is programme with Java Swing and with Java FX (Martinie, Navarre, Palanque, Barboni, & Canny, 2018). Figure 31 depicts a screenshot of a co-execution step between task models and a flight control unit software application.

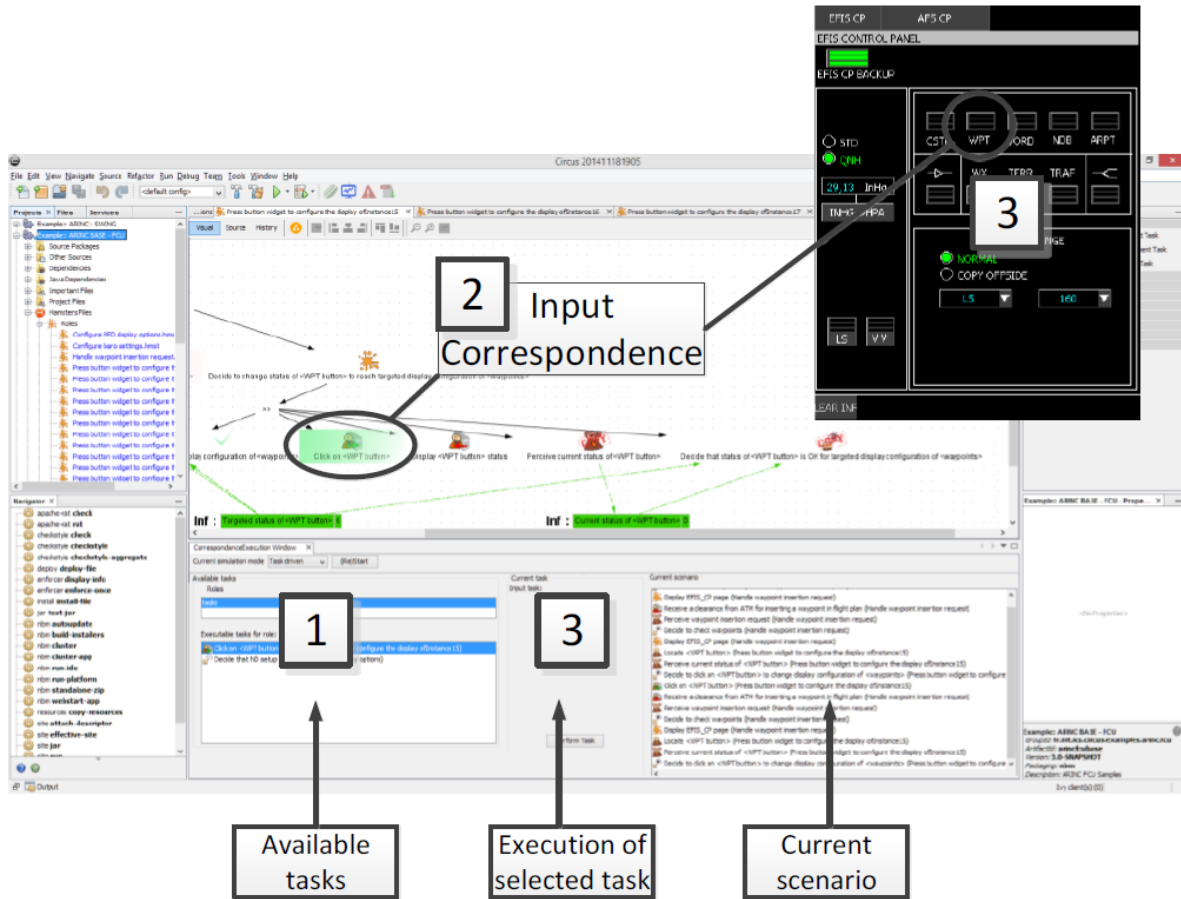

Figure 31. Illustration of a co-execution step between task models and FCU Software application from (Martinie, Navarre, Palanque, & Fayollas, 2015)

All of the parts of critical interactive systems do not require the same level of design assurance and an interactive critical system may be the integration of components that require formal modelling techniques with components that do not require formal modelling. We proposed to apply a synergistic approach for interactive applications programmed with both formal models and interpreted textual programming language (Fayollas C. , Martinie, Navarre, & Palanque, 2016). Depending on the expected level of reliability and on the resources allocated for the development of the different parts of the critical LSSTS, the relevant stakeholders may choose the appropriate type of combination (as depicted in Figure 32).

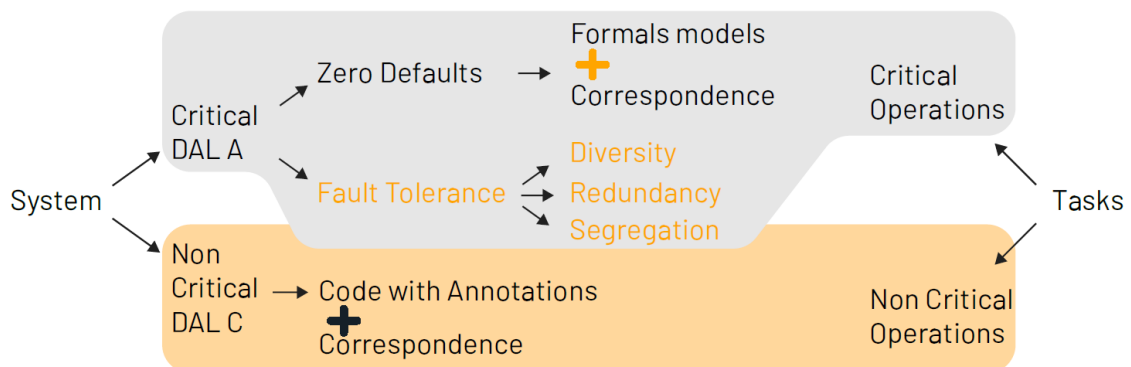

Figure 32. Engineering mixed-criticality interactive systems with a task-system Integrated Development Environment (example with commercial aircrafts Design Assurance Levels)

Beyond the checking of the consistency between users' tasks and interactive system behaviour, ensuring effectiveness requires to verify that each task that the user has to perform is feasible by the user in her work environment and that each device in the work environment is meant to perform a task. This issue is particularly salient in the case of large scale command and control systems as the operators may have to use several devices to reach a goal. We thus proposed to extend the task-system synergistic approach by adding a hierarchical model (concept map) of manipulated devices (e.g. yawl, mouse, display...) and objects in the devices (e.g. graphical button in a display). We extended HAMSTERS task modelling environment to enable to put in correspondence devices elements in task models with devices in the concept map and in the 3D layout description (Fahssi, Martinie, & Palanque, 2016).

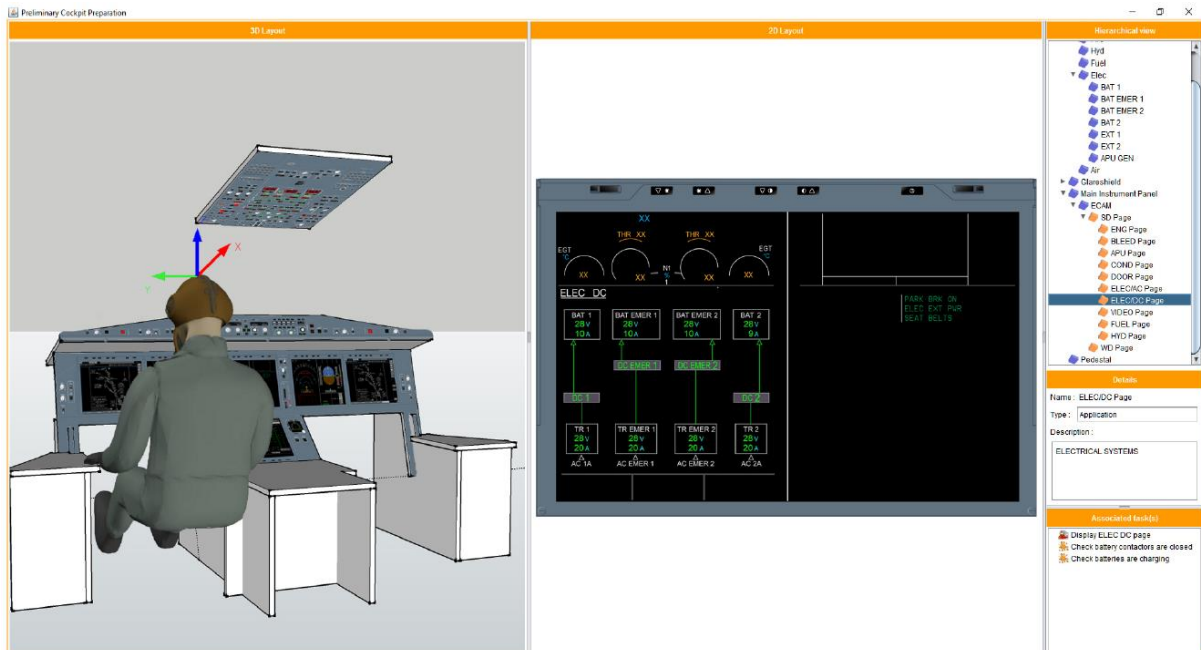

Figure 33. Screenshot of HAMSTERS (frame for visualisation of 3D and 2D models with associated tasks) from (Fahssi, Martinie, & Palanque, 2016)

2.2. Provide support for the analysis of the impact of operators' actions and of interactive systems' states on the whole critical LSSTS

Modelling approaches in the context of safety management usually focus on failure modes of technical systems and on human errors. Systems performance is generally considered as binary: the system performs as prescribed or fails to do so. In the context of large scale system, perturbation can occur not only because of components failure but also because of the interactions between the various components by affecting their resources, their time to perform, their ability to adjust to their environment. In order to take into account these types of perturbations, models have to be able to address the variability of each of these components as well as the variability related to their interrelations. Furthermore, the coupling between operator task models and interactive system behavioural model focuses on the effectiveness and efficiency of the human-technology joint performance for a set of tasks. Additional types of models are required to support the analysis of the impact of the variability of the human-technology joint performance on the critical LSSTS in which they operate, in particular models that provide support for describing the organisational aspects and for describing the dynamic coupling between the actions performed by the different views (humans, systems).

We proposed a systematic approach based on a federation of complementary models to reason about the variability of the performance of a critical LSSTS (Hollnagel, et al., 2011) (Martinie C., et al., 2012)

(Ragosta, 2015) (Ragosta, Martinie, Palanque, Navarre, & Sujan, 2015). In addition to task models and system behavioural models, we proposed to integrate models of the dynamic coupling between human actions and system functions. For that purpose, we used FRAM (Functional Resonance Analysis Model) method (Hollnagel E. , 2012) that aims to support both accident investigation and risk assessment processes based on a set of principle related to large scale socio-technical systems structure and dynamic. Figure 34 depicts an example of correspondence between the three types of models.

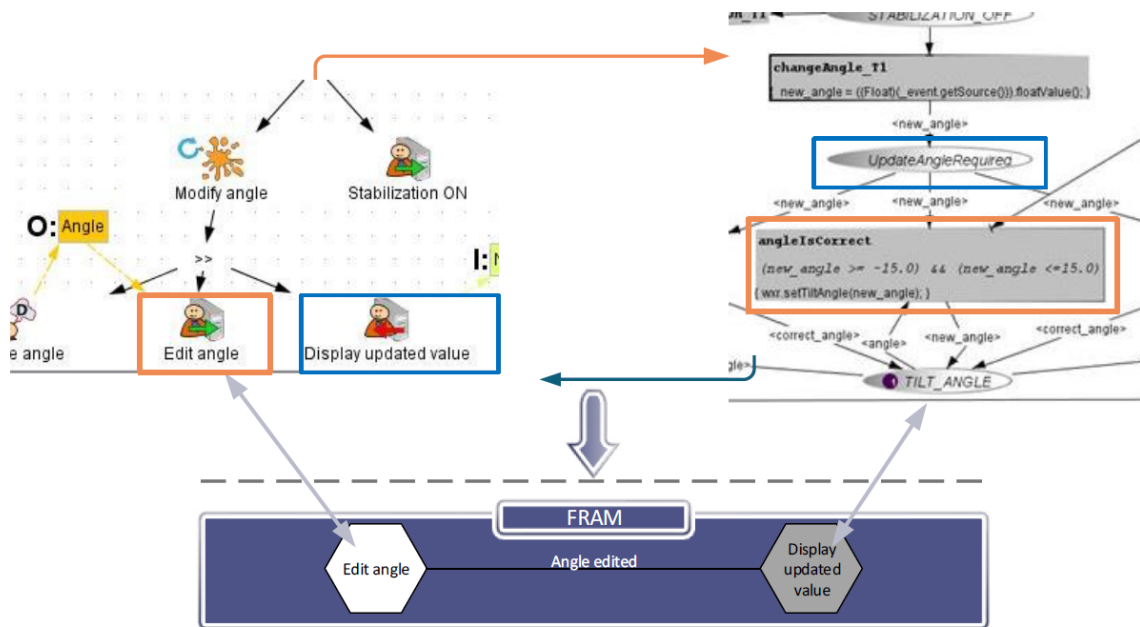

Figure 34. Example of correspondence between elements in task model, system behavioral model and FRAM model from (Ragosta, Martinie, Palanque, Navarre, & Sujan, 2015)

Figure 35 depicts and extract of a FRAM model where a problem may occur on the function named “check weather conditions” (its output may be imprecise and/or too late) and have a negative impact on the critical LSSTS functions that follow (the adequate procedure cannot be applied on time). Such complementary use of models provide support for estimating overall performance of a crew and for identifying possible bottlenecks that could influence the entire critical LSSTS (Martinie C. , et al., 2013a).

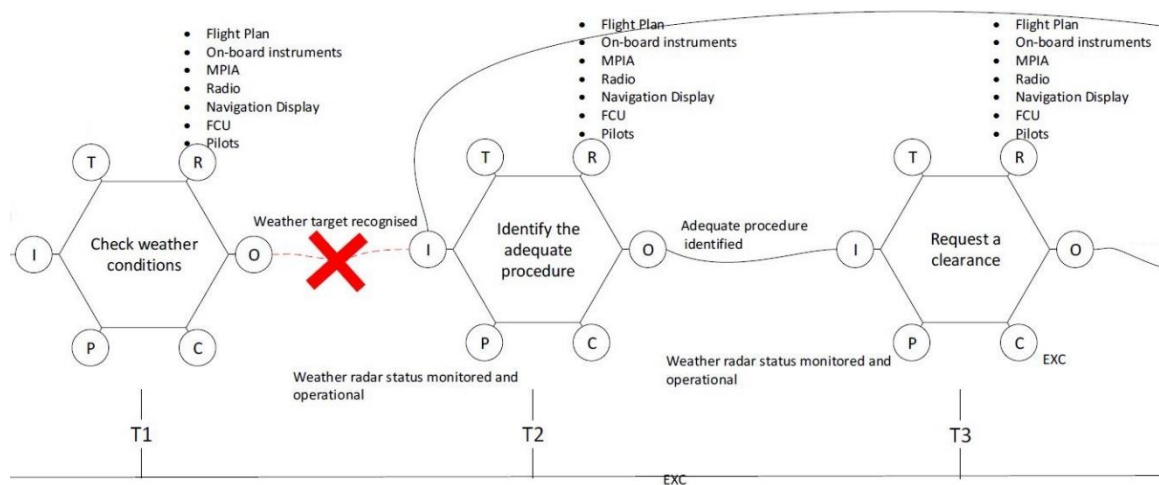

Figure 35. Extract from a FRAM model of the WXR case study from (Ragosta, 2015)

2.3. Provide support for automation of usability testing

This task-system synergistic approach presented in the previous section has the advantage that it enables the exploration of the design, but the fact that the co-execution is performed manually means that the analysis may not be exhaustive, as it relies on the person performing the verification and is highly dependent of the quantity of tasks and of system functions to verify. In order to address this issue, we proposed a stepwise technique to automate the scenario-based testing with the synergistic task-system Integrated Development Environment (Campos J. C., et al., 2016). First, we propose to prepare a set of normative scenarios and a set of non-normative scenarios. Then these scenarios are automatically executed with the task-system co-execution environment. For these scenarios. At last, the results of the execution of the scenarios are available for analysis (as depicted in Figure 36).

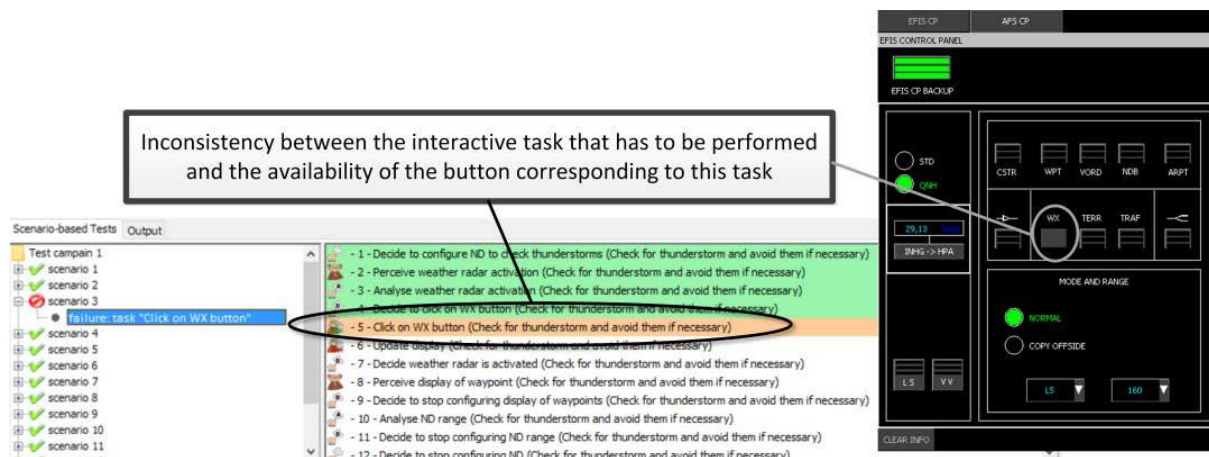

Figure 36. Screenshot of an extract of the result of a test campaign showing a task that could not be executed from (Campos J. C., et al., 2016)

Generating test cases to cover all possible sequences of user actions with the system is not feasible as there is an infinite number of possible sequences of user actions (Nguyen, Banerjee, & Memon, 2014). Testing interactive systems then requires strategies to reduce the number of test cases to be checked and to elicit the most relevant ones. We analysed and proposed strategies based on task models manipulations (e.g., modifying task nodes, operator nodes, information...) in order to limit the number of test cases (Campos J. , et al., 2017). These strategies are meant to be so-called “more intelligent” test cases generation approach, combining “brute force” avoidance and usage-centred selection of test cases. The goal is to guarantee that a specified subset of all possible interactions between user and system (as defined in a task model) can be fully covered by the testing process.

2.4. Provide support for training and for contextual help at runtime

The co-execution of task models with its associated interactive application is not only a mean to facilitate interactive system development but can also be a support for end users. It provides support for executing training sessions by guiding the trainees to learn and execute procedures, and for assessing the results of the trainees by enabling the trainer to analyse what part of the procedure is not mastered by the trainee (Martinie C. , Palanque, Navarre, Winckler, & Poupart, 2011) (Martinie, Palanque, Navarre, & Poupart, 2012). It also provides support for helping the users at runtime by providing them insights on the next actions that can be performed with the system in its current state and according to the current goal of the user (Palanque & Martinie, 2011) (Martinie, Navarre, & Palanque, 2013).

3. Related PhD supervisions and collaborations

Figure 37 depicts the timeline for the co-supervision of the students that I have been co-supervising for the contributions on engineering command and control systems and critical interactive systems.

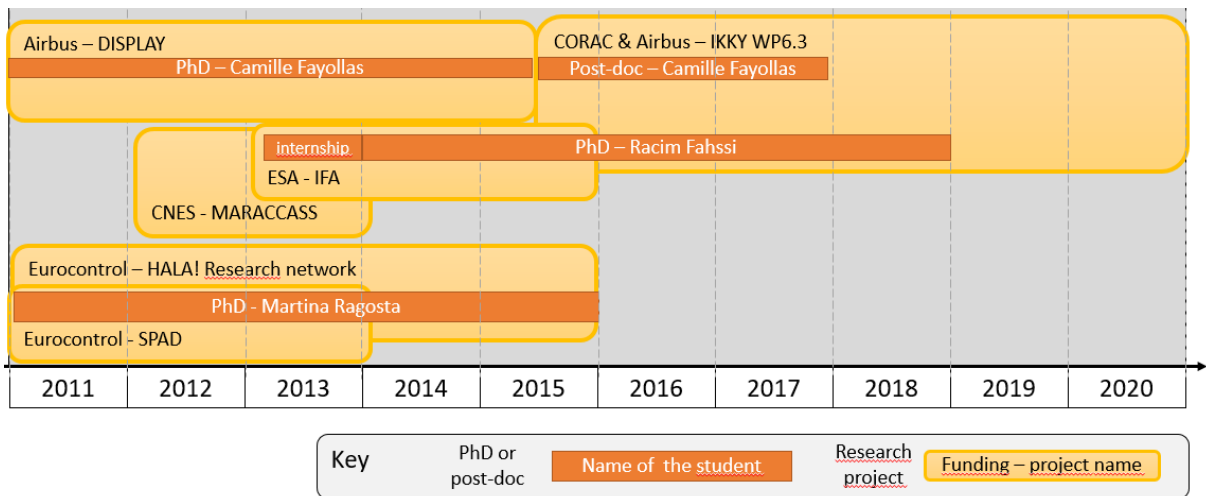

Figure 37. Timeline of supervision of PhD students for the contributions related to the engineering of synergistic views of Human, System and Organisation

Table 16 presents the detailed view on the relationships between the contributions, the supervised PhD students and the associated project(s).

Table 16. Contributions on operators and their tasks that result from the co-supervision of PhD students and/or of post-doctoral students

PhD student and/or post-doc	Start and end dates for the PhD	Topic of the PhD or post-doc	Contribution(s) on operators and their tasks issued from the co-supervision of PhD or post-doc	Associated project(s)
Martina Ragosta (PhD)	2011-2015	Models based approach for the analysis and modelling of usable and resilient partly autonomous interactive systems	Provide support for the analysis of the impact of operators’ actions and of interactive systems’ states on the whole critical LSSTS	SPAD (Eurocontrol)
	Associated publications	<ul style="list-style-type: none"> - Hollnagel, E., Martinie, C., Palanque, P., Pasquini, A., Ragosta, M., Rigaud, E., Silvagni, S. 2011. System Performances under Automation Degradation (SPAD). SESAR Innovation Days. - Martinie, C., Palanque, P., Pasquini, A., Ragosta, M., Rigaud, E., Silvagni, S. 2012. Using Complementary ModelS-Based Approaches for Representing and Analysing ATM Systems’ Variability. International Conference on Application and Theory of Automation in Command and Control Systems (ATACCS 2012), 146-157, ACM - Martinie, C., Palanque, P., Pasquini, A., Ragosta, M., Sujan, M.-A., Navarre, D. 2013. Understanding functional resonance through a federation of models: preliminary findings of an avionics case study. International Conference on Computer Safety, Reliability and Security (SAFECOMP 2013), pp. 216-227, Springer. - Ragosta, M., Martinie, C., Palanque, P., Navarre, D., Sujan, M.-A. 2015. Concept Maps as a Glue for Integrating Modeling Techniques for the Analysis and Re-Design of Partly-Autonomous Interactive Systems. International Conference on Application and Theory of Automation in Command and Control Systems (ATACCS 2015), 41-52, ACM. 		

Synergies between the models of the views on critical LSSTS

PhD student and/or post-doc	Start and end dates for the PhD	Topic of the PhD or post-doc	Contribution(s) on operators and their tasks issued from the co-supervision of PhD or post-doc	Associated project(s)
Camille Fayollas (PhD and post-doc)	2011-2015	Models-based approach for the dependability of critical interactive systems	- Provide support for ensuring that user goals can be reached with an interactive system	DISPLAY System (Airbus)
	2015-2017	Model-based approaches for the design and development of usable and reliable recommender systems	- Provide support for automation of usability testing	IKKY WP6.3 (CORAC and Airbus)
	Associated publications	<ul style="list-style-type: none"> - <i>Martinie, C., Navarre, D., Palanque, P., Fayollas, C. 2015. A Generic Tool-Supported Framework for Coupling Task Models and Interactive Applications. ACM SIGCHI conference Engineering Interactive Computing Systems (EICS 2015), 244-253, ACM.</i> - <i>Fayollas, C., Martinie, C., Navarre, D., Palanque, P. 2016. Engineering mixed-criticality interactive applications. ACM SIGCHI conference Engineering Interactive Computing Systems (EICS 2016), 108-119, ACM.</i> - <i>Campos, J. C., Fayollas, C., Martinie, C., Navarre, D., Palanque, P., Pinto, M. 2016. Systematic automation of scenario-based testing of user interfaces. ACM SIGCHI conference Engineering Interactive Computing Systems (EICS 2016), 138-148, ACM.</i> - <i>Campos, J., Fayollas, C., Gonçalves, M., Martinie, C., Navarre, D., Palanque, P., Pinto, M. 2017. A More Intelligent Test Case Generation Approach through Task Models Manipulation. Proceedings of the ACM on Human-Computer Interaction, 1(9), 20 pages, ACM.</i> 		
Racim Fahssi (PhD)	2014-2018	Systematic identification and description of human errors in task models	Provide support for ensuring that user goals can be reached with an interactive system	IKKY WP6.3 (CORAC and Airbus)
	Associated publications	<ul style="list-style-type: none"> - <i>Martinie, C., Barboni, E., Navarre, D., Palanque, P., Fahssi, R. M., Poupart, E., & Cubero-Castan, E. 2014. Multi-Models-Based Engineering of Collaborative Systems: Application to Collision Avoidance Operations for Spacecrafts. ACM SIGCHI conference Engineering Interactive Computing Systems (EICS 2014), 85-94, ACM.</i> - <i>Fahssi, R., Martinie, C., & Palanque, P. 2016. Embedding explicit representation of cyber-physical elements in task models. IEEE International Conference on Systems, Man and Cybernetics (SMC 2016), 1969-1974, IEEE.</i> 		
Alexandre Canny	2017-20xx On-going	Model-based generation of test cases for validation of interactive systems	Provide support for ensuring that user goals can be reached with an interactive system	IKKY WP6.3 (CORAC and Airbus)
	Associated publications	<ul style="list-style-type: none"> - <i>Martinie, C., Navarre, D., Palanque, P., Barboni, E., Canny, A. 2018. TOUCAN: An IDE Supporting the Development of Effective Interactive Java Applications. ACM SIGCHI conference Engineering Interactive Computing Systems (EICS 2018), 1-7, ACM.</i> 		

We needed the expertise of colleague researchers for specific topics. Table 17 presents the researchers with whom we have collaborated for specific contributions.

Table 17. Contributions that results from the collaboration with other researchers

Researcher	Period of the collaboration	Background of the researcher	Contribution issued from collaboration	Associated publication(s)
José Campos Professor, University of Braga, Portugal	2015-2017	Formal methods for interactive systems	Provide support for automation of usability testing	(Campos J. C., et al., 2016) (Campos J. , et al., 2017)
Erik Hollnagel Professor, University of Jönköping, Sweden	2011-2014	Resilience engineering	Provide support for the analysis of the impact of operators' actions and of interactive systems' states on the whole critical LSSTS	(Hollnagel, et al., 2011) (Martinie C. , et al., 2012) (Ragosta, 2015)
Alberto Pasquini DeepBlue srl, Italy	2011 - 2015	Human Factors in Air Traffic Control	Provide support to the analysis and design of task/function allocation and of interactive applications embedding automation	(Hollnagel, et al., 2011) (Martinie C. , et al., 2011) (Martinie C. , et al., 2012) (Ragosta, 2015) (Ragosta, 2015) (Martinie C. , et al., 2011)
Mark Suján University of Warwick, Coventry, UK	2011 - 2015	Safety and human factors engineering	Provide support to the analysis and design of task/function allocation and of interactive applications embedding automation	(Martinie C. , et al., 2013a) (Ragosta, Martinie, Palanque, Navarre, & Suján, 2015)
Michael Feary, Dorit Billman, Human Automation Interaction Group, NASA Ames Research Center, USA	2013-2015	Human Factors in aviation	Provide support for ensuring that user goals can be reached with an interactive system	(Billman, Fayollas, Feary, Martinie, & Palanque, 2016)

4. Case studies

The case studies have been implemented thanks to the Circus IDE and to the TOUCAN IDE. The Circus IDE integrates the HAMSTERS task modelling software environment, the PetShop IDE, the Netbeans IDE (for software programming) as well as a software component to support the mapping and co-execution between task models and system models. The TOUCAN IDE integrates the HAMSTERS task modelling software environment with the Netbeans IDE (for software programming) as well as the software component to support the mapping and co-execution between task models and interactive application software. The presented contributions on the integration of the models of the views on the critical LSSTS have been applied to the industrial case studies that are listed in Table 18 (the projects for which these case studies have been implemented are described in Annex B – Projects). I was in charge of coordinating and supervising the application of the contributions to these industrial case studies.

Table 18. Application of the contributions on integration of multiple views for systematic design and development to large scale case studies

Case study	Interconnections between models of different types				Applied contributions	Associated publications
	Type of model	Type of element	Type of element	Type of model		
Picard Tortuga (CNES) (2010-2011)	HAMSTERS model	Interactive input tasks	Activation function	ICO model	- provide support for ensuring that user goals can be reached with an interactive system - provide support for training and for contextual help at runtime	(Palanque, Winckler, & Martinie, 2011) (Martinie C. , Palanque, Navarre, Winckler, & Poupart, 2011) (Martinie, Palanque, Navarre, & Poupart, 2012) (Palanque & Martinie, 2011) (Martinie, Navarre, & Palanque, 2013)
	HAMSTERS model	Interactive output tasks	Rendering function	ICO model		
Change route SPAD (Eurocontrol) (2011-2013)	HAMSTERS model	Interactive input tasks	Activation function	ICO model	provide support for the analysis of the impact of operators' actions and of interactive systems' states on the whole critical LSSTS	(Hollnagel, et al., 2011) (Martinie C. , et al., 2012) (Ragosta, 2015) (Ragosta, 2015) (Ragosta, Martinie, Palanque, Navarre, & Sujan, 2015)
	HAMSTERS model	Interactive output tasks	Rendering function	ICO model		
	HAMSTERS model	Interactive input tasks	Interactive function	FRAM model		
	HAMSTERS model	Interactive output tasks	Interactive function	FRAM model		
	HAMSTERS model	User task	Human function	FRAM model		
	ICO model	Activation function	Interactive function	FRAM model		
	ICO model	Rendering function	Interactive function	FRAM model		
FCU Software (Software prototype of the Flight Control Unit) IKKY WP6.3 (CORAC and Airbus) (2015-2019)	HAMSTERS model	Interactive input tasks	Activation function	ICO model	- provide support for ensuring that user goals can be reached with an interactive system - provide support for automation of usability testing	(Martinie, Navarre, Palanque, & Fayollas, 2015) (Campos J. C., et al., 2016) (Campos J. , et al., 2017)
	HAMSTERS model	Interactive output tasks	Rendering function	ICO model		
	HAMSTERS model	Interactive input tasks	Event handler	Textual event driven programming language		
	HAMSTERS model	Interactive output tasks	Rendering event	Textual event driven programming language		

Chapter 7 Research directions

This chapter first presents, for each view, a set of selected perspectives that I believe should be investigated in the near future as they correspond to relevant problems to analyse in order support the design and development of critical LSSTS. Then, by highlighting the relationships between the perspectives for each view, I propose main research directions across views for reaching the target of taking into account altogether the needed properties for the design and development of critical LSSTS.

1. Selected perspectives for each view on the design and development of critical LSSTS

I propose differentiated outlooks for each view because the contributions presented in the document cover differently each view (with a different progress). However, all perspectives are driven by the need for techniques, methods, processes and tools to explicitly model the characteristics needed to analyse target properties for each of the views, and to provide support for the analysis of these properties.

1.1 Human, operators and their tasks

Provide support to the analysis of the possible workflows of tasks between different user roles in a work organisation. Task models for each user role is required to understand the different part of the work that is performed to accomplish the main objectives of the work organisation. The model of the workflows and constraints (temporal, required data...) is also necessary to be able to propose an optimal workflow. Some of the existing task modelling techniques that target the analysis of collaborative work, as CTT (Mori & Paterno, 2002), CUA (Pinelle, Gutwin, & Greenberg, 2003), FlowiXML (Guerrero, Vanderdonckt, & Gonzalez Calleros, 2008) and COMM (Jourde, Laurillau, & Nigay, 2010), provide explicit support for the description of temporal relationships between cooperative tasks (i.e. between tasks that are performed by different actors having different roles) and the outcome of these techniques is a model of the workflow between the cooperative tasks. The HAMSTERS-XLE notation provide explicit support to explicitly make a relationship between a task in the task model of a role and another task in the task model of another role but has limited support in terms of description of possible temporal relationships between cooperative tasks (only the description of sequence is supported). Several possible solutions, starting with the ones proposed in the here above cited contributions (which deal with workflow modelling and/or temporal operators supported modelling), need to be investigated.

Provide support for the predictive evaluation of user performance. Task models provide support to check that a computing system is designed so that the user can effectively perform her/his tasks. Some of the task modelling techniques, such as GOMS (John & Kieras, 1996), aims to make predictive assessments of the temporal performance of a user with a computing system for a predefined subset of tasks. There are currently no task modelling techniques that provide support to describe the exhaustive set of user tasks (in a hierarchical and temporal ordered way), such as HAMSTERS-XL, and to provide support for predictive assessment of user effectiveness with a computing system. The refinement of HAMSTERS user tasks in perceptive, cognitive and motor actions has been inspired from the Card, Moran and Newell cognitive architecture (Card, Moran, & Newell, 1983) and was a first step to analyse qualitatively and roughly the cognitive load (by calculating the number of cognitive tasks), the possible human fatigue (by computing the number of motor tasks and of perceptive tasks). Several possible solutions need to be investigated to use human models to compute quantitative performance: cognitive such as ACT-R (Anderson, 2007) and physical such as digital 3D models of human postures (Aromaa, Frangakis, Tedone, Viitaniemi, & Aaltonen, 2018).

Provide support for the analysis of the impact of security policies on usability and user experience. Our contributions have targeted the properties of Usability, User eXperience, and Dependability and Safety. Since a few years, the Security property is the main target of several research programs as

*“Cyber-attacks can be more dangerous to the stability of democracies and economies than guns and tanks. [...] Cyber-attacks know no borders and no one is immune.”*⁶. Security policies have an impact on human performance (Sasse, 2003). There are actually no techniques for systematic and explicit identification of which threats are targeted by a security policy and what is the impact of a security policy on user tasks. I would like to investigate how the application of the approach we proposed to analyse the impact of fault tolerance mechanisms on human performance (presented in section 2.1) could suit for the analysis of the impact of security policies on usability and on user experience.

1.2 Computing systems, command and control systems and interactive systems

Study the applicability of the abstract and state-based decomposition of the devices and services to other safety-critical application domains. Our proposed technique for the systematic abstraction and decomposition of system devices and services (DSCU) and of their states (OQCR) has been validated for aircraft cockpits. The approach is generic enough and applicable to other command and control systems. For example, the design of ground segment applications to monitor and control the various sets of devices of the satellites and of the ground communications systems also requires knowledge beyond the UI/UX designers and UCD experts’ knowledge. I would like to investigate this hypothesis by applying this approach to critical LSSTS in other application domains such as ground segments for spacecraft missions.

Provide support for the predictive evaluation of the performance of the couple user-cyber-physical systems. The prediction of the performance of cyber-physical systems requires different types of analogous models (e.g. model of the hardware, of the mechanical behaviour, of the physical environment...) whereas models of interactive systems behaviour are discrete. In the computer science domain, recent approaches advocate for the need of having an execution framework that integrates the different types of models (hardware, software, mechanical...) to simulate and predict performance of a whole cyber-physical system (González, Varmazyar, Nejati, Briand, & Isasi, 2018). Using this kind of approach, I would like to investigate how to integrate several types of cyber-physical models with interactive system models to provide support for the predictive evaluation of user performance with cyber-physical systems, leveraging our contributions on evaluation of user performance (presented in previous section 2.2). A first possible work would be to use the integration of models of cyber-physical systems with ICO models and with enriched ICO models to predict user performance. Another possible work would be to use the integration of models and simulators of the components of the cyber-physical system with ICO models in the PetShop high-fidelity prototyping environment to support experimental evaluations of user performance.

Provide support for automated testing of user interfaces. In the same way that the integration of a user interface description language with the ICO formalism enabled to automate the runtime generation of user interfaces, this integration could also provide support for automating the testing of user interfaces. (Gonzales Calleros, Guerrero Garcia, & Vanderdonckt, 2013) proposed an approach based on the UsiXML user interface description language which enables to automate the testing of usability and accessibility recommendations of the UI layout. By integrating this approach, it would be interesting to study how the UsiXML-ICO tool-supported technique could be extended in order to automate the testing of UI layout recommendations and standards on ICO based specified UIs of critical interactive systems. Furthermore, this integration could provide support to extend this approach by automating the testing of behavioural recommendations as the ICO models describe the behaviour of the UI.

⁶ European Commission President Jean-Claude Juncker, State of the Union Address, 13 September 2017

1.3 Automation

Study of the applicability and refinement of the A-FAR technique for industrial applications. The proof of feasibility and relevance of the A-FAR technique has been performed with a simple example (Game of 15). We are currently investigating how this technique can be applied to the analysis of the automation design differences between alerting systems as they exist in commercial aircrafts and prototypes of recommender systems for managing alarms. In particular, this case study is interesting because it is complementary with the previous ones. It deals with the automation of multiple cognitive analysis and decision tasks (e.g. determining the possible options for managing one or several alarms, determining the possible orderings of actions for solving the alarms, choosing an option...)

Provide support to analyse the impact of automation on User eXperience. There is a variety of approaches and processes that provide support for the design of automation with a focus on the dimensions of effectiveness and efficiency of usability as these dimensions are directly related to the allocation of functions and tasks between systems and users. But automation also has an impact on user eXperience in industrial contexts (Roto, Palanque, & Karhonen, 2018) and can influence the user performance and the user acceptance of these industrial systems (Fröhlich, et al., 2018). I would like to investigate the most relevant ways of supporting how to analyse the impact of automation on user eXperience. We recently started to study the feasibility of such investigation as presented in the following workshop paper (Bouzekri, Martinie, Wallner, Palanque, & Bernhaupt, 2019). One of the major difficulties with this topic is that UX and behaviour changes over time. The potential techniques thus need to take time into account to properly convey the evolution of experience and enable comparison. These comparisons may focus on changes over time, individual versus collective experience, and intended versus actual experience.

1.4 Training and operational procedures

Provide support for guiding trainees to perform their tasks and for supporting the monitoring activities of the instructor. Our contributions based on models of task, procedures and system behaviour, when tool supported, provide support for the trainee to learn and rehearse operations with the system, but they do not provide explicit support neither for pointing out the device(s) that should be used to perform a task nor to the instructors' activities related to guiding and monitoring trainees during a training session. In the application domain of industrial maintenance, Augmented Reality has been studied for many years starting in military (Sims, 1994) to train manufacturing operators (Haritos & Macchiarella, 2005) for repair and assembly tasks (Caudell & Mizell, 1992). It has been shown to provide learning benefits and to facilitate instructors' activities (Tang, Owen, Biocca, & Mou, 2003). We are currently investigating the relevance and feasibility of integrating Augmented Reality technologies within a Flight Simulator that is coupled with a task models simulator to support instructors' and trainees' activities.

Provide support for training cooperative tasks and for team learning. Our contributions based on models of task, procedures and system behaviour, when tool supported, provide support for individual training. The cooperative aspects in training have to be taken into account as operators of critical systems are working in teams in several industrial contexts (e.g. crew members in the cockpit, team of operators for satellite missions...). State of the art work in educational science has highlighted that team training was increasing team performance (Salas, Wilson, Priest, & Guthrie, 2006). I would like to investigate the relevance and feasibility of adapting our model-based approach to training to the learning of cooperative tasks and to team training.

Provide support to refine training objectives and describe training requirements. Work organisations may fail in identifying the detailed requirements that have to be fulfilled thanks to

operators training (this type of issue contributed to the two fatal accidents which are discussed in the introduction). This type of issue has been identified more than 20 years ago by (Johnson C. , 1997) who proposed to use formal methods to describe in a complete and unambiguous way training requirements. Such approach could be used and integrated within our model-based approach to support the training development process and to support the analysis of consistency between training program requirements and critical interactive system requirements.

1.5 Standards and development processes

Study the applicability of the process to support the design and development of complex command and control system to other safety-critical domains. Our proposed process for the design and development of complex command and control systems (presented in previous section 2.3) has been validated for aircraft cockpits. The approach is generic enough and applicable to other command and control systems. For example, the design of ground segment applications to monitor and control the various sets of devices of the satellites and of the ground communications systems also requires knowledge beyond the UI/UX designers and UCD experts' knowledge. I would like to investigate this hypothesis by applying this approach to critical LSSTS in other application domains such as ground segments for spacecraft missions.

Provide support for the systematic identification of work organisation processes. The design of critical LSSTS requires to take into account the view on organisation and in particular, what is missing today in our work is to provide support to the identification and analysis of the hierarchical structure of the organisation and of the workflows between the human accomplishing their respective missions in order to reach the main high-level objectives of the organisation. Existing contributions in the domains of human factors (Stanton, Salmon, & Walker, 2019) and business process modelling (Mazhar, Wu, & Rosemann, 2018) need to be investigated in order to analyse how they could be integrated within our approach.

Provide support for systematic integration of the design and development of interactive systems, operators' tasks, work organisation processes, training program and operational procedures. I would like to investigate the feasibility of a design and development process that integrates and handles in an even way the requirements for all of the views and that provide support to check consistency between the models of each view at the end of each step of the design and development process.

1.6 Synergies between the models of the views on critical LSSTS

Provide support for the explicit mapping of data between models of operator tasks and models of system behaviour. The proposed mappings between the tasks, system, procedures and functional models have been driven by the need of analysing the impact of an action performed by an entity on the other entities of the critical LSSTS. The mappings between the elements of the models are event-based. However, the transfer of data between entities (e.g. auditory information from an operator to another..) and the possible ranges of values for these data, may also have an impact on the downstream entities and thus on the overall performance of the critical LSSTS. The possibilities to map data between each type of models need to be investigated along with a technique to systematically identify and take them into account when connecting the models.

Provide support for the analysis of the impact of work organisation process on operators' tasks. As discussed in the 2nd perspective in previous section 1.5 our approach neither provide support for the identification and analysis of the hierarchical structure of the organisation and of the workflows between the human accomplishing their respective missions in order to reach the main high-level objectives of the organisation, nor for the identification and analysis of the relationships of the social network in

which the operators are acting. I would like to investigate the relevance and feasibility of integrating techniques from the Cognitive Work Analysis method (Vicente, 1999), in particular the phase of social organisation and cooperation analysis, and from the EAST (Event Analysis of Systemic Teamwork) method (Stanton, Salmon, & Walker, 2019), in particular the Social Network Analysis. I will have to figure out how to transform the output of these techniques in explicit models that can be integrated synergistically to our approach. Once integrated, I will have to investigate the best ways to use this synergy to analyse the impact of the work organisation on operators' tasks.

Provide support for the systematic mapping between models of different views. In the same way that there are correspondences between elements in system behavioural models and elements in task models, we have to provide correspondences (guidelines for systematic mapping) between elements of each type of models used for each view of the framework. I would like to investigate what could be learned from the discipline of ontologies engineering (Kalfoglou & Schorlemmer, 2003) and from the contributions on transformation of models in the discipline of model-based engineering (Diskin, Xiong, & Czarnecki, 2010). This would help to identify the possible semantics for the connection between model, as well as the way to provide tool support to deal with the large amount of data to connect.

2. Synthesis of the perspectives for the views on critical LSSTS

Table 19 contains a summary of the perspectives and aims to discuss the relevant relationships between several of the perspectives of each view.

Table 19. Summary of the perspectives for each view (from sections 5 in chapter 2 to chapter 6)

View	Perspectives		
Human, operators and tasks	Provide support for the analysis of the impact of security policies on user performance	Provide support for the predictive evaluation of user performance	Provide support to the analysis of the possible workflows of tasks between different user roles in a work organisation
Computing systems, Command and control systems and interactive systems	Study the applicability of the abstract and state-based decomposition of the devices and services to other safety-critical application domains	Provide support for the predictive evaluation of the performance of the couple user-cyber-physical systems	Provide support for automated testing of user interfaces
Automation	Study of the applicability and refinement of the A-FAR technique for industrial applications	Provide support to analyse the impact of automation on User eXperience	
Training and operational procedures	Provide support for guiding trainees to perform their tasks and for supporting the monitoring activities of the instructor	Provide support to refine training objectives and describe training requirements	Provide support for training cooperative tasks and for team learning
Standards and development processes	Study the applicability of the process to support the design and development of complex command and control system to other safety-critical domains	Provide support for systematic integration of the design and development of interactive systems, operators' tasks, work organisation processes, training program and operational procedures	
Organisation, work organisation and work organisation processes			

Synergies between the models of the views	Provide support for the explicit mapping of data between models of operator tasks and models of system behaviour	Provide support for the systematic mapping between models of different views	Provide support for the analysis of the impact of work organisation process on operators' tasks
--	--	--	---

In Table 19, the bold rectangle surrounding the two cells in the first two rows in the 2nd column of the perspectives highlights the fact that I intend to exploit models in order propose techniques, methods, processes and tools to provide support to the **predictive assessment of the properties that have to be reached for the human and technological views**. It will be interesting to work on both of the highlighted topics at the same time as it will increase the support to precisely predict usability and reliability of the interactions between the operators and the cyber-physical systems. To continue along that path, the synergistic use of models of the different views could provide support to predict the performance of a whole critical LSSTS for several contexts. However, the investigations on the relevant techniques, methods, processes and tools for the views on organisation, work organisation and work organisation processes has to be handled before.

The investigation of the feasibility of **integrating several design and development processes, which are usually applied apart from each other**, cannot be performed without investigating how to integrate the requirements elicitation processes for all of the artefacts that have to be produced during the application of these design and development processes (highlighted by the dotted bold rectangle surrounding the two cells in the 4th and 5th rows in the 2nd column of the perspectives in Table 19).

Although, the **view on organisation and on organisation processes** has started to be covered indirectly with preliminary work on the engineering of collaborative software applications (Martinie, et al., 2014), our work did not explicitly address this view (the corresponding empty line is highlighted in grey in Table 19). I plan to start to investigate how to address this view by addressing the perspectives highlighted in grey for the other views in Table 19. For the view on “Human, Operators and Tasks” (last cell in the first line in Table 19), I intend to investigate the possible extensions to task modelling techniques or the use of another modelling technique to support the analysis of the possible workflows between tasks of different user roles. Such contribution will enable the investigations on how to provide support for the analysis of the impact of work organisation process on operators’ tasks (last cell in the line “Synergies between the models of the views” in Table 19). This support may be achieved by using synergistically models of user tasks and of workflows. I plan to first study the set of concepts proposed by (Guerrero, Vanderdonckt, & Gonzalez Calleros, 2008) for the FlowiXML modelling technique for workflow management systems. At last, the synergistic use of task and workflow models will provide support for the design of training programs for cooperative tasks (line “Training and operational procedures” in Table 19).

3. Long-term research perspectives

The synergistic use of different types of models for the design and development of critical LSSTS aim to provide support to analyse whether the target properties (dependability, usability, learnability, ...) are reached and to take into account the whole socio-technical aspects of the safe integration of the operations on these systems in an organisation. In particular, it provides support to analyse the impact of one property and/or of design choices made for a view (user tasks, system behaviour, organisation process...) on the other views of the critical LSSTS and on the whole performance of the critical LSSTS. The main driver of my research is to extend the support for covering the modelling of the views and for analysing target properties for critical LSSTS.

Until today, our work mainly focused on the views on command and control systems, interactive systems, design and development processes, operators’ tasks, automation and training. We now need to

include more the **organisational and cooperative aspects of the operations on critical LSSTS** by finding appropriate modelling techniques and appropriate ways to integrate them with the rest of the framework. The synergistic use of the models of all the views on the critical LSSTS will enable to analyse issues such as the possible impact of the modification of a team size with no changes in the procedures and no changes in the computing systems. An example of such change for the operations at the ATV (Automated Transfer Vehicle) control centre is presented by (Frard, Francillout, Galet, & Michel, 2010). The modelling of the views on work organisation and on work organisation process need to be investigated and several selected perspectives deal with this possibility. Existing approaches in the domain of human factors (Stanton, Salmon, & Walker, 2019) and business process modelling (Cortes-Cornax, Dupuy-Chessa, & Rieu, 2017) need to be investigated in order to analyse whether and how they could be suitable. Furthermore, our contributions on allocation of functions, authority and responsibility (described in section 2.3 in Chapter 3) may be applicable to the analysis of allocation of tasks, authority and responsibility between team members in an organisation. I would thus also like to investigate the applicability of the AFAR technique to this analysis.

As discussed in the perspectives of the work on the view on operators' tasks (in previous section 1.1), the Security property has to be taken into account more carefully as security policies have often a negative impact on human performance (Sasse, 2003). Security is a concept that has relationships with Dependability (Avizienis, Laprie, Randell, & Landwehr, 2004). Figure 38 represents the properties that are common between Security and Dependability.

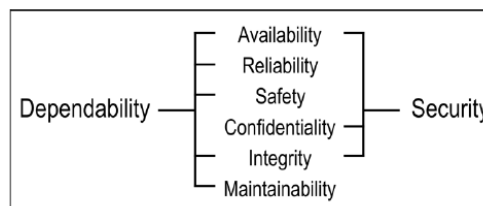

Figure 38. Dependability and Security properties from (Avizienis, Laprie, Randell, & Landwehr, 2004)

As for dependability, there are means to address the possible threats in order to attain Security. Not only techniques are needed to **analyse the impact of security policies on user tasks**, but techniques are needed to **understand the impact of the target threats and to identify the possible means to addressing these threats**, and this for each of the views on the critical LSSTS. For example, from the computing system point of view, it is needed to understand which threats the security policy aims to deal with. From the organisational point of view, it is needed to understand who is responsible for applying which part of the policy and what will be the impact on the performance of the organisation. A global view is also required to perform informed design and development choices.

The number of types of models and of elements in the models is already very large and is thus likely to increase. The tool support and the usability of the tools has to be carefully dealt with. The possibility of **automating part of the modelling and analysis tasks** is another important perspective of the presented work. For that purpose, we have to investigate what part of the modelling and analysis tasks are suitable to be automated. The problem of allocation of functions and tasks between the tool and the expert/analyst can maybe be studied under the same approach that we followed to support the allocation of functions for the design and development of critical LSSTS, i.e. in taking into account the potential impact on of a misallocation of the modelling tasks on the quality of the analysis and then on the potential errors in the design supported by the modelling activities.

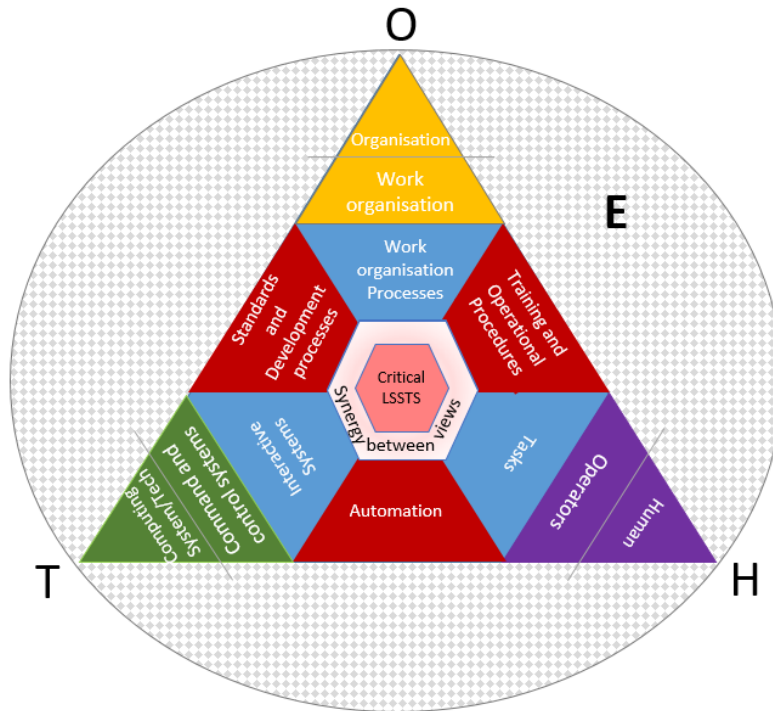

Figure 39. The main views on the design and development of critical LSSTS (with Environment aspect highlighted)

At last, we need to investigate how to model and to **analyse the impact of the variability of the environment** in which the critical LSSTS is being operated (illustrated in Figure 39). The variability of the environment may influence all of the views on the critical LSSTS and thus needs to be dealt with at low-level for each type of model of each type of view (e.g. vibration models connected to human physical models to analyse the impact of vibrations on motoric tasks and connected to system physical model to analyse the impact of the system behaviour and on the usability of the system under these conditions).

References

- Abras, C., Maloney-Krichmar, D., & Preece, J. (2004). User-Centered Design. In W. Bainbridge, *Encyclopedia of Human-Computer Interaction*. Thousand Oaks: Sage Publications.
- Aguinis, H., & Kraiger, K. (2009). Benefits of Training and Development for Individuals and Teams, Organizations, and Society. *60*, 451-475.
- Anderson, J. (2007). *How can the human mind occur in the physical universe*. New York: Oxford University Press.
- Appert, C., Chapuis, O., & Pietriga, E. (2012). Dwell-and-Spring: Undo for Direct Manipulation. *ACM SIGCHI Conference on Computer Human Interaction* (pp. 1957-1966). Austin, Texas: ACM.
- Aromaa, S., Frangakis, N., Tedone, D., Viitaniemi, J., & Aaltonen, I. (2018). Digital Human Models in Human Factors and Ergonomics Evaluation of Gesture Interfaces. *Proc. ACM Hum.-Comput. Interact.*, 2(EICS), 14 pages.
- Avizienis, A., Laprie, J.-C., Randell, B., & Landwehr, C. (2004). Basic concepts and taxonomy of dependable and secure computing. *IEEE Transactions on Dependable and Secure Computing*, 1(1), 11-33.
- Bainbridge, L. (1983). Ironies of Automation. *Automatica*, 19(6), 775-779.
- Barboni, E., Hamon, A., Martinie, C., & Palanque, P. (2015). A User-Centered View on Formal Methods: Interactive Support for Validation and Verification (regular paper). *Workshop on Formal Methods in Human Computer Interaction (FoMHCI 2015), Duisburg, Germany, 23/06/15-23/06/15* (pp. 24-29). <https://publications.rwth-aachen.de/>: RWTH Aachen University. Retrieved from <https://publications.rwth-aachen.de/record/479353/files/FoMHCI2015proceedings.pdf> - <http://oatao.univ-toulouse.fr/15405/>
- Barboni, E., Ladry, J.-F., Navarre, D., Palanque, P., & Winckler, M. (2010). Beyond modeling: an integrated environment supporting co-execution of tasks and systems models. *ACM SIGCHI Conference on Engineering Computing Interactive Systems (EICS 2010)*, (pp. 165-174).
- Barboni, E., Martinie, C., Navarre, D., Palanque, P., & Winckler, M. A. (2011). UsiXML Concrete Behaviour with a Formal Description Technique for Interactive Systems (regular paper). In A. Coyette, D. Faure, J. Gonzalez, & J. Vanderdonckt (Ed.), *IFIP WG 2.7/13.4 Workshop on User Interface Description Languages (UIDL 2011), Lisbonne, Portugal, 06/09/11-06/09/11* (p. (electronic medium)). <http://www.thalesgroup.com>: Thales Research and Technology.
- Barboni, E., Martinie, C., Navarre, D., Palanque, P., & Winckler, M. A. (2014). Bridging the Gap between a Behavioural Formal Description Technique and User Interface description language: Enhancing ICO with a Graphical User Interface markup language. *Science of Computer Programming*, 86, 3-29. Retrieved from <http://dx.doi.org/10.1016/j.scico.2013.04.001> - <http://oatao.univ-toulouse.fr/12617/>
- Baxter, G., & Sommerville, I. (2011). Socio-technical systems: From design methods to systems engineering. *Interacting with Computers*, 23, 4-17.

- Baxter, G., Rooksby, J., Wang, Y., & Khajeh-Hosseini, A. (2012). The ironies of automation ... still going strong at 30? *European Conference on Cognitive Ergonomics* (pp. 65-71). Edinburgh: ACM.
- Bell, J., & Holyroyd, J. (2009). *Review of human reliability assessment methods, RR679*. Buxton, UK : Health and Safety Executive.
- Benyon, D. (1992). The role of task analysis in systems design. *Interacting with Computers*, 4(1), 102-123.
- Bernhaupt, R., Cronel, M., Manciet, F., Martinie, C., & Palanque, P. (2015). Transparent Automation for Assessing and Designing better Interactions between Operators and Partly-Autonomous Interactive Systems (regular paper). *International Conference on Application and Theory of Automation in Command and Control Systems (ATACCS 2015), Toulouse, 30/09/15-02/10/15* (p. (on line)). <http://portal.acm.org/dl.cfm>: ACM Digital Library. Retrieved from <http://dl.acm.org/> - <http://oatao.univ-toulouse.fr/16929/>
- Bernhaupt, R., Palanque, P., Drouet, D., & Martinie, C. (2018). Enriching Task Models with Usability and User Experience Evaluation Data (regular paper). In C. Bogdan, K. Kuusinen, M. Larusdottir, P. Palanque, & M. Winckler (Ed.), *Human-Centered Software Engineering (HCSE 2018), Sophia Antipolis, France, 03/09/18-05/09/18. 11262*, pp. 146-163. <https://link.springer.com>: Springer. Retrieved from <https://www.springerprofessional.de/enriching-task-models-with-usability-and-user-experience-evaluat/16366132> - <http://oatao.univ-toulouse.fr/22695/>
- Bernhaupt, R., Palanque, P., Manciet, F., & Martinie, C. (2016). User-Test Results Injection into Task-Based Design Process for the Assessment and Improvement of Both Usability and User Experience (regular paper). In C. Bogdan, J. Gulliksen, S. Sauer, P. Forbrig, & M. Winckler (Ed.), *International Working Conference on Human-Centred Software Engineering International Working Conference on Human Error, Safety, and System Development (HCSE+HESSD 2016), Stockholm, Sweden, 29/08/16-31/08/16. 9856*, pp. 56-72. <http://www.springer.com>: Springer International Publishing. Retrieved from http://link.springer.com/chapter/10.1007/978-3-319-44902-9_5
- Bias, R., & Mayhew, D. (2005). *Cost-Justifying Usability, Second Edition: An Update for the Internet Age (Interactive Technologies)*. Morgan Kaufmann.
- Billman, D., Fayollas, C., Feary, M., Martinie, C., & Palanque, P. (2016). Complementary Tools and Techniques for Supporting Fitness_for_Purpose of Interactive Critical Systems (regular paper). *International Working Conference on Human-Centred Software Engineering International Working Conference on Human Error, Safety, and System Development (HCSE+HESSD 2016), Stockholm, Su_de, 29/08/2016-31/08/2016* (p. (on line)). <https://link.springer.com>: Springer. Retrieved from https://link.springer.com/chapter/10.1007/978-3-319-44902-9_12
- Bisantz, A., Roth, E., Brickman, B., Gosbee, L., Hettinger, L., & McKinney, J. (2002). Integrating cognitive analyses in a large-scale system design process. *International Journal on Human-Computer Studies*, 177-206.
- Boehm, B. (1986). A spiral model of software development and enhancement. *ACM SIGSOFT Software Engineering Notes*, 11(4), 14-24.

- Bolton, M., Bass, E. J., & Siminiceanu, R. I. (2013). Using formal verification to evaluate human-automation interaction in safety critical systems, a review. *IEEE Transactions on Systems, Man and Cybernetics: Systems*, 43(3), 488-503.
- Bouzekri, E., Canny, A., Fayollas, C., Martinie, C., Palanque, P., Barboni, E., . . . Gris, C. (2017). A List of Pre-Requisites to Make Recommender Systems Deployable in Critical Context (regular paper). *ACM SIGCHI conference Engineering Interactive Computing Systems (EICS 2017)*, 2017, 26/06/17-26/06/17. 1945, pp. 42-55. <http://CEUR-WS.org>: CEUR-WS : Workshop proceedings. Retrieved from http://ceur-ws.org/Vol-1945/paper_7.pdf
- Bouzekri, E., Canny, A., Fayollas, C., Martinie, C., Palanque, P., Barboni, E., . . . Gris, C. (2019a, 1). Engineering Issues Related to the Development of a Recommender System in a Critical Context: Application to Interactive Cockpits. *International Journal of Human-Computer Studies*, 121, 122-141. Retrieved from <https://doi.org/10.1016/j.ijhcs.2018.05.001>
- Bouzekri, E., Canny, A., Martinie, C., & Palanque, P. (2018). *A Generic Software and Hardware Architecture for Hybrid Interactive Systems (EICS 2018 - Workshop on Heterogeneous Models and Modeling Approaches for Engineering of Interactive Systems, Paris, France, 19/06/2018-19/06/2018)*. unpublished. Retrieved from https://www.researchgate.net/publication/331742164_A_Generic_Software_and_Hardware_Architecture_for_Hybrid_Interactive_Systems
- Bouzekri, E., Canny, A., Martinie, C., & Palanque, P. (2018). *Specific Task Modeling for Cyber Physical Systems (EICS 2018 - Workshop on Heterogeneous Models and Modeling Approaches for Engineering of Interactive Systems, Paris, France, 19/06/18-19/06/18)*. unpublished. Retrieved from https://www.researchgate.net/publication/331741889_Specific_Task_Modeling_for_Cyber_Physical_Systems
- Bouzekri, E., Canny, A., Martinie, C., Palanque, P., & Gris, C. (2018). Using Task Descriptions with Explicit Representation of Allocation of Functions, Authority and Responsibility to Design and Assess Automation (education paper). In B. Baricelli, V. Roto, T. Clemmensen, P. Campos, & A. Lopes (Ed.), *IFIP WG 13.6 Working Conference Human Work Interaction Design (HWID 2018)*, Espoo, Finland, 20/08/18-21/08/18. 544, pp. 36-56. <https://link.springer.com>: Springer. Retrieved from <https://www.springer.com/us/book/9783030052966> - <http://oatao.univ-toulouse.fr/22696/>
- Bouzekri, E., Canny, A., Martinie, C., Palanque, P., & Gris, C. (2019). Deep System Knowledge Required: Revisiting UCD Contribution in the Design of Complex Command and Control Systems. *IFIP TC 13 International Conference on Human Computer Interaction* (pp. 699-720). Paphos, Cyprus: Springer.
- Bouzekri, E., Canny, A., Martinie, C., Palanque, P., & Gris, C. (2019, 9). Deep System Knowledge Required: Revisiting UCD Contribution in the Design of Complex Command and Control Systems (regular paper). *IFIP TC 13 International Conference on Human-Computer Interaction (INTERACT)*, Paphos, Cyprus, 02/09/2019-06/09/2019 (p. (on line)). <https://link.springer.com>: Springer. Retrieved from <https://3A%2F%2Flink.springer.com%2Fconference%2Finteract>
- Bouzekri, E., Canny, A., Martinie, C., Palanque, P., Barboni, E., Navarre, D., . . . Deleris, Y. (2019b, 9). Revisiting system's pages in engine indication and alerting system for flight crew using the

- DSCU architecture and the OQCR system generic state description (regular paper). *INCOSE International Conference on Human System Integration (INCOSE HSI 2019)*, Biarritz, France, 11/09/2019-13/09/2019 (p. (on line)). <https://www.incose.org/>: INCOSE : International Council on Systems Engineering. Retrieved from <https://connect.incose.org/pages/store.aspx>
- Bouzekri, E., Martinie, C., Wallner, G., Palanque, P., & Bernhaupt, R. (2019). Investigating the effect of automation on user experience: enriching a task-modeling notation. *Workshop on Everyday Automation Experience at CHI2019*. Glasgow.
- Bowen, D. (2015, May 4). *Exploratory Research in ATM*. Retrieved from <https://www.sesarju.eu/>: https://www.sesarju.eu/sites/default/files/documents/events/sesar2020-20150504/3_SESAR2020_ER_Info_Day_FV_David_Bowen.pdf
- Boy, G. (2013). *Orchestrating Human-Centered Design*. Springer.
- Branson, R., Rayner, G., Cox, J., & Furman, J. (1975). *Interservice procedures*. Fort Monroe, VA: U.S. Army Training and Doctrine Command.
- Brat, G., Martinie, C., & Palanque, P. (2013). V&V of Lexical, Syntactic and Semantic Properties for Interactive Systems Through Model Checking of Formal Description of Dialog (regular paper). *International Conference on Human-Computer Interaction, Las Vegas, Nevada, Etats-Unis, 21/07/13-26/07/13* (pp. 290-299). <http://www.springerlink.com>: Springer. Retrieved from <http://oatao.univ-toulouse.fr/12679/>
- Brooke, J. (1996). SUS: a "quick and dirty" usability scale. In P. Jordan, B. Thomas, B. Weerdmester, & A. McClelland, *Usability Evaluation in Industry*.
- Caffiau, S., Scapin, D., Girard, P., Baron, M., & Jambon, F. (2010). Increasing the expressive power of task analysis: Systematic comparison and empirical assessment of tool-supported task models. *Interacting with Computers*, 22, 569-593.
- Calvary, G., Coutaz, J., Thevenin, D., Limbourg, Q., Bouillon, L., & Vanderdonckt, J. (2003). A Unifying Reference Framework for multi-target user interfaces. *Interacting with Computers*, 15(3), 289-308.
- Campos, J. C., Fayollas, C., Martinie, C., Navarre, D., Palanque, P., & Pinto, M. (2016). Systematic automation of scenario-based testing of user interfaces (regular paper). *ACM SIGCHI conference Engineering Interactive Computing Systems (EICS 2016)*, Bruxelles, Belgique, 21/06/16-24/06/16 (pp. 138-148). <http://portal.acm.org/dl.cfm>: ACM Digital Library. Retrieved from <http://dx.doi.org/10.1145/2933242.2948735> - <http://oatao.univ-toulouse.fr/17072/>
- Campos, J. C., Nuno, N., Campos, P., Calvary, G., Nichols, J., Martinie, C., & Silva, J. L. (Eds.). (2017). Proceedings of the ACM SIGCHI Symposium on Engineering Interactive Computing Systems, EICS 2017, Lisbon, Portugal, 26/06/2017 - 29/06/2017. <http://www.acm.org/>: ACM.
- Campos, J., Fayollas, C., Gonçalves, M., Martinie, C., Navarre, D., Palanque, P., & Pinto, M. (2017). A More Intelligent Test Case Generation Approach through Task Models Manipulation. *Proceedings of the ACM on Human-Computer Interaction*, 1(9), 20.
- Canny, A., Bouzekri, E., Martinie, C., & Palanque, P. (2018). Rationalizing the Need of Architecture-Driven Testing of Interactive Systems. *International Conference on Human-Centered Software Engineering* (pp. 164-186). Sophia Antipolis: Springer.

- Canny, A., Bouzekri, E., Martinie, C., & Palanque, P. (2018). Rationalizing the Need of Architecture-Driven Testing of Interactive Systems (regular paper). In C. Bogdan, K. Kuusinen, M. Larusdottir, P. Palanque, & M. Winckler (Ed.), *Human-Centered Software Engineering (HCSE 2018)*, Sophia Antipolis, France, 03/09/2018-05/09/2018. 11262, pp. 164-186. <https://link.springer.com>: Springer. Retrieved from <https://www.springerprofessional.de/rationalizing-the-need-of-architecture-driven-testing-of-interac/16366082> - <http://oatao.univ-toulouse.fr/22694/>
- Canny, A., Bouzekri, E., Martinie, C., & Palanque, P. (2019). On the Importance of Supporting Multiple Stakeholders Points of View for the Testing of Interactive Systems. *Workshop on Research and Practice Challenges for Engineering Interactive Systems while Integrating Multiple Stakeholders Viewpoints, Valencia, Spain, 18/06/2019*.
- Canny, A., Fayollas, C., Martinie, C., Navarre, D., Palanque, P., Bouzekri, E., Dél  ris, Y. (2019). Divide to Conquer: Functional Decomposition to Support Model-Based Engineering of Command and Control of Cyber-Physical Systems. *IEEE International Conference on Cyber Physical and Social Computing 2019 (CPSCom)* (pp. 694-701). Atlanta, Georgia: IEEE.
- Canny, A., Fayollas, C., Martinie, C., Navarre, D., Palanque, P., Bouzekri, E., Deleris, Y. (2019). Divide to Conquer: Functional Decomposition to Support Model-Based Engineering of Command and Control of Cyber-Physical Systems (regular paper). *IEEE International Conference on Cyber Physical and Social Computing (CPSCom 2019)*, Atlanta, USA, 14/07/2019-17/07/2019 (p. (on line)). <http://www.ieee.org/>: IEEE : Institute of Electrical and Electronics Engineers. Retrieved from <https://ieeexplore.ieee.org>
- Card, S. M., & Newell, A. (1983). *The Psychology of Human-Computer Interaction*. New Jersey: Lawrence Erlbaum Associates.
- Card, S., Moran, T., & Newell, A. (1983). *The Psychology of Human-Computer Interaction*. New Jersey: Lawrence Erlbaum Associates.
- Caudell, T., & D., M. (1992). Augmented reality: an application of heads-up display technology to manual manufacturing processes. *Proceedings of the Twenty-Fifth Hawaii International Conference on System Sciences*, (pp. 659-669). Kauai, HI, USA.
- Caudell, T., & Mizell, D. (1992). Augmented reality: an application of heads-up display technology to manual manufacturing processes. *Proceedings of the Twenty-Fifth Hawaii International Conference on System Sciences*, (pp. 659-669). Kauai, HI, USA.
- Cortes-Cornax, M., Dupuy-Chessa, D., & Rieu, D. (2017). Evaluating the Appropriateness of the BPMN 2.0 Standard for Modeling Service Choreographies - Using an Extended Quality Framework. *Software and System Modeling*, 219-255.
- CS 25 EASA. (2017). *Certification Specifications and Acceptable Means of Compliance for Large Aeroplanes, Amendment 19*. EASA.
- Desmet, P., Hekkert, P., & Jacobs, J. (2000). When a car makes you smile: Development and application of an instrument to measure product emotions. In B. M.A., O. K., M. A.F., & W. P.C., *Funology Human-Computer Interaction Series, vol. 3*. Springer.

- Diskin, Z., Xiong, Y., & Czarnecki, K. (2010). Specifying Overlaps of Heterogeneous Models for Global Consistency Checking. *International Conference on Model Driven Engineering Languages and Systems (MODELS 2010)* (pp. 165-179). Springer.
- Dix, A. (1995). Formal methods: an introduction to and overview of the use of formal methods within HCI. In A. Monk, & N. Gilbert, *Perspectives on HCI* (pp. 9-43). London: Academic Press.
- Drogoul, F., & Palanque, P. (2018). *Design and Assessment of Systems Using Human Centered Approaches*. Bruxelles: Eurocontrol.
- Drogoul, F., & Palanque, P. (2018). *Design and Assessment of Systems Using Human Centered Approaches*. Luxembourg: Eurocontrol. Retrieved from <https://trainingzone.eurocontrol.int/ilp/pages/coursedescription.jsf?courseId=7269593&catalogId=896431>
- Emery, F., & Trist, E. (1960). Socio-technical systems. (C. Churchman, & M. Verhulst, Eds.) *Management Science Models and Techniques*, 2, 83-97.
- EU 2015/340. (2015). REGULATIONS. *COMMISSION REGULATION (EU) 2015/340 of 20 February 2015*. Official Journal of the European Union.
- EUROCAE. (2012). *ED-12C - Software considerations in airborne systems and equipment certification*. Saint-Denis: EUROCAE.
- Eurocontrol. (2010). *ESARR 6. Safety Regulatory Requirement. Software in ATM Systems*. Bruxelles: Eurocontrol.
- Fahssi, R. (2018). *Systematic identification and representation of human errors in task models*. Toulouse: Université Paul Sabatier Toulouse 3.
- Fahssi, R. M. (2018). *Identification systématique et représentation des erreurs humaines dans les modèles de tâches*. Thèse de doctorat, Université Paul Sabatier, Toulouse.
- Fahssi, R. M., Martinie, C., & Palanque, P. (2014, 10). HAMSTERS : un environnement d'édification et de simulation de modèles de tâches (D_m) (poster). *Interaction Homme-Machine (IHM 2014)*, Lille, 28/10/2014-31/10/2014 (p. (en ligne)). <http://portal.acm.org/dl.cfm>: ACM Digital Library. Retrieved from <http://dl.acm.org/> - <http://oatao.univ-toulouse.fr/13231/>
- Fahssi, R. M., Martinie, C., & Palanque, P. (2015, 9). Enhanced Task Modelling for Systematic Identification and Explicit Representation of Human Errors (regular paper). *IFIP TC13 Conference on Human-Computer Interaction (INTERACT 2015)*, Bamberg, 14/09/15-18/09/15 (p. (electronic medium)). <http://www.springerlink.com/>: Springer-Verlag. Retrieved from <http://oatao.univ-toulouse.fr/15322/>
- Fahssi, R., Martinie, C., & Palanque, P. (2015). Enhanced Task Modelling for Systematic Identification and Explicit Representation of Human Errors. *IFIP TC13 Conference on Human Computer Interaction INTERACT* (pp. 192-212). Bamberg: Springer.
- Fahssi, R., Martinie, C., & Palanque, P. (2016, 10). Embedding explicit representation of cyber-physical elements in task models (regular paper). *IEEE International Conference on Systems, Man and Cybernetics, Budapest, Hongrie, 09/10/16-12/10/16* (pp. 1969-1974). <http://www.ieeesmc.org>: IEEE Systems, Man, and Cybernetics Society. Retrieved from

- <http://ieeexplore.ieee.org/stamp/stamp.jsp?arnumber=7844528> - <http://oatao.univ-toulouse.fr/18941/>
- Fayollas, C. (2015). *Architecture logicielle générique et approche à base de modèles pour la sûreté de fonctionnement des systèmes interactifs critiques*. Thèse de doctorat, Université Paul Sabatier, Toulouse.
- Fayollas, C., Fabre, J.-C., Palanque, P., Cronel, M., Navarre, D., & Deleris, Y. (2014). A Software-Implemented Fault-Tolerance Approach for Control and Display Systems in Avionics. *IEEE 20th Pacific Rim International Symposium on Dependable Computing* (pp. 21-30). Singapore: IEEE.
- Fayollas, C., Martinie, C., Navarre, D., & Palanque, P. (2015). A Generic Approach for Assessing Compatibility between Task Descriptions and Interactive Systems: Application to the Effectiveness of a Flight Control Unit. *i-com, Model-Based Interface Engineering, 14*, 170-191.
- Fayollas, C., Martinie, C., Navarre, D., & Palanque, P. (2016). Engineering mixed-criticality interactive applications (regular paper). *ACM SIGCHI conference Engineering Interactive Computing Systems (EICS 2016), Bruxelles, Belgique, 21/06/16-24/06/16* (pp. 108-119). <http://portal.acm.org/dl.cfm>: ACM Digital Library. Retrieved from <http://dx.doi.org/10.1145/2933242.2933258> - <http://oatao.univ-toulouse.fr/17071/>
- Fayollas, C., Martinie, C., Navarre, D., Palanque, P., & Fahssi, R. M. (2014). Fault-Tolerant User Interfaces for Critical Systems: Duplication, Redundancy and Diversity as New Dimensions of Distributed User Interfaces (regular paper). *Workshop on Distributed User Interfaces (DUI 2014), Toulouse, France, 01/07/14* (p. (on line)). <http://www.acm.org/>: ACM : Association for Computing Machinery. Retrieved from <http://dui.uclm.es/2014/submissions/Fault-Tolerant%2520User%2520Interfaces%2520for%2520Critical%2520Systems.pdf>
- Fayollas, C., Martinie, C., Palanque, P., & Ait Ameer, Y. (2017, 9). QBP Notation for Explicit Representation of Properties, their Refinement and their Potential Conflicts: Application to Interactive Systems (regular paper). *Workshop on Dealing with Conflicting User Interface Properties in User-Centered Development Processes at INTERACT 2017, Mumbai, India, 26/09/2017-26/09/2017* (pp. 91-105). <https://link.springer.com>: Springer.
- Fayollas, C., Martinie, C., Palanque, P., & Deleris, Y. (2015). Beyond Formal Methods for Critical Interactive Systems: Dealing with Faults at Runtime (regular paper). *Workshop on Formal Methods in Human Computer Interaction (FoMHCI 2015), Duisburg, Germany, 23/06/15-23/06/15* (pp. 19-23). <https://publications.rwth-aachen.de/>: RWTH Aachen University. Retrieved from <https://publications.rwth-aachen.de/record/479353/files/FoMHCI2015proceedings.pdf> - <http://oatao.univ-toulouse.fr/15399/>
- Fayollas, C., Martinie, C., Palanque, P., & Fahssi, R. M. (2015). Accounting for Organisational faults in Task Model Based Systematic Analysis of System Failures and Human Errors (regular paper). *IFIP WG 13.5 Workshop on Resilience, Reliability, Safety and Human Error in System Development, Bamberg, Germany, 14/09/15* (pp. 101-116). <http://www.uni-bamberg.de/en/ubp/>: University of Bamberg Press.
- Fayollas, C., Martinie, C., Palanque, P., & Fahssi, R. M. (2016). Task Models for Supporting Function Allocation between Operators and Autonomous Systems: Application to Collision Avoidance

- Operations for Spacecraft (regular paper). *AAAI 2015 Spring Symposium on Intelligent systems for supporting distributed human teamwork*, Stanford CA, USA, 21/03/16-23/03/16 (p. (electronic medium)). <http://www.aaai.org/Press/press.php>: AAAI Press.
- Fayollas, C., Martinie, C., Palanque, P., Barboni, E., & Deleris, Y. (2016). What Can Be Learnt from Engineering Safety Critical Partly-Autonomous Systems when Engineering Recommender Systems (regular paper). *EncWorkshop on Engineering Computer-Human Interaction in Recommender Systems (EnCHIReS 2016)*, Bruxelles, Belgique, 21/06/2016 (p. (on line)). <http://CEUR-WS.org>: CEUR-WS : Workshop proceedings. Retrieved from https://www.google.com/url?sa=t&rct=j&q=&esrc=s&source=web&cd=1&cad=rja&uact=8&ved=2ahUKEwigwtPW_cziAhWUBWMBHa61AWcQFjAAegQIABAB&url=http%253A%252F%252Fceur-ws.org%252F
- Fayollas, C., Martinie, C., Palanque, P., Barboni, E., Fahssi, R. M., & Hamon, A. (2017, 9). Exploiting Action Theory as a Framework for Analysis and Design of Formal Methods Approaches: Application to the CIRCUS Integrated Development Environment. In B. Weyers, J. Bowen, A. Dix, & P. Palanque (Eds.), *Handbook of Formal Methods in Human-Computer Interaction* (pp. 465-504). <http://www.springer.com>: Springer International Publishing.
- Fayollas, C., Martinie, C., Palanque, P., Barboni, E., Fahssi, R., & Hamon, A. (2017). Exploiting Action Theory as a Framework for Analysis and Design of Formal Methods Approaches: Application to the CIRCUS Integrated Development Environment. In *The Handbook of Formal Methods in Human-Computer Interaction* (pp. 465-504). Springer.
- Fayollas, C., Martinie, C., Palanque, P., Deleris, Y., Fabre, J.-C., & Navarre, D. (2014, 5). An approach for assessing the impact of dependability on usability: application to interactive cockpits. (regular paper). *European Dependable Computing Conference (EDCC 2014)*, Newcastle upon Tyne, UK, 13/05/14-16/05/14 (pp. 198-209). <http://www.ieee.org/>: IEEE. Retrieved from <http://dx.doi.org/10.1109/EDCC.2014.17>
- Fayollas, C., Martinie, C., Palanque, P., Masci, P., Harrison, M., Campos, J. C., & Rodrigues E Silva, S. (2017). Evaluation of Formal IDEs for Human-Machine Interface Design and Analysis: The Case of CIRCUS and PVSio-web (regular paper). *Workshop on Formal Integrated Development Environment (F-IDE 2016)*, Limassol, Cyprus, 08/11/16-08/11/16 (p. (on line)). <http://opa.eptcs.org/>: Open Publishing Association. Retrieved from <http://eptcs.web.cse.unsw.edu.au/paper.cgi?FIDE2016.1> - <http://oatao.univ-toulouse.fr/18933/>
- Fayollas, C., Palanque, P., Fabre, J.-C., Martinie, C., & Deleris, Y. (2017, 9). Dealing with Faults During Operations: Beyond Classical Use of Formal Methods. In B. Weyers, J. Bowen, A. Dix, & P. Palanque (Eds.), *Handbook of Formal Methods in Human-Computer Interaction* (pp. 549-575). <http://www.springer.com>: Springer International Publishing.
- Feary, M., Feuerle, T., Gonzalez Rechea, C., Saez, F., Johnson, C., Martinie, C., . . . Winckler, M. A. (Eds.). (2015, 10). 5th International Conference on Application and Theory of Automation in Command and Control Systems, Toulouse, France, 30/09/2015 - 02/10/2015. <http://portal.acm.org/dl.cfm>: ACM DL. Retrieved from <http://dl.acm.org/citation.cfm?id=2899361>
- Feary, M., Martinie, C., Palanque, P., & Tscheligi, M. (2016, 5). Multiple Views on Safety-Critical Automation: Aircrafts, Autonomous Vehicles, Air Traffic Management and Satellite Ground

- Segments Perspectives. *ACM SIGCHI Conference on Human Factors in Computing Systems, San José, USA, 07/05/16-12/05/16* (p. (on line)). <http://portal.acm.org/dl.cfm>: ACM Digital Library. Retrieved from <http://dl.acm.org/citation.cfm?id=2886430&CFID=637165741&CFTOKEN=31278608> - <http://oatao.univ-toulouse.fr/17081/>
- Fitts, P. M. (1951). *Human Engineering for an Effective Air Navigation and Traffic Control System*. Columbus: Ohio State University Research Foundation.
- Forbrig, P., Martinie, C., Palanque, P., Winckler, M. A., & Fahssi, R. M. (2014, 9). Rapid Task-Models Development Using Sub-models, Sub-routines and Generic Components (regular paper). *Human-Centered Software Engineering (HCSE 2014), Paderborn, 16/09/14-18/09/14* (pp. 144-163). <http://www.springer.com>: Springer Berlin / Heidelberg. Retrieved from <http://www.springer.com/computer/swe/book/978-3-662-44810-6> - <http://oatao.univ-toulouse.fr/13230/>
- Frard, V., Francillout, L., Galet, G., & Michel, S. (2010). ATV-CC Vehicle Team Staffing from Jules Verne to Johannes Kepler Mission. *SpaceOps*.
- Friedenthal, S., Moore, A., & Steiner, R. (2011). *A practical guide to SysML: the systems modeling language (2nd edition)*. The MK/OMG Press .
- Fröhlich, P., Sackl, A., Trösterer, S., Meschtscherjakov, A., Diamond, L., & Tscheligi, M. (2018). Acceptance Factors for Future Workplaces in Highly Automated Trucks. *International Conference on Automotive User Interfaces and Interactive Vehicular Applications* (pp. 129-136). ACM.
- Galindo, M., Martinie, C., Palanque, P., Winckler, M. A., & Forbrig, P. (2013). Tuning an HCI Curriculum for Master Students to Address Interactive Critical Systems Aspects (regular paper). In K. Masaaki (Ed.), *HCI International, LAS VEGAS Nevada USA, 21/07/13-26/07/13. Lecture Notes Computer Sc 8004*, pp. 51-60. <http://www.springer.com>: Springer USA. Retrieved from <http://oatao.univ-toulouse.fr/12569/>
- Gonzales Calleros, J., Guerrero Garcia, J., & Vanderdonckt, J. (2013). Advance human-machine interface automatic evaluation. (Springer, Ed.) *Universal Access in the Information Society* , 12, 387-401.
- González, C., Varmazyar, M., Nejati, S., Briand, L., & Isasi, Y. (2018). Enabling Model Testing of Cyber-Physical Systems. *Proceedings of the 21th ACM/IEEE International Conference on Model Driven Engineering Languages and Systems (MODELS '18)* (pp. 176–186). ACM.
- Göransson, B., Gulliksen, J., & Boivie, I. (2003). The usability design process - integrating user-centered systems design in the software development process. *Software Process Improvement and Practice*, 8(2), pp. 111--131.
- Greenberg, S. (2004). Working through Task-Centered System Design. In D. Diaper, & N. Stanton, *The Handbook of Task Analysis for Human-Computer Interaction* (pp. 49-66). Lawrence Erlbaum Associates.
- Guerrero, J., Vanderdonckt, J., & Gonzalez Calleros, J. (2008). FlowiXML: a Step towards Designing Workflow Management Systems. *Journal of Web Engineering*, 163-182.

- Hamon, A., Palanque, P., Cronel, M., André, R., Barboni, E., & Navarre, D. (2014). Formal modelling of dynamic instantiation of input devices and interaction techniques: application to multi-touch interactions. *ACM SIGCHI Conference on Engineering Interactive Systems (EICS)* (pp. 173-178). Roma, Italy: ACM.
- Hamon, A., Palanque, P., Navarre, D., Martinie, C., Tankeu Choitat, A., & Barboni, E. (2012). Interactive Cockpits Applications: Modelling and Validation using a Petri-net based Formalism (regular paper). *European Congress on Embedded Real-Time Software (ERTS 2012), Toulouse, France, 01/02/12-03/02/12* (p. (electronic medium)). <http://www.erts2012.org/>: Site web ERTS 2012.
- Hamon, A., Palanque, P., Navarre, D., Martinie, C., Tankeu-Choitat, A., & Barboni, E. (2012). Interactive Cockpits Applications: Modelling and Validation using a Petri-net based Formalism. *European Congress on Embedded Real-Time Software* (p. 8). Toulouse: SEE.
- Haritos, T., & Macchiarella, N. (2005). A mobile application of augmented reality for aerospace maintenance training. *24th Digital Avionics Systems*.
- Hassenzahl, M., Platz, A., Burmester, M., & Lehner, K. (2000). Hedonic and ergonomic quality aspects determine a software's appeal. *ACM SIGCHI Conference on Computer Human Interaction (CHI)* (pp. 201-208). ACM.
- Hewett, T., Baecker, R., Card, S., Carey, T., Gasen, J., Mantei, M., . . . Verplank, W. (1992). *ACM SIGCHI Curricula for Human-Computer Interaction*. New York, NY, USA: Association for Computing Machinery.
- Hollnagel, E. (1997). Cognitive ergonomics: it's all in the mind. *Ergonomics*, 40(10), 1170-1182.
- Hollnagel, E. (1998). *Cognitive reliability and error analysis method (CREAM)*. Elsevier.
- Hollnagel, E. (2006). Resilience - the challenge of the unstable. In E. Hollnagel, D. Woods, & N. Leveson, *Resilience engineering: concepts and precepts* (pp. 9-18). Ashgate.
- Hollnagel, E. (2012). *FRAM - The Functional Resonance Analysis Method*. Farnham, UK: Ashgate.
- Hollnagel, E., Martinie, C., Palanque, P., Pasquini, A., Ragosta, M., Rigaud, E., & Silvagni, S. (2011). System Performances under Automation Degradation (SPAD) (regular paper). *The First SESAR Innovation Days, Toulouse, France, 29/11/11-01/12/11* (p. (on line)). <http://www.sesarinnovationdays.eu>: SESAR Work Package E. Retrieved from <http://sesarinnovationdays.eu/files/SIDs/SID%25202011-SPAD.pdf>
- International Standard Organisation. (2019, July). *ISO 9241-210:2019 Ergonomics of human-system interaction -- Part 210: Human-centred design for interactive systems*. Geneva, Switzerland: ISO.
- ISO 9241 part 11. (2018). *ISO 9241 Ergonomic of human-system interaction - part 11: Usability: Definition and concepts*. Geneva, Switzerland: ISO.
- JAA. (2006). *JAR - FCL 1—Flight Crew Licensing (Aeroplane)*. Joint Aviation Authorities.
- Janssen, C., Donker, S., Brumby, D. P., & Kun, A. L. (2019). History and future of human-automation interaction. *International Journal of Human-Computer Studies*, 99-107.

- John, B., & Kieras, D. (1996). The GOMS family of user interface analysis techniques: comparison and contrast. *ACM Transactions Computer-Human Interaction*, 3(4).
- John, B., & Kieras, D. (1996). Using GOMS for User Interface Design and Evaluation: Which Technique? *ACM Transactions on Computer-Human Interaction*, 3(4), 287-319.
- Johnson, C. (1995). Using Z to support the design of interactive safety-critical systems. (IEEE, Ed.) *Software Engineering Journal*, 10(2), pp. 49-60.
- Johnson, C. (1997). Beyond Belief: Representing Knowledge Requirements For The Operation Of Safety-Critical Interfaces. *IFIP TC 13 Conference in Human-Computer Interaction (INTERACT)*, (pp. 315-322).
- Johnson, C., Feary, M., Martinie, C., Palanque, P., & Peldszus, R. (2015). IFIP WG 13.5 Workshop on Resilience, Reliability, Safety and Human Error in System Development. *IFIP TC13 Human Computer Interaction (INTERACT 2015), Bamberg, Germany, 14/09/15-18/09/15* (pp. 663-664). <http://www.springerlink.com>: Springer. Retrieved from http://dx.doi.org/10.1007/978-3-319-22723-8_91
- Johnson, P. (1992). *Human-Computer Interaction: psychology, task analysis and software engineering*. Maidenhead, UK: McGraw Hill.
- Johnson, P., Johnson, H., & Hamilton, F. (2000). Getting the Knowledge into HCI: Theoretical and Practical Aspects of Task Knowledge Structures. In J. Schraagen, S. Chipman, & V. Shalin, *Cognitive Task Analysis*. LEA.
- Jourde, F., Laurillau, Y., & Nigay, L. (2010). COMM notation for specifying collaborative and multimodal interactive systems. *ACM SIGCHI Conference on Engineering Interactive Computing Systems* (pp. 125-134). Grenoble, France: ACM.
- Kalfoglou, Y., & Schorlemmer, M. (2003). Ontology mapping: the state of the art. (Cambridge, Ed.) *The Knowledge Engineering Review*, 18(1), 1-31.
- Limbourg, Q., Vanderdonckt, J., Michotte, B., Bouillon, L., & Lopez-Jacquero, V. (2004). UsiXML: a language supporting multi-path development of user interfaces. *9th IFIP Working Conference on Engineering for Human-Computer Interaction (EHCI)* (pp. 200-220). Springer.
- Marsden, P., & Kirby, M. (2005). Allocation of Functions. In N. Stanton, A. Hedge, K. Brookhuis, E. Salas, & H. Hendrick, *Handbook of Human Factors and Ergonomics Methods* (pp. 34-1 34-8). CRC Press.
- Martinie, C. (2011). A Model-Based and Systematic Approach to Design and Assess the Level of Automation of Large Interactive Critical Systems (student paper). *International Conference on Application and Theory of Automation in Command and Control Systems, Barcelona, 26/05/11-27/05/11* (p. (electronic medium)). <http://www.irit.fr>: IRIT Press.
- Martinie, C. (2011). *Une approche à base de modèles synergiques pour la prise en compte simultanée de l'utilisabilité, la fiabilité et l'opérabilité des systèmes interactifs critiques*. Thèse de doctorat, Université Paul Sabatier, Toulouse. Retrieved from <http://thesesups.ups-tlse.fr/1509/1/2011TOU30254.pdf>

- Martinie, C. (2014). Game Jam 4 Investigating Design Issues with (partly) autonomous systems. *GameJam workshop at ACM Conference on Human Computer Interaction, CHI 2014 (GameJam[4Research] 2014), Toronto, Canada, 26/04/14-27/04/14* (p. (on line)). <http://www.gamesjam.nl/>: Games Jam web site. Retrieved from <http://www.gamesjam.nl/project/game-jam-4-investigating-design-issues-with-partly-autonomous-systems/> - <http://oatao.univ-toulouse.fr/13036/>
- Martinie, C., & Palanque, P. (2011). *A Multi-Models Based Development Process for Critical Interactive Systems Integrating Formal and Informal Approaches (IFIP WG 2.7/13.4 Workshop on Combining Models and Design for interactive systems (ComDeisMoto 2011), Lisbonne, Portugal, 06/09/2011-06/09/2011)*. unpublished.
- Martinie, C., & Palanque, P. (2013). *Predicting and Mitigating Human Error Through Detailed Descriptions of Operators' Tasks (HUDEP, Oberpfaffenhofen, Allemagne, 13/11/2013-14/11/2013)*. unpublished. Retrieved from <http://www.congrexprojects.com/2013-events/13m19/hudep-2013>
- Martinie, C., & Palanque, P. (2014). Fine Grain Modeling of Task Deviations for Assessing Qualitatively the Impact of Both System Failures and Human Error on Operator Performance (regular paper). *AAAI 2014 Symposium on Formal Verification on Human-Machine Systems, Stanford University, Palo Alto, 24/03/14-26/03/14* (p. (electronic medium)). <http://www.aaai.org/Press/press.php>: AAAI Press. Retrieved from <http://oatao.univ-toulouse.fr/12910/>
- Martinie, C., & Palanque, P. (2015, 5). Design, Development and Evaluation Challenges for Future Mobile User Interfaces in Safety-Critical Contexts. *Workshop on Future Mobile User Interfaces. 13th International Conference on Mobile Systems, Applications and Services, Florence, Italie, 18/05/15-22/05/15* (p. (electronic medium)). <http://www.acm.org/>: ACM Press. Retrieved from <http://oatao.univ-toulouse.fr/15313/>
- Martinie, C., & Palanque, P. (2015). *Modeling and Analysis of Human Error Based on Tasks Descriptions: Connecting Research Knowledge with Practice (Human Dependability Workshop (HUDEP 2015), ESA/ESOC, Darmstadt, Germany, 06/10/15-07/10/15)*. unpublished.
- Martinie, C., & Palanque, P. (2017, 11). Safety-Critical Automation - Aircrafts, Autonomous Vehicles, Air Traffic Management and Satellite Ground Segments Perspectives. Retrieved from <https://www.comet-cnes.fr/resource-access/HUDEP%2520Programme.pdf>
- Martinie, C., & Palanque, P. (2018). *Explicit representation of function allocation and authority sharing (initiative and responsibility) (CHI 2018 Workshop - Interacting with Autonomous Vehicles: Learning from other Domains, Montr_al, Canada, 22/04/2018-22/04/2018)*. unpublished. Retrieved from <https://hci.sbg.ac.at/wp-content/uploads/2018/03/martinie2018.pdf>
- Martinie, C., Barboni, E., Navarre, D., Palanque, P., Fahssi, R. M., Poupart, E., & Cubero-Castan, E. (2014). Multi-Models-Based Engineering of Collaborative Systems: Application to Collision Avoidance Operations for Spacecrafts. *ACM SIGCHI conference Engineering Interactive Computing Systems (EICS 2014)* (pp. 85-94). ACM. Retrieved from <http://dl.acm.org/> - <http://oatao.univ-toulouse.fr/13035/>

- Martinie, C., Galindo, M., & Palanque, P. (2013, 5). *Report on the requirements for careers kits identifying the content of the Kits*. Rapport de recherche, IRIT, Universit_ Paul Sabatier, Toulouse.
- Martinie, C., Ladry, J.-F., Navarre, D., Palanque, P., & Winckler, M. A. (2010). Embedding Requirements in Design Rationale to Deal Explicitely with User eXperience and Usability in an _intensive_ Model-Based Development Approach (regular paper). In J. Van den Bergh, S. Sauer, K. Breiner, H. Hu_mann, & G. Meixner (Ed.), *Workshop on Model Driven Development of Advanced User Interfaces (MDDAUI 2010)*, Atlanta Georgia USA, 10/04/10. 617, pp. 29-32. <http://CEUR-WS.org>: CEUR-WS : Workshop proceedings. Retrieved from http://ceur-ws.org/Vol-617/MDDAUI2010_Paper08.pdf
- Martinie, C., Navarre, D., & Palanque, P. (2013, 9). A Multi-Formalism Approach for Model-Based Dynamic Distribution of User Interfaces of Critical Interactive Systems. *International Journal of Human-Computer Studies*, 2013.08, (on line). Retrieved from <http://dx.doi.org/10.1016/j.ijhcs.2013.08.013> - <http://oatao.univ-toulouse.fr/12676/>
- Martinie, C., Navarre, D., & Palanque, P. (2018, 5). Exploiting Tasks Descriptions to Assess and Ensure Effectiveness during the programming of interactive Java software. Retrieved from <https://www.doi.org/10.13140/RG.2.2.26070.50240>
- Martinie, C., Navarre, D., Palanque, P., & Fayollas, C. (2015). A Generic Tool-Supported Framework for Coupling Task Models and Interactive Applications. *ACM SIGCHI conference Engineering Interactive Computing Systems (EICS 2015)* (pp. 244-253). ACM. Retrieved from <http://oatao.univ-toulouse.fr/15321/>
- Martinie, C., Navarre, D., Palanque, P., Barboni, E., & Canny, A. (2018). TOUCAN: An IDE Supporting the Development of Effective Interactive Java Applications. *ACM SIGCHI conference Engineering Interactive Computing Systems (EICS 2018)*, Paris, 19/06/18-22/06/18 (pp. 1-7). <http://www.acm.org/>: ACM : Association for Computing Machinery.
- Martinie, C., Palanque, P., & Fayollas, C. (2018). Performance Evaluation of Interactive Systems with Interactive Cooperative Objects Models. In A. Oulasvirta, P. O. Kristensson, X. Bi, & A. Howes (Eds.), *Computational Interaction* (pp. 249-283). <http://www.oup.com/>: Oxford University Press.
- Martinie, C., Palanque, P., & Ragosta, M. (2012). Some Issues with Interaction Design and Implementation in the Context of Autonomous Interactive Critical Systems (regular paper). *ACM International Conference on Human Factors in Computer Science (Workshop on End-user Interactions with Intelligent and Autonomous Systems)*, Austin, Texas, 05/05/12-10/05/12 (pp. 25-30). <http://portal.acm.org/dl.cfm>: ACM Digital Library.
- Martinie, C., Palanque, P., & Winckler, M. A. (2011). Structuring and Composition Mechanisms to Address Scalability Issues in Task Models. *IFIP TC13 Human Computer Interaction (INTERACT 2011)*, Lisboa, 05/09/11-09/09/11 (pp. 134-152). <http://www.springerlink.com/>: Springer-Verlag.
- Martinie, C., Palanque, P., & Winckler, M. A. (2015, 11). Designing and Assessing Interactive Systems Using Task Models. In A. Kronbauer, E. Mattos, A. L. Sampaio, & C. Boscaroli (Eds.), *Book of Tutorials of the 14th Brazilian Symposium on Human Factors in Computing Systems* (pp. 29-58). <http://www.sbc.org.br/>: Brazilian Computing Society.

- Martinie, C., Palanque, P., Barboni, E., & Ragosta, M. (2011, 10). Task-Model Based Assessment of Automation Levels: Application to Space Ground Segments. *IEEE International Conference on Systems, Man and Cybernetics* (pp. 3267-3273). Anchorage: IEEE Computer Society - Conference Publishing Services.
- Martinie, C., Palanque, P., Barboni, E., Winckler, M. A., Ragosta, M., Pasquini, A., & Lanzi, P. (2011). Formal Tasks and Systems Models as a Tool for Specifying and Assessing Automation Designs. *International Conference on Application and Theory of Automation in Command and Control Systems, Barcelone, 26/05/11-27/05/11* (pp. 50-59). <http://www.irit.fr>: ACM.
- Martinie, C., Palanque, P., Bouzekri, E., Cockburn, A., Canny, A., & Barboni, E. (2019). Analysing and Demonstrating Tool-Supported Customizable Task Notations. *Proceedings of the ACM*, 3(12), 26.
- Martinie, C., Palanque, P., Bouzekri, E., Cockburn, A., Canny, A., & Barboni, E. (2019). Analysing and Demonstrating Tool-Supported Customizable Task Notations. *Proceedings of the ACM on Human-Computer Interaction*, 3(12 (EICS)), 26 pages. Retrieved from <https://doi.org/10.1145/3331154>
- Martinie, C., Palanque, P., Fahssi, R. M., Blanquart, J.-P., Fayollas, C., & Seguin, C. (2016). Task Model-Based Systematic Analysis of Both System Failures and Human Errors. *IEEE Transactions on Human-Machine Systems*, 46, 243-254. Retrieved from <http://dx.doi.org/10.1109/THMS.2014.2365956>
- Martinie, C., Palanque, P., Navarre, D., & Barboni, E. (2012, 10). A Development Process for Usable Large Scale Interactive Critical Systems: Application to Satellite Ground Segments (regular paper). In W. Marco, F. Peter, & B. Regina (Ed.), *Human-Centered Software Engineering (HCSE 2012)*, Toulouse, 29/10/12-31/10/12 (pp. 112-134). <http://www.springerlink.com>: Springer.
- Martinie, C., Palanque, P., Navarre, D., & Barboni, E. (2012). A Tool-Supported Training Framework for Improving Operators: Dependability Confronted with Faults and Errors (regular paper). *Safety and Reliability for managing Risk (ESREL 2012)*, Helsinki, Finland, 25/06/12-29/06/12 (pp. 25-36). <http://www.taylorandfrancisgroup.com/>: Taylor & Francis Group.
- Martinie, C., Palanque, P., Navarre, D., & Poupart, E. (2012). A Systematic Approach to Training for Ground Segment using Tasks and Scenarios: Application to PICARD satellite (regular paper). *International Conference on Space Operations (SpaceOps 2012)*, Stockholm, Sweden, 11/06/12-15/06/12 (p. (electronic medium)). <http://www.aiaa.org>: American Institute of Aeronautics and Astronautics (AIAA).
- Martinie, C., Palanque, P., Navarre, D., & Winckler, M. A. (2010). A formal approach supporting effective and efficient training program for improving operators reliability (regular paper). *Safety and Reliability for managing Risk (ESREL 2010)*, Rhodes Grece, 05/09/10-09/09/10 (pp. 234-243). <http://www.taylorandfrancisgroup.com/>: Taylor & Francis Group.
- Martinie, C., Palanque, P., Navarre, D., Barboni, E., & Poupart, E. (2012, 9). Systematic Approaches to Training Encompassing Operators' mission and Interaction Techniques. *International Conference on Human-Computer Interaction in Aeronautics (HCI'Aero 2012)*. Brussels. Retrieved from <http://dl.acm.org/>

- Martinie, C., Palanque, P., Navarre, D., Barboni, E., & Winckler, M. A. (2012, 10). Un processus de développement outillé pour l'exploitation systématique des bénéfices offerts par une conception des systèmes interactifs centrés. (regular paper). *Interaction Homme-Machine (IHM 2012)*, Biarritz, 17/10/2012-19/10/2012 (p. (en ligne)). <http://portal.acm.org/dl.cfm>: ACM Digital Library. Retrieved from <http://dl.acm.org/>
- Martinie, C., Palanque, P., Navarre, D., Winckler, M. A., & Poupart, E. (2011). Model-Based Training: An Approach Supporting Operability of Critical Interactive Systems: Application to Satellite Ground Segments (regular paper). *ACM SIGCHI conference Engineering Interactive Computing Systems (EICS 2011)*, Pise, Italie, 13/06/11-16/06/11 (pp. 589-609). <http://www.springerlink.com/>: Springer-Verlag.
- Martinie, C., Palanque, P., Pasquini, A., Ragosta, M., Rigaud, E., & Silvagni, S. (2012). Using Complementary Model-Based Approaches for Representing and Analysing ATM Systems' Variability (regular paper). *International Conference on Application and Theory of Automation in Command and Control Systems (ATACCS 2012)* (pp. 146-157). ACM.
- Martinie, C., Palanque, P., Pasquini, A., Ragosta, M., Silvagni, S., Sujan, M.-A., . . . Hollnagel, E. (2013b, 11). Modelling of Automation Degradation: a Case Study (regular paper). *SESAR Innovation Days, Stockholm, Suède, 26/11/13-28/11/13* (p. (on line)). <http://www.sesarinnovationdays.eu>: SESAR Work Package E. Retrieved from <http://www.sesarinnovationdays.eu/> - <http://oatao.univ-toulouse.fr/12807/>
- Martinie, C., Palanque, P., Pasquini, A., Ragosta, M., Sujan, M.-A., & Navarre, D. (2013a, 9). Understanding functional resonance through a federation of models: preliminary findings of an avionics case study (regular paper). In F. Bitsch, J. Guiochet, & M. Kainiche (Ed.), *International Conference on Computer Safety, Reliability and Security (SAFECOMP 2013)*, Toulouse, France, 24/09/13-27/09/13 (pp. 216-227). <http://www.springerlink.com/>: Springer-Verlag. Retrieved from http://dx.doi.org/10.1007/978-3-642-40793-2_20 - <http://oatao.univ-toulouse.fr/12647/>
- Martinie, C., Palanque, P., Ragosta, M., & Fahssi, R. M. (2013, 10). Extending Procedural Task Models by Explicit and Systematic Integration of Objects, Knowledge and Information (regular paper). *European Conference on Cognitive Ergonomics (ECCE 2013)*, Toulouse, France, 26/08/13-28/08/13 (pp. 1-10). <http://www.acm.org/>: ACM : Association for Computing Machinery. Retrieved from <http://doi.acm.org/10.1145/2501907.2501954> - <http://oatao.univ-toulouse.fr/12675/>
- Martinie, C., Palanque, P., Silva, J. L., & Navarre, D. (2013). Properties verification of interactive systems by tool-supported analysis of its formal specification. Retrieved from http://www.irit.fr/Celia.Martinie-De-Almeida/Technical_report_on_properties_verification_April_2013.pdf
- Martinie, C., Palanque, P., Winckler, M. A., & Bernhaupt, R. (2015). AUTOM AT ICS: Research activities on Automation. *International Conference on Application and Theory of Automation in Command and Control Systems (ATACCS 2015)*, Toulouse, 30/09/15-02/10/15 (p. (on line)). <http://portal.acm.org/dl.cfm>: ACM Digital Library. Retrieved from <http://dl.acm.org/> - <http://oatao.univ-toulouse.fr/16928/>
- Martinie, C., Palanque, P., Winckler, M. A., & Conversy, S. (2010, 9). DREAMER: a Design Rationale Environment for Argumentation, Modeling and Engineering Requirements (regular paper). In

- J. C. Anacleto, R. Fortes M. Pontin, & C. J. Costa (Ed.), *ACM International Conference on Design of Communication (ACM SIGDOC 2010)*, Sao Paulo, Brasil, 26/09/10-29/09/10 (pp. 73-80). <http://www.acm.org/>: ACM : Association for Computing Machinery.
- Masip, L., Martinie, C., Winckler, M. A., Palanque, P., Granollers, T., & Oliva, M. (2012, 10). A Design Process for Exhibiting Design Choices and Trade-offs in (potentially) Conflicting User Interface Guidelines (regular paper). In M. Winckler, P. Forbrig, & R. Bernhaupt (Ed.), *Human-Centered Software Engineering (HCSE 2012)*, Toulouse, France, 29/10/12-31/10/12 (pp. 53-71). <http://www.springerlink.com>: Springer.
- Mazhar, S., Wu, P., & Rosemann, M. (2018). Designing complex socio-technical process systems – the airport example. *Business Process Management Journal*, 25(5), 1101-1125.
- McDermid, J., & Ripken, K. (1983). Life cycle support in the Ada environment. *SIGAda Letters*.
- Miller, C., & Parasuraman, R. (2007). Designing for Flexible Interaction Between Humans and Automation: Delegation Interfaces for Supervisory Control. *Human Factors*, 49, 57-75.
- MIL-STD-1629A. (1980). *Procedures for Performing a Failure Mode, Effects and Criticality Analysis*. Washington: US Department of Defense.
- Mori, G., & Paterno, F. a. (2002). CTTE: support for developing and analyzing task models for interactive system design. *IEEE Transactions on Software Engineering*, 28(8), 797-813.
- Mumford, E. (2006). The story of socio-technical design: reflections in its successes, failures and potential. *Information Systems Journal*, 16, 317-342.
- Navarre, D., Martinie, C., Palanque, P., Pasquini, A., & Ragosta, M. (2013). Model-based dynamic distribution of user interfaces of critical interactive systems (regular paper). *International Conference on Application and Theory of Automation in Command and Control Systems (ATACCS 2013)*, Naples, Italy, 28/05/13-30/05/13 (pp. 66-75). <http://www.acm.org/>: ACM : Association for Computing Machinery. Retrieved from <http://oatao.univ-toulouse.fr/12646/>
- Navarre, D., Palanque, P., Barboni, E., Ladry, J.-F., & Martinie, C. (2011, 1). Designing for resilience to hardware failures in interactive systems: A model and simulation-based approach. *Elsevier's Safety Science, Reliability Engineering and System Safety*, 96, 38-52.
- Navarre, D., Palanque, P., Ladry, J.-F., & Barboni, E. (2009). ICOs: A model-based user interface description technique dedicated to interactive systems addressing usability, reliability and scalability. (ACM, Ed.) *ACM Transactions on Computer-Human Interaction (TOCHI)*, 16(4), 18:1-18:56.
- Navarre, D., Palanque, P., Martinie, C., & Steere, S. (2011). Formal Description Techniques for Human-Machine Interfaces - Model-Based Approaches for the Design and Evaluation of Dependable Usable Interactive Systems. In G. A. Boy (Ed.), *Handbook of Human-Machine Interaction, A Human-Centered Approach* (p. (on line)). <http://www.ashgate.com>: Ashgate Publishing. Retrieved from <http://www.ashgate.com/isbn/9780754675808>
- Nguyen, B. R., Banerjee, I., & Memon, A. (2014). GUITAR: an innovative tool for automated testing of GUI-driven software. *Automated Software Engineering*, 21(1), 65-105.
- Nielsen, J. (1994). *Usability engineering*. Morgan Kaufmann.

- Norman, D. (2002). *The design of everyday things*. Basic Books.
- Norman, D., & Drapper, S. (1986). *User Centred System Design*. Lawrence Erlbaum.
- Obrist, M., Reitberger, W., Wurhofer, D., Förster, F., & Tscheligi, M. (2011). User Experience Research in the Semiconductor Factory: A Contradiction? *IFIP Conference on Human-Computer Interaction (INTERACT 2011)* (pp. 144-151). Springer.
- Palanque, P. (2019). TC13 Open Symposium 2019 – London, UK – March 29th, 2019. *A Systemic View on Resilient Interactive Systems*.
- Palanque, P., & Bastide, R. (1994). A Formalism for Reliable User Interfaces. *Workshop Software Engineering/Human Computer Interaction associated with the IEEE/ICSE 16 conference*. Sorrento, Italy.
- Palanque, P., & Bastide, R. (1994). Petri net based Design of User-driven Interfaces Using the Interactive Cooperative Objects Formalism. *Design, Specification and Verification of Interactive Systems DSV-IS'94*, (pp. 383-400). Bocca di Magra, Italy.
- Palanque, P., & Martinie, C. (2011). Contextual Help for Supporting Critical Systems' Operators: Application to Space Ground Segments. *Workshop on Activity Context Representation*. San Francisco: AAAI.
- Palanque, P., & Martinie, C. (2011). *Contextual Help for Supporting Critical Systems' Operators: Application to Space Ground Segments (Workshop on Activity Context Representation, San Francisco, 07/08/2011-08/08/2011)*. unpublished.
- Palanque, P., & Martinie, C. (2015). Designing and Assessing Interactive Systems Using Task Models . *SIGCHI Conference on Human Factors in Computing Systems, Seoul, Korea, 18/04/15-23/04/15* (p. (electronic medium)). <http://www.acm.org/>: ACM Press. Retrieved from <http://oatao.univ-toulouse.fr/15320/>
- Palanque, P., & Martinie, C. (2016, 5). Designing and Assessing Interactive Systems Using Task Models . *ACM SIGCHI Conference on Human Factors in Computing Systems, San Jos_, USA, 07/05/16-12/05/16* (p. (on line)). <http://portal.acm.org/dl.cfm>: ACM Digital Library. Retrieved from <http://dl.acm.org/citation.cfm?id=2856686&CFID=637165741&CFTOKEN=31278608> - <http://oatao.univ-toulouse.fr/17080/>
- Palanque, P., Barboni, E., Martinie, C., Navarre, D., & Winckler, M. A. (2011). A Tool Supported Model-based Approach for Engineering Usability Evaluation of Interaction Techniques (regular paper). *ACM SIGCHI conference Engineering Interactive Computing Systems (EICS 2011), Pise, Italie, 13/06/11-16/06/11* (pp. 21-30). <http://www.acm.org/>: ACM Press.
- Palanque, P., Basnyat, S., Bernhaupt, R., Boring, R., Johnson, C., & Johnson, P. (2007). Beyond usability for safety critical systems: how to be sure (safe, usable, reliable, and evolvable)? *Proceeding of CHI* (pp. 2133-2136). ACM.
- Palanque, P., Bernhaupt, R., & Martinie, C. (2012, 9). Designing and Engineering Interactive Critical Systems Using Contributions from Gaming Research and Practice. *Workshop on Safety-Critical Systems and Video Games: Contradictions and Commonalities. In conjunction with 4th International Conference on Fun and Games (Fun&Games2012), Toulouse, 04/09/12-06/09/12* (p. (on line)). <http://portal.acm.org/dl.cfm>: ACM Digital Library. Retrieved from dl.acm.org

- Palanque, P., Fahssi, R. M., Martinie, C., Winckler, M. A., & Galindo, M. (2015). *Retour d'exp_rience sur l'enseignement de la mod_lisation des taches au Master Interaction Homme-Machine de Toulouse (GT Mod_les de T_ches - IHM 2015, Toulouse, 27/10/2015-30/10/2015)*. unpublished.
- Palanque, P., Farenc, C., & Bastide, R. (1999). Embedding Ergonomic Rules as Generic Requirements in a Formal Development Process of Interactive Software. *Proc. of 7th IFIP Conference on Human-Computer Interaction Interact'99* (pp. 408-416). Edinburgh: Chapman & Hall.
- Palanque, P., Ladry, J.-F., Navarre, D., & Barboni, E. (2009). High-Fidelity Prototyping of Interactive Systems Can Be Formal Too. *HCI International*, (pp. 667-676).
- Palanque, P., Martinie, C., & Bouzekri, E. (2019). IFIP TC 13 International Conference on Human Computer Interaction INTERACT. *Introduction to Automation and to Its Potential for Interactive Systems Design*, 523-526. Paphos, Cyprus.
- Palanque, P., Martinie, C., & Fayollas, C. (2017, 5). Automation: Danger or Opportunity? Designing and Assessing Automation for Interactive Systems. *ACM SIGCHI Conference on Human Factors in Computing Systems, Denver, Colorado, USA, 06/05/17-11/05/17* (pp. 1257-1260). <http://www.acm.org/>: ACM : Association for Computing Machinery.
- Palanque, P., Martinie, C., & Fayollas, C. (2018). Automation: Danger or Opportunity? Designing and Assessing Automation for Interactive Systems. *ACM SIGCHI Conference on Human Factors in Computing Systems, Montr_al, 21/04/18-26/04/18* (p. (on line)). <http://www.acm.org/>: ACM : Association for Computing Machinery. Retrieved from <https://doi.org/10.1145/3170427.3170652>
- Palanque, P., Martinie, C., & Winckler, M. A. (2017, 9). Designing and Assessing Interactive Systems Using Task Models. *IFIP TC13 Conference on Human-Computer Interaction (INTERACT 2017), Mumbai, India, 25/09/17-29/09/17* (pp. 383-386). <http://www.springerlink.com/>: Springer-Verlag.
- Palanque, P., Martinie, C., Galindo, M., & Maroni, A. (2013, 5). *Report on skills, knowledge and background of Career Advisors and counsellors in most European countries*. Rapport de recherche, IRIT, Universit_ Paul Sabatier, Toulouse.
- Palanque, P., Winckler, M. A., & Martinie, C. (2011). A Formal Model-Based Approach for Designing Interruptions-Tolerant Advanced User Interfaces. In H. Hussmann, G. Meixner, & D. Zuehlke (Eds.), *Model-Driven Development of Advanced User Interfaces* (Vol. Vol. 340, pp. 143-170). <http://www.springerlink.com>: Springer. Retrieved from <http://www.springer.com/computer/swe/book/978-3-642-14561-2>
- Palmer, E. (1995). Oops, it didn't arm'- A case study of two automation surprises. *International Symposium on Aviation Psychology, 8th,* (pp. 227-232). Columbus, Ohio.
- Parasuraman, R., Sheridan, T., & Wickens, C. (2000, May). A model for types and levels of human interaction with automation. *IEEE Transactions on Systems, Man and Cybernetics, Part A: Systems and Humans*, 30(3), 286-297.
- Paterno, F. (2002). Task models in interactive software systems. In *Handbook of Software Engineering and Knowledge Engineering*. World Scientific.

- Paterno, F., & Zini, E. (2004). Applying information visualization techniques to visual representations of task models. *TAMODIA* (pp. 105-111). ACM.
- Paternò, F., Mancini, C., & Meniconi, S. (1997). A Diagrammatic Notation for Specifying Task Models. *IFIP TC13 Conference on Human-Computer Interaction (INTERACT'97)*, (pp. 362-369).
- Philipart, M. (2018). Human reliability analysis methods and tools. In T. Sgobba, B. Kanki, J.-F. Clervoy, & G. M. Sandal, *Space Safety and Human Performance* (pp. 501-568). Butterworth-Heinemann.
- Pilarski, M. (2014). The concept of recommender system supporting command and control system in hierarchical organization. *Proceedings of the Conference on European Network Intelligence* (pp. 138-141). IEEE.
- Pinelle, D., Gutwin, C., & Greenberg, G. (2003). Task analysis for groupware usability evaluation: Modeling shared-workspace tasks with the mechanics of collaboration. *ACM Trans. Comput.-Hum. Interact.*, 10(4), 281-311.
- Ragosta, M. (2015, 5). *A multi-modelS based approach for the modelling and the analysis of usable and resilient partly-autonomous interactive systems*. Thèse de doctorat, Université Paul Sabatier, Toulouse.
- Ragosta, M. (2015). *A multi-modelS based approach for the modelling and the analysis of usable and resilient partly-autonomous interactive systems*. Toulouse: Université Paul Sabatier Toulouse III.
- Ragosta, M., Martinie, C., Palanque, P., Navarre, D., & Sujan, M.-A. (2015). Concept Maps as a Glue for Integrating Modeling Techniques for the Analysis and Re-Design of Partly-Autonomous Interactive Systems (regular paper). *International Conference on Application and Theory of Automation in Command and Control Systems (ATACCS 2015), Toulouse, 30/09/15-02/10/15* (pp. 41-52). ACM. Retrieved from <http://dl.acm.org/> - <http://oatao.univ-toulouse.fr/16927/>
- Razali, R., & Garratt, P. (2010). Usability Requirements of Formal Verification Tools: A Survey. *Journal of Computer Science*, 6(10), 1189-1198.
- Regulation 2017/373. (2017, March). COMMISSION IMPLEMENTING REGULATION (EU) 2017/373. *Official Journal of the European Union*.
- Reiser, R. A. (2001). A History of Instructional Design and Tech-nology: Part II: A History of Instructional Design. *Educa-tional Technology Research and Development*, 49(2), 57-61.
- Rigaud, E., Hollnagel, E., Martinie, C., Palanque, P., Pasquini, A., Ragosta, M., . . . Sujan, M.-A. (2012). A framework for modeling the consequences of the propagation of automation degradation: application to air traffic control systems (regular paper). *SESAR Innovation Days, Braunschweig, 27/11/12-29/11/12* (p. (on line)). <http://www.eurocontrol.int>: Eurocontrol. Retrieved from <http://www.sesarinnovationdays.eu/2012/papers>
- Roto, V., Palanque, P., & Kar-nonen, H. (2018). Engaging Automation at Work - A Literature Review. *IFIP WG 13.6 Working Conference on Human Work Interaction Design (HWID)* (pp. 158-172). Springer.

- Royce, W. (1970). Managing the Development of Large Software Systems. *IEEE Wescon* (pp. 1-9). IEEE.
- RTCA. (2011). *Do-178c, software considerations in airborne systems and equipment*. RTCA.
- Rumbaugh, J., Jacobson, I., & Booch, G. (2004). *Unified Modeling Language Reference Manual*. Pearson Higher Education.
- Salas, E., & Cannon-Bowers, J. (2001). The Science of Training: A Decade of Progress. *Annual Review of Psychology*, 471-499.
- Salas, E., Tannenbaum, S., Kraiger, K., & Smith-Jentsch, K. (2012). The Science of Training and Development in Organizations: What Matters in Practice. *Psychological Science in the Public Interest*, 13(2), 74-101.
- Salas, E., Wilson, K., Priest, H., & Guthrie, J. (2006). Design, Delivery, and Evaluation of Training Systems. In G. Salvendy, *Handbook of Human Factors and Ergonomics* (pp. 472-512). John Wiley & Sons, Inc. .
- Salmon, P., Stanton, N., Lenné, M., Jenkins, D., Rafferty, L., & Walker, G. (2011). *Human Factors Methods and Accident Analysis Practical Guidance and Case Study Applications*. Ashgate, UK.
- Sarter, N., Woods, D., & Billings, C. (1997). Automation surprises. In G. Salvendy (Ed.), *Handbook of Human Factors & Ergonomics, second edition*, (pp. 1926-1943). Wiley.
- Sarter, N., Woods, D., & C.E., B. (1997). Automation surprises. In G. Salvendy (Ed.), *Handbook of Human Factors & Ergonomics, second edition*, (pp. 1926-1943). Wiley.
- Sasse, A. (2003). Computer security: anatomy of a usability disaster, and a plan for recovery. *Proceedings of CHI 2003 Workshop on HCI and Security Systems*. Fort Lauderdale, Florida.
- Silva, J. L., Fayollas, C., Hamon, A., Palanque, P., Martinie, C., & Barboni, E. (2013). Analysis of WIMP and Post WIMP Interactive Systems based on Formal Specification (regular paper). *International Workshop on Formal Methods for Interactive Systems (FMIS 2013), London, 24/06/13* (p. (electronic medium)). <http://eceaast.cs.tu-berlin.de/>: Electronic Communications of the EASST.
- Sims, D. (1994). New realities in aircraft design and. *IEEE Computer Graphics and Applications*, 14(2), 91-.
- Singer, G. (2001). Minimizing pilot-error by design: Are test pilot doing a good enough job? (A. Publishing, Ed.) *Human Factors and Aerospace Safety*, 1(4), 301-324.
- Singer, G., & Dekker, S. (2000). Pilot performance during multiple failures: An Empirical study of different warning systems. *Transportation Human Factors*, 2(1), 63-76.
- Skybrary. (2017, July 24). *Arrival Manager (AMAN)*. Retrieved from <https://www.skybrary.aero>: [https://www.skybrary.aero/index.php/Arrival_Manager_\(AMAN\)](https://www.skybrary.aero/index.php/Arrival_Manager_(AMAN))
- Sommerville, I. (2011). *Software engineering*. Pearson.

- Stanton, N., Harris, D., Salmon, P., Demagalski, J., Marshall, A., Waldmann, T., . . . Young, M. (2010). Predicting design induced error in the cockpit. *Journal of Aeronautics, Astronautics and Aviation*, 42(1), 1-10.
- Stanton, N., Harris, D., Salmon, P., Demagalski, J., Marshall, A., Young, M., . . . Waldmann, A. (2006). Predicting Design Induced Pilot Error using HET (Human Error Template) – A New Formal Human Error Identification Method for Flight Decks. *The Aeronautical Journal*, 110, 107-115.
- Stanton, N., McIroy, R., Harvey, C., Blainey, S., Hickford, A., Preston, J., & Ryan, B. (2013). Following the cognitive work analysis train of thought: exploring the constraints of modal shift to rail transport. *Ergonomics*, 56(3), 522-540.
- Stanton, N., Salmon, P., & Walker, G. (2019). *Systems Thinking in Practice - Applications of the Event Analysis of Systemic Teamwork Method*. CRC Press.
- Tang, A., Owen, C., B. F., & Mou, W. (2003). Comparative effectiveness of augmented reality in object assembly. *Proceedings of the SIGCHI Conference on Human Factors in Computing Systems* (pp. 73-80). ACM.
- Vicente, K. (1999). *Cognitive work analysis: toward safe, productive, and healthy computer-based work*. Mahwah, NJ: Lawrence Erlbaum Associates.
- Vigo, M., Santoro, C., & Paterno, F. (2017). The usability of task modeling tools. *IEEE Symposium on Visual Languages and Human-Centric Computing (VL/HCC)* (pp. 95-99). Raleigh, NC: IEEE.
- Winckler, M., Palanque, P., & Freitas, C. (2004). Tasks and scenario-based evaluation of information visualization techniques. *Proceedings of the 3rd annual conference on Task models and diagrams (TAMODIA '04)* (pp. 165-172). ACM.
- Winter, J., & Dodou, D. (2014). Why the Fitts list has persisted throughout the history of function allocation. *Cognition Technology and Work* , 16(1), 1-11.

Abstract

Large scale critical interactive systems, such as air traffic management systems, aircrafts cockpits and ground segment applications for managing spacecraft missions (illustrated in Figure 1), are said critical because a failure of one of their part or function can endanger human life or damage to the system and its environment. The design and development of such systems requires to apply specific techniques and processes in order to ensure that they will fulfil a predetermined set of properties (dependability, usability...) and to integrate safely the operations that will be performed using them in a large scale organisational context (human dependability, safety...). Existing techniques and methods are applied in a dedicated stage of the design and development processes (e.g. software programming, unit testing, deployment), they focus on one aspect (e.g. tasks, interactive system, training...) of the design and development and target a specific property (e.g. usability, dependability...). Existing techniques, methods, processes and tools do not provide support for explicitly taking into account all of the properties in an even way along while dealing with technological, human and organisational aspects. The need for taking into account technical, human and organisational aspects for system design has been raised several decades ago and socio-technical approaches have been proposed to take into account all of these aspects when analysing systems. Our work targets to support the design and development of critical Large Scale Socio-Technical Systems (named critical LSSTS). This term encompasses large scale critical interactive systems and their integration within an organisational context for safe operations. Our modelS-based approach addresses high level and global aspects (by explicitly taking into account all of the different views on the critical LSSTS) together with low-level and local aspects (by explicitly taking into account the specificities of each view required to design and develop each part of the critical LSSTS). The contributions presented in this document are the result of the work of I have done with my colleagues in the ICS team at IRIT through the co-supervision of 5 PhD students and 2 post-doctoral students from 2012 to now on. They are the continuation of the work I have done for the PhD that I defended in December 2011 (Martinie C. , 2011). These contributions have been applied to industrial case studies (civil aircrafts cockpits, satellite ground segments application, air traffic control applications), in collaboration with industrial partners such as Airbus, as well as with national and European agencies (CNES, ESA, EUROCONTROL).

Annex A – Co-supervised PhD students and post-doctoral students

PhD students

PhD student	Dates	Topic	Co-supervised with	Number of co-publications
Martina Ragosta	2011-2015	Models based approach for the analysis and modelling of usable and resilient partly autonomous interactive systems	Philippe Palanque	7
Camille Fayollas	2011-2015	Models-based approach for the dependability of critical interactive systems	Philippe Palanque (for her work on cockpit usability)	3
Racim Fahssi	2014-2018	Systematic identification and description of human errors in task models	Philippe Palanque	8
Alexandre Canny	2017-2020 (on-going)	Model-based generation of test cases for validation of interactive systems	Philippe Palanque and David Navarre	7
Elodie Bouzekri	2017-2020 (on-going)	Model-based approaches for the description, analysis, and design of automation in command and control systems	Philippe Palanque	5

Post-doctoral students

Post-doc student	Dates	Topic	Co-supervised with	Number of co-publications
José Luis Silva	2012-2013	Validation of formal models of interactive systems	Philippe Palanque	1
Camille Fayollas	2015-2017	Specification, verification and evaluation of safe, usable and fault tolerant interactive systems: application to aircrafts' cockpit	Philippe Palanque	9

Annex B – Projects

Title	Date	Topic	Role within the project	Funding
TORTUGA (Tasks, Operations, Reliability and Training for Users of Ground Applications)	sept. 2008-sept. 2011	Methods and techniques to design and develop usable and reliable ground segments applications with their associated training program	Responsible for the work package on «Training and Tasks»	CNES (160k€)
ALDABRA (Architecture and Language for Dynamic and Behaviourally Rich Application)	Sept. 2011 – Dec. 2012	Adaptation of User Interface according to User Tasks	Responsible for operators' task modelling	CNES (50 k€)
GEN-ISIS	Oct. 2012 – jan. 2013	Task modelling and user interface prototyping for the next generation of command and control ground segment applications	Responsible for the work package on operators' tasks modelling	CNES (42,69 k€)
MARACASS (Models and Architectures for the Resilience and Adaptability of Collaborative Collision Avoidance System for Spacecraft)	July 2012 – July 2013	Models-based approaches to design and develop collaborative applications: application to collision avoidance operations for spacecraft	Responsible for all of the work packages (state of the art, report on extensions for the notations and tools, prototypes for the case study and final report and recommendations)	CNES (50 k€)
SPAD (System Performance under Automation Degradation)	May 2011 – Dec. 2013	Federation of models to evaluate and estimate the impact of automation degradation on the ATM socio-technical system	Participated to the development and application of the multi-models based method	Eurocontrol SESAR WPE (131,49k€)
IFA (System Level Integrated Failure Analysis)	Feb. 2013 – March 2015	Techniques and methods to take into account potential human errors and system failures at design time	Participated to the development and application of a technique to analyse the effects of human errors and/or system failures during design	European Space Agency (ESA, 29,4k€)
MAGIC - IKKY WP6.3	July 2015 – June 2020	Techniques and methods to enable the representation of aircraft state for operations (in complement to the representation of unit systems failures)	Coordinated task modelling research activities Participated to the development of the DSCU system generic architecture and OCQR states generic representation.	CORAC and Airbus Operations (558 k€)
FLY HIGHER	June 2012- June 2014	European project for raising the interest of young Europeans for engineering and scientific activities in the field of aeronautics	Co-responsible of work package 3 « Bringing adequate knowledge and materials to career advisors »	EU FP7 (79,2k€)

Annex C – Curriculum Vitae

PERSONAL INFORMATION

Célia Martinie



- 📍 IRIT, University Toulouse 3, 118, route de Narbonne, 31062 Toulouse, France
- ☎ +33 5 61 55 77 07 📠 +33 6 88 16 22 21
- ✉ martinie@irit.fr
- 🌐 <https://www.irit.fr/recherches/ICS/people/martinie>
- 💬 Skype [martinie@irit.fr](https://www.irit.fr/recherches/ICS/people/martinie)

Sex Female | Date of birth 22/11/1977 | Nationality French

Research domains Human-Computer Interaction, Model-based approaches to the design and development of interactive systems, Task models

WORK EXPERIENCE

Since September 2012	<p>Assistant Professor in Computer Science</p> <p>University Paul Sabatier Toulouse 3 (http://www.univ-tlse3.fr/), IRIT (www.irit.fr)</p> <ul style="list-style-type: none"> ▪ Involved in several research projects dealing with techniques and tools to analyse, design and develop interactive critical systems (such as satellite ground segment applications, flight deck applications and air traffic management applications): IKKY-CORAC (with French Civil Aviation Authority), IFA (with European Space Agency), SPAD (with Eurocontrol) ▪ Head of the 1st year of the Master Degree in HCI at Université Paul Sabatier Toulouse III
Dec 2011 – Aug 2012	<p>Post-doc researcher</p> <p>IRIT Toulouse (www.irit.fr)</p> <ul style="list-style-type: none"> ▪ Responsible for all work packages and deliverables in the MARACCASS R&T Project (funded by the National French Space Agency)
Oct 2009 – Dec 2011	<p>Assistant researcher</p> <p>IRIT Toulouse (www.irit.fr)</p> <ul style="list-style-type: none"> ▪ Responsible of work package « Training and Tasks » Tortuga R&T Project (funded by National French Space Agency)
Sept 2001 – Oct 2009	<p>R&D Software Engineer</p> <p>Motorola, Toulouse, France</p> <ul style="list-style-type: none"> ▪ Design, prototyping of innovative applications for smartphones and mobile devices, software integration.

EDUCATION AND TRAINING

- Dec 2011 **PhD in Computer Science – Title: A Synergistic Models-Based Approach to Develop Usable, Reliable and Operable Interactive Critical Systems**
University Paul Sabatier Toulouse 3, France
- Sept 2001 **Master’s degree in Digital Communication Systems**
Telecom ParisTech, Paris, France
- Sept 2001 **Master’s degree in Engineering Electronics and Telecommunications**
EPF Graduate School of Engineering, Sceaux, France

ADDITIONAL INFORMATION

Current PhD supervision	<p>Elodie Bouzekri (September 2017 - September 2020) - "Model-based approaches for the Design and Development of Usable and Dependable Recommender Systems" - Funding CORAC IKKY (French Civil Aviation Authority) - Co-supervision with Philippe Palanque.</p>
Past PhD supervision	<p>Alexandre Canny (September 2017 - September 2020) - "Systematic approaches to validation of interactive system generation of test cases from formal models" - Funding CORAC IKKY (French Civil Aviation Authority) - Co-supervision with Philippe Palanque.</p>
Past Post-Doc supervision	<p>Racim Fahssi, December 4th, 2018 - "Task models based approach for systematic identification and explicit representation of human errors" - Funding CORAC IKKY (French Civil Aviation Authority) - Co-supervision with Philippe Palanque.</p> <p>Camille Fayollas, July 21th, 2015 - "Generic Software Architecture and Model-Based Approach for the Dependability of Critical Interactive Systems" - Funding Airbus - Co-supervision with Philippe Palanque (50% for the work on cockpit usability).</p> <p>Martina Ragosta, May 7th, 2015 - "A multi-modelS based approach for the analysis and modelling of usable and resilient partly autonomous interactive systems" - Funding Eurocontrol (HALA! Research Network) - Co-supervision with Philippe Palanque.</p>
Publications	<p>Camille Fayollas, September 2015 – August 2017 - "Specification, verification and evaluation of safe, usable and fault tolerant interactive systems: application to aircrafts' cockpit" – Funding: CORAC-IKKY - Co-supervision with Philippe Palanque</p> <p>José Luis Silva, September 2012 - August 2013 – "Validation of formal models of interactive systems" – Funding: Airbus - Co-supervision with Philippe Palanque</p> <p>Journals</p> <ul style="list-style-type: none"> • Celia Martinie, Philippe Palanque, Elodie Bouzekri, Andy Cockburn, Alexandre Canny, Eric Barboni. Analysing and Demonstrating Tool-Supported Customizable Task Notations. Proceedings of the ACM on Human-Computer Interaction, Vol. 3, EICS, Article 12 (June 2019), 26 pages. • Elodie Bouzekri, Alexandre Canny, Camille Fayollas, Celia Martinie, Philippe Palanque, Eric Barboni, Yannick Deleris, Christine Gris. Engineering Issues Related to the Development of a Recommender System in a Critical Context: Application to Interactive Cockpits. International Journal of Human-Computer Studies, Elsevier, Vol. 121, p. 122-141, janvier 2019. • José Creissac Campos, Camille Fayollas, Marcelo Gonçalves, Célia Martinie, David Navarre, Philippe Palanque, Miguel Pinto. A More Intelligent Test Case Generation Approach through Task Models Manipulation. Proceedings of the ACM in HCI, volume 1, article 9, 2017. • Célia Martinie, Philippe Palanque, Racim Fahssi, Jean Paul Blanquart, Camille Fayollas and Christel Seguin, Task Model-Based Systematic Analysis of Both System Failures and Human Errors, in IEEE Transactions on Human-Machine Systems, vol. 46, no. 2, pp. 243-254, April 2016. • Camille Fayollas, Célia Martinie, David Navarre, Philippe Palanque. A Generic Approach for Assessing Compatibility Between Task Descriptions and Interactive Systems: Application to the Effectiveness of a Flight Control Unit. i-com, 14(3), April 2015, pp. 170-191. • Eric Barboni, Célia Martinie, David Navarre, Philippe Palanque, Marco Winckler. Bridging the Gap between a Behavioural Formal Description Technique and User Interface description language: Enhancing ICC with a Graphical User Interface markup language. Science of Computer Programming vol:86. p:3-29. Elsevier. 2014 • Célia Martinie, David Navarre, Philippe Palanque. A Multi-Formalism Approach for Model-Based Dynamic Distribution of User Interfaces of Critical Interactive Systems. International Journal of Human-Computer Studies vol: (72) 1. Elsevier. 2014. • José Luís Silva, Camille Fayollas, Arnaud Hamon, Philippe A. Palanque, Célia Martinie, Eric Barboni. Analysis of WIMP and Post WIMP Interactive Systems based on Formal Specification. ECEASST 69 (2013). • David Navarre, Philippe Palanque, Eric Barboni, Jean-François Ladry, Célia Martinie. Designing for resilience to hardware failures in interactive systems: A model and simulation-based approach. Int. Journal on Reliability Engineering and System Safety (2010), pp. 854-890. <p>Book chapters</p> <ul style="list-style-type: none"> • Célia Martinie, Philippe Palanque, Camille Fayollas. Performance Evaluation of Interactive Systems with ICO Models. Oxford University Press, Chapter in Book Computational Interaction, February 2018. • Camille Fayollas, Célia Martinie, Philippe A. Palanque, Eric Barboni, Racim Fahssi, Arnaud Hamon. Exploiting Action Theory as a Framework for Analysis and Design of Formal Methods Approaches: Application to the CIRCUS Integrated Development Environment. Springer, chapter in handbook of Formal Methods in Human-Computer Interaction, December 2017.

- Célia Martinie, Philippe Palanque, Marco Winckler. Designing and Assessing Interactive Systems Using Task Models. p:29-58. Brazilian Computing Society, 2015 (book chapter associated to a tutorial given at the Brazilian conference on HCI, IHC2015).
- Philippe Palanque, Marco Antonio Winckler, Celia Martinie. Formal Model-Based Approach for Designing Interruptions-Tolerant Advanced User Interfaces. In Model-Driven Development of Advanced User Interfaces. Heinrich Hussmann, Gerrit Meixner, Detlef Zuehlke (Eds.), Springer, p. 143-170, Vol. Vol. 340, Studies in Computational Intelligence, 2011.
- David Navarre, Philippe Palanque, Celia Martinie, Sandra Steere. Formal Description Techniques for Human-Machine Interfaces - Model-Based Approaches for the Design and Evaluation of Dependable Usable Interactive Systems. In Handbook of Human-Machine Interaction, A Human-Centered Approach. Guy A. Boy (Eds.), Ashgate Publishing, avril 2011.

International conferences (regular papers)

- Elodie Bouzekri, Alexandre Canny, Celia Martinie, Philippe Palanque, Christine Gris. Deep System Knowledge Required: Revisiting UCD Contribution in the Design of Complex Command and Control Systems. In IFIP TC 13 International Conference on Human-Computer Interaction (INTERACT 2019). Paphos, Cyprus, 02/09/2019-06/09/2019, Springer, septembre 2019.
- Alexandre Canny, Camille Fayollas, Celia Martinie, David Navarre, Philippe Palanque, Elodie Bouzekri, Christine Gris, Yannick Deleris. Divide to Conquer: Functional Decomposition to Support Model-Based Engineering of Command and Control of Cyber-Physical Systems. In IEEE International Conference on Cyber Physical and Social Computing (CPSCoM 2019), Atlanta, USA, 14/07/2019-17/07/2019, IEEE Institute of Electrical and Electronics Engineers, juillet 2019.
- Elodie Bouzekri, Alexandre Canny, Celia Martinie, Philippe Palanque, Eric Barboni, David Navarre, Christine Gris, Yannick Deleris. Revisiting system's pages in engine indication and alerting system for flight crew using the DSCU architecture and the OQCR system generic state description. In INCOSE International Conference on Human System Integration (INCOSE HSI 2019), Biarritz, France, 11/09/2019-13/09/2019, INCOSE : International Council on Systems Engineering, septembre 2019.
- Elodie Bouzekri, Alexandre Canny, Celia Martinie, Philippe Palanque, Christine Gris. Using Task Descriptions with Explicit Representation of Allocation of Functions, Authority and Responsibility to Design and Assess Automation. In IFIP WG 13.6 Working Conference Human Work Interaction Design (HWID 2018), Espoo, Finland, 20/08/2018-21/08/2018, Vol. 544, Barbara Baricelli, Virpi Roto, Torkil Clemmensen, Pedro Campos, A. Lopes (Eds.), Springer, IFIP Advances in Information and Communication Technology ISBN 978-3-030-05297-3, p. 36-56, décembre 2018.
- Célia Martinie, David Navarre, Philippe A. Palanque, Eric Barboni, Alexandre Canny. TOUCAN: An IDE Supporting the Development of Effective Interactive Java Applications. EICS 2018, 1-7.
- Regina Bernhaupt, Philippe Palanque, Dimitri Drouet, Celia Martinie. Enriching Task Models with Usability and User Experience Evaluation Data. In Human-Centered Software Engineering (HCSE 2018), Sophia Antipolis, France, 03/09/2018-05/09/2018, Vol. 11262, Cristian Bogdan, Kati Kuusinen, Marta Larusdóttir, Philippe Palanque, Marco Winckler (Eds.), Springer, Lecture Notes in Computer Science ISBN 978-3-030-05908-8, p. 146-163, décembre 2018.
- Alexandre Canny, Elodie Bouzekri, Celia Martinie, Philippe Palanque. Rationalizing the Need of Architecture-Driven Testing of Interactive Systems. In Human-Centered Software Engineering (HCSE 2018), Sophia Antipolis, France, 03/09/2018-05/09/2018, Vol. 11262, Cristian Bogdan, Kati Kuusinen, Marta Larusdóttir, Philippe Palanque, Marco Winckler (Eds.), Springer, Lecture Notes in Computer Science ISBN 978-3-030-05908-8, p. 164-186, décembre 2018.
- Celia Martinie, David Navarre, Philippe Palanque, Eric Barboni, Alexandre Canny. TOUCAN: An IDE Supporting the Development of Effective Interactive Java Applications. In ACM SIGCHI conference Engineering Interactive Computing Systems (EICS 2018), Paris, 19/06/2018-22/06/2018, ACM Association for Computing Machinery, p. 1-7, juin 2018.
- Camille Fayollas, Célia Martinie, David Navarre, Philippe Palanque. Engineering mixed-criticality interactive applications. ACM SIGCHI conference Engineering Interactive Computing Systems 2016 (EICS). p:108-119. ACM DL.
- José Creissac Campos, Camille Fayollas, Célia Martinie, David Navarre, Philippe Palanque, Migue Pinto. Systematic automation of scenario-based testing of user interfaces. ACM SIGCHI conference Engineering Interactive Computing Systems 2016 (EICS). p:138-148. ACM DL.
- Dorit Billman, Camille Fayollas, Michael Feary, Célia Martinie, Philippe Palanque. Complementary Tools and Techniques for Supporting Fitness-for-Purpose of Interactive Critical Systems. International Conference on Human Error, Safety, and System Development. HCSE 2016, HESSD 2016. Lecture Notes in Computer Science, vol 9856, p. 181-202. Springer, Cham
- Regina Bernhaupt, Philippe Palanque, François Manciet, Célia Martinie. User-Test Results Injection into Task-Based Design Process for the Assessment and Improvement of Both Usability and User Experience. International Conference on Human-Centred Software Engineering International Conference on Human Error, Safety, and System Development 2016 (HCSE+HESSD), vol:9856. p:56-72. Springer International Publishing.
- Racim Fahssi, Célia Martinie and Philippe Palanque, Embedding explicit representation of cyber-physical elements in task models, 2016 IEEE International Conference on Systems, Man, and Cybernetics (SMC), Budapest, 2016, pp. 001969-001974.

	<ul style="list-style-type: none"> • Racim Fahssi, Célia Martinie, Philippe Palanque. Enhanced Task Modelling for Systematic Identification and Explicit Representation of Human Errors. In: Abascal J., Barbosa S., Fetter M., Gross T., Palanque P., Winckler M.(eds) Human-Computer Interaction – INTERACT 2015. INTERACT 2015. Lecture Notes in Computer Science, vol 9299. Springer, Cham. • Martina Ragosta, Célia Martinie, Philippe Palanque, David Navarre, Mark-Alexander Sujan. Concept Maps as a Glue for Integrating Modeling Techniques for the Analysis and Re-Design of Partly-Autonomous Interactive Systems. In Proceedings of the 5th International Conference on Application and Theory of Automation in Command and Control Systems (ATACCS '15). ACM, New York, NY, USA. • Regina Bernhaupt, Martin Cronel, François Manciet, Célia Martinie, and Philippe Palanque. 2015. Transparent Automation for Assessing and Designing better Interactions between Operators and Partly-Autonomous Interactive Systems. In Proceedings of the 5th International Conference on Application and Theory of Automation in Command and Control Systems (ATACCS '15). ACM, New York, NY, USA, 129-139. • Peter Forbrig, Célia Martinie, Philippe Palanque, Marco Winckler, Racim Fahssi. Rapid Task-Models Development Using Sub-models, Sub-routines and Generic Components. In: Sauer S., Bogdan C., Forbrig P., Bernhaupt R., Winckler M. (eds) Human-Centered Software Engineering. HCSE 2014. Lecture Notes in Computer Science, vol 8742. Springer, Berlin, Heidelberg • Célia Martinie, Eric Barboni, David Navarre, Philippe Palanque, Racim Fahssi, Erwann Poupart, and Eliane Cubero-Castan. Multi-models-based engineering of collaborative systems: application to collision avoidance operations for spacecraft. In Proceedings of the 2014 ACM SIGCHI symposium on Engineering interactive computing systems (EICS '14). ACM, New York, NY, USA, 85-94. • Celia Martinie, Philippe Palanque. Fine Grain Modeling of Task Deviations for Assessing Qualitatively the Impact of Both System Failures and Human Error on Operator Performance. AAAI 2014 Symposium on Formal Verification on Human-Machine Systems - 2014, Mar 2014, Palo Alto, United States. pp. 27-32 2014. • Camille Fayollas, Célia Martinie, Philippe Palanque, Yannick Deleris, Jean Charles Fabre and David Navarre. An Approach for Assessing the Impact of Dependability on Usability: Application to Interactive Cockpits. 2014 Tenth European Dependable Computing Conference, Newcastle, 2014, pp. 198-209. • Celia Martinie, Philippe Palanque, Alberto Pasquini, Martina Ragosta, Sara Silvagni, Mark-Alexander Sujan, Eric Rigaud, Erik Hollnagel. Modelling of Automation Degradation: a Case Study. In SESAR Innovation Days, Stockholm, Suède, 26/11/2013-28/11/2013, SESAR Work Package E, novembre 2013 • Guillaume Brat, Celia Martinie, Philippe Palanque. V&V of Lexical, Syntactic and Semantic Properties for Interactive Systems Through Model Checking of Formal Description of Dialog. In HCI International. Springer, LNCS, p. 290-299, juillet 2013. • Michel Galindo, Célia Martinie, Philippe A. Palanque, Marco Winckler, Peter Forbrig. • Tuning an HCI Curriculum for Master Students to Address Interactive Critical Systems Aspects. HCI (1) 2013, Springer, LNCS, 51-60. • Celia Martinie, Philippe Palanque, Martina Ragosta, Racim Mehdi Fahssi. Extending Procedural Task Models by Explicit and Systematic Integration of Objects, Knowledge and Information. In European Conference on Cognitive Ergonomics (ECCE 2013), Toulouse, France, 26/08/2013-28/08/2013, ACM : Association for Computing Machinery, ECCE '13 23, p. 1-10, octobre 2013. • Celia Martinie, Philippe Palanque, Alberto Pasquini, Martina Ragosta, Mark-Alexander Sujan, David Navarre. Understanding functional resonance through a federation of models: preliminary findings of an avionics case study. In International Conference on Computer Safety, Reliability and Security (SAFECOMP 2013), Toulouse, France, 24/09/2013-27/09/2013, Friedemann Bitsch, Jérémie Guiochet, Mohamed Kaâniche (Eds.), Springer-Verlag, p. 216-227, septembre 2013. • David Navarre, Celia Martinie, Philippe Palanque, Alberto Pasquini, Martina Ragosta. Model-based dynamic distribution of user interfaces of critical interactive systems. In International Conference on Application and Theory of Automation in Command and Control Systems (ATACCS 2013), Naples, Italy 28/05/2013-30/05/2013, ACM : Association for Computing Machinery, p. 66-75, 2013. • Eric Rigaud, Erik Hollnagel, Celia Martinie, Philippe Palanque, Alberto Pasquini, Martina Ragosta, Sara Silvagni, Mark-Alexander Sujan. A framework for modeling the consequences of the propagation of automation degradation: application to air traffic control systems. In SESAR Innovation Days, Braunschweig, 27/11/2012-29/11/2012, Eurocontrol, décembre 2012. • Celia Martinie, Philippe Palanque, David Navarre, Eric Barboni, Erwann Poupart. Systematic Approaches to Training Encompassing Operators' mission and Interaction Techniques. In International Conference on Human-Computer Interaction in Aeronautics (HCI/Aero 2012), Brussels, 12/09/2012-14/09/2012. ACM Digital Library, septembre 2012. • Lúcia Masip, Celia Martinie, Marco Antonio Winckler, Philippe Palanque, Toni Granollers, Marta Oliva. A Design Process for Exhibiting Design Choices and Trade-offs in (potentially) Conflicting User Interface Guidelines. In Human-Centered Software Engineering (HCSE 2012), Toulouse, France, 29/10/2012-31/10/2012, Marco Winckler, Peter Forbrig, Regina Bernhaupt (Eds.), Springer, LNCS 7623, p. 53-71, octobre 2012.
--	--

- Célia Martinie, Philippe Palanque, David Navarre, Eric Barboni. A Development Process for Usable Large Scale Interactive Critical Systems: Application to Satellite Ground Segments. In Human-Centered Software Engineering (HCSE 2012), Toulouse, France, 29/10/2012-31/10/2012, Marco Winckler, Peter Forbrig, Regina Bernhaupt (Eds.), Springer, LNCS 7623, p. 53-71, octobre 2012.
- Arnaud Hamon, Philippe Palanque, David Navarre, Celia Martinie, Adrienne Tankeu Choitot, Eric Barboni. Interactive Cockpits Applications: Modelling and Validation using a Petri-net based Formalism. In European Congress on Embedded Real-Time Software (ERTS 2012), Toulouse, France, 01/02/2012-03/02/2012, ERTS : Embedded Real Time Software and Systems, février 2012.
- Celia Martinie, Philippe Palanque, Alberto Pasquini, Martina Ragosta, Eric Rigaud, Sara Silvagni. Using Complementary Models-Based Approaches for Representing and Analysing ATM Systems' Variability. In International Conference on Application and Theory of Automation in Command and Control Systems (ATACCS 2012), London, UK, 28/05/2012-31/05/2012, ACM Digital Library, 2012.
- Celia Martinie, Philippe Palanque, David Navarre, Erwann Poupart. A Systematic Approach to Training for Ground Segment using Tasks and Scenarios: Application to PICARD satellite. In International Conference on Space Operations (SpaceOps 2012), Stockholm, Sweden, 11/06/2012-15/06/2012, American Institute of Aeronautics and Astronautics (AIAA), 2012.
- Celia Martinie, Philippe Palanque, David Navarre, Eric Barboni. A Tool-Supported Training Framework for Improving Operators: Dependability Confronted with Faults and Errors. In Safety and Reliability for managing Risk (ESREL 2012), Helsinki, Finland, 25/06/2012-29/06/2012, Taylor & Francis Group, p. 25-36, 2012.
- Erik Hollnagel, Celia Martinie, Philippe Palanque, Alberto Pasquini, Martina Ragosta, Eric Rigaud, Sara Silvagni. System Performances under Automation Degradation (SPAD). In The First SESAR Innovation Days, Toulouse, France, 29/11/2011-01/12/2011, SESAR Work Package E, 2012.
- Celia Martinie, Philippe Palanque, Eric Barboni, Martina Ragosta. Task-Model Based Assessment of Automation Levels: Application to Space Ground Segments. In IEEE International Conference on Systems, Man and Cybernetics, Anchorage, 09/10/2011-12/10/2011, IEEE Computer Society - Conference Publishing Services, p. 3267-3273, octobre 2011.
- Celia Martinie, Philippe Palanque, Marco Antonio Winckler. Structuring and Composition Mechanisms to Address Scalability Issues in Task Models. In IFIP TC 13 International Conference on Human-Computer Interaction (INTERACT 2011), Lisboa, 05/09/2011-09/09/2011, Springer-Verlag, p. 134-152, 2011.
- Celia Martinie, Philippe Palanque, Eric Barboni, Marco Antonio Winckler, Martina Ragosta, Alberto Pasquini, Paola Lanzi. Formal Tasks and Systems Models as a Tool for Specifying and Assessing Automation Designs. In International Conference on Application and Theory of Automation in Command and Control Systems (ATACCS 2011), Barcelone, 26/05/2011-27/05/2011, IRIT Press, 2011.
- Philippe Palanque, Eric Barboni, Celia Martinie, David Navarre, Marco Antonio Winckler. A Tool Supported Model-based Approach for Engineering Usability Evaluation of Interaction Techniques. In ACM SIGCHI conference Engineering Interactive Computing Systems (EICS 2011), Pise, Italie, 13/06/2011-16/06/2011, ACM Press, p. 21-30, 2011.
- Celia Martinie, Philippe Palanque, Marco Antonio Winckler, David Navarre, Erwann Poupart. Model-Based Training: An Approach Supporting Operability of Critical Interactive Systems: Application to Satellite Ground Segments. In ACM SIGCHI conference Engineering Interactive Computing Systems (EICS 2011), Pise, Italie, 13/06/2011-16/06/2011, Springer-Verlag, p. 589-609, juin 2011.
- Philippe Palanque, Regina Bernhaupt, Florent Montesano, Celia Martinie. Exploiting gaming research and practice for engineering interactive critical systems. Dans: International Conference on Application and Theory of Automation in Command and Control Systems (ATACCS 2011), Barcelone, 26/05/2011-27/05/2011, 41-49.
- Celia Martinie, Philippe Palanque, Marco Antonio Winckler, Stéphane Conversy. DREAMER: a Design Rationale Environment for Argumentation, Modeling and Engineering Requirements. In ACM International Conference on Design of Communication (ACM SIGDOC 2010), Sao Paulo, Brésil, 26/09/2010-29/09/2010, Junia C. Anacleto, Renata Fortes M. Pontin, Carlos J. Costa (Eds.), ACM Association for Computing Machinery, p. 73-80, septembre 2010.
- Celia Martinie, Philippe Palanque, David Navarre, Marco Antonio Winckler. A formal approach supporting effective and efficient training program for improving operators' reliability. In Safety and Reliability for managing Risk (ESREL 2010), Rhodes Grece, 05/09/2010-09/09/2010, Taylor & Francis Group, p. 234-243, 2010.

International conferences (short papers)

- Michael Feary, Célia Martinie, Philippe Palanque, and Manfred Tscheligi. 2016. Multiple Views on Safety-Critical Automation: Aircrafts, Autonomous Vehicles, Air Traffic Management and Satellite Ground Segments Perspectives. In Proceedings of the 2016 CHI Conference Extended Abstracts on Human Factors in Computing Systems (CHI EA '16). ACM, New York, NY, USA, 1069-1072.
- Chris Johnson, Michael Feary, Célia Martinie, Philippe A. Palanque, Regina Peldszus: IFIP WG 13.5 Workshop on Resilience, Reliability, Safety and Human Error in System Development. INTERACT (4) 2015: 663-664.

	<p>Tutorials</p> <ul style="list-style-type: none"> • Célia Martinie, David Navarre, Philippe Palanque. Exploiting Tasks Descriptions to Assess and Ensure Effectiveness during the programming of interactive Java software. ACM SIGCHI Conference on Engineering Interactive Systems (EICS 2018) • Philippe Palanque, Célia Martinie, Camille Fayollas. Automation: Danger or Opportunity? Designing and Assessing Automation for Interactive Systems. ACM SIGCHI Conference on Human Factors in Computing Systems (CHI 2018). ACM. • Philippe Palanque, Célia Martinie, Camille Fayollas. Automation: Danger or Opportunity? Designing and Assessing Automation for Interactive Systems. ACM SIGCHI Conference on Human Factors in Computing Systems 2017. p:1257-1260. ACM. • Philippe Palanque, Marco Winckler. Designing and Assessing Interactive Systems Using Task Models. In Bernhaupt R., Dalvi G., Joshi A., K. Balakrishnan D., O'Neill J., Célia Martinie Winckler M. (eds) Human-Computer Interaction – INTERACT 2017. INTERACT 2017. Lecture Notes in Computer Science, vol 10516. Springer, Cham. • Philippe Palanque and Célia Martinie. Designing and Assessing Interactive Systems Using Task Models. In Proceedings of the 2016 CHI Conference Extended Abstracts on Human Factors in Computing Systems (CHI EA '16). ACM, New York, NY, USA, 976-979. • Philippe Palanque and Célia Martinie. Designing and Assessing Interactive Systems Using Task Models. In Proceedings of the 33rd Annual ACM Conference Extended Abstracts on Human Factors in Computing Systems (CHI EA '15). ACM, New York, NY, USA, 2465-2466. • Célia Martinie, Philippe Palanque, Marco Winckler. Designing and Assessing Interactive Systems Using Task Models. Book of Tutorials of the 14th Brazilian Symposium on Human Factors in Computing Systems, 29-58, Springer. <p>Workshop papers</p> <ul style="list-style-type: none"> • Alexandre Canny, Elodie Bouzekri, Celia Martinie, Philippe Palanque. On the Importance of Supporting Multiple Stakeholders Points of View for the Testing of Interactive Systems. Dans: Workshop on Research and Practice Challenges for Engineering Interactive Systems while Integrating Multiple Stakeholders Viewpoints (EISMS 2019), Valencia, Spain, 18/06/2019, 2019 • Elodie Bouzekri, Alexandre Canny, Camille Fayollas, Celia Martinie, Philippe Palanque, Eric Barboni, Yannick Deleris, Christine Gris. A List of Pre-Requisites to Make Recommender Systems Deployable in Critical Context. Dans: ACM SIGCHI conference Engineering Interactive Computing Systems (EICS 2017), 2017, 26/06/2017-26/06/2017, Vol. 1945, CEUR-WS : Workshop proceedings, CEUR Workshop Proceedings, p. 42-55, 2017. • Celia Martinie. From Aircrafts Interactive Cockpits to Autonomous Vehicles: Are Design Principles Transferable? In Workshop HCI and Autonomous Vehicles@ CHI 2016, San Jose, USA, 07/05/2016-12/05/2016, ACM SIGCHI. • Camille Fayollas, Celia Martinie, Philippe Palanque, Racim Mehdi Fahssi. Task Models for Supporting Function Allocation between Operators and Autonomous Systems: Application to Collision Avoidance Operations for Spacecraft. In AAAI 2015 Spring Symposium on Intelligent systems for supporting distributed human teamwork, Stanford CA, USA, 21/03/2016-23/03/2016, AAAI Press. • Camille Fayollas, Célia Martinie, Philippe Palanque, Paolo Masci, Michael Harrison, José Creissac Campos, Saulo Rodrigues E Silva. Evaluation of Formal IDEs for Human-Machine Interface Design and Analysis: The Case of CIRCUS and PVSio-web. Workshop on Formal Integrated Development Environment 2017 (F-IDE). Open Publishing Association. • Camille Fayollas, Célia Martinie, Philippe Palanque, Yamine Ait Ameur. QBP Notation for Explicit Representation of Properties, their Refinement and their Potential Conflicts: Application to Interactive Systems. Workshop on Dealing with Conflicting User Interface Properties in User-Centered Development Processes at INTERACT 2017. p:324-340. Springer. • Camille Fayollas, Célia Martinie, Philippe Palanque, Eric Barboni, Yannick Délérís. What Can Be Learnt from Engineering Safety Critical Partly-Autonomous Systems when Engineering Recommender Systems. Proceedings of the Workshop on Engineering Computer-Human Interaction in Recommender Systems co-located with the eight ACM SIGCHI Symposium on Engineering Interactive Computing Systems, EnCHIReS@EICS 2016, Bruxelles, Belgium, June 21, 2016. • Camille Fayollas, Célia Martinie, Philippe A. Palanque, Paolo Masci, Michael D. Harrison, José Creissac Campos, Saulo Rodrigues e Silva. Evaluation of Formal IDEs for Human-Machine Interface Design and Analysis: The Case of CIRCUS and PVSio-web. F-IDE@FM 2016: 1-19 • Célia Martinie and Philippe Palanque. Design, Development and Evaluation Challenges for Future Mobile User Interfaces in Safety-Critical Contexts. In Proceedings of the 2015 Workshop on Future Mobile User Interfaces (FutureMobileUI '15). ACM, New York, NY, USA, 5-7. • Camille Fayollas, Célia Martinie, Philippe Palanque, Yannick Délérís. Beyond Formal Methods for Critical Interactive Systems: Dealing with Faults at Runtime. Workshop on Formal Methods in Human Computer Interaction 2015 (FoMHCI). p:19-23. RWTH Aachen University. • Eric Barboni, Arnaud Hamon, Célia Martinie, Philippe Palanque. A User-Centered View on Formal Methods Interactive Support for Validation and Verification. Workshop on Formal Methods in Human Computer Interaction 2015 (FoMHCI). p:24-29. RWTH Aachen University.
--	--

- Camille Fayollas, Célia Martinie, Philippe Palanque, Racim Fahssi. Accounting for Organisational faults in Task Model Based Systematic Analysis of System Failures and Human Errors. IFIP WG 13.5 Workshop on Resilience Reliability, Safety and Human Error in System Development 2015. p:101-116. University of Bamberg Press.
- Célia Martinie. Game Jam 4 Investigating Design Issues with (partly) autonomous systems. GameJam workshop at ACM Conference on Human Computer Interaction, CHI 2014 (GameJam[4Research]).
- Camille Fayollas, Célia Martinie, David Navarre, Philippe Palanque, and Racim Fahssi. 2014. Fault-Tolerant User Interfaces for Critical Systems: Duplication, Redundancy and Diversity as New Dimensions of Distributed User Interfaces. In Proceedings of the 2014 Workshop on Distributed User Interfaces and Multimodal Interaction (DUI '14), María Dolores Lozano, Jean Vanderdonckt, Habib M. Fardoun, Ricardo Tesoriero, José A. Gallud, and Víctor M. R. Penichet (Eds.). ACM, New York, NY, USA, 27-30.
- Celia Martinie. Game Jam 4 Investigating Design Issues with (partly) autonomous systems. In GameJam workshop at ACM Conference on Human Computer Interaction, CHI 2014 (GameJam[4Research] 2014), Toronto, Canada 26/04/2014-27/04/2014.
- Celia Martinie, Philippe Palanque. Fine Grain Modeling of Task Deviations for Assessing Qualitatively the Impact of Both System Failures and Human Error on Operator Performance. In AAAI 2014 Symposium on Formal Verification on Human-Machine Systems, Stanford University, Palo Alto, 24/03/2014-26/03/2014, AAAI Press.
- José Luis Silva, Camille Fayollas, Arnaud Hamon, Philippe Palanque, Celia Martinie, Eric Barboni. Analysis of WIMP and Post WIMP Interactive Systems based on Formal Specification. In International Workshop on Formal Methods for Interactive Systems (FMIS 2013), London, 24/06/2013, Electronic Communications of the EASST.
- Philippe Palanque, Regina Bernhaupt, Celia Martinie. Designing and Engineering Interactive Critical Systems Using Contributions from Gaming Research and Practice. In Workshop on Safety-Critical Systems and Video Games: Contradictions and Commonalities. In conjunction with 4th International Conference on Fun and Games (Fun&Games2012), Toulouse, 04/09/2012-06/09/2012, ACM Digital Library.
- Celia Martinie, Philippe Palanque, Martina Ragosta. Some Issues with Interaction Design and Implementation in the Context of Autonomous Interactive Critical Systems. In ACM International Conference on Human Factors in Computer Science (Workshop on End-user Interactions with Intelligent and Autonomous Systems), Austin, Texas 05/05/2012-10/05/2012.
- Eric Barboni, Celia Martinie, David Navarre, Philippe Palanque, Marco Antonio Winckler. UsiXML Concrete Behaviour with a Formal Description Technique for Interactive Systems. In IFIP WG 2.7/13.4 Workshop on User Interface Description Languages (UIDL 2011), Lisbonne, Portugal, 06/09/2011-06/09/2011, Adrien Coyette, David Faure, Juan Gonzalez, Jean Vanderdonckt (Eds.)
- Celia Martinie, Jean-François Ladry, David Navarre, Philippe Palanque, Marco Antonio Winckler. Embedding Requirements in Design Rationale to Deal Explicitly with User eXperience and Usability in an “intensive” Model-Based Development Approach. Workshop on Model Driven Development of Advanced User Interfaces (MDDAU 2010), Atlanta Georgia USA, 10/04/2010, Vol. 617, Jan Van den Bergh, Stefan Sauer, Kai Breiner, Heinrich Fußmann, Gerrit Meixner (Eds.), CEUR-WS : Workshop proceedings, p. 29-32, juillet 2010.

Proceedings

- José Creissac Campos, Nunes Nuno, Pedro Campos, Gaele Calvary, Jeffrey Nichols, Celia Martinie, José Luis Silva. Proceedings of the ACM SIGCHI Symposium on Engineering Interactive Computing Systems, EICS 2017, Lisbon, Portugal, 26/06/2017 - 29/06/2017, ACM : Association for Computing Machinery, juin 2017.
- Michael Feary, Thomas Feuerle, Cristina Gonzalez Rechea, Francisco Saez, Chris Johnson, Celia Martinie, Philippe Palanque, Alberto Pasquini, Pim Van Leeuwen, Marco Antonio Winckler. 5th International Conference on Application and Theory of Automation in Command and Control Systems. Toulouse, France, 30/09/2015 - 02/10/2015, ACM Digital Library, octobre 2015.
- Sybille Caffiau, Célia Martinie. French journal on Person System Interaction (Journal D'Interaction Personne-Système, JIPS), vol. 3, num. 3, special issue on task modelling, 2014, Episciences. <https://jips.episciences.org/volume/view/id/156>

Editorial boards

- Member of the editorial board of the EICS issues of the Proceedings of the ACM (PACM) since 2017

<p>Projects</p>	<p>IKKY (Integration of the Cockpit with its sYstems) WP6.3: "Failure modes: state based-approaches" Dates: Jul. 2015 – Feb. 2019 - Funding: DGAC (558k€) Airvet (Aeronautic Industry Skills Resolution for a more efficient VET offer) Dates: Oct. 2013 – Sept. 2015 - Funding: EU LLP (50k€) IFA (Integrated Failure Analysis) Dates: Feb. 2013 – March 2015 - Funding: European Space Agency (57k€) SPAD (System Performance under Automation Degradation) Dates: May 2011 – Dec. 2013 - Funding EUROCONTROL (139k€) MARACCASS (Models and Architectures for the Resilience and Adaptability of Collaborative Collision Avoidance System for Spacecraft) Dates: Jul. 2012- Jul. 2013 – Funding : CNES (50 k€) GEN-ISIS (GENèse de la ligne de produit ISIS, prototyping and modelling of the future ground segment control and command applications) Dates : Oct. 2012 – Jan. 2013 - Funding : CNES (42,69 k€) TORTUGA (Tasks, Operations, Reliability and Training for Users of Ground Applications) Dates: Sept. 2008-Sept. 2011, Funding: CNES, French National Space Agency (160k€) Fly Higher (Shaping the new evolving generation of aeronautic professionals) Dates: July 2012 – July 2014 – Funding EU FP6 (49k€) Aldabra (Architecture and Language for Dynamic and Behaviourally Rich interactive Application) Dates: Sep. 2011 – Dec. 2012 - Funding: CNES, French National Space Agency (50k€)</p>
<p>Visiting researcher</p>	<p>NASA Ames Research Center Automation Interaction Design and Evaluation Group (Lead: Michael Feary) Robust Software Engineering Group (Lead: Guillaume Brat) (July – August 2013, March 2014)</p>
<p>Member of Jury of PhDs</p>	<p>Racim Fahssi, December 4th, 2018 – PhD in Computer Science: "Task models based approach for systematic identification and explicit representation of human errors" Université Paul Sabatier Toulouse III. Thiago Silva, September 17th, 2018 – PhD in Computer Science: « A Behavior-Driven Approach for Specifying and Testing User Requirements in Interactive Systems", Université Paul Sabatier Toulouse III. Martin Cronel – Oct. 18th, 2017 – PhD in Computer Science: "Engineering Multimodal and Multi-user Interactions in Critical Environments: Application to the Next Generation of Aircraft Cockpits", Université Paul Sabatier Toulouse III. Martina Ragosta, May 7th, 2015 - PhD in Computer Science: "A multi-modelS based approach for the analysis and modelling of usable and resilient partly autonomous interactive systems", Université Paul Sabatier Toulouse III.</p>
<p>Participation in Program Committees</p>	<p>Co-chair</p> <ul style="list-style-type: none"> • Late-breaking results co-chair, ACM SIGCHI Symposium on Engineering Interactive Computing Systems EICS 2020 • Late-breaking results co-chair for the 9th ACM SIGCHI Symposium on Engineering Interactive Computing Systems EICS 2017 • Posters and demonstrations co-chair for the 5th International Conference on Application and Theory of Automation in Command and Control Systems ATACCS 2015 <p>Program committee member (international events)</p> <ul style="list-style-type: none"> • Associate chair, IFIP TC13 Conference on Human-Computer Interaction INTERACT 2019 • Senior program committee member of the ACM SIGCHI Symposium on Engineering Interactive Computing Systems in 2016 and 2017 • Program committee member of the IFIP TC 13.2 conference on Human-Centered Software Engineering HCSE 2018. • Program committee member of the 16th IFIP TC13 Conference on Human-Computer Interaction INTERACT 2017 • Program committee member of the 8th NASA Formal Methods Symposium NFM 2016 • Program committee member of the 15th IFIP TC13 Conference on Human-Computer Interaction INTERACT 2015 • Program committee member of the 5th International Conference on Application and Theory of Automation in Command and Control Systems ATACCS 2015 • Program committee member of the 3rd International Conference on Application and Theory of Automation in Command and Control Systems ATACCS 2013

Working groups	<p>Program committee member (French national events)</p> <ul style="list-style-type: none">• IHM 2019, 31st French National Conference in HCI, Grenoble, France, December 2019.• IHM 2017, 29th French National Conference in HCI, Poitiers, France, August 2017. <p>IFIP Working Group 13.5 – “Human Error, Safety, and System Development”, Member (2014-) IFIP</p> <p>Working Group 13.2 - "Methodologies for user centered design", Member (2012-)</p>
----------------	--