



**HAL**  
open science

# Some Aspects Of Representation Theory Of Walled Brauer Algebras

Daria V. Bulgakova

► **To cite this version:**

Daria V. Bulgakova. Some Aspects Of Representation Theory Of Walled Brauer Algebras. Representation Theory [math.RT]. Aix Marseille Université, 2020. English. NNT : . tel-02554375

**HAL Id: tel-02554375**

**<https://hal.science/tel-02554375>**

Submitted on 25 Apr 2020

**HAL** is a multi-disciplinary open access archive for the deposit and dissemination of scientific research documents, whether they are published or not. The documents may come from teaching and research institutions in France or abroad, or from public or private research centers.

L'archive ouverte pluridisciplinaire **HAL**, est destinée au dépôt et à la diffusion de documents scientifiques de niveau recherche, publiés ou non, émanant des établissements d'enseignement et de recherche français ou étrangers, des laboratoires publics ou privés.

UNIVERSITÉ D'AIX-MARSEILLE  
ÉCOLE DOCTORALE 352  
FACULTÉ DES SCIENCES  
CENTRE DE PHYSIQUE THÉORIQUE DE MARSEILLE

Thèse présentée pour obtenir le grade universitaire de docteur

*Discipline :*

PHYSIQUE ET SCIENCES DE LA MATIÈRE

*Spécialité :*

Physique Théorique et Mathématique

Daria BULGAKOVA

Quelques aspects de la théorie des représentations  
des algèbres de Brauer murées

Some Aspects of Representation Theory  
of Walled Brauer Algebras

Soutenue le 30 janvier 2020 devant le jury composé de:

M. Oleg OGIEVETSKY	CPT	Directeur de thèse
Mme Maud DE VISSCHER	CUL	Rapporteuse
M. Sergey KHOROSHKIN	ITEP	Rapporteur
M. Robert COQUEREAUX	CPT	Examinateur
Mme Valeria SHIHEEVA	MISIS	Examinatrice

## Résumé

La thèse couvre certains aspects de la théorie des représentations de l'algèbre de Brauer murée  $B_{r,s}(\delta)$  et son analogue quantique.

Dans ce texte, le corps est supposé être le corps  $\mathbb{C}$  des nombres complexes. L'algèbre de Brauer murée  $B_{r,s}(\delta)$  est une algèbre unitaire associative définie pour tous  $\delta \in \mathbb{C}$ . La dimension de cette algèbre est  $(r+s)!$ . Il s'agit d'une algèbre de diagramme engendré par des diagrammes «murés» particuliers, définis comme suit. Soit  $p_{r,s}^u = p_r^u \cup p_s^u$  et  $p_{r,s}^d = p_r^d \cup p_s^d$  deux ensembles, chacun composé de  $r+s$  nœuds alignés horizontalement sur le plan. Les nœuds de l'ensemble  $p_{r,s}^d$  sont placés sous les nœuds de l'ensemble  $p_{r,s}^u$  et un mur vertical sépare les premiers  $r$  nœuds  $p_r^u$  ( $p_r^d$ ) dans la ligne supérieure (inférieure) des derniers nœuds  $p_s^u$  ( $p_s^d$ ). Un diagramme murée  $d$  est une bijection entre l'ensemble  $p_{r,s}^u \cup p_{r,s}^d$  et visualisé en plaçant les segments entre les points correspondants de la manière suivante :

1. les segments reliant les nœuds entre  $p_{r,s}^u$  et  $p_{r,s}^d$  ne traversent pas le mur (nous les appelons lignes de propagation),
2. les segments reliant les nœuds entre  $p_r^u$  et  $p_r^u$  et entre  $p_r^d$  et  $p_r^d$  traversent le mur (nous les appelons arcs).

Le produit de deux éléments de base  $\mathbf{d}_2\mathbf{d}_1$  est obtenu en plaçant  $\mathbf{d}_1$  au-dessus de  $\mathbf{d}_2$  et en identifiant les nœuds de la ligne supérieure de  $\mathbf{d}_2$  avec les nœuds correspondants dans la ligne inférieure de  $\mathbf{d}_1$ . Soit  $\ell$  le nombre de boucles fermées ainsi obtenues. Le produit  $\mathbf{d}_1\mathbf{d}_2$  est donné par  $\delta^\ell$  fois le diagramme résultant avec boucles omises.

Les diagrammes murés suivants représentent les générateurs  $s_i$  (la ligne pointillée verticale représente le mur):

$$\begin{array}{l}
 s_i := \begin{array}{ccccccc}
 \bullet & \dots & \bullet & \bullet & \dots & \bullet & \dots & \bullet \\
 | & & \diagdown & \diagup & & | & & | \\
 \bullet & \dots & \bullet & \bullet & \dots & \bullet & & \bullet \\
 1 & & i & i+1 & & r & & r+1 & & r+s
 \end{array}, & \begin{array}{l}
 1 \leq i < r+s, \\
 i \neq r
 \end{array} \\
 \\
 s_r := \begin{array}{ccccccc}
 \bullet & \dots & \bullet & \bullet & \dots & \bullet & \dots & \bullet \\
 | & & | & \cup & & | & & | \\
 \bullet & \dots & \bullet & \bullet & \dots & \bullet & & \bullet \\
 1 & & r & r+1 & & r+s
 \end{array}.
 \end{array}$$

Cette algèbre peut être définie par des générateurs  $s_i$ ,  $1 \leq i < r + s$  et des relations suivantes

$$\begin{aligned}
s_i^2 &= 1, \quad i \neq r, \\
s_r^2 &= \delta s_r, \\
s_i s_{i+1} s_i &= s_{i+1} s_i s_{i+1}, \quad i, i+1 \neq r, \\
s_i s_j &= s_j s_i \text{ if } |i - j| > 1, \\
s_r s_{r \pm 1} s_r &= s_r, \\
s_r s_{r+1} s_{r-1} s_r s_{r-1} &= s_r s_{r+1} s_{r-1} s_r s_{r+1}, \\
s_{r-1} s_r s_{r+1} s_{r-1} s_r &= s_{r+1} s_r s_{r+1} s_{r-1} s_r.
\end{aligned}$$

Dans le premier chapitre de la thèse, nous construisons la forme normale  $\mathfrak{B}_{r,s}$  pour l'algèbre  $\mathbb{B}_{r,s}(\delta)$  - un ensemble de monômes de base (mots) dans les générateurs  $s_i$ . Pour construire l'ensemble  $\mathfrak{B}_{r,s}$ , nous introduisons une modification "ordonnée" du fameux lemme du diamant de Bergman [B], à savoir, nous présentons un ensemble de règles qui, étant appliquées dans un certain ordre, permet de réduire tout monôme dans les générateurs à un élément de  $\mathfrak{B}_{r,s}$ .

On note  $\mathfrak{S}_r^L$  l'ensemble des mots sous forme normale  $[1, 1 - i_1] \dots [r - 1, r - 1 - i_{r-1}]$  avec  $-1 \leq i_1 < 1, \dots, -1 \leq i_{r-1} < r - 1$  pour le groupe symétrique  $\mathfrak{S}_r$ , et  $\mathfrak{S}_s^R$  l'ensemble des mots sous forme normale  $[r + 1 + j_{s-1}, r + 1] \dots [r + s - 1 + j_1, r + s - 1]$  avec  $-1 \leq j_1 < 1, \dots, -1 \leq j_{s-1} < s - 1$  pour  $\mathfrak{S}_s$ .

On note  $\mathfrak{D}_{r,s}^{(f)}$  l'ensemble des mots

$$[r + i_1, r - j_1][r + i_2, r - j_2] \dots [r + i_f, r - j_f]$$

avec  $0 \leq i_1 < i_2 < \dots < i_f < s$  and  $r > j_1 > j_2 > \dots > j_f \geq 0$ . Par convention,  $\mathfrak{D}_{r,s}^{(0)} = \{1\}$ .

Dans cette notation, l'ensemble  $\mathfrak{B}_{r,s}$  se décompose comme

$$\mathfrak{B}_{r,s} = \bigcup_{f=0}^{\min(r,s)} \mathfrak{B}_{r,s}^{(f)}, \text{ où } \mathfrak{B}_{r,s}^{(f)} = \mathfrak{S}_r^L \mathfrak{D}_{r,s}^{(f)} \mathfrak{S}_s^R.$$

Nous appliquons ensuite la forme normale pour calculer la fonction génératrice du nombre de mots avec une longueur minimale donnée. Soit  $\nu_\ell$  le nombre de mots de longueur  $\ell$  in  $\mathfrak{B}_{r,s}$  et  $F_{r,s}(q) = \sum_\ell \nu_\ell q^\ell$  la fonction de génération correspondante. Nous avons

$$F_{r,s}(q) = (r + s)_q!,$$

où  $(m)_q := 1 + q + q^2 + \dots + q^{m-1}$  désigne le nombre quantique  $m$ .

Soit  $\lambda = (\lambda_1, \lambda_2, \dots)$  une partition;  $\lambda_1, \lambda_2, \dots$  sont des entiers non négatifs,  $\lambda_1 \geq \lambda_2 \geq \dots$ . Soit  $|\lambda| = \sum_{i \geq 1} \lambda_i$ . À chaque partition  $\lambda$ , nous associons son diagramme de Young - un tableau

de lignes de boîtes justifiées à gauche contenant des  $\lambda_1$  boîtes dans la ligne supérieure, des  $\lambda_2$  boîtes dans la deuxième ligne, etc. Une bipartition est une paire de partitions  $\boldsymbol{\lambda} = (\lambda^L, \lambda^R)$ . On note  $\Lambda$  l'ensemble de toutes les bipartitions. Pour chaque entier  $0 \leq f \leq \min(r, s)$ , nous fixons

$$\Lambda_{r,s}(f) = \{\boldsymbol{\lambda}_f = (\lambda_f^L, \lambda_f^R) \in \Lambda \mid r - |\lambda_f^L| = s - |\lambda_f^R| = f\}, \quad \text{et} \quad \Lambda_{r,s} = \bigcup_{f=0}^{\min(r,s)} \Lambda_{r,s}(f).$$

Les modules simples de  $\mathbf{B}_{r,s}(\delta)$  sont indexés par des éléments de l'ensemble  $\Lambda_{r,s}$  (voir [CDDM]). Le module indexé par  $\boldsymbol{\lambda}_f$  est désigné par  $C_{r,s}(\boldsymbol{\lambda}_f)$ .

Nous décrivons les modules de cellule en termes d'idéaux à gauche dans  $\mathbf{B}_{r,s}(\delta)$ . À savoir, nous utilisons la forme normale pour construire une base de l'idéal annihilateur d'un vecteur particulier  $v_f$  dans un module.

Soit  $\mathbf{A}_a$  une sous-algèbre de  $\mathbf{B}_{r,s}(\delta)$  générée par  $\langle s_1, \dots, s_{a-1} \rangle$ . Nous avons la tour de sous-algèbres suivante:

$$\mathbb{C} = \mathbf{A}_0 \subset \mathbf{A}_1 \subset \mathbf{A}_2 \subset \dots \subset \mathbf{A}_{r+s} = \mathbf{B}_{r,s}(\delta). \quad (0.1)$$

Par convention,  $\mathbf{A}_0 \simeq \mathbb{C}$  et  $\mathbf{A}_1 \simeq \mathbb{C}$ . Dans le régime semi-simple, la restriction, déterminée dans [CDDM], de tout module simple de  $\mathbf{A}_a$  à  $\mathbf{A}_{a-1}$  est sans multiplicité. En itérant les restrictions, une décomposition canonique d'un module simple de  $\mathbf{B}_{r,s}(\delta)$  en une somme directe d'espaces vectoriels unidimensionnels peut être obtenue. Les restrictions définissent le diagramme de Bratteli (le graphe de branchement de la tour (0.1)). Chaque chemin  $T$  remontant dans la tour depuis le module unique de  $\mathbf{A}_0$  vers  $\boldsymbol{\lambda}$  représente un vecteur de base  $\mathbf{v}_T$  dans le module étiqueté par une paire de diagrammes  $\boldsymbol{\lambda}$ .

Il s'avère que les vecteurs  $\mathbf{v}_T$  sont des vecteurs propres des éléments dits de Jucys-Murphy (construits pour le groupe symétrique dans [Ju] et [Mu])  $x_j$ ,

$$x_j \mathbf{v}_T = c_j(T) \mathbf{v}_T, \quad j = 1, \dots, r + s.$$

Les valeurs propres  $c_j(T)$  sont liées au contenu des cellules des diagrammes de Young. La sous-algèbre générée par les éléments  $x_1, \dots, x_{r+s}$  est une sous-algèbre commutative maximale de  $\mathbf{B}_{r,s}(\delta)$  appelée parfois sous-algèbre de Gelfand-Zetlin.

Une procédure de fusion donne une construction de la famille maximale d'idempotents orthogonaux minimaux par paire dans l'algèbre et, par conséquent, fournit un moyen de comprendre les bases dans les représentations irréductibles de l'algèbre  $\mathbf{B}_{r,s}(\delta)$ . La procédure de fusion (pour le groupe symétrique) trouve son origine dans le travail de Jucys [Ju], voir aussi [Ch, Na, GP]. Molev [Mo] a proposé une version simplifiée de cette construction pour le groupe symétrique impliquant des évaluations consécutives. Plus tard, les analogues de

cette procédure de fusion simplifiée ont été suggérés pour l'algèbre de Hecke, l'algèbre de Brauer, les algèbres cyclotomiques de Hecke et Brauer, les algèbres Birman - Murakami - Wenzl, etc. En tant que deuxième résultat principal du premier chapitre, nous construisons la procédure de fusion pour l'algèbre de Brauer murée.

Considérons la fonction rationnelle, dans les variables  $u_1, \dots, u_n$ , avec des valeurs dans l'algèbre de Brauer murée  $\mathbf{B}_{r,s}(\delta)$ :

$$\Psi_{r,s} := \mathcal{D}_{r,s} \mathfrak{S}_r \mathring{\mathfrak{S}}_s ,$$

où

$$\mathcal{D}_{r,s} := \prod_{\substack{1 \leq i \leq r \\ r+1 \leq j \leq n}} d_{i,j}(u_i + u_j)$$

et

$$\mathfrak{S}_r := \prod_{1 \leq i < j \leq r} s_{i,j}(u_i - u_j) , \quad \mathring{\mathfrak{S}}_s := \prod_{r+1 \leq i < j \leq n} s_{i,j}(u_i - u_j) .$$

Les produits dans les définitions de  $\mathcal{D}_{r,s}$ ,  $\mathfrak{S}_r$  et  $\mathring{\mathfrak{S}}_s$  sont calculés dans l'ordre lexicographique sur les paires  $(i, j)$  (c'est-à-dire,  $(i_1, j_1)$  précède  $(i_2, j_2)$  si  $i_1 < i_2$  ou  $i_1 = i_2$  et  $j_1 < j_2$ ).

Soit  $T = (\boldsymbol{\lambda}^{(0)}, \dots, \boldsymbol{\lambda}^{(n)})$ ,  $\boldsymbol{\lambda}^{(n)} = \boldsymbol{\lambda} \in \Lambda_{r,s}$ , un  $\boldsymbol{\lambda}$ -tableau standard décrivant un chemin dans le diagramme de Bratteli pour l'algèbre de Brauer murée  $\mathbf{B}_{r,s}(\delta)$ . Nous définissons la fonction rationnelle dans les variables  $u_1, \dots, u_n$ :

$$z_T := \prod_{i=1}^n \frac{u_i - c_i}{u_i - \delta \varepsilon(i)} \times \prod_{\substack{1 \leq j < i \leq r \\ \text{or} \\ r < j < i \leq n}} \frac{(u_i - u_j)^2}{(u_i - u_j)^2 - 1} ,$$

où la fonction  $\varepsilon$  est définie par

$$\varepsilon(j) = \begin{cases} 0 & \text{if } j \leq r , \\ 1 & \text{if } j > r . \end{cases}$$

et par souci de concision, nous avons noté  $c_i = c_i(T)$ ,  $i = 1, \dots, n$ .

Nous fixons

$$\Psi_T(u_1, \dots, u_n) := z_T \cdot \Psi_{r,s} .$$

**Theorem 0.1** *L'idempotent primitif  $E_T$ , correspondant au standard  $\boldsymbol{\lambda}$ -tableau  $T$ , est trouvé par les évaluations consécutives*

$$E_T = \Psi_T(u_1, \dots, u_n) \Big|_{u_1=c_1} \Big|_{u_2=c_2} \cdots \Big|_{u_n=c_n} .$$

Les premières études de l'algèbre de Brauer murée  $\mathbf{B}_{r,s}(\delta)$  ont été motivées par l'intérêt pour les généralisations de la dualité de Schur-Weyl pour le groupe  $GL_\delta(\mathbb{C})$ . Pour  $\delta \in \mathbb{N}$ , la dualité relie les actions mutuellement commutatives de  $\mathbf{B}_{r,s}(\delta)$  et  $GL_\delta(\mathbb{C})$  sur le produit tensoriel mixte  $V^{\otimes r} \otimes (V^*)^{\otimes s}$  de la représentation naturelle et son dual pour  $GL_\delta(\mathbb{C})$ . Le super analogue de cette dualité entre l'algèbre de Brauer et la superalgèbre de Lie  $gl(M|N)$  a été étudié dans [BS]. La deuxième partie de la thèse est consacrée à la dualité quantique de Schur-Weyl entre l'algèbre de Brauer murée quantique  $q\mathbf{B}_{m,n}$  et l'algèbre de Hopf  $U_qsl(2|1)$  chaque fois que  $q$  n'est pas une racine de l'unité.

Nous étudions le produit tensoriel mixte  $\mathbf{3}^{\otimes m} \otimes \overline{\mathbf{3}}^{\otimes n}$  des représentations fondamentales tridimensionnelles de l'algèbre de Hopf  $U_qsl(2|1)$ . L'un des principaux résultats du deuxième chapitre consiste à établir des formules explicites pour la décomposition des produits tensoriels de tout module de  $U_qsl(2|1)$  simple ou projectif avec les modules générateurs  $\mathbf{3}$  et  $\overline{\mathbf{3}}$ . Le centralisateur de  $U_qsl(2|1)$  sur le produit tensoriel mixte est un quotient  $X_{m,n}$  de l'algèbre de Brauer murée quantique  $q\mathbf{B}_{m,n}$ .

En appliquant en partie les méthodes développées dans [CD] pour trouver des nombres de décomposition pour l'algèbre de Brauer murée, nous décrivons explicitement la structure des modules projectifs sur  $X_{m,n}$ . Les algèbres de Brauer murées quantiques forment une tour infinie. Nous calculons les foncteurs de restriction correspondants sur des modules simples et projectifs sur  $X_{m,n}$ . En raison de ces résultats, nous obtenons un autre résultat important du deuxième chapitre de la thèse consistant à décomposer le produit tensoriel mixte en un bimodule sur  $X_{m,n} \boxtimes U_qsl(2|1)$ .

# Introduction

The dissertation covers some aspects of representation theory of the walled Brauer algebra  $\mathbf{B}_{r,s}(\delta)$  and its quantum analogue.

In this text the ground field is assumed to be the field  $\mathbb{C}$  of complex numbers. The walled Brauer algebra  $\mathbf{B}_{r,s}(\delta)$  is an associative unital  $(r+s)!$ -dimensional algebra defined for all  $\delta \in \mathbb{C}$ . It is a diagram algebra spanned by particular ‘walled’ diagrams. This algebra can be defined in terms of generators  $s_i$ ,  $1 \leq i < r+s$ , obeying certain relations, see Section 1.1. In the first Chapter of the dissertation we construct the normal form  $\mathfrak{B}_{r,s}$  for  $\mathbf{B}_{r,s}(\delta)$  – a set of basis monomials (words) in generators  $s_i$ . To construct the set  $\mathfrak{B}_{r,s}$  we introduce an ‘ordered’ modification of the so-called Bergman’s diamond lemma [B], namely, we present a set of rules which, being applied in a certain order, allows to reduce any monomial in generators to an element from  $\mathfrak{B}_{r,s}$ . We then apply the normal form to calculate the generating function for the numbers of words with a given minimal length.

Representation theory of the walled Brauer algebra is well understood. In [CDDM] it was shown that cell modules arising from a certain cellular algebra structure on  $\mathbf{B}_{r,s}(\delta)$  are labeled by pairs  $\boldsymbol{\lambda} = (\lambda^L, \lambda^R)$  of Young diagrams. The criterion for semisimplicity of  $\mathbf{B}_{r,s}(\delta)$  was also established there.

We describe the cell modules in terms of left ideals in  $\mathbf{B}_{r,s}(\delta)$ . Namely, we utilize the normal form to construct a basis of the annihilator ideal of a particular vector  $v_f$  in a module.

Let  $\mathbf{A}_a$  be a subalgebra of  $\mathbf{B}_{r,s}(\delta)$  generated by  $\langle s_1, \dots, s_{a-1} \rangle$ . We have the following tower of subalgebras:

$$\mathbb{C} = \mathbf{A}_0 \subset \mathbf{A}_1 \subset \mathbf{A}_2 \subset \dots \subset \mathbf{A}_{r+s} = \mathbf{B}_{r,s}(\delta). \quad (0.1)$$

By convention,  $\mathbf{A}_0 \simeq \mathbb{C}$  and  $\mathbf{A}_1 \simeq \mathbb{C}$ . In the semisimple regime the restriction, determined in [CDDM], of any simple module of  $\mathbf{A}_a$  to  $\mathbf{A}_{a-1}$  is multiplicity-free. By iterating the restrictions, a canonical decomposition of a simple  $\mathbf{B}_{r,s}(\delta)$ -module into a direct sum of one-dimensional vector spaces can be obtained. The restrictions define the Bratteli diagram (the branching graph of the tower (0.1)). Each path  $T$  going upwards in the diagram from the unique  $\mathbf{A}_0$ -module to  $\boldsymbol{\lambda}$  represents a basis vector  $\mathbf{v}_T$  in the module labeled by a pair  $\boldsymbol{\lambda}$  of diagrams.



It turns out that the vectors  $\mathbf{v}_T$  are eigenvectors of the so-called Jucys-Murphy elements (constructed for the symmetric group in [Ju] and [Mu])  $x_j$ ,

$$x_j \mathbf{v}_T = c_j(T) \mathbf{v}_T, \quad j = 1, \dots, r + s.$$

The eigenvalues  $c_j(T)$  are related to the contents of cells of Young diagrams. The subalgebra generated by the elements  $x_1, \dots, x_{r+s}$  is a maximal commutative subalgebra of  $\mathbf{B}_{r,s}(\delta)$  called sometimes the Gelfand-Zetlin subalgebra.

A fusion procedure gives a construction of a maximal family of pairwise orthogonal minimal idempotents in the algebra, and therefore, provides a way to understand bases in the irreducible representations of the algebra  $\mathbf{B}_{r,s}(\delta)$ . The fusion procedure (for the symmetric group) originates in the work of Jucys [Ju], see also the subsequent works [Ch, Na, GP]. A simplified version of this construction for the symmetric group involving the consecutive evaluations was suggested by Molev [Mo]. Later the analogues of this simplified fusion procedure were suggested for the Hecke algebra, Brauer algebra, cyclotomic Hecke and Brauer algebras, Birman–Murakami–Wenzl algebras etc (see Section 1.5.2 for references). As a second main result of the first Chapter we construct the fusion procedure for the walled Brauer algebra and show that all primitive idempotents for  $\mathbf{B}_{r,s}(\delta)$  can be found by evaluating a rational function in several variables

$$\Psi_T(u_1, \dots, u_{r+s}) \Big|_{u_1=c_1} \Big|_{u_2=c_2} \cdots \Big|_{u_{r+s}=c_{r+s}},$$

where  $c_i$  are the contents of  $T$ .

The first studies of the walled Brauer algebra  $\mathbf{B}_{r,s}(\delta)$  were motivated by interest in generalizations of the Schur-Weyl duality for the group  $GL_\delta(\mathbb{C})$ . For  $\delta \in \mathbb{N}$ , the duality relates mutually commuting actions of  $\mathbf{B}_{r,s}(\delta)$  and  $GL_\delta(\mathbb{C})$  on the mixed tensor product  $V^{\otimes r} \otimes (V^*)^{\otimes s}$  of the natural representation and its dual for  $GL_\delta(\mathbb{C})$ . The super analogue of this duality between the walled Brauer algebra and the Lie superalgebra  $gl(M|N)$  was studied in [BS]. The second part of the dissertation is devoted to the quantum Schur-Weyl duality between the quantum walled Brauer algebra  $q\mathbf{B}_{m,n}$  and the Hopf algebra  $U_qsl(2|1)$  whenever  $q$  is not a root of unity.

We study the mixed tensor product  $\mathbf{3}^{\otimes m} \otimes \overline{\mathbf{3}}^{\otimes n}$  of three-dimensional fundamental representations of the Hopf algebra  $U_qsl(2|1)$ . One of the main results of the second Chapter consists in the establishing of the explicit formulae for the decomposition of tensor products of any simple or any projective  $U_qsl(2|1)$ -module with the generating modules  $\mathbf{3}$  and  $\overline{\mathbf{3}}$ . The centralizer of  $U_qsl(2|1)$  on the mixed tensor product is a quotient  $X_{m,n}$  of the quantum walled Brauer algebra  $q\mathbf{B}_{m,n}$ .

By applying in part the methods developed in [CD] for finding decomposition numbers for the walled Brauer algebra, we explicitly describe the structure of projective modules

over  $X_{m,n}$ . The quantum walled Brauer algebras form an infinite tower. We calculate the corresponding restriction functors on simple and projective modules over  $X_{m,n}$ . Due to these results we obtain another important outcome of the second Chapter of the dissertation consisting in decomposing the mixed tensor product as a bimodule over  $X_{m,n} \boxtimes U_qsl(2|1)$ .

The dissertation is based on works [BO, BGO, BTS].

## Acknowledgements

I would like to thank my supervisor Pr. Oleg Ogievetsky and my co-authors Yegor Goncharov, Alexander Kiselev and Ilya Tipunin for the intensive and productive work together. I am grateful to Sergey Khoroshkin, Maud De Visscher, Robert Coquereaux and Valeria Shiheeva to have accepted to be in the jury of my thesis.

I would like to thank Centre de Physique Théorique (CPT) for hospitality and especially the director of CPT Thierry Martin.

I acknowledge the financial support for my research studies of the Excellence Initiative of Aix-Marseille University – A\*MIDEX and Excellence Laboratory Archimedes LabEx, French “Investissements d’Avenir” programmes.

# Contents

<b>1</b>	<b>Walled Brauer algebra</b>	<b>6</b>
1.1	Definition	6
1.2	Normal form and reduction algorithm	7
1.3	Modules over $\mathbf{B}_{r,s}(\delta)$	12
1.3.1	Diagrammatical description of $\mathbf{B}_{r,s}(\delta)$	12
1.3.2	$\mathbf{B}_{r,s}(\delta)$ -modules	13
1.3.4	Annihilator ideal	16
1.3.7	Gelfand-Zetlin basis	20
1.4	Jucys–Murphy elements	24
1.5	Orthogonal primitive idempotents	26
1.5.1	Algebraic background	26
1.5.2	Fusion procedure for the walled Brauer algebra	27
<b>2</b>	<b>Schur-Weyl duality between <math>\mathcal{U}_q\mathit{sl}(2 1)</math> and quantum walled Brauer algebra</b>	<b>39</b>
	$\mathfrak{B}_{m,n}$	
2.1	The Hopf algebra $\mathcal{U}_q\mathit{sl}(2 1)$	40
2.1.1	Definition of $\mathcal{U}_q\mathit{sl}(2 1)$	40
2.1.2	Simple $\mathcal{U}_q\mathit{sl}(2 1)$ -modules	41
2.1.3	$\mathcal{U}_q\mathit{sl}(2 1)$ -action on simple modules	42
2.1.4	$\text{Ext}^1$ spaces for atypical modules	44
2.1.5	Projective $\mathcal{U}_q\mathit{sl}(2 1)$ -modules	45
2.2	The mixed tensor product	47
2.2.2	The centralizer of $\mathcal{U}_q\mathit{sl}(2 1)$ on the mixed tensor product	50
2.3	Quantum walled Brauer algebra	52
2.3.1	Definition	52
2.3.3	Cell modules	53
2.4	Modules over $\mathcal{X}_{m,n}$	56
2.4.1	Modules in the decomposition of the mixed tensor product	56

2.4.2	The restriction functors . . . . .	63
2.5	The mixed tensor product as a bimodule . . . . .	69
2.5.1	Bimodule decomposition . . . . .	70
2.5.3	Verification . . . . .	73
<b>Appendix</b>		<b>76</b>
A:	partial order on $\widehat{\mathbf{B}}_{r,s}$ . . . . .	76
B:	multiplication by generators . . . . .	77
C:	atypical part of the bimodule . . . . .	78

# Chapter 1

## Walled Brauer algebra

In the first Chapter we discuss the walled Brauer algebra  $\mathbf{B}_{r,s}(\delta)$  and its representation theory. In Section 1.2 we construct the normal form  $\mathfrak{B}_{r,s}$  of the walled Brauer algebra by the reduction algorithm using a modification of the Bergman's diamond lemma [B]. In Section 1.3 we recall a diagrammatic presentation of the walled Brauer algebra and explain the constructions of the cell basis and the Gelfand-Zetlin basis in modules. We construct a basis of the annihilator ideal of a particular vector  $v_f$  in a module. In Section 1.4 we recall the construction of Jucys-Murphy elements. In Section 1.5 we prove a second result of the Chapter consisting in two fusion procedures for the walled Brauer algebra. It gives a way to construct a complete system of primitive pairwise orthogonal idempotents by consecutive evaluations of a rational function with values in the algebra.

### 1.1 Definition

The walled Brauer algebra  $\mathbf{B}_{r,s}(\delta)$  is an associative unital  $(r+s)!$ -dimensional algebra\* defined for all  $\delta \in \mathbb{C}$ . It is generated by elements  $s_i$ ,  $i = 1 \dots r+s-1$ , with the following defining

---

\*According to [NV]: “The history of the definition of this algebra is as follows. Turaev [T] was the first to define it by a presentation; he also pointed out to the second author that it is  $(r+s)!$ -dimensional and resembles the group algebra of the symmetric group. The walled Brauer algebra was independently defined in [Ko].”

relations (see, *e.g.*, [BS, JK])

$$s_i^2 = 1, \quad i \neq r, \quad (1.1)$$

$$s_r^2 = \delta s_r, \quad (1.2)$$

$$s_i s_{i+1} s_i = s_{i+1} s_i s_{i+1}, \quad i, i+1 \neq r, \quad (1.3)$$

$$s_i s_j = s_j s_i \text{ if } |i-j| > 1, \quad (1.4)$$

$$s_r s_{r\pm 1} s_r = s_r, \quad (1.5)$$

$$s_r s_{r+1} s_{r-1} s_r s_{r-1} = s_r s_{r+1} s_{r-1} s_r s_{r+1}, \quad (1.6)$$

$$s_{r-1} s_r s_{r+1} s_{r-1} s_r = s_{r+1} s_r s_{r+1} s_{r-1} s_r. \quad (1.7)$$

Note that the elements  $s_i$  with  $1 \leq i < r$  ( $r < i < r+s$ ) generate symmetric group algebra  $\mathbb{C}\mathfrak{S}_r$  ( $\mathbb{C}\mathfrak{S}_s$ ). As a result,  $\mathbf{B}_{r,s}(\delta)$  contains  $\mathbf{B}_{r,0}(\delta) \cong \mathbb{C}\mathfrak{S}_r$  and  $\mathbf{B}_{0,s}(\delta) \cong \mathbb{C}\mathfrak{S}_s$  as commuting subalgebras, together generating  $\mathbb{C}[\mathfrak{S}_r \times \mathfrak{S}_s]$ .

The algebra  $\mathbf{B}_{r,s}(\delta)$  admits an anti-automorphism  $\iota$ , which acts as identity on the generators,

$$\iota(s_i) = s_i, \quad \iota(d) = d, \quad \iota(xy) = \iota(y)\iota(x). \quad (1.8)$$

## 1.2 Normal form and reduction algorithm

Monomials in generators  $s_i$ ,  $1 \leq i < r+s$ , whose lengths cannot be reduced by any composition of relations (1.1)-(1.7) will be referred to as minimal words. It may happen that an element of the algebra  $\mathbf{B}_{r,s}(\delta)$  can be represented by several monomials of the same length in view of relations (1.3), (1.4), (1.6), (1.7) which do not affect monomial lengths.

In this Section we shall consider bases of the algebra  $\mathbf{B}_{r,s}(\delta)$  consisting of elements which can be represented by minimal words. By a *normal form* for the algebra  $\mathbf{B}_{r,s}(\delta)$  we mean a basis of  $\mathbf{B}_{r,s}(\delta)$  and a unique choice of a word representing each basis element.

To construct a normal form we make use of Bergman's diamond lemma [B]. Let  $\widehat{\mathbf{B}}_{r,s}$  denote the monoid freely generated by elements  $\widehat{s}_i$ ,  $1 \leq i < r+s$ . Let also  $\widehat{\mathbf{B}}_{r,s}\langle\widehat{\delta}\rangle$  denote the monoid freely generated by elements  $\widehat{s}_i$ ,  $1 \leq i < r+s$ , and a central element  $\widehat{\delta}$ . For a subset  $\mathfrak{E}$  of  $\widehat{\mathbf{B}}_{r,s}$  we denote by  $\mathfrak{E}\langle\widehat{\delta}\rangle$  the subset of  $\widehat{\mathbf{B}}_{r,s}\langle\widehat{\delta}\rangle$  consisting of words  $\widehat{\delta}^j \mathbf{e}$  for  $\mathbf{e} \in \mathfrak{E}$  and  $j = 0, 1, 2, \dots$

We propose a reduction system  $\mathfrak{R}$ , a set of words  $\mathfrak{B}_{r,s} \subset \widehat{\mathbf{B}}_{r,s}$  and an algorithm  $\varphi_{\mathfrak{R}} : \widehat{\mathbf{B}}_{r,s}\langle\widehat{\delta}\rangle \rightarrow \mathfrak{B}_{r,s}\langle\widehat{\delta}\rangle$  transforming any given monomial to a particular reduced form. We show that the image of  $\mathfrak{B}_{r,s}$  under the natural map

$$\mathbb{C}\widehat{\mathbf{B}}_{r,s}\langle\widehat{\delta}\rangle \rightarrow \mathbf{B}_{r,s}(\delta), \quad \widehat{s}_i \mapsto s_i, \widehat{\delta} \mapsto \delta, \quad (2.9)$$

forms a basis of the algebra  $\mathbf{B}_{r,s}(\delta)$ .

Reduction system  $\mathfrak{R}$  is constituted by ordered pairs  $\rho = (\mathbf{w}_\rho, \mathbf{w}'_\rho)$  of monomials  $\mathbf{w}_\rho \in \widehat{\mathbf{B}}_{r,s}$ ,  $\mathbf{w}_\rho \neq 1$ , and  $\mathbf{w}'_\rho \in \mathfrak{B}_{r,s}\langle\widehat{\delta}\rangle$ ; such a pair is written as  $\mathbf{w}_\rho \rightarrow \mathbf{w}'_\rho$  and understood as the substitution instruction, or *reduction*: the instruction, applied to a word  $\mathbf{e}$ , chooses a subword, equal to the *lhs* and replaces it by the *rhs*. A monomial is called irreducible if no reduction can be applied to it.

Reductions can be subject to ambiguities meaning that more than one instruction from  $\mathfrak{R}$  can be applicable to a given monomial. All ambiguities are analyzed in terms of the following two elementary ones [B]. If  $\mathbf{v}_1\mathbf{v}_2 = \mathbf{w}_\rho$  and  $\mathbf{v}_2\mathbf{v}_3 = \mathbf{w}_\tau$ , where  $\mathbf{v}_1, \mathbf{v}_2, \mathbf{v}_3 \neq 1$ , for some  $\rho, \tau \in \mathfrak{R}$  one faces an alternative of transforming  $\mathbf{v}_1\mathbf{v}_2\mathbf{v}_3$  either into  $\mathbf{w}'_\rho\mathbf{v}_3$  or into  $\mathbf{v}_1\mathbf{w}'_\tau$ . This is called an overlap ambiguity of  $\mathfrak{R}$ . If  $\mathbf{v}_2 = \mathbf{w}_\rho$  and  $\mathbf{v}_1\mathbf{v}_2\mathbf{v}_3 = \mathbf{w}_\tau$ , where  $\mathbf{v}_1 \neq 1$  or  $\mathbf{v}_3 \neq 1$ , one can transform  $\mathbf{v}_1\mathbf{v}_2\mathbf{v}_3$  either into  $\mathbf{v}_1\mathbf{w}'_\rho\mathbf{v}_3$  or into  $\mathbf{w}'_\tau$ . This is referred to as inclusion ambiguity. An ambiguity of  $\mathfrak{R}$  is said to be resolvable when there exist reductions  $\varphi_1, \varphi_2$  such that  $\varphi_1(\mathbf{w}'_\rho\mathbf{v}_3) = \varphi_2(\mathbf{v}_1\mathbf{w}'_\tau)$  in case of an overlap and  $\varphi_1(\mathbf{v}_1\mathbf{w}'_\rho\mathbf{v}_2) = \varphi_2(\mathbf{w}'_\tau)$  in case of an inclusion.

For generators  $\hat{s}_i$ ,  $1 \leq i < r + s$ , denote the word  $\hat{s}_p\hat{s}_{p-1}\dots\hat{s}_q \in \widehat{\mathbf{B}}_{r,s}$  ( $1 \leq q \leq p < r + s$ ) by  $[p, q]$ , and set  $[q - 1, q] = 1$  by definition.

**Proposition 1.2.1** *Let  $\mathfrak{R}$  be the following reduction system*

$$\hat{s}_i^2 \rightarrow 1, \quad i \neq r, \quad (2.10)$$

$$\hat{s}_j\hat{s}_i \rightarrow \hat{s}_i\hat{s}_j, \quad j - i > 1, \quad (2.11)$$

$$\hat{s}_{i+1}\hat{s}_i \dots \hat{s}_{i-j}\hat{s}_{i+1} \rightarrow \hat{s}_i\hat{s}_{i+1}\hat{s}_i \dots \hat{s}_{i-j}, \quad i < r - 1, 0 \leq j < i, \quad (2.12)$$

$$\hat{s}_i\hat{s}_{i+j} \dots \hat{s}_{i+1}\hat{s}_i \rightarrow \hat{s}_{i+j} \dots \hat{s}_{i+1}\hat{s}_i\hat{s}_{i+1}, \quad i > r, 1 \leq j < r + s - i, \quad (2.13)$$

$$\hat{s}_r^2 \rightarrow \widehat{\delta}\hat{s}_r, \quad (2.14)$$

$$\hat{s}_r\hat{s}_{r-1} \dots \hat{s}_{r-i}\hat{s}_r \rightarrow \hat{s}_{r-2} \dots \hat{s}_{r-i}\hat{s}_r, \quad 1 \leq i < r, \quad (2.15)$$

$$\hat{s}_r\hat{s}_{r+i} \dots \hat{s}_{r+1}\hat{s}_r \rightarrow \hat{s}_r\hat{s}_{r+i} \dots \hat{s}_{r+2}, \quad 1 \leq i < s, \quad (2.16)$$

$$[r + j, r - i][r + j, r] \rightarrow \hat{s}_{r-1}[r + j - 1, r - i][r + j, r], \quad 1 \leq i < r, 1 \leq j < s, \quad (2.17)$$

$$[r, r - i][r + j, r - i] \rightarrow [r, r - i][r + j, r - i + 1]\hat{s}_{r+1}, \quad 1 \leq i < r, 1 \leq j < s. \quad (2.18)$$

Then

- (i) All ambiguities of  $\mathfrak{R}$  are resolvable.
- (ii) The factor-algebra of the monoid algebra  $\mathbb{C}\widehat{\mathbf{B}}_{r,s}\langle\widehat{\delta}\rangle$  by the ideal generated by the elements  $\mathbf{w}_\rho - \mathbf{w}'_\rho$ , for  $\rho$  ranging through the set of instructions, and  $\widehat{\delta} - \delta$ , is isomorphic to the walled Brauer algebra  $\mathbf{B}_{r,s}(\delta)$ .

**Proof.** (i) We start by turning defining relations for  $\mathbf{B}_{r,s}(\delta)$  (1.1)-(1.7) into the following

set  $\mathfrak{A}_0$  of instructions

$$\begin{aligned}
\hat{s}_i^2 &\rightarrow 1, \quad i \neq r, \\
\hat{s}_j \hat{s}_i &\rightarrow \hat{s}_i \hat{s}_j, \quad j - i > 1, \\
\hat{s}_{i+1} \hat{s}_i \hat{s}_{i+1} &\rightarrow \hat{s}_i \hat{s}_{i+1} \hat{s}_i, \quad i < r - 1, \\
\hat{s}_i \hat{s}_{i+1} \hat{s}_i &\rightarrow \hat{s}_{i+1} \hat{s}_i \hat{s}_{i+1}, \quad i > r, \\
\hat{s}_r^2 &\rightarrow \hat{\delta} \hat{s}_r, \\
\hat{s}_r \hat{s}_{r\pm 1} \hat{s}_r &\rightarrow \hat{s}_r, \\
\hat{s}_{r+1} \hat{s}_r \hat{s}_{r-1} \hat{s}_{r+1} \hat{s}_r &\rightarrow \hat{s}_{r-1} \hat{s}_r \hat{s}_{r-1} \hat{s}_{r+1} \hat{s}_r, \\
\hat{s}_r \hat{s}_{r-1} \hat{s}_{r+1} \hat{s}_r \hat{s}_{r-1} &\rightarrow \hat{s}_r \hat{s}_{r-1} \hat{s}_{r+1} \hat{s}_r \hat{s}_{r+1},
\end{aligned}$$

which is a subset  $\mathfrak{A}_0 \subset \mathfrak{A}$ . It is straightforward to check that the reduction system  $\mathfrak{A}_0$  is free from inclusion ambiguities while overlap ambiguities are not resolvable unless one inductively extends  $\mathfrak{A}_0$  to the reduction system  $\mathfrak{A}$ . The latter is subject only to overlap ambiguities as well. Resolvability of these ambiguities can be verified by a successive check considering first all ambiguities of (2.10) with (2.11)-(2.18) then all ambiguities of (2.11) with (2.12)-(2.18) etc.

The assertion (ii) follows since the instructions from  $\mathfrak{A}$  are consequences of the instructions from  $\mathfrak{A}_0$ . ■

To guarantee that a reduction system  $\mathfrak{A}$  leads to a set of irreducible words in a finite number of steps, Theorem 1.2 [B] assumes the existence of a partial order  $<$  on the set of free monomials such that: i)  $w_1 < w_2$  implies  $uw_1v < uw_2v$  for all  $u, v$ , ii)  $<$  is compatible with  $\mathfrak{A}$  in a sense that  $w'_\rho < w_\rho$  for each instruction  $w_\rho \rightarrow w'_\rho$ , iii) any chain  $v_1 > v_2 > \dots$  terminates. For the system  $\mathfrak{A}$  such order does not exist. Indeed, assume that it does. Applying the rule (2.18) to the monomial  $\hat{s}_r \hat{s}_{r-1} \hat{s}_{r+1} \hat{s}_r \hat{s}_{r-1} \hat{s}_r \hat{s}_{r-1} \hat{s}_{r+1} \hat{s}_r$  we arrive at  $\hat{s}_r \hat{s}_{r-1} \hat{s}_{r+1} \hat{s}_r \hat{s}_{r+1} \hat{s}_r \hat{s}_{r-1} \hat{s}_{r+1} \hat{s}_r$ , so we must have

$$\hat{s}_r \hat{s}_{r-1} \hat{s}_{r+1} \hat{s}_r \hat{s}_{r+1} \hat{s}_r \hat{s}_{r-1} \hat{s}_{r+1} \hat{s}_r < \hat{s}_r \hat{s}_{r-1} \hat{s}_{r+1} \hat{s}_r \hat{s}_{r-1} \hat{s}_r \hat{s}_{r-1} \hat{s}_{r+1} \hat{s}_r. \quad (2.19)$$

Then, by applying (2.17) to the result, one gets the opposite relation

$$\hat{s}_r \hat{s}_{r-1} \hat{s}_{r+1} \hat{s}_r \hat{s}_{r-1} \hat{s}_r \hat{s}_{r-1} \hat{s}_{r+1} \hat{s}_r < \hat{s}_r \hat{s}_{r-1} \hat{s}_{r+1} \hat{s}_r \hat{s}_{r+1} \hat{s}_r \hat{s}_{r-1} \hat{s}_{r+1} \hat{s}_r, \quad (2.20)$$

which is a contradiction. This example shows that some sequences of instructions from  $\mathfrak{A}$  do not terminate so the reduction system  $\mathfrak{A}$ , directly understood, does not lead to a normal form. We shall not investigate the question about the existence of another reduction system compatible with a certain order. Instead, we will present a trick allowing to construct a well-defined algorithm  $\varphi_{\mathfrak{A}}$  which uses precisely the reduction system  $\mathfrak{A}$ . Namely we will specify the order of applying the rules from  $\mathfrak{A}$ .



For that purpose we split  $\mathfrak{R} = \mathfrak{R}' \cup \mathfrak{R}''$ , with  $\mathfrak{R}'$  constituted by instructions (2.10)-(2.16) and  $\mathfrak{R}''$  – by (2.17), (2.18). For the set  $\mathfrak{R}'$  a partial order  $\triangleleft$ , satisfying conditions i)-iii), on  $\widehat{\mathfrak{B}}_{r,s}$  does exist; it is described in Appendix A. Therefore, the reduction system  $\mathfrak{R}'$  leads to a set of irreducible words  $\mathfrak{B}_{r,s}^*$  and gives a well-defined algorithm  $\varphi_{\mathfrak{R}'} : \widehat{\mathfrak{B}}_{r,s} \langle \widehat{\delta} \rangle \rightarrow \mathfrak{B}_{r,s}^* \langle \widehat{\delta} \rangle$ . To describe the words from  $\mathfrak{B}_{r,s}^*$ , we first note that instructions (2.10)-(2.13) move generators of  $\mathfrak{S}_r$  (respectively,  $\mathfrak{S}_s$ ) to the left (respectively, to the right) and arrange them into a certain normal form (it is of no importance at the moment and will be specified later). With this in hand, it is a straightforward exercise to check that  $\mathfrak{B}_{r,s}^*$  is constituted by monomials of the form

$$\mathbf{w}_{j_1, \dots, j_f}^{i_1, \dots, i_f} = \mathbf{w}_L [r + i_1, r - j_1] [r + i_2, r - j_2] \dots [r + i_f, r - j_f] \mathbf{w}_R \quad (2.21)$$

where  $\mathbf{w}_L \in \mathfrak{S}_r$  and  $\mathbf{w}_R \in \mathfrak{S}_s$  are in a normal form,  $r > i_1 \geq 0$ ,  $s > j_f \geq 0$ ,  $s > i_2, \dots, i_f \geq 1$ ,  $r > j_1, \dots, j_{f-1} \geq 1$  and  $0 \leq f \leq \min(r, s)$ .

Clearly, the instructions from  $\mathfrak{R}''$  do not preserve the set  $\mathfrak{B}_{r,s}^*$ . We specify the algorithm  $\varphi_{\mathfrak{R}''}$  of applying the reductions from  $\mathfrak{R}''$  to the monomials  $\mathbf{w} \in \mathfrak{B}_{r,s}^*$ . Assume, for a monomial  $\mathbf{w}$  of the form (2.21) with  $f \geq 2$ , that the set  $\{j_1, \dots, j_f\}$  is not strictly decreasing. Then there exists the maximal value  $k = 1 \dots f - 1$  such that  $j_k \leq j_{k+1}$ . The word  $\mathbf{w}$  contains a subword  $[r, r - j_k] [r + i_{k+1}, r - j_k]$  and we apply the instruction (2.18) to it, obtaining  $[r, r - j_k] [r + i_{k+1}, r - j_k + 1] \widehat{s}_{r+1}$ . Reductions of this kind (call them  $\psi$ ) break the structure (2.21),  $\psi(\mathbf{w}) \notin \mathfrak{B}_{r,s}^*$ . It is straightforward to check that  $\mathbf{w}$  and  $\varphi_{\mathfrak{R}'} \circ \psi(\mathbf{w}) \in \mathfrak{B}_{r,s}^*$  have the same  $f$ , while, for the word  $\varphi_{\mathfrak{R}'} \circ \psi(\mathbf{w})$ , the maximal  $k' = 1 \dots f - 1$  such that  $j_{k'} < j_{k'+1}$  (if exists) is less than  $k$ . Iterating this procedure, we arrive at the word which has the form (2.21) with  $j_1 > j_2 > \dots > j_f \geq 0$  and thus is irreducible with respect to the union of  $\mathfrak{R}'$  and (2.18). As soon as the ordering in  $j$ 's is achieved, we start to apply, in a similar way, the instruction (2.17) to arrive at the ordering  $0 \leq i_1 < i_2 < \dots < i_f$  of  $i$ 's (now we look for the minimal  $l = 1 \dots f - 1$  such that  $i_{l-1} \geq i_l$ ).

Our final algorithm  $\varphi_{\mathfrak{R}}$  is the composition of the algorithm  $\varphi_{\mathfrak{R}''}$  and the algorithm  $\varphi_{\mathfrak{R}'}$ ,  $\varphi_{\mathfrak{R}} = \varphi_{\mathfrak{R}''} \circ \varphi_{\mathfrak{R}'}$ .

We have established the following Proposition.

**Proposition 1.2.2** *The set  $\mathfrak{B}_{r,s}$  of irreducible words with respect to the algorithm  $\varphi_{\mathfrak{R}}$  consists of the monomials  $\mathbf{w}_{j_1, \dots, j_f}^{i_1, \dots, i_f}$  of the form (2.21) with  $0 \leq i_1 < i_2 < \dots < i_f < s$  and  $r > j_1 > j_2 > \dots > j_f \geq 0$ .*

**Lemma 1.2.3** *The set  $\mathfrak{B}_{r,s}$  contains  $(r + s)!$  elements.*

**Proof.** The set of monomials with a given  $f$  is in bijection with the product of the set of subsets of cardinality  $f$  in a set of cardinality  $r$  by the set of subsets of cardinality  $f$  in a

set of cardinality  $s$ , so

$$\#\mathfrak{B}_{r,s} = r!s! \sum_{f=0}^{\min(r,s)} \binom{s}{f} \binom{r}{f} = (r+s)! . \quad (2.22)$$

■

**Lemma 1.2.4** *The image of the set  $\mathfrak{B}_{r,s}$  under the map (2.9) forms a basis in  $\mathbf{B}_{r,s}(\delta)$ .*

**Proof.** By construction, the images of the words from  $\mathfrak{B}_{r,s}$  are linearly independent. The assertion follows, since the cardinality of  $\mathfrak{B}_{r,s}$  coincides, by Lemma 1.2.4, with the dimension of  $\mathbf{B}_{r,s}(\delta)$ . ■

Multiplication in  $\mathbf{B}_{r,s}(\delta)$  is expressed in terms of the basis monomials  $\mathbf{v}_1, \mathbf{v}_2 \in \mathfrak{B}_{r,s}$  as  $\varphi_{\mathfrak{A}}(\mathbf{v}_1\mathbf{v}_2) \in \mathfrak{B}_{r,s}$ . Left multiplication by generators  $s_i \varphi_{\mathfrak{A}}(s_i\mathbf{v})$ ,  $s_i, \mathbf{v} \in \mathfrak{B}_{r,s}$ , is presented in Appendix B.

Note that the Lemma 1.2.4 holds for any choice of normal forms for  $\mathbf{w}_L \in \mathfrak{S}_r$  and  $\mathbf{w}_R \in \mathfrak{S}_s$ . The ones we consider in this work are obtained via the reduction system  $\mathfrak{A}$ . We denote by  $\mathfrak{S}_r^L$  the set of words in normal form  $[1, 1 - i_1] \dots [r - 1, r - 1 - i_{r-1}]$  with  $-1 \leq i_1 < 1, \dots, -1 \leq i_{r-1} < r - 1$  for the symmetric group  $\mathfrak{S}_r$ , and by  $\mathfrak{S}_s^R$  the set of words in normal form  $[r + 1 + j_{s-1}, r + 1] \dots [r + s - 1 + j_1, r + s - 1]$  with  $-1 \leq j_1 < 1, \dots, -1 \leq j_{s-1} < s - 1$  for  $\mathfrak{S}_s$ .

We denote by  $\mathfrak{D}_{r,s}^{(f)}$  be the set of words

$$[r + i_1, r - j_1][r + i_2, r - j_2] \dots [r + i_f, r - j_f] \quad (2.23)$$

with  $0 \leq i_1 < i_2 < \dots < i_f < s$  and  $r > j_1 > j_2 > \dots > j_f \geq 0$ . We set  $\mathfrak{D}_{r,s}^{(0)} = \{1\}$ .

In this notation the set  $\mathfrak{B}_{r,s}$  decomposes as

$$\mathfrak{B}_{r,s} = \bigcup_{f=0}^{\min(r,s)} \mathfrak{B}_{r,s}^{(f)}, \text{ where } \mathfrak{B}_{r,s}^{(f)} = \mathfrak{S}_r^L \mathfrak{D}_{r,s}^{(f)} \mathfrak{S}_s^R. \quad (2.24)$$

Let  $\nu_\ell$  be the number of words of length  $\ell$  in  $\mathfrak{B}_{r,s}$  and  $F_{r,s}(q) = \sum_{\ell} \nu_\ell q^\ell$  the corresponding generating function.

**Lemma 1.2.5** *We have*

$$F_{r,s}(q) = (r+s)_q! , \quad (2.25)$$

where  $(m)_q := 1 + q + q^2 + \dots + q^{m-1}$  denotes the quantum number  $m$ .

**Proof.** The generating function for the numbers of words of given length  $F_{r,s}(q)$  for  $\mathfrak{B}_{r,s}$  has the factorized form

$$F_{r,s}(q) = F_r(q) \tilde{F}_{r,s}(q) F_s(q), \quad (2.26)$$

where  $F_r(q)$  (respectively,  $F_s(q)$ ) are generating functions for  $\mathfrak{S}_r^L$  (respectively,  $\mathfrak{S}_s^R$ ), while  $\tilde{F}_{r,s}(q)$  is a generating function for  $\bigcup_f \mathfrak{D}_{r,s}^{(f)}$ . The length of the word (2.23) is  $f + \sum_a i_a + \sum_b j_b$  so the generating function  $\tilde{F}_{r,s}(q)$  is easily found using, e.g., Theorem 6.1 in [KC],

$$\tilde{F}_{r,s}(q) = \sum_f q^{f^2} \binom{r}{f}_q \binom{s}{f}_q = \binom{r+s}{r}_q$$

by the  $q$ -Vandermonde identity. Here  $\binom{a+b}{b}_q := \frac{(a+b)_q!}{a_q! b_q!}$  is the  $q$ -binomial coefficient,  $a_q! := 1_q 2_q \dots a_q$ . The rest follows. ■

Abusing notation we will denote by the symbol  $\mathfrak{B}_{r,s}$  the image of the set  $\mathfrak{B}_{r,s}$  in the algebra  $\mathbb{B}_{r,s}(\delta)$ . As well, we will denote the word  $s_p s_{p-1} \dots s_q$  by the symbol  $[p, q]$ .

**Remark.** It appears that the normal form (2.24) is also appropriate for the  $q$ -deformed walled Brauer algebra  $q\mathbb{B}_{r,s}$ . In [KM] the basis of  $q\mathbb{B}_{r,s}$  analogous to (2.24) was introduced for a specific value of  $\delta$  and generalized to all values in [H].

## 1.3 Modules over $\mathbb{B}_{r,s}(\delta)$

### 1.3.1 Diagrammatical description of $\mathbb{B}_{r,s}(\delta)$

Aside from the definition of  $\mathbb{B}_{r,s}(\delta)$  as a factor-algebra of  $\widehat{\mathbb{B}}_{r,s}$ , there is also a convenient graphical presentation for a basis of  $\mathbb{B}_{r,s}(\delta)$  in terms of the so-called walled diagrams, which are defined as follows. Let  $p_{r,s}^u = p_r^u \cup p_s^u$  and  $p_{r,s}^d = p_r^d \cup p_s^d$  be two sets, each consisting of  $r+s$  nodes aligned horizontally on the plane. The nodes in the set  $p_{r,s}^d$  are placed under the nodes in the set  $p_{r,s}^u$  and a vertical wall separates the first  $r$  nodes  $p_r^u$  ( $p_r^d$ ) in the upper (lower) row from the last  $s$  nodes  $p_s^u$  ( $p_s^d$ ). A walled diagram  $\mathbf{d}$  is a bijection between the set  $p_{r,s}^u \cup p_{r,s}^d$  and visualised by placing the edges between the corresponding points in the following way:

1. edges connecting nodes between  $p_{r,s}^u$  and  $p_{r,s}^d$  do not cross the wall (we call them propagating lines),
2. edges connecting nodes between  $p_{r,s}^u$  and  $p_{r,s}^u$  and between  $p_{r,s}^d$  and  $p_{r,s}^d$  cross the wall (we call them arcs).

Let  $\delta$  be a complex parameter. As a vector space, the walled Brauer algebra  $\mathbf{B}_{r,s}(\delta)$  is identified with the  $\mathbb{C}$ -linear span of the walled diagrams. The product of two basis elements  $\mathbf{d}_2\mathbf{d}_1$  is obtained by placing  $\mathbf{d}_1$  above  $\mathbf{d}_2$  and identifying the nodes of the top row of  $\mathbf{d}_2$  with the corresponding nodes in the bottom row of  $\mathbf{d}_1$ . Let  $\ell$  be the number of closed loops so obtained. The product  $\mathbf{d}_1\mathbf{d}_2$  is given by  $\delta^\ell$  times the resulting diagram with loops omitted.

The following walled diagrams represent the generators  $s_i$  (the vertical dotted line represents the wall):

$$\begin{aligned}
s_i := & \begin{array}{ccccccc} \bullet & \cdots & \bullet & \bullet & \cdots & \bullet & \cdots & \bullet \\ | & & \diagdown & \diagup & & | & \cdots & | \\ \bullet & \cdots & \bullet & \bullet & \cdots & \bullet & \cdots & \bullet \\ 1 & & i & i+1 & & r & \cdots & r+s \end{array}, & \quad 1 \leq i < r+s, \\ & & & & & & & & i \neq r \\ & & & & & & & & \\ s_r := & \begin{array}{ccccccc} \bullet & \cdots & \bullet & \bullet & \cdots & \bullet & \cdots & \bullet \\ | & & | & \frown & & | & \cdots & | \\ \bullet & \cdots & \bullet & \bullet & \cdots & \bullet & \cdots & \bullet \\ 1 & & r & r+1 & & r+s & & \end{array}.
\end{aligned} \tag{3.27}$$

### 1.3.2 $\mathbf{B}_{r,s}(\delta)$ -modules

Modules over  $\mathbf{B}_{r,s}(\delta)$ , induced from simple modules over  $\mathbb{C}[\mathfrak{S}_r \times \mathfrak{S}_s] \subset \mathbf{B}_{r,s}(\delta)$ , are referred to as cell modules [CDDM]. In this section we describe the cell modules in terms of left ideals in  $\mathbf{B}_{r,s}(\delta)$ . Namely we calculate the annihilator ideal of a particular vector in a module.

Let  $\lambda = (\lambda_1, \lambda_2, \dots)$  be a partition;  $\lambda_1, \lambda_2, \dots$  are non-negative integers,  $\lambda_1 \geq \lambda_2 \geq \dots$ . Let  $|\lambda| = \sum_{i \geq 1} \lambda_i$ . To each partition  $\lambda$  we associate its Young diagram – a left-justified array of rows of boxes containing  $\lambda_1$  boxes in the top row,  $\lambda_2$  boxes in the second row, etc. A bipartition is a pair of partitions  $\boldsymbol{\lambda} = (\lambda^L, \lambda^R)$ . We denote by  $\Lambda$  the set of all bipartitions. For each integer  $0 \leq f \leq \min(r, s)$ , we set

$$\Lambda_{r,s}(f) = \{\boldsymbol{\lambda}_f = (\lambda_f^L, \lambda_f^R) \in \Lambda \mid r - |\lambda_f^L| = s - |\lambda_f^R| = f\}, \quad \text{and} \quad \Lambda_{r,s} = \bigcup_{f=0}^{\min(r,s)} \Lambda_{r,s}(f). \tag{3.28}$$

Simple  $\mathbf{B}_{r,s}(\delta)$ -modules are indexed by elements of the set  $\Lambda_{r,s}$  (see [CDDM]). The module indexed by  $\boldsymbol{\lambda}_f$  is denoted by  $C_{r,s}(\boldsymbol{\lambda}_f)$ .

Standard tableaux  $t_f^L$  (respectively,  $t_f^R$ ) of the shape  $\lambda_f^L$  (respectively,  $\lambda_f^R$ ) parameterize basis vectors  $|t_f^L\rangle$  (respectively,  $|t_f^R\rangle$ ) of the Specht module  $S(\lambda_f^L)$  (respectively,  $S(\lambda_f^R)$ )

over  $\mathfrak{S}_{r-f}$  (respectively,  $\mathfrak{S}_{s-f}$ ). Choose subsets  $l' = \{a'_1, \dots, a'_f\} \subset \{1, \dots, r\}$  and  $l = \{a_1, \dots, a_f\} \subset \{r+1, \dots, r+s\}$  and an isomorphism  $l' \rightarrow l$  between them. There is a basis of the module  $C_{r,s}(\lambda_f)$  with the basis vectors

$$|l' \rightarrow l, t_f^L, t_f^R\rangle. \quad (3.29)$$

Vectors (3.29) admit a graphical presentation in terms of the so-called ‘partial one-row’ diagrams [CDDM], see Fig. 1.1.

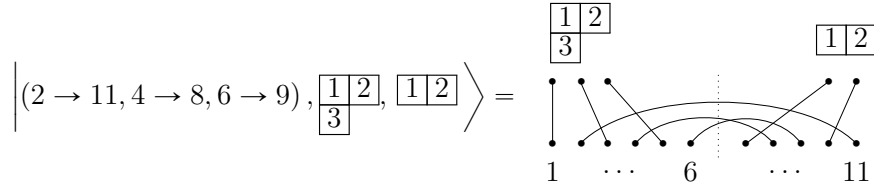

Figure 1.1: an example of a vector for  $\mathbb{B}_{6,5}(\delta)$ .

Extending the terminology for the walled diagrams, we call lines, starting at tableaux, ‘propagating lines’ of the partial one-row diagram; other lines will of course be called ‘arcs’.

We shall define the action of the algebra  $\mathbb{B}_{r,s}(\delta)$  on the vector space  $C_{r,s}(\lambda_f)$ . To this end, it is sufficient to define the action of a walled diagram  $\mathbf{d}$  from  $\mathbb{B}_{r,s}(\delta)$  on a partial one-row diagram  $\mathbf{v}_f$  with  $f$  arcs. Place  $\mathbf{d}$  under  $\mathbf{v}_f$  and identify the nodes of  $\mathbf{v}_f$  with the corresponding nodes in the top row of  $\mathbf{d}$ . This is not necessarily a partial one-row diagram: two propagating lines might start to form an arc. In this case the result of action is zero. Otherwise, let  $\ell$  be the number of closed loops obtained after the above identification. Omitting the loops we obtain some one-row diagram  $\bar{\mathbf{v}}_f$ . The diagram  $\bar{\mathbf{v}}_f$  may also contain intersections of propagating lines. We numerate the propagating lines of  $\mathbf{v}_f$  by  $1, \dots, r-f$  on the left of the wall and by  $1, \dots, s-f$  on the right. Let  $\pi_L$  and  $\pi_R$  be permutations of  $1, \dots, r-f$  and  $1, \dots, s-f$  respectively such that the application of  $\pi_L \pi_R$  to the propagating lines’ ends of  $\mathbf{v}_f$  gives  $\bar{\mathbf{v}}_f$ . The result of the action of  $\mathbf{d}$  on  $\mathbf{v}_f$  is the combination of the partial one-row diagrams obtained from  $\bar{\mathbf{v}}_f$  by forgetting the intersections of propagating lines and writing out the result of the action  $\pi_L |t_f^L\rangle$  and  $\pi_R |t_f^R\rangle$  on the vectors of the modules  $S(\lambda_f^L)$  and  $S(\lambda_f^R)$ .

Consider the following vector in the module  $C_{r,s}(\lambda_f)$

$$v_f = |(r \rightarrow r+1, r-1 \rightarrow r+2, \dots, r-f+1 \rightarrow r+f), \check{t}_f^L, \check{t}_f^R\rangle, \quad (3.30)$$

where  $\check{t}_f^L$  and  $\check{t}_f^R$  are filled with numbers  $1 \dots r-f$  and  $1 \dots s-f$ , respectively, in natural order reading down the column from left to right (for an example, see Fig. 1.2).

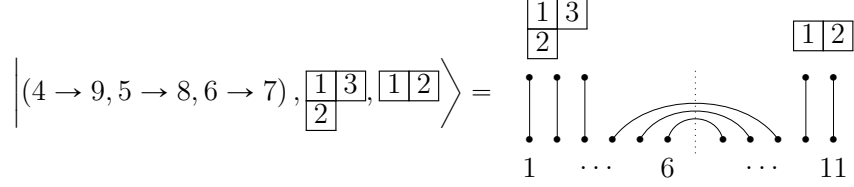

Figure 1.2: the vector  $v_3$  for  $B_{6,5}(\delta)$

Consider the set  $\text{Sh}_{r-f,f}^L \subset \mathfrak{S}_r^L$  (respectively,  $\text{Sh}_{f,s-f}^R \subset \mathfrak{S}_s^R$ ) of words  $[1 + i_1, 1][2 + i_2, 2] \dots [r - f + i_{r-f}, r - f]$  with  $-1 \leq i_1 \leq i_2 \leq \dots \leq i_{r-f} < f$  (respectively,  $[r + 1 + j_f, r + 1] \dots [r + f + j_1, r + f]$  with  $-1 \leq j_f \leq \dots \leq j_1 \leq s - f$ ). The elements of the set  $\text{Sh}_{r-f,f}^L$  (respectively,  $\text{Sh}_{f,s-f}^R$ ) represent  $(r - f, f)$ -shuffles (respectively,  $(f, s - f)$ -shuffles).

Let  $\mathfrak{S}_f^L \subset \mathfrak{S}_r^L$  (respectively,  $\mathfrak{S}_f^R \subset \mathfrak{S}_s^R$ ) be a subset of all monomials in  $\mathfrak{S}_r^L$  which include only generators  $s_{r-f+1}, \dots, s_{r-1}$  (respectively,  $s_{r+1}, \dots, s_{r+f-1}$ ) for  $f > 0$ . We suppose  $\mathfrak{S}_0^L = \{1\}$  and  $\mathfrak{S}_0^R = \{1\}$ . In other words, the elements of  $\mathfrak{S}_f^L$  (respectively,  $\mathfrak{S}_f^R$ ) are permutations of the nodes  $\{r - f + 1, \dots, r\}$  (respectively,  $\{r + 1, \dots, r + f\}$ ).

Let  $\Theta_f$  with  $f \geq 0$  denote the following set of permutations from  $\mathfrak{S}_r \times \mathfrak{S}_s$ :

$$\Theta_f = \text{Sh}_{r-f,f}^L \mathfrak{S}_f^L \text{Sh}_{f,s-f}^R. \quad (3.31)$$

It is straightforward to see that the cardinality of  $\Theta_f$  is  $\binom{r}{f} \binom{s}{f} f!$ .

The set  $\Theta_f$  contains those and only those permutations, from  $\mathfrak{S}_r \times \mathfrak{S}_s$ , of the nodes of the partial one-row diagram corresponding to the vector  $v_f$  which do not permute the propagating lines of the diagram. Thus  $\Theta_f$  produces all possible subsets  $l'$  and  $l$  of cardinality  $f$  and isomorphisms  $l' \rightarrow l$  as in (3.29), *i.e.*

$$\Theta_f v_f = \{|l' \rightarrow l, \tilde{t}_f^L, \tilde{t}_f^R\}. \quad (3.32)$$

Let  $\Sigma_f^L$  (respectively,  $\Sigma_f^R$ ) be the set of all permutations of  $\{1, \dots, r - f\}$  (respectively,  $\{r + f + 1, \dots, r + s\}$ ) such that  $\sigma_L \tilde{t}_f^L$  and  $\sigma_R \tilde{t}_f^R$  reproduce all possible standard tableaux. Let  $\Sigma_f$  be the set constituted by permutations  $\sigma = \sigma_L \sigma_R$  with  $\sigma_L \in \Sigma_f^L$  and  $\sigma_R \in \Sigma_f^R$ . In particular,  $\#\Sigma_f = \dim S(\lambda_f^L) \dim S(\lambda_f^R)$ .

We introduced the sets  $\Sigma_f^L$  and  $\Sigma_f^R$  in order to generate vectors (3.29) with all possible standard tableaux. Namely, define the set  $X_f$  of permutations from  $\mathfrak{S}_r \times \mathfrak{S}_s$

$$X_f = \Theta_f \Sigma_f. \quad (3.33)$$

**Lemma 1.3.3** *The set of vectors  $X_f v_f$  forms a basis of  $C_{r,s}(\lambda_f)$ . We have*

$$\dim C_{r,s}(\lambda_f) = \#X_f = \binom{r}{f} \binom{s}{f} f! \dim S(\lambda_f^L) \dim S(\lambda_f^R). \quad (3.34)$$

### 1.3.4 Annihilator ideal

We proceed by describing the ideal annihilating the vector  $v_f \in C_{r,s}(\lambda_f)$ . The basis  $\mathfrak{B}_{r,s}$  will be convenient for that purpose. We associate to any monomial

$$\mathfrak{x} = [r + i_1, r - j_1] [r + i_2, r - j_2] \dots [r + i_f, r - j_f] \in \mathfrak{D}_{r,s}^{(f)} \quad (3.35)$$

the element

$$\varpi(\mathfrak{x}) := [r + i_1, r - j_1] [r + i_2, r - j_2] \dots [r + i_f, r + 1]. \quad (3.36)$$

We denote by  $\bar{\mathfrak{D}}_{r,s}^{(f)}$  the image of the set  $\mathfrak{D}_{r,s}^{(f)}$ ,

$$\bar{\mathfrak{D}}_{r,s}^{(f)} := \{\varpi(\mathfrak{x}) \mid \mathfrak{x} \in \mathfrak{D}_{r,s}^{(f)}\}.$$

In words, to construct elements in  $\bar{\mathfrak{D}}_{r,s}^{(f)}$  we delete the ends  $[r, r - j_f]$  of the monomials in  $\mathfrak{D}_{r,s}^{(f)}$ .

Note that  $0 \leq i_1 < i_2 < \dots < i_f < r$  and  $s > j_1 > j_2 > \dots > j_f \geq 0$  for an element  $\mathfrak{x} \in \mathfrak{D}_{r,s}^{(f)}$  so  $0 \leq i_1 < i_2 < \dots < i_f < r$  and  $s > j_1 > j_2 > \dots > j_{f-1} > 0$  for the element (3.36).

We define the product of an element

$$\mathfrak{y} = [r + i_1, r - j_1] \dots [r + i_f, r + 1] \in \bar{\mathfrak{D}}_{r,s}^{(f)}$$

and the monomial  $[r, r - k]$ ,  $k \geq 0$ , to be

$$\mathfrak{y} * [r, r - k] := \begin{cases} [r + i_1, r - j_1] \dots [r + i_f, r - k] & \text{if } j_{f-1} > k, \\ \emptyset & \text{otherwise.} \end{cases}$$

We introduce the sets

$$\bar{\mathfrak{B}}_{r,s}^{(t)} = \mathfrak{S}_r^L \bar{\mathfrak{D}}_{r,s}^{(t)}, \quad t = 1 \dots \min(r, s). \quad (3.37)$$

We describe the basis of the annihilator ideal of the vector  $v_f$  in three steps.

**Part 1.** Let us introduce the following sets of elements of the algebra  $\mathbf{B}_{r,s}(\delta)$ :

$$\bigcup_{i=0}^{f-1} ([r, r - i] [r + i, r + 1]^{-1} - \delta), \quad (3.38)$$

$$\bigcup_{i=0}^{\min(f, s-1)-1} ([r, r - i] [r + i + 1, r + 1]^{-1} - 1), \quad (3.39)$$

$$\bigcup_{i=1}^{\min(f, r-1)} ([r, r - i] [r + i - 1, r + 1]^{-1} - 1), \quad (3.40)$$

$$[r, r - f] [r + f, r + 1]^{-1}. \quad (3.41)$$

The elements (3.38)-(3.41) annihilate the vector  $v_f$  which is clear from the following schematic representation in terms of partial one-row diagrams:

$\dots$   $\dots$   $- \delta \cdot \dots$   $\dots = 0$  ,

$\dots$   $\dots$   $- \dots$   $\dots = 0$  ,

$\dots$   $\dots = 0$  .

Let  $\Upsilon_f^k \subset \text{Sh}_{f,s-f}^R \mathfrak{S}_f^R \Sigma_f^R$  be a subset of all monomials in  $\mathfrak{S}_s^R$  which include only generators  $s_{r+k}, \dots, s_{r+s-1}$ . For brevity denote by  $\llbracket r+1 \rrbracket^{(i)}$  for  $i = 1 \dots f$  the set of words

$$[r+1+k_1, r+1] \dots [r+i+k_i, r+i], \quad 0 \leq k_1 < s-1, \dots, 0 \leq k_i < s-i. \quad (3.42)$$

We set  $\llbracket r+1 \rrbracket^{(0)} = \{1\}$ .



We construct the following sets ( $t = 1 \dots \min(r, s)$ ) of elements of the algebra  $\mathbb{B}_{r,s}(\delta)$ :

$$\bar{\mathfrak{B}}_{r,s}^{(t)} * \bigcup_{i=0}^{f-1} ([r, r-i][[r+1]]^{(i)} - \delta) \Upsilon_f^{i+2}, \quad (3.43)$$

$$\bar{\mathfrak{B}}_{r,s}^{(t)} * \bigcup_{i=0}^{\min(f,s-1)-1} ([r, r-i][[r+1]]^{(i+1)} - 1) \Upsilon_f^{i+2}, \quad (3.44)$$

$$\bar{\mathfrak{B}}_{r,s}^{(t)} * \bigcup_{i=1}^{\min(f,r-1)} \bigcup_{j=i+1}^r ([r, j-i][[r+1]]^{(i-1)} - 1) \Upsilon_f^{i+1}, \quad (3.45)$$

$$\bar{\mathfrak{B}}_{r,s}^{(t)} * [r, r-f][[r+1]]^{(f)} \Upsilon_f^{f+1}. \quad (3.46)$$

A direct inspection shows that the elements (3.43)-(3.46) annihilate the vector  $v_f$  since the elements (3.38)-(3.41) do.

**Part 2** Consider the set  $\{s_{r+i} - s_{r-i}, i = 1, \dots, f-1\}$ . The elements of this set annihilate the vector  $v_f$ , see figure below

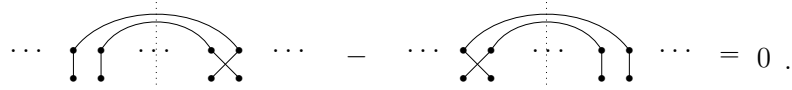

Given a word  $\mathbf{x}$  in  $\mathfrak{S}_f^R \setminus \{1\}$  let  $s_{r+i}$  be its leftmost generator ( $i = 1 \dots f-1$ ). Denote by  $\mathbf{x}_c$  the element of the algebra  $\mathbb{B}_{r,s}(\delta)$  obtained by replacing the letter  $s_{r+i}$  in the word  $\mathbf{x}$  by the combination  $(s_{r+i} - s_{r-i})$ . Define the set  $\bar{\mathfrak{S}}_f^R$  constituted by elements  $\mathbf{x}_c$ ,  $\mathbf{x} \in \mathfrak{S}_f^R \setminus \{1\}$ . The elements of the set

$$\Theta_f \bar{\mathfrak{S}}_f^R \Sigma_f \quad (3.47)$$

annihilate the vector  $v_f$  as well.

**Part 3** We recall some results from [P]. Let  $S(\lambda)$  be the Specht module for the symmetric group  $\mathfrak{S}_n$  for some  $n$ . Consider the vector in  $S(\lambda)$  corresponding to the tableau  $\check{t}$  filled with numbers  $1 \dots n$  in natural order reading down the column from left to right. The annihilator ideal of  $\check{t}$  is the left ideal generated by the Garnir elements and  $1 + \tau$  where  $\tau$  are transpositions in the column stabiliser of the tableau.

Denote  $\mathfrak{g}_f^L$  (respectively,  $\mathfrak{g}_f^R$ ) a basis of the annihilator ideal of the vector  $\check{t}_f^L$  in  $S(\lambda_f^L)$  (respectively,  $\check{t}_f^R$  in  $S(\lambda_f^R)$ ). The following elements of the algebra  $\mathbb{B}_{r,s}(\delta)$

$$\mathfrak{S}_r^L \mathfrak{D}_{r,s}^{(f)} \text{Sh}_{f,s-f}^R \mathfrak{S}_f^R \mathfrak{g}_f^R, \quad (3.48)$$

$$\Theta_f \mathfrak{S}_f^R (\mathfrak{g}_f^L \Sigma_f^R \cup \Sigma_f^L \mathfrak{g}_f^R \cup \mathfrak{g}_f^L \mathfrak{g}_f^R). \quad (3.49)$$

annihilate the vector  $v_f$  because they annihilate  $\check{t}_f^L$  and  $\check{t}_f^R$ .

Let  $A_f$  be the union of all sets (3.43)-(3.46), (3.47), (3.48), (3.49). The following Lemma holds.

**Lemma 1.3.5** *The set  $A_f$  is a basis of annihilator ideal of the vector  $v_f$ ,*

$$\#A_f = \dim \mathbf{B}_{r,s}(\delta) - \dim C_{r,s}(\boldsymbol{\lambda}_f). \quad (3.50)$$

**Proof.** First let us show that the sets (3.43)-(3.46) and (3.48) are linearly independent. For that purpose consider the ‘higher’ terms in (3.43)-(3.45):

$$\bar{\mathfrak{B}}_{r,s}^{(t)} * \bigcup_{i=0}^{f-1} ([r, r-i][r+1]^{(i)}) \Upsilon_f^{i+2}, \quad (3.51)$$

$$\bar{\mathfrak{B}}_{r,s}^{(t)} * \bigcup_{i=0}^{\min(f,s-1)-1} ([r, r-i][r+1]^{(i+1)}) \Upsilon_f^{i+2}, \quad (3.52)$$

$$\bar{\mathfrak{B}}_{r,s}^{(t)} * \bigcup_{i=1}^{\min(f,r-1)} \bigcup_{j=i+1}^r ([r, j-i][r+1]^{(i-1)}) \Upsilon_f^{i+1}. \quad (3.53)$$

Let

$$M_i^{(1)} := \bar{\mathfrak{B}}_{r,s}^{(t)} * ([r, r-i][r+1]^{(i)}) \Upsilon_f^{i+2},$$

so that the set in (3.51) is the union of sets  $M_i$ ,  $i = 0, 1, \dots, f-1$ . Similarly, let

$$M_i^{(2)} := \bar{\mathfrak{B}}_{r,s}^{(t)} * ([r, r-i][r+1]^{(i+1)}) \Upsilon_f^{i+2},$$

and

$$M_i^{(3)} := \bar{\mathfrak{B}}_{r,s}^{(t)} * \bigcup_{j=i+1}^r ([r, j-i][r+1]^{(i-1)}) \Upsilon_f^{i+1}.$$

The union of sets  $M_i^{(1)}$ ,  $M_i^{(2)}$  and  $M_i^{(3)}$  for fixed  $i$  ( $0 \leq i < f$ ) is

$$\begin{aligned} \bar{\mathfrak{B}}_{r,s}^{(t)} * [r, r-i] & \left( [r+1]^{(i)} \Upsilon_f^{i+2} \cup [r+1]^{(i+1)} \Upsilon_f^{i+2} \cup \left( \bigcup_{k=1}^i [r+1]^{(k-1)} \Upsilon_f^{k+1} \right) \right) \\ & = \bar{\mathfrak{B}}_{r,s}^{(t)} * [r, r-i] \Upsilon_f^1, \quad t = 1 \dots \min(r, s). \end{aligned} \quad (3.54)$$

For  $i = f$  there are no sets (3.51) and (3.52); the union of  $M_f^{(1)}$  and the set (3.46) is, similarly to (3.54):

$$\bar{\mathfrak{B}}_{r,s}^{(t)} * [r, r-f] \Upsilon_f^1, \quad t = 1 \dots \min(r, s). \quad (3.55)$$

It follows from the definition of  $\bar{\mathfrak{B}}_{r,s}^{(t)}$  that the union of the expressions (3.54) for  $i = 0 \dots f-1$  and (3.55) forms a subset  $\mathfrak{S}_r^L \mathfrak{D}_{r,s}^{(t)} \Upsilon_f^1 \subset \mathfrak{B}_{r,s}^{(t)}$ , thus the expressions (3.54) for  $i = 0 \dots f-1$  and (3.55) are linearly independent. Moreover, we have, by construction,  $\Upsilon_f^1 = \text{Sh}_{f,s-f}^R \mathfrak{S}_f^R \Sigma_f^R$ .

The union of the expressions (3.48), (3.54) and (3.55) over  $t = 1 \dots \min(r, s)$  and  $i = 0 \dots f$  will be denoted by  $\mathcal{B}$ . Since, by [P], the elements of  $\mathfrak{g}_f^L$  (respectively,  $\mathfrak{g}_f^R$ ) and  $\Sigma_f^L$  (respectively,  $\Sigma_f^R$ ) together form a basis in  $\mathfrak{S}_r$  (respectively,  $\mathfrak{S}_s$ ), we conclude that  $\mathcal{B}$  is a linearly independent set. The same is true for the expressions (3.43)-(3.46) and (3.48). Indeed, each element in (3.43)-(3.45) is a combination of two monomials: the first one is a minimal word and contains more letters  $s_r$  than the second. The number of occurrences of the letter  $s_r$  in a word defines a filtration on the algebra  $\mathbb{B}_{r,s}(\delta)$ . Assume that the expressions (3.43)-(3.46) and (3.48) are not linearly independent. Choose then a shortest non-trivial linear dependency. The coefficients of the words containing the maximal number of letters  $s_r$  are zero (because these are the ones from  $\mathcal{B}$ ) contradicting to the minimality of length of dependency.

Each expression (3.47) is a sum of two words from the set  $\Theta_f \mathfrak{S}_f^R \Sigma_f$ , one containing more generators from  $\mathfrak{S}_r^R$  than the other. This implies the linear independence of the set (3.47).

Next, we move to showing that the union of the sets (3.47) and (3.49) is linearly independent. First, note that replacing in the expressions (3.47) the elements from  $\overline{\mathfrak{S}}_f^R$  by their pullbacks from  $\mathfrak{S}_f^R \setminus \{1\}$  we obtain a set  $\mathcal{N}$  whose union with the expressions (3.49) is disjoint and equals  $(\Theta_f \mathfrak{S}_f^R \Sigma_f) \setminus X_f$ . The set  $\Theta_f \mathfrak{S}_f^R \Sigma_f$  is a basis in  $\mathbb{C}[\mathfrak{S}_r \times \mathfrak{S}_s]$ . Therefore the union of the sets  $\mathcal{N}$  and (3.49) is linearly independent. The argument appealing to the length, defined by the number of generators from  $\mathfrak{S}_r^R$ , completes the proof of the linear independence of union of the sets (3.47) and (3.49).

The expressions from the sets (3.47) and (3.49) do not contain generators  $s_r$  and therefore the whole set  $A_f$  is linearly independent.

To calculate  $\#A_f$ , note that:

- a)  $\#\mathcal{B} = (r + s)! - r!s!$  because  $\mathcal{B} = \mathfrak{B}_{r,s} \setminus \mathfrak{B}_{r,s}^{(0)}$ ,
- b) the cardinality of the union of the sets (3.47) and (3.49) is  $r!s! - \dim C_{r,s}(\boldsymbol{\lambda}_f)$  (see Lemma 1.3.3).

As a result, we arrive at the correct cardinality for the annihilator ideal  $\#A = \dim \mathbb{B}_{r,s}(\delta) - \dim C_{r,s}(\boldsymbol{\lambda}_f)$ . ■

Lemmas 1.3.3 and 1.3.5 together provide a constructive proof of the following Theorem.

**Theorem 1.3.6** *Fix a  $\mathbb{B}_{r,s}(\delta)$ -module  $C_{r,s}(\boldsymbol{\lambda}_f)$ . Let  $A_f$  and  $X_f$  be the sets given in lemmas 1.3.3 and 1.3.5. Then the union  $A_f \cup X_f$  is a basis of the algebra  $\mathbb{B}_{r,s}(\delta)$ .*

### 1.3.7 Gelfand-Zetlin basis

The walled Brauer algebra  $\mathbb{B}_{r,s}(\delta)$  is semisimple if and only if one of the following conditions holds ([CDDM], Theorem 6.3):

$$\begin{aligned}
& r = 0 \text{ or } s = 0, \\
& \delta \notin \mathbb{Z}, \\
& |\delta| > r + s - 2, \\
& \delta = 0 \text{ and } (r, s) \in \{(1, 2), (1, 3), (2, 1), (3, 1)\}.
\end{aligned}$$

In this section we assume that  $\delta$  is generic, that is, the walled Brauer algebra is semisimple.

Let  $\mathbf{A}_u$  be the subalgebra in the algebra  $\mathbf{B}_{r,s}(\delta)$  generated by the walled diagrams non-trivial only at the first  $u$  sites of the sets  $p_{r,s}^u$  and  $p_{r,s}^d$  (that is, to the right of the  $u$ -th site the diagram has only vertical segments). For  $u \leq r$ , the algebra  $\mathbf{A}_u$  is isomorphic to  $\mathbf{B}_{u,0}(\delta) \equiv \mathbb{C}[\mathbb{S}_u]$  while for  $r < u \leq r + s$  the algebra  $\mathbf{A}_u$  is isomorphic to  $\mathbf{B}_{r,u-r}(\delta)$ . The algebras  $\mathbf{A}_u$ ,  $0 \leq u \leq r + s$ , form an ascending chain of algebras

$$\mathbb{C} \equiv \mathbf{A}_0 \subset \mathbf{A}_1 \subset \dots \subset \mathbf{A}_{r+s} \equiv \mathbf{B}_{r,s}(\delta). \quad (3.56)$$

Let  $C_u(\boldsymbol{\lambda})$  be a  $\mathbf{A}_u$ -module. We have (see [CDDM])

$$\text{Res}_{\mathbf{A}_{u-1}}^{\mathbf{A}_u} C_u(\boldsymbol{\lambda}) \simeq \bigoplus_{\boldsymbol{\mu}} C_{u-1}(\boldsymbol{\mu}) \quad (3.57)$$

where the sum runs over all bipartitions  $\boldsymbol{\mu}$  such that  $\boldsymbol{\lambda}$  is obtained from  $\boldsymbol{\mu}$  by

- adding a box to the first diagram in the bipartition  $\boldsymbol{\mu}$  when  $1 \leq u \leq r$ ;
- adding a box to the second diagram or by removing a box from the first diagram when  $r + 1 \leq u \leq r + s$ .

The formula (3.57) represents the branching rules for  $\mathbf{B}_{r,s}(\delta)$  and defines the corresponding Bratteli diagram. Here is the figure showing the Bratteli diagram for the chain on the example of the walled Brauer algebra  $\mathbf{B}_{2,2}(\delta)$ .

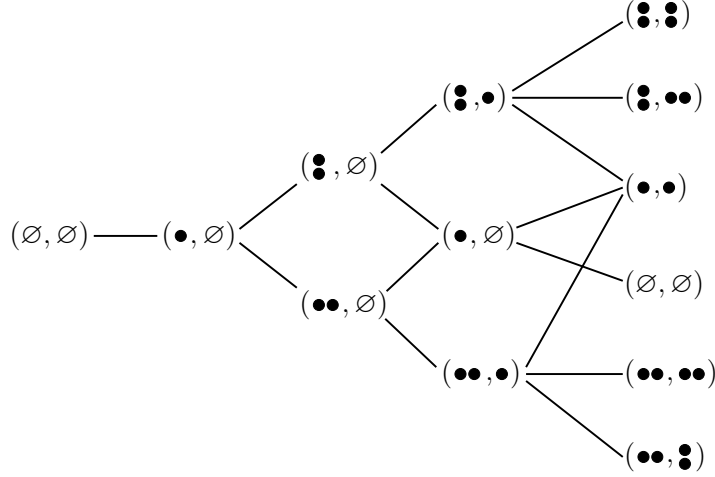

Figure 1.3: Bratteli diagram

Define a *standard walled  $\lambda$ -tableau* as a sequence  $T = (\lambda^{(0)}, \dots, \lambda^{(r+s)})$  of bipartitions such that  $\lambda^{(0)} = (\emptyset, \emptyset)$ ,  $\lambda^{(r+s)} = \lambda$  and for each  $k = 1, \dots, r + s$  the bipartition  $\lambda^{(k)}$  is obtained from  $\lambda^{(k-1)}$  by the rules described above. Thus,  $T$  represents a path in the Bratteli diagram of the algebra  $\mathbb{B}_{r,s}(\delta)$ .

We say that  $r + s$  is the length of  $T$ . We write  $U \nearrow T$  if the standard walled tableau  $U$  of length  $r + s - 1$  is obtained by removing the last entry  $\lambda^{(r+s)}$  from the sequence  $T$ . We shall denote by  $\mathcal{T}_\lambda$  the set of all standard walled  $\lambda$ -tableaux.

Since the branching rules for the Bratteli diagram are simple, we obtain a canonical decomposition of a simple  $\mathbb{B}_{r,s}(\delta)$ -module  $C_{r,s}(\lambda)$  into a direct sum of simple  $A_0$ -module, i.e. 1-dimensional subspaces

$$C_{r,s}(\lambda) = \bigoplus_T V_T,$$

where the sum runs over all standard walled  $\lambda$ -tableaux. Choose an arbitrary non-zero vector  $v_T \in V_T$ . The vectors  $\{v_T\}$ ,  $T \in \mathcal{T}_\lambda$ , form a basis of  $C_{r,s}(\lambda)$ , called the *Gelfand-Zetlin basis* of  $C_{r,s}(\lambda)$ .

To each standard walled tableau  $T$  we attach its sequence of *contents*  $(c_1(T), \dots, c_{r+s}(T))$ , where

$$c_k(T) = j - i \tag{3.58}$$

if  $1 \leq k \leq r$  and  $\lambda^{(k)}$  is obtained from  $\lambda^{(k-1)}$  by adding a box  $(i, j)$  to the first diagram in the bipartition,

$$c_k(T) = -(j - i) \tag{3.59}$$

if  $k \geq r + 1$  and  $\lambda^{(k)}$  is obtained from  $\lambda^{(k-1)}$  by removing a box  $(i, j)$  from the first diagram,

$$c_k(T) = (j - i) + \delta \quad (3.60)$$

if  $k \geq r + 1$  and  $\lambda^{(k)}$  is obtained from  $\lambda^{(k-1)}$  by adding a box  $(i, j)$  to the second diagram.

It is convenient to decorate the Bratteli diagram, writing at each edge of the path  $T$  the corresponding content, as shown below on our example of the algebra  $B_{2,2}(\delta)$ .

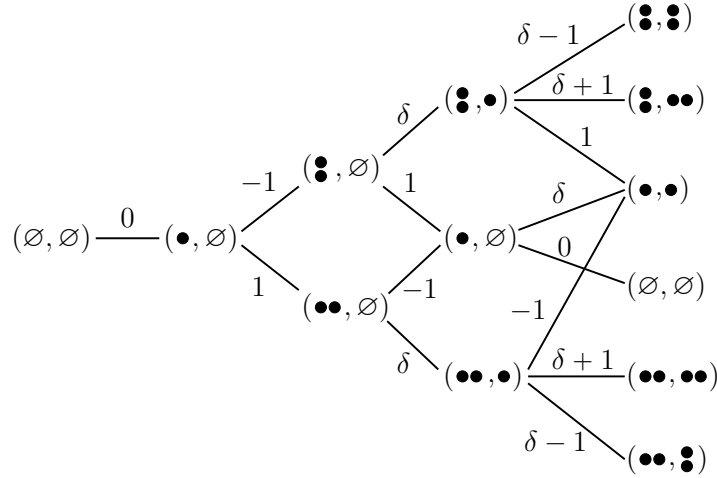

Figure 1.4: Paths and contents

Clearly, a path  $T$  can be reconstructed from its sequence of contents.

We encode the sequence  $T$  of bipartitions in the following way. We first associate to the sequence  $T$  three Young diagrams  $\lambda'(T)$ ,  $\nu(T)$  and  $\lambda''(T)$  such that  $\nu(T) \subseteq \lambda'(T)$ . The diagram  $\lambda'(T) := \lambda_L^{(r)}$  is the left diagram in the bipartition  $\lambda^{(r)}$ . The diagram  $\nu(T) := \lambda_L^{(r+s)}$  is the left final diagram and the diagram  $\lambda''(T) := \lambda_R^{(r+s)}$  is the right final diagram in the bipartition  $\lambda^{(r+s)}$ . We call

$$D_T := [\lambda'(T), \nu(T), \lambda''(T)]$$

the *triple diagram* corresponding to the path  $T$ .

Next, we fill the boxes of the diagrams  $\lambda'(T)$ ,  $\lambda''(T)$  and the set-theoretical difference  $\lambda'(T) \setminus \nu(T)$ . Exactly as for the symmetric group, the boxes of the diagram  $\lambda'(T)$  are filled with numbers  $1, \dots, r$ , representing the order in which the boxes were added in the sequence  $(\lambda_L^{(0)}, \dots, \lambda_L^{(r)})$ . The boxes of the union  $(\lambda'(T) \setminus \nu(T)) \sqcup \lambda''(T)$  are filled with numbers

$r + 1, \dots, r + s$  in the order in which the boxes were removed or added in the sequence  $(\lambda^{(r+1)}, \dots, \lambda^{(r+s)})$ . The resulting filling we call the *standard triple tableau*  $W_T$  corresponding to the path  $T$ .

It is straightforward to see that the correspondence between the set of all paths and the set of all standard triple tableaux is one to one.

We visualize the standard triple tableau by putting the numbers corresponding to the filling of  $\lambda'(T)$  in the upper left corner of boxes and the numbers corresponding to the filling of  $\lambda'(T) \setminus \nu(T)$  in the lower right corners. This should be clear on the following example of a path for the algebra  $\mathbb{B}_{3,5}(\delta)$ .

**Example 1.3.7.1** *For the sequence  $T$*

$$\left[ (\emptyset, \emptyset), (\square, \emptyset), (\square\square, \emptyset), (\square\square, \square), (\square\square, \square), (\square\square, \square\square), (\square, \square\square), (\square, \square\square), (\square, \square\square) \right]$$

the corresponding triple diagram is  $[(2, 1), (1), (2, 1)]$  and the standard triple tableau  $W_T$  is

$$\left[ \begin{array}{|c|c|} \hline 1 & 2 \\ \hline 3 & 6 \\ \hline \end{array}, \begin{array}{|c|c|} \hline 4 & 5 \\ \hline 8 & \\ \hline \end{array} \right].$$

The contents of boxes in the sets  $\lambda'(T)$ ,  $\lambda'(T) \setminus \nu(T)$  and  $\lambda''(T)$  are calculated according to the formulas (3.58), (3.59) and (3.60) respectively. The content of the box occupied by the number  $j$  in the standard triple diagram corresponding to a path  $T$  will be denoted by  $c_j(T)$ .

## 1.4 Jucys–Murphy elements

For convenience in the following two sections we denote the generator  $s_r$  by  $d$ .

The Jucys–Murphy elements for the walled Brauer algebras are adapted to the chain (3.56).

Let  $s_{i,k}$ , where  $1 \leq i < k \leq r$  or  $r+1 \leq i < k \leq r+s$ , and  $d_{i,k}$ , where  $1 \leq i \leq r < k \leq r+s$ , denote the following walled diagrams:

$$s_{i,k} = \begin{array}{c} \dots & \dots & \dots & \dots & \dots & \dots \\ | & \diagdown & \diagup & | & | & | \\ \dots & & & \dots & \dots & \dots \\ | & \diagup & \diagdown & | & | & | \\ 1 & i & k & r & r+1 & r+s \end{array},$$

$$\begin{aligned}
s_{i,k} &= \left| \begin{array}{cccccc} \dots & & \dots & & \dots & \\ \dots & & \dots & & \dots & \\ 1 & & r & r+1 & i & k & r+s \end{array} \right| , \\
d_{i,k} &= \left| \begin{array}{cccccc} \dots & & \dots & & \dots & \\ \dots & & \dots & & \dots & \\ 1 & & i & r & r+1 & k & r+s \end{array} \right| .
\end{aligned}$$

In particular,  $s_i = s_{i,i+1}$ ,  $1 \leq i < r$  or  $r < i < r+s$ ,  $d = d_{r,r+1}$ .

In terms of generators, the elements  $s_{i,k}$  and  $d_{i,k}$  can be written as

$$\begin{aligned}
s_{i,k} &= s_i s_{i+1} \dots s_{k-2} s_{k-1} s_{k-2} \dots s_{i+1} s_i , \\
d_{i,k} &= s_i s_{i+1} \dots s_{r-1} s_{k-1} s_{k-2} \dots s_{r+1} d s_{r+1} \dots s_{k-2} s_{k-1} s_{r-1} \dots s_{i+1} s_i .
\end{aligned}$$

The Jucys-Murphy elements for the walled Brauer algebra are (see [BS, SS, JK]):

$$x_k = \begin{cases} \sum_{i=1}^{k-1} s_{i,k} & \text{if } 1 \leq k \leq r , \\ -\sum_{i=1}^r d_{i,k} + \sum_{i=r+1}^{k-1} s_{i,k} + \delta & \text{if } k \geq r+1 . \end{cases} \quad (4.61)$$

In [JK] it was proved that for each  $k \in \mathbb{Z}_{\geq 0}$  the element

$$x_1^k + \dots + x_r^k + (-1)^{k+1} (x_{r+1}^k + \dots + x_{r+s}^k)$$

belongs to the center of  $\mathbb{B}_{r,s}(\delta)$ .

One checks that the element  $x_k$  commutes with any element of the subalgebra  $\mathbb{A}_{k-1}$ , see (3.56). This implies that the elements  $x_1, \dots, x_{r+s}$  of  $\mathbb{B}_{r,s}(\delta)$  pairwise commute. Moreover, it follows from the representation theory of the walled Brauer algebras that the subalgebra generated by the elements  $x_1, \dots, x_{r+s}$  is a maximal commutative subalgebra of the algebra  $\mathbb{B}_{r,s}(\delta)$ . It is called the Gelfand-Zetlin subalgebra of  $\mathbb{B}_{r,s}(\delta)$ .

It turns out that the vectors  $\mathbf{v}_T$  introduced in (1.3.7) are eigenvectors for the Jucys-Murphy element  $x_j$ ,  $j = 1, \dots, r+s$  and the eigenvalues are precisely the contents,

$$x_j \mathbf{v}_T = c_j(T) \mathbf{v}_T , \quad j = 1, \dots, r+s .$$



## 1.5 Orthogonal primitive idempotents

### 1.5.1 Algebraic background

We remind some basic results from the theory of semisimple finite dimensional algebras (for a brief introduction see [OP]). Let  $A(K)$  be a finite-dimensional unital associative algebra over a field  $K$ . Consider the regular left  $A$ -module  $A_{reg}$ . Suppose  $A_{reg}$  decomposes into a direct sum of left  $A$ -modules  $M_i$ ,  $i = 1, \dots, k$ ,

$$A_{reg} = \bigoplus_{i=1}^k M_i.$$

The subspaces  $M_i \subset A$  are left ideals of  $A$ . The corresponding decomposition of unit element of  $A_{reg}$  is

$$1 = \sum_{i=1}^k e_i \quad \text{where} \quad e_i \in M_i. \quad (5.62)$$

It follows that  $e_i e_j = \delta_{ij} e_i$  and the elements  $\{e_i\}_{i=1}^k$  form the set of mutually orthogonal idempotents in  $A$ . We have

$$A_{reg} = \bigoplus_{i=1}^k A e_i.$$

Thus, there is the one-to-one correspondence between the decompositions of the regular module  $A_{reg}$  into a direct sum of submodules and the resolutions of the unit element of the algebra  $A$  into a sum of mutually orthogonal idempotents.

The module  $M_i$  is indecomposable if and only if the corresponding idempotent cannot be resolved into a sum of nontrivial mutually orthogonal idempotents. An idempotent possessing this property is called ‘primitive idempotent’.

Further, we recall some standard facts valid in the situation when the branching rules are simple and the vectors  $\mathbf{v}_T$  are common eigenvectors of a set of elements generating a maximal commutative subalgebra.

Since the vectors  $\mathbf{v}_T$ ,  $T \in \mathcal{T}_\lambda$ , form a basis of  $C_{r,s}(\boldsymbol{\lambda})$ , we have the complete set  $\{E_T\}$  of primitive idempotents in  $\text{Mat}(C_{r,s}(\boldsymbol{\lambda}))$ ; the operator  $E_T$  is the projector on the one-dimensional subspace  $V_T$  along the subspace of codimension one spanned by the vectors  $\mathbf{v}_{T'}$ ,  $T' \in \mathcal{T}_\lambda \setminus \{T\}$ . The primitive idempotent  $E_T$ , corresponding to the vector  $\mathbf{v}_T$ , satisfies

$$x_t E_T = E_T x_t = c_t(T) E_T, \quad t = 1, \dots, r + s. \quad (5.63)$$

Consider the standard walled tableau  $U = (\boldsymbol{\lambda}^{(0)}, \dots, \boldsymbol{\lambda}^{(r+s-1)})$ ; recall that we assume that  $s > 0$ .

For a Young diagram  $\lambda$  we let

$A(\lambda)$  be the set of all addable cells

and

$R(\lambda)$  the set of all removable cells

Let  $\alpha \in R(\nu(U)) \sqcup A(\lambda''(U))$  be the box of  $W_T$  occupied by the number  $r + s$ . By construction, we have

$$E_T = E_U \frac{(x_{r+s} - a_1) \cdots (x_{r+s} - a_\ell)}{(c_{r+s}(T) - a_1) \cdots (c_{r+s}(T) - a_\ell)}, \quad (5.64)$$

where  $a_1, \dots, a_\ell$  are the contents of all boxes in  $(R(\nu(U)) \sqcup A(\lambda''(U))) \setminus \{\alpha\}$ .

The elements  $\{E_T\}$  for  $T$  a standard walled  $\lambda$ -tableau,  $\lambda \in \Lambda_{r,s}$ , form a complete set of pairwise orthogonal primitive idempotents for  $B_{r,s}(\delta)$ .

The relation (5.64) can be written in the form

$$E_T = E_U \frac{u - c_{r+s}}{u - x_{r+s}} \Big|_{u=c_{r+s}}, \quad (5.65)$$

where  $u$  is a complex variable. Indeed, the actions of the right hand sides of (5.64) and (5.65) on the vectors  $\mathbf{v}_T$ ,  $T \in \mathcal{T}$ , coincide.

Given a standard walled tableau  $U = (\lambda^{(0)}, \dots, \lambda^{(r+s-1)})$ , we have

$$E_U = \sum_{T:U \nearrow T} E_T. \quad (5.66)$$

### 1.5.2 Fusion procedure for the walled Brauer algebra

A fusion procedure gives a construction of the maximal family of pairwise orthogonal minimal idempotents in the algebra.

The fusion procedure (for the symmetric group) originates in the work of Jucys [19], see also the subsequent works [Ch, Na, GP]. A simplified version of the fusion procedure for the symmetric group involving the consecutive evaluation was suggested by Molev in [Mo]. Later the analogues of this simplified fusion procedure were suggested for the Hecke algebra [IMOs], for the Brauer algebra [IM, IMO], for the complex reflection groups of type  $G(m, 1, n)$ , for the cyclotomic Hecke algebras [OP1, OP2], for the cyclotomic Brauer algebras [C], for the

Birman–Murakami–Wenzl algebras [IMO2]. In [OP3] this fusion procedure was applied for the calculation of weights of certain Markov traces on the cyclotomic Hecke algebras.

The fusion procedure is closely related with the inductive approach to the representation theory of towers of algebras, see [OV] for the symmetric groups, and the generalizations for the Hecke algebra [IO], for the cyclotomic Hecke algebra [OP4], complex reflection groups [OP5] and Brauer algebras [IO2].

### Spectral parameters

To shorten the formulation of our results it is convenient to introduce the following function on the set  $\{1, \dots, r + s\}$

$$\varepsilon(j) = \begin{cases} 0 & \text{if } j \leq r, \\ 1 & \text{if } j > r. \end{cases} \quad (5.67)$$

Denote, for  $i \neq j$ ,

$$s_{i,j}(u) = 1 - \frac{s_{i,j}}{u} \quad \text{if } \varepsilon(i) + \varepsilon(j) \text{ is even,}$$

$$d_{i,j}(u) = 1 - \frac{d_{i,j}}{u} \quad \text{if } \varepsilon(i) + \varepsilon(j) \text{ is odd.}$$

Let  $w_{i,j}(u)$  be, depending on  $\varepsilon(i) + \varepsilon(j)$ , either  $s_{i,j}(u)$  or  $d_{i,j}(u)$ . If the indices  $i, j, k, l$  are pairwise distinct then

$$w_{i,j}(u)w_{k,l}(v) = w_{k,l}(v)w_{i,j}(u). \quad (5.68)$$

We have

$$s_{i,j}(u)s_{i,j}(-u) = \frac{u^2 - 1}{u^2}, \quad (5.69)$$

and

$$d_{i,j}(u)d_{i,j}(\delta - u) = 1. \quad (5.70)$$

The functions  $s_{i,j}(u)$  satisfy the Yang-Baxter equation with the spectral parameter

$$s_{i,j}(u)s_{i,k}(u+v)s_{j,k}(v) = s_{j,k}(v)s_{i,k}(u+v)s_{i,j}(u), \quad (5.71)$$

with pairwise distinct indices  $i, j, k$ .

Additionally, we have ( $i \neq j \neq k \neq i$ )

$$d_{j,i}(u)d_{k,i}(u-v)s_{j,k}(v) = s_{j,k}(v)d_{k,i}(u-v)d_{j,i}(u), \quad (5.72)$$

and

$$d_{i,j}(u)s_{i,k}(\delta - u - v)d_{k,j}(v) = d_{k,j}(v)s_{i,k}(\delta - u - v)d_{i,j}(u). \quad (5.73)$$

**Remark.** Equations (5.71), (5.72) and (5.73) can be elegantly written in a uniform manner. Let

$$\tilde{w}_{i,j}(u) := \begin{cases} s_{i,j}(u) & \text{if } \varepsilon(i) + \varepsilon(j) \text{ is even ,} \\ d_{i,j}(\delta/2 - u) & \text{if } \varepsilon(i) + \varepsilon(j) \text{ is odd .} \end{cases}$$

Then

$$\tilde{w}_{i,j}(u)\tilde{w}_{i,k}(u+v)\tilde{w}_{j,k}(v) = \tilde{w}_{j,k}(v)\tilde{w}_{i,k}(u+v)\tilde{w}_{i,j}(u)$$

whenever  $i \neq j \neq k \neq i$ .

### First fusion procedure

The original fusion procedure for the Brauer algebra was given in [IM]. In this section we formulate its analogue for the walled Brauer algebra.

In what follows we let

$$n = r + s .$$

Consider the rational function, in variables  $u_1, \dots, u_n$ , with values in the walled Brauer algebra  $\mathbb{B}_{r,s}(\delta)$ :

$$\Psi_{r,s} := \mathcal{D}_{r,s} \mathfrak{S}_r \mathring{\mathfrak{S}}_s , \quad (5.74)$$

where

$$\mathcal{D}_{r,s} := \prod_{\substack{1 \leq i \leq r \\ r+1 \leq j \leq n}} d_{i,j}(u_i + u_j)$$

and

$$\mathfrak{S}_r := \prod_{1 \leq i < j \leq r} s_{i,j}(u_i - u_j) , \quad \mathring{\mathfrak{S}}_s := \prod_{r+1 \leq i < j \leq n} s_{i,j}(u_i - u_j) . \quad (5.75)$$

The products in the definitions of  $\mathcal{D}_{r,s}$ ,  $\mathfrak{S}_r$  and  $\mathring{\mathfrak{S}}_s$  are calculated in the lexicographical order on the pairs  $(i, j)$  (that is,  $(i_1, j_1)$  precedes  $(i_2, j_2)$  if  $i_1 < i_2$  or  $i_1 = i_2$  and  $j_1 < j_2$ ).

Let  $T = (\boldsymbol{\lambda}^{(0)}, \dots, \boldsymbol{\lambda}^{(n)})$ ,  $\boldsymbol{\lambda}^{(n)} = \boldsymbol{\lambda} \in \Lambda_{r,s}$ , be a standard walled  $\boldsymbol{\lambda}$ -tableau describing a path in the Bratteli diagram for the walled Brauer algebra  $\mathbb{B}_{r,s}(\delta)$ . We define the rational function in the variables  $u_1, \dots, u_n$ :

$$z_T := \prod_{i=1}^n \frac{u_i - c_i}{u_i - \delta \varepsilon(i)} \times \prod_{\substack{1 \leq j < i \leq r \\ \text{or} \\ r < j < i \leq n}} \frac{(u_i - u_j)^2}{(u_i - u_j)^2 - 1} , \quad (5.76)$$

where the function  $\varepsilon$  is defined by (5.67), and for brevity we denoted  $c_i = c_i(T)$ ,  $i = 1, \dots, n$ .

Set

$$\Psi_T(u_1, \dots, u_n) := z_T \cdot \Psi_{r,s} . \quad (5.77)$$

**Theorem 1.5.3** *The primitive idempotent  $E_T$ , corresponding to the standard walled  $\lambda$ -tableau  $T$ , is found by the consecutive evaluations*

$$E_T = \Psi_T(u_1, \dots, u_n) \Big|_{u_1=c_1} \Big|_{u_2=c_2} \cdots \Big|_{u_n=c_n} .$$

**Example 1.5.3.1** *For  $r = s = 2$ , let  $T$  be the standard walled tableau corresponding to the contents sequence  $(0, -1, 1, 0)$ , see Figure 1.4. We have*

$$\begin{aligned} \Psi(0, u_2, u_3, u_4) &= \left(1 - \frac{d_{1,3}}{u_3}\right) \left(1 - \frac{d_{1,4}}{u_4}\right) \left(1 - \frac{d}{u_2 + u_3}\right) \left(1 - \frac{d_{2,4}}{u_2 + u_4}\right) \\ &\quad \times \left(1 + \frac{s_1}{u_2}\right) \left(1 - \frac{s_3}{u_3 - u_4}\right) . \end{aligned}$$

*This expression has singularities at  $u_3 = -u_2$  or  $u_4 = 0$ . However in the process of the consecutive evaluations of the product of  $\Psi(u_1, u_2, u_3, u_4)$  with the prefactor  $z(u_1, u_2, u_3, u_4)$  the singularities cancel and we find*

$$E_T = \frac{1}{2\delta(\delta - 1)} (1 - s_1) \cdot ds_1 s_3 d \cdot (1 - s_1) .$$

**Remark.** The function

$$\prod_{1 \leq i < j \leq n} d_{i,j}(u_i + u_j) \prod_{1 \leq i < j \leq n} s_{i,j}(u_i - u_j) \quad (5.78)$$

for the Brauer algebra  $\mathbf{B}_n(\delta)$  was suggested in [Na2]. Note that the function  $\Psi_{r,s}$ , defined in (5.74), can be obtained by dropping in the expression (5.78) factors corresponding to the diagrams which do not exist in the walled Brauer algebra. Thus the function  $\Psi_{r,s}$  makes sense in the Brauer algebra  $\mathbf{B}_n(\delta)$  and the consecutive evaluations of the product  $z_T \cdot \Psi_{r,s}$  give rise to certain idempotents of the Brauer algebra  $\mathbf{B}_n(\delta)$ . It would be interesting to understand the representation-theoretic/combinatorial meaning of these idempotents.

### Reformulation of Theorem 1.5.3

As we already stressed, we are interested in the fusion procedure only after the wall crossing so we shall accordingly change the notation. A standard walled  $\lambda$ -tableau  $T = (\lambda^{(0)}, \dots, \lambda^{(r+s)})$ ,  $\lambda^{(r+s)} = \lambda$ , will be denoted by  $T = (T_r, \lambda^{(r+1)}, \dots, \lambda^{(r+s)})$  where  $T_r = (\lambda^{(0)}, \dots, \lambda^{(r)})$  is the standard Young tableau of shape  $\lambda'(T)$ . We fix the tableau  $T$  till the end of Section and set  $c_i = c_i(T)$ .

For  $j$  such that  $r + s \geq j > r$  let

$$\mathfrak{d}_j^\downarrow := d_{r,j}(u_r + u_j)d_{r-1,j}(u_{r-1} + u_j) \dots d_{1,j}(u_1 + u_j)$$

and

$$\mathring{\mathfrak{d}}_j^\downarrow := \mathfrak{d}_j^\downarrow|_{u_1=c_1} \dots |_{u_r=c_r} = d_{r,j}(c_r + u_j)d_{r-1,j}(c_{r-1} + u_j) \dots d_{1,j}(c_1 + u_j) .$$

The symbol  $\mathring{\circ}$  (it appeared already in (5.74)) over a letter signifies that we are dealing with a rational function which depends only on the variables  $u_{r+1}, \dots, u_n$ .

With the help of the equalities (5.72), one finds

$$\mathcal{D}_{r,s} \mathfrak{S}_r = \mathfrak{S}_r \mathfrak{d}_{r+1}^\downarrow \mathfrak{d}_{r+2}^\downarrow \dots \mathfrak{d}_n^\downarrow .$$

The fusion procedure of [Mo] for the symmetric group says that the primitive idempotent  $E_{T_r}$  corresponding to the standard tableau  $T_r$  of the symmetric group  $\mathbb{S}_r$  is obtained by the consecutive evaluations

$$E_{T_r} = \left( \prod_{i=1}^r \frac{u_i - c_i}{u_i} \times \prod_{1 \leq j < i \leq r} \frac{(u_i - u_j)^2}{(u_i - u_j)^2 - 1} \cdot \mathfrak{S}_r \right) \Big|_{u_1=c_1} \dots \Big|_{u_r=c_r} .$$

The part of the prefactor  $z_T$ , see (5.76), which corresponds to the after-wall tail  $(\dots, \boldsymbol{\lambda}^{(r+1)}, \dots, \boldsymbol{\lambda}^{(r+s)})$  of the tableau  $T$ , is the rational function in the variables  $u_{r+1}, \dots, u_n$ :

$$\mathring{z}_T := \prod_{i=1}^n \frac{u_i - c_i}{u_i - \delta} \times \prod_{r < j < i \leq n} \frac{(u_i - u_j)^2}{(u_i - u_j)^2 - 1} .$$

Let now

$$\mathring{\Psi}_{n;T_r}(u_{r+1}, \dots, u_n) := E_{T_r} \mathring{\mathfrak{d}}_{r+1}^\downarrow \mathring{\mathfrak{d}}_{r+2}^\downarrow \dots \mathring{\mathfrak{d}}_n^\downarrow \mathring{\mathfrak{S}}_s$$

and

$$\mathring{\Psi}_T(u_{r+1}, \dots, u_n) := \mathring{z}_T \cdot \mathring{\Psi}_{n;T_r}(u_{r+1}, \dots, u_n) .$$

We reformulate Theorem 1.5.3 in the following way: *the idempotent  $E_T$  is found by the consecutive evaluations*

$$E_T = \mathring{\Psi}_T(u_{r+1}, \dots, u_n) \Big|_{u_{r+1}=c_{r+1}} \dots \Big|_{u_n=c_n} .$$

**Proof of Theorem 1.5.3**

We repeat that we assume that  $s > 0$  because before crossing the wall our formulas reproduce the formulas for the symmetric groups from [Mo].

We shall often write  $d_{i,j}(u, v)$  and  $s_{i,j}(u, v)$  instead of  $d_{i,j}(u + v)$  and  $s_{i,j}(u - v)$ .

We rewrite the function  $\Psi_{r,s}$ , defined by (5.74), in the form adapted to the consecutive evaluations. Let

$$\psi_n := d_{r,n}(u_r, u_n) \dots d_{1,n}(u_1, u_n) \cdot s_{r+1,n}(u_{r+1}, u_n) \dots s_{n-1,n}(u_{n-1}, u_n) . \quad (5.79)$$

**Lemma 1.5.4** *We have*

$$\Psi_{r,s} = \Psi_{r,s-1} \cdot \psi_n .$$

**Proof.** Clearly,  $\mathcal{D}_{r,s} = \mathcal{D}_{r,s-1} \cdot d_{1,n}(u_1, u_n) \dots d_{r,n}(u_r, u_n)$ . The Yang–Baxter equations (5.72) imply the identity

$$d_{1,n}(u_1, u_n) \dots d_{r,n}(u_r, u_n) \cdot \mathfrak{S}_r = \mathfrak{S}_r \cdot d_{r,n}(u_r, u_n) \dots d_{1,n}(u_1, u_n) .$$

The well-known equality  $\mathring{\mathfrak{S}}_s = \mathring{\mathfrak{S}}_{s-1} \cdot s_{r+1,n}(u_{r+1}, u_n) \dots s_{n-1,n}(u_{n-1}, u_n)$  and the commutativity relation

$$d_{r,n}(u_r, u_n) \dots d_{1,n}(u_1, u_n) \cdot \mathring{\mathfrak{S}}_{s-1} = \mathring{\mathfrak{S}}_{s-1} \cdot d_{r,n}(u_r, u_n) \dots d_{1,n}(u_1, u_n) ,$$

complete the proof. ■

We first analyze what happens when we cross the wall.

**Lemma 1.5.5** *Let  $U$  be a standard walled tableau for the algebra  $\mathbb{B}_{r,0}(\delta)$ , that is, for the symmetric group  $\mathbb{S}_r$ . The following identity holds in the walled Brauer algebra  $\mathbb{B}_{r,1}(\delta)$ :*

$$E_U \cdot d_{1,r+1}(w - c_1) \dots d_{r,r+1}(w - c_r) = \frac{w - \delta + x_{r+1}}{w} \cdot E_U , \quad (5.80)$$

where  $c_i = c_i(U)$ ,  $i = 1, \dots, r$ .

**Proof.** The proof is by induction in  $r$ . The induction base, for the algebra  $\mathbb{B}_{1,1}(\delta)$ , is straightforward.

Let  $W \nearrow U$ . By the recursive construction of the primitive idempotents for the symmetric group in [Mo] (which is exactly the ‘before the wall’ part of our formula), we have

$$E_U = b(v) E_W \cdot s_{1,r}(c_1, v) \dots s_{r-1,r}(c_{r-1}, v)|_{v=c_r}$$

with some rational function  $b(v)$ ; its precise expression is not important at the moment. Let  $\xi = s_{1,r}(c_1, v) \dots s_{r-1,r}(c_{r-1}, v)$ . The Yang–Baxter equations (5.72) imply that

$$\begin{aligned} & \xi \cdot d_{1,r+1}(w - c_1) \dots d_{r-1,r+1}(w - c_{r-1}) \cdot d_{r,r+1}(w - v) \\ &= d_{r,r+1}(w - v) \cdot d_{1,r+1}(w - c_1) \dots d_{r-1,r+1}(w - c_{r-1}) \cdot \xi . \end{aligned}$$

Since

$$E_W d_{r,r+1}(w - v) = d_{r,r+1}(w - v) E_W ,$$

we can write the left hand side of (5.80) in the form

$$b(v) d_{r,r+1}(w - v) E_W \cdot d_{1,r+1}(w - c_1) \dots d_{r-1,r+1}(w - c_{r-1}) \cdot \xi|_{v=c_r} .$$

The diagrams with the vertical line connecting the  $r$ -th upper and lower points linearly span the subalgebra  $\mathcal{A}$  in  $\mathbf{B}_{r,1}(\delta)$ , isomorphic to  $\mathbf{B}_{r-1,1}(\delta)$ . Thus we can use the induction hypothesis and write

$$E_W \cdot d_{1,r+1}(w - c_1) \dots d_{r-1,r+1}(w - c_{r-1}) = \frac{w - d_{1,r+1} - \dots - d_{r-1,r+1}}{w} \cdot E_W .$$

Now,

$$\begin{aligned} & d_{r,r+1}(w - v) \cdot \frac{w - d_{1,r+1} - \dots - d_{r-1,r+1}}{w} \\ &= \frac{w - d_{1,r+1} - \dots - d_{r-1,r+1}}{w} - \frac{d_{r,r+1} \cdot (w - d_{1,r+1} - \dots - d_{r-1,r+1})}{w(w - v)} \\ &= \frac{w - d_{1,r+1} - \dots - d_{r-1,r+1}}{w} - \frac{d_{r,r+1} \cdot (w - s_{1,r} - \dots - s_{r-1,r})}{w(w - v)} \\ &= \frac{w - d_{1,r+1} - \dots - d_{r-1,r+1}}{w} - \frac{d_{r,r+1} \cdot (w - x_r)}{w(w - v)} \\ &= \frac{w - \delta + x_{r+1}}{w} - \frac{d_{r,r+1} \cdot (v - x_r)}{w(w - v)} . \end{aligned}$$

Here in the second equality we used the formula  $d_{r,r+1}d_{j,r+1} = d_{r,r+1}s_{j,r}$ .

We have

$$b(v) \frac{d_{r,r+1} \cdot (v - x_r)}{w(v - w)} \cdot E_W \cdot \xi|_{v=c_r} = \frac{d_{r,r+1} \cdot (v - x_r)}{w(v - w)} \cdot E_U|_{v=c_r} ,$$

so we are done since  $x_r E_U = c_r E_U$ . ■



**Lemma 1.5.6** *Let  $U$  be a standard walled tableau for the algebra  $\mathbb{B}_{r,s-1}(\delta)$  with  $s > 0$ . Then*

$$E_U \cdot \zeta_n = \frac{u - x_n}{u - \delta} \cdot E_U , \quad (5.81)$$

where  $\zeta_n$  is the following rational function in the variable  $u$ :

$$\zeta_n = s_{n-1,n}(u, c_{n-1}) \cdots s_{r+1,n}(u, c_{r+1}) \cdot d_{1,n}(\delta - u, -c_1) \cdots d_{r,n}(\delta - u, -c_r)$$

with  $c_i = c_i(U)$ ,  $i = 1, \dots, n-1$ .

**Proof.** We employ the induction on  $s$ . The induction base, for  $s = 1$  is the formula (5.80). Let  $W \nearrow U$ . We have  $E_U = E_U E_W$ . Thus

$$E_U \cdot \zeta_n = E_U E_W \cdot s_{n-1,n}(u, c_{n-1}) \zeta'_n = E_U \cdot s_{n-1,n}(u, c_{n-1}) \cdot E_W \cdot \zeta'_n ,$$

where

$$\zeta'_n := s_{n-2,n}(u, c_{n-2}) \cdots s_{r+1,n}(u, c_{r+1}) \cdot d_{1,n}(\delta - u, -c_1) \cdots d_{r,n}(\delta - u, -c_r) .$$

The diagrams with the vertical line connecting the  $(n-1)$ -st upper and lower points linearly span the subalgebra  $\mathcal{A}'$  in  $\mathbb{B}_{r,s}(\delta)$ , isomorphic to  $\mathbb{B}_{r,s-1}(\delta)$ . By the induction assumption,

$$E_W \cdot \zeta'_n = E_W \rho_n ,$$

where

$$\rho_n := \frac{u - (\delta - d_{1,n} - \cdots - d_{r,n} + s_{r+1,n} + \cdots + s_{n-2,n})}{u - \delta} .$$

So,

$$\begin{aligned} E_U \cdot \zeta_n &= E_U \cdot s_{n-1,n}(u, c_{n-1}) \cdot E_W \cdot \rho_n = E_U E_W \cdot s_{n-1,n}(u, c_{n-1}) \rho_n \\ &= E_U \cdot s_{n-1,n}(u, c_{n-1}) \rho_n . \end{aligned}$$

Now,

$$s_{n-1,n}(u, c_{n-1}) \rho_n = \left( 1 - \frac{s_{n-1,n}}{u - c_{n-1}} \right) \rho_n = \rho_n - \frac{s_{n-1,n}}{u - c_{n-1}} \rho_n . \quad (5.82)$$

Since

$$\rho_n = \frac{u - x_n + s_{n-1,n}}{u - \delta} \quad \text{and} \quad s_{n-1,n} \rho_n = \frac{u - x_{n-1}}{u - \delta} s_{n-1,n} ,$$

we rewrite the right hand side of the formula (5.82) in the form

$$\frac{u - x_n + s_{n-1,n}}{u - \delta} - \frac{1}{u - c_{n-1}} \frac{u - x_{n-1}}{u - \delta} s_{n-1,n}$$

$$= \frac{u - x_n}{u - \delta} + \frac{1}{u - \delta} \left( 1 - \frac{u - x_{n-1}}{u - c_{n-1}} \right) s_{n-1,n} ,$$

which completes the proof since  $E_U x_{n-1} = c_{n-1} E_U$ . ■

We define the following rational function in the variable  $u = u_n$ :

$$\psi_n^U := \psi_n|_{u_1=c_1, \dots, u_{n-1}=c_{n-1}}$$

where  $\psi_n$  is defined in (5.79).

**Lemma 1.5.7** *The following identity holds:*

$$E_U \cdot \psi_n^U = \frac{u - \delta}{u - c_n} \prod_{i=r+1}^{n-1} \left( 1 - \frac{1}{(u - c_i)^2} \right) E_U \frac{u - c_n}{u - x_n} . \quad (5.83)$$

**Proof.** The formula (5.83) is obtained from the formula (5.81) by using the equalities (5.69) and (5.70). ■

**Proof** of Theorem 1.5.3. Clearly,

$$z_T = z_U z_U^T \quad \text{where} \quad z_U^T = \frac{u_n - c_n}{u_n - \delta} \prod_{i=r+1}^{n-1} \frac{(u_i - u_n)^2}{(u_i - u_n)^2 - 1} . \quad (5.84)$$

Thus,

$$\begin{aligned} \Psi_T(u_1, \dots, u_{r+s})|_{u_1=c_1} |_{u_2=c_2} \cdots |_{u_n=c_n} &= \left( z_U^T|_{u_1=c_1, \dots, u_{n-1}=c_{n-1}} E_U \psi_n^U \right) |_{u_n=c_n} \\ &= E_U \frac{u - c_n}{u - x_n} |_{u_n=c_n} = E_T \end{aligned}$$

by (5.65). ■

## Second fusion procedure

Our second fusion procedure resembles the fusion procedure of [IMO] for the Brauer algebra.

**Modified baxterized elements.** Let  $h$  be an indeterminate. It will be convenient to use also the following modified functions:

$$\begin{aligned} s'_{i,j}(u; h) &:= 1 + \frac{s_{i,j}}{u - h} \quad \text{if } \varepsilon(i) + \varepsilon(j) \text{ is even} , \\ d'_{i,j}(u; h) &:= 1 + \frac{d_{i,j}}{u + h - \delta} \quad \text{if } \varepsilon(i) + \varepsilon(j) \text{ is odd} . \end{aligned}$$

In virtue of the equalities (5.71), we have

$$s'_{i,j}(u; h) s'_{i,k}(u - v; h) s_{j,k}(v) = s_{j,k}(v) s'_{i,k}(u - v; h) s'_{i,j}(u; h) ,$$

in virtue of the equalities (5.72),

$$d'_{j,i}(v; h) d'_{k,i}(u + v; h) s_{j,k}(u) = s_{j,k}(u) d'_{k,i}(u + v; h) d'_{j,i}(v; h) ,$$

and, in virtue of the equalities (5.73),

$$d_{i,j}(u) s'_{i,k}(u - v; h) d'_{k,j}(v; h) = d'_{k,j}(v; h) s'_{i,k}(u - v; h) d_{i,j}(u) .$$

In the sequel we omit the symbol  $h$  in the notation for brevity.

**Second fusion procedure.** We shall formulate the results in the notation introduced for the first fusion procedure.

We define several more rational functions, in variables  $u_{r+1}, \dots, u_n$ , with values in the algebra  $\mathbb{B}_{r,s}(\delta)$ . First, for  $j$  such that  $r + s \geq j > r$  let

$$\mathring{\mathfrak{d}}_j^\uparrow := d'_{1,j}(c_1 - u_j) d'_{2,j}(c_2 - u_j) \dots d'_{r,j}(c_r - u_j) .$$

Next, let

$$\mathring{\mathfrak{A}}_{r,s} := \mathring{\mathfrak{d}}_{r+1}^\downarrow \mathring{\mathfrak{d}}_{r+2}^\downarrow \dots \mathring{\mathfrak{d}}_n^\downarrow , \quad \mathring{\mathfrak{A}}'_{r,s} := \mathring{\mathfrak{d}}_{r+1}^\uparrow \mathring{\mathfrak{d}}_{r+2}^\uparrow \dots \mathring{\mathfrak{d}}_n^\uparrow .$$

Finally, let

$$\begin{aligned} \mathring{\Psi}_{n;T_r,h}(u_{r+1}, \dots, u_n) &:= E_{T_r} \mathring{\mathfrak{A}}'_{r,s} \mathring{\mathfrak{S}}'_s \mathring{\mathfrak{A}}_{r,s} \mathring{\mathfrak{S}}_s , \\ \mathring{\tilde{\Psi}}_{n;T_r,h}(u_{r+1}, \dots, u_n) &:= E_{T_r} \mathring{\mathfrak{A}}_{r,s} \mathring{\mathfrak{S}}'_s \mathring{\mathfrak{A}}'_{r,s} \mathring{\mathfrak{S}}_s , \end{aligned}$$

where  $\mathring{\mathfrak{S}}_s$  is defined in (5.75) and

$$\mathring{\mathfrak{S}}'_s := \prod_{r+1 \leq i < j \leq r+s} s'_{i,j}(u_i + u_j) .$$

The prefactor  $\mathring{z}_T$  we replace with the following rational function in the variables  $u_{r+1}, \dots, u_n$ :

$$\mathring{z}_{T;h} := \prod_{i=r+1}^n \frac{(u_i - c_i)(u_i - h + \delta)}{(u_i - \delta)(u_i + c_i - h)} \times \prod_{r < j < i \leq n} \frac{(u_i - u_j)^2}{(u_i - u_j)^2 - 1} . \quad (5.85)$$

Set

$$\begin{aligned} \mathring{\Psi}_{T;h}(u_{r+1}, \dots, u_n) &:= \mathring{z}_{T;h} \cdot \mathring{\Psi}_{n;T_r,h}(u_{r+1}, \dots, u_n) , \\ \mathring{\tilde{\Psi}}_{T;h}(u_{r+1}, \dots, u_n) &:= \mathring{z}_{T;h} \cdot \mathring{\tilde{\Psi}}_{n;T_r,h}(u_{r+1}, \dots, u_n) . \end{aligned}$$

**Proposition 1.5.8** *The primitive idempotent  $E_T$ , corresponding to the standard walled  $\lambda$ -tableau  $T$ , is found by any of the consecutive evaluations*

$$E_T = \overset{\circ}{\Psi}_{T;h}(u_{r+1}, \dots, u_n) \Big|_{u_{r+1}=c_{r+1}} \cdots \Big|_{u_n=c_n} \quad (5.86)$$

or

$$E_T = \overset{\circ}{\Psi}_{T;h}(u_{r+1}, \dots, u_n) \Big|_{u_{r+1}=c_{r+1}} \cdots \Big|_{u_n=c_n} . \quad (5.87)$$

**Remark.** The fusion procedure of Theorem 1.5.3 is the limit, as  $h$  tends to infinity, of the second fusion procedure, given in Proposition 1.5.8.

### Proof of Proposition 1.5.8

1. We prove the assertion (5.86). Some gymnastics, à la in the Proof of Lemma 1.5.4, with the baxterized elements leads to the recursion

$$\overset{\circ}{\Psi}_{n;T_r,h} = \overset{\circ}{\Psi}_{n-1;T_r,h} \cdot \overset{\circ}{s}'_n \overset{\circ}{\mathfrak{d}}_n \overset{\circ}{\mathfrak{d}}_n \overset{\circ}{s}_n .$$

Here

$$\overset{\circ}{s}'_n := s'_{n-1,n}(u_{n-1} + u_n) s'_{n-2,n}(u_{n-2} + u_n) \cdots s'_{r+1,n}(u_{r+1} + u_n)$$

and

$$\overset{\circ}{s}_n := s_{r+1,n}(u_{r+1} + u_n) s_{r+2,n}(u_{r+2} + u_n) \cdots s_{n-1,n}(u_{n-1} + u_n) .$$

As before, it suffices to analyze the last evaluation  $\cdots \Big|_{u_n=c_n}$ . Extracting the factors containing  $u_n$  in the prefactor  $\overset{\circ}{\Psi}_{T;h}$ , see (5.85), we see that we have to prove that for  $U \nearrow T$  the evaluation of the expression

$$z_U^T z_U^T E_U \cdot \mathfrak{X} \quad , \quad \text{with } \mathfrak{X} := \left( \overset{\circ}{s}'_n \overset{\circ}{\mathfrak{d}}_n \overset{\circ}{\mathfrak{d}}_n \overset{\circ}{s}_n \right) \Big|_{u_{r+1}=c_{r+1}, \dots, u_{n-1}=c_{n-1}} ,$$

at  $u_n = c_n$  is equal to  $E_T$ . Here  $z_U^T$  is defined in (5.84) and  $z_U^T$  is the following rational function in  $u_n$ :

$$z_U^T := \frac{u_n - h + \delta}{u_n + c_n - h} .$$

Lemma 1.5.6 implies that

$$E_U \cdot \left( \overset{\circ}{s}'_n \overset{\circ}{\mathfrak{d}}_n \overset{\circ}{\mathfrak{d}}_n \overset{\circ}{s}_n \right) \Big|_{u_{r+1}=c_{r+1}, \dots, u_{n-1}=c_{n-1}} = \frac{h - u_n - x_n}{h - u_n - \delta} E_U .$$

By the fusion procedure of Theorem 1.5.3, the evaluation of the expression

$$z_U^T E_U \cdot \left( \overset{\circ}{\mathfrak{d}}_n \overset{\circ}{s}_n \right) \Big|_{u_{r+1}=c_{r+1}, \dots, u_{n-1}=c_{n-1}}$$

at  $u_n = c_n$  equals  $E_T$ , and  $x_n E_T = c_n E_T$ , so we are done.

2. It is straightforward to see that the Jucys–Murphy elements are stable with respect to the anti-involution  $\iota$  defined in (1.8). Therefore the idempotents  $E_T$  are stable with respect to  $\iota$  as well. However, we have the identity

$$\iota\left(\overset{\circ}{\Psi}_{n;T_r,h}\right) = \overset{\circ}{\Psi}_{n;T_r,h}$$

which implies the assertion (5.87). ■

## Chapter 2

# Schur-Weyl duality between $\mathcal{U}_{\mathbf{q}}\mathfrak{sl}(2|1)$ and quantum walled Brauer algebra $\mathbf{qB}_{m,n}$

The classical Schur-Weyl duality relates the representations of the general linear group with the representations of the symmetric group. It asserts that the actions of the general linear group  $G = GL_n(\mathbb{C})$  and the symmetric group  $\mathfrak{S}_m$  on the tensor space  $V^{\otimes m}$  with  $V = \mathbb{C}^{\otimes n}$  satisfy the bicentralizer property, i.e.  $\text{End}_{\mathfrak{S}_m}(V^{\otimes m})$  is generated by the action of  $G$  and correspondingly,  $\text{End}_G(V^{\otimes m})$  is generated by the action of  $\mathfrak{S}_m$ . There exist many generalizations of this duality to subgroups of  $G$  (e.g., orthogonal, symplectic groups, and Levi subgroups) and respective algebras related with the group algebra of the symmetric group (e.g., Brauer algebras and Ariki-Koike algebras) along with deformations of these algebras. Generally, the phrase “Schur-Weyl duality” has come to point out such a bicentralizer property for two algebras acting on some module.

One such generalization is the mixed tensor space  $V^{\otimes r} \otimes (V^*)^{\otimes s}$  where  $V$  is the natural representation of  $GL_\delta(\mathbb{C})$  and  $V^*$  is its dual. The centralizer algebra is the walled Brauer algebra  $\mathbf{B}_{r,s}(\delta)$ ,  $\delta \in \mathbb{N}$ . It was shown by [T, Ko, BCHLLS] that mixed tensor space satisfies Schur-Weyl duality under the action of  $GL_\delta(\mathbb{C})$  and  $\mathbf{B}_{r,s}(\delta)$ .

The super analogue of the mixed Schur-Weyl duality was studied in [BS]. Let  $V$  and  $V^*$  be a natural representation and its dual for  $gl_{M|N}(\mathbb{C})$  then there is induced surjective homomorphism

$$\Psi_{r,s}^{M,N} : \mathbf{B}_{r,s}(\delta) \rightarrow \text{End}_G(V^{\otimes r} \otimes (V^*)^{\otimes s})^{\text{op}},$$

where  $\delta = M - N$ . It is an isomorphism if and only if  $r + s < (M + 1)(N + 1)$ .

The mixed Schur-Weyl duality for the complex general linear Lie superalgebra  $gl(M, N)$  and subalgebra of walled Brauer algebra  $\mathbf{B}_{r,s}(M - N)$  was discussed in [SM].

In [KM] it was introduced a one-parameter deformation  $\mathbf{B}_{r,s}(\delta, q)$  of the walled Brauer algebra and proved Schur–Weyl duality where the general linear group is replaced by the generic quantum group  $U_{\mathbb{C}(q)}(\mathfrak{gl}_n)$ .

In this Chapter we study a mixed tensor product  $\mathbf{3}^{\otimes m} \otimes \overline{\mathbf{3}}^{\otimes n}$  of the three-dimensional fundamental representations of the Hopf algebra  $\mathcal{U}_q sl(2|1)$ , whenever  $q$  is not a root of unity. In Section 2.1 we give the definition of  $\mathcal{U}_q sl(2|1)$  and describe the construction of modules. In Section 2.2 we obtain formulas for decomposition of tensor products of any simple and projective  $\mathcal{U}_q sl(2|1)$ -module with the generating modules  $\mathbf{3}$  and  $\overline{\mathbf{3}}$ . We show that the centralizer of  $\mathcal{U}_q sl(2|1)$  on the mixed tensor product is the quotient  $X_{m,n}$  of the quantum walled Brauer algebra  $\mathfrak{qB}_{m,n}$ . We recall the definition of the quantum walled Brauer algebra in Section 2.3.1 and discuss the construction of the cell modules in Section 2.3.3. In Section 2.4 we give explicit structure of projective modules over  $X_{m,n}$ . The walled Brauer algebras form an infinite tower. We calculate the corresponding restriction functors on simple and projective modules over  $X_{m,n}$ . This result forms a crucial step in decomposition of the mixed tensor product as a bimodule over  $X_{m,n} \boxtimes \mathcal{U}_q sl(2|1)$ . Finally, in Section 2.5 we give an explicit bimodule structure for all  $m, n$ .

## 2.1 The Hopf algebra $\mathcal{U}_q sl(2|1)$

The quantized universal enveloping algebras are an important class of quantum groups. A quantum algebra  $\mathcal{U}_q g$  associated with the algebra  $g$  is a deformation of the universal enveloping algebra  $\mathcal{U}[g]$  of  $g$  endowed with a structure of a Hopf algebra.

### 2.1.1 Definition of $\mathcal{U}_q sl(2|1)$

The quantum superalgebras  $\mathcal{U}_q sl(2|1)$  and  $\mathcal{U}_q gl(2|1)$ , i.e., quantum algebras associated with a Lie superalgebras  $sl(2|1)$  and  $gl(2|1)$ , were studied in [PT, PSV, Z, KV].

The Hopf algebra  $\mathcal{U}_q sl(2|1)$  is a free unital associative algebra generated by  $k, K, E, F, B, C$  and the relations listed below. We choose the generators adapted to the Hopf subalgebra structure  $\mathcal{U}_q sl(2|1) \supset \mathcal{U}_q gl(2) \supset \mathcal{U}_q sl(2)$  (we extensively use these subalgebras while working with  $\mathcal{U}_q sl(2|1)$ -modules in the sequel). The Hopf subalgebra  $\mathcal{U}_q sl(2)$  in  $\mathcal{U}_q sl(2|1)$  is generated as an associative algebra by  $E, K$ , and  $F$  with the relations

$$KF = q^{-2}FK, \quad EF - FE = \frac{K - K^{-1}}{q - q^{-1}}, \quad KE = q^2EK. \quad (1.1)$$

The larger algebra  $\mathcal{U}_q gl(2)$  contains an additional generator  $k$  satisfying the relations

$$kF = qFk, \quad kE = q^{-1}Ek, \quad kK = Kk. \quad (1.2)$$

We call the generators  $E, F, K$  and  $k$  bosonic. There are two additional generators  $B$  and  $C$ , which extend  $\mathcal{U}_q\mathfrak{gl}(2)$  to  $\mathcal{U}_q\mathfrak{sl}(2|1)$ ; we will call them fermionic, or simply fermions. The relations that involve the fermions  $B$  and  $C$  are

$$\begin{aligned} kB &= -Bk, & KB &= qBK, & kC &= -Ck, & KC &= q^{-1}CK, \\ B^2 &= 0, & BC - CB &= \frac{k - k^{-1}}{q - q^{-1}}, & C^2 &= 0, \\ FC - CF &= 0, & BE - EB &= 0, \\ FFB - [2]FBF + BFF &= 0, & EEC - [2]ECE + CEE &= 0, \end{aligned} \tag{1.3}$$

where  $[n] = \frac{q^n - q^{-n}}{q - q^{-1}}$  is a  $q$ -integer.

The Hopf-algebra structure of  $\mathcal{U}_q\mathfrak{sl}(2|1)$  (the coproduct, the antipode, and the counit) is given by

$$\Delta(F) = F \otimes 1 + K^{-1} \otimes F, \quad \Delta(E) = E \otimes K + \mathbf{1} \otimes E, \tag{1.4}$$

$$\Delta(B) = B \otimes 1 + k^{-1} \otimes B, \quad \Delta(C) = C \otimes k + \mathbf{1} \otimes C,$$

$$S(B) = -kB, \quad S(F) = -KF, \quad S(C) = -Ck^{-1}, \quad S(E) = -EK^{-1}, \tag{1.5}$$

$$\epsilon(B) = 0, \quad \epsilon(F) = 0, \quad \epsilon(C) = 0, \quad \epsilon(E) = 0, \tag{1.6}$$

with  $k$  and  $K$  being group-like.

### 2.1.2 Simple $\mathcal{U}_q\mathfrak{sl}(2|1)$ -modules

Every finite-dimensional irreducible module over the Lie superalgebra  $\mathfrak{sl}(n|1)$  can be deformed into an irreducible module over  $\mathcal{U}_q\mathfrak{sl}(n|1)$ , see [PT]. The Lie superalgebras  $\mathfrak{sl}(n|1)$  belong to the class of the simple complex Lie superalgebras, classified by Kac [K1]-[K3]. Following his terminology we use notations "typical" and "atypical" to classify  $\mathcal{U}_q\mathfrak{sl}(2|1)$ -modules (see also [S]).

In the sequel we use notations from [ST]. We consider a subcategory of  $\mathcal{U}_q\mathfrak{sl}(2|1)$ -modules with  $k$  eigenvalues of the form  $q^{-n}$  for  $n \in \mathbb{Z}$ . The subcategory is closed under tensor products. The simple finite-dimensional  $\mathcal{U}_q\mathfrak{sl}(2|1)$ -modules can be labeled as (see [ST] and references therein)

$$\mathcal{Z}_{s,r}^{\alpha,\beta}, \quad \alpha, \beta = \pm 1, \quad s \geq 1, \quad r \in \mathbb{Z}. \tag{1.7}$$

The module  $\mathcal{Z}_{s,r}^{\alpha,\beta}$  contains a unique highest-weight vector  $|\alpha, s, \beta, r\rangle_0^-$ , such that

$$E|\alpha, s, \beta, r\rangle_0^- = 0, \quad C|\alpha, s, \beta, r\rangle_0^- = 0, \tag{1.8}$$

$$K|\alpha, s, \beta, r\rangle_0^- = \alpha q^{s-1}|\alpha, s, \beta, r\rangle_0^-, \tag{1.9}$$

$$k|\alpha, s, \beta, r\rangle_0^- = \beta q^{-r}|\alpha, s, \beta, r\rangle_0^-. \tag{1.10}$$



The eigenvalues of the generators  $K$  and  $k$  when acting on the highest weight vector are parametrized by the pairs  $(\alpha, s)$  and  $(\beta, r)$  respectively. Therefore,  $\mathcal{U}_qsl(2|1)$ -modules are parametrized by  $(\alpha, s, \beta, r)$  uniquely. It is convenient to use this parametrization because the dimensions of the modules and some its structural features become dependent only on  $s$  and  $r$ . The structure of the modules will be explained in more detail in the next subsection. For a pictorial explanation of the notations for vectors in the module see Figure 2.1. The modules have dimensions

$$\dim \mathcal{Z}_{s,r}^{\alpha,\beta} = \begin{cases} 2s - 1, & r = 0, \\ 2s + 1, & r = s, \\ 4s, & r \neq 0, s. \end{cases} \quad (1.11)$$

The modules with  $r = 0$  and  $r = s$  are atypical, and others are typical. The trivial module corresponds to  $\mathcal{Z}_{1,0}^{+,+}$ , see (1.7).

We note that there are four nonisomorphic modules in each dimension, which differ only in the sign of the Cartan generators action. There are four one-dimensional modules and only one of them is trivial.

### 2.1.3 $\mathcal{U}_qsl(2|1)$ -action on simple modules

Each  $\mathcal{U}_qsl(2|1)$ -module decomposes into a direct sum of simple  $\mathcal{U}_qgl(2)$ -modules  $\mathcal{X}_{s,r}^{\alpha,\beta}$ , where  $\alpha, \beta = \pm$ ,  $s \geq 1$ ,  $r \in \mathbb{Z}$ . Their dimensions are  $\dim \mathcal{X}_{s,r}^{\alpha,\beta} = s$ . Eigenvalues of generators  $K$  and  $k$  on the highest weight vector in the module  $\mathcal{X}_{s,r}^{\alpha,\beta}$  are  $\alpha q^{s-1}$  and  $\beta q^{-r}$  respectively.

We describe (following [ST]) the action of  $\mathcal{U}_qsl(2|1)$  on its simple modules explicitly, using the basis adapted to the decomposition into  $\mathcal{U}_qgl(2)$ -modules. The examples of each type of modules are shown in the Figure 2.1.

**Atypical modules with  $r = 0$ ,  $\mathcal{Z}_{s,0}^{\alpha,\beta}$**

As  $\mathcal{U}_qgl(2)$ -modules, these modules decompose as

$$\mathcal{Z}_{s,0}^{\alpha,\beta} = \mathcal{X}_{s,0}^{\alpha,\beta} \oplus \mathcal{X}_{s-1,-1}^{\alpha,\beta}, \quad (1.12)$$

and we choose a basis in  $\mathcal{Z}_{s,0}^{\alpha,\beta}$  in accordance with this decomposition, as

$$\left( |\alpha, s, \beta, 0\rangle_n^{\leftarrow} \in \mathcal{X}_{s,0}^{\alpha,\beta} \right)_{0 \leq n \leq s-1}, \quad \left( |\alpha, s, \beta, 0\rangle_m^{\rightarrow} \in \mathcal{X}_{s-1,-1}^{\alpha,\beta} \right)_{0 \leq m \leq s-2}.$$

The fermionic generators relate these two types of vectors as

$$B|\alpha, s, \beta, 0\rangle_n^{\leftarrow} = -[n]|\alpha, s, \beta, 0\rangle_{n-1}^{\rightarrow}, \quad C|\alpha, s, \beta, 0\rangle_m^{\rightarrow} = \beta|\alpha, s, \beta, 0\rangle_{m+1}^{\leftarrow}.$$

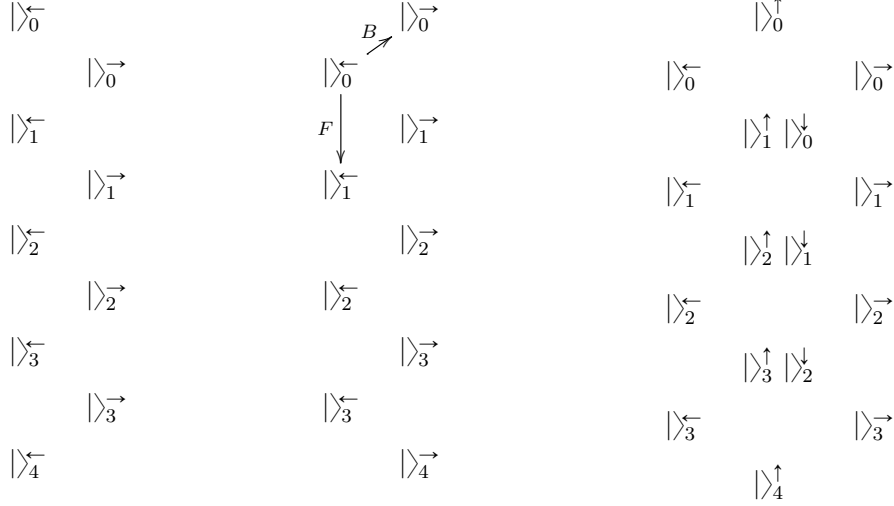

Figure 2.1: LEFT: An atypical module  $\mathcal{Z}_{s,0}^{\alpha,\beta}$  (with  $s = 5$ ). Each vertical column is a  $\mathcal{U}_q\mathfrak{gl}(2)$ -module  $\mathcal{X}_{s,r}^{\alpha,\beta}$  in (1.12). The top state is  $|\alpha, s; \beta, 0\rangle_0^{\leftarrow}$  and the bottom,  $|\alpha, s; \beta, 0\rangle_{s-1}^{\leftarrow}$ . MIDDLE: An atypical module  $\mathcal{Z}_{s,s}^{\alpha,\beta}$  (with  $s = 4$ ). Each vertical column is a  $\mathcal{U}_q\mathfrak{gl}(2)$ -module in (1.13). The top state is  $|\alpha, s; \beta, s\rangle_0^{\rightarrow}$  and the bottom,  $|\alpha, s; \beta, s\rangle_s^{\rightarrow}$ . RIGHT: The typical module  $\mathcal{Z}_{s,r}^{\alpha,\beta}$  ( $s = 4$ ). Each column is a  $\mathcal{U}_q\mathfrak{gl}(2)$ -module in (1.14). The directions in which the generators map are common for both modules.

### Atypical modules with $s = r$ , $\mathcal{Z}_{s,s}^{\alpha,\beta}$

The modules decompose as

$$\mathcal{Z}_{s,s}^{\alpha,\beta} = \mathcal{X}_{s,s}^{\alpha,\beta} \oplus \mathcal{X}_{s+1,s}^{\alpha,-\beta}, \quad (1.13)$$

and we choose a basis in  $\mathcal{Z}_{s,s}^{\alpha,\beta}$  accordingly, as

$$\left( |\alpha, s, \beta, s\rangle_n^{\leftarrow} \in \mathcal{X}_{s,s}^{\alpha,\beta} \right)_{0 \leq n \leq s-1}, \quad \left( |\alpha, s, \beta, s\rangle_m^{\rightarrow} \in \mathcal{X}_{s+1,s}^{\alpha,-\beta} \right)_{0 \leq m \leq s}.$$

The fermions act between these two sets of basis vectors as

$$B|\alpha, s, \beta, s\rangle_n^{\leftarrow} = [s - n]|\alpha, s, \beta, s\rangle_n^{\rightarrow}, \quad C|\alpha, s, \beta, s\rangle_m^{\rightarrow} = \beta|\alpha, s, \beta, s\rangle_m^{\leftarrow}.$$

### Typical modules ( $r \neq 0, s$ )

The modules decompose as

$$\mathcal{Z}_{s,r}^{\alpha,\beta} = \mathcal{X}_{s,r}^{\alpha,\beta} \oplus \mathcal{X}_{s+1,r}^{\alpha,-\beta} \oplus \mathcal{X}_{s-1,r-1}^{\alpha,-\beta} \oplus \mathcal{X}_{s,r-1}^{\alpha,\beta}, \quad (1.14)$$

and we choose the basis in  $\mathcal{Z}_{s,r}^{\alpha,\beta}$  as

$$\begin{aligned} (|\alpha, s, \beta, r\rangle_j^{\leftarrow})_{0 \leq j \leq s-1}, \quad (|\alpha, s, \beta, r\rangle_m^{\uparrow})_{0 \leq m \leq s}, \\ (|\alpha, s, \beta, r\rangle_n^{\downarrow})_{0 \leq n \leq s-2}, \quad (|\alpha, s, \beta, r\rangle_j^{\rightarrow})_{0 \leq j \leq s-1}. \end{aligned}$$

The fermions act on these vectors as

$$\begin{aligned} B|\alpha, s, \beta, r\rangle_j^{\leftarrow} &= \frac{[j]}{[s]}|\alpha, s, \beta, r\rangle_{j-1}^{\downarrow} + \beta \frac{[r][s-j]}{[s]}|\alpha, s, \beta, r\rangle_j^{\uparrow}, \\ B|\alpha, s, \beta, r\rangle_m^{\uparrow} &= [m]|\alpha, s, \beta, r\rangle_{m-1}^{\rightarrow}, \quad C|\alpha, s, \beta, r\rangle_m^{\uparrow} = |\alpha, s, \beta, r\rangle_m^{\leftarrow}, \\ B|\alpha, s, \beta, r\rangle_n^{\downarrow} &= \beta[r][n+1-s]|\alpha, s, \beta, r\rangle_n^{\rightarrow}, \quad C|\alpha, s, \beta, r\rangle_n^{\downarrow} = \beta[r-s]|\alpha, s, \beta, r\rangle_{n+1}^{\leftarrow}, \\ C|\alpha, s, \beta, r\rangle_j^{\rightarrow} &= \frac{1}{[s]}|\alpha, s, \beta, r\rangle_j^{\downarrow} + \beta \frac{[s-r]}{[s]}|\alpha, s, \beta, r\rangle_{j+1}^{\uparrow}. \end{aligned}$$

## 2.1.4 Ext<sup>1</sup> spaces for atypical modules

For two modules  $\mathcal{Z}_1$  and  $\mathcal{Z}_2$ , we define  $\text{Ext}^1(\mathcal{Z}_2, \mathcal{Z}_1)$  as a linear space with basis identified with nontrivial short exact sequences

$$0 \rightarrow \mathcal{Z}_1 \rightarrow \mathcal{Z}_1 \oplus \mathcal{Z}_2 \rightarrow \mathcal{Z}_2 \rightarrow 0.$$

modulo a certain equivalence relation [M].

The groups  $\text{Ext}^1$  vanish for the typical  $\mathcal{U}_q\mathfrak{sl}(2|1)$ -modules. For the atypical modules, the  $\text{Ext}^1(\mathcal{Z}_1, \mathcal{Z}_2)$  group is at most 1-dimensional. Whenever  $\text{Ext}^1(\mathcal{Z}_1, \mathcal{Z}_2)$  is nontrivial, we describe the algebra action in terms of generators: the action of a  $\mathcal{U}_q\mathfrak{sl}(2|1)$ -generator  $A$  on  $\mathcal{Z}_1 \oplus \mathcal{Z}_2$  is given by

$$\rho_A = \rho_A^{(0)} + \xi_A,$$

where  $\rho_A^{(0)}$  is the direct sum of actions of  $\mathcal{U}_q\mathfrak{sl}(2|1)$ -generators on the simple modules and  $\xi_A = \xi_A^{\mathcal{Z}_1, \mathcal{Z}_2} : \mathcal{Z}_1 \rightarrow \mathcal{Z}_2$  are linear maps.

We list the  $\xi_A$  maps in terms of the bases introduced above. The formulas can be somewhat uniformized by adopting the following convention for the 1-dimensional modules  $\mathcal{Z}_{1,0}^{\alpha,-\beta}$ : we denote this module also by  $\mathcal{Z}_{0,0}^{\alpha,\beta}$ , with a basis vector  $|\alpha, 0, \beta, 0\rangle_0^{\rightarrow} = |\alpha, 1, -\beta, 0\rangle_0^{\leftarrow}$

(and, formally, with  $|\alpha, 0, \beta, 0\rangle_m^{\leftarrow} = 0$ ,  $m \neq 0$ ). We then have

$$\begin{aligned}
\text{Ext}^1(\mathcal{Z}_{s,0}^{\alpha,\beta}, \mathcal{Z}_{s+1,0}^{\alpha,-\beta}) &= \{b_{s+1}\}, & \xi_B : |\alpha, s, \beta, 0\rangle_m^{\leftarrow} &\mapsto -[s-m]|\alpha, s+1, -\beta, 0\rangle_m^{\leftarrow}, \\
(s \geq 1) & & \xi_B : |\alpha, s, \beta, 0\rangle_m^{\rightarrow} &\mapsto [s-m-1]|\alpha, s+1, -\beta, 0\rangle_m^{\rightarrow}, \\
\text{Ext}^1(\mathcal{Z}_{s,0}^{\alpha,\beta}, \mathcal{Z}_{s-1,0}^{\alpha,-\beta}) &= \{c_{s-1}\}, & \xi_C : |\alpha, s, \beta, 0\rangle_m^{\leftarrow} &\mapsto |\alpha, s-1, -\beta, 0\rangle_m^{\leftarrow}, \\
(s \geq 2) & & \xi_C : |\alpha, s, \beta, 0\rangle_m^{\rightarrow} &\mapsto |\alpha, s-1, -\beta, 0\rangle_m^{\rightarrow}, \\
\text{Ext}^1(\mathcal{Z}_{s,s}^{\alpha,\beta}, \mathcal{Z}_{s-1,s-1}^{\alpha,-\beta}) &= \{\bar{b}_{s-1}\}, & \xi_B : |\alpha, s, \beta, s\rangle_m^{\leftarrow} &\mapsto -[m]|\alpha, s-1, -\beta, s-1\rangle_{m-1}^{\leftarrow}, \\
(s \geq 1) & & \xi_B : |\alpha, s, \beta, s\rangle_m^{\rightarrow} &\mapsto [m]|\alpha, s-1, -\beta, s-1\rangle_{m-1}^{\rightarrow}, \\
\text{Ext}^1(\mathcal{Z}_{s,s}^{\alpha,\beta}, \mathcal{Z}_{s+1,s+1}^{\alpha,-\beta}) &= \{\bar{c}_{s+1}\}, & \xi_C : |\alpha, s, \beta, s\rangle_m^{\leftarrow} &\mapsto |\alpha, s+1, -\beta, s+1\rangle_{m+1}^{\leftarrow}, \\
(s \geq 0) & & \xi_C : |\alpha, s, \beta, s\rangle_m^{\rightarrow} &\mapsto |\alpha, s+1, -\beta, s+1\rangle_{m+1}^{\rightarrow}.
\end{aligned}$$

### 2.1.5 Projective $\mathcal{U}_qsl(2|1)$ -modules

There are two types of projective  $\mathcal{U}_qsl(2|1)$ -modules.

#### Simple projective modules

All simple typical modules described in **2.1.3** are projective.

#### Projective covers of atypical modules

We use the notation  $\mathcal{R}_{s,0}^{\alpha,\beta}$  and  $\mathcal{R}_{s,s}^{\alpha,\beta}$  for projective covers of  $\mathcal{Z}_{s,0}^{\alpha,\beta}$  and  $\mathcal{Z}_{s,s}^{\alpha,\beta}$  (where, as before,  $\alpha, \beta = \pm 1$  and  $s \geq 1$ ). We describe the projective covers in terms of Loewy graphs. The reconstruction of the  $\mathcal{U}_qsl(2|1)$ -action on a projective module from its Loewy graph is described in detail in [ST, Sec. 6]. The action  $\rho_A(\nu)$  of a generator  $A$  on a vector  $\nu$  has three parts:

$$\rho_A(\nu) = \rho_A^{(0)}(\nu) + c(\nu)\xi_A(\nu) + \eta_A(\nu),$$

where  $\rho_A^{(0)}(\nu)$  is the action of  $A$  in the irreducible subquotient,  $\xi_A$  is determined in **2.1.4**, and for the map  $\eta_A$  we give explicit formulas after each Loewy graph (whenever  $\eta_A$  is nonzero). Here  $c(\nu)$  are some coefficients depending on a pair of simple subquotients in the projective module in question. We write them on edges in Loewy graphs (see [ST] for a detailed explanation).

It is convenient to distinguish between two series and two exceptional cases of projective

covers. The first series is  $\mathcal{R}_{s,0}^{\alpha,\beta}$ ,  $s \geq 2$ , with the Loewy graph

$$\begin{array}{ccc}
 & \mathcal{Z}_{s,0}^{\alpha,\beta} & \\
 -[s-1] \swarrow & & \searrow -[s] \\
 \mathcal{Z}_{s+1,0}^{\alpha,-\beta} & & \mathcal{Z}_{s-1,0}^{\alpha,-\beta} \\
 1 \searrow & & \swarrow 1 \\
 & \mathcal{Z}_{s,0}^{\alpha,\beta} &
 \end{array} \tag{1.15}$$

where

$$\eta_B : |\alpha, s, \beta, 0\rangle_n^{\leftarrow \Delta} \mapsto -\beta[n]|\alpha, s, \beta, 0\rangle_{n-1}^{\rightarrow \nabla}.$$

Here  $v^\Delta$  denotes the vector  $v$  from the top subquotient, and  $v_\nabla$  denotes vector  $v$  from the bottom subquotient.

The second series is  $\mathcal{R}_{s,s}^{\alpha,\beta}$ ,  $s \geq 2$ , with the Loewy graph

$$\begin{array}{ccc}
 & \mathcal{Z}_{s,s}^{\alpha,\beta} & \\
 -[s] \swarrow & & \searrow -[s+1] \\
 \mathcal{Z}_{s+1,s+1}^{\alpha,-\beta} & & \mathcal{Z}_{s-1,s-1}^{\alpha,-\beta} \\
 1 \searrow & & \swarrow 1 \\
 & \mathcal{Z}_{s,s}^{\alpha,\beta} &
 \end{array} \tag{1.16}$$

and with

$$\eta_C : |\alpha, s, \beta, s\rangle_n^{\rightarrow \Delta} \mapsto |\alpha, s, \beta, s\rangle_n^{\leftarrow \nabla}.$$

The two exceptional cases are  $\mathcal{R}_{1,0}^{\alpha,\beta}$  and  $\mathcal{R}_{1,1}^{\alpha,\beta}$ , with the respective Loewy graphs

$$\begin{array}{ccc}
 & \mathcal{Z}_{1,0}^{\alpha,\beta} & \\
 1 \swarrow & & \searrow -1 \\
 \mathcal{Z}_{2,0}^{\alpha,-\beta} & & \mathcal{Z}_{1,1}^{\alpha,\beta} \\
 1 \searrow & & \swarrow 1 \\
 & \mathcal{Z}_{1,0}^{\alpha,\beta} &
 \end{array}
 \qquad
 \begin{array}{ccc}
 & \mathcal{Z}_{1,1}^{\alpha,\beta} & \\
 -[1] \swarrow & & \searrow -[2] \\
 \mathcal{Z}_{2,2}^{\alpha,-\beta} & & \mathcal{Z}_{1,0}^{\alpha,\beta} \\
 1 \searrow & & \swarrow 1 \\
 & \mathcal{Z}_{1,1}^{\alpha,\beta} &
 \end{array} \tag{1.17}$$

These modules have dimensions

$$\begin{aligned}\dim \mathcal{R}_{s,0}^{\alpha,\beta} &= 8s - 4, & s > 1, \\ \dim \mathcal{R}_{s,s}^{\alpha,\beta} &= 8s + 4, & s \geq 1, \\ \dim \mathcal{R}_{1,0}^{\alpha,\beta} &= 8.\end{aligned}$$

## 2.2 The mixed tensor product

We study the mixed tensor product

$$\mathcal{F}_{m,n} = \mathbf{3}^{\otimes m} \otimes \bar{\mathbf{3}}^{\otimes n}, \quad (2.18)$$

where  $\mathbf{3} = \mathcal{Z}_{1,1}^{1,-1}$  and  $\bar{\mathbf{3}} = \mathcal{Z}_{2,0}^{1,1}$  are two three-dimensional simple  $\mathcal{U}_q\mathfrak{sl}(2|1)$ -modules with the following structure

$$\begin{array}{ccc} & |\rangle_0^{\rightarrow} & |\rangle_0^{\leftarrow} \\ \mathbf{3} = & |\rangle_0^{\leftarrow} & \bar{\mathbf{3}} = & |\rangle_0^{\rightarrow} \\ & |\rangle_1^{\rightarrow} & & |\rangle_1^{\leftarrow} \end{array} \quad (2.19)$$

We are interested in decomposing  $\mathcal{F}_{m,n}$  as a bimodule over  $\mathcal{U}_q\mathfrak{sl}(2|1)$  and its centralizer  $\mathcal{X}_{m,n}$ . As a necessary first step, we decompose tensor products of relevant  $\mathcal{U}_q\mathfrak{sl}(2|1)$ -modules with the fundamental modules  $\mathcal{Z}_{1,1}^{\alpha,\beta}$  and  $\mathcal{Z}_{2,0}^{\alpha,\beta}$ .

**Theorem 2.2.1** *Tensor products  $\mathcal{Z} \otimes \mathcal{Z}_{1,1}^{\alpha,\beta}$ , where  $\mathcal{Z}$  ranges the atypical and typical simple modules and their projective covers, decompose as follows:*

$$\begin{aligned}\mathcal{Z}_{s,0}^{\alpha_1,\beta_1} \otimes \mathcal{Z}_{1,1}^{\alpha_2,\beta_2} &= \mathcal{Z}_{s-1,0}^{\alpha_{12},-\beta_{12}} + \mathcal{Z}_{s,1}^{\alpha_{12},\beta_{12}}, & s \geq 2, \\ \mathcal{Z}_{s,s}^{\alpha_1,\beta_1} \otimes \mathcal{Z}_{1,1}^{\alpha_2,\beta_2} &= \mathcal{Z}_{s+1,s+1}^{\alpha_{12},-\beta_{12}} + \mathcal{Z}_{s,s+1}^{\alpha_{12},\beta_{12}}, & s \geq 1, \\ \mathcal{Z}_{s,r}^{\alpha_1,\beta_1} \otimes \mathcal{Z}_{1,1}^{\alpha_2,\beta_2} &= \begin{cases} \mathcal{R}_{s+1,0}^{\alpha_{12},-\beta_{12}} + \mathcal{Z}_{s-1,-1}^{\alpha_{12},-\beta_{12}}, & r = -1, \\ \mathcal{R}_{s-1,s-1}^{\alpha_{12},-\beta_{12}} + \mathcal{Z}_{s+1,s}^{\alpha_{12},-\beta_{12}}, & r = s-1, \\ \mathcal{Z}_{s,r+1}^{\alpha_{12},\beta_{12}} + \mathcal{Z}_{s+1,r+1}^{\alpha_{12},-\beta_{12}} + \mathcal{Z}_{s-1,r}^{\alpha_{12},-\beta_{12}} & \text{otherwise,} \end{cases} & s \geq 2\end{aligned}$$

and

$$\begin{aligned}\mathcal{R}_{s,0}^{\alpha_1,\beta_1} \otimes \mathcal{Z}_{1,1}^{\alpha_2,\beta_2} &= \mathcal{R}_{s-1,0}^{\alpha_{12},-\beta_{12}} + 2\mathcal{Z}_{s,1}^{\alpha_{12},\beta_{12}} + \mathcal{Z}_{s-1,1}^{\alpha_{12},-\beta_{12}} + \mathcal{Z}_{s+1,1}^{\alpha_{12},-\beta_{12}}, & s \geq 3, \\ \mathcal{R}_{s,s}^{\alpha_1,\beta_1} \otimes \mathcal{Z}_{1,1}^{\alpha_2,\beta_2} &= \mathcal{R}_{s+1,s+1}^{\alpha_{12},-\beta_{12}} + 2\mathcal{Z}_{s,s+1}^{\alpha_{12},\beta_{12}} + \mathcal{Z}_{s-1,s}^{\alpha_{12},-\beta_{12}} + \mathcal{Z}_{s+1,s+2}^{\alpha_{12},-\beta_{12}}, & s \geq 2,\end{aligned}$$

where we write  $\alpha_{12} = \alpha_1\alpha_2$  and  $\beta_{12} = \beta_1\beta_2$ .

The exceptional cases are listed below:

$$\begin{aligned}
\mathcal{Z}_{1,0}^{\alpha_1,\beta_1} \otimes \mathcal{Z}_{1,1}^{\alpha_2,\beta_2} &= \mathcal{Z}_{1,1}^{\alpha_{12},\beta_{12}}, \\
\mathcal{Z}_{1,-1}^{\alpha_1,\beta_1} \otimes \mathcal{Z}_{1,1}^{\alpha_2,\beta_2} &= \mathcal{R}_{2,0}^{\alpha_{12},-\beta_{12}}, \\
\mathcal{Z}_{1,r}^{\alpha_1,\beta_1} \otimes \mathcal{Z}_{1,1}^{\alpha_2,\beta_2} &= \mathcal{Z}_{1,r+1}^{\alpha_{12},\beta_{12}} + \mathcal{Z}_{2,r+1}^{\alpha_{12},-\beta_{12}}, \quad r \neq -1, 0, 1, \\
\mathcal{R}_{2,0}^{\alpha_1,\beta_1} \otimes \mathcal{Z}_{1,1}^{\alpha_2,\beta_2} &= \mathcal{R}_{1,0}^{\alpha_{12},-\beta_{12}} + 2\mathcal{Z}_{2,1}^{\alpha_{12},\beta_{12}} + \mathcal{Z}_{3,1}^{\alpha_{12},-\beta_{12}}, \\
\mathcal{R}_{1,0}^{\alpha_1,\beta_1} \otimes \mathcal{Z}_{1,1}^{\alpha_2,\beta_2} &= \mathcal{R}_{1,1}^{\alpha_{12},\beta_{12}} + \mathcal{Z}_{1,2}^{\alpha_{12},\beta_{12}} + \mathcal{Z}_{2,1}^{\alpha_{12},-\beta_{12}}, \\
\mathcal{R}_{1,1}^{\alpha_1,\beta_1} \otimes \mathcal{Z}_{1,1}^{\alpha_2,\beta_2} &= \mathcal{R}_{2,2}^{\alpha_{12},-\beta_{12}} + 2\mathcal{Z}_{1,2}^{\alpha_{12},\beta_{12}} + \mathcal{Z}_{2,3}^{\alpha_{12},-\beta_{12}}.
\end{aligned}$$

The tensor products  $\mathcal{Z} \otimes \mathcal{Z}_{2,0}^{\alpha,\beta}$  decompose as:

$$\left. \begin{aligned}
\mathcal{Z}_{s,0}^{\alpha_1,\beta_1} \otimes \mathcal{Z}_{2,0}^{\alpha_2,\beta_2} &= \mathcal{Z}_{s+1,0}^{\alpha_{12},\beta_{12}} + \mathcal{Z}_{s-1,-1}^{\alpha_{12},\beta_{12}}, \\
\mathcal{Z}_{s,s}^{\alpha_1,\beta_1} \otimes \mathcal{Z}_{2,0}^{\alpha_2,\beta_2} &= \mathcal{Z}_{s-1,s-1}^{\alpha_{12},\beta_{12}} + \mathcal{Z}_{s+1,s}^{\alpha_{12},\beta_{12}}, \\
\mathcal{Z}_{s,r}^{\alpha_1,\beta_1} \otimes \mathcal{Z}_{2,0}^{\alpha_2,\beta_2} &= \begin{cases} \mathcal{R}_{s,0}^{\alpha_{12},-\beta_{12}} + \mathcal{Z}_{s+1,1}^{\alpha_{12},\beta_{12}}, & r = 1, \\ \mathcal{R}_{s,s}^{\alpha_{12},-\beta_{12}} + \mathcal{Z}_{s-1,s}^{\alpha_{12},\beta_{12}}, & r = s + 1, \\ \mathcal{Z}_{s+1,r}^{\alpha_{12},\beta_{12}} + \mathcal{Z}_{s,r-1}^{\alpha_{12},-\beta_{12}} + \mathcal{Z}_{s-1,r-1}^{\alpha_{12},\beta_{12}}, & \text{otherwise,} \end{cases} \quad s \geq 2
\end{aligned} \right\}$$

and

$$\begin{aligned}
\mathcal{R}_{s,0}^{\alpha_1,\beta_1} \otimes \mathcal{Z}_{2,0}^{\alpha_2,\beta_2} &= \mathcal{R}_{s+1,0}^{\alpha_{12},\beta_{12}} + 2\mathcal{Z}_{s-1,-1}^{\alpha_{12},\beta_{12}} + \mathcal{Z}_{s,-1}^{\alpha_{12},-\beta_{12}} + \mathcal{Z}_{s-2,-1}^{\alpha_{12},-\beta_{12}}, \quad s \geq 3, \\
\mathcal{R}_{s,s}^{\alpha_1,\beta_1} \otimes \mathcal{Z}_{2,0}^{\alpha_2,\beta_2} &= \mathcal{R}_{s-1,s-1}^{\alpha_{12},\beta_{12}} + 2\mathcal{Z}_{s+1,s}^{\alpha_{12},\beta_{12}} + \mathcal{Z}_{s+2,s+1}^{\alpha_{12},-\beta_{12}} + \mathcal{Z}_{s,s-1}^{\alpha_{12},-\beta_{12}}, \quad s \geq 2.
\end{aligned}$$

The exceptional cases are:

$$\begin{aligned}
\mathcal{Z}_{1,0}^{\alpha_1,\beta_1} \otimes \mathcal{Z}_{2,0}^{\alpha_2,\beta_2} &= \mathcal{Z}_{2,0}^{\alpha_{12},\beta_{12}}, \\
\mathcal{Z}_{1,1}^{\alpha_1,\beta_1} \otimes \mathcal{Z}_{2,0}^{\alpha_2,\beta_2} &= \mathcal{Z}_{1,0}^{\alpha_{12},-\beta_{12}} + \mathcal{Z}_{2,1}^{\alpha_{12},\beta_{12}}, \\
\mathcal{Z}_{1,2}^{\alpha_1,\beta_1} \otimes \mathcal{Z}_{2,0}^{\alpha_2,\beta_2} &= \mathcal{R}_{1,1}^{\alpha_{12},-\beta_{12}}, \\
\mathcal{Z}_{1,r}^{\alpha_1,\beta_1} \otimes \mathcal{Z}_{2,0}^{\alpha_2,\beta_2} &= \mathcal{Z}_{1,r-1}^{\alpha_{12},-\beta_{12}} + \mathcal{Z}_{2,r}^{\alpha_{12},\beta_{12}}, \quad r \neq 0, 1, 2, \\
\mathcal{R}_{2,0}^{\alpha_1,\beta_1} \otimes \mathcal{Z}_{2,0}^{\alpha_2,\beta_2} &= \mathcal{R}_{3,0}^{\alpha_{12},\beta_{12}} + 2\mathcal{Z}_{1,-1}^{\alpha_{12},\beta_{12}} + \mathcal{Z}_{2,-1}^{\alpha_{12},-\beta_{12}}, \\
\mathcal{R}_{1,0}^{\alpha_1,\beta_1} \otimes \mathcal{Z}_{2,0}^{\alpha_2,\beta_2} &= \mathcal{R}_{2,0}^{\alpha_{12},\beta_{12}} + \mathcal{Z}_{1,-1}^{\alpha_{12},-\beta_{12}} + \mathcal{Z}_{2,1}^{\alpha_{12},\beta_{12}}, \\
\mathcal{R}_{1,1}^{\alpha_1,\beta_1} \otimes \mathcal{Z}_{2,0}^{\alpha_2,\beta_2} &= \mathcal{R}_{1,0}^{\alpha_{12},-\beta_{12}} + 2\mathcal{Z}_{2,1}^{\alpha_{12},\beta_{12}} + \mathcal{Z}_{3,2}^{\alpha_{12},-\beta_{12}}.
\end{aligned}$$

**Remark.** It follows, in particular, that the set of simple modules and their projective covers is closed under tensor product decompositions.

**Proof.** We discuss two cases:  $\mathcal{Z}_{s,s}^{\alpha_1,\beta_1} \otimes \mathcal{Z}_{1,1}^{\alpha_2,\beta_2}$  and  $\mathcal{Z}_{s,s-1}^{\alpha_1,\beta_1} \otimes \mathcal{Z}_{1,1}^{\alpha_2,\beta_2}$ . Other cases are similar.

We consider the  $\mathcal{U}_q\mathfrak{sl}(2|1)$ -modules in the left-hand side of the tensor product as  $\mathcal{U}_q\mathfrak{gl}(2)$ -modules (as explained in **2.1.3**) and calculate their tensor product using the results from [BGT]. For the tensor product  $\mathcal{Z}_{s,s}^{\alpha_1,\beta_1} \otimes \mathcal{Z}_{1,1}^{\alpha_2,\beta_2}$ , we have

$$\begin{aligned} \mathcal{Z}_{s,s}^{\alpha_1,\beta_1} \otimes \mathcal{Z}_{1,1}^{\alpha_2,\beta_2} &= \left( \mathcal{X}_{s,s}^{\alpha_1,\beta_1} \oplus \mathcal{X}_{s+1,s}^{\alpha_1,-\beta_1} \right) \otimes \left( \mathcal{X}_{1,1}^{\alpha_2,\beta_2} \oplus \mathcal{X}_{2,1}^{\alpha_2,-\beta_2} \right) \\ &= \mathcal{X}_{s,s+1}^{\alpha_{12},\beta_{12}} \oplus \mathcal{X}_{s+1,s+1}^{\alpha_{12},-\beta_{12}} \oplus \mathcal{X}_{s-1,s}^{\alpha_{12},-\beta_{12}} \oplus \mathcal{X}_{s+1,s+1}^{\alpha_{12},-\beta_{12}} \oplus \mathcal{X}_{s+2,s+1}^{\alpha_{12},\beta_{12}} \oplus \mathcal{X}_{s,s}^{\alpha_{12},\beta_{12}}. \end{aligned} \quad (2.20)$$

Decomposition (2.20) contains six  $\mathcal{U}_q\mathfrak{gl}(2)$ -modules. Taking into account that a typical module contains four  $\mathcal{U}_q\mathfrak{gl}(2)$ -summands and an atypical one contains two, the module in (2.20) can be the direct sum of either three atypical  $\mathcal{U}_q\mathfrak{sl}(2|1)$ -modules or one typical and one atypical module. Explicitly writing the decompositions of possible  $\mathcal{U}_q\mathfrak{sl}(2|1)$ -modules shows that there exists only one  $\mathcal{U}_q\mathfrak{sl}(2|1)$ -module that has the decomposition (2.20). The second and the fifth summands can be combined into  $\mathcal{Z}_{s+1,s+1}^{\alpha_{12},-\beta_{12}}$  and the other four summands give  $\mathcal{Z}_{s,s+1}^{\alpha_{12},\beta_{12}}$ . Thus, we have

$$\mathcal{Z}_{s,s}^{\alpha_1,\beta_1} \otimes \mathcal{Z}_{1,1}^{\alpha_2,\beta_2} = \mathcal{Z}_{s+1,s+1}^{\alpha_{12},-\beta_{12}} \oplus \mathcal{Z}_{s,s+1}^{\alpha_{12},\beta_{12}}.$$

We next consider the product  $\mathcal{Z}_{s,s-1}^{\alpha_1,\beta_1} \otimes \mathcal{Z}_{1,1}^{\alpha_2,\beta_2}$ . The  $\mathcal{U}_q\mathfrak{gl}(2)$ -decomposition is

$$\begin{aligned} \mathcal{Z}_{s,s-1}^{\alpha_1,\beta_1} \otimes \mathcal{Z}_{1,1}^{\alpha_2,\beta_2} &= \left( \mathcal{X}_{s,s-1}^{\alpha,\beta} \oplus \mathcal{X}_{s+1,s-1}^{\alpha_1,-\beta_1} \oplus \mathcal{X}_{s-1,s-2}^{\alpha_1,-\beta_1} \oplus \mathcal{X}_{s,s-2}^{\alpha_1,\beta_1} \right) \otimes \left( \mathcal{X}_{1,1}^{\alpha_2,\beta_2} \oplus \mathcal{X}_{2,1}^{\alpha_2,-\beta_2} \right) \\ &= \mathcal{X}_{s,s}^{\alpha_{12},\beta_{12}} \oplus \mathcal{X}_{s+1,s}^{\alpha_{12},-\beta_{12}} \oplus \mathcal{X}_{s-1,s-1}^{\alpha_{12},-\beta_{12}} \oplus \mathcal{X}_{s,s-1}^{\alpha_{12},\beta_{12}} \oplus \mathcal{X}_{s+1,s}^{\alpha_{12},-\beta_{12}} \oplus \mathcal{X}_{s+2,s}^{\alpha_{12},\beta_{12}} \\ &\quad \oplus \mathcal{X}_{s,s-1}^{\alpha_{12},\beta_{12}} \oplus \mathcal{X}_{s+1,s-1}^{\alpha_{12},-\beta_{12}} \oplus \mathcal{X}_{s-1,s-1}^{\alpha,-\beta} \oplus \mathcal{X}_{s,s-1}^{\alpha_{12},\beta_{12}} \oplus \mathcal{X}_{s-2,s-2}^{\alpha_{12},\beta_{12}} \oplus \mathcal{X}_{s-1,s-2}^{\alpha_{12},-\beta_{12}}. \end{aligned} \quad (2.21)$$

Because  $\mathcal{Z}_{s,s-1}^{\alpha_1,\beta_1}$  is a projective simple module (see **2.1.5**), the decomposition of  $\mathcal{Z}_{s,s-1}^{\alpha_1,\beta_1} \otimes \mathcal{Z}_{1,1}^{\alpha_2,\beta_2}$  involves only projective modules, which, as we recall from **2.1.5**, consist of all typical simple modules and the  $\mathcal{R}_{s,r}^{\alpha,\beta}$ . There are several  $\mathcal{U}_q\mathfrak{sl}(2|1)$ -modules that have the  $\mathcal{U}_q\mathfrak{gl}(2)$ -decomposition (2.21), but only one of them is projective.\* Thus, we have

$$\mathcal{Z}_{s,s-1}^{\alpha_1,\beta_1} \otimes \mathcal{Z}_{1,1}^{\alpha_2,\beta_2} = \mathcal{R}_{s-1,s-1}^{\alpha_{12},-\beta_{12}} \oplus \mathcal{Z}_{s+1,s}^{\alpha_{12},-\beta_{12}}.$$

The cases  $\mathcal{R}_{s,0}^{\alpha_1,\beta_1} \otimes \mathcal{Z}_{1,1}^{\alpha_2,\beta_2}$  and  $\mathcal{R}_{s,s}^{\alpha_1,\beta_1} \otimes \mathcal{Z}_{1,1}^{\alpha_2,\beta_2}$  are worked out similarly. We consider  $\mathcal{U}_q\mathfrak{gl}(2)$ -decompositions of both tensorands and calculate tensor products of  $\mathcal{U}_q\mathfrak{gl}(2)$ -modules. This gives a long direct sum of simple and projective  $\mathcal{U}_q\mathfrak{gl}(2)$ -modules that each time are combined uniquely into a sum of projective  $\mathcal{U}_q\mathfrak{sl}(2|1)$ -modules. ■

---

\*For example, the direct sum of simple  $\mathcal{U}_q\mathfrak{sl}(2|1)$ -modules  $2\mathcal{Z}_{s-1,s-1}^{\alpha_{12},-\beta_{12}} \oplus \mathcal{Z}_{s,s}^{\alpha_{12},\beta_{12}} \oplus \mathcal{Z}_{s-2,s-2}^{\alpha_{12},\beta_{12}} \oplus \mathcal{Z}_{s+1,s}^{\alpha_{12},-\beta_{12}}$  is compatible with the  $\mathcal{U}_q\mathfrak{gl}(2)$ -decomposition (2.21), but is not a projective  $\mathcal{U}_q\mathfrak{sl}(2|1)$ -module.



**Remark.** Decomposition of all tensor products of finite dimensional  $sl(2|1)$ -representations into their indecomposable building blocks was found in [GQS].

## 2.2.2 The centralizer of $\mathcal{U}_qsl(2|1)$ on the mixed tensor product

We calculate decomposition of  $\mathcal{T}_{m,n}$  iteratively using Theorem 2.2.1. The multiplicities of indecomposable  $\mathcal{U}_qsl(2|1)$ -modules are dimensions of  $\mathcal{X}_{m,n}$ -modules, which we discuss below.

We fix bases in the  $\mathbf{3}$  and  $\bar{\mathbf{3}}$  modules in accordance with 2.1.3 and introduce a shorthand notation for them:

$$\begin{aligned} f_1 &= |1, 1; -1, 1\rangle_0^{\leftarrow}, & f_2 &= |1, 1; -1, 1\rangle_0^{\rightarrow}, & f_3 &= |1, 1; -1, 1\rangle_1^{\rightarrow}, \\ v_1 &= |1, 2; 1, 0\rangle_0^{\rightarrow}, & v_2 &= |1, 2; 1, 0\rangle_1^{\leftarrow}, & v_3 &= |1, 2; 1, 0\rangle_0^{\leftarrow}. \end{aligned}$$

In the tensor products of two  $\mathcal{U}_qsl(2|1)$ -modules, we then have the operators

$$g : \mathbf{3} \otimes \mathbf{3} \mapsto \mathbf{3} \otimes \mathbf{3}, \quad \mathcal{E} : \mathbf{3} \otimes \bar{\mathbf{3}} \mapsto \mathbf{3} \otimes \bar{\mathbf{3}}, \quad h : \bar{\mathbf{3}} \otimes \bar{\mathbf{3}} \mapsto \bar{\mathbf{3}} \otimes \bar{\mathbf{3}},$$

that commute with  $\mathcal{U}_qsl(2|1)$  and given explicitly by

$$g : \begin{pmatrix} f_1 \otimes f_1 & f_1 \otimes f_2 & f_1 \otimes f_3 \\ f_2 \otimes f_1 & f_2 \otimes f_2 & f_2 \otimes f_3 \\ f_3 \otimes f_1 & f_3 \otimes f_2 & f_3 \otimes f_3 \end{pmatrix} \mapsto \begin{pmatrix} q^{-2}f_1 \otimes f_1 & -q^{-1}f_2 \otimes f_1 & -q^{-1}f_3 \otimes f_1 \\ (q^{-2}-1)f_2 \otimes f_1 - q^{-1}f_1 \otimes f_2 & -f_2 \otimes f_2 & -q^{-1}f_3 \otimes f_2 \\ (q^{-2}-1)f_3 \otimes f_1 - q^{-1}f_1 \otimes f_3 & (q^{-2}-1)f_3 \otimes f_2 - q^{-1}f_2 \otimes f_3 & -f_3 \otimes f_3 \end{pmatrix},$$

$$\mathcal{E} : \begin{pmatrix} f_1 \otimes v_1 & f_1 \otimes v_2 & f_1 \otimes v_3 \\ f_2 \otimes v_1 & f_2 \otimes v_2 & f_2 \otimes v_3 \\ f_3 \otimes v_1 & f_3 \otimes v_2 & f_3 \otimes v_3 \end{pmatrix} \mapsto \begin{pmatrix} 1 & 0 & 0 \\ 0 & -q & 0 \\ 0 & 0 & 1 \end{pmatrix} \cdot (q^2 f_1 \otimes v_1 + q f_2 \otimes v_2 - f_3 \otimes v_3),$$

and

$$h : \begin{pmatrix} v_1 \otimes v_1 & v_1 \otimes v_2 & v_1 \otimes v_3 \\ v_2 \otimes v_1 & v_2 \otimes v_2 & v_2 \otimes v_3 \\ v_3 \otimes v_1 & v_3 \otimes v_2 & v_3 \otimes v_3 \end{pmatrix} \mapsto \begin{pmatrix} q^{-2}v_1 \otimes v_1 & (q^{-2}-1)v_1 \otimes v_2 - q^{-1}v_2 \otimes v_1 & (q^{-2}-1)v_1 \otimes v_3 - q^{-1}v_3 \otimes v_1 \\ -q^{-1}v_1 \otimes v_2 & -v_2 \otimes v_2 & (q^{-2}-1)v_2 \otimes v_3 - q^{-1}v_3 \otimes v_2 \\ -q^{-1}v_1 \otimes v_3 & -q^{-1}v_2 \otimes v_3 & -v_3 \otimes v_3 \end{pmatrix}.$$

On  $\mathcal{T}_{m,n}$ , we define the operators

$$g_j = \underbrace{\mathbf{1} \otimes \cdots \otimes \mathbf{1}}_{m-j-1} \otimes g \otimes \underbrace{\mathbf{1} \otimes \cdots \otimes \mathbf{1}}_{n+j-1}, \quad (2.22)$$

$$h_i = \underbrace{\mathbf{1} \otimes \cdots \otimes \mathbf{1}}_{m+i-1} \otimes h \otimes \underbrace{\mathbf{1} \otimes \cdots \otimes \mathbf{1}}_{n-i-1}, \quad (2.23)$$

$$\mathcal{E} = \underbrace{\mathbf{1} \otimes \cdots \otimes \mathbf{1}}_{m-1} \otimes \mathcal{E} \otimes \underbrace{\mathbf{1} \otimes \cdots \otimes \mathbf{1}}_{n-1}. \quad (2.24)$$

These operators represent the generators of a quantum walled Brauer algebra. We have the following Theorem

**Theorem 2.2.3** *The generators  $g$ ,  $\mathcal{E}$ ,  $h$  (2.22)-(2.24) satisfy the  $\mathfrak{qB}_{m,n}$  relations with the parameters*

$$\begin{aligned} \gamma &= -1, \\ \delta &= q^{-2}, \\ \theta &= -q^{-2}. \end{aligned} \quad (2.25)$$

**Proof.** Straightforward verification. ■

**Remark.** By choice of normalization in matrices, the parameters  $\gamma$  and  $\delta$  can be changed, however the relation

$$\theta = \frac{\delta}{\gamma} \quad (2.26)$$

remains invariant. This relation means that we consider a degenerate case in which the algebra becomes non-semisimple as we discuss below.

**Corollary 2.2.4** *The endomorphism algebra of  $\mathcal{U}_q\mathfrak{sl}(2|1)$ -module  $\mathcal{T}_{m,n}$  is isomorphic to the quotient of the algebra  $\mathfrak{qB}_{m,n}$  with special parameters (2.25).*

One can consider an algebra  $\mathcal{U}_q\mathfrak{sl}(M|N)$  for arbitrary positive integers  $M$  and  $N$ . Let  $V$  and  $V^*$  be fundamental representation of  $\mathcal{U}_q\mathfrak{sl}(M|N)$  and its dual. We let  $\mathcal{X}_{m,n}^{M,N}$  denote the algebra of endomorphisms of  $\mathcal{U}_q\mathfrak{sl}(M|N)$  on mixed tensor product  $V^{\otimes m} \otimes V^{\otimes n}$ . As was shown in [SM] (see also [SM2, BS]) there is a surjective homomorphism

$$\Psi_{m,n}^{M,N} : \mathfrak{qB}_{m,n}(\gamma = -1, \delta = q^{-2}, \theta = -q^{-2(M-N)}) \rightarrow \mathcal{X}_{m,n}^{M,N}. \quad (2.27)$$

Here the parameter  $q$  is the same as in the algebra  $\mathcal{U}_q\mathfrak{sl}(M|N)$ .

We note that for  $N = 0$  the algebra  $\mathcal{X}_{m,n}^{M,0}$  is semisimple and  $\ker \Psi_{m,n}^{M,0}$  contains the whole radical of  $\mathfrak{qB}_{m,n}$ , see [H].

In entire work we consider only the case  $M = 2$ ,  $N = 1$  and use the notation  $\mathcal{X}_{m,n}$  for  $\mathcal{X}_{m,n}^{2,1}$ .

## 2.3 Quantum walled Brauer algebra

### 2.3.1 Definition

The algebra  $\mathfrak{qB}_{m,n}$  is an associative unital algebra generated by  $g_i, \mathcal{E}, h_j$ , where  $1 \leq i \leq m-1$  and  $1 \leq j \leq n-1$ , presented graphically by the following diagrams

$$\begin{aligned}
 g_i &:= \begin{array}{c} \cdots \quad \diagdown \quad \diagup \quad \cdots \\ | \quad \quad \quad | \quad \quad \quad | \\ \cdots \quad \quad \quad \cdots \quad \quad \quad \cdots \\ m \quad \quad i+1 \quad i \quad \quad 1 \quad 1 \quad \quad n \end{array}, \quad i = 1, \dots, m-1 \\
 \mathcal{E} &:= \begin{array}{c} \cdots \quad | \quad \cup \quad | \quad \cdots \\ | \quad \quad \quad | \quad \quad \quad | \\ \cdots \quad \quad \quad 1 \quad 1 \quad \quad \cdots \\ m \quad \quad \quad \quad \quad \quad n \end{array} \\
 h_i &:= \begin{array}{c} \cdots \quad | \quad \cdots \quad \diagdown \quad \diagup \quad \cdots \\ | \quad \quad \quad | \quad \quad \quad | \quad \quad \quad | \\ \cdots \quad \quad \quad \cdots \quad \quad \quad \cdots \quad \quad \quad \cdots \\ m \quad \quad 1 \quad 1 \quad \quad i \quad i+1 \quad \quad n \end{array}, \quad i = 1, \dots, n-1
 \end{aligned}$$

and relations (see [ST2, L, H, KM])

$$\begin{aligned}
 g_i h_j &= h_j g_i, \\
 (g_i - \gamma)(g_i - \delta) &= 0, \quad (h_j - \gamma)(h_j - \delta) = 0, \\
 g_i g_j &= g_j g_i, \quad |i - j| > 1, \quad h_i h_j = h_j h_i, \quad |i - j| > 1, \\
 g_i g_{i+1} g_i &= g_{i+1} g_i g_{i+1}, \quad h_i h_{i+1} h_i = h_{i+1} h_i h_{i+1}, \\
 \mathcal{E} \mathcal{E} &= \frac{\theta + 1}{\gamma + \delta} \mathcal{E}, \\
 \mathcal{E} g_1 \mathcal{E} &= \mathcal{E}, \quad \mathcal{E} h_1 \mathcal{E} = \mathcal{E}, \\
 \mathcal{E} g_i &= g_i \mathcal{E}, \quad 2 \leq i \leq m-1, \quad \mathcal{E} h_j = h_j \mathcal{E}, \quad 2 \leq j \leq n-1, \\
 \mathcal{E} g_1 h_1^{-1} \mathcal{E} &= 0, \quad (g_1 - h_1) \mathcal{E} g_1 h_1^{-1} \mathcal{E} = 0.
 \end{aligned}$$

These relations involve complex parameters  $\gamma, \delta$ , and  $\theta$ , and we sometimes use the notation  $\mathfrak{qB}_{m,n}(\gamma, \delta, \theta)$  for the algebra, although one parameter can be eliminated from the relations by

renormalizing the generators. We write the relations in the present form for more convenient comparison with different choices in literature.

We use the following statement (see [E]) in the next subsection

**Proposition 2.3.2** *There is an anti-involution  $\sigma$  on  $\mathfrak{qB}_{m,n}$  which fixes all generators  $\mathcal{E}$ ,  $g_i$  and  $h_j$ ,  $1 \leq g_i \leq m-1$  and  $1 \leq h_i \leq n-1$ .*

We define  $g_{i,j} = g_{i-1}g_{i-2}\dots g_j$ ,  $h_{i,j} = h_i h_{i+1} \dots h_{j-1}$  and  $\mathcal{E}_{i,j} = g_{1,i}^{-1} h_{j,1} \mathcal{E} g_{1,i} h_{j,1}^{-1}$ . For  $i < \min(m,n)$  we denote  $\mathcal{E}_i = \mathcal{E}_{i,i}$ .

**Remark.** The one-parameter walled Brauer algebra discussed in previous section can be considered as a classical limit of quantum walled Brauer algebra  $\mathfrak{qB}_{m,n}$ . To get this limit from the algebra with relations listed above we can do the following. By renormalization of generators, parameter  $\gamma$  can be set to  $\gamma = -1$ . We introduce a complex parameter  $r$ :

$$\theta = -\delta^r$$

so that the relation reads  $\mathcal{E}\mathcal{E} = -\frac{\delta^r - 1}{\delta - 1}\mathcal{E}$ . Then we consider the limit  $\delta \rightarrow 1$ . The dependent on parameters algebra relations become

$$\begin{aligned} g_i^2 &= h_i^2 = 1, \\ \mathcal{E}\mathcal{E} &= -r\mathcal{E}. \end{aligned}$$

### 2.3.3 Cell modules

#### Algebraic background

We recall the definition of cellular algebras from [GL].

**Definition.** Let  $A$  be an  $R$ -algebra, where  $R$  is a commutative ring containing the multiplicative identity 1. Fix a partially ordered set  $\Lambda = (\Lambda, \succeq)$  and for each  $\lambda \in \Lambda$  let  $T(\lambda)$  be a finite set. Finally, fix  $C_{\mathfrak{s}\mathfrak{t}} \in A$  for all  $\lambda \in \Lambda$  and  $\mathfrak{s}, \mathfrak{t} \in T(\lambda)$ .

Then the triple  $(\Lambda, T, C)$  is a *cell datum* for  $A$  if:

- a)  $\{C_{\mathfrak{s}\mathfrak{t}} \mid \lambda \in \Lambda \text{ and } \mathfrak{s}, \mathfrak{t} \in T(\lambda)\}$  is an  $R$ -basis for  $A$ ;
- b) the  $R$ -linear map  $*$  :  $A \rightarrow A$  determined by  $(C_{\mathfrak{s}\mathfrak{t}})^* = C_{\mathfrak{t}\mathfrak{s}}$ , for all  $\lambda \in \Lambda$  and for all  $\mathfrak{s}, \mathfrak{t} \in T(\lambda)$  is an anti-involution of  $A$ ;

c) for all  $\lambda \in \Lambda$ ,  $\mathfrak{s}, \mathfrak{t} \in T(\lambda)$  and  $a \in A$  there exist scalars  $r_{\mathfrak{t}\mathfrak{u}}(a) \in R$  such that

$$C_{\mathfrak{s}\mathfrak{t}}a = \sum_{\mathfrak{u} \in T(\lambda)} r_{\mathfrak{t}\mathfrak{u}}(a)C_{\mathfrak{s}\mathfrak{u}} \pmod{A^{\triangleright\lambda}},$$

where  $A^{\triangleright\lambda} = R\text{-span}\{C_{\mathfrak{u}\mathfrak{v}} \mid \mu \triangleright \lambda \text{ and } \mathfrak{u}, \mathfrak{v} \in T(\mu)\}$ . Furthermore, each scalar  $r_{\mathfrak{t}\mathfrak{u}}(a)$  is independent of  $\mathfrak{s}$ .

An algebra  $A$  is a *cellular algebra* if it has a cell datum. We call  $\{C_{\mathfrak{s}\mathfrak{t}} \mid \mathfrak{s}, \mathfrak{t} \in T(\lambda), \lambda \in \Lambda\}$  a *cellular basis* of  $A$ .

### Construction of the basis

Quantum walled Brauer algebra  $\mathfrak{q}\mathcal{B}_{m,n}$  is a cellular algebra ([E, RS]). It was shown in [E] that each cellular basis for the tensor product of Iwahori-Hecke algebras  $H_m(q) \otimes H_n(q)$  gives rise to a cellular structure on  $\mathfrak{q}\mathcal{B}_{m,n}$ . We discuss the construction of the cell basis of module following [RS]. Without loss of generality we use parameters of algebra given in [RS], it can be bring to the form used in present work.

Consider the Iwahori-Hecke algebra  $H_m$  with generators  $g_1, \dots, g_{m-1}$  and the Symmetric group  $\mathfrak{S}_m$  with generators  $s_1, \dots, s_{m-1}$ . Let  $g_w = g_{i_1} \dots g_{i_k}$  where  $w = s_{i_1} \dots s_{i_k}$  is a word in Symmetric group with minimal length.

Let  $\mathfrak{S}_m \times \mathfrak{S}_n$  be the product of  $\mathfrak{S}_m$  and  $\mathfrak{S}_n$ . We use  $s_i$  (respectively,  $s_i^*$ ) to denote generators in  $\mathfrak{S}_m$  (respectively,  $\mathfrak{S}_n$ ). For convenience, we denote  $s_{i,j} = s_{i-1}s_{i-2} \dots s_j$ ,  $i > j$  and  $s_{i,j} = s_i s_{i+1} \dots s_j$ ,  $i < j$  (similarly for  $s_{i,j}^*$ ). We have the following statement [E]

**Lemma 2.3.3.1** Fix  $m, n \in \mathbb{Z}^{>0}$  and  $f \in \mathbb{N}$  with  $f < \min(m, n)$ . Let  $\mathfrak{S}_f$  be a subgroup of  $\mathfrak{S}_m \times \mathfrak{S}_n$  generated by  $s_i s_i^*$ ,  $1 \leq i \leq f-1$ . Then  $\mathcal{D}_{m,n}^f$  is a complete set of right coset representatives for  $\mathfrak{S}_{m-f} \times \mathfrak{S}_f \times \mathfrak{S}_{n-f}$  in  $\mathfrak{S}_m \times \mathfrak{S}_n$  where

$$\mathcal{D}_{m,n}^f = \{s_{f,i_f} s_{f,j_f}^* \dots s_{1,i_1} s_{1,j_1}^* \mid k \leq j_k, 1 \leq i_1 < i_2 < \dots < j_f \leq m\}. \quad (3.28)$$

For each  $d \in \mathcal{D}_{m,n}^f$  we define  $g_{f,i_f} h_{f,j_f} \dots g_{1,i_1} h_{1,j_1}$ .

Let  $\lambda = (\lambda_1, \lambda_2, \dots, \lambda_d)$  be a partition and  $\Lambda(n)$  be the set of all partitions of  $n$ .  $\Lambda(n)$  is the poset with the following partial order: we set  $\lambda \trianglelefteq \mu$  for  $\lambda, \mu \in \Lambda(n)$  if  $\sum_{j=1}^i \lambda_j \leq \sum_{j=1}^i \mu_j$  for all possible  $i \leq d$ . We write  $\lambda \triangleleft \mu$  if  $\lambda \trianglelefteq \mu$  and  $\lambda \neq \mu$ .

For each Young diagram associated with partition  $\lambda \in \Lambda(n)$  we define a  $\lambda$ -tableau. The Symmetric group acts on a  $\lambda$ -tableau  $\mathfrak{s}$  by permuting its entries. We denote by  $\mathfrak{t}^\lambda$  a tableau obtained from  $\lambda$  by adding  $1, \dots, n$  from left to right along the rows. We write  $w = d(\mathfrak{s})$  if  $\mathfrak{t}^\lambda w = \mathfrak{s}$ .

Given a  $\lambda \in \Lambda(n)$ , let  $\mathfrak{S}_\lambda$  be the row stabilizer of  $\mathfrak{t}^\lambda$ . Define  $\mathbf{n}_\lambda = \sum_{w \in \mathfrak{S}_\lambda} (-q)^{l(w)} g_w$ , where  $l(w)$  is the length of  $w$ .

Let  $\boldsymbol{\lambda} = (\lambda^L, \lambda^R)$  be a bipartition and  $\Lambda$  be the set of all bipartitions as in Section 1.3.2. For each integer  $0 \leq f \leq \min(m, n)$ , we set

$$\Lambda_{m,n}(f) = \{(f, \boldsymbol{\lambda}) \mid \boldsymbol{\lambda} \in \Lambda, m - |\lambda^L| = n - |\lambda^R| = f\}, \quad (3.29)$$

where  $|\lambda|$  is the sum of elements of a partition, and

$$\Lambda_{m,n} = \bigcup_{f=0}^{\min(m,n)} \Lambda_{m,n}(f). \quad (3.30)$$

We say that  $(f, \boldsymbol{\lambda}) \supseteq (l, \boldsymbol{\mu})$  if either  $f > l$  or  $f = l$  and  $\boldsymbol{\lambda} \supseteq \boldsymbol{\mu}$  in the sense  $\lambda^{L(R)} \supseteq \mu^{L(R)}$ . We write  $(f, \boldsymbol{\lambda}) \triangleright (l, \boldsymbol{\mu})$  if  $(f, \boldsymbol{\lambda}) \supseteq (l, \boldsymbol{\mu})$  and  $(f, \boldsymbol{\lambda}) \neq (l, \boldsymbol{\mu})$ . Then  $\Lambda_{m,n}$  is a poset.

For  $\boldsymbol{\lambda} \in \Lambda_{m,n}^f$  we define  $\mathfrak{t}^\lambda = (\mathfrak{t}^{\lambda^L}, \mathfrak{t}^{\lambda^R})$  where  $\mathfrak{t}^{\lambda^{L(R)}}$  is defined as described above. Let  $\mathcal{T}^{std}(\lambda^{L(R)})$  be the set of standard  $\lambda^{L(R)}$ -tableau then  $\mathcal{T}^{std}(\boldsymbol{\lambda}) = \mathcal{T}^{std}(\lambda^L) \times \mathcal{T}^{std}(\lambda^R)$ . If  $\mathfrak{s}, \mathfrak{t} \in \mathcal{T}^{std}(\boldsymbol{\lambda})$  with  $\mathfrak{s} = (\mathfrak{s}_1, \mathfrak{s}_2)$  and  $\mathfrak{t} = (\mathfrak{t}_1, \mathfrak{t}_2)$  we define

$$\mathbf{n}_{\mathfrak{s}, \mathfrak{t}} = \sigma(g_{d(\mathfrak{s}_1)}, h_{d(\mathfrak{s}_2)}) \mathbf{n}_{\lambda^L} \mathbf{n}_{\lambda^R} g_{d(\mathfrak{t}_1)}, h_{d(\mathfrak{t}_2)} \quad (3.31)$$

The anti-involution  $\sigma$  is given in proposition 2.3.2.

Let  $\mathcal{B}_{m,n}^f$  be the two-sided ideal of  $\mathfrak{q}\mathcal{B}_{m,n}$  generated by  $\mathcal{E}^f = \mathcal{E}_1 \dots \mathcal{E}_f$ . Let  $\mathcal{B}_{m,n}^{\supseteq(f, \boldsymbol{\lambda})}$  be the two-sided ideal of  $\mathfrak{q}\mathcal{B}_{m,n}$  generated by  $\mathcal{B}_{m,n}^{f+1}$  and all  $\mathbf{n}_{\mathfrak{s}, \mathfrak{t}}$  with  $\mathfrak{s}, \mathfrak{t} \in \mathcal{T}^{std}(\boldsymbol{\mu})$  and  $(f, \boldsymbol{\mu}) \supseteq (f, \boldsymbol{\lambda})$ . Define

$$\mathcal{B}_{m,n}^{\triangleright(f, \boldsymbol{\lambda})} = \sum_{(f, \boldsymbol{\mu}) \triangleright (f, \boldsymbol{\lambda})} \mathcal{B}_{m,n}^{\supseteq(f, \boldsymbol{\mu})}$$

Thus, we have all building blocks to formulate the following proposition [RS]

**Proposition 2.3.4** *Suppose  $(f, \boldsymbol{\lambda}) \in \Lambda_{m,n}$ . We have*

- $S^R(f, \boldsymbol{\lambda})$  is a right  $\mathfrak{q}\mathcal{B}_{m,n}$ -module if  $S^R(f, \boldsymbol{\lambda})$  is the submodule of  $\mathcal{B}^{\supseteq(f, \boldsymbol{\lambda})} / \mathcal{B}^{\triangleright(f, \boldsymbol{\lambda})}$  spanned by  $\{\mathcal{E}^f \mathbf{n}_{\mathfrak{t}, \mathfrak{s}} g_d + \mathcal{B}^{\triangleright(f, \boldsymbol{\lambda})} \mid (\mathfrak{s}, d) \in \mathcal{T}^{std}(\boldsymbol{\lambda}) \times \mathcal{D}_{m,n}^f\}$ ;
- $S^L(f, \boldsymbol{\lambda})$  is a left  $\mathfrak{q}\mathcal{B}_{m,n}$ -module if  $S^L(f, \boldsymbol{\lambda})$  is the submodule of  $\mathcal{B}^{\supseteq(f, \boldsymbol{\lambda})} / \mathcal{B}^{\triangleright(f, \boldsymbol{\lambda})}$  spanned by  $\{\sigma(g_d) \mathcal{E}^f \mathbf{n}_{\mathfrak{t}, \mathfrak{s}} + \mathcal{B}^{\triangleright(f, \boldsymbol{\lambda})} \mid (\mathfrak{s}, d) \in \mathcal{T}^{std}(\boldsymbol{\lambda}) \times \mathcal{D}_{m,n}^f\}$ .

By [GL] every simple  $\mathfrak{q}\mathcal{B}_{m,n}$ -module arises in a unique way as the simple head of some cell module.

The results of the next Chapter are based on the following Conjecture

**Conjecture 1** *Representation categories of the algebra  $\mathfrak{q}\mathcal{B}_{m,n}$  with generic values of parameter  $\frac{\delta}{\gamma}$  and of the (classical) walled Brauer algebra are equivalent as abelian categories.*

## Properties of $q\mathcal{B}_{m,n}$ -modules arising from quasi-hereditary structure of the quantum walled Brauer algebra

In [RS] it was mentioned that the quantum walled Brauer algebra  $q\mathcal{B}_{m,n}$  with generic values of parameters  $\frac{\delta}{\gamma}$  is quasi-hereditary with standard modules  $S_{m,n}(\boldsymbol{\lambda})$ , with simple heads  $D_{m,n}(\boldsymbol{\lambda})$  and projective covers  $P_{m,n}(\boldsymbol{\lambda})$ .

Given the set of all bipartitions  $\Lambda_{m,n}$  we define a partial order on  $\Lambda_{m,n}$  by setting  $\boldsymbol{\lambda} \leq \boldsymbol{\mu}$  if  $\deg(\boldsymbol{\lambda}) \leq \deg(\boldsymbol{\mu})$ . The decomposition multiplicity

$$[S_{m,n}(\boldsymbol{\lambda}) : D_{m,n}(\boldsymbol{\mu})]$$

is zero unless  $\boldsymbol{\lambda} \leq \boldsymbol{\mu}$ .

From quasi-hereditary structure of  $q\mathcal{B}_{m,n}$  it follows that each projective module  $P_{m,n}(\boldsymbol{\lambda})$  has a filtration by standard modules. We denote the multiplicity of a given standard  $S_{m,n}(\boldsymbol{\lambda})$  in such filtration as

$$d_{\boldsymbol{\lambda},\boldsymbol{\mu}} = (P_{m,n}(\boldsymbol{\lambda}) : S_{m,n}(\boldsymbol{\mu}))$$

By Brauer-Humphreys reciprocity we have

$$d_{\boldsymbol{\lambda},\boldsymbol{\mu}} = [S_{m,n}(\boldsymbol{\mu}) : D_{m,n}(\boldsymbol{\lambda})]$$

In [CD] the decomposition numbers  $d_{\boldsymbol{\lambda},\boldsymbol{\mu}}$  for the classical walled Brauer algebra were determined using so-called cap diagrams. Without specifying any details we implicitly use these results in this Chapter.

## 2.4 Modules over $\mathcal{X}_{m,n}$

The results of this section are based on the Conjecture 1 and the Conjecture 2

**Conjecture 2** *The algebra  $\mathcal{X}_{m,n}$  is quasi-hereditary.*

### 2.4.1 Modules in the decomposition of the mixed tensor product

As a  $\mathcal{X}_{m,n} \boxtimes \mathcal{U}_q \mathfrak{sl}(2|1)$ -bimodule, the mixed tensor product  $\mathcal{T}_{m,n}$  decomposes into a direct sum of indecomposable bimodules.

**Definition 2.4.1.1** *For non-negative integers  $p, q$ , a partition  $\mu$  is called a  $(p, q)$ -hook partition if it doesn't contain a box in the  $(p+1, q+1)$ -position, i.e.  $\mu_{p+1} < q+1$ .*

Some examples of (2, 1)-hook partitions are

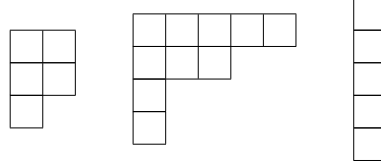

**Definition 2.4.1.2** (see [CW]) For non-negative integers  $p, q$  a bipartition  $\lambda = (\lambda^L, \lambda^R)$  is called a  $(p, q)$ -cross bipartition if there exist non-negative integers  $p_1, p_2, q_1, q_2$  such that  $\lambda^L$  is a  $(p_1, q_1)$ -hook partition,  $\lambda^R$  is a  $(p_2, q_2)$ -hook partition and  $p_1 + p_2 \leq p$ ,  $q_1 + q_2 \leq q$ .

Some examples of (2, 1)-cross bipartitions are

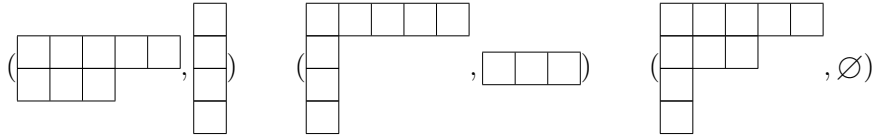

Let  $\mathcal{C}r_{m,n}$  be the subset of all (2, 1)-cross bipartitions in  $\Lambda_{m,n}$ . Assuming the Conjecture 1 and applying the statements from [BS, CW] for  $M = 2$ ,  $N = 1$ , we have

**Proposition 2.4.1.3** If  $\lambda \in \mathcal{C}r_{m,n}$  then  $\ker \Psi_{m,n}^{2,1}$  acts as zero on  $D(\lambda)$ . The modules  $D(\lambda)$ ,  $\lambda \in \mathcal{C}r_{m,n}$  give a complete set of simple  $\mathcal{X}_{m,n}$ -modules.

**Proposition 2.4.1.4** Each  $\mathcal{X}_{m,n}$ -simple module  $D(\lambda)$ ,  $\lambda \in \mathcal{C}r_{m,n}$  occurs as a subquotient in the bimodule decomposition of  $\mathcal{T}_{m,n}$ .

In the following we use notation  $a = |m - n|$ . For bipartitions from  $\mathcal{C}r_{m,n}$  we introduce the notation

for  $m \geq n$

$$\begin{aligned} A_s^a &= ((a, 1^s), (s)), \quad a > 0, \quad 0 \leq s \leq n, \\ B_s^a &= ((a, s), (1^s)), \quad a > 0, \quad 1 \leq s \leq \min(a, n), \\ C_s^a &= ((s+1, a+1), (1^{s+2})), \quad a \leq s \leq n-2, \quad a \geq 0, \end{aligned}$$

for  $m \leq n$

$$\begin{aligned} \hat{A}_s^a &= ((s), (a, 1^s)), \quad a > 0, \quad 0 \leq s \leq m, \\ A_0^0 &= \hat{A}_0^0 = (\emptyset, \emptyset), \\ \hat{B}_s^a &= ((1^s), (a, s)), \quad a > 0, \quad 1 \leq s \leq \min(a, m), \\ \hat{C}_s^a &= ((1^{s+2}), (s+1, a+1)), \quad a \leq s \leq m-2, \quad a \geq 0. \end{aligned}$$



We note that  $B_1^a = A_1^a$  and  $\hat{C}_0^0 = C_0^0$ .

For given  $m, n$  we define a subset  $\mathcal{At}_{m,n}$  of bipartitions in  $\mathcal{Cr}_{m,n}$  as

$$\mathcal{At}_{m,n} = \begin{cases} \{A_s^a | 0 \leq s \leq n\} \cup \{B_s^a | 2 \leq s \leq \min(a, n)\} \cup \{C_s^a | a \leq s \leq n-2\}, & m > n, \\ \{A_0^0\} \cup \{C_s^0 | 0 \leq s \leq n-2\} \cup \{\hat{C}_s^0 | 1 \leq s \leq n-2\}, & m = n, \\ \{\hat{A}_s^a | 0 \leq s \leq m\} \cup \{\hat{B}_s^a | 2 \leq s \leq \min(a, m)\} \cup \{\hat{C}_s^a | a \leq s \leq m-2\}, & m < n. \end{cases} \quad (4.32)$$

We call these bipartitions atypical. If  $\lambda \in \mathcal{At}_{m,n}$  we call corresponding modules  $S(\lambda)$  and  $D(\lambda)$  atypical also.

We define the operation  $\hat{G}$  from the set of  $\mathfrak{qB}_{m,n}$ -modules to the set of  $\mathfrak{qB}_{n,m}$ -modules. The operation  $\hat{G}$  acts on the simple  $\mathfrak{qB}_{m,n}$ -module by the formula

$$\hat{G}(D[\lambda^L, \lambda^R]) = D[\lambda^R, \lambda^L], \quad (4.33)$$

i.e. it changes left and right partitions in a bipartition. We note that  $\hat{G}A_s^a = \hat{A}_s^a$ , and similarly for  $B_s^a, C_s^a$ . When applied to projective modules, the operation  $\hat{G}$  acts on each simple subquotient by the formula (4.33) and does not change the structure of the Loewy graph. It is obvious that

$$K[\lambda^R, \lambda^L] = \hat{G}(K[\lambda^L, \lambda^R]). \quad (4.34)$$

The action of the algebra  $\mathcal{X}_{m,n}$  on an arbitrary  $\mathfrak{qB}_{m,n}$ -module is not defined in general. In particular, it is not defined on some  $\mathfrak{qB}_{m,n}$ -modules, that contain  $D(\lambda')$ ,  $\lambda' \notin \mathcal{Cr}_{m,n}$  as a subquotient. For  $\lambda \in \mathcal{Cr}_{m,n}$  we define a standard module over  $\mathcal{X}_{m,n}$  (abusing notation we use the same symbol  $S(\lambda)$  for it) as a factor of corresponding standard  $\mathfrak{qB}_{m,n}$ -module  $S(\lambda)$  over all subquotients  $D(\lambda')$  with  $\lambda' \notin \mathcal{Cr}_{m,n}$ .

Similarly we denote by  $K(\lambda)$  the projective cover for  $\mathcal{X}_{m,n}$ -module  $S(\lambda)$ . This projective cover is a subquotient of  $\mathfrak{qB}_{m,n}$  projective module  $K(\lambda)$ .

Assuming the Conjecture 2 we use the results of [CD] and Proposition 2.4.1.3 to compute decomposition numbers of  $\mathcal{X}_{m,n}$ . We write down the structure of the Loewy graphs for  $\mathcal{X}_{m,n}$ -projective modules (analogously to the formulas (1.15)–(1.17) for  $\mathcal{U}_qsl(2|1)$ -projective modules). These are oriented graphs where arrows mean the action of the algebra  $\mathcal{X}_{m,n}$ . Vectors from the subquotient at the beginning of an arrow are mapped to the vectors in the subquotient at the end of an arrow and (possibly) in the subquotients further the arrows. Investigation of  $\text{Ext}^1$  spaces for the algebra  $\mathcal{X}_{m,n}$  and the detailed action of all  $\mathcal{X}_{m,n}$ -generators on projective modules are beyond the scope of present work. We have the following Theorem

**Theorem 2.4.1.5** *For  $\lambda \in \mathcal{Cr}_{m,n}$ ,  $\lambda \notin \mathcal{At}_{m,n}$ , the projective module over  $\mathcal{X}_{m,n}$  coincides with the simple module:  $K(\lambda) = D(\lambda)$ . For  $\lambda \in \mathcal{At}_{m,n}$ , we have the following structure of projective modules over  $\mathcal{X}_{m,n}$*

for  $m > n$

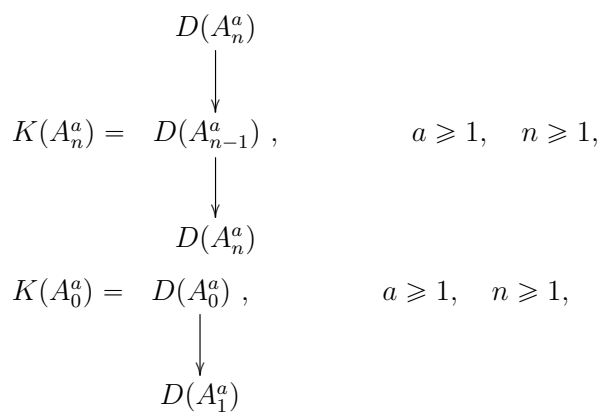
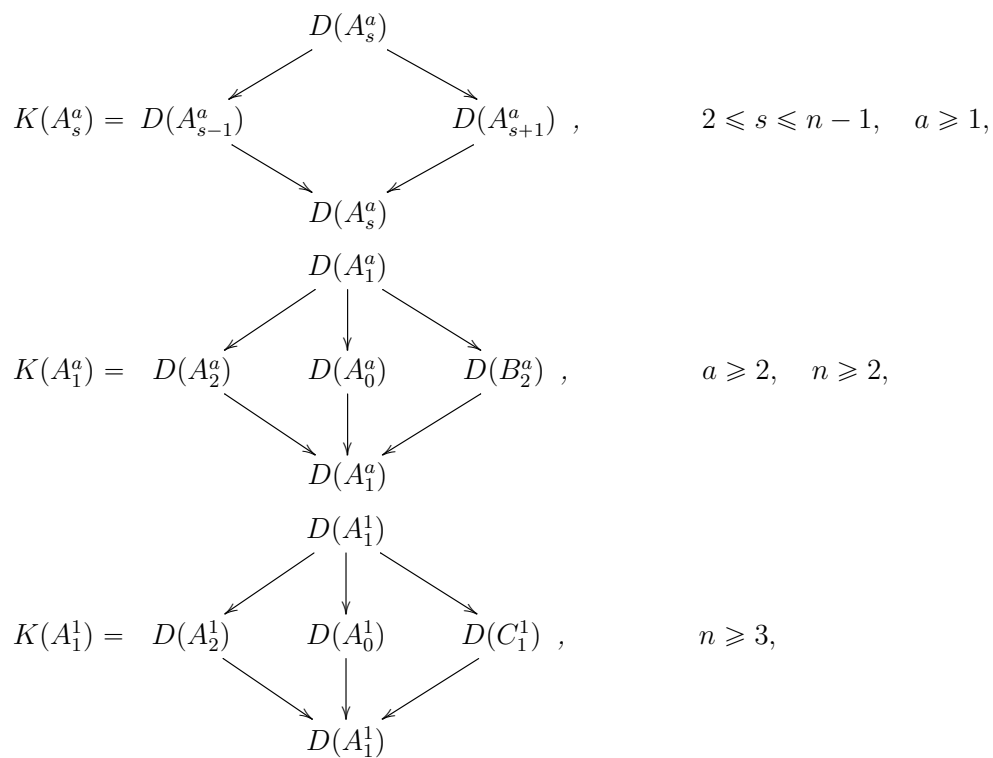

$$\begin{array}{ccc}
 & D(B_s^a) & \\
 & \swarrow \quad \searrow & \\
 K(B_s^a) = D(B_{s-1}^a) & & D(B_{s+1}^a) , \\
 & \swarrow \quad \searrow & \\
 & D(B_s^a) &
 \end{array} , \quad 2 \leq s \leq \min(a, n) - 1 ,$$

$$\begin{array}{ccc}
 & D(B_a^a) & \\
 & \swarrow \quad \searrow & \\
 K(B_a^a) = D(B_{a-1}^a) & & D(C_a^a) , \\
 & \swarrow \quad \searrow & \\
 & D(B_a^a) &
 \end{array} , \quad 2 \leq a \leq n - 2 ,$$

$$\begin{array}{ccc}
 & D(B_a^a) & \\
 & \downarrow & \\
 K(B_a^a) = D(B_{a-1}^a) , & & a = n - 1, \quad n \geq 3, \\
 & \downarrow & \\
 & D(B_a^a) & \\
 & D(B_n^a) & \\
 & \downarrow & \\
 K(B_n^a) = D(B_{n-1}^a) , & & a \geq n, \quad n \geq 2, \\
 & \downarrow & \\
 & D(B_n^a) &
 \end{array}$$

$$\begin{array}{ccc}
 & D(C_s^a) & \\
 & \swarrow \quad \searrow & \\
 K(C_s^a) = D(C_{s-1}^a) & & D(C_{s+1}^a), \\
 & \swarrow \quad \searrow & \\
 & D(C_s^a) &
 \end{array}, \quad a+1 \leq s \leq n-3, \quad a \geq 1,$$

$$\begin{array}{ccc}
 & D(C_a^a) & \\
 & \swarrow \quad \searrow & \\
 K(C_a^a) = D(B_a^a) & & D(C_{a+1}^a), \\
 & \swarrow \quad \searrow & \\
 & D(C_a^a) &
 \end{array}, \quad 2 \leq a \leq n-3,$$

$$\begin{array}{ccc}
 & D(C_1^1) & \\
 & \swarrow \quad \searrow & \\
 K(C_1^1) = D(A_1^1) & & D(C_2^1), \\
 & \swarrow \quad \searrow & \\
 & D(C_1^1) &
 \end{array}, \quad n \geq 4,$$

$$\begin{array}{ccc}
 & D(C_{n-2}^a) & \\
 & \downarrow & \\
 K(C_{n-2}^a) = D(C_{n-3}^a), & & 1 \leq a \leq n-3, \\
 & \downarrow & \\
 & D(C_{n-2}^a) & \\
 & D(C_{n-2}^{n-2}) & \\
 & \downarrow & \\
 K(C_{n-2}^{n-2}) = D(B_{n-2}^{n-2}), & & n \geq 3. \\
 & \downarrow & \\
 & D(C_{n-2}^{n-2}) &
 \end{array}$$

for  $m = n$

$$K(A_0^0) = D(A_0^0), \quad n \geq 2,$$

$$\downarrow$$

$$D(C_0^0)$$

$$\begin{array}{c}
 D(C_0^0) \\
 \swarrow \quad \downarrow \quad \searrow \\
 K(C_0^0) = D(\hat{C}_1^0) \quad D(A_0^0) \quad D(C_1^0), \quad n \geq 3, \\
 \swarrow \quad \downarrow \quad \searrow \\
 D(C_0^0) \\
 \downarrow \\
 D(C_s^0) \\
 \swarrow \quad \searrow \\
 K(C_s^0) = D(C_{s-1}^0) \quad D(C_{s+1}^0), \quad 1 \leq s \leq n-3, \\
 \swarrow \quad \searrow \\
 D(C_s^0)
 \end{array}$$

$$\begin{array}{c}
 D(C_{n-2}^0) \\
 \downarrow \\
 K(C_{n-2}^0) = D(C_{n-3}^0), \quad n \geq 3, \\
 \downarrow \\
 D(C_{n-2}^a)
 \end{array}$$

Structure of projective modules  $K(\hat{C}_s^0)$ ,  $0 \leq s \leq n-2$  for  $m = n$  and all projective modules for  $m < n$  can be obtained from this using the formula (4.34).

We note that the Loewy length of the projective modules coincide with the Loewy length given in [He] (Corollary 4.2) taking into account the Theorem 8.19 in [BS].

## 2.4.2 The restriction functors

There are two natural embeddings between quantum walled Brauer algebras (see [RS])

$$\mathfrak{q}\mathcal{B}_{m-1,n} \rightarrow \mathfrak{q}\mathcal{B}_{m,n}, \quad \mathfrak{q}\mathcal{B}_{m,n-1} \rightarrow \mathfrak{q}\mathcal{B}_{m,n}. \quad (4.35)$$

The first embedding acts by identification of the corresponding generators  $\mathcal{E}, g_1, g_2, \dots, g_{m-2}, h_1, h_2, \dots, h_{n-1}$ . The second embedding acts by identification of the generators  $\mathcal{E}, g_1, g_2, \dots, g_{m-1}, h_1, h_2, \dots, h_{n-2}$ . These two maps induce two restriction functors  $\text{res}_{m-1,n}^{m,n}$  and  $\text{res}_{m,n-1}^{m,n}$  from the category of  $\mathfrak{q}\mathcal{B}_{m,n}$ -modules to the categories of  $\mathfrak{q}\mathcal{B}_{m-1,n}$  and  $\mathfrak{q}\mathcal{B}_{m,n-1}$ -modules respectively.

Let  $\text{add}(\mu)$  be the set of boxes for a partition  $\mu$ , which can be added singly to  $\mu$  such that the result  $\mu + \square$  is a partition. Let  $\text{rem}(\mu)$  be a set of boxes which can be removed from  $\mu$  such that  $\mu/\square$  is a partition.

In what follows the sign  $\bigsqcup$  denotes the non-direct sum of modules. Following [CDDM], where the classical case  $q = 1$  is considered, we have for modules over  $\mathfrak{q}\mathcal{B}_{m,n}$

**Proposition 2.4.2.1** *For  $\lambda \in \Lambda_{m,n}(f)$  with  $n \geq 1$  we have*

$$\begin{aligned} \text{res}_{m,n-1}^{m,n} S(\lambda) &= \bigsqcup_{\square \in \text{rem}(\lambda^R)} S(\lambda^L, \lambda^R - \square), \quad \text{for } f = 0, \\ \text{res}_{m,n-1}^{m,n} S(\lambda) &= \bigsqcup_{\square \in \text{add}(\lambda^L)} S(\lambda^L + \square, \lambda^R) \bigsqcup_{\square \in \text{rem}(\lambda^R)} S(\lambda^L, \lambda^R - \square), \quad \text{for } f > 0. \end{aligned}$$

This statement is valid for the algebra  $\mathfrak{q}\mathcal{B}_{m,n}$  with either generic or special parameters. For  $\mathfrak{q}\mathcal{B}_{m,n}$  with generic parameters all  $\bigsqcup$  become direct sums.

As a consequence of the previous statement and Proposition 2.4.1.3 we have for modules over  $\mathcal{X}_{m,n}$

**Proposition 2.4.2.2** *For  $\lambda \in \Lambda_{m,n}(f) \cap \mathcal{C}r_{m,n}$  with  $n \geq 1$  we have*

$$\begin{aligned} \text{res}_{m,n-1}^{m,n} S(\lambda) &= \bigoplus_{\square \in \text{rem}(\lambda^R)} S(\lambda^L, \lambda^R - \square), \quad \text{for } f = 0, \\ \text{res}_{m,n-1}^{m,n} S(\lambda) &= \bigsqcup_{\square \in \text{add}(\lambda^L), (\lambda^L + \square, \lambda^R) \in \mathcal{C}r_{m,n-1}} S(\lambda^L + \square, \lambda^R) \bigsqcup_{\square \in \text{rem}(\lambda^R)} S(\lambda^L, \lambda^R - \square), \quad \text{for } f > 0. \end{aligned}$$

We formulate the important Conjecture. Other statements 2.4.2.4 and 2.4.2.5 formulated as theorems are based on this Conjecture.

**Conjecture 2.4.2.3** *Restriction for projective module  $K(\lambda)$  over algebra  $\mathcal{X}_{m,n}$  is a sum of projective modules.*

**Theorem 2.4.2.4** *Let  $\lambda \in \mathcal{A}_{m,n}$  and  $n \geq 1$  then the restrictions for projective modules  $K(\lambda)$  over the algebra  $\mathcal{X}_{m,n}$  are*

$$\begin{aligned}
\text{res}_{m,n-1}^{m,n} K(A_s^a) &= K(A_s^{a+1}) \oplus D[(a, 1^{s+1}), (s)] \oplus 2D[(a, 1^s), (s-1)] \oplus D[(a, 1^{s-1}), (s-2)], \\
&2 \leq s \leq n-1, \quad a \geq 1, \\
\text{res}_{m,n-1}^{m,n} K(A_1^a) &= K(A_1^{a+1}) \oplus D[(a, 1^2), (1)] \oplus 2D[(a, 1), \emptyset] \oplus D[(a, 2), (1)], \quad a \geq 2, n \geq 2, \\
\text{res}_{m,n-1}^{m,n} K(A_1^1) &= K(A_1^2) \oplus D[(1^3), (1)] \oplus 2D[(1^2), \emptyset], \quad n \geq 2, \\
\text{res}_{m,n-1}^{m,n} K(A_n^a) &= D(A_{n-1}^{a+1}) \oplus 2D[(a, 1^n), (n-1)] \oplus D[(a, 1^{n-1}), (n-2)], \quad n \geq 2, \\
\text{res}_{m,n-1}^{m,n} K(A_0^a) &= K(A_0^{a+1}) \oplus D[(a, 1), \emptyset], \quad a \geq 1, \quad n \geq 1, \\
\text{res}_{m,n-1}^{m,n} K(A_0^0) &= K(A_0^1), \quad n \geq 1,
\end{aligned}$$

$$\begin{aligned}
\text{res}_{m,n-1}^{m,n} K(B_s^a) &= K(B_s^{a+1}) \oplus D[(a, s+1), (1^s)] \oplus 2D[(a, s), (1^{s-1})] \oplus D[(a, s-1), (1^{s-2})], \\
&2 \leq s \leq \min(a, n) - 1, \\
\text{res}_{m,n-1}^{m,n} K(B_a^a) &= K(B_a^{a+1}) \oplus 2D[(a, a), (1^{a-1})] \oplus D[(a, a-1), (1^{a-2})], \quad 2 \leq a \leq n-1, \\
\text{res}_{m,n-1}^{m,n} K(B_n^a) &= D(B_{n-1}^{a+1}) \oplus 2D[(a, n), (1^{n-1})] \oplus D[(a, n-1), (1^{n-2})], \quad 2 \leq n \leq a,
\end{aligned}$$

$$\begin{aligned}
\text{res}_{m,n-1}^{m,n} K(C_s^a) &= K(C_s^{a+1}) \oplus D[(s+2, a+1), (1^{s+2})] \oplus 2D[(s+1, a+1), (1^{s+1})] \oplus \\
&\oplus D[(s, a+1), (1^s)], \quad a+2 \leq s \leq n-3, \\
\text{res}_{m,n-1}^{m,n} K(C_a^a) &= K(B_{a+1}^{a+1}) \oplus D[(a+2, a+1), (1^{a+2})] \oplus D[(a, a), (1^{a-1})], \quad 2 \leq a \leq n-3, \\
\text{res}_{m,n-1}^{m,n} K(C_{a+1}^a) &= K(C_{a+1}^{a+1}) \oplus D[(a+3, a+1), (1^{a+3})] \oplus 2D[(a+2, a+1), (1^{a+2})], \quad a \leq n-4, \\
\text{res}_{m,n-1}^{m,n} K(C_{n-2}^a) &= D(C_{n-3}^{a+1}) \oplus 2D[(n-1, a+1), (1^{n-1})] \oplus D[(n-2, a+1), (1^{n-2})], \\
&a \leq n-4, \\
\text{res}_{m,n-1}^{m,n} K(C_{n-2}^{n-3}) &= D(B_{n-2}^{n-2}) \oplus 2D[(n-1, n-2), (1^{n-1})], \quad n \geq 3, \\
\text{res}_{m,n-1}^{m,n} K(C_{n-2}^{n-2}) &= K(B_{n-1}^{n-1}) \oplus D[(n-2, n-2), (1^{n-3})], \quad n \geq 3, \\
\text{res}_{m,n-1}^{m,n} K(C_1^1) &= K(B_2^2) \oplus D[(3, 2), (1^3)] \oplus D[(1^2), \emptyset], \quad n \geq 4, \\
\text{res}_{m,n-1}^{m,n} K(C_0^0) &= K(A_1^1) \oplus D[(2, 1), (1^2)] \oplus D[(1^3), (1^2)], \quad n \geq 3,
\end{aligned}$$

$$\begin{aligned}
res_{m,n-1}^{m,n} K(\hat{A}_s^a) &= K(\hat{A}_s^{a-1}) \oplus D[(s+1), (a, 1^s)] \oplus 2D[(s), (a, 1^{s-1})] \oplus D[(s-1), (a, 1^{s-2})], \\
&2 \leq s \leq m-1, \quad a \geq 2, \\
res_{m,n-1}^{m,n} K(\hat{A}_1^a) &= K(\hat{A}_1^{a-1}) \oplus D[(2), (a, 1)] \oplus 2D[(1), (a)] \oplus D[(1^2), (a, 1)], \quad a \geq 2, \quad m \geq 2, \\
res_{m,n-1}^{m,n} K(\hat{A}_m^a) &= K(\hat{A}_m^{a-1}) \oplus 2D[(m), (a, 1^{m-1})] \oplus D[(m-1), (a, 1^{m-2})], \quad m \geq 2, \quad a \geq 2, \\
res_{m,n-1}^{m,n} K(\hat{A}_s^1) &= K(C_{s-1}^0) \oplus D[(s+1), (1^{s+1})] \oplus 2D[(s), (1^s)] \oplus D[(s-1), (1^{s-1})], \quad 2 \leq s < m, \\
res_{m,n-1}^{m,n} K(\hat{A}_m^1) &= D(C_{m-2}^0) \oplus 2D[(m), (1^m)] \oplus D[(m-1), (1^{m-1})], \quad m \geq 2, \\
res_{m,n-1}^{m,n} K(\hat{A}_1^1) &= K(C_0^0) \oplus D[(2), (1^2)] \oplus 2D[(1), (1)], \quad m \geq 2, \\
res_{m,n-1}^{m,n} K(\hat{A}_0^a) &= K(\hat{A}_0^{a-1}) \oplus D[(1), (a)], \quad a \geq 1, \quad m \geq 1,
\end{aligned}$$

$$\begin{aligned}
res_{m,n-1}^{m,n} K(\hat{B}_s^a) &= K(\hat{B}_s^{a-1}) \oplus D[(1^{s+1}), (a, s)] \oplus 2D[(1^s), (a, s-1)] \oplus D[(1^{s-1}), (a, s-2)], \\
&2 \leq s \leq \min(a, m) - 1, \\
res_{m,n-1}^{m,n} K(\hat{B}_a^a) &= K(\hat{C}_{a-1}^{a-1}) \oplus 2D[(1^a), (a, a-1)] \oplus D[(1^{a-1}), (a, a-2)], \quad 2 \leq a \leq m-1, \\
res_{m,n-1}^{m,n} K(\hat{B}_m^a) &= K(\hat{B}_m^{a-1}) \oplus 2D[(1^m), (a, m-1)] \oplus D[(1^{m-1}), (a, m-2)], \quad 2 \leq m < a, \\
res_{m,n-1}^{m,n} K(\hat{B}_m^m) &= D(\hat{B}_{m-1}^{m-1}) \oplus 2D[(1^m), (m, m-1)] \oplus D[(1^{m-1}), (m, m-2)], \quad m \geq 2,
\end{aligned}$$

$$\begin{aligned}
res_{m,n-1}^{m,n} K(\hat{C}_s^a) &= K(\hat{C}_s^{a-1}) \oplus D[(1^{s+3}), (s+1, a+1)] \oplus 2D[(1^{s+2}), (s, a+1)] \\
&\oplus D[(1^{s+1}), (s-1, a+1)], \quad a+2 \leq s \leq m-3, \quad a \geq 1, \\
res_{m,n-1}^{m,n} K(\hat{C}_s^0) &= K(A_{s+1}^1) \oplus D[(1^{s+3}), (s+1, 1)] \oplus 2D[(1^{s+2}), (s, 1)] \oplus D[(1^{s+1}), (s-1, 1)], \\
&2 \leq s \leq m-3, \\
res_{m,n-1}^{m,n} K(\hat{C}_a^a) &= K(\hat{C}_a^{a-1}) \oplus D[(1^{a+3}), (a+1, a+1)] \oplus D[(1^a), (a, a-1)], \quad 1 \leq a \leq m-3, \\
res_{m,n-1}^{m,n} K(\hat{C}_{a+1}^a) &= K(\hat{C}_{a+1}^{a-1}) \oplus D[(1^{a+4}), (a+2, a+1)] \oplus 2D[(1^{a+3}), (a+1, a+1)], \quad 1 \leq a \leq m-4, \\
res_{m,n-1}^{m,n} K(\hat{C}_{m-2}^a) &= K(\hat{C}_{m-2}^{a-1}) \oplus 2D[(1^m), (m-2, a+1)] \oplus D[(1^{m-1}), (m-3, a+1)], \quad 1 \leq a \leq m-4, \\
res_{m,n-1}^{m,n} K(\hat{C}_1^0) &= K(A_2^1) \oplus D[(1^4), (2, 1)] \oplus 2D[(1^3), (1, 1)], \quad m \geq 4, \\
res_{m,n-1}^{m,n} K(\hat{C}_{m-2}^0) &= K(A_{m-1}^1) \oplus 2D[(1^m), (m-2, 1)] \oplus D[(1^{m-1}), (m-3, 1)], \quad m \geq 4, \\
res_{m,n-1}^{m,n} K(\hat{C}_{m-2}^{m-3}) &= K(\hat{C}_{m-2}^{m-4}) \oplus 2D[(1^m), (m-2, m-2)], \quad m \geq 4, \\
res_{m,n-1}^{m,n} K(\hat{C}_{m-2}^{m-2}) &= K(\hat{C}_{m-2}^{m-3}) \oplus D[(1^{m-2}), (m-2, m-3)], \quad m \geq 3.
\end{aligned}$$

where we imply  $(0) = (1^0) = \emptyset$  and  $(s, 0) = (s)$ .



**Proof.** We discuss the case  $K(A_s^a)$  for  $2 \leq s \leq n-1$ ,  $a \geq 1$ . Other cases are similar. The projective module  $K(A_s^a)$  has a filtration by two atypical standard modules, so one can write it as a non direct sum

$$K(A_s^a) = S(A_s^a) \bigsqcup S(A_{s-1}^a).$$

Applying the Proposition 2.4.2.2 one obtains the sum of simple and atypical standard modules:

$$\begin{aligned} \text{res}_{m,n-1}^{m,n} K(A_s^a) &= \text{res}_{m,n-1}^{m,n} (S(A_s^a) \bigsqcup S(A_{s-1}^a)) = \\ &= S(A_s^{a+1}) \bigsqcup S[(a, 1^{s+1}), (s)] \bigsqcup S[(a, 1^s), (s-1)] \\ &\quad \bigsqcup S(A_{s-1}^{a+1}) \bigsqcup S[(a, 1^s), (s-1)] \bigsqcup S[(a, 1^{s-1}), (s-2)]. \end{aligned}$$

In this sum only two modules are atypical, other modules are simple

$$\begin{aligned} \text{res}_{m,n-1}^{m,n} K(A_s^a) &= S(A_s^{a+1}) \bigsqcup S(A_{s-1}^{a+1}) \bigsqcup \\ &\quad D[(a, 1^{s+1}), (s)] \bigsqcup 2D[(a, 1^s), (s-1)] \bigsqcup D[(a, 1^{s-1}), (s-2)]. \end{aligned}$$

These two atypical standard modules are glued uniquely into a projective module, thus

$$\text{res}_{m,n-1}^{m,n} K(A_s^a) = K(A_s^{a+1}) \oplus D[(a, 1^{s+1}), (s)] \oplus 2D[(a, 1^s), (s-1)] \oplus D[(a, 1^{s-1}), (s-2)].$$

■

To formulate the next theorem we introduce notation  $a' = |m - n + 1|$ .

**Theorem 2.4.2.5** *Let  $\lambda \in \Lambda_{m,n}(f) \cap \mathcal{C}r_{m,n}$  for  $n \geq 1$  then the restrictions for simple modules  $D(\lambda)$  over the algebra  $\mathcal{X}_{m,n}$  are*

for  $\lambda \in \mathcal{A}t_{m,n}$ :

$$\begin{aligned} \text{res}_{m,n-1}^{m,n} D(A_s^a) &= D(A_s^{a+1}) \oplus D[(a, 1^s), (s-1)], \quad a \geq 1, \quad 1 \leq s \leq n-1, \\ \text{res}_{m,n-1}^{m,n} D(A_n^a) &= D[(a, 1^n), (n-1)], \quad a \geq 1, \quad n \geq 1, \\ \text{res}_{m,n-1}^{m,n} D(A_0^a) &= D(A_0^{a+1}), \quad a \geq 0, \quad n \geq 0, \\ \text{res}_{m,n-1}^{m,n} D(B_s^a) &= D(B_s^{a+1}) \oplus D[(a, s), (1^{s-1})], \quad 1 \leq s \leq n-1, \quad s \leq a, \\ \text{res}_{m,n-1}^{m,n} D(B_n^a) &= D[(a, n), (1^{n-1})], \quad 1 \leq n \leq a, \\ \text{res}_{m,n-1}^{m,n} D(C_s^a) &= D(C_s^{a+1}) \oplus D[(s+1, a+1), (1^{s+1})], \quad a+1 \leq s \leq n-3, \quad a \geq 0, \\ \text{res}_{m,n-1}^{m,n} D(C_{n-2}^a) &= D[(n-1, a+1), (1^{n-1})], \quad 0 \leq a \leq n-3, \\ \text{res}_{m,n-1}^{m,n} D(C_a^a) &= D(B_{a+1}^{a+1}), \quad 0 \leq a \leq n-2, \end{aligned}$$

$$\begin{aligned}
res_{m,n-1}^{m,n} D(\hat{A}_s^a) &= D(\hat{A}_s^{a-1}) \oplus D[(s), (a, 1^{s-1})], \quad 1 \leq s \leq m, \quad a \geq 2, \\
res_{m,n-1}^{m,n} D(\hat{A}_0^a) &= D(\hat{A}_0^{a-1}), \quad a \geq 1, \quad m \geq 0, \\
res_{m,n-1}^{m,n} D(\hat{A}_s^1) &= D(C_{s-1}^0) \oplus D[(s), (1^s)], \quad 1 \leq s \leq m-1, \\
res_{m,n-1}^{m,n} D(\hat{A}_m^1) &= D[(m), (1^m)], \quad m \geq 1, \\
res_{m,n-1}^{m,n} D(\hat{B}_s^a) &= D(\hat{B}_s^{a-1}) \oplus D[(1^s), (a, s-1)], \quad 2 \leq s \leq m, \quad s < a, \\
res_{m,n-1}^{m,n} D(\hat{B}_a^a) &= D(\hat{C}_{a-1}^{a-1}) \oplus D[(1^a), (a, a-1)], \quad 2 \leq a \leq m-1, \\
res_{m,n-1}^{m,n} D(\hat{B}_m^m) &= D[(1^m), (m, m-1)], \quad 1 \leq m, \\
res_{m,n-1}^{m,n} D(\hat{C}_s^a) &= D(\hat{C}_s^{a-1}) \oplus D[(1^{s+2}), (s, a+1)], \quad a+1 \leq s \leq m-2, \quad a \geq 1, \\
res_{m,n-1}^{m,n} D(\hat{C}_a^a) &= D(\hat{C}_a^{a-1}), \quad 1 \leq a \leq m-2, \\
res_{m,n-1}^{m,n} D(\hat{C}_s^0) &= D(A_{s+1}^1) \oplus D[(1^{s+2}), (s, 1)], \quad 1 \leq s \leq m-2.
\end{aligned}$$

For  $\lambda \notin At_{m,n}$  the exceptional cases are:

$$\begin{aligned}
res_{m,n-1}^{m,n} D[(a', 1^{s-1}), (s)] &= K(A_s^{a'}) \oplus D[(a'+1, 1^{s-1}), (s)], \quad 1 \leq s \leq n-1, \quad a' \geq 1, \\
res_{m,n-1}^{m,n} D[(a', s), (1^{s+1})] &= K(B_{s+1}^{a'}) \oplus D[(a'+1, s), (1^{s+1})], \quad 1 \leq s \leq a'-1, \quad s \leq n-2, \\
res_{m,n-1}^{m,n} D[(s, a'+1), (1^{s+2})] &= K(C_s^{a'}) \oplus D[(s, a'+2), (1^{s+2})], \quad a'+2 \leq s \leq n-3, \\
res_{m,n-1}^{m,n} D[(a'+1, a'+1), (1^{a'+3})] &= K(C_{a'+1}^{a'}), \quad a' \leq n-4, \\
res_{m,n-1}^{m,n} D[(s), (a', 1^{s+1})] &= K(\hat{A}_{s+1}^{a'}) \oplus D[(s), (a'-1, 1^{s+1})], \quad 0 \leq s \leq m-1, \quad a' \geq 2, \\
res_{m,n-1}^{m,n} D[(s), (1^{s+2})] &= K(\hat{A}_{s+1}^1) \oplus D[(s, 1), (1^{s+2})], \quad 1 \leq s \leq m-1, \\
res_{m,n-1}^{m,n} D[(1^{s-1}), (a', s)] &= K(\hat{B}_s^{a'}) \oplus D[(1^{s-1}), (a'-1, s)], \quad 2 \leq s \leq a'-1, \quad s \leq m, \\
res_{m,n-1}^{m,n} D[(1^{a'-1}), (a', a')] &= K(\hat{B}_{a'}^{a'}), \quad 1 \leq a' \leq m, \\
res_{m,n-1}^{m,n} D[(1^s), (s, a'+1)] &= K(\hat{C}_{s-1}^{a'}) \oplus D[(1^s), (s, a')], \quad a'+1 \leq s \leq m-1,
\end{aligned}$$

where we imply  $(0) = (1^0) = \emptyset$  and  $(s, 0) = (s)$ .

For  $\lambda \notin At_{m,n}$  the general rule is:

for  $f = 0$

$$res_{m,n-1}^{m,n} D(\lambda) = \sum_{\square \in rem(\lambda^R)} D(\lambda^L, \lambda^R - \square),$$

for  $f > 0$

$$res_{m,n-1}^{m,n} D(\lambda) = \bigoplus_{\square \in add(\lambda^L), (\lambda^L + \square, \lambda^R) \in \mathcal{C}r_{m,n-1}} D(\lambda^L + \square, \lambda^R) \oplus \bigoplus_{\square \in rem(\lambda^R)} D(\lambda^L, \lambda^R - \square).$$

**Proof.** If  $\lambda \notin \mathcal{A}t_{m,n}$  then  $D(\lambda) = S(\lambda)$ , and the proof follows from **2.4.2.2** similarly to the proof of Theorem **2.4.2.4**.

Now we consider  $\lambda \in \mathcal{A}t_{m,n}$ . We discuss only  $D(A_s^a)$  for  $a \geq 1$ ,  $1 \leq s \leq n-1$ , other cases are similar. We prove that

$$\text{res}_{m,n-1}^{m,n} D(A_s^a) = D(A_s^{a+1}) \oplus D[(a, 1^s), (s-1)], \quad a \geq 1, s \leq n-1,$$

by induction on  $s$ . First, we prove the induction base for  $s = n-1$ , then we check the induction step from  $s$  to  $s-1$ . The  $\mathcal{X}_{m,n}$ -module  $S(A_n^a)$  is simple:  $S(A_n^a) = D(A_n^a)$ , so we have from **2.4.2.2**

$$\text{res}_{m,n-1}^{m,n} D(A_n^a) = \text{res}_{m,n-1}^{m,n} S(A_n^a) = S[(a, 1^n), (n-1)] = D[(a, 1^n), (n-1)]. \quad (4.36)$$

According to **2.4.2.2** we have for  $s < n$

$$\text{res}_{m,n-1}^{m,n} S(A_s^a) = S(A_s^{a+1}) \oplus D[(a, 1^{s+1}), (s)] \oplus D[(a, 1^s), (s-1)]. \quad (4.37)$$

We write  $\mathcal{X}_{m,n}$ -Specht modules as a non-direct sum  $S(A_s^a) = D(A_s^a) \uplus D(A_{s+1}^a)$  for  $s < n$ . The  $\mathcal{X}_{m,n-1}$ -module  $S(A_{n-1}^{a+1}) = D(A_{n-1}^{a+1})$ , so from (4.37) for  $s = n-1$  we get

$$\text{res}_{m,n-1}^{m,n} \left( D(A_{n-1}^a) \uplus D(A_n^a) \right) = D(A_{n-1}^{a+1}) \uplus D[(a, 1^n), (n-1)] \uplus D[(a, 1^{n-1}), (n-2)].$$

Now having in mind (4.36) we get the induction base

$$\text{res}_{m,n-1}^{m,n} D(A_{n-1}^a) = D(A_{n-1}^{a+1}) \uplus D[(a, 1^{n-1}), (n-2)].$$

We also note that  $\mathcal{X}_{m,n-1}$  module  $S(A_s^{a+1}) = D(A_s^{a+1}) \uplus D(A_{s+1}^{a+1})$  for  $s < n-1$ , so from (4.37) we get

$$\text{res}_{m,n-1}^{m,n} \left( D(A_s^a) \uplus D(A_{s+1}^a) \right) = D(A_s^{a+1}) \uplus D(A_{s+1}^{a+1}) \uplus D[(a, 1^s), (s-1)] \uplus D[(a, 1^{s+1}), (s)],$$

and now the induction step is straightforward.  $\blacksquare$

**Remark.** The second restriction functor  $\text{res}_{m-1,n}^{m,n}$  can be calculated from the first one. Actually

$$\text{res}_{m-1,n}^{m,n} K(\lambda) = \hat{G} \text{res}_{n,m-1}^{n,m} \hat{G} K(\lambda), \quad (4.38)$$

$$\text{res}_{m-1,n}^{m,n} D(\lambda) = \hat{G} \text{res}_{n,m-1}^{n,m} \hat{G} D(\lambda). \quad (4.39)$$

We can also make generalization to the  $\mathfrak{q}\beta_{m,n}$ -modules.

**Conjecture 2.4.2.6** Consider the algebra  $\mathfrak{qB}_{m,n}$  with special parameter  $\theta = -(-\frac{\delta}{\gamma})^{M-N}$  for  $M \neq N$ . Let  $\lambda \in \Lambda_{m,n}$  be an  $(M, N)$ -cross bipartition, then  $\text{res}_{m,n-1}^{m,n} D(\lambda)$  contains only subquotients  $D(\lambda')$  for which  $\lambda' \in \Lambda_{m,n-1}$  is an  $(M, N)$ -cross bipartition.

In other words, the restriction functor for  $\mathfrak{qB}_{m,n}$  with special parameters preserves the class of all  $(M, N)$ -cross bipartitions. We note that the case  $M = N$  requires additional investigation.

In particular we have the next important consequence for  $M = 2, N = 1$ .

**Conjecture 2.4.2.7** For  $\lambda \in \mathcal{C}r_{m,n}$  the restrictions  $\text{res}_{m,n-1}^{m,n} D(\lambda)$  for simple modules over  $\mathfrak{qB}_{m,n}$  with  $\theta = \frac{\delta}{\gamma}$  are explicitly given by the formulas from theorem 2.4.2.5 without any changes.

This conjecture was directly checked for all  $\mathfrak{qB}_{m,n}$ -modules whenever  $m + n \leq 8$ .

## 2.5 The mixed tensor product as a bimodule

We introduce new notations in order to simplify the formula for the bimodule decomposition. We denote by  $\bar{\mathcal{Z}}_{t,r}^p$  the simple  $\mathcal{U}_q \mathfrak{sl}(2|1)$  modules:

$$\begin{aligned}\bar{\mathcal{Z}}_{t,r}^p &= \mathcal{Z}_{t+r,r}^{1,(-1)^p}, \quad r \neq 0, \\ \bar{\mathcal{Z}}_{t,0}^p &= \mathcal{Z}_{t+1,0}^{1,(-1)^{p+1}}, \quad t \geq 0.\end{aligned}$$

We denote by  $\bar{\mathcal{R}}_{t,r}^p$  the projective covers of atypical modules  $\bar{\mathcal{Z}}_{t,r}^p$ :

$$\begin{aligned}\bar{\mathcal{R}}_{0,r}^p &= \mathcal{R}_{r,r}^{1,(-1)^p}, \quad r \geq 1, \\ \bar{\mathcal{R}}_{t,0}^p &= \mathcal{R}_{t+1,0}^{1,(-1)^{p+1}}, \quad t \geq 0.\end{aligned}$$

Typical modules  $\bar{\mathcal{Z}}_{t,r}^p$  coincide with their projective covers, so we do not introduce any new notation for them. We rewrite the formulas (1.15)–(1.17) in new notations:

$$\begin{array}{ccc} & \bar{\mathcal{Z}}_{t,0}^p & \\ & \swarrow \quad \searrow & \\ \bar{\mathcal{R}}_{t,0}^p = \bar{\mathcal{Z}}_{t+1,0}^{p+1} & & \bar{\mathcal{Z}}_{t-1,0}^{p-1} \\ & \swarrow \quad \searrow & \\ & \bar{\mathcal{Z}}_{t,0}^p & \end{array} \quad \begin{array}{ccc} & \bar{\mathcal{Z}}_{0,t}^p & \\ & \swarrow \quad \searrow & \\ \bar{\mathcal{R}}_{0,t}^p = \bar{\mathcal{Z}}_{0,t+1}^{p+1} & & \bar{\mathcal{Z}}_{0,t-1}^{p-1} \\ & \swarrow \quad \searrow & \\ & \bar{\mathcal{Z}}_{0,t}^p & \end{array} \quad t \geq 1, \quad (5.40)$$

and the exceptional case is

$$\begin{array}{ccc}
 & \bar{\mathcal{Z}}_{0,0}^p & \\
 & \swarrow \quad \searrow & \\
 \bar{\mathcal{R}}_{0,0}^p = \bar{\mathcal{Z}}_{1,0}^{p+1} & & \bar{\mathcal{Z}}_{0,1}^{p-1} \\
 & \searrow \quad \swarrow & \\
 & \bar{\mathcal{Z}}_{0,0}^p &
 \end{array} \tag{5.41}$$

Then the dimensions are:

$$\begin{aligned}
 \dim \bar{\mathcal{R}}_{r,0}^p &= \dim \bar{\mathcal{R}}_{0,r}^p = 8r + 4, \quad r > 0, \\
 \dim \bar{\mathcal{R}}_{0,0}^p &= 8.
 \end{aligned}$$

### 2.5.1 Bimodule decomposition

The bimodule is a direct sum of subbimodules

$$\mathcal{T}_{m,n} = T_{m,n}^s \oplus T_{m,n}^{\text{at}}, \tag{5.42}$$

where the  $T_{m,n}^s$  part is the direct sum of simple  $\mathcal{X}_{m,n} \boxtimes \mathcal{U}_q \mathfrak{sl}(2|1)$ -bimodules, and  $T_{m,n}^{\text{at}}$  is an indecomposable  $\mathcal{X}_{m,n} \boxtimes \mathcal{U}_q \mathfrak{sl}(2|1)$ -bimodule. Each subquotient in  $T_{m,n}^s$  contains a typical  $\mathcal{U}_q \mathfrak{sl}(2|1)$ -module and a typical  $\mathcal{X}_{m,n}$ -module, and each subquotient in  $T_{m,n}^{\text{at}}$  contains an atypical  $\mathcal{U}_q \mathfrak{sl}(2|1)$ -module and an atypical  $\mathcal{X}_{m,n}$ -module. We call  $T_{m,n}^s$  the semisimple part and  $T_{m,n}^{\text{at}}$  the atypical part.

#### Examples

Before giving a general formula for the decomposition of  $\mathcal{T}_{m,n}$  in Theorem 2.5.2, we illustrate the structure of the semisimple part  $T_{m,n}^s$  with two examples.  $T_{m,n}^s$  has the structure

$$T_{m,n}^s = \bigoplus_{t,r} D(\lambda_{m,n}(t,r)) \boxtimes \bar{\mathcal{Z}}_{t,r}^{p(t,r)} \tag{5.43}$$

For given  $m, n$ , we represent the sum in (5.43) as a table of bipartitions  $\lambda_{m,n}(t,r)$  in coordinates  $(t,r)$ . All parts of the sum outside the table vanish, and 0 in the table means that the corresponding submodule in (5.43) vanishes.

For  $m = 5$  and  $n = 3$ , the table of bipartitions  $\lambda_{5,3}(t, r)$  reads

$r = 5$	0		0			
$r = 4$			0			
$r = 3$			0			
$r = 2$	0	$(\square, \emptyset)$	0			0
$r = 1$	0	0	0		0	0
	$t = -2$	$t = -1$	$t = 0$	$t = 1$	$t = 2$	$t = 3$

For  $m = 4$  and  $n = 4$ , the table of bipartitions  $\lambda_{4,4}(t, r)$  reads

$r=4$	0	0				
$r=3$	0	0				
$r = 2$		0				
$r=1$	0	0				
$r=0$	0	0	0	0	0	0
$r=-1$	0	0	0		0	0
	$t = -1$	$t = 0$	$t = 1$	$t = 2$	$t = 3$	$t = 4$

### Decomposition formula

In the next Theorem, we give explicit formulas for the decomposition of  $\mathcal{T}_{m,n}$  for  $m \geq n$ ; the case  $m < n$  can be easily recovered from  $m > n$  using operation  $\hat{G}$  interchanging  $m$  with  $n$

$$\mathcal{T}_{n,m} = \hat{G}\mathcal{T}_{m,n}.$$

The operation is involutive,  $\hat{G}^2 = 1$ , and additive,  $\hat{G}(X \oplus Y) = \hat{G}(X) \oplus \hat{G}(Y)$ . It acts on the indecomposable summands in the semisimple part  $T_{m,n}^s$  by the formula

$$\hat{G}\left(D[\lambda^L, \lambda^R] \boxtimes \bar{\mathcal{Z}}_{t,r}^p\right) = \hat{G}\left(D[\lambda^L, \lambda^R]\right) \boxtimes \hat{G}\left(\bar{\mathcal{Z}}_{t,r}^p\right), \quad (5.44)$$

where the action  $\hat{G}(D[\lambda^L, \lambda^R])$  is defined in (4.33) and

$$\hat{G}\bar{\mathcal{Z}}_{t,r}^p = \bar{\mathcal{Z}}_{r,t}^p. \quad (5.45)$$

When applied to the atypical part  $T_{m,n}^{\text{at}}$ , the operation  $\hat{G}$  acts on each simple subquotient by the formula (5.44) and does not change the structure of the Loewy graph.

**Theorem 2.5.2** *The  $\mathcal{X}_{m,n} \boxtimes \mathcal{U}_q \mathfrak{sl}(2|1)$ -bimodule decomposition of  $\mathcal{T}_{m,n}$ ,  $m \geq n$ , has the form  $\mathcal{T}_{m,n} = T_{m,n}^s \oplus T_{m,n}^{\text{at}}$  with the semisimple part*

$m > n$

$$\begin{aligned} T_{m,n}^s = & \bigoplus_{s=1}^n \bigoplus_{\substack{k=1, \\ k \neq a}}^{a+s} D[(k, 1^{s-k+a}), (s)] \boxtimes \bar{\mathcal{Z}}_{k-a, s+a}^{s+k+a+1} \oplus \\ & \bigoplus_{s=a+2}^m \bigoplus_{k=1}^{s-a-1} D[(s), (k, 1^{s-k-a})] \boxtimes \bar{\mathcal{Z}}_{s-a, k+a}^{s+k+a+1} \oplus \\ & \bigoplus_{s=1}^{n-1} \bigoplus_{k=1}^{\min(s, n-s)} D[(1^{s+k+a}), (s, k)] \boxtimes \bar{\mathcal{Z}}_{1-k-a, s+a}^{s+k+a} \oplus \\ & \bigoplus_{s=a+1}^{m-1} \bigoplus_{\substack{k=1, \\ k \neq a+1}}^{\min(s, m-s)} D[(s, k), (1^{s+k-a})] \boxtimes \bar{\mathcal{Z}}_{s-a, 1-k+a}^{s+k+a} \oplus \\ & \bigoplus_{k=1}^{\lfloor \frac{a}{2} \rfloor} \bigoplus_{s=k}^{a-k} D[(s, k, 1^{a-s-k}), \emptyset] \boxtimes \bar{\mathcal{Z}}_{s-a, 1-k+a}^{s+k+a} \oplus \\ & \bigoplus_{s=\lfloor \frac{a}{2} \rfloor + 1}^{a-1} \bigoplus_{k=1-s+a}^{\min(s, m-s)} D[(s, k), (1^{s+k-a})] \boxtimes \bar{\mathcal{Z}}_{s-a, 1-k+a}^{s+k+a}, \end{aligned}$$

$m = n$

$$\begin{aligned} T_{m,m}^s = & \bigoplus_{s=1}^m \bigoplus_{k=1}^s D[(k, 1^{s-k}), (s)] \boxtimes \bar{\mathcal{Z}}_{k,s}^{s+k+1} \oplus \\ & \bigoplus_{s=2}^m \bigoplus_{k=1}^{s-1} D[(s), (k, 1^{s-k})] \boxtimes \bar{\mathcal{Z}}_{s,k}^{s+k+1} \oplus \\ & \bigoplus_{s=2}^{m-1} \bigoplus_{k=2}^{\min(s, m-s)} D[(1^{s+k}), (s, k)] \boxtimes \bar{\mathcal{Z}}_{1-k,s}^{s+k} \oplus \\ & \bigoplus_{s=1}^{m-1} \bigoplus_{k=2}^{\min(s, m-s)} D[(s, k), (1^{s+k})] \boxtimes \bar{\mathcal{Z}}_{s, 1-k}^{s+k}, \end{aligned}$$

and the atypical part  $T_{m,n}^{\text{at}}$  is given by figures 2.2–2.6 in Appendix C.

### 2.5.3 Verification

To check the decomposition formula for the bimodule we make two powerful verifications using formulas for tensor product decompositions for  $\mathcal{U}_q\mathfrak{sl}(2|1)$ -modules and restrictions for  $\mathcal{X}_{m,n}$ -modules. We check that  $\mathcal{T}_{m,n} \otimes \bar{\mathbf{3}}$  coincides with  $\text{res}_{m,n}^{m,n+1} \mathcal{T}_{m,n+1}$  as  $\mathcal{U}_q\mathfrak{sl}(2|1)$ -module in the first verification and as  $\mathcal{X}_{m,n}$ -module in the second one. In order to do this we introduce two Grothendieck (forgetful) functors  $\mathbb{P}$  and  $\mathbb{Q}$ .

We define the Grothendieck functor  $\mathbb{P}$  on the category of  $\mathcal{U}_q\mathfrak{sl}(2|1)$ -modules which maps an indecomposable module into a direct sum of its simple subquotients. The functor  $\mathbb{P}$  on any  $\mathcal{U}_q\mathfrak{sl}(2|1)$ -module is known from **2.1.5**. For example

$$\begin{aligned} \mathbb{P}\bar{\mathcal{R}}_{t,0}^p &= 2\bar{\mathcal{Z}}_{t,0}^p \oplus \bar{\mathcal{Z}}_{t+1,0}^{p+1} \oplus \bar{\mathcal{Z}}_{t-1,0}^{p-1}, \quad t \geq 1, \\ \mathbb{P}\bar{\mathcal{Z}}_{t,r}^p &= \bar{\mathcal{Z}}_{t,r}^p, \quad \forall p, t, r. \end{aligned}$$

We define the other Grothendieck functor  $\mathbb{Q}$  on the category of  $\mathcal{X}_{m,n}$ -modules which maps an indecomposable module into a direct sum of its simple subquotients. The functor  $\mathbb{Q}$  on any  $\mathcal{X}_{m,n}$ -module is known from **2.4.1.5**. For example

$$\begin{aligned} \mathbb{Q}K(A_1^1) &= 2D(A_1^1) \oplus D(A_2^1) \oplus D(A_0^1) \oplus D(C_1^1), \quad n \geq 3, \\ \mathbb{Q}D(\lambda) &= D(\lambda), \quad \forall m, n, \lambda. \end{aligned}$$

The functors  $\mathbb{P}$  and  $\mathbb{Q}$  do not change semisimple part of the bimodule:

$$\mathbb{P}T_{m,n}^s = \mathbb{Q}T_{m,n}^s = T_{m,n}^s,$$

because semisimple part is a direct sum of simple bimodules.

#### As $\mathcal{U}_q\mathfrak{sl}(2|1)$ -module

The action of  $\mathbb{Q}$  on the atypical part  $T_{m,n}^{\text{at}}$  has the form



$m > n$

$$\begin{aligned} \mathbb{Q}T_{m,n}^{\text{at}} &= \bigoplus_{s=1}^n D(A_s^a) \boxtimes \bar{\mathcal{R}}_{0,a+s-1}^s \oplus \\ &\quad \bigoplus_{s=2}^{\min(a,n)} D(B_s^a) \boxtimes \bar{\mathcal{R}}_{0,a-s+1}^s \oplus \\ &\quad \bigoplus_{s=a}^{n-2} D(C_s^a) \boxtimes \bar{\mathcal{R}}_{s-a,0}^{s+1} \oplus \\ &\quad D(A_0^a) \boxtimes \bar{\mathcal{Z}}_{0,a}^1, \end{aligned}$$

$m = n$

$$\begin{aligned} \mathbb{Q}T_{m,m}^{\text{at}} &= \bigoplus_{s=1}^{m-2} D(\hat{C}_s^0) \boxtimes \bar{\mathcal{R}}_{0,s}^{s-1} \oplus \\ &\quad \bigoplus_{s=0}^{m-2} D(C_s^0) \boxtimes \bar{\mathcal{R}}_{s,0}^{s-1} \oplus \\ &\quad D(A_0^0) \boxtimes \bar{\mathcal{Z}}_{0,0}^1. \end{aligned}$$

We introduce the notation  $\overline{\mathcal{T}}_{m,n} = \mathbb{Q}\mathcal{T}_{m,n}$ . The following relation must hold:

$$\overline{\mathcal{T}}_{m,n} \otimes \bar{\mathfrak{3}} = \mathbb{Q} \text{res}_{m,n}^{m,n+1} \overline{\mathcal{T}}_{m,n+1}. \quad (5.46)$$

Because  $\overline{\mathcal{T}}_{m,n}$  has the form  $\overline{\mathcal{T}}_{m,n} = \bigoplus D \boxtimes \mathcal{R} \oplus D \boxtimes \mathcal{Z}$ , we can calculate  $\overline{\mathcal{T}}_{m,n} \otimes \bar{\mathfrak{3}}$  using formulas from **2.2.1**. Because  $\overline{\mathcal{T}}_{m,n+1}$  contains as subquotients only modules  $D(\lambda)$  for  $\lambda \in \mathcal{C}r_{m,n+1}$ , we can calculate  $\text{res}_{m,n}^{m,n+1} \overline{\mathcal{T}}_{m,n+1}$  using formulas from **2.4.2.5**, and then apply the functor  $\mathbb{Q}$ . We have checked the validity of relation (5.46) for all  $m, n$  whenever  $m + n \leq 25$ .

### As $\mathcal{X}_{m,n}$ module

The action of  $\mathbb{P}$  on the atypical part  $T_{m,n}^{\text{at}}$  has the form

$m > n$

$$\begin{aligned} \mathbb{P}T_{m,n}^{\text{at}} &= \bigoplus_{s=1}^n K(A_s^a) \boxtimes \bar{\mathcal{Z}}_{0,a+s-1}^s \oplus \\ &\quad \bigoplus_{s=2}^{\min(a,n)} K(B_s^a) \boxtimes \bar{\mathcal{Z}}_{0,a-s+1}^s \oplus \\ &\quad \bigoplus_{s=a}^{n-2} K(C_s^a) \boxtimes \bar{\mathcal{Z}}_{s-a,0}^{s+1} \\ &\quad \oplus D(A_n^a) \boxtimes \bar{\mathcal{Z}}_{0,m}^{n+1} \\ &\quad \oplus PT_{m,n}^{\text{right}}, \end{aligned}$$

where

$$PT_{m,n}^{\text{right}} = \begin{cases} 0, & n = 0, \\ D(B_n^a) \boxtimes \bar{\mathcal{Z}}_{0,m-2n}^{n+1}, & 1 \leq n \leq \frac{m}{2}, \\ D(B_a^a) \boxtimes \bar{\mathcal{Z}}_{0,0}^{a+1}, & n = \frac{m+1}{2}, \quad n \geq 2, \\ D(C_{n-2}^a) \boxtimes \bar{\mathcal{Z}}_{2n-m-1,0}^n, & \frac{m}{2} + 1 \leq n \leq m-1, \end{cases}$$

$m = n \geq 2$

$$\begin{aligned} \mathbb{P}T_{m,m}^{\text{at}} &= \bigoplus_{s=1}^{m-2} K(\hat{C}_s^0) \boxtimes \bar{\mathcal{Z}}_{0,s}^{s-1} \oplus \\ &\quad \bigoplus_{s=0}^{m-2} K(C_s^0) \boxtimes \bar{\mathcal{Z}}_{s,0}^{s-1} \\ &\quad \oplus D(\hat{C}_{m-2}^0) \boxtimes \bar{\mathcal{Z}}_{0,m-1}^{m-2} \\ &\quad \oplus D(C_{m-2}^0) \boxtimes \bar{\mathcal{Z}}_{m-1,0}^{m-2}, \end{aligned}$$

$m = n = 1$

$$\mathbb{P}T_{1,1}^{\text{at}} = D(A_0^0) \boxtimes \bar{\mathcal{Z}}_{0,0}^1.$$

We introduce the notation  $\underline{\mathcal{I}}_{m,n} = \mathbb{P}\mathcal{I}_{m,n}$ . The following relation must hold:

$$\mathbb{P}(\underline{\mathcal{I}}_{m,n} \otimes \bar{\mathbf{3}}) = \text{res}_{m,n}^{m,n+1} \underline{\mathcal{I}}_{m,n+1}. \quad (5.47)$$

Because  $\underline{\mathcal{I}}_{m,n}$  has the form  $\underline{\mathcal{I}}_{m,n} = \bigoplus K \boxtimes \bar{\mathcal{Z}} \oplus D \boxtimes \bar{\mathcal{Z}}$ , we can calculate  $\underline{\mathcal{I}}_{m,n} \otimes \bar{\mathbf{3}}$  using formulas from **2.2.1**. Because  $\underline{\mathcal{I}}_{m,n+1}$  contains as subquotients only modules  $\bar{K}(\lambda)$  and  $D(\lambda)$  for  $\lambda \in \mathcal{C}\Gamma_{m,n+1}$ , we can calculate  $\text{res}_{m,n}^{m,n+1} \underline{\mathcal{I}}_{m,n+1}$  using formulas from **2.4.2.5** and **2.4.2.4** and then apply the functor  $\mathbb{P}$ . We have checked the validity of relation 5.47 for all  $m, n$  whenever  $m + n \leq 25$ .

# Appendix

## A: partial order on $\widehat{\mathbf{B}}_{r,s}$

In the following section we introduce a partial order  $\triangleleft$  on the monoid  $\widehat{\mathbf{B}}_{r,s}$  which is compatible with  $\mathfrak{X}$  (see Section 1.2). For generators  $\hat{s}_i$ ,  $i = 1 \dots r + s - 1$ , and a word  $\mathbf{w} \in \widehat{\mathbf{B}}_{r,s}$  we will write  $\hat{s}_i \in \mathbf{w}$  (respectively,  $\hat{s}_i \notin \mathbf{w}$ ) whenever  $\hat{s}_i$  is contained (respectively, not contained) in  $\mathbf{w}$ . The notation  $\pi_L(\mathbf{w})$  (respectively,  $\pi_R(\mathbf{w})$ ) stands for the substitution  $\hat{s}_i \rightarrow 1$  for all generators with  $i > r$  (respectively,  $i < r$ ), where the unit element 1 stands for the empty word. By definition,  $\pi_L(1) = \pi_R(1) = 1$ . We denote by  $|\mathbf{w}|$  the length of a monomial  $\mathbf{w} \in \widehat{\mathbf{B}}_{r,s}$ , while  $|\mathbf{w}|_i$  denotes the number of occurrences of a generator  $\hat{s}_i$  in  $\mathbf{w}$ . The notation  $|\mathbf{w}|_L$  (respectively,  $|\mathbf{w}|_R$ ) stands for the number of generators  $\hat{s}_i \in \mathbf{w}$  with  $i = 1 \dots r - 1$  (respectively,  $r + 1 \dots r + s - 1$ ). By definition,  $|1| = |1|_i = |1|_L = |1|_R = 0$ .

First, we introduce the following partial order  $\blacktriangleleft$  on the subset  $\widehat{\mathfrak{S}}_{r,s} \subset \widehat{\mathbf{B}}_{r,s}$  constituted by all monomials such that  $\mathbf{w} = \pi_L(\mathbf{w})\pi_R(\mathbf{w})$ . Comparing the lengths of monomials  $\mathbf{u}, \mathbf{v} \in \widehat{\mathfrak{S}}_{r,s}$ , we set  $|\mathbf{u}|_L < |\mathbf{v}|_L \Rightarrow \mathbf{u} \blacktriangleleft \mathbf{v}$ , while  $|\mathbf{u}|_L = |\mathbf{v}|_L$  and  $|\mathbf{u}|_R < |\mathbf{v}|_R \Rightarrow \mathbf{u} \blacktriangleleft \mathbf{v}$ . In case  $|\mathbf{u}| = |\mathbf{v}| = N > 0$  and  $|\mathbf{u}|_L = |\mathbf{v}|_L = N' > 0$  we compare  $\pi_L(\mathbf{u}) = \hat{s}_{i_1} \dots \hat{s}_{i_{N'}}$  and  $\pi_L(\mathbf{v}) = \hat{s}_{j_1} \dots \hat{s}_{j_{N'}}$  lexicographically from left to right: let  $k = 1 \dots N'$  be the minimal number such that  $i_p = j_p$  for all  $p < k$  and not for  $p = k$ . Then  $i_k < j_k$  implies  $\mathbf{u} \blacktriangleleft \mathbf{v}$ . If such  $k$  does not exist, as well as if  $N' = 0$ , we compare  $\pi_R(\mathbf{u}) = \hat{s}_{m_1} \dots \hat{s}_{m_{N''}}$  and  $\pi_R(\mathbf{v}) = \hat{s}_{n_1} \dots \hat{s}_{n_{N''}}$  lexicographically from right to left: let  $l = 1 \dots N''$  be the maximal number such that  $m_q = n_q$  for all  $q > l$  and not for  $q = l$ . Then  $m_l > n_l$  implies  $\mathbf{u} \blacktriangleleft \mathbf{v}$ . Otherwise,  $\mathbf{u}, \mathbf{v} \in \widehat{\mathfrak{S}}_{r,s}$  are incomparable with respect to  $\blacktriangleleft$ .

To compare  $\mathbf{u}, \mathbf{v} \in \widehat{\mathbf{B}}_{r,s}$  (*i.e.* to check for presence in  $\triangleleft$ ) one proceeds consecutively along the following steps. If monomials  $\mathbf{u}, \mathbf{v}$  do not meet any condition at a given step, then one moves to the next one.

- i. Compare the lengths of monomials:  $|\mathbf{u}| < |\mathbf{v}| \Rightarrow \mathbf{u} \triangleleft \mathbf{v}$ .
- ii. If  $|\mathbf{u}| = |\mathbf{v}|$  then compare  $|\mathbf{u}|_r$  and  $|\mathbf{v}|_r$ :  $|\mathbf{u}|_r < |\mathbf{v}|_r \Rightarrow \mathbf{u} \triangleleft \mathbf{v}$ .

- iii. Let  $|\mathbf{u}| = |\mathbf{v}|$ ,  $|\mathbf{u}|_r = |\mathbf{v}|_r$ . Compare  $\mathbf{u} = \hat{s}_{i_1} \dots \hat{s}_{i_N}$  and  $\mathbf{v} = \hat{s}_{j_1} \dots \hat{s}_{j_N}$  lexicographically from left to right: let  $k = 1 \dots N$  be the minimal number such that either  $i_{k'}, j_{k'} < r$  or  $i_{k'}, j_{k'} > r$  or  $i_{k'} = j_{k'} = r$  for all  $k' < k$  and not for  $k' = k$ . If either  $i_k \leq r < j_k$  or  $i_k < r \leq j_k$  then  $\mathbf{u} \triangleleft \mathbf{v}$ .
- iv. If two monomials  $\mathbf{u}$  and  $\mathbf{v}$  are such that  $|\mathbf{u}| = |\mathbf{v}|$  and  $|\mathbf{u}|_r = |\mathbf{v}|_r$ , but comparison by iii does not apply then  $\mathbf{u} = \mathbf{u}_0 \hat{s}_r \mathbf{u}_1 \hat{s}_r \dots \hat{s}_r \mathbf{u}_H$  and  $\mathbf{v} = \mathbf{v}_0 \hat{s}_r \mathbf{v}_1 \hat{s}_r \dots \hat{s}_r \mathbf{v}_H$  where  $\mathbf{u}_0, \dots, \mathbf{u}_H, \mathbf{v}_0, \dots, \mathbf{v}_H$  do not contain  $s_r$  and  $|\mathbf{u}_\alpha|_L = |\mathbf{v}_\alpha|_L \geq 0$ ,  $|\mathbf{u}_\alpha|_R = |\mathbf{v}_\alpha|_R \geq 0$  for all  $\alpha = 0 \dots H$ . Then compare  $\pi_L(\mathbf{u}_\alpha) \pi_R(\mathbf{u}_\alpha), \pi_L(\mathbf{v}_\alpha) \pi_R(\mathbf{v}_\alpha) \in \widehat{\mathfrak{S}}_{r,s}$  with respect to  $\blacktriangleleft$ : let  $\alpha_0 = 0 \dots H$  be the minimal number such that  $\pi_L(\mathbf{u}_\beta) \pi_R(\mathbf{u}_\beta), \pi_L(\mathbf{v}_\beta) \pi_R(\mathbf{v}_\beta)$  are incomparable with respect to  $\blacktriangleleft$  for all  $\beta < \alpha_0$  but not for  $\beta = \alpha_0$ . Then  $\pi_L(\mathbf{u}_{\alpha_0}) \pi_R(\mathbf{u}_{\alpha_0}) \blacktriangleleft \pi_L(\mathbf{v}_{\alpha_0}) \pi_R(\mathbf{v}_{\alpha_0})$  implies  $\mathbf{u} \triangleleft \mathbf{v}$ .

## B: multiplication by generators

In what follows we write down formulas for the left multiplication of elements from the set  $\mathfrak{B}_{r,s}$  by the generators  $s_p \in \mathbf{B}_{r,s}(\delta)$ . Let  $[1, 1 - q_1] \dots [r - 1, r - 1 - q_{r-1}] \in \mathfrak{S}_r^L$  with  $-1 \leq q_1 < 1, \dots, -1 \leq q_{r-1} < r - 1$ . We will use a shorthand notation  $[\dots][r - 1, r - 1 - q]$  with  $[\dots] = [1, 1 - q_1] \dots [r - 2, r - 2 - q_{r-2}]$ . For the products of the form  $[r + i_1, r - f + 1 - j_f] \dots [r + f - 1 + i_f, r - j_1]$  we impose by default  $s - f \geq i_f \geq \dots \geq i_1 \geq 0$  and  $r - f \geq j_f \geq \dots \geq j_1 \geq 0$ , unless else is specified. For brevity we do not write out the well-known multiplication of the elements from  $\mathfrak{S}_r^L$  (respectively,  $\mathfrak{S}_s^R$ ) by the generator  $s_i \in \mathfrak{S}_r$  (respectively,  $s_i \in \mathfrak{S}_s$ ).

I.  $1 \leq p < r$ :

$$s_p \cdot \mathfrak{S}_r^L \mathfrak{D}_{r,s}^{(f)} \mathfrak{S}_s^R = (s_p \cdot \mathfrak{S}_r^L) \mathfrak{D}_{r,s}^{(f)} \mathfrak{S}_s^R$$

II.  $p = r, f > 0$ :

a)  $\mathfrak{S}_r^L$  is represented by  $[\dots]$  and  $i_1 = 0$ :

$$\begin{aligned} s_r \cdot [\dots][r, r - f + 1 - j_f] \dots [r + f - 1 + i_f, r - j_1] \mathfrak{S}_s^R \\ = \delta [\dots][r, r - f + 1 - j_f] \dots [r + f - 1 + i_f, r - j_1] \mathfrak{S}_s^R, \end{aligned}$$

b)  $i_1 = 0$  and  $q \geq 0$ :

$$\begin{aligned} s_r \cdot [\dots][r - 1, r - 1 - q][r, r - f + 1 - j_f] \dots [r + f - 1 + i_f, r - j_1] \mathfrak{S}_s^R \\ = ([\dots] \cdot [r - 2, r - 1 - q])[r, r - f + 1 - j_f] \dots [r + f - 1 + i_f, r - j_1] \mathfrak{S}_s^R, \end{aligned}$$

c)  $s - f \geq i_f \geq \dots \geq i_1 \geq 1$  and  $r - f > q - f + 1 \geq j_f \geq \dots \geq j_1 \geq 0$ :

$$\begin{aligned} s_r \cdot [\dots] [r-1, r-1-q] [r+i_1, r-f+1-j_f] \dots [r+f-1+i_f, r-j_1] \mathfrak{S}_s^R \\ = [\dots] [r, r-1-q] [r+i_1, r-f+1-j_f] \dots [r+f-1+i_f, r-j_1] \mathfrak{S}_s^R, \end{aligned}$$

d)  $-1 \leq q < j_f + f - 1$  (put  $i_0 = 1$ ) and  $s - f \geq i_f \geq \dots \geq i_1 \geq 1$ :

$$\begin{aligned} s_r \cdot [\dots] [r-1, r-1-q] [r+i_1, r-f+1-j_f] \dots [r+f-1+i_f, r-j_1] \mathfrak{S}_s^R \\ = [\dots] [r, r-f+1-j_f] [r+i_1, r-f+2-j_{f-1}] \dots \\ \dots [r+q+i_{q+1}, r-f+q+2-j_{f-q-1}] [r+q+2+i_{q+3}, r-f+q+3-j_{f-q-2}] \dots \\ \dots [r+f-1+i_f, r-j_1] ([r+f+i_{q+2}-1, r+f+1] \cdot \mathfrak{S}_s^R). \end{aligned}$$

III.  $p = r, f = 0$  and  $-1 \leq q < r - 1$ :

$$s_r \cdot [\dots] [r-1, r-1-q] \mathfrak{S}_s^R = [\dots] [r, r-1-q] \mathfrak{S}_s^R,$$

IV.  $r < p \leq r + f + i_f$ :

a)  $p = r + k + i_k, i_{k+1} > i_k$ :

$$\begin{aligned} s_p \cdot \mathfrak{S}_r^L \dots [r+k-1+i_k, r-f+k-j_{f-k+1}] \dots \mathfrak{S}_s^R = \\ \mathfrak{S}_r^L \dots [r+k+i_k, r-f+k-j_{f-k+1}] \dots \mathfrak{S}_s^R, \end{aligned}$$

b)  $p = r + k + i_k, i_{k+1} = i_k$ :

$$\begin{aligned} s_p \cdot \mathfrak{S}_r^L \dots [r+k-1+i_k, r-f+k-j_{f-k+1}] \dots \mathfrak{S}_s^R = \\ (\mathfrak{S}_r^L \cdot s_{r-k}) \dots [r+k-1+i_k, r-f+k-j_{f-k+1}] \dots \mathfrak{S}_s^R. \end{aligned}$$

V.  $p > r + f + i_f$ :

$$s_p \cdot \mathfrak{S}_r^L \mathfrak{D}_{r,s}^{(f)} \mathfrak{S}_s^R = \mathfrak{S}_r^L \mathfrak{D}_{r,s}^{(f)} (s_p \cdot \mathfrak{S}_s^R).$$

## C: atypical part of the bimodule

In this section we represent the structure of Loewy graph for the indecomposable bimodule  $T_{m,n}^{\text{at}}$ , see 5.42. Detailed investigation of  $\mathcal{X}_{m,n}$  action on these bimodules are beyond the

scope of this work. See paper [GV], where the mixed tensor product of  $\mathcal{U}_q\mathfrak{sl}(2)$ -modules is investigated for comparison.

In each vertex of the graph there is some subquotient  $D(\lambda) \boxtimes \bar{\mathcal{Z}}_{t,r}^p$ . The meaning of the arrows is the same as in 2.4.1.5. On the figures the action of algebra  $\mathcal{U}_q\mathfrak{sl}(2|1)$  is denoted by solid lines, and the action of  $\mathcal{X}_{m,n}$  is denoted by dash lines.

The subquotients connected by dash lines have the same  $\mathcal{U}_q\mathfrak{sl}(2|1)$  module as a tensor multiplier. The subquotients connected by solid lines have the same  $\mathcal{X}_{m,n}$  module as a tensor multiplier. To simplify the figures we omit  $\mathcal{X}_{m,n}$  multiplier where it does not cause inconsistency. We also do not write symbol  $D$  each time, and write only  $\lambda$  for simple module  $D(\lambda)$ .

For example, the bimodule for  $T_{3,2}^{\text{at}}$  is

$$\begin{array}{ccccc}
 & D(A_2^1) \boxtimes \bar{\mathcal{Z}}_{0,2}^2 & & D(A_1^1) \boxtimes \bar{\mathcal{Z}}_{0,1}^1 & \\
 & \swarrow & & \downarrow & \searrow \\
 D(A_2^1) \boxtimes \bar{\mathcal{Z}}_{0,3}^3 & & D(A_2^1) \boxtimes \bar{\mathcal{Z}}_{0,1}^1 & \leftarrow & D(A_1^1) \boxtimes \bar{\mathcal{Z}}_{0,2}^2 \quad D(A_0^1) \boxtimes \bar{\mathcal{Z}}_{0,1}^1 \quad D(A_1^1) \boxtimes \bar{\mathcal{Z}}_{0,0}^2 \\
 & \searrow & \swarrow & \downarrow & \swarrow \\
 & D(A_2^1) \boxtimes \bar{\mathcal{Z}}_{0,2}^2 & & D(A_1^1) \boxtimes \bar{\mathcal{Z}}_{0,1}^1 & 
 \end{array}
 \tag{5.48}$$

We use shorthand notation for  $T_{3,2}^{\text{at}}$ :

$$\begin{array}{ccccc}
 & A_2^1 \boxtimes \bar{\mathcal{Z}}_{0,2}^2 & & A_1^1 \boxtimes \bar{\mathcal{Z}}_{0,1}^1 & \\
 & \swarrow & & \downarrow & \searrow \\
 \bar{\mathcal{Z}}_{0,3}^3 & & \bar{\mathcal{Z}}_{0,1}^1 & \leftarrow & \bar{\mathcal{Z}}_{0,2}^2 \quad A_0^1 \boxtimes \bar{\mathcal{Z}}_{0,1}^1 \quad \bar{\mathcal{Z}}_{0,0}^2 \\
 & \searrow & \swarrow & \downarrow & \swarrow \\
 & \bar{\mathcal{Z}}_{0,2}^2 & & \bar{\mathcal{Z}}_{0,1}^1 & 
 \end{array}
 \tag{5.49}$$

We mark in red the subquotient where the figure has irregular form.

The structure of  $T_{m,n}^{\text{at}}$  for the case  $1 \leq n \leq \frac{m}{2}$  is shown in figure 2.2.

The case  $\frac{m}{2} + 1 \leq n \leq m - 2$  is shown in figure 2.3.

The case  $n = \frac{m+1}{2}, n \geq 2$  is shown in figure 2.4.

The case  $n = m - 1, n \geq 1$  is shown in figure 2.5.

The case  $n = m, n \geq 2$  is shown in figure 2.6.

Two exceptional cases are:

$$\begin{aligned}
 T_{m,0}^{\text{at}} &= D(A_0^m) \boxtimes \bar{\mathcal{Z}}_{0,m}^1, \\
 T_{1,1}^{\text{at}} &= D(A_0^0) \boxtimes \bar{\mathcal{Z}}_{0,0}^1.
 \end{aligned}$$

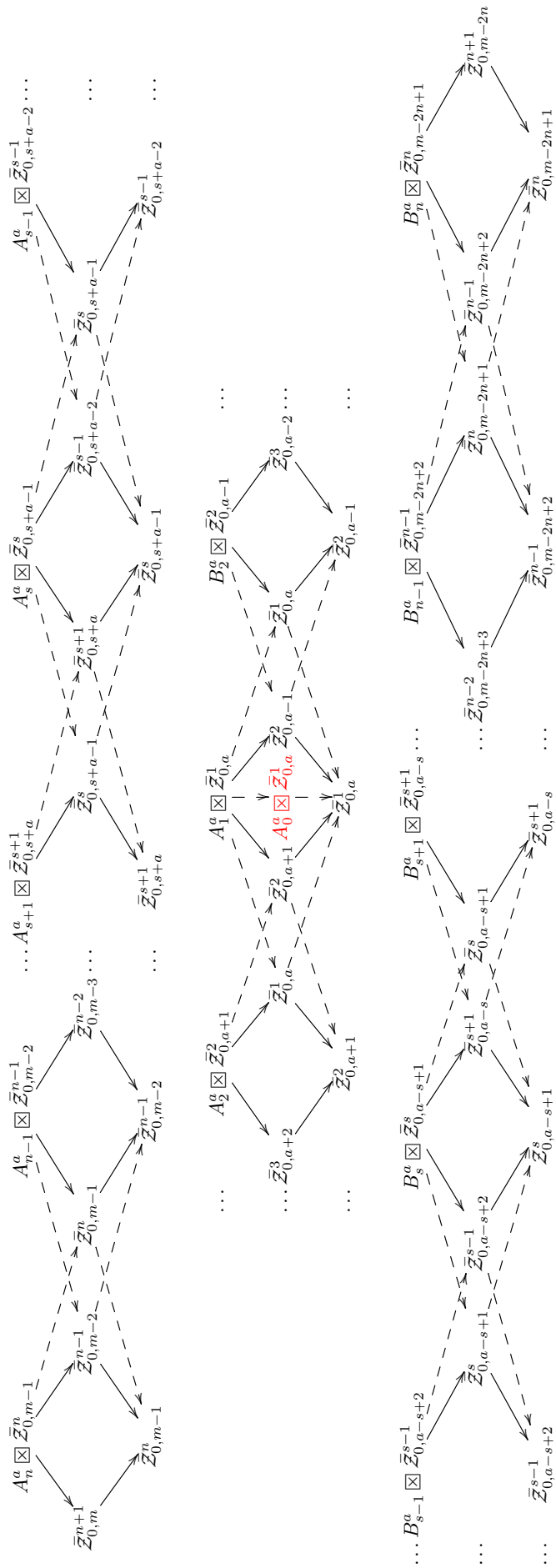

Figure 2.2:  $T_{m,n}^d$ ,  $1 \leq n \leq \frac{m}{2}$

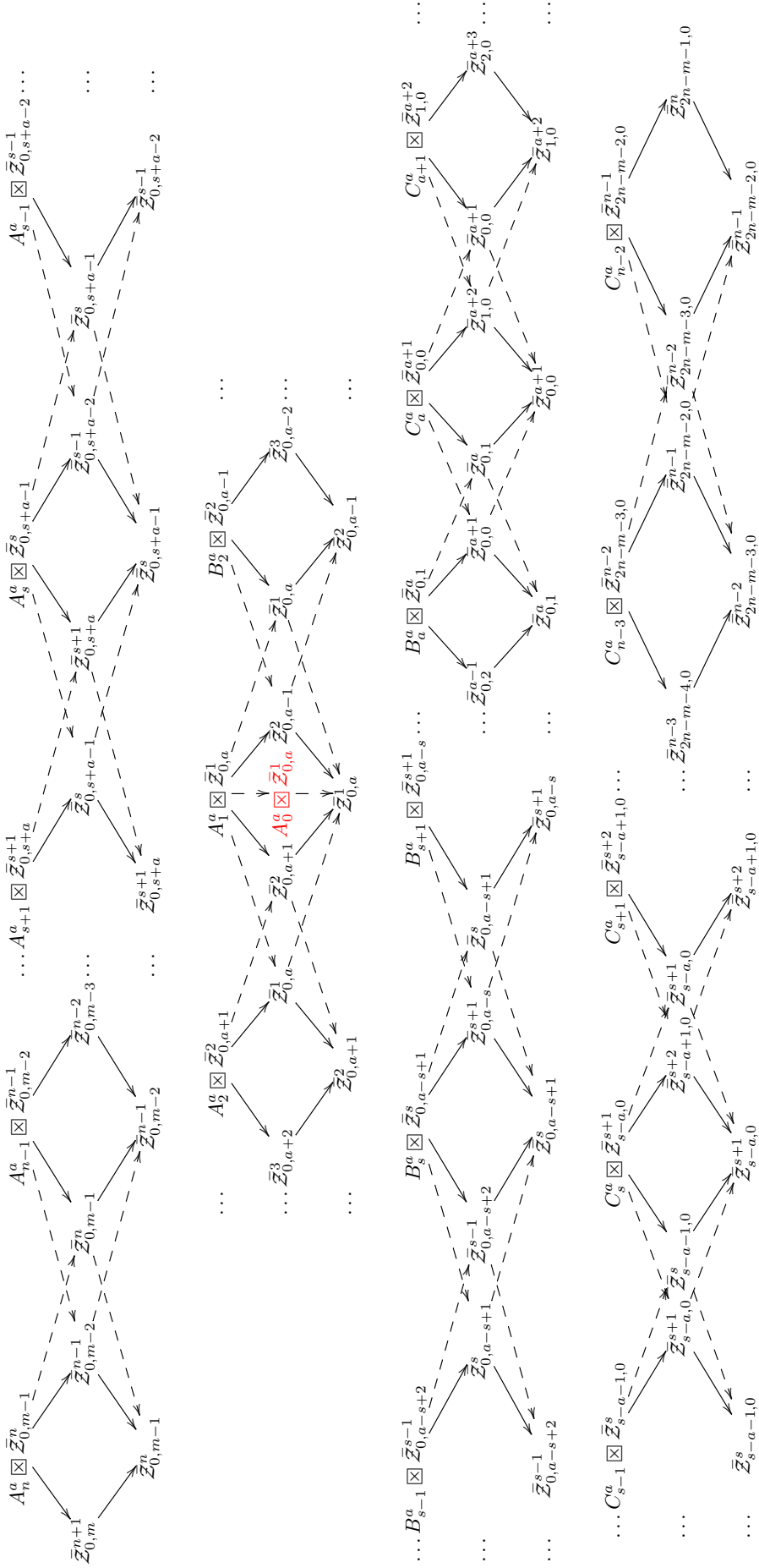

Figure 2.3:  $T_{m,n}^d$ ,  $\frac{m}{2} + 1 \leq n \leq m - 2$ .



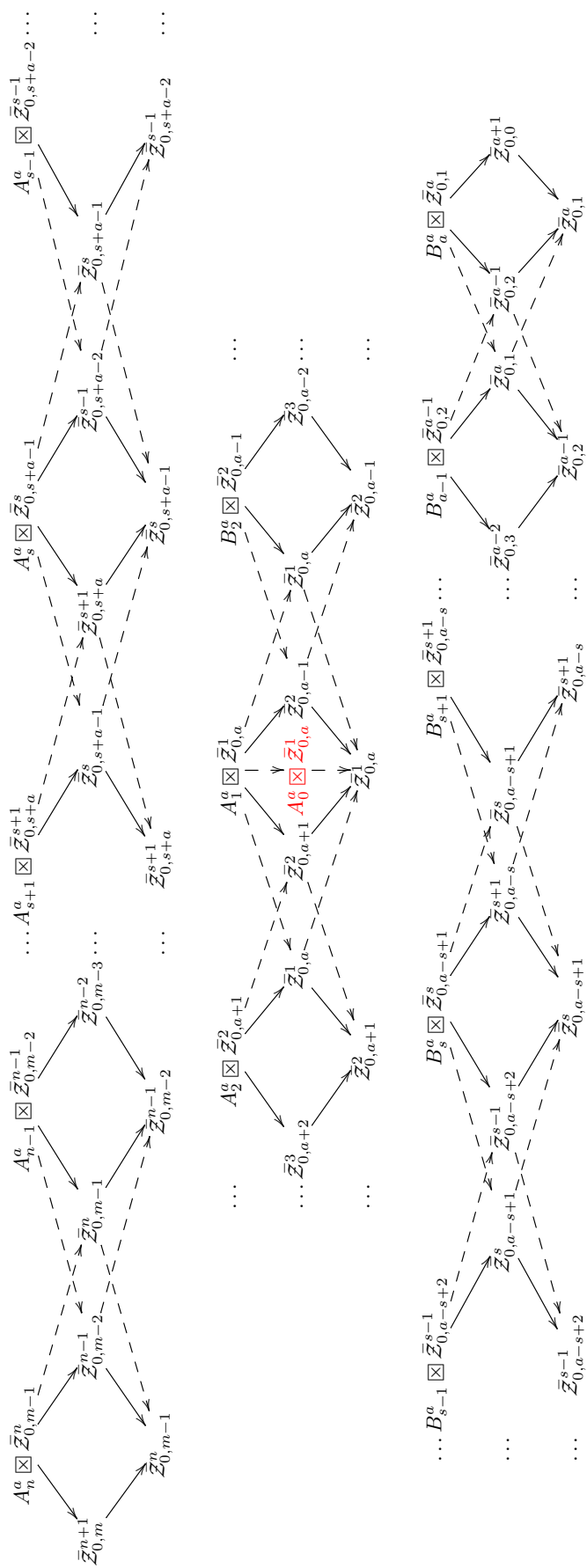

Figure 2.4:  $T_{m,n}^d, n = \frac{m+1}{2}, n \geq 2, (a = n-1)$

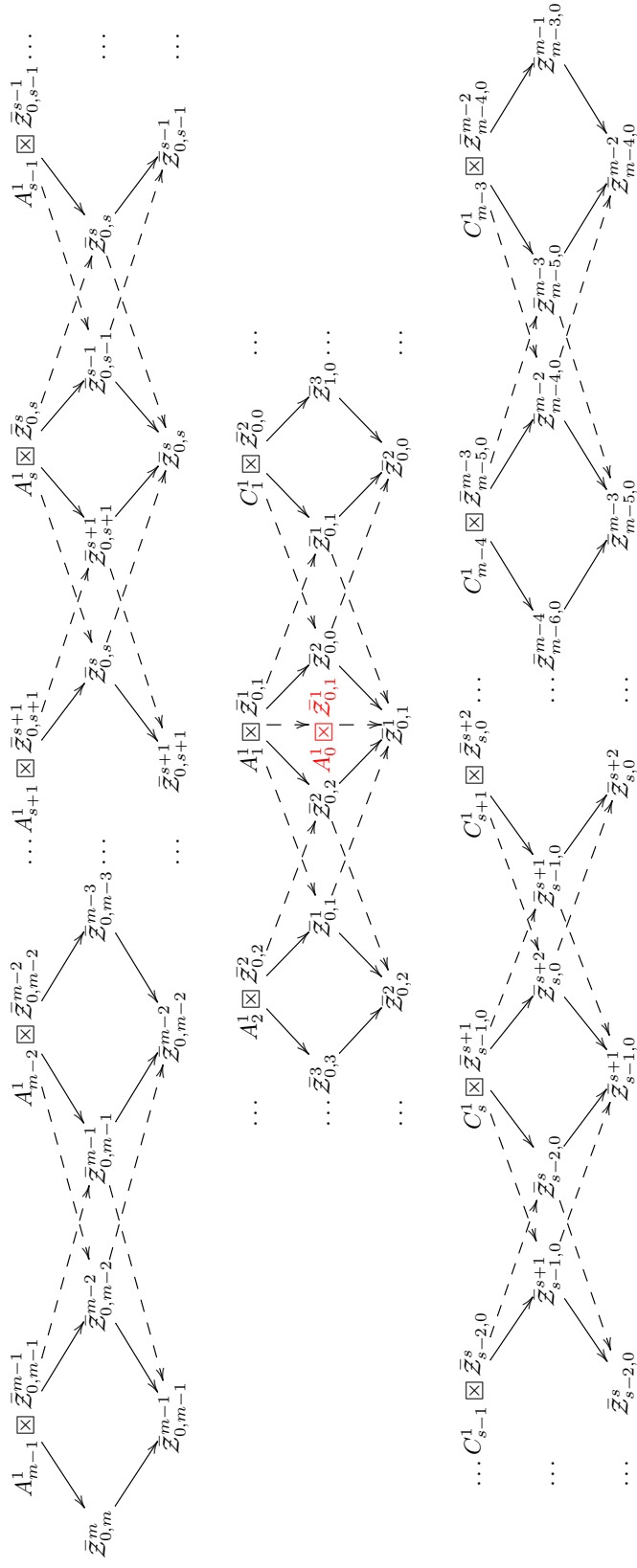

Figure 2.5:  $T_{m,m-1}^d$ ,  $m \geq 2$

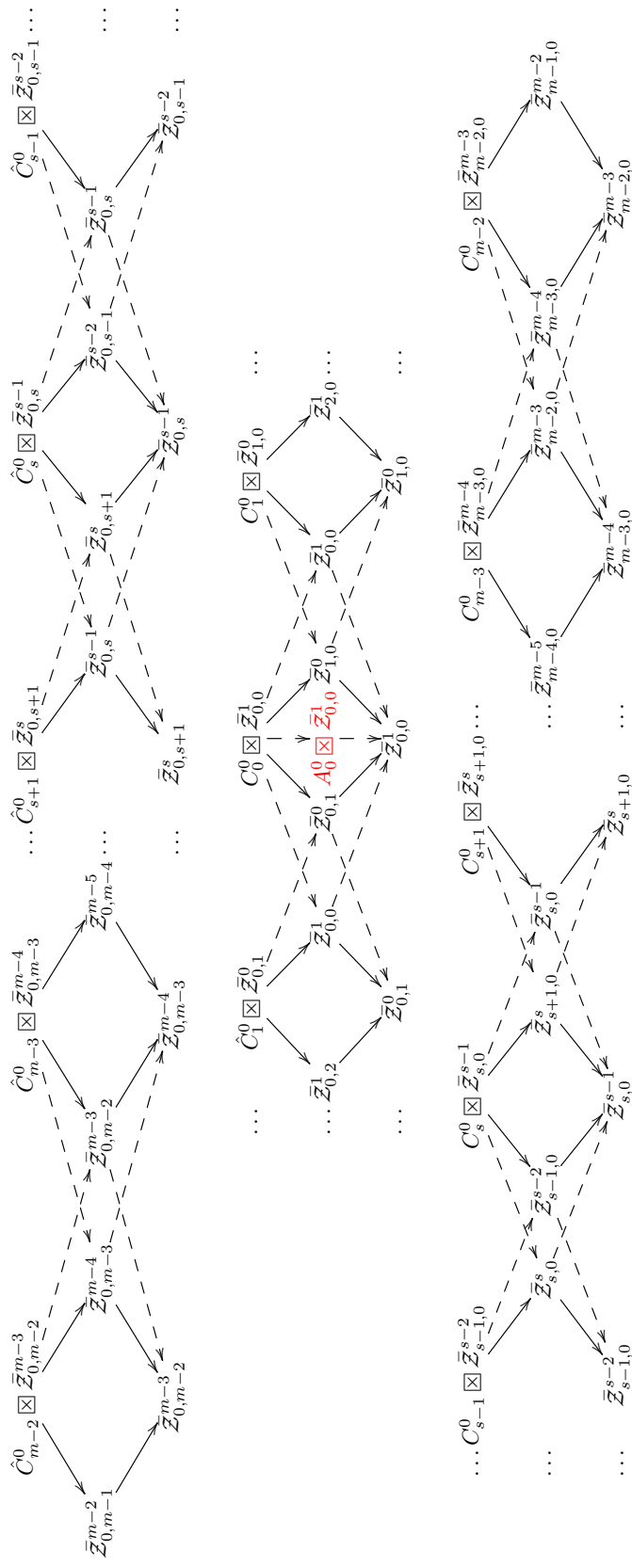

Figure 2.6:  $T_{m,m}^d$ ,  $m \geq 2$

# Bibliography

- [ASS] I. Assem, D. Simson and A. Skowronski, *Elements of the Representation Theory of Associative Algebras: Volume 1: Techniques of Representation Theory*, Cambridge University Press, 2006.
- [B] G. M. Bergman, *The diamond lemma for ring theory*, Adv. Math. **29** (1978) 178–218.
- [BCHLLS] G. Benkart, M. Chakrabarti, T. Halverson, R. Leduc, C. Lee and J. Stroomer, *Tensor product representations of general linear groups and their connections with Brauer algebras* J. of Algebra **166**:3 (1994) 529–567.
- [BO] D. Bulgakova and O. Ogievetsky, *Fusion procedure for the walled Brauer algebra*, Journal of Geometry and Physics (2019). DOI: <https://doi.org/10.1016/j.geomphys.2019.103580>
- [BGO] D. Bulgakova, Y. Goncharov and O. Ogievetsky, *Normal form for the walled Brauer algebra: construction and applications*, arXiv:1912.12869 [math.RT]
- [BTS] D. V. Bulgakova, A. M. Kiselev and I. Yu. Tipunin, *Bimodule structure of the mixed tensor product over  $U_qsl(2|1)$  and quantum walled Brauer algebra*, Nuclear Physics B **928** (2018) 217-257
- [BE] C. Bowman and J. Enyang, *Skew cell modules for diagram algebras*; arXiv:1605.03448v2.
- [BGT] P. V. Bushlanov, A. M. Gainutdinov, I. Yu. Tipunin, *Kazhdan-Lusztig equivalence and fusion of Kac modules in Virasoro logarithmic models*, Nucl.Phys. B862 (2012).
- [BS] J. Brundan and C. Stroppel, *Gradings on walled Brauer algebras and Khovanov’s arc algebra*, Advances in Mathematics **231** (2012) 709-773.
- [C] W. Cui, *Fusion procedure for cyclotomic BMW algebras*, Algebras and Representation Theory (2018) 1-14.
- [Ch] I. V. Cherednik, *A new interpretation of Gel’fand–Tzetlin bases*, Duke Math. J. **54** (1987) 563–577.
- [CD] A. Cox and M. De Visscher, *Diagrammatic Kazhdan-Lusztig theory for the (walled) Brauer algebra*, Journal of Algebra 340(1) (2011).

- [CDDM] A. Cox, M. De Visscher, S. Doty, and P. Martin, *On the blocks of the walled Brauer algebra*, J. Algebra **320**:1 (2008) 169–212.
- [CMPX] A.G. Cox, P.P. Martin, A.E. Parker, and C. Xi, *Representation theory of towers of recollement: theory, notes, and examples*, J. Algebra **302** (2006), 340–360.
- [CW] J. Comes and B. Wilson, *Deligne’s category  $\underline{\text{Rep}}(GL_\delta)$  and representations of general linear supergroups*; arXiv:1108.0652.
- [DK] Yu.A. Drozd and V.V. Kirichenko, *Finite dimensional algebras*, Springer-Verlag, 1994.
- [E] J. Enyang, *Cellular bases of the two-parameter version of the centraliser algebra for the mixed tensor representations of the quantum general linear group*, Combinatorial representation theory and related topics (Kyoto, 2002) 1310 (2003) 134–153.
- [E1] J. Enyang, *Bases of certain algebras associated with quantum groups*, Ph.D. thesis, Univ. Illinois at Chicago, 2002.
- [FP] H.K. Farahat and M. H. Peel, *On the representation theory of Symmetric groups*, J. Algebra **67** (1980), 280-304.
- [GV] A. M. Gainutdinov, R. Vasseur, *Lattice fusion rules and logarithmic operator product expansions*, Nucl. Phys. B 868, 223-270 (2013)
- [GL] J.J. Graham and G.I. Lehrer, *Cellular algebras*, Invent. Math. 123 (1996), 1–34.
- [GP] V. Guizzi and P. Papi, *A combinatorial approach to the fusion process for the symmetric group*, Europ. J. Comb. **19** (1998) 835–845.
- [GQS] G. Gotz, T. Quella, V. Schomerus, *Representation theory of  $sl(2|1)$* , Journal of Algebra 312:2 (2007).
- [H] T. Halverson, *Characters of the centralizer algebras of mixed tensor representations of  $GL(r, \mathbb{C})$  and the quantum group  $U_q(\mathfrak{gl}(r, \mathbb{C}))$* , Pacific Journal of Mathematics, 174 (1996) 259-410.
- [He] T. Heidersdorf, *Mixed Tensors of the General Linear Supergroup*, Journal of Algebra, 491 (2014)
- [IM] A. P. Isaev and A. I. Molev, *Fusion procedure for the Brauer algebra*, St. Petersburg Math. J. **22**:3 (2011) 437–446.
- [IMO] A. P. Isaev, A. I. Molev, and O. V. Ogievetsky, *A New Fusion Procedure for the Brauer Algebra and Evaluation Homomorphisms*, International Mathematics Research Notices **11** (2011) 2571–2606.
- [IMO2] A. P. Isaev, A. I. Molev, and O. V. Ogievetsky, *Idempotents for Birman–Murakami–Wenzl algebras and reflection equation*, Advances in Theoretical and Mathematical Physics **18**:1 (2014) 1–25.

- [IMOs] A. P. Isaev, A. I. Molev, and A. F. Os'kin, *On the Idempotents of Hecke Algebras*, Lett. Math. Phys **85**:1 (2008) 79–90
- [IO] A. P. Isaev and O. V. Ogievetsky, *On representations of Hecke algebras*, Czechoslovak Journal of Physics **55** no. 11 (2005) 1433–1441.
- [IO2] A. P. Isaev and O. V. Ogievetsky, *Jucys-Murphy elements for Birman-Murakami-Wenzl algebras*, Part. Nuclei Lett. **8**:234 (2011) 234–243.
- [Ju] A. Jucys, *Factorization of Young projection operators for the symmetric group*, Lietuvos Fizikos Rinkinys **11** (1971) 5–10.
- [JK] J. H. Jung and M. Kim, *Supersymmetric polynomials and the center of the walled Brauer algebra*, arXiv:1508.06469 [math.RT]
- [K1] V.G. Kac, *Classification of simple Lie superalgebras*, Funct. Anal. **9**:263 (1975)
- [K2] V.G. Kac, *Lie superalgebras*, Adv. Math. **26**:8 (1977)
- [K3] V.G. Kac, *A sketch of Lie superalgebra theory*, Commun. Math. Phys. **53**:31 (1977)
- [KC] V. Kac, P. Cheung, *Quantum Calculus*, Springer-Verlag, New York (2002)
- [Ko] K. Koike, *On the decomposition of tensor products of the representations of classical groups: by means of the universal characters*, Adv. Math. **74**:1 (1989) 57–86.
- [KM] M. Kosuda and J. Murakami, *Centralizer algebras of the mixed tensor representations of quantum group  $U_q gl(m, \mathbb{C})$* , Osaka J. Math. **30** (1993) 475–507.
- [KV] Nguyen Anh Ky and Nguyen Thi Hong Van, *Finite-dimensional representations of  $U_q gl(2|1)$  in a basis of  $U_q[gl(2) \oplus gl(1)]$* , Advances in Natural Sciences **5** (2004), p.1.
- [KX] S. König and C. Xi, *Cellular algebras: inflations and Morita equivalences* J. London Math Soc. **60** (1999), 700–722.
- [L] R. Leduc, *A two-parameter version of the centralizer algebra of the mixed tensor representation of the general linear group and quantum general linear group*, thesis, University of Wisconsin-Madison (1994).
- [M] S. MacLane, *Homology*, Springer Verlag, 1963.
- [Mo] A. I. Molev, *On the fusion procedure for the symmetric group*, Reports Math. Phys. **61** (2008) 181–188.
- [Mu] G. E. Murphy, *A new construction of Young's seminormal representation of the symmetric groups*, Journal of Algebra **69** (1981) 287–297.

- [Na] M. Nazarov, *Yangians and Capelli identities*, in Kirillov's Seminar on Representation Theory, G. I. Olshanski, ed., Amer. Math. Soc. Transl. 181, Amer. Math. Soc., Providence RI (1998) 139–163.
- [Na2] M. Nazarov, *Representations of twisted Yangians associated with skew Young diagrams*, Selecta Math. (N.S.) **10** (2004) 71–129.
- [Ni] P. Nikitin, *The centralizer algebra of the diagonal action of the group  $GL_n(\mathbb{C})$  in a mixed tensor space*, J. Math. Sci. **141** (2007) 1479–1493.
- [NV] P. P. Nikitin and A. M. Vershik, *Traces on Infinite-Dimensional Brauer Algebras*, Funct. Anal. Appl. **40**:3 (2006) 165–172.
- [OP] O. Ogievetsky and P. Pyatov, *Lecture on Hecke algebras*, in: Proc. of the International School "Symmetries and Integrable Systems", Dubna (1999); preprint MPIM (Bonn), MPI 2001–40, www.mpim-bonn.mpg.de
- [OP1] O. Ogievetsky and L. Poulain d'Andecy, *Fusion procedure for Coxeter groups of type B and complex reflection groups  $G(m, 1, n)$* , Proceedings of the American Mathematical Society **142**:9 (2014) 2929–2941.
- [OP2] O. Ogievetsky and L. Poulain d'Andecy, *Fusion procedure for cyclotomic Hecke algebras*, Sigma (Symmetry, Integrability and Geometry: Methods and Applications) **10** (2014) 039, 13 pages.
- [OP3] O. V. Ogievetsky and L. Poulain d'Andecy, *Induced representations and traces for chains of affine and cyclotomic Hecke algebras*, Journal of Geometry and Physics **87** (2015) 354–372.
- [OP4] O. Ogievetsky and L. Poulain d'Andecy, *On representations of cyclotomic Hecke algebras*, Mod. Phys. Lett. A **26** No. 11 (2011) 795–803.
- [OP5] O. Ogievetsky and L. Poulain d'Andecy, *An inductive approach to representations of complex reflection groups  $G(m, 1, n)$* , Theoretical and Mathematical Physics **174** (2013) 95–108 (translated from: Teoret. Matem. Fyz. **174** (2013) 109–124).
- [OV] A. Okounkov and A. Vershik, *A new approach to representation theory of symmetric groups*, Selecta Math., New Ser. Vol. **2**, No. 4 (1996) 581–605.
- [P] M. H. Peel, *Specht modules and the symmetric groups*, J. Algebra **36** (1975), 88–97.
- [PT] T. D. Palev and V. N. Tolstoy, *Finite dimensional irreducible representations of the quantum superalgebra  $U_q\mathfrak{gl}(n|1)$* , Commun. Math. Phys. **141** (1991).
- [PSV] T. D. Palev, N. I. Stoilova and J. Van der Jeugt, *Finite-dimensional representations of the quantum superalgebra  $U_q\mathfrak{gl}(n|m)$  and related  $q$ -identities*, Commun. Math. Phys. **166** (1994).

- [RS] H. Rui and L. Song, *The representations of quantized walled Brauer algebra*, J. Pure and Applied Algebra 219:5 (2014)
- [S] Yucai Su, *Classification of finite dimensional modules of the Lie superalgebra  $sl(2|1)$* , Communications in Algebra 20:11 3259-3277 (1992).
- [SS] A. Sartori and C. Stroppel, *Walled Brauer algebras as idempotent truncations of level 2 cyclotomic quotients*, J. of Algebra 440 (2015) 602–638.
- [SM] C. L. Shader and D. Moon, *Mixed tensor representations of quantum superalgebra  $U_q\mathfrak{gl}(m, n)$* , Commun. Algebra, 35:3 (2007), 781-806.
- [SM2] C. L. Shader and D. Moon, *Mixed tensor representations and rational representations for the general linear Lie superalgebras*, Commun. Algebra 30:2 (2002), 839-857.
- [ST] A. M. Semikhatov, I. Yu. Tipunin, *Representations of  $\bar{U}_qsl(2|1)$  at even roots of unity*, J. Math. Phys. 57 (2), (2016).
- [ST2] A. M. Semikhatov, I. Yu. Tipunin, *Quantum walled Brauer algebra: commuting families, Baxterization, and representations*, arXiv:1512.06994v1 [math.QA].
- [SW] F. Stoll, M. Werth, *A cell filtration of mixed tensor space*, arXiv:1408.6720 [math.RT] (2014)
- [T] V. Turaev, *Operator invariants of tangles, and R-matrices*, Math. USSR-Izv. **35**:2 (1990) 411–444.
- [Z] R. B. Zhang, *Finite dimensional irreducible representations of the quantum supergroup  $U_q\mathfrak{gl}(m|n)$* , J. Math. Phys. 34 (3) (1993).