

UNIVERSITE DE FRANCHE-COMTE

U.F.R. des Sciences du Langage, de l'Homme et de la Société

THESE DE DOCTORAT

Spécialité : Archéologie

**CERAMIQUE INDIGENE ET FACIES CULTURELS
A LA TENE FINALE DANS LA VALLEE DE LA SAONE**

Philippe BARRAL

sous la direction de Michel MANGIN

Volume III : planches



Composition du jury :

Patrice Arcelin, Jean-Paul Jacob, Gilbert Kaenel, Michel Mangin, Claude Rolley

Besançon, juin 1994

UNIVERSITE DE FRANCHE-COMTE

U.F.R. des Sciences du Langage, de l'Homme et de la Société

THESE DE DOCTORAT

Spécialité : Archéologie

**CERAMIQUE INDIGENE ET FACIES CULTURELS
A LA TENE FINALE DANS LA VALLEE DE LA SAONE**

Philippe BARRAL

sous la direction de Michel MANGIN

Volume III : planches

Composition du jury :

Patrice Arcelin, Jean-Paul Jacob, Gilbert Kaenel, Michel Mangin, Claude Rolley

Besançon, juin 1994

Sommaire du volume 3

Sommaire.....	p. 2-7
St.-Symphorien-Varennnes (fin IIè.-début Ier s. av.).....	Pl. 1
St.-Symphorien-Varennnes (fin IIè.-début Ier s. av.).....	Pl. 2
St.-Symphorien-Varennnes (fin IIè.-début Ier s. av.).....	Pl. 3
St.-Symphorien-Varennnes (fin IIè.-début Ier s. av.).....	Pl. 4
St.-Symphorien-Varennnes (fin IIè.-début Ier s. av.).....	Pl. 5
St.-Symphorien-Varennnes (fin IIè.-début Ier s. av.).....	Pl. 6
St.-Symphorien-Varennnes (fin IIè.-début Ier s. av.).....	Pl. 7
Mâcon -Cours Moreau, Carmélites (2è. moitié Ier s. av.).....	Pl. 8
Mâcon -Cours Moreau, Carmélites (2è. moitié Ier s. av.).....	Pl. 9
Mâcon -Cours Moreau, Carmélites (2è. moitié Ier s. av.).....	Pl. 10
Mâcon -Cours Moreau, Carmélites (2è. moitié Ier s. av.).....	Pl. 11
Azé -Le Saulé (fin IIè.-Ier s. av.).....	Pl. 12
Azé -Le Saulé (fin IIè.-Ier s. av.).....	Pl. 13
Azé -Le Saulé (fin IIè.-Ier s. av.).....	Pl. 14
Azé -Le Saulé (fin IIè.-Ier s. av.).....	Pl. 15
Azé -Le Saulé (fin IIè.-Ier s. av.).....	Pl. 16
Tournus -Champsemard (fin IIè.-déb. Ier s. av.).....	Pl. 17
Tournus -Champsemard (fin IIè.-déb. Ier s. av.).....	Pl. 18
Tournus -Champsemard (fin IIè.-déb. Ier s. av.).....	Pl. 19
Tournus -Champsemard (fin IIè.-déb. Ier s. av.).....	Pl. 20
Tournus -Champsemard (fin IIè.-déb. Ier s. av.).....	Pl. 21
Tournus -Sept Fontaines (Ier s. av.).....	Pl. 22
Tournus -Sept Fontaines (Ier s. av.).....	Pl. 23

Tournus -Sept Fontaines (Ier s. av.).....	Pl. 24
Tournus -Sept Fontaines (Ier s. av.).....	Pl. 25
Tournus -Sept Fontaines (Ier s. av.).....	Pl. 26
Tournus -Sept Fontaines (Ier s. av.).....	Pl. 27
Tournus -Clos-roy (2è. moitié Ier s. av.).....	Pl. 28
Tournus -Clos-roy (2è. moitié Ier s. av.).....	Pl. 29
Tournus -Clos-roy (2è. moitié Ier s. av.).....	Pl. 30
Tournus -Clos-roy (2è. moitié Ier s. av.).....	Pl. 31
Tournus -Clos-roy (2è. moitié Ier s. av.).....	Pl. 32
Tournus -Clos-roy (2è. moitié Ier s. av.).....	Pl. 33
Mellecey -Marloux (fin IIè. Ier s. av.).....	Pl. 34
Verdun -Petit-Chauvort (2è. moitié IIè.-déb. Ier s. av.).....	Pl. 35
Verdun -Petit-Chauvort (2è. moitié IIè.-déb. Ier s. av.).....	Pl. 36
Verdun -Petit-Chauvort (2è. moitié IIè.-déb. Ier s. av.).....	Pl. 37
Verdun -Petit-Chauvort (2è. moitié IIè.-déb. Ier s. av.).....	Pl. 38
Verdun -Petit-Chauvort (2è. moitié IIè.-déb. Ier s. av.).....	Pl. 39
Verdun -Petit-Chauvort (2è. moitié IIè.-déb. Ier s. av.).....	Pl. 40
Verdun -Petit-Chauvort (2è. moitié IIè.-déb. Ier s. av.).....	Pl. 41
Verdun -Petit-Chauvort (2è. moitié IIè.-déb. Ier s. av.).....	Pl. 42
Verdun -Petit-Chauvort (2è. moitié IIè.-déb. Ier s. av.).....	Pl. 43
Verdun -Petit-Chauvort (2è. moitié IIè.-déb. Ier s. av.).....	Pl. 44
Verdun -Petit-Chauvort (2è. moitié IIè.-déb. Ier s. av.).....	Pl. 45
Verdun -Petit-Chauvort (2è. moitié IIè.-déb. Ier s. av.).....	Pl. 46
Verdun -Petit-Chauvort (2è. moitié IIè.-déb. Ier s. av.).....	Pl. 47
Verdun -Petit-Chauvort (2è. moitié IIè.-déb. Ier s. av.).....	Pl. 48

Verdun -Petit-Chauvort (2è. moitié IIè.-déb. Ier s. av.).....	Pl. 49
Verdun -Petit-Chauvort (2è. moitié IIè.-déb. Ier s. av.).....	Pl. 50
Verdun -Petit-Chauvort (2è. moitié IIè.-déb. Ier s. av.).....	Pl. 51
Verjux -Es Chezeaux (fin IIè.- 1ère moitié Ier s. av.).....	Pl. 52
Verjux -Es Chezeaux (fin IIè.- 1ère moitié Ier s. av.).....	Pl. 53
Verjux -mare-grillot (fin IIè.- 1ère moitié Ier s. av.).....	Pl. 54
Vignolles -Pièce Barot (IIè.-Ier s. av.).....	Pl. 55
La Saône de Mâcon à Seurre (IIè.-Ier s. av.).....	Pl. 56
La Saône de Mâcon à Seurre (IIè.-Ier s. av.).....	Pl. 57
La Saône de Mâcon à Seurre (IIè.-Ier s. av.).....	Pl. 58
La Saône de Mâcon à Seurre (IIè.-Ier s. av.).....	
Nuits-St.-Georges -Les Bolards -Fosse du fanum I (fin IIè-déb. Ier s. av.).....	Pl. 60
Nuits-St.-Georges -Les Bolards -Fosse du fanum I (fin IIè-déb. Ier s. av.).....	Pl. 61
Nuits-St.-Georges -Les Bolards -Fosse du fanum I (fin IIè-déb. Ier s. av.).....	Pl. 62
Nuits-St.-Georges -Les Bolards -Fosse du fanum I (fin IIè-déb. Ier s. av.).....	Pl. 63
Nuits-St.-Georges -Les Bolards -Fosse du fanum I (fin IIè-déb. Ier s. av.).....	Pl. 64
Nuits-St.-Georges -Les Bolards -Fosse du fanum I (fin IIè-déb. Ier s. av.) -zone du sanctuaire (n° 51-63 ; fin IIè. -Ier av.).....	Pl. 65
Nuits-St.-Georges -Les Bolards --zone du sanctuaire (fin IIè. -Ier av.) -zone de l'habitat (Ier s. av.).....	Pl. 66
Nuits-St.-Georges -Les Bolards -zone de l'habitat (Ier s. av.) ; -sans provenance.....	Pl. 67
Mirebeau -La Fenotte -Dépôts (fin IIè. -déb. Ier s. av.).....	Pl. 68
Mirebeau -La Fenotte -Dépôts (fin IIè. -déb. Ier s. av.).....	Pl. 69
Mirebeau -La Fenotte -Dépôts (fin IIè. -déb. Ier s. av.).....	Pl. 70
Mirebeau -La Fenotte -Dépôts (fin IIè. -déb. Ier s. av.).....	Pl. 71
Mirebeau -La Fenotte -Dépôts (fin IIè. -déb. Ier s. av.).....	Pl. 72

Mirebeau -La Fenotte -Dépôts (fin IIè. -déb. Ier s. av.).....	Pl. 73
Mirebeau -La Fenotte -Dépôts (fin IIè. -déb. Ier s. av.).....	Pl. 74
Mirebeau -La Fenotte -Dépôts (fin IIè. -déb. Ier s. av.).....	Pl. 75
Mirebeau -La Fenotte -Dépôts (fin IIè. -déb. Ier s. av.).....	Pl. 76
Mirebeau -La Fenotte -Dépôts (fin IIè. -déb. Ier s. av.).....	Pl. 77
Mirebeau -La Fenotte -Dépôts (fin IIè. -déb. Ier s. av.) -couche d'épandage (IIè. -Ier av.).....	Pl. 78
Mirebeau -La Fenotte -couche d'épandage (IIè. -Ier av.).....	Pl. 79
Mirebeau -La Fenotte -couche d'épandage (IIè. -Ier av.).....	Pl. 80
Mirebeau -La Fenotte -couche d'épandage (IIè. -Ier av.).....	Pl. 81
Mirebeau -La Fenotte -couche d'épandage (IIè. -Ier av.).....	Pl. 82
Mirebeau -La Fenotte -couche d'épandage (IIè. -Ier av.).....	Pl. 83
Gueugnon -Le Vieux Fresne (fin IIè.-déb. Ier s. av.).....	Pl. 84
Gueugnon -Le Vieux Fresne (fin IIè.-déb. Ier s. av.).....	Pl. 85
Decize -Rue des Fossés (fin IIè.-Ier s. av.).....	Pl. 86
Decize -Rue des Fossés (fin IIè.-Ier s. av.).....	Pl. 87
Mont-Beuvray -Pâture du Couvent (fin IIè. -début Ier s. av.).....	Pl. 88
Mont-Beuvray -Pâture du Couvent (fin IIè. -début Ier s. av.).....	Pl. 89
Mont-Beuvray -Pâture du Couvent (fin IIè. -début Ier s. av.).....	Pl. 90
Mont-Beuvray -Pâture du Couvent (fin IIè. -début Ier s. av.).....	Pl. 91
Mont-Beuvray -Provenances diverses (fin IIè. -Ier s. av.).....	Pl. 92
Mâlain -La Boussière (Ier s. av.).....	Pl. 93
Alésia -Centre monumental (70-60/40-30 av.).....	Pl. 94
Alésia -Centre monumental (70-60/40-30 av.).....	Pl. 95
Alésia -Centre monumental (70-60/40-30 av.) et QSEF, En Curiot (2è. moit. Ier s. av.).....	Pl. 96

Alésia -QSEF, En Curiot (2è. moit. Ier s. av.).....	Pl. 97
Braux -La Croisée (Ier s. av.).....	Pl. 98
Braux -La Croisée (Ier s. av.).....	Pl. 99
Braux -La Croisée (Ier s. av.).....	Pl. 100
Braux -La Croisée (Ier s. av.).....	Pl. 101
Villiers-le-Duc -Le Tremblois (fin IIè. - Ier s. av.).....	Pl. 102
Avallon -Grande Rue (2è. moitié Ier av.).....	Pl. 103
Avallon -Grande Rue (2è. moitié Ier av.).....	Pl. 104
St.-Denis-les-Sens -Champ Notre-Dame (2ème. moitié Ier av.).....	Pl. 105
St.-Denis-les-Sens -Champ Notre-Dame (2ème. moitié Ier av.).....	Pl. 106
St.-Denis-les-Sens -Champ Notre-Dame (2ème. moitié Ier av.).....	Pl. 107
St.-Denis-les-Sens -Champ Notre-Dame (2ème. moitié Ier av.).....	Pl. 108
St.-Denis-les-Sens -Champ Notre-Dame (2ème. moitié Ier av.).....	Pl. 109
St.-Denis-les-Sens -Champ Notre-Dame (2ème. moitié Ier av.).....	Pl. 110
St.-Denis-les-Sens -Champ Notre-Dame (2ème. moitié Ier av.).....	Pl. 111
St.-Denis-les-Sens -Champ Notre-Dame (2ème. moitié Ier av.).....	Pl. 112
St.-Denis-les-Sens -Champ Notre-Dame (2ème. moitié Ier av.).....	Pl. 113
St.-Denis-les-Sens -Champ Notre-Dame (2ème. moitié Ier av.).....	Pl. 114
St.-Denis-les-Sens -Champ Notre-Dame (2ème. moitié Ier av.).....	Pl. 115
Lons-Le-Saunier -La Comédie (fin IIè.- déb. Ier av. ?).....	Pl. 116
Lons-Le-Saunier -La Comédie (fin IIè.- déb. Ier av. ?).....	Pl. 117
Langres Marché-couvert -Fosse 2042 (-40/-30 à -20/-10).....	Pl. 118
Langres Marché-couvert -Fosse 2042 (n°21-24) et contextes divers (-40/-30 à -20/-10).....	Pl. 119
Langres Marché-couvert -Contextes divers (-40/-30 à -20/-10).....	Pl. 120
Langres Marché-couvert -Contextes divers (-40/-30 à -20/-10).....	Pl. 121

Vallée de la Saône : céramiques importées à vernis noir (IIè.-Ier s. av.).....	Pl. 122
Vallée de la Saône : céramiques importées à vernis noir (IIè.-Ier s. av.).....	Pl. 123
Vallée de la Saône : céramique non tournée grossière, pâte et engobe micacés.....	Pl. 124
Vallée de la Saône : céramique non tournée grossière (groupe Mâcon-Tournus).....	Pl. 125
Vallée de la Saône : céramique non tournée grossière.....	Pl. 126
Vallée de la Saône : céramique non tournée grossière.....	Pl. 127
Vallée de la Saône : céramique non tournée grossière.....	Pl. 128
Vallée de la Saône : céramique non tournée grossière..... et céramique tournée mi-fine.....	Pl. 129
Vallée de la Saône : céramique tournée fine lissée.....	Pl. 130
Vallée de la Saône : céramique tournée fine lissée.....	Pl. 131
Vallée de la Saône : céramique tournée fine lissée..... et céramique tournée, fine claire, engobe micacé.....	Pl. 132
Vallée de la Saône : céramique tournée, fine claire, sans décor ou à décor peint partiel.....	Pl. 133
Vallée de la Saône : céramique tournée, fine peinte.....	Pl. 134
Vallée de la Saône : céramique tournée, fine peinte.....	Pl. 135



ST.-SYMPHORIEN-VARENNES (fin II^e.-début I^{er} s. av.).

1 : non tournée, grossière claire micacée ; 2-11 : non tournée grossière, siliceuse. (2-7, 10 : St. Symphorien ; 1, 8-9, 11 : Varennes). Ech. : 1/3.

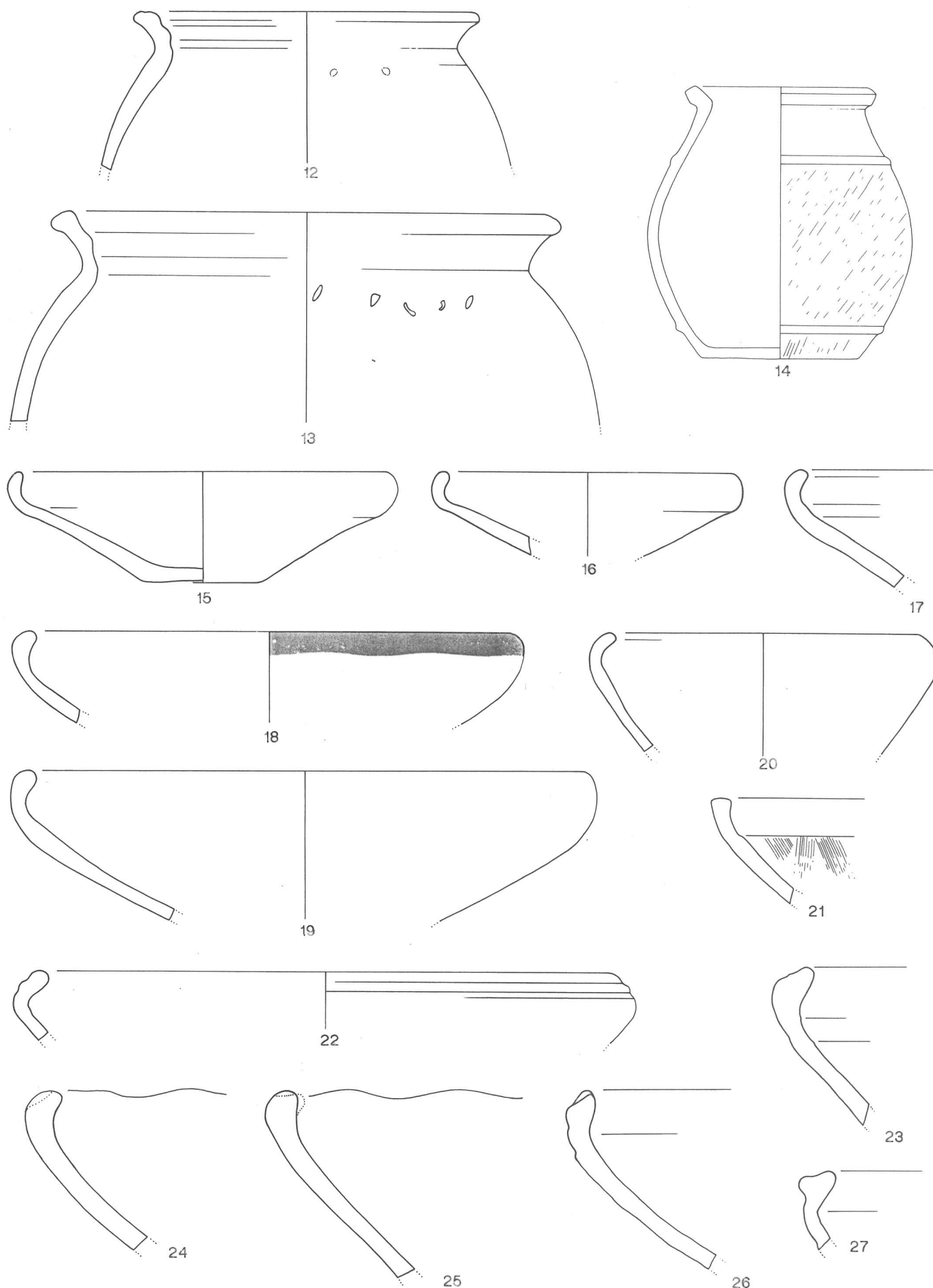

ST.-SYMPHORIEN-VARENNES (fin II^e.-début I^{er} s. av.).

12-27 : non tournée grossière, siliceuse. (15-17, 21, 23-24, 26-27 : St. Symphorien ; 12-14, 18-20, 22, 25 : Varennes). Ech. : 1/3 ; sauf n° 14 (extrait de Barthélémy 1985, fig. 5) : éch. 1/8.

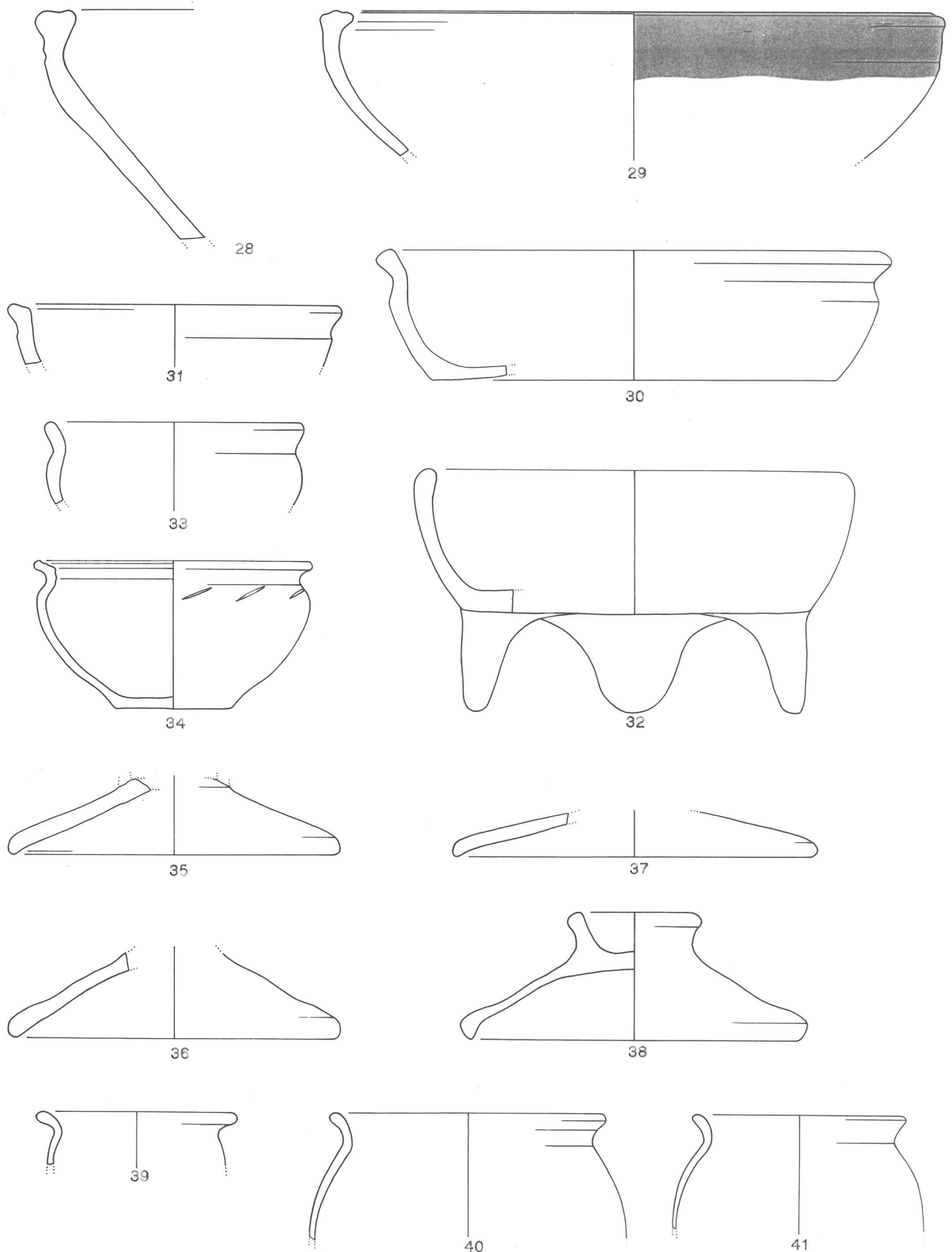

ST.-SYMPHORIEN-VARENNES (fin II^e.-début I^{er} s. av.).

28-38 : non tournée grossière, siliceuse ; 39-41 : fine sombre lissée. (28, 30-31, 33-35, 37, 40-41 : St. Symphorien ; 29, 32, 36, 38-39 : Varennes). Ech. : 1/3.

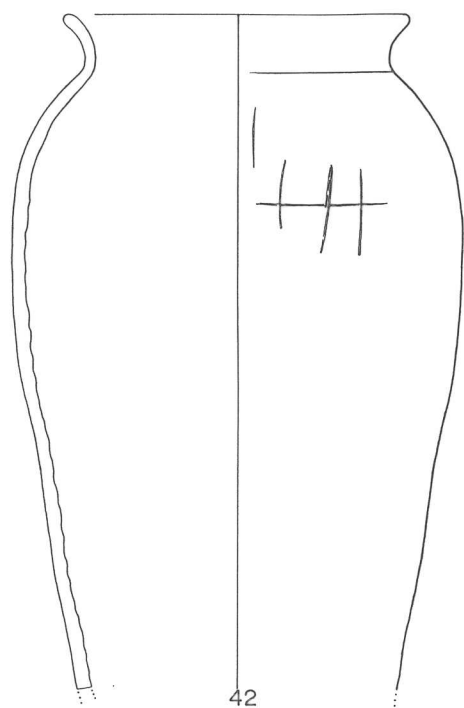

42

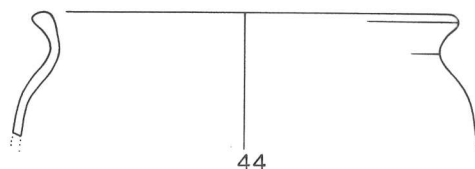

44

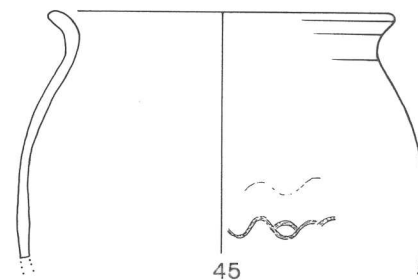

45

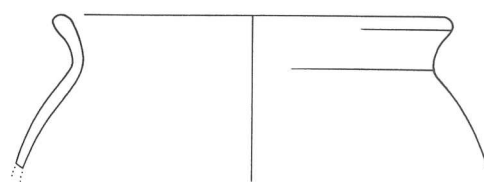

46

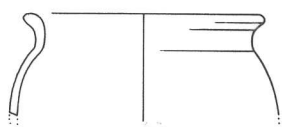

43

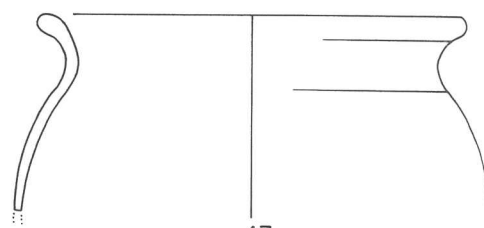

47

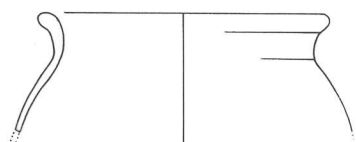

48

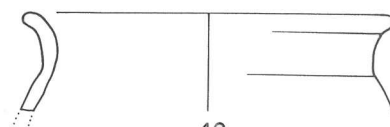

49

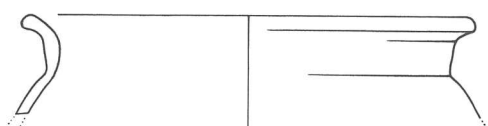

50

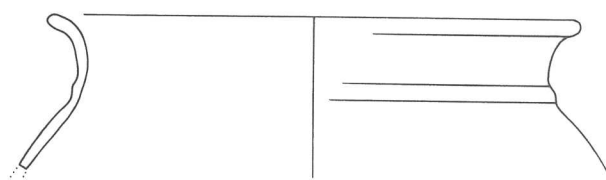

51

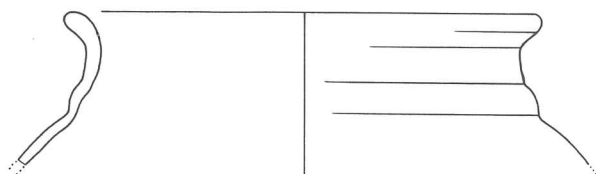

52

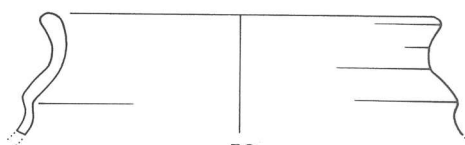

53

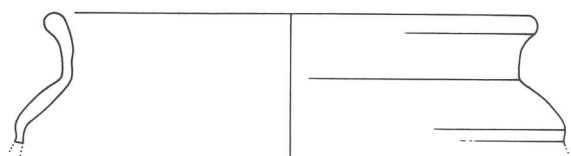

54

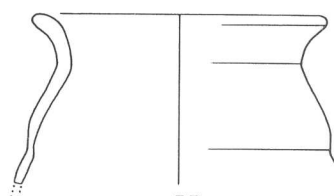

55

ST.-SYMPHORIEN-VARENNES (fin IIè.-début Ier s. av.).

42-55 : fine sombre lissée. (43, 45-46, 53 : St. Symphorien : 42, 44, 47-52, 54-55 : Varennes). Ech. : 1/3.

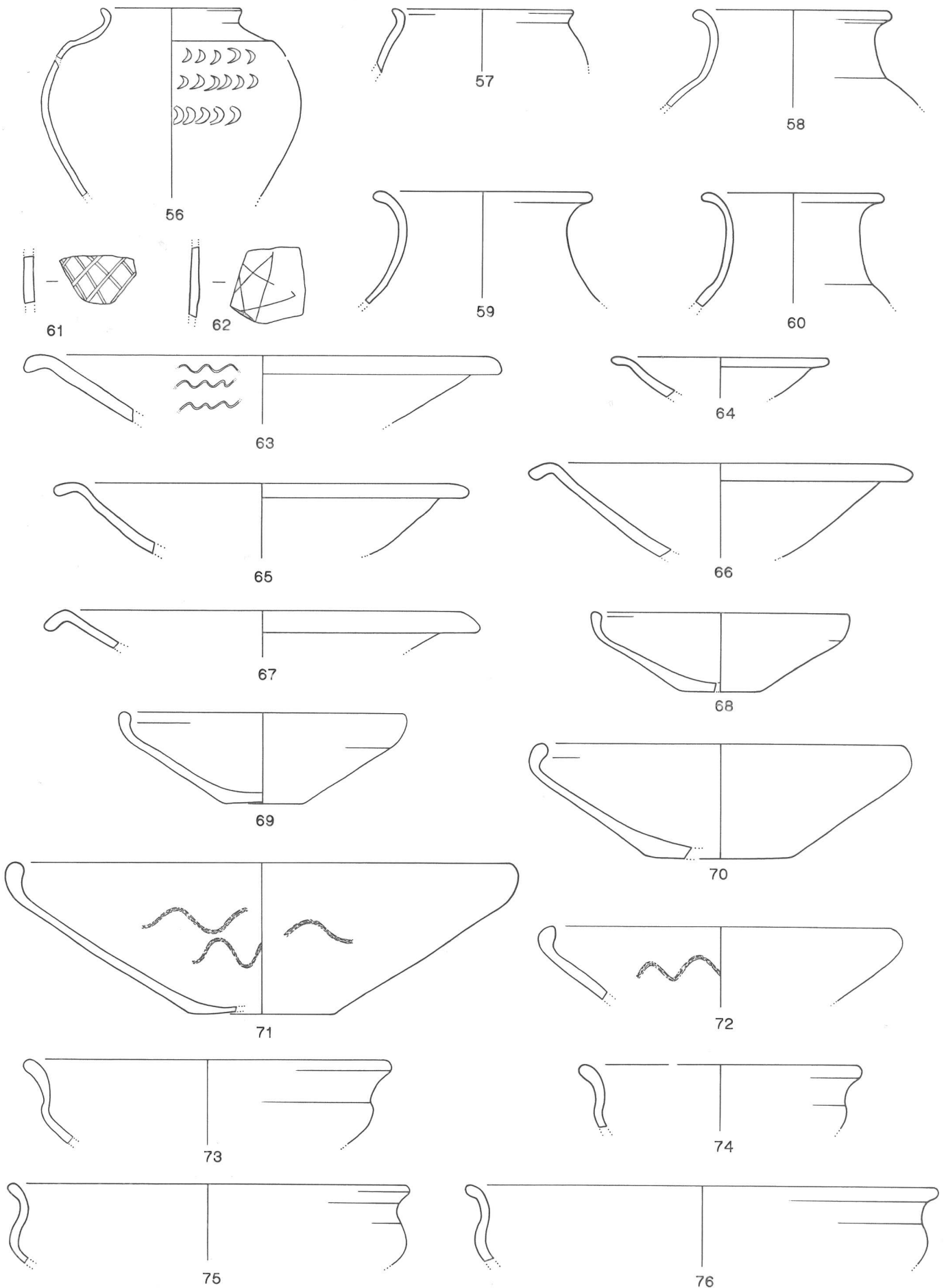

ST.-SYMPHORIEN-VARENNES (fin IIè.-début Ier s. av.).

56-76 : fine sombre lissée. (56-57, 61-69, 73 : St. Symphorien ; 58-60, 70-72, 74-76 : Varennes). Ech. : 1/3.

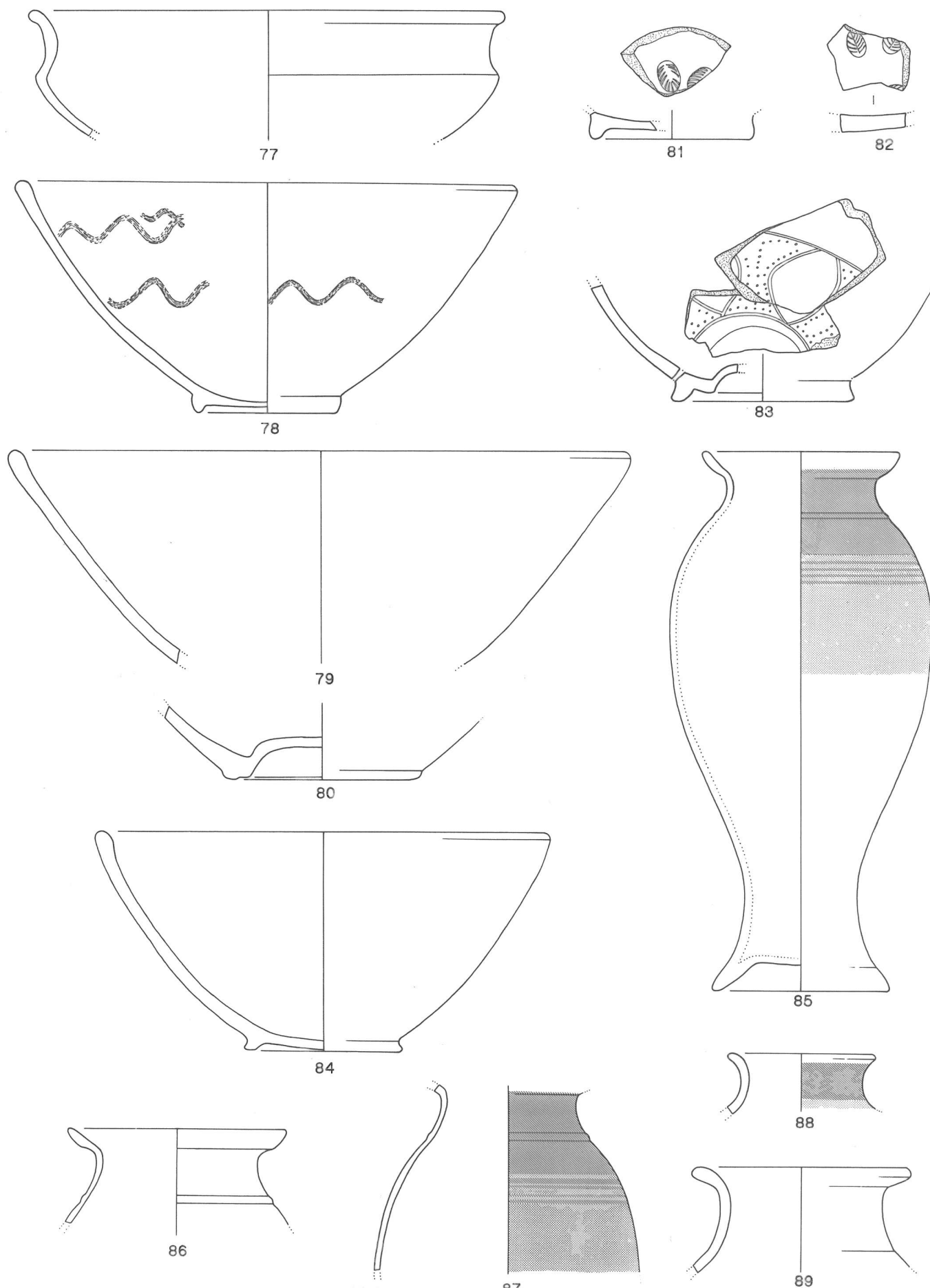

ST.-SYMPHORIEN-VARENNES (fin II^e.-début I^{er} s. av.).

77-83 : fine sombre lissée ; 84 : fine claire lissée ; 85-89 : fine peinte. (77-80, 83-87, 89 : St. Symphorien ; 81-82, 88 : Varennes). Ech. : 1/3.

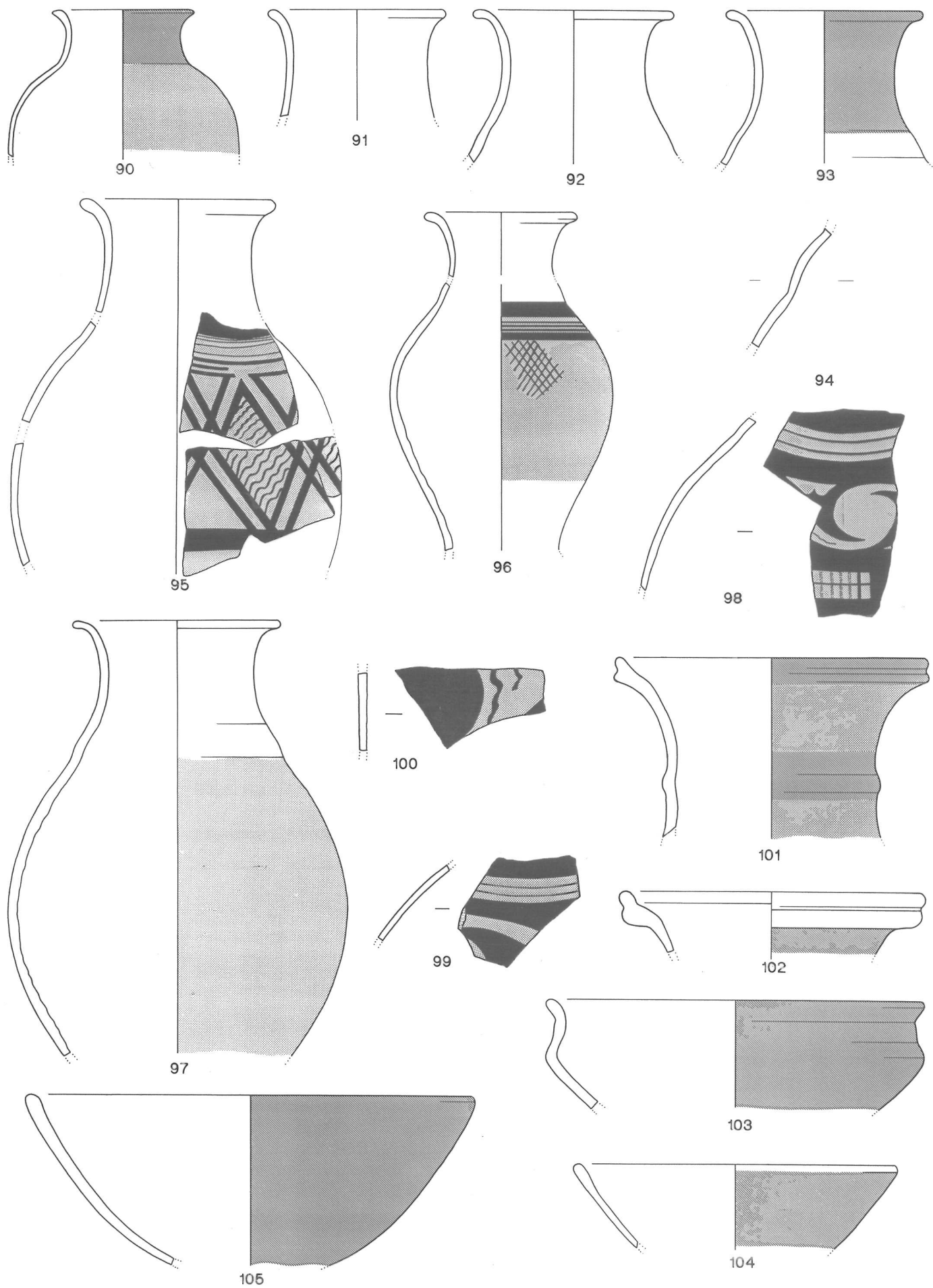

ST.-SYMPHORIEN-VARENNES (fin IIè.-début Ier s. av.).

90-105 : fine peinte. (90-101, 103-105 : St. Symphorien ; 102 : Varennes). Ech. : 1/3.

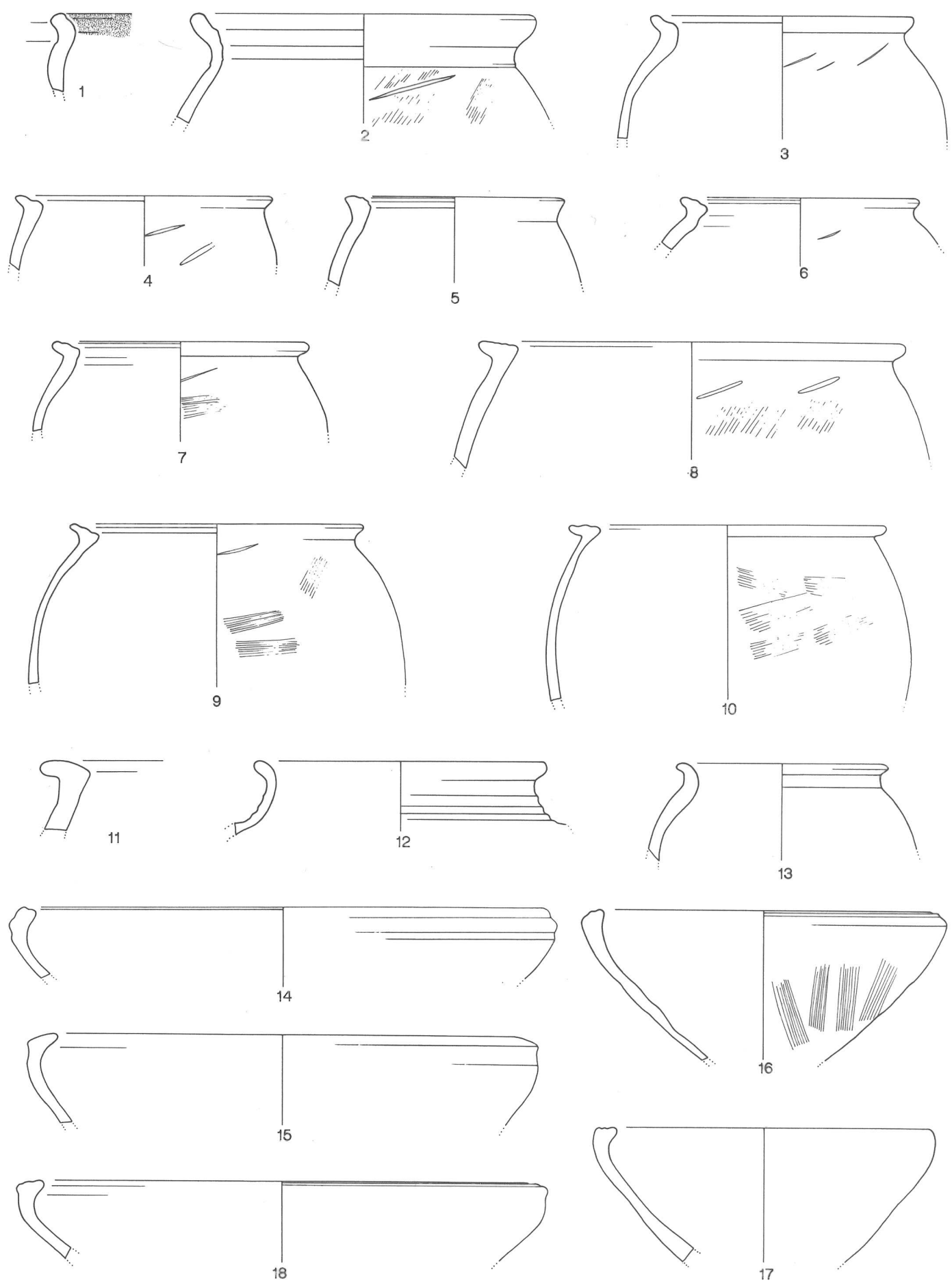

MACON -COURS MOREAU, CARMELITES (2è. moitié Ier s. av.).

1 : grossière claire micacée ; 2-18 : non tournée grossière, siliceuse. (2, 4 : Cours Moreau 1965 ; 1, 5-8, 10-11, 13, 16, 18 : Cours Moreau 1991 ; 3, 9, 12, 14-15, 17 : Carmélites). Ech. : 1/3.

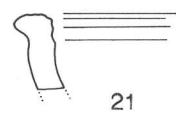
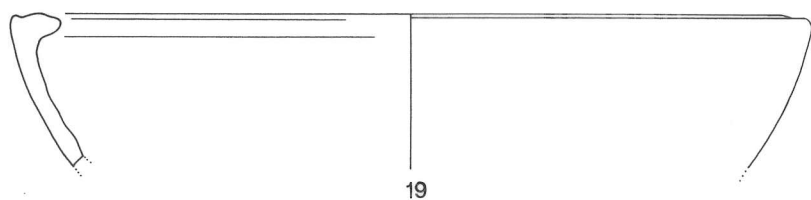

19

21

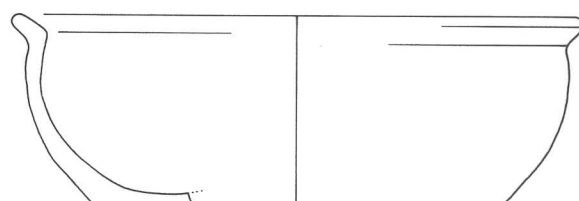
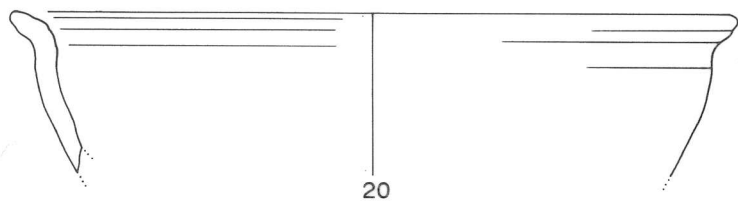

20

22

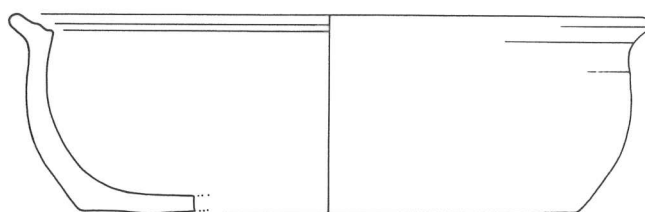
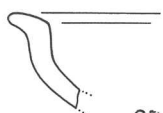

23

24

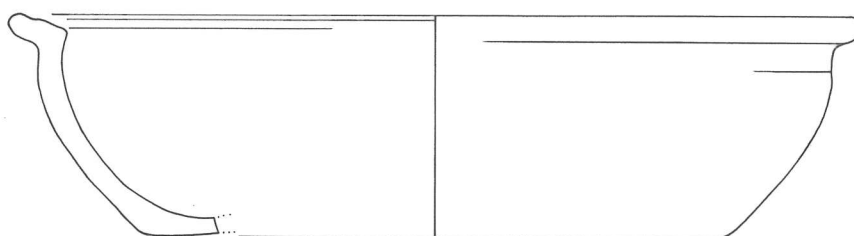

25

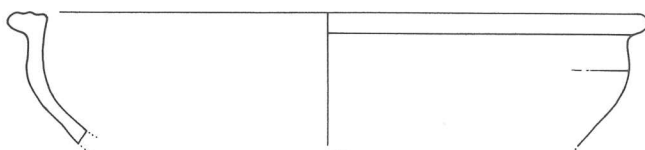

26

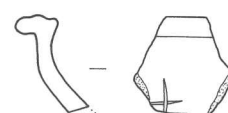

27

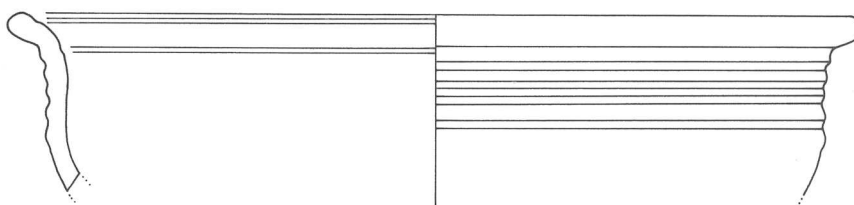

28



29



30



32

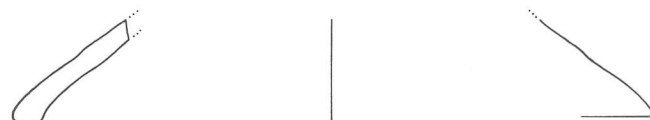

31

MACON -COURS MOREAU, CARMELITES (2è. moitié Ier s. av.).

19-32 : non tournée grossière, siliceuse. (24, 30 : Cours Moreau 1965 ; 18-19, 21, 23, 27, 29, 32 : Cours Moreau 1991 ; 20, 22, 25-26, 28, 31 : Carmélites). Ech. : 1/3.

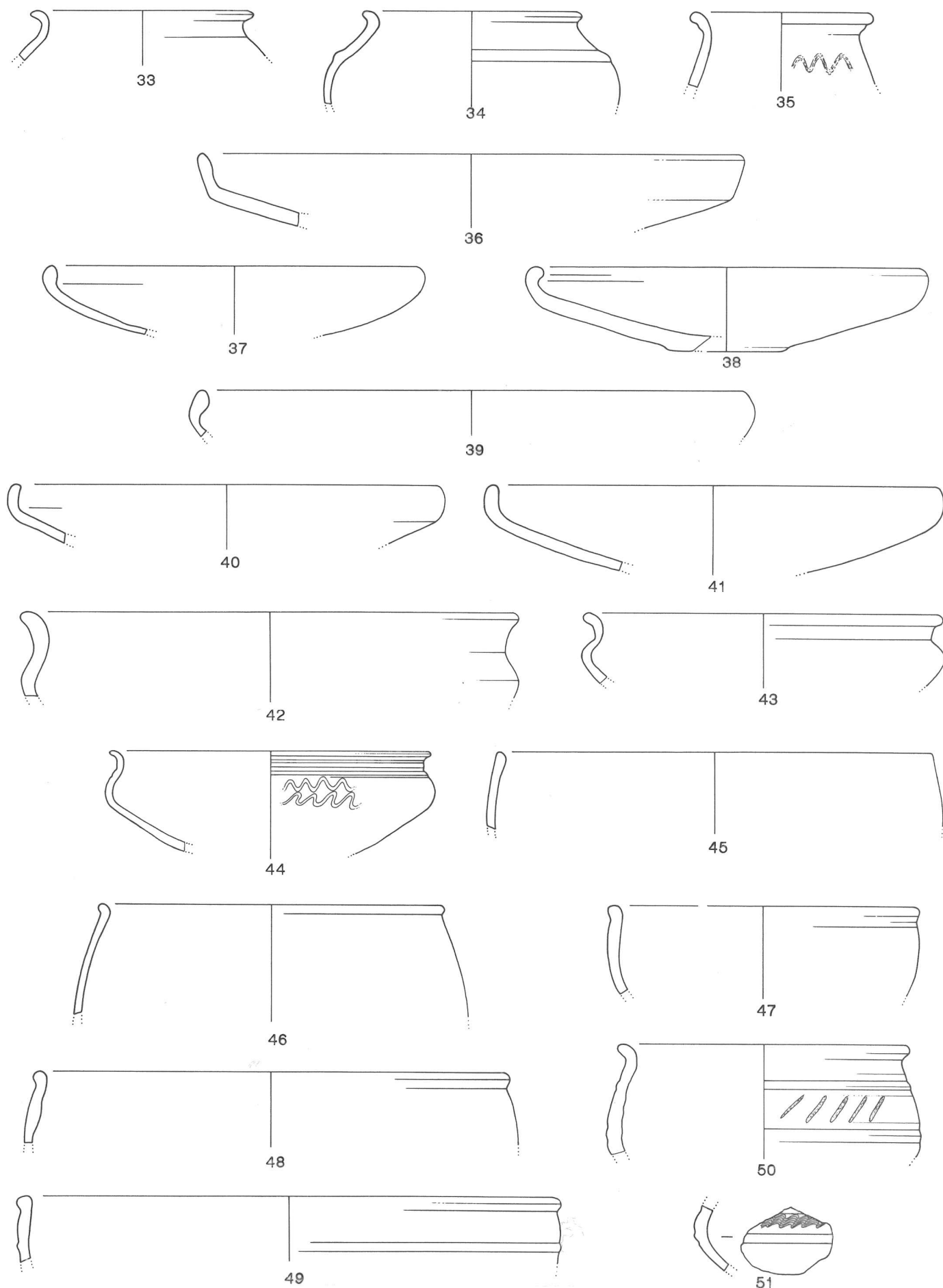

MACON -COURS MOREAU, CARMELITES (2^e. moitié Ier s. av.).

33-51 : fine sombre lissée. (34, 42 : Cours Moreau 1965 ; 36, 37, 39, 40, 45 : Cours Moreau 1991 ; 33, 35, 38, 41, 43, 44, 46-51 : Carmélites). Ech. : 1/3.

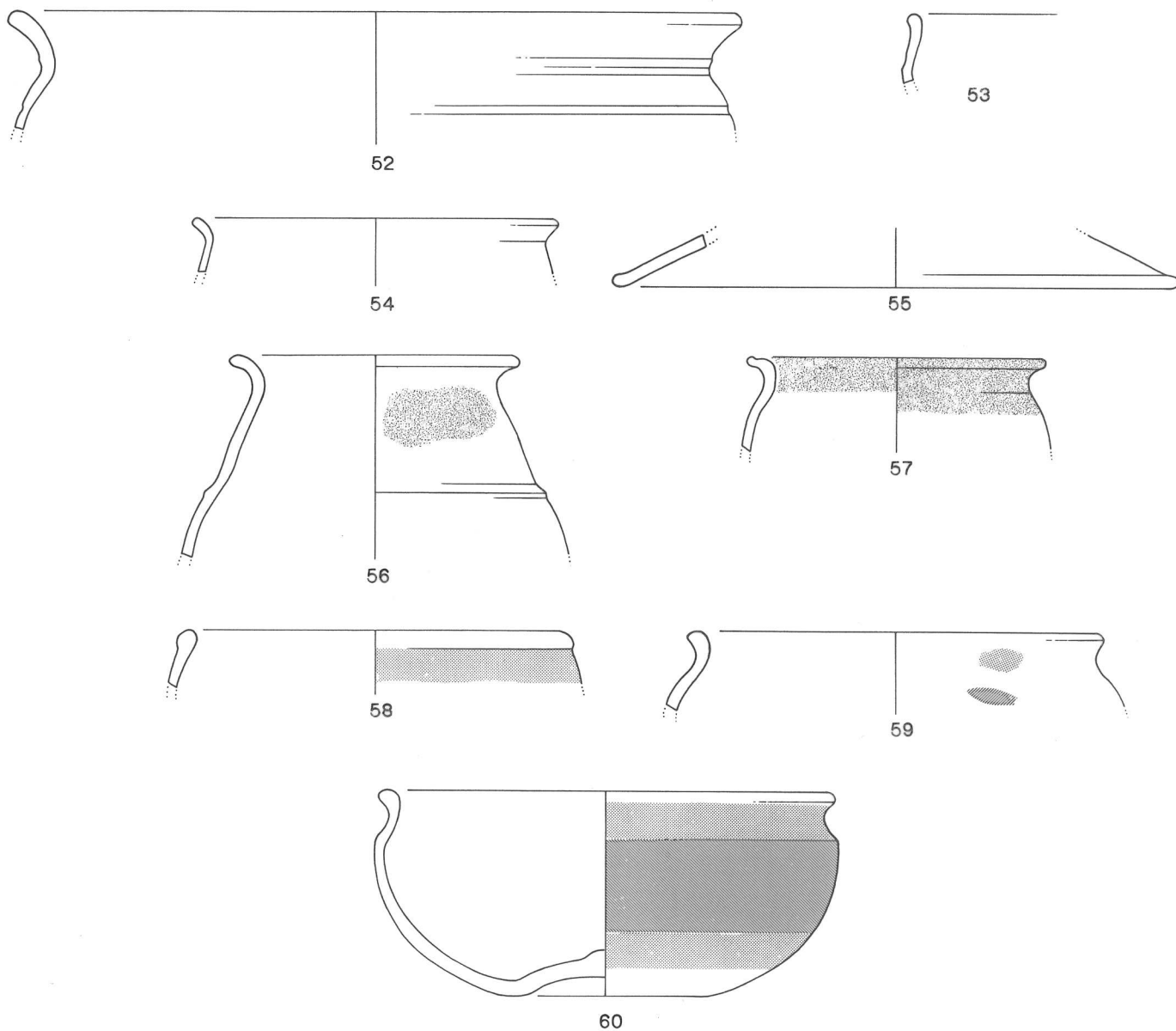

MACON -COURS MOREAU, CARMELITES (2^e. moitié Ier s. av.).

52-54 : fine sombre lissée ; 55 : fine claire ; 56-57 : fine claire micacée ; 58-60 : fine peinte. (53, 54 : Cours Moreau 1991 ; 52, 55-60 : Carmélites). Ech. : 1/3.

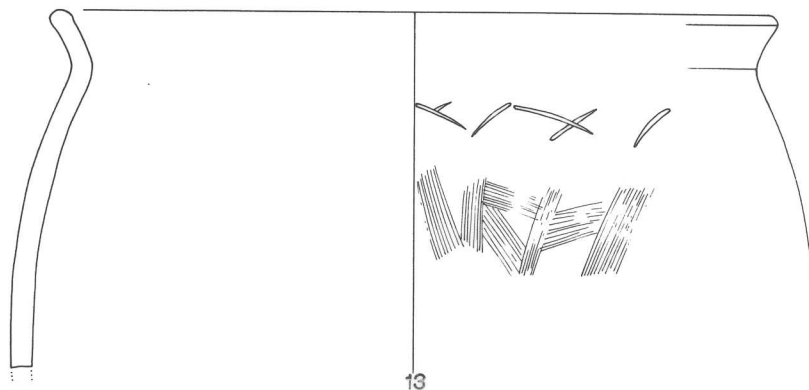
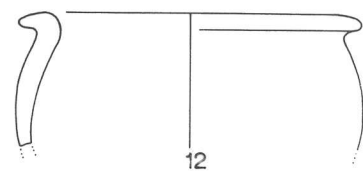
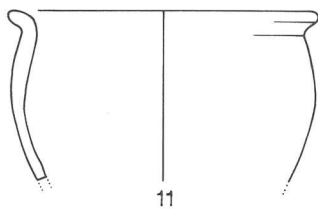
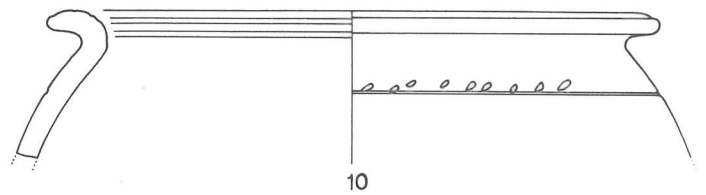
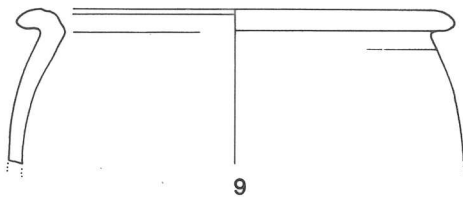
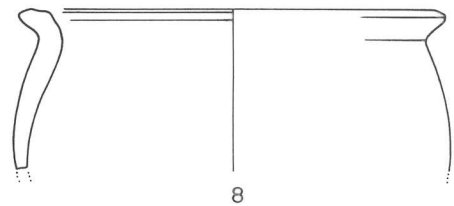
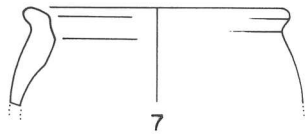
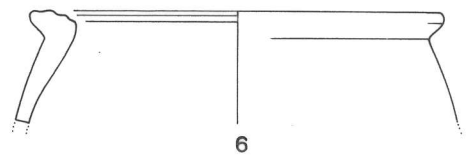
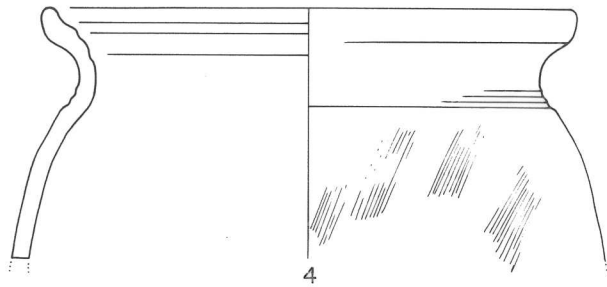
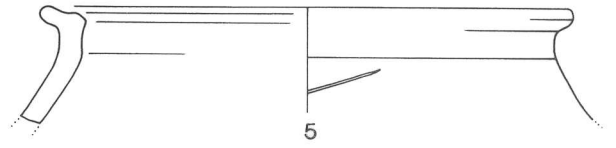
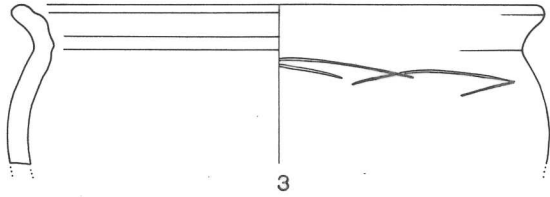
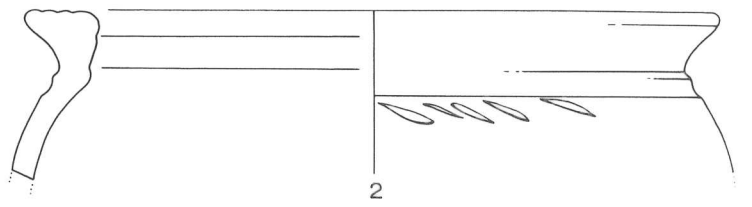
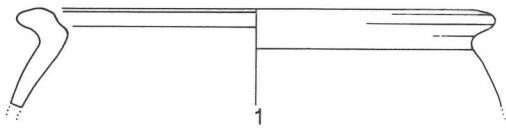

AZE -LE SAULE (fin IIè.-Ier s. av.).

1-2 : non tournée, grossière claire micacée ; 3-13 : non tournée grossière, siliceuse. Ech. : 1/3.

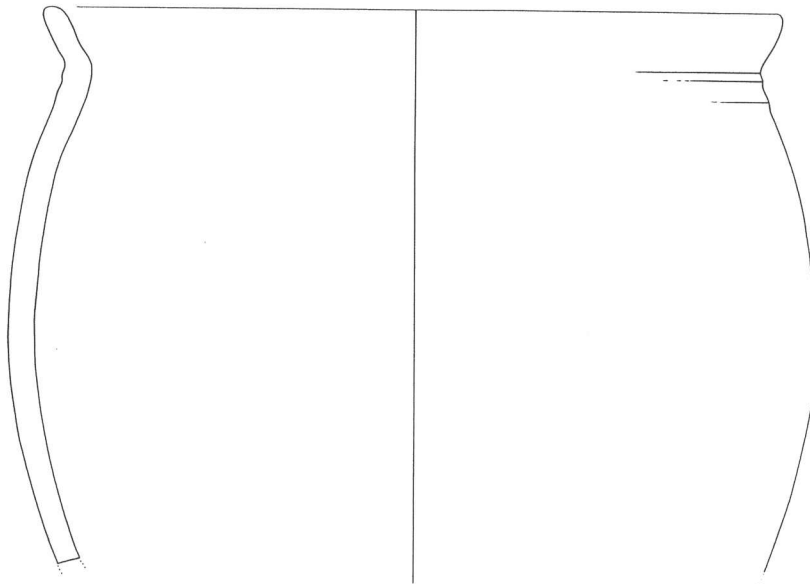

14

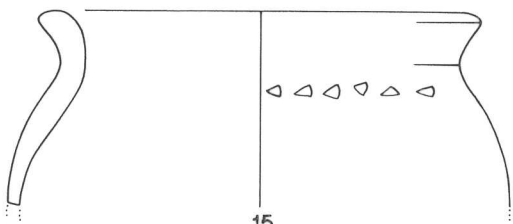

15

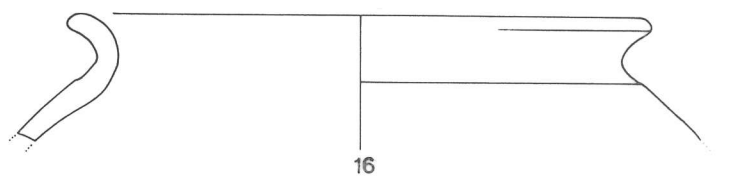

16

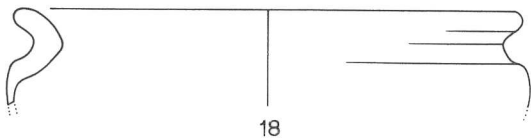

18

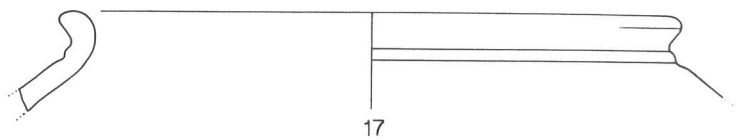

17

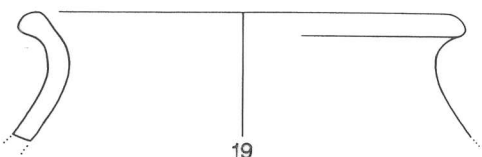

19

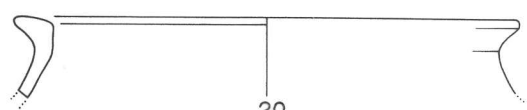

20

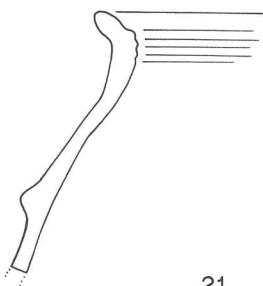

21

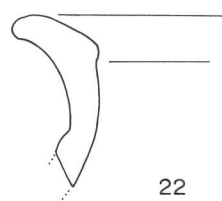

22

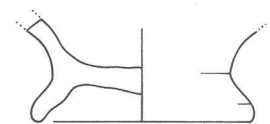

23

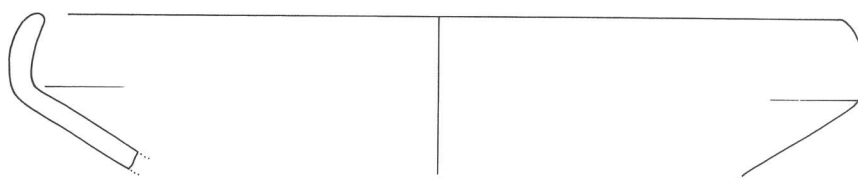

24

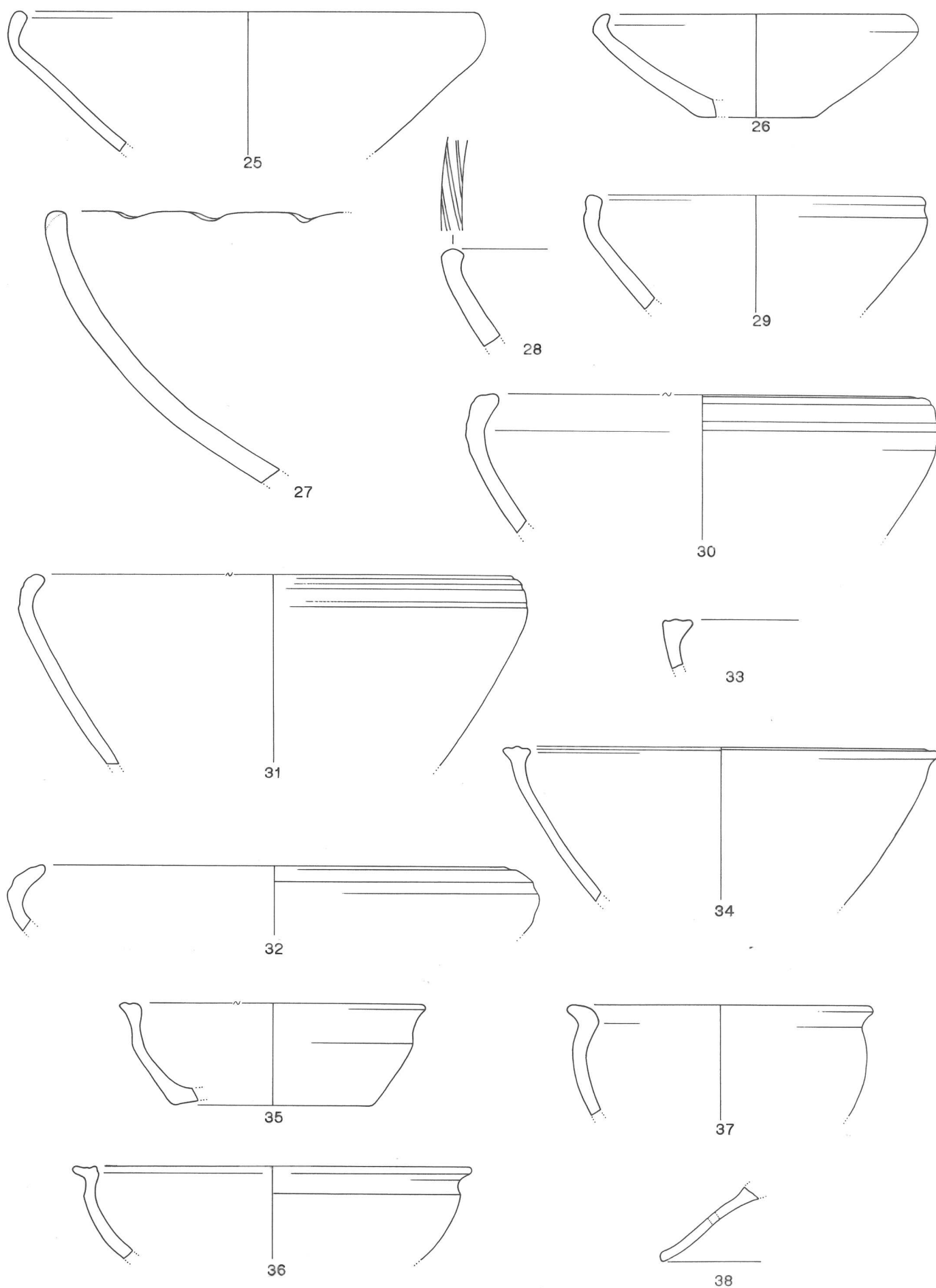

AZE -LE SAULE (fin IIè.-Ier s. av.).
25-38 : non tournée grossière, siliceuse. Ech. : 1/3.

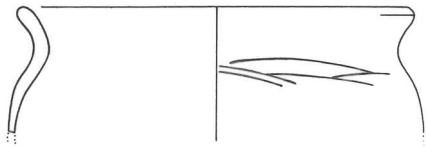

39

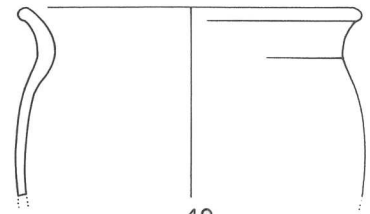

40

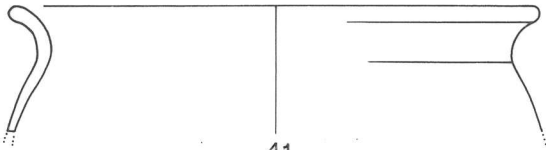

41

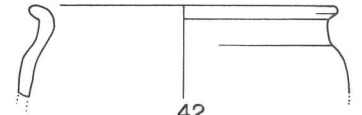

42

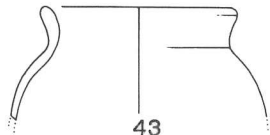

43

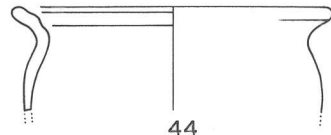

44

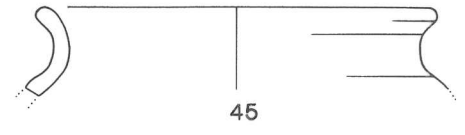

45

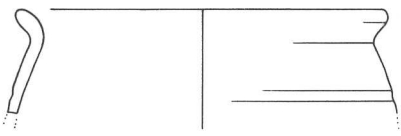

46

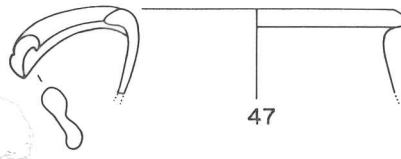

47

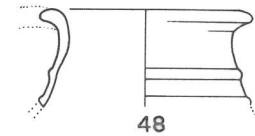

48

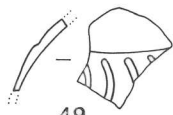

49

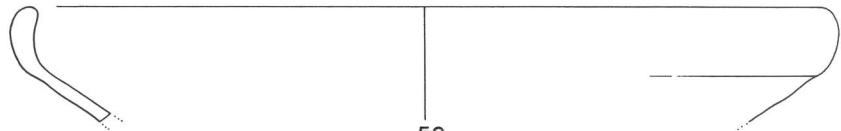

50

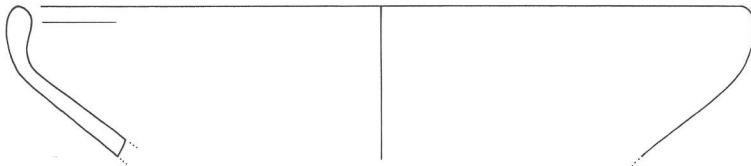

51

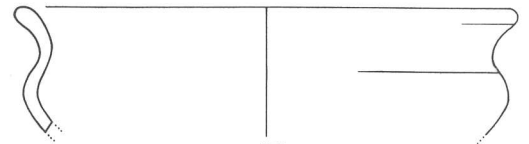

52

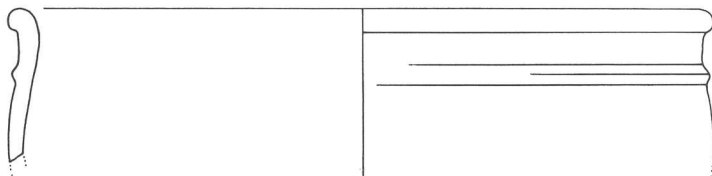

54

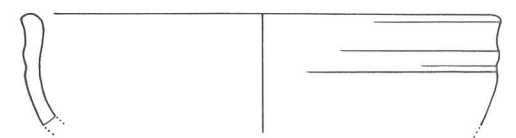

53

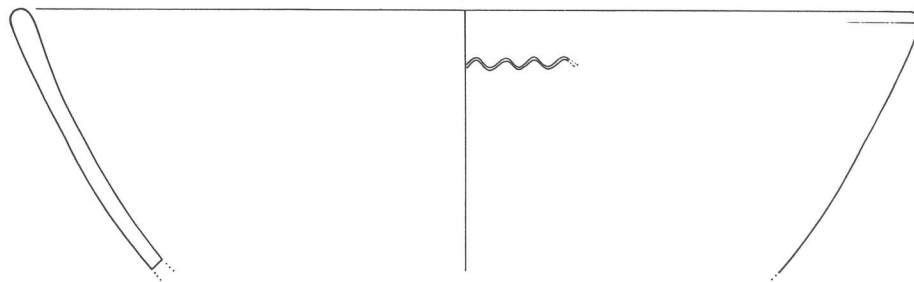

55

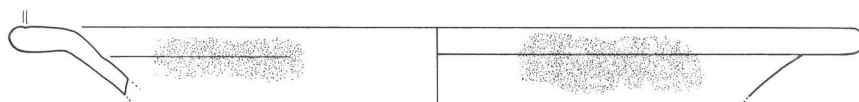

56

AZE -LE SAULE (fin IIè.-Ier s. av.).

39-55 : mi-fine sombre lissée ; 56 : fine claire micacée. Ech. : 1/3.

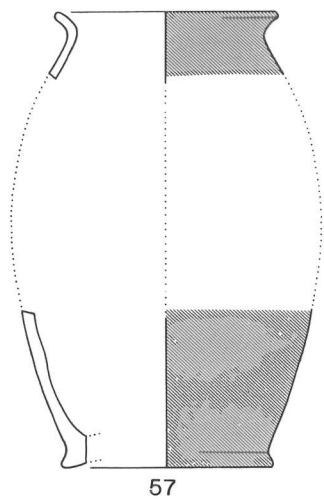

57

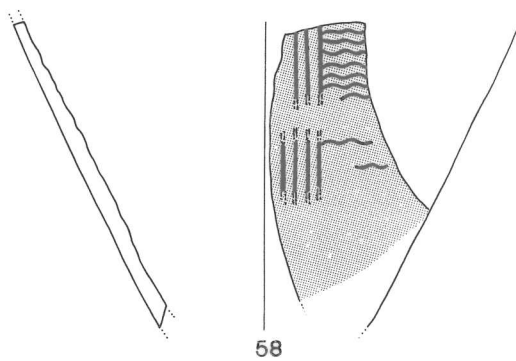

58

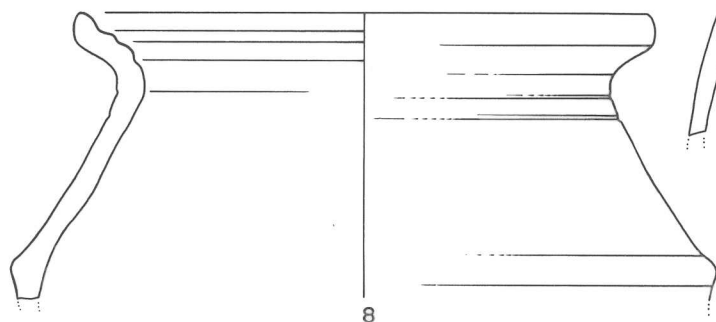
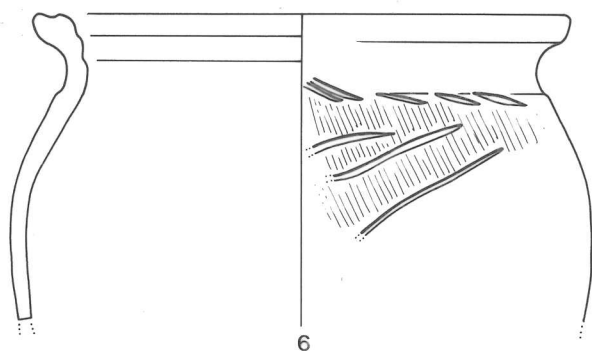
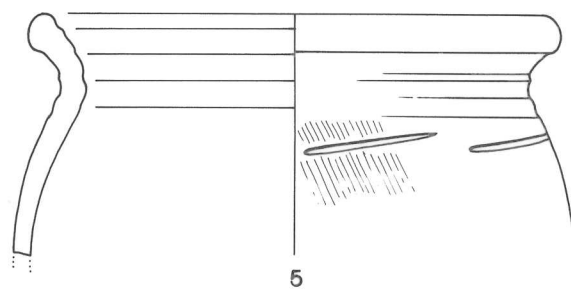
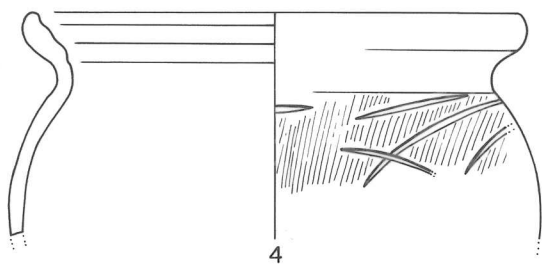
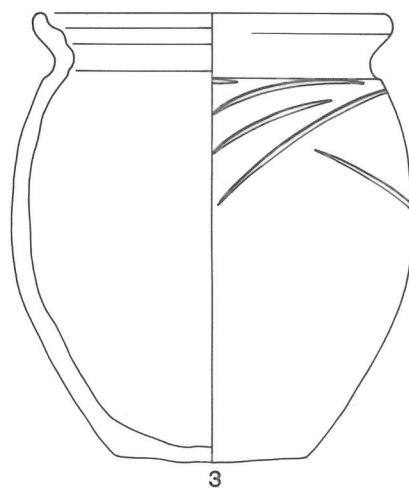
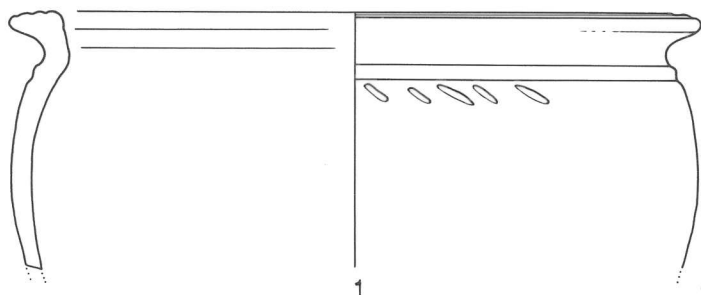
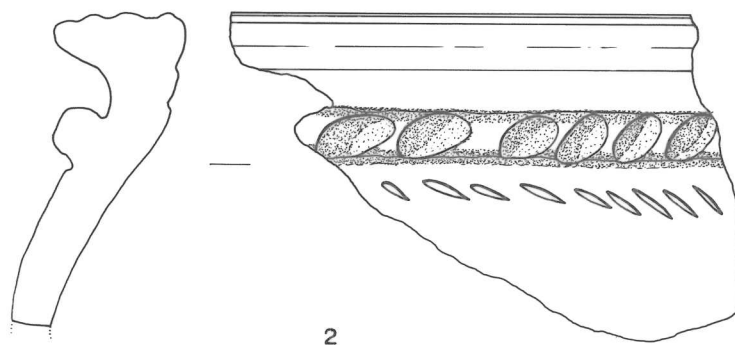

TOURNUS -CHAMPSEMARD (fin II^e.-déb. I^{er} s. av.).

1-2 : non tournée, grossière claire micacée ; 3-8 : non tournée grossière, siliceuse (n°8 : enduit noir). Ech. : 1/3.

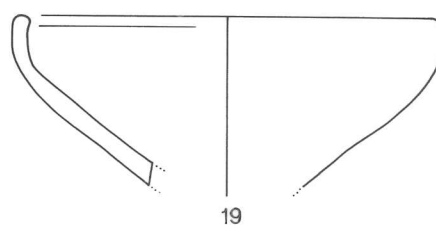
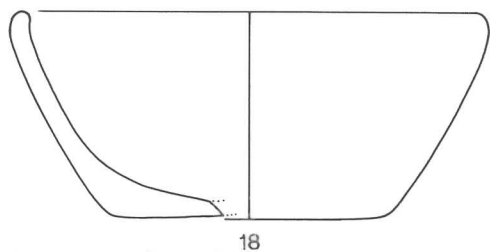
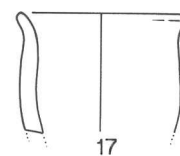
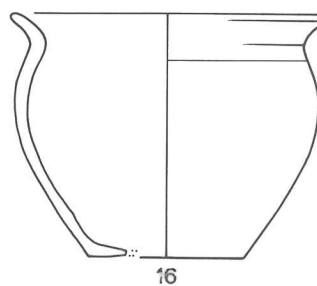
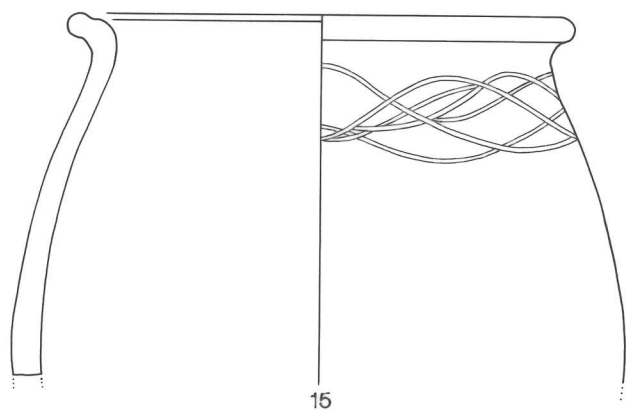
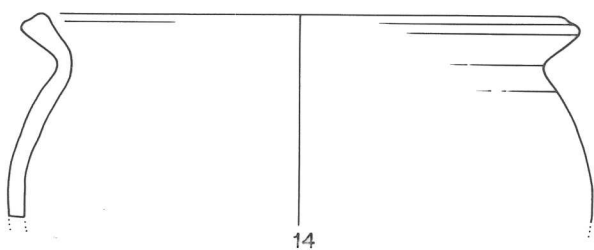
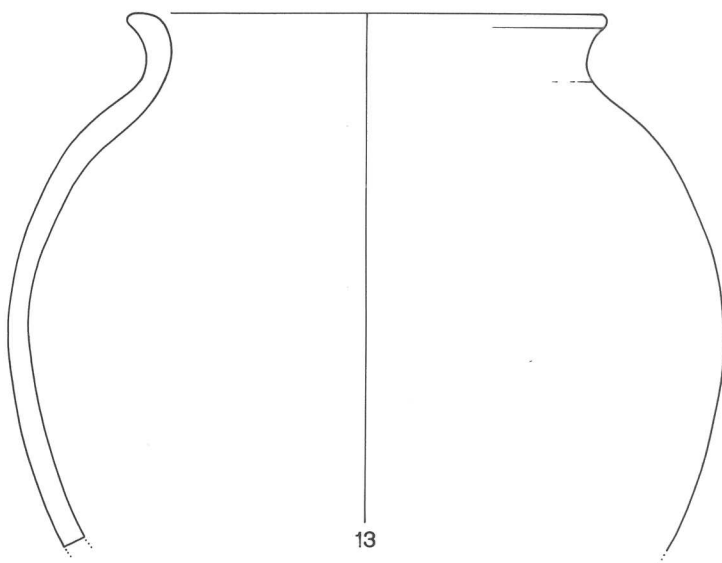
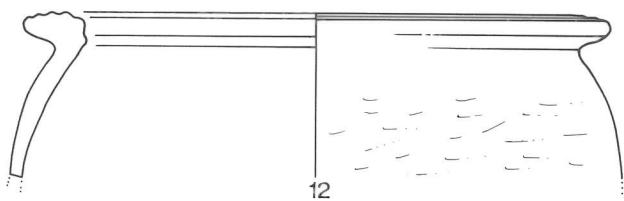
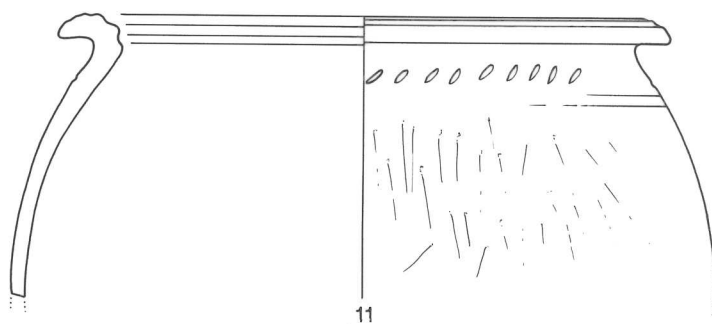
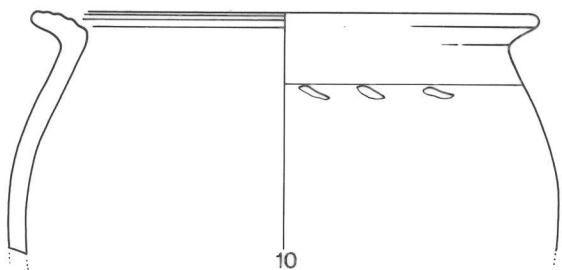
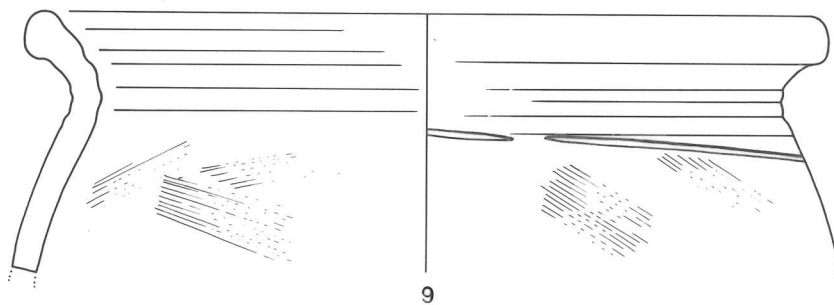

TOURNUS -CHAMPSEMARD (fin II^e.-déb. I^{er} s. av.).
9-19 : non tournée grossière, siliceuse (n^o9 : enduit noir). Ech. : 1/3.

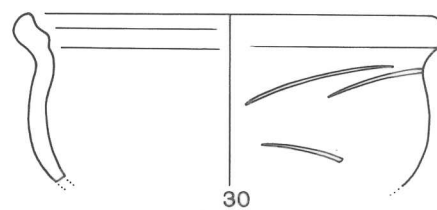
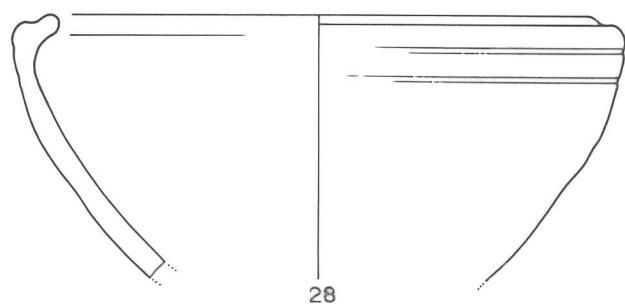
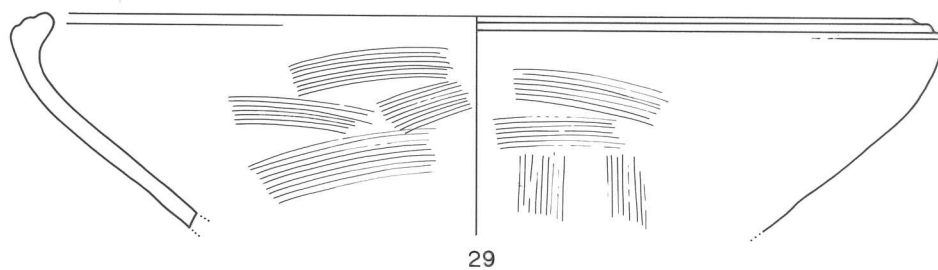
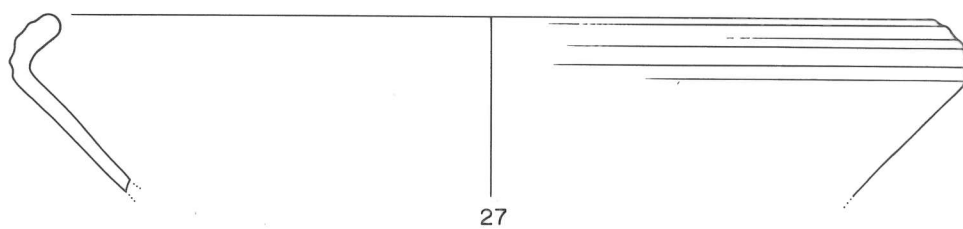
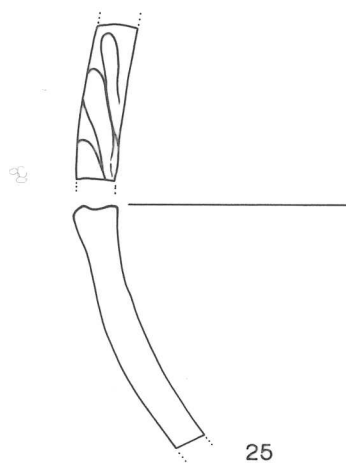
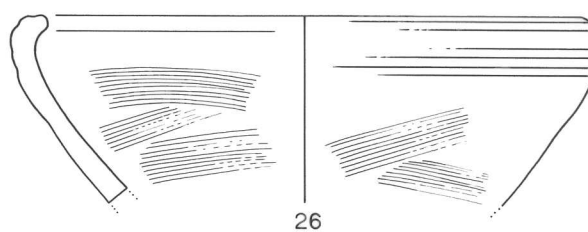
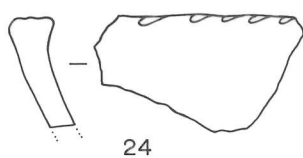
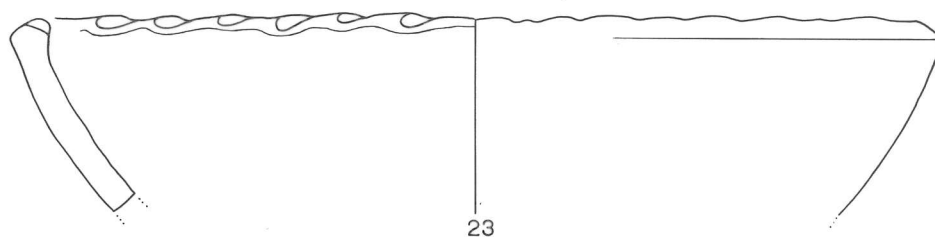
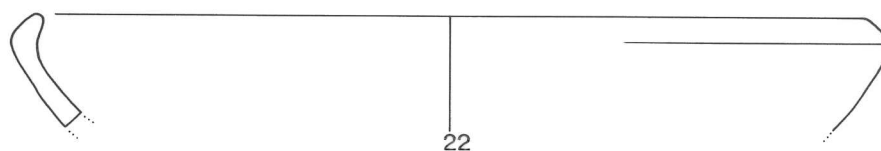
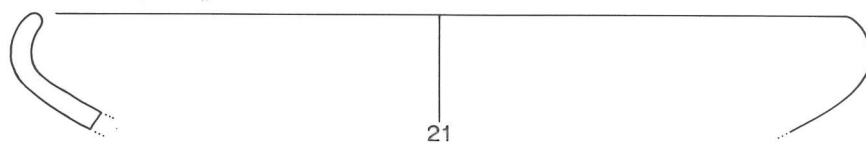
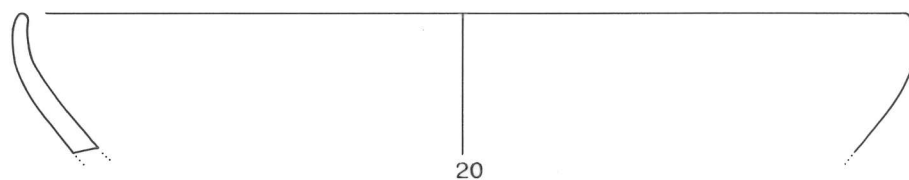

TOURNUS -CHAMPSEMARD (fin II^e.-déb. I^{er} s. av.).
20-30 : non tournée grossière, siliceuse. Ech. : 1/3.

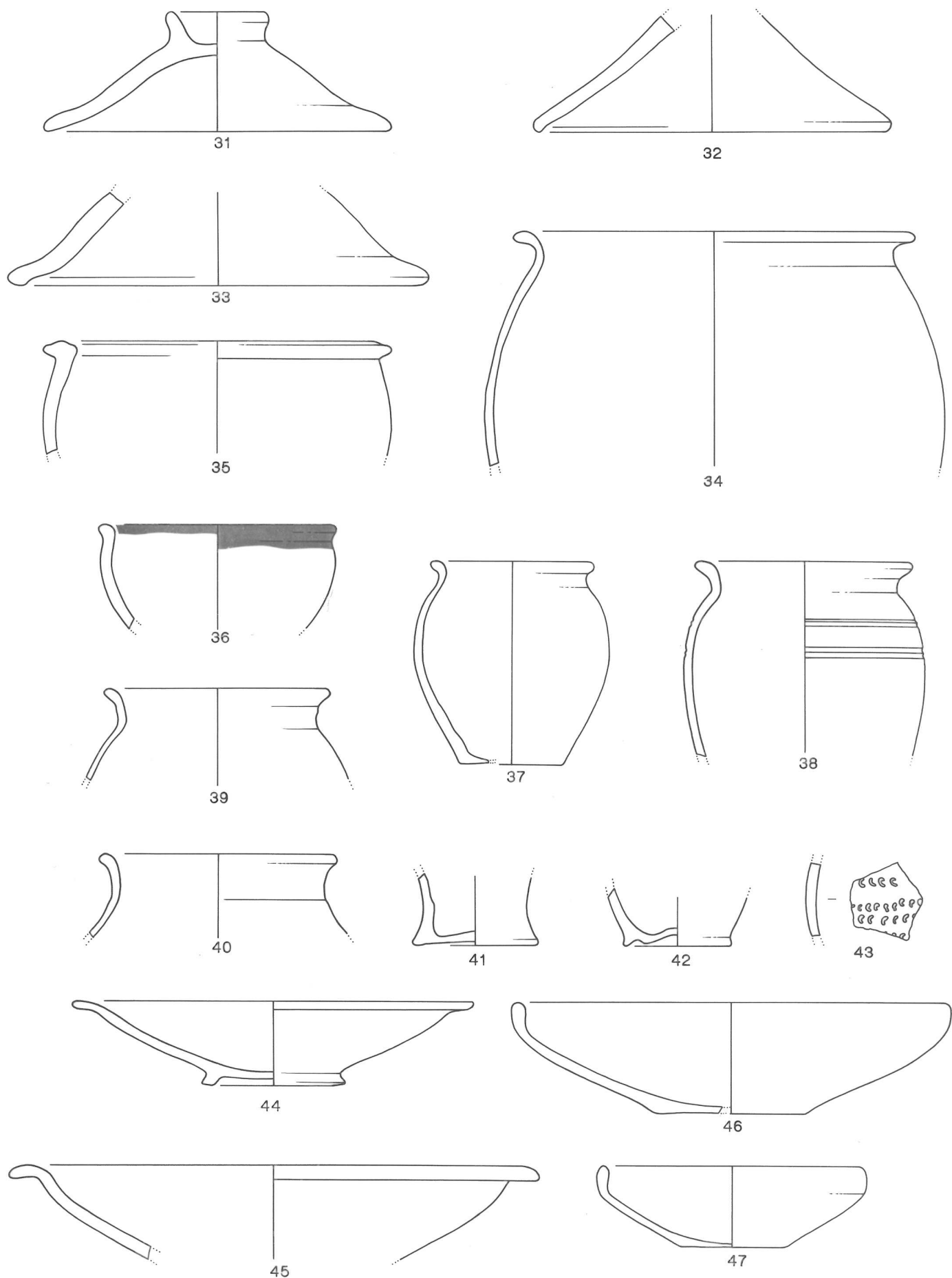

TOURNUS -CHAMPSEMARD (fin IIè.-déb. Ier s. av.).

31-33 : non tournée grossière, siliceuse ; 34-36 : mi-fine siliceuse ; 37-47 : fine sombre lissée. Ech. : 1/3.

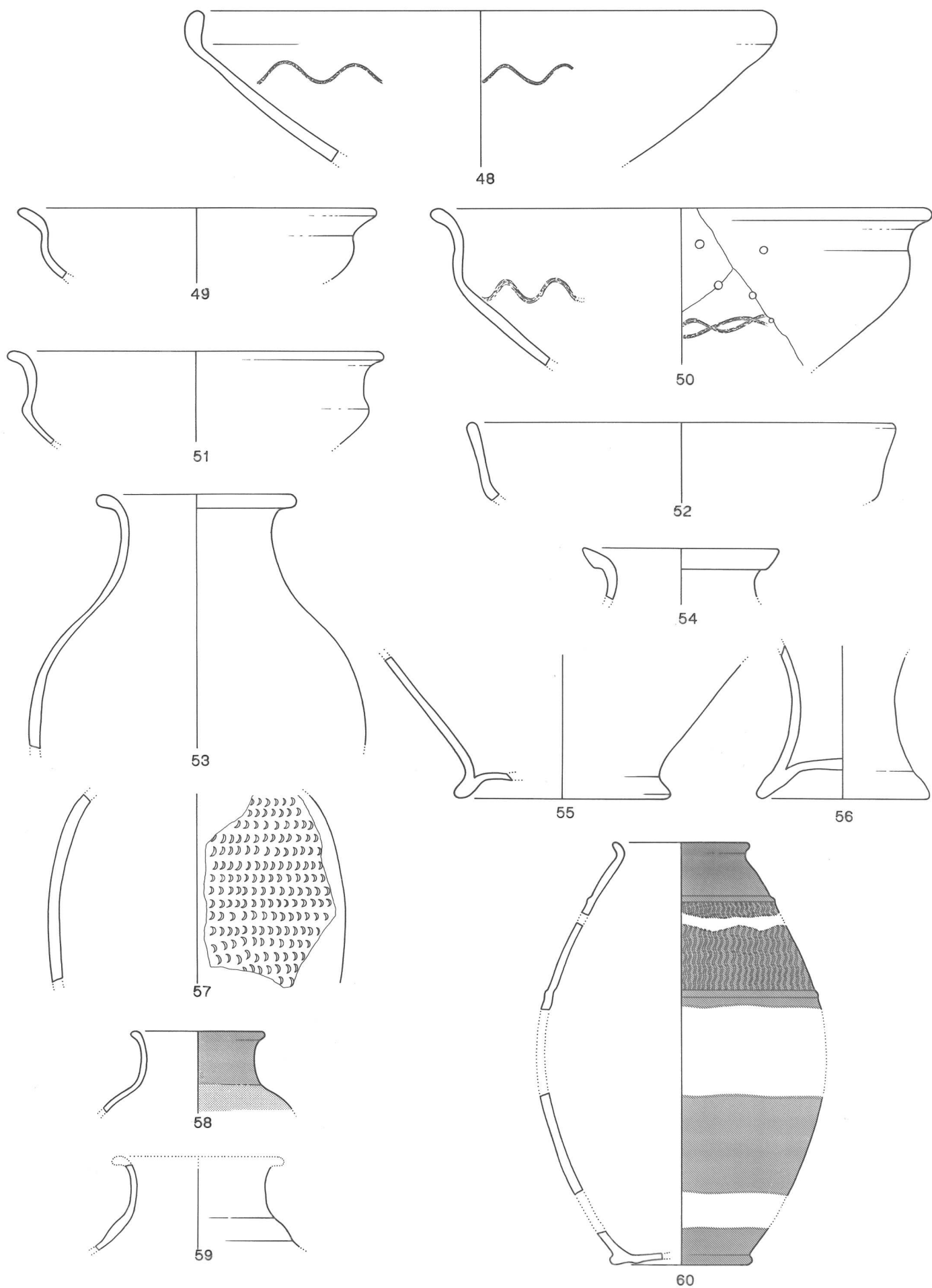

TOURNUS -CHAMPSEMARD (fin IIè.-déb. Ier s. av.).

48-52 : fine sombre lissée ; 53-57 : fine claire ; 58-60 : fine peinte. Ech. : 1/3.

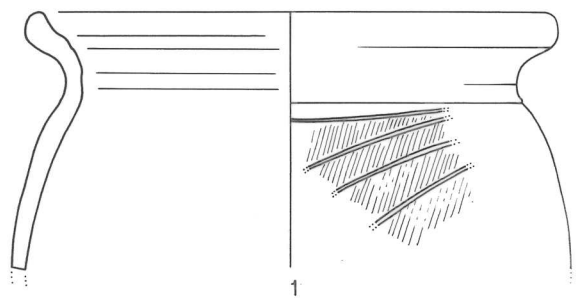

1

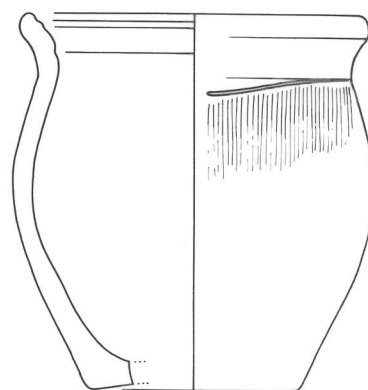

2

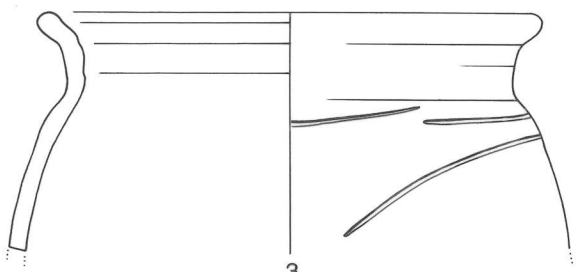

3

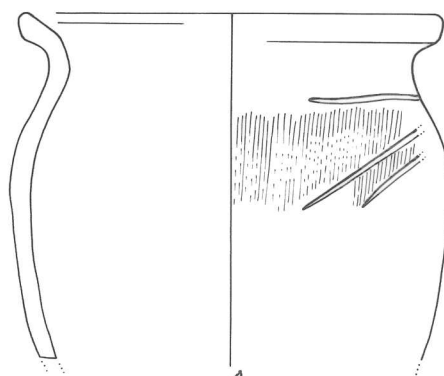

4

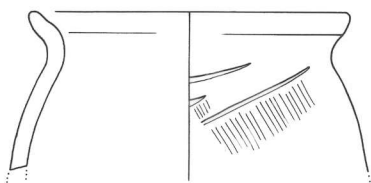

5

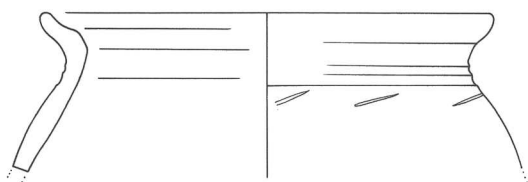

6

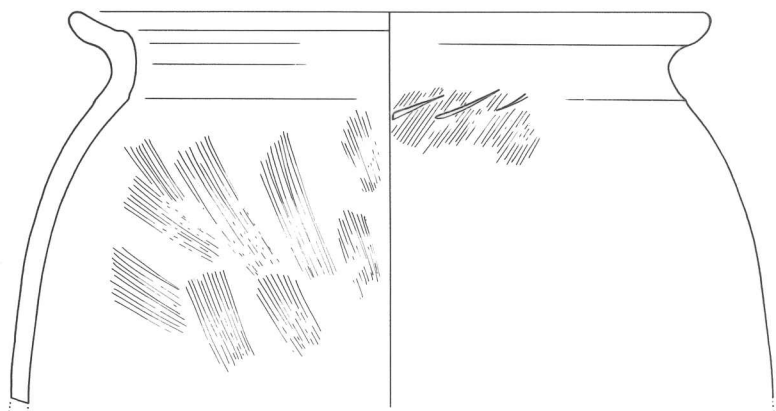

7

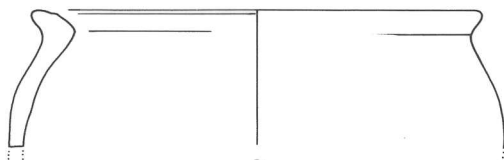

8

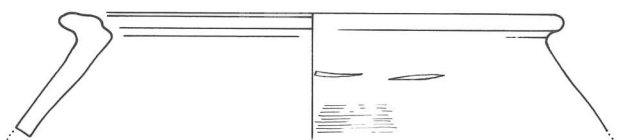

9

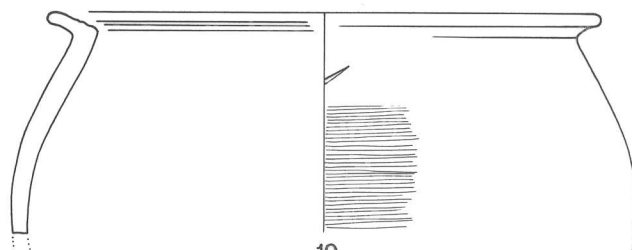

10

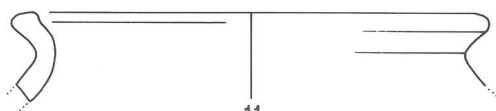

11

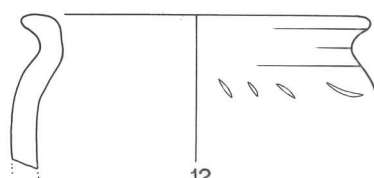

12

TOURNUS -SEPT FONTAINES (Ier s. av.).
1-12 : non tournée grossière, siliceuse. Ech. : 1/3.

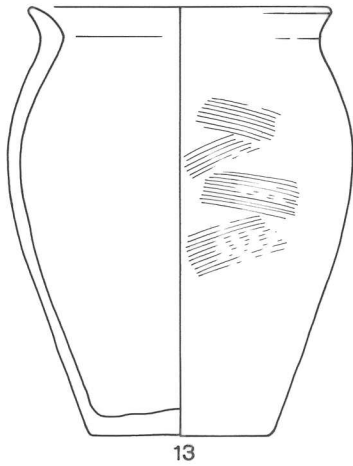

13

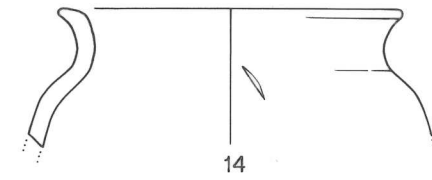

14

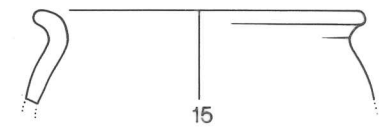

15

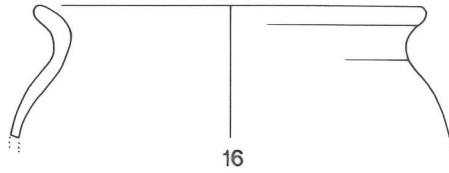

16

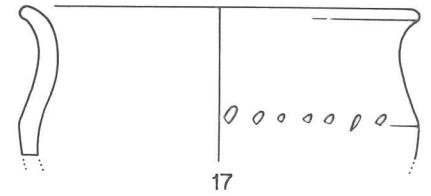

17

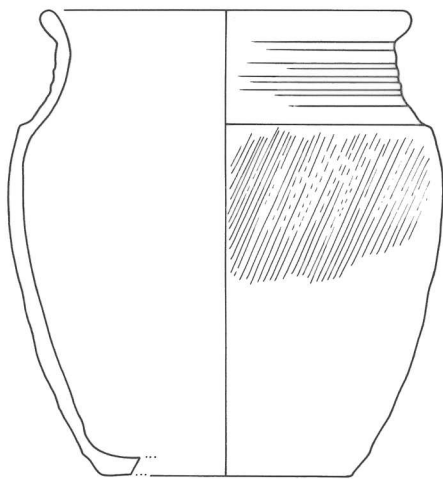

18

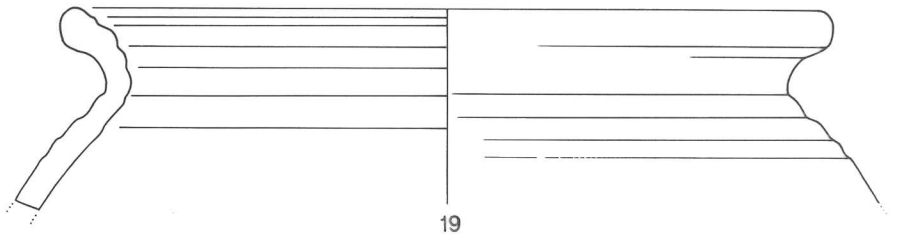

19

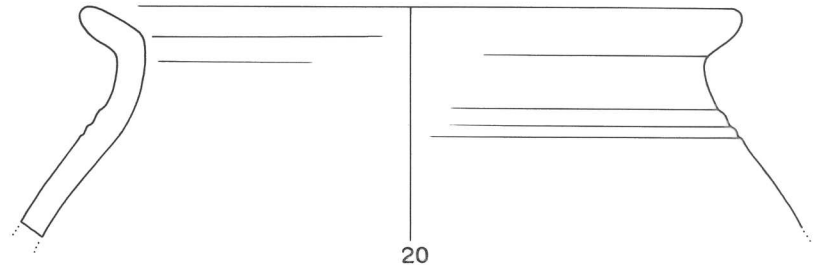

20

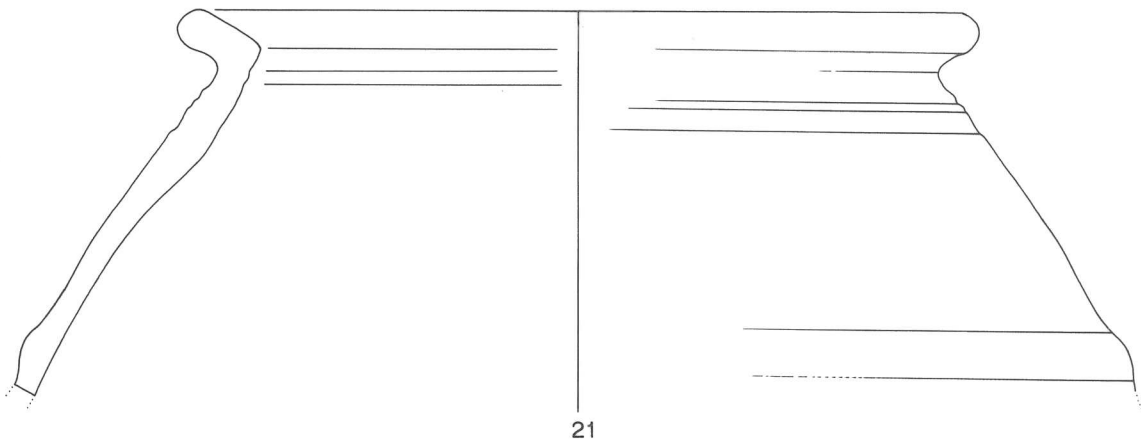

21

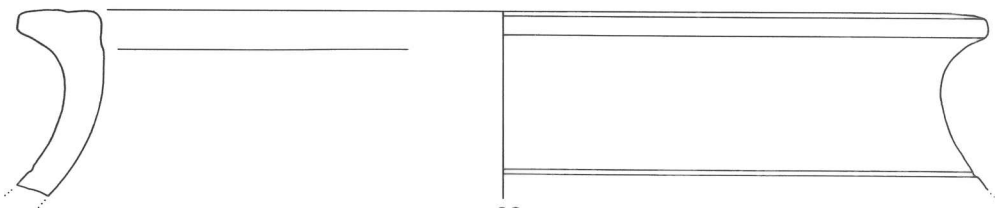

22

TOURNUS -SEPT FONTAINES (Ier s. av.).
13-22 : non tournée grossière, siliceuse. Ech. : 1/3.

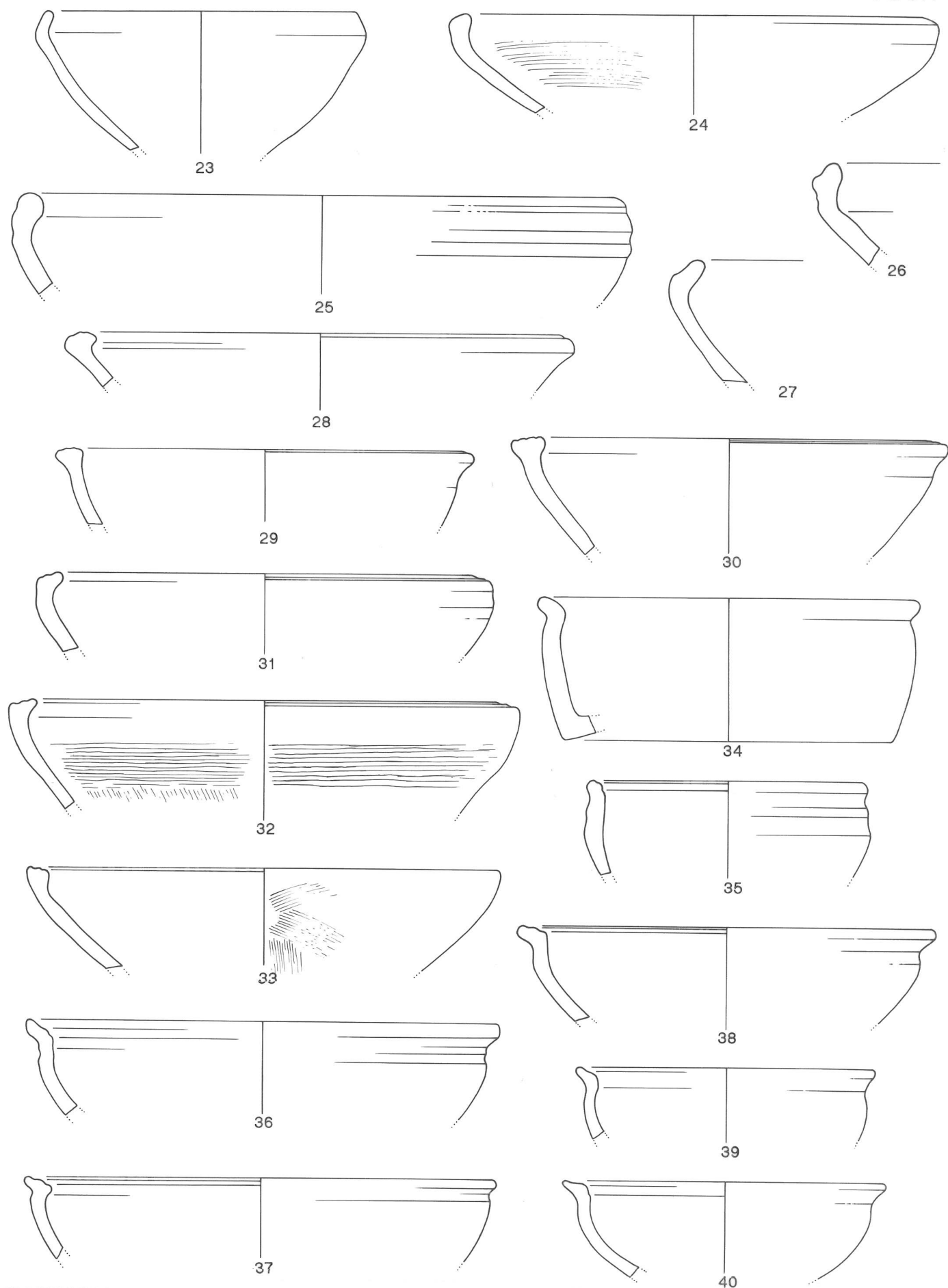

TOURNUS -SEPT FONTAINES (Ier s. av.).
23-40 : non tournée grossière, siliceuse. Ech. : 1/3.

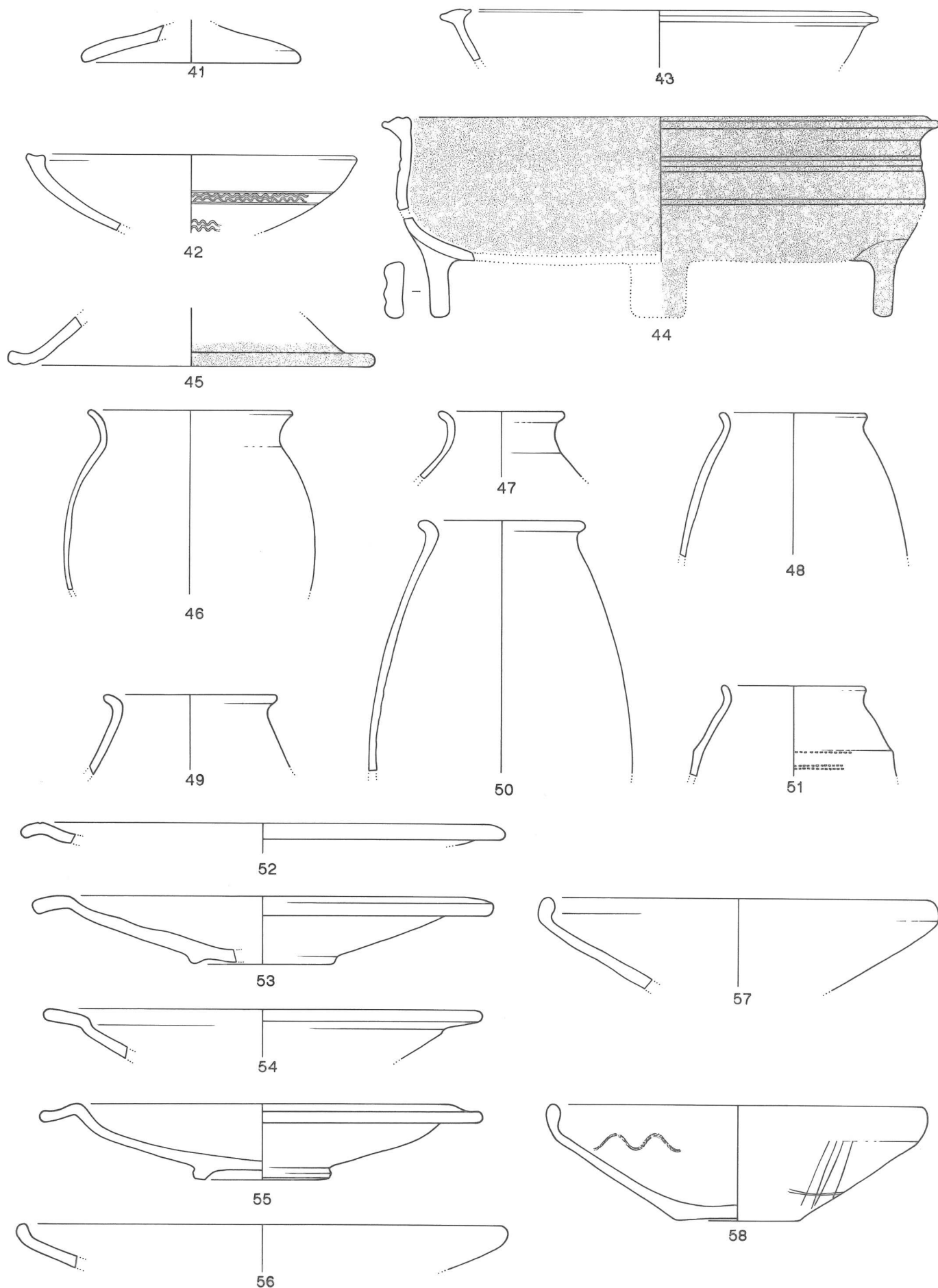

TOURNUS -SEPT FONTAINES (Ier s. av.).

41: non tournée grossière, siliceuse ; 42-43 : mi-fine siliceuse ; 44-45 : mi-fine claire micacée ; 46-58 : fine sombre lissée. Ech. : 1/3.

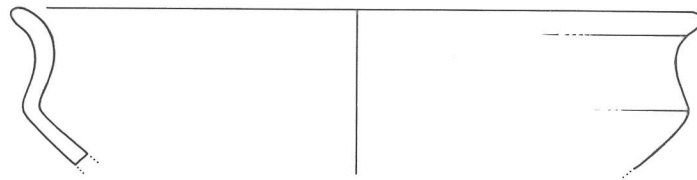

59

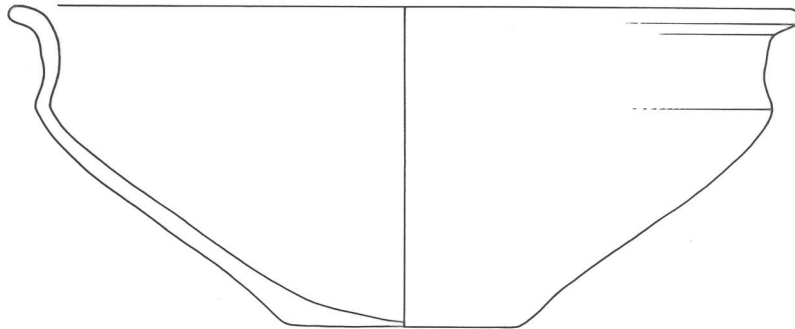

60

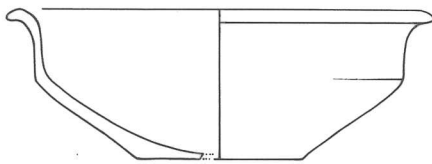

61

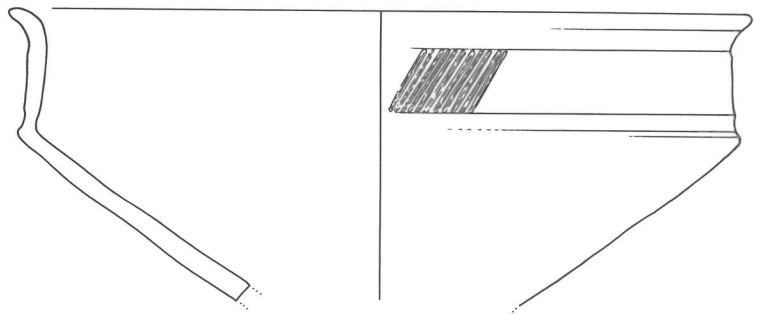

62

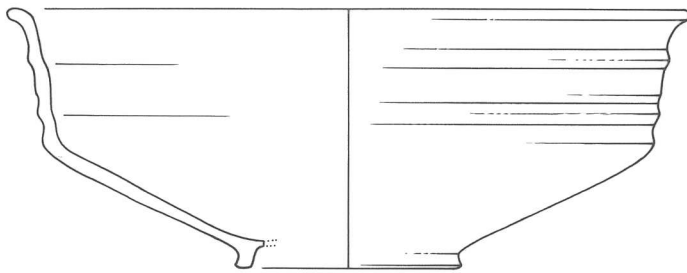

63

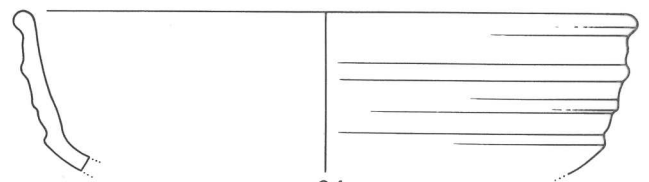

64

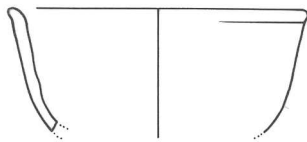

65

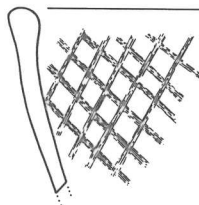

66

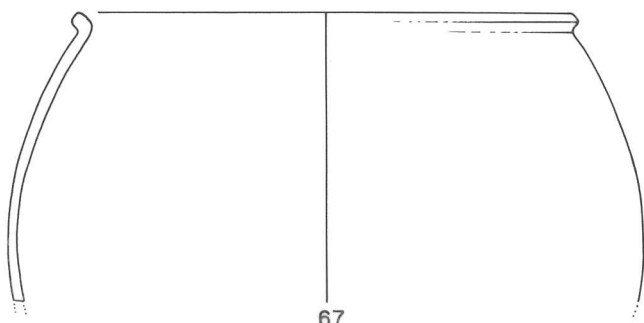
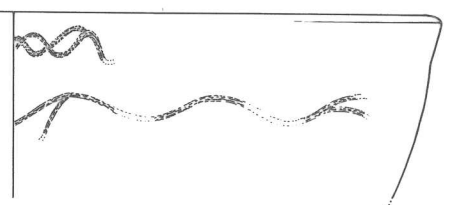

67

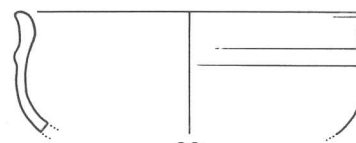

68

TOURNUS -SEPT FONTAINES (Ier s. av.).
59-68 : fine sombre lissée. Ech. : 1/3.

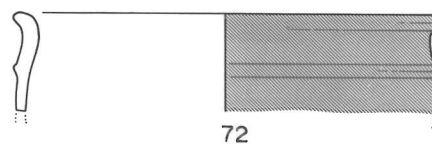
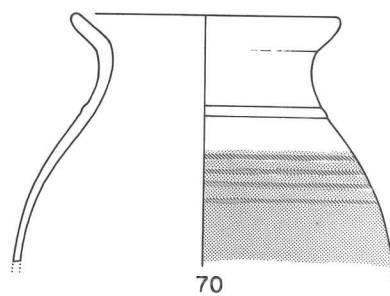
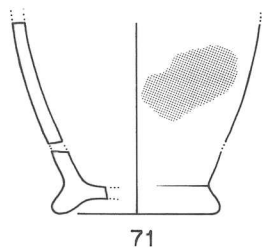
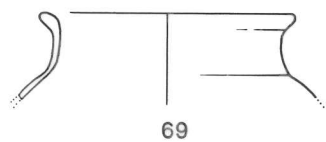

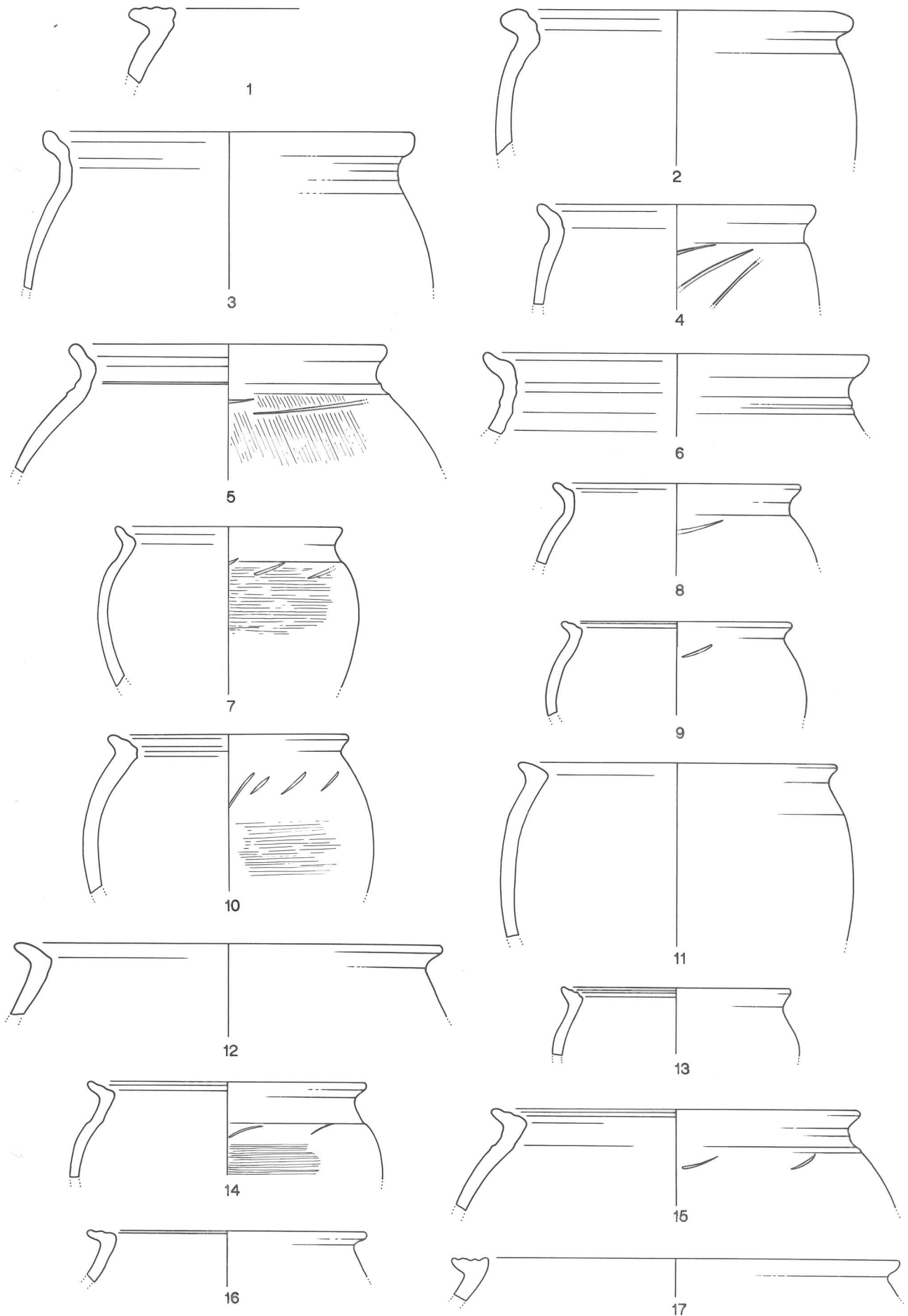

TOURNUS -CLOS-ROY (2^e. moitié 1^{er} s. av.).

1-2 : grossière claire, micacée ; 3-17 : non tournée grossière siliceuse. Ech. : 1/3.

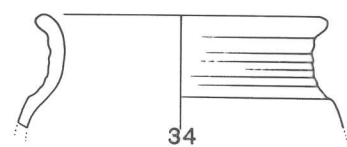
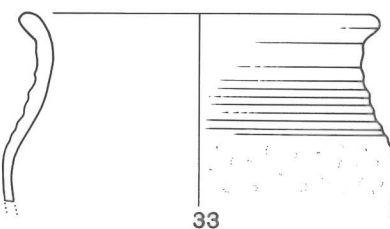
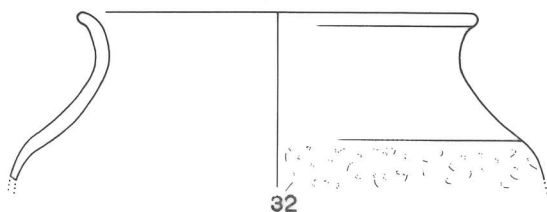
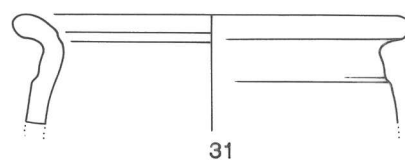
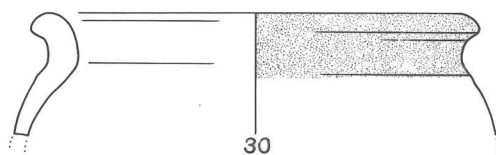
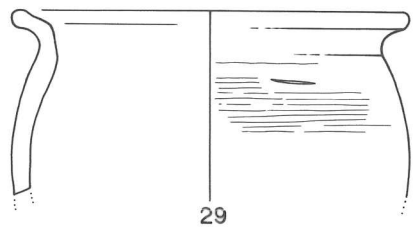
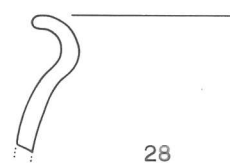
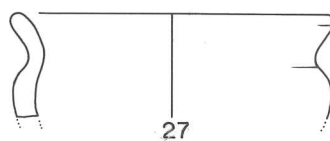
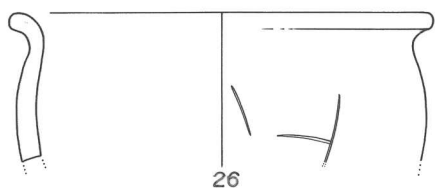
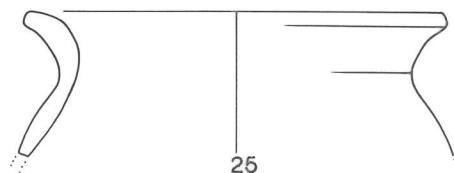
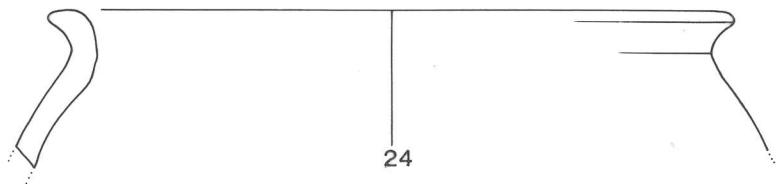
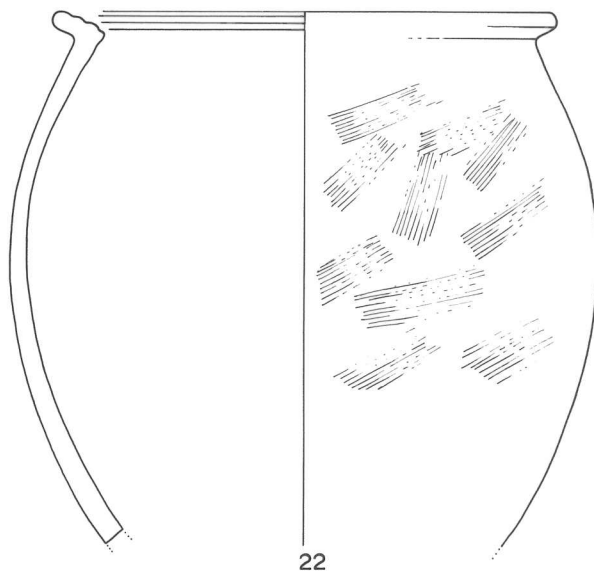
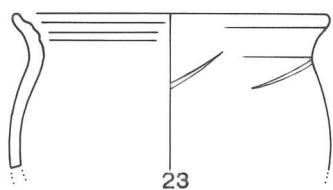
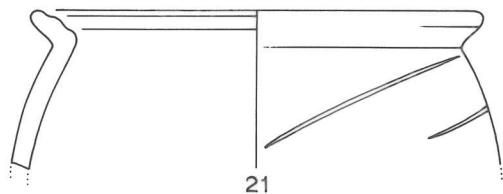
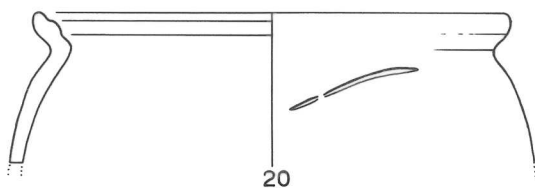
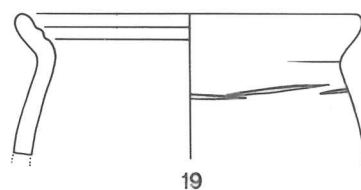
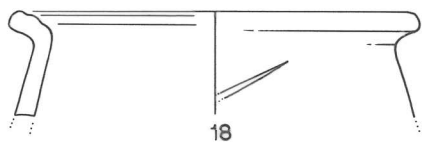

TOURNUS -CLOS-ROY (2^e. moitié 1^{er} s. av.).
18-34 : non tournée grossière siliceuse. Ech. : 1/3.

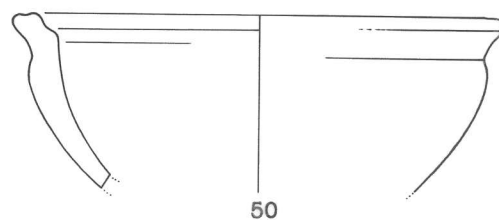
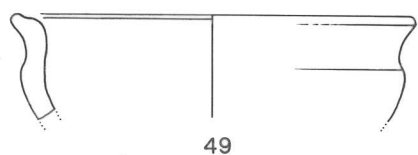
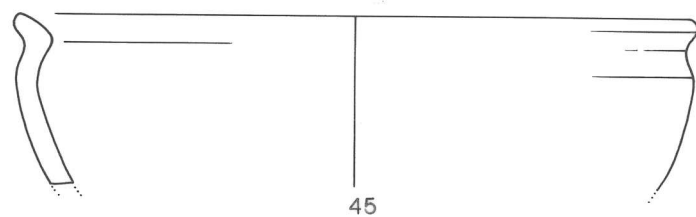
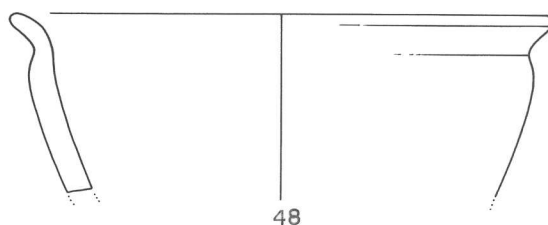
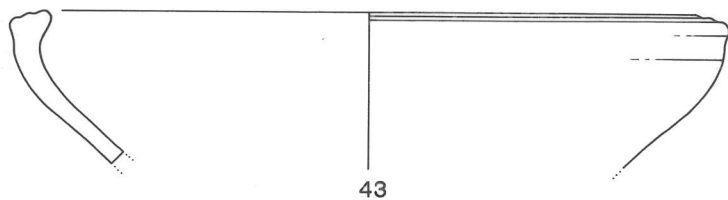
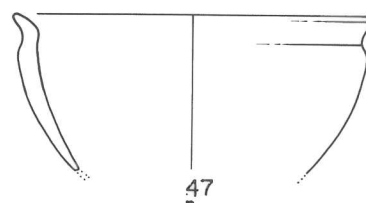
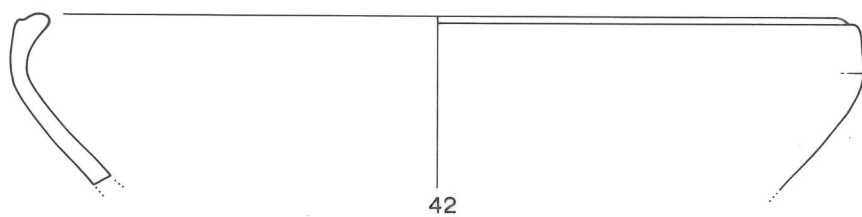
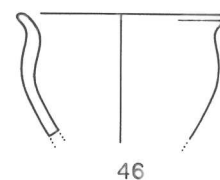
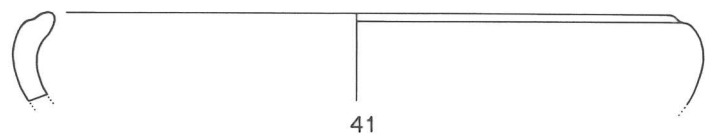
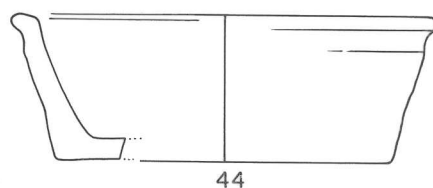
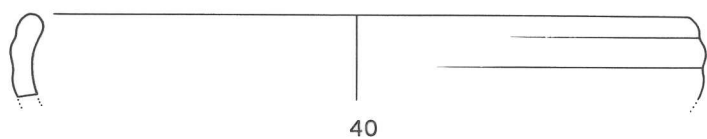
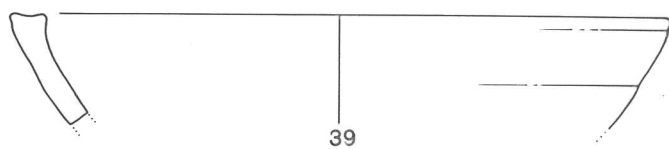
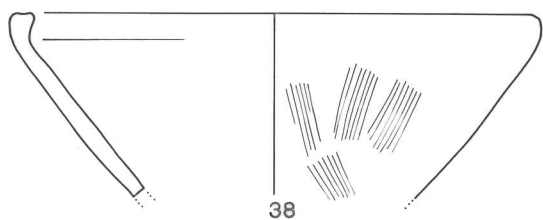
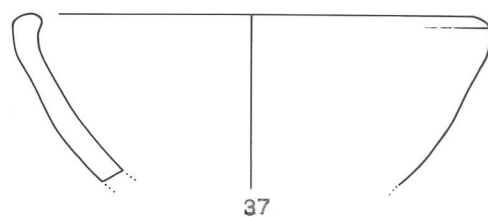
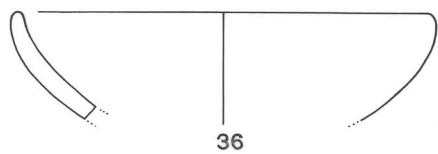
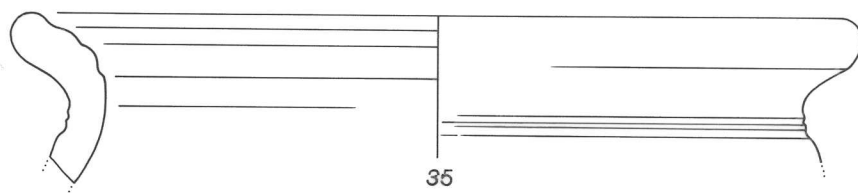

TOURNUS -CLOS-ROY (2^e. moitié 1^{er} s. av.).
35-50 : non tournée grossière siliceuse. Ech. : 1/3.

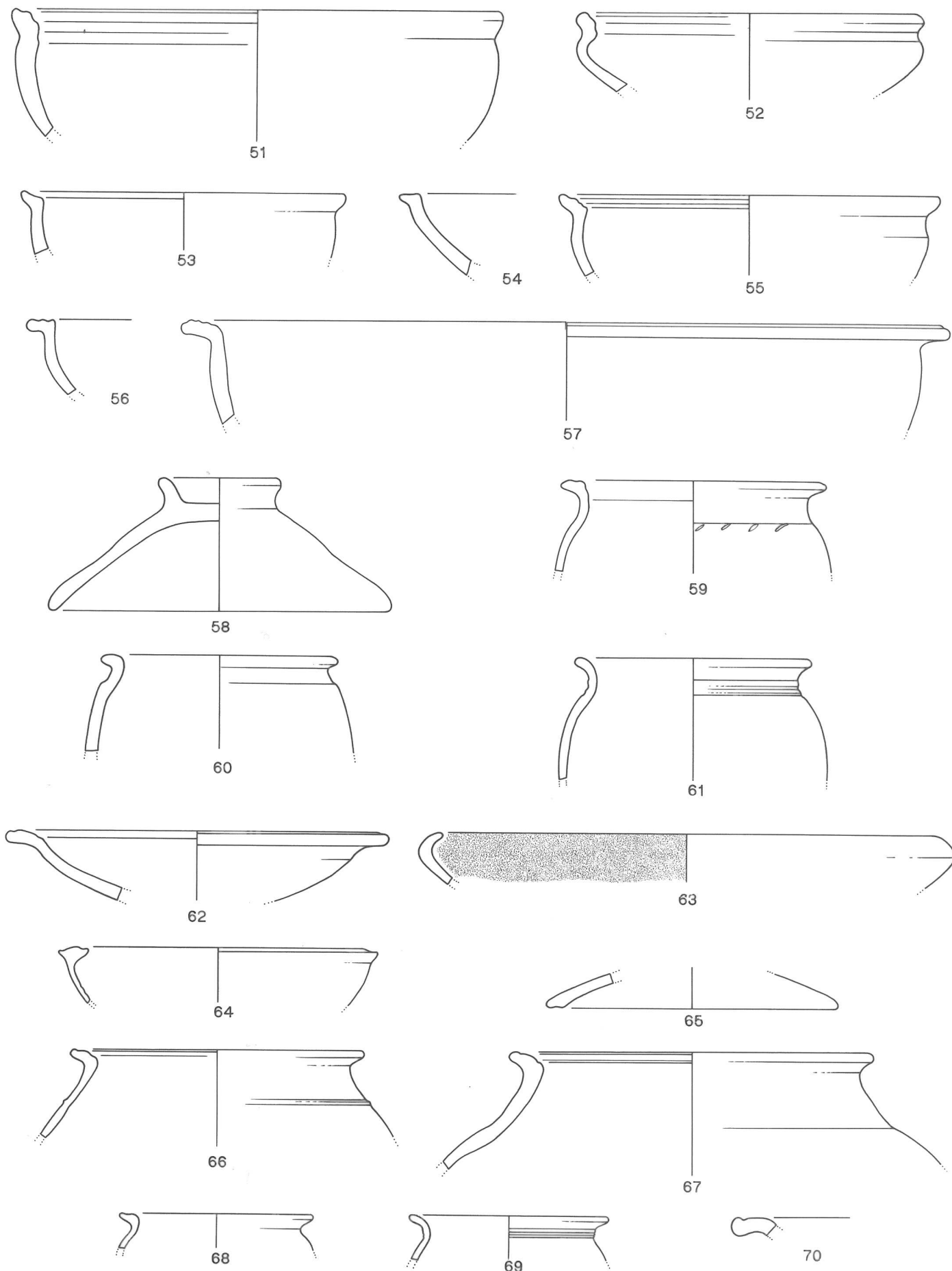

TOURNUS -CLOS-ROY (2^e. moitié 1^{er} s. av.).

51-58 : non tournée grossière siliceuse ; 59-65 : mi-fine siliceuse sombre (63 : micacée) ; 66-70 : mi-fine siliceuse claire. Ech. : 1/3.

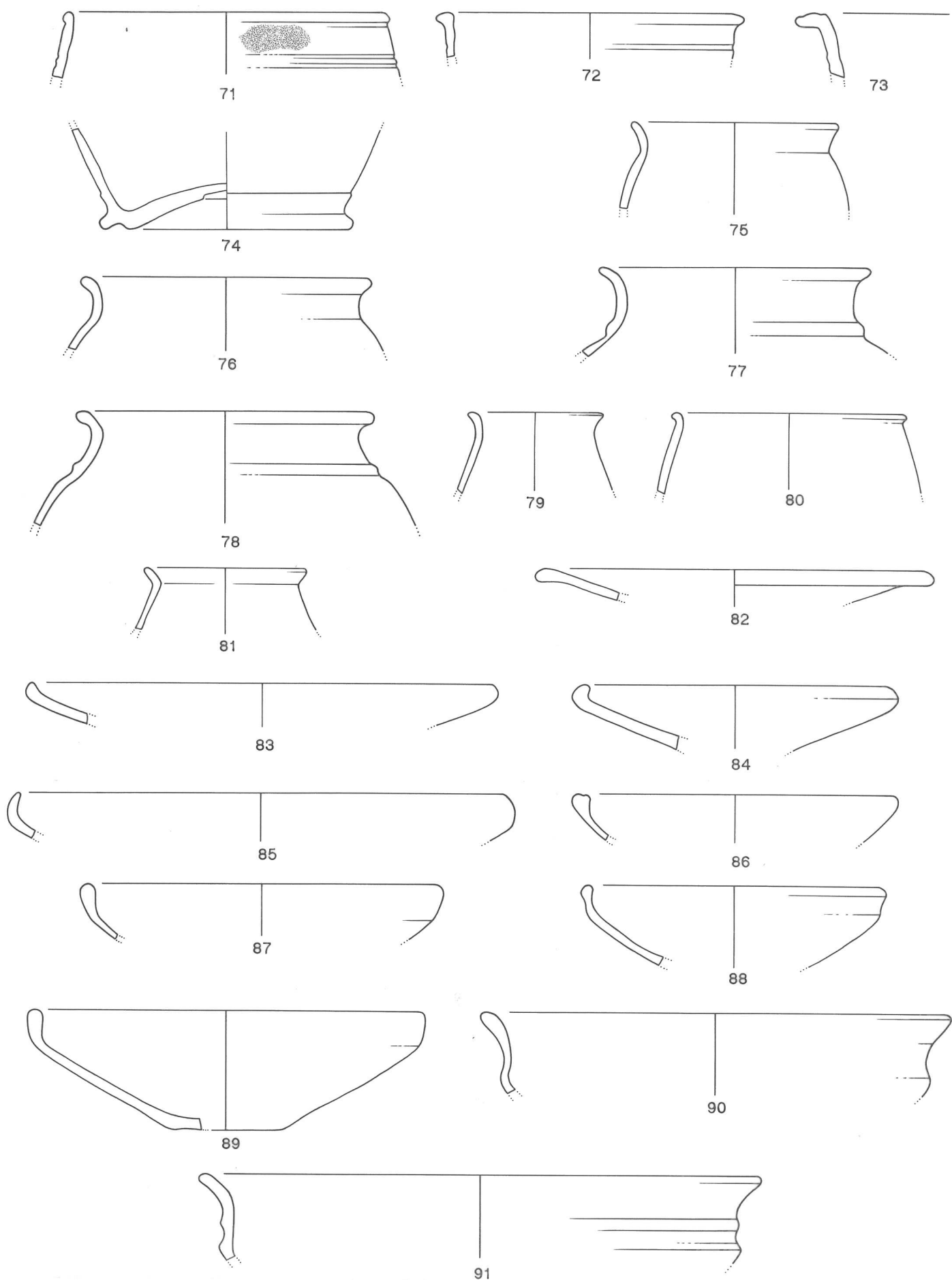

TOURNUS -CLOS-ROY (2^e. moitié 1^{er} s. av.).

71-74 : mi-fine siliceuse claire (71 : micacée); 75-91 : fine sombre lissée. Ech. : 1/3.

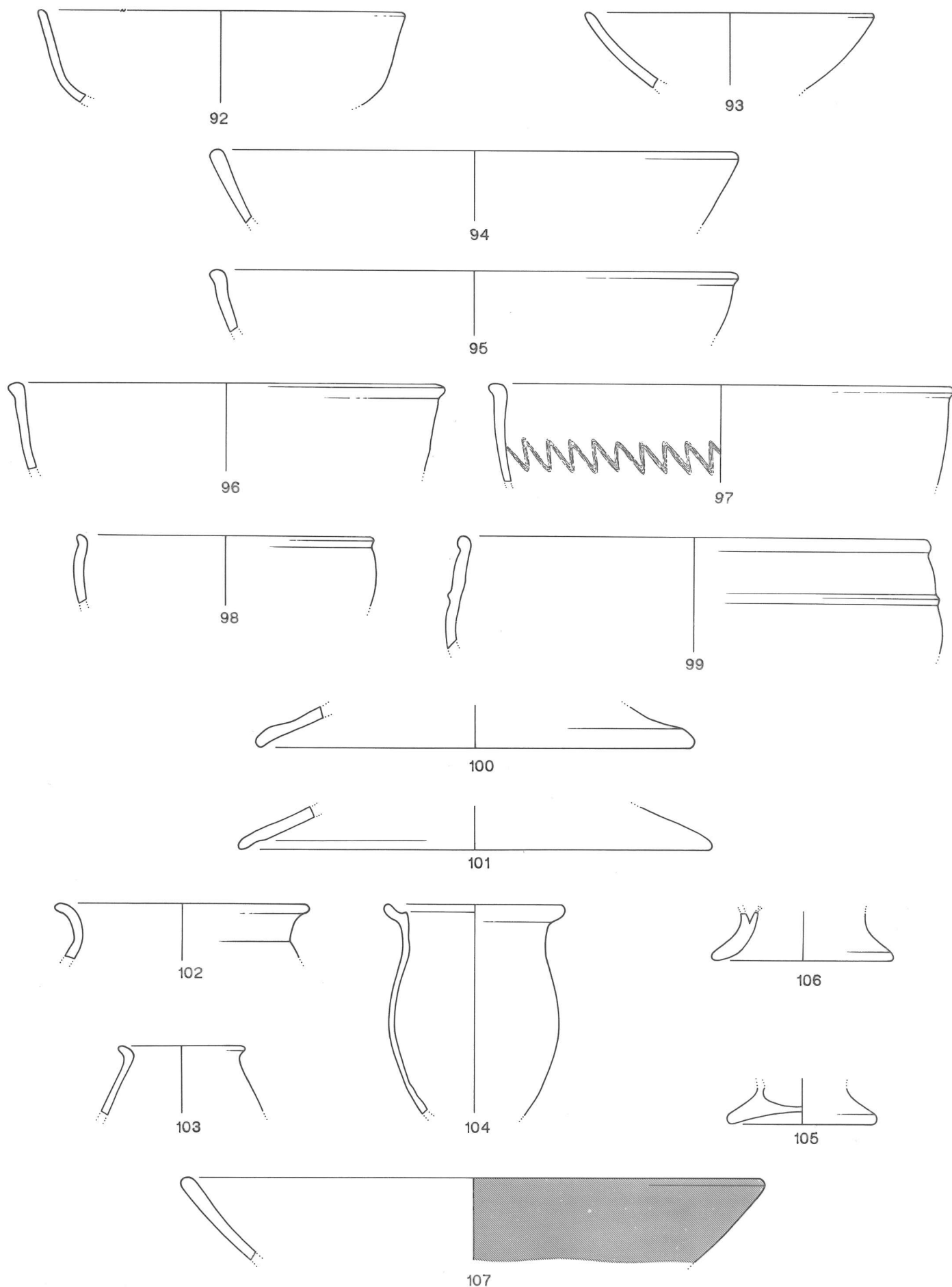

TOURNUS -CLOS-ROY (2è. moitié Ier s. av.).

92-101 : fine sombre lissée ; 102-106 : fine claire ; 107 : fine peinte. Ech. : 1/3.

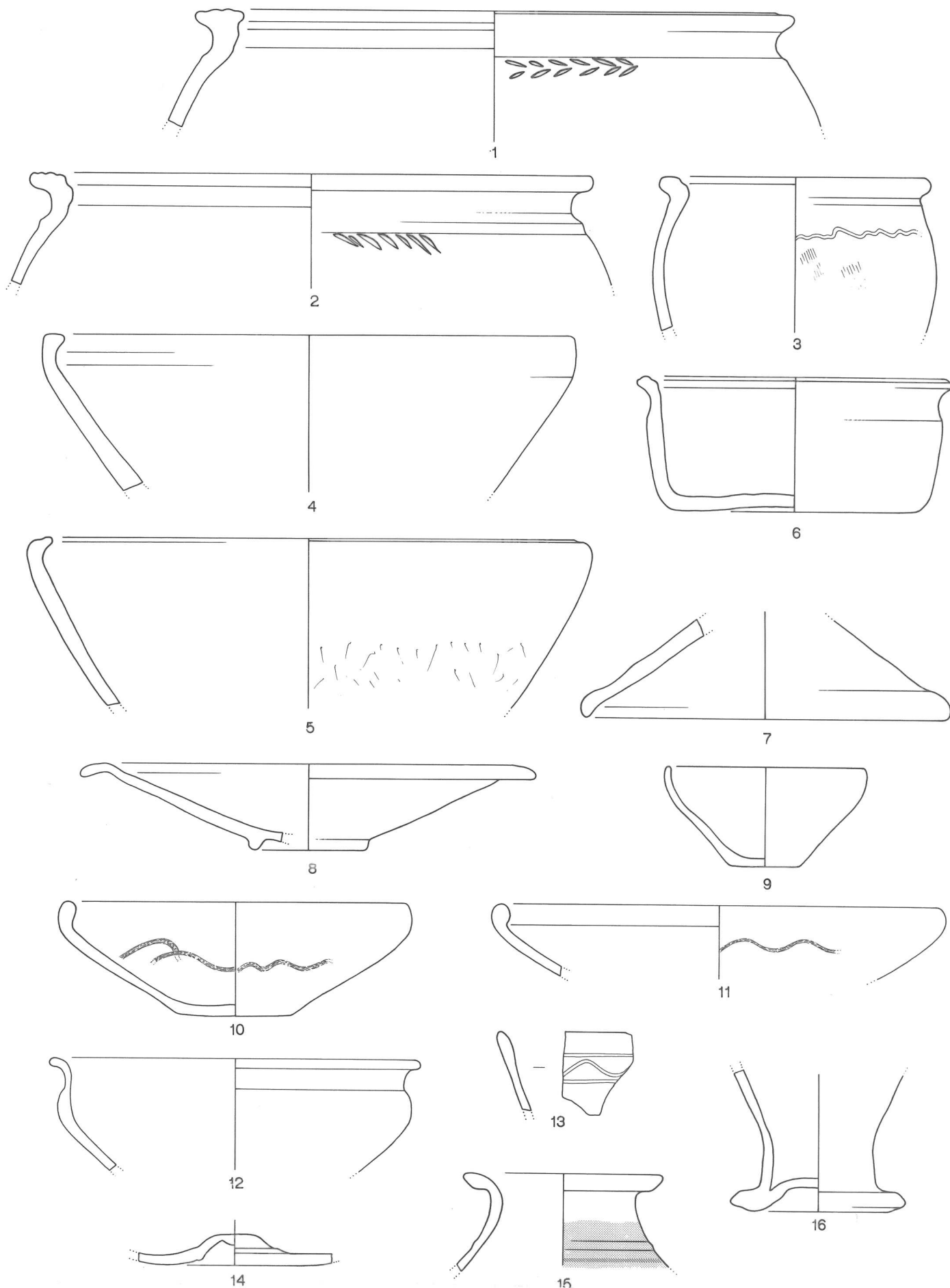

MELLECEY -MARLOUX (fin II^e. Ier s. av.).

1-2 : non tournée grossière claire micacée ; 3-7 : non tournée grossière siliceuse ; 8-14 : fine sombre lissée ; 15-16 : fine peinte. Ech. : 1/3.

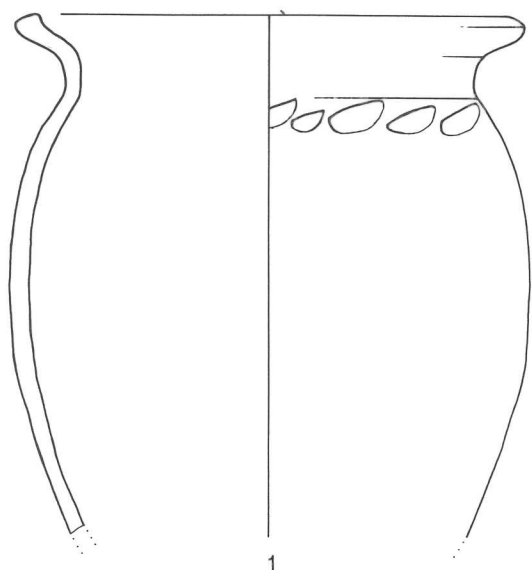

1

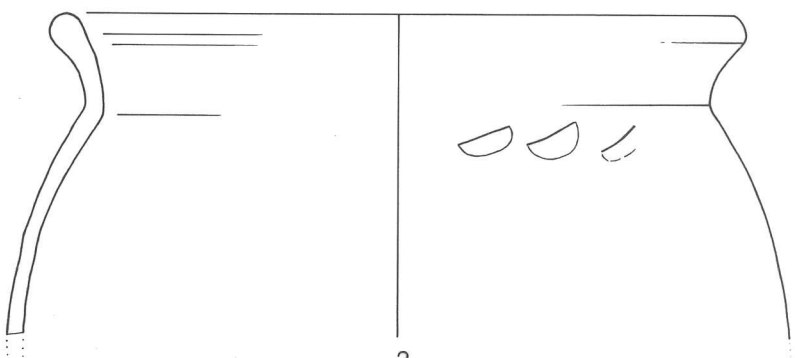

2

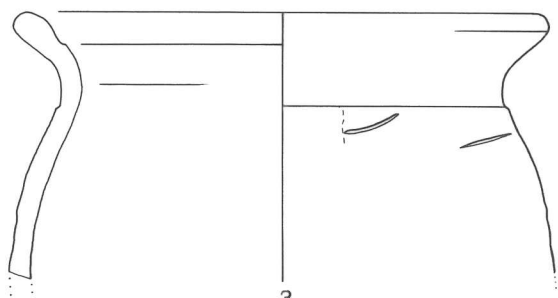

3

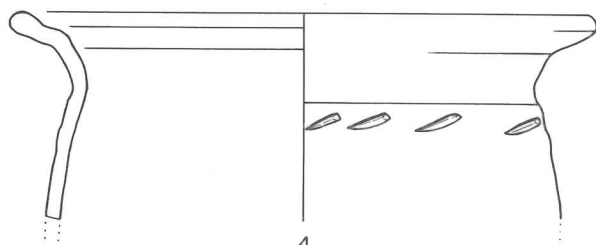

4

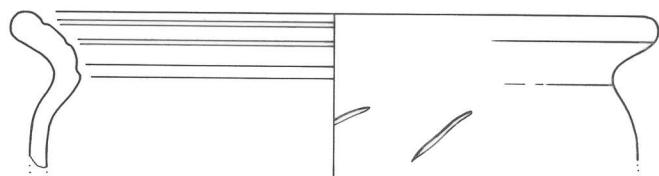

5

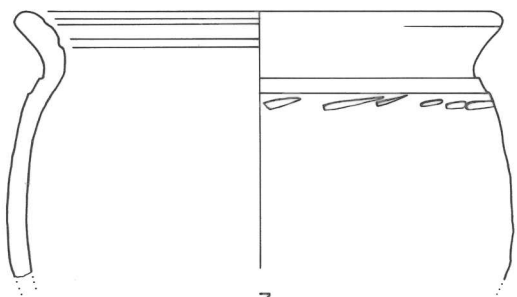

7

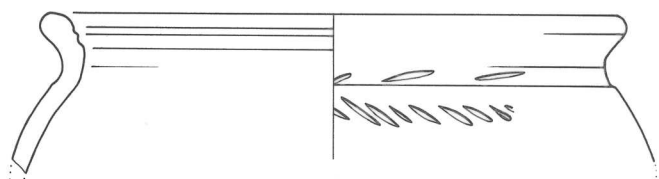

6

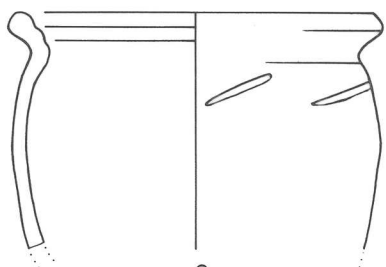

8

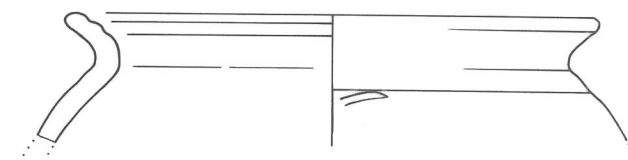

10

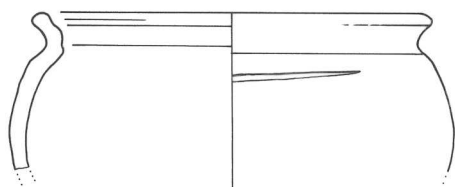

9

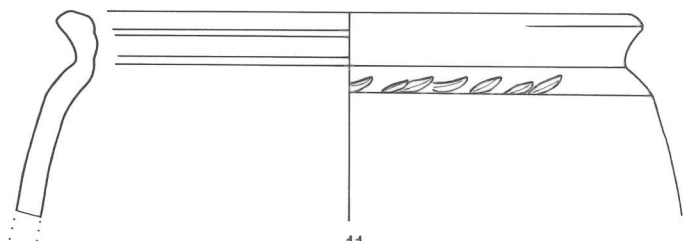

11

VERDUN -PETIT-CHAUVORT (2è. moitié IIè.-déb. Ier s. av.).
1-11 : non tournée, grossière claire micacée. Ech. : 1/3.

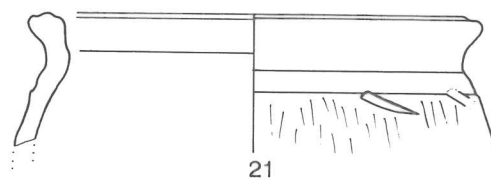
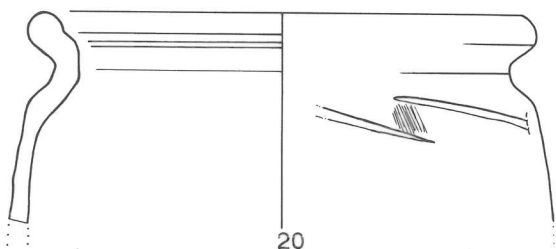
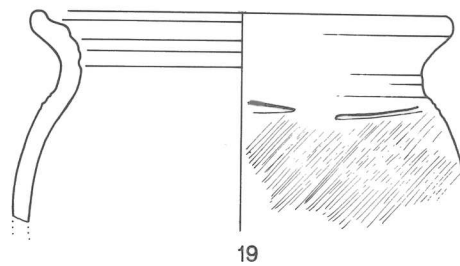
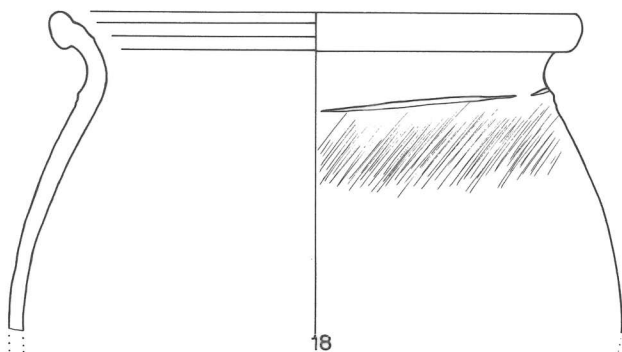
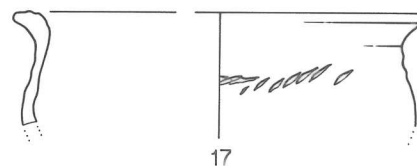
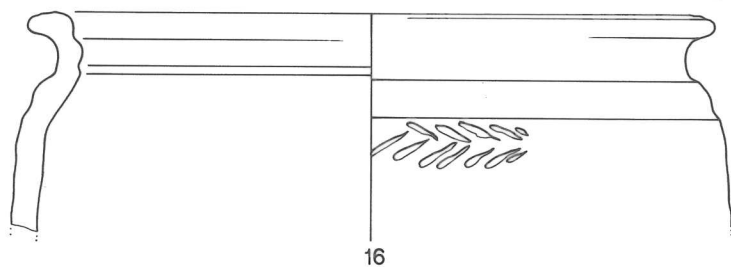
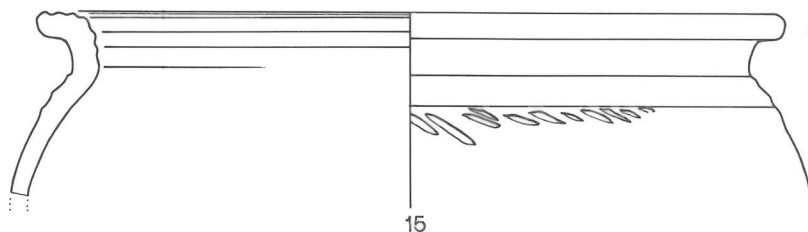
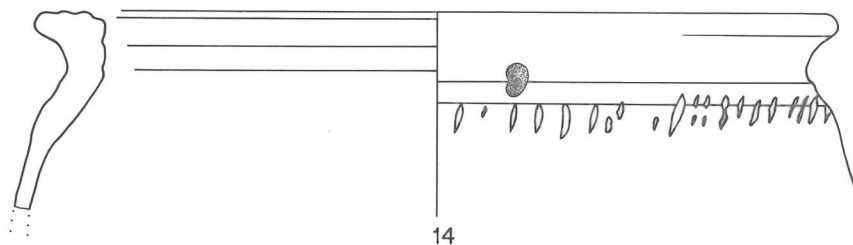
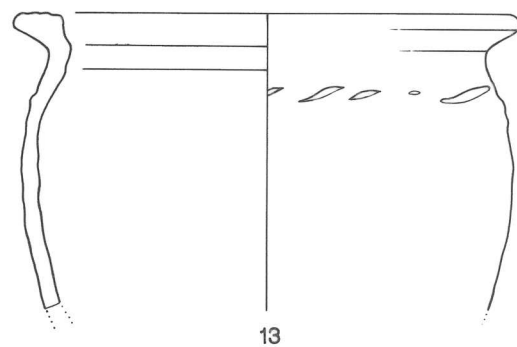
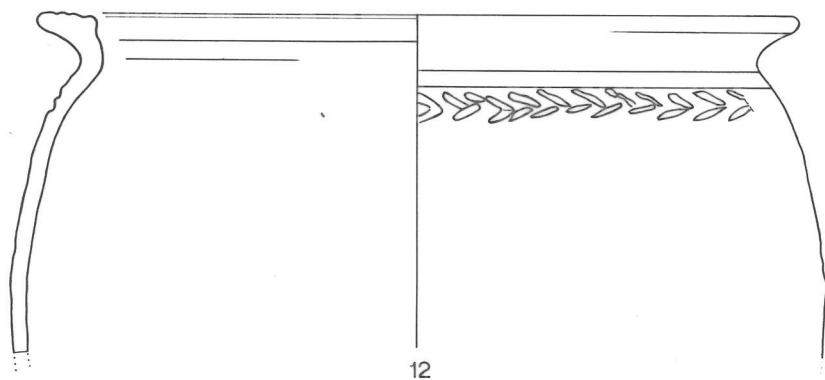

VERDUN -PETIT-CHAUVORT (2^e. moitié II^e.-déb. I^{er} s. av.).

12-17 : non tournée, grossière claire micacée ; 18-21 : non tournée grossière siliceuse. Ech. : 1/3.

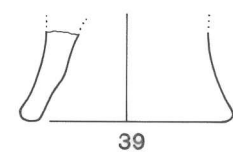
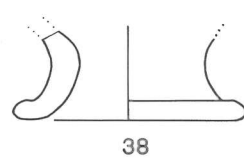
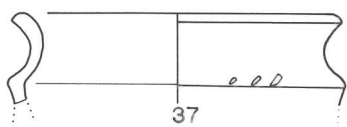
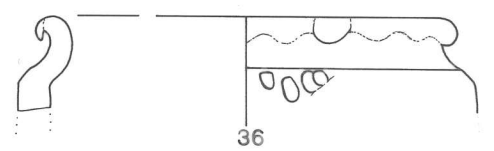
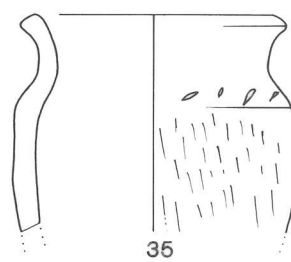
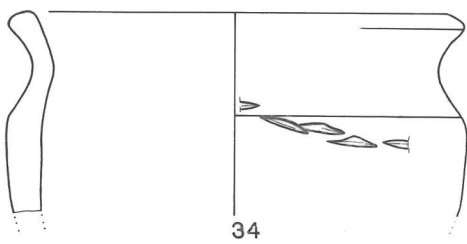
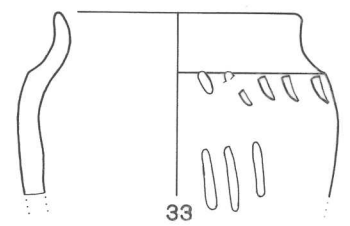
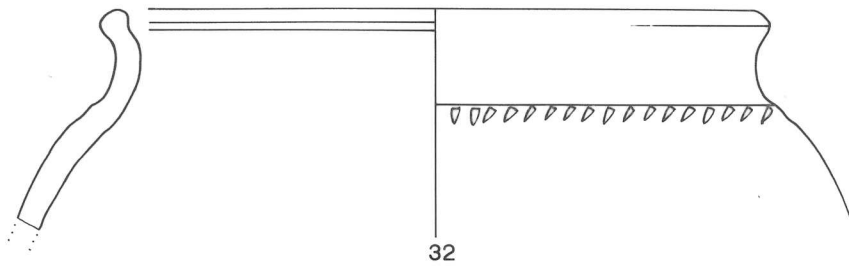
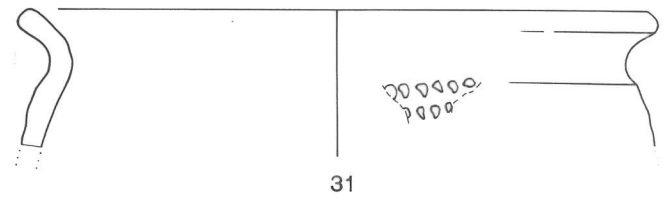
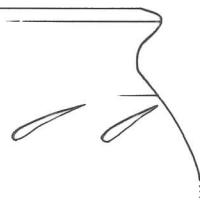
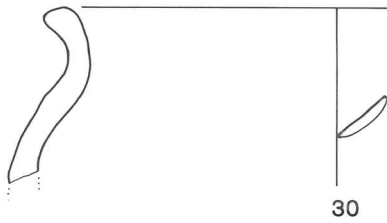
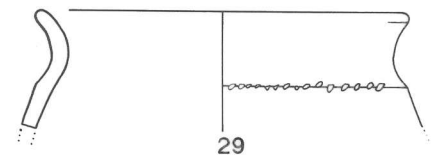
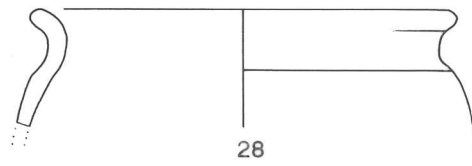
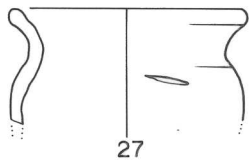
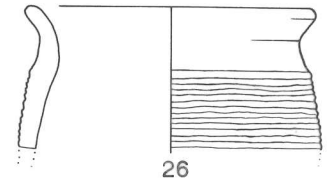
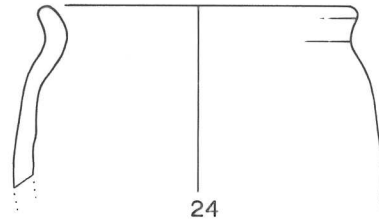
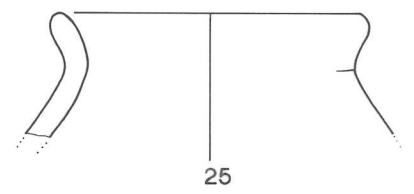
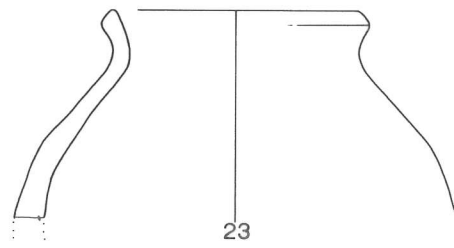
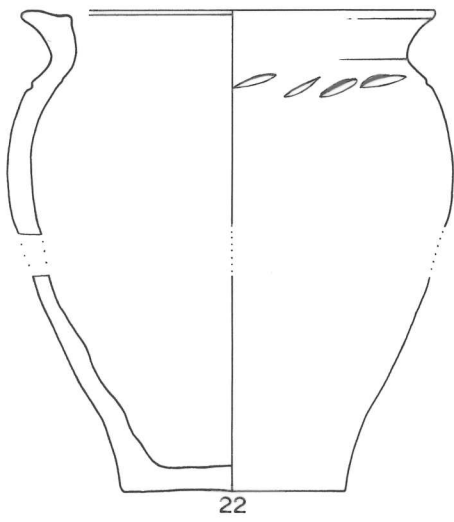

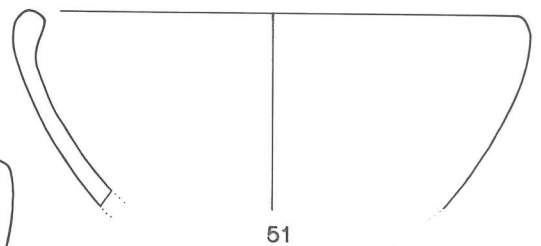
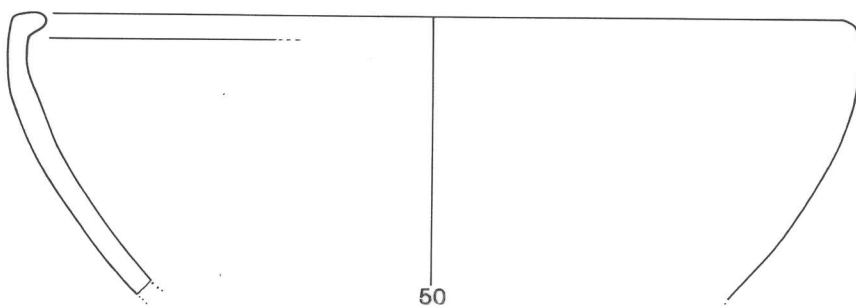
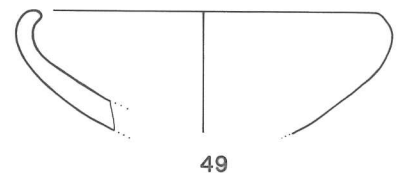
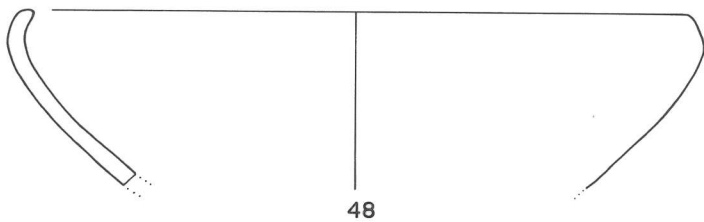
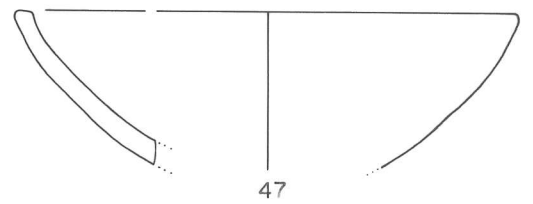
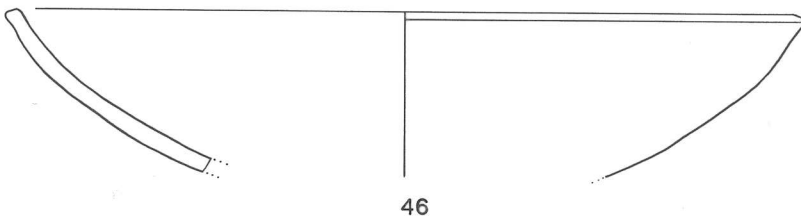
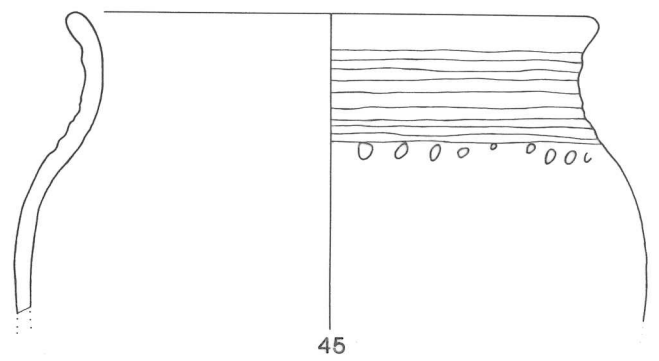
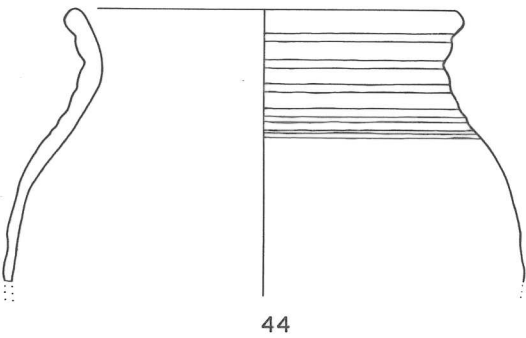
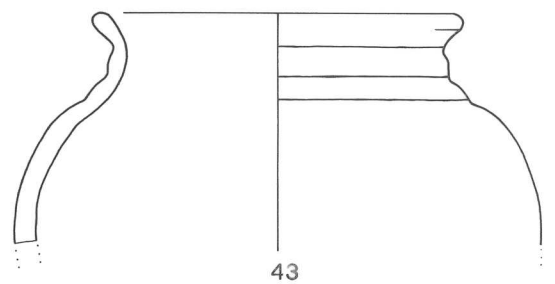
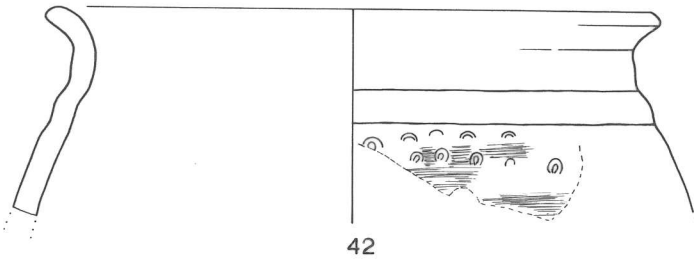
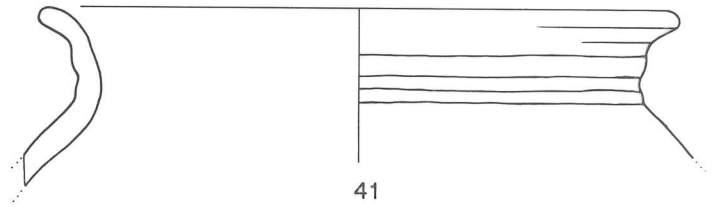
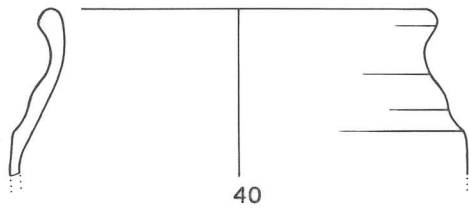

VERDUN -PETIT-CHAUVORT (2è. moitié IIè.-déb. Ier s. av.).
40-51 : non tournée grossière siliceuse. Ech. : 1/3.

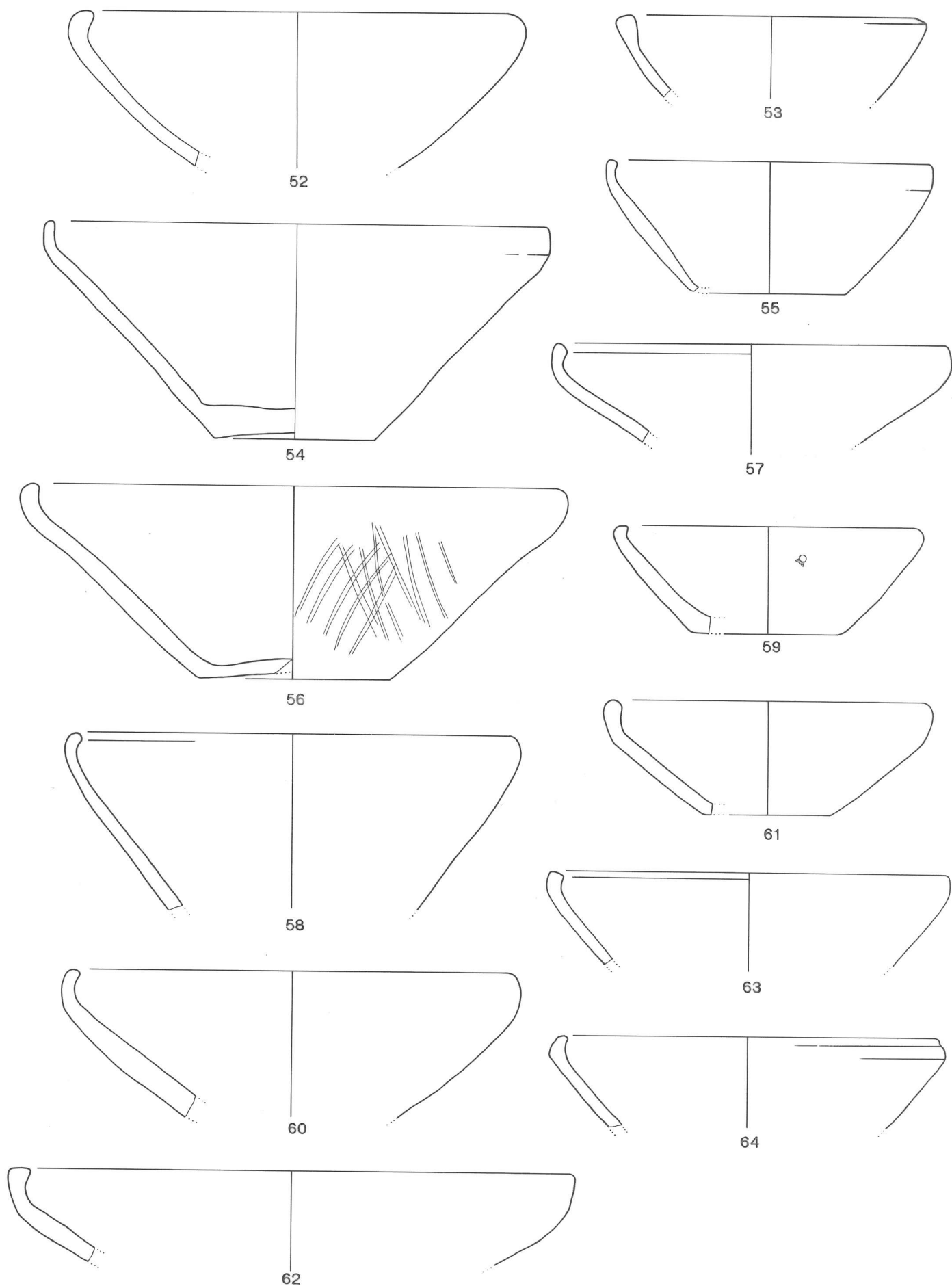

VERDUN -PETIT-CHAUVORT (2^e. moitié II^e.-déb. I^{er} s. av.).
52-64 : non tournée grossière siliceuse. Ech. : 1/3.

pppppp

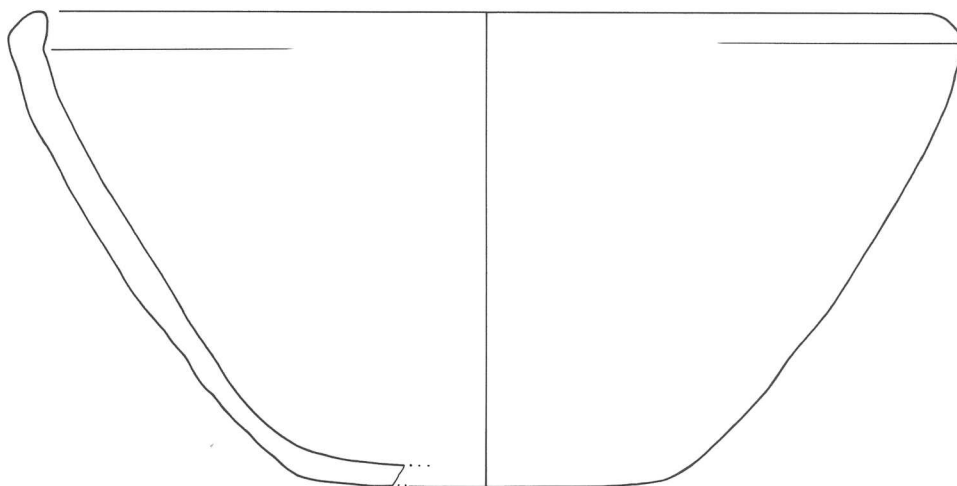

65

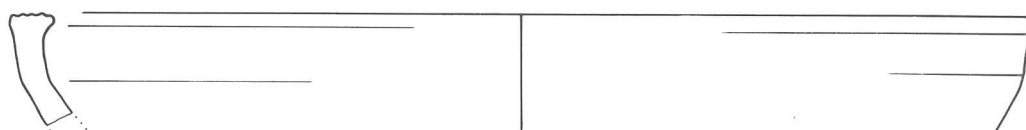

66

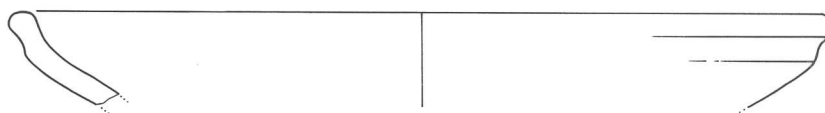

68

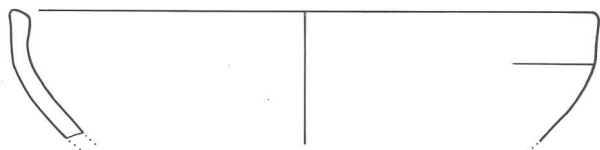

67

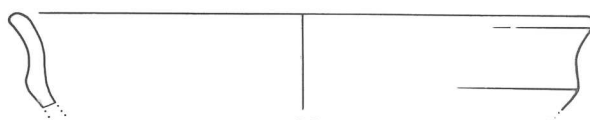

69

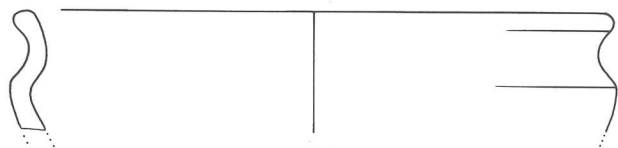

70

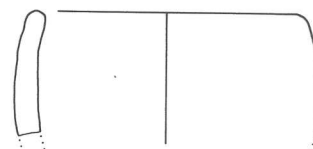

71

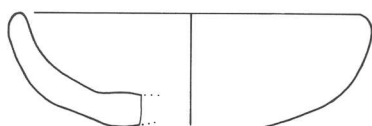

72



73

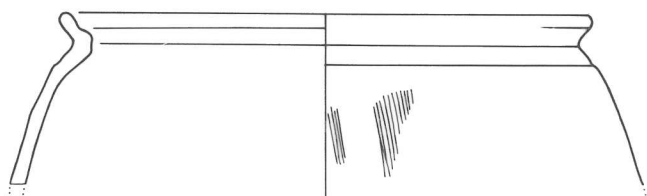

75

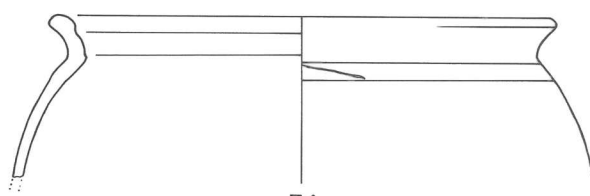

74

VERDUN -PETIT-CHAUVORT (2^e. moitié II^e.-déb. I^{er} s. av.).

65-73 : non tournée grossière siliceuse ; 74-75 : non tournée, mi-fine micacée. Ech. : 1/3.

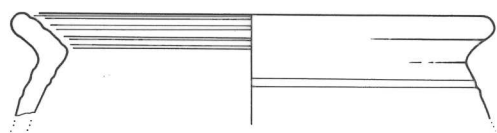

76

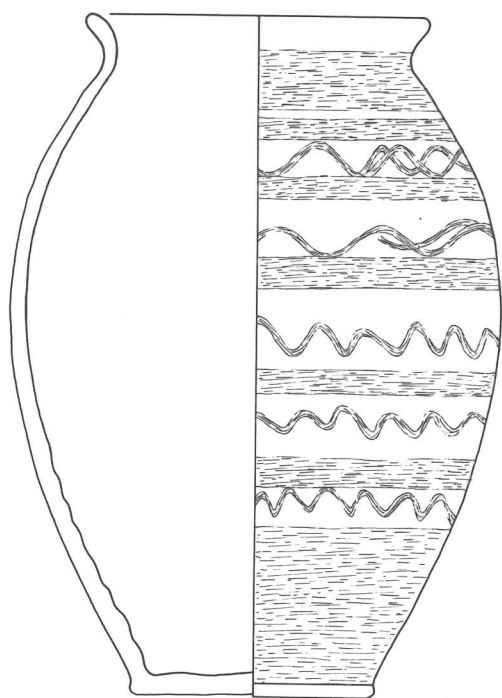

77

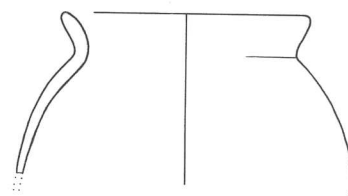

78

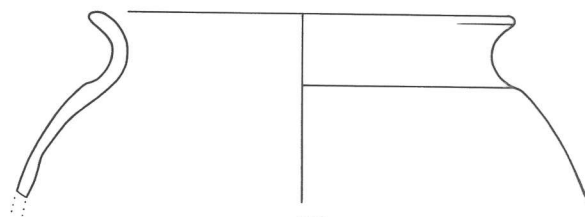

79

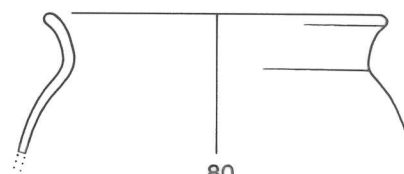

80

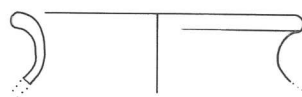

81

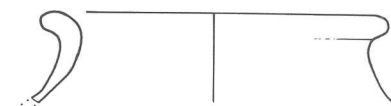

82

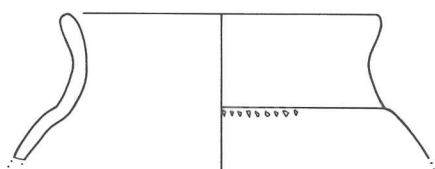

83

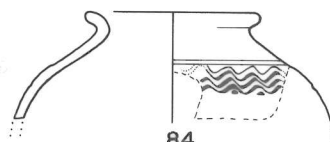

84

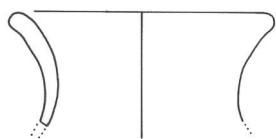

86

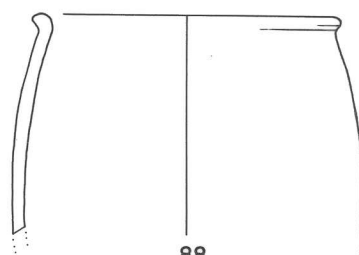

88

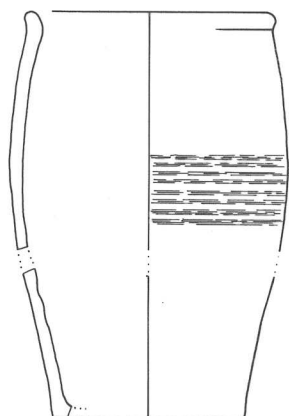

87

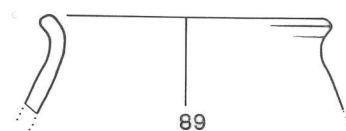

89

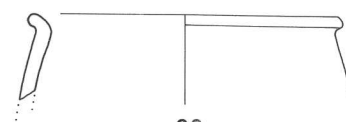

90

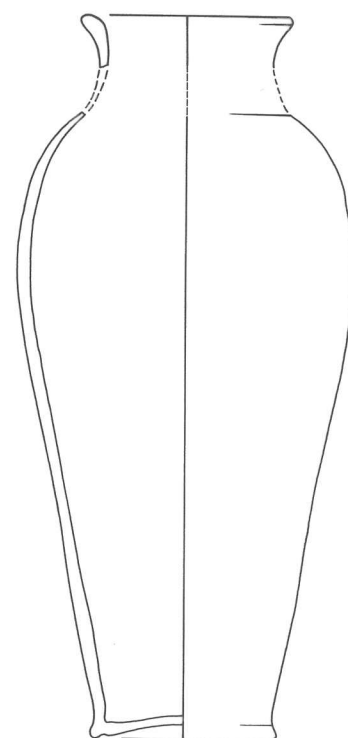

85

VERDUN -PETIT-CHAUVORT (2^e. moitié II^e.-déb. I^{er} s. av.).
76 : tournée, mi-fine siliceuse ; 78-90 : fine sombre lissée. Ech. : 1/3.

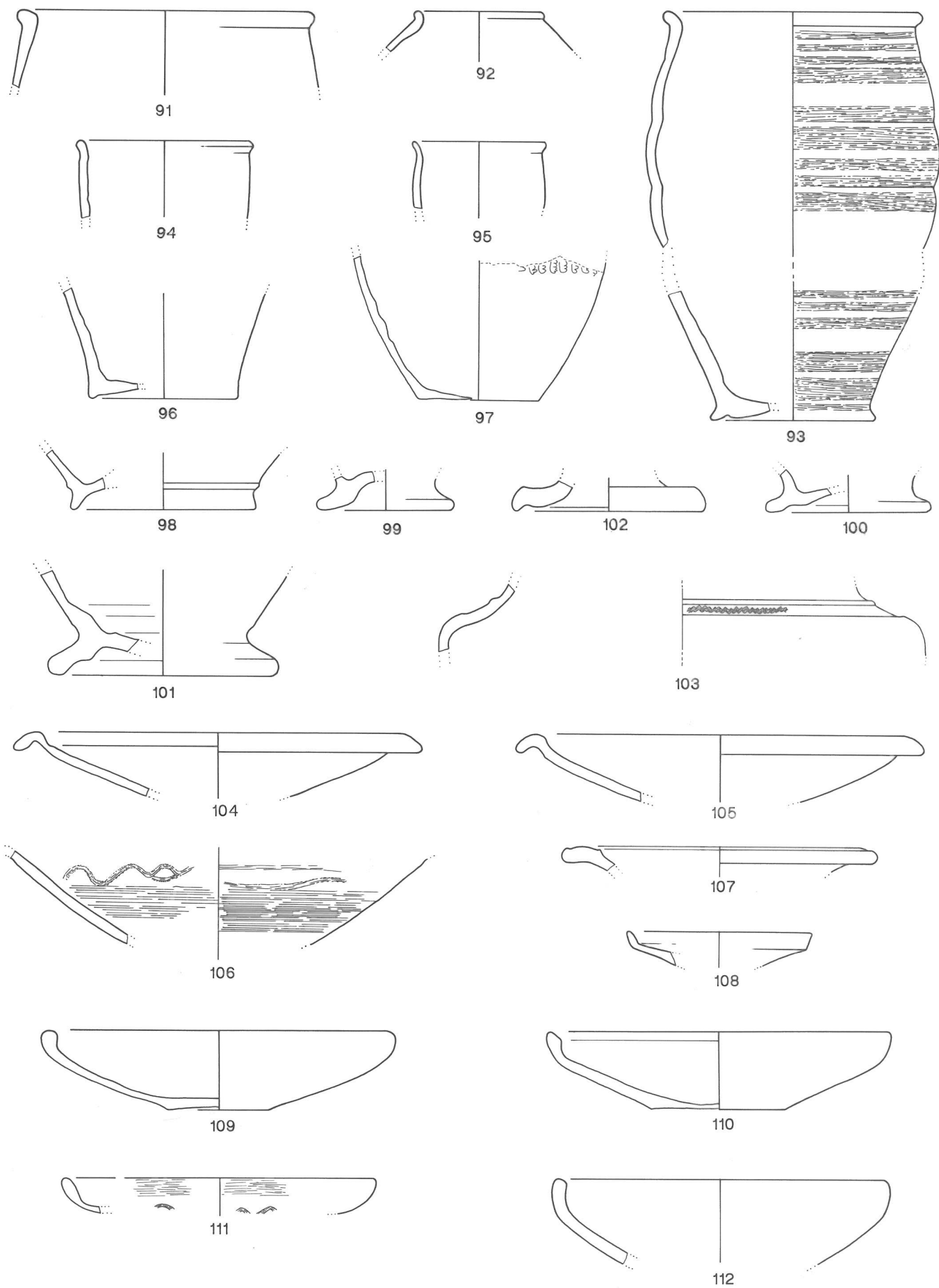

VERDUN -PETIT-CHAUVORT (2è. moitié IIè.-déb. Ier s. av.).
91-112 : fine sombre lissée. Ech. : 1/3.

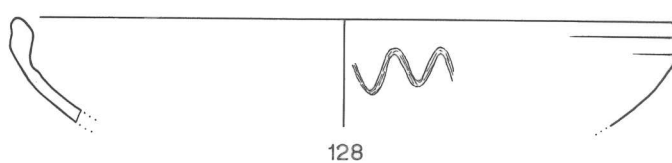
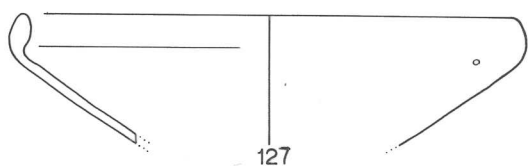
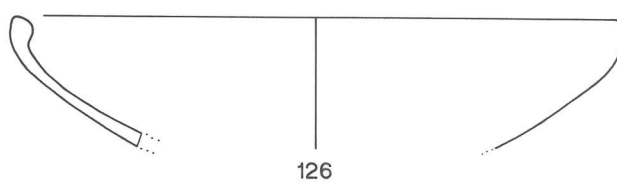
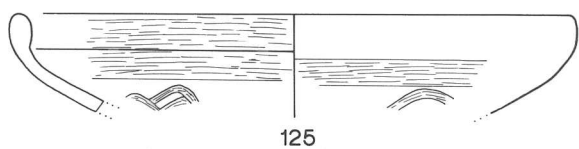
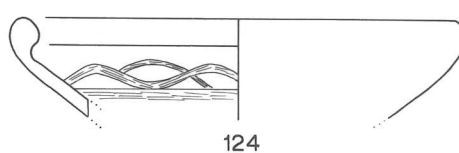
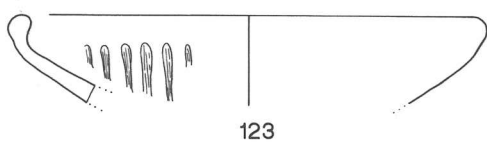
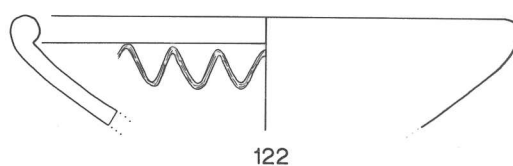
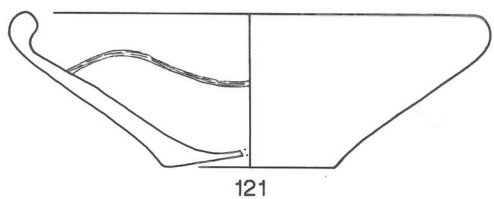
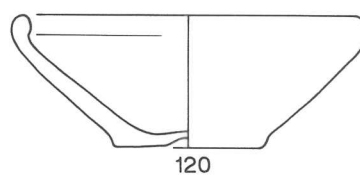
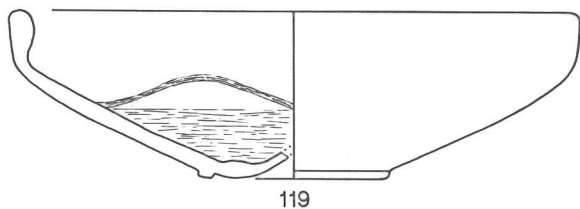
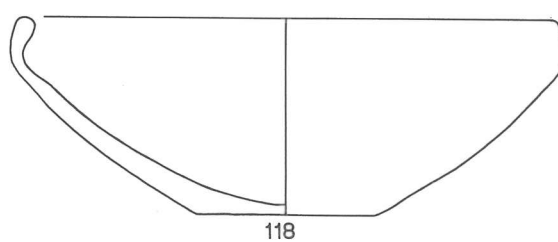
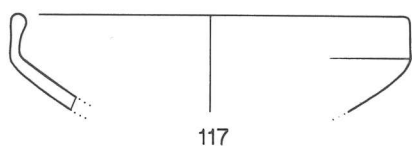
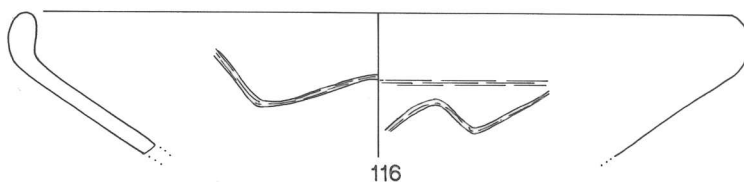
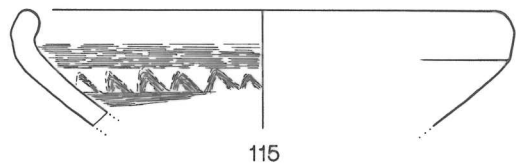
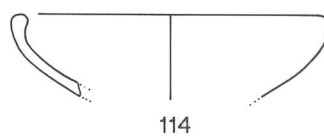
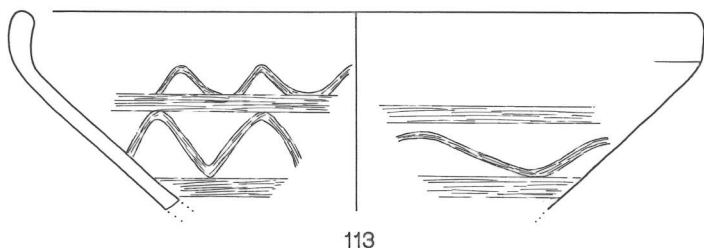

VERDUN -PETIT-CHAUVORT (2è. moitié IIè.-déb. Ier s. av.).
113-128 : fine sombre lissée. Ech. : 1/3.

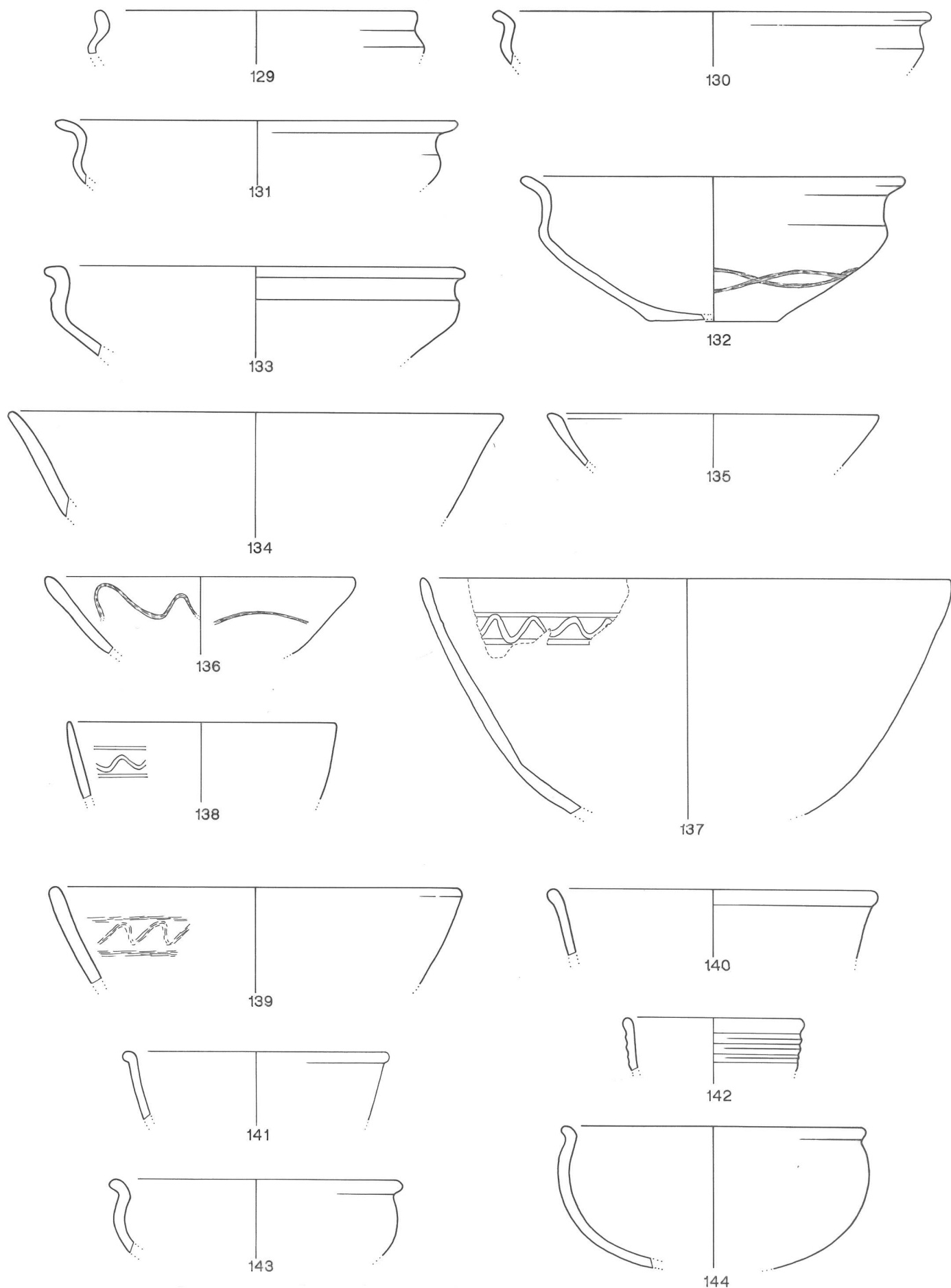

VERDUN -PETIT-CHAUVORT (2^e. moitié II^e.-déb. Ier s. av.).
129-144 : fine sombre lissée. Ech. : 1/3.

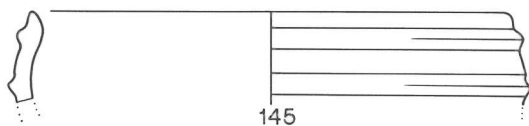

145



153

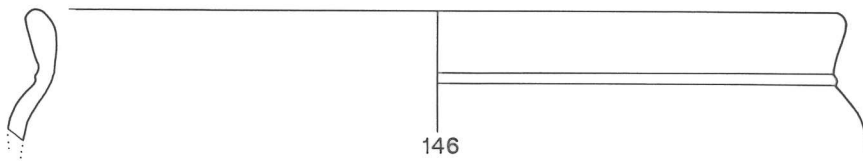

146



154

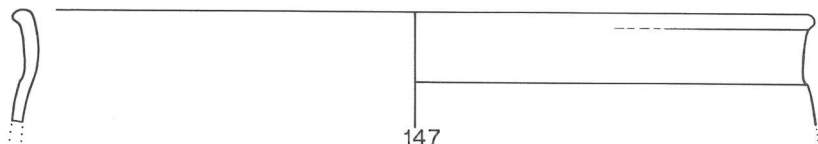

147



155

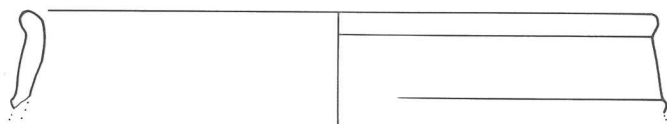

148



156

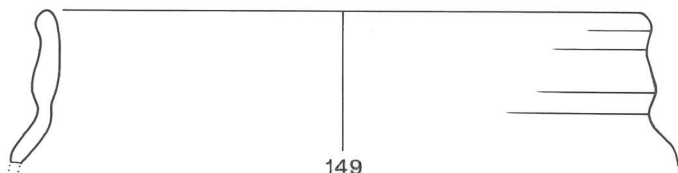

149

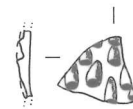

157

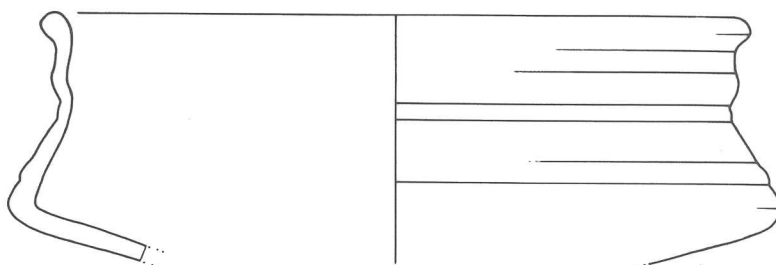

150

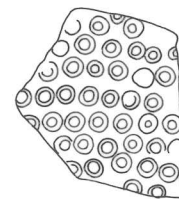

158

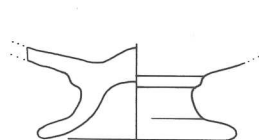

151

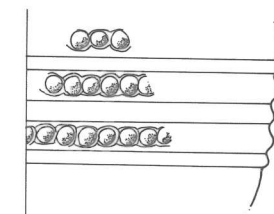

152

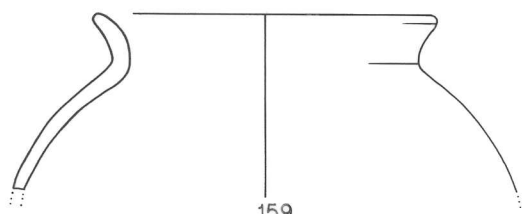

159

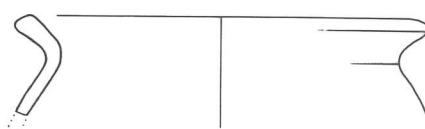

160



161

VERDUN -PETIT-CHAUVORT (2^e. moitié II^e.-déb. I^{er} s. av.).
145-158 : fine sombre lissée ; 159-161 : fine claire lissée. Ech. : 1/3.

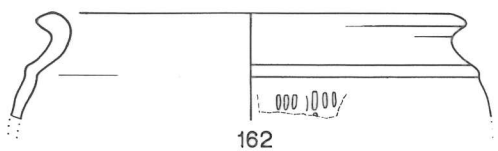

162

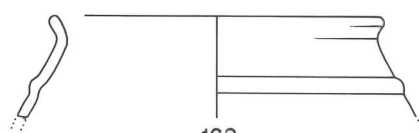

163

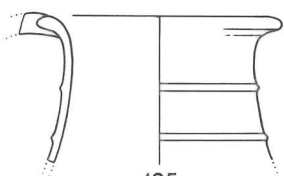

165

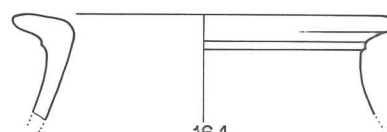

164

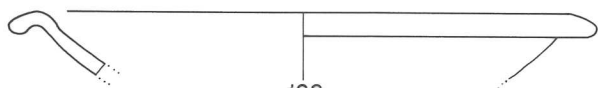

166

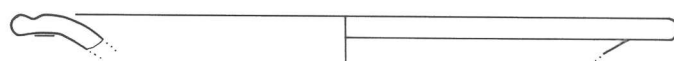

167



168

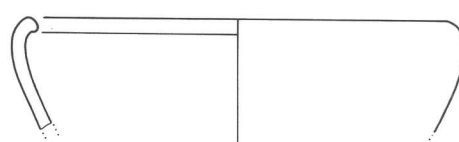

169



170

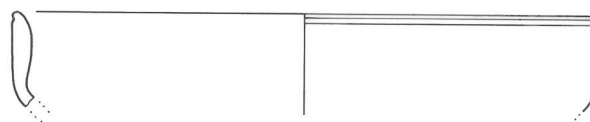

171



172

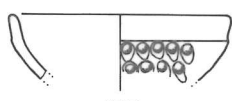

173

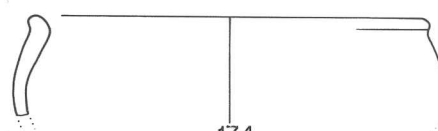

174

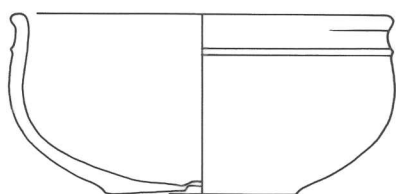

175

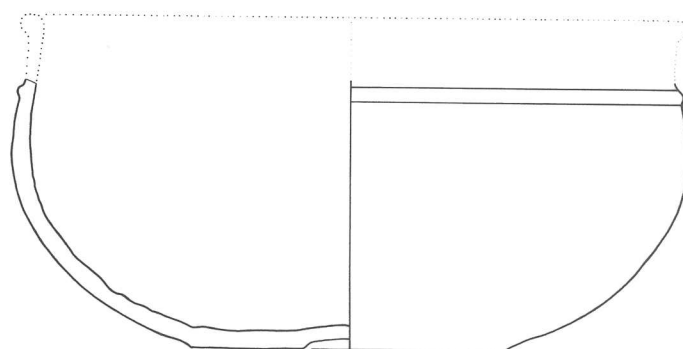

176



177



178

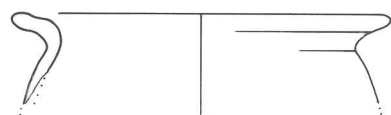

179



180

VERDUN -PETIT-CHAUVORT (2^e. moitié II^e.-déb. I^{er} s. av.).
162-178 : fine claire lissée ; 179-180 : fine claire micacée. Ech. : 1/3.

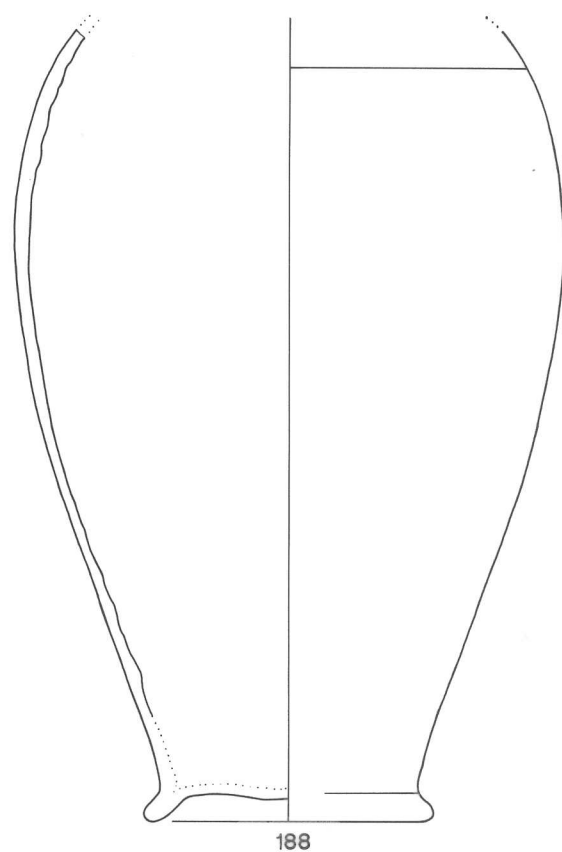
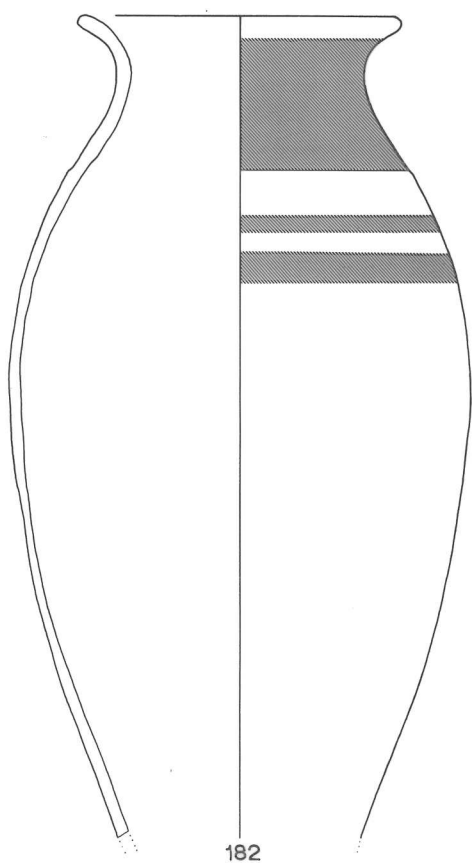
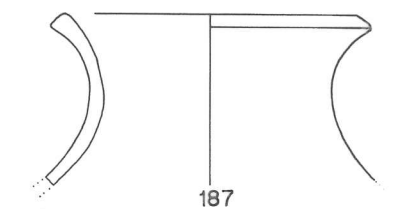
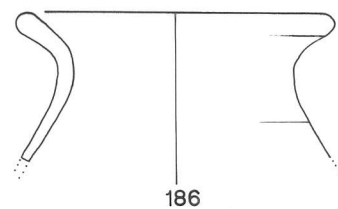
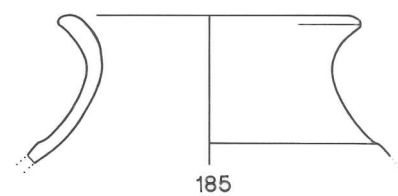
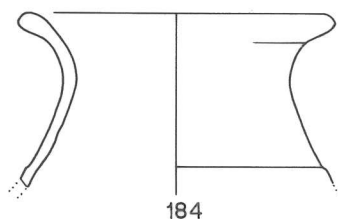
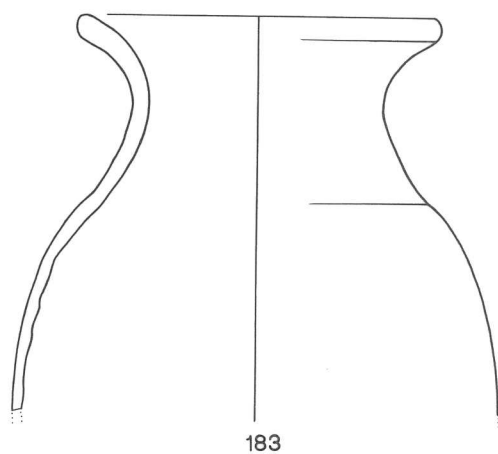
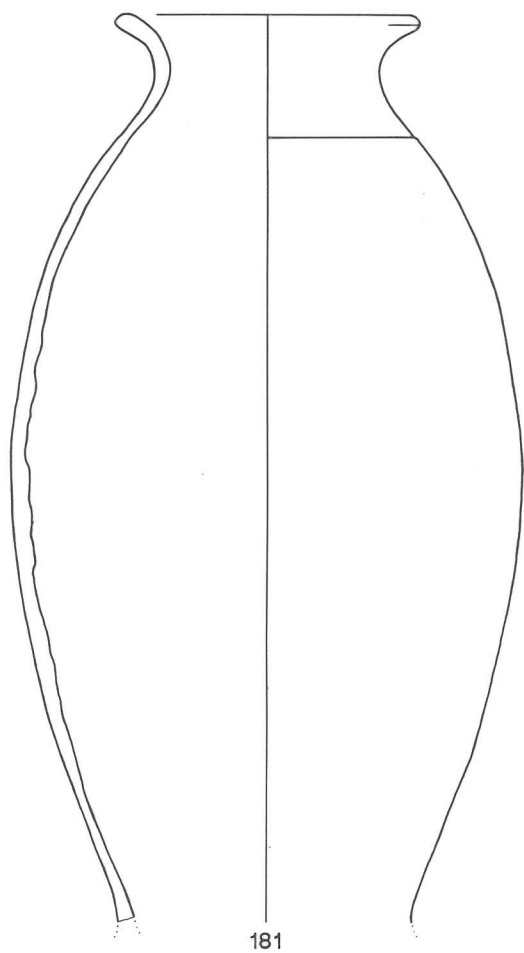

VERDUN -PETIT-CHAUVORT (2^e. moitié II^e.-déb. Ier s. av.).
181-188 : fine claire non peinte ou peinte partiellement. Ech. : 1/3.

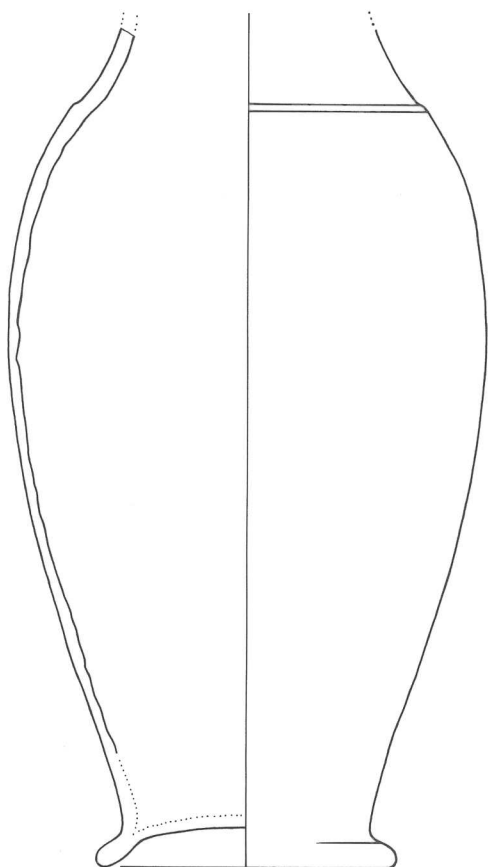

189

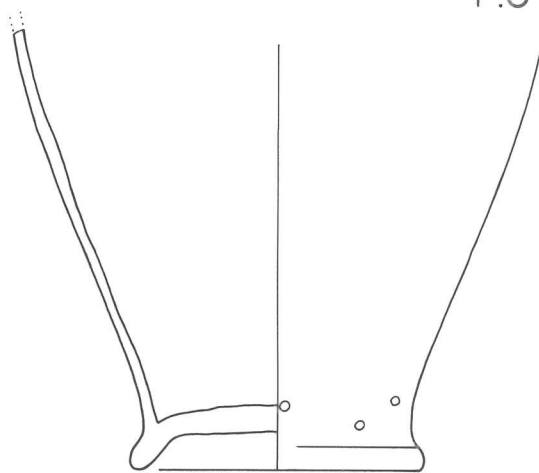

190

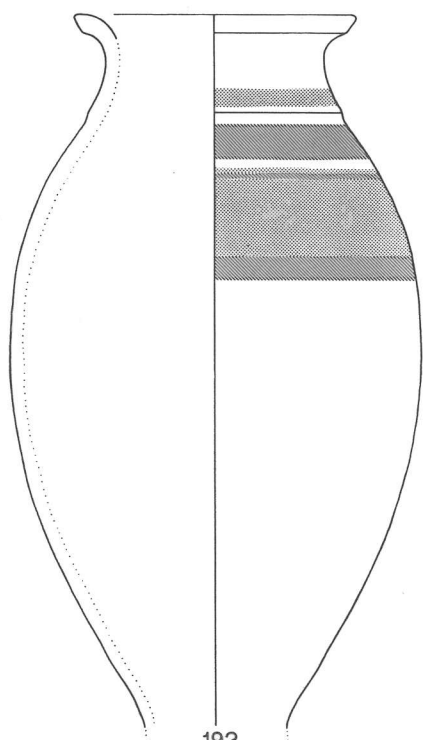

192

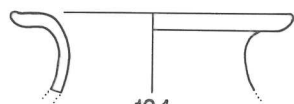

194

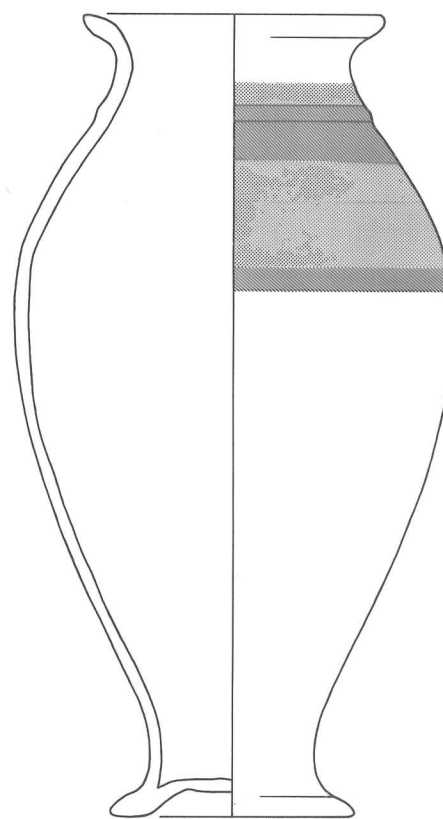

191

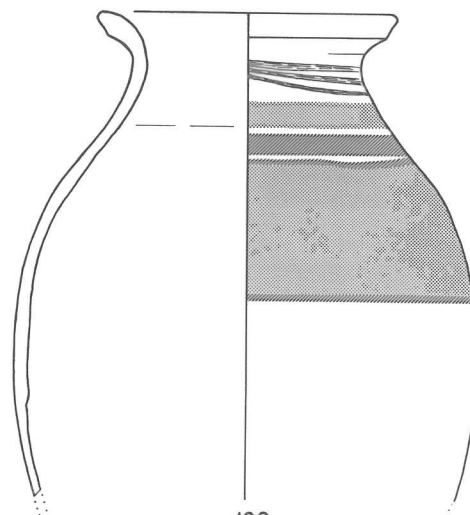

193

VERDUN -PETIT-CHAUVORT (2è. moitié IIè.-déb. 1er s. av.).
189-194 : fine claire non peinte ou peinte partiellement. Ech. : 1/3.

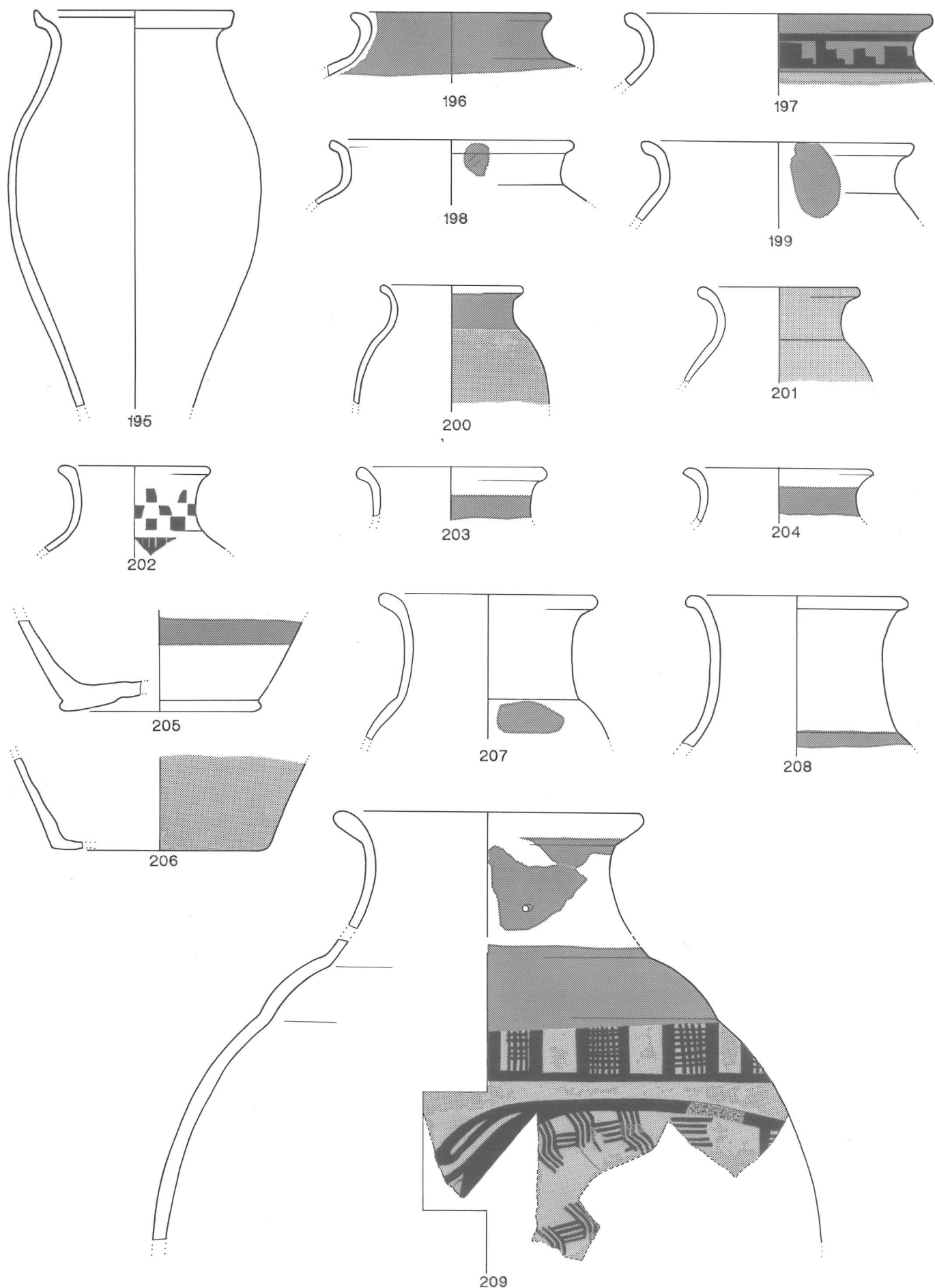

VERDUN -PETIT-CHAUVORT (2è. moitié IIè.-déb. Ier s. av.).
195 : fine claire ; 196-209 : fine peinte. Ech. : 1/3.

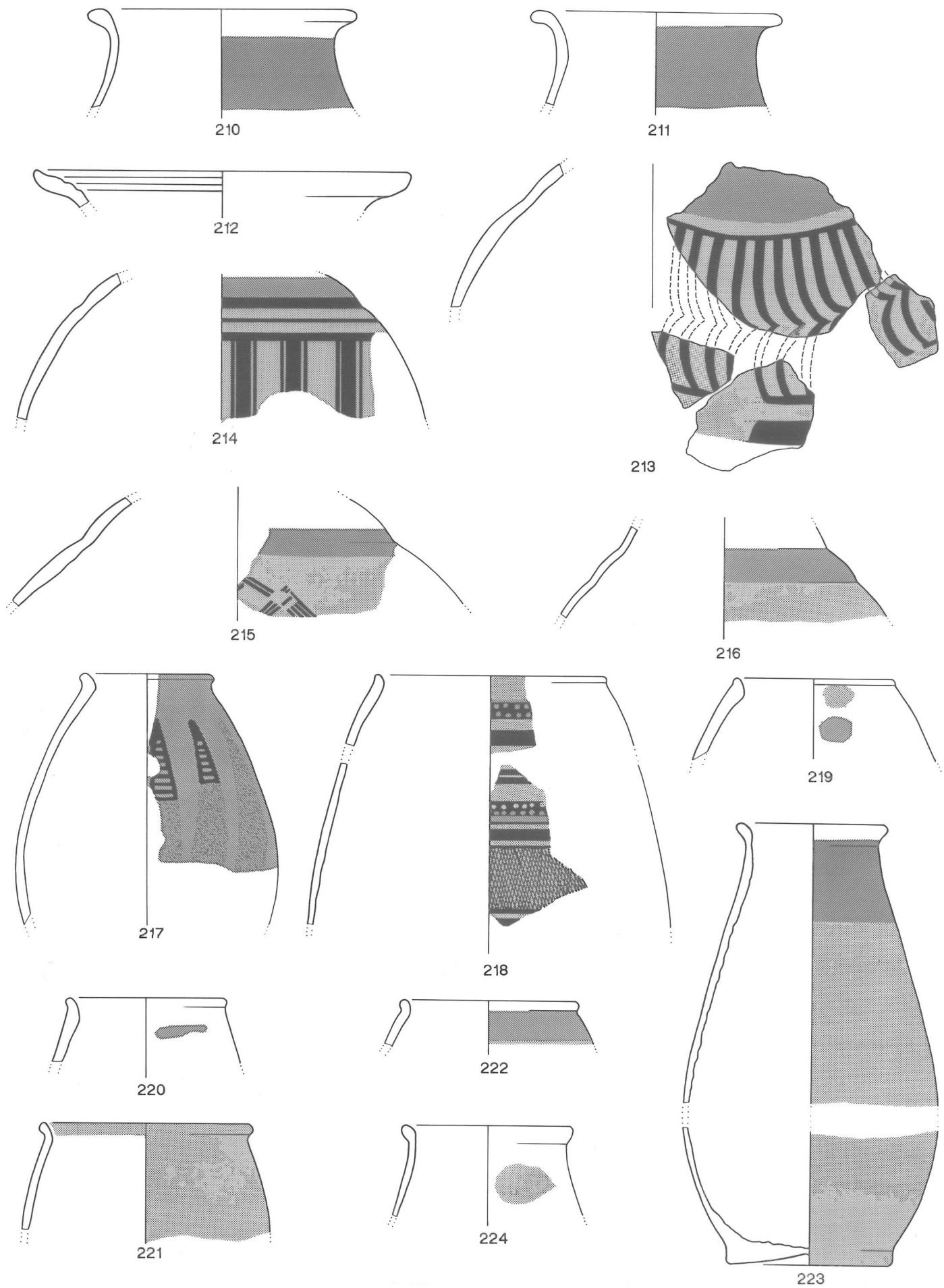

VERDUN -PETIT-CHAUVORT (2è. moitié IIè.-déb. Ier s. av.).
210-224 : fine peinte. Ech. : 1/3.

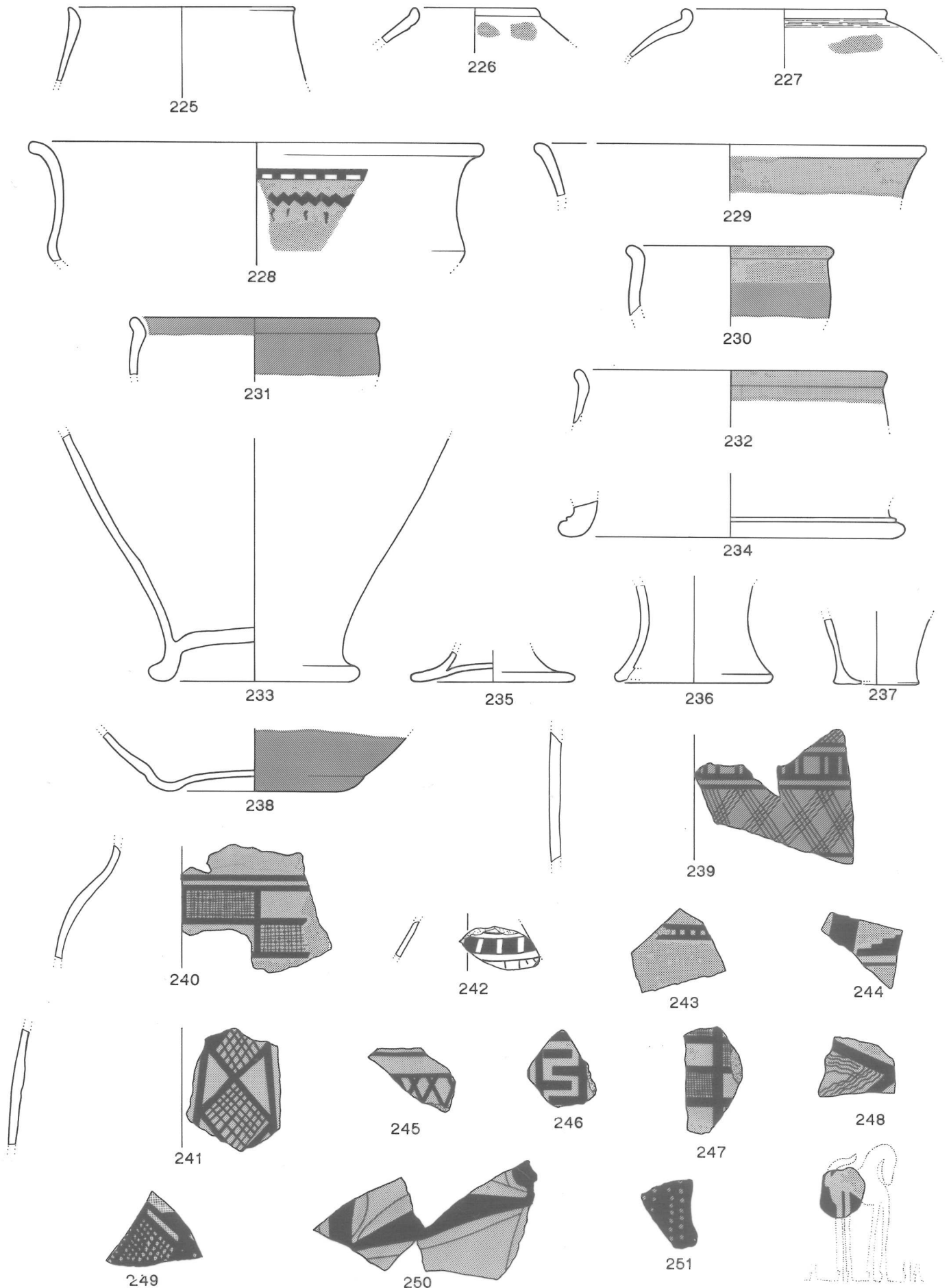

VERDUN -PETIT-CHAUVORT (2è. moitié IIè.-déb. Ier s. av.).
225-252 : fine peinte. Ech. : 1/3.

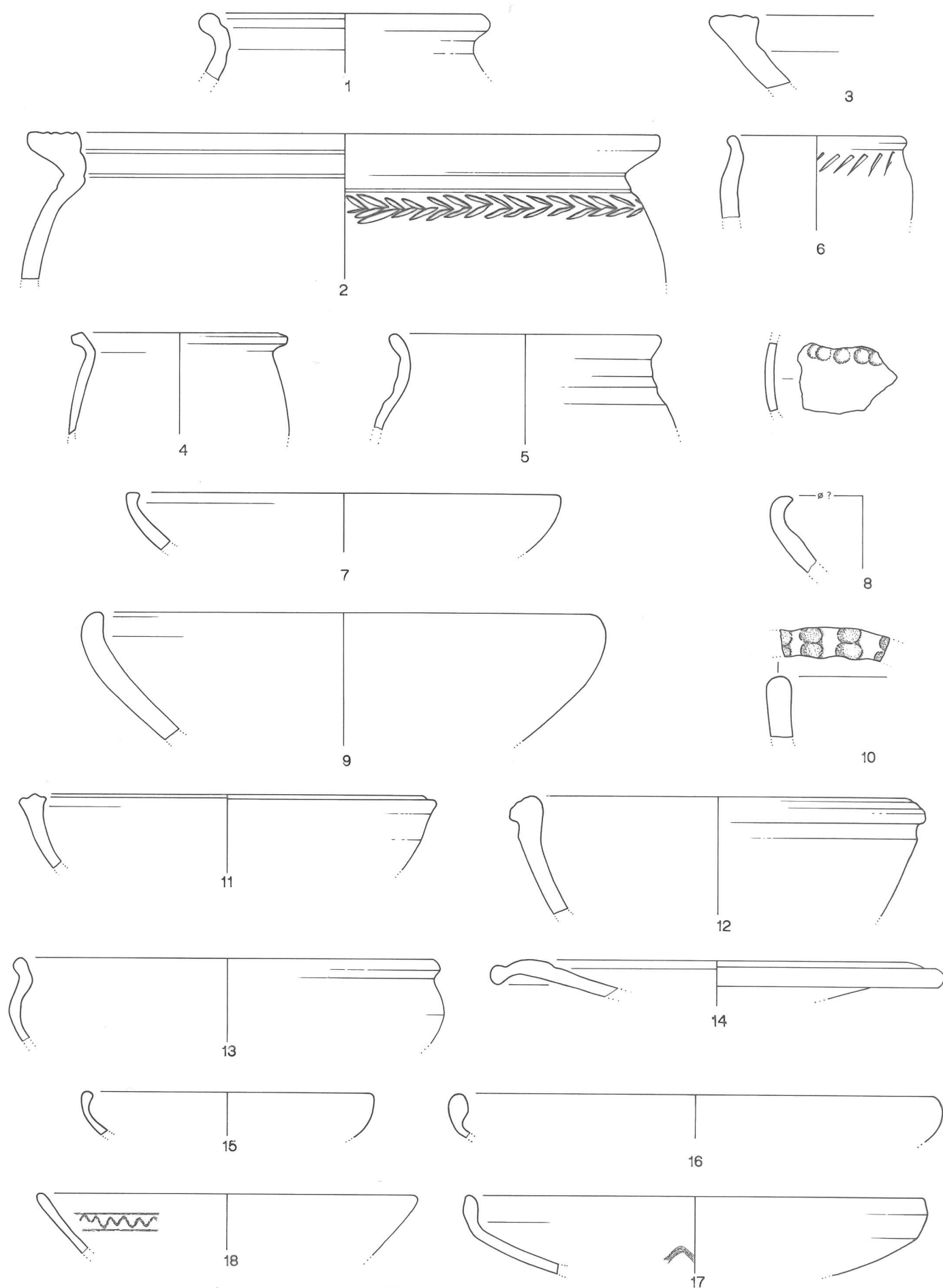

VERJUX -ES CHEZEAUX (fin IIè.- 1ère moitié Ier s. av.).

1-3 : non tournée, grossière claire micacée ; 4-13 : non tournée grossière, siliceuse ; 14-18 : fine sombre lissée. Ech. : 1/3.

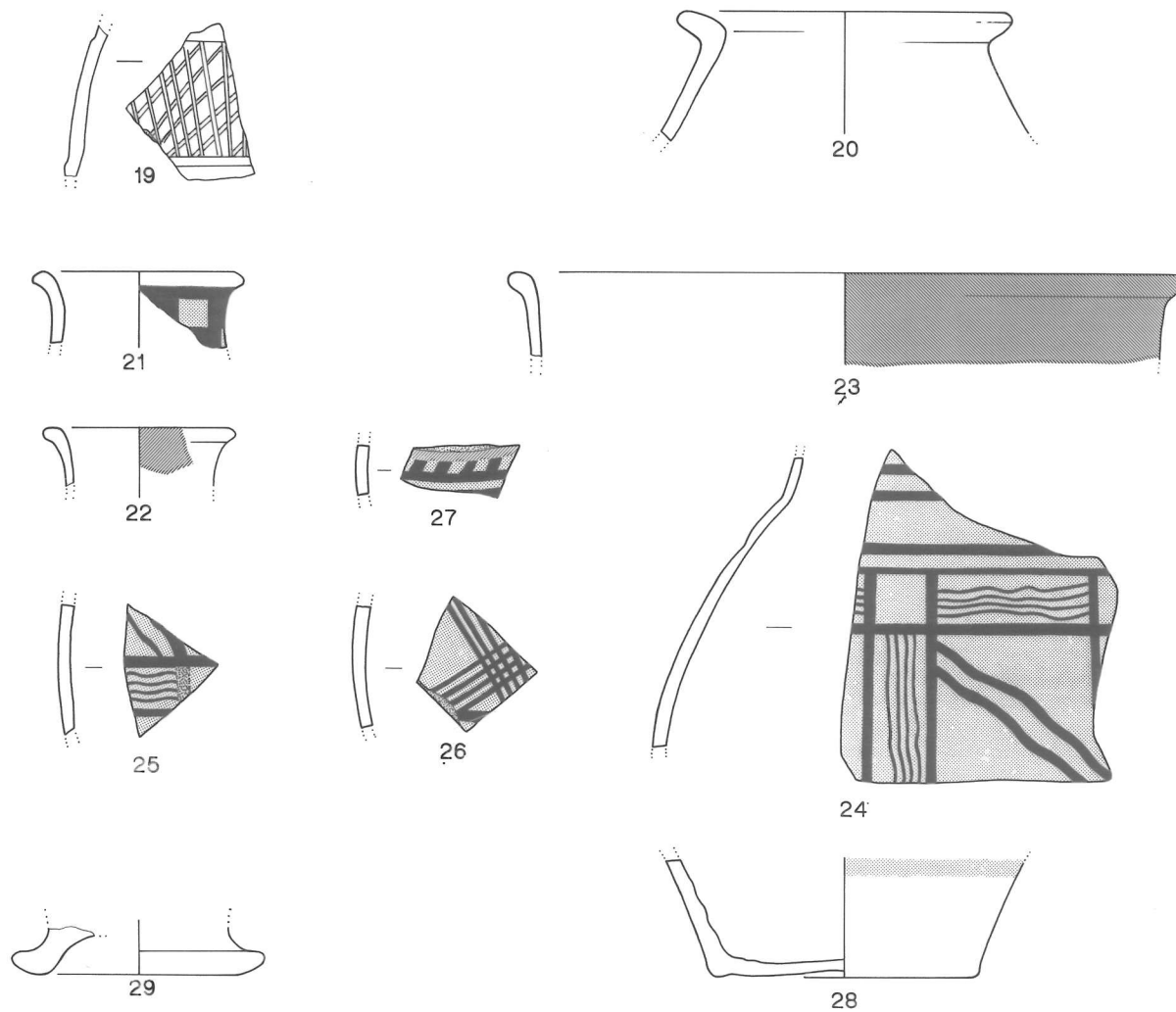

VERJUX -ES CHEZEAUX (fin IIè.- 1ère moitié Ier s. av.).
19 : fine sombre lissée ; 20, 29 : fine claire ; 21-28 : fine peinte. Ech. : 1/3.

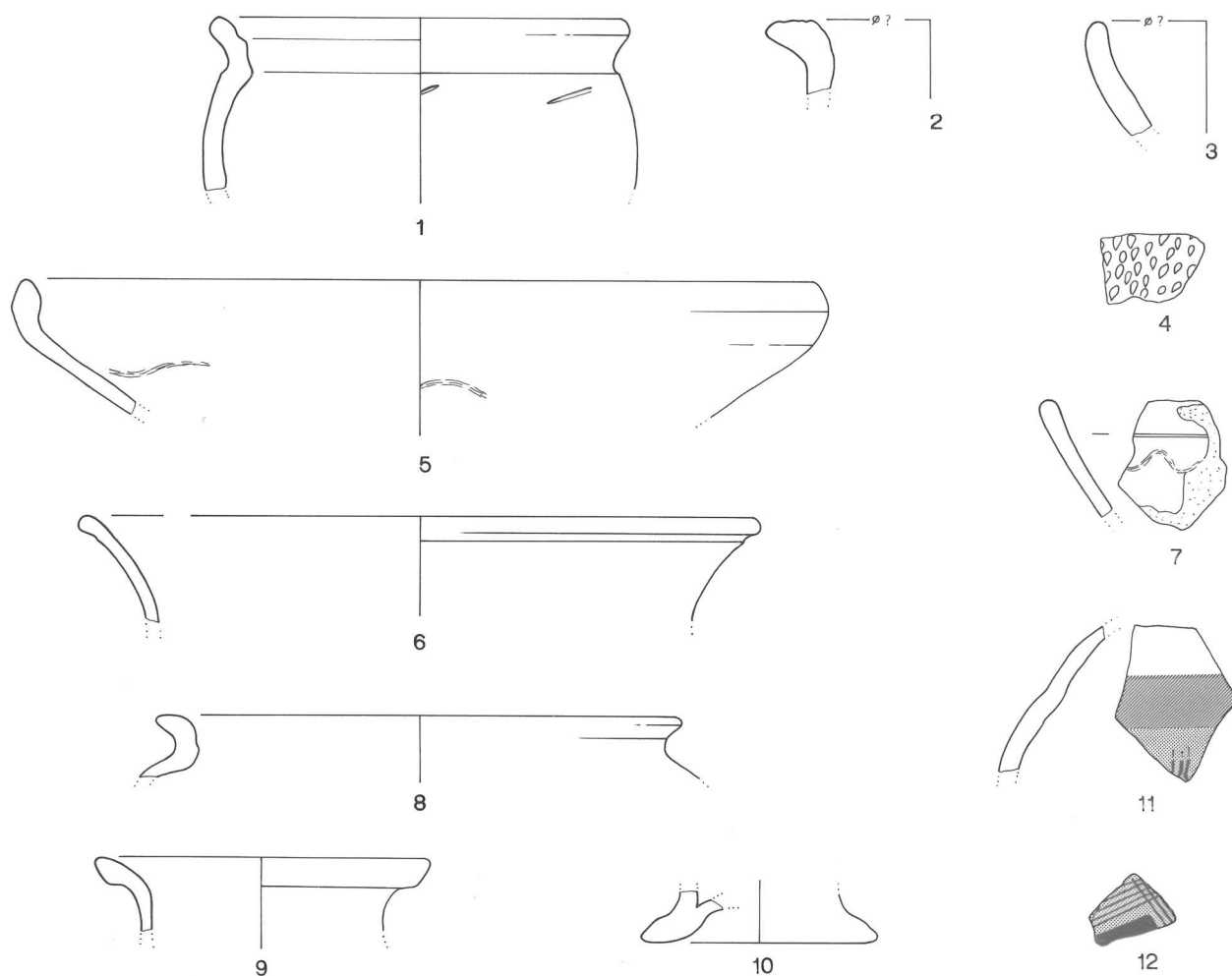

VERJUX -MARE-GRILLOT (fin IIè.- 1ère moitié Ier s. av.).

1-2 : non tournée, grossière claire micacée ; 3-4 : non tournée grossière, siliceuse ; 5-7 : fine sombre lissée ;
8-10 : fine claire ; 11-12 : fine peinte. Ech. : 1/3.

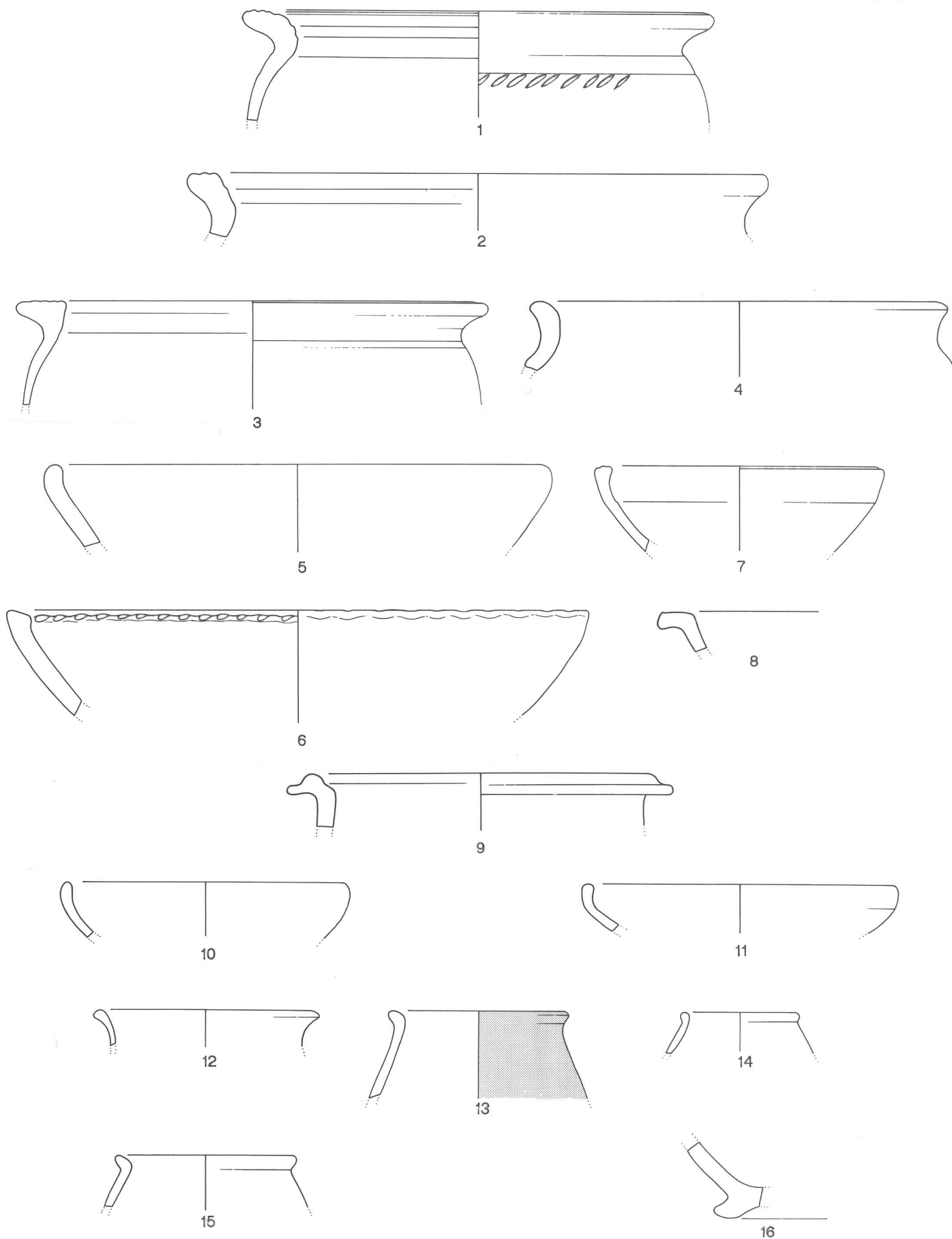

VIGNOLLES -PIECE BAROT (IIè.-Ier s. av.).

1-2 : grossière claire micacée ; 3-9 : non tournée grossière siliceuse ou calcaire ; 10-11 : fine sombre lissée ; 12-16 : fine claire non peinte ou peinte. Ech. : 1/3.

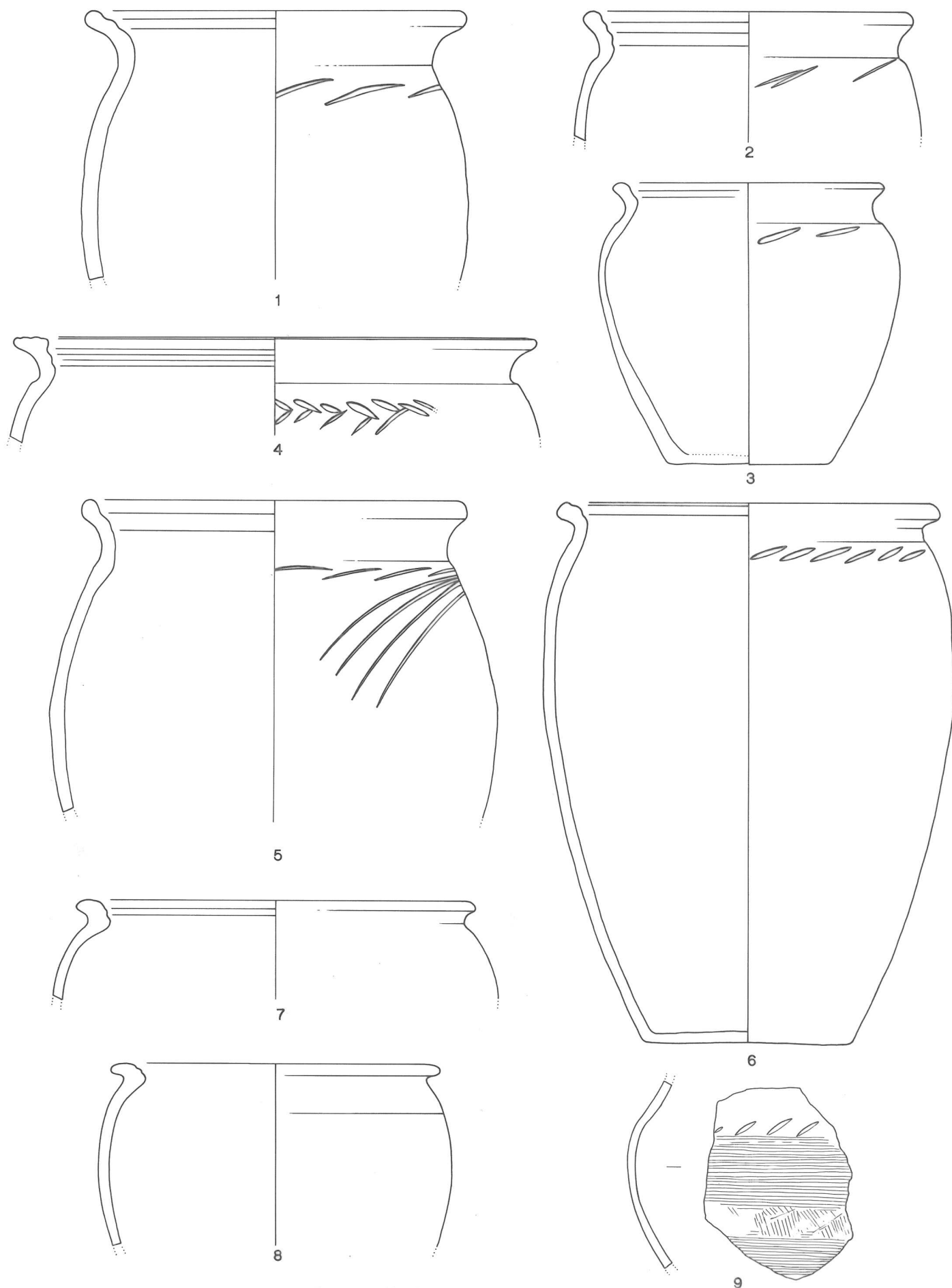

LA SAONE DE MACON A SEURRE (IIè.-Ier s. av.).

1-4 : non tournée, grossière claire micacée ; 5-9 : non tournée grossière, siliceuse. (N° 1, 5-6, 8-9 : dessins C. Michel). Ech. : 1/3.

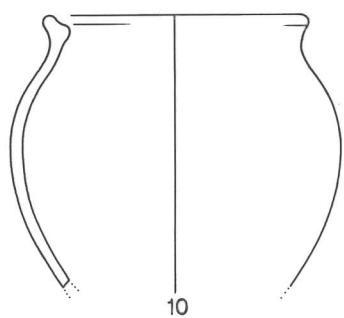

10

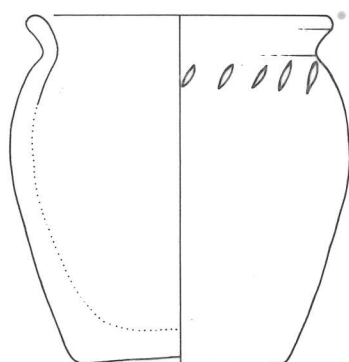

11

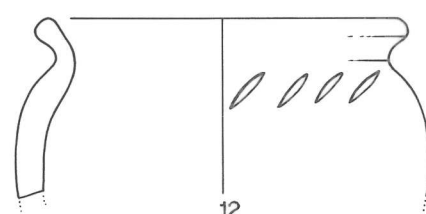

12

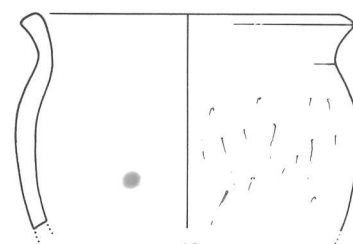

13

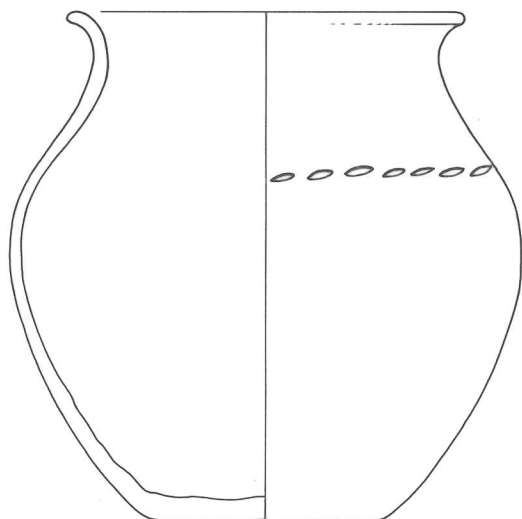

14

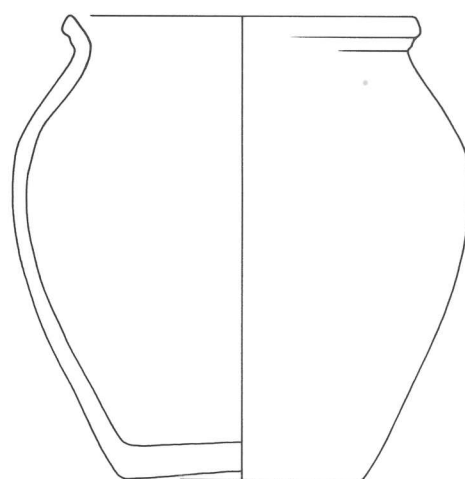

15

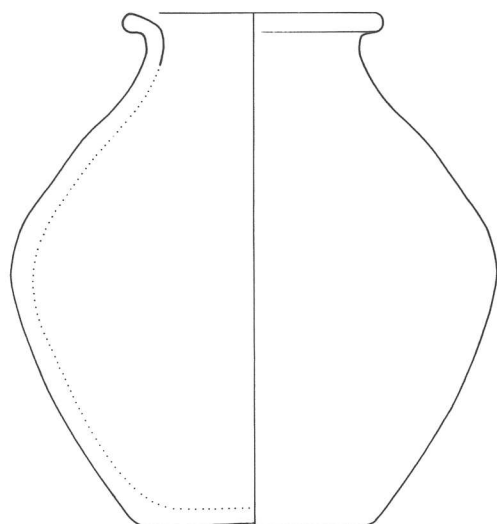

16

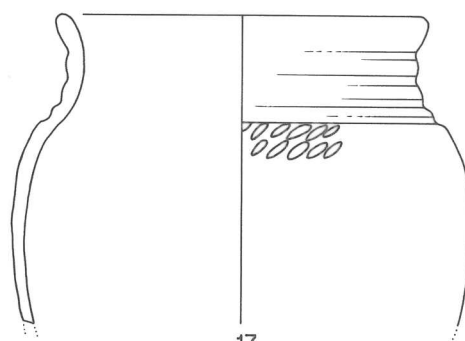

17

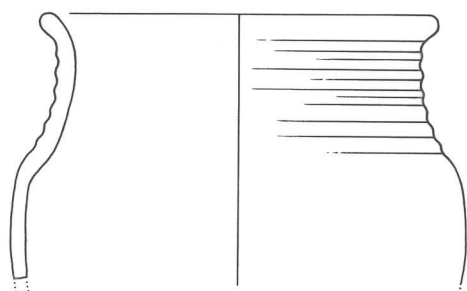

18

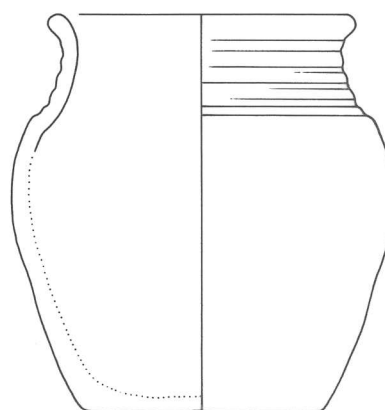

19

LA SAONE DE MACON A SEURRE (IIè.-Ier s. av.).

10-19 : non tournée grossière, siliceuse. (N° 10, 14-15 : dessins C. Michel). Ech. : 1/3.

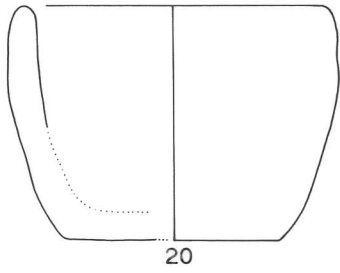

20

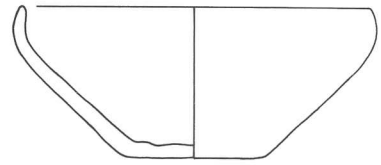

21

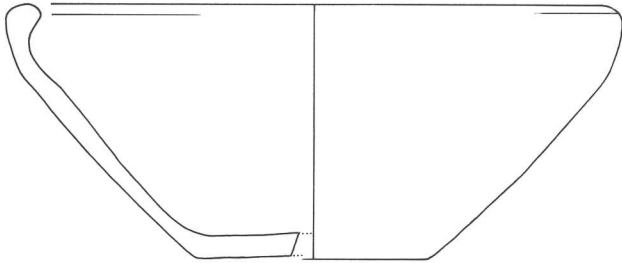

22

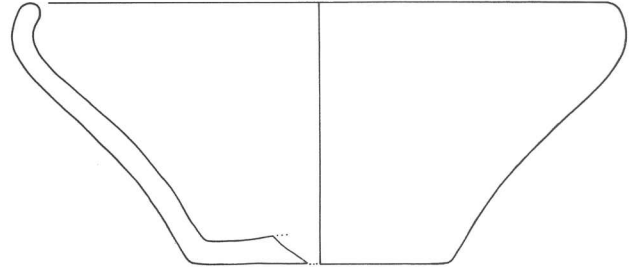

23

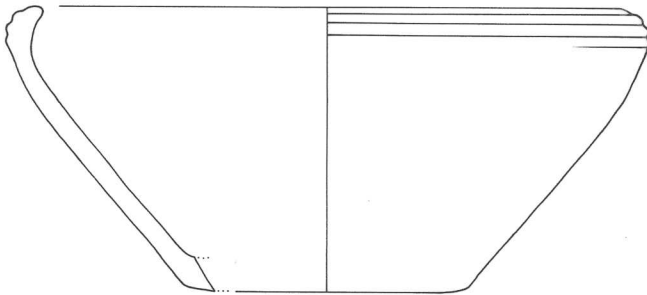

24

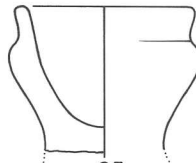

25

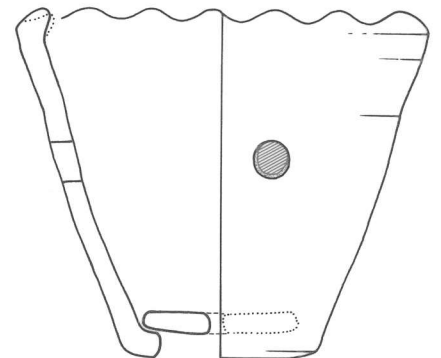
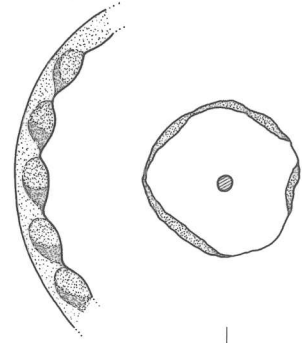

26

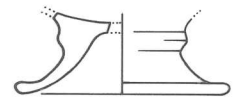

29

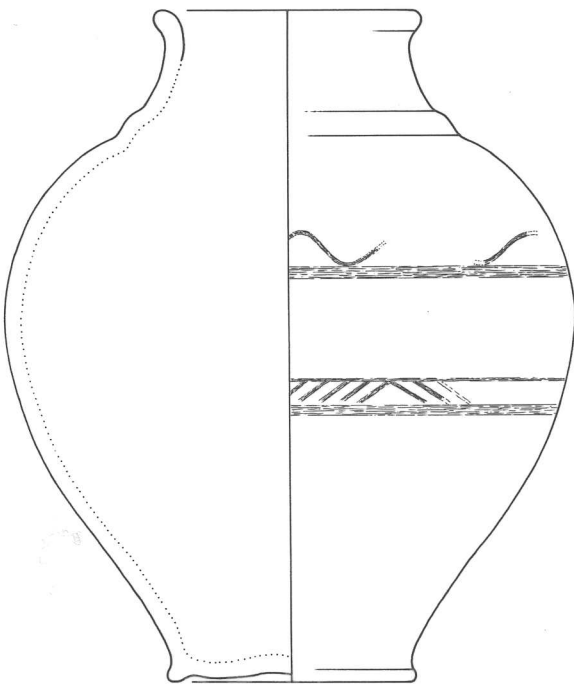

27

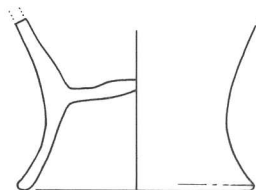

28



30

LA SAONE DE MACON A SEURRE (IIè.-Ier s. av.).

20-26 : non tournée grossière, siliceuse ; 27-30 : fine sombre lissée. (N° 21, 28, 30 : dessins C. Michel).

Ech. : 1/3.

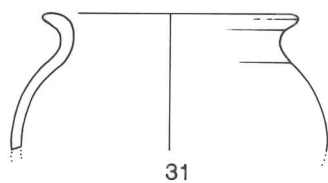

31

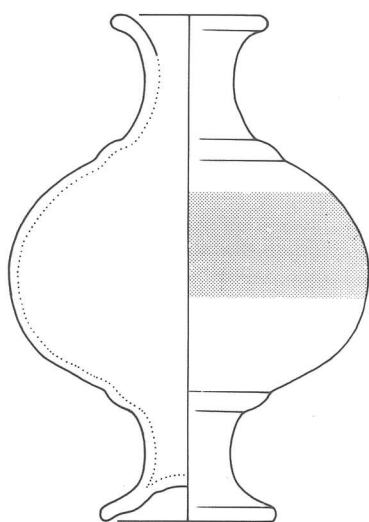

32

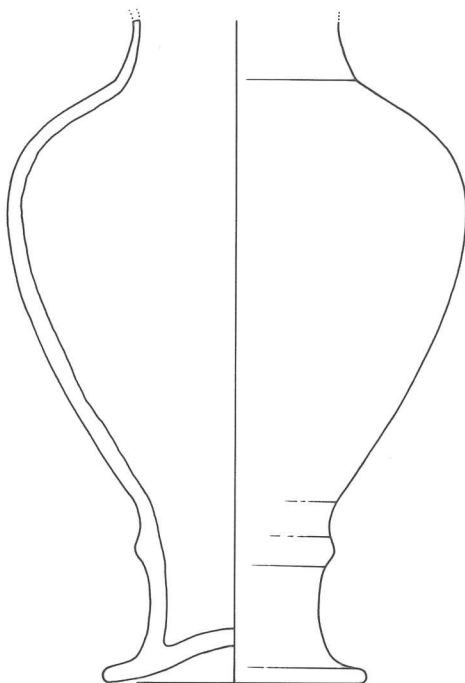

33

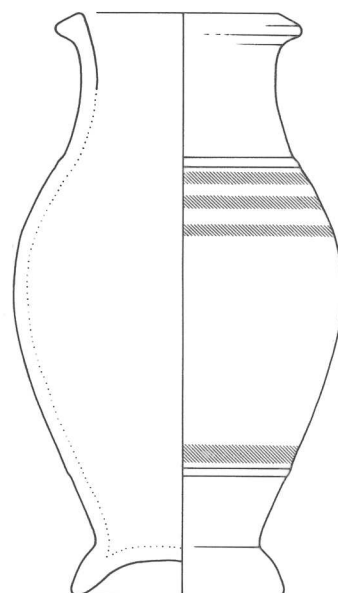

34

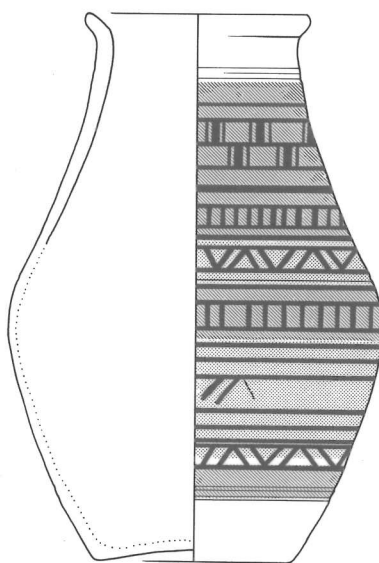

35

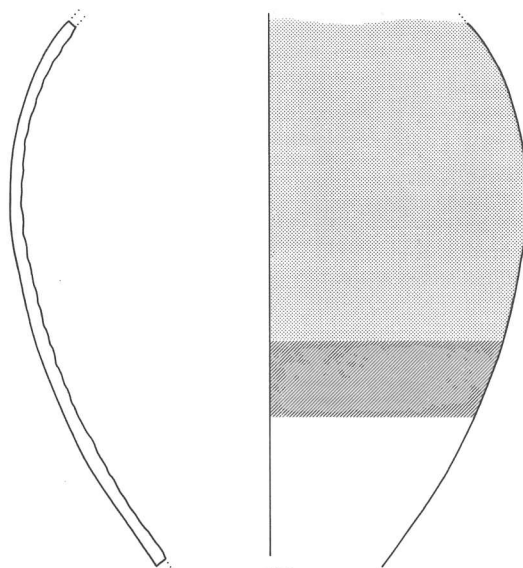

36

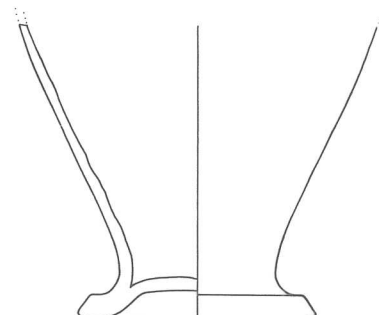

37

LA SAONE DE MACON A SEURRE (IIè.-Ier s. av.).

31 : fine claire ; 32-37 : fine peinte. (N° 33, 36 : dessins C. Michel). Ech. : 1/3.

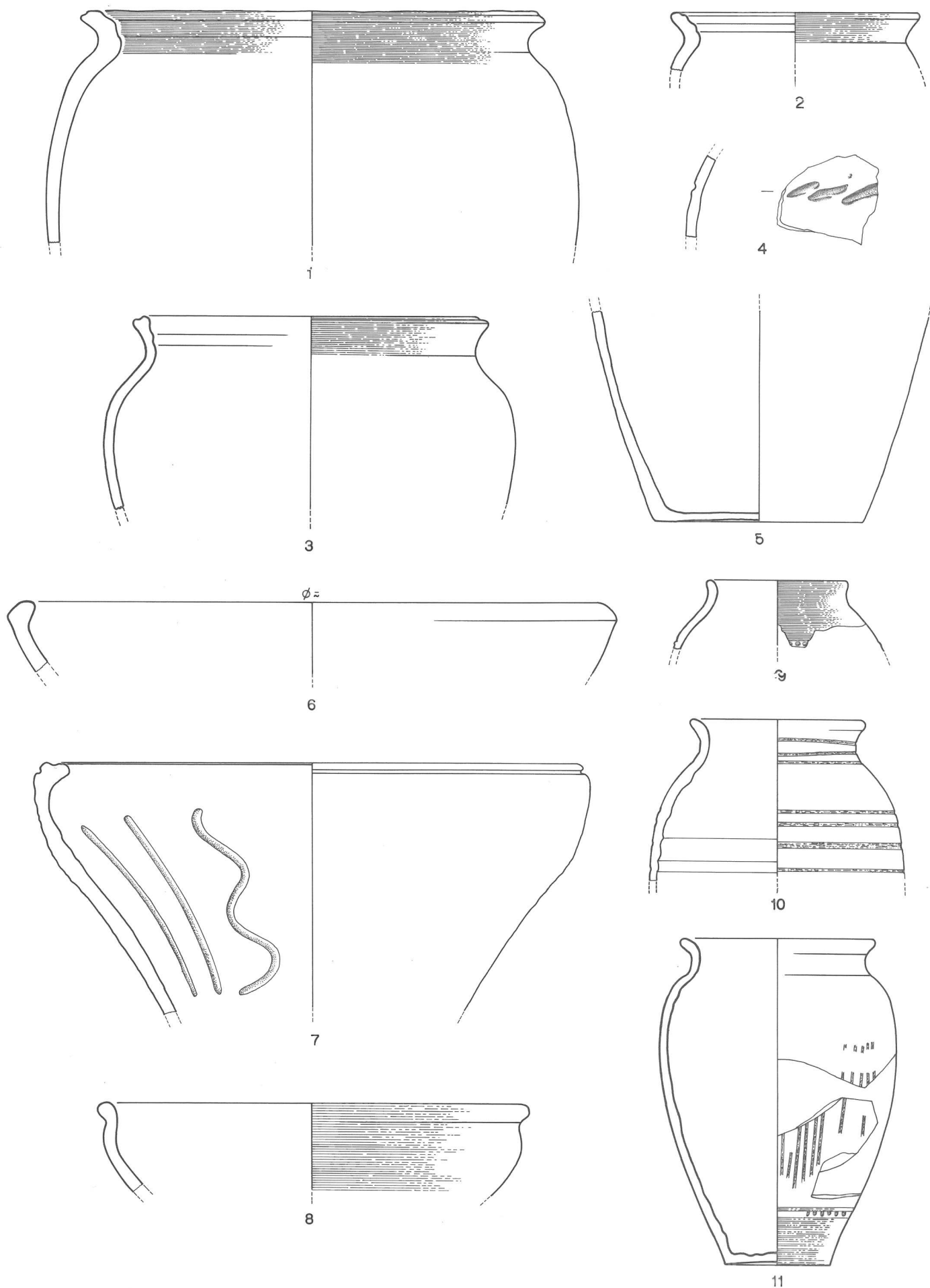

NUITS-ST.-GEORGES -LES BOLARDS -Fosse du fanum I (fin IIè-déb. Ier s. av.)

1-8 : non tournée, grossière siliceuse ou calcaire ; 9-11 : fine sombre lissée (dessins : J.-F. Enault, Ph. Barral). Ech. : 1/3.

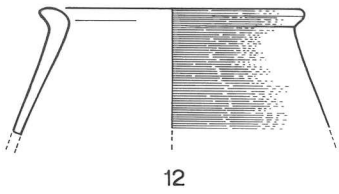

12

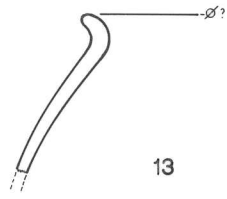

13

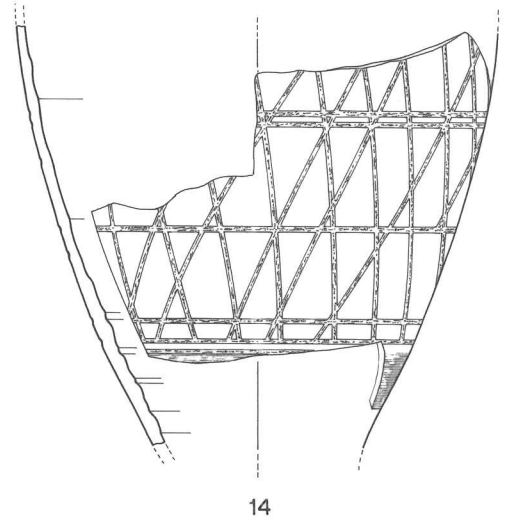

14

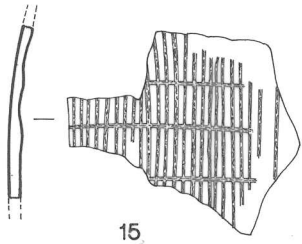

15

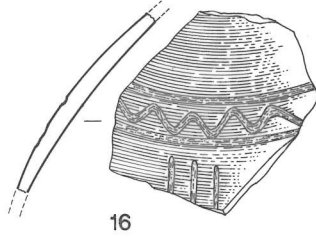

16

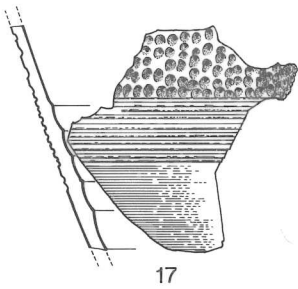

17

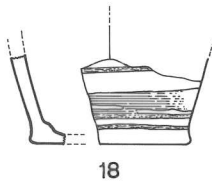

18

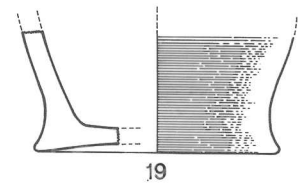

19

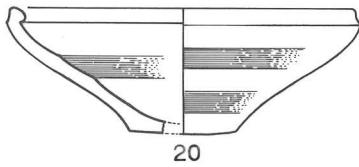

20

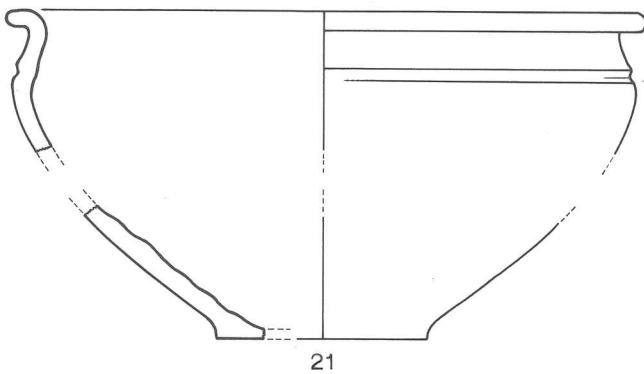

21

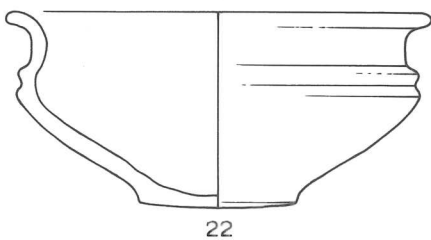

22

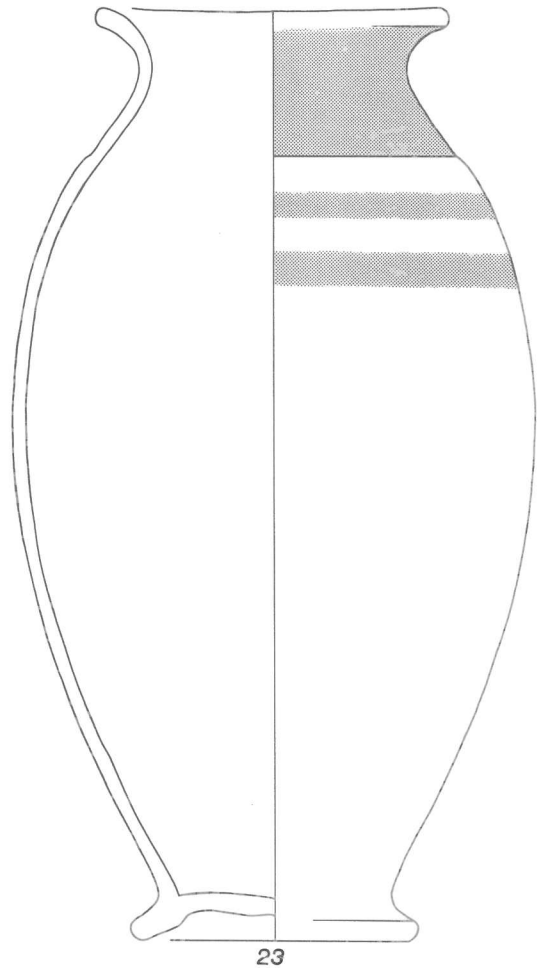

23

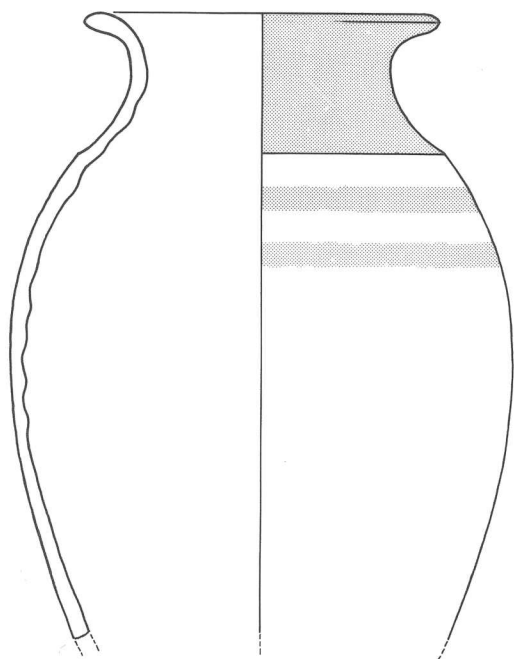

24

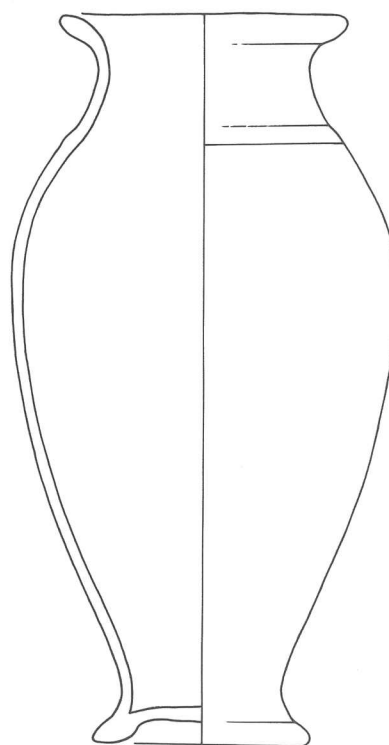

26

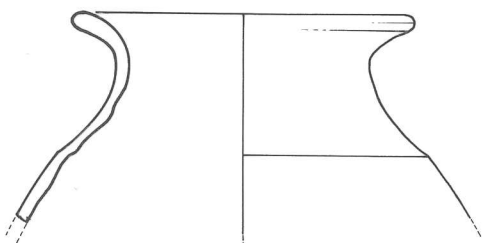

25

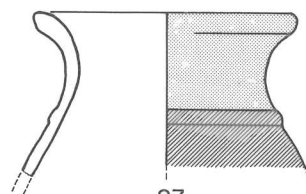

27

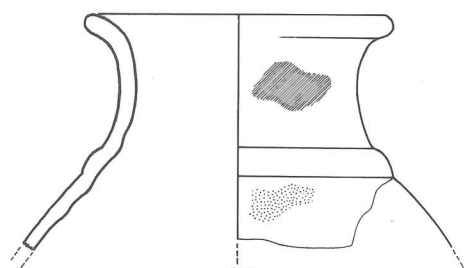

29

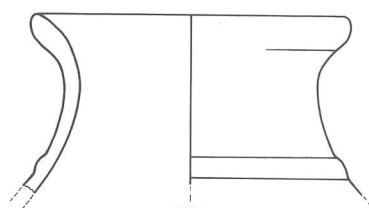

28

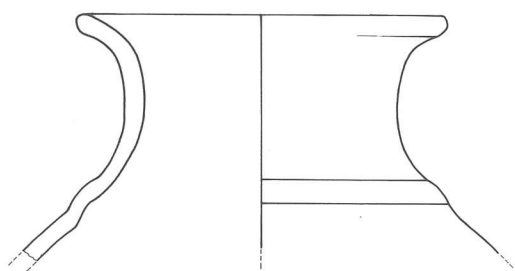

30

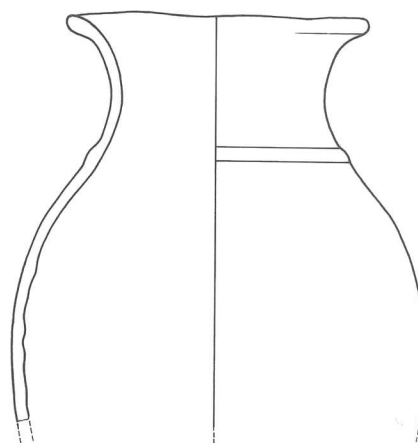

31

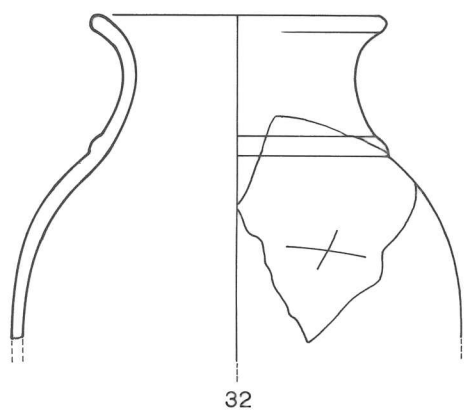

32

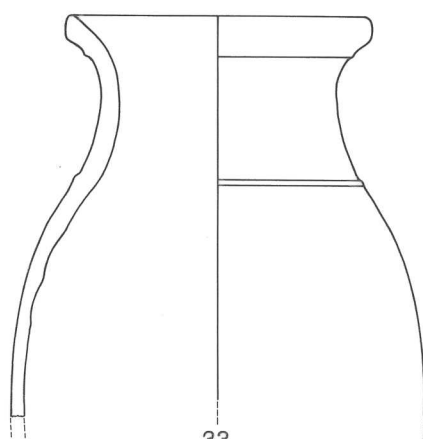

33

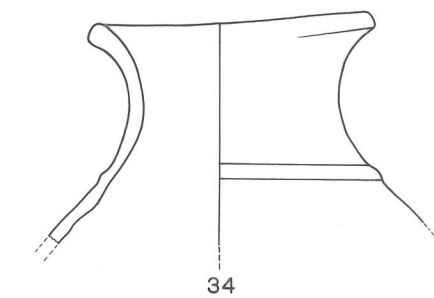

34

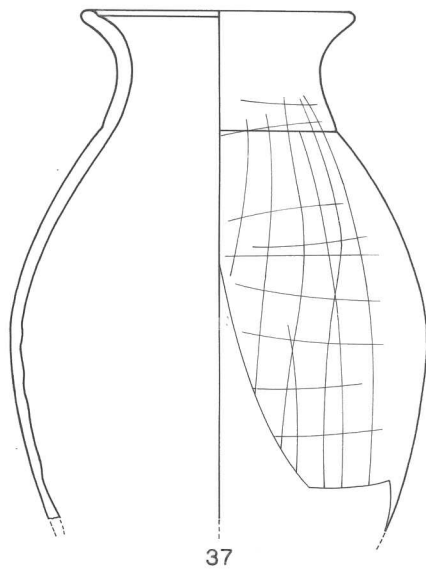

37

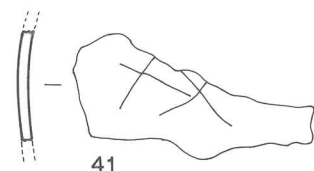

41

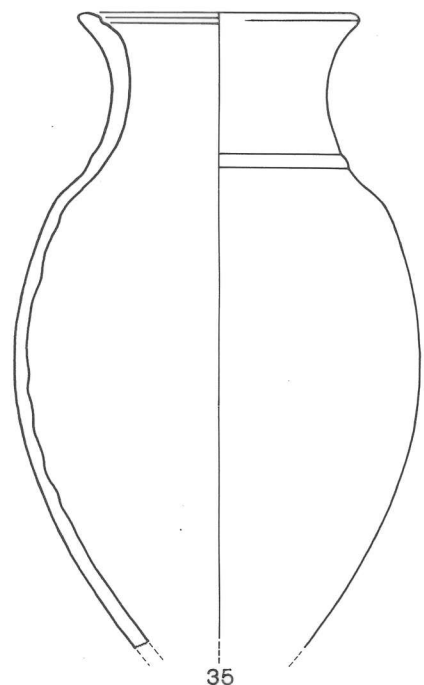

35

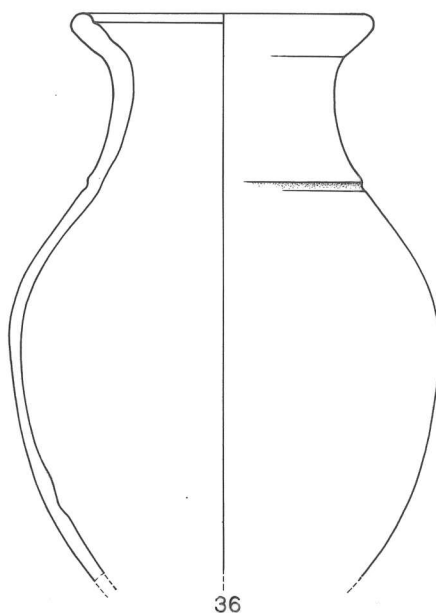

36

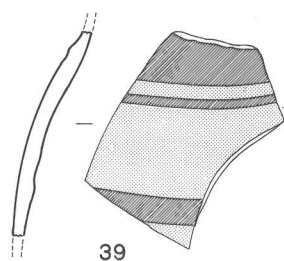

39

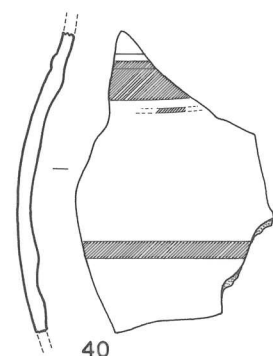

40

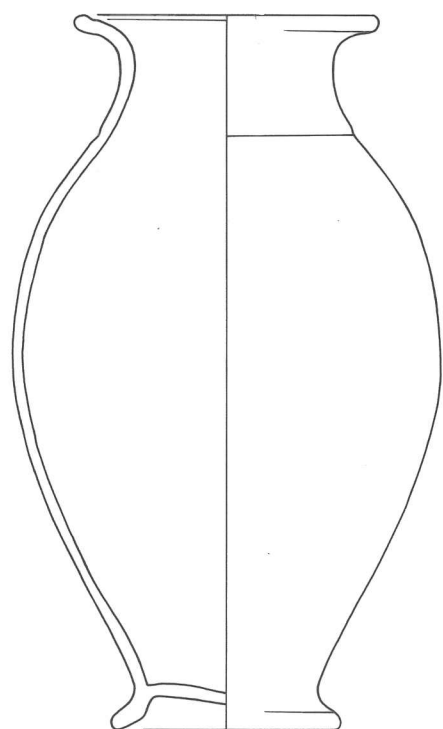

38

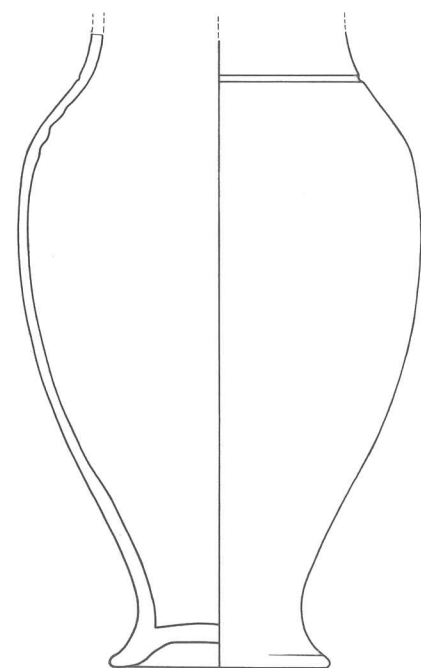

42

NUIITS-ST.-GEORGES -LES BOLARDS -Fosse du fanum I (fin IIè-déb. Ier s. av.)
32-42 : fine claire peinte ou non peinte. (dessins : J.-F. Enault, Ph. Barral). Ech. : 1/3.

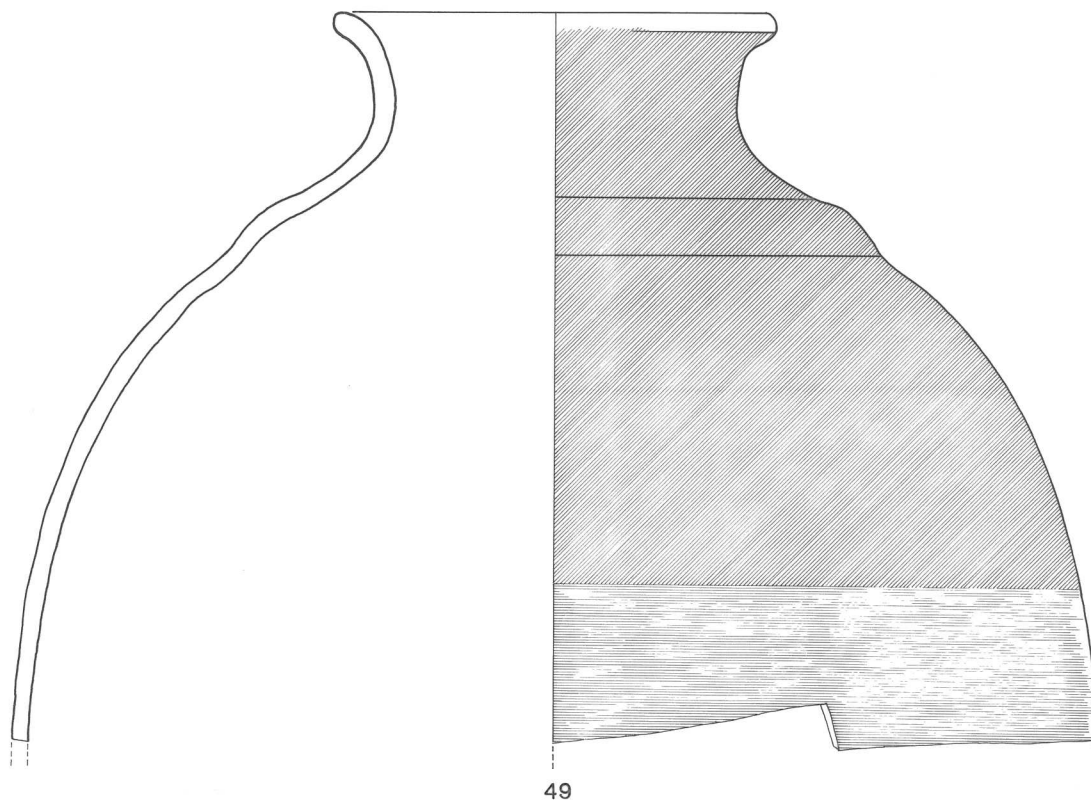
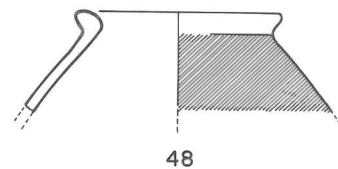
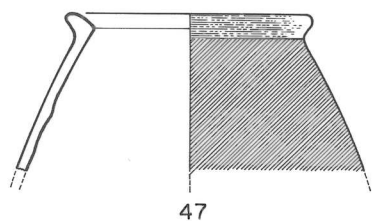
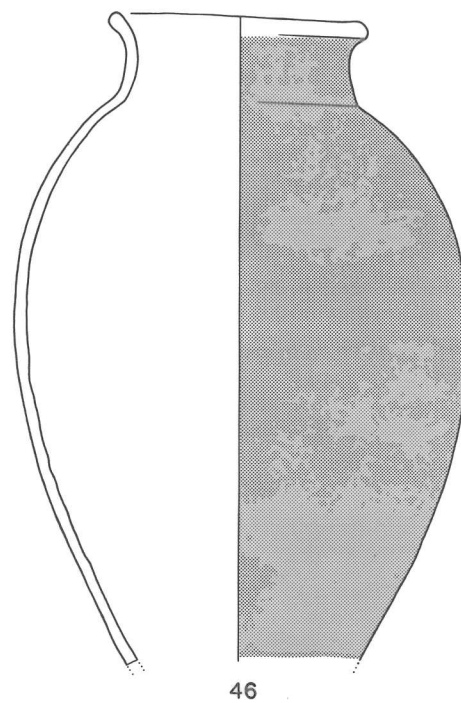
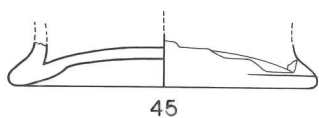
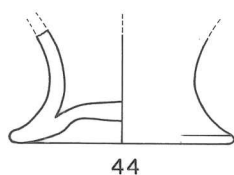
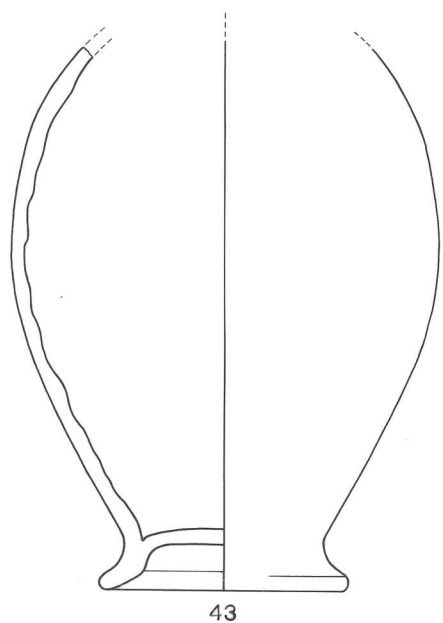

NUITS-ST.-GEORGES -LES BOLARDS -Fosse du fanum I (fin II^e-déb. I^{er} s. av.)
43-49 : fine claire peinte ou non peinte. (dessins : J.-F. Enault, Ph. Barral). Ech. : 1/3.

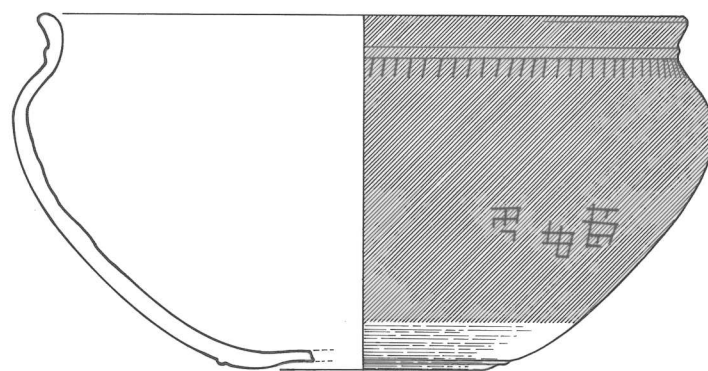

50

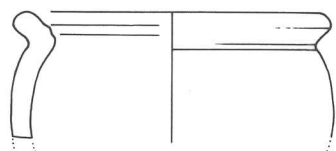

51

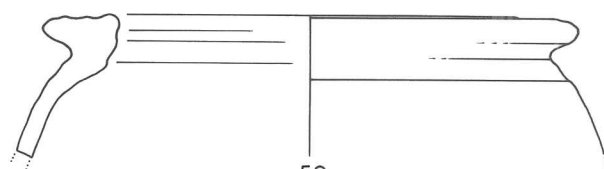

52

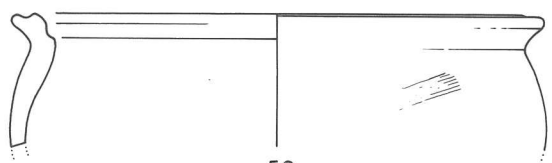

53

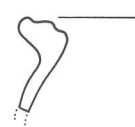

54

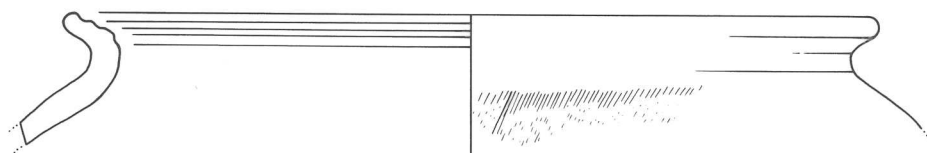

55

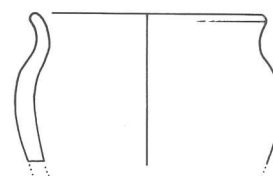

60

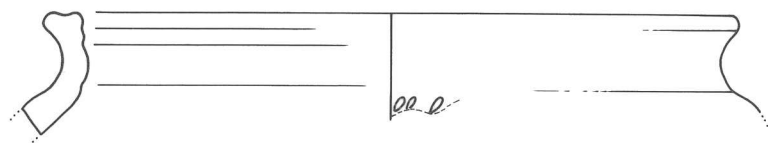

56

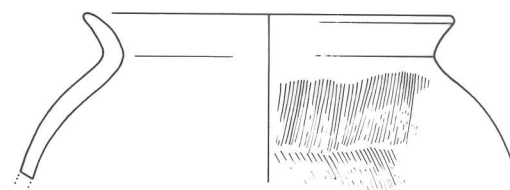

61

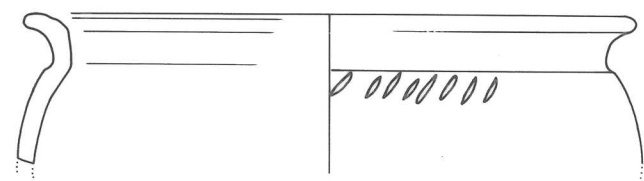

57

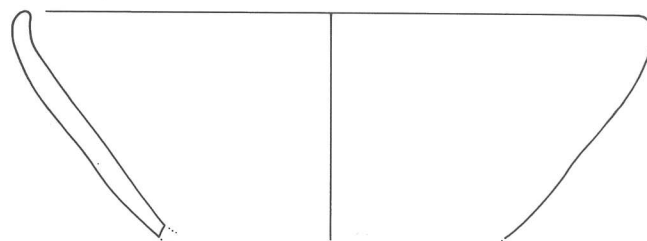

62

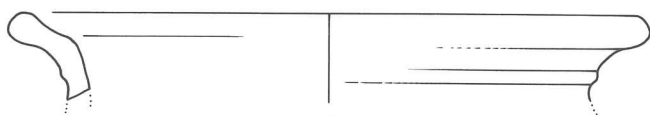

58

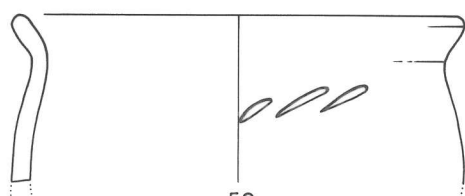

59

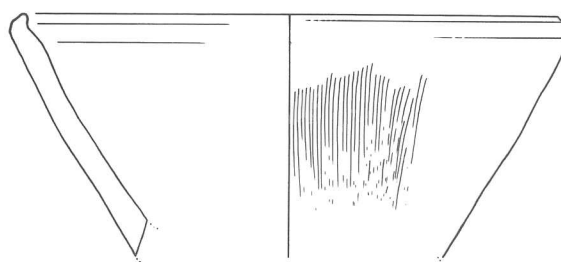

63

NUITS-ST.-GEORGES -LES BOLARDS -Fosse du fanum I (n°50 ; fin IIè-déb. Ier s. av.) ; -zone du sanctuaire (n° 51-63 ; fin IIè. -Ier s. av.).

50 : fine peinte ; 51-52 : non tournée grossière claire micacée ; 53-63 : non tournée, grossière siliceuse ou calcaire. Ech. : 1/3.

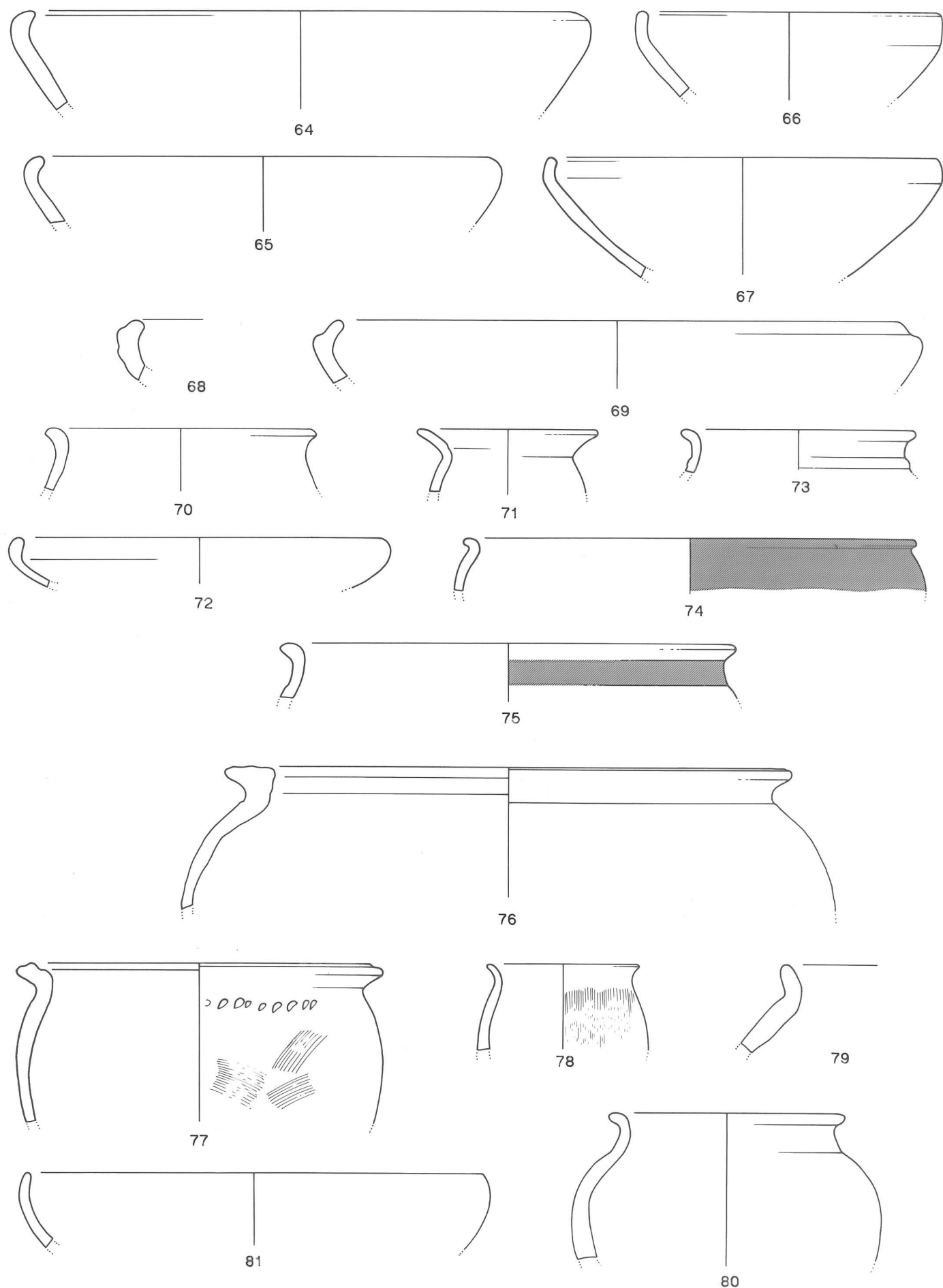

NUITS-ST.-GEORGES -LES BOLARDS -zone du sanctuaire (n° 64-75 ; fin IIè. -Ier s. av.) ; -zone de l'habitat (n° 76-80 ; Ier s. av.).

64-69 : non tournée, grossière siliceuse ou calcaire ; 70-73 : fine sombre lissée ; 74-75 : fine peinte ; 76 : non tournée grossière claire micacée ; 77-81 : non tournée, grossière siliceuse ou calcaire. Ech. : 1/3.

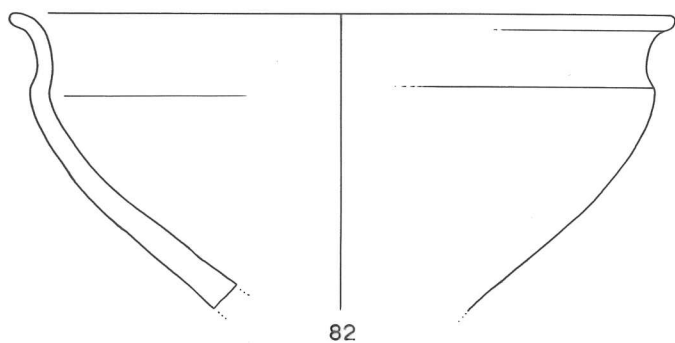

82



83

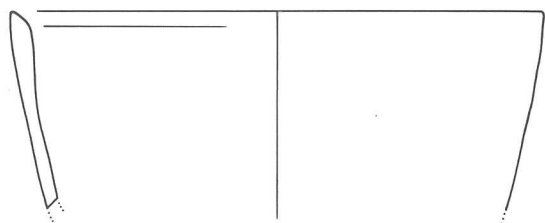

84

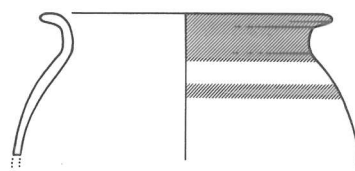

85

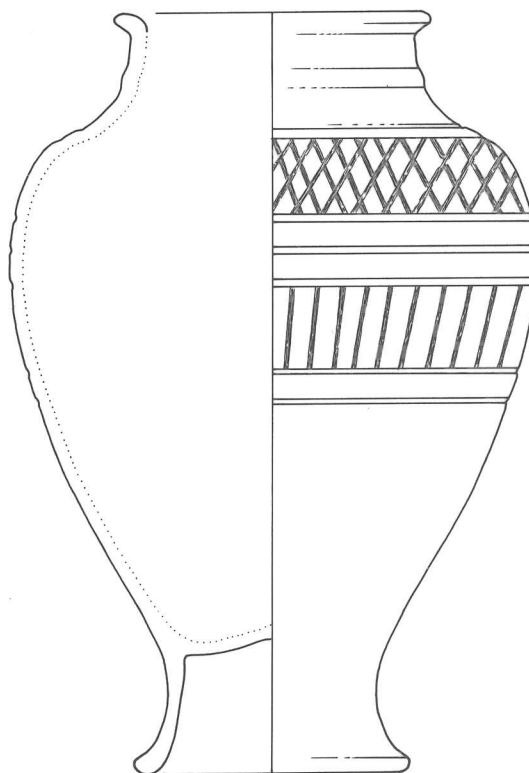

86

NUITS-ST.-GEORGES -LES BOLARDS -zone de l'habitat (n° 82-85 ; Ier s. av.) ; -sans provenance (n°86).

82 : non tournée, grossière calcaire ; 83-84 : fine sombre lissée ; 85 : fine peinte ; 86 : fine claire. Ech. : 1/3.

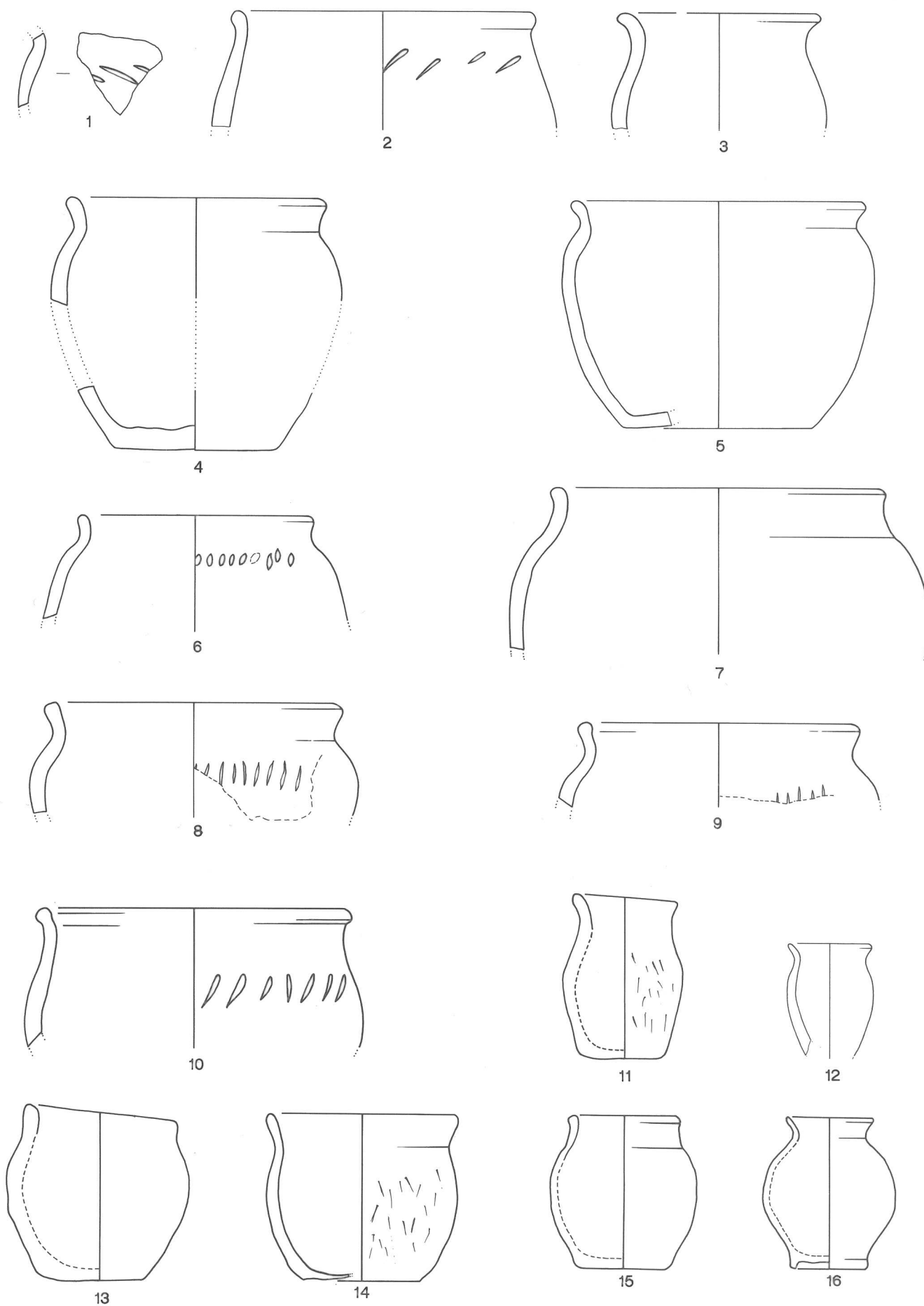

MIREBEAU -LA FENOTTE -Dépôts (fin IIè. -déb. Ier s. av.).

1 : non tournée, grossière claire micacée ; 2-16 : non tournée, grossière siliceuse ou calcaire. Ech. 1/3.

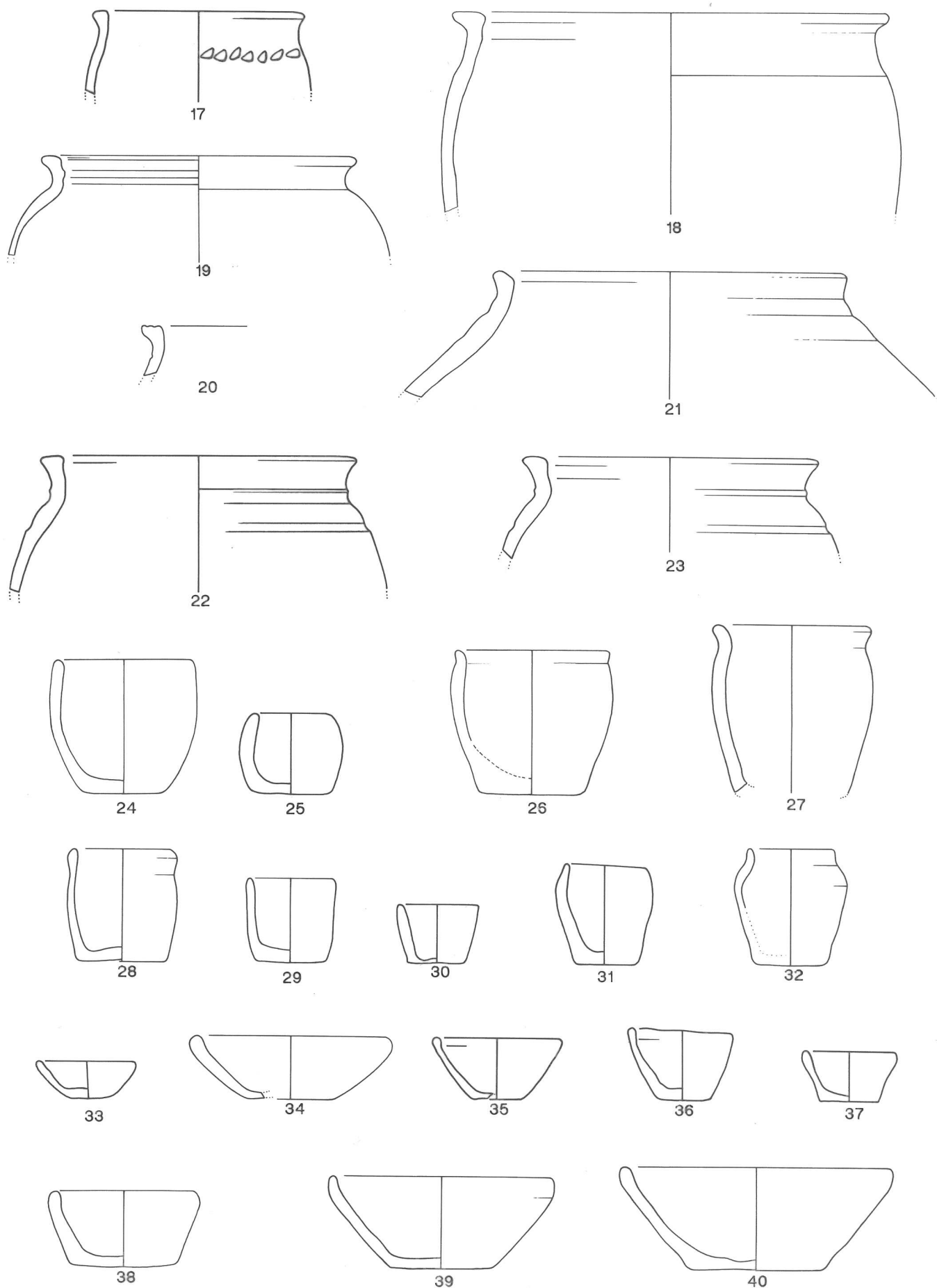

MIREBEAU -LA FENOTTE -Dépôts (fin IIè. -déb. Ier s. av.).
17-40 : non tournée, grossière siliceuse ou calcaire. Ech. 1/3.

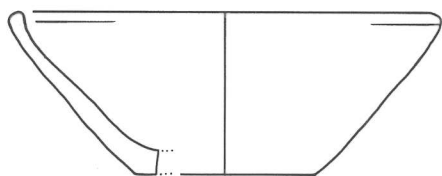

41

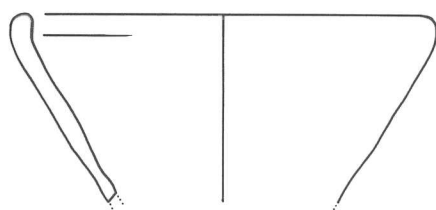

42

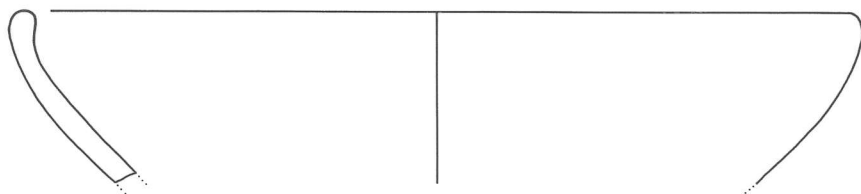

43



44

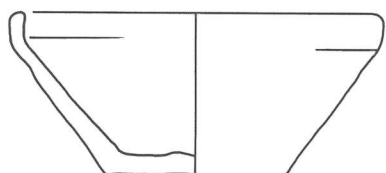

45



46

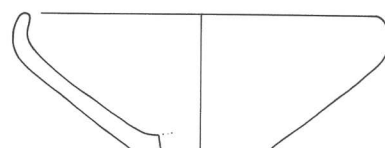

47

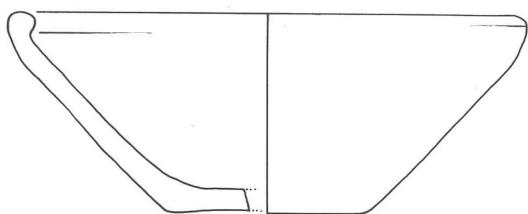

48

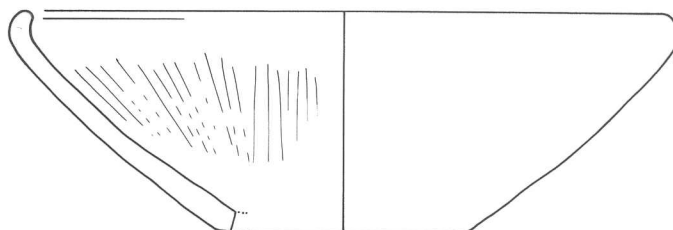

49

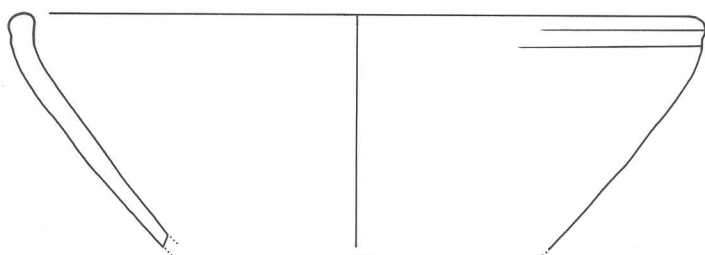

50

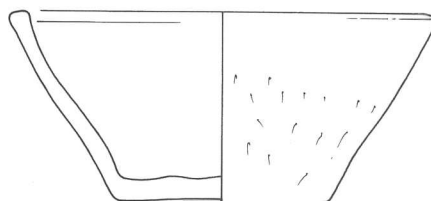

52

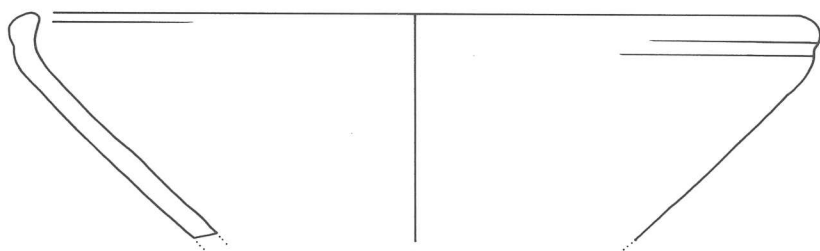

51

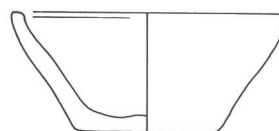

53

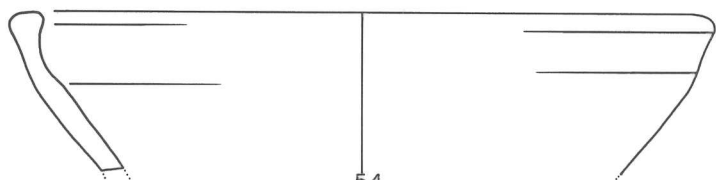

54

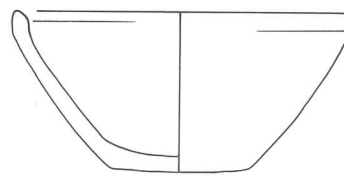

55

MIREBEAU -LA FENOTTE -Dépôts (fin IIè. -déb. Ier s. av.).
41-55 : non tournée, grossière siliceuse ou calcaire. Ech. 1/3.

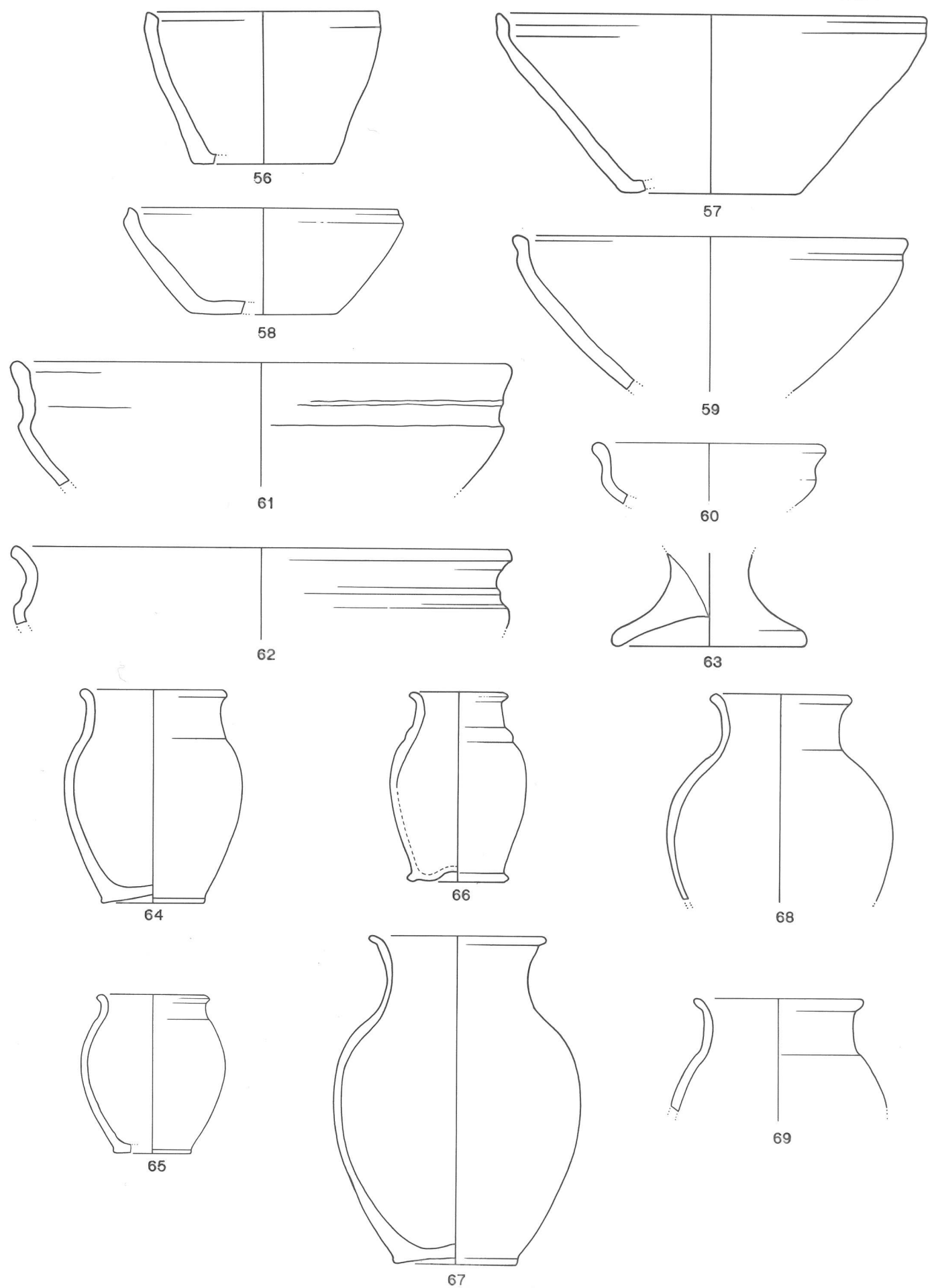

MIREBEAU -LA FENOTTE -Dépôts (fin IIè. -déb. Ier s. av.).

56-63 : non tournée, grossière siliceuse ou calcaire ; 64-69 : fine sombre lissée. Ech. 1/3.

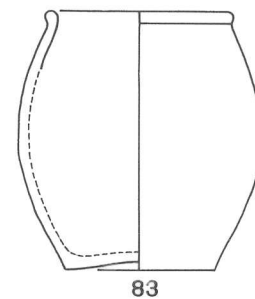
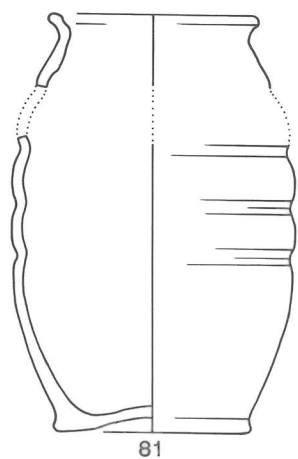
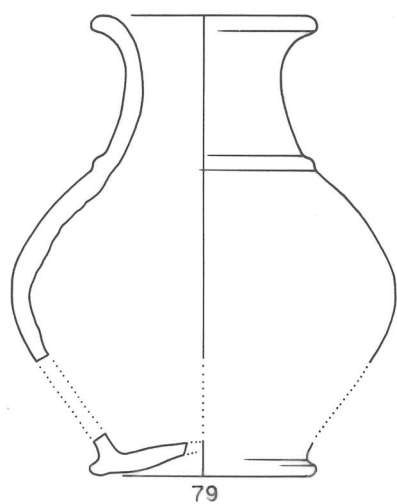
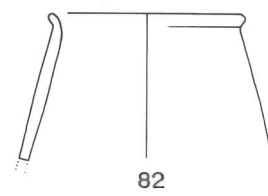
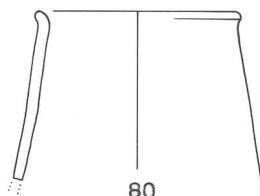
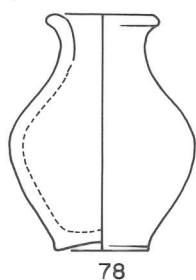
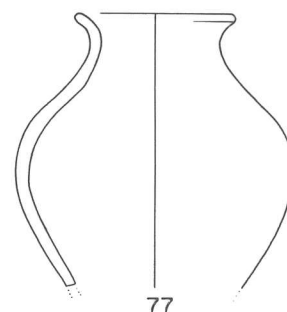
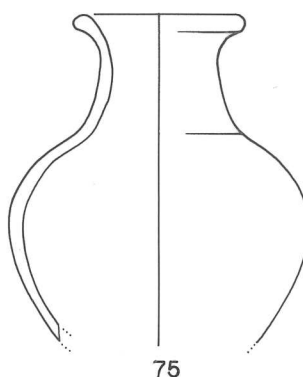
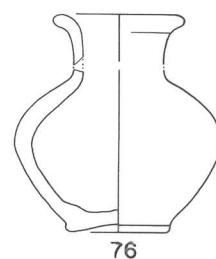
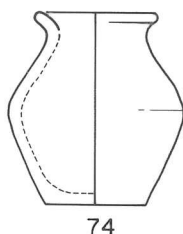
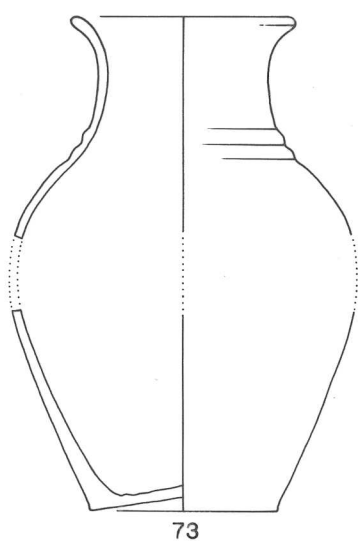
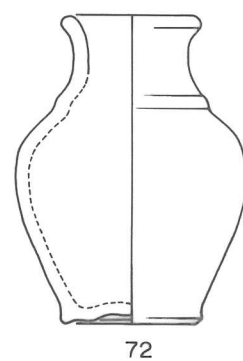
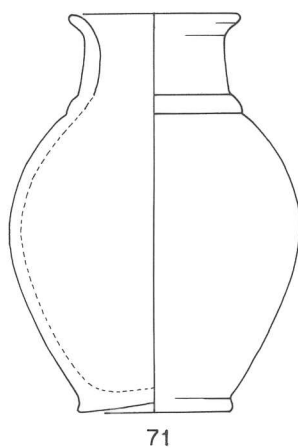
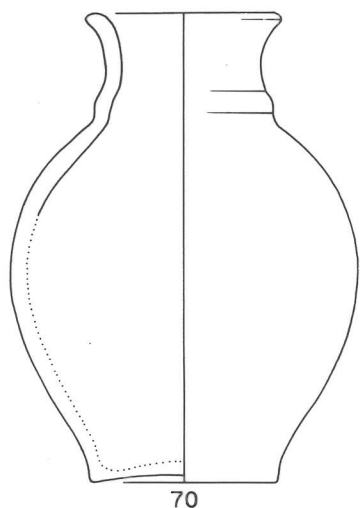

MIREBEAU -LA FENOTTE -Dépôts (fin II^e. -déb. I^{er} s. av.).
70-83 : fine sombre lissée. Ech. 1/3.

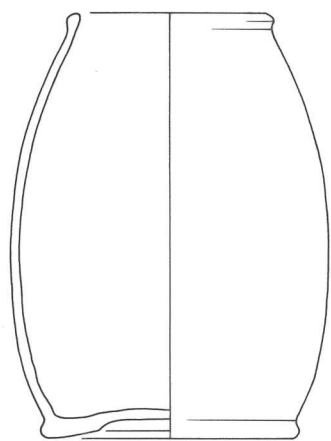

84

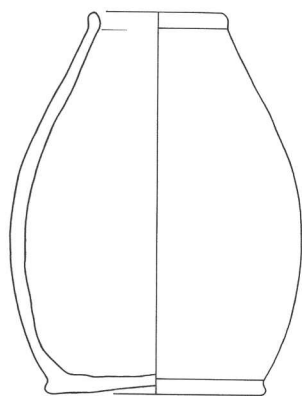

85

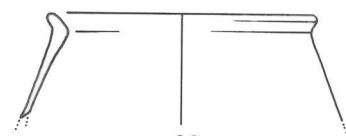

86

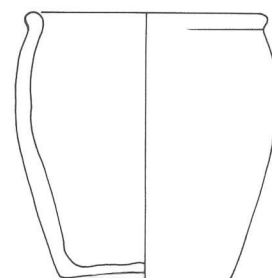

87

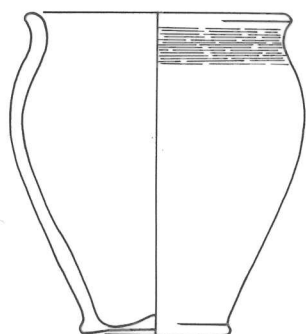

88

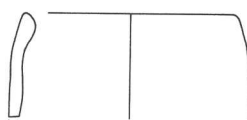

89

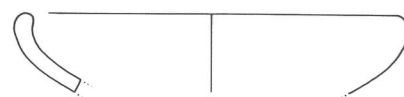

90

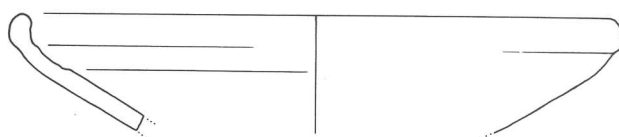

91

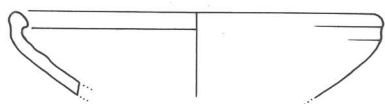

92

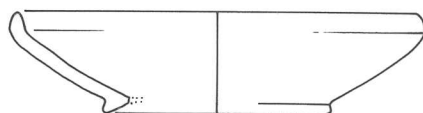

93



94

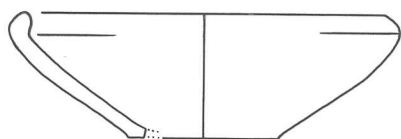

95

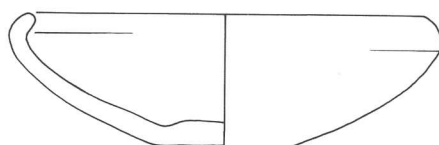

96

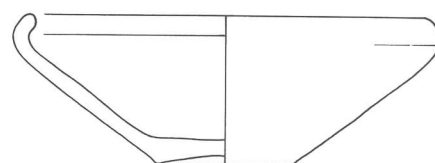

97

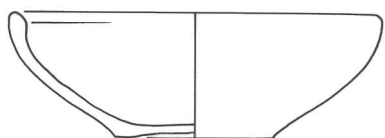

98

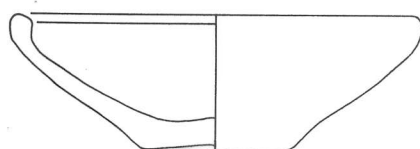

99



100

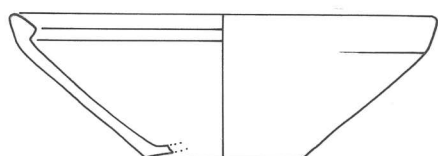

101

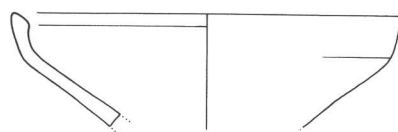

102

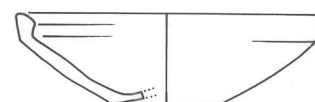

103

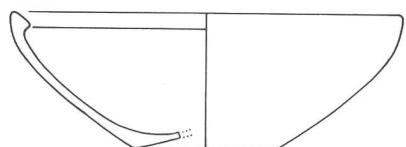

104

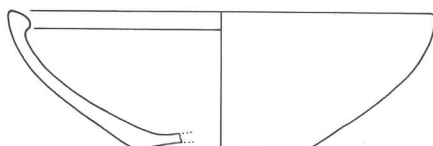

105

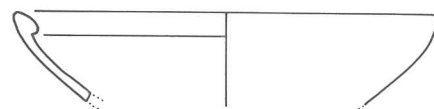

106

MIREBEAU - LA FENOTTE - Dépôts (fin II^e. - déb. I^{er} s. av.).
84-106 : fine sombre lissée. Ech. 1/3.

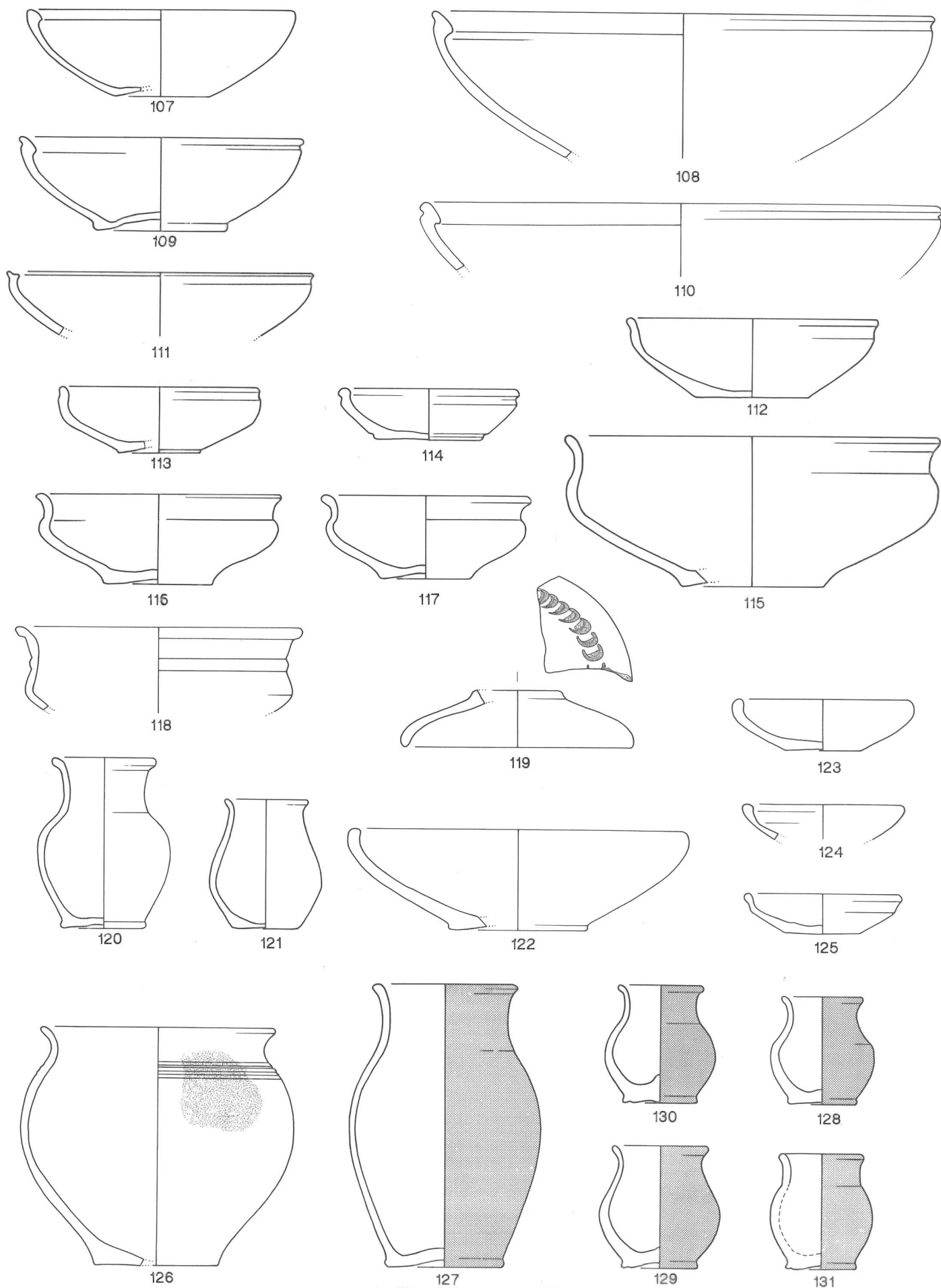

MIREBEAU - LA FENOTTE - Dépôts (fin II^e. - déb. I^{er} s. av.).

107-119 : fine sombre lissée ; 120-125 : fine claire lissée ; 126 : fine claire micacée ; 127-131 : fine peinte.
Ech. 1/3.

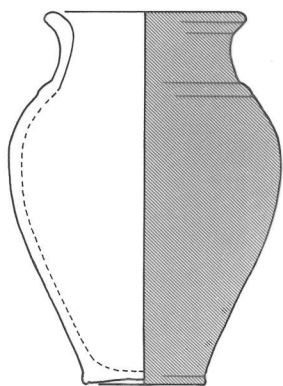

132

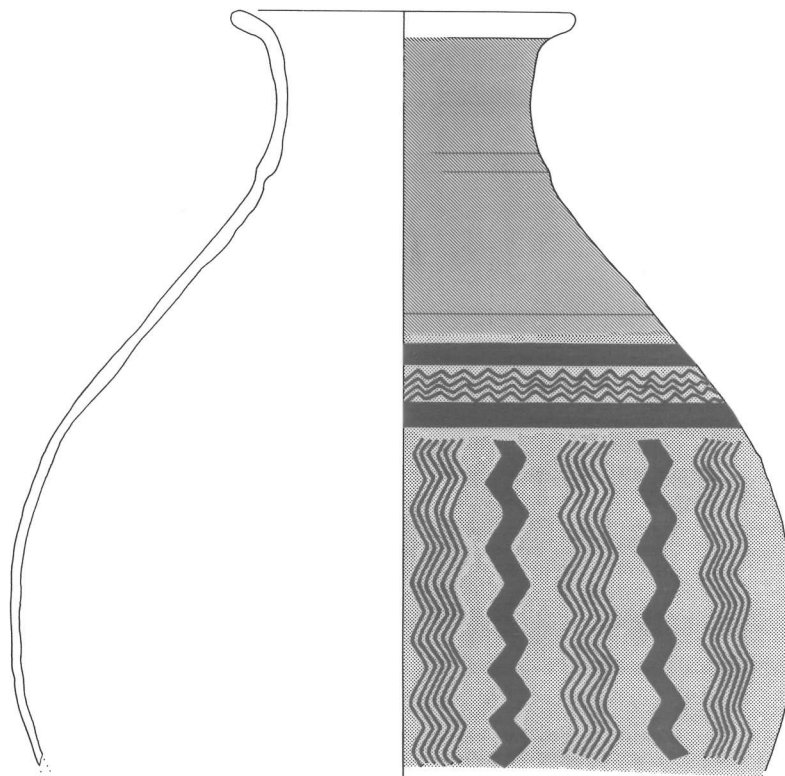

137

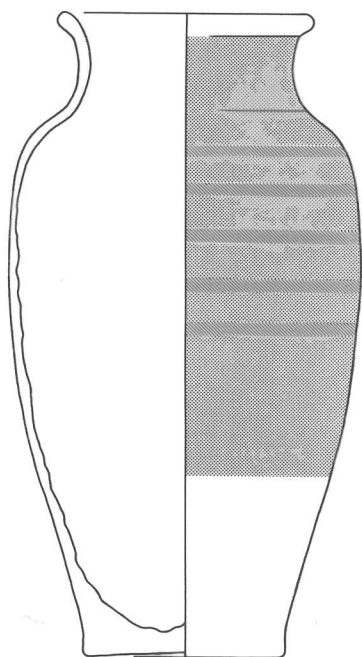

133

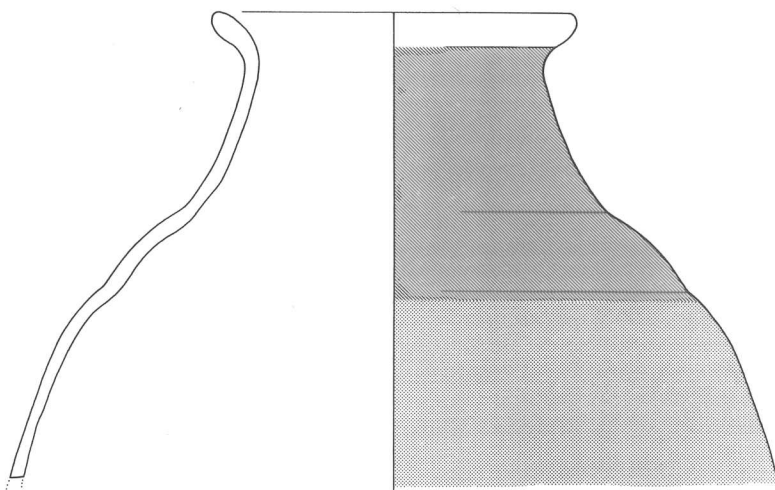

138

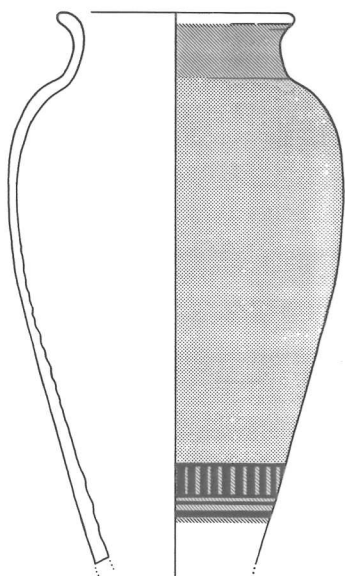

134

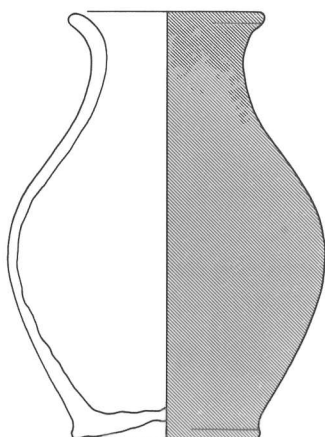

135

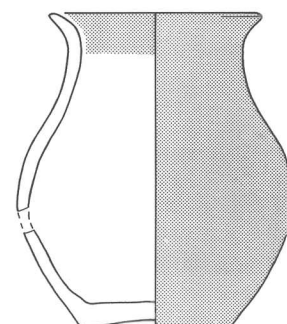

136

MIREBEAU - LA FENOTTE - Dépôts (fin II^e. - déb. I^{er} s. av.).
132-138 : fine peinte. Ech. 1/3.

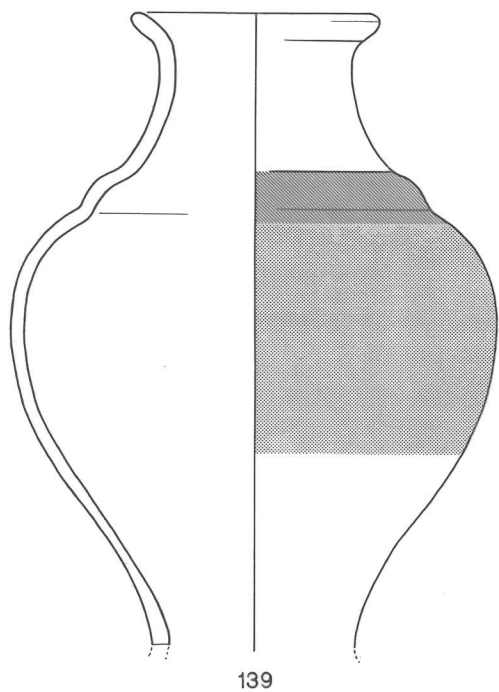

139

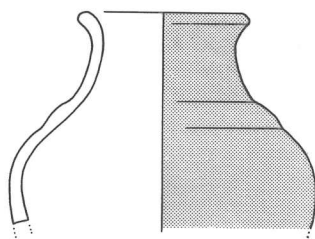

140

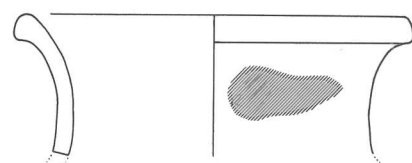

144

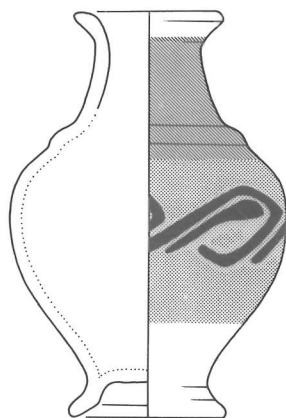

141

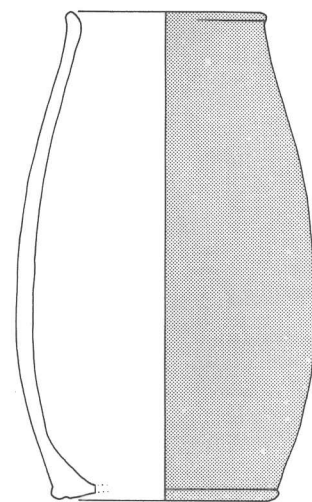

145

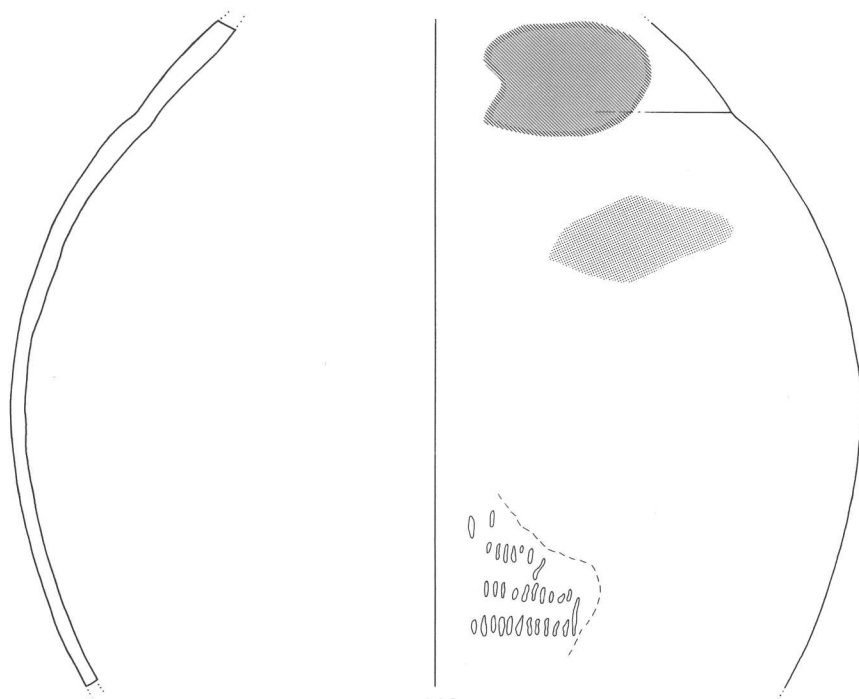

142

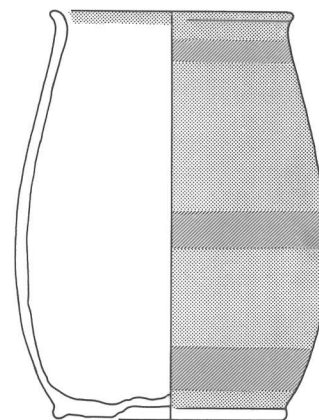

146

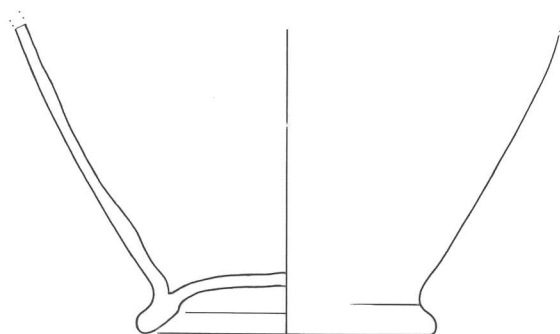

143

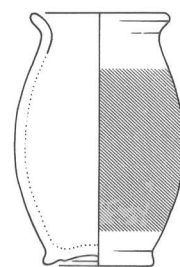

147

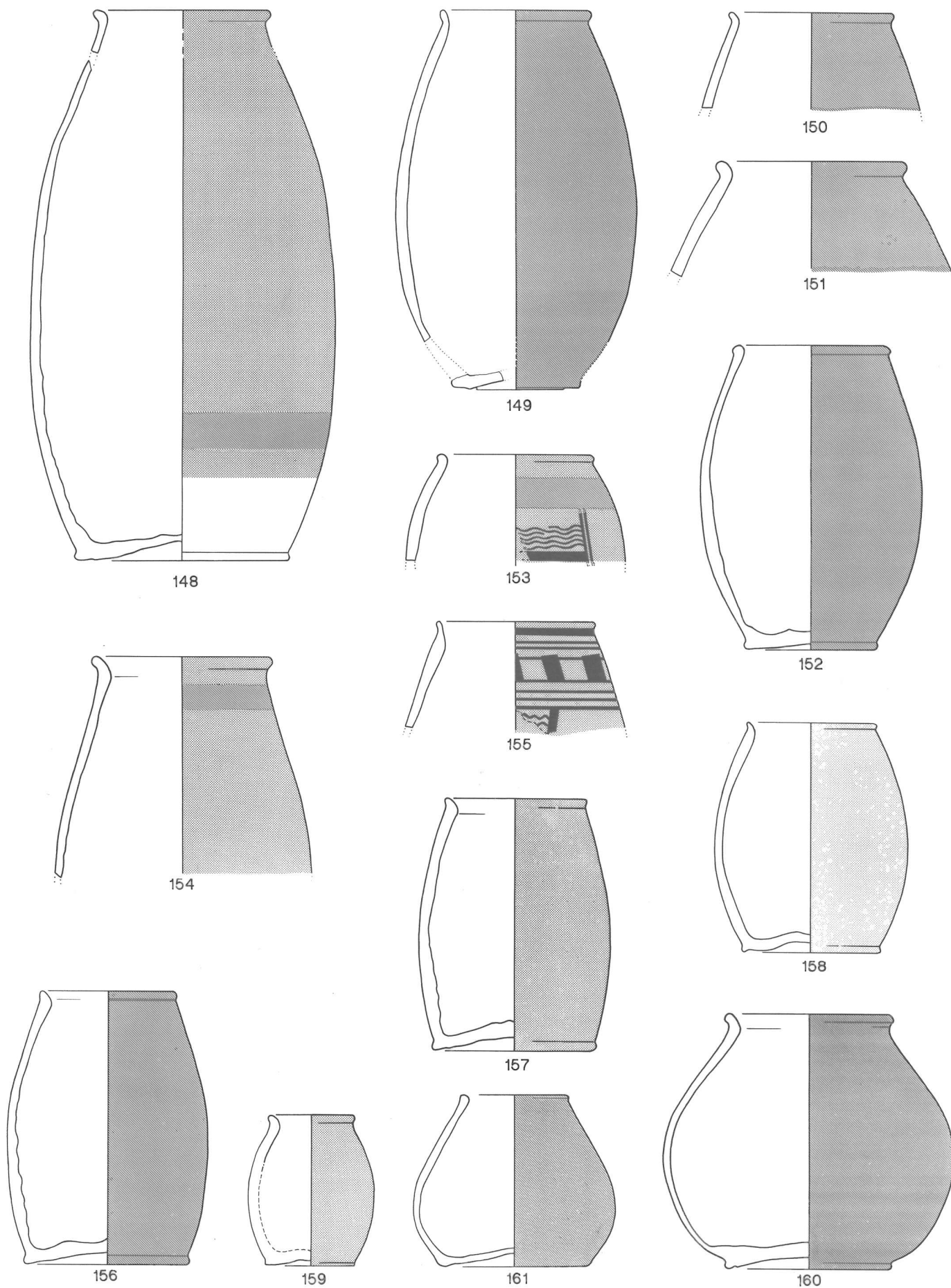

MIREBEAU -LA FENOTTE -Dépôts (fin IIè. -déb. Ier s. av.).
148-161 : fine peinte. Ech. 1/3.

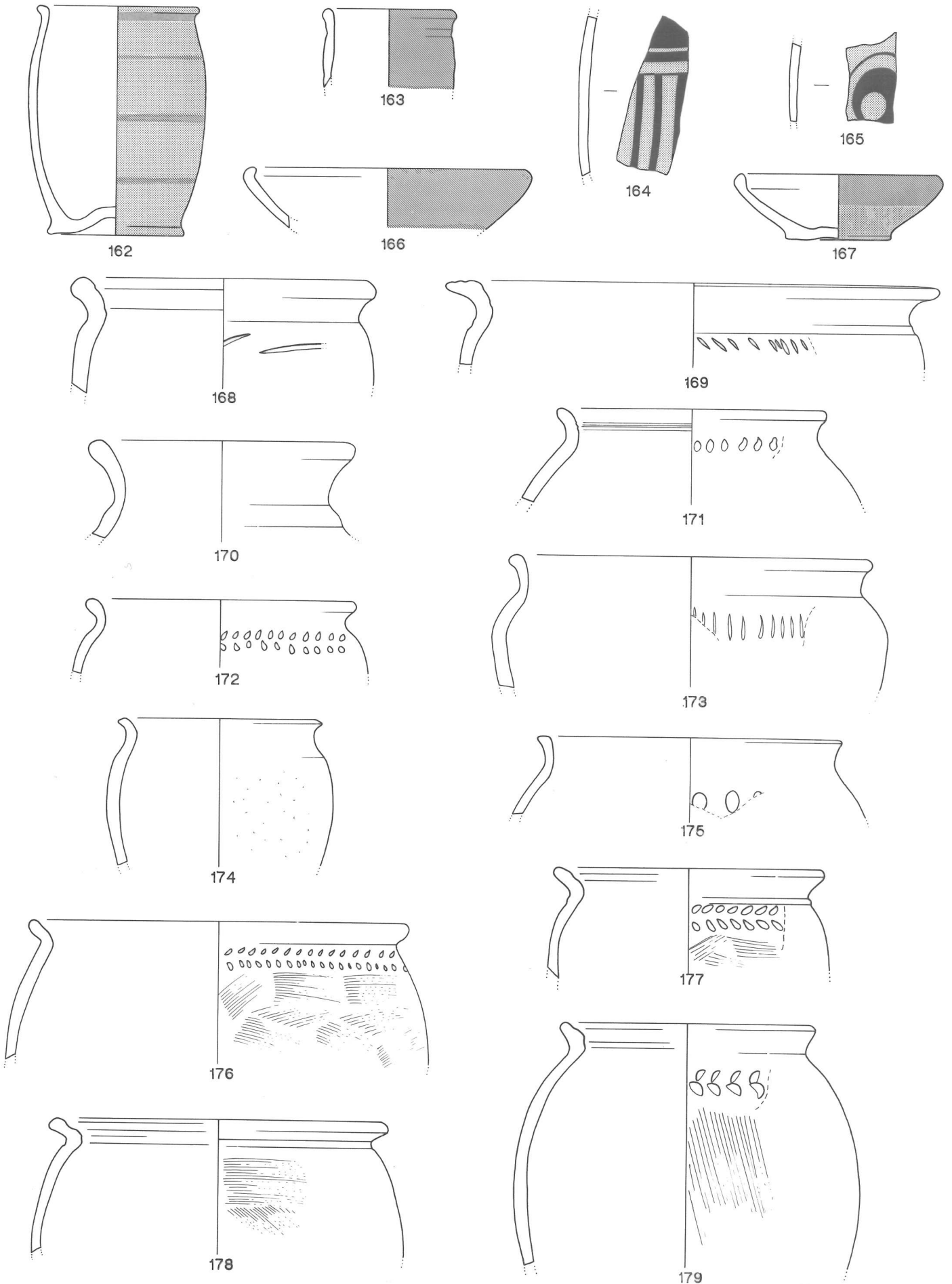

MIREBEAU -LA FENOTTE -Dépôts (n° 162-167 ; fin IIè. -déb. Ier s. av.) ; -Couche d'épandage (n° 168-179 ; IIè. -Ier av.).

162-167 : fine peinte ; 168-169 : non tournée, grossière claire micacée ; 170-179 : non tournée siliceuse ou calcaire. Ech. 1/3.

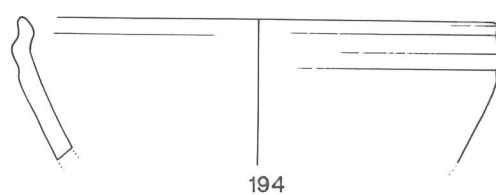
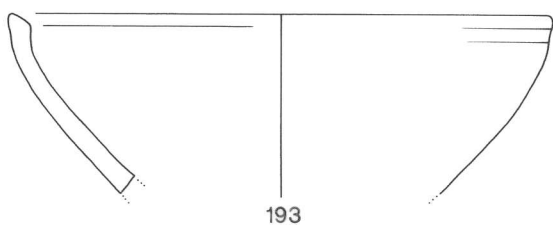
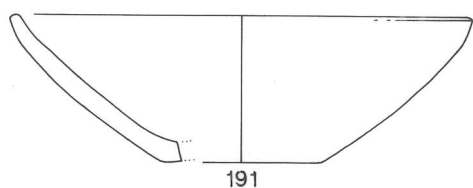
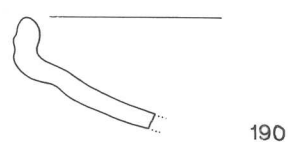
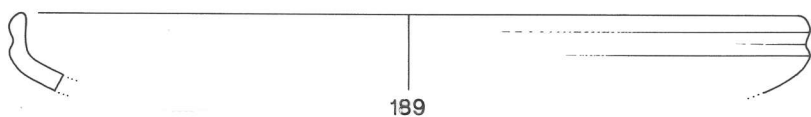
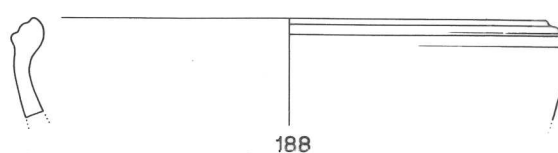
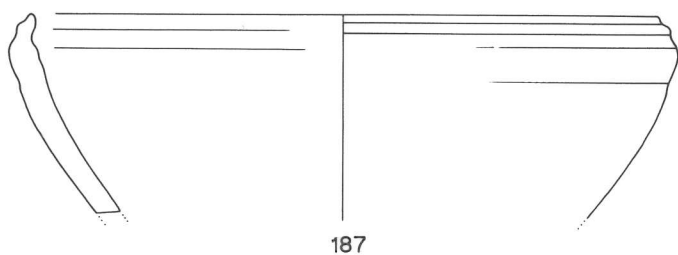
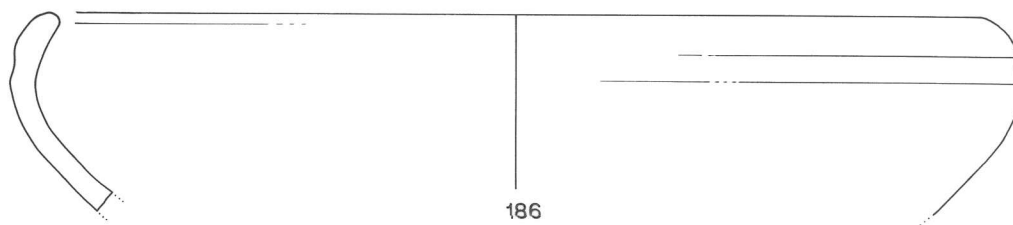
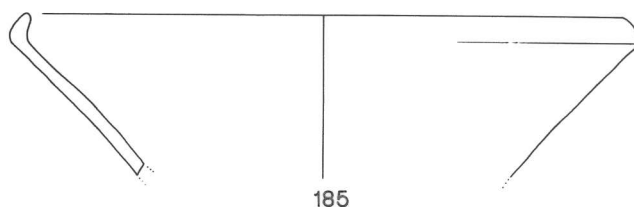
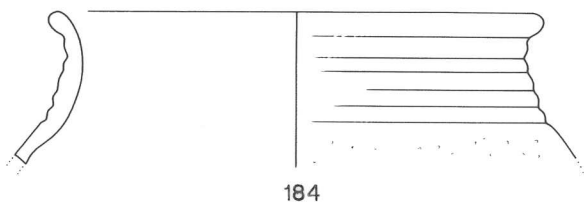
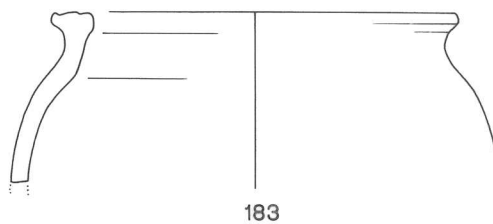
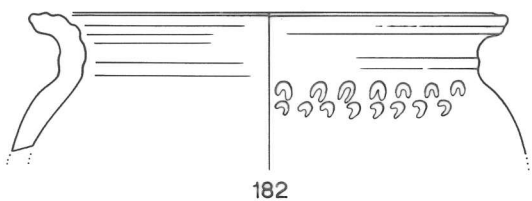
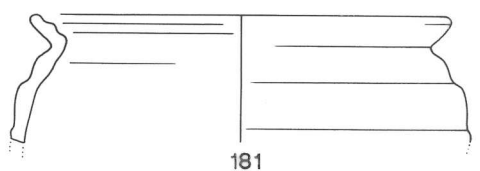
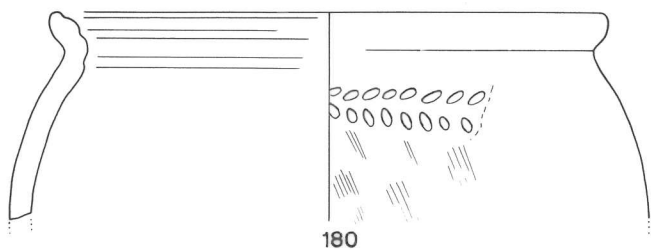

MIREBEAU -LA FENOTTE -Couche d'épandage (IIè. -Ier av.).
180-194 : non tournée grossière, siliceuse ou calcaire. Ech. 1/3.

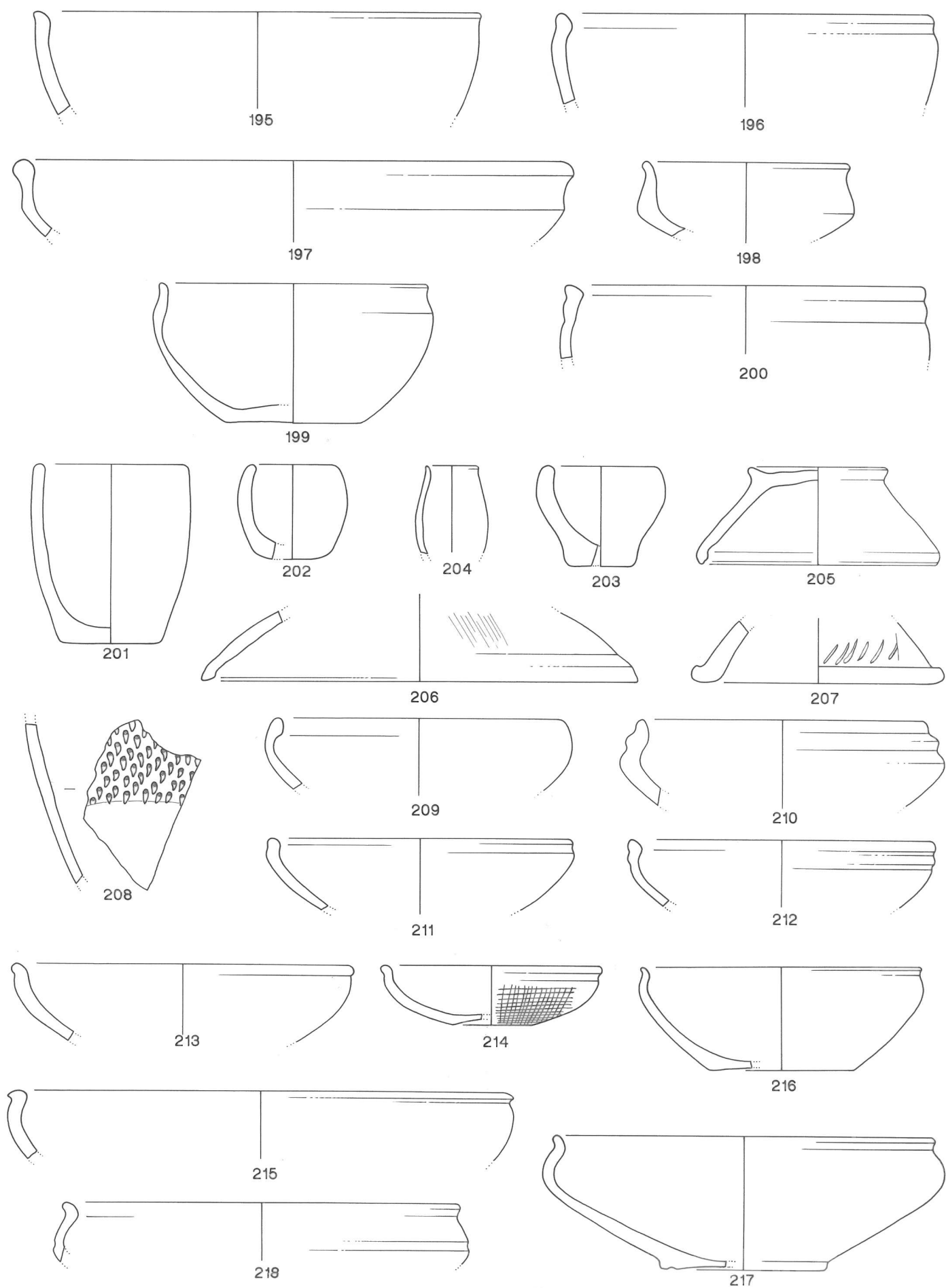

MIREBEAU -LA FENOTTE -Couche d'épandage (IIè. -Ier av.).

195-207 : non tournée grossière, siliceuse ou calcaire. 208-218 : fine sombre lissée. Ech. 1/3.

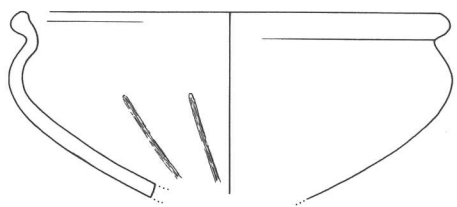

219

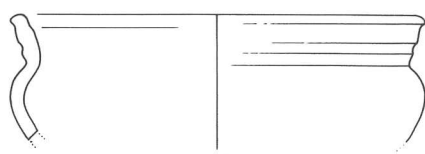

220

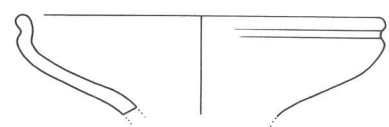

221

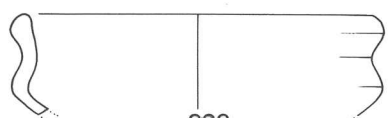

222

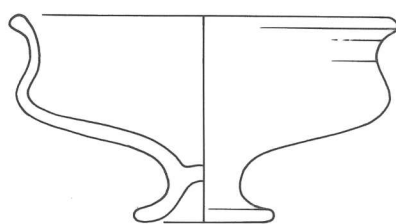

223

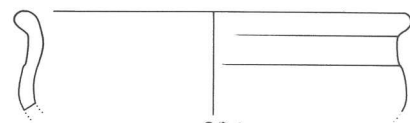

224



226

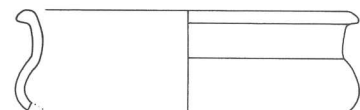

225

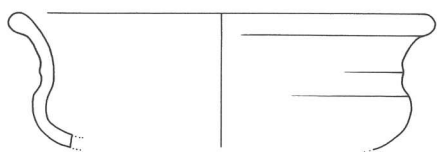

227

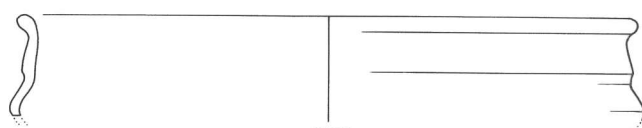

229

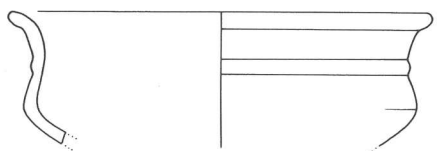

228

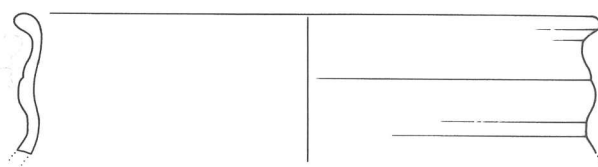

230

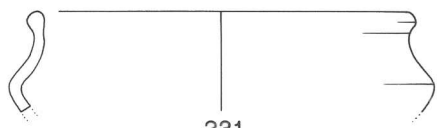

231

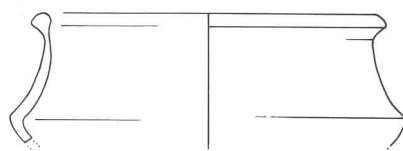

232

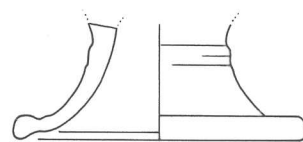

233

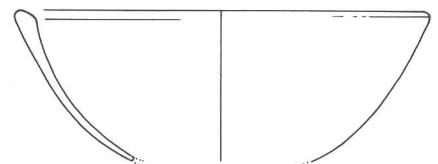

234

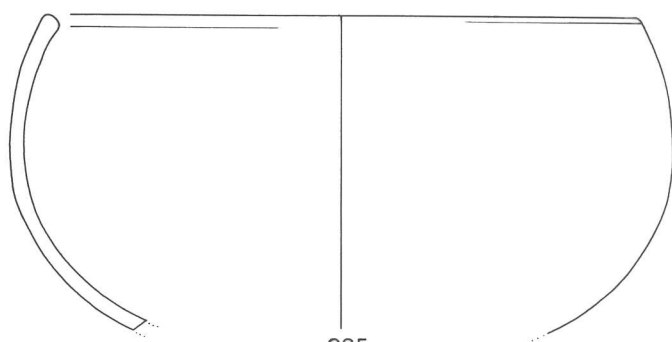

235

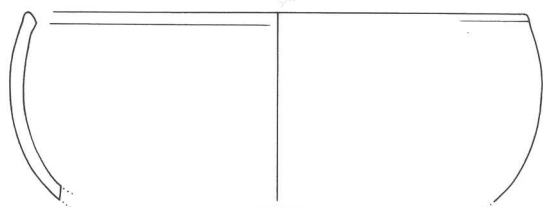

236

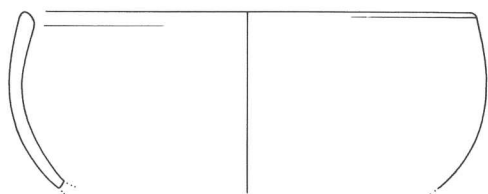

237

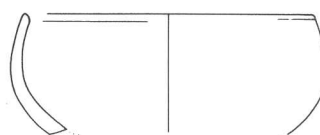

238

MIREBEAU -LA FENOTTE -Couche d'épandage (IIè. -Ier s. av.).
219-238 : fine sombre lissée. Ech. 1/3.

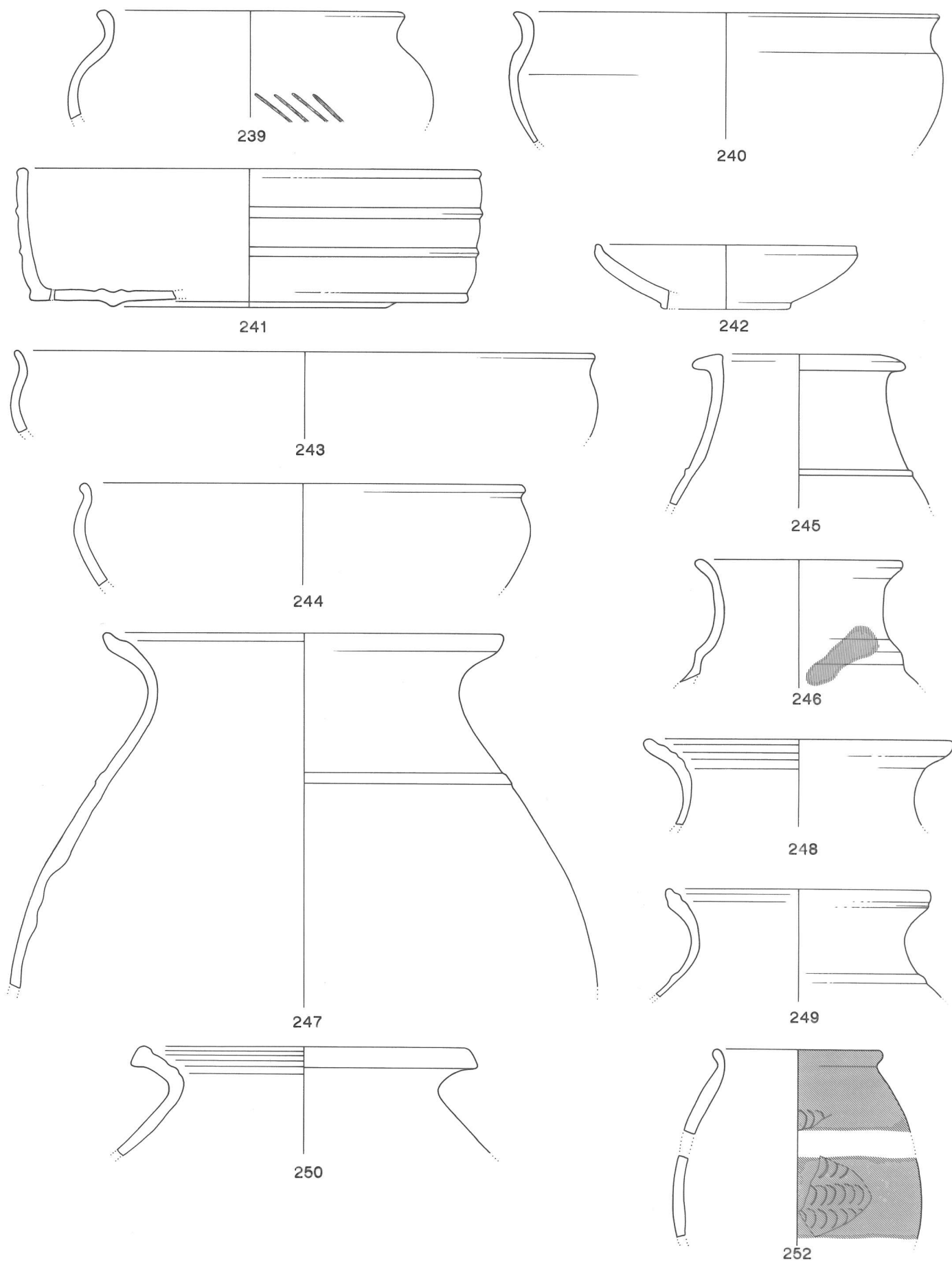

MIREBEAU -LA FENOTTE -Couche d'épandage (IIè. -Ier s. av.).

239-241 : fine sombre lissée ; 242-244 : fine claire lissée ; 245-252 : fine claire non peinte ou peinte. Ech. 1/3.

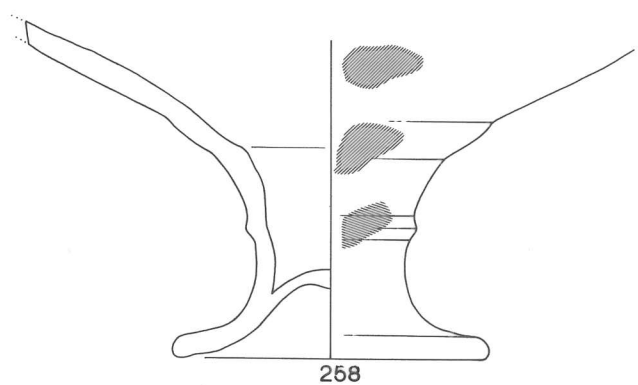
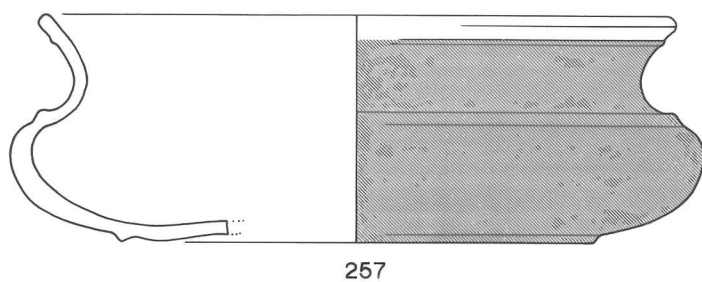
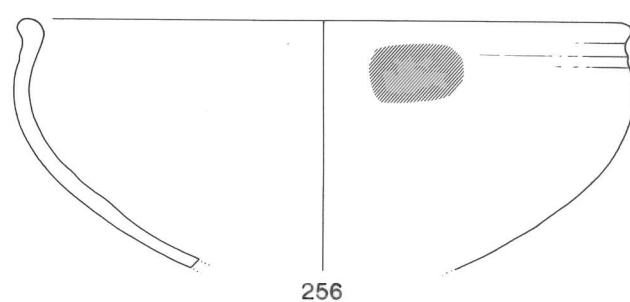
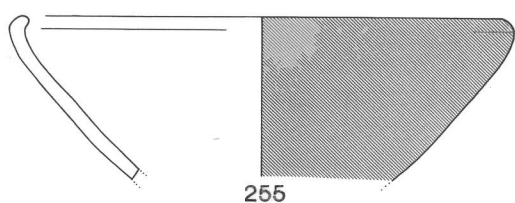
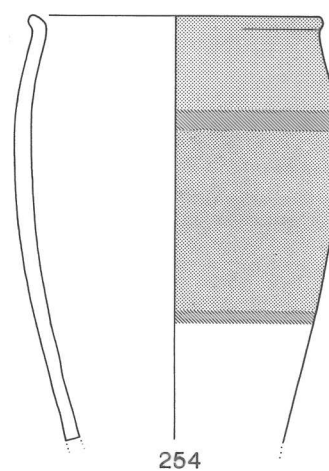
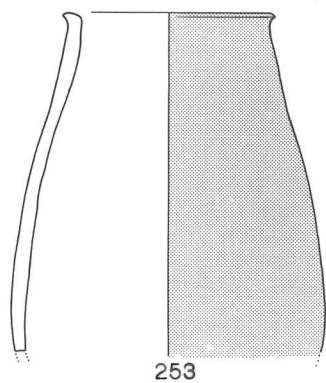

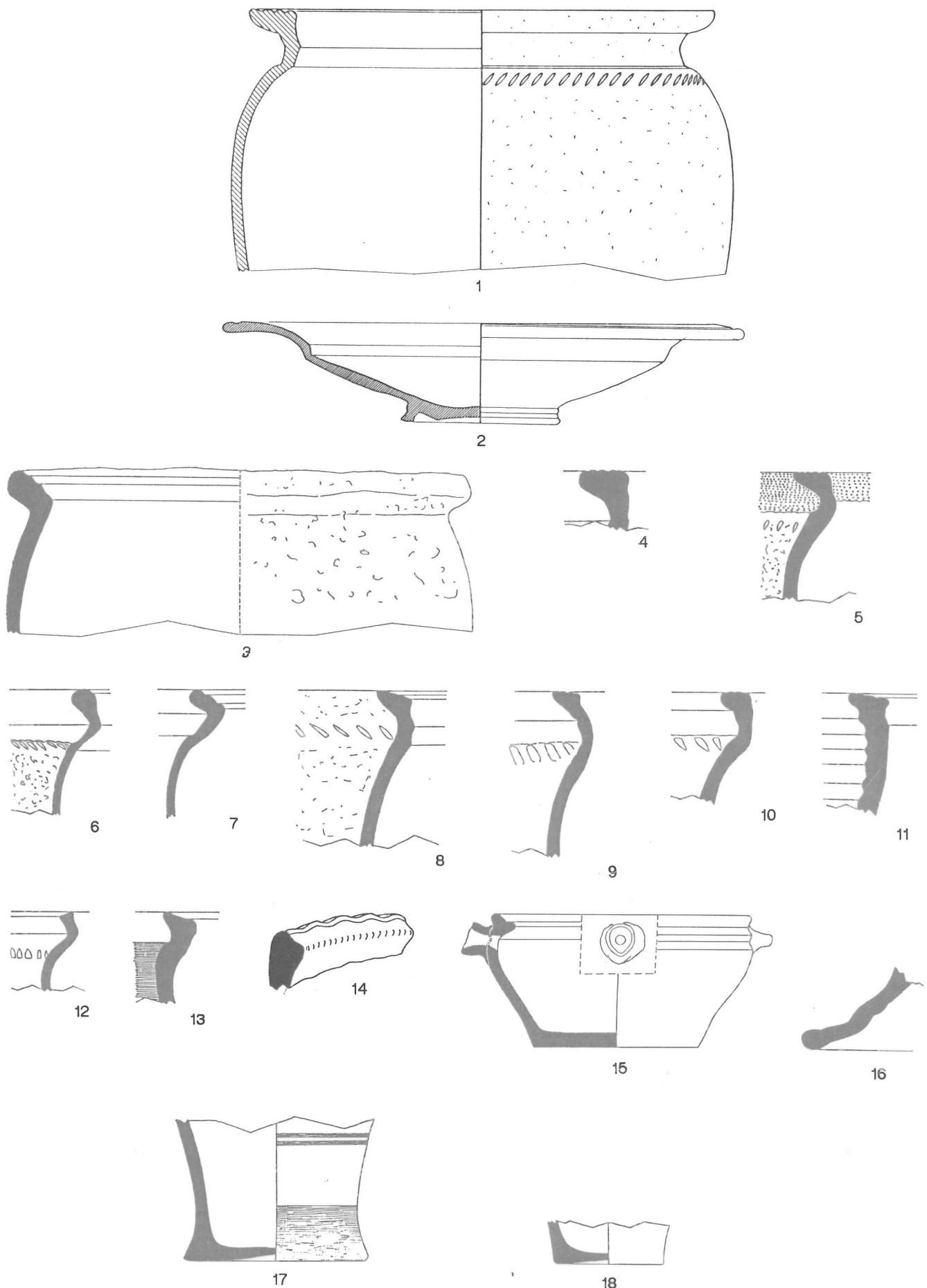

GUEUGNON -LE VIEUX FRESNE (fin IIè.-déb. Ier s. av.).

- Provenance non précisée - 1 : non tournée, grossière claire micacée ; 2 : fine sombre lissée (Extraits de Notet 1991, pl. 11-12) ; - dépôt en fosse de 1982 - 3-5 : non tournée, grossière claire micacée ; 6-16 : grossière non tournée ; 17-18 : fine sombre lissée. (Extraits de Notet 1984, pl. 3-4). Ech. : 1/3.



19

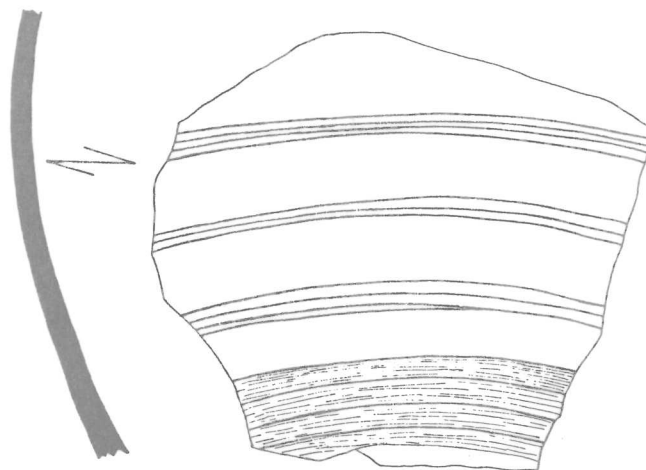

20

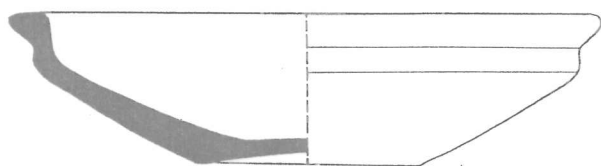

21

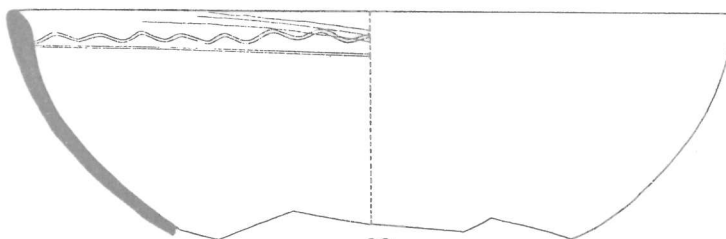

22



23

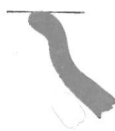

24



25



26

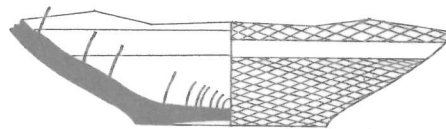

27

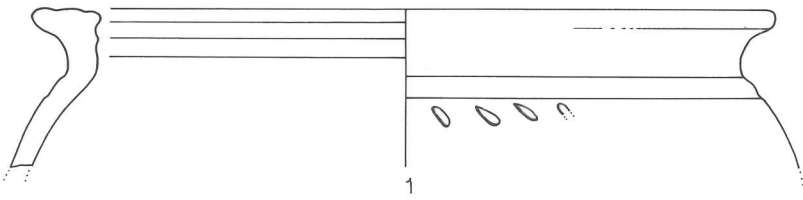

1

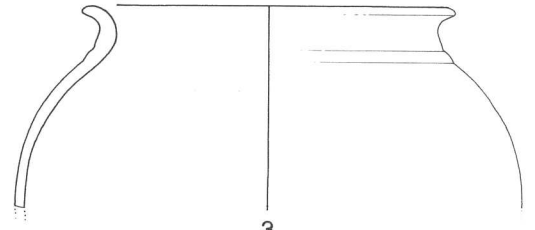

3

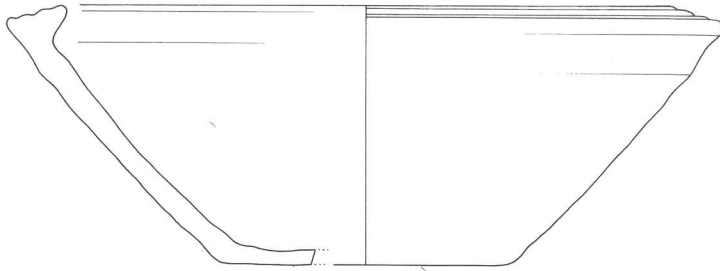

2

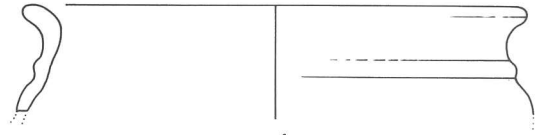

4

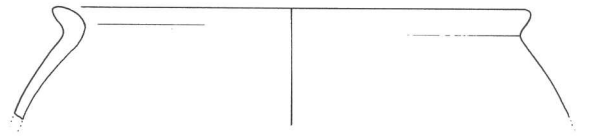

5

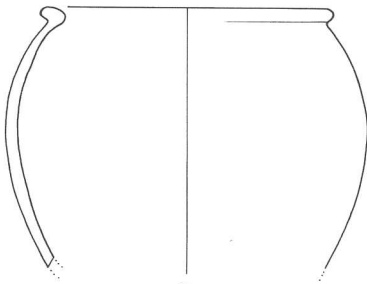

6

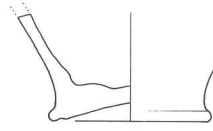

8

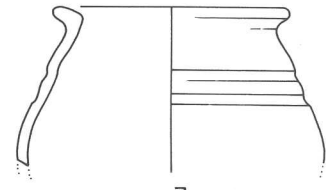

7

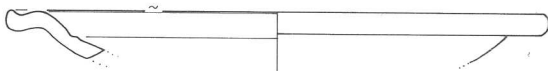

9

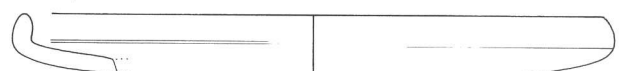

10

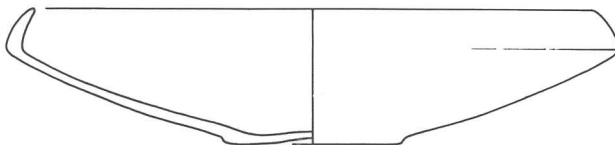

11

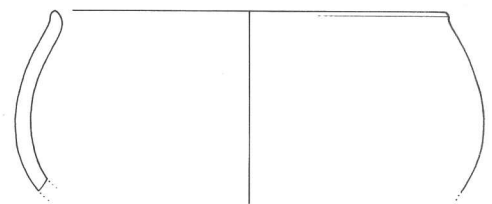

12

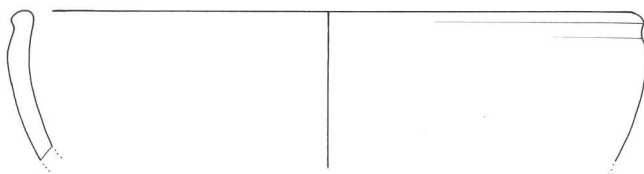

13

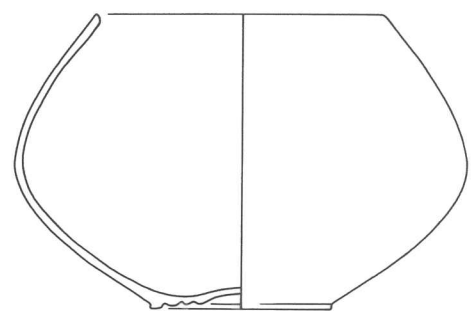

14

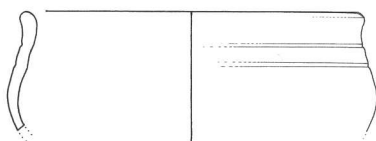

15

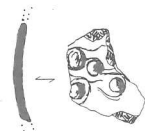

16

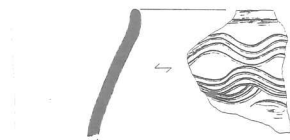

17

DECIZE -RUE DES FOSSES (fin IIè.-Ier s. av.).

1-2 : non tournée, grossière claire micacée ; 3-17 : mi-fine-fine sombre lissée (16 et 17 : extraits de Périchon-Péronnet 1989). Ech. : 1/3.

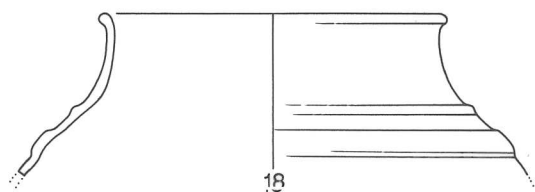

18

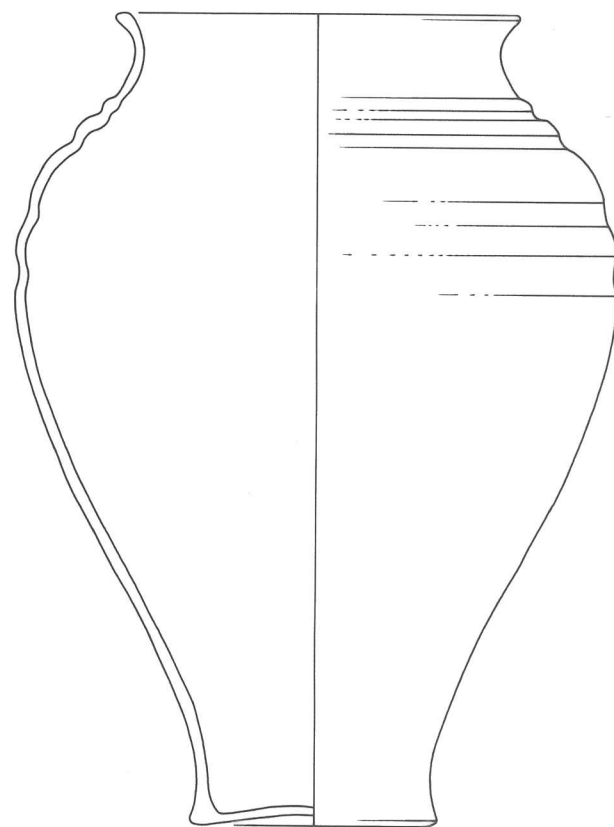

19

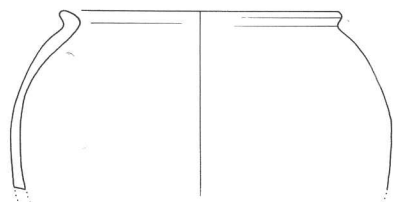

20

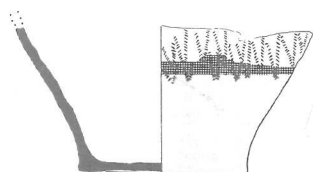

21

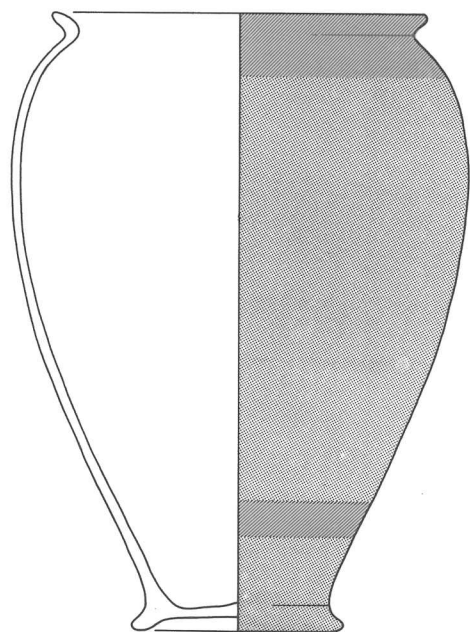

22



23

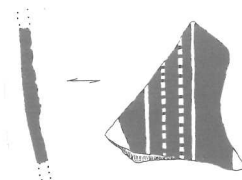

24

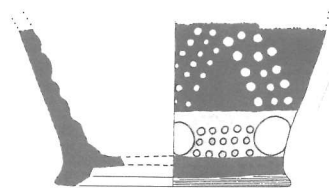

25

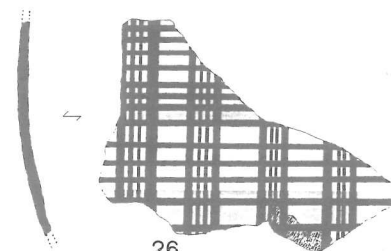

26

DECIZE -RUE DES FOSSES (fin IIè.-Ier s. av.).

18-20 : fine claire lissée ; 21 : fine claire engobe rouge ("Terra Rubra") ; 22-26 : fine peinte. (21, 24-26 : extraits de Périchon-Péronnet 1989). Ech. : 1/3.

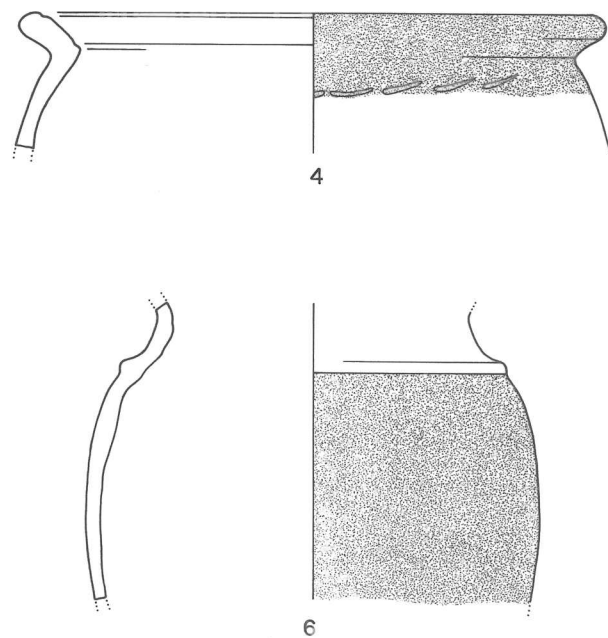
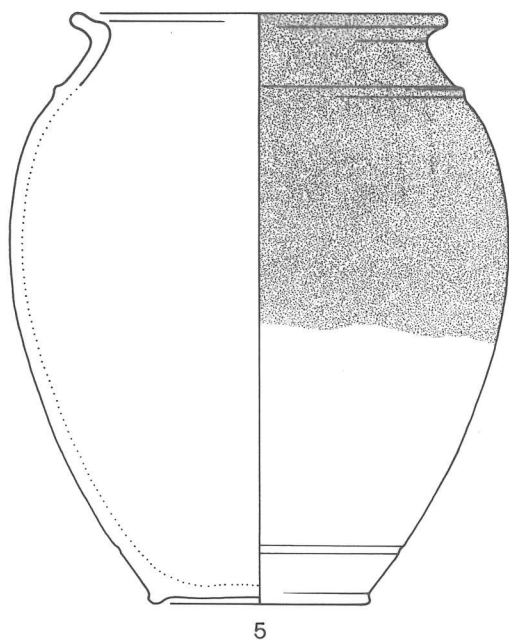
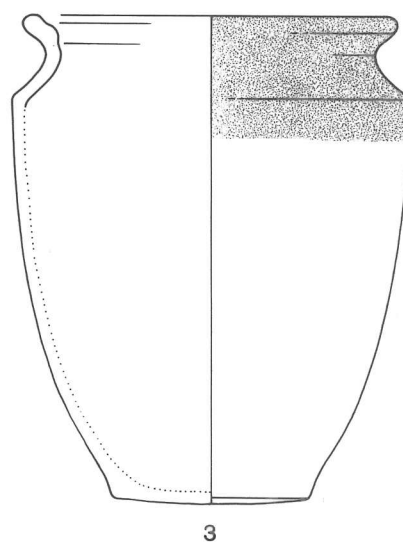
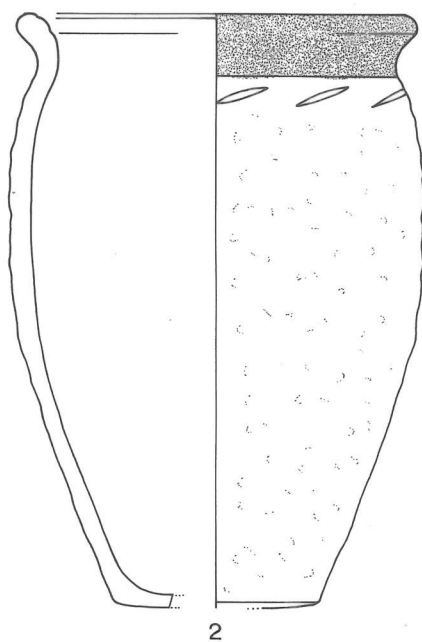
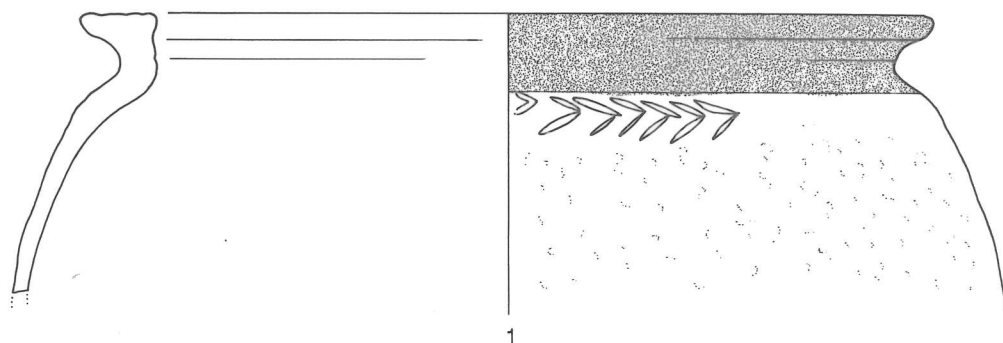

MONT-BEUVRAY -PÂTURE DU COUVENT (fin IIè. -début Ier s. av.).

1-2 : non tournée, grossière claire micacée ; 3-6 : non tournée grossière claire engobée. Ech. : 1/3.

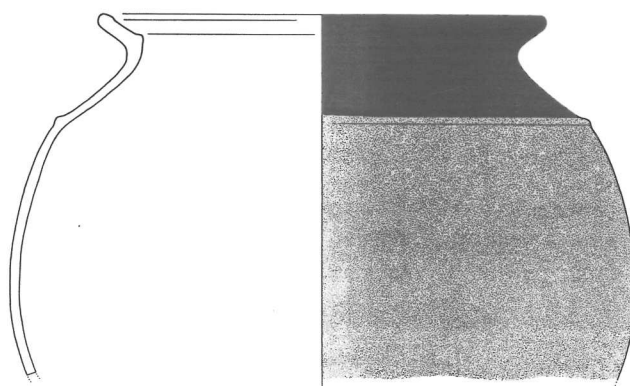

7

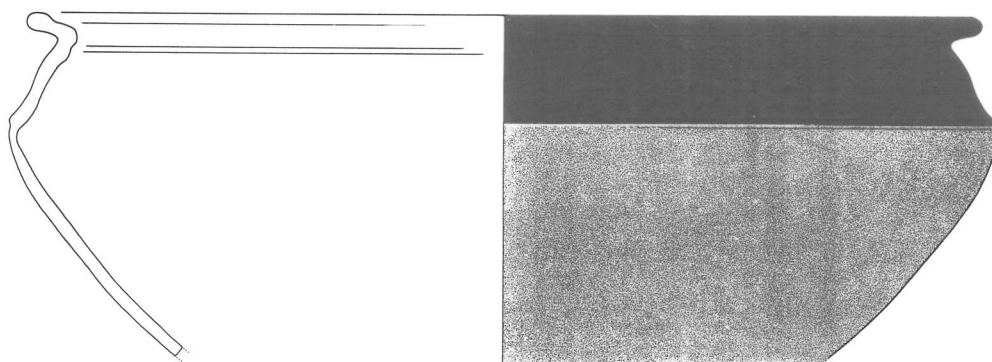

8

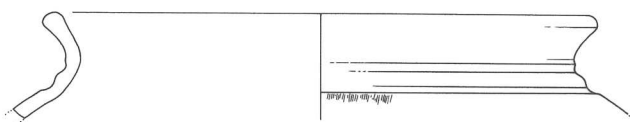

9

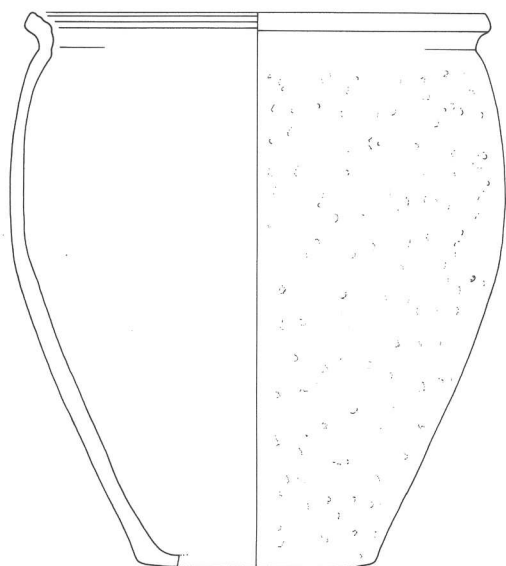

10

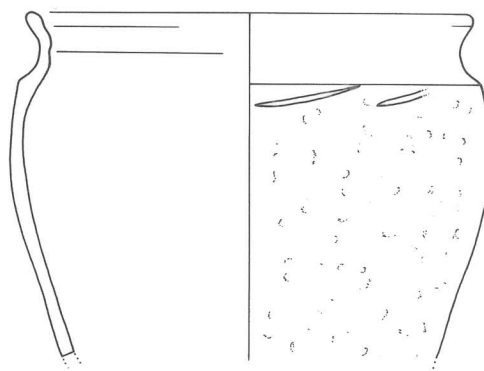

11

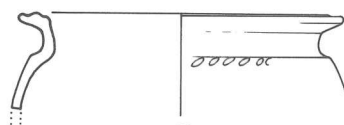

12

MONT-BEUVRAY -PÂTURE DU COUVENT (fin IIè. -début Ier s. av.).

7-8 : non tournée grossière claire engobée ; 9-11 : non tournée, grossière sombre siliceuse ; 12 : mi-fine siliceuse. 7-10 : éch. : 1/4 ; 11-12 : éch. : 1/3.

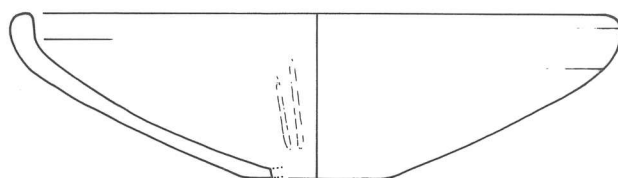

13

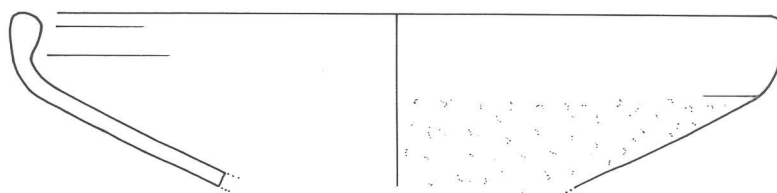

14

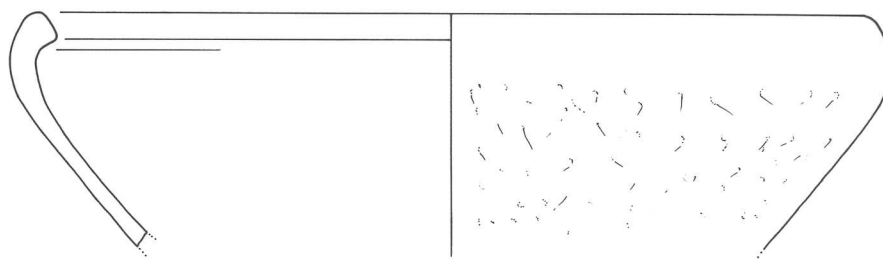

15

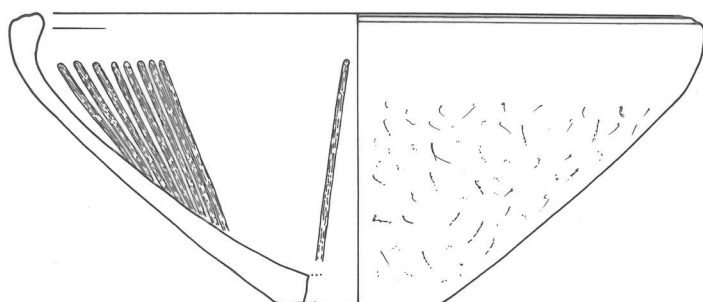

16

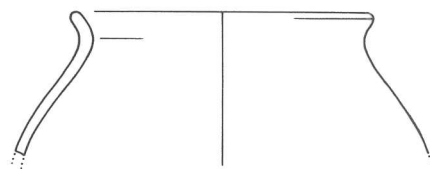

18

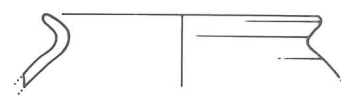

19

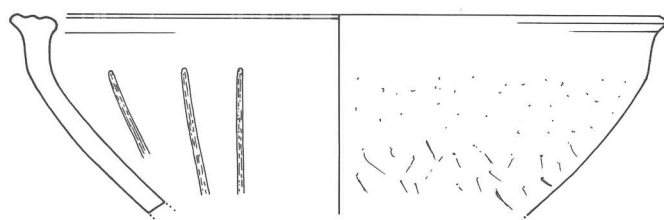

17

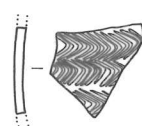

20



21



22

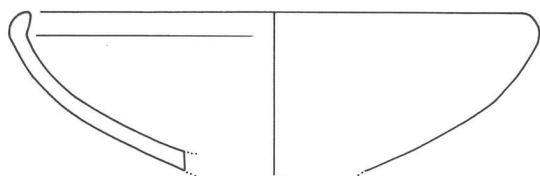

23

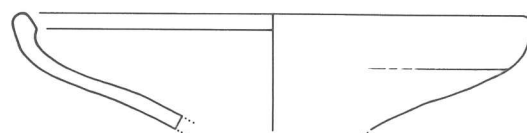

24

MONT-BEUVRAY -PÂTURE DU COUVENT (fin IIè. -début Ier s. av.).

13-17 : non tournée, grossière siliceuse ; 18-24 : mi-fine-fine sombre lissée. Ech. : 1/3.

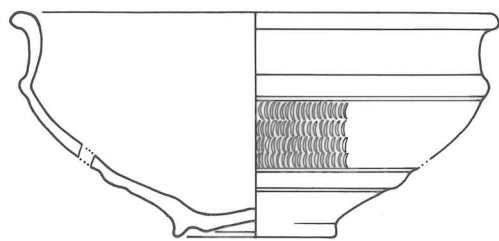

25

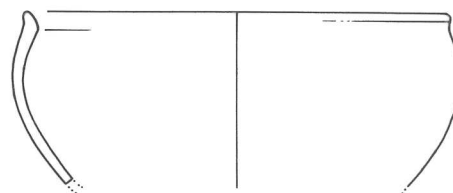

26

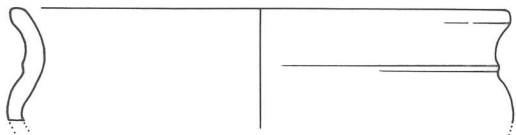

27

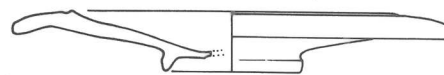

28

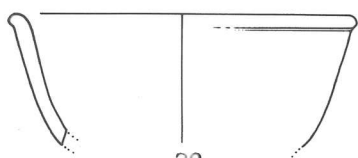

29

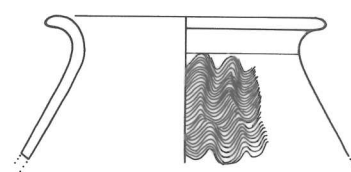

30

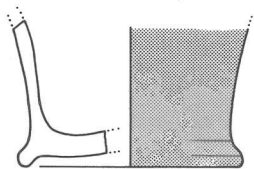

31

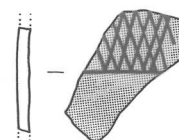

32

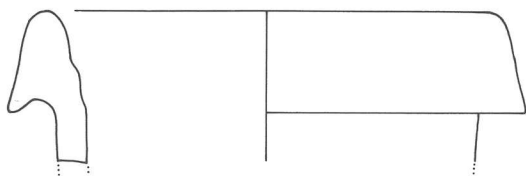

34



33

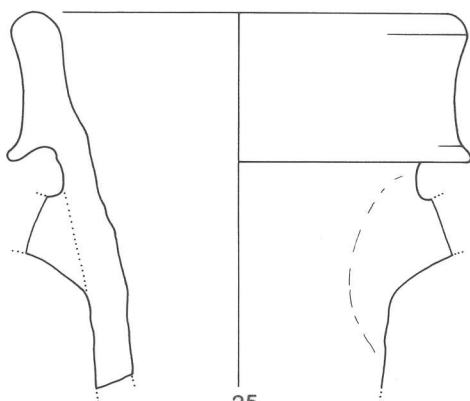

35

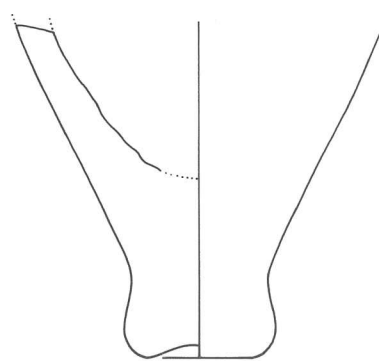

36

MONT-BEUVRAY -PÂTURE DU COUVENT (fin IIè. -début Ier s. av.).

25-27 : mi-fine-fine sombre lissée ; 28-29 : fine grise "Terra Nigra" ; 30 : mi-fine-fine claire siliceuse ; 31-32 : fine peinte ; 33 : campanienne Boïde ; 34-35 : amphores Dr. 1. Ech. : 1/3.

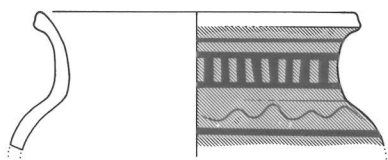

37

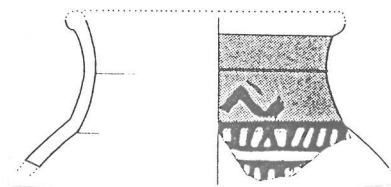

38

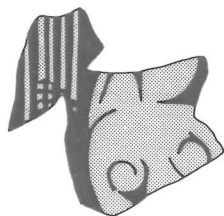

39

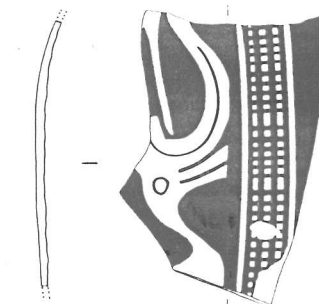

40

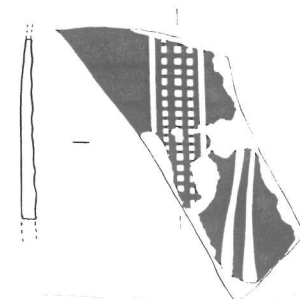

41



43



44

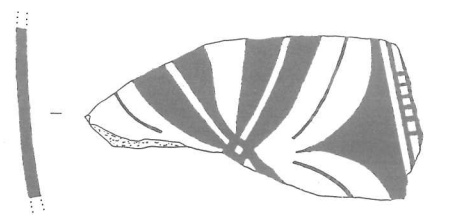

42

MONT-BEUVRAY (fin II^e. -I^{er} s. av.).

37-44 : fine peinte (37, 39, 43-44 : Fontaine Saint-Pierre ; 38 : Parc aux Chevaux (PC1 : extrait de Guillaumet 1989) ; 40-41 : Porte du Rebout, extrait de *R.A.E.* 1987 fig. 7 ; 42 : Pâtûre du Couvent, extrait de Guillaumet 1990). Ech. : 1/3.

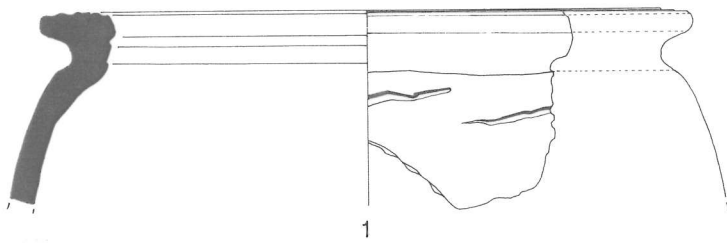

1

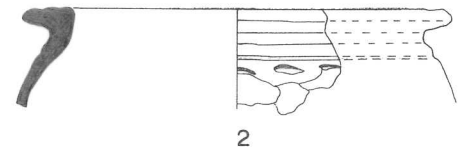

2

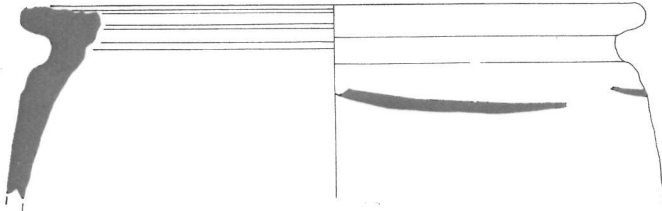

3

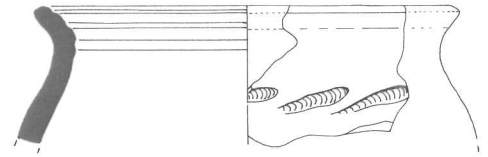

4

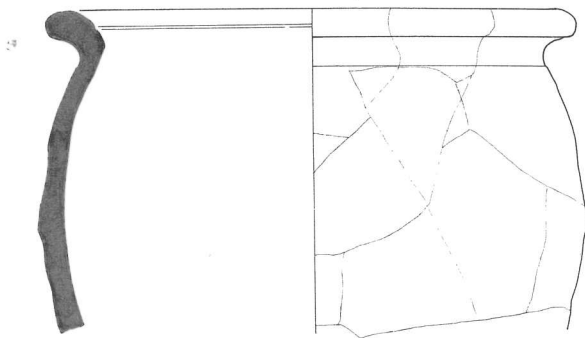

5

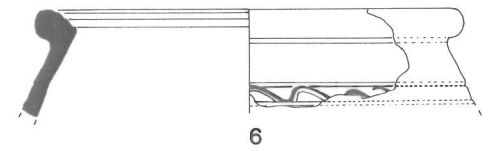

6

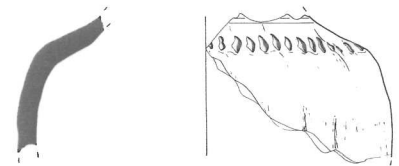

8

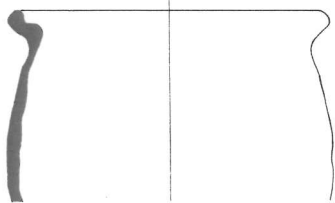

7

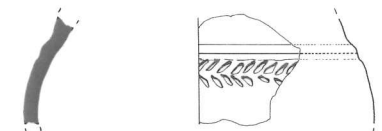

9

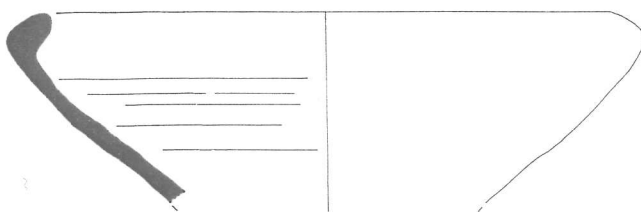

10



11



12

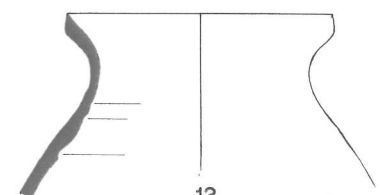

13

MALAIN -LA BOUSSIÈRE (Ier s. av.).

1-3 : non tournée, grossière claire micacée ; 4-11 : non tournée grossière ; 12 : mi-fine sombre ; 13 : fine claire. (Extraits de Roussel 1979, pl. 83 et Roussel 1988, pl. 61-62). Ech. : 1/3.

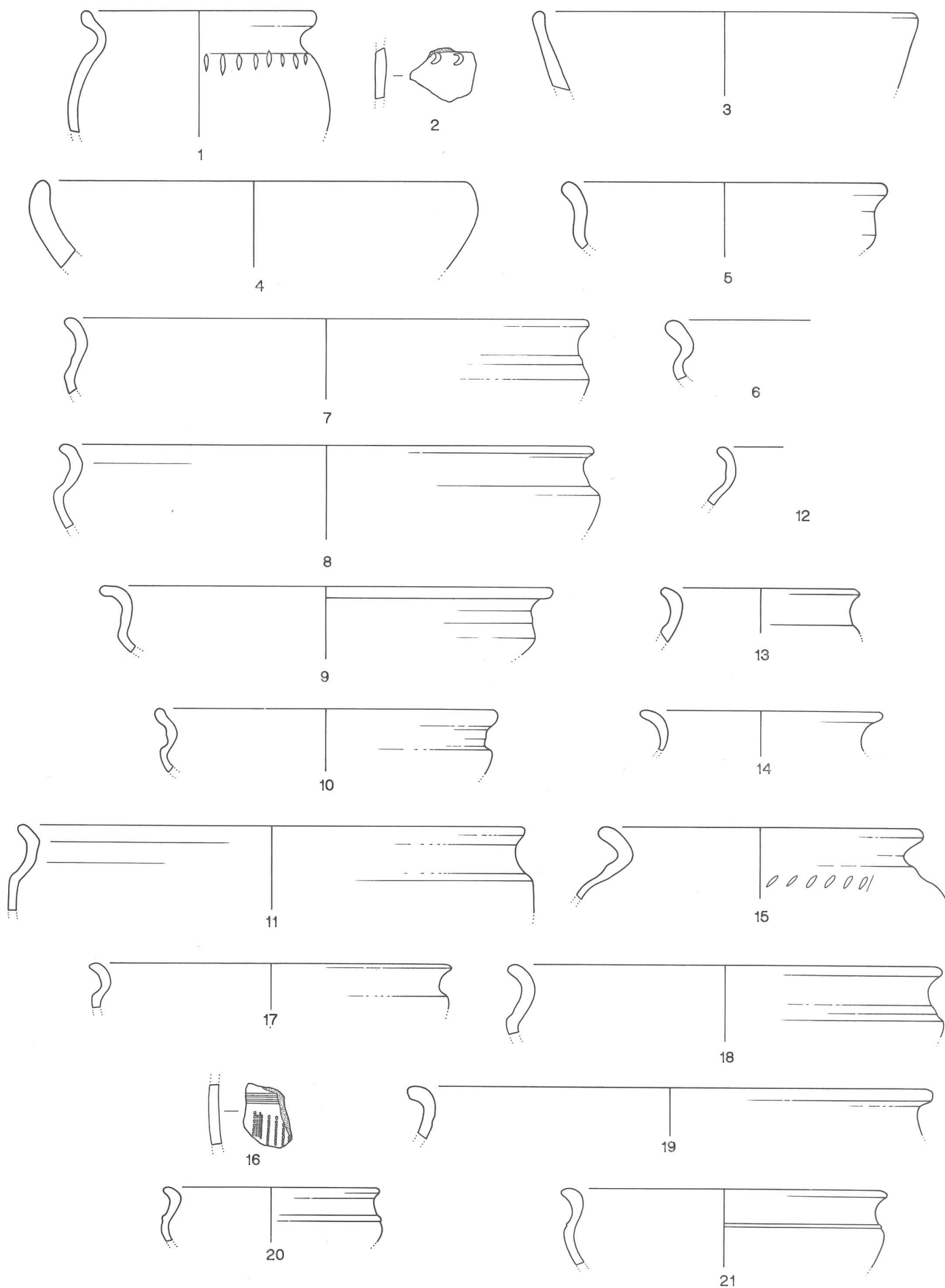

ALESIA -CENTRE MONUMENTAL (70-60/40-30 av.).

1-11 : non tournée grossière (1, 5-11 : siliceuse ; 2-4 : calcaire) ; 12-21 : tournée, grossière siliceuse. Ech. : 1/3.

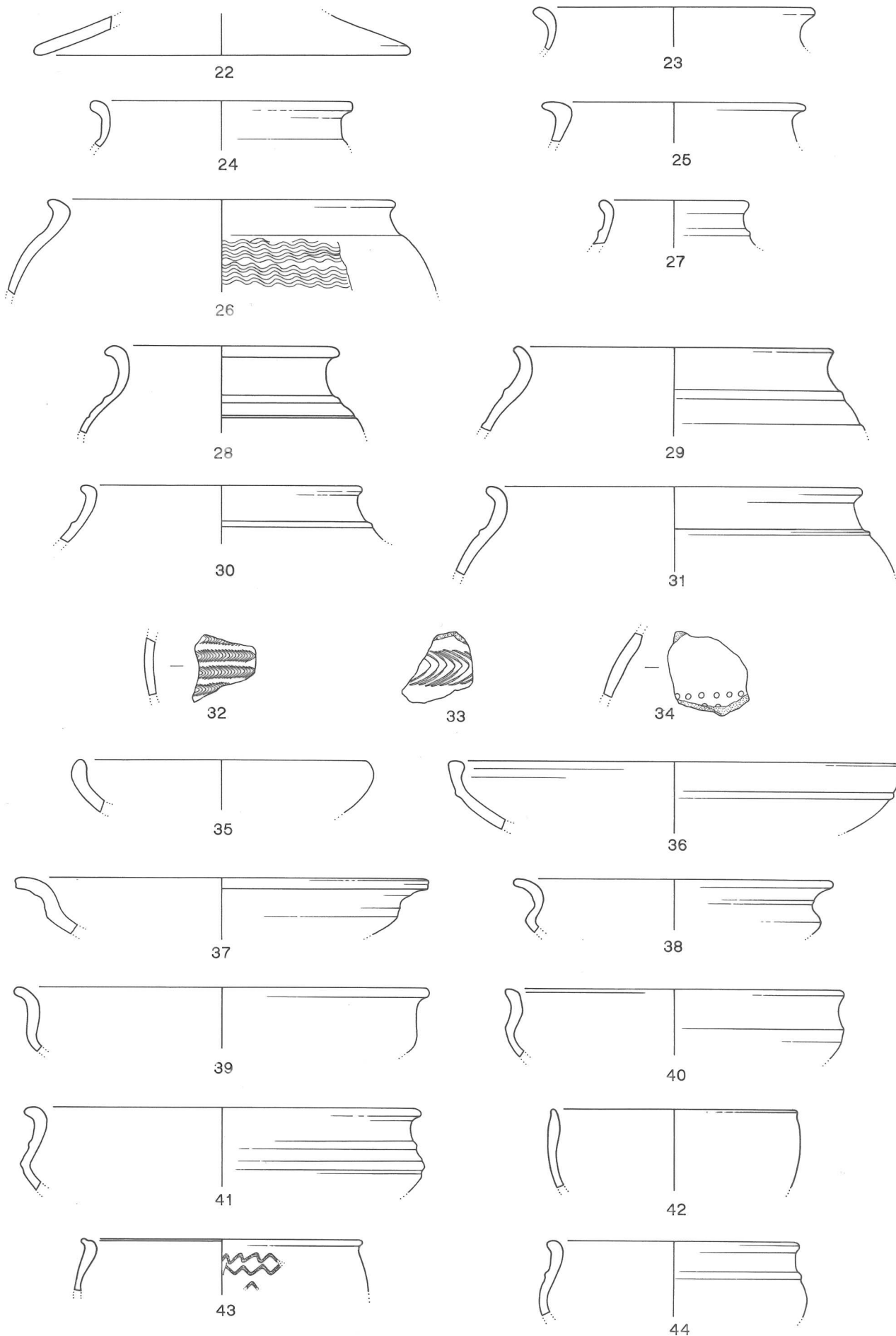

ALESIA -CENTRE MONUMENTAL (70-60/40-30 av.).

22 : mi-fine claire, engobe micacé ; 23-44: mi-fine sombre lissée. Ech. : 1/3.

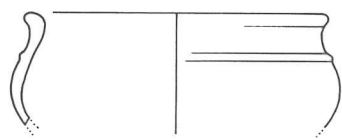

45

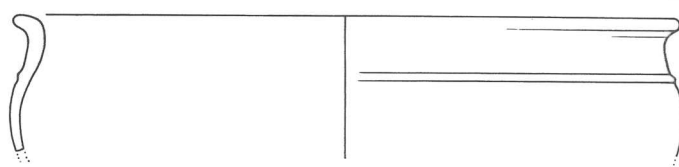

46

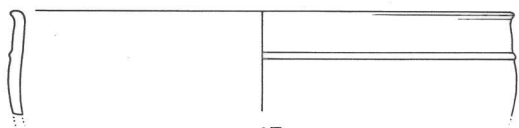

47

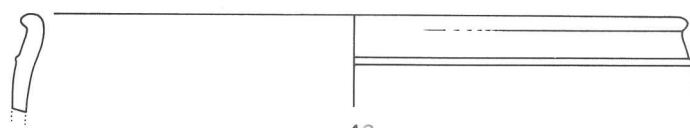

48

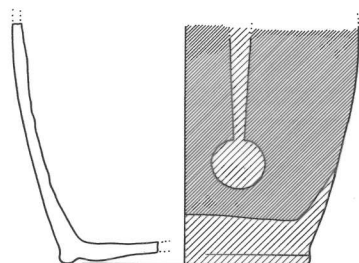

49

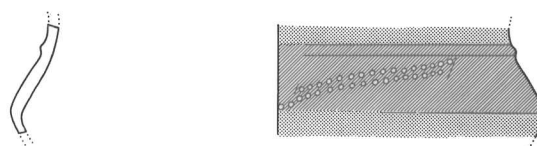

50

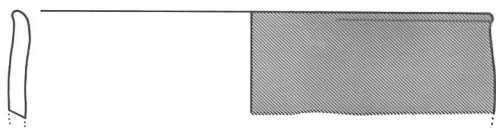

51

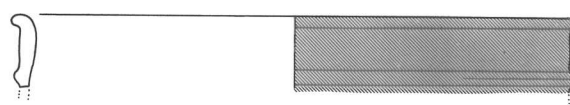

52

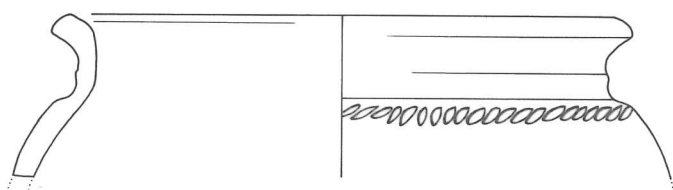

53

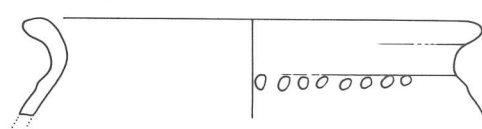

54

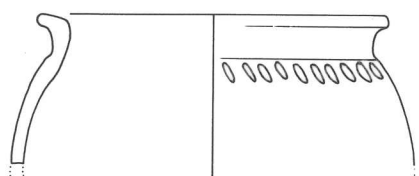

55

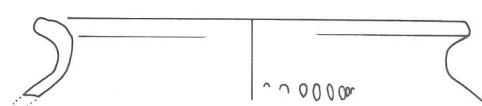

56



57



58

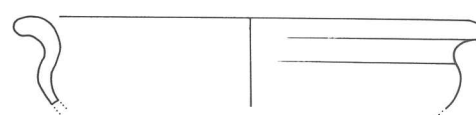

59

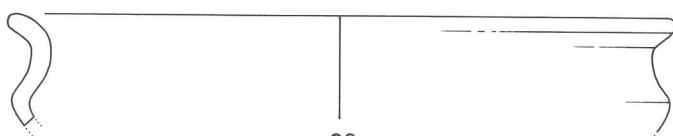

60

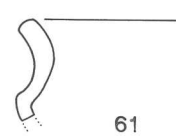

61

ALESIA -CENTRE MONUMENTAL (70-60/40-30 av.) ; -QSEF, EN CURIOT (2è. moit. Ier s. av.).
45-48 : mi-fine sombre lissée ; 49-52 : peinte "lie de vin" ; 53-61 : grossière.
45-52 : Centre monumental ; 53-61 : QSEF, En Curiot. (53, 55, 57, 58, 61 : extraits de Creusenet 1993 ; 54, 56, 59, 60 : extraits de Mangin 1981a). Ech. : 1/3.

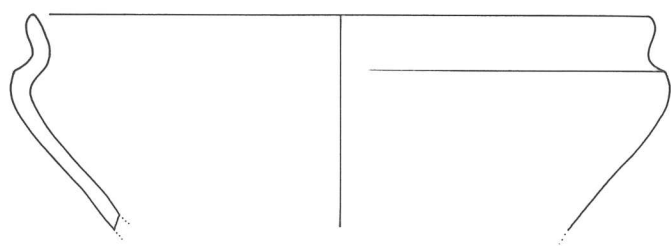

62

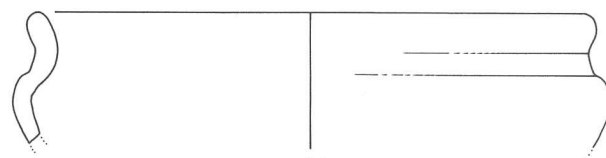

63

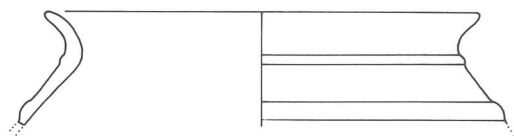

64

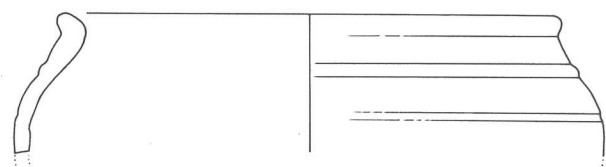

65

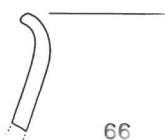

66

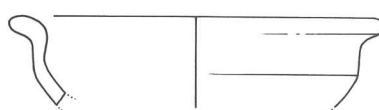

67

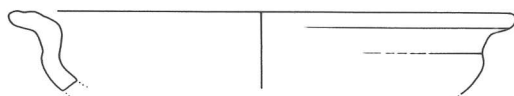

68

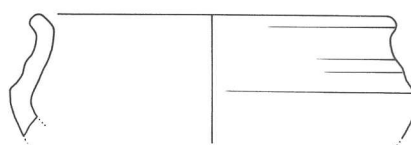

69

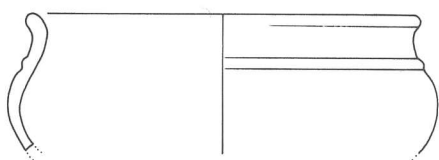

70

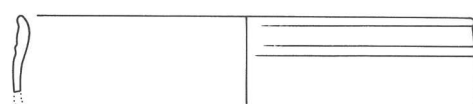

71

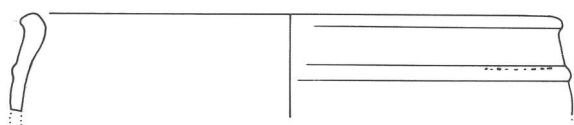

72

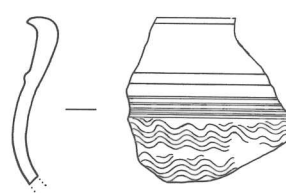

73

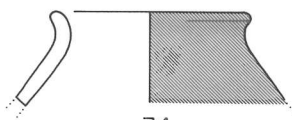

74

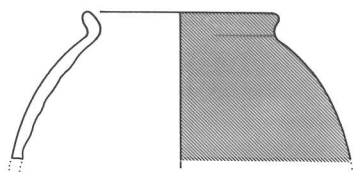

75

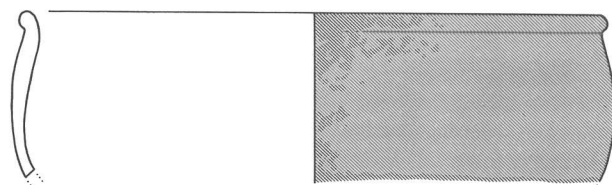

76

ALESIA -QSEF, EN CURIOT (2^e. moit. Ier s. av.).

62-63 : grossière ; 64-73 : mi-fine sombre lissée ; 74-76 : peinte "lie de vin".

(62-64, 65, 72, 74, 75 : extraits de Mangin 1981a ; 66, 73, 76 : extraits de Creusenet 1993). Ech. : 1/3.

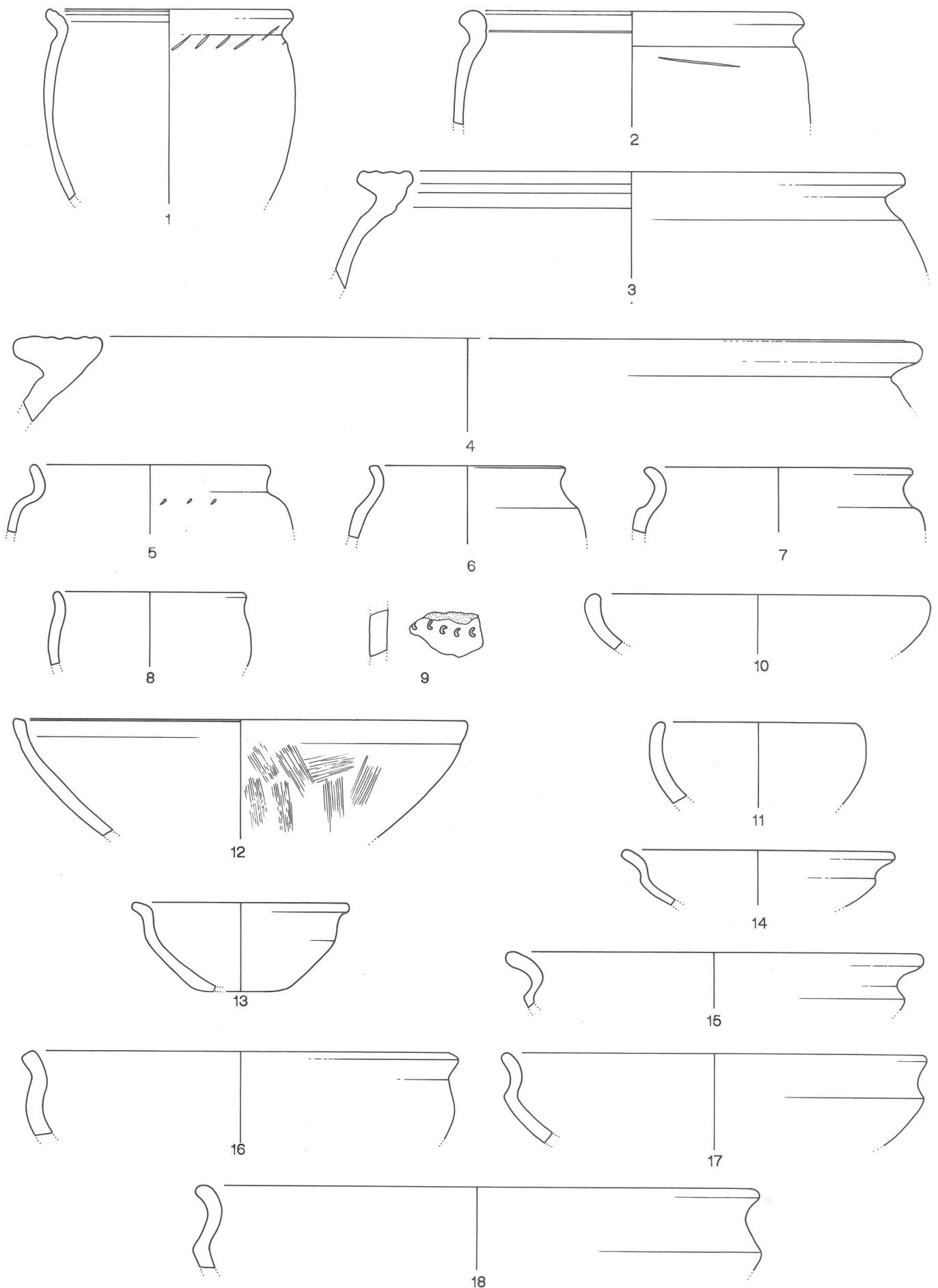

BRAUX -LA CROISEE (Ier s. av.).

1-4 : non tournée, grossière claire micacée ; 5-18 : non tournée grossière, siliceuse ou calcaire. Ech. : 1/3.

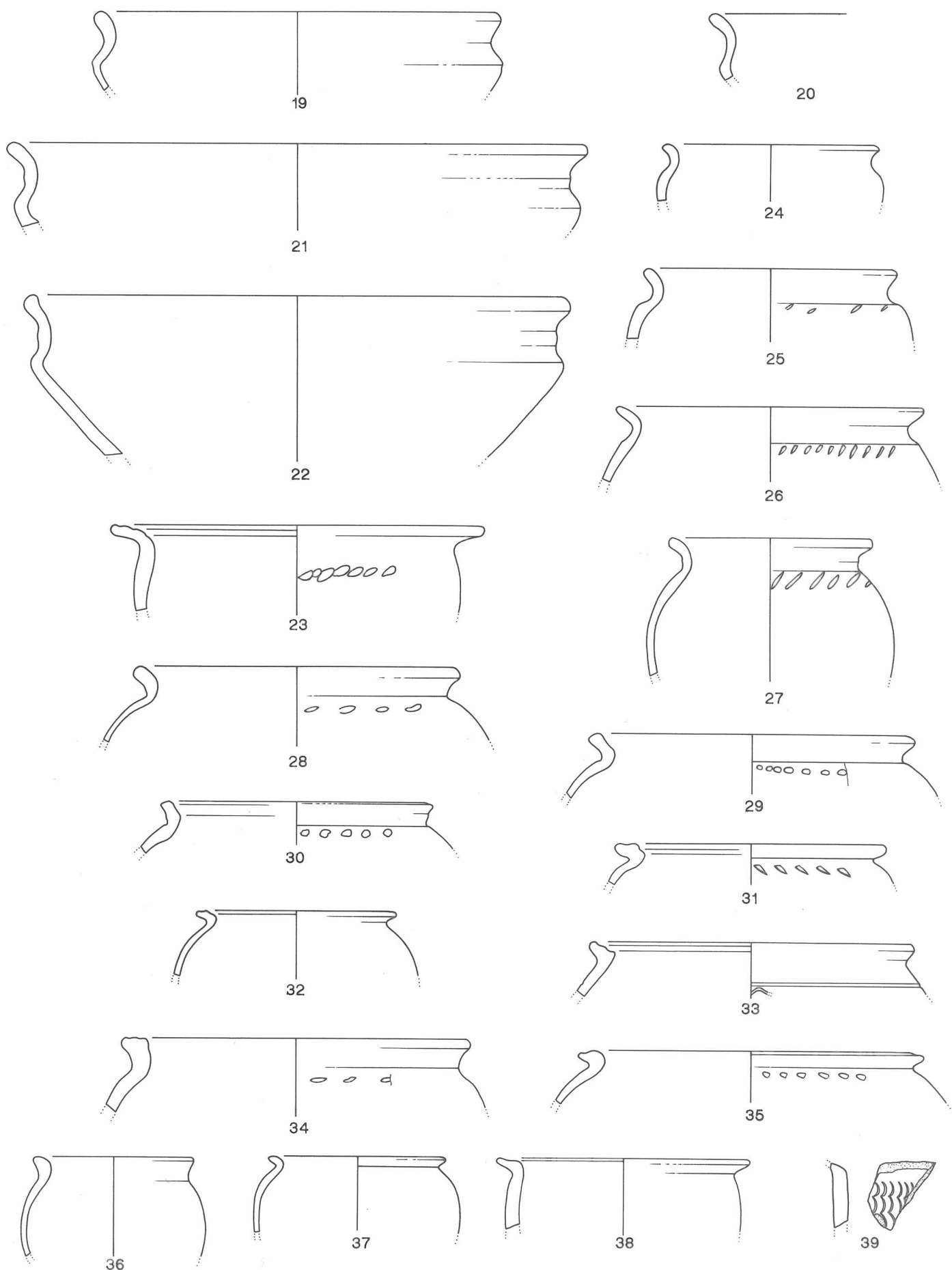

BRAUX -LA CROISEE (Ier s. av.).

19-23 : non tournée grossière, siliceuse ou calcaire ; 24-39 : tournée grossière, siliceuse.

Ech. : 1/3.

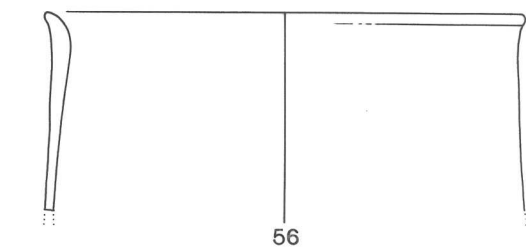
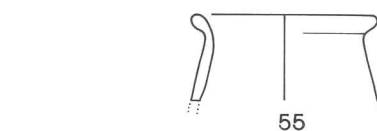
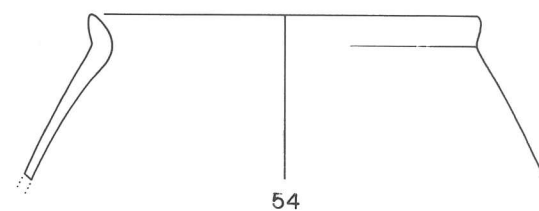
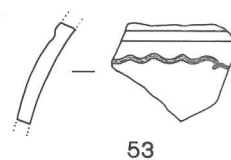
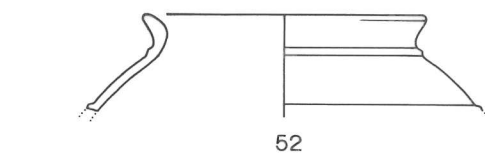
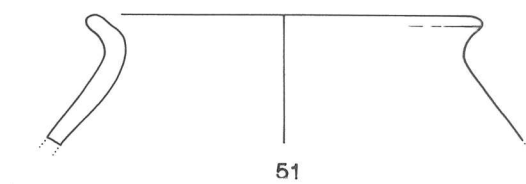
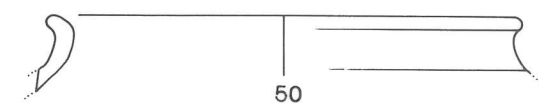
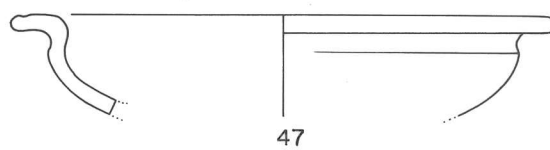
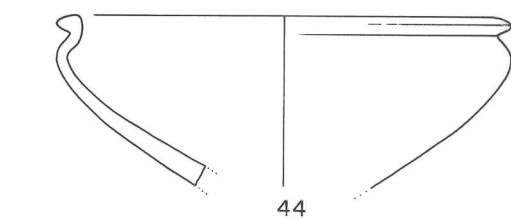
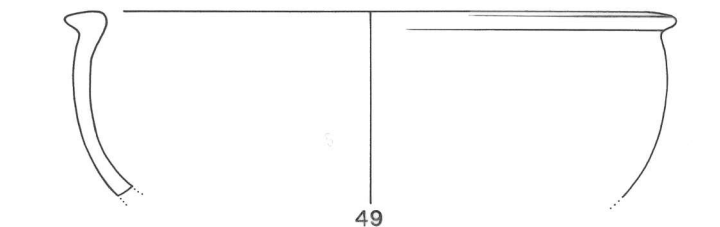
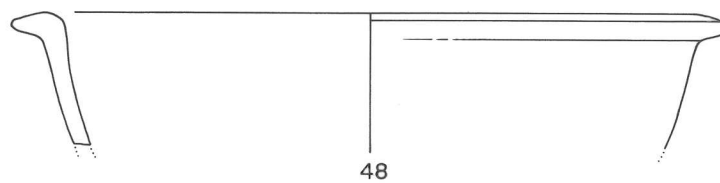
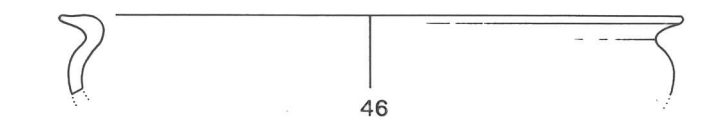
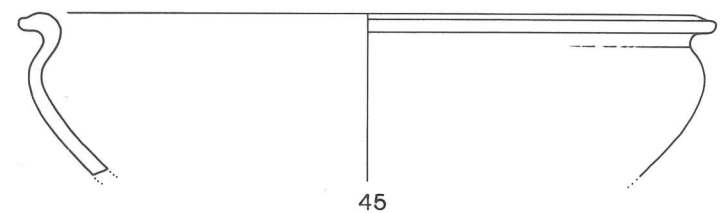
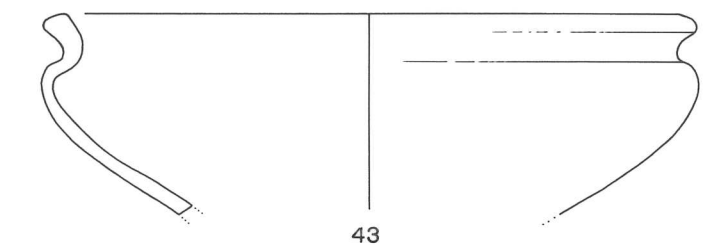
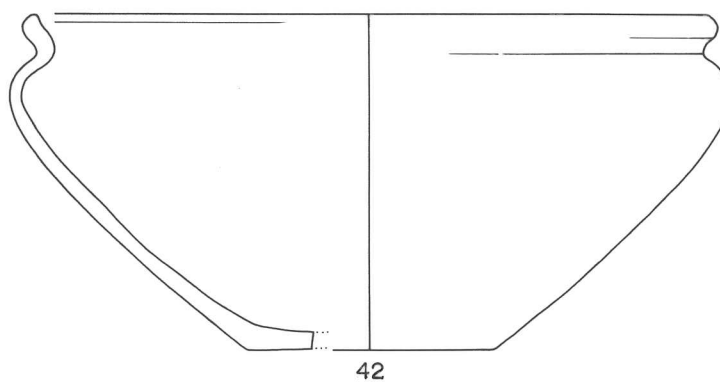
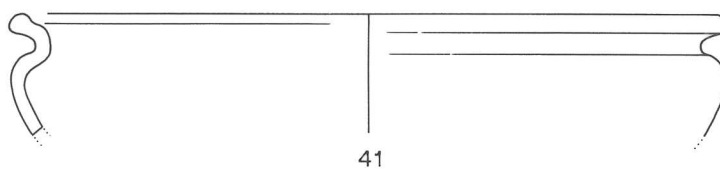
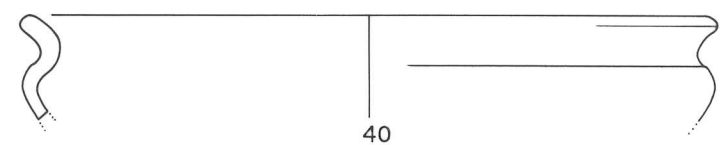

BRAUX -LA CROISEE (1er s. av.).

40-49 : tournée grossière, siliceuse ; 50-56 : mi-fine-fine sombre lissée. Ech. : 1/3.

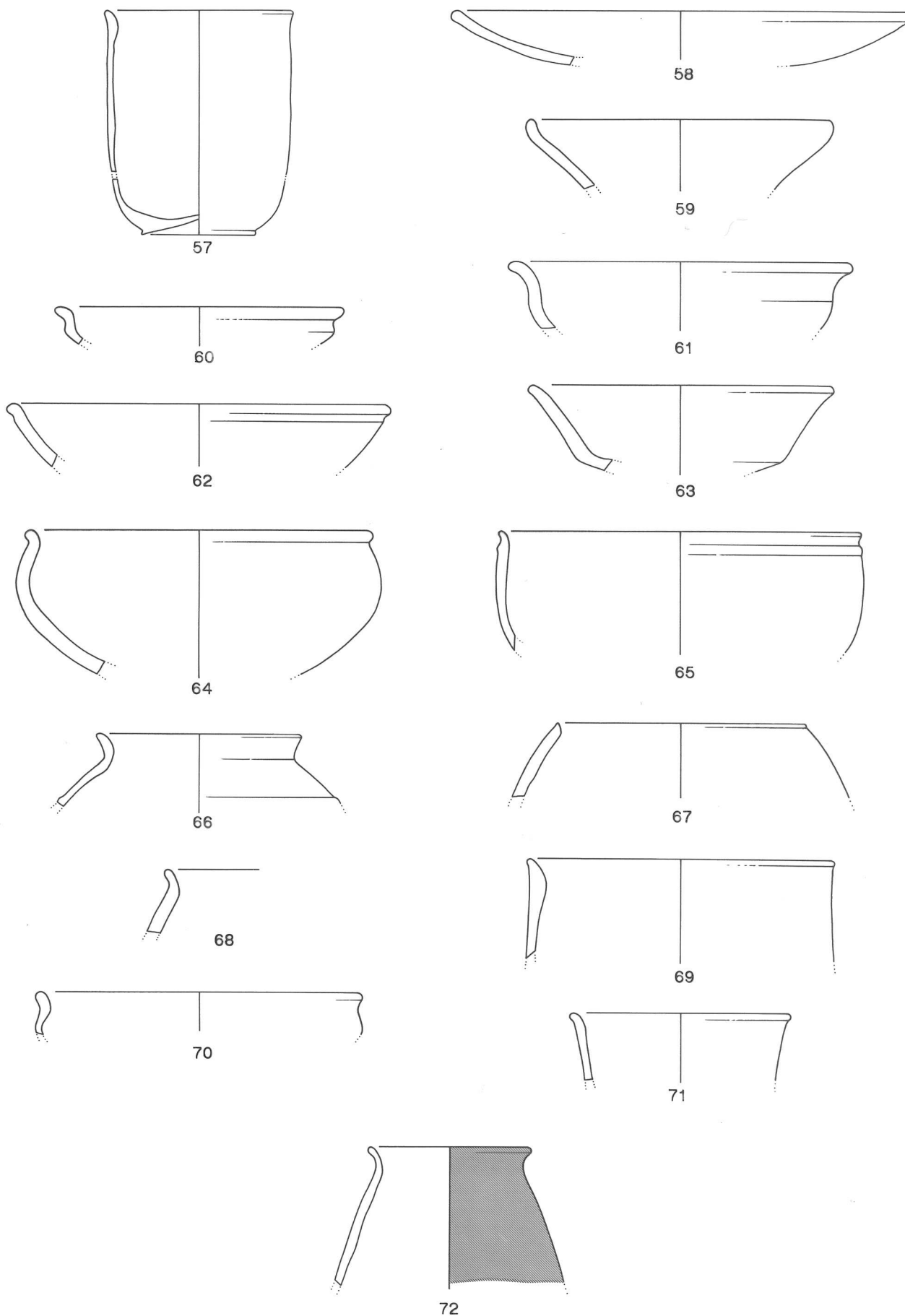

BRAUX -LA CROISEE (Ier s. av.).

57-65 : mi-fine-fine sombre lissée ; 66-71 : fine claire lissée ; 72 : fine peinte "lie de vin".

Ech. : 1/3.

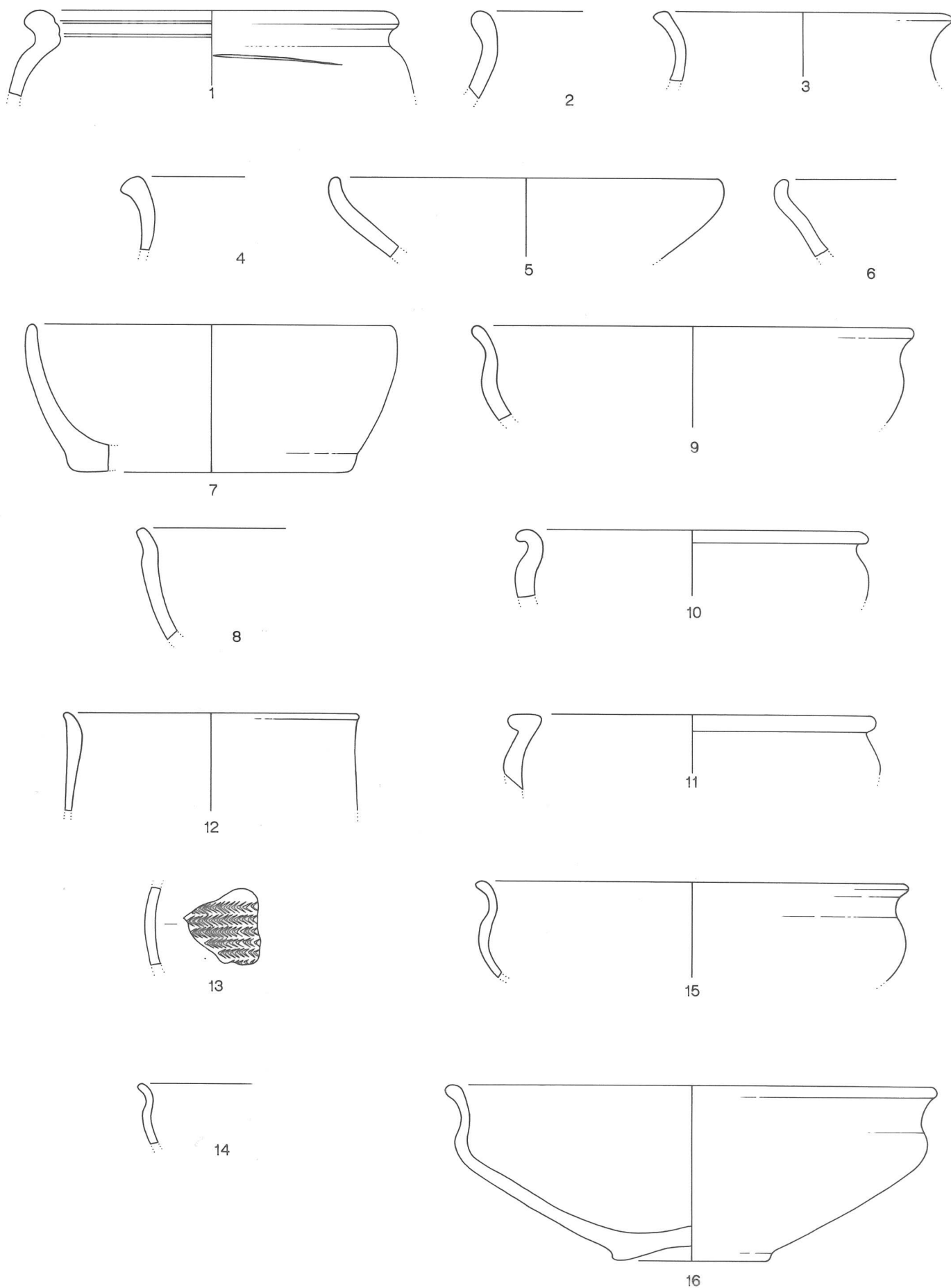

VILLIERS-LE-DUC -LE TREMBLOIS (fin II^e. - I^{er} s. av.).

1 : non tournée, grossière claire micacée ; 2-11 : tournée grossière, siliceuse (7-9) ou calcaire (2-6; 10, 11) ;
12-16 : mi-fine sombre lissée. Ech. : 1/3.

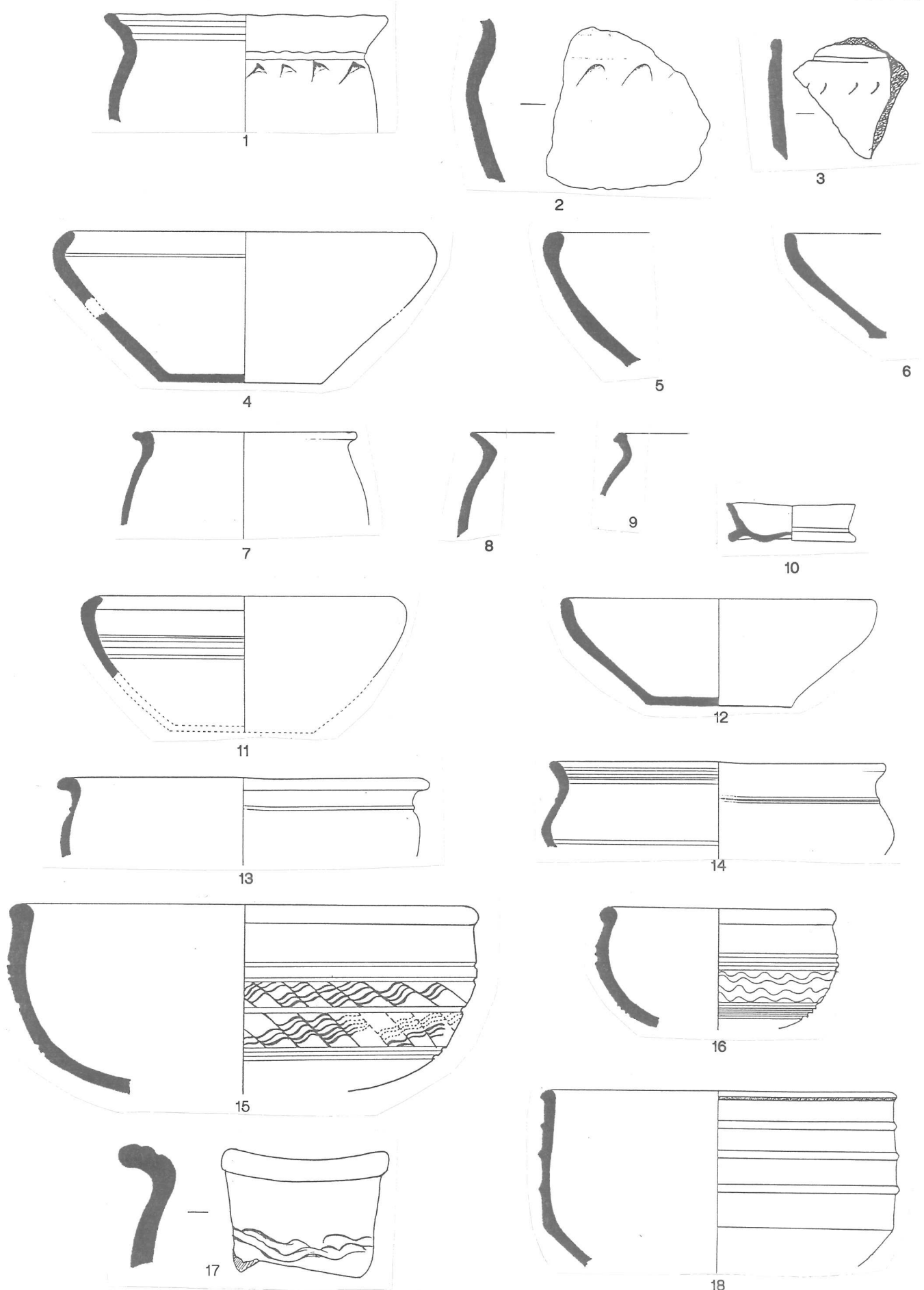

AVALLON -GRANDE RUE (2^e. moitié Ier s. av.).

1-6 : non tournée, grossière ; 7-18 : fine sombre lissée. Ech. diverses (extraits de Deffressigne 1985).

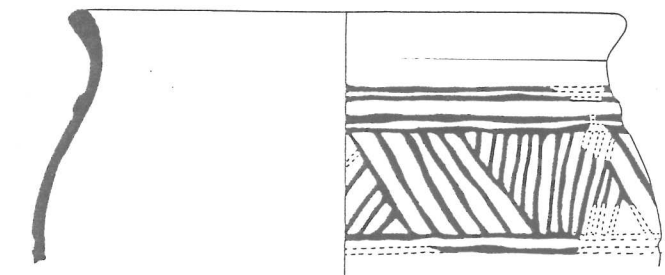

19

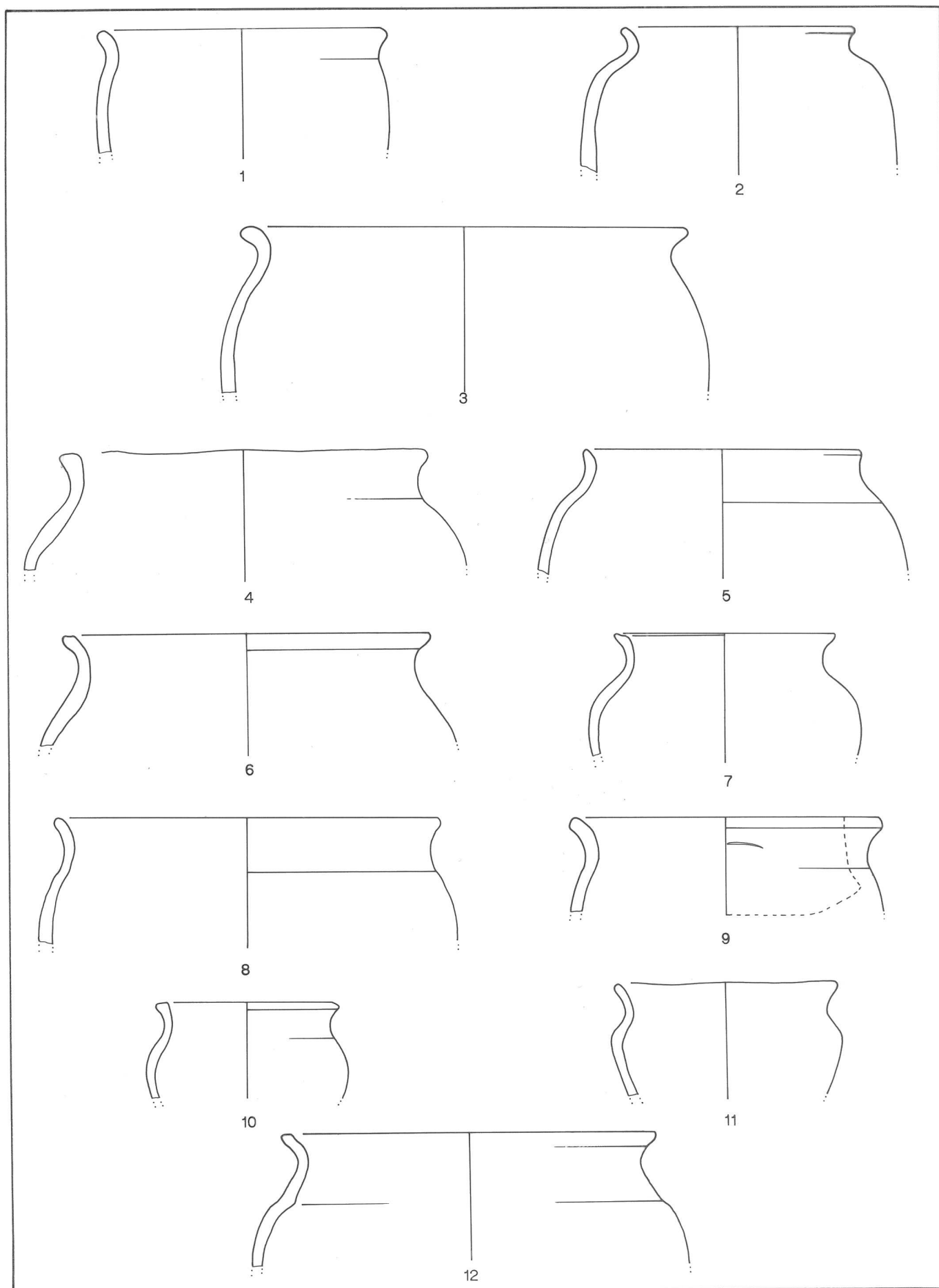

ST.-DENIS-LES-SENS -CHAMP NOTRE-DAME (2ème. moitié Ier s. av.).
1-12 : non tournée grossière. (Extraits de Joly à paraître). Ech. : 1/3.

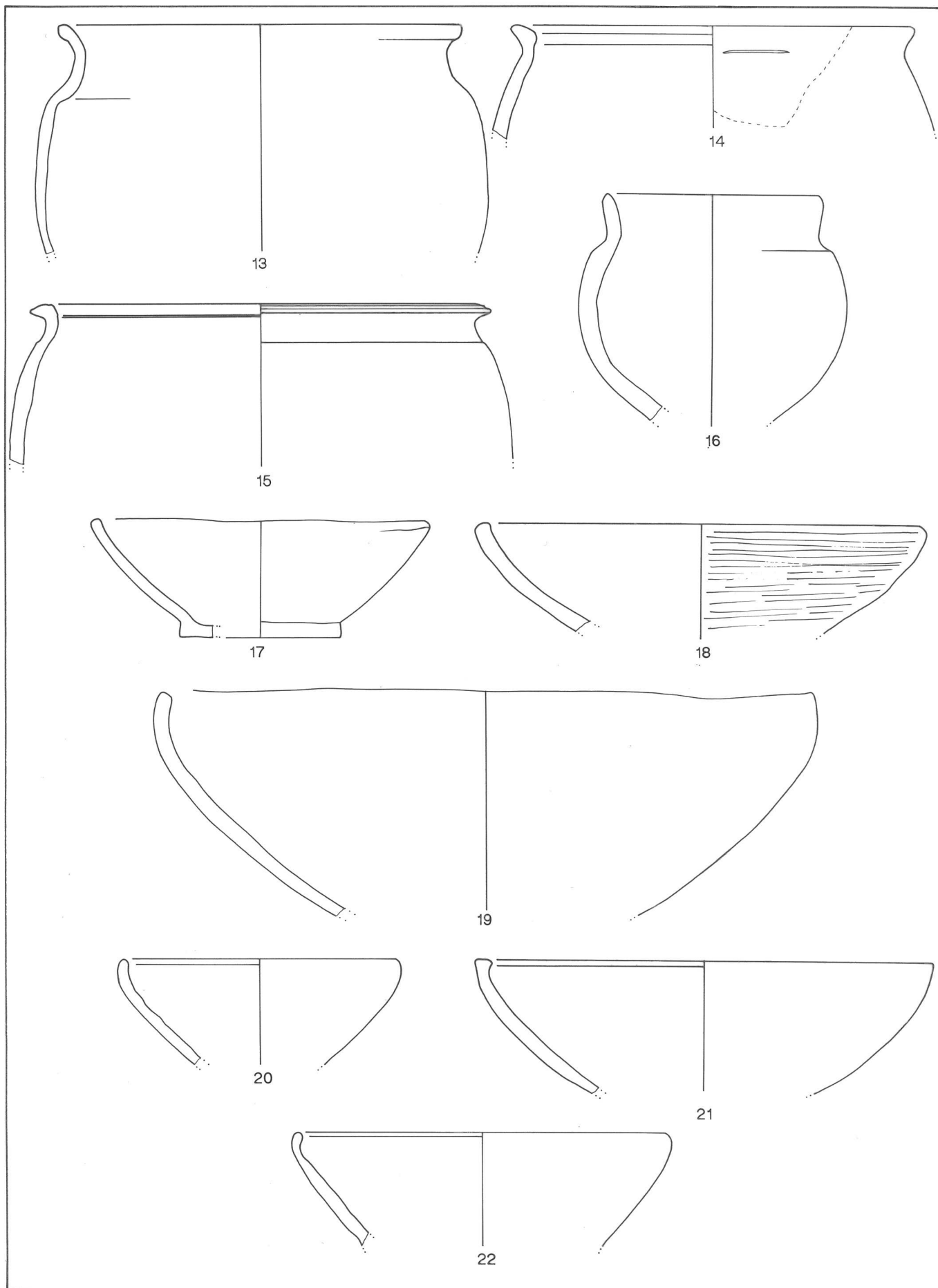

ST.-DENIS-LES-SENS -CHAMP NOTRE-DAME (2ème. moitié 1er s. av.).
13-22 : non tournée grossière. (Extraits de Joly à paraître). Ech. : 1/3.

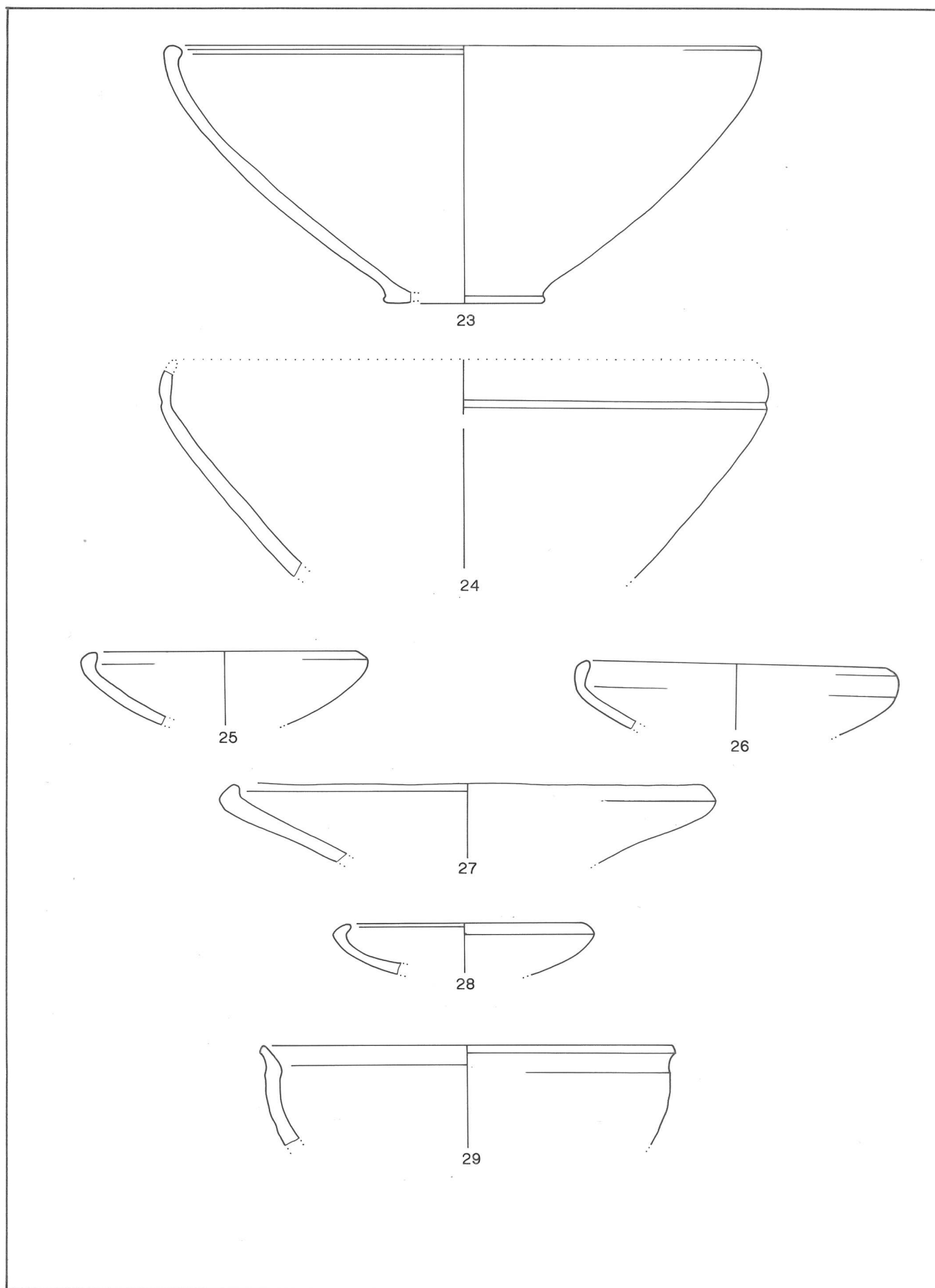

ST.-DENIS-LES-SENS -CHAMP NOTRE-DAME (2ème. moitié 1er s. av.).
23-29 : non tournée grossière. (Extraits de Joly à paraître). Ech. : 1/3.

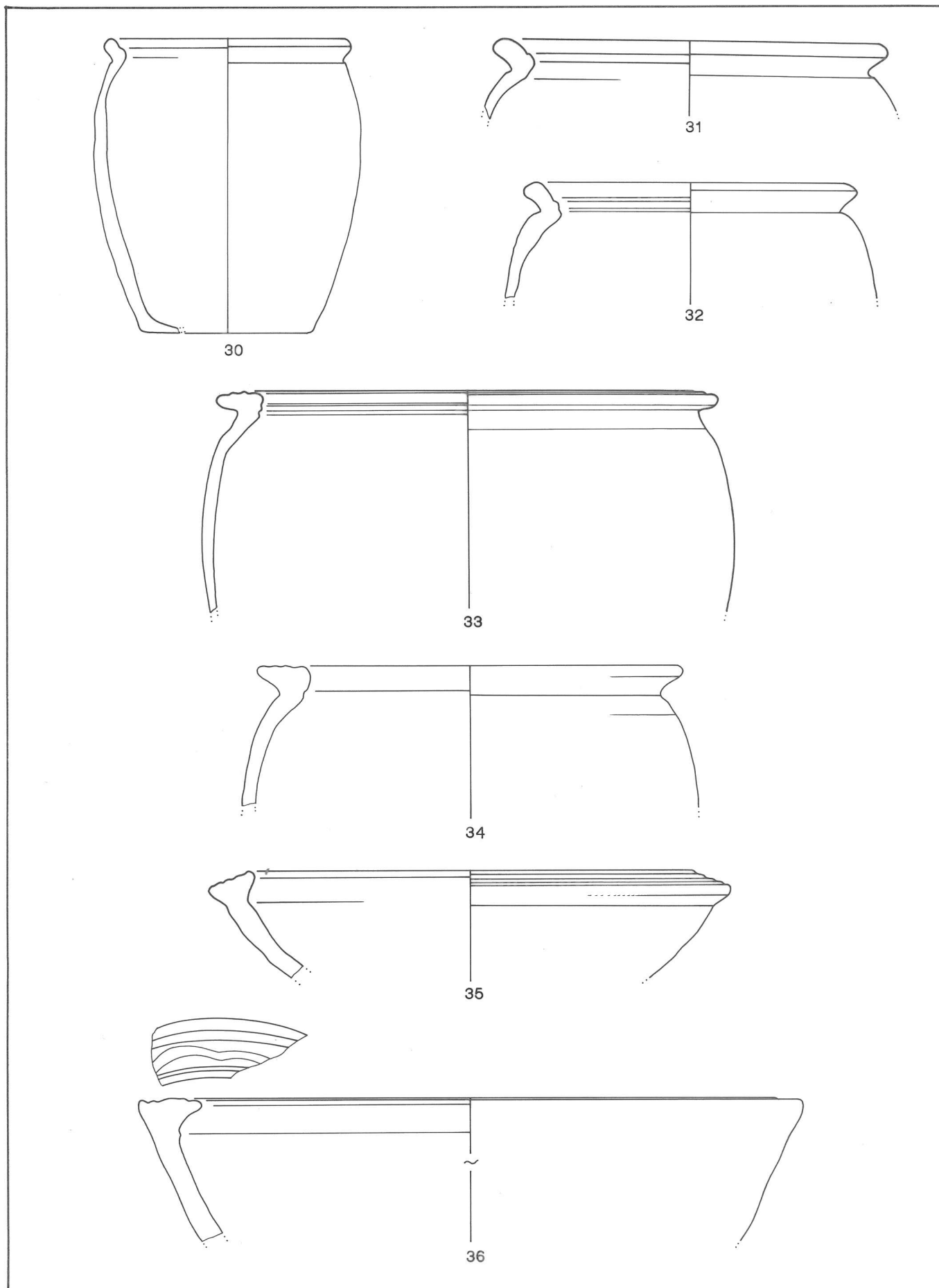

ST.-DENIS-LES-SENS -CHAMP NOTRE-DAME (2ème. moitié Ier s. av.).
30-36 : non tournée, grossière claire, micacée. (Extraits de Joly à paraître). Ech. : 1/3.

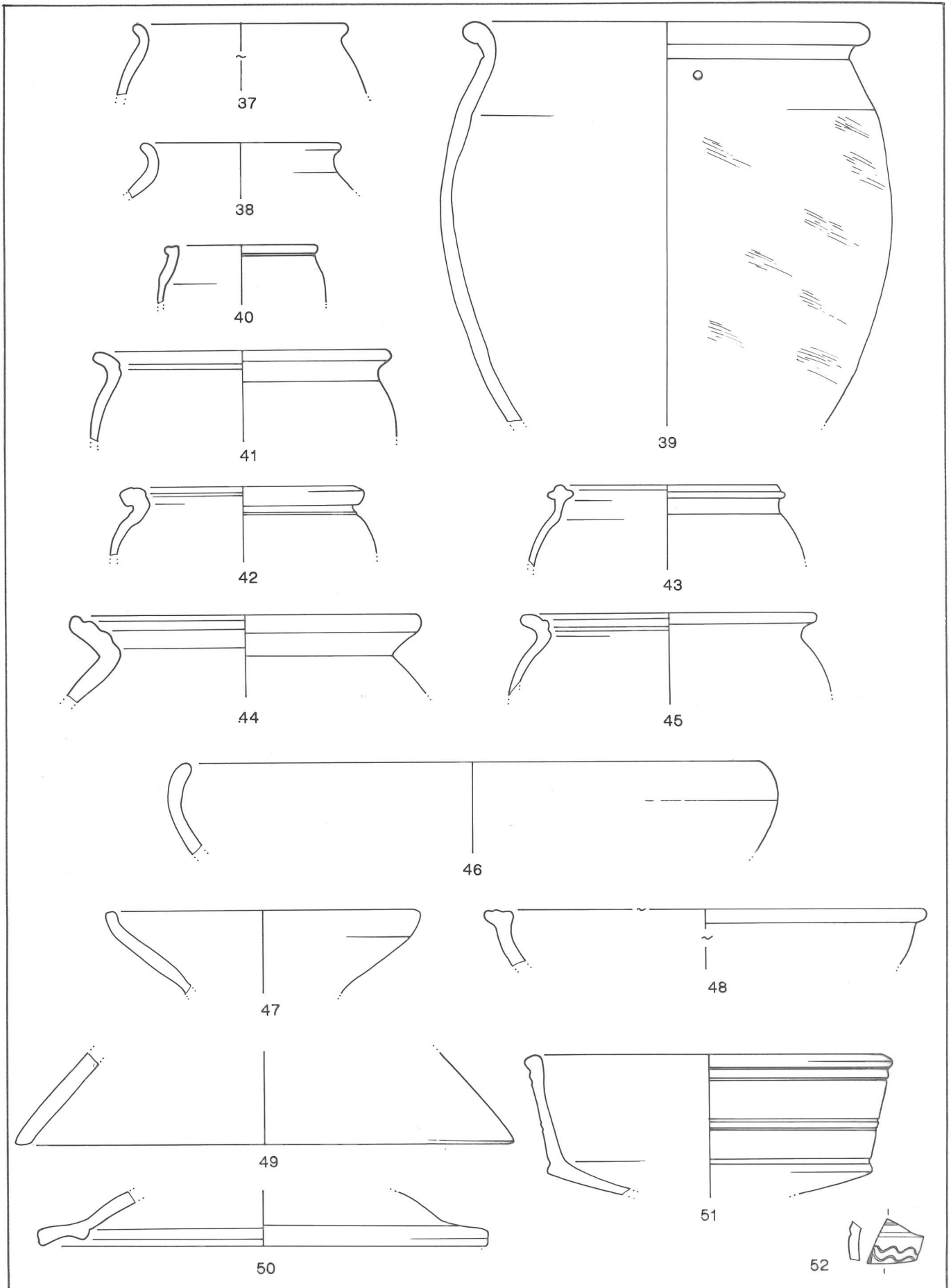

ST.-DENIS-LES-SENS -CHAMP NOTRE-DAME (2ème. moitié 1er s. av.).
37-52 : grossière-mi-fine claire (51 : micacée). (Extraits de Joly à paraître). Ech. : 1/3.

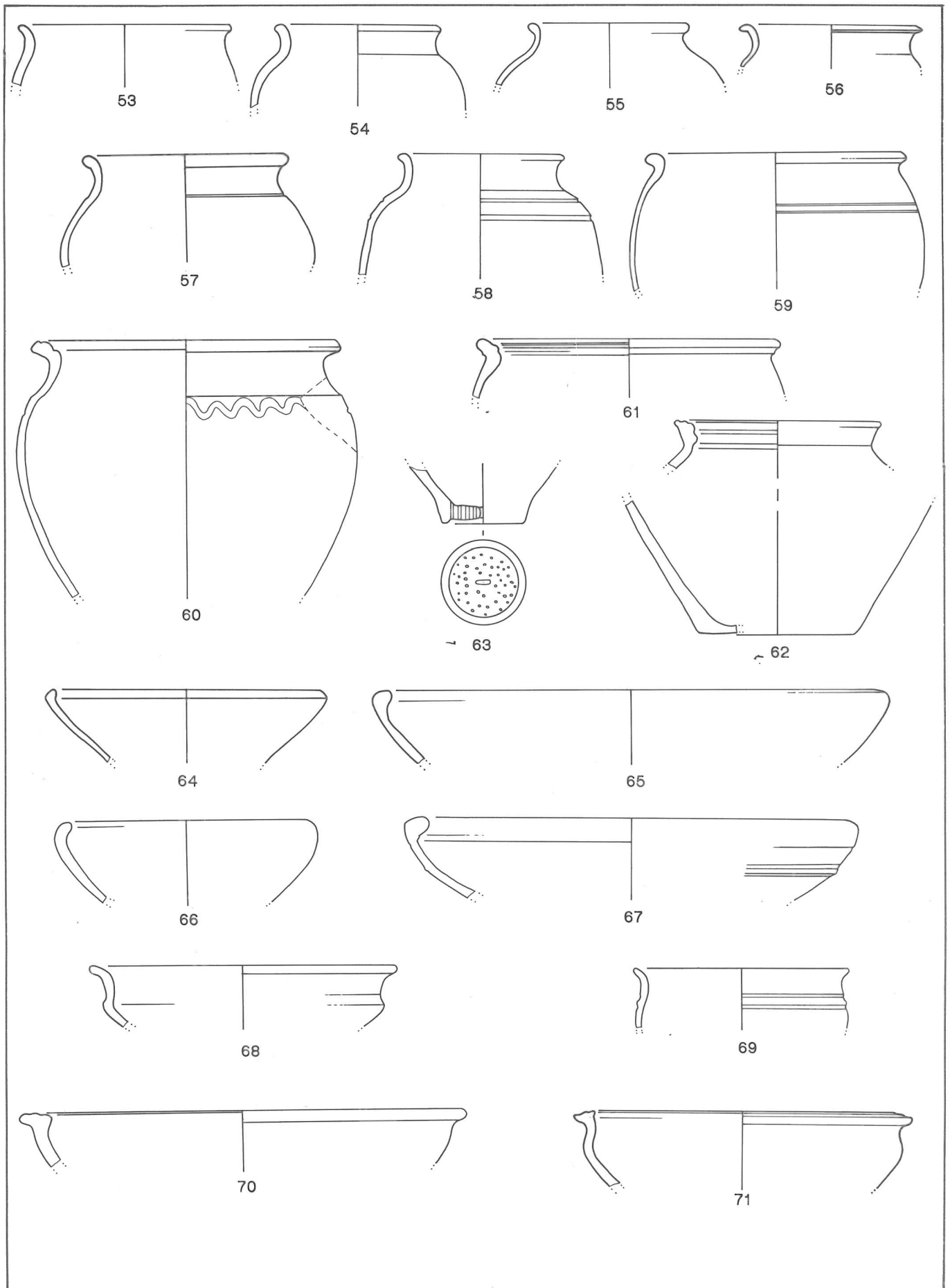

ST.-DENIS-LES-SENS -CHAMP NOTRE-DAME (2ème. moitié Ier s. av.).
53-71 : mi-fine siliceuse sombre. (Extraits de Joly à paraître). Ech. : 1/3.

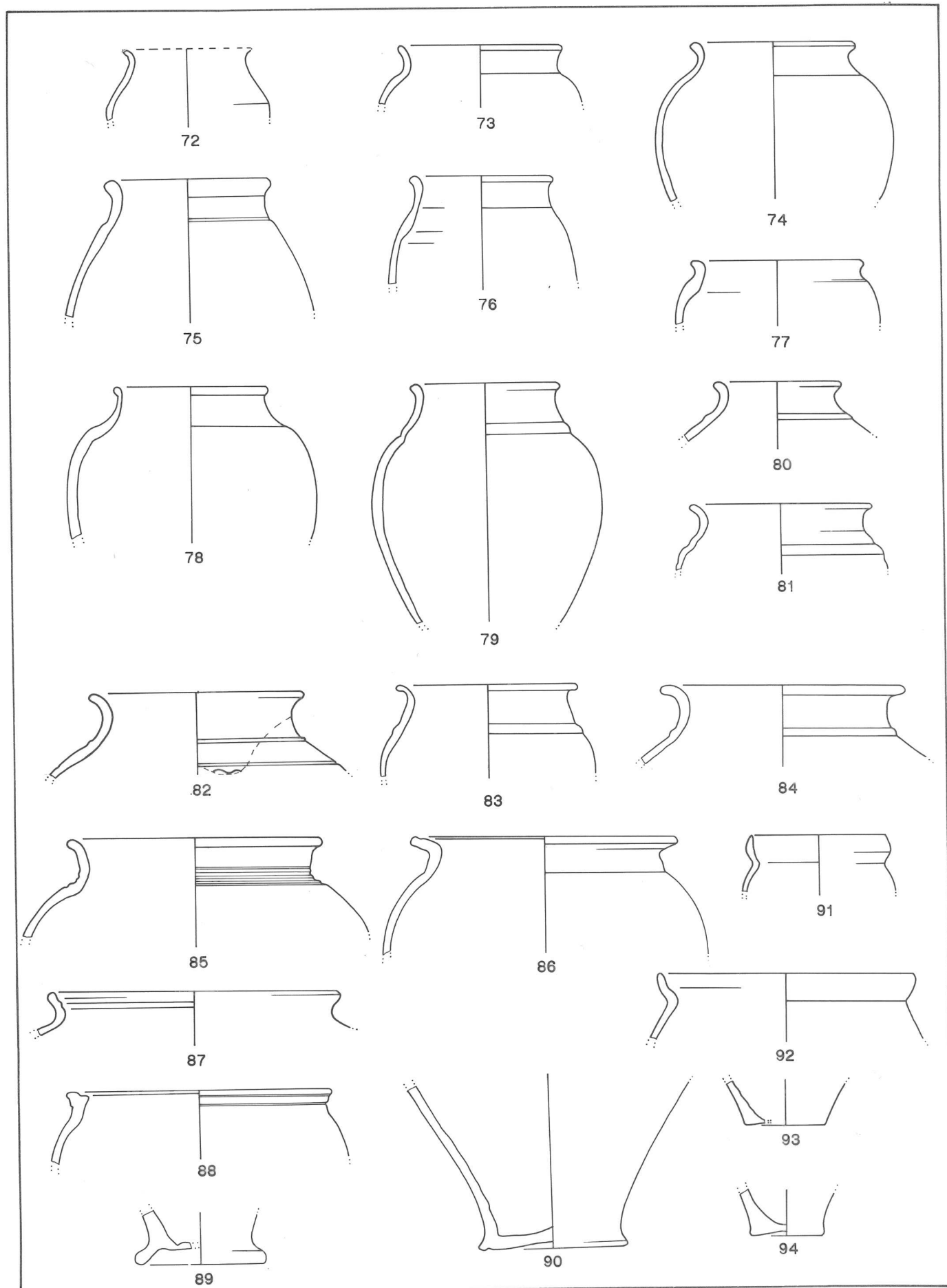

ST.-DENIS-LES-SENS -CHAMP NOTRE-DAME (2ème. moitié 1er s. av.).
72-94 : mi-fine sombre lissée. (Extraits de Joly à paraître). Ech. : 1/3.

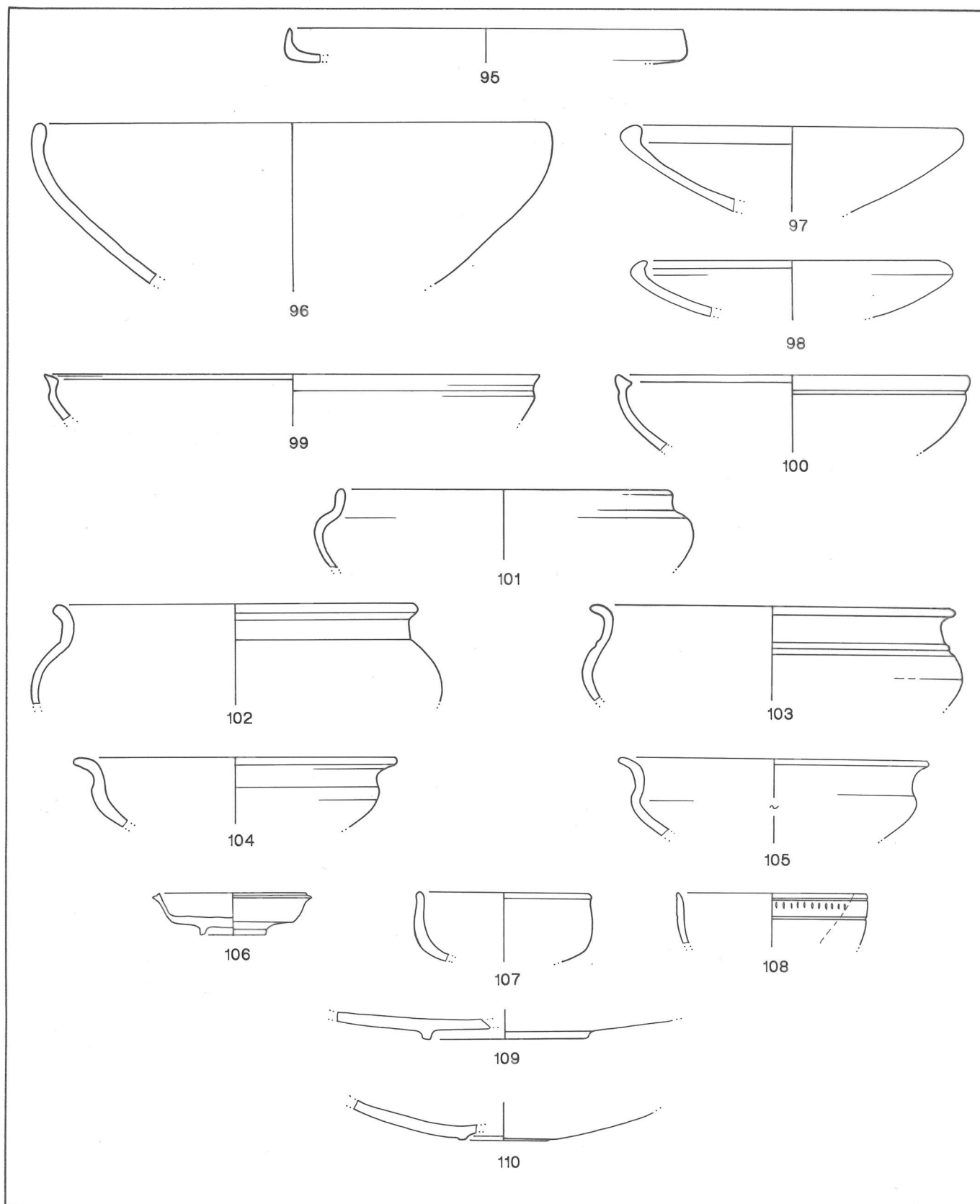

ST.-DENIS-LES-SENS -CHAMP NOTRE-DAME (2ème. moitié 1er s. av.).
95-110 : mi-fine sombre lissée. (Extraits de Joly à paraître). Ech. : 1/3.

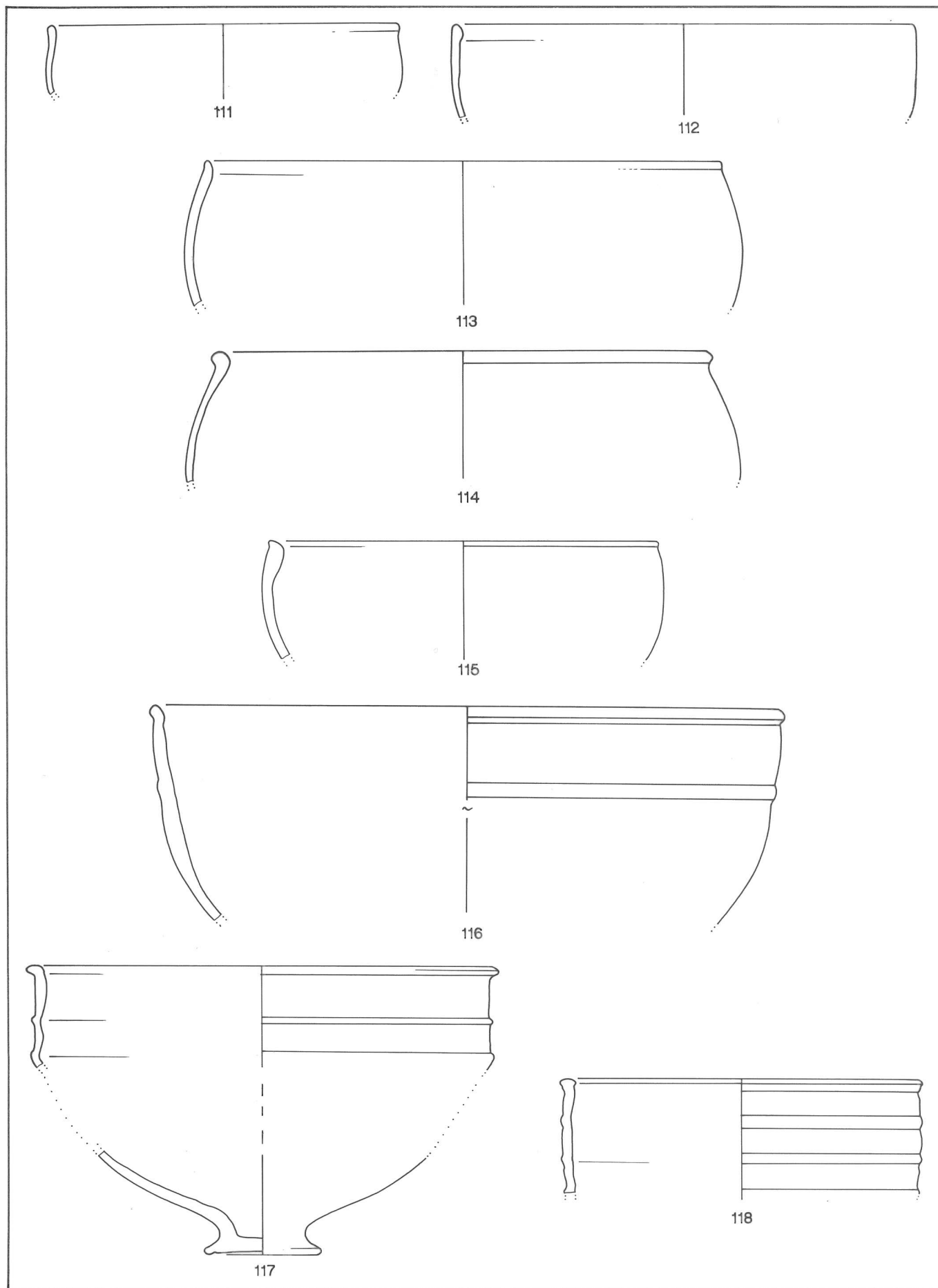

ST.-DENIS-LES-SENS -CHAMP NOTRE-DAME (2ème. moitié Ier s. av.).
111-118 : mi-fine sombre lissée. (Extraits de Joly à paraître). Ech. : 1/3.

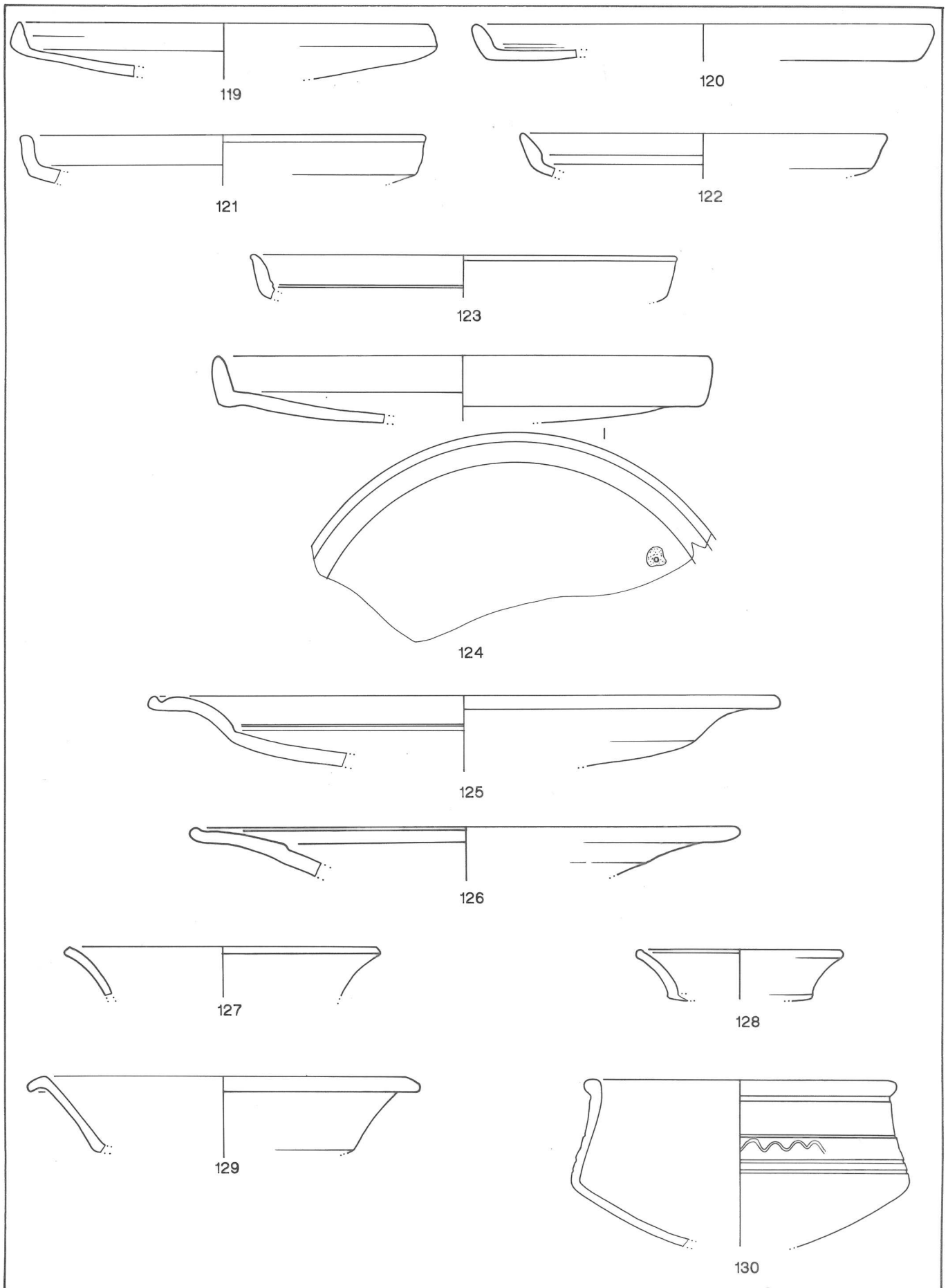

ST.-DENIS-LES-SENS -CHAMP NOTRE-DAME (2ème. moitié Ier s. av.).
119-130 : fine sombre homogène. (Extraits de Joly à paraître). Ech. : 1/3.

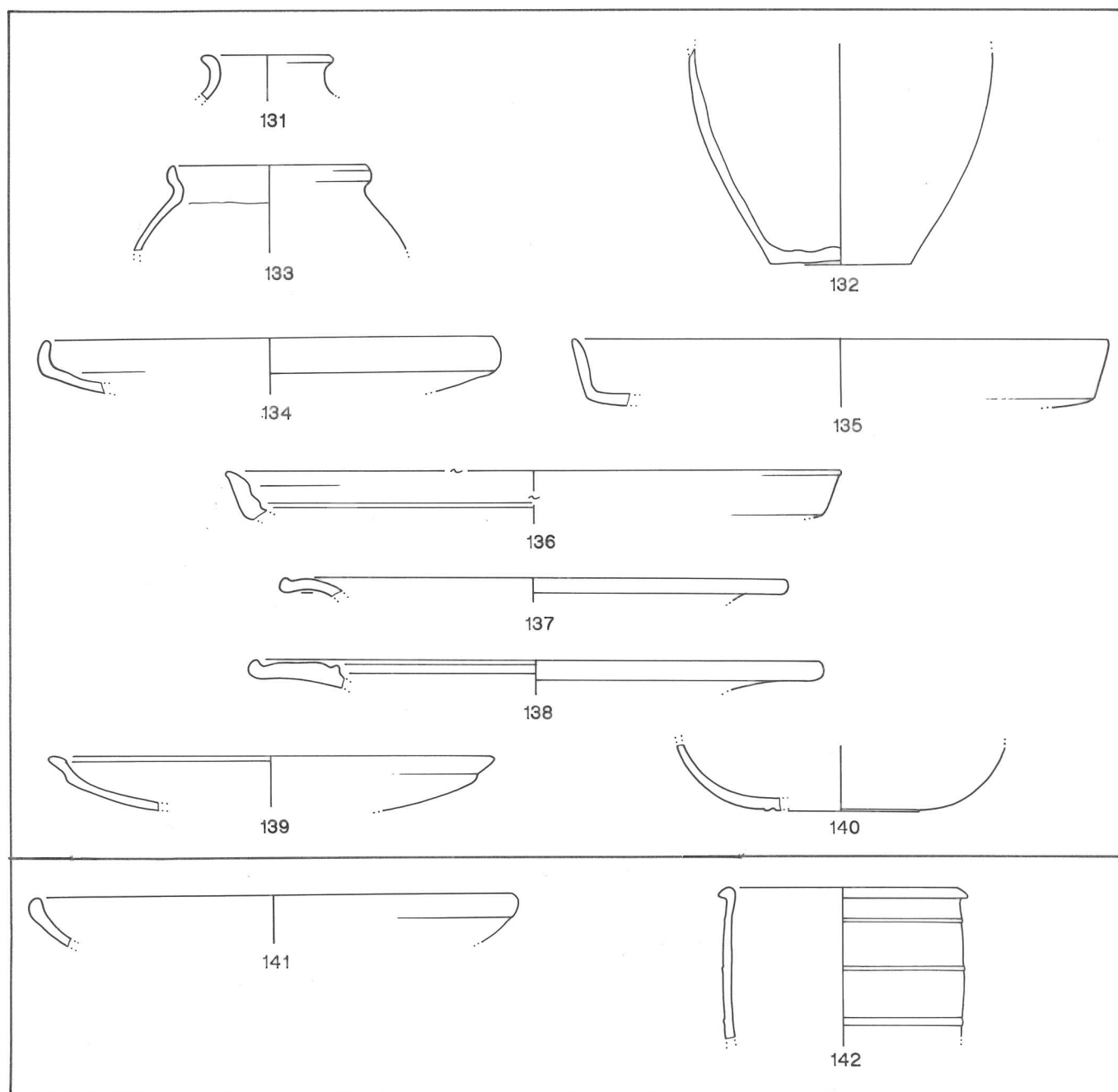

ST.-DENIS-LES-SENS -CHAMP NOTRE-DAME (2ème. moitié 1er s. av.).

131-140 : fine claire (135 : engobe rouge ; 136, 137, 139, 140 : lissée ; 138 : engobe micacé) ; 141 : claire siliceuse à engobe rouge interne ; 142 : fine claire calcaire. (Extraits de Joly à paraître). Ech. : 1/3.

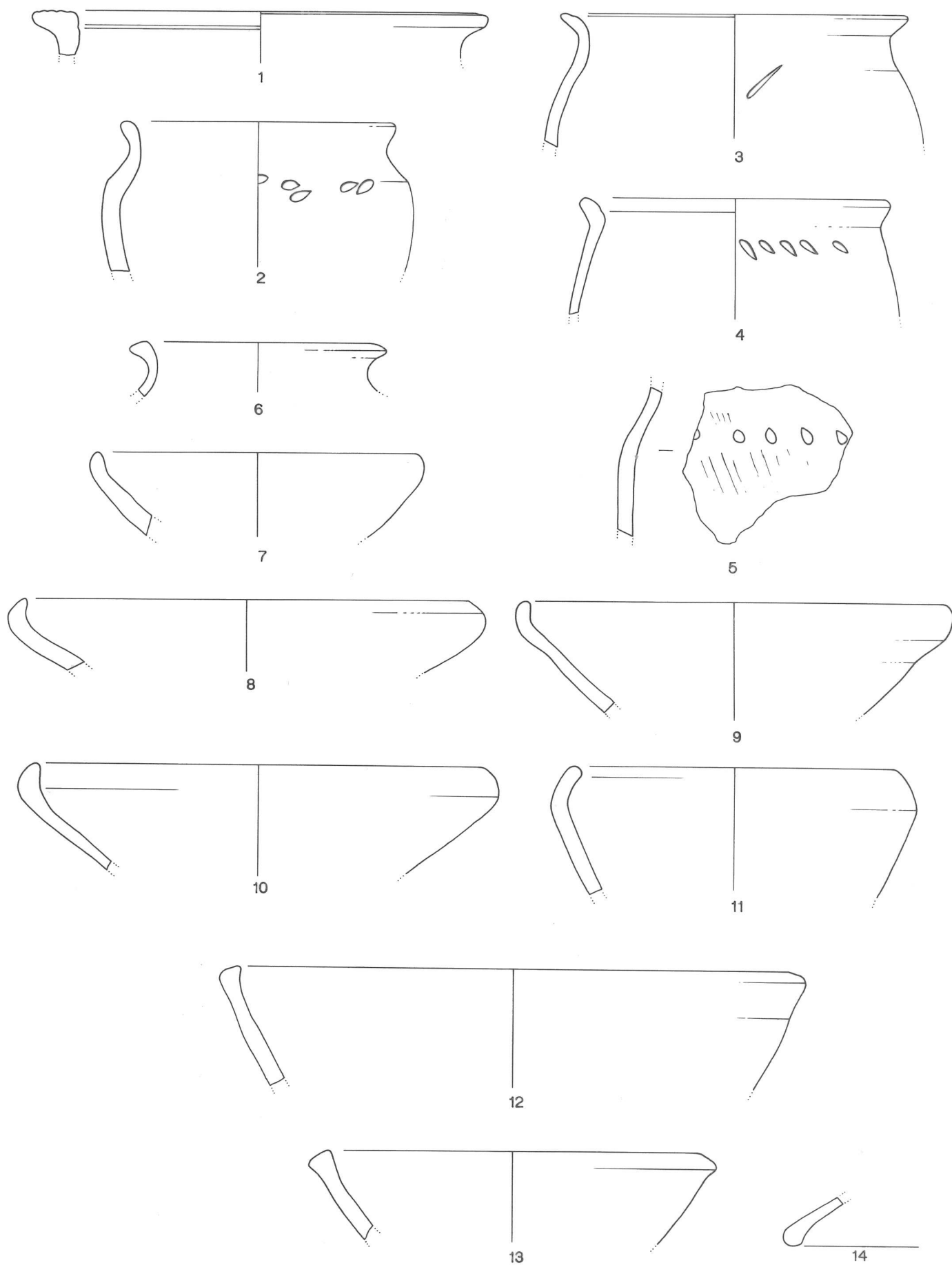

LONS-LE-SAUNIER -LA COMEDIE (fin IIè.- déb. Ier s. av. ?).

1 : non tournée, grossière claire micacée ; 2-14 : non tournée, grossière siliceuse ou calcaire. Ech. : 1/3.

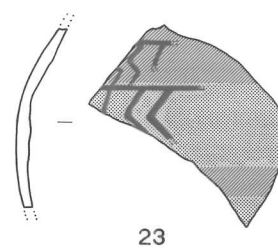
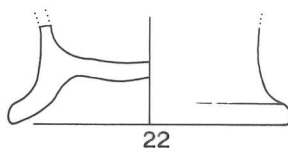
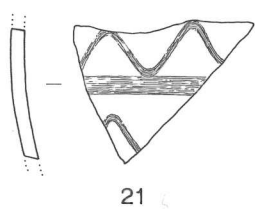
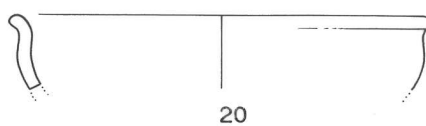
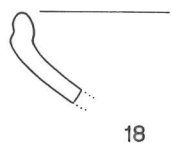
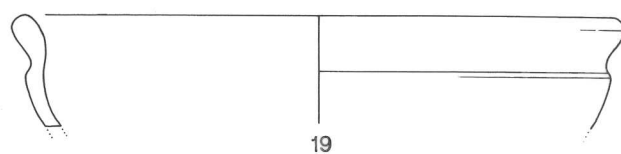
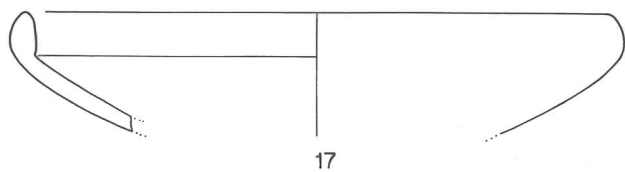
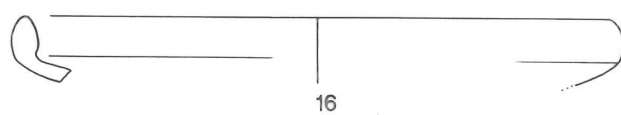
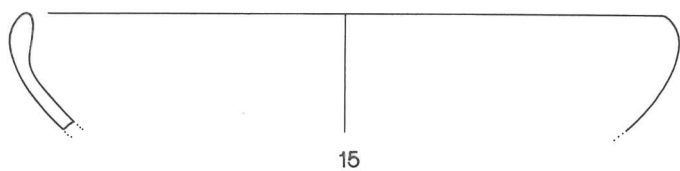

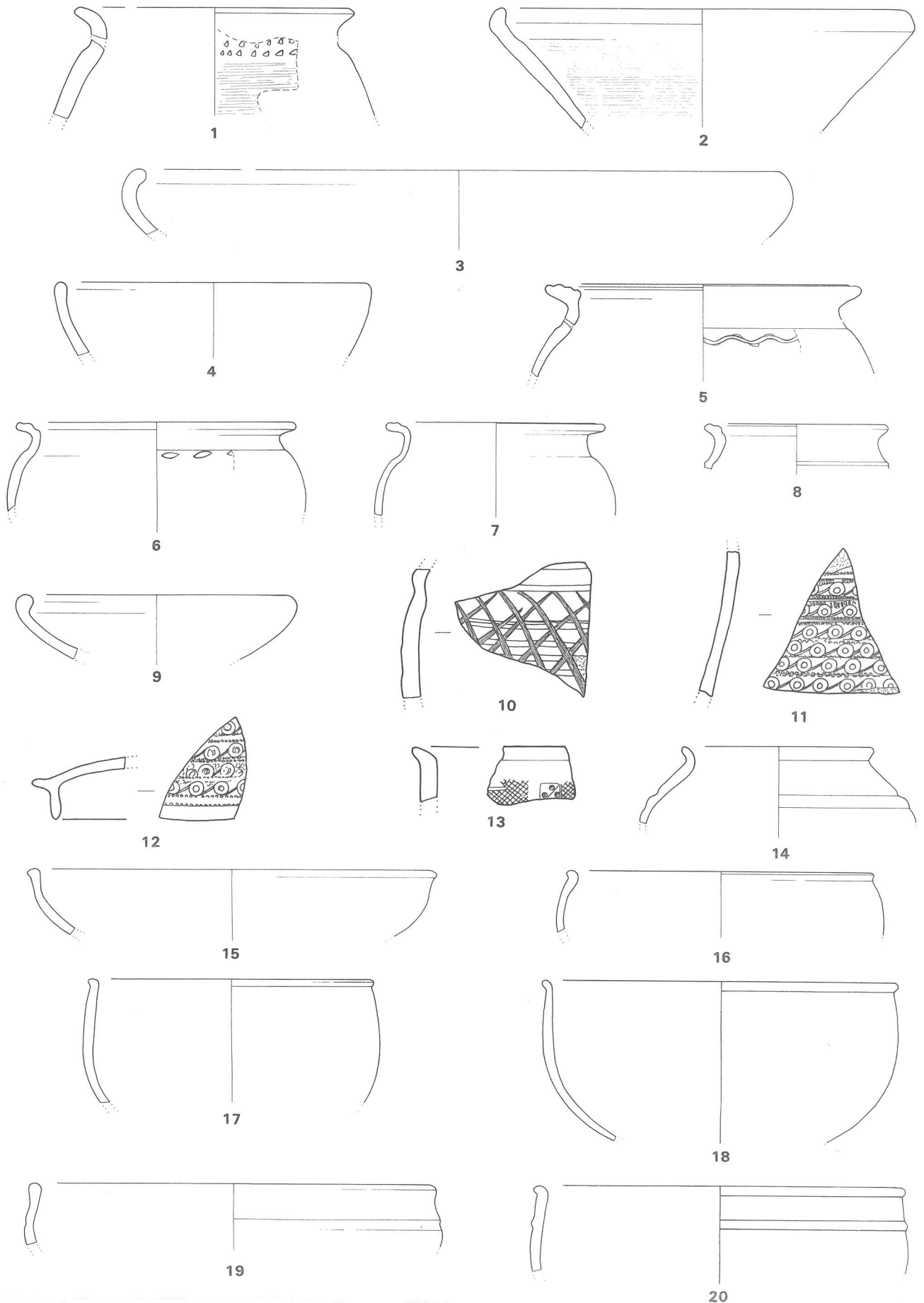

LANGRES MARCHE-COUVERT -Fosse 2042 (-40/-30 à -20/-10).

1-4 : grossière non tournée ; 5-9 : mi-fine-grossière tournée ; 10-20 : fine sombre lissée. (Extraits de Barral, Joly, Belarbi à paraître). Ech. 1/3, sauf n° 10 à 13 : 1/2.

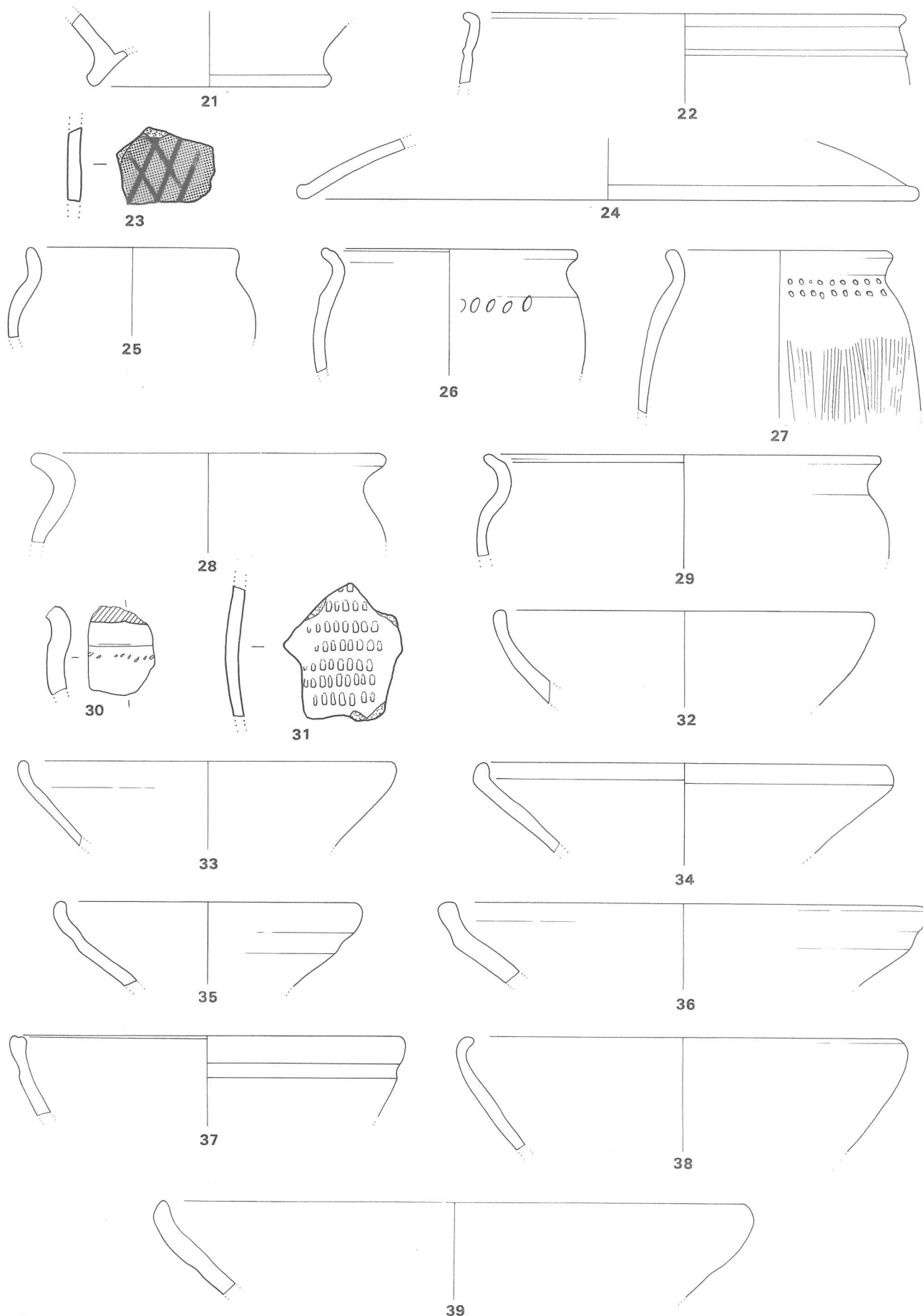

LANGRES MARCHE-COUVERT -Fosse 2042 (n°21-24) et contextes divers (-40/-30 à -20/-10).
21-24 : fine claire ; 25-39 : grossière non tournée. (Extraits de Barral, Joly, Belarbi à paraître). Ech. 1/3,
sauf n° 31 : 1/2.

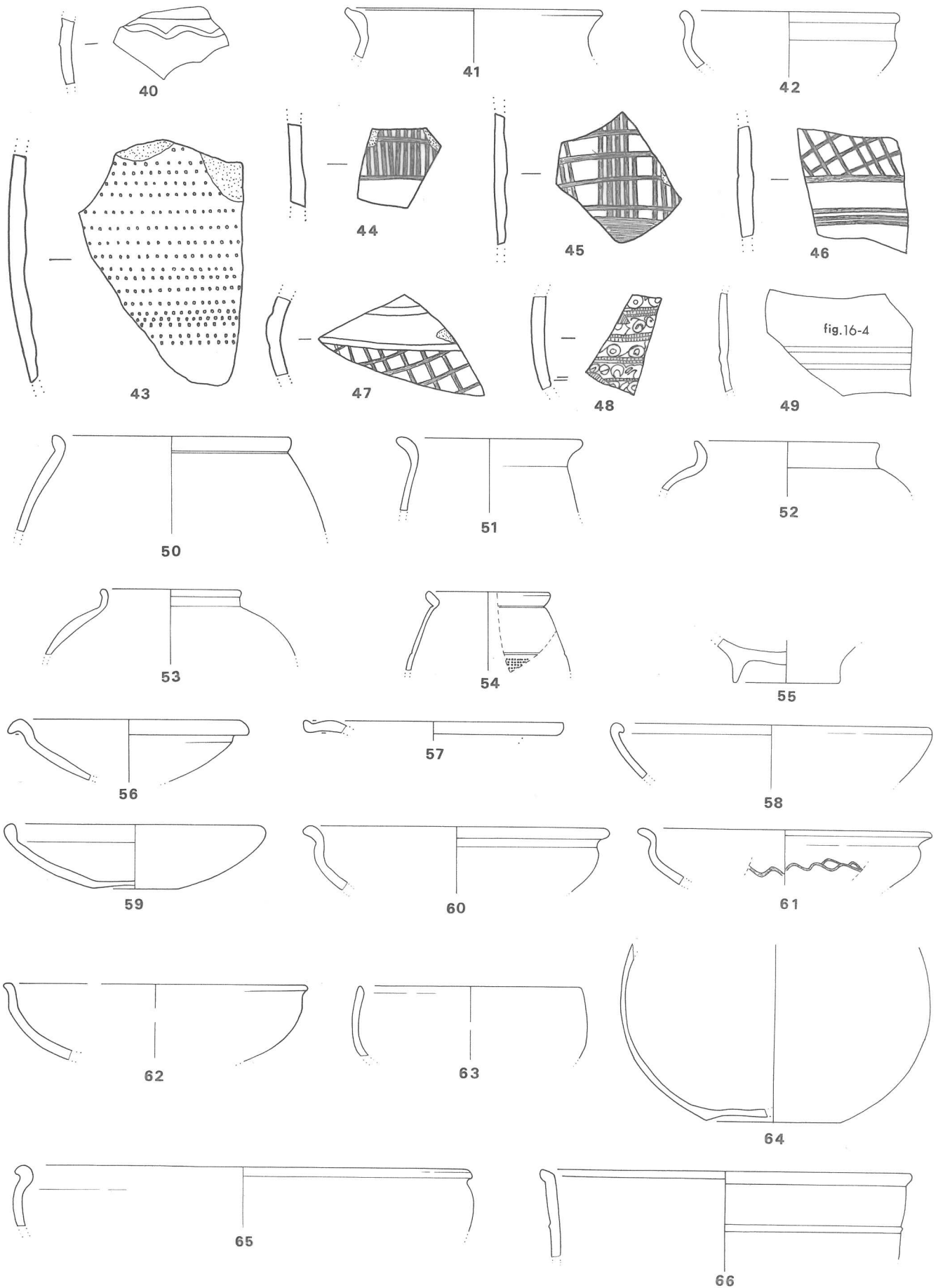

LANGRES MARCHE-COUVERT -Contextes divers (-40/-30 à -20/-10).

40-42 : mi-fine-grossière tournée ; 43-48, 50- 53 et 55-66 : fine sombre lissée ; 49-54 : fine grise homogène. (Extraits de Barral, Joly, Belarbi à paraître). Ech. 1/3, sauf n° 43 à 48 : 1/2.

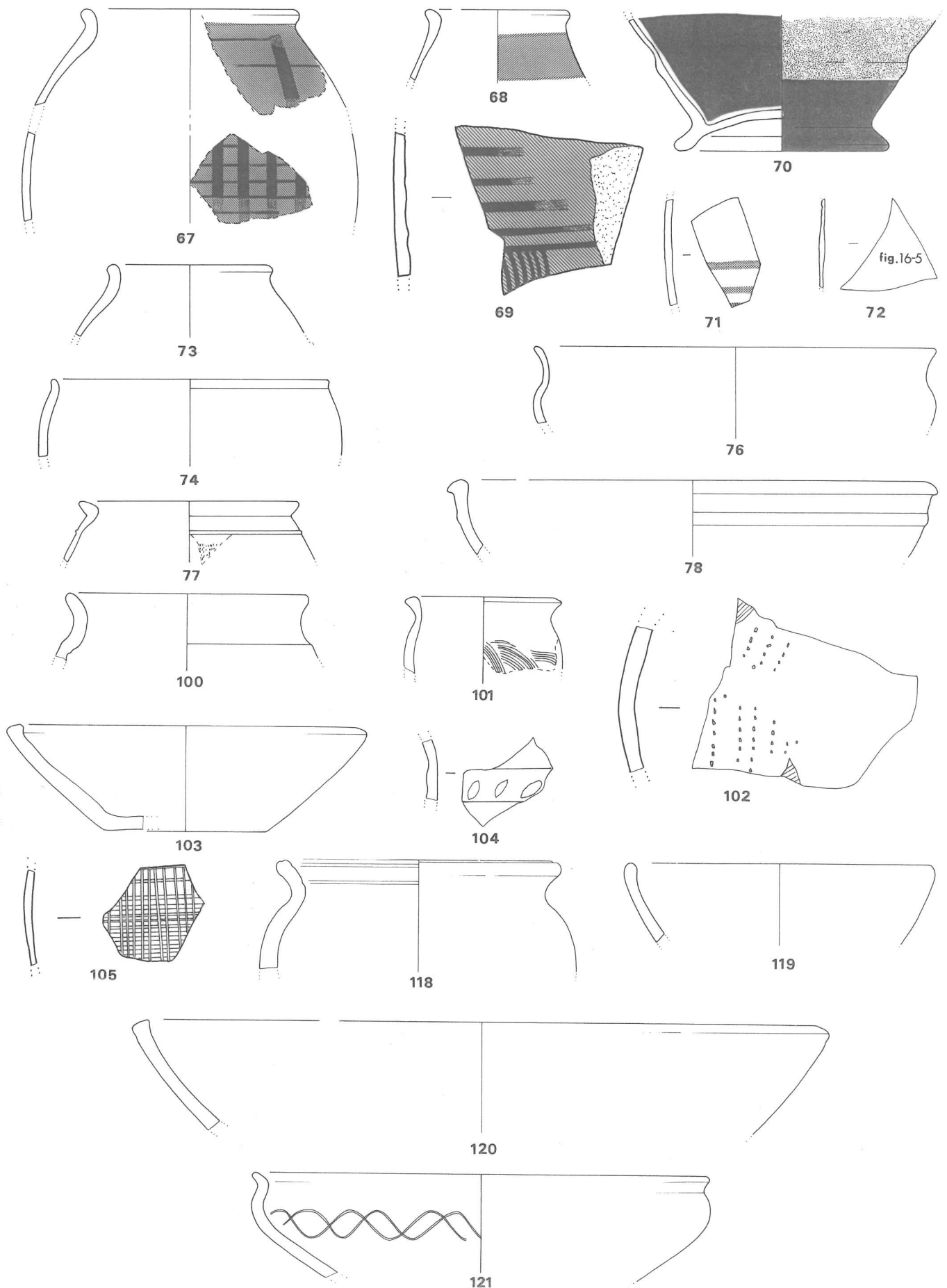

LANGRES MARCHE-COUVERT -Contextes divers.

-Contextes divers (-40/-30 à -20/-10). 67-69, 71 : peinte ; 70 : fine claire micacée ; 72-78 : fine claire. -

-Contextes divers non datés. 100-102 : grossière non tournée ; 105 : fine sombre lissée. -Hors stratigraphie. 118-120 : grossière non tournée ; 121, 123, 125 : fine sombre lissée ; 131-134 : campanienne Boïde. (Extraits de Barral, Joly, Belarbi à paraître). Ech. 1/3, sauf 102 et 105 : 1/2.

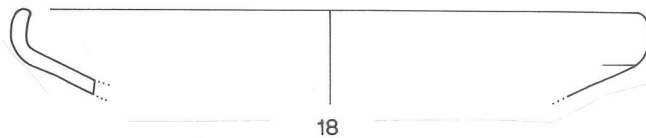
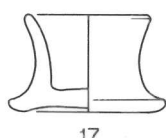
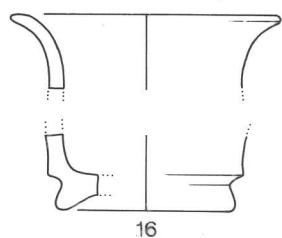
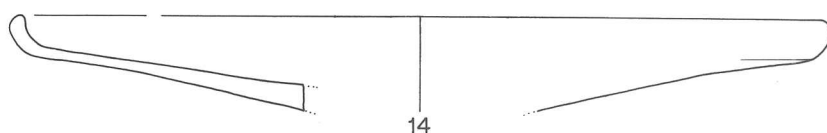
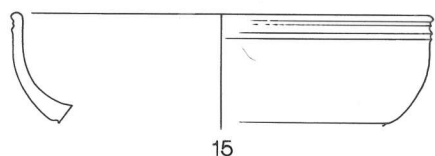
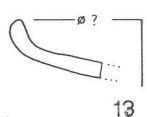
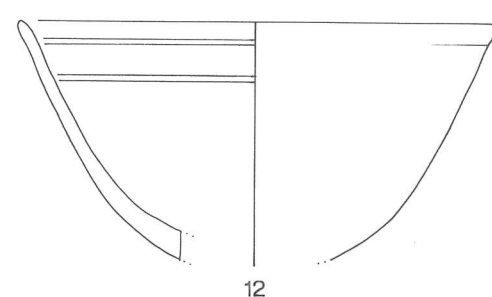
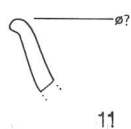
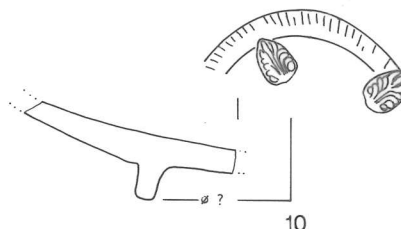
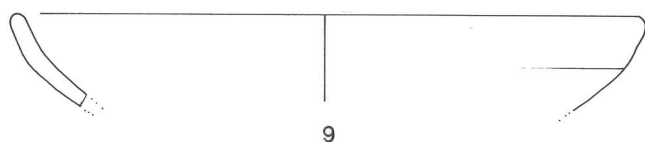
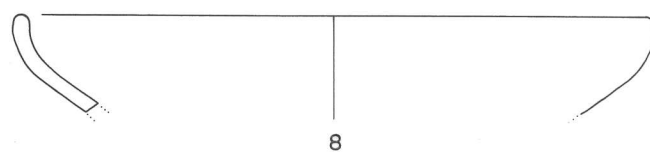
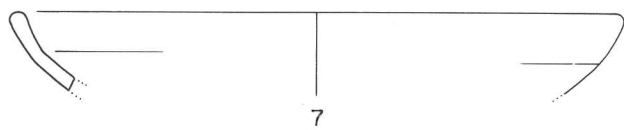
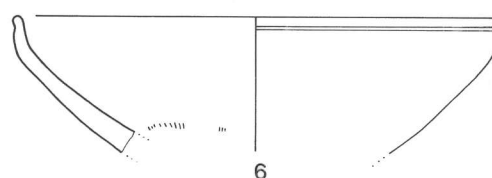
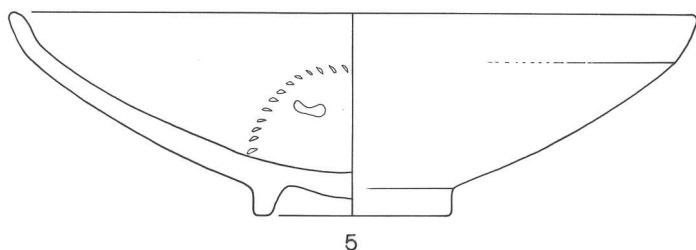
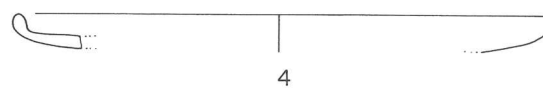
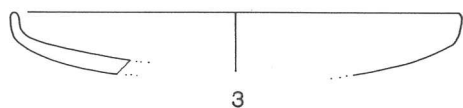
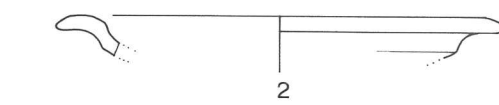
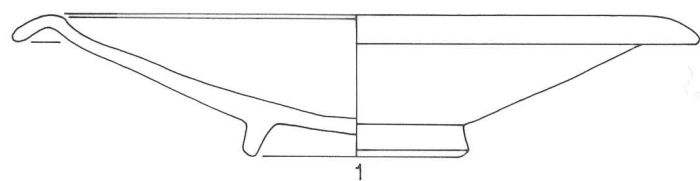

VALLEE DE LA SAONE : céramiques importées à vernis noir (IIè.-Ier s. av.).

1-12. **Camp. A.** 1, 2 : assiette Lamb. 36 ; 3-4 : assiettes Lamb. 5 ; 5-9 : coupe Lamb. 27 (5, 7-9 : Lamb. 27B) ; 11 : coupe Lamb. 28 ab ? ; 12 : bol Lamb. 31 ; 13-17. **Camp. Boïde.** 13-14 : assiettes Lamb. 5 ; 15 : bol Lamb. 1 ; 16 : coupelle Lamb. 2 ; 17 : pyxis Lamb. 3 ; 18. **Camp. C.** Assiette Lamb. 5/7.

1, 7, 8 : Mirebeau ; 2-4, 9-13 : Verdun P.C. ; 5 : St.-Symphorien ; 6 : Verjux E.C. ; 14-17 : Tournus 7FN ; 18 : Mâcon C.M.

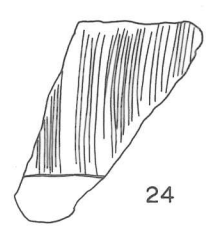
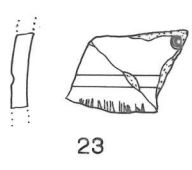
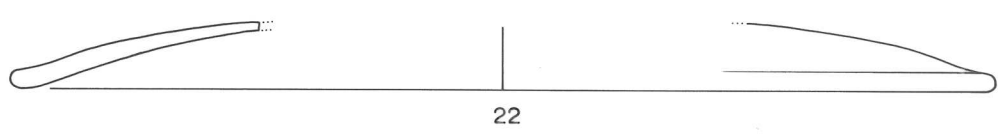
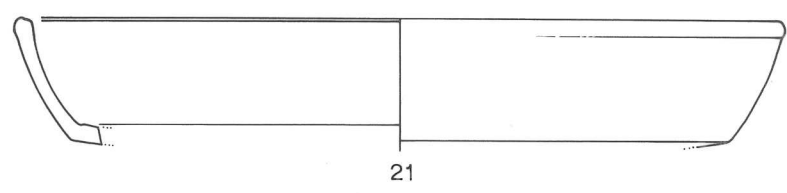
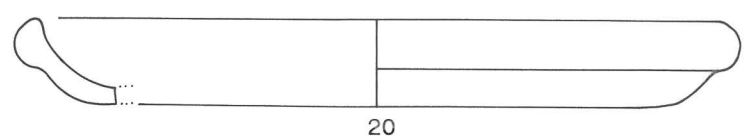
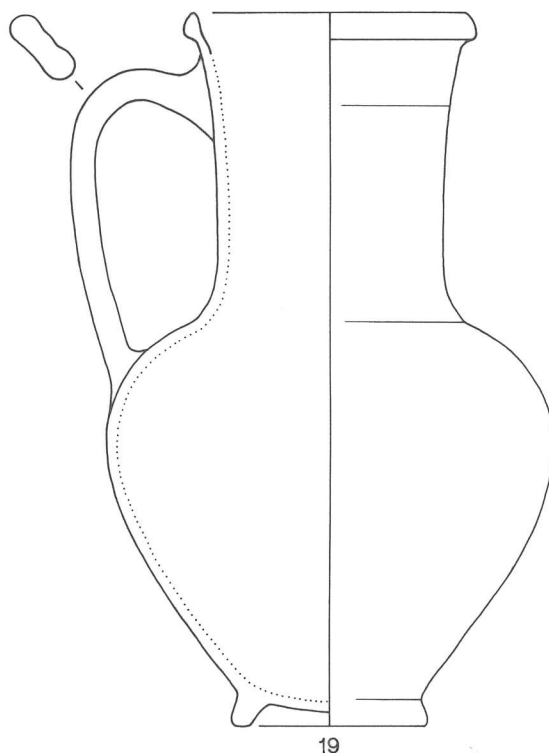

VALLEE DE LA SAONE : céramiques importées (IIè.-Ier s. av.).

19 : pâte claire calcaire (cruche) ; 20 : Pâte mi-fine claire siliceuse à engobe rouge interne (plat) ; 21-22 : pâte mi-fine claire siliceuse (plat et couvercle) ; 23-24 : céramique graphitée.

19 : St. Symphorien ; 20 : Mâcon C.M. ; 21 : Tournus 7FN ; 22 : Tournus CLR ; 23-24 : Verdun P.C.

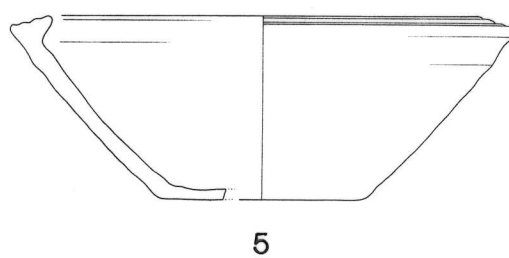
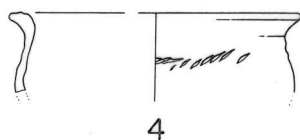
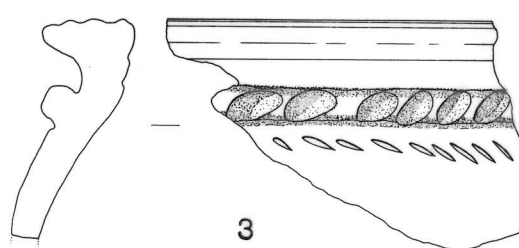
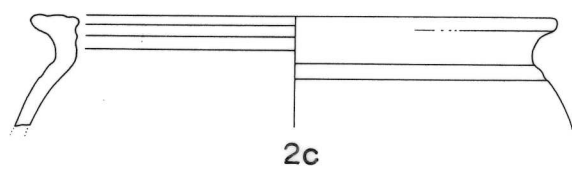
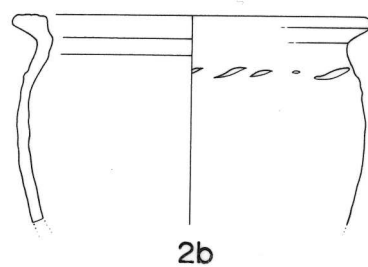
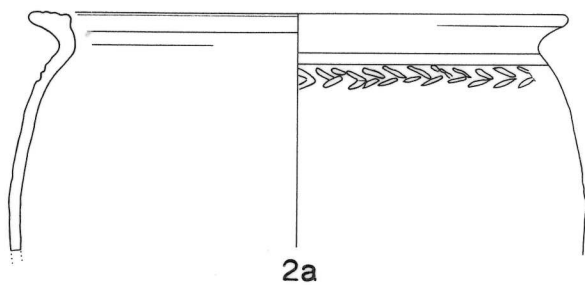
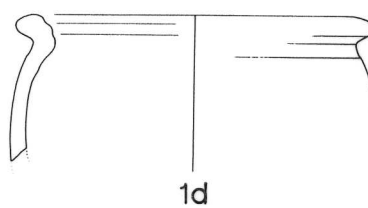
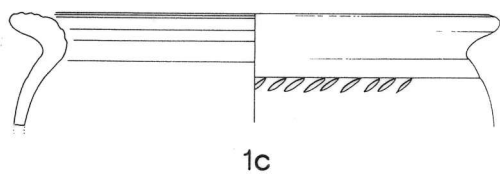
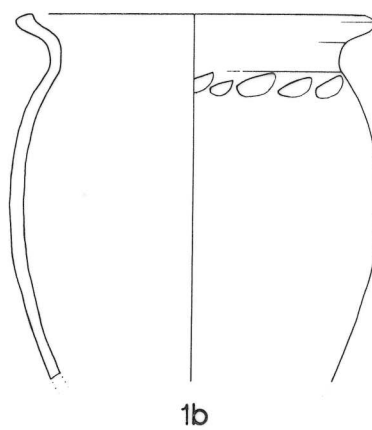
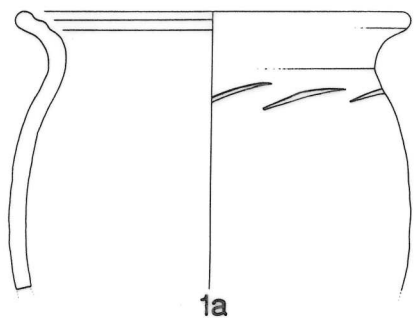

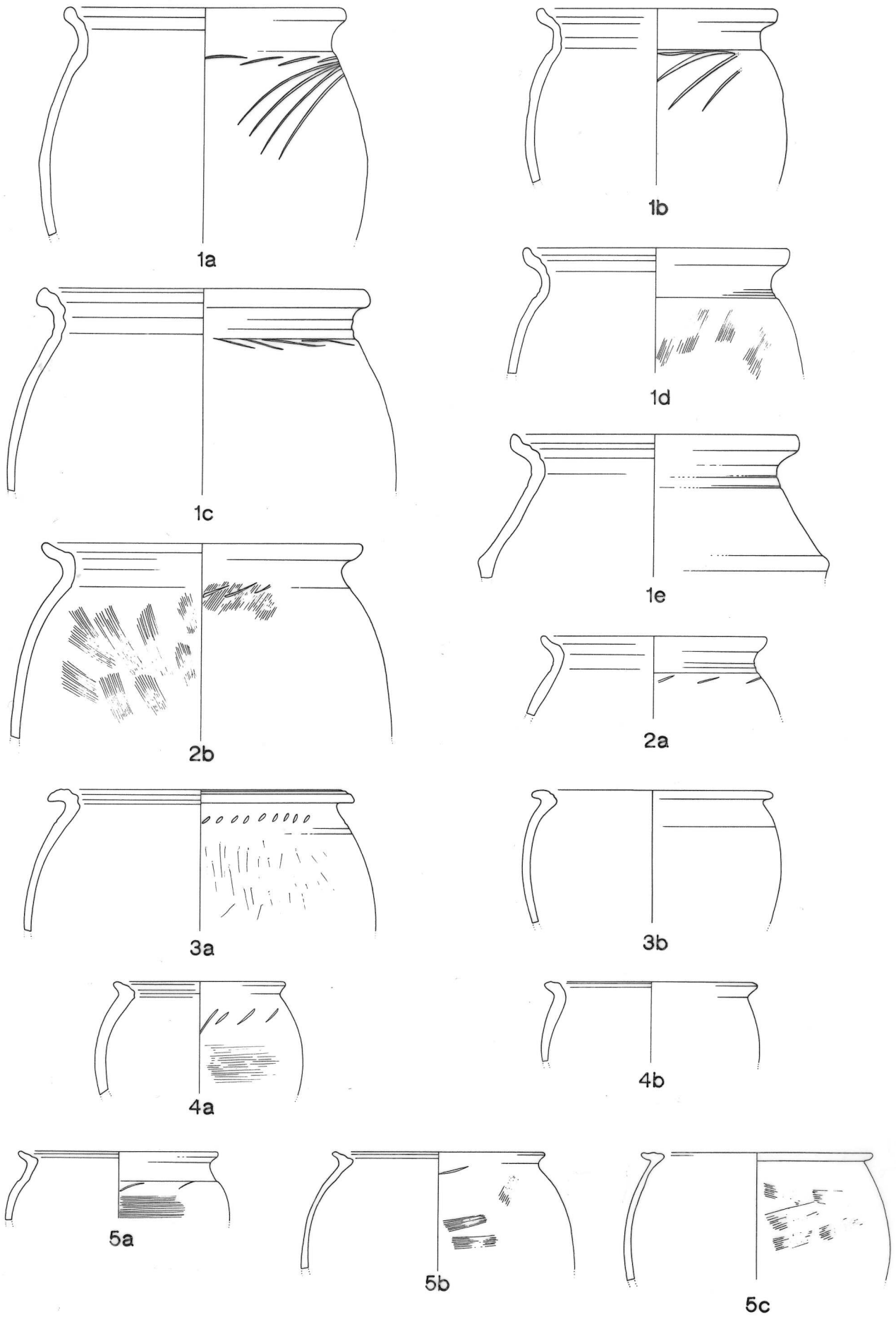

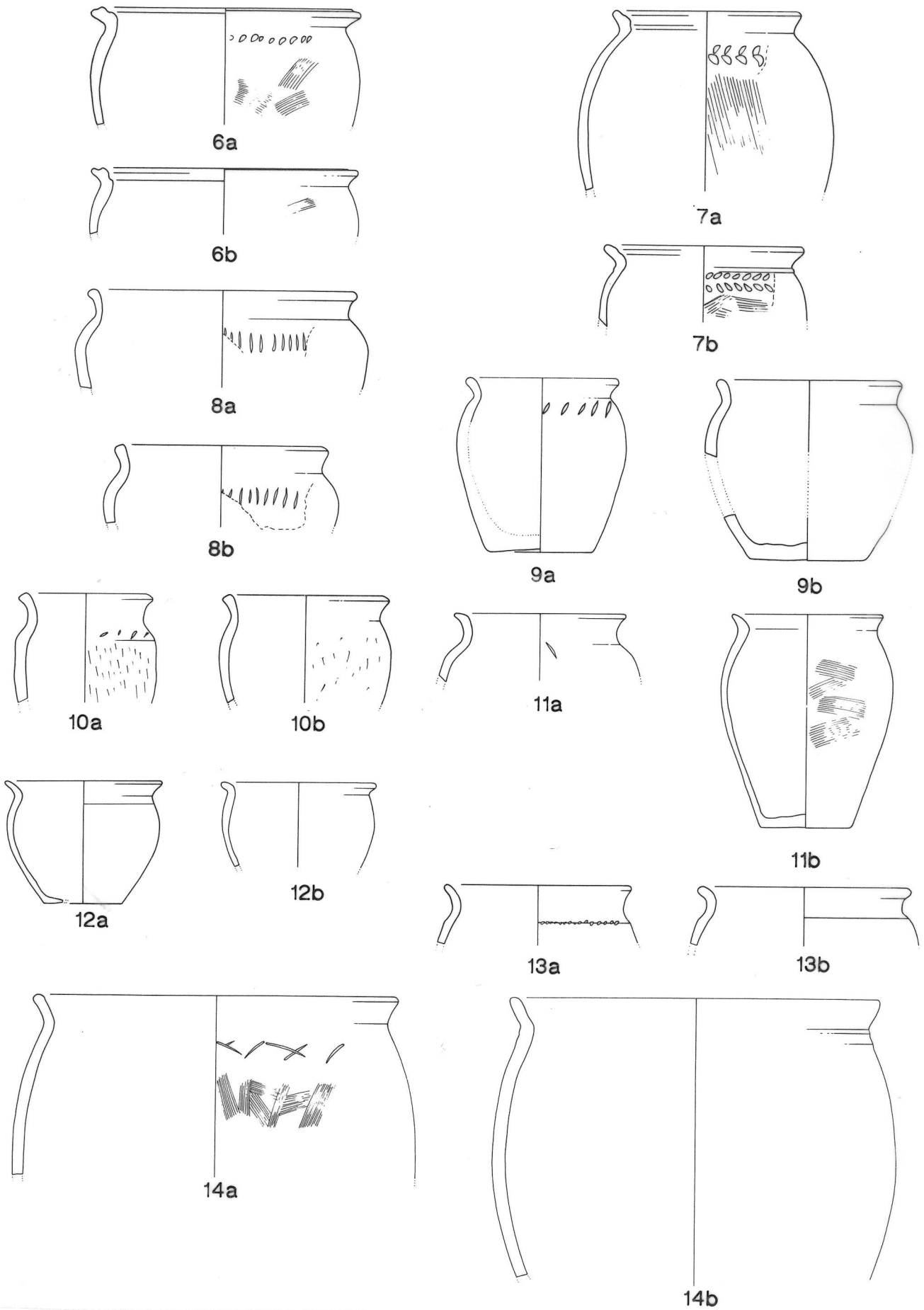

VALLEE DE LA SAONE : céramique non tournée grossière. Ech. 1/4.

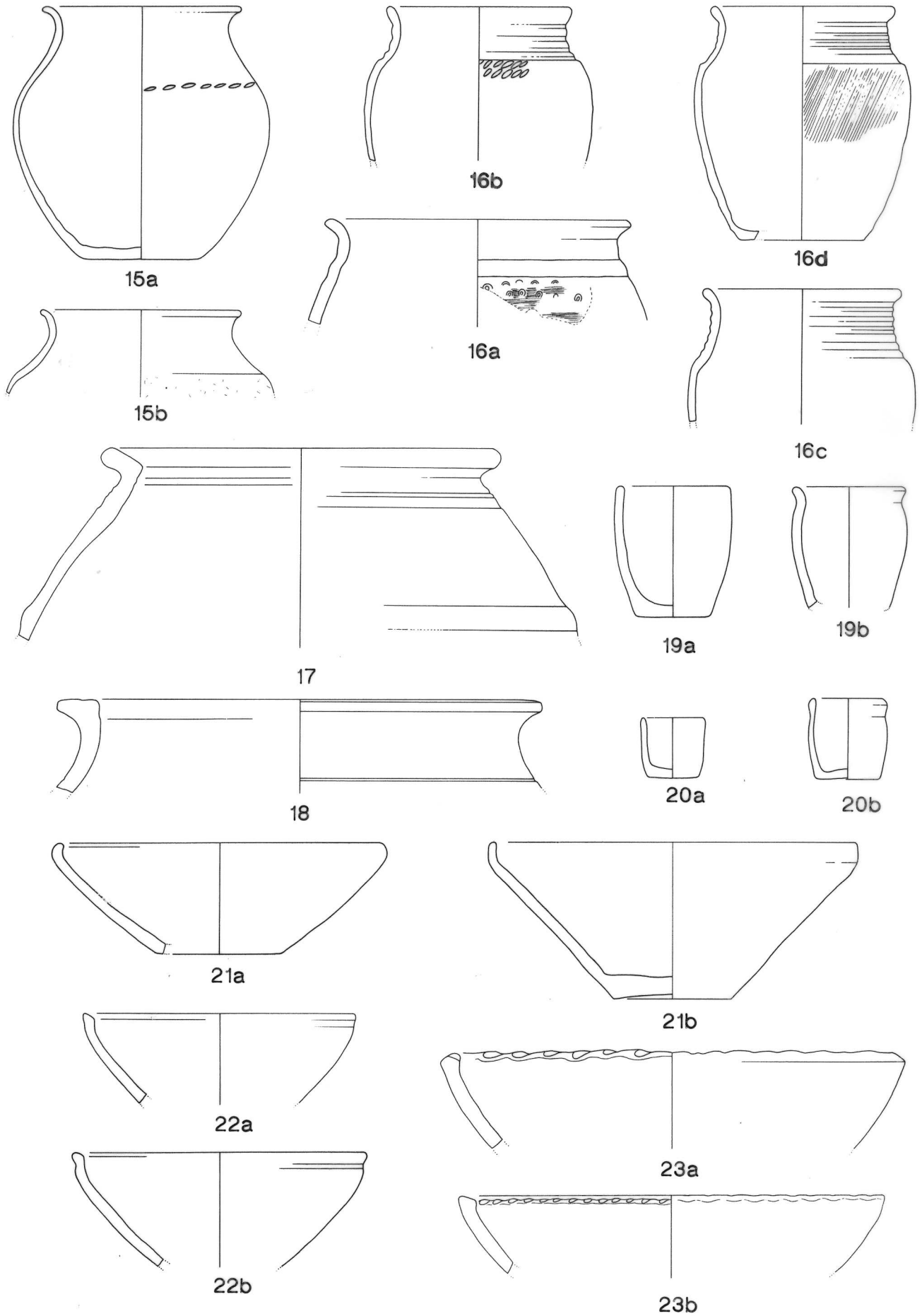

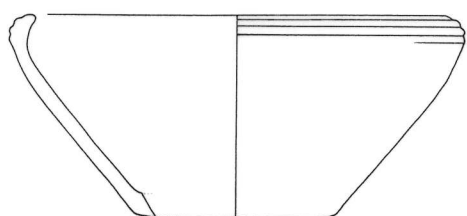

24a

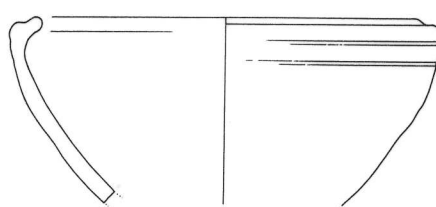

24b

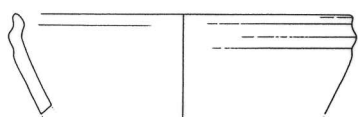

24c

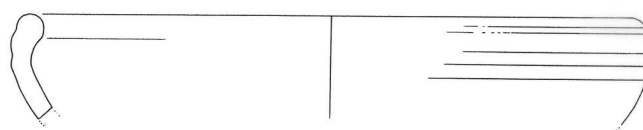

24d

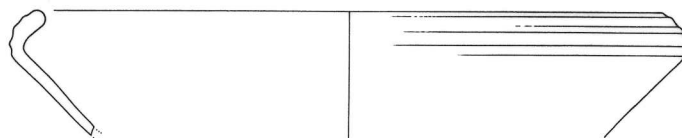

24e

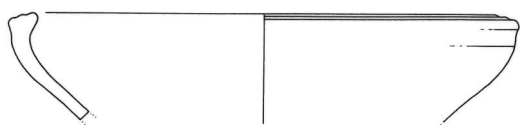

25a

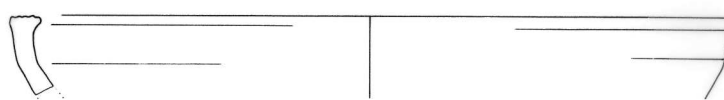

25b

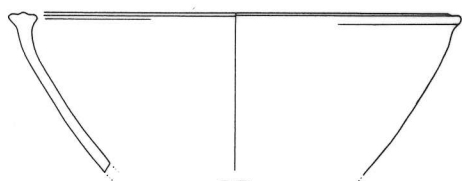

25c

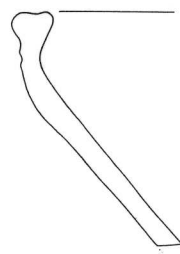

25d

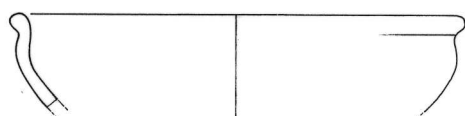

26a

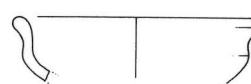

26b

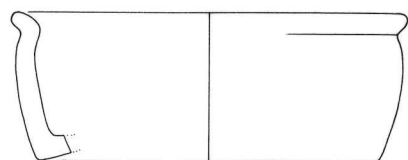

27a

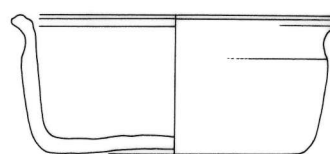

27b

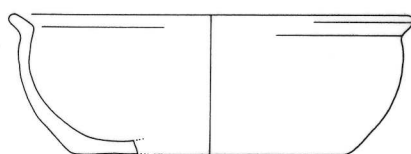

27c

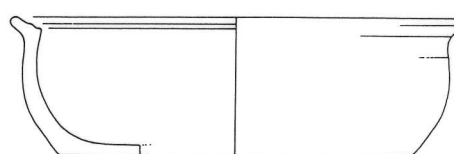

27d

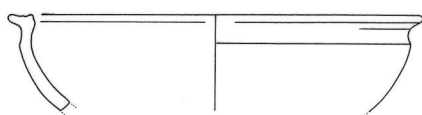

27e

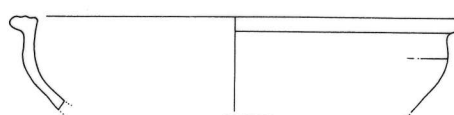

27f

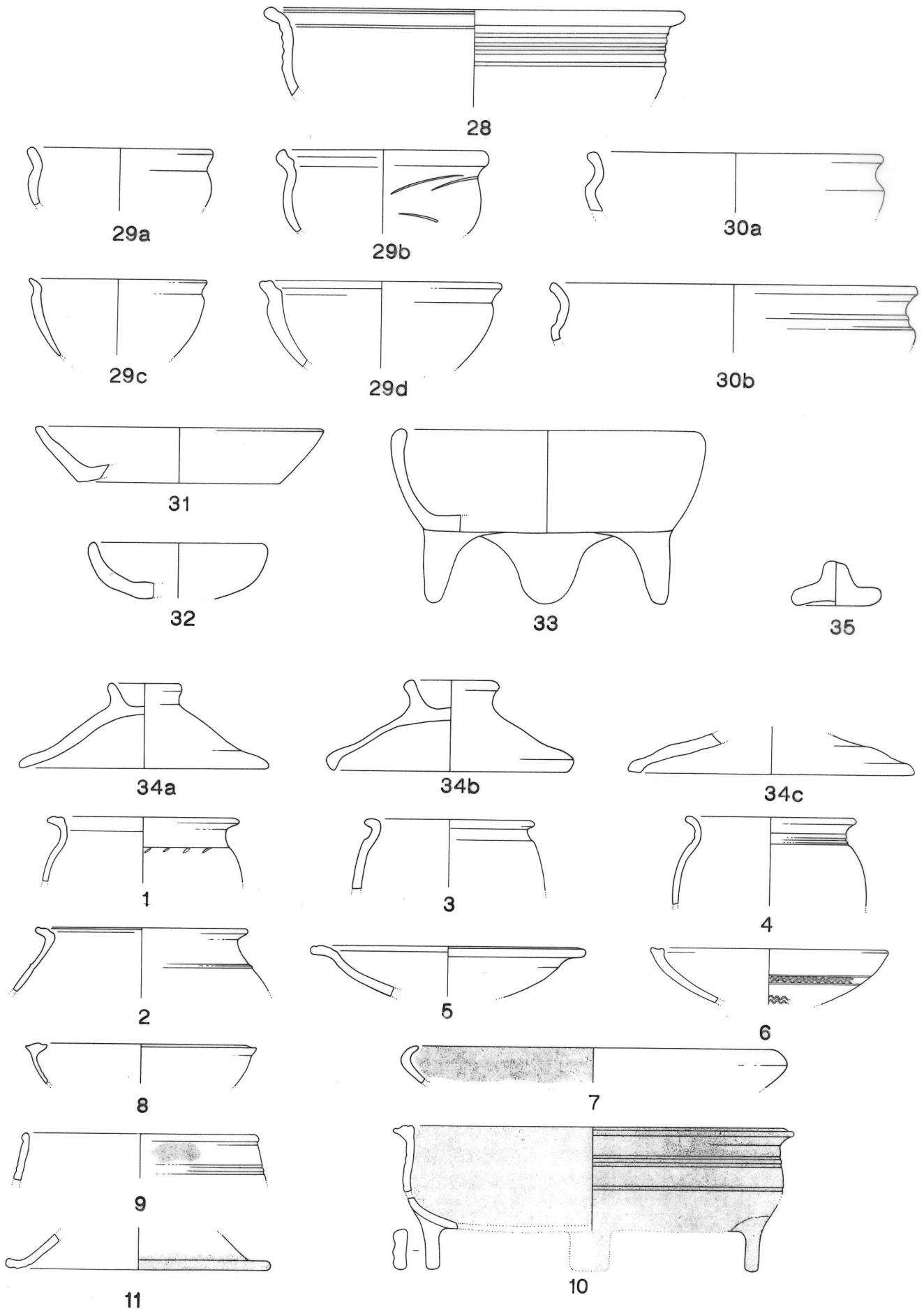

VALLEE DE LA SAONE : céramique non tournée grossière (n° 28-29) ; céramique tournée mi-fine (n° 1-11). Ech. 1/4.

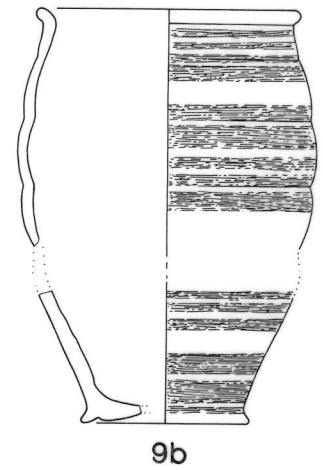
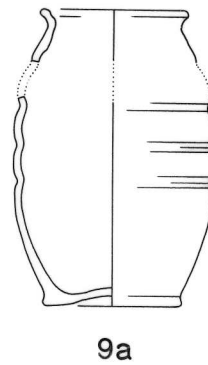
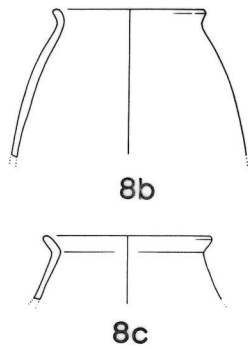
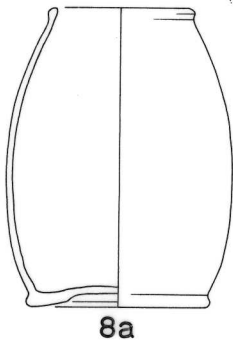
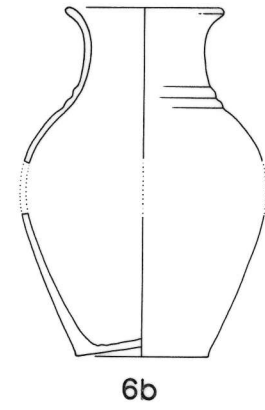
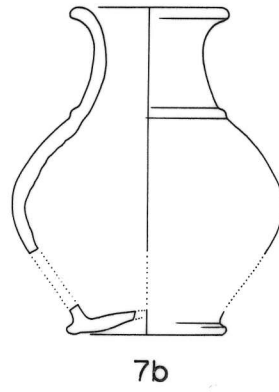
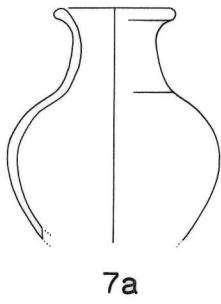
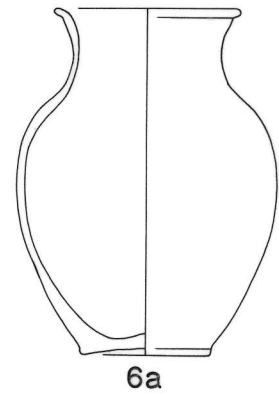
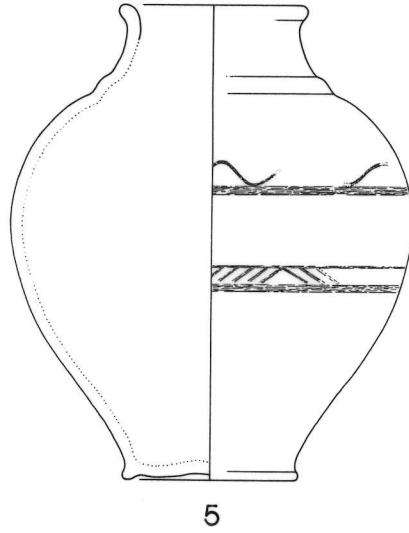
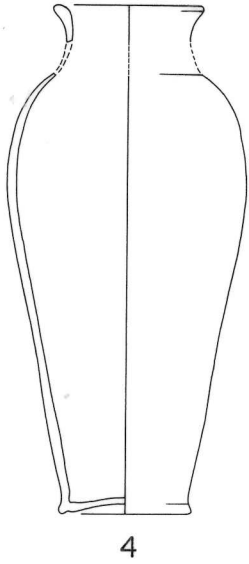
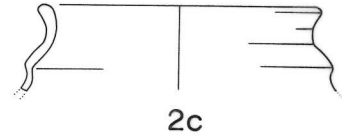
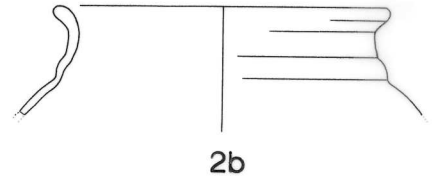
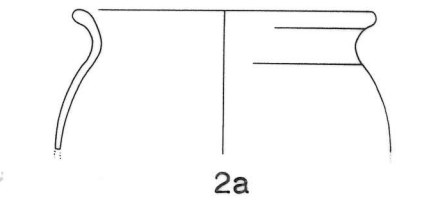
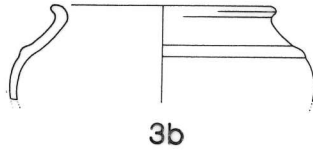
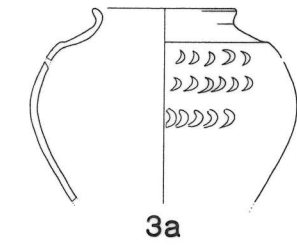
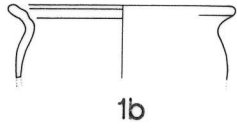
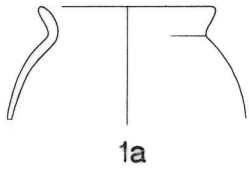

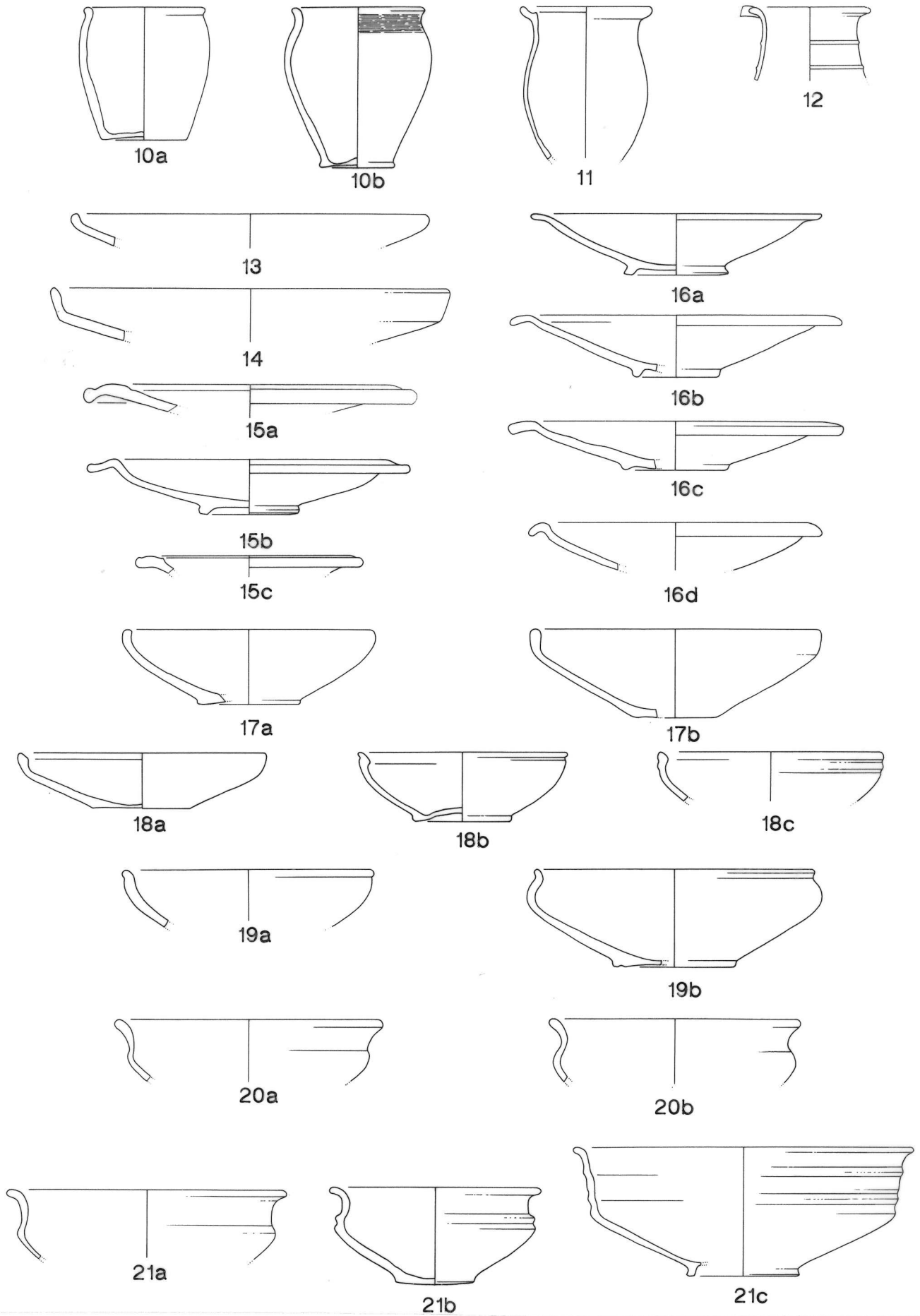

VALLEE DE LA SAONE : céramique tournée fine lissée. Ech. 1/4.

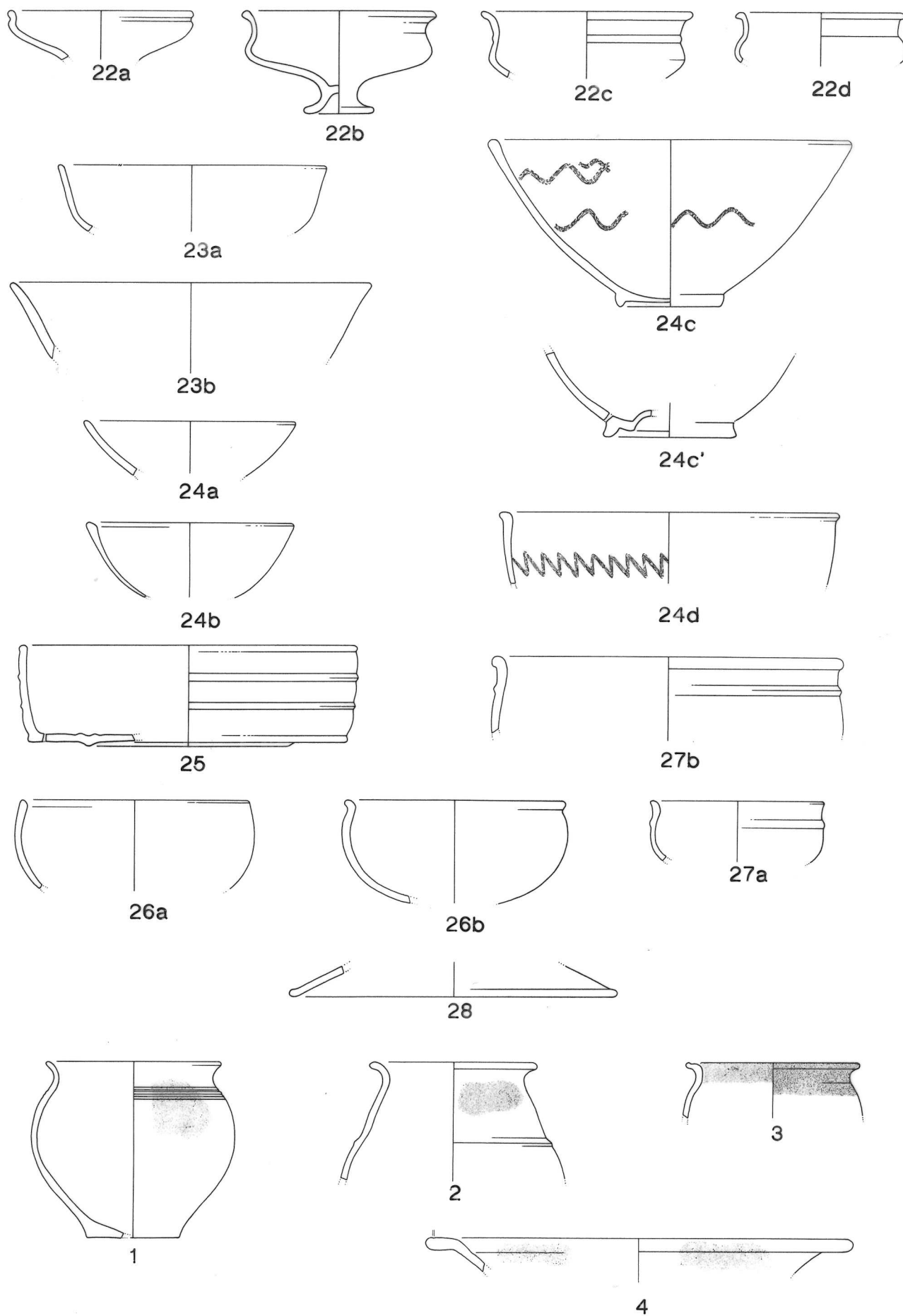

VALLEE DE LA SAONE : céramique tournée fine lissée (n° 22-28) ; céramique tournée, fine claire, engobe micacé (n° 1-4). Ech. 1/4.

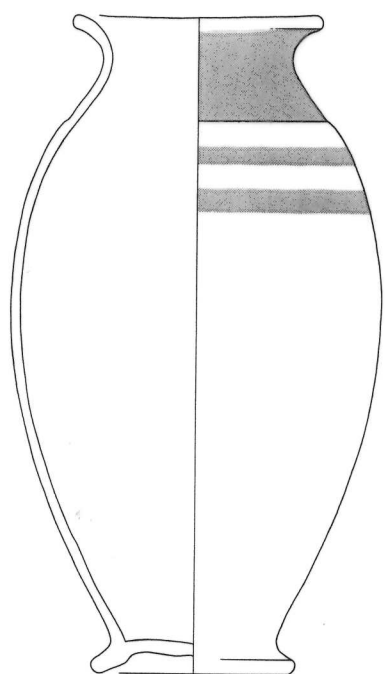

1b

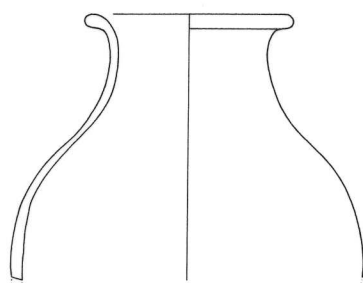

1a

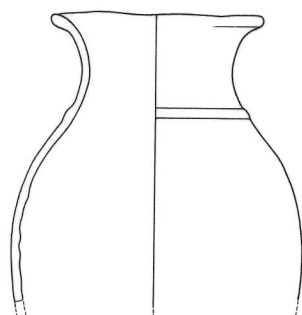

1d

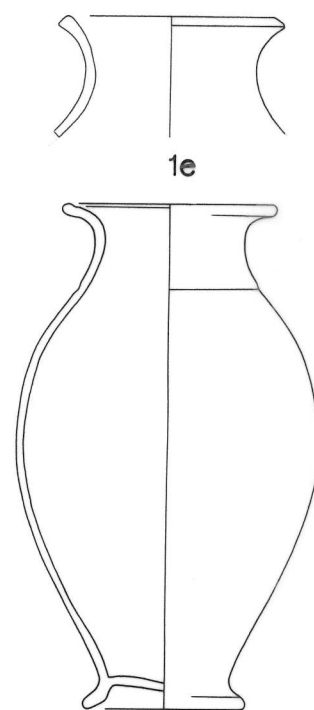

1e

1c

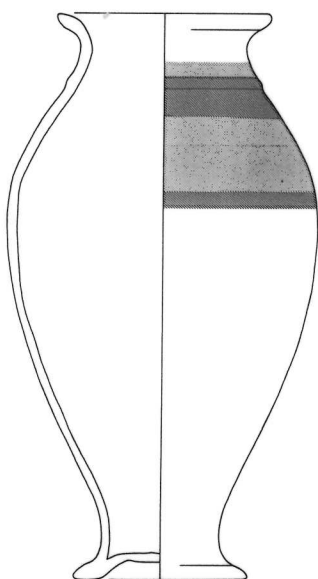

2

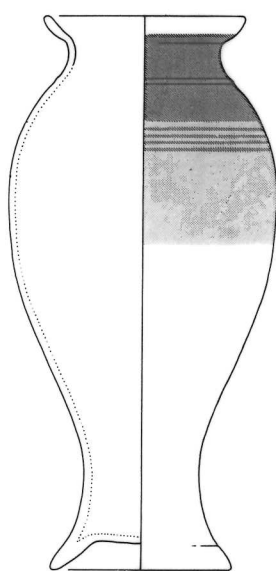

3

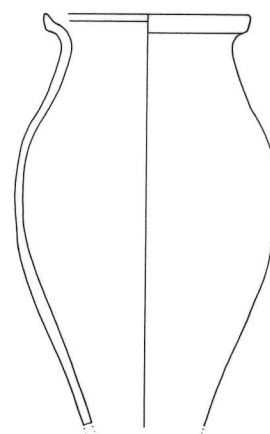

4

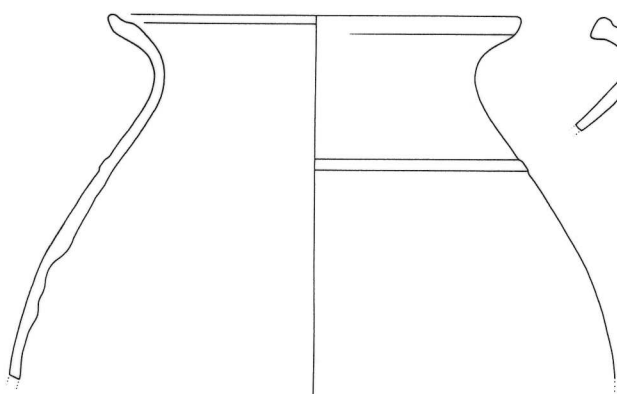

7

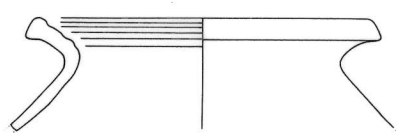

8

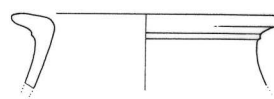

6

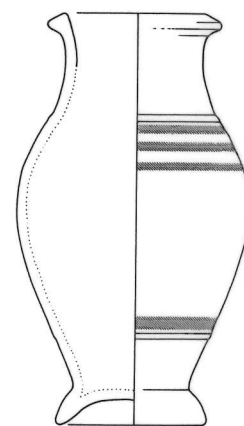

5

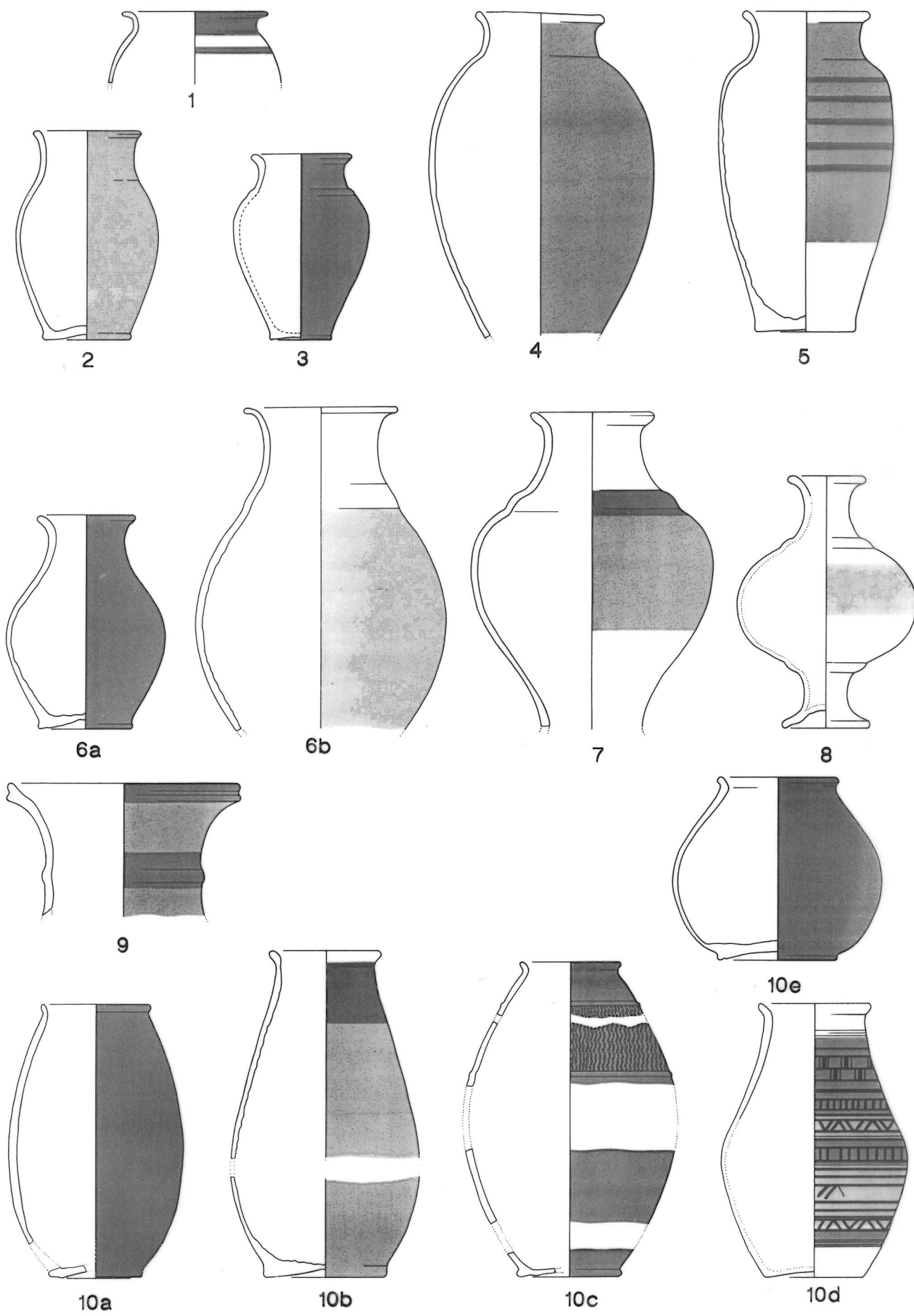

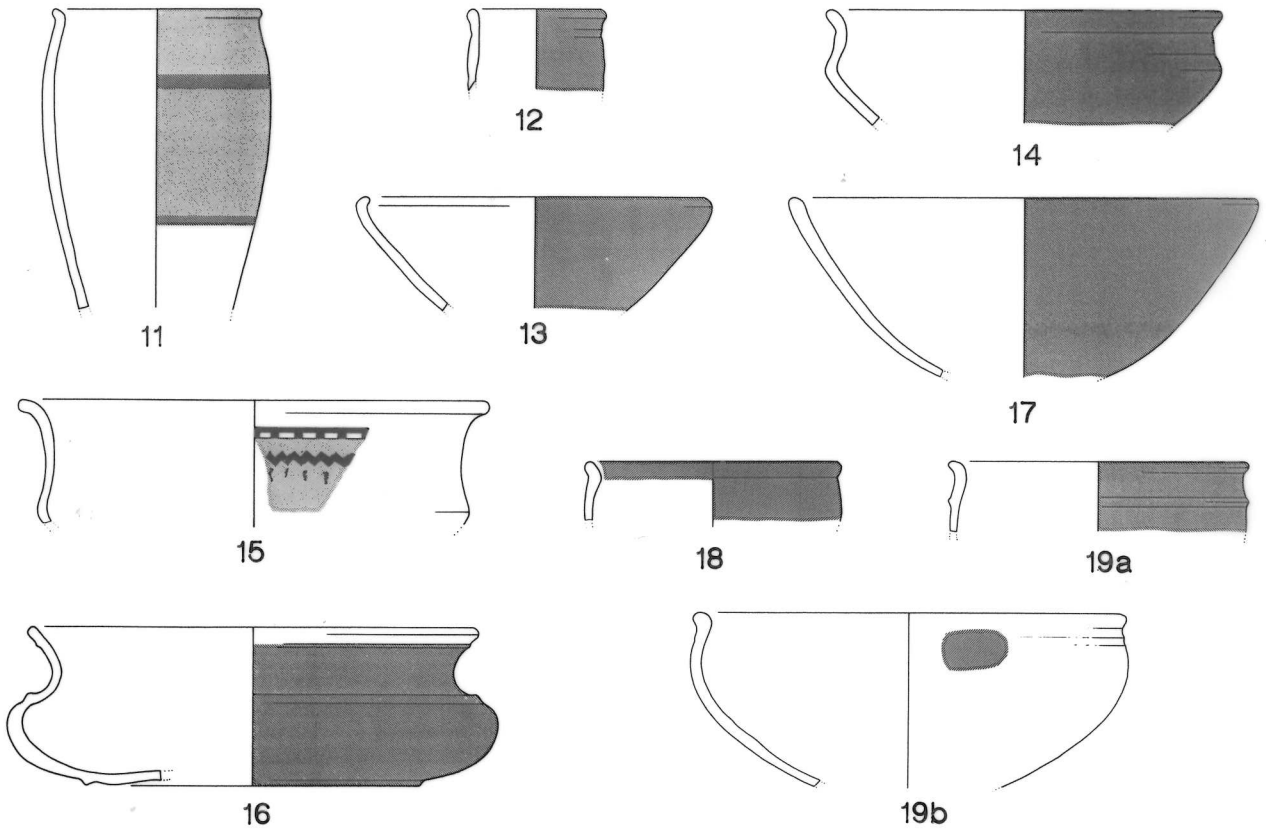

Résumé : Céramique indigène et faciès culturels à La Tène finale dans la vallée de la Saône

Le but de cette thèse est d'étudier sous l'aspect culturel la céramique gauloise (III^e- I^{er} siècles avant notre ère) mise au jour sur les sites de la moyenne vallée de la Saône (entre Mâcon et Mirebeau-sur-Bèze). Une première partie expose le cadre de l'étude (contexte géographique et historique), ainsi que les contraintes liées aux contextes de découvertes et à l'historique des recherches. La méthode d'étude des céramiques mise en oeuvre découle de ce faisceau de données et des objectifs fixés dans l'introduction. La seconde partie est constituée par un corpus des ensembles mobiliers, par site (types de production, répertoire des formes, données statistiques). La documentation disponible à l'échelon régional (Bourgogne essentiellement) se trouve ainsi rassemblée sous une forme cohérente. La dernière partie présente une synthèse des données, organisée suivant plusieurs thèmes : caractérisation des productions indigènes, évolution des productions et du répertoire, tradition protohistorique et influences méditerranéennes, économie de l'artisanat céramique (production, diffusion), définition de faciès locaux ou micro-régionaux correspondant à des entités culturelles et économiques.

Mots clé : céramique indigène, La Tène finale, chronologie, faciès culturels, production, diffusion, commerce, technique

Abstract : Local Pottery and cultural aspects during Late La Tène in the Saône valley

The aim of this thesis is the study of local pottery during Late La Tène, in the Saône valley. Its first part deals with external aspects (geographical, historical, archaeological outline) and expose the study method of local pottery (criteria of analysis). The second part settles the regional documentation (material for analysis from each settlement). The third part presents a synthesis organised through several themes : major aspects of local pottery, evolution of local coarse wares, influences of mediterranean contacts, pottery industry, local and regional trades, cultural, economical and political relations.