



**HAL**  
open science

Variation et évolution de la composition du venin des guêpes parasitoïdes *Psytalia* (Hymenoptera, Braconidae) et *Leptopilina* (Hymenoptera, Figitidae) : Une cause possible d'échec et de succès en lutte biologique?

Hugo Mathe-Hubert

► To cite this version:

Hugo Mathe-Hubert. Variation et évolution de la composition du venin des guêpes parasitoïdes *Psytalia* (Hymenoptera, Braconidae) et *Leptopilina* (Hymenoptera, Figitidae) : Une cause possible d'échec et de succès en lutte biologique?. Evolution [q-bio.PE]. Université de Nice - Sophia Antipolis, 2014. Français. NNT: . tel-02488934

**HAL Id: tel-02488934**

**<https://hal.science/tel-02488934>**

Submitted on 24 Feb 2020

**HAL** is a multi-disciplinary open access archive for the deposit and dissemination of scientific research documents, whether they are published or not. The documents may come from teaching and research institutions in France or abroad, or from public or private research centers.

L'archive ouverte pluridisciplinaire **HAL**, est destinée au dépôt et à la diffusion de documents scientifiques de niveau recherche, publiés ou non, émanant des établissements d'enseignement et de recherche français ou étrangers, des laboratoires publics ou privés.

# THÈSE

Pour obtenir le titre de

**DOCTEUR DE L'UNIVERSITE DE NICE SOPHIA ANTIPOLIS**

Spécialité: Biologie des interactions et écologie

Présentée et soutenue publiquement par

**Hugo MATHE-HUBERT**

Le 23 Octobre 2014

**Variation et évolution de la composition du venin des guêpes parasitoïdes  
*Psytalia* (Hymenoptera, Braconidae) et *Leptopilina* (Hymenoptera, Figitidae) :  
Une cause possible d'échec et de succès en lutte biologique?**

Directrice de thèse : Marylène Poirié  
Co-directeur de thèse : Thibaut Malausa

## JURY

**Nathalie VOLKOFF**, Directrice de Recherche INRA, Montpellier  
**David BIRON**, Chargé de Recherches CNRS, Clermont-Ferrand  
**Christoph VORBURGER**, Professeur, Université de Zürich  
**Guillaume MARTIN**, Chargé de Recherches CNRS, Montpellier II  
**Simon FELLOUS**, Chargé de Recherches INRA, Montpellier  
**Marylène POIRIE**, Professeur, Université de Nice Sophia Antipolis  
**Thibaut MALAUSA**, Chargé de Recherches INRA, Sophia Antipolis

**Rapporteuse**  
**Rapporteur**  
**Examineur**  
**Examineur**  
**Examineur**  
**Directrice de thèse**  
**Co-Directeur de thèse**



## ABSTRACT

### **Variation and evolution of venom contents in the parasitoid wasps *Psytalia* (Hymenoptera, Braconidae) and *Leptopilina* (Hymenoptera, Figitidae): a cause of success and failure in biological control?**

Endoparasitoid wasps are insects that lay eggs and develop inside arthropod hosts, leading to their death. They have evolved various strategies to ensure parasitism success, notably the injection along with the eggs of venom that suppress the host immunity and manipulate its physiology. Although venom composition has been characterized in a growing number of parasitoid families and recent studies suggest parasitoid virulence can rapidly evolve in response to selection, the intraspecific variation of venom and its short-term evolvability remained to be investigated. This information is however essential for understanding the evolution of parasitoid host range and may have implications in biological control using parasitoids.

This thesis focused on the analysis of the inter-individual variability of global venom composition using (i) two parasitoid species of the *Psytalia* genus, biological control agents of the olive fly and (ii) two well characterized species of *Drosophila* parasitoids of the *Leptopilina* genus. Having demonstrated the occurrence of inter-individual variability of venom both in laboratory strains and field populations, I developed a analysis method based on electrophoretic 1D profiles and the use of R functions allowing the without *a priori* statistic comparison of quantities of different proteins from numerous individuals and identification of discriminating protein bands. Thanks to experimental evolution studies, I then (i) analyzed venom changes in *Psytalia lounsburyi* following field collection and rearing under laboratory conditions (including the use of a substitute host), (ii) integrate results with venom data obtained from two *Psytalia* species and strains (iii) analyzed *Leptopilina boulardi* venom evolution in response to the resistance / susceptibility of its host and identified venom factors under selection.

Overall, the data obtained evidence an important variability in parasitoid venom components at all studied biological levels. Moreover, they demonstrate for the first time that venom composition importantly impact the parasitoid biology and can evolve rapidly, in response to selection. Rearing conditions or host resistance are parameters that strongly affect venom contents, which may have important consequences for biological control. Finally, the mechanisms sustaining venom variability remains to be investigated in the future.

*Keywords: parasitoid venom ; variability ; population proteomics ; experimental evolution, Psytalia spp.; Leptopilina spp.*

## RESUME

### **Variation et évolution de la composition du venin des guêpes parasitoïdes *Psytalia* (Hymenoptera, Braconidae) et *Leptopilina* (Hymenoptera, Figitidae) : Une cause possible d'échec et de succès en lutte biologique?**

Les guêpes endoparasitoïdes effectuent leur développement dans un hôte arthropode, entraînant sa mort. Parmi les stratégies assurant leur succès parasitaire, la plus commune est l'injection de venin dans l'hôte lors de l'oviposition, provoquant la suppression de l'immunité de l'hôte et la régulation de sa physiologie. La composition du venin a été caractérisée dans un nombre croissant de familles de parasitoïdes et des études récentes suggèrent que la virulence des parasitoïdes peut évoluer rapidement en réponse à la sélection. Cependant, la variation intraspécifique de cette composition et la capacité du venin à évoluer à court-terme n'avaient pas été étudiées. Cette information est pourtant essentielle pour comprendre l'évolution de la gamme d'hôte des parasitoïdes et elle peut avoir des implications importantes en terme de lutte biologique.

Cette thèse s'est intéressée à l'analyse de la variabilité de la composition du venin en utilisant deux couple d'espèces, l'un du genre *Psytalia*, utilisé en lutte biologique contre la mouche de l'olivier et l'autre du genre *Leptopilina*, des parasitoïdes de la Drosophile. Après avoir démontré l'existence de variabilité inter-individuelle du venin, j'ai développé une méthode sans *a priori* basée sur d'analyser des profils d'électrophorèse 1D à l'aide de fonctions R, permettant la comparaison statistique des quantités des différentes protéines à partir de nombreux individus. En utilisant des approches d'évolution expérimentale, j'ai ainsi pu (i) analyser les changements du venin dans des populations naturelles de *Psytalia lounsburyi* élevées en dans des conditions de laboratoire sur un hôte de substitution (ii) intégrer les résultats avec les données vénomiques obtenues sur deux espèces de *Psytalia* (iii) analyser l'évolution du venin de *Leptopilina bouvardi* en réponse à la résistance/sensibilité.

Les données montrent une variabilité importante des composants du venin chez les parasitoïdes à tous les niveaux biologiques. Ils démontrent aussi pour la première fois que la composition de ce venin peut changer rapidement, confirmant son fort potentiel évolutif. Les conditions d'élevage ainsi que la résistance de l'hôte sont des paramètres qui affectent fortement le contenu du venin ce qui peut avoir des conséquences importantes en lutte biologique. Enfin, la composition du venin affecte la probabilité d'extinction des petites populations. Les mécanismes à l'origine de sa variabilité restent à étudier.

*Mots clés : Venin de parasitoïdes ; protéomique des populations ; Evolution expérimentale ; Psytalia spp. ; Leptopilina spp.*



"Point n'est besoin d'espérer pour entreprendre, ni de réussir pour persévérer" Guillaume d'Orange-Nassau

Mais quand même, ça aide un peu ...

–Data is not information, information is not knowledge, knowledge is not wisdom, wisdom is not truth,” —Robert Royar (1994) paraphrasing Frank Zappa’s (1979)

... Ben, on n'est pas rendu !

D'où l'intérêt d'entreprendre même sans espoirs, et persévérer même sans réussite ?

## REMERCIEMENTS

Pour le cadre et les moyens, sans lesquels cette thèse n'aurait pas eu lieu, je remercie l'INRA, le CNRS, l'Université de Nice Sophia Antipolis, la Région PACA, le département « Santé des Plantes et Environnement » (SPE). Je remercie aussi l'ANR dans le cadre du financement « Climevol », ainsi que le Génoscope pour la réalisation d'une partie du séquençage des transcrits de l'appareil à venin de *Psytalia lounsburyi*. Je remercie Afidol, l'association inter-professionnelle de l'olive, sans l'appui de laquelle cette thèse n'aurait pu être financée.

Pour la grande qualité de leur encadrement et leur patience face à mon léger manque de communication, je tiens à très très vivement remercier Marylène et Thibaut dont je résumerais l'encadrement ainsi car ceci vaut mieux qu'un trop long discours mal maîtrisé :

« Ils ne savaient pas que c'était impossible, alors ils l'ont fait ! ».

Je remercie aussi vivement pour leurs conseils voire leur encadrement Jean-Luc Gatti, Dominique Colinet, Nicolas Ris et Thomas Guillemaud.

Pour leurs conseils avisés, je remercie l'ensemble des membres de mon comité de thèse.

Pour avoir accepté de participer à ce jury et avoir eu la patience de lire ce manuscrit qui ne prend pas toujours les chemins les plus courts, je tiens à remercier Nathalie Volkoff, David Biron, Christoph Vorburger, Guillaume Martin et Simon Fellous.

Merci à Didier Forcioli pour m'avoir initié à l'enseignement ... Qui comme la science est un domaine très agréable, mais où il est difficile de savoir si l'on a un niveau adéquat !

Je tiens à remercier Marcel Thaon pour m'avoir initié à l'élevage, en particulier à l'élevage de *P. lounsburyi*, et surtout pour ta bienveillance !

Pour les échantillonnages de *P. lounsburyi* sur le terrain qui m'ont permis de mettre en place une des principales expériences de ma thèse, je remercie particulièrement Kim Holmer, Alexandre Beltrà Ivars et Addison Pia, ainsi que l'ensemble des gens de l'EBCL (Laboratoire de Lutte Biologique Européen) et de l'ICIPE (Centre International de Physiologie et d'Écologie de l'Insecte) qui n'ont pas été moins impliqués, mais qui sont simplement trop nombreux pour être cités ici.

Je remercie les stagiaires Marie Monrolin et Sylvain Perini et les techniciennes Isabelle Le Goff et Séverine Lemauf pour le travail de qualité qu'ils ont fourni. Ce travail a représenté une part importante de cette expérience souvent contrariante, toujours fastidieuse mais finalement concluante bien que l'interprétation d'une part des résultats semble préférer demeurer mystérieuse.

Toujours en lien avec cette expérience, je remercie le technicien de l'IAEA Sohel Ahmad pour avoir pris le temps de nous enseigner l'élevage de la mouche de l'olive, même si nous n'y sommes pas parvenus, et ce malgré le travail soigné réalisé par Marie Monrolin.

Je remercie aussi Christian Rebuf et Marcel Thaon pour l'élevage et le maintien des nombreuses souches d'insectes sur lesquels repose la majeure partie des expérimentations.

Pour leur aide si précieuse pour les aspects « omiques » et leur bonne humeur, je remercie Maya Belghazi (protéomique) et Emeline Deleury (transcriptomique). Je remercie aussi Marc

Ravallec pour la microscopie électronique ainsi que Antonin Schmitz et Joris Villalba pour les images de microscopie en fluorescence.

Je remercie aussi l'ensemble des gens que j'ai (pas assez) côtoyé au cours de cette thèse, et en particulier, l'ensemble des membres des trois équipes impliquées dans cette thèse (ESIM, BPI et RDLB) ainsi que les personnes du journal club « Bio des pop » et du groupe de discussions « écoevol » pour leur bonne humeur et le plaisir des échanges scientifiques.

Je remercie aussi *Psytalia lounsburyi*, qui à défaut de bien vouloir s'acclimater, a bien voulu produire un venin très variable. Parallèlement, je remercie *Leptopilina boulardi* pour avoir été bien plus sage que *Psytalia lounsburyi* en conditions de laboratoire et avoir su produire des résultats plus facilement interprétables.

Tant qu'à remercier *Leptopilina boulardi*, je remercie aussi les deux stagiaires Laurent Kremmer et Fanny Cavigliasso qui ont produit et analysé avec moi l'ensemble des résultats liés à cette espèce présentés dans cette thèse.

**Parallèlement à ces gens impliqués de près ou de loin dans ma thèse, je remercie l'ensemble des gens qui – parfois à l'insu de leur plein gré – m'ont aidé à tenir le coup durant cette thèse.**

Je remercie donc Virginie Ravigné, notamment pour une phrase prononcée pendant mon stage de M1 qu'elle a encadré. La phrase ressemblait à « Si un jour tu fais une thèse, des fois tu auras envie d'arrêter, il faudra s'accrocher, ça vaut le coup ». Oui, quelquefois j'ai eu envie d'arrêter et quelle que soit la qualité de cette thèse, pour le plaisir, oui ça valait le coup !

Et si ça valait le coup, c'est en grande partie grâce à mes encadrants et à l'ensemble des gens déjà remerciés ci-dessus, mais merci encore quand même !

Et tant que l'on est sur les citations, les thèses et l'entêtement, je remercie aussi Thomas Guillemaud pour une phrase, prononcée au début de ma thèse, ressemblant à « Quand on a une idée, il ne faut pas la lâcher et il faut la creuser jusqu'au bout ! ». (Le problème, c'est que chaque bout d'idée a plusieurs bouts !; Merci Devos)

**Et pour m'avoir aidé à tenir le coup, avant ou pendant cette thèse, je remercie**

La dame de mes pensées grâce à qui j'ai compris à quel point

" l'amour est « corps ailé, Hoo ... plaisir » ! ",

(les statisticiens comprendront – bienvenu à tous ceux qui ne se considéraient pas statisticiens)

Et sans qui je n'aurais probablement pas tenu le coup.

Mes deux parents et Mrs Némausat sans qui mon plaisir scientifique ne serait peut-être jamais né.

Ma petite sœur dont les voyages font rêver.

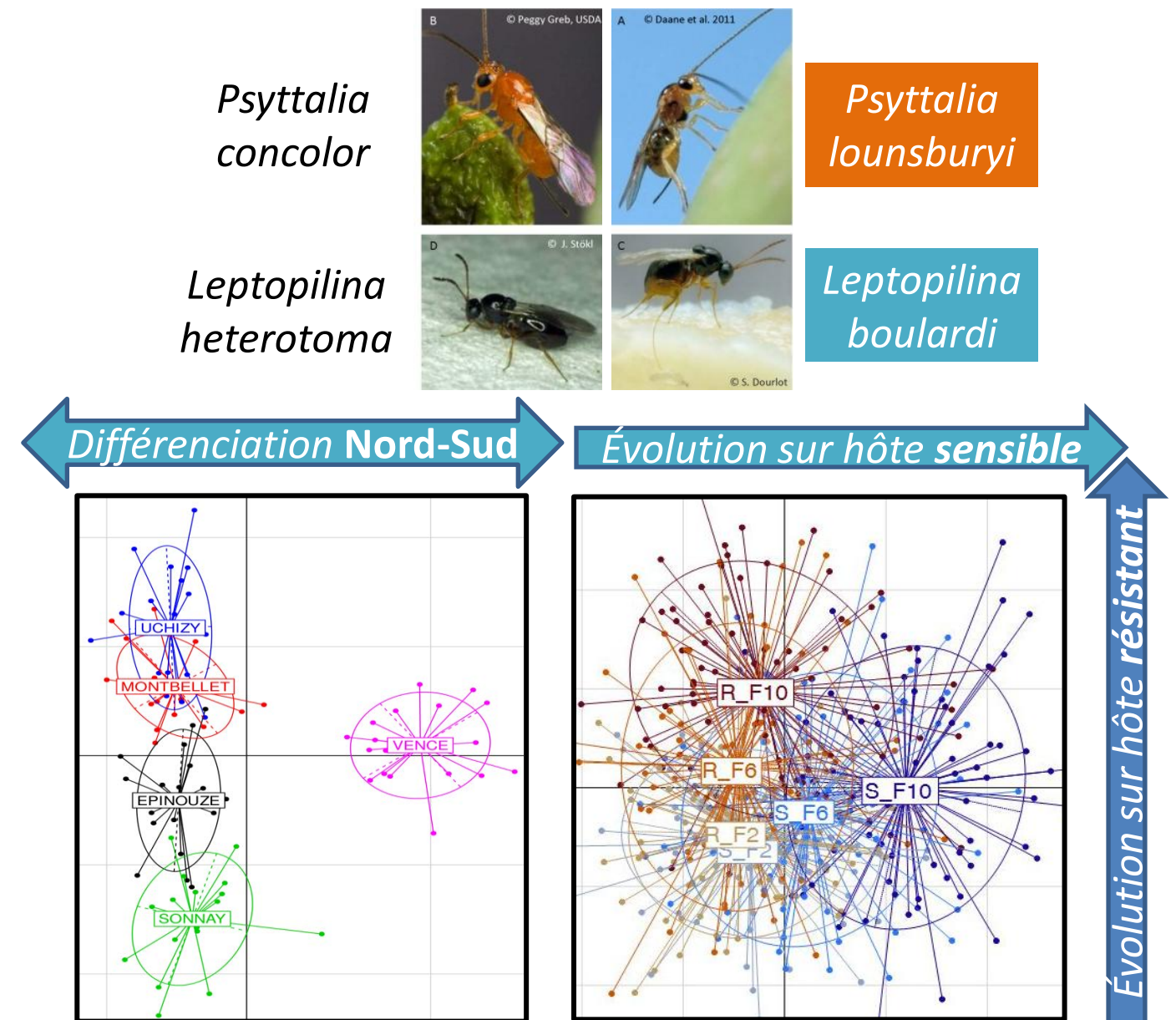
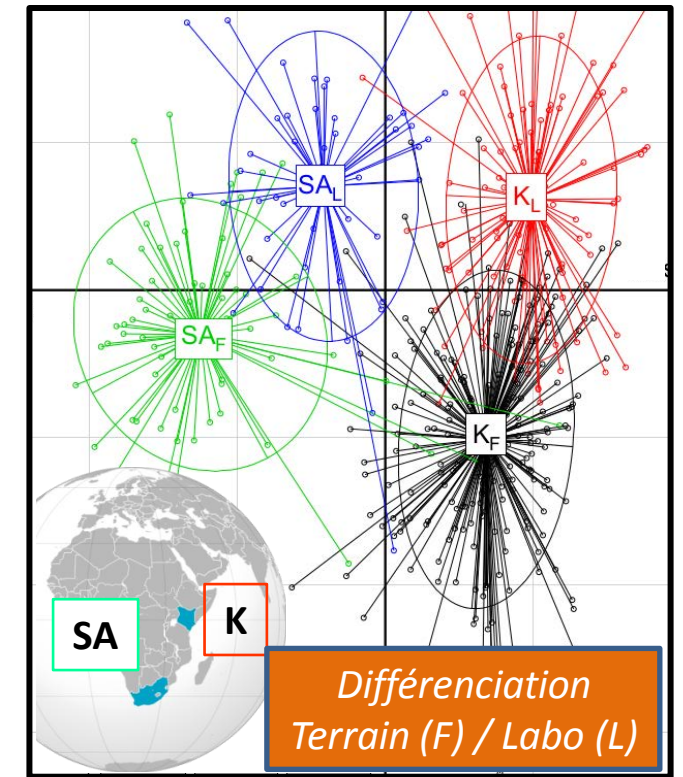
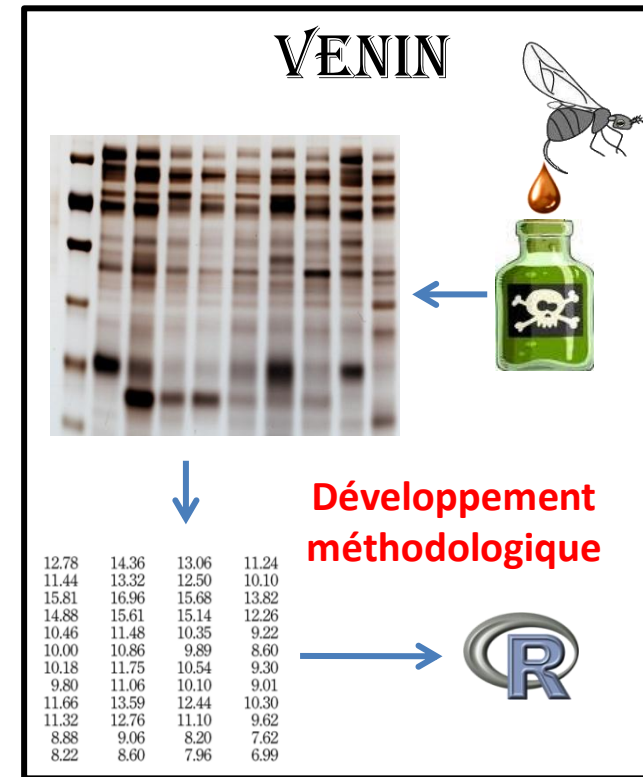
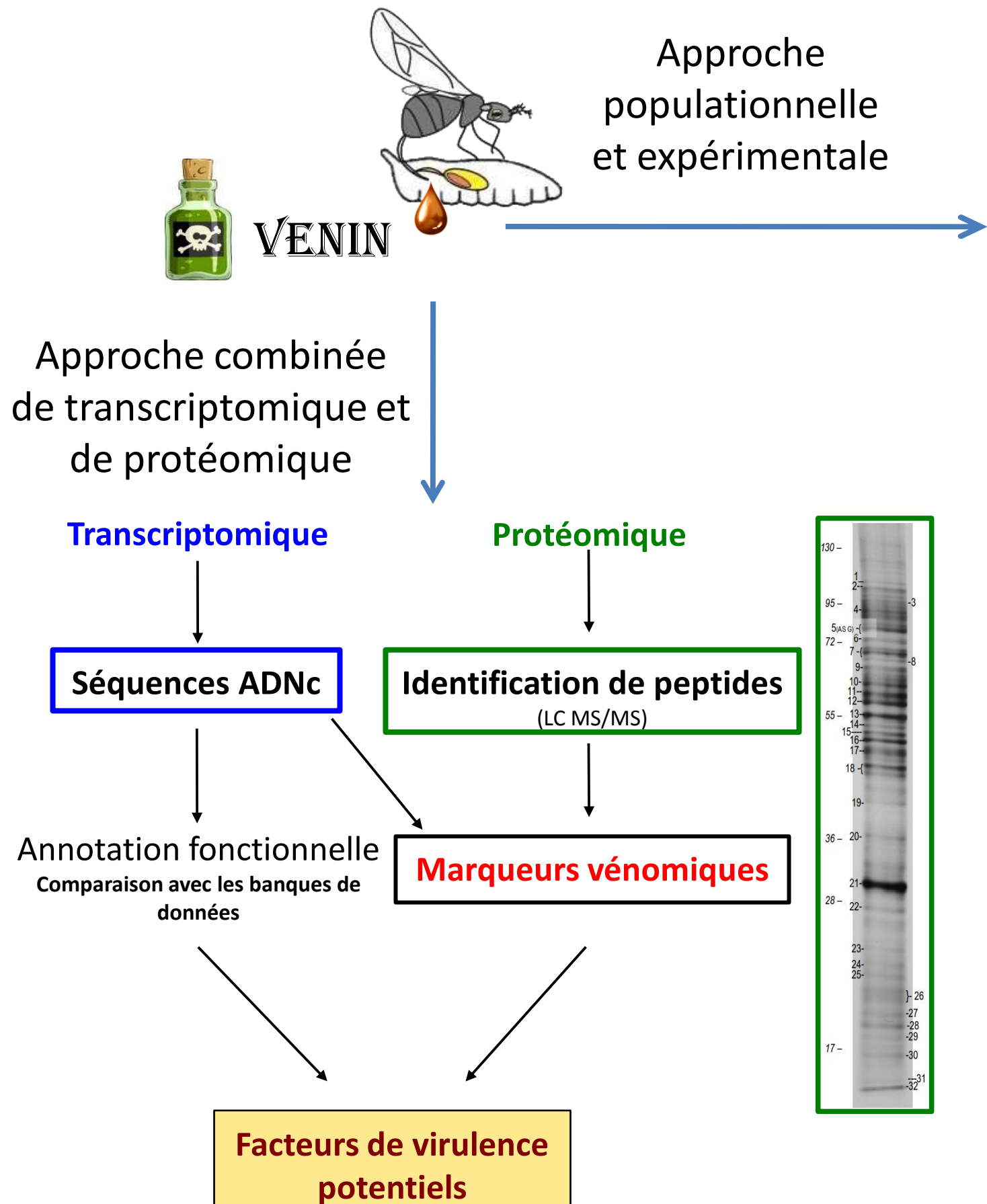
La chatte communiste et mélomane qui pour me soutenir en fin de thèse a décidé qu'après tout, chez moi c'était aussi et surtout chez elle !

# SOMMAIRE

<u>Ma thèse en images</u> .....	9
<b>I. INTRODUCTION : GENERALITES ET CONTEXTE</b>	
1. <u>L'écologie évolutive</u> : Pourquoi le vivant est-il tel qu'il est ? .....	10
2. <u>La lutte biologique</u>	
a. L'impasse des pesticides .....	13
b. La lutte biologique .....	13
c. Les auxiliaires de lutte biologique .....	15
3. <u>Les parasitoïdes</u>	
a. Généralités .....	15
b. Un cas extrême d'interaction antagoniste .....	16
- L'antagonisme évolutif .....	17
- Spécialisation et changement d'hôte : un paradoxe apparent .....	18
- Deux types d'espèces généralistes .....	21
- L'antagonisme phénotypique .....	23
- Stratégies de virulence des parasitoïdes .....	24
4. <u>Problématique</u> .....	27
5. <u>Les modèles biologiques</u> .....	28
<b>II. OBJECTIFS DE LA THESE</b> .....	31
1. Développement et applications de méthodes de caractérisation de la variabilité des protéines du venin au niveau individuel .....	31
2. Caractérisation du potentiel évolutif du venin de parasitoïdes en lien avec le passage en conditions d'élevage ou la résistance de l'hôte : approches d'évolution expérimentale...	32
<b>III. PARTIE 1 Vers l'analyse de la <u>variabilité individuelle</u> des venins de parasitoïdes</b>	
1. <u>Variability of venom components in immune suppressive parasitoid wasps: from a phylogenetic to a population approach.</u>	
- Présentation de l'article .....	35
- Article .....	36
2. <u>Statistical analysis of the individual variability of 1D protein profiles as a tool in ecology.</u>	
- Présentation de l'article .....	46
- Article .....	48
3. <u>Analysis of individual venom profiles discriminates populations of <i>L. boulandi</i> and <i>L. heterotoma</i> parasitoids along a climatic gradient in the Rhône Valley.</u>	
- Présentation de l'article .....	72
- Article .....	73

<b>IV.</b>	<b>PARTIE 2 Potentiel évolutif du venin de parasitoïdes en lien avec la mise en élevage ou la résistance de l'hôte : <u>approches d'évolution expérimentale.</u></b>	
	Introduction .....	90
1.	<u>A PCR-based method for estimating parasitism rates in the olive fly parasitoids <i>Psytalia concolor</i> and <i>P. lounsburyi</i> (Hymenoptera: Braconidae).</u>	
-	Présentation de l'article .....	93
-	Article .....	94
-	Données non présentées dans l'article .....	101
2.	<u>Venom composition of the parasitoid <i>Psytalia lounsburyi</i> changes in a new environment and together with allelic richness and <i>Wolbachia</i> influences the extinction dynamics.</u>	
-	Présentation .....	103
-	Article .....	105
3.	<u>Venomic comparison of <i>Psytalia lounsburyi</i> (Silvestri 1913) and <i>P. concolor</i>, two parasitoid wasps used in olive fly <i>Bactrocera oleae</i> biological control.</u>	
-	Présentation de l'article .....	148
-	Article .....	150
4.	<u>Evolution of the venom of the parasitoid wasp <i>Leptopilina boulardi</i> (Hymenoptera: Figitidae) in response to resistance of the <i>Drosophila melanogaster</i> host.</u>	
-	Présentation de l'article .....	195
-	Article .....	197
<b>V.</b>	<b><u>SYNTHESE DES PRINCIPAUX RESULTATS</u></b> .....	218
<b>VI.</b>	<b><u>DISCUSSION ET PERSPECTIVES</u></b> .....	220
	<b>1. La variabilité individuelle du venin</b>	
	Impact de la variabilité du venin : valeur sélective, extinction, et évolvabilité .....	221
	Maintien de la variabilité du venin dans les populations naturelles .....	223
	- <i>Le coût de l'existence ... et l'existence du coût</i> .....	224
	- <i>Par la coévolution</i> ... ..	225
	- <i>... Sans coévolution</i> .....	226
	<b>2. Apports méthodologiques de cette thèse pour combiner les approches d'écologie évolutive et de protéomique</b> .....	227
	- <i>Du point de vue de la protéomique</i> .....	229
	- <i>Du point de vue de l'écologie évolutive</i> .....	230
	- <i>En résumé</i> .....	231
	<b>3. Apport de la vénomique des populations pour la lutte biologique</b> .....	231
<b>VII.</b>	<b><u>CONCLUSIONS</u></b> .....	232

# Ma thèse en images



## I. INTRODUCTION : GENERALITES ET CONTEXTE

Ma thèse s'inscrit dans le cadre d'une question d'actualité : comment utiliser au mieux l'avancée des techniques, outils et connaissances dans le domaine de la biologie moléculaire ou biochimie pour mieux comprendre les processus éco-évolutifs et appréhender leur complexité. Son contexte théorique est celui de l'écologie évolutive mais le problème abordé présente aussi un intérêt pour la lutte biologique puisque le modèle biologique concerné est celui des insectes parasitoïdes qui sont souvent utilisés en tant qu'auxiliaires pour le contrôle des ravageurs de cultures. Ce modèle est très étudié, l'originalité de ma thèse étant de s'intéresser à un composant particulier de la fitness, le venin injecté par les femelles, et plus particulièrement à l'évolution de sa composition protéique en lien avec l'adaptation à de nouvelles conditions environnementales dont la mise en élevage sur un nouvel hôte. Les différentes notions abordées dans ce travail sont discutées ci-dessous.

### 1. L'écologie évolutive

#### Pourquoi le vivant est-il tel qu'il est ?

Cette question « ultime » a deux principaux axes :

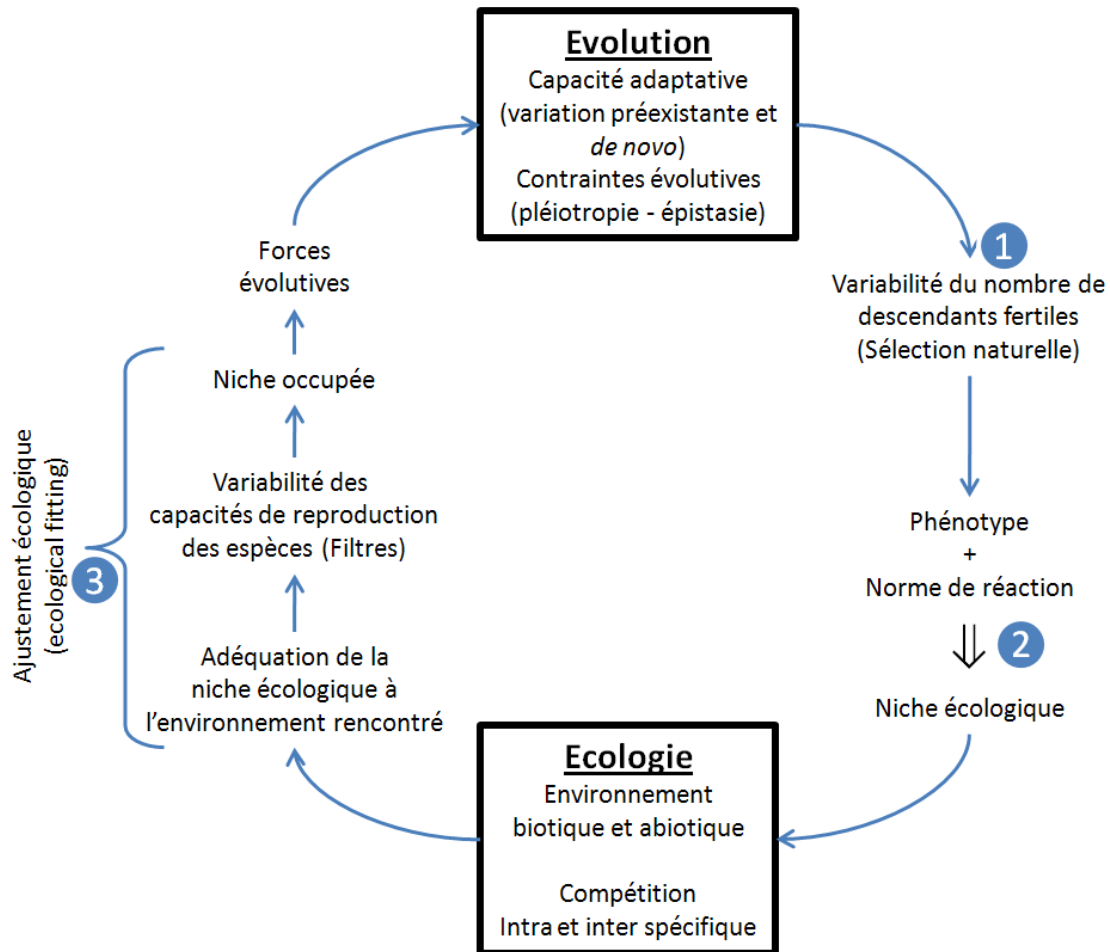
#### - **Pourquoi les espèces sont-elles là où elles sont ?**

Cette question concerne l'écologie des communautés qui cherche à comprendre les forces agissant sur les communautés d'espèces. Cette discipline repose en grande partie sur le concept de filtres : si une espèce n'est pas apte à se reproduire de manière pérenne dans une communauté, elle va disparaître de cette communauté. L'ensemble des conditions environnementales biotiques et abiotiques et des interactions nécessaires à une espèce définissent la « niche écologique réalisée » de l'espèce. Cette niche dépend des capacités de l'espèce à se reproduire dans différents environnements et donc de ses caractéristiques phénotypiques.

#### - **Pourquoi et comment les espèces sont-elles devenues ce qu'elles sont ?**

Cette question de biologie évolutive vise à comprendre les mécanismes sous-tendant l'évolution des différents caractères des êtres vivants. Le principal mécanisme en jeu est la sélection naturelle qui s'appuie sur une variation héritable du nombre de descendants viables et fertiles entre individus.

Ces deux questions sont étroitement liées, puisque la niche écologique d'un groupe d'individus dépend de leurs caractéristiques et que, réciproquement, les pressions de sélection s'exerçant sur ces caractéristiques dépendent de l'environnement dans lequel ils se trouvent. C'est à ce lien que s'intéresse l'**écologie évolutive** (Fig. 1).



**Figure 1 : Interactions entre écologie et évolution**

Les caractéristiques d'une espèce dépendent de l'évolution passée de cette espèce et donc notamment de la sélection naturelle que celle-ci a subie (1). Ensuite, les caractéristiques d'une espèce déterminent sa "niche écologique" (2), c'est à dire, les caractéristiques environnementales nécessaires à la formation de populations viables. L'adéquation entre les environnements rencontrés et la niche écologique exerce des "filtres" qui vont restreindre l'espèce à certains environnements au-delà desquels les populations ne sont pas viables, c'est l'ajustement écologique (3). Les environnements dans lesquels des populations viables se seront formées vont alors déterminer les forces sélectives qui vont s'exercer sur les populations de l'espèce (1).

Il y a de nombreuses sources de variabilité phénotypique héritable. Elle peut notamment avoir des bases génétiques, épigénétiques mais aussi reposer sur l'effet de symbiotes à transmission verticale ou la transmission culturelle. La variation « génétique » peut provenir d'une variation de séquence des gènes (et donc, dans certains cas, des protéines codées, ce qui peut modifier leur fonction et donc le phénotype) ou d'une variation de leur niveau d'expression (modulation de la quantité de protéine produite avec un effet potentiel sur le phénotype) due par exemple à des



différences dans les séquences régulatrices d'un gène. Le niveau d'expression d'un gène peut aussi être régulé épigénétiquement, en réponse à des variations environnementales. Ces modifications épigénétiques sont parfois (mais pas toujours) héritables.

La variation de niveau d'expression des gènes a un rôle important, voire majeur dans la variation phénotypique héritable entre espèces et entre individus et elle est également largement impliquée dans la plasticité. Ces deux aspects en font un trait particulièrement intéressant en écologie évolutive (Britten & Davidson 1971; Li *et al.* 2006; Fay & Wittkopp 2008; Gibson 2008; Hodgins-Davis & Townsend 2009; Espinosa-Soto *et al.* 2011; Zheng *et al.* 2011).

Enfin, la variation héritable de quantité d'une protéine peut être liée à la variation du nombre de copies de gène correspondant dans le génome (duplication, variation du nombre de copies via des crossing-over inégaux). Ce phénomène peut générer de la variabilité individuelle du nombre de copies de gènes (« copy number variation » ou CNV), dont il semble qu'elle explique une part importante de la variabilité phénotypique individuelle. Par exemple, il a été estimé que chez l'homme les gènes affectés par ce phénomène représentent 12 % du génome (Redon *et al.* 2006) et de nombreuses maladies ont pu lui être imputées (Fanciulli *et al.* 2010). Par ailleurs, il a été montré chez des primates que les CNVs sont vraisemblablement une source d'adaptation (Conrad *et al.* 2010; Schrider & Hahn 2010; Gokcumen *et al.* 2011).

En plus de leur intérêt fondamental évident, les questions liées à l'écologie et l'évolution peuvent présenter des applications dans tous les domaines de la biologie. Ce qui est résumé par la maxime de Theodosius Dobzhansky : «Rien n'a de sens en biologie, si ce n'est à la lumière de l'évolution ».

Par exemple, en médecine, en plus de l'intérêt évident de l'approche éco-évolutive en épidémiologie, la compréhension des pressions évolutives agissant sur les réponses immunitaires peut permettre de mieux comprendre ces réponses et donc de mieux les gérer ou de mieux les utiliser. On peut citer le cas de la fièvre (Nesse 2006) et de l'effet placebo (Trimmer *et al.* 2013). En agronomie, le phénomène de sélection naturelle qui est aujourd'hui couramment étudié, a été utilisé avant même d'être compris, via l'abattage des animaux les moins productifs ou l'utilisation des graines produites l'année précédente par les plantes les plus productives ou résistantes. Une autre application de l'écologie évolutive en agronomie est liée à la **lutte biologique** qui consiste à lutter contre un ravageur ou une plante adventice en utilisant des organismes naturels.

## 2. La lutte biologique

### a. L'impasse des pesticides

Les pertes de productivité dues aux ravageurs et adventices sont actuellement limitées par l'usage de pesticides mais elles pourraient être étonnamment élevées en absence de contrôle. En 2006, Oerke a ainsi estimé les pertes agricoles mondiales à 28,8 %, 37,4 %, 31,2 % et 40,3 % respectivement pour le blé, le riz, le maïs et la pomme de terre, alors qu'elles seraient de 49,8 %, 77 %, 68,5 % et 74,9 % en absence de contrôle.

S'il est essentiel de contrôler les espèces nuisibles, la nécessité de diminuer les pesticides est également largement reconnue (Alavanja *et al.* 2004; Weichenthal *et al.* 2010; Damalas & Eleftherohorinos 2011; Mostafalou & Abdollahi 2013). Outre leurs effets cumulatifs sur l'environnement (pollution) et la santé humaine et animale, il s'avère que la plupart des pesticides ont un spectre d'action bien plus large que l'espèce ciblée. L'utilisation des pesticides a donc pour conséquence de diminuer drastiquement la biodiversité et ce même à des doses considérées comme n'affectant pas l'environnement (Beketov *et al.* 2013). Cette perte de biodiversité peut atteindre 42% localement (Beketov *et al.* 2013). Par ailleurs, les ravageurs et adventices ont un potentiel évolutif important et l'apparition de résistance aux pesticides est fréquente (Ffrench-Constant 1994; Gressel 2009; Kakani *et al.* 2010, 2013). C'est notamment le cas pour la mouche de l'olive *Bactrocera oleae* dont certaines populations sont devenues tolérantes au principal pesticide utilisé (Kakani *et al.* 2010). L'apparition de ces résistances conduit fréquemment à une augmentation des quantités de pesticides utilisés. Face à ce problème, il est nécessaire de mettre en place des stratégies de lutte alternative ou complémentaire à l'utilisation de pesticides.

### b. La lutte biologique

Une des alternatives à l'utilisation de pesticides est la lutte biologique qui consiste à contrôler les populations de ravageurs via l'utilisation d'autres organismes vivants appelés auxiliaires. Il y a quatre principaux types de lutte biologique (Eilenberg *et al.* 2001).

La **lutte biologique par conservation** consiste à aménager l'environnement (ex : modification des pratiques agricoles) pour protéger et favoriser les organismes indigènes, ennemis naturels des ravageurs. Toutefois, il n'existe pas toujours d'organismes indigènes capables de diminuer l'impact des ravageurs. Par ailleurs, les modifications des pratiques agricoles sont parfois considérées comme trop contraignantes.

Dans ces situations, une stratégie souvent employée et à laquelle nous allons nous intéresser par la suite, est la **lutte biologique classique** qui consiste à introduire intentionnellement un organisme

exotique afin qu'il s'établisse durablement et contrôle le ravageur avec lequel il a généralement co-évolué. Cependant, l'auxiliaire de lutte ne s'établit pas toujours durablement.

On utilise alors la **lutte biologique par inoculation** qui consiste à réintroduire l'auxiliaire régulièrement. Après chaque inoculation, l'auxiliaire se reproduit jusqu'à atteindre une taille de population suffisante pour contrôler la population de ravageurs puis s'éteint, par exemple quand les conditions saisonnières deviennent défavorables. Enfin, dans certains cas, l'auxiliaire ne se reproduit pas suffisamment dans l'environnement dans lequel il est lâché pour que sa population augmente.

On peut alors utiliser la **lutte biologique par inondation** qui consiste à lâcher très massivement l'auxiliaire afin d'obtenir une taille de population initiale suffisante pour ponctuellement contrôler la population de ravageur.

Le taux d'établissement des espèces introduites lors des campagnes de lutte biologique varie entre 20 et 55% et la probabilité de contrôle effectif du ravageur entre 5 et 20% (Orr & Lahiri 2014). Pour les introductions fortuites, les taux sont plus faibles puisqu'on estime approximativement que sur 1000 espèces importées, 100 seront introduites (rencontrées dans la nature), 10 s'établiront durablement et une deviendra invasive (règle des dix ; Williamson & Fitter 1996). La compréhension des différents facteurs pouvant expliquer l'échec des populations introduites pourrait permettre d'augmenter le taux de succès en lutte biologique et éventuellement de limiter les invasions biologiques.

Dans le domaine de l'écologie évolutive, l'introduction d'un auxiliaire exotique donne l'opportunité d'étudier les mécanismes d'établissement d'une population dans un écosystème. En retour, l'étude de ces mécanismes peut permettre d'améliorer les pratiques de lutte biologique pour améliorer son taux de succès.

Un autre aspect intéressant des campagnes de lutte biologique est qu'elles fournissent un cadre expérimental simplifié permettant d'étudier les relations antagonistes entre ravageur et auxiliaire de lutte (espèce antagoniste de type prédateur ou parasite), souvent en l'absence d'autres ennemis naturel du ravageur. La présence de l'espèce antagoniste a généralement pour effet de diminuer la population du ravageur. Par ailleurs, l'agrosystème constitue un écosystème simplifié, ce qui peut parfois faciliter l'étude des relations antagonistes.

### c. Les auxiliaires de lutte biologique

La très large majorité des auxiliaires de lutte biologique sont des prédateurs ou des parasitoïdes. Les prédateurs ont été utilisés très tôt au cours de l'histoire. La première trace d'utilisation de prédateurs comme agents de lutte biologique remonte à 300 ans après J-C lorsque des agriculteurs chinois ont utilisé des fourmis contre des insectes ravageurs. De même, la première trace écrite décrivant le mode de vie des parasitoïdes remonterait au 11<sup>ème</sup> siècle, toujours en Chine, où il a été remarqué que des mouches *tachinidae* pondaient leurs œufs sur des vers à soie qui mouraient au cours du développement de ces mouches-parasitoïdes (Cai *et al.* 2005; Orr 2009). Ce laps de temps important entre l'utilisation concrète de prédateurs et la simple compréhension du mode de vie des parasitoïdes est vraisemblablement lié à l'aspect cryptique de ce dernier mode de vie.

## 3. Les parasitoïdes

### a. Généralités

Les parasitoïdes se développent en tant que parasites, au dépens d'un hôte qu'ils finissent inévitablement par tuer (Eggleton & Gaston 1990). Ce mode de vie est souvent considéré comme à mi-chemin entre le parasitisme et la prédation. Certaines espèces sont d'ailleurs intermédiaires entre parasite et parasitoïde car elles ne tuent pas systématiquement leur hôte. C'est le cas par exemple de la guêpe parasitoïde *Dinocampus coccinellae* dont 25 % des hôtes coccinelles survivent au parasitisme (Maure *et al.* 2011). C'est aussi le cas de plusieurs plantes qui se développent sur une ou plusieurs autres plantes et finissent souvent par les tuer (ex : les cuscutes et les figuiers étrangleurs).

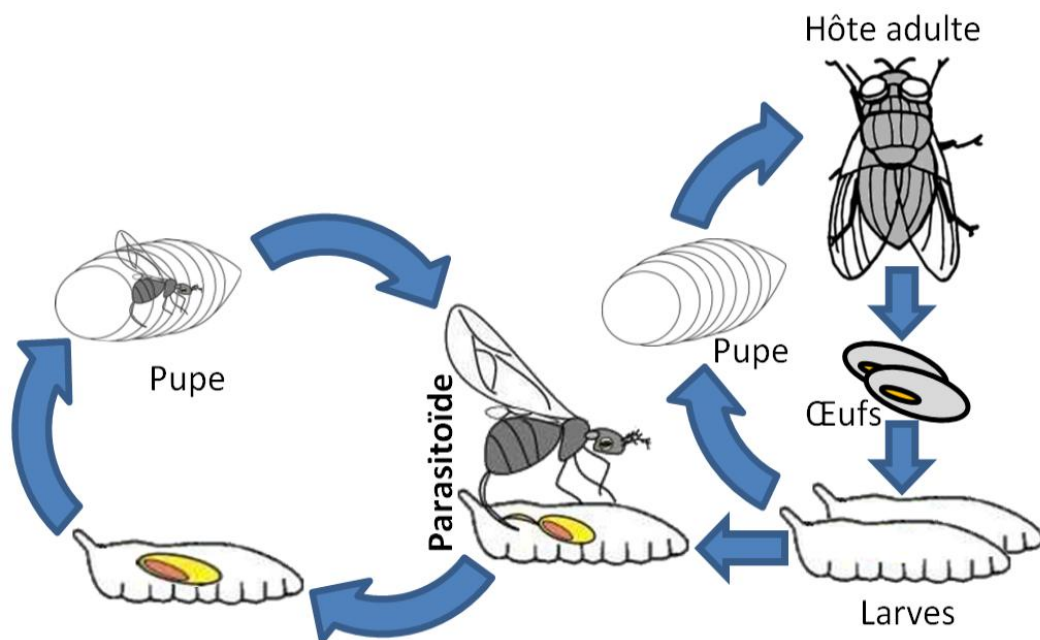
Le mode de vie « parasitoïde » est apparu de nombreuses fois dans l'évolution et il est présent dans la majeure partie des grands embranchements du vivant (insectes, nématodes, champignons, ciliés, bactéries ou virus ; Eggleton & Gaston 1990; Gómez-Gutiérrez *et al.* 2003; Forde *et al.* 2004). Cependant, il est principalement représenté chez les insectes et la plupart des parasitoïdes sont des petites guêpes de l'ordre des Hyménoptères (Quicke 1997). On estime qu'il existe vraisemblablement plus de 200 000 espèces de guêpes parasitoïdes (Pennacchio & Strand 2006).

Les guêpes parasitoïdes sont utilisées en lutte biologique car elles pondent leurs œufs sur ou dans des insectes en cours de développement et sont souvent spécialistes. Les insectes hôtes sont majoritairement des diptères ou des lépidoptères, ordres auxquels un grand nombre de ravageurs des cultures appartiennent.

Deux principaux types de critères permettent de classifier les parasitoïdes. Ils peuvent être ectoparasitoïdes ou endoparasitoïdes, selon qu'ils pondent leurs œufs à l'extérieur ou à l'intérieur de

l'hôte. Ils sont également idiobiontes s'ils paralysent ou tuent leur hôte dès le début de leur développement ou koïnobiontes si l'hôte s'alimente et poursuit son développement pendant un certain temps. Ces deux critères sont partiellement redondants, car la plupart des ectoparasitoïdes sont idiobiontes et la plupart des endoparasitoïdes koïnobiontes. En conséquence, les facteurs de virulence des parasitoïdes idiobiontes sont souvent essentiellement paralysants, alors que ceux des parasitoïdes koïnobiontes ont pour principal effet la modification de la physiologie de l'hôte à l'avantage du parasitoïde (Asgari 2012).

Les parasitoïdes auxquels je me suis intéressé au cours de ma thèse sont des guêpes endoparasitoïdes koïnobiontes qui pondent leurs œufs dans des larves de diptères. L'hôte se développe jusqu'au stade pupal au cours duquel ses tissus finissent d'être consommés par le parasitoïde (Figure 2).



**Figure 2 : Cycle de vie simplifié : Exemple d'un endoparasitoïde d'hôtes de stade larvaire, émergeant au stade pupal**

#### b. Un cas extrême d'interaction antagoniste

De par leur mode de vie, les parasitoïdes sont en interaction antagoniste étroite avec leur hôte qui représente à la fois le site de ponte et la principale source de nourriture.

Au niveau **populationnel**, par définition, chaque parasitoïde qui émerge a tué un hôte. Ceci rend les dynamiques de populations d'hôtes et de parasitoïdes extrêmement interdépendantes, une

augmentation de la population d'hôte conduisant à une augmentation de la population de parasitoïdes alors qu'une augmentation de la population de parasitoïdes conduit à une diminution de la population d'hôtes. Ceci peut mener à des dynamiques de populations cycliques voire chaotiques (ex : Hochberg *et al.* 1990; Ginzburg & Taneyhill 1994; Hassell 2000; Kon & Takeuchi 2001; Tuda & Shimada 2005; Klemola *et al.* 2010). Cette interdépendance des populations hôtes-parasitoïdes rend les parasitoïdes très efficaces pour contrôler les populations d'hôtes. C'est cette caractéristique qui est utilisée en lutte biologique lorsque les hôtes sont aussi des ravageurs des cultures.

### **L'antagonisme évolutif**

Au niveau **évolutif**, la valeur sélective d'un parasitoïde dépend directement de sa capacité à trouver des hôtes et à pondre sur ou dans un hôte des œufs qui parviendront à se développer. A l'opposé, la survie d'un hôte dépend de sa capacité à échapper au parasitisme ou à y survivre, ce qui entraîne la mort du parasitoïde en développement.

Il est souvent supposé que cet antagonisme induit une dynamique coévolutive. Les trois principaux scénarios de coévolution ont notamment été décrits par (Dupas *et al.* 2009). Ces scénarios ne sont pas mutuellement exclusifs. Succinctement, selon le premier scénario (polymorphisme coévolutif), la dynamique coévolutive peut générer un avantage au rare : s'il n'est pas possible ou pas avantageux de parasiter tous les génotypes d'une espèce hôte, les parasitoïdes capables de parasiter les génotypes d'hôtes les plus représentés seront sélectionnés, ce qui avantagera les génotypes d'hôtes rares. Ce type de dynamique coévolutive permet le maintien d'un fort niveau de polymorphisme des stratégies de virulence et de résistance. Selon un second scénario (course aux armements), certaines stratégies de virulence et de résistance peuvent être efficaces contre l'ensemble des génotypes de l'espèce antagoniste. Ces stratégies vont alors rapidement augmenter en fréquences jusqu'à se fixer, ce qui contraint l'espèce antagoniste à s'adapter. Selon le troisième scénario (l'alternance coévolutive), le parasitoïde ne s'adapte pas, mais change d'espèce hôte : le parasitoïde est sélectionné pour choisir l'espèce d'hôte qui lui conférera la valeur sélective la plus élevée et a donc tendance à parasiter les espèces qui n'ont pas de réactions de défense efficaces. Ceci induit une pression de sélection sur l'espèce d'hôte nouvellement parasitée. Si elle s'adapte et devient résistante, le parasitoïde sera à nouveau sélectionné pour changer d'hôte.

Ce dernier scénario fait apparaître que l'antagonisme n'est pas symétrique. En effet, si le parasitoïde peut être sélectionné pour changer d'hôte, ce n'est pas le cas de l'hôte qui subit le parasitisme. Ceci est souligné par l'hypothèse d'asymétrie (« asymmetry hypothesis » ; Lapchin 2002; Lapchin & Guillemaud 2005). Cette hypothèse met aussi en avant qu'un parasitoïde incapable

de se développer dans un hôte ne laissera aucun descendant (valeur sélective nulle) alors qu'un hôte non résistant aura en moyenne une valeur sélective non-nulle, inversement proportionnelle à la fréquence de parasitisme. Ainsi, les pressions de sélection exercées sur les parasitoïdes pour une augmentation de la virulence sont plus élevées que celles exercées sur les hôtes pour une augmentation de la résistance. Par ailleurs, il peut également être avantageux pour un hôte de ne pas développer de résistance si cette résistance possède un coût.

L'asymétrie a donc pour conséquence que la virulence devrait évoluer plus vite que la résistance, ce qui peut avoir pour conséquence d'empêcher la dynamique de co-évolution. On voit donc qu'il est difficile de savoir à quoi s'attendre et ce d'autant plus que chacun des mécanismes mentionnés ci-dessus a probablement un rôle dans la diversité des interactions antagonistes.

### *Spécialisation et changement d'hôte : un paradoxe apparent*

Les parasitoïdes sont souvent supposés extrêmement spécialistes. En effet, leur interaction très étroite avec leur hôte entraîne la sélection de phénotypes comportementaux et physiologiques qui peuvent être spécifiques de certaines espèces hôtes (Dupas & Carton 1999; Rouchet & Vorburger 2014), voire de certaines souche d'hôtes ne diffèrent que par leur endosymbiote (Rouchet & Vorburger 2014). Par ailleurs, la coévolution avec l'hôte a longtemps été considérée comme induisant un désavantage des généralistes par rapport aux spécialistes ce qui sélectionnerait pour une augmentation de la spécialisation des parasitoïdes (Kawecki 1994; Whitlock 1996; Ostrowski *et al.* 2007). Ce désavantage aurait deux principales causes :

- i) l'existence de compromis entre le niveau d'adaptation à différents hôtes qui est résumée par la maxime « **Jack of all trades – master of none** ». Il y aurait dans ce cas des corrélations négatives entre les capacités à parasiter des hôtes différents.
- ii) une **évolution plus lente des généralistes** qui pourrait les désavantager si les hôtes s'adaptent rapidement. Cette évolution plus lente d'une espèce généraliste serait due au fait que les différentes pressions de sélection s'exerçant sur ses capacités à parasiter différents hôtes avec succès (en supposant ces capacités indépendantes) seraient chacune plus faibles que la pression de sélection s'exerçant sur une espèce spécialiste (Kawecki 1994; Whitlock 1996; Ostrowski *et al.* 2007). Les pressions de sélections indépendantes sur chacun des hôtes sont principalement attendues si les facteurs de virulence sont spécifiques de chacun des hôtes.

**Le paradoxe** est que si les parasites et en particulier les parasitoïdes deviennent effectivement de plus en plus spécialistes, alors un changement d'hôte nécessiterait l'adaptation rapide et simultanée d'un très grand nombre de traits ce qui est biologiquement improbable (Agosta *et al.*

2010). Ceci a conduit à considérer la spécialisation comme un « cul de sac » évolutif (« evolutionary dead-end »). Pourtant, on observe de nombreux changements d'hôtes et des analyses phylogénétiques ont montré que le taux d'augmentation de la spécialisation n'est pas globalement plus élevé que le taux de diminution de la spécialisation. Ceci suggère qu'il est également fréquent que des espèces spécialistes deviennent généralistes (Stireman 2005; Mouillot *et al.* 2006; Poulin & Keeney 2008; Tripp & Manos 2008; Johnson *et al.* 2009; Vienne 2013; Mendlová & Šimková 2014).

Pour résoudre ce paradoxe apparent, il a été proposé que les parasites soient partiellement **préadaptés** à leurs nouveaux hôtes. Le nombre de traits devant évoluer pour que le parasite puisse changer d'hôte serait alors plus faible que généralement supposé (Agosta *et al.* 2010). Plus généralement, ce phénomène de préadaptation à un nouvel environnement correspond au phénomène d'**ajustement écologique** (« ecological fitting » ; Janzen 1985; Agosta 2006) selon lequel les espèces présentent une haute valeur sélective dans leur environnement parce qu'elles ont pu s'y installer et non suite à leur adaptation spécifiquement à cet environnement. Il est intéressant de noter ici que même si une préadaptation à un changement d'environnement ne permet pas de fonder une population viable (taux d'accroissement positif), elle augmente la probabilité que la population subsiste le temps de s'adapter suffisamment au nouvel environnement pour devenir viable (Antia *et al.* 2003).

Si la capacité des parasites et parasitoïdes à changer d'hôte est effectivement due à l'existence de préadaptations aux nouveaux hôtes, **la plupart des traits devraient n'être que peu ou pas soumis à des compromis sur le niveau d'adaptation à différents hôtes**. Ces compromis sont pourtant le principal phénomène étudié pour rechercher s'il existe un avantage aux spécialistes par rapport aux généralistes (Palaima 2007; Ravigné *et al.* 2009). Le plus souvent, les études réalisées au laboratoire ne sont pas parvenues à mettre en évidence de compromis (Futuyma & Moreno 1988; Joshi & Thompson 1995; Fry 1996; Ferrari *et al.* 2001; García-Robledo & Horvitz 2012), ce qui suggère effectivement l'existence de préadaptations : les individus ou espèces particulièrement bien adaptées à leur hôte actuel ne sont pas particulièrement mal-adaptés à d'autres hôtes.

Il est intéressant de mettre en relation cette fréquente absence de détection de compromis avec le fait qu'il semble exister une **inadéquation entre le niveau de spécificité détecté par des expériences au laboratoire et celui détecté sur des individus de terrain par des méthodes moléculaires**. En effet, comme mis en avant par Poulin & Keeney (2008), le niveau de spécialisation des parasites est généralement élevé lorsqu'il est évalué sur le terrain par des méthodes moléculaires et faible lorsqu'il est estimé au laboratoire. Il y aurait donc une différence assez générale entre le



comportement sur le terrain (révélé par des méthodes moléculaires) et les capacités physiologiques observées au laboratoire (Futuyma & Moreno 1988; Fry 1996; Forister *et al.* 2012). Elle pourrait être dû à la **compétition interspécifique** qui, sur le terrain, pourrait restreindre les parasites à leur hôte de prédilection et les rendre comportementalement plus spécialistes (Agosta *et al.* 2010). Cependant, les résultats de Johnson *et al.* (2009) semblent suggérer que la compétition interspécifique diminuerait au contraire la spécialisation.

Une autre explication possible à cette différence entre études de terrain et de laboratoire est que même en l'absence de compromis et de compétition interspécifique, les parasites aient souvent intérêt à avoir un **comportement spécialiste et qu'ensuite, seulement dans certains cas, leur physiologie deviennent plus spécialiste** (faisant alors apparaître des compromis). Ceci a été suggéré en 1996 par Fry qui a montré que, sous certaines conditions (hard sélection), une espèce doit préférer l'hôte qui lui confèrera la valeur sélective la plus élevée, même en absence de compromis (Futuyma & Moreno 1988; Fry 1996; Forister *et al.* 2012). Ceci a été redémontré et généralisé à de nombreuses situations et notamment aux espèces non parasites par Ravigné *et al.* (2009).

**En résumé, ceci suggère que la spécialisation serait d'abord due au comportement et se ferait en réponse à une différence de niveau de virulence sur différents hôtes** (mais n'impliquant pas forcément de compromis). Du point de vue des changements d'hôtes, la relative absence de spécialisation morpho-physiologique correspond à une forme de préadaptation qui peut permettre le phénomène « d'ajustement écologique » (ecological fitting) proposé par Agosta *et al.* (2010) pour résoudre le paradoxe apparent lié aux importantes capacités de changements d'hôtes des parasites et parasitoïdes.

La faible spécialisation morpho-physiologique pourrait être liée à l'**antagonisme asymétrique hôte-parasitoïde** abordé précédemment (asymmetry hypothesis ; Lapchin 2002; Lapchin & Guillemaud 2005). En effet, cette asymétrie a pour conséquence que la virulence devrait évoluer plus vite que la résistance, ce qui peut empêcher la dynamique de coévolution. Si le niveau de résistance évolue généralement peu, les parasitoïdes subissent moins de pression de sélection et pourraient être physiologiquement assez généralistes.

**Ce généralisme physiologique est toutefois relatif et loin d'être systématique.** Par exemple, Desneux *et al.* (2012) ont montré un effet significatif de la phylogénie de l'hôte sur la survie du parasitoïde au stade pupal. De façon similaire, Dupas & Carton (1999) ont identifié un gène de résistance de *D. melanogaster* à *L. bouvardi* ainsi qu'un « locus » de *L. bouvardi* permettant de surmonter cette résistance, ce qui suggère une dynamique de coévolution au niveau physiologique.

En 2013, Dupas *et al.*, ont aussi mis en relation la phylogénie du genre *Leptopilina* et le niveau de virulence des espèces sur différentes espèces hôtes de Drosophiles ce qui leur a permis de mettre en évidence une importante inertie phylogénétique du niveau de virulence. L'inertie phylogénétique estime ici la similarité de niveau de virulence d'espèces parasitoïdes proches. Elle a longtemps été interprétée comme la signature d'une capacité évolutive limitée mais de nombreuses autres explications existent (Crisp & Cook 2012), telle la faible pression de sélection pour évoluer prédite par l'antagonisme asymétrique. Par ailleurs, les résultats de Dupas *et al.* (2013) montrent aussi que les inerties phylogénétiques des niveaux de virulence mesurés sur différents hôtes ne sont souvent pas corrélées. Ceci montre que les mécanismes de résistance peuvent différer d'un hôte à l'autre et suggère que la capacité à parasiter différentes espèces hôtes est liée à différents facteurs de virulence. Notamment, il est intéressant de voir que les taux de virulence d'un groupe d'espèces proche de *L. heterotoma* (incluant *L. heterotoma* ; Allemand & Lemaitre 2002) sur deux souches de *D. yakuba* ne sont pas corrélés, ce qui suggère une variation intraspécifique de certains mécanismes de résistance de *D. yakuba* comme montré pour *D. melanogaster* (Dupas & Carton 1999). Des facteurs de virulence différents seraient donc utilisés pour réussir sur ces deux souches de *D. yakuba*.

La variabilité intra-spécifique de résistance des hôtes suggère que ces derniers pourraient avoir un certain niveau de spécialisation par rapport à certains parasitoïdes ce qui n'est pas attendu sous l'hypothèse d'antagonisme asymétrique. Il pourrait donc exister, au moins au sein de certaines associations hôtes – parasitoïdes, une **dynamique coévolutive**.

#### Les deux types d'espèces généralistes

Si la capacité des parasites et parasitoïdes à changer d'hôte repose effectivement sur un important « généralisme physiologique » (constituant une préadaptation au changement d'hôte), il faut noter que **deux types d'espèces généralistes** sont généralement envisagés : des espèces ayant une grande variabilité intraspécifique de gamme d'hôte et paraissant donc généralistes et les espèces formées d'individus effectivement généralistes.

Le premier cas est lié à la notion de **réseaux trophiques individuels** consistant à regarder, non pas quelles espèces « mangent » (ou parasitent) quelles espèces, mais quels individus (génotypes) d'une espèce « mangent » quels individus (génotypes) d'une autre espèce (Melián *et al.* 2011). Par exemple, en 2013, Lavandero & Tylianakis ont montré que certains génotypes du parasitoïde *Aphelinus mali* étaient spécialisés sur des génotypes du puceron *Eriosoma lanigerum*. Ce résultat suggère une forte dynamique coévolutive où certains génotypes de parasitoïdes se développent mieux sur certains génotypes de pucerons et ont appris les reconnaître. Ici, c'est donc la

spécialisation, poussée jusqu'à l'échelle individuelle, qui donne l'apparence d'une espèce généraliste.

Le deuxième type d'espèce généraliste, composée d'individus intrinsèquement généralistes, a été prédit comme désavantageux par rapport aux stratégies spécialistes. Le ralentissement de l'évolution associé à l'utilisation d'une large gamme d'hôtes, diminuerait en effet leur capacité d'adaptation sur chacun des hôtes (Kawecki 1994; Whitlock 1996; Ostrowski *et al.* 2007). Ce coût peut cependant être contrebalancé par différents phénomènes tels la variabilité spatio-temporelle de disponibilité des différents types d'hôtes, ce qui est particulièrement attendue pour les dynamiques hôtes – parasitoïdes (Hassell 2000; Xu & Boyce 2005; Klemola *et al.* 2010).

L'existence d'espèces apparemment ou effectivement généralistes suggère une grande variabilité de niveau de spécificité des « cocktails » **de facteurs de virulence**, avec certains « cocktails » efficaces sur un grand nombre d'hôtes (généralistes) et d'autres particulièrement efficaces sur une espèce ou une population d'hôtes (spécialistes). Les « cocktails » peuvent être généralistes soit parce que les facteurs de virulence sont efficaces sur différentes espèces et donc soumis à la sélection sur chacun des hôtes (mais pouvant éventuellement faire l'objet de compromis), soit parce qu'ils contiennent différents facteurs de virulence efficaces sur certains hôtes seulement et donc soumis à sélection uniquement lorsque ces hôtes sont parasités, ce qui pourrait ralentir l'évolution de ces facteurs.

Pour aller plus loin dans l'étude des questions posées précédemment, il est nécessaire **d'identifier les facteurs de virulence majeurs des parasitoïdes et de caractériser leurs effets sur différents hôtes**. Des premiers éléments suggèrent par exemple que les facteurs de virulence d'une espèce généraliste et d'une espèce spécialiste proche peuvent être très différents (Colinet *et al.* 2013a).

**Ceci m'amène aux objectifs de ma thèse qui vise à apporter des données permettant d'améliorer la compréhension de la dynamique d'interaction hôte-parasitoïde via l'étude des facteurs présents dans le venin, associé au succès parasitaire dans la grande majorité des espèces.**

## L'antagonisme phénotypique

L'antagonisme évolutif hôte-parasitoïde est probablement à l'origine de la sélection de phénotypes antagonistes variés chez le parasitoïde.

Par exemple, au niveau **comportemental**, le parasitoïde doit parvenir à trouver l'hôte. De nombreux comportements visant à optimiser la recherche d'hôtes ont évolué chez les parasitoïdes. Classiquement, ceux-ci commencent par repérer une des plantes de prédilection de l'hôte, puis y cherchent un hôte. Certaines espèces de parasitoïdes du stade œuf, tels les trichogrammes (micro-hyménoptères), utilisent les phéromones sexuelles de leurs hôtes pour repérer les femelles qui vont s'accoupler ou qui viennent de le faire. Ils montent ensuite sur ces femelles et y restent jusqu'à ce qu'elles pondent, avant de déposer leurs propres œufs dans les œufs de l'hôte (ex : Arakaki *et al.* 1996; Fatouros & Huigens 2011). Une fois l'hôte au stade adéquat repéré, le parasitoïde doit parvenir à piquer l'hôte. Si cela semble simple pour un hôte au stade œuf, le parasitisme de stades larvaires est souvent plus compliqué. Par exemple, lorsque le parasitoïde *Aphidius ervi* attaque une colonie de pucerons hôtes, les premiers pucerons attaqués émettent une phéromone d'alarme, générant des réactions de défense de l'ensemble de la colonie telles que la chute de la plante (« faire le mort ») ou la production de sécrétions susceptibles d'engluer le parasitoïde (Kunert *et al.* 2010).

Au niveau **physiologique**, une fois l'œuf pondu, l'interaction devient encore plus étroite en particulier pour les endoparasitoïdes. L'hôte constitue la principale source de nourriture dont le parasitoïde disposera au cours de sa vie. L'adéquation physiologique de l'hôte aux besoins du parasitoïde est donc une contrainte importante sur la physiologie du parasitoïde (Slansky 1986; Harvey 2005; Strand & Casas 2008). Il a par exemple été montré que l'espèce ou la qualité de la plante dont se nourrit l'hôte affecte le développement du parasitoïde (Talaei 2009; Bukovinszky *et al.* 2012). Les parasitoïdes modifient souvent la physiologie de leur hôte à leur avantage, par exemple, en améliorant leurs ressources nutritives (Slansky 1986). Par exemple, un des effets majeurs du venin injecté par *A. ervi* dans un puceron avec l'œuf est la castration du puceron, qui augmente la quantité de ressource que le parasitoïde en développement peut utiliser (Tremblay *et al.* 1998; Digilio *et al.* 2000; Li *et al.* 2002).

Un autre aspect de l'interaction est lié à la réaction de défense de l'hôte en réponse au parasitisme. Cette réaction repose principalement sur la mise en place d'une **réponse immunitaire**, appelée encapsulement et dans certains cas, sur l'effet de bactéries symbiotiques (ou de leurs phages ; Weldon *et al.* 2013). Par exemple, deux des symbiotes facultatifs du puceron (les bactéries

*Hamiltonella defensa* et *Serratia symbiotica*) ont été montrés comme augmentant la résistance contre le parasitoïde *A. ervi* (Oliver *et al.* 2003; Moran & Russell 2005).

Chez les diptères et les lépidoptères, la formation de la capsule débute par la reconnaissance de l'œuf du parasitoïde comme un corps étranger (non-soi), probablement via l'altération de la membrane basale suite au parasitisme. On observe ensuite une prolifération des hémocytes qui vont venir former plusieurs couches organisées de cellules autour de l'œuf (Schmidt *et al.* 2001; Lavine & Strand 2002; Carton *et al.* 2008). En parallèle, l'activation de la cascade phénoloxydase (qui conduit à la production d'une phénoloxydase active) va conduire à la mélanisation de la capsule et à la production de radicaux cytotoxiques probablement responsables de la mort du parasitoïde.

### Stratégies de virulence des parasitoïdes

Les parasitoïdes sont capables de s'adapter à la résistance de leur hôte. Ainsi, Dion *et al.* (2011) ont mis en évidence une sélection de la virulence du parasitoïde *Aphidius ervi* en réponse à la résistance symbiotique du puceron hôte *Acyrtosiphon pisum*. Rouchet et Vorburger (2014) ont récemment complété cette étude en montrant que la guêpe parasitoïde *Lysiphlebus fabarum* est capable de s'adapter à la résistance du puceron *Aphis fabae* associée à la présence de *Hamiltonella* mais aussi que cette adaptation est spécifique de certaines souches de ce symbiote. Dans la nature, ceci pourrait permettre un maintien de la diversité de « virulence » en lien avec la fréquence des différentes souches de symbiote (avantage du rare). Cependant, les mécanismes de virulence « sélectionnés » n'ont pas encore été identifiés.

Plus généralement, les stratégies des parasitoïdes qui leur permettent de surmonter les défenses de leurs hôtes sont très diverses (et non mutuellement exclusives). Ces stratégies ont été notamment décrites par Poirié *et al.* (2009).

Un premier type de stratégie consiste à éviter la réponse immunitaire en pondant dans des parties du corps de l'hôte inaccessibles (comme la tête) ou en parasitant des espèces incapables de mettre en place une défense immunitaire. Ceci pourrait notamment être le cas de *Drosophila subobscura* (Eslin & Doury 2006) qui ne présente pas de lamellocytes. Cette « faiblesse immunitaire » pourrait être liée au coût énergétique associé à la mise en place d'une réponse (Kraaijeveld & Godfray 2003; Vijendravarma *et al.* 2009; Niogret *et al.* 2009). Une autre stratégie d'évitement consiste à parasiter des stades de développement dont le système immunitaire n'est pas mature. Par exemple, on a longtemps considéré que les trichogrammes qui parasitent leur hôte au stade œuf ne rencontraient pas de défense immunitaire (Salt 1968; Strand & Pech 1995). Mais il semblerait – au moins pour

certaines espèces – qu’il existe un système immunitaire actif dès le stade œuf (Reed *et al.* 2007; Abdel-latif & Hilker 2008). Il a aussi été suggéré que le stade pupal pourrait ne pas avoir de système immunitaire actif (Kraaijeveld & Godfray 2003; Kacsoh & Schlenke 2012). Enfin, certains parasitoïdes « camouflent » leurs œufs dans les tissus de leur hôte. Par exemple, le chorion collant des œufs d’une souche du parasitoïde *Asobara tabida* lui permet de s’entourer de tissus de son hôte, empêchant ainsi l’encapsulation (Eslin *et al.* 1996).

Une autre stratégie consiste à altérer le système immunitaire de l’hôte, via des facteurs de virulence. Ces facteurs peuvent être produits par le parasitoïde en développement ou sécrétés par des cellules géantes issues de la dissociation de la membrane séreuse de l’œuf, les tératocytes. Ces cellules ont un rôle nourricier, antimicrobien (Salt 1971; Dahlman 1991; Burke & Strand 2014) et sont souvent considérées comme ayant également un rôle immunosuppresseur. Les facteurs de virulence sont cependant plus généralement injectés par la mère lors de l’oviposition et donc assez bien connus car accessibles à l’étude. Leur production est localisée dans les ovaires (notamment une partie des ovaires appelée « calice ») et/ou dans une glande spécialisée annexe de l’appareil reproducteur (la glande à venin). Ces facteurs peuvent être, selon les espèces, des polydnavirus (PDVs pour Polydisperse DNA Viruses), des « Virus-Like Particles » (VLPs) et/ou des protéines.

Les connaissances sur les facteurs de virulence de types viraux (PDV) ont notamment été résumées par Beckage & Drezen (2012) et celles concernant les VLPs par Gatti *et al.* (2012).

Les PDVs sont des symbiotes viraux à ADN double brin dont le génome est intégré au génome du parasitoïde. Les virions produits dans le calice des ovaires du parasitoïde contiennent des cercles d’ADN dans lesquels on trouve des gènes d’origine « guêpe » codant des facteurs de virulence mais pas de gènes associés à la réplication virale. Ces gènes de virulence sont exprimés dans les cellules de l’hôte lépidoptère et certains sont impliqués dans l’inhibition de la réponse immunitaire de l’hôte. Tous les parasitoïdes n’ont pas de PDVs (association avec certains groupes de parasitoïdes de la super-famille des Ichneumonoidea seulement) et les parasitoïdes que j’ai étudiés durant ma thèse n’en possèdent pas.

Les VLPs sont des particules ou des vésicules ressemblant plus ou moins à des virus, mais qui ne contiennent pas d’acides nucléiques. Elles sont produites dans les ovaires ou dans les glandes à venin, selon l’espèce de parasitoïde et sont beaucoup moins bien caractérisées que les PDVs. Du fait de leur définition assez large, les VLPs englobent vraisemblablement plusieurs types de particules de nature différente. Toutefois, les données suggèrent que certaines des VLPs caractérisées, dont celles

présentes dans le venin des *Leptopilina* que j'ai étudiés, sont d'origine cellulaire et non virale (Gatti *et al.* 2012).

Enfin, le **venin**, injecté par la très grande majorité des espèces parasitoïdes, a une composition essentiellement protéique. Son injection dans l'hôte est généralement indispensable au succès parasitaire, y compris semble-t-il pour des espèces produisant des PDVs. En effet, une glandectomie de la glande à venin chez les parasitoïdes du genre *Cotesia* porteurs de PDVs montre qu'aucun œuf pondu sans venin ne se développe normalement dans l'hôte (Kitano 1986; Wago & Tanaka 1989; Asgari 2012). De manière similaire, Soller & Lanzrein (1996) ont montré que le venin et les PDV du parasitoïde *Chelonus inanitus* ont un effet synergique sur la virulence, le venin pouvant avoir pour effet de permettre aux PDV d'entrer dans les cellules de l'hôte (Kaeslin *et al.* 2010). Toutefois, une étude récente suggère que le venin d'un ichneumonide à PDVs, *Hyposoter didymator*, pourrait ne pas avoir d'effet protecteur tout au moins vis-à-vis d'un de ses hôtes (Dorémus *et al.* 2013).

Plusieurs protéines contenues dans le venin ont pu être identifiées comme facteurs de virulence. Par exemple, Labrosse *et al.* (2005) ont montré que la protéine LbGAP (domaine RhoGAP) présente dans le venin de *Leptopilina boulardi*, un parasitoïde de *Drosophila melanogaster*, provoque une déformation des lamellocytes (cellules immunitaires de *D. melanogaster* impliquées dans l'encapsulation) et empêche ainsi la formation de la capsule. Chez cette même espèce, une serpine (LbSPNy) a été mise en évidence comme inhibant la cascade phénoloxydase impliquée dans la mélanisation lors de l'encapsulation (Colinet *et al.* 2009). Cette même réaction de mélanisation est aussi inhibée *in vitro* par une Superoxyde Dismutase sécrétée dans le venin (Colinet *et al.* 2011). Cette dernière protéine est aussi présente dans le venin de *Leptopilina heterotoma*, une espèce proche de *Leptopilina boulardi*, mais elle y est 100 fois moins exprimée. A l'opposé, une des protéines majeures du venin de *Leptopilina heterotoma* est une Aspartyl-glucosaminidase (AGA) qui n'a pas été trouvée dans le venin de *Leptopilina boulardi* (Colinet *et al.* 2013a).

#### 4. Problématique

Comme nous venons de le voir, la virulence des parasitoïdes a un fort potentiel adaptatif et de nombreuses théories décrivent les forces s'exerçant sur l'évolution de la gamme d'hôte ainsi que les dynamiques coévolutives. Afin de mieux les comprendre, il est nécessaire de déchiffrer les phénomènes moléculaires en jeu dans les interactions hôte – parasitoïde.

Les récents développements techniques ont permis de mieux caractériser la nature des composants du venin. Ces composants peuvent être très différents d'une espèce à l'autre, y compris entre espèces proches, suggérant une importante évolvabilité de la composition des cocktails de facteurs de virulence (Colinet *et al.* 2013a).

Si l'implication de certains facteurs du venin dans la virulence a été démontrée (Labrosse *et al.* 2005; Colinet *et al.* 2009), le lien entre la composition globale du venin et le niveau de virulence sur différents hôtes n'a encore jamais été étudiée. De même, la forte variabilité intraspécifique des facteurs du venin sur laquelle repose théoriquement l'évolvabilité de la virulence n'a été que rarement étudiée (Colinet *et al.* 2013b). C'est à ces questions liées à la variabilité et l'évolvabilité du venin que je me suis intéressé au cours de ma thèse.

Ces questions ont des implications en lutte biologique, telles que le risque d'effets collatéraux provoqués par les changements d'hôtes. En effet, même si de plus en plus de précautions sont prises, il y a toujours un risque non nul qu'un auxiliaire introduit s'attaque à des espèces non cibles et que ceci modifie le fonctionnement de l'écosystème (Howarth 1991; Messing & Wright 2006; Clercq *et al.* 2011). Un autre aspect important est lié à la méthode d'élevage des auxiliaires de lutte. En effet, elle peut entraîner une diminution de la survie et/ou de la fécondité, ce qui peut mener à la perte de la souche d'auxiliaire (Mackauer 1971, 1976; Hopper *et al.* 1993). Les pressions de sélection associées aux conditions d'élevage peuvent également modifier certaines caractéristiques du parasitoïde jusqu'à le rendre inefficace une fois sur le terrain. Une des conditions d'élevage consiste par exemple à utiliser un hôte de substitution, différent de l'hôte ciblé par la campagne de lutte biologique, qui parfois ne fait pas partie de la gamme d'hôte naturelle du parasitoïde. Cette pratique est fréquente car il est souvent difficile d'élever l'hôte ciblé, et elle représente un changement d'hôte contraint. Ce changement modifie vraisemblablement les pressions de sélection exercées et ce d'autant plus que l'interaction hôte – parasitoïde est étroite. L'effet du changement d'hôte provoqué par l'utilisation d'un hôte de substitution a souvent été étudié et la majorité des études ont mis en évidence une « adaptation » très rapide au nouvel hôte (5 à 12 générations) [revu par Hopper *et al.* (1993)]. Toutefois, la plupart de ces études se sont intéressées aux aspects comportementaux alors que les



effets de l'utilisation d'un hôte de substitution s'étendent probablement aux autres aspects physiologiques.

D'une manière générale, les conditions de laboratoire sont connues pour entraîner des adaptations spécifiques qui peuvent rendre les auxiliaires mal-adaptés à l'environnement dans lequel ils sont destinés à être lâchés (Hopper *et al.* 1993; van Lenteren 2003). En particulier, il est fréquent d'observer d'importants changements comportementaux (Boller 1972), même si ils sont souvent réversibles (Boller 1972; ex : Canale & Benelli 2011). L'évolution en réponse aux conditions de laboratoire a aussi été mise en évidence pour de nombreux traits d'histoires de vie généraux (Tayeh *et al.* 2012).

## 5. Les modèles biologiques

Afin d'étudier la variation et l'évolution du venin, j'ai utilisé deux modèles biologiques, un modèle « de terrain » sur lequel peu de données sont disponibles, les parasitoïdes Braconidae (Ichneumonoidea), *Psytalia concolor* et *P. lounsburyi*, utilisés en lutte biologique contre la mouche de l'olive et, de manière plus annexe, un modèle de laboratoire bien caractérisé, les parasitoïdes Figitidae (Cynipoidea) *Leptopilina bouvardi* et *L. heterotoma*.

Les parasitoïdes *P. concolor* et *P. lounsburyi* sont deux espèces proches appartenant au même complexe d'espèces (Kimani-Njogu *et al.* 2001; Rugman-Jones *et al.* 2009). *P. concolor* est réputé généraliste et parasite naturellement de nombreuses espèces de mouches des fruits de la famille des Tephritidae, comme *Trirhithrum coffeae*, *Ceratitis capitata*, *C. cosyra*, *Parafreutreta regalis* et la mouche de l'olivier *Bactrocera oleae* (Trostle Duke 2005; Mohamed *et al.* 2007; Daane *et al.* 2011). A l'opposé, les études de terrain suggèrent que *P. lounsburyi* est spécialiste de la mouche de l'olive *B. oleae* (Daane *et al.* 2011). Les parasitoïdes *Leptopilina bouvardi* et *L. heterotoma* sont deux espèces proches parasitant des drosophiles au stade larvaire. *L. bouvardi*, considéré comme spécialiste, est inféodé dans nos régions à *D. melanogaster* et *D. simulans* (Fleury *et al.* 2009). Toutefois, une population issue du Congo a été montrée comme moins virulente contre *D. melanogaster* mais capable de parasiter quelques espèces de drosophiles d'Afrique tropicale dont *D. yakuba* (Carton *et al.* 1992). Cette différence de gamme d'hôte pourrait être due à la présence d'un nombre d'hôtes plus élevé en région tropicale. Cette population congolaise et une population « classique » originaire de Tunisie sont représentées par deux lignées iso-femelles bien caractérisées et maintenues en laboratoire. Elles ont notamment permis d'identifier un gène de *D. melanogaster* impliqué dans la résistance à *L. bouvardi* (lignée Congo) ainsi que deux loci associés à la virulence contre *D. melanogaster* pour l'un et contre *D. yakuba* pour l'autre (Dupas & Carton 1999). *L.*

*heterotoma* est décrit comme une espèce généraliste parasitant de nombreuses espèces de drosophiles (*D. busckii*, *D. funebris*, *D. kuntzei*, *D. melanogaster*, *D. obscura*, *D. phalerata*, *D. simulans*, *D. subobscura* et *D. willistoni*) ainsi que des espèces proches du genre *Drosophila* (*Chymomyza* et *Scaptomyza*) (Fleury *et al.* 2009).

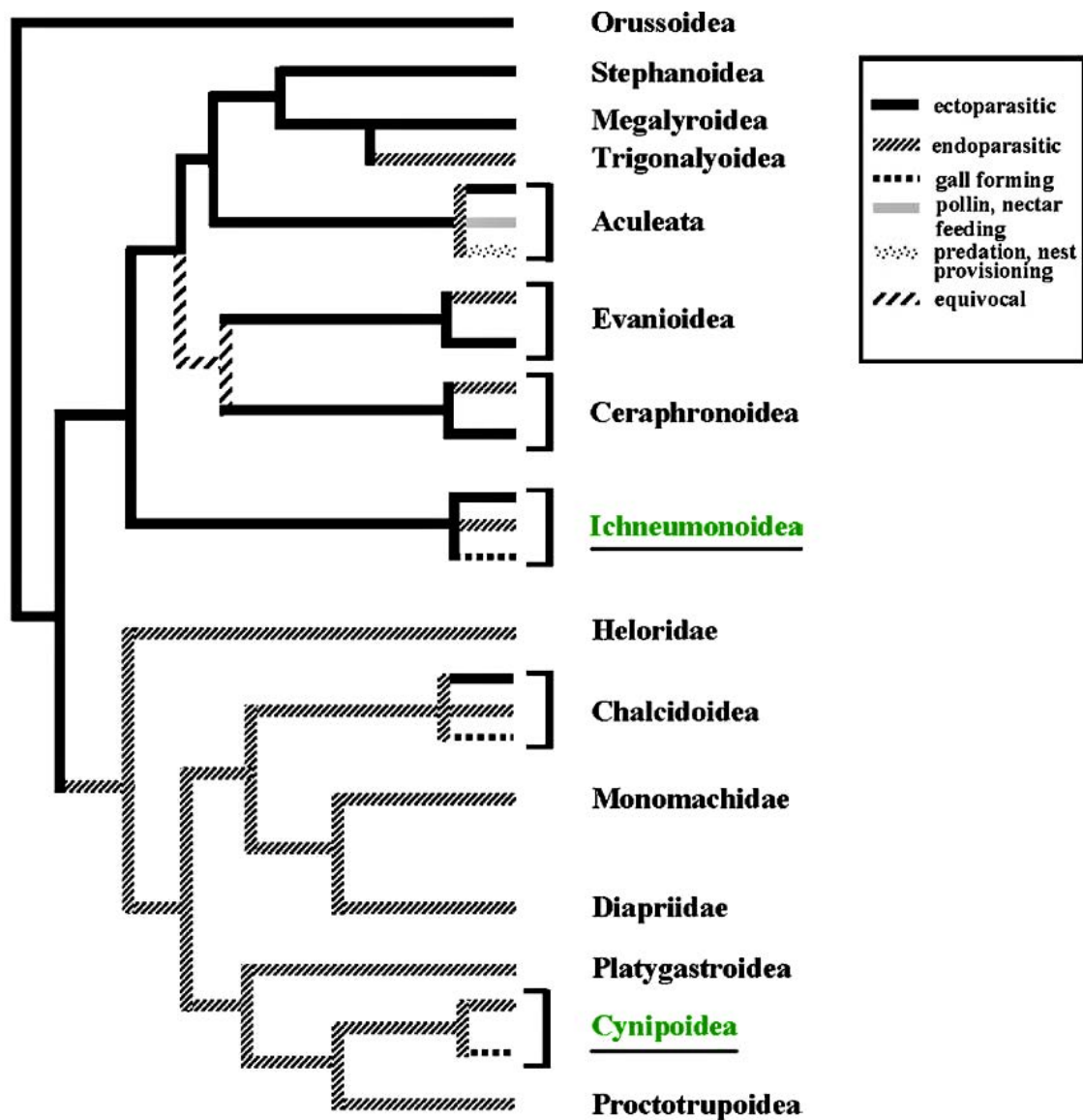


Figure 3 : Phylogénie des super-familles de guêpes parasitoïdes. Les deux super-familles dont font parties les espèces étudiées sont soulignées. *Psytalia spp.* sont des Ichneumonoidea et *Leptopilina spp.* des Cynipoidea. Figure modifiée d'après (Pennacchio & Strand 2006).

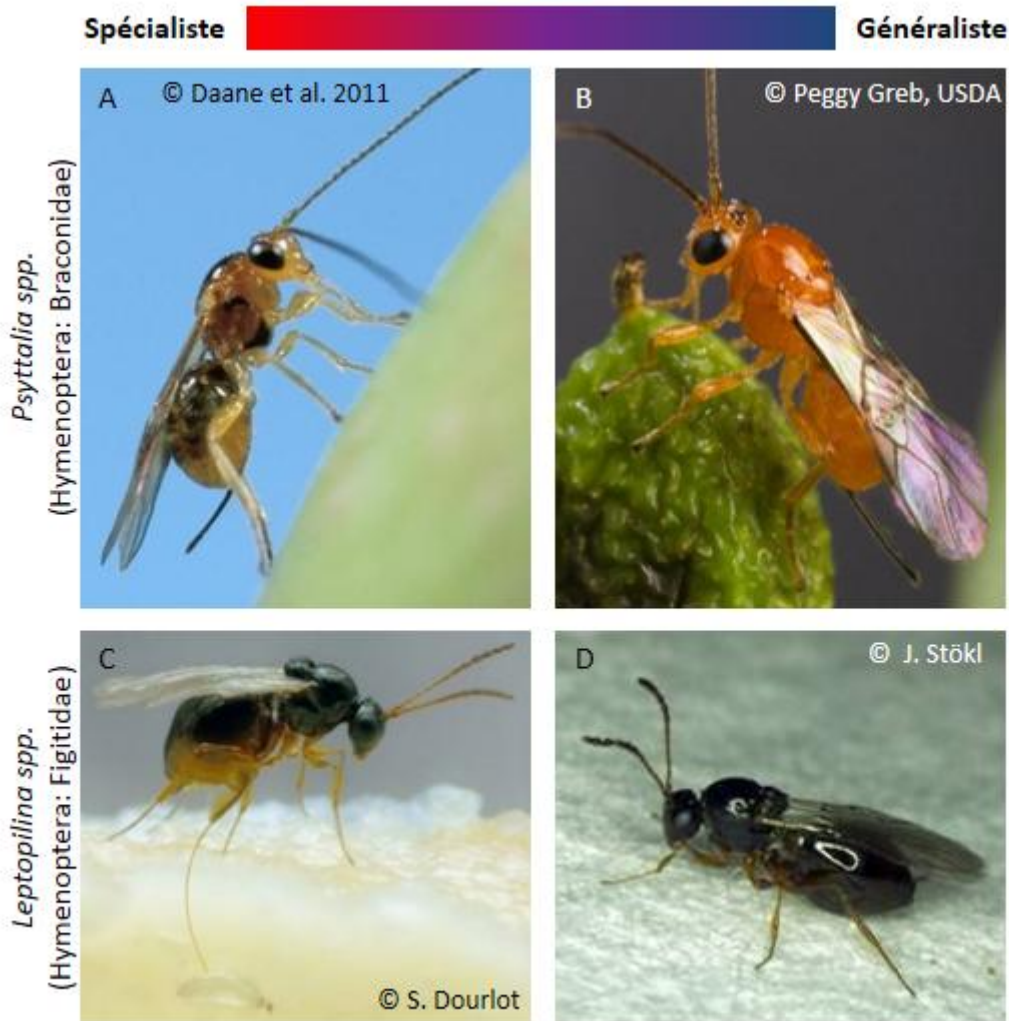


Figure 4 : Parasitoïdes étudiés. A. *Psyttalia lounsburyi* ; B. *Psyttalia concolor* ; C. *Leptopilina boulandi* ; D. *Leptopilina heterotoma*.

Le modèle *Psyttalia* permet d'étudier l'évolution des facteurs du venin d'un auxiliaire au cours d'un programme de lutte biologique. Il constitue également un moyen d'évaluer les perspectives ouvertes par les méthodes et outils d'analyse de vénomique pour améliorer les pratiques de lutte biologique. Par ailleurs, les principales expériences réalisées sur *P. lounsburyi* ont été effectuées avec des individus du terrain, ce qui permet de déterminer si la variabilité naturelle (standing variation) est suffisante pour permettre une adaptation rapide à un changement d'environnement. Par contre, toutes les variables ne peuvent être bien contrôlées. Le modèle *Leptopilina spp.* est mieux connu et les principales expériences ont été réalisées sur deux souches bien caractérisées, ce qui facilite la production rapide et l'interprétation des résultats. Par contre, il est plus difficile de savoir dans quelle mesure les résultats peuvent être extrapolés à un environnement « naturel ».

## II. OBJECTIFS DE LA THESE

**Cette thèse est divisée en deux parties, correspondant aux deux objectifs complémentaires, et se présente sous forme d'articles, publiés, soumis ou à soumettre.**

L'objectif global de ma thèse est d'étudier la variabilité et l'évolvabilité de la composition protéique du venin. La première partie de ma thèse a été centrée sur l'étude des variations du venin entre individus et entre populations. En effet, l'existence de telles variations est un prérequis à l'évolution rapide du venin. Les objectifs de cette première partie ont donc été principalement de développer et tester une méthode permettant d'étudier la variabilité du venin au niveau individuel et d'appliquer cette méthode aux deux modèles biologiques. La seconde partie de ma thèse s'est focalisée sur l'étude de l'évolvabilité à court-terme du venin à l'aide de la méthode mise au point. Elle s'est appuyée sur des approches d'évolution expérimentale menées sur les deux modèles. Une première interprétation des changements observés en termes de fonction potentielle des protéines impliquées dans les changements a pu être réalisée grâce à une approche de transcriptomique et de protéomique sur le modèle *Psytalia* ainsi qu'aux données déjà disponibles sur le modèle *Leptopilina*.

La structure générale de la thèse est donc la suivante :

*Partie 1 : Développement et applications de méthodes de caractérisation de la variabilité des protéines du venin au niveau individuel.*

Une première étape a été de montrer que le venin dont la composition essentiellement protéique est connue pour être assez complexe présente aussi une importante variation inter-individuelle (Article 1). Ensuite, afin d'étudier quantitativement cette variabilité, il était nécessaire de pouvoir mesurer « facilement » et de façon reproductible cette variabilité individuelle de la composition protéique d'un extrait de fluide ou de tissu. Mon premier objectif a donc été de développer une méthode d'analyse de marqueurs protéiques permettant de réaliser ce type d'étude.

Cette méthode a ensuite été utilisée dans une étude menée avec un étudiant de Master, Laurent Kremmer, sur le modèle *Leptopilina*. La question était de déterminer si des populations de deux espèces (4 populations de *L. bouvardi* et 5 populations de *L. heterotoma*) prélevées dans différentes parties de la vallée du Rhône présentaient une structuration par rapport aux marqueurs du venin, en lien avec un gradient climatique.

*Partie 2 : Caractérisation du potentiel évolutif du venin de parasitoïdes en lien avec le passage en conditions d'élevage ou la résistance de l'hôte : approches d'évolution expérimentale.*

Afin de tester si le changement d'hôte ou la mise en élevage peuvent entraîner une évolution de la composition du venin, nous avons réalisé une évolution expérimentale sur un modèle de terrain, *P. lounsburyi*, lors de laquelle j'ai encadré les stages de Marie Monrolin (participation à la préparation et la réalisation de l'expérience) et Sylvain Perini (caractérisation génétique des individus). Pour cette expérience, différents réplicats constitués à partir de populations prélevées sur le terrain (Kenya et Afrique du Sud) ont été mis en élevage en conditions de laboratoire sur un hôte de substitution non naturel, *Ceratitis capitata*, et les changements de la composition du venin, ainsi que d'autres paramètres, ont été analysés. Pour pouvoir interpréter les changements observés au niveau du venin en terme de protéines potentiellement impliquées, nous avons réalisé l'analyse transcriptomique et protéomique de ce venin pour deux espèces du genre *Psytalia*.

Une seconde expérience d'évolution expérimentale a été réalisée sur un modèle mieux caractérisé en laboratoire, *L. bouvardi*, lors des stages de Master de Laurent Kremmer (réalisation de l'expérience) et Fanny Cavigliasso (caractérisation des individus et analyses statistiques). Nous avons analysé l'évolution du venin d'hybrides *L. bouvardi* issus de croisements individuels entre une souche virulente (se développant sur une souche de *D. melanogaster* résistante) et une souche avirulente (ne se développant pas sur cette souche résistante). Les hybrides ont été répartis dans chaque réplicat en deux groupes élevés soit sur une souche de *D. melanogaster* sensible soit sur la souche hôte résistante pendant 10 générations. Ceci a permis de tester l'évolution de la composition du venin en fonction de la résistance de l'hôte et de déterminer quels facteurs du venin « évoluent ».

# 1<sup>ère</sup> Partie

## Vers l'analyse de la variabilité individuelle des venins de parasitoïdes

**Article 1** : Variability of venom components in immune suppressive parasitoid wasps: from a phylogenetic to a population approach. *J. Insect Physiol*, 2012.

**Article 2** : Statistical analysis of the individual variability of 1D protein profiles as a tool in ecology. Soumis.

**Article 3** : Analysis of individual venom profiles discriminates populations of *L. boulandi* and *L. heterotoma* parasitoids along a climatic gradient in the Rhône Valley. En préparation.

# ARTICLE 1

Variability of venom components in immune suppressive parasitoid wasps:  
from a phylogenetic to a population approach

Journal of Insect Physiology, 2012

Dominique Colinet, Hugo Mathé-Hubert, Roland Allemand, Jean-Luc Gatti, Marylène Poirié

*Revue des méthodes d'étude du venin de parasitoïdes et des connaissances sur leur composition. Démonstration de l'existence d'une variabilité inter-individuelle du venin dans deux familles différentes de parasitoïdes*

## Présentation de l'article

Ma thèse s'intéresse au venin des endoparasitoïdes et plus particulièrement à l'estimation de leur potentiel évolutif. Jusqu'à récemment, les connaissances sur la composition de ce venin provenaient essentiellement d'études spécifiques de certaines protéines (Poirié *et al.* 2009; Asgari & Rivers 2011; Asgari 2012) réalisées dans des espèces appartenant à différents taxa. Il était également largement considéré que le venin était caractéristique d'une espèce donnée. Le développement des nouvelles technologies a vu se multiplier les études globales de la composition du venin (transcriptomique + protéomique) mais l'image que nous en avons actuellement est toujours très partielle. En effet, elle est focalisée sur quelques familles de parasitoïdes et surtout, une majorité des protéines identifiées n'a aucune homologie avec une protéine connue ou n'a pas de fonction prédite. La partie « revue » de cet article présente les données disponibles fin 2012 sur les composants majeurs du venin ayant une fonction biochimique connue ou putative. Un état des connaissances plus récent pourra être trouvé Partie 2, Article 6.

De façon curieuse, la question de l'existence d'une variabilité intraspécifique du venin des parasitoïdes et de sa quantification a été longtemps négligée. Le principal exemple étudié était celui de la différence de composition du venin observée en termes de profil protéique entre deux lignées de parasitoïdes de l'espèce *Leptopilina boulardi*, issues de régions différentes (Congo et Tunisie), variabilité corrélée à une différence de virulence contre deux espèces hôtes. Les recherches menées par l'équipe ont depuis conduit à associer cette variation de virulence à la forte variation quantitative d'un facteur immunosuppresseur, une protéine RhoGAP (Colinet *et al.* 2010). Des données cumulées de transcriptomique et protéomique ont aussi récemment confirmé la différence de composition de venin entre les deux lignées (Colinet *et al.* 2013a). **Les données présentées dans cet article montrent l'existence d'une variation inter-individuelle des profils protéiques de venin pour des souches de laboratoire et des populations de terrain de deux espèces phylogénétiquement éloignées, *L. boulardi* (Figitidae) et *Psytalia lounsburyi* (Braconidae).**

La démonstration de l'existence d'une variabilité interindividuelle de composition du venin était l'un des pré-requis à toute étude de l'évolution possible du venin en réponse à des facteurs environnementaux, qu'ils soient biotiques ou abiotiques. Ce résultat est donc à la base de mon travail de thèse.





## Variability of venom components in immune suppressive parasitoid wasps: From a phylogenetic to a population approach

Dominique Colinet<sup>a,b,c</sup>, Hugo Mathé-Hubert<sup>a,b,c</sup>, Roland Allemand<sup>d</sup>, Jean-Luc Gatti<sup>a,b,c</sup>, Marylène Poirié<sup>a,b,c,\*</sup>

<sup>a</sup> Institut National de la Recherche Agronomique (INRA), Evolution and Specificity of Multitrophic Interactions (ESIM), UMR 1355 Institut Sophia Agrobiotech (ISA), Sophia Antipolis, France

<sup>b</sup> Centre National de la Recherche Scientifique (CNRS), UMR 7254, Sophia Antipolis, France

<sup>c</sup> Université Nice Sophia Antipolis, UFR Sciences, Sophia Antipolis, France

<sup>d</sup> Université de Lyon, F-69000, Lyon; Université Lyon 1; CNRS, UMR 5558, Laboratoire de Biométrie et Biologie Evolutive, F-69622, Villeurbanne, France

### ARTICLE INFO

#### Article history:

Available online 24 October 2012

#### Keywords:

Parasitoid wasps  
Venom proteins  
Immune suppression  
Intraspecific variability  
Individual electrophoretic profiles  
Leptopilina  
Psytalia  
Drosophila

### ABSTRACT

Endoparasitoid wasps develop at the expense of other insects, leading to their death. Eggs deposited inside the host body induce an immune response, which results in the formation of a melanized cellular capsule around the egg. To evade or counteract this response, endoparasitoids have evolved different strategies, the most often reported being injection into the host of immunosuppressive factors, notably venom proteins, along with the egg. The analysis of venom components has been performed independently in species of different taxa, but the present picture is far from complete. Intriguingly, the question of the level of venom variability inside species has been neglected, although it may partly determine the potential for parasitoid adaptation. Here, we present a short review of our present knowledge of venom components in endoparasitoids, as well as of the only well-known example of intraspecific variability in a venom immune suppressive protein being responsible for variation in parasitoid virulence. We then present data evidencing inter-individual variation of venom protein profiles, using a gel electrophoresis approach, both in laboratory strains and field populations of a figitid and a braconid species. Whether occurrence of such variability may permit a selection of parasitoid venom components driven by the host remains to be tested, notably in the context of the production and use of biological control auxiliaries.

© 2012 Elsevier Ltd. All rights reserved.

### 1. Introduction

Within parasites, insect parasitoids are remarkable by the diversity and originality of their virulence strategies. They lay eggs on or inside the body of other insects (mainly egg, larval or pupal stages) and achieve their development by consuming the host tissues, leading to its death (Godfray, 1994; Quicke, 1997). The parasitoid lifestyle is predominantly found in two insect orders: more than 60,000 species belong to Hymenoptera, others being mainly Diptera. Parasitoids are also classified into idiobionts which generally paralyze their host immediately following parasitism, stopping them from further development, and koinobionts which allow the host to continue feeding and developing. Ectoparasitoids feed externally on the host in contrast to endoparasitoids that develop inside the host (Godfray, 1994; Quicke, 1997). There is a large body of literature on parasitoid life-history traits such as host choice

behavior, foraging strategies, population dynamics, or resources allocation (Jervis et al., 2008; Lohse et al., 2012; Wajnberg et al., 2012). As parasitoids develop an obligate and intimate relationship with their hosts, and often exert a strong selection pressure on their populations, focus has also been made on co-evolutionary aspects, notably for immune traits (e.g. geographic variation in parasitoid virulence and host resistance) (Dupas et al., 2009; Kraaijeveld and van Alphen, 1994). Selection of specific adaptations in response to host defenses may partly explain the specialization of many parasitoids to one host or a narrow range of hosts, a trait that makes them valuable tools for biological control of vectors and pests.

Comparative studies of host-endoparasitoid interactions, mainly performed for dipteran and lepidopteran hosts, have provided insights on insect immune processes. The insect response to the intrusion of a foreign object too large to be phagocytized, such as a parasitoid egg, is the encapsulation process, which requires both cellular and humoral components (Carton et al., 2008). Specialized hemocytes adhere to the egg and surround it with organized successive layers, while activation of the phenoloxidase cascade leads to melanization of the capsule and the production of cytotoxic radicals that ends in the parasitoid

\* Corresponding author. Address: Evolution and Specificity of Multitrophic Interactions (ESIM), UMR 1355 "Sophia Agrobiotech Institute" (ISA), Institut National de la Recherche Agronomique, INRA PACA, 400 route des Chappes, Sophia Antipolis 06903, France. Tel.: +33 492386409.

E-mail address: [poirie@sophia.inra.fr](mailto:poirie@sophia.inra.fr) (M. Poirié).

death (Fauvarque and Williams, 2011; Nappi, 2010; Nappi et al., 2009; Strand, 2008). To evade or counteract the host immune reaction, endoparasitoids have evolved different strategies (Poirié et al., 2009), the more often described being active immunosuppression that can be local or systemic. It generally involves alteration or destruction of immune cells whether circulating or present in the hematopoietic organ, and/or inhibition of the melanization process by targeting of the phenoloxidase (PO) cascade, notably the serine proteases involved in the pro-phenoloxidase (proPO) activation into active PO (Poirié et al., 2009). Interestingly, ectoparasitoid females can inject factors that alter host immune components, as do endoparasitoid females (Danneels et al., 2010).

Important modifications of the stinging apparatus and the secretions it delivers have occurred in the evolution of Hymenoptera, as strong adaptations to their lifestyle (e.g. prey capture, defense against enemies). In addition to the egg and ovarian fluids, parasitoid females inject secretions produced in specialized glands derived from the reproductive tissue (notably venom glands) that will ensure host immune suppression. Female-injected components are thus a complex mixture of ovarian and venom proteins, that can also include peptides, vesicular or virus-like components (equally described as Virus-Like Particles, VLPs) produced in the ovarian calyx or the venom gland, and viruses (such as polydnviruses, PDVs) (Asgari and Rivers, 2010; Beckage, 2012; Gatti et al., 2012; Poirié et al., 2009; Strand, 2012). Polydnviruses, being considered as a unique example of a symbiotic association between a virus and an eukaryotic organism, have been paid a lot of attention (for recent reviews see Beckage, 2012; Burke and Strand, 2012; Strand, 2012) and will not be further discussed here.

Venom peptides and small proteins have been scarcely studied in parasitoids although analyses of venom gland transcriptomes suggest they are indeed present in the venom (Hauser et al., 2010). For instance, a venom defensin-like peptide of 56 aa has been characterized in *Nasonia vitripennis* that may interfere with the host phenoloxidase cascade (Tian et al., 2010). Interestingly, a venom peptide from *Cotesia rubecula* (Vn1.5) was also found to be required for expression of its PDV-associated genes in *Pieris rapae* host cells (Zhang et al., 2004a).

The VLPs observed in the venom of a large range of phylogenetically distant parasitoid wasps (Dupas et al., 1996; Morales et al., 2005; review in Gatti et al., 2012) are diverse in form and size among species but also heterogeneous within species. The observed particles more or less resemble viruses, but they are apparently devoid of DNA or RNA, and the few VLPs-associated proteins characterized to date have no similarity with viral proteins (Gatti et al., 2012). VLPs were first purified following separation on density gradients of the venom reservoir content of the figitid *Leptopilina heterotoma* (Rizki and Rizki, 1990), and shown to be involved in suppression of the *Drosophila melanogaster* host immunity. Although they were demonstrated to enter lamellocytes (the main capsule-forming hemocytes) and to induce changes in their morphology (Rizki and Rizki, 1984, 1990, 1994), their mechanism of entry and mode of action have not been described, and none of the reported VLP proteins have yet been clearly identified nor their function described (Chiu et al., 2006; Gatti et al., 2012). A role of venom VLPs of the phylogenetically distant braconid *Meteorus pulchricornis* in modifying hemocyte properties was also demonstrated in the host *Pseudaletia separata* (Suzuki et al., 2008).

The analysis of components injected by parasitoid females is far from being complete. Besides, the factors present in different fluids (ovarian fluid, venom) can have antagonistic or agonistic effects on the host physiology (Mabiala-Moundougou et al., 2010; Zhang et al., 2004a). In this paper, we will mainly focus on venom components in endoparasitoids, and the different levels at which variability may be observed.

## 2. Analysis of venom components: from venom markers to virulence factors?

A main problem in studying venom composition is to obtain venom free of cellular proteins. Parasitoid venom apparatus are diverse (Edson and Vinson, 1979; Vardal, 2006): for instance, venom glands can appear as a long filament with only a small canal filled with venom (e.g. in *Leptopilina* figitid species), or as large multi-lobed glands containing a substantial quantity of secreted fluid (e.g. in *Psytalia* braconid wasps). The shape and histological structure of reservoirs also varies from a thick muscular layer enclosing a small amount of venom (Edson et al., 1982), which likely serve as a pump (in most braconid wasps), to a large cylinder with a thin cellular wall, containing up to several nanoliters of venom (for example in *Leptopilina* wasps). As collection of venom without damaging tissues can be difficult depending on species, typical cellular proteins may be found among venom proteins (Vincent et al., 2010), and whether they are indeed secreted or correspond to contaminants can prove hard to determine.

Different levels of analysis can be performed on collected “pure” venom, from a simple observation and comparison of protein profiles to a proteomic approach aimed at identifying proteins and assign them putative functions. The use of targeted approaches, such as extensive characterization of a given protein band, has proved successful in the past (Asgari, 2012; Asgari and Rivers, 2010; Poirié et al., 2009). However, it requires an accurate choice of the protein to focus on, and, until now, the number of proteins characterized from parasitoid venom fluids with this approach is rather limited. Enzymatic functions can often be easily identified by gel zymography (e.g. for superoxide dismutase activity; Colinet et al., 2011), or by enzymatic assays with crude venom (e.g. for hyaluronidase; Nakamatsu and Tanaka, 2004 or acid phosphatase activity; Zhu et al., 2008). Further identification of the involvement of a given protein in suppressing host immunity for instance (e.g. inhibition of the phenoloxidase cascade, alteration of hemocyte adhesion or morphology) requires further *in vivo* and *in vitro* analyses using the purified or a recombinant protein. At the moment, final demonstration of the major role of a protein as a virulence factor has been performed by microinjecting the protein *in vivo* in presence of a specific antibody (Colinet et al., 2010), other methods such as RNAi being unfortunately not available yet for endoparasitoids.

Parasitoid studies have also focused on the question of the venom protein diversity in more or less related species. Global approaches based on comparisons of protein electrophoretic profiles do not easily allow concluding on the common origin or function of a given protein in absence of accurate molecular identification, such identification being difficult when the protein does not match any sequence in databases. Meanwhile, gel electrophoresis is a routinely used method, and we thus questioned whether more information could be obtained from protein profiles. With the interest in discovering markers from protein samples in human pathologies as cancer, new digital imaging technologies have been developed that allows analyzing such profiles both qualitatively and quantitatively from dozens of samples (Hanash and Taguchi, 2010; Wulfskuhle et al., 2003). Using this approach, venom variability can be estimated not only between closely-related species or populations (i.e. pooled samples), but also between individuals of a given population, a parameter that has not been investigated in depth until now. This question is of high interest since the occurrence of such variability is a pre-requisite for selection on parasitoid venom, which may drive parasitoid adaptation in response to parameters such as host species or host resistance. Moreover, the capacity of venom to rapidly evolve may explain the diversity of venom contents between species, the presence or abundance of specific proteins

resulting from short-term adaptive processes rather than a common evolutionary origin. The differences between protein profiles may also focus our attention to proteins of interest possibly involved in adaptive processes, and acting as virulence factors.

### 3. Venom components function and diversity: available data

#### 3.1. Virulence factors in different species

Global comparisons of venom electrophoretic profiles of parasitoid and non-parasitoid (bees, aculeate wasps, ants) hymenopteran species have been performed. The largest study included 25 hymenopteran species from 21 genera, with 4 braconid and 2 unknown ichneumonid parasitic wasps (Leluk et al., 1989). It showed that parasitoid wasp venom contain proteins ranging from 20 kDa to several hundred kDa, some of them being glycosylated, but with no major protein bands in the “peptide” range (<15 kDa). The protein patterns strongly differed from one species to another, even between the closely related braconids, *Chelonus insularis* and *C. near curvimaculatus*. Interestingly, a large number of *C. insularis*, but also of ants venom proteins, were recognized by an antiserum raised against *C. near curvimaculatus* venom, while fewer proteins were detected in aculeate wasp and bee venoms. This confirms that accurate comparison of venom between species cannot simply rely on visual comparisons of protein profiles.

Over the last few years, the development of DNA sequencing and mass spectrometry technologies has allowed a booming increase of venom protein characterization (Asgari and Rivers, 2010; Formesyn et al., 2012). The first large-scale analyses combining transcriptome and partial proteome analyses to identify putative venom proteins were performed in the ichneumonid *Pimpla hypochondriaca* (Parkinson et al., 2003, 2004) and two braconid *Microctonus* species (Crawford et al., 2008). More recently, a number of venom proteins were identified from the chalcidoids *Pteromalus puparum* (Zhu et al., 2010b) and *N. vitripennis* (de Graaf et al., 2010), using a proteomic approach. For *N. vitripennis*, whose genome sequence is available, the proteomic analysis was combined with bioinformatics, leading to identification of as much as 79 putative venom constituents (de Graaf et al., 2010). Finally, a total of 29 venom proteins were recently identified from the endoparasitoid *Chelonus inanitus* using a combined transcriptomic and proteomic approach aimed at discriminating between cellular and true venom proteins (Vincent et al., 2010). However, many of the identified proteins in these and other studies did not show any similarity with known proteins, a recurrent problem in parasitoid venom analyses. This is certainly due to the absence of complete annotated genomes of parasitoids species (except those of *Nasonia* spp.), a severe drawback for a complete identification and comparison of proteins.

With more than 50 venom proteins identified in different species, a better picture of the complex nature and diversity of venom components has recently been acquired. However, only <20% of them have been demonstrated to alter host physiology (Table 1). Three venom proteins that inhibit the host cellular immune response have been described so far (Table 1). In *L. bouvardi*, a RhoGAP domain-containing protein, LbGAP, targets *Drosophila* lamellocytes, and induces changes in their morphology rendering them unable to perform encapsulation (Labrosse et al., 2005). LbGAP has been demonstrated to inactivate two *Drosophila* Rho GTPases, Rac1 and Rac2 (Colinet et al., 2007), both involved in cytoskeletal rearrangements and adhesions necessary for cell-shape change and migration and proved to be necessary for parasitism success. A calreticulin from *C. rubecula* has been shown to prevent encapsulation *in vitro* by inhibiting hemocyte spreading behavior, although the mechanism is still unclear (Zhang et al., 2006). This

protein is also present in the venom of *N. vitripennis* (de Graaf et al., 2010) and *P. puparum* (Zhu et al., 2010b). Finally, a *P. hypochondriaca* venom protein, without any similarity to known proteins, also shows insect hemocyte anti-aggregation properties thus inhibiting encapsulation (Richards and Dani, 2008). Some venom proteins were demonstrated to inhibit the humoral component of the anti-parasitoid response, by interfering with the PO cascade (Table 1). Vn50, a serine protease homolog devoid of activity is secreted in *C. rubecula* venom. It acts as an inhibitor of *P. rapae* host hemolymph melanization, presumably by competing with host serine protease homologs for binding to proPO, while remaining non cleaved and stable in the hemolymph (Asgari et al., 2003a; Zhang et al., 2004b). Interestingly, members of the serine protease family have also been found in the venom of four other parasitoids (Table 1). *C. rubecula* venom also contains a small protein (Vn4.6), with similarities to atracotoxins but also to cysteine-rich protease inhibitors, that inhibits melanization through an unknown mechanism (Asgari et al., 2003b). In *L. bouvardi*, a venom protein from the serine protease inhibitor (serpin) family, LbSPNy, was demonstrated to prevent melanization in *Drosophila* through inhibition of PO activation (Colinet et al., 2009). Interestingly, *L. bouvardi* venom also contains an extracellular SOD that *in vitro* inhibits the host phenoloxidase activity and might interfere locally with the melanization process (Colinet et al., 2011). In addition to venom proteins regulating host immunity, a gamma glutamyl transpeptidase from *Aphidius ervi* was shown to target host reproduction by inducing apoptosis in aphid ovaries (Falabella et al., 2007), a repressin-type metalloprotease from *Eulophus pennicornis* manipulates host development and display toxicity towards the host (Price et al., 2009), and pimplin, a small polypeptide from *P. hypochondriaca*, with no similarities with any known protein, induces paralysis of the host (Parkinson et al., 2002c) (Table 1).

Comparisons of identified proteins between Hymenoptera suggest that some venom components are largely shared (e.g. acid phosphatases, venom-allergen proteins related to cysteine-rich secretory proteins, metalloproteases, serine proteases) and may have an ancestral origin, while others are specific to one or a few parasitoid species (Table 1). Interestingly, the shared proteins, or family-related proteins, are also retrieved in the venom of a large number of organisms such as snakes, scorpions or centipedes, as well as in secretions from salivary glands and different exocrine organs, in species ranging from insects to mammals (Pilch and Mann, 2006; Zhou et al., 2007; Chapman, 2008; Fry et al., 2009; Belleannée et al., 2010). This set of proteins, which has likely been selected for its role in predation or defense, might also be important for protection/maturation of secreted proteins or involved in the process of secretion.

Venom proteins have rarely been globally analyzed in closely related parasitoid species. The only work carried out on two *Microctonus* parasitoid species only focused on variation of the expression level of a small number of genes in the venom apparatus (Crawford et al., 2008). An interesting model would be *Leptopilina* species whose interactions with *Drosophila* hosts have long been studied (Jenni, 1951; Nappi, 1977; Rizki et al., 1990), *L. bouvardi* being also the species whose venom virulence factors are among the best characterized. To our knowledge, the main immune suppressive factor, LbGAP, is also the only factor demonstrated to be required for parasitoid virulence (Colinet et al., 2010). Studies on other *Leptopilina* species are still far from this point but venom analyses are currently performed. *L. bouvardi* and *L. heterotoma* differ by the host range (Fleury et al., 2009), venom effects on the *Drosophila* host (Lee et al., 2009), and changes in expression profiles of host genes following parasitism (Lee et al., 2011; Schlenke et al., 2007). Interestingly, we observed major differences in venom protein profiles of the two species (Fig. 1). Accordingly, we also evidenced a quantitative difference in expres-

**Table 1**  
Venom proteins identified from parasitic wasps, having known or putative biochemical functions. Ae, *Aphidius ervi*; At, *Asobara tabida*; Cc, *Chelonus* sp. near *curvimaculatus*; Ci, *Chelonus inanitus*; Cr, *Cotesia rubecula*; Ep, *Eulophus pennicornis*; Ma, *Microctonus aethioides*; Mh, *Microctonus hyperodae*; Nv, *Nasonia vitripennis*; Ph, *Pimpla hypochondriaca*; Pp, *Pteromalus puparum*; Pt, *Pimpla turionellae*. Only proteins with a demonstrated effect on the host physiology are discussed in the manuscript.

	Demonstrated effect on host physiology	Species	References
<i>Enzymes</i>			
Alpha-N-acetyl glucosaminidase		Ci	Vincent et al. (2010)
Alkaline phosphatase		Pp	Zhu et al. (2010a)
Aminotransferase-like venom protein		Nv, Pp	de Graaf et al. (2010) and Zhu et al. (2010b)
Angiotensin-converting enzyme		Ci	Vincent et al. (2010)
Apyrase		Nv	de Graaf et al. (2010)
Arginine kinase		Pp	Zhu et al. (2010b)
Arylsulfatase		Nv	de Graaf et al. (2010)
Aspartylglucosaminidase		At	Moreau et al. (2004)
ATP synthase		Pp	Zhu et al. (2010b)
C1A protease		Ci	Vincent et al. (2010)
Chitinase		Cc, Ci	Krishnan et al. (1994) and Vincent et al. (2010)
Dipeptidylpeptidase IV		Nv	de Graaf et al. (2010)
Endonuclease-like venom protein		Nv	de Graaf et al. (2010)
Esterase/lipase		Ci	Vincent et al. (2010)
Gamma glutamyl transpeptidase	Induction of apoptosis in host ovaries (Ae)	Ae, Nv	Falabella et al. (2007) and de Graaf et al. (2010)
Glucose-Methanol-Choline (GMC) oxidoreductase		Nv	de Graaf et al. (2010)
Inosine-uridine preferring nucleoside hydrolase		Nv, Pp	de Graaf et al. (2010) and Zhu et al. (2010b)
Laccase		Ph	Parkinson et al. (2003)
Metalloprotease	Toxicity towards the host, manipulation of host development (Ep)	Ci, Ep, Ph	Vincent et al. (2010), Price et al. (2009) and Parkinson et al. (2002a)
Multiple inositol polyphosphate phosphatase-like venom protein		Nv	de Graaf et al. (2010)
Neprilysin		Mh	Crawford et al. (2008)
Phenoloxidase		Ph	Parkinson et al. (2001)
Phospholipase B		Pt	Uçkan et al. (2006)
Serine proteases and serine protease homologs	Inhibition of melanization (Cr)	Ci, Cr, Nv,	Vincent et al. (2010), Asgari et al. (2003a), de Graaf et al. (2010), Parkinson et al. (2002b) and Zhu et al. (2010b)
Superoxide dismutase	In vitro inhibition of <i>Drosophila</i> phenoloxidase activity	Ph, Pp Lb	Colinet et al. (2011)
Trehalase		Ph	Parkinson et al. (2003)
Venom acid phosphatase		Nv, Ph, Pp	de Graaf et al. (2010), Dani et al. (2005) and Zhu et al. (2008)
<i>Recognition/binding proteins</i>			
Beta-1,3-glucan recognition protein		Nv	de Graaf et al. (2010)
Chitin binding protein		Ci, Nv	Vincent et al. (2010), de Graaf et al. (2010)
Lectin		Ci	Vincent et al. (2010)
Low-density lipoprotein receptor		Nv	de Graaf et al. (2010)
<i>Protease inhibitors</i>			
Cysteine-rich protease inhibitor		Nv, Ph	de Graaf et al. (2010) and Parkinson et al. (2004)
Kazal-type serine protease inhibitor		Nv	de Graaf et al. (2010)
Serpin	Inhibition of melanization	Lb	Colinet et al. (2009)
<i>Chaperone</i>			
Calreticulin	Inhibition of hemocyte spreading behavior, suppression of encapsulation (Cr)	Cr, Nv, Pp	Zhang et al. (2006), de Graaf et al. (2010) and Zhu et al. (2010b)
Heat shock protein		Pp	Zhu et al. (2010b)
<i>Cytoskeleton components</i>			
Actin		Pp	Zhu et al. (2010b)
Tropomyosin		Pp	
<i>Neurotoxin-like/Paralytic factors</i>			
Fire Ant venom allergen III	Paralysis of the host	Ma, Mh	Crawford et al. (2008)
Pimplin		Ph	Parkinson et al. (2002c)
Vn4.6 (similar to atracotoxins)	Inhibition of melanization	Cr	Asgari et al. (2003b)
<i>Others</i>			
Antigen 5-like protein		Nv	de Graaf et al. (2010)
Chemosensory protein-like protein		Ci	Vincent et al. (2010)
General odorant binding protein		Ci, Nv	Vincent et al. (2010) and de Graaf et al. (2010)
Hexamerin		Pp	Zhu et al. (2010b)
Imaginal disc Growth Factors-like		Ci	Vincent et al. (2010)
Immunoglobulin-like venom protein		Nv	de Graaf et al. (2010)
Insect hemocyte anti-aggregation protein	Inhibition of hemocyte spreading and aggregation, suppression of encapsulation	Ph	Richards and Dani (2008)
RhoGAP	Deformation of host hemocytes, suppression of encapsulation	Lb	Labrosse et al. (2005)
Similar to lethal (1) G0193 isoforms		Ci	Vincent et al. (2010)
Yellow-e3-like protein		Ci	Vincent et al. (2010)



sion of the gene encoding extracellular SOD in the venom apparatus of the two species, the SOD protein being secreted in *L. boucardi* venom only (Colinet et al., 2011). This raises the question whether the venom of closely related species might essentially differ in the quantity of given proteins, leading to variation in virulence and/or host specificity.

### 3.2. Venom differences between strains and populations

Occurrence of intraspecific polymorphism in parasitoid virulence has rarely been documented. In *L. boucardi*, two well-defined strains were characterized, ISm, highly virulent only against *D. melanogaster*, and ISy, able to suppress immune defenses of both *D. melanogaster* and *D. yakuba* hosts, but depending on the host resistance genotype (Dubuffet et al., 2009). Physiological and biochemical approaches have demonstrated that these strains use different virulence strategies against *Drosophila* hosts, ISm inducing a permanent immunosuppression in *D. melanogaster* while suppression of *D. yakuba* encapsulation by ISy is transitory. Besides, ISm is known to target immune cellular components, resulting in changes in the morphology of *D. melanogaster* lamellocytes, whereas ISy targets the humoral component of encapsulation through inhibition of melanization. Remarkably, the venom composition of the strains differs extensively, as shown by protein electrophoretic profiles (Fig. 1).

Among the main venom factors identified in *L. boucardi*, some show no variation between strains (e.g. the extracellular SOD, qualitatively and quantitatively similar), while others display significant differences. The major virulence factor LbGAP for instance is secreted in a high amount in the venom of the ISm strain only (Fig. 1) (Colinet et al., 2010). Thanks to genetic analyses, it was

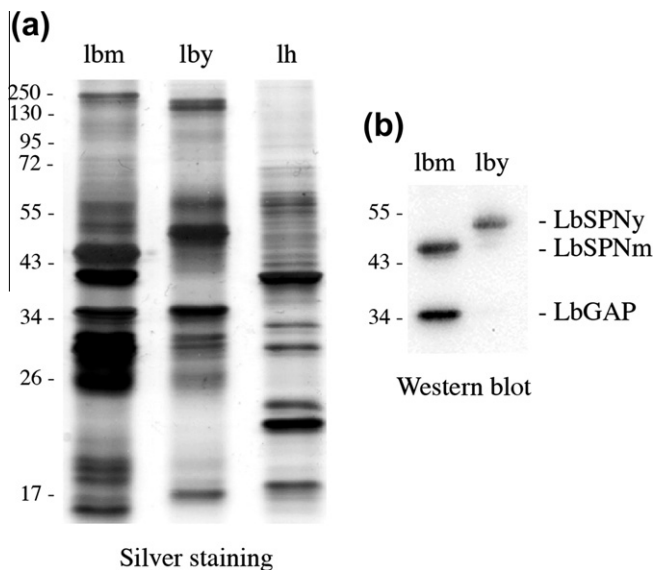
shown that the quantitative variation between strains is likely due to differences in cis-regulation of transcription (Colinet et al., 2010). We have now indications that quantitative variation occurs for a number of venom proteins, suggesting that this mechanism may be largely involved in intraspecific variation of virulence (Colinet et al., preparation). Some preliminary data suggest that qualitative differences might also occur for some venom proteins: an antibody raised against a peptide from LbSPNy, identified from the ISy strain venom (Colinet et al., 2009), specifically recognizes an abundant protein in ISm venom that migrates at a lower position in the electrophoresis gel (Fig. 1). An open area of research is now to determine the respective contribution of quantitative and qualitative variation in the diversity of venom components and to decipher the molecular mechanisms responsible for this variation between strains and species.

### 3.3. Venom differences between individuals

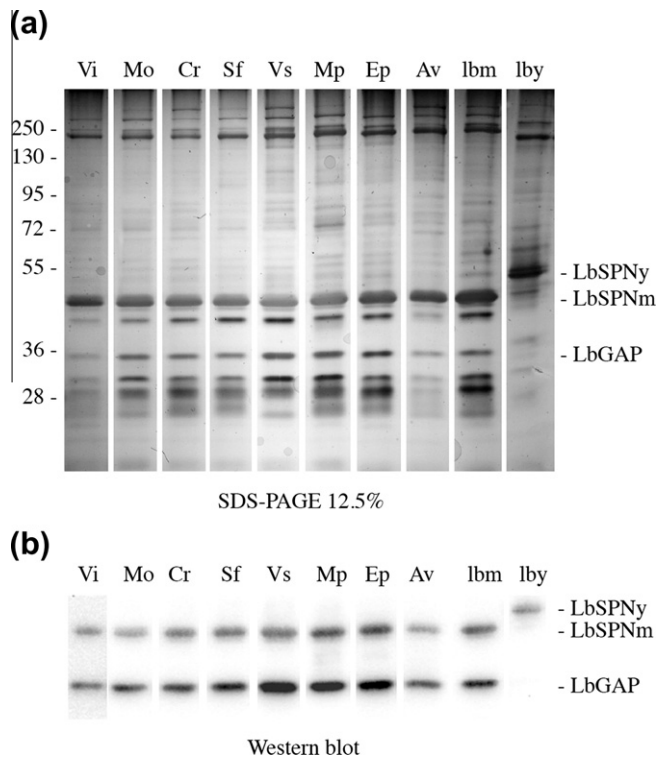
It is intriguing and somehow frustrating that so little is known of the occurrence of venom components variability among individuals. We thus used a silver staining method with enough sensitivity to allow global analysis of venom electrophoretic patterns at the individual level, and tested this method on two species: the figitid *L. boucardi*, and the braconid *Psytalia lounsburyi*. This last species, also raised in the laboratory, is used as a biological control agent against the devastating pest olive fly, *Bactrocera oleae* (Daane et al., 2011; Malausa et al., 2010). Since antibodies against *L. boucardi* virulence factors LbGAP and LbSPNy were available, we improved the method by using half of *L. boucardi* venom reservoir for individual electrophoretic analysis, and the other half to specifically detect and quantify proteins of interest on immunoblots (Fig. 2).

Electrophoretic profiles have been obtained for *L. boucardi* individuals from laboratory strains and from 8 natural populations sampled at different locations in the Rhône valley (France) (Fig. 2). Interestingly, all individuals from the Rhône valley had a *L. boucardi* ISm typical profile, with specific detection of LbGAP and LbSPNm (Fig. 2). To further investigate the inter-individual variability in venom proteins, reservoirs from 12 *L. boucardi* females of a population sampled in St. Laurent d'Agny (Rhône valley, France) were individually separated by SDS-PAGE. Although the electrophoretic profiles were again roughly similar to the ISm profile for all individuals, clear differences were observed such as the presence or absence of specific bands (Fig. 3). Moreover, preliminary analyses on dot blots suggest occurrence of a quantitative variation of both LbGAP and LbSPNm between individuals, although this remains to be confirmed with more individuals, and precisely quantified. For *P. lounsburyi*, whose venom proteins have not yet been identified, the full content of the reservoir was analyzed on a gel. Venom protein profiles were obtained from 6 females recently collected in Sirimon Forest (Kenya) and 6 females from a strain also sampled in Kenya but maintained under laboratory conditions for more than 8 years (>100 generations). They were roughly similar for all females, either recently collected or long-time reared in artificial conditions (Fig. 4). Interestingly, however, inter-individual variation was observed both qualitatively (presence/absence) and quantitatively (intensity of specific bands).

Interpretation of differences between individual electrophoretic profiles may encounter some difficulties. First, only one-dimensional electrophoresis can be performed with the quantity of material available in a single venom apparatus, and one band may contain different proteins. Besides, the presence/absence of a band may be due to strong quantitative differences, or to variation in the migration of a protein indicating the presence of different alleles or of post-translational modifications. However, all these modifica-



**Fig. 1.** Electrophoretic and immunoblot analyses of venom proteins in *Leptopilina* species. Venom reservoirs were dissected in insect Ringer solution supplemented with a protease inhibitors cocktail (PI; Roche) and residual tissues were removed by centrifugation. The total protein content of 10 *L. boucardi* ISm (lbm), 10 *L. boucardi* ISy (lby) and 10 *L. heteretoma* (lh) venom reservoirs was split in two, each part being run on a 10% SDS-PAGE under reducing conditions. One gel (a) was silver stained, the other (b) blotted onto nitrocellulose and used for immunodetection of LbGAP (rabbit polyclonal antibody; Labrosse et al., 2005) and LbSPN (rabbit polyclonal antibody raised against a synthetic peptide). Chemiluminescence signal detection was performed after incubation with a goat anti-rabbit IgG horseradish peroxidase conjugate. Positions of LbSPNy, LbSPNm and LbGAP venom proteins are indicated. Molecular weight standards in kDa.



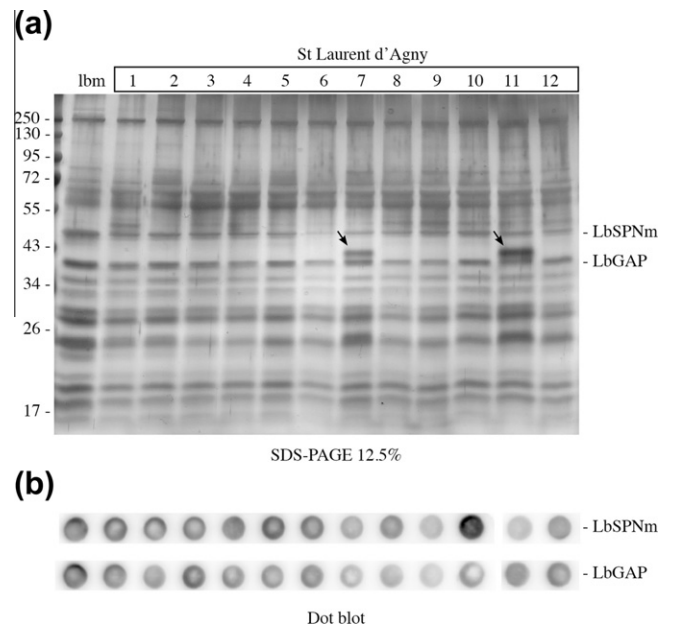
**Fig. 2.** Electrophoretic and immunoblot analyses of venom contents from *Leptopilina bouvardi* individuals of natural populations. Individual protein contents of 8 *L. bouvardi* venom reservoirs (collected as in Fig. 1) were split and migrated on two 10% SDS–PAGE under reducing conditions. The two gels were treated as in Fig. 1. *L. bouvardi* individuals were samples from 8 populations along a 300 km N–S gradient in the Rhône valley (France): Villette-de-Vienne (Vi), Mollèges (Mo), La Crau (Cr), Sainte-Foy-lès-Lyon (Sf), Ville-Sollier (Vs), Montpellier (Mp), Epinouze (Ep) and Avignon (Av). Controls are aliquots (equivalent to one individual) from a pool of either 10 *L. bouvardi* lSm (lbm) or 10 *L. bouvardi* lSy (lby) venom reservoirs. Positions of LbSPNy, LbSPNm and LbGAP venom proteins and molecular weight standards (in kDa) are indicated.

tions might be correlated with changes in parasitoid virulence and are worth to be taken into consideration.

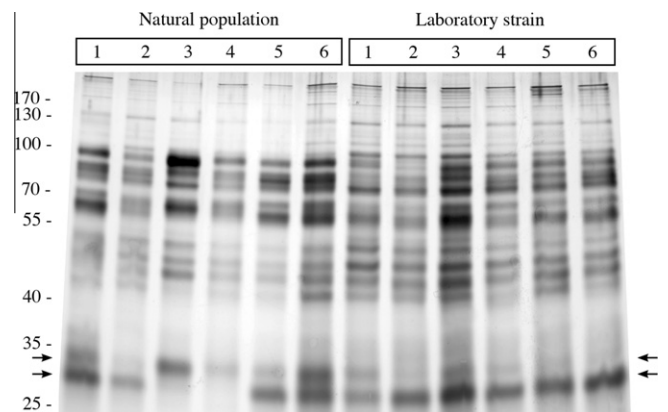
Altogether, these preliminary data demonstrate the occurrence of parasitoid venom variability at the individual level, both in field populations and laboratory strains, in different phylogenetic groups. The consistent variability observed in parasitoid venom, even with a low number of tested individuals, suggest a large potential for rapid adaptation of parasitoids to changes in host physiology or host species.

#### 4. Conclusion

Thanks to new impressive technological steps, our knowledge of parasitoid venom proteins will rapidly increase. cDNA can now be extracted and sequenced from nanogram amounts by next generation sequencing (Head et al., 2011), and less than picograms amount of peptides can be identified by mass spectrometry (Bantscheff et al., 2008). The sequencing of endoparasitoid genomes will allow wide population analyses of venom transcripts and proteins, thus leading to accurate estimations of individual variation. Parasitoid wasps however represent a large and diverse group and simplest approaches, such as individual electrophoretic comparisons, may remain of interest for species without genome sequence support. Regarding genetic approaches, RNA interference techniques have proved efficient in an ectoparasitoid wasp (Lynch and Desplan, 2006; Werren et al., 2009), and their development for endoparasitoids will be crucial. By helping determining if a given protein plays a role in parasitoid virulence, it will both allow to



**Fig. 3.** Electrophoretic and dot blot analyses of venom proteins from *Leptopilina bouvardi* individuals from one field population. The individual protein contents of 12 *L. bouvardi* individual venom reservoirs were treated as in Fig. 2. Individuals belong from a population of St. Laurent d'Agny (Rhône valley, near Lyon, France). Controls are as in Fig. 2. The arrows point to a specific band present in the venom of two females, as an example of the observed inter-individual variation. Positions of LbSPNm and LbGAP and molecular weight standards (in kDa) are indicated.



**Fig. 4.** Electrophoretic comparison of venom proteins from *Psytalia lounsburyi* individuals. The individual protein contents of 12 individual venom glands (prepared as in Fig. 1), was analyzed under reducing conditions on a 12.5% SDS–PAGE and visualized by silver staining. 6 individuals originate from a population sampled in Sirimon Forest (Kenya), the other 6 being issued from a strain collected in Kenya but reared in laboratory conditions for more than 8 years. Arrows point to examples of inter-individual variation with the presence/absence of bands in the natural population or quantitative variation of specific bands in the laboratory strain. Molecular weight standards are in kDa.

focus studies on essential proteins, and to obtain venom protein markers under selection for population approaches.

#### Acknowledgements

We are grateful to Christian Rebuf and Marcel Thaon for help in insect rearing, Pierre Girod and Fanny Cavigliasso for technical assistance, the French National Institute for Agricultural Research (INRA) units of Avignon and Gotheron and the land owners for allowing insect collection in their orchards, Julien Martinez for sending *L. bouvardi* samples from the Rhône valley (France), and

the ICIPE fruit fly project staff for sampling *P. lounsburyi* in Kenya. We also thank Thibaut Malausa and Nicolas Ris for fruitful discussions. This work was funded by the CLIMEVOL (ANR-08-BLAN-0231) Project from the French National Research Agency, and grants from the INRA Department of Plant Health and Environment (SPE). H. Mathé-Hubert is supported by a Ph.D. funding from the Provence Alpes Côte d'Azur (PACA) region and INRA.

## References

- Asgari, S., 2012. Venoms from endoparasitoids. In: Beckage, N.E., Drezen, J.-M. (Eds.), *Parasitoid Viruses: Symbionts and Pathogens*. Academic Press, London, pp. 215–231.
- Asgari, S., Rivers, D.B., 2010. Venom proteins from endoparasitoid wasps and their role in host-parasite interactions. *Annual Review of Entomology* 56, 313–335.
- Asgari, S., Zhang, G., Zareie, R., Schmidt, O., 2003a. A serine proteinase homolog venom protein from an endoparasitoid wasp inhibits melanization of the host hemolymph. *Insect Biochemistry and Molecular Biology* 33, 1017–1024.
- Asgari, S., Zareie, R., Zhang, G., Schmidt, O., 2003b. Isolation and characterization of a novel venom protein from an endoparasitoid, *Cotesia rubecula* (Hym: Braconidae). *Archives of Insect Biochemistry and Physiology* 53, 92–100.
- Bantscheff, M., Boesche, M., Eberhard, D., Matthieson, T., Sweetman, G., Kuster, B., 2008. Robust and sensitive iTRAQ quantification on an LTQ orbitrap mass spectrometer. *Molecular & Cellular Proteomics* 7 (9), 1702–1713.
- Beckage, N.E., 2012. Polydnnaviruses as endocrine regulators. In: Beckage, N.E., Drezen, J.-M. (Eds.), *Parasitoid Viruses: Symbionts and Pathogens*. Academic Press, London, pp. 163–168.
- Belleannée, C., Labas, V., Teixeira-Gomes, A.P., Gatti, J.-L., Dacheux, J.-L., Dacheux, F., 2010. Identification of luminal and secreted proteins in bull epididymis. *Journal of Proteomics* 74, 59–78.
- Burke, G.R., Strand, M.R., 2012. Polydnnaviruses of parasitic wasps: domestication of viruses to act as gene delivery vectors. *Insects* 3, 91–119.
- Carton, Y., Poirié, M., Nappi, A.J., 2008. Insect immune resistance to parasitoids. *Insect Science* 15, 67–87.
- Chapman, T., 2008. The soup in my fly: evolution, form and function of seminal fluid proteins. *PLoS Biology* 6, e179.
- Chiu, H., Morales, J., Govind, S., 2006. Identification and immuno-electron microscopy localization of p40, a protein component of immunosuppressive virus-like particles from *Leptopilina heterotoma*, a virulent parasitoid wasp of *Drosophila*. *Journal of General Virology* 87, 461–470.
- Colinet, D., Schmitz, A., Depoix, D., Crochard, D., Poirié, M., 2007. Convergent use of RhoGAP toxins by eukaryotic parasites and bacterial pathogens. *PLoS Pathogens* 3, e203.
- Colinet, D., Dubuffet, A., Cazes, D., Moreau, S., Drezen, J.-M., Poirié, M., 2009. A serpin from the parasitoid wasp *Leptopilina boulardi* targets the *Drosophila* phenoloxidase cascade. *Developmental and Comparative Immunology* 33, 681–689.
- Colinet, D., Schmitz, A., Cazes, D., Gatti, J.-L., Poirié, M., 2010. The origin of intraspecific variation of virulence in an eukaryotic immune suppressive parasite. *PLoS Pathogens* 6, e1001206.
- Colinet, D., Cazes, D., Belghazi, M., Gatti, J.-L., Poirié, M., 2011. Extracellular superoxide dismutase in insects: characterization, function, and interspecific variation in parasitoid wasp venom. *Journal of Biological Chemistry* 286, 40110–40121.
- Colinet D., Deleury E., Anselme C., Cazes D., Poulain J., Belghazi M., Gatti J.-L., Poirié M., Closely related parasites targeting the same host can show extensive venom variation: the case of *Leptopilina parasitoids of Drosophila*, in preparation.
- Crawford, A.M., Brauning, R., Smolenski, G., Ferguson, C., Barton, D., Wheeler, T.T., McCulloch, A., 2008. The constituents of *Microctonus* sp. parasitoid venoms. *Insect Molecular Biology* 17, 313–324.
- Daane, M.K., Johnson, M.W., Pickett, C.H., Sime, K.R., Wang, X.-G., Nadel, H., Andrews Jr., J.W., Hoelmer, K.A., 2011. Biological controls investigated to aid management of olive fruit fly in California. *California Agriculture* 65, 21–28.
- Dani, M.P., Edwards, J.P., Richards, E.H., 2005. Hydrolase activity in the venom of the pupal endoparasitic wasp, *Pimpla hypochondriaca*. *Comparative Biochemistry and Physiology B* 141, 373–381.
- Danneels, E.L., Rivers, D.B., de Graaf, D.C., 2010. Venom proteins of the parasitoid wasp *Nasonia vitripennis*: recent discovery of an untapped pharmacopee. *Toxins* 2, 494–516.
- de Graaf, D.C., Aerts, M., Brunain, M., Desjardins, C.A., Jacobs, F.J., Werren, J.H., Devreese, B., 2010. Insights into the venom composition of the ectoparasitoid wasp *Nasonia vitripennis* from bioinformatic and proteomic studies. *Insect Molecular Biology* 19, 11–26.
- Dubuffet, A., Colinet, D., Anselme, C., Dupas, S., Carton, Y., Poirié, M., 2009. Variation of *Leptopilina boulardi* success in *Drosophila* hosts: what is inside the black box? *Advances in Parasitology* 70, 147–188.
- Dupas, S., Brehelin, M., Frey, F., Carton, Y., 1996. Immune suppressive virus-like particles in a *Drosophila* parasitoid: significance of their intraspecific morphological variations. *Parasitology* 113, 207–212.
- Dupas, S., Dubuffet, A., Carton, Y., Poirié, M., 2009. Local, geographic and phylogenetic scales of coevolution in *Drosophila*-parasitoid interactions. *Advances in Parasitology* 70, 281–295.
- Edson, K.M., Vinson, S.B., 1979. A comparative morphology of the venom apparatus of female braconids (Hymenoptera: Braconidae). *Canadian Entomologist* 111, 1013–1024.
- Edson, K.M., Barlin, M.R., Vinson, S.B., 1982. Venom apparatus of braconid wasps: comparative ultrastructure of reservoirs and gland filaments. *Toxicon* 20, 553–562.
- Falabella, P., Riviello, L., Caccialupi, P., Rossodivita, T., Teresa Valente, M., Luisa De Stradis, M., Tranfaglia, A., Varricchio, P., Gigliotti, S., Graziani, F., Malva, C., Pennacchio, F., 2007. A gamma-glutamyl transpeptidase of *Aphidius ervi* venom induces apoptosis in the ovaries of host aphids. *Insect Biochemistry and Molecular Biology* 37, 453–465.
- Fauvarque, M.O., Williams, M.J., 2011. *Drosophila* cellular immunity: a story of migration and adhesion. *Journal of Cell Science* 124, 1373–1382.
- Fleury, F., Gibert, P., Ris, N., Allemand, R., 2009. Ecology and life history evolution of frugivorous *drosophila* parasitoids. *Advances in Parasitology* 70, 3–44.
- Formesyn, E.M., Danneels, E.L., de Graaf, D.C., 2012. Proteomics of the venom of the parasitoid *Nasonia vitripennis*. In: Beckage, N.E., Drezen, J.-M. (Eds.), *Parasitoid Viruses: Symbionts and Pathogens*. Academic Press, London, pp. 233–246.
- Fry, B.G., Roelants, K., Champagne, D.E., Scheib, H., Tyndall, J.D.A., King, G.F., Nevalainen, T.J., Norman, J.A., Lewis, R.J., Norton, R.S., Renjifo, C., de la Vega, R.C.R., 2009. The toxicogenomic multiverse: convergent recruitment of proteins into animal venoms. *Annual Review of Genomics and Human Genetics* 10, 483–511.
- Gatti, J.-L., Schmitz, A., Colinet, D., Poirié, M., 2012. Diversity of virus-like particles in parasitoids' venom: viral or cellular origin? In: Beckage, N.E., Drezen, J.-M. (Eds.), *Parasitoid Viruses: Symbionts and Pathogens*. Academic Press, London, pp. 181–192.
- Godfray, H.C.J., 1994. *Parasitoids: Behavioural and Evolutionary Ecology*. Princeton University Press, Princeton.
- Hanash, S., Taguchi, A., 2010. The grand challenge to decipher the cancer proteome. *Nature Reviews Cancer* 10, 652–660.
- Hauser, F., Neupert, S., Williamson, M., Predel, R., Tanaka, Y., Grimmelikhuisen, C.J., 2010. Genomics and peptidomics of neuropeptides and protein hormones present in the parasitic wasp *Nasonia vitripennis*. *Journal of Proteome Research* 9, 5296–5310.
- Head, S.R., Komori, H.K., Hart, G.T., Shimashita, J., Schaffer, L., Salomon, D.R., Ordoukhanian, P.T., 2011. Method for improved Illumina sequencing library preparation using NuGEN ovation RNA-Seq system, 2011. *BioTechniques* 50, 177–180.
- Jenni, W., 1951. Beitrag zur morphologie und biologie der cynipide *Pseudocoila bochei* Weld, eines larvenparasiten von *Drosophila melanogaster* Meig. *Acta Zoologica* 32, 177–254.
- Jervis, M.A., Eilers, J., Harvey, J.A., 2008. Resource acquisition, allocation, and utilization in parasitoid reproductive strategies. *Annual Review of Entomology* 53, 361–385.
- Kraaijeveld, A.R., van Alphen, J., 1994. Geographical variation in resistance of the parasitoid *Asobara tabida* against encapsulation by *Drosophila melanogaster* larvae: the mechanisms explored. *Physiological Entomology* 19, 9–14.
- Krishnan, A., Nair, P.N., Jones, D., 1994. Isolation, cloning, and characterization of new chitinase stored in active form in chitin-lined venom reservoir. *Journal of Biological Chemistry* 33, 20971–20976.
- Labrosse, C., Stasiak, K., Lesobre, J., Grangeia, A., Huguet, E., Drezen, J.-M., Poirié, M., 2005. A RhoGAP protein as a main immune suppressive factor in the *Leptopilina boulardi* (Hymenoptera, Figitidae)-*Drosophila melanogaster* interaction. *Insect Biochemistry and Molecular Biology* 35, 93–103.
- Lee, M.J., Kalamaz, M.E., Paddibhatla, I., Small, C., Rajwani, R., Govind, S., 2009. Virulence factors and strategies of *Leptopilina* spp.: selective responses in *Drosophila* hosts. *Advances in Parasitology* 70, 123–145.
- Lee, M.J., Mondal, A., Small, C., Paddibhatla, I., Kawaguchi, A., Govind, S., 2011. A database for the analysis of immunity genes in *Drosophila*: PADMA database. *Fly* 5, 155–161.
- Leluk, J., Schmidt, J., Jones, D., 1989. Comparative studies on the protein composition of hymenopteran venom reservoirs. *Toxicon* 27, 105–114.
- Lohse, K., Barton, N.H., Melika, G., Stone, G.N., 2012. A likelihood-based comparison of population histories in a parasitoid guild. *Molecular Ecology* 21 (18), 4605–4617.
- Lynch, J.A., Desplan, C., 2006. A method for parental RNA interference in the wasp *Nasonia vitripennis*. *Nature Protocols* 1, 486–494.
- Mabiala-Moundougou, A., Doury, G., Eslin, P., Cherqui, A., Prévost, G., 2010. Deadly venom of *Asobara japonica* parasitoid needs ovarian antidote to regulate host physiology. *Journal of Insect Physiology* 56, 35–41.
- Malausa, J.-C., Auguste-Maros, A., Cheyppé-Buchmann, S., Groussier-Bout, G., Ris, N., Thaon, M., Warot, S., Fauvergue, X., 2010. Introductions of the African parasitoid *Psyttalia lounsburyi* in South of France for classical biological control of *Bactrocera oleae*. *IOBC/wprs Bulletin* 59, 163–170.
- Morales, J., Chiu, H., Oo, T., Plaza, R., Hoskins, S., Govind, S., 2005. Biogenesis, structure, and immune-suppressive effects of virus-like particles of a *Drosophila* parasitoid, *Leptopilina victorica*. *Journal of Insect Physiology* 51, 181–195.
- Moreau, S.J.M., Cherqui, A., Doury, G., Dubois, F., Fourdrain, Y., Sabatier, L., Bulet, P., Saarela, J., Prévost, G., Giordanengo, P., 2004. Identification of an aspartylglucosaminidase-like protein in the venom of the parasitic wasp *Asobara tabida* (Hymenoptera: Braconidae). *Insect Biochemistry and Molecular Biology* 34, 485–492.
- Nakamatsu, Y., Tanaka, T., 2004. Venom of *Euplectrus separatae* causes hyperlipidemia by lysis of host fat body cells. *Journal of Insect Physiology* 50, 267–275.

- Nappi, A.J., 1977. Factors affecting the ability of the wasp parasite *Pseudeucoila bochei* to inhibit tumorigenesis in *Drosophila melanogaster*. *Journal of Insect Physiology* 23, 809–812.
- Nappi, A.J., 2010. Cellular immunity and pathogen strategies in combative interactions involving *Drosophila* hosts and their endoparasitic wasps. *Invertebrate Survival Journal* 7, 198–210.
- Nappi, A.J., Poirié, M., Carton, Y., 2009. The role of melanization and cytotoxic by-products in the cellular immune response of *Drosophila* against parasitic wasps. *Advances in Parasitology* 70, 100–121.
- Parkinson, N., Smith, I., Weaver, R., Edwards, J.P., 2001. A new form of arthropod phenoloxidase is abundant in venom of the parasitoid wasp *Pimpla hypochondriaca*. *Insect Biochemistry and Molecular Biology* 31, 57–63.
- Parkinson, N., Conyers, C., Smith, I., 2002a. A venom protein from the endoparasitoid wasp *Pimpla hypochondriaca* is similar to snake venom reprolysin-type metalloproteases. *Journal of Invertebrate Pathology* 79, 129–131.
- Parkinson, N., Richards, E.H., Conyers, C., Smith, I., Edwards, J.P., 2002b. Analysis of venom constituents from the parasitoid wasp *Pimpla hypochondriaca* and cloning of a cDNA encoding a venom protein. *Insect Biochemistry and Molecular Biology* 32, 729–735.
- Parkinson, N., Smith, I., Audsley, N., Edwards, J.P., 2002c. Purification of pimplin, a paralytic heterodimeric polypeptide from venom of the parasitoid wasp *Pimpla hypochondriaca*, and cloning of the cDNA encoding one of the subunits. *Insect Biochemistry and Molecular Biology* 32, 1769–1773.
- Parkinson, N.M., Conyers, C.M., Keen, J.N., MacNicol, A.D., Smith, I., Weaver, R.J., 2003. cDNAs encoding large venom proteins from the parasitoid wasp *Pimpla hypochondriaca* identified by random sequence analysis. *Comparative Biochemistry and Physiology* 134, 513–520.
- Parkinson, N.M., Conyers, C., Keen, J., MacNicol, A., Smith, I., Audsley, N., Weaver, R., 2004. Towards a comprehensive view of the primary structure of venom proteins from the parasitoid wasp *Pimpla hypochondriaca*. *Insect Biochemistry and Molecular Biology* 34, 565–571.
- Pilch, B., Mann, M., 2006. Large-scale and high-confidence proteomic analysis of human seminal plasma. *Genome Biology* 7, R40.
- Poirié, M., Carton, Y., Dubuffet, A., 2009. Virulence strategies in parasitoid hymenoptera as an example of adaptive diversity. *Comptes Rendus de l'Académie des Sciences* 332, 311–320.
- Price, D., Bell, H., Hinchliffe, G., Fitches, E., Weaver, R., Gatehouse, J., 2009. A venom metalloproteinase from the parasitic wasp *Eulophus pennicornis* is toxic towards its host, tomato moth (*Lacanobia oleraceae*). *Insect Molecular Biology* 18, 195–202.
- Quicke, D.L.J., 1997. *Parasitic Wasps*. Chapman & Hall, London.
- Richards, E.H., Dani, M.P., 2008. Biochemical isolation of an insect haemocyte anti-aggregation protein from the venom of the endoparasitic wasp, *Pimpla hypochondriaca*, and identification of its gene. *Journal of Insect Physiology* 54, 1041–1049.
- Rizki, R.M., Rizki, T.M., 1984. Selective destruction of a host blood cell type by a parasitoid wasp. *Proceedings of the National Academy of Sciences United States of America* 81, 6154–6158.
- Rizki, R.M., Rizki, T.M., 1990. Parasitoid virus-like particles destroy *Drosophila* cellular immunity. *Proceedings of the National Academy of Sciences United States of America* 87, 8388–8392.
- Rizki, T.M., Rizki, R.M., 1994. Parasitoid-induced cellular immune deficiency in *Drosophila*. *Annals of the New York Academy of Sciences* 712, 178–194.
- Rizki, T.M., Rizki, R.M., Carton, Y., 1990. *Leptopilina heterotoma* and *L. boulardi*: strategies to avoid cellular defense responses of *Drosophila melanogaster*. *Experimental Parasitology* 70, 466–475.
- Schlenke, T.A., Morales, J., Govind, S., Clark, A.G., 2007. Contrasting infection strategies in generalist and specialist wasp parasitoids of *Drosophila melanogaster*. *PLoS Pathogens* 3, 1486–1501.
- Strand, M., 2008. Insect hemocytes and their role in immunity. In: Beckage, N.E. (Ed.), *Insect Immunity*. Academic Press, San Diego, CA, pp. 248–256.
- Strand, M.R., 2012. Polydnavirus gene products that interact with the host immune system. In: Beckage, N.E., Drezen, J.-M. (Eds.), *Parasitoid Viruses: Symbionts and Pathogens*. Academic Press, London, pp. 149–161.
- Suzuki, M., Miura, K., Tanaka, T., 2008. The virus-like particles of a Braconid endoparasitoid wasp, *Meteorus pulchricornis*, inhibit hemocyte spreading in its noctuid host, *Pseudaletia separata*. *Journal of Insect Physiology* 54, 1015–1022.
- Tian, C., Wang, L., Ye, G., Zhu, S., 2010. Inhibition of melanization by a Nasonia defensin-like peptide: implications for host immune suppression. *Journal of Insect Physiology* 56, 1857–1862.
- Uçkan, F., Ergin, E., Rivers, D.B., Gençer, N., 2006. Age and diet influence the composition of venom from the endoparasitic wasp *Pimpla turionellae* L. (Hymenoptera: Ichneumonidae). *Archives of Insect Biochemistry and Physiology* 63, 177–187.
- Vardal, H., 2006. Venom gland and reservoir morphology in cynipoid wasps. *Arthropod Structure and Development* 35, 127–136.
- Vincent, B., Kaeslin, M., Roth, T., Heller, M., Poulain, J., Cousserans, F., Schaller, J., Poirié, M., Lanzrein, B., Drezen, J.-M., Moreau, S.J.M., 2010. The venom composition of the parasitic wasp *Chelonus inanitus* resolved by combined expressed sequence tags analysis and proteomic approach. *BMC Genomics* 11, 693.
- Wajnberg, E., Coquillard, P., Vet, L.E.M., Hoffmeister, T., 2012. Optimal resource allocation to survival and reproduction in parasitic wasps foraging in fragmented habitats. *PLoS One* 7, e38227.
- Werren, J.H., Loehlin, D.W., Giebel, J.D., 2009. Larval RNAi in *Nasonia* (parasitoid wasp). *CSH Protocols*, pdb.prot5311.
- Wulfskuhle, J.D., Liotta, L.A., Petricoin, E.F., 2003. Proteomic applications for the early detection of cancer. *Nature Reviews Cancer* 3, 267–275.
- Zhang, G., Schmidt, O., Asgari, S., 2004a. A novel venom peptide from an endoparasitoid wasp is required for expression of polydnavirus genes in host hemocytes. *Journal of Biological Chemistry* 279, 41580–41585.
- Zhang, G., Lu, Z.-Q., Jiang, H., Asgari, S., 2004b. Negative regulation of prophenoloxidase (proPO) activation by a clip-domain serine proteinase homolog (SPH) from endoparasitoid venom. *Insect Biochemistry and Molecular Biology* 34, 477–483.
- Zhang, G., Schmidt, O., Asgari, S., 2006. A calreticulin-like protein from endoparasitoid venom fluid is involved in host hemocyte inactivation. *Developmental and Comparative Immunology* 30, 756–764.
- Zhou, L., Lu, Z., Yang, A., Deng, R., Mai, C., Sang, X., Faber, N.F., Lu, X.H., 2007. Comparative proteomic analysis of human pancreatic juice. *Methodological study*. *Proteomics* 7 (8), 1345–1355.
- Zhu, J., Ye, G., Hu, C., 2008. Molecular cloning and characterization of acid phosphatase in venom of the endoparasitoid wasp *Pteromalus puparum* (Hymenoptera: Pteromalidae). *Toxicon* 51, 1391–1399.
- Zhu, J.-Y., Ye, G.Y., Fang, Q., Hu, C., 2010a. Alkaline phosphatase from venom of the endoparasitoid wasp, *Pteromalus puparum*. *Journal of Insect Science* 10, 1–15.
- Zhu, J.-Y., Fang, Q., Wang, L., Hu, C., Ye, G.Y., 2010b. Proteomic analysis of the venom from the endoparasitoid wasp *Pteromalus puparum* (Hymenoptera: Pteromalidae). *Archives of Insect Biochemistry and Physiology* 75, 28–44.





## ARTICLE 2

Statistical analysis of the individual variability of 1D protein profiles  
as a tool in ecology: an application to parasitoid venom

Molecular Ecology Resources (soumis)

Mathé-Hubert H., Gatti J-L., Colinet D., Ris N., Poirié M., Malausa T

*Développement d'une méthode d'analyse semi-automatique de profils électrophorétiques 1D individuels basée sur l'utilisation du logiciel Phoretix et l'implémentation de fonctions R permettant d'analyser une grande quantité d'échantillons et d'aborder ainsi des questions écologiques et évolutives. Application à l'analyse du venin de 3 espèces endoparasitoïdes couplée à des analyses statistiques permettant de discriminer des populations, même proches, de chacune de ces espèces.*

## Présentation de l'article

Dans l'article précédent, nous avons mis évidence l'existence d'une forte variabilité interindividuelle du venin dans des espèces parasitoïdes. L'étude approfondie de cette variabilité et du potentiel évolutif associé nécessitait de pouvoir comparer le contenu protéique du venin d'un très grand nombre d'individus. **A cette fin, j'ai développé une méthode semi-automatique permettant de comparer rapidement et efficacement un grand nombre de profils d'électrophorèse 1D.** On peut en effet raisonnablement prédire qu'une part de la variation d'intensité observée au niveau des bandes protéiques sera due à la variabilité du niveau d'expression de protéines.

Des logiciels automatiques d'analyse de profils électrophorétiques 1D étaient déjà disponibles avant ce travail. Les modifications essentielles apportées par la méthode sont i) l'homogénéisation des échantillons protéiques via la prise de plusieurs photos correspondant à différents niveaux de coloration pour chaque gel et ii) une inversion de l'ordre de deux étapes clés de l'analyse des profils. En effet, avec les méthodes existantes, les bandes sont généralement détectées dans chacune des pistes (étape 1), puis les bandes de même poids moléculaire sont regroupées ce qui permet la construction de « bandes de références » (étape 2). Ces deux étapes créent des erreurs récurrentes lorsque les profils présentent une forte variabilité et que certaines bandes sont proches voire chevauchantes, ce qui est le cas pour le venin. Les erreurs doivent alors être corrigées à la main, ce qui est trop long pour être réalisé sur un grand nombre d'échantillons. La méthode que j'ai développée inverse ces deux étapes. Une détection de bandes de référence est d'abord réalisée semi-automatiquement sur la base d'un profil médian. Ces « bandes de références » ne sont pas uniquement caractérisées par la position de leur maximum d'intensité (peak), mais aussi par les positions de leurs bordures (i.e. leurs frontières). Ensuite, l'intensité entre les bords d'une bande est mesurée dans chacune des pistes.

La méthode présentée permet de comparer rapidement le contenu protéique d'un large nombre d'échantillons tel que le contenu d'appareils à venin de parasitoïdes. Cette méthode devrait permettre d'analyser n'importe quel type d'échantillon classiquement analysable par une électrophorèse 1D. La caractérisation et la comparaison de contenus protéiques peuvent

avoir de nombreuses applications en écologie évolutive. Par exemple, elles pourraient être utilisées pour suivre l'effet du changement climatique sur les populations en produisant des données sur leur réponse en terme de plasticité et d'adaptation (Reusch & Wood 2007).

Pour interpréter les résultats en terme d'effet phénotypique de la (ou les) bande(s) identifiée(s), il sera nécessaire d'identifier les protéines présentes dans cette ou ces bandes, par exemple par les approches classiques de protéomique et de transcriptomique. A la différence de la méthode développée ici, la protéomique nécessite souvent des quantités non-négligeables de protéines. Il devrait être possible par exemple d'analyser individuellement la moitié de chaque échantillon à l'aide de la méthode développée et de grouper certains échantillons (autre moitié) en vue d'une analyse protéomique. De façon intéressante, le choix des échantillons à regrouper pourra être éventuellement guidé par l'analyse statistique des données individuelles.

L'article présente également des résultats de l'analyse individuelle du venin d'individus de trois espèces, *Psytalia lounsburyi*, *P. concolor* et *Leptopilina boulardi* avec la méthode développée. Les analyses statistiques mettent en évidence une structuration des populations de ces espèces (populations géographiquement éloignées dans le cas des *Psytalia*, proches dans le cas de *Leptopilina*) sur la base de la composition du venin et elles permettent l'identification de bandes protéiques discriminantes.

L'exemple présenté permet donc i) de démontrer la puissance de la méthode en tant qu'outil dans un contexte de questionnement éco-évolutif ii) de montrer que les populations de parasitoïdes peuvent être discriminées sur la base de la composition du venin.

# Statistical analysis of the individual variability of 1D protein profiles as a tool in ecology: an application to parasitoid venom

H. MATHÉ-HUBERT,\*†‡<sup>1</sup> J.-L. GATTI,\*†‡<sup>1</sup> D. COLINET,\*†‡<sup>1</sup> M. POIRIÉ\*†‡<sup>1,3</sup> and T. MALAUSA\*†‡<sup>2,3</sup>

\*INRA, UMR 1355 Institut Sophia Agrobiotech, 06903 Sophia Antipolis, France, †Univ. Nice Sophia Antipolis, UMR 7254 Institut Sophia Agrobiotech, 06903 Sophia Antipolis, France, ‡CNRS, UMR 7254 Institut Sophia Agrobiotech, 06903 Sophia Antipolis, France

## Abstract

Understanding the forces that shape eco-evolutionary patterns often requires linking phenotypes to genotypes, allowing characterization of these patterns at the molecular level. DNA-based markers are less informative in this aim compared to markers associated with gene expression and, more specifically, with protein quantities. The characterization of eco-evolutionary patterns also usually requires the analysis of large sample sizes to accurately estimate interindividual variability. However, the methods used to characterize and compare protein samples are generally expensive and time-consuming, which constrains the size of the produced data sets to few individuals. We present here a method that estimates the interindividual variability of protein quantities based on a global, semi-automatic analysis of 1D electrophoretic profiles, opening the way to rapid analysis and comparison of hundreds of individuals. The main original features of the method are the *in silico* normalization of sample protein quantities using pictures of electrophoresis gels at different staining levels, as well as a new method of analysis of electrophoretic profiles based on a median profile. We demonstrate that this method can accurately discriminate between species and between geographically distant or close populations, based on interindividual variation in venom protein profiles from three endoparasitoid wasps of two different genera (*Psytalia concolor*, *Psytalia lounsburyi* and *Leptopilina bouvardi*). Finally, we discuss the experimental designs that would benefit from the use of this method.

**Keywords:** individual 1D SDS-PAGE, non-neutral markers, parasitoid venom, population proteomics, proteins, quantitative variation

Received 18 August 2014; revision received 12 February 2015; accepted 13 February 2015

## Introduction

Deciphering the molecular basis of eco-evolutionary processes requires a range of informative molecular markers (Stapley *et al.* 2010; Davidson 2012). Common genetic markers include microsatellites, SNPs (single nucleotide polymorphisms) or markers obtained, for example, by the recent RADseq technique (Davey & Blaxter 2010). The large sets of markers identified are supposed to be randomly distributed in the genome, and most of them are expected to be neutral. However, neutral markers are not the most informative to measure the evolvability of

phenotypic traits (Kirk & Freeland 2011; Karl *et al.* 2012). Moreover, it is not easy to link non-neutral SNPs to phenotypes, and an important part of the phenotypic variability is not determined by SNPs.

An important way to gather information on non-neutral molecular variation is to consider gene expression levels, as gene expression is a main step in the building of a phenotype (Diz *et al.* 2012) and a main source of intra- and interspecific phenotypic variability (Fay & Wittkopp 2008; Hodgins-Davis & Townsend 2009; Zheng *et al.* 2011). Variation in gene expression can be estimated through mRNA quantification using next-generation sequencing (NGS) approaches. However, mRNA quantification is only a tool to approximate the variation in protein quantities. Moreover, evolutionary signals are often clearer when considering protein rather than mRNA quantities (Feder & Walser 2005; Schimpf *et al.* 2009; Guimaraes *et al.* 2014). Finally, natural selection

Correspondence: Hugo Mathé-Hubert, Fax: +33(0)4 92 38 64 01; E-mail: Hugomh@gmx.fr

<sup>1</sup>Evolution and Specificity of Multitrophic Interactions (ESIM)

<sup>2</sup>Biology of Introduced Populations (BPI)

<sup>3</sup>These authors codirected the work.

rather acts on proteins, more directly involved in the realization of a phenotype. Population proteomics has thus been developed as a relevant tool to measure non-neutral molecular variation occurring in the field (Biron *et al.* 2006; Karr 2008; Diz *et al.* 2012).

Proteins can be separated using different methods, from one (1D) or two dimensions (2D) SDS-PAGE, including 2D DIGE (Differential gel electrophoresis), to high performance chromatography. Their subsequent identification and quantification can be performed using methods based on mass spectrometry, such as proteomic shotgun combined or not with chemical labelling (Domon & Aebersold 2010; Slattery *et al.* 2012), that have been successfully used in an eco-evolutionary context (Burstin *et al.* 1994; López *et al.* 2001; Mosquera *et al.* 2003; Chevalier *et al.* 2004; López 2005; Diz & Skibinski 2007; Gonzalez *et al.* 2010; Rees *et al.* 2011; Papakostas *et al.* 2012; Slattery *et al.* 2012; Blein-Nicolas *et al.* 2013). However, these methods do not easily apply to population proteomics. Indeed, accurate estimation of interindividual variability relies on large sample sizes to ensure statistical accuracy (Crawford & Oleksiak 2007; Bolnick *et al.* 2011; Dall *et al.* 2012) whereas the number of individuals that can be analysed remains pretty low (mean number of 11.4 per group in the studies mentioned above). This leads to data sets composed of a large number of variables measured on a few individuals, that are thus statistically 'ill posed' and difficult to analyse. Altogether, proteomic techniques are too costly and time-consuming for being routinely used in large-scale population approaches. Besides, they require substantial protein quantities that cannot be obtained from small size individuals or individual tissues.

1D electrophoresis, a simple and low-cost method, has rarely been used to estimate interindividual variability in eco-evolutionary studies (see Bobkov & Lazareva 2012; Krishnan *et al.* 2012). This is probably because no automated method is available to rapidly and accurately analyse large numbers of individual gel lanes. Several image processing packages can correct for gel deformation, detect and align lanes, and transform each lane into an 'intensity profile' (the description of a lane through variations of intensity associated with bands). However, they reach their limit when protein samples are complex, mainly because of band overlapping. Indeed, automatic bands detection in each individual lane leads to recurring errors as soon as the intensities of the overlapping bands are variable. The matching of bands across the different lanes is often a second source of error. These errors call for manual corrections, incompatible with large sample size analyses.

We report here the development of a semi-automated method, implemented by a set of R functions, that allows analysis of individual 1D electrophoresis

profiles obtained from digital analysis of gel pictures. This method is based on a semi-automated detection of 'reference bands' performed on a 'median profile', obtained from the whole set of individual lanes. Then, the intensities of these reference bands are recorded for each individual lane. Because it avoids the automatic detection of each band in each lane and thus the subsequent tedious manual screening of results, our method is more suitable for large sets of complex 1D profiles. The ultimate output of R functions mainly contains coordinates of reference bands as well as raw and normalized band intensities, as statistically analysable data sets. It is noteworthy that in addition to any protein sample analysable by 1D electrophoresis, the method might be used to compare high numbers of profiles of any kind, such as those obtained by HPLC, chromatography, ALFP or RFLP.

The method has been set up and tested on venom samples from three endoparasitoid wasp species, *Leptopilina boulardi* (Hymenoptera: Figitidae), *Psytalia concolor* and *P. lounsburyi* (Hymenoptera: Braconidae), to assess its power for detecting intergroup structure and thus potential eco-evolutionary patterns. Endoparasitoid wasps are insects that lay eggs in the body of their host and develop at its expense, leading to its death. To ensure parasitism success, they largely rely on injection of venom inside the host along with the egg (Poirié *et al.* 2009), this venom being mainly composed of proteins. Interstrain and interindividual variability have been evidenced for venom of *Leptopilina* and *Psytalia* endoparasitoids (Colinet *et al.* 2013). Moreover, the virulence of *Leptopilina* spp. was shown to evolve rather rapidly (Dupas *et al.* 2013), suggesting venom evolution might be involved in the observed variations of virulence. Using our method, we show that species, as well as geographically distant or close populations, can be discriminated based on individual venom profiles.

## Material and methods

### *Samples and electrophoresis conditions*

*Origin and number of individuals, electrophoresis.* *Psytalia lounsburyi* populations from Burguret (Kenya) and Stellenbosch (South Africa) were collected in 2003 and 2005, respectively (Cheyppé-Buchmann *et al.* 2011), and reared since under laboratory conditions (Mathé-Hubert *et al.* 2013). *P. concolor* populations were collected in 2010 in Sicily and Crete. *Leptopilina boulardi* populations were sampled in 2010 in four sites of the Rhône Valley (France): Avignon, Eyguières, Sainte-Foy-lès-Lyon and Saint-Laurent-d'Agny. *P. lounsburyi* analyses were performed using reared females stored at  $-80^{\circ}\text{C}$  before analysis. *P. concolor* and *L. boulardi* analysed individuals

were females that were stored at  $-80^{\circ}\text{C}$  following field collection.

*Sample preparation and analysis.* *Leptopilina bouvardi* venom reservoirs and *Psytalia* spp. venom glands (*Psytalia* reservoirs are mainly composed of muscle tissue) were dissected individually in  $15\ \mu\text{L}$  of insect Ringer solution supplemented with a protease inhibitors cocktail (PI; Roche). Residual tissues were removed by centrifugation ( $500\ \text{g}$ ,  $5\ \text{min}$ ), and  $10\ \mu\text{L}$  of supernatant was mixed with an equivalent volume of Laemmli reducing buffer and heated ( $95^{\circ}\text{C}$ ,  $5\ \text{min}$ ). Proteins were separated by 1D SDS-PAGE electrophoresis using commercial gels (AnykD Mini-PROTEAN<sup>®</sup> TGX<sup>™</sup>, Bio-Rad) for gel homogeneity. Silver stained gels (Morrissey 1981) were photographed (EOS-5D-MkII, Canon, Japan), and the high-resolution digital pictures ( $5626 \times 3745$  pixels; 16 bit; TIFF file) were analysed with the PHORETIX-1D software (TotalLab, UK). *Psytalia* spp. venom samples were more variable in protein quantity than *L. bouvardi* samples (data not shown). Therefore, for *Psytalia*, three pictures were taken per gel at different times during the staining step and analysed with Phoretix 1D. The linear optical density (OD) range of the camera was around 2 (OD grey scale; T2115, Stouffer, IN, USA). Approximate cost of consumables was 2 € per sample.

#### *Main steps of analysis of individual electrophoretic profiles*

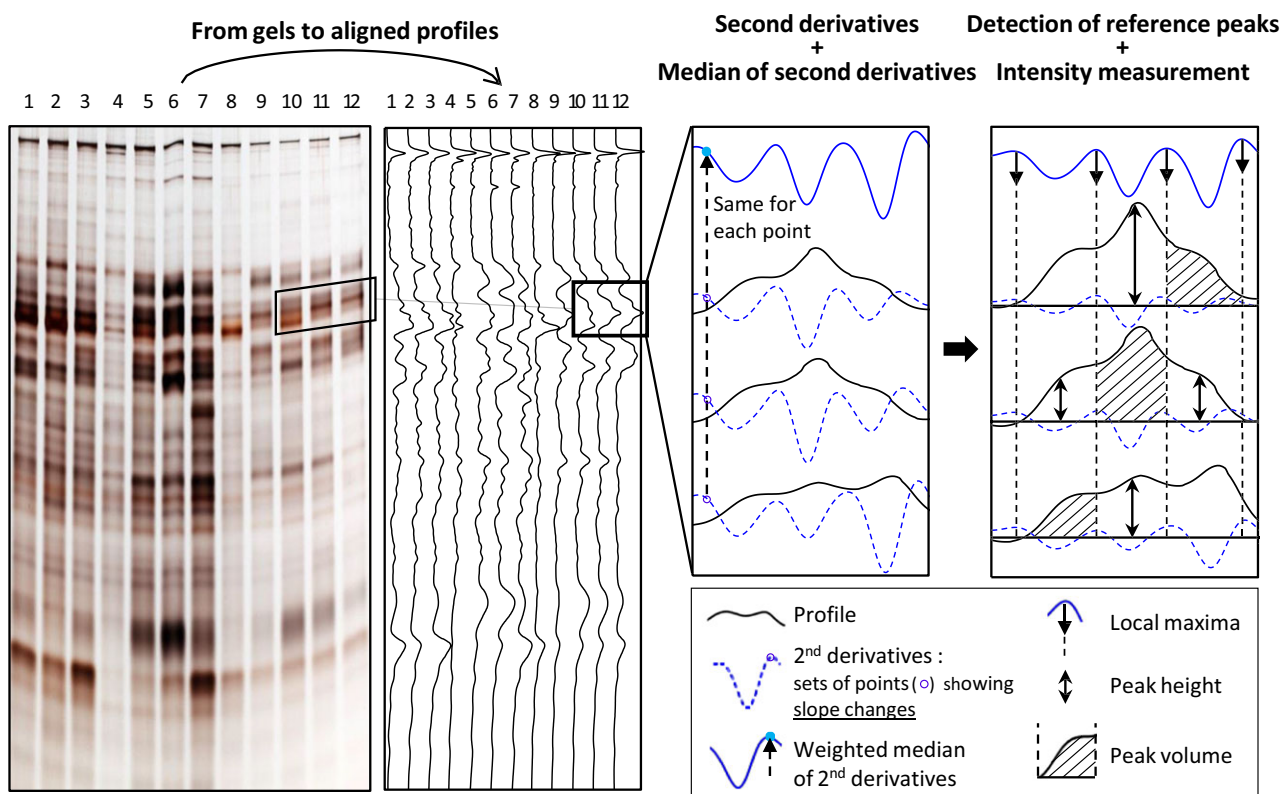
*Adjusting for heterogeneity of gel migration and staining intensity.* *Step one*—Alignment of individual protein profiles was performed with PHORETIX 1D. It relies on manual correction for relative mobility (hereafter abbreviated 'Rf'), using a set of chosen reference Rf positions (e.g. protein bands with few or no variation, easy to identify in all lanes) to deal with gel deformation such as 'gel smiling' (Biostep, 2008). Reference Rf positions are manually placed in all lanes of a gel picture and then linked to each other to create a Rf line. The software then calculates the Rf coordinates for all points between the Rf lines, thus allowing alignment of bands within and between gels (see Phoretix or GelAnalyzer information manuals). For *Psytalia* spp., this step was performed for each of the three pictures per gel. As neither the gel nor the camera moved between pictures, an R script was used to map Rf lines from one analysed picture to the others (R script available in Appendix S1, Supporting information). Approximately 15 reference Rf positions were used in the analysis.

*Step two*—The local level of background intensity can vary between gels and lanes due to (i) variation in the loaded protein quantities, (ii) variation of intensity of

adjacent bands or (iii) variations of gel staining and illumination. To assess whether the background introduces bias, we analysed each profile before and after removing the background by the 'rolling ball' method (based on the rolling of a 'ball' of 10 000 pixels of radius), following PHORETIX 1D instructions. The intensity profile of each lane (from each gel and picture) was thus exported two times, with and without the background, into a data table containing Rf positions and the intensity value for each pixel along the profile. Profiles with or without the background were, respectively, called 'B' and 'NB'.

*Detecting and quantifying bands (corresponding to peaks on profiles).* *Step three*—In this step, a median profile was 'calculated' and used to semi-automatically detect 'reference bands'. Then, the intensity of these bands was quantified in each individual lane using the height (maximum intensity of the band) and the volume (surface under the peak and between borders). Three profiles were obtained for each *Psytalia* lane, corresponding to the three pictures. In this case, the method semi-automatically selects for each lane the profile showing the best staining level (i.e. compromise between detection of the weakest bands and absence of saturation of the most intense bands; see Fig. S1). This part of the analysis relies on the successive use of nine R functions (available in Appendix S1; see Figs 1 and S1). The function (*read.Profiles*) creates transformed profiles from the data table generated by PHORETIX 1D. Raw profiles are reduced to a set of points corresponding to the same Rf positions instead of pixel positions. These transformed profiles are used for the detection of reference bands (functions *Estim.2nd.derivative*, *Median.profiles\_derivate*, *Detect.peaks*, *plot.profile* and *modify.peaks.manually*). The first two functions, (*Estim.2nd.derivative*) and (*Median.profiles\_derivate*), calculate respectively for each Rf position (i) the second derivative of each profile and (ii) the weighted median of these second derivatives. To make the analysis more sensitive for the detection of rare bands, the median is weighted for each Rf position by the absolute value of the individual second derivatives. Thus, for each Rf position in the median profile, more weight is given to samples for which the second derivative has a signal, that is samples that display a band at the given Rf position. (*Detect.peaks*) function then detects local minima and maxima of the weighted median second derivative. Local minima reveal the position of bands common to individual profiles and they are used as reference peaks. Local maxima correspond to borders of these reference peaks. The function (*plot.profile*) plots notably the median second derivative calculated by the function (*Median.profiles\_derivate*) and the position of detected peaks (Fig. S2, Supporting information). This helps to decide how reference peaks should be adjusted using the function





**Fig. 1** Summary of the main analysis steps. The left part of the figure describes the preprocessing of gels pictures. The right part illustrates the analysis steps (details in the Material and Methods). Briefly, slope changes along the intensity profiles are calculated for each point of each profile, using second derivatives. The positions of the different points that correspond to the second derivatives are summarized by the blue dashed lines (only one point is represented per profile, as a circle). Second derivatives are then used to compute the weighted median (blue line) which summarizes the slope changes of the analysed profiles. Local maxima of this weighted median of second derivatives correspond to the mean position of the inflection points of the profiles, and they are thus considered as borders of the 'reference bands' (vertical dashed lines with arrows at the top). These borders are used to measure the bands intensity, either with the height or the volume.

(*modify.peaks.manually*). Once borders are set for each reference peak of a profile, the seventh function (*Measure.peak*) records the coordinate of the top of peaks and their intensity (measure of the volume and the height of the peak). This procedure prevents two recurrent problems that occur in classical automated analyses of 1D electrophoresis. First, if two bands of unequal intensity partly overlap, the weaker band often appears as a shoulder of the stronger band instead of an independent peak. As band detection usually relies on the use of local maxima of the profiles (instead of the second derivative), only one large band is detected. Our method bypasses this problem by the use of second derivatives. Second, the automated step of band matching makes recurrent errors in case of polymorphism for the presence of bands that are close to each other. This problem is avoided by the use of fixed border coordinates, corresponding to the reference bands detected on the median profile, instead of the use of the band matching.

Taking into account the heterogeneity in the loaded protein quantity. *Step four*—This step aims at removing experimental variation to accurately analyse the variability in sample protein composition. The last  $R$  functions, (*select.photo*) and (*Compare.normalizations*), correct for the variability in the amount of loaded proteins, based on the analysis of different pictures of a gel (different stain levels). These functions can be used independently and (*select.photo*) is optional. The function (*select.photo*) selects for a given lane the picture that provides the best match between the intensity of the lane and the median intensity of all lanes (of all gels). This prevents heterogeneity in the level of saturation of lanes (see also Fig S1). The function (*Compare.normalizations*) normalizes the intensities using the 'limma'  $R$  package (Smyth 2005) to perform the three main normalization procedures (scale, quantiles and cyclic-loess; Smyth *et al.* 2003; Bolstad *et al.* 2003; Smyth 2005). The function 'removeBatchEffect' of the 'limma' package is also used at this step to remove



the gel effect, estimated through a linear model. Then, the function produces a graph comparing results obtained with different parameters combinations ('B' or 'NB'  $\times$  peak height or volume  $\times$  normalization by cyclic-loess, quantiles or scale procedures).

#### *Tests of the method accuracy*

*Sensitivity of the method.* For the sensitivity analysis, a pool of venom was prepared from 13 venom glands of *P. lounsburyi* (see Sample preparation and analysis) and volumes equivalent to 0.1, 0.25, 0.5, 0.75, 1, 1.5 and 2 individual gland(s) were loaded twice on separate lanes of an SDS-PAGE gel. Following migration, the gel was silver stained and pictures were taken at three different staining levels (Fig. S3, Supporting information). This experiment was used to (i) analyse the saturation on profiles using different protein quantities and pictures, (ii) assess the power of the method to accurately describe variations of band intensity and (iii) check whether band intensity was equally sensitive to variations in protein quantity and staining duration. The pictures were analysed as described above without the functions *select.photo* and *Compare.normalizations* to obtain raw intensities.

To fulfil the first objective, the saturation range was characterized graphically (Fig. S3). For the second objective, a Box-Cox model (MASS package of the R 3.0.2 software; Venables & Ripley 2002) was fitted for each reference band and for the four parameters combinations ('B' or 'NB'  $\times$  peak volume or height). Explanatory variables were (i) the loaded quantity, in equivalent of a venom gland, as a continuous variable, (ii) the picture as a discrete variable and (iii) the loaded quantity  $\times$  picture interaction. To assess the power of the method, the coefficient of determination of each model was measured by the adjusted  $R^2$ , providing one coefficient of determination by band and parameters combination. This allowed comparison of accuracy of parameters combinations (Fig. S4, Supporting information). To compare the sensitivity of band intensity to staining and protein quantity, we used four coefficients per Box-Cox model to construct the two variables 'sensitivity to protein quantity' and 'sensitivity to staining duration'. The first coefficient of each model, the slope associated to the variation of protein quantity, represents the variable 'sensitivity to protein quantity'. In each model, three other coefficients describe the band intensity at the three staining duration (three pictures). The standard deviations of these three coefficients correspond to the variable 'sensitivity to staining duration'. We then checked graphically whether the relationship between the two constructed variables was linear, as expected if bands are equally sensitive to variation in protein quantity and staining duration.

*Case studies: Test of the method.* To test whether the method could discriminate between species and populations, we compared venom profiles between samples from different species (*P. concolor* and *P. lounsburyi*) and from different populations of a species (*P. concolor*, *P. lounsburyi* and *L. boucardi*). *Psytalia* comparisons were based on analysis of 14 individuals for each of the two *P. lounsburyi* populations and the two *P. concolor* populations, loaded on four gels in a mixed design. *L. boucardi* sample sizes were 11, 20, 25 and 29 for 'Avignon', 'Eyguières', 'Sainte-Foy-lès-Lyon' and 'Saint-Laurent-d'Agny', respectively. Individuals were analysed on seven gels in a mixed design. *Psytalia* spp. and *L. boucardi* gels were analysed separately.

*Comparison of the accuracy of combinations of parameters—*To compare the 'false' intersample variability (hereafter called noise) associated with the 12 parameter combinations ('B' or 'NB'  $\times$  peak height or volume  $\times$  the three normalization procedures), we calculated the ratio of intergroup variability to intragroup variability. This ratio is expected to decrease when the noise level increases, as noise introduces artificial interindividual variability but is not predicted to change interpopulation variability. The ratio was computed for each reference band, in the four studies designed to check intergroup variability [(i) *P. concolor* and *P. lounsburyi*, (ii) Cretan and Sicilian *P. concolor* populations, (iii) South African and Kenyan *P. lounsburyi* populations and (iv) the four *L. boucardi* populations] and a generalized linear model (GLM) with a gamma-distributed dependent variable was fitted to this ratio. Explanatory variables were the 12 parameters combinations and the identification number of the reference band. The gamma distribution was selected based on a Park test ('LDdiag' R package). Explanatory variables were tested with log-likelihood ratio tests. To compare the effect of each parameter combination, post hoc comparisons were performed with the 'multcomp' package (Hothorn *et al.* 2008).

*Sensitivity of results to the combination of parameters—*To check the power of the method to detect intergroup variation, we performed linear discriminant analyses (LDA) on normalized venom band intensities, for each case study and each combination of parameters. The sensitivity of LDA to the combination of parameters was tested for each case by selecting and comparing two LDAs. The first LDA used the combination of parameters with the highest ratio of intergroup versus intragroup variability. The second LDA used the combination of parameters that had both (i) a high inter- versus intragroup ratio and (ii) one of the most different combination of parameters compared to the first LDA. The parameters combinations

**Table 1** Combinations of parameters used for the LDAs in the four case studies. The parameter combination used for each of the two LDAs of each case study is provided in the three last columns. The column 'Background' indicates whether the background was subtracted (NB) or not (B). The column 'Intensity' indicates whether band intensity was measured with the peak height (H) or the peak volume (V)

Case studies (Groups)	LDA	Parameters combination		
		Background	Normalization	Intensity
<i>Psytalia</i> spp.	1	NB	Quantiles	H
( <i>P. lounsburyi</i> , <i>P. concolor</i> ) Fig. 4a	2	NB	Scale	V
<i>P. lounsburyi</i>	1	NB	Scale	H
(South Africa, Kenya) Fig. 4b	2	NB	Quantiles	V
<i>P. concolor</i>	1	NB	Quantiles	H
(Crete, Sicily) Fig. 4c	2	B	Cyclic-loess	V
<i>L. bouvardi</i>	1	B	Scale	H
(Avignon, Eyguières, Ste Foy Lès Lyon, St Laurent d'Agny) Fig. 5	2	NB	Quantiles	V

of the two LDAs for each case study are summarized in Table 1. In each case, the two LDAs were compared using correlations of bands to LDA axes, which allow identifying bands that show intergroup variation. More precisely, we checked whether each band was similarly correlated to axes of the two LDA. The correlations of bands to the LDA axis were tested by a Spearman rank correlation test with a Bonferroni correction for the number of reference bands (38 for *Psytalia* spp. and 32 for *L. bouvardi*). LDAs were performed and tested with the ADE4 R package (Dray & Dufour 2007).

## Results

### *Sensitivity and validity of the method*

Comparison of electrophoretic profiles between individuals requires (i) the accurate alignment of profiles and (ii) the detection of variation in staining intensity as a reliable evaluation of the protein amount per band. The first requirement was fulfilled by the profile analysis performed using Phoretix 1D and the following treatment of data based on R functions, combined with a manual adjustment for some of the reference bands based on the constructed 'median profile'. For the second requirement, a sensitivity analysis was performed using protein profiles corresponding to different amounts of the same sample and three pictures corresponding to different stain levels. Although a low saturation of the band intensity occurred in the tested range of protein amounts (Fig. S3), it did not prevent detection of variations in intensity (Fig. S4). Indeed, the adjusted  $R^2$  that describe for each band the amount of variation in intensity explained by the loaded quantity and the staining duration were overall much higher than 0.95 before background subtraction and ranged between 0.9 and 1 after background subtraction.

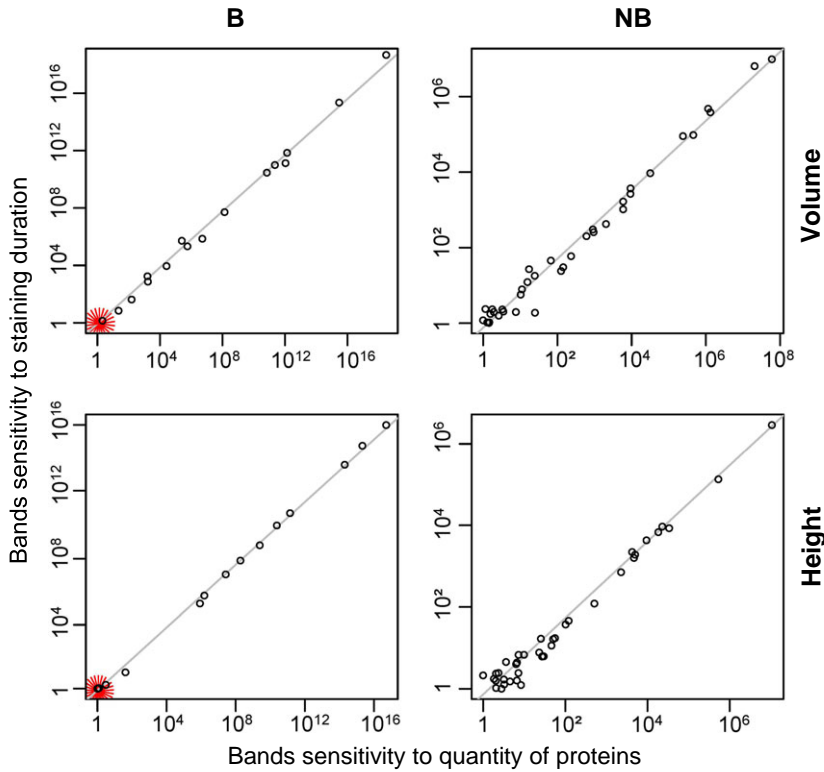
This indicates that background subtraction marginally reduced the sensitivity (Fig. S4).

We also used this experiment to check whether the shooting of gels at different staining times was a useful approach to deal with the variation in loaded protein amounts, thus allowing comparing lanes of similar stain levels. This required that the band intensity varied similarly with changes in the staining duration and the loaded protein amount. A strong linear relationship was indeed observed between the variables 'sensitivity to protein quantity' and 'sensitivity to staining duration', although the correlation was lower after background subtraction (Fig. 2).

### *Comparison of the accuracy of combinations of parameters on real data sets*

In this section, we have used real data sets of venom of three wasp species to compare the 12 combinations of parameters with respect to their capacity to identify interpopulation differences.

The developed analysis was used on two independent data sets. Venom profiles of *P. lounsburyi* and *P. concolor* were analysed together, providing 38 reference bands, while analysis of *L. bouvardi* profiles led to identification of 32 reference bands. To compare the noise level associated with different parameter combinations, the ratio between the inter- and intragroup variability was computed for each parameter combination and each band, using data from the four cases (venom profiles comparison between *Psytalia* species and between populations of *P. concolor*, *P. lounsburyi* and *L. bouvardi*; see 3b. in material and methods). A significant effect of the two explanatory variables ('combination of parameters' and 'reference band') was observed in all cases (Table S1, Supporting information), with post hoc comparisons evi-



**Fig. 2** Linearity of the effect of the protein quantity and of the staining duration on the band intensity. Four parameters combinations [with (B), or without (NB) background; detection of height (H) or volume (V)] were tested. For each reference band, a model was fitted to explain the band intensity by the protein quantity and the picture identifying number. Each point represents one reference band. The  $x$ -axis and  $y$ -axis correspond to the variable 'sensitivity to the protein quantity' and 'sensitivity to the staining duration', respectively. For logarithmic scale, the two variables were transformed by subtracting each value by the minimum of the variable and adding one. The red spiny shapes at the lower left of the two left graphs represent overlapping points (one 'spine' per overlapping point).

dencing differences between specific parameters combinations (Fig. 3). Although the best parameter combination was not the same in all cases, it always involved the 'peak height' quantification. Moreover, similar trends occurred for (i) *P. lounsburyi* and *P. concolor* and (ii) *P. lounsburyi* populations (Fig. 3a and b), with higher ratio values without background subtraction and using a quantiles normalization. However, striking differences were also observed. For example, although the combination 'No background' ('NB'), height, with quantiles normalization was among the best ones in all situations involving *Psytalia* spp., it was one of the worst when considering *L. bouhardi* data (Fig. 3). This absence of common trend is probably due to interactions between the combination of parameters and the characteristics of the bands showing a high intergroup variability (e.g. size, shape flat or pointed and distances to adjacent bands).

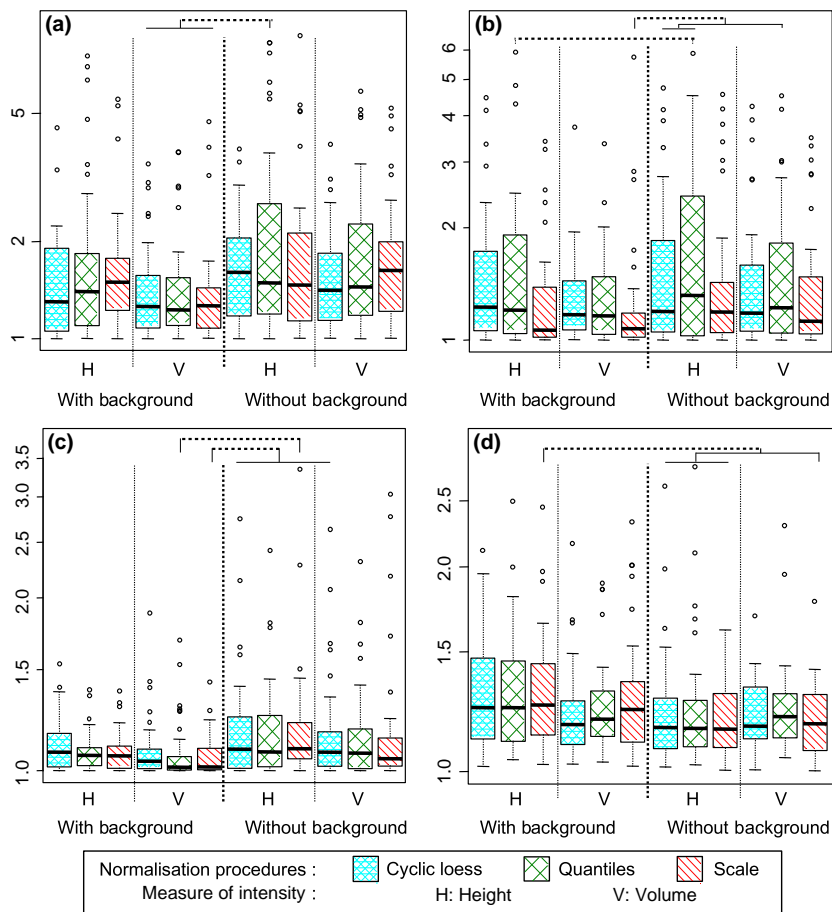
Background subtraction was shown to introduce some noise in the sensitivity test (Fig. S4), performed with a unique venom sample, while it seemed to decrease noise when using data from *Psytalia* species (Fig. 3). This suggests that local background subtraction may improve analyses in some cases. Although results seem to be rather robust to the combination of parameters, it is then advisable to compare results obtained with different combinations of parameters as far as new samples/biological models are to be analysed.

Nonetheless, the ratio values were clearly higher for comparisons of (i) *P. lounsburyi* and *P. concolor* and (ii) *P. lounsburyi* populations whatever the combination of parameters, suggesting a higher intergroup differentiation. Similarly, the lowest ratio values were observed for comparison of *P. concolor* populations whatever the combination of parameters.

#### Case studies: Test of the method

Linear discriminant analyses (LDA) were used in the four comparisons to test the power of the method to detect intergroup variation. All combinations of parameters allowed the detection of highly significant ( $P < 10^{-3}$ ) intergroup differences in venom in the four cases. Pattern detection was thus not hampered by the noise due to a combination of parameters despite the small sample sizes (11–20 individuals per population).

To compare LDA layouts obtained with different parameters (Table 1), we used the correlations of bands with LDA axes, which allow identifying bands that show intergroup variation. When venom composition was compared at the species level (*P. concolor* vs. *P. lounsburyi*), 18 bands were significantly correlated with the LDA axes and two bands with the axis of the first LDA only (Fig. 4a).



**Fig. 3** Comparisons of the accuracy of combinations of parameters. The ratio (Inter-group variation/Intra-group variation) + 1 is shown for each band and parameters combination. Boxplots compare the ability of parameters combinations to detect venom-based intergroup structure between (a) *P. lounsburyi* and *P. concolor*, (b) *P. lounsburyi* populations, (c) *P. concolor* populations and (d) *L. bouvardi* populations. Horizontal lines above boxplots indicate significant differences. Thin lines group combinations that are related by a dotted thick line indicate significant differences between parameters combinations on the left versus the right side of this dotted thick line. This graph resembles graphs produced by the  $\kappa$  function (*Compare.normalizations*), except for the statistical significance part.

At the population level, for *P. lounsburyi* (South Africa vs. Kenya), four bands were significantly correlated with the discriminant axis of the two LDA, while six bands were correlated with the axis of the first LDA only (Fig. 4b). For *P. concolor* (Cretan vs. Sicilian populations), only the band #6 was significantly correlated with axis of both LDAs, one band being correlated with the axis of the second LDA only (Fig. 4c). This low number of discriminating bands is in agreement with the low intergroup versus intragroup variation for *P. concolor* populations (see above). Interestingly, variation of intensity of band #6 was detectable (Fig. 4d) although this band is among the weakest ones in terms of intensity (Fig. S5a, Supporting information). This indicates that the method is powerful enough to detect intergroup differences based on a low number of bands of low intensity, even using small sample sizes.

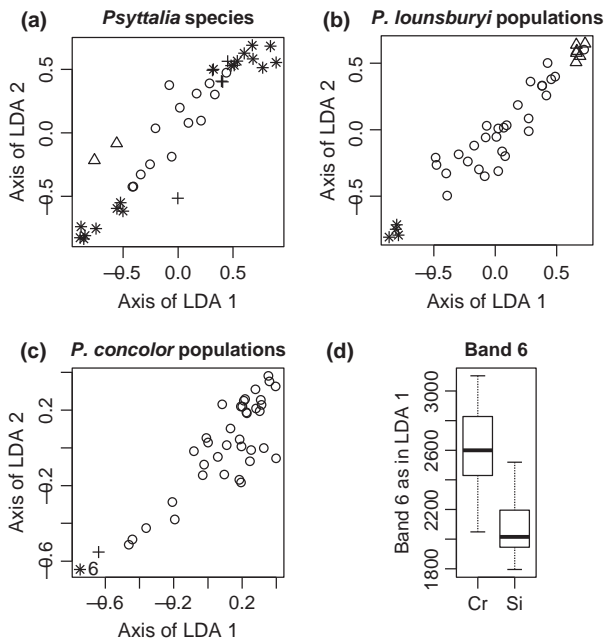
In the comparison of venom proteins of *L. bouvardi* French populations (Avignon, Eyguières, Sainte-Foy-lès-Lyon and Saint-Laurent-d'Agny), the first and second discriminant axes were inverted, probably because eigenvalues of first and second axes were similar (0.78 and 0.72 in the first LDA, 0.79 and 0.70 in the second LDA). Once the two axes of the second LDA were

inverted, the global patterns of LDAs 1 and 2 were qualitatively similar, the main difference being a slight clockwise rotation from LDA 1 to LDA 2 (Fig. 5). Seven bands were significantly correlated to the first axis of LDA1 and the second axis of LDA2 (horizontal axes; arrows with triangle or star at the origin and at the end, Fig. 5b), while 12 bands were correlated to one of these two axes only (arrows with triangle or star at one of the two extremities only; Fig. 5b). For the vertical axes, one band was correlated to the second axis of LDA1 only (arrow with a cross at the origin only, Fig. 5b) and two bands to the first axis of LDA2 only (arrows with a cross or a star at the end only, Fig. 5b). This lack of conservation of the significance level is mainly due to the slight clockwise rotation from LDA 1 to LDA 2.

Overall, variability in band correlations to discriminant axes was mainly found for bands that were poorly or not correlated to LDA axes (Figs 4 and 5).

In summary, the structures between groups described by the LDAs are well conserved through the different parameters combinations, meaning that the choice of a combination only marginally affects the results, provided that the selected combination is one of those displaying the highest 'intergroup vs. intragroup variation'.





**Fig. 4** Discriminant analyses on *Psytalia* spp. venom. The graphs compare results of LDAs performed on data from *Psytalia* spp. with different parameter combinations. (a) Comparison between *P. lounsburyi* and *P. concolor*, (b) Comparison between South African and Kenyan *P. lounsburyi* populations, (c) Comparison between Cretan (Cr) and Sicilian (Si) *P. concolor* populations. There is only one discriminant axis per LDA as only two groups are to be discriminated. Plots describe the adequacy between the first and second LDA obtained with different combinations of parameters (see Table 1): *x*- and *y*-axes correspond to the correlation between the LDA axes and the band intensities obtained with the combination of parameters used in the LDA. Symbols 'stars', 'triangles', 'crosses' and 'circles' correspond, respectively, to bands significantly correlated to (i) the axis of the two LDAs, (ii) the LDA1 axis, (iii) the LDA2 axis, (iv) none of the axis. (d) Intensity of band #6 (only band significantly correlated to both LDA axes) in Cretan and Sicilian *P. concolor* populations measured with the same combination of parameters as for the LDA1 (Table 1). The position of band #6 is indicated on Fig. S4a by the arrows.

## Discussion

### The method

The last 10 years have seen an increasing number of applications of proteomics to a wide range of biological fields such as behavioural ecology, molecular ecology or evolution (Navas & Albar 2004; Biron *et al.* 2006; Karr 2008; Melzer *et al.* 2008; Rees *et al.* 2011; Diz *et al.* 2012; Valcu & Kempenaers 2014). Proteomes show large differences in protein abundance which carry biological information not accessible through genomics or transcriptomics (Feder & Walser 2005; Maier *et al.* 2009; Laurent

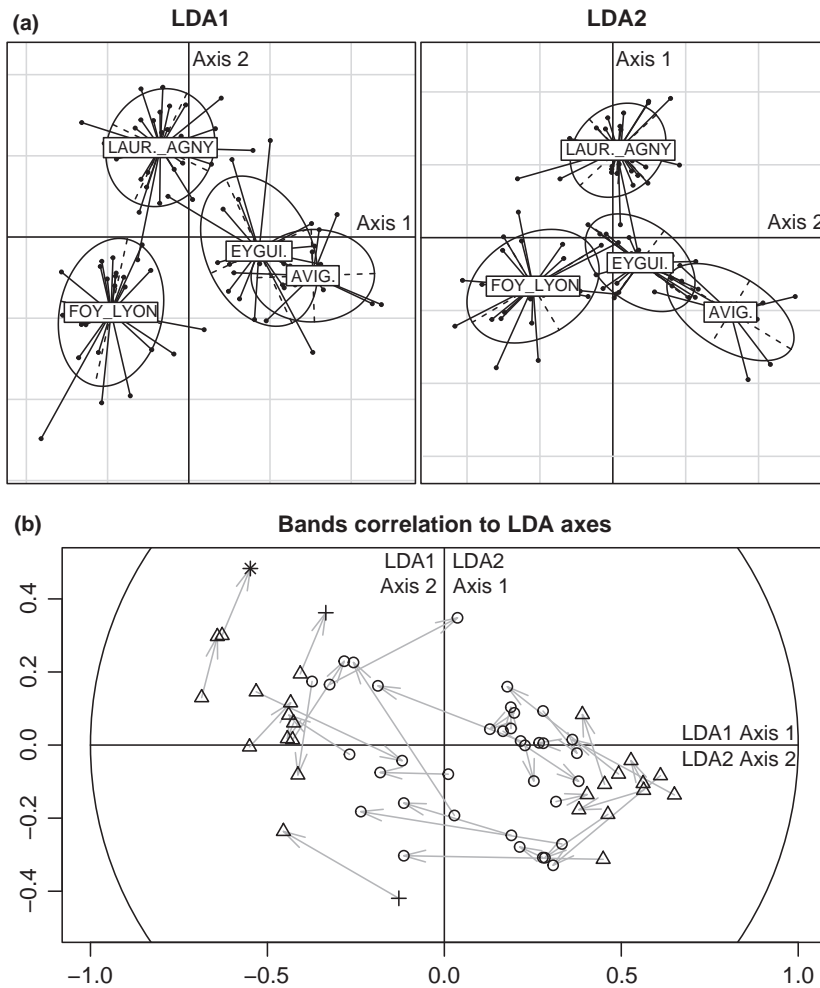
*et al.* 2010; Diz *et al.* 2012). Here, we have developed and tested a method allowing the semi-automated analysis of 1D protein electrophoresis profiles as an helpful tool to address eco-evolutionary questions.

Because this method relies on simple 1D electrophoresis, it makes it possible and affordable to analyse the large numbers of individuals required for accurate estimation of interindividual variation, a keystone to ecological and evolutionary studies (Crawford & Oleksiak 2007; Bolnick *et al.* 2011; Violle *et al.* 2012). For instance, although we present here significant results from analysis of a low number of individuals and populations, gathering information from a higher number of locations and individuals will be required to identify the causes of the observed population structure. Results are currently being obtained from experimental evolution experiments using the developed method, which already required analysis of the venom content of more than 1000 parasitoid individuals in a short period of time.

A critical step in biochemical experiments is to normalize sample quantities to make them comparable. This step is tedious and can require a large amount of each protein sample, as for parasitoid venom. Here, we show that sample quantities can be homogenized *in silico* by analysing gels at different staining level. The number of pictures required per gel depending on the variability in protein quantities (Appendix S2, Supporting information). This makes it possible to compare lanes of similar stain level, equally prone to saturation, following a last normalization step to deal with the remaining variability.

Another important feature of the method is that it bypasses the problem of recurrent errors arising from automated band detection on gel lanes, by detecting reference bands on a median profile and by recording the intensity between the borders of these reference bands. However, one constraint is that the method accuracy depends on the precision of the detection of the reference bands which itself depends on the homogeneity of the profiles. For example, it could be preferable to analyse the intraspecific variability of *P. lounsburyi* and *P. concolor* venom profiles separately (with one set of reference bands per species) because the venom profiles of these species largely differ.

Analysis of 1D electrophoresis patterns has some intrinsic limitations, such as the absence of detection of low-abundant proteins, or the problem of band overlapping with adjacent bands that can result in artefactual correlations between bands intensities. Notably, statistical approaches to handle multicollinearity and its possible modulation by the choice of the combination of parameters are discussed in Appendix S2. Another limitation is that a large part of the post-translational modifications is not detected by 1D electrophoresis-based



**Fig. 5** Discriminant analyses on the venom of the four populations of *L. bouvardi* venom. (a) Results of the first and second LDAs performed on the four *L. bouvardi* populations using different parameter combinations (each point show the position of one individual on discriminant axes). To make the two LDAs comparable, LDA2 axes have been transposed. (b) Correlation of bands to axes of the two LDAs. As in Fig. 4, coordinates on axes indicate the correlation coefficient. The origin and end of the arrows correspond to the correlations of the bands with axes of the LDA1 and of the LDA2, respectively (with transposed axes). Thus, symbols at the origin and end of arrows describe the significance of band correlation to axes of the LDA1 the LDA2, respectively. Symbols 'stars', 'triangles', 'crosses' and 'circles' correspond to bands significantly correlated to (i) horizontal and vertical axes, (ii) horizontal axis only, (iii) vertical axis only, (iv) none of the axes, respectively. Changes induced by differences in the parameter combination are evidenced by the length of arrows and the concordance of symbols at the origin and the end of arrows. Most arrows indicate a clockwise rotation.

studies (Sickmann *et al.* 2001; Jensen 2006; Jacob & Turck 2008; Karve & Cheema 2011). Future technological advances will hopefully overcome part of these limitations. Overall, the best statistical approaches for analysis of the data sets obtained with the method seem to be multivariate analyses. Alternative approaches, R packages and softwares are also discussed in Appendix S2.

Although the individual variation in protein expression cannot be entirely described by 1D electrophoresis, our method still identified enough variation to perform accurate analyses of the populations structure. This opens the way to a rapid and cost-effective analysis of natural variability of protein expression.

#### The example of parasitoid venom analysis

Endoparasitoid venom was a good protein sample to test the developed method because it is a protein-composed fluid of medium complexity, easy to collect through individual dissection. Our results demonstrate that the method can accurately discriminate between species, as

well as geographically distant or close populations of a species, through estimation of interindividual variation in protein quantities. They also provide the first evidence that endoparasitoid populations can be discriminated on the basis on their venom composition.

At the intraspecific level, laboratory populations of *P. lounsburyi* were the most differentiated, followed by field populations of *L. bouvardi* and *P. concolor*. Although differences in *P. lounsburyi* may also be attributed to genetic drift and/or rearing effects, they are in agreement with the strong neutral differentiation in the field between Kenyan and South African populations ( $F_{ST} = 0.4$ ; Cheyppé-Buchmann *et al.* 2011). In contrast, Mediterranean *P. concolor* populations have a low level of genetic divergence (Karam *et al.* 2008). Finally, the four *L. bouvardi* populations could all be discriminated by their venom content although some of them were sampled in close locations.

Explaining an observed quantitative variation in a protein band detected on 1D SDS-PAGE is not straightforward. Indeed, variation can be due to post-transla-

tional differences (frequency of isoforms) or to genetic or epigenetic differences in the regulation of protein expression. Protein profiles can also be influenced by individual variables (e.g. sex, age) and environmental conditions. Their geographic variation thus probably results from both plasticity and genetically based modifications that may be neutral or involve local adaptation. As we only aimed here at measuring and statistically analyse the naturally occurring proteomic variability, the presented data do not discriminate between neutral genetic variation and local adaptation as main factors of the venom-based population structure. Disentangling the causes of the observed variability will require specifically designed approaches as for instance common garden experiments or/and the coupling of protein profiles characterization with neutral markers. Once protein bands associated with population divergence have been identified, such as the band #6 of *P. concolor*, they can be more thoroughly investigated to identify the molecular bases of the observed variability. As one protein band usually contains several proteins, complementary approaches to the global analysis may be useful, for example the use of tools specific to already characterized proteins or the knock-down of specific genes through RNA interference (e.g. Li *et al.* 2012; Colinet *et al.* 2014). The primary identification of protein markers may thus lead to the final characterization of proteins involved in population structuring or associated to a specific phenotype.

#### *Perspectives: Application for ecology and population studies*

Not all protein samples may be suitable for analysis using the developed method. Indeed, it relies on the assumption that abundant proteins, easily detected in 1D SDS-PAGE, are those that display eco-evolutionary patterns of interest. Specific tissues, such as glands or fluid compartments, have often been successfully analysed by classical 1D electrophoresis [see for instance: venom (Colinet *et al.* 2013), vitelline envelope (Aagaard *et al.* 2006), seeds storage proteins (Bobkov & Lazareva 2012), eyes tear film (Green-Church *et al.* 2008), liver and brain extracts (Gonzalez *et al.* 2010; Fig. S2)], but the interest of this approach remains to be tested for other tissues or small entire organisms. The use of individual 1D electrophoresis in an ecological or evolutionary context has only been reported, to our knowledge, for snake venom (Angulo *et al.* 2007; Alape-giron *et al.* 2008; Sanz *et al.* 2008; Núñez *et al.* 2009) and rodent seminal fluid (Ramm *et al.* 2009).

The method generates a set of markers independently from prior knowledge on the studied species. It is thus suitable for ecological studies on nonmodel organisms.

Moreover, the protein content of chosen bands can be easily characterized even for nonmodel organisms (Armengaud *et al.* 2014), paving the way for identification of sets of proteins and genes involved in an adaptive trait. This method can thus be useful in the process of identifying environmental or geographic factors that explain variation in protein expression, or of testing hypotheses based, for instance, on experimental evolution studies.

Finally, such markers of protein expression may be helpful to track and predict the effects of global change on population dynamics by providing data on adaptive and plastic responses to environmental conditions (Reusch & Wood 2007). They could also be valuable in the context of trait-based community ecology that aims to explain the structure of community of species by their traits. For instance, the data produced could be integrated in the framework that relies on estimation of traits variability at each organizational level (from individuals to communities of species) to determine which level mostly impacts the trait in the community (Violle *et al.* 2012).

#### Acknowledgements

We thank R. Allemand for *Leptopilina* populations and K. Variakou and V. Caleca for *P. concolor* samples (Crete and Sicily, respectively). We are also grateful to N. Ris for fruitful discussions, M. Thaon and N. Ris for rearing *Ceratitis capitata* and *Psytalia* strains, and L. Kremmer for help with analysis of *Leptopilina* samples. This work was funded by the INRA Division 'Santé des Plantes et Environnement' (SPE), the French National Research Agency through CLIMEVOL ANR-08-BLAN-0231 and the 'Investments for the Future' LABEX SIGNALIFE program reference ANR-11-LABX-0028, and the European Union's Seventh Framework Programme for research, technological development and demonstration under grant agreement No. 613678 (DROPSA). H. Mathé-Hubert Ph.D. was funded by the 'Provence Alpes Côte d'Azur' (PACA) region and the INRA SPE Division.

#### References

- Aagaard JE, Yi X, MacCoss MJ, Swanson WJ (2006) Rapidly evolving zona pellucida domain proteins are a major component of the vitelline envelope of abalone eggs. *Proceedings of the National Academy of Sciences, USA*, **103**, 17302–17307.
- Alape-giron A, Sanz L, Madrigal M, Sasa M, Calvete JJ (2008) Snake venomomics of the lancehead pitviper *Bothrops asper*: geographic, individual, and ontogenetic variations. *Journal of Proteome Research*, **7**, 3556–3571.
- Angulo Y, Escolano J, Lomonte B *et al.* (2007) Snake venomomics of Central American pitvipers: clues for rationalizing the distinct envenomation profiles of *Atropoides nummifer* and *Atropoides picadoi*. *Journal of Proteome Research*, **7**, 708–719.
- Armengaud J, Trapp J, Pible O *et al.* (2014) Non-model organisms, a species endangered by proteogenomics. *Journal of Proteomics*, **105**, 1–14.
- Biostep (2008) Lane relationship studies. <http://www.biostep.de/DocumentDownloadServlet?docid=48>, 1–2.

- Biron DG, Loxdale HD, Ponton F *et al.* (2006) Population proteomics: an emerging discipline to study metapopulation ecology. *Proteomics*, **6**, 1712–1715.
- Blein-Nicolas M, Albertin W, Valot B *et al.* (2013) Yeast proteome variations reveal different adaptive responses to grape must fermentation. *Molecular Biology and Evolution*, **30**, 1368–1383.
- Bobkov SV, Lazareva TN (2012) Band composition of electrophoretic spectra of storage proteins in interspecific pea hybrids. *Russian Journal of Genetics*, **48**, 56–61.
- Bolnick DI, Amarasekare P, Araújo MS *et al.* (2011) Why intraspecific trait variation matters in community ecology. *Trends in Ecology & Evolution*, **26**, 183–192.
- Bolstad BM, Irizarry RA, Astrand M, Speed TP (2003) A comparison of normalization methods for high density oligonucleotide array data based on variance and bias. *Bioinformatics*, **19**, 185–193.
- Burstin J, De Vienne D, Dubreuil P, Damerval C (1994) Molecular markers and protein quantities as genetic descriptors in maize. I. Genetic diversity among 21 inbred lines. *Theoretical and Applied Genetics*, **89**, 943–950.
- Chevalier F, Martin O, Rofidal V *et al.* (2004) Proteomic investigation of natural variation between Arabidopsis ecotypes. *Proteomics*, **4**, 1372–1381.
- Cheyppe-Buchmann S, Bon MC, Warot S *et al.* (2011) Molecular characterization of *Psytalia lounsburyi*, a candidate biocontrol agent of the olive fruit fly, and its Wolbachia symbionts as a pre-requisite for future intraspecific hybridization. *BioControl*, **56**, 713–724.
- Colinet D, Mathé-Hubert H, Allemard R, Gatti JL, Poirié M (2013) Variability of venom components in immune suppressive parasitoid wasps: from a phylogenetic to a population approach. *Journal of Insect Physiology*, **59**, 205–212.
- Colinet D, Kremmer L, Lemauf S *et al.* (2014) Development of RNAi in a *Drosophila* endoparasitoid wasp and demonstration of its efficiency in impairing venom protein production. *Journal of Insect Physiology*, **63**, 56–61.
- Crawford DL, Oleksiak MF (2007) The biological importance of measuring individual variation. *The Journal of Experimental Biology*, **210**, 1613–1621.
- Dall SRX, Bell AM, Bolnick DI, Ratnieks FLW (2012) An evolutionary ecology of individual differences. *Ecology Letters*, **15**, 1189–1198.
- Davey JW, Blaxter ML (2010) RADSeq: next-generation population genetics. *Briefings in Functional Genomics*, **9**, 416–423.
- Davidson W (2012) Adaptation genomics: next generation sequencing reveals a shared haplotype for rapid early development in geographically and genetically distant populations of rainbow trout. *Molecular Ecology*, **21**, 219–222.
- Diz AP, Skibinski DOF (2007) Evolution of 2-DE protein patterns in a mussel hybrid zone. *Proteomics*, **7**, 2111–2120.
- Diz AP, Martínez-Fernández M, Rolán-Alvarez E (2012) Proteomics in evolutionary ecology: linking the genotype with the phenotype. *Molecular Ecology*, **21**, 1060–1080.
- Domon B, Aebersold R (2010) Options and considerations when selecting a quantitative proteomics strategy. *Nature Biotechnology*, **28**, 710–721.
- Dray S, Dufour AB (2007) The ade4 Package: implementing the Duality Diagram for Ecologists. *Journal of Statistical Software*, **22**, 1–18.
- Dupas S, Poirié M, Frey F, Carton Y (2013) Is parasitoid virulence against multiple hosts adaptive or constrained by phylogeny? A study of *Lepidopilina* spp./*Drosophila* interactions. *Annales de la Société Entomologique de France*, **49**, 222–231.
- Fay JC, Wittkopp PJ (2008) Evaluating the role of natural selection in the evolution of gene regulation. *Heredity*, **100**, 191–199.
- Feder ME, Walser J-C (2005) The biological limitations of transcriptomics in elucidating stress and stress responses. *Journal of Evolutionary Biology*, **18**, 901–910.
- Gonzalez EG, Krey G, Espiñeira M *et al.* (2010) Population proteomics of the European Hake (*Merluccius merluccius*). *Journal of Proteome Research*, **9**, 6392–6404.
- Green-Church KB, Nichols KK, Kleinholz NM, Zhang L, Nichols JJ (2008) Investigation of the human tear film proteome using multiple proteomic approaches. *Molecular Vision*, **14**, 456–470.
- Guimaraes JC, Rocha M, Arkin AP (2014) Transcript level and sequence determinants of protein abundance and noise in *Escherichia coli*. *Nucleic Acids Research*, **42**, 4791–4799.
- Hodgins-Davis A, Townsend JP (2009) Evolving gene expression: from G to E to GxE. *Trends in Ecology & Evolution*, **24**, 649–658.
- Hothorn T, Bretz F, Westfall P (2008) Simultaneous inference in general parametric models. *Biometrical Journal*, **50**, 346–363.
- Jacob AM, Turck CW (2008) Detection of post-translational modifications by fluorescent staining of two-dimensional gels. *Methods in Molecular Biology*, **446**, 21–32.
- Jensen ON (2006) Interpreting the protein language using proteomics. *Nature Reviews Molecular Cell Biology*, **7**, 391–403.
- Karam N, Guglielmino CR, Bertin S *et al.* (2008) RAPD analysis in the parasitoid wasp *Psytalia concolor* reveals Mediterranean population structure and provides SCAR markers. *Biological Control*, **47**, 22–27.
- Karl S, Toonen RJ, Grant WS, Bowen BW (2012) Common misconceptions in molecular ecology: echoes of the modern synthesis. *Molecular Ecology*, **21**, 4171–4189.
- Karr TL (2008) Application of proteomics to ecology and population biology. *Heredity*, **100**, 200–206.
- Karve TM, Cheema AK (2011) Small changes huge impact: the role of protein posttranslational modifications in cellular homeostasis and disease. *Journal of Amino Acids*, **2011**, 207691.
- Kirk H, Freeland JR (2011) Applications and Implications of Neutral versus Non-neutral Markers in Molecular Ecology. *International Journal of Molecular Sciences*, **12**, 3966–3988.
- Krishnan HB, Jang S, Baxter I, Wiebold WJ (2012) Growing location has a pronounced effect on the accumulation of cancer chemopreventive agent Bowman-Birk inhibitor in soybean seeds. *Crop Science*, **52**, 1786.
- Laurent JM, Vogel C, Kwon T *et al.* (2010) Protein abundances are more conserved than mRNA abundances across diverse taxa. *Proteomics*, **10**, 4209–4212.
- Li K-M, Ren L-Y, Zhang Y-J, Wu K-M, Guo Y-Y (2012) Knockdown of microplitis mediator odorant receptor involved in the sensitive detection of two chemicals. *Journal of Chemical Ecology*, **38**, 287–294.
- López JL (2005) Role of proteomics in taxonomy: the *Mytilus* complex as a model of study. *Journal of Chromatography. B*, **815**, 261–274.
- López J, Mosquera E, Fuentes J *et al.* (2001) Two-dimensional gel electrophoresis of *Mytilus galloprovincialis*: differences in protein expression between intertidal and cultured mussels. *Marine Ecology Progress Series*, **224**, 149–156.
- Maier T, Güell M, Serrano L (2009) Correlation of mRNA and protein in complex biological samples. *FEBS Letters*, **583**, 3966–3973.
- Mathé-Hubert H, Gatti J-L, Poirié M, Malausa T (2013) A PCR-based method for estimating parasitism rates in the olive fly parasitoids *Psytalia concolor* and *P. lounsburyi* (Hymenoptera: Braconidae). *Biological Control*, **67**, 44–50.
- Melzer D, Perry JRB, Hernandez D *et al.* (2008) A genome-wide association study identifies protein quantitative trait loci (pQTLs). *PLoS Genetics*, **4**, e1000072.
- Morrissey JH (1981) Silver stain for proteins in polyacrylamide gels: a modified procedure with enhanced uniform sensitivity. *Analytical Biochemistry*, **117**, 307–310.
- Mosquera E, López JL, Alvarez G (2003) Genetic variability of the marine mussel *Mytilus galloprovincialis* assessed using two-dimensional electrophoresis. *Heredity*, **90**, 432–442.
- Navas A, Albar JP (2004) Application of proteomics in phylogenetic and evolutionary studies. *Proteomics*, **4**, 299–302.
- Núñez V, Cid P, Sanz L *et al.* (2009) Snake venomomics and antivenomics of *Bothrops atrox* venoms from Colombia and the Amazon regions of Brazil, Perú and Ecuador suggest the occurrence of geographic variation of venom phenotype by a trend towards paedomorphism. *Journal of Proteomics*, **73**, 57–78.



- Papakostas S, Vasemägi A, Vähä J-P *et al.* (2012) A proteomics approach reveals divergent molecular responses to salinity in populations of European whitefish (*Coregonus lavaretus*). *Molecular Ecology*, **21**, 3516–3530.
- Poirié M, Carton Y, Dubuffet A (2009) Virulence strategies in parasitoid Hymenoptera as an example of adaptive diversity. *Comptes Rendus Biologies*, **332**, 311–320.
- Ramm S, McDonald L, Hurst JL, Beynon RJ, Stockley P (2009) Comparative proteomics reveals evidence for evolutionary diversification of rodent seminal fluid and its functional significance in sperm competition. *Molecular Biology and Evolution*, **26**, 189–198.
- Rees BB, Andacht T, Skripnikova E, Crawford DL (2011) Population proteomics: quantitative variation within and among populations in cardiac protein expression. *Molecular Biology and Evolution*, **28**, 1271–1279.
- Reusch TBH, Wood TE (2007) Molecular ecology of global change. *Molecular Ecology*, **16**, 3973–3992.
- Sanz L, Escolano J, Ferretti M *et al.* (2008) The South and Central American Bushmasters. Comparison of the toxin composition of *Lachesis muta* gathered from proteomic versus transcriptomic analysis. *Journal of Proteomics*, **71**, 46–60.
- Schrimpf SP, Weiss M, Reiter L *et al.* (2009) Comparative functional analysis of the *Caenorhabditis elegans* and *Drosophila melanogaster* proteomes. *PLoS Biology*, **7**, e48.
- Sickmann A, Marcus K, Schäfer H *et al.* (2001) Identification of post-translationally modified proteins in proteome studies. *Electrophoresis*, **22**, 1669–1676.
- Slattery M, Ankisetty S, Corrales J *et al.* (2012) Marine proteomics: a critical assessment of an emerging technology. *Journal of Natural Products*, **75**, 1833–1877.
- Smyth GK (2005) Limma: linear models for microarray data. In: *Bioinformatics and Computational Biology Solutions Using R and Bioconductor* (eds Gentleman R, Carey V, Huber W, Irizarry R, Dudoit S), pp. 397–420. Springer, New York, New York.
- Smyth GK, Yang YH, Speed T (2003) Statistical issues in cDNA microarray data analysis. *Methods in Molecular Biology*, **224**, 111–136.
- Stapley J, Reger J, Feulner PGD *et al.* (2010) Adaptation genomics: the next generation. *Trends in Ecology & Evolution*, **25**, 705–712.
- Valcu C-M, Kempnaers B (2014) Proteomics in behavioral ecology. *Behavioral Ecology*, **26**, 1–15.
- Venables WN, Ripley BD (2002) *Modern Applied Statistics with S*, 4th edn. Springer Verlag, New York, New York.
- Violle C, Enquist BJ, McGill BJ *et al.* (2012) The return of the variance: intraspecific variability in community ecology. *Trends in Ecology & Evolution*, **27**, 244–252.
- Zheng W, Gianoulis TA, Karczewski KJ, Zhao H, Snyder M (2011) Regulatory variation within and between species. *Annual Review of Genomics and Human Genetics*, **12**, 327–346.

---

T.M., M.P., J.-L.G., H.M.-H. and D.C. conceived and designed the method. H.M.-H. wrote R codes and performed data analysis. H.M.-H. performed the experiments. J.-L.G., T.M., M.P. and H.M.-H. wrote the manuscript.

---

## Data Accessibility

R scripts and functions and help files: see online supporting information (Appendix S1). Data sets supporting the results of this article are available in the Dryad repository <http://datadryad.org/review?doi=doi:10.5061/dryad.d1d1m>.

## Supporting Information

Additional Supporting Information may be found in the online version of this article:

**Appendix S1** R scripts and functions, with help files.

**Appendix S2** General statistical and practical advices and possible improvements of the method.

**Fig. S1** Schematic diagram of the main analysis steps.

**Fig. S2** Example of graph of a median profile and reference bands produced by the (*plot.profile*) function.

**Fig. S3** Sensitivity experiment results: saturation range and gels used to test the linearity between the 'sensitivity to staining duration' and the 'sensitivity to protein quantity'.

**Fig. S4** Sensitivity experiment results: Assessment of the power of the method to describe variation in band intensity.

**Fig. S5** Examples of the gels used in case studies and identification of band #6.

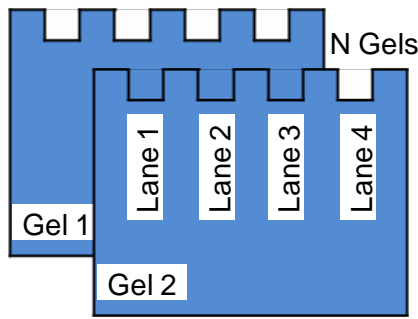
**Table S1.** Summary of the four gamma GLM fitted to the ratio of inter group/ intra group variability.

**Figure S1.**

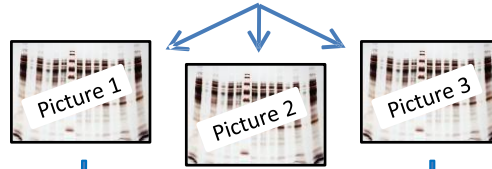
**Details of the main analysis steps**

The two first steps summarize the experimental design, the third step correspond to the pre-processing of gel pictures with the Phoretix software. The next steps were performed using the developed R functions.

Several gels



Several pictures for each gel



Several pictures by gel

For each picture: lane alignment within and between gels with Rf lines

Picture analysis

For each picture: Lane profile exportation with AND without the background



Profile analysis

For each profile (each lane and picture): Band detection and quantification (with height and volume)

For each lane:  
Picture selection

Choice of dark pictures for lanes with low amounts of material  
Choice of light pictures for lanes with high amounts of material

Data analysis:  
Normalization

Statistical normalization for the remaining heterogeneity in material amount between lanes (three normalization methods are tested)

Comparison of methods

Comparison of results :  
With or without the background  
With the height or the volume  
With each of the three normalization methods

Choice of one combination of methods

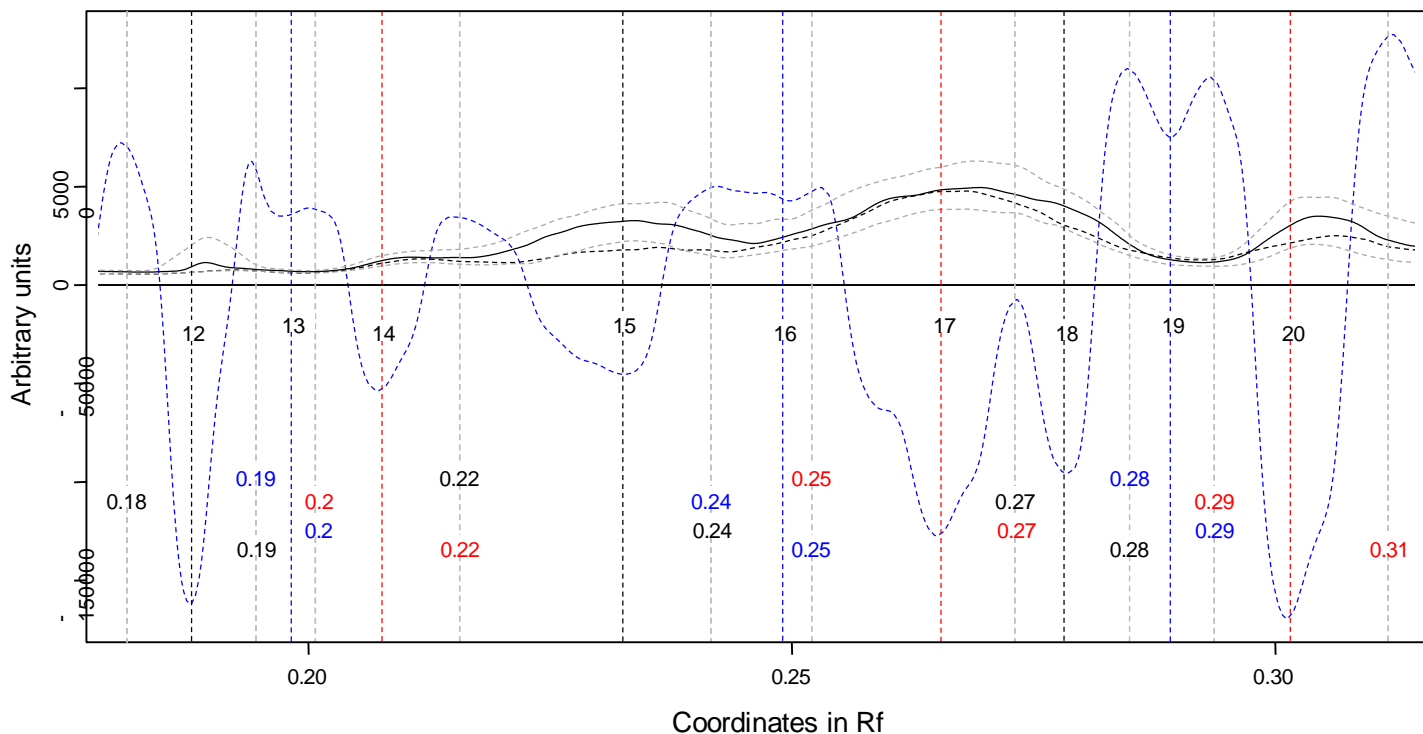
Data set

	Gel 1 Lane 1	Gel 1 Lane 2	...	Gel 2 Lane 1	Gel 2 Lane 2	...
Band1						
Band2						
...						
Band ...						

Normalised intensities

Phoretix

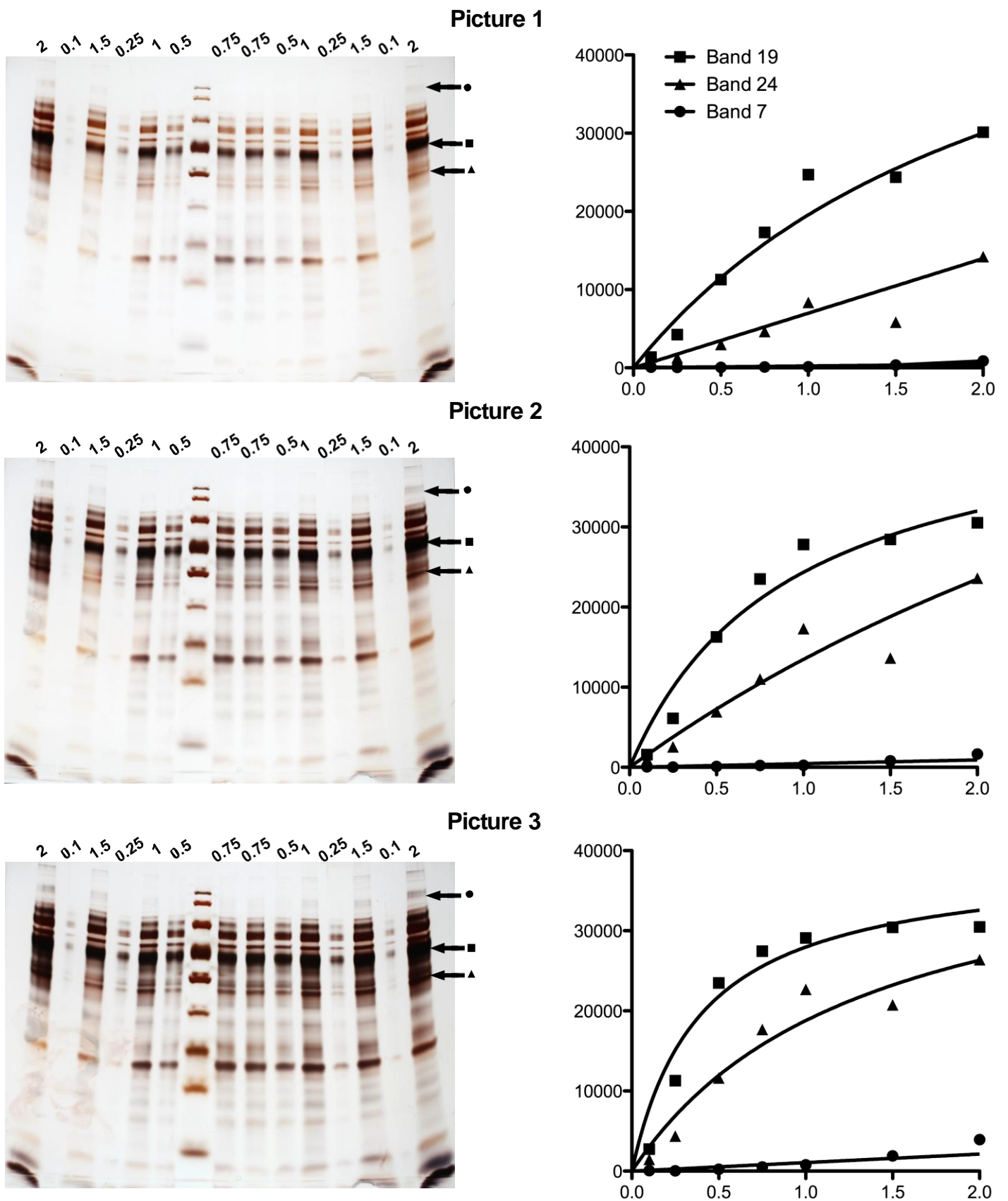
R



**Figure S2. Example of a graph produced by the *plot.profile* function**

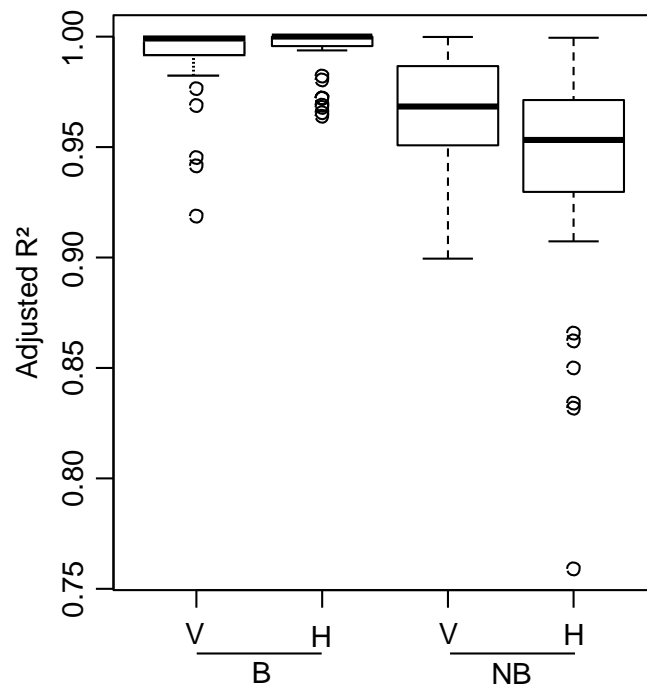
The graph shows (i) the median profile and part of its variability (ii) the second derivative that is used to detect the peaks and (iii) the automatically detected peaks. These peaks have to be edited manually, this task being performed using both the gel pictures and the graphs. Due to space constraints, only part of the whole Rf range (0 to 1) is shown. The solid and dotted black lines represent the weighted and unweighted median of intensities, respectively. Dotted grey lines are the weighted quartiles of median. The dotted blue line, the most informative, corresponds to the weighted median of the second derivatives used for the automatic detection of reference peaks. Colored vertical lines (by default, blue, red and black) are the peak positions (local minima of the weighted median of second derivatives), and grey vertical lines are the borders of the peaks (local maxima of the weighted median of second derivatives). Black numbers below the horizontal 0 line are the ID (reference number) of peaks, which allow the handling of peaks in the function *modify.peaks.manually*. Colored numbers (on grey dotted lines) indicate the Rf coordinates of the borders of peaks. The color of these numbers correspond to the color of the vertical line that indicates the position of the center of the peak to which borders coordinates refer. Colored numbers are positioned on four lines on the y axes, the two first ones corresponding to left borders, the others to right borders.

Peaks shown on the figure have been automatically detected and manual corrections have to be performed using the function *modify.peaks.manually*. For example, peak 19 may not exist at all, while supplementary peaks are likely present between peaks 14 and 15 and peaks 16 and 17 (to be confirmed on gels pictures). Band 12 is typically a rare but intense band as the weighted 0.75 quartiles of median (grey dotted line) is much higher than the weighted median (solid black line).



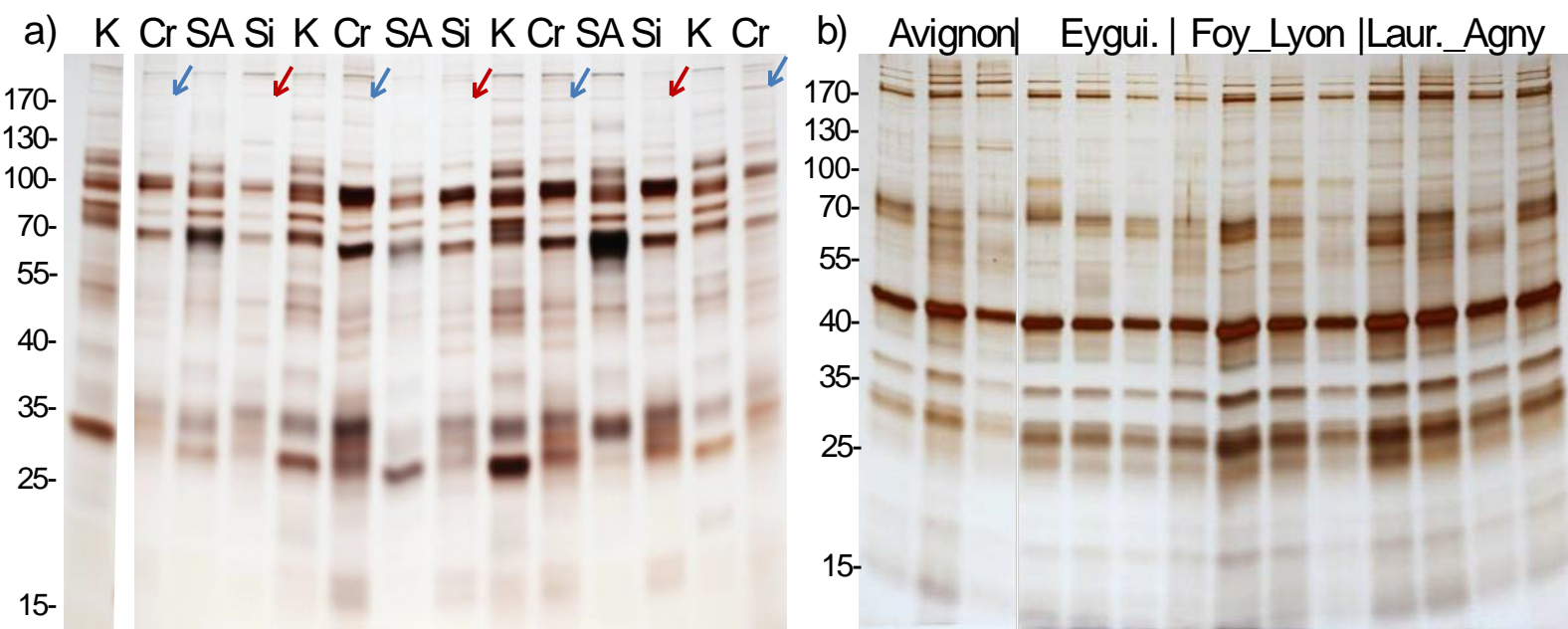
**Figure S3. Sensitivity experiment results: Saturation range**

Pictures 1, 2 and 3 correspond to the three pictures taken at different times during the gel staining procedure. Values above the pictures indicate the amount of loaded sample as individual venom gland fractions. Plots illustrate the relationship between the amount of loaded sample and the intensity of three bands (7, weak intensity - 19, high intensity - 24, medium intensity), indicated on gels by arrows.



**Figure S4. Sensitivity experiment results: Assessment of the power of the method in describing variation in band intensity.**

The boxplots represent for each reference band and each of the four parameter combinations, the adjusted- $R^2$  of models explaining the band intensity by the protein quantity, the staining duration and their interaction. “V” and “H” letters indicate respectively if the peak volume or the peak height was recorded. “B” and “NB” letters correspond to the analysis of profiles with or without the background, respectively.



**Figure S5. Examples of the gels used to test the analysis method**

a) Picture of a gel used to analyze *Psyttalia* spp. venom. Letters indicate the species and population for each individual. “K”, Kenyan *P. lounsburyi*; “SA”, South African *P. lounsburyi*; “Cr”, Cretan *P. concolor*; “Si”, Sicilian *P. concolor*. Arrows points to the *P. concolor* band #6 which variability in intensity is described Figure 4c. (blue and red arrows for Cretan and Sicilian individuals, respectively). b) Picture of a gel used to analyze *L. boulardi* venom. Molecular weight standards are in kDa.

**Table S1. Summary of the four gamma GLM fitted to the ratio of inter group / intra group variability**

Groups	Explanatory variables	Likelihood-ratio test		
		$\chi^2$	d.f.	<i>P</i> value
<i>Psytalia sp</i> ( <i>P. lounsburyi</i> , <i>P. concolor</i> )	Parameters	38.18	11	< 1.10 <sup>-3</sup>
	Ref Bands	571.67	37	< 1.10 <sup>-3</sup>
<i>P. concolor</i> (Crete, Sicily)	Parameters	39.85	11	< 1.10 <sup>-3</sup>
	Ref Bands	388.31	37	< 1.10 <sup>-3</sup>
<i>P. lounsburyi</i> (South Africa, Kenya)	Parameters	34.33	11	< 1.10 <sup>-3</sup>
	Ref Bands	713.80	37	< 1.10 <sup>-3</sup>
<i>L. boulandi</i> (Avignon, Eyguières, Ste Foy Lès Lyon, St Laurent d'Agny)	Parameters	34.26	11	< 1.10 <sup>-3</sup>
	Ref Bands	380.62	31	< 1.10 <sup>-3</sup>

Gamma GLM models are used to compare, for each case study (“Groups”), the power of the parameters combination in detecting the inter-group structure. For each model, the explained variable is the ratio between the inter group and the intra group variability.

## ***Appendix S2: General statistical and practical advices***

### ***In silico sample quantities homogenization by the use of several pictures (select.photo)***

Sample quantities can be homogenized *in silico* using pictures of different staining levels.

To this end, the function (*select.photo*) selects, for a given lane, the picture ensuring the best match between the intensity of the lane and the median<sup>1</sup> intensity of all lanes (of all gels).

It is recommended that each lane has one picture with the desired coloration level. Thus the number of pictures to analyze for a given gel will depend on the level of variability in protein quantities on the gel. It is advised to take many pictures during coloration (e.g. 10 or even more pictures), and then to choose a subset of pictures to analyze.

### ***What before and after this method?***

In terms of data analysis, the method developed is positioned between two major steps of the 1D data analysis. Upstream, it requires the preliminary conversion of gel pictures into a set of aligned intensity profiles (second step of the Fig. S1).

For some kind of profiles (e.g. gels of low complexity or variability), future improvement may come from the automation of the alignment between lanes, instead of manual setting of Rf lines (as we did with Phoretix). This might be done using the R package PTW (Parametric Time Warping; Eilers 2004) that uses aligned profiles using warping for optimizing cross-correlation between profiles. But this seems to be only efficient if the cross-correlation between profiles (once aligned) is high, or if peaks are well delimited.

Downstream, statistical analyses can be performed on the output of our procedure, which is composed of a great number of continuous variables, each corresponding to a reference band.

---

<sup>1</sup>: or other manually set value



Below, we present a list (far from exhaustive) of the statistical tools that could be useful to analyze the datasets provided by the method. These datasets are characterized by the presence of many continuous variables, and multivariate statistics are thus the most suitable for their analysis.

Generally, the first step will be to describe the main features of the dataset. To this end, methods such as PCA that allows reducing the dimensionality of datasets, or heatmaps that allow the sorting of individuals into clusters and the characterization of these clusters by clusters of bands may be useful. R packages dedicated to the analysis of ecological data are specifically suitable to this aims. The ADE4 package implements many useful multivariate tools (such as within and between PCA, instrumental PCA, and others K-tables methods), a large documentation is available on the [website](#) (Dray & Dufour 2007; Dray *et al.* 2007), and this package contains a Graphical User Interface. However, many other packages can also be successfully used (e.g.: “labdsv”, “cluster”, “pvclust”, and “vegan”; Dixon 2003; Suzuki & Shimodaira 2006; Roberts 2013; Maechler *et al.* 2014). For example, the “pvclust” package allows testing the significance of a given cluster viewed in a heatmap.

**An objective of the analysis performed with the method might be to test the effect of the variation of protein composition on a particular phenotype.** This approach requires first to test if the overall protein variability has an effect on the phenotype of interest. This can be achieved using multivariate regression, possibly with a previous reduction of dimensionality through PCAs methods. If the overall protein variability has a phenotypic effect, a next step would be to identify bands that contain proteins involved. This will be particularly difficult if bands of interest are prone to multicollinearity, a recurrent problem in studies aiming to identify such candidates. Indeed, accurate identification of the respective roles of highly correlated factors requires large sample sizes. Various statistical

methods allowing to handle multicollinearity have been compared and discussed by Dormann *et al.* (2013) and El-Dereny & Rashwan (2011).

But the level of multicollinearity can also be modulated by the choice of the combination of parameters. For instance, removal of the background (mainly linked to the problem of adjacent bands), will reduce multicollinearity. Similarly, although the volume may be more accurate than the height to quantify band intensity, it measures intensity at the borders of the band and thus is more likely to co-vary with adjacent bands. **This should be taken into account when choosing a combination of parameters.**

Another approach might be to virtually merge too highly correlated bands in the analysis and accept the uncertainty about the respective role of the proteins they contain. This approach may be particularly valuable if few bands are highly correlated since this will only increase the number of candidate proteins to investigate. Importantly, it is also expected that some bands are highly correlated for biological reasons. For example, bands containing subunits of a same protein are expected to be strongly positively correlated. An interesting and friendly discussion about multicollinearity can be found here:

<http://psychologicalstatistics.blogspot.fr/2013/11/multicollinearity-and-collinearity-in.html>.

**Another aim of such analyses might be to test if geographical or environmental factors may explain multivariate differences in the protein expression** MANOVA would be particularly suitable for such analyses but it requires multivariate normality that is sometimes impossible to obtain. The non parametric MANOVA (Anderson 2001) that is implemented by the “adonis” function of the R package “vegan” could be a good alternative. Interestingly, this approach has already been used for proteomic analysis (Zerzucha *et al.* 2012). However, caution must be taken when interpreting the results of this function (Roff *et al.* 2012b). Functions developed by Roff *et al.* (2012a) and Aguirre *et al.* (2014) might be more appropriate.

Many of these tools are available in other statistical software.

## Applicability of the method for the analysis of bands on Western-blot

Although the method can easily be used for Western-blot analysis, the normalization step must be avoided because of the very low number of bands usually analyzed. In addition, the interest of the method is that it allows a very rapid analysis of a large number of bands. It may be less useful when a low number of bands are to be analysed.

## References

- Aguirre JD, Hine E, McGuigan K, Blows MW (2014) Comparing G: multivariate analysis of genetic variation in multiple populations. *Heredity*, **112**, 21–9.
- Anderson M (2001) A new method for non- parametric multivariate analysis of variance. *Austral Ecology*, 32–46.
- Dixon P (2003) VEGAN, a package of R functions for community ecology. *Journal of Vegetation Science*, **14**, 927–930.
- Dormann CF, Elith J, Bacher S *et al.* (2013) Collinearity: a review of methods to deal with it and a simulation study evaluating their performance. *Ecography*, **36**, 27–46.
- Dray S, Dufour AB (2007) The ade4 Package: Implementing the Duality Diagram for Ecologists. *Journal Of Statistical Software*, **22**, 1–18.
- Dray S, Dufour AB, Chessel D (2007) The ade4 Package — II: Two-table and K -table Methods. *R News*, **7**, 47–52.
- Eilers PHC (2004) Parametric time warping. *Analytical Chemistry*, **76**, 404–11.
- El-Dereny M, Rashwan N (2011) Solving multicollinearity problem using ridge regression models. *International Journal of Contemporary Mathematical Science*, **6**, 585–600.
- Maechler M, Rousseeuw P, Struyf A, Hubert M, Hornik K (2014) cluster: Cluster Analysis Basics and Extensions.
- Roberts DW (2013) labdsv: Ordination and Multivariate Analysis for Ecology.
- Roff D a, Prokkola JM, Krams I, Rantala MJ (2012a) There is more than one way to skin a G matrix. *Journal of Evolutionary Biology*, **25**, 1113–1126.
- Roff DI, Wright ST, Wang Y (2012b) Distance-based multivariate analyses confound location and dispersion effects. *Methods in Ecology and Evolution*, **3**, 89–101.
- Suzuki R, Shimodaira H (2006) Pvcust: an R package for assessing the uncertainty in hierarchical clustering. *Bioinformatics (Oxford, England)*, **22**, 1540–2.
- Zerzucha P, Boguszevska D, Zagdańska B, Walczak B (2012) Non-parametric multivariate analysis of variance in the proteomic response of potato to drought stress. *Analytica Chimica Acta*, **719**, 1–7.

## ARTICLE 3

Individual venom composition discriminates  
populations of *L. boulardi* and *L. heterotoma* parasitoids  
along a climatic gradient in the Rhône Valley

Mathé-Hubert et al.

En préparation.

*Analyse de la composition du venin des populations de L. heterotoma et L. boulardi le long d'un gradient Nord – Sud dans la vallée du Rhône.*

## Présentation de l'article

La méthode d'analyse des gels mise au point dans l'article précédent a été utilisée pour (i) caractériser et comparer la structuration des populations des parasitoïdes *Leptopilina boulardi* et *L. heterotoma* dans la vallée du Rhône, en fonction de la composition du venin (ii) déterminer si il existe une structuration Nord-Sud de ces populations.

La vallée du Rhône est un modèle de choix pour étudier l'effet des changements climatiques sur les systèmes hôtes-parasitoïdes. Elle abrite une communauté d'espèces de drosophiles (dont les majeures sont *D. melanogaster*, *D. simulans* et *D. immigrans*) et deux espèces principales d'endoparasitoïdes, *L. heterotoma* et *L. boulardi* dont l'aire de distribution s'étant progressivement vers le nord. La limite nord de distribution de *L. boulardi* était il y a une dizaine d'année le 45ème parallèle cependant les changements climatiques semblent être à l'origine de sa remontée plus au Nord dans la vallée du Rhône (Delava et al., 2014). Dans ce contexte, il était intéressant d'étudier la structuration des populations des parasitoïdes *L. heterotoma* et *L. boulardi* sur un gradient Nord-Sud, dans l'axe de remontée de *L. boulardi*.

L'analyse de la composition du venin a mis en évidence une structuration des populations chez les deux espèces, même pour des populations très proches. Ceci montre pour la première fois que le venin de parasitoïde constitue un trait phénotypique permettant d'analyser les populations des parasitoïdes. L'analyse confirme également un résultat surprenant déjà observé pour d'autres traits, à savoir que la différenciation entre populations proches (dizaines de km) est du même ordre qu'entre populations éloignées (centaines de km).

Un deuxième résultat important est le niveau de différenciation beaucoup plus faible chez *L. boulardi* par rapport à *L. heterotoma* pour lequel différentes explications peuvent être proposées. Enfin, il semble exister une structuration Nord-Sud au moins pour *L. heterotoma*.

Outre les résultats obtenus dans le cas de cette étude en particulier, ma participation à ce travail m'a permis de valider l'intérêt de la méthode développée dans ma thèse pour traiter des questions d'écologie évolutive.

# Individual venom composition discriminates populations of *L. boulandi* and *L. heterotoma* parasitoids along a North-South gradient in the Rhône Valley

Mathé-Hubert H. et al.

*Dedicated to the memory of Roland Allemand*

## INTRODUCTION

The *Drosophila*-parasitoid community is one of the best studied of host-parasitoid communities. In France, this community has been extensively investigated for more than 10 years along the Rhône-Saône valley. *Drosophila melanogaster* and *D. simulans*, the main *Drosophila* species in this area, are parasitized by three larval parasitoid species: *Asobara tabida*, *Leptopilina boulandi* and *L. heterotoma*. *L. boulandi* is generally considered as a specialist of these two host species while *L. heterotoma* has been found on nine *Drosophila* species as well as the *Chymomyza* and *Scaptomyza* genus (Allemand et al. 1999, Fleury et al. 2004, 2009).

The gradient of temperature along the Rhône valley prevents the establishment of *L. boulandi*, a mediterranean species, in its North part. In the South, *L. boulandi* outcompetes the other parasitoid species (Allemand et al. 1999; Fleury et al. 2004, 2009). The community is then mainly composed of *D. simulans* and *L. boulandi* in the South of the valley and *D. melanogaster* and *L. heterotoma* in the North (Fleury et al. 2004). However, changes have occurred in the community in the last 30 years with the rapid northward progression of *L. boulandi* (90 km per decade), probably in relation with the temperature increase associated with global warming (Delava et al. 2014). The presence of this new competitor impacts the life history traits of *Asobara japonica* but not of *L. heterotoma*, possibly because of a larger overlap of its ecological niche with the niche of *A. tabida* (Vayssade et al. 2012).

*Leptopilina* parasitoids have been largely studied for life history traits [fecundity (egg load at emergence, egg size, lifetime, ovigeny index), maintenance (lipid content, metabolic rate), mobility (e.g. locomotor activity)] and features associated with parasitism success or competitiveness (Fleury *et al.* 1995; Vayssade *et al.* 2012; Vuarin *et al.* 2012), notably in the Rhône valley. For instance, in *L. heterotoma*, the same order of North-South differentiation of resource allocation in different life history traits was found as between close populations, (Vuarin *et al.* 2012), suggesting a high variability of this species over a small geographical scale. Differences in locomotor activity have also been observed by Fleury *et al.* (1995), parasitoids from South populations (Nasrallah, Tunisie; Antibes, France) being more active at the beginning and the end of the photophase (lower temperature) while populations from the North (Lyon, France; Leiden, Netherlands) were more active during the afternoon (higher temperature). In addition, their results also indicate that this differentiation has a genetic basis.

Occurrence of spatial population structuring, a prerequisite for local adaptation, has been described in *Leptopilina* parasitoids based on neutral markers (e.g.: Seyahoei *et al.* 2011). Moiroux *et al.* (2013) also evidenced local adaptation in *L. boulardi*, with significant differentiation between orchards and forest habitats. This is likely due to a difference of resource distribution (e.g. host distribution) in these environments. A similar pattern may explain the characteristics of a Congolese *L. boulardi* population which is less efficient on *D. melanogaster* compared to mediterranean populations but can successfully develop on the tropical species *D. yakuba*. A genetic analysis using two isofemale lines suggests that these differences involved two non linked loci, each needed to parasitize one of the two hosts (Dupas & Carton 1999). For *L. heterotoma*, a comparison of the Seattle (USA) and Igé (France) populations revealed local adaptation to the *D. subobscura* host, the parasitoid fecundity being higher when host and parasitoid were from the same locality (Gibert *et al.* 2010). Overall, population differentiation mostly involves local adaptation, either to host distribution (Moiroux *et al.* 2013), presence of competitors (Vayssade *et al.* 2012), or yet unidentified variables such as microclimate, microhabitats, or competition intensity (Vuarin *et al.* 2012).

Surprisingly, although the coevolutionary theory predicts that local adaptation may be particularly frequent for traits involved in host-parasitoid interaction (Dupas *et al.* 2009), occurrence of population structure based on such traits has rarely been tested. One example is the study performed by Dupas *et al.* (2003) that analyzed the large geographic variation of *D. melanogaster* resistance and *L. boulardi* virulence using reference parasitoid and host line. Host populations displayed rather similar resistance patterns while parasitoids of tropical Africa were less virulent compared to parasitoid of other areas.

One of the key component ensuring successful parasitoid development inside the host (i.e. virulence) is the venom injected with the egg at oviposition. Although never demonstrated, it is also believed that differences in venom composition of parasitoids may explain their difference in host range (e.g. Lee *et al.* 2009). Parasitoid venom is a complex fluid containing a large number of proteins. They have been characterized in a number of species, including *L. boulandi* and *L. heterotoma* (Goecks *et al.* 2013; Colinet *et al.* 2013a). Colinet *et al.* (2013a) also investigated the intraspecific variation of venom composition by comparing two *L. boulandi* strains having different virulence properties. Surprisingly, only about 50% of the abundant proteins were shared between these strains. Finally, it was also recently evidenced that venom composition vary between individuals in species of the *Leptopilina* and *Psytalia* genera (Colinet *et al.* 2013a; b). These results suggest that parasitoid venom may quickly evolve, which could at least partly explain the rapid evolution of parasitoid virulence under experimental selection (Dion *et al.* 2011; Rouchet & Vorburger 2014). Another interesting question was whether parasitoid populations might be differentiated based on venom composition.

Here, we have investigated the population structure of *L. heterotoma* and *L. boulandi* in the Rhône-Saône valley based on individual venom composition. North populations tested for *L. boulandi* (close to Lyon) were invaded by this species between 1993 and 2003 (Delava *et al.* 2014). In the North populations sampled for *L. heterotoma*, *L. boulandi* appeared between 2003 and 2011 (Delava *et al.* 2014). The analysis of venom composition was performed using a recently developed method based on 1D electrophoresis and further analysis of protein bands intensity (Mathé-Hubert *et al.*, submitted). We report for the first time parasitoid population structuring based on venom composition, a trait directly related to the outcome of host-parasitoid interactions. We also evidence that the level of venom differentiation between populations differ between *L. boulandi* and *L. heterotoma*. These results are compared to those previously obtained using different parasitoid traits in the Rhône-Saône valley and are discussed in the context of coevolution theories.



## MATERIAL AND METHODS

### *Sampling and analysed individuals*

The five populations of *L. heterotoma* were sampled in 2008 and then maintained until the beginning of 2013 when individuals were stored at  $-80^{\circ}\text{C}$ . 20 female individuals were analyzed for each population. Sampling locations were Uchizy and Montbellet for Northern populations, Sonnay and Epinouze for middle populations, and Vence as a Southern population (out of the Rhône-Saône valley). Northern and middle populations are separated by a distance of 125 km while Vence is located 400 km away from Northern populations (Fig. 1).

The four *L. boulandi* populations were sampled in 2010. Field-collected females were isolated and the offspring of each female was stored at  $-80^{\circ}\text{C}$ . One female was analyzed per offspring. Sampling locations were S<sup>te</sup> Foy Les Lyon and S<sup>t</sup> Laurent d'Agny for North populations (25 and 29 individuals analyzed) and Eyguieres and Avignon for South populations (20 and 11 individuals analyzed). Southern and Northern *L. boulandi* populations are separated by a distance of 250 km (Fig. 1).



Figure 1: Sampling locations

*L. heterotoma* (blue) and *L. boulandi* (red) sampling locations

### *Venom characterization: Sample preparation and analysis*

Venom reservoirs were dissected individually, treated as described in Mathé-Hubert *et al.* (submitted), and loaded on eight and seven 1D SDS-PAGE gels (Any-kD Mini-PROTEAN® TGXTM, Bio-Rad) for *L. heterotoma* and *L. bouleardi*, respectively. Following migration, gels were silver stained (Morrissey 1981) and photographed (digital camera EOS-5D-MkII, Canon, Japan). The resulting high-resolution pictures (5626 × 3745 pixels; 16 bit; TIFF file) were then semi-automatically analyzed with a recently developed method based on the transformation of lanes into intensity profiles by Phoretix 1D (TotalLab, UK) and analysis of these profiles by R functions (details in Mathé-Hubert *et al.*, submitted). Analysis resulted in the choice of 29 and 32 “reference bands” of identified molecular weight for *L. heterotoma* and *L. bouleardi*, respectively. The intensity of these reference bands was estimated in each lane with the following combination of parameters for *L. heterotoma* (Lh) and *L. bouleardi* (Lb), [(i) “height” for Lh and “volume” for Lb (respectively maximal intensity between borders of reference band or total intensity between borders), (ii) background removed in Phoretix-1D with a “rolling ball” of 10 000 pixels of radius for both species), (iii) cyclicloess for Lh and quantiles normalization for Lb (Bolstad *et al.* 2003; Smyth 2005)].

### *Statistical analyses*

The measured intensities of reference bands are the variables describing the venom composition that were used to test for population differentiation. *L. bouleardi* and *L. heterotoma* individuals were thus characterized for 29 and 32 variables, respectively. From these variables, we constructed two variables to characterize the venom composition:  $V_T$ , the total variance of venom composition and  $V_{T\ inter}$ , the proportion of venom variance due to inter-group differences. To handle multicollinearity, the computation of these two variables was based on the “total variance” [sum of eigenvalues i.e. the sum of the variance of each uncorrelated dimension (Kirkpatrick 2009)].

$V_{T\ inter}$ , the inter-group proportion of variance was used to estimate the level of venom differentiation between a set of groups. To compute this value, reference bands were standardized by their weighted mean intensity, with a weight chosen to give the same importance to each group, whatever its size. The mean proportion of the inter-group variance was not directly estimated by averaging this proportion over all bands because of multicollinearity. Indeed, this would have given more weight to dimensions to which many bands are correlated. We rather used the “total variance” to compute the “inter-group

proportion of total variance” (hereafter  $V_T$  and  $V_{T\ inter}$ ). The “total variance” defined for the genetic covariance by Kirkpatrick (2009) was used here for covariance between protein bands. It corresponds to the sum of eigenvalues i.e. the sum of variances of each uncorrelated dimension.  $V_T$  is thus a good measure of the variance of a dataset of continuous variables. To compute  $V_{T\ inter}$ , we used the following formula:

$$V_{T\ inter} = 1 - \frac{\overline{V_{T\ intra}}}{V_{T\ all}} .$$

Where  $\overline{V_{T\ intra}}$  is the mean of the  $V_T$  of each group and  $V_{T\ all}$  is the  $V_T$  estimated over all groups by weighting individuals to give the same weight to each group whatever its size. To compute  $V_{T\ all}$ , the weighted covariance matrix was obtained with the function “cov.wt” of the R package “stats”. These functions are available in Appendix S1.

The significance of venom differentiation (measured by  $V_{T\ inter}$ ) was tested with linear discriminant analyses (LDA) followed by randomization tests (ADE4; Dray & Dufour 2007). LDAs were also used to identify specific bands significantly correlated to LDA axes.

This procedure was used to measure and test pairwise differentiations between populations of *L. heterotoma* and between populations of *L. boulandi*. Pairwise comparisons involving the Avignon population should be interpreted with caution (values reported in grey) due to the low number of analyzed individuals (N=11).

In addition, we performed two LDAs on populations of *L. boulandi* and populations of *L. heterotoma* to analyze more thoroughly the pattern of populations differentiation. This allowed testing if different populations were discriminated by the same bands. Bands significantly discriminating populations were identified by testing their correlations to discriminant axes using a Pearson test, with a Bonferroni correction of  $p$ -values for the number of bands. In addition, to handle multicollinearity, we tested if correlations were still significant using partial correlations (after removal of the part of the variation due to the correlations between bands if at least equal to 0.5). This was performed with the function “partial.cor” of the package “Rcmdr”.

## RESULTS

### *L. heterotoma* populations are strongly differentiated for venom composition

Pairwise differentiations between the five *L. heterotoma* populations were all significant with high  $V_{T\ inter}$  values, even between close populations (0.14 between Northern populations, 0.16 between middle populations). However, the strongest differentiations were clearly observed when the South population of Vence was involved (mean  $V_{T\ inter} = 0.46$ ).

**Table 1: Pairwise differentiation between *L. heterotoma* populations**

The level of differentiation ( $V_{T\ inter}$ ) is indicated, with the  $p$ -value in brackets. In the first column and line, values in brackets are the number of analyzed individuals.

<i>L. heterotoma</i>	Uchizy (20)	Montbellet (20)	Sonnay (20)	Epinouze (20)
Montbellet (20)	0.14 ; (0.01)			
Sonnay (20)	0.19 ; ( $<10^{-3}$ )	0.17 ; ( $<10^{-3}$ )		
Epinouze (20)	0.19 ; ( $2 \cdot 10^{-3}$ )	0.23 ; ( $<10^{-3}$ )	0.16 ; ( $<10^{-3}$ )	
Vence (20)	0.49 ; ( $<10^{-3}$ )	0.53 ; ( $<10^{-3}$ )	0.41 ; ( $<10^{-3}$ )	0.41 ; ( $<10^{-3}$ )

As expected from pairwise differentiation results, LDA evidenced that the venom composition of Vence largely differed from that of populations from the Rhône Valley. Indeed, the first axis clearly discriminated this population from the others (Fig 2A.). In addition, LDA revealed that (i) this first axis did not discriminate other populations and (ii) Vence was not separated from other populations by the three other axes (Fig 2A, B). This indicates that the bands that discriminate Vence are different from the bands that discriminate the other populations. The second axis mainly discriminated the Northern and middle populations, while the third and fourth axes separated close populations from each other (respectively middle and Northern populations).

Analysis of correlation circle showed that Vence differentiation from other populations (Axis 1) involves more bands (a dozen of bands) than differentiation of other populations. Only three bands were significantly correlated to the middle – North axis (Axis 2) while six bands were significantly correlated to each of the two axes discriminating close populations. This suggests that the middle – North differentiation is of the same order as differentiation of close populations, in agreement with pairwise differentiation values (Table 1).

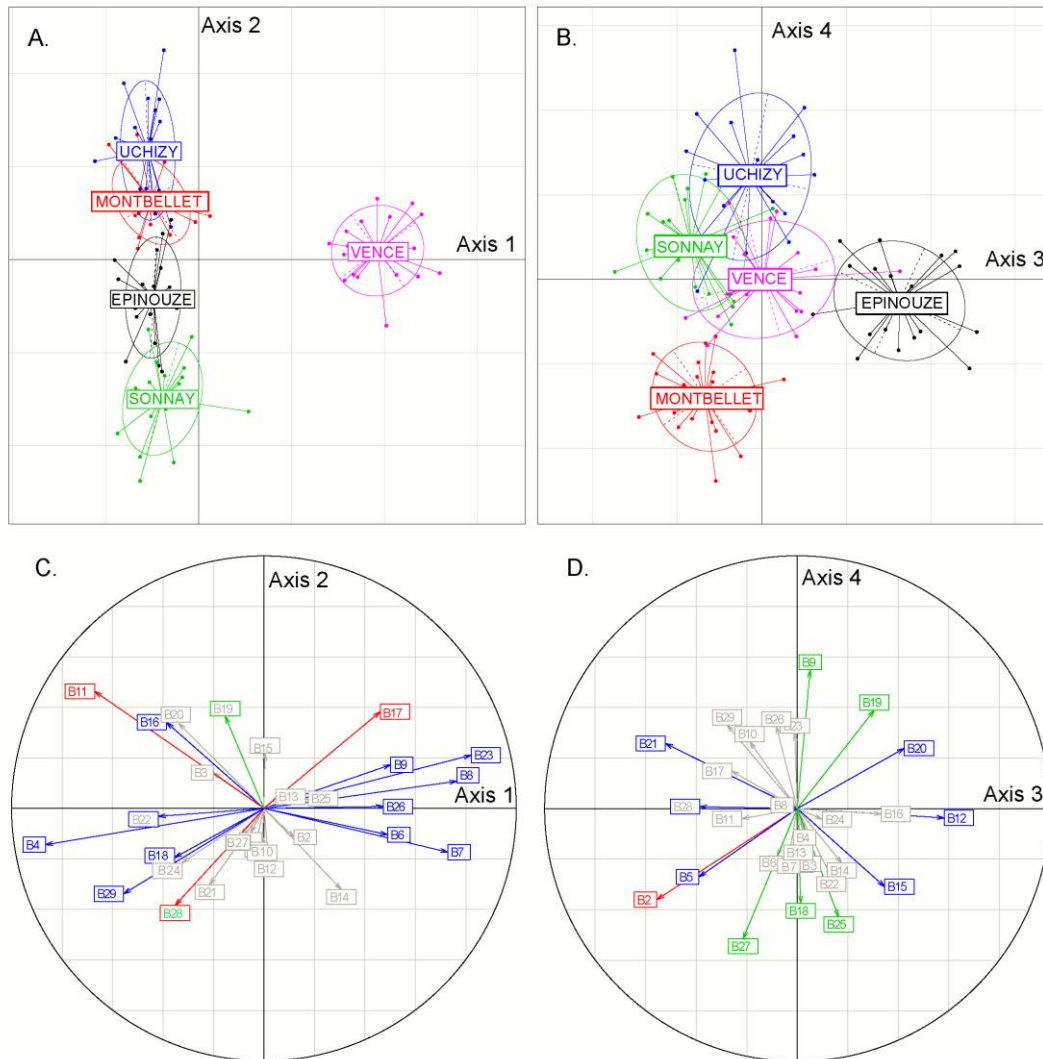


Figure 2: Linear discriminant analysis of *L. heterotoma* populations

A and B: Position of individuals (points) on discriminant axes. Individuals are grouped and colored according to their origin. C and D: correlations circles describing the correlations of bands to discriminant axes. Colors indicate the significance of the correlations. Red: correlation to the two axes; blue: correlation to the horizontal axis; green: correlation to the vertical axis; grey: no correlation to the axes. Colors of arrows and boxes indicate the significance of classical correlations, while colors of the text in boxes indicate the significance of correlations to axes after accounting for correlation between bands.

### *L. bouleardi* populations are weakly but significantly differentiated

The differentiation of *L. bouleardi* populations was clearly much lower (mean of 0.075 with Avignon and 0.056 without Avignon) than the one observed for *L. heterotoma* (Table 2). Close populations were nevertheless significantly discriminated ( $P = 0.02$  in both cases) as were Northern versus Southern populations. The non significant value obtained for the discrimination of Ste Foy Les Lyon and Avignon ( $P = 0.14$ ) is likely due to the low number of Avignon individuals available (Table 2).

**Table 2: Pairwise differentiation between *L. bouleardi* populations**

The level of differentiation ( $V_{T\ inter}$ ) is indicated, with the  $p$ -value in brackets. In the first column and line, values in brackets are the number of analyzed individuals. Grey values are less reliable values due to the low number of analyzed individuals from Avignon.

<i>L. bouleardi</i>	Ste Foy Les Lyon (25)	St Laurent d'Agny (29)	Avignon (11)
S <sup>t</sup> Laurent D'Agny (29)	0.05 ; (0.02)		
Avignon (11)	0.16 ; (0.14)	0.09 ; (7.10 <sup>-3</sup> )	
Eyguieres (20)	0.09 ; (3.10 <sup>-3</sup> )	0.03 ; (0.02)	0.03 ; (0.02)

In agreement with the low  $V_{T\ inter}$  values, LDA revealed a rather unclear pattern. Indeed, the first axis mainly separates S<sup>t</sup> Laurent d'Agny from the other populations. The second axis suggests a slight North – South differentiation. The third axis discriminate the Eyguières population from the others. Remarkably, there was only one band (B29) correlated to the first axis and one band (B3) to the third axis, suggesting that the discrimination of S<sup>t</sup> Laurent d'Agny or Eyguières versus other populations relies on a tiny difference in venom composition. In contrast, several bands were correlated to the second axis that may correspond to a North – South differentiation. This suggests that this axis is the most biologically meaningful.

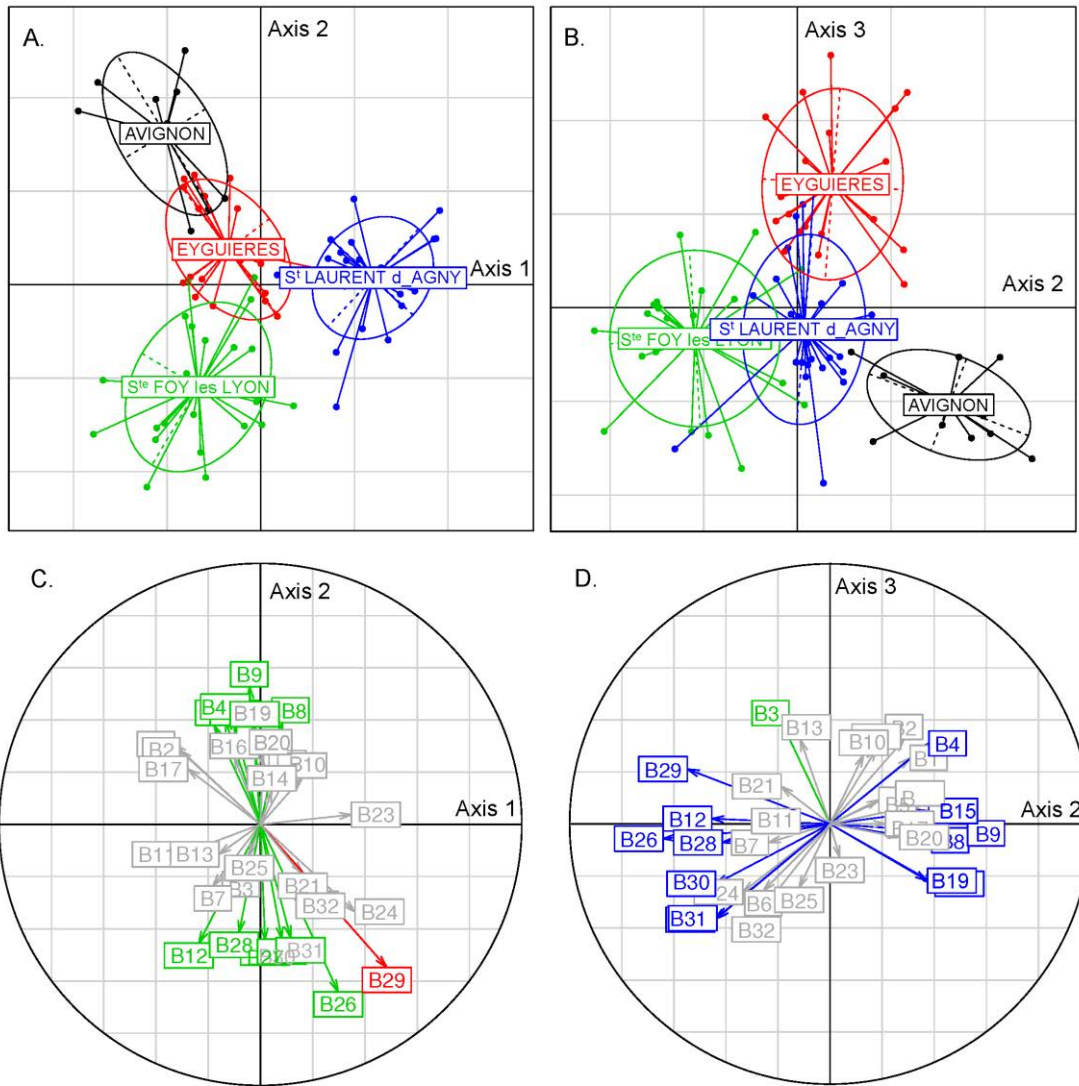


Figure 3: Linear discriminant analysis of *L. boulandi* populations

A and B: Position of individuals (points) on discriminant axes. Individuals are grouped and colored according to their origin. C and D: correlations circles describing the correlations of bands to discriminant axes. Colors indicate the significance of the correlations. Red: correlation to the two axes; blue: correlation to the horizontal axis; green: correlation to the vertical axis; grey: no correlation to the axes. Colors of arrows and boxes indicate the significance of classical correlations, while colors of the text in boxes indicate the significance of correlations to axes after accounting for correlation between bands.

## DISCUSSION

The venom is a key component of parasitoid success and its composition varies between individuals (Colinet et al., 2013). However, this trait has never been used for population biology studies, although it is expected to constrain the parasitoid capacity to succeed on locally available hosts. One explanation is probably that a rapid, accurate method to analyze quantitative variation of large sets of proteins from several individual samples was missing. We recently developed such a method and demonstrated its efficiency in discriminating parasitoid species and populations, based on their venom composition (Mathé-Hubert et al., submitted). This method was used here to analyze and compare the venom-based differentiation of five *L. heterotoma* and four *L. boulardi* samples originating from North to South populations of the Rhône-Saône valley (over a gradient of 300 km, South-East France).

A main result of the analyses is that the venom composition allowed discriminating each population from the others in both *L. heterotoma* and *L. boulardi* (except for Avignon - Ste Foy Les Lyon). This is quite surprising since some populations were very close to each other, such as Uchizy and Montbellet which are only 2.6 km apart. Venom composition thus appears as a useful trait for parasitoid population studies.

Interestingly, although a North-South differentiation was observed for both species (LDA discriminant axis), the level of pairwise differentiation between close and distant populations in the Rhône valley was rather similar. This suggests that the level of venom differentiation is weakly influenced by the geographic distance. Results of circle correlations also evidenced that venom-based discriminations of populations could rely on only a few reference protein bands (in two cases, only one band), or on several bands. This suggests that some populations may display specific venom band characteristics.

### *L. boulardi* vs. *L. heterotoma*

A much higher differentiation of venom was observed for *L. heterotoma* compared to *L. boulardi*, whatever the considered population. This difference could result from a different level of gene flow between populations. To our knowledge, no information is available on the genetic structure of *L. boulardi* populations in the Rhône valley. In contrast, previous studies in the South-East of France evidenced a low structuration of *L. heterotoma* based on neutral markers (Ris 2003). This suggests that the high differentiation of venom composition in this species is more likely explained by local adaptation, possibly in relation with hosts availability. Data indeed indicate a both spatial and seasonal variation of the presence of



*Drosophila* species in the Rhône valley (Allemand *et al.* 1999; Ris 2003). *L. heterotoma* is a generalist species whose venom may either contain “generalist” virulence factors or combinations of factors efficient on a given host. In this last case, local host availability might strongly influence venom composition. Another important trait that may induce population structuring is the infection by *Wolbachia* and induced cytoplasmic incompatibilities. Infection by this symbiont was indeed reported in *L. heterotoma* (with three different strains) but not in *L. boulandi* (Vavre *et al.* 1999). In addition, *Wolbachia* has a physiological cost in *L. heterotoma* (Fleury *et al.* 2000), and eggs laid by infected females suffer higher encapsulation rates by *Drosophila* hosts (Fytrou *et al.*, 2005). Infection by *Wolbachia* might then select for changes in venom composition.

#### *L. heterotoma*

A strong differentiation, involving a high number of bands, was observed between Vence and all other populations. Vence was included as a Southern population for this species, but it is located outside the Rhône-Saône valley and it is the most distant of all populations. The observed differentiation might then be due to a lower gene flow. Alternatively, it could correspond to the same North-South genetic differentiation evidenced by Fleury *et al.* (1995) for the preferred locomotor activity time, with a separation line passing between Lyon and Antibes. Indeed, Vence is not far from Antibes and the middle populations from the Rhône Valley are not far from Lyon. Additional sampling, notably in the South of the Rhône valley, will help determining if Vence is discriminated as a “South population” or as “an East population, outside of the valley”.

Differentiation of venom composition was also observed between the North and middle parts of the Rhône-Saône valley (Axis 2). This differentiation may correspond to a North-South differentiation but only if this is not the case for Vence (as suggested above). Indeed Axis 2 is orthogonal to Axis 1 that discriminates Vence from other populations. Alternatively, the North-middle differentiation could result from local adaptation to the competition with *L. boulandi*. Indeed, *L. boulandi*, both a specialist and a strong competitor, was absent from Northern populations in 2003 and reported in 2011. Its arrival may have induced changes in the exploitation pattern of *Drosophila* species by *L. heterotoma*, resulting in different selection pressures on venom components. Interestingly, a strong latitudinal differentiation of *L. heterotoma* was also previously reported, based on fitness traits (Fleury *et al.* 1995, Fleury *et al.* 2003). However, it might be explained either by differences in abiotic conditions (e.g. temperature), variation in the presence of the *L. boulandi* competitor or both.

### *L. bouleardi*

The repartition area of *L. bouleardi* has shifted 170 km northwards in the recent 19 years (Delava *et al.* 2014). The wave front of expanding populations is known to experience important drift because individuals that drive this expansion are sampled from individuals previously sampled (Travis *et al.* 2007; Hallatschek & Nelson 2010). When the front wave is expanding rapidly enough, drift is expected to create an important differentiation gradient from the source to the front of the wave (e.g.: Moreau *et al.* 2011). However, only a slight North-South differentiation was observed for *L. bouleardi*. In addition, this differentiation is of the same order as the differentiation of close populations. This may be the consequence of (i) a lack of venom genetic diversity in the source population (ii) stabilizing selection on venom composition that would counteract the effect of drift (iii) a slow Northward expansion of *L. bouleardi* together with substantial migration rates in the recently occupied area.

A weak but significant differentiation of venom was evidenced between the two North populations which are close to the wave front and only distant from 15 km. This suggests that there is variation in venom composition on the wave front, which makes unlikely the two first hypotheses. For the same reason, the weak North-South differentiation may not result from a balance between drift and stabilizing selection, as these two evolutionary strengths are expected to decrease the genetic diversity.

The significant differentiation between the close Northern populations also makes unlikely the hypothesis that the expansion was too slow considering the migration rate. Indeed, a high migration rate seems rather incompatible with observation of a significant differentiation. However, a metapopulation dynamics with frequent extinctions and recolonizations –due to a high migration rate– can create this kind of pattern if colonization events are associated with important founder effects, as already evidenced (Weisser 2000; Rauch & Weisser 2007; Nyabuga *et al.* 2011).

Interpretation of the observed patterns will await the seasonal sampling of more populations as well as a more thorough investigation of the observed changes in venom composition. If part of the observed variation may result from venom plasticity, the analysis of the genetically-based variation will likely uncover new host-parasitoid ecological features. The next step will then be the identification of the proteins involved in the observed population structuring based on the previous extensive analysis of venom contents of both *L. bouleardi* and *L. heterotoma*.

## Bibliography

- Allemand R, Fleury F, Lemaitre C, Boulétreau M (1999) Population dynamics and competitive interactions in two species of *Leptopilina* (Hymenoptera: Figitidae) which parasitize *Drosophila* in the Rhone valley (S-E France). *Annales De La Société Entomologique De France*, **35**, 97–103.
- Asgari S (2012) Venoms from endoparasitoids. In: *Parasitoid viruses: symbionts and pathogens*, Eds Nancy Beckage and Jean-Michel Drezen, Elsevier, pp. 217–231.
- Bolstad BM, Irizarry R, Astrand M, Speed TP (2003) A comparison of normalization methods for high density oligonucleotide array data based on variance and bias. *Bioinformatics (Oxford, England)*, **19**, 185–93.
- Colinet D, Deleury E, Anselme C *et al.* (2013a) Extensive inter- and intraspecific venom variation in closely related parasites targeting the same host: The case of *Leptopilina* parasitoids of *Drosophila*. *Insect Biochemistry and Molecular Biology*, **43**, 601–611.
- Colinet D, Mathé-Hubert H, Allemand R, Gatti JL, Poirié M (2013b) Variability of venom components in immune suppressive parasitoid wasps: from a phylogenetic to a population approach. *Journal of Insect Physiology*, **59**, 205–12.
- Delava E, Allemand R, Léger L, Fleury F, Gibert P (2014) The rapid northward shift of the range margin of a Mediterranean parasitoid insect (Hymenoptera) associated with regional climate warming (R Whittaker, Ed.). *Journal of Biogeography*, **41**, 1379–1389.
- Dion E., Zélé F., Simon J-C, Outreman Y. (2011) Rapid evolution of parasitoids when faced with the symbiont-mediated resistance of their hosts. *J Evol Biol.* **24**(4):741-50.
- Dray S, Dufour AB (2007) The ade4 Package: Implementing the Duality Diagram for Ecologists. *Journal Of Statistical Software*, **22**, 1–18.
- Dupas S, Carton Y (1999) Two non-linked genes for specific virulence of *Leptopilina bouvardi* against *Drosophila melanogaster* and *D. yakuba*. *Evolutionary Ecology*, **13**, 211–220.
- Dupas S, Dubuffet A, Carton Y, Poirié M (2009) Local, geographic and phylogenetic scales of coevolution in *Drosophila*-parasitoid interactions. In: *Advances in Parasitology*, 70, ed. Prévost G., pp. 281–95.
- Fleury F, Allemand R, Fouillet P, Boulétreau M (1995) Genetic variation in locomotor activity rhythm among populations of *Leptopilina heterotoma* (Hymenoptera: Eucoilidae), a larval parasitoid of *Drosophila* species. *Behavior Genetics*, **25**, 81–89.
- Fleury F, Vavre F, Ris N, Fouillet P, Boulétreau M (2000) A physiological cost induced by the maternally-transmitted endosymbiont *Wolbachia* in the *Drosophila* parasitoid *Leptopilina heterotoma*. *Parasitology*, **121**(05), 493-500.

- Fleury F, Ris N, Allemand R *et al.* (2004) Ecological and genetic interactions in *Drosophila*-parasitoids communities: a case study with *D. melanogaster*, *D. simulans* and their common *Leptopilina* parasitoids in south-eastern France. *Genetica*, **120**, 181–194.
- Fleury F, Gibert P, Ris N, Allemand R (2009) Ecology and life history evolution of frugivorous *Drosophila* parasitoids. In: *Advances in Parasitology*, **70**, pp. 3–44.
- Fytrou A, Schofield P, Kraaijeveld AR, Hubbard SF (2006) *Wolbachia* infection suppresses both host defence and parasitoid counter-defence. *Proceedings of the Royal Society B*, **273**(1588), 791–796.
- Gibert P, Allemand R, Henri H, Huey RB (2010) Local adaptation and evolution of parasitoid interactions in an invasive species, *Drosophila subobscura*. *Evolutionary Ecology Research*, **12**, 873–883.
- Goecks J., Mortimer NT, Mobley JA, Bowersock GJ, Taylor J, et al. (2013) Integrative approach reveals composition of endoparasitoid wasp venoms. *PLoS One* **8**, e64125 .
- Hallatschek O, Nelson DR (2010) Life at the front of an expanding population. *Evolution*, **64**, 193–206.
- Kirkpatrick M (2009) Patterns of quantitative genetic variation in multiple dimensions. *Genetica*, **136**, 271–284.
- Lee MJ, Kalamarz ME, Paddibhatla I *et al.* (2009) Virulence factors and strategies of *Leptopilina* spp.: selective responses in *Drosophila* hosts. In: *Advances in Parasitology*, **70**, pp. 123–45.
- Moiroux J, Delava E, Fleury F, van Baaren J (2013) Local adaptation of a *Drosophila* parasitoid: habitat-specific differences in thermal reaction norms. *Journal of Evolutionary Biology*, **26**, 1108–16.
- Moreau C, Bhérer C, Vézina H *et al.* (2011) Deep human genealogies reveal a selective advantage to be on an expanding wave front. *Science (New York, N.Y.)*, **334**, 1148–50.
- Morrissey JH (1981) Silver stain for proteins in polyacrylamide gels: a modified procedure with enhanced uniform sensitivity. *Analytical Biochemistry*, **117**, 307–10.
- Nyabuga FN, Loxdale HD, Heckel DG, Weisser WW (2011) Temporal genetic structuring of a specialist parasitoid, *Lysiphlebus hirticornis* Mackauer (Hymenoptera: Braconidae) attacking a specialist aphid on tansy. *Biological Journal of the Linnean Society*, **102**, 737–749.
- Rauch G, Weisser WW (2007) Local and spatial dynamics of a host–parasitoid system in a field experiment. *Basic and Applied Ecology*, **8**, 89–95.
- Ris N (2003) Hétérogénéité spatiale, plasticité phénotypique et trade-off environnementaux : Rôle de l'espèce hôte et de la température dans la différenciation génétique des populations du parasitoïde *Leptopilina heterotoma* (Hymenoptera). Thèse de doctorat, Université Claude Bernard, Lyon.

- Rouchet R, Vorburger C (2014) Experimental Evolution of Parasitoid Infectivity on Symbiont-Protected Hosts Leads To the Emergence of Genotype Specificity. *Evolution*, **66**(6): 1607-1616.
- Seyahooei MA, van Alphen JJM, Kraaijeveld K (2011) Genetic structure of *Leptopilina boulardi* populations from different climatic zones of Iran. *BMC ecology*, **11**, 4.
- Smyth GK (2005) Limma: linear models for microarray data. In: *Bioinformatics and Computational Biology Solutions Using R and Bioconductor* (ed Huber RG and VC and SD and RI and W), pp. 397–420. Springer, New York.
- Travis JMJ, Münkemüller T, Burton OJ *et al.* (2007) Deleterious mutations can surf to high densities on the wave front of an expanding population. *Molecular biology and evolution*, **24**, 2334–43.
- Vavre F, Fleury F, Lepetit D, Fouillet P, Boulétreau M (1999). Phylogenetic evidence for horizontal transmission of Wolbachia in host-parasitoid associations. *Molecular Biology and Evolution*, **16** (12), 1711-1723.
- Vayssade C, Martel V, Moiroux J *et al.* (2012) The response of life-history traits to a new species in the community: a story of *Drosophila* parasitoids from the Rhône and Saône valleys. *Biological Journal of the Linnean Society*, **107**, 153–165.
- Vuarin P, Allemand R, Moiroux J, van Baaren J, Gibert P (2012) Geographic variations of life history traits and potential trade-offs in different populations of the parasitoid *Leptopilina heterotoma*. *Naturwissenschaften*, **99**, 903–12.
- Weisser W (2000) Metapopulation dynamics in an aphid-parasitoid system. *Entomologia Experimentalis et Applicata*, **97**, 83–92.

# 2<sup>ème</sup> Partie

Potentiel évolutif du venin de parasitoïdes en lien avec la mise en élevage ou la résistance de l'hôte : approches d'évolution expérimentale.

**Article 4** : Mathé-Hubert H., Gatti J-L., Poirié M., Malausa T. (2013) A PCR-based method for estimating parasitism rates in the olive fly parasitoids *Psytalia concolor* and *P. lounsburyi* (Hymenoptera: Braconidae). *Biological control*, 67: 44-50.

**Article 5** : Mathé-Hubert H. et al. Venom composition of the parasitoid *Psytalia lounsburyi* changes in a new environment and together with allelic richness and *Wolbachia* influences the extinction dynamics. En préparation.

**Article 6** : Venomic comparison of *Psytalia lounsburyi* (Silvestri 1913) and *P. concolor*, two parasitoid wasps used in olive fly *Bactrocera oleae* biological control. En préparation.

**Article 7** : Cavigliasso F., Mathé-Hubert H. *et al.* (co-premier auteurs) Evolution of the venom of the parasitoid wasp *Leptopilina boulardi* (Hymenoptera: Figitidae) in response to resistance of the *Drosophila melanogaster* host. En préparation.

## Introduction

La première partie de la thèse a cherché à évaluer la variabilité des protéines du venin. Elle a conduit à la mise au point et au test d'une méthode facilitant l'analyse globale, individuelle, du venin. Cette méthode a permis de documenter des variations entre populations et individus dans les modèles biologiques *Psytalia* et *Leptopilina* et son utilisation pour répondre à des questions populationnelles a été validée.

Cependant, cette caractérisation n'apporte que des informations indirectes sur le potentiel d'évolution à court terme du venin. Cette seconde partie de thèse a donc consisté à réaliser des approches d'évolution expérimentale, sur les deux modèles biologiques de ma thèse, dans le but de documenter l'évolution du venin à l'échelle de quelques générations dans des conditions contrôlées.

Les expérimentations sur le modèle *Psytalia lounsburyi* ont été menées en étroite collaboration avec l'équipe RDLB (ISA-INRA PACA) responsable du programme de lutte biologique contre la mouche de l'olive en France. Préalablement à l'évolution expérimentale, un développement méthodologique a été réalisé afin de faciliter la caractérisation de l'efficacité des populations de *Psytalia* au laboratoire (Article 4). J'ai ainsi mis au point une méthode de détection par PCR des œufs de *Psytalia* dans son hôte qui permet d'évaluer rapidement et de façon fiable le succès parasitaire des populations de *P. lounsburyi* et d'autres espèces proches du genre *Psytalia*. L'évolution expérimentale réalisée sur *P. lounsburyi* (Article 5) a suivi un scénario de programme d'acclimatation, avec l'importation au laboratoire de populations exotiques du Kenya et d'Afrique du Sud (aire native de *P. lounsburyi*). Les populations expérimentales se sont donc vues confrontées à un violent changement d'environnement, associé à l'arrivée au laboratoire et à un changement d'hôte (de *Bactrocera oleae* à *Ceratitis capitata*), ce qui nous a donné l'occasion de suivre l'évolution du venin lors d'un tel changement.

Une faiblesse de l'étude du modèle *Psytalia* était le manque de connaissance dans ce genre sur la composition protéique du venin et même sur la structure de l'appareil à venin. Dans le but d'intégrer à terme les résultats de l'approche d'évolution expérimentale et de la vénomique, une caractérisation du venin de deux espèces de *Psytalia* a été menée par une approche couplée de protéomique et de transcriptomique (Article 6). Cette caractérisation a été réalisée parallèlement aux expérimentations sur matériel vivant et le croisement des

données issues des approches expérimentales avec les résultats de la caractérisation du venin sont en cours. La mise en relation entre les changements observés au niveau des bandes du venin et la fonction de la ou des protéines qu'elles contiennent n'est donc pas finalisée dans ce manuscrit de thèse.

Au contraire des expérimentations sur le modèle *Psytalia*, les expérimentations sur le modèle *Leptopilina* n'avaient pas pour but de reproduire une situation pertinente d'un point de vue appliqué. Elles ont mis à profit l'existence de souches et lignées bien caractérisées dans ce modèle et les connaissances acquises antérieurement sur la composition du venin et sa variabilité, ainsi que la caractérisation fonctionnelle de plusieurs protéines impliquées dans la virulence. L'évolution expérimentale en fonction de la résistance de l'hôte a consisté à croiser des parasitoïdes de deux lignées différant par leur virulence sur une souche hôte résistante et par la composition de leur venin. Les descendants de la première génération ont été répartis en réplicats qui ont été mis à parasiter soit sur la souche hôte résistante, soit sur la souche sensible et les générations suivantes ont été maintenues sur le même hôte. A chaque génération testée, une moitié du venin des individus a été analysé avec la méthode développée précédemment et l'autre moitié à l'aide d'anticorps dirigés contre les protéines déjà caractérisées, ce qui a permis de tester l'efficacité de la méthode. Le contenu des bandes « évoluant » a ensuite été déterminé grâce aux données disponibles.



## ARTICLE 4

A PCR-based method for estimating parasitism rates in the olive fly parasitoids *Psytalia concolor* and *P. lounsburyi* (Hymenoptera: Braconidae).

Biological Control, 2013

Mathé-Hubert H., Jean-Luc Gatti, Marylène Poirié, Thibaut Malausa

*Mise au point d'une approche PCR permettant de détecter les œufs des endoparasitoïdes *Psytalia concolor* et *P. lounsburyi* dans les larves hôtes de la mouche des fruits *Ceratitis capitata* et d'estimer ainsi les taux de parasitisme.*

## Présentation de l'article

Dans les programmes de lutte biologique utilisant des espèces du genre *Psytalia*, comme dans des expérimentations en recherche fondamentale, l'estimation des « taux de parasitisme » dans des populations ou souches de laboratoire est un travail particulièrement long et fastidieux. En prévision des expérimentations à venir et afin d'apporter un outil aux équipes de lutte biologique travaillant sur les espèces du genre *Psytalia*, j'ai donc développé une méthode pour estimer et comparer le taux de parasitisme dans cette espèce. Cette méthode utilise une réaction de PCR (« Polymerase Chain Reaction ») pour détecter la présence d'œufs et de larves du parasitoïdes dans les larves hôtes. Afin de rendre cette méthode « universelle » j'ai sélectionné un jeu d'amorces qui permet d'amplifier l'ADN de différentes populations de *Psytalia concolor* et *P. lounsburyi* ainsi que l'ADN de deux autres espèces de *Psytalia*, *P. humilis* et *P. ponerophaga*. Par ailleurs, de par la zone amplifiée, ces amorces peuvent aussi être utilisées pour des analyses de type « DNA barcoding ».

Pour *P. concolor* et *P. lounsburyi*, j'ai pu montrer une forte corrélation entre les taux de parasitisme estimés par PCR, par dissection des larves hôtes ou en comptant les parasitoïdes émergents, même si les taux de parasitisme détectés par PCR sont significativement plus élevés que ceux basés sur le comptage des émergences. Cette observation suggère l'existence d'une mortalité au cours du développement parasitaire. Par ailleurs, les taux de parasitisme détectés par PCR quelques heures après exposition au parasitisme (jour 0) sont plus élevés que ceux estimés 24 heures après exposition (jour 1), suggérant qu'il pourrait y avoir de la mortalité précoce, peut-être due à une réaction immunitaire de l'hôte. La méthode PCR développée permet donc une estimation précoce et fiable des taux de parasitisme pour différentes espèces de *Psytalia*. Elle constitue un outil diagnostique rapide pour évaluer l'efficacité d'auxiliaires potentiels de lutte biologique du genre *Psytalia* contre différents hôtes.



## A PCR-based method for estimating parasitism rates in the olive fly parasitoids *Psytalia concolor* and *P. lounsburyi* (Hymenoptera: Braconidae)



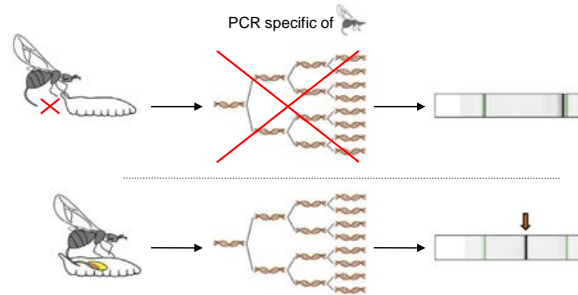
Hugo Mathé-Hubert\*, Jean-Luc Gatti, Marylène Poirié, Thibaut Malausa

Institut National de la Recherche Agronomique (INRA), UMR 1355, Sophia Antipolis, France  
 Centre National de la Recherche Scientifique (CNRS), UMR 7254, Sophia Antipolis, France  
 Université Nice Sophia Antipolis, UFR Sciences, Sophia Antipolis, France

### HIGHLIGHTS

- Biological control of *Bactrocera oleae* needs a reliable estimation of parasitoid efficiency.
- We present a specific PCR tool to compare parasitism rates of *Psytalia* species.
- The PCR method allows early and sensitive detection of *Psytalia* eggs.
- The PCR method is more reliable than traditional ones (rearing and dissection).

### GRAPHICAL ABSTRACT



### ARTICLE INFO

#### Article history:

Received 4 January 2013

Accepted 5 July 2013

Available online 15 July 2013

#### Keywords:

*Psytalia* spp.

*Ceratitis capitata*

*Bactrocera oleae*

Tephritidae

Braconidae

Cytochrome oxidase I (COI)

PCR detection kit

### ABSTRACT

Several parasitoids of the genus *Psytalia* have been repeatedly introduced as biological control agents against the principal pest of olive, the fly *Bactrocera oleae*. However, few of the parasitoids released have become established and proved effective against *B. oleae*. It may however still be possible to find effective biological control agents adapted to local environmental conditions among the highly diverse *Psytalia* species and populations infesting *B. oleae* worldwide. For this purpose, we have developed a rapid, sensitive molecular method based on the polymerase chain reaction (PCR) for estimating and comparing the parasitism success of *Psytalia* parasitoids through the detection of eggs and larvae within the host. This method was tested and shown to be appropriate for two *Psytalia* species (*Psytalia concolor* and *Psytalia lounsburyi*). The possible detection of DNA was also demonstrated for several populations of these species and for other *Psytalia* species, namely *Psytalia humilis* and *Psytalia ponerophaga*. For *P. concolor* and *P. lounsburyi*, a strong correlation was observed between the parasitism rates estimated by PCR, host larva dissection and counts of emerging parasitoids. No significant difference was found between the rates of parasitism estimated by host larva dissection and PCR, whereas the rates of parasitism estimated by PCR were significantly higher than those estimated from emergence, suggesting occurrence of mortality during the parasitoid development. This PCR method is thus highly reliable and provides an objective criterion for estimating the efficacy of biological control agent candidates from diverse taxa and populations of *Psytalia*.

© 2013 Elsevier Inc. All rights reserved.

\* Corresponding author. Address: UMR 1355 "Sophia Agrobiotech Institute" (ISA), Institut National de la Recherche Agronomique, 400 route des Chappes, Sophia Antipolis 06903, France. Fax: +33 4 92386401.

E-mail address: [Hugo.Mathe-Hubert@sophia.inra.fr](mailto:Hugo.Mathe-Hubert@sophia.inra.fr) (H. Mathé-Hubert).

## 1. Introduction

The fruit fly pest *Bactrocera oleae* (Rossi) (Diptera: Tephritidae) is considered one of the most damaging pests of olive, causing estimated losses of 5% worldwide and of up to 98% in some parts of the Mediterranean Basin (Bueno and Jones, 2002). It can rapidly colonize new areas (Zygouridis et al., 2009), and thus occurs in most places in which cultivated or wild olive trees are present. It damages olives in various ways, from oviposition stings on the surface rendering the fruit unsuitable for table consumption, to a loss of production due to fruits rotting and dropping and a decrease in the quality of the oil, which is acidified by the presence of larvae. This damage results in economic losses of approximately US\$ 800 million/year (Bueno and Jones, 2002; Nardi et al., 2005). The main methods for controlling *B. oleae* are mass trapping and insecticide treatments (Daane and Johnson, 2010). However, increasing insecticide resistance in *B. oleae* (Kakani et al., 2010; Vontas et al., 2001) and the need to decrease pesticide use has led to the repeated testing of biological control, with various degrees of success (Daane and Johnson, 2010; for review, see Daane et al., 2011). The main biological control agents used against *B. oleae* in the last 60 years have been the solitary endoparasitoids of the tephritids *Psytalia concolor*, *Psytalia humilis* and *Psytalia lounsburyi* (Braconidae: Opiinae) (Daane et al., 2011), all of which belong to the *P. concolor* species complex (Kimani-Njogu et al., 2001; Rugman-Jones et al., 2009). This complex comprises several closely related taxa, most of which are difficult to distinguish morphologically, and some can hybridize (Billah et al., 2007). A strong genetic differentiation has been observed between geographically distant populations of part of these taxa (Cheyppé-Buchmann et al., 2011; Karam et al., 2008; Rugman-Jones et al., 2009), and local adaptation of some taxa to the host or to environmental conditions may occur (Rugman-Jones et al., 2009). Thanks to this diversity, it may still be possible to find appropriate biological control agents combining high levels of successful parasitism with adaptation to local environmental conditions in the target area. However, this will require accurate estimates of parasitism rate (PR) and parasitism success (i.e. the rate of success for parasitoid development within the initially parasitized host) for the candidate parasitoid species or populations.

Molecular-based approaches have largely contributed to improve our knowledge of insect pests and biological control auxiliaries. For instance, a large part of the diversity of tephritid pests and of their parasitoids has been characterized (Jenkins et al., 2012). DNA-barcoding and microsatellite genotyping have notably provided insights on the taxonomy and population structure in the *Psytalia* genus (Cheyppé-Buchmann et al., 2011; Rugman-Jones et al., 2009). In contrast, the evaluation of PR, an important parameter for biological control, still encounters technical limitations. One easy-to-perform method, referred to hereafter as the “rearing method”, is based on the counting of parasitoid adults emerging from hosts previously exposed to parasitism. However, this method provides only an apparent PR because parasitism may end in the death of the parasitoid or of both the host and the parasitoid, making it difficult, if not impossible, to determine whether the host was initially parasitized (Garipey et al., 2005, 2007; Garipey, 2007; Greenstone, 2003, 2006; Jones et al., 2005; Ratcliffe et al., 2002). Another method for estimating PR gets around this problem by estimating the proportion of hosts containing parasitoid eggs through the dissection of host larvae (the “dissection method”). This approach is time-consuming and tedious, and it may lead to more or less severe underestimations of PR depending on whether eggs are difficult to find in the host tissue (Agustí et al., 2005). Examples of PCR-based detection of parasitoid species, whether inside the

host or inside the fruit, have been reported (Jenkins et al., 2012), and PR estimation techniques based on such detection of parasitoid eggs within the host are among the best alternatives (Garipey et al., 2007; Greenstone, 2006). They are increasingly used, as they are less time-consuming and often more reliable than the “dissection” and “rearing” methods. They are also generally more sensitive, cheaper, and they require less expertise compared to other molecular methods aimed at detecting parasitoid specific proteins, e.g. enzyme electrophoresis and serological assays using monoclonal antibodies (Stuart and Greenstone, 1997; for a complete overview, see Greenstone, 2006). We present here a PCR-based method for the detection of eggs of *Psytalia* spp. within host larvae, and demonstrate that this method accurately estimates PR from the first day of oviposition, for both *P. concolor* and *P. lounsburyi*. Successful PCR amplification suggests that it may also be appropriate for *P. humilis* and other related taxa. This method will then be useful for estimating the PR of some of the candidate biological control agents of the genus *Psytalia*, providing an objective criterion of choice for the various taxa and populations. Moreover, it could also be used for quality control on mass-reared biological control agent populations.

## 2. Materials and methods

### 2.1. Biological material

The *P. concolor* and *P. lounsburyi* populations used to estimate PRs originate from Sicily, Italy (collection in 2010) and Stellenbosch, South Africa (collection in 2005; Cheyppé-Buchmann et al., 2011), respectively. Since collection, they have been reared in the laboratory as described in Thaon et al. (2009), under controlled conditions ( $22 \pm 1$  °C; relative humidity 55%; photoperiod 16L:8D), on the alternative host *Ceratitidis capitata*. Briefly, a nutrient media (104 g of brewer's yeast, 112 g of carrot powder, 180 g of potato flakes, 1.8 g of Nipagin (Specialites Chimiques Distribution, Gellainville, France), 1.8 g of sodium Benzoate, 40 mL of hydrochloric acid at 16,5‰ and 900 mL of water) containing one week-old *C. capitata* larvae is used to coat a ping pong ball, which is then wrapped in stretched Parafilm™ (Pechiney Plastic Packaging, Chicago, US) and suspended in a cage containing 400 *Psytalia* parasitoids to allow parasitism for approximately seven hours. Parasitoid-exposed *C. capitata* larvae are then transferred to a rearing box containing the same nutrient media until parasitoid adults emerge. A more detailed version of the rearing protocol can be found in Benvenuto et al. (2012).

### 2.2. Design of PCR primers

For PCR amplification purposes, sequences from the mitochondrial cytochrome oxidase subunit I gene (COI – LCO/HCO) and from the ribosomal region between the 5.8S and 28S (including the internal transcribed spacer 2 [ITS2]) were tested. Primers were designed so as to ensure amplification of the target sequence from *Psytalia* species (*P. concolor* and *P. lounsburyi*), while avoiding amplification from the host species (*B. oleae* and *C. capitata*). The available sequences for the host and parasitoid species (six ITS2 and two COI sequences for the hosts; eight ITS2 and 34 COI sequences for the parasitoids) were recovered from GenBank (ITS2 sequences: EU761063 and EU761064, EU761048 to EU761052, AF276515, AF276516, AY209010, AF332590, AF187102, AF189691, AF307848 and DQ490237; COI sequences: EU761020 to EU761025, GU725008 to GU725031, EU761036 to EU761038, DQ116368 and GQ505009) and aligned with the Clustal W program (Larkin et al., 2007). Primers were designed with Primer 3

software (Rozen and Skaletsky, 2000). Six and four primer pairs were chosen for amplification of the COI and ITS2 sequences, respectively. Following PCR, gel electrophoresis and sequencing of some of the PCR products, we found that only two pairs of primers for ITS2 and one for COI successfully amplified the expected fragments in the various conditions tested. However, the ITS2 primers gave less reliable and sensitive results than the COI primers. We therefore retained the COI primer pair (Forward: 5'-GTTTATTAATAAATGATCAGATTATAATAG-3'; Reverse: 5'-AAAATTGCTAAATCAACTGAAG-3'), which amplifies a 307 bp fragment, for the PCR test.

### 2.3. DNA extraction and amplification

We extracted DNA from parasitized or unparasitized *C. capitata* second-instar larvae or from parasitoid adults as follows. Individual specimens were placed in each well of a 96-well plate (Fullskirt PCR Plates AB-2800, Thermo-Fisher Scientific, Brumath, France) with 20  $\mu$ L of DNA extraction solution (*prepGEM*<sup>TM</sup> Insect kit, ZYGEM, Hamilton, New Zealand). DNA extraction was then performed according to the *prepGEM*<sup>TM</sup> Insect kit protocol, with a modified enzymatic digestion procedure (2 h at 75 °C rather than 15 min). For host larvae, two steps have been added to the extraction protocol: before the enzymatic digestion, individual were crushed by adding one 2 mm-diameter glass marble per well, sealing the plates with flat-cap strips (AB-0784, Thermo-Fisher) and shaking the plates with a motorized Mixer Mills MM 301 (Retsch GmbH, Haan, Germany) until each larva was crushed. After the enzymatic digestion, the plate was centrifuged for 15 min at 2000g and 2  $\mu$ L out of the 20  $\mu$ L of supernatant were used as DNA template for PCR.

PCR was carried out with the QIAGEN Multiplex PCR Kit (Qiagen, Hilden, Germany), in a total volume of 15  $\mu$ L. The selected forward and reverse primers were each used at a final concentration of 0.4  $\mu$ M. PCR conditions were 95 °C for 15 min, 40 cycles of 94 °C for 30 s, 52 °C for 60 s and 72 °C for 60 s, and a final extension at 72 °C for 10 min. PCR-amplified fragments were analyzed with the QIAxcel Advanced System and the QIAxcel DNA Fast Analysis Kit (QIAGEN).

### 2.4. Assessment of PCR sensitivity

We assessed the sensitivity of the PCR method as follows: a pool of six *P. concolor* eggs (obtained by the dissection of parasitoid females) was submitted to the DNA extraction procedure in 80  $\mu$ L of extraction solution. Amounts of DNA equivalent to 0.7, 0.4, 0.2, and 0.1 eggs were then used independently to spike the extract of one non parasitized *C. capitata* larva in a final volume of 20  $\mu$ L. PCR was then carried out, as described above, with 1/10th of the volume of each spiked DNA extract (final amounts

of *P. concolor* eggs DNA equivalent to 0.07, 0.04, 0.02 and 0.01 eggs). The dilution and PCR steps were repeated three times.

### 2.5. Assessment of PCR specificity

The PCR specificity was first tested *in silico* by comparing the alignment of the mitochondrial COI sequences used to design the primers (EU761020 to EU761025, GU725008 to GU725031 and EU761036 to EU761038) to the COI sequences of *P. humilis*, *Psytalia phaeostigma*, *Psytalia cosyrae*, *Psytalia perproxima*, and *Psytalia ponerophaga* (respectively: EU761026 to EU761031; EU761045; EU761039 to EU761042; EU761032 to EU761035 and EU761043; EU761015 to EU761019). Unfortunately, there was no COI sequence available for *Psytalia dacicida*. We then assessed the specificity of the primers *in situ* by performing individual PCR assays on adult parasitoids from different populations and species belonging to the *Psytalia* genus. To this end, 32 *P. concolor* (Corsica, collection in 2012,  $N = 5$ ; Crete, collection in 2010,  $N = 10$ ; Sardinia, collection in 2012,  $N = 17$ ), 6 *P. lounsburyi* (Kenyan strain reared in the laboratory since 2003), 5 *P. ponerophaga* (Pakistani strain reared at the EBCL, Montpellier, France) and 8 *P. humilis* (Otavi, Namibia, collection in 2008) were used. Nine negative controls were added to test for occurrence of false positives due to DNA contamination. The identity of the amplified products was confirmed by sequencing.

### 2.6. Comparison of the three detection methods in *P. concolor* and validation on *P. lounsburyi*

We evaluated the *P. concolor* PR on *C. capitata* larvae by three methods (see introduction part): the “rearing method”, the “dissection method” and the “PCR method”. Six host groups (ping-pong balls of 5 cm diameter containing a large number of second-instar host larvae) were exposed to parasitism in a same box containing approximately 1–3 weeks-old *Psytalia* (200 males and 200 females), but with three different length of exposure: 1 h (low expected PR), 5 h (medium expected PR) and 8 h (high expected PR). Following parasitism, each host group was divided into 5 subgroups of unequal size, in which the PR was estimated by one of the three methods. Two subgroups (15–42 larvae) were used for the PCR, and two subgroups (13–38 larvae) for the dissection method, the analysis being performed either 8 h (“day 0”; first subgroup) or one day (“day 1”; second subgroup) after the beginning of exposure to *Psytalia*. The fifth subgroup, composed of all remaining larvae (several hundred) was used to estimate the apparent PR by the “rearing” method (ratio of the number of adult parasitoids to the total number of *Ceratitis* pupae estimated after the completion of development of the remaining larvae). The number of larvae used to estimate the PR by the three methods, for each group, each exposure length and each development period post-exposure is indicated in Table 1. For the PCR method, we systematically added at

**Table 1**  
Parasitism rate (PR) estimated for the various subgroups of host larvae with different PR estimation methods.

Species	Parasitism duration	Group	PCR		Dissection		Rearing
			Day 0	Day 1	Day 0	Day 1	
<i>P. concolor</i>	1 h	1	0.10 ( $N = 20$ )	0.00 ( $N = 22$ )	0.10 ( $N = 20$ )	0.11 ( $N = 18$ )	0.04 ( $N = 523$ )
		2	0.29 ( $N = 28$ )	0.14 ( $N = 22$ )	0.30 ( $N = 27$ )	0.12 ( $N = 33$ )	0.06 ( $N = 677$ )
	5 h	3	0.27 ( $N = 15$ )	0.18 ( $N = 22$ )	0.31 ( $N = 13$ )	0.25 ( $N = 20$ )	0.20 ( $N = 635$ )
		4	0.66 ( $N = 29$ )	0.66 ( $N = 15$ )	0.42 ( $N = 31$ )	0.37 ( $N = 24$ )	0.30 ( $N = 359$ )
	8 h	5	0.36 ( $N = 14$ )	0.50 ( $N = 42$ )	0.63 ( $N = 19$ )	0.71 ( $N = 24$ )	0.37 ( $N = 611$ )
		6	0.73 ( $N = 15$ )	0.33 ( $N = 21$ )	0.53 ( $N = 38$ )	0.48 ( $N = 25$ )	0.31 ( $N = 413$ )
<i>P. lounsburyi</i>	8 h		0.61 ( $N = 99$ )	0.19 ( $N = 32$ )	0.47 ( $N = 55$ )	0.35 ( $N = 20$ )	0.31 ( $N = 75$ )

Values in brackets are the number of individuals (larvae or pupae for the rearing method) used to estimate PR.

least 10 negative controls per PCR plate to check for occurrence of false positives due to DNA contamination.

For validation of the method on *P. lounsburyi*, PR was estimated by PCR and dissection at “day 0” and “day 1” on one group of *C. capitata* larvae exposed to parasitism for 8 h, as described above.

### 2.7. Statistical analysis

The three methods used to estimate PR for *P. concolor* were compared with “parasitized vs unparasitized” binary data, with a binomial GLMM (glmer function of the lme4 package; Bates et al., 2010). The method (PCR at “day 0”, PCR at “day 1”, dissection at “day 0”, dissection at “day 1”, rearing method) was considered as a fixed effect. The experimental replicate (groups subjected to the same treatment) was considered as a random effect. Post-hoc comparisons were then performed with the “multcomp” package (Hothorn et al., 2008). We also checked for overdispersion of the data with the following formula: the Pearson goodness-of-fit statistic divided by the residual degree of freedom (McCullagh and Nelder, 1989). Finally, Spearman’s rank correlation coefficients were calculated to assess the agreement between the methods. The mean PR for each length of exposure to parasitism were weighted to give the same weight to all methods and larval groups exposed to parasitism. For *P. lounsburyi*, we used the same method as for *P. concolor*, except that no random effect was considered in the model since data were collected only for one length of exposure to parasitism. We thus used a classical GLM (“glm” function of “R”), and, for the same reason, no correlation coefficient was calculated.

## 3. Results

### 3.1. Development and validation of the PCR method

To develop a PCR method suitable for estimating the parasitism rate in *Psytalia* species, we designed primers predicted to amplify either part of the COI or the ITS2 sequence in *P. concolor* and *P. lounsburyi* but not in the hosts *B. oleae* and *C. capitata*. As results with ITS2 primers proved less reliable and sensitive, we focused on the use of COI primers for validation of the parasitoid egg detection method in *P. concolor* and *P. lounsburyi*. COI amplification was specific to *Psytalia* DNA, as demonstrated by the production of a single

307 bp fragment when *P. concolor* or *P. lounsburyi* DNA was present in the PCR solution, versus the absence of PCR products when only DNA from *B. oleae* or *C. capitata* was present (Fig. 1A). The PCR method described also proved highly sensitive since it detected an amount of *Psytalia* egg DNA as low as that of 1/100 of an individual egg (Fig. 1B). This ensures that eggs could be detected in parasitized samples even if the extraction of parasitoid DNA was of low efficiency.

### 3.2. Comparison of the three detection methods in *P. concolor*

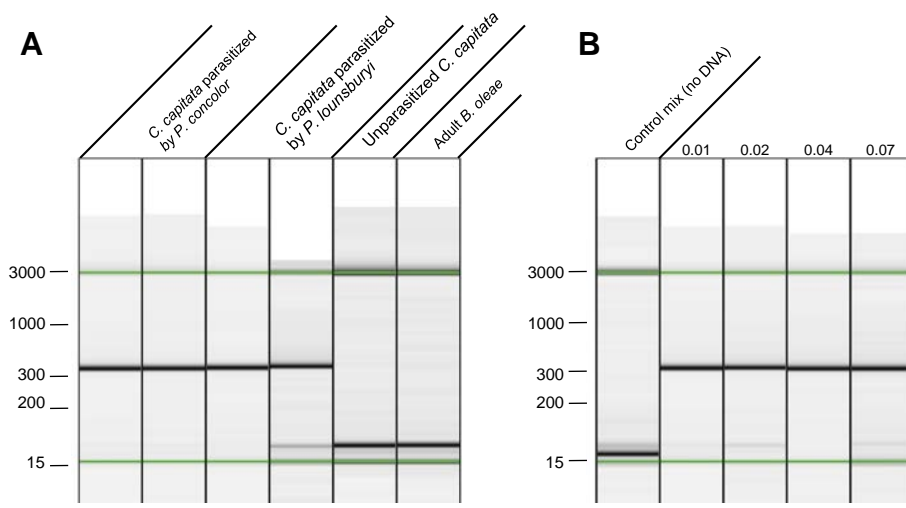
For *P. concolor*, the mean PR obtained with the various methods increased with the length of exposure to parasitism: 12% ± 9.7 after 1 h, 36% ± 17.4 after 5 h, and 52% ± 15 after 8 h (values calculated from raw data in Table 1 weighted to give the same weight to all methods and larval groups; mean PR ± standard deviation).

This made it possible to assess the covariation of the methods (using data from PCR and dissection at times “day 0” and “day 1”, and from the rearing method) with different PR values. Estimates obtained with the different methods at different times were roughly similar with some notable exceptions; the PR estimates obtained by PCR and dissection were not significantly different ( $P = 0.57$  at “day 0”;  $P = 0.84$  at “day 1”), but those obtained with the rearing method were highly significantly lower than those obtained with the two other methods at “day 0” ( $P < 0.001$  with dissection;  $P < 0.001$  with PCR) and significantly lower than those obtained by dissection at “day 1” ( $P = 0.02$  with dissection,  $P = 0.32$  for PCR; see Fig. 2). With the PCR method, estimated PR was higher at “day 0” than at “day 1” ( $P = 0.015$ ; Fig. 2) while the trend toward higher PR values at day 0 than at day 1 was not significant for the dissection method ( $P = 0.93$ ; Fig. 2).

High Spearman’s correlation coefficients were obtained between PR estimates obtained by the PCR and dissection methods ( $r = 0.77$ ,  $P = 0.10$  at “day 0”;  $r = 0.83$ ,  $P = 0.058$  at “day 1” and  $r = 0.81$ ,  $P < 0.001$  for estimates based on pooled “day 0” and “day 1”).

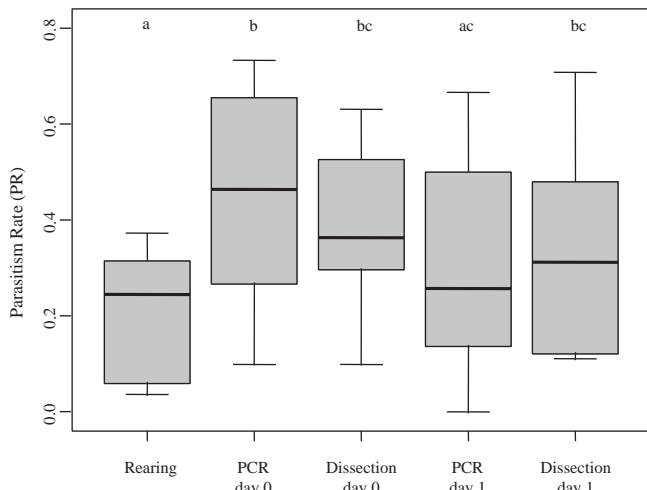
### 3.3. Validation on *P. lounsburyi*

All the trends observed with *P. concolor* were also observed with *P. lounsburyi*. The mean PR estimate with the various methods was 38% ± 16 (as for *P. concolor*, the mean was weighted so as to give



**Fig. 1.** PCR results, as generated with the Qiaxcel Advanced System. Each lane shows the electrophoresis result for a single sample. Fig. 1A illustrates specificity of the primers for *Psytalia* species. Fig. 1B shows the high sensitivity of the PCR method (the lanes correspond to one of the three replicates from the sensitivity experiment). The values indicated above the lanes are the number of eggs used to spike the DNA. Fragment size estimates were obtained with the Qiagen 15 bp–3 kb alignment marker (Cat no: 929522), corresponding to the bands under the green lines. They are displayed in bp on the left. (For interpretation of the references to colour in this figure legend, the reader is referred to the web version of this article.)

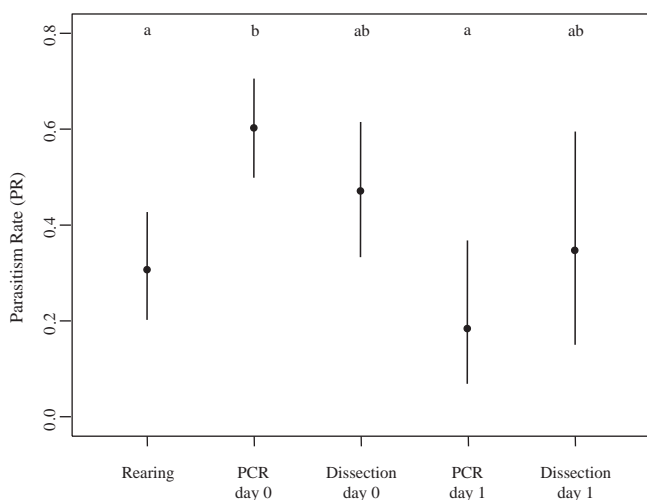




**Fig. 2.** Observed parasitism rates for *P. concolor* estimated by the different methods. Methods are the rearing method, PCR at “day 0”, dissection at “day 0”, PCR at “day 1”, dissection at “day 1”. The box plots represent the PR estimates obtained for the various groups of larvae exposed to *P. concolor* oviposition for different periods of time. The letters indicate the level of significance for multiple comparison tests.

the same weight to each method). The PR estimates obtained by PCR and dissection were not significantly different ( $P = 0.49$  with the group “day 0”;  $P = 0.68$  with the group “day 1”) while the estimates obtained with the “rearing” method and with the PCR method at “day 1” were significantly lower than those obtained by the PCR method at “day 0” ( $P < 0.001$  in both cases). Thus, as for *P. concolor*, PCR yielded a higher estimate of PR at “day 0” than at “day 1”. With the dissection method, a similar trend was observed but the PR estimated at “day 0” was not significantly higher than that estimated at “day 1” ( $P = 0.87$ ; Fig. 3).

Among the nine PCR plates used to measure PR by *P. concolor* and *P. lounsburyi*, only one of the 93 negative controls provide a positive result. We nevertheless decided to retain the corresponding plate for the analysis since the contamination rate (10% for the plate, 1.08% over all plates) remained low and did not affect the overall results.



**Fig. 3.** Observed parasitism rates for *P. lounsburyi* estimated by the different methods. Methods are the rearing method, PCR at “day 0”, dissection at “day 0”, PCR at “day 1”, dissection at “day 1”. Dots indicate the PR estimated for the group of larvae exposed to *P. lounsburyi* oviposition for 8 h. Error bars indicate the 95% confidence interval. Letters indicate the level of significance in multiple comparison tests.

### 3.4. Assessment of PCR specificity

*In silico* analyses revealed that the COI primers we designed were exactly matching to *P. lounsburyi*, *P. concolor* and *P. humilis* sequences only. Differences at one or two positions were observed for each primer when compared to the sequences of *P. phaeostigma*, *P. cosyrae* or *P. ponerophaga*. For *P. perproxima*, only the reverse primer differed at two positions.

PCR amplification assays were then performed on individuals from three populations of *P. concolor* ( $N = 32$  in total) and one population of *P. lounsburyi* ( $N = 6$ ) other than those used to develop the parasitism-detection method, as well as on individuals from one population of the species *P. humilis* ( $N = 8$ ) and *P. ponerophaga* ( $N = 5$ ). Successful amplifications were obtained for all tested *Psytalia* individuals (data not shown).

## 4. Discussion

### 4.1. PCR is an effective method for estimating early PR

We have developed a reliable and sensitive method for the early detection of parasitism by *P. concolor* and *P. lounsburyi*. This method was able to detect parasitoid DNA down to levels corresponding to 1/100 of an egg, and the PR estimated by PCR was not significantly different from that obtained by the dissection of host larvae. Furthermore, the correlation between PR estimates by PCR and dissection was highly significant regardless of the time at which PR was estimated (8 or 24 h post-parasitism). This confirms the value of molecular methods for such applications (Agustí et al., 2005; Garipey et al., 2007; Greenstone, 2006). Moreover, this PCR method can be used to detect eggs at very early stages of parasitoid development, which should provide a better estimate of PR because of the occurrence of parasitoid mortality (Garipey, 2007; Garipey et al., 2005; Jones et al., 2005; Ratcliffe et al., 2002; for reviews, see: Garipey et al., 2007; Greenstone 2003, 2006). Indeed, we observed that PR estimates at early stages of parasitoid development (via PCR or dissection) were higher than those obtained after the completion of host and parasitoid development (rearing method). The comparison of mean PRs estimated just after oviposition and at the end of the development (rearing method) suggests mortality rates of about 46% and 43% for *P. concolor* and *P. lounsburyi*, respectively. These high values are nevertheless within the range of those usually reported in other parasitoid species (Garipey, 2007; Garipey et al., 2005; Jones et al., 2005; Ratcliffe et al., 2002). Interestingly, PR estimates by PCR just after oviposition were also higher than those obtained 24 h later, an observation that is in agreement with the much higher difference between the apparent PR (rearing method) and the PCR-based estimates at “day 0”, compared to “day 1”. This suggests that *Psytalia* parasitoids death mainly occurs during the first 24 h after oviposition, and that the PCR method is sensitive enough not to be significantly influenced by the egg development. The small size of the recently-laid egg is indeed generally thought to result in the underestimation of PCR-based PR at early stages of development (Garipey, 2007; Garipey et al., 2005; Jones et al., 2005; Weathersbee et al., 2004). The parasitoid death in the first 24 h may be explained by the oviposition of non viable eggs and/or by the host immune reaction. We never observed encapsulated eggs in *C. capitata* but for instance in *Drosophila paramelanica*, dead endoparasitoid eggs can be observed as early as 6–12 h post-infection in absence of any encapsulation reaction (Carton et al., 2009). If the difference between PR estimates at the two time points can indeed be explained by egg mortality, it should be observed whatever the method used (PCR or dissection) while significant differences occurred only with the PCR method. However, this may result from the difficulty in finding eggs by dissection a

few hours after oviposition while the PCR method may be sensitive enough to detect even traces of DNA from eggs in the process of degradation.

#### 4.2. Applications of the developed PCR method

PCR detection methods are often designed for field studies, for instance, the monitoring of a released biological control agent (e.g. Jenkins et al., 2012). To this end, PCR primers are generally highly specific to one particular parasitoid species or population (the parasitoid to be monitored). Our aim here was to develop a unique tool for the comparison of several populations and species within the *Psytalia* genus. We thus designed primers from a region that tends to be more conserved than other regions at the genus level. PCR assays demonstrated successful amplification of the target sequence from the four *P. concolor* and the two *P. lounsburyi* populations tested, as well as from the *P. humilis* and *P. ponerophaga* species. *In silico* assays suggest that this PCR method can also be used with *P. phaeostigma*, *P. cosyrae* and *P. perproxima* and may possibly be appropriate for several other parasitoid species of the *Psytalia* genus. Indeed, the number of differences between the primers sequence and the target sequence is not higher for *P. phaeostigma*, *P. cosyrae* and *P. perproxima* than for *P. ponerophaga*.

Comparing the PR of different species through PCR with a single pair of primers should make comparisons more reliable when evaluating several candidate biological control agents. However, this lack of specificity may lead to a misinterpretation of results in field studies if not combined with an accurate taxonomic characterization of sampled individuals. If necessary, this PCR method may be followed by a RFLP or sequencing analysis. Indeed, complementary analyses are easy to perform here because the amplified fragment is part of the COI region used for DNA barcoding (LCO/HCO).

The PCR method, combined with the rearing method, will also allow comparison of the parasitism success in different populations and closely related taxa. Parasitism can lead to three alternatives outcomes (i) the death of both the host and the parasitoid, (ii) the host recovery and (iii) the emergence of the parasitoid, which probability can be estimated from parallel estimations of early PR by PCR and apparent PR (rearing method). Indeed, the parasitism success can be calculated as the ratio of the apparent PR to the PR at day 0 while a “host basal mortality rate” can be estimated using the rearing method on a group of unparasitized hosts of known size. The comparison of this “basal mortality rate” with the observed mortality rate of a group of hosts of known PR allows to calculate the “mortality rate of parasitized larvae”. Finally, the comparison of the “parasitism success rate” and the “mortality rate of parasitized larvae” allows to deduce the rate of host recovery.

Detailed comparisons of parasitism success would be relevant in many biological control programs. Indeed, geographic variations of the outcome of host-parasitoid interactions are frequently observed. A biological control agent that is effective in one area may then be maladapted in another, which could be detected by a parasitism success analysis. This analysis would also be useful for the quality control of laboratory strains. Indeed, laboratory conditions (e.g. the use of a non natural host or an artificial diet) may lead to the evolution of unwanted features (Chailleux et al., 2012; Hoffmann et al., 2001; Hopper and Roush, 1993; Hufbauer, 2002; Tayeh et al., 2012). Parasitism success and PR may not necessarily provide the same information since they do not respond similarly to environmental conditions. For example, PR is thought to be strongly influenced by behavioural factors and, thus, highly changeable, whereas parasitism success is thought to be more strongly influenced by physiological factors and then less affected by environmental variation (Canale and Benelli, 2011).

## 5. Conclusion

In conclusion, we describe here a rapid and accurate method for detecting early parasitism by *P. lounsburyi* and *P. concolor* based on the use of a single protocol. This should make it possible to assess the variability in parasitism success at the intra- and interspecific levels, and thus to guide the choice of candidate biological control agents from the genus *Psytalia* in programs for the biological control of the olive fruit fly.

## Acknowledgments

We thank Marcel Thaon, Nicolas Ris and Fabrice Pustoc'h for maintaining the populations of *Ceratitis* flies and *Psytalia* parasitoids, and for their help in the design of the PCR experiment, as well as Dominique Colinet for fruitful discussions and Marie Claude Bon from EBCL (Montpellier, France) for great help in supplying *Psytalia* samples. We also thank the three anonymous reviewers for their comments that largely helped improving the manuscript. This work was funded by the French “Bibliothèque du Vivant” project and the INRA Department “Santé des Plantes et Environnement”. H. Mathé-Hubert is supported by a Ph.D. funding from the “Provence Alpes Côte d'Azur” (PACA) French region and the INRA “Santé des Plantes et Environnement” Department.

## References

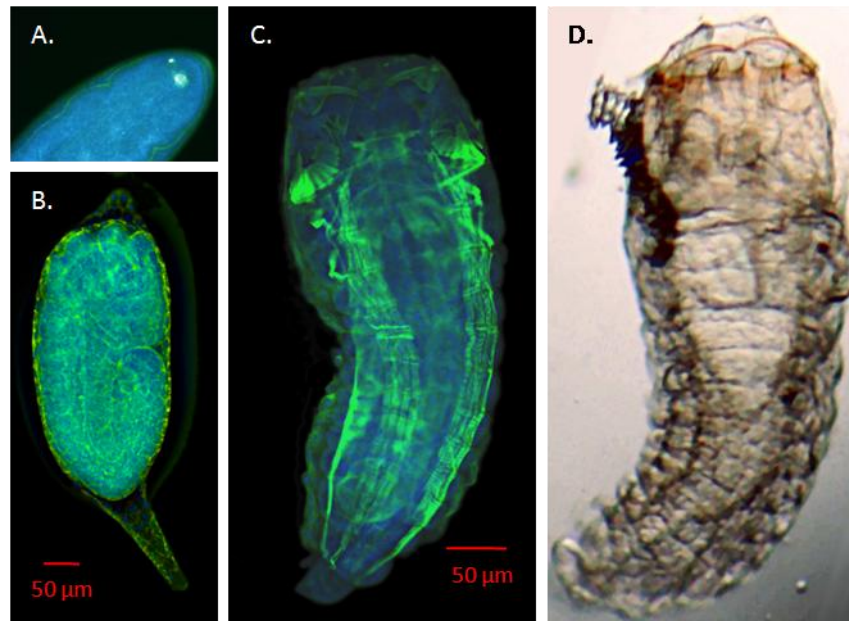
- Agustí, N., Bourguet, D., Spataro, T., Delos, M., Eychenne, N., Folcher, L., Arditi, R., 2005. Detection, identification and geographical distribution of European corn borer larval parasitoids using molecular markers. *Mol. Ecol.* 14, 3267–3274.
- Bates, D., Maechler, M., Bolker, B., 2010. lme4: Linear mixed-effects models using Eigen and S4 classes. R package version 0.999375-39.
- Benvenuto, C., Cheyenne-Buchmann, S., Bermond, G., Ris, N., Fauvergue, X., 2012. Intraspecific hybridization, life history strategies and potential invasion success in a parasitoid wasp. *Evol. Ecol.* 26, 1311–1329.
- Billah, M.K., Kimani-Njogu, S.W., Wharton, R.A., Overholt, W.A., Wilson, D.D., Cobblah, M.A., 2007. Cross mating studies among five fruit fly parasitoid populations: potential biological control implications for tephritid pests. *BioControl* 53, 709–724.
- Bueno, A.M., Jones, O., 2002. Alternative methods for controlling the olive fly, *Bactrocera oleae*, involving semiochemicals. *IOBC WPRS Bull.* 25, 147–156.
- Canale, A., Benelli, G., 2011. Impact of mass-rearing on the host seeking behaviour and parasitism by the fruit fly parasitoid *Psytalia concolor* (Szépligeti) (Hymenoptera: Braconidae). *J. Pest Sci.* 85, 65–74.
- Carton, Y., Frey, F., Nappi, A.J., 2009. Parasite-induced changes in nitric oxide levels in *Drosophila paramelanica*. *J. Parasitol.* 5, 1134–1141.
- Chailleux, A., Desneux, N., Seguret, J., Do Thi Khanh, H., Maignet, P., Tabone, E., 2012. Assessing European Egg Parasitoids as a Mean of Controlling the Invasive South American Tomato Pinworm *Tuta absoluta*. *PLoS One* 7, 1–8.
- Cheyenne-Buchmann, S., Bon, M.-C., Warot, S., Jones, W., Malausa, T., Fauvergue, X., Ris, N., 2011. Molecular characterization of *Psytalia lounsburyi*, a candidate biocontrol agent of the olive fruit fly, and its *Wolbachia* symbionts as a pre-requisite for future intraspecific hybridization. *Biocontrol* 56, 713–724.
- Daane, K.M., Johnson, M., Pickett, C., Sime, K., Wang, X.G., Nadel, H., Andrews, J.W., Hoelmer, K., 2011. Biological controls investigated to aid management of olive fruit fly in California. *Calif. Agric.* 65, 21–28.
- Daane, K.M., Johnson, M.W., 2010. Olive fruit fly: managing an ancient pest in modern times. *Annu. Rev. Entomol.* 55, 151–169.
- Garipey, T.D., 2007. Molecular Markers for *Lygus* Parasitoids to Assess Host Specificity of Candidate Entomophagous Biological Control Agents.
- Garipey, T.D., Kuhlmann, U., Gillott, C., Erlandson, M., 2007. Parasitoids, predators and PCR: the use of diagnostic molecular markers in biological control of Arthropods. *J. Appl. Entomol.* 131, 225–240.
- Garipey, T.D., Kuhlmann, U., Haye, T., Gillott, C., Erlandson, M., 2005. A single-step multiplex PCR assay for the detection of European *Peristenus* spp., parasitoids of *Lygus* spp. *Biocontrol Sci. Technol.* 15, 481–495.
- Greenstone, M.H., 2003. Assessing insect endoparasitism by PCR: applications to classical biological control, in: *Proceedings of the 1st International Symposium on Biological Control of Arthropods*. pp. 98–101.
- Greenstone, M.H., 2006. Molecular methods for assessing insect parasitism. *Bull. Entomol. Res.* 96, 1–13.
- Hoffmann, M.P., Ode, P.R., Walker, D.L., Gardner, J., Van Nouhuys, S., Shelton, A.M., 2001. Performance of *Trichogramma ostrinia* (Hymenoptera: Trichogrammatidae) reared on factitious hosts, including the target host, *Ostrinia nubilalis* (Lepidoptera: Crambidae). *Biol. Control* 21, 1–10.
- Hopper, K.R., Roush, R.T., Powell, W., 1993. Management of genetics of biological-control introductions. *Annu. Rev. Entomol.* 38, 27–51.



- Hothorn, T., Bretz, F., Westfall, P., 2008. Simultaneous inference in general parametric models. *Biom. J.* 50, 346–363.
- Hufbauer, R.A., 2002. Evidence for nonadaptive evolution in parasitoid virulence following a biological control introduction. *Ecol. Appl.* 12, 66–78.
- Jenkins, C., Chapman, T.A., Micallef, J.L., Reynolds, O.L., 2012. Molecular techniques for the detection and differentiation of host and parasitoid species and the implications for fruit fly management. *Insects* 3, 763–788.
- Jones, D.B., Giles, K.L., Chen, Y., Shufran, K.A., 2005. Estimation of hymenopteran parasitism in cereal aphids by using molecular markers. *J. Econ. Entomol.* 98, 217–221.
- Kakani, E.G., Zygouridis, N.E., Tsoumani, K.T., Seraphides, N., Zalom, F.G., Mathiopoulos, K.D., 2010. Spinosad resistance development in wild olive fruit fly *Bactrocera oleae* (Diptera: Tephritidae) populations in California. *Pest Manag. Sci.* 66, 447–453.
- Karam, N., Guglielmino, C.R., Bertin, S., Gomulski, L.M., Bonomi, A., Baldacchino, F., Simeone, V., Malacrida, A.R., 2008. RAPD analysis in the parasitoid wasp *Psytalia concolor* reveals Mediterranean population structure and provides SCAR markers. *Biol. Control* 47, 22–27.
- Kimani-Njogu, S., Trostle, M.K., Wharton, R.A., Woolley, J.B., Raspi, A., 2001. Biosystematics of the *Psytalia concolor* species complex (Hymenoptera: Braconidae: Opiinae): the identity of populations attacking *Ceratitis capitata* (Diptera: Tephritidae) in coffee in Kenya. *Biol. Control* 20, 167–174.
- Larkin, M.A., Blackshields, G., Brown, N.P., Chenna, R., McGettigan, P.A., McWilliam, H., Valentin, F., Wallace, I.M., Wilm, A., Lopez, R., Thompson, J.D., Gibson, T.J., Higgins, D.G., 2007. Clustal W and Clustal X version 2.0. *Bioinformatics* 23, 2947–2948.
- McCullagh, P., Nelder, J.A., 1989. *Generalized Linear Models*. Monographs on Statistics and Applied Probability, Second Edition. Chapman & Hall/CRC, Lavoisier.fr.
- Nardi, F., Carapelli, A., Dallai, R., Roderick, G.K., Frati, F., 2005. Population structure and colonization history of the olive fly, *Bactrocera oleae* (Diptera, Tephritidae). *Mol. Ecol.* 14, 2729–2738.
- Ratcliffe, S.T., Robertson, H.M., Jones, C.J., Bollero, G.A., Weinzierl, R.A., 2002. Assessment of parasitism of house fly and stable fly (Diptera: Muscidae) pupae by pteromalid (Hymenoptera: Pteromalidae) parasitoids using a polymerase chain reaction assay. *J. Med. Entomol.* 39, 52–60.
- Rozen, S., Skaletsky, H., 2000. Primer3 on the WWW for general users and for biologist programmers. *Methods Mol. Biol.* 132, 365–386.
- Rugman-Jones, P.F., Wharton, R., Noort, T.V., Stouthamer, R., 2009. Molecular differentiation of the *Psytalia concolor* (Szépligeti) species complex (Hymenoptera: Braconidae) associated with olive fly, *Bactrocera oleae* (Rossi) (Diptera: Tephritidae), in Africa. *Biol. Control* 49, 17–26.
- Stuart, M.K., Greenstone, M.H., 1997. Immunological Detection of Hymenopteran Parasitism in *Helicoverpa zea* and *Heliothis virescens*. *Biol. Control* 202, 197–202.
- Tayeh, A., Estoup, A., Laugier, G., Loiseau, A., Turgeon, J., Toepfer, S., Facon, B., 2012. Evolution in biocontrol strains: insight from the harlequin ladybird *Harmonia axyridis*. *Evol. Appl.* 5, 481–488.
- Thaon, M., Blanchet, A., Ris, N., 2009. Contribution à l'optimisation de l'élevage du parasitoïde. *Cahier Technique de l'INRA* 66, 21–31.
- Vontas, J.G., Cosmidis, N., Loukas, M., Tsakas, S., Hejazi, M.J., Ayoutanti, A., Hemingway, J., 2001. Altered Acetylcholinesterase confers organophosphate resistance in the olive fruit fly *Bactrocera oleae*. *Pest. Biochem. Physiol.* 71, 124–132.
- Weathersbee, A.A., Shufran, K.A., Panchal, T.D., Dang, P.M., Evans, G.A., 2004. Detection and differentiation of parasitoids (Hymenoptera: Aphidiidae and Aphelinidae) of the brown citrus aphid (Homoptera: Aphididae): species-specific polymerase chain reaction amplification of 18S rDNA. *Ann. Entomol. Soc. Am.* 97, 286–292.
- Zygouridis, N.E., Augustinos, A.A., Zalom, F.G., Mathiopoulos, K.D., 2009. Analysis of olive fly invasion in California based on microsatellite markers. *Heredity* 102, 402–412.

Données non présentées dans l'article :

Afin de tester si la différence de taux de parasitisme détecté avant ou après 24 heures de développement pouvait être liée à une réaction immunitaire de type encapsulement, des œufs et des larves de *P. lounsburyi* ont été obtenus par dissection de larves de *C. capitata* à différents temps après parasitisme. Aucune capsule complètement ou partiellement mélanisée n'a été observée après dissection. J'ai donc cherché la présence de cellules immunitaires adhérentes (début de capsule) après marquage fluorescent (Figure 5).



#### Observation de différents stades de développement de *P. lounsburyi*.

Les œufs ou larves de *P. lounsburyi* obtenues par dissection de larves de *C. capitata* sont marquées de façon fluorescente [cytosquelette d'actine à la phalloïdine (vert) et des noyaux au DAPI (bleu)]. A et B : œufs de *P. lounsburyi* observé à 24 et 48h : la tache claire en A correspond à un hémocyte (cellule immunitaire) de l'hôte. C et D : Troisième stade larvaire.

Sur une trentaine d'œufs observés, la figure 5A. montre le seul hémocyte adhérent de *C. capitata* qui ait été vu. De même aucune forme de début de capsule n'a été observée sur les larves plus âgées. Ceci suggère que la diminution du parasitisme dans les premières 24 heures n'est pas liée à une réaction d'encapsulement. Cependant, il a été montré qu'une réaction immunitaire de l'hôte peut se produire en absence de capsules (ex : *Drosophila paramelanica* Carton *et al.* 2009). On ne peut donc pas exclure qu'une réaction de ce type soit à l'origine de l'effet observé.

## ARTICLE 5

Venom composition of the parasitoid *Psyttalia lounsburyi* changes in a new environment and together with allelic richness and *Wolbachia* influences the extinction dynamics.

En préparation

Mathé-Hubert H., et al.

*Evolution expérimentale de petites populations de P. lounsburyi collectées sur le terrain et mises en élevage au laboratoire sur un hôte de substitution*

*Les résultats montrent :*

- *des changements répétables de composition du venin*
- *l'impact de la composition du venin et de l'homozygotie sur la valeur sélective des individus*
- *l'effet de caractéristiques des fondatrices : la composition du venin, la richesse allélique et l'infection par Wolbachia sur la vitesse d'extinction des populations expérimentales.*

## Présentation de l'article

Les importations d'auxiliaires exotiques utilisés en lutte biologique constituent des situations particulièrement intéressantes pour étudier l'évolution à court terme des populations face à de brusques changements environnements. Elles nous ont donné ici l'occasion de documenter l'évolution des protéines du venin dans des populations expérimentales de *Psytalia lounsburyi*.

Les populations expérimentales étudiées ont été fondées à partir d'individus collectés au Kenya et en Afrique du Sud. A leur arrivée au laboratoire, les individus ont été répartis en 19 populations expérimentales. Ces populations expérimentales ont fait face à un double challenge. Elles ont subi un important changement d'environnement : du terrain à des conditions contrôlées en laboratoire. Elles ont également été élevées sur un hôte de substitution (*Ceratitis capitata*) et non sur leur hôte naturel (la mouche de l'olive) qui est extrêmement difficile à élever en laboratoire (et que nous n'avons pas réussi à élever malgré cinq mois d'essais intensifs !). Les 19 populations expérimentales ont été suivies jusqu'à leur extinction, en mesurant plusieurs types de caractères à chaque génération. La composition du venin a été analysée grâce à la méthode développée dans la partie 1. La diversité génétique a été étudiée par génotypage avec des marqueurs microsatellites. Le statut d'infection par deux types distincts de l'endosymbionte *Wolbachia* – connus pour induire de l'incompatibilité cytoplasmique chez *Psytalia lounsburyi* (Cheyppé-Buchmann *et al.* 2011) – a été déterminé par PCR. Enfin, le nombre de descendants de chaque femelle a été inféré à partir de la reconstruction des liens de parenté en utilisant les données microsatellites. La méthode développée au cours de l'article précédent a aussi été utilisée pour estimer l'évolution du taux de succès parasitaire (comparaison du taux de parasitisme apparent, estimé à partir des émergences, et du taux de parasitisme estimé avec la méthode PCR développée). Les premières analyses PCR ont révélé que le taux de parasitisme des individus provenant du terrain était extrêmement faible (0 à 3%), ce qui rendait les estimations de succès parasitaire très peu fiables. Pour cette raison, cette méthode n'a pas été utilisée pour analyser cette expérience.

Bien que la plupart des populations expérimentales se soient éteintes avant d'atteindre 5 générations en laboratoire, les données obtenues lors des premières générations ont révélé de nombreuses variations des traits et caractéristiques mesurés.

Contrairement aux fréquences d'infection par *Wolbachia* et aux fréquences alléliques des marqueurs microsatellites, les intensités des bandes protéiques du venin ont évolué de façon répétable entre les différentes populations expérimentales. Ce résultat, et le fait que certaines des bandes protéiques se soient révélées héréditaires, suggèrent que le venin a rapidement évolué en réponse à la sélection suite au changement d'environnement. Toutefois, cette interprétation est compliquée par l'observation de changements opposés d'une génération à l'autre pour la composition du venin, les fréquences alléliques et les fréquences d'infection par *Wolbachia*. Bien que plusieurs hypothèses puissent expliquer ce résultat, différents éléments laissent penser qu'il pourrait s'agir d'un effet de la présence de *Wolbachia*. Ces éléments sont détaillés dans l'Appendice S3 de la publication.

Par ailleurs, un effet significatif de la composition du venin a été détecté sur la valeur sélective des femelles et sur le nombre de génération avant extinction des populations. La richesse allélique et *Wolbachia* ont également un effet sur le nombre de générations atteintes avant extinction.

**Venom composition of the parasitoid *Psytalia lounsburyi* changes in a new environment and together with allelic richness and *Wolbachia* influences the extinction dynamics.**

**Mathé-Hubert H. et al.**

**En préparation**

Abstract

The extent to which organisms are pre-adapted, or are able to adapt to a sudden environmental change is a key question in the field of ecology. Indeed, this question is not only important to predict the effects of global change but it is also relevant for biological control, invasion biology, or more specifically to understand how the host range of parasites is constrained and can evolve. Although parasitoid virulence was shown to evolve rapidly in response to host resistance, suggesting a high evolutionary potential of virulence-associated factors, the importance of such factors in the population response to a sudden environmental change has never been tested.

Here, we show that the composition of the parasitoid venom (a main source of virulence factors), as well as the genetic diversity, *Wolbachia* and the fitness of founders affect the rapidity of extinction of experimental parasitoid populations reared under laboratory conditions, on a non natural host. In addition, venom composition changed repeatably during the experiment, unlike other variables, and had a positive effect on the female individual fitness. Parasitoid venom composition thus appears as a trait of major importance in populations enduring sudden environmental changes.

### **Introduction**

The ability to adapt to a new environment is a key feature for living organisms. A large majority of fortuitously or intentionally introduced populations do not establish and finally go extinct (Williamson & Fitter 1996; Orr & Lahiri 2014). The successful populations are generally supposed to be either pre-adapted to the new conditions or prone to rapid adaptation. The processes that influence short-term evolution of small populations are more and more understood theoretically, but few concrete examples have yet been documented.

The causes of extinction of small populations mainly include genetic and demographic

processes (Fauvergue *et al.* 2012). The loss of genetic diversity increases inbreeding which often leads to a decrease in the mean fitness. It can also prevent the adaptations needed by small populations to achieve sufficient growth under new environmental conditions and avoid deterministic or stochastic extinction (Vander Wal *et al.* 2013). If genetic diversity thus largely influences the probability of extinction, neutral variation can be poorly relevant when adaptation is required (Le Corre & Kremer 2003; Knopp *et al.* 2006; Holderegger *et al.* 2006). For instance, differences in the founders phenotype may induce variation in the populations risk of extinction (e.g. Vercken *et al.* 2013) which cannot be estimated by neutral diversity. Another important parameter affecting insect population dynamics is the infection by *Wolbachia*, an endosymbiont that manipulates its host reproduction to increase its own transmission. One of the main mechanisms is the induction of “cytoplasmic incompatibility” (CI) which is observed when populations are polymorphic for the infection by *Wolbachia* (Vavre *et al.* 2000). In diploid species, incompatible crosses do not produce offspring while in haplodiploids CI mainly results in the absence of female offspring. *Wolbachia*-induced CI can lead to extinction of diploid host populations (Charlat *et al.* 2003; Engelstädter & Hurst 2009) and it may also decrease genetic diversity (Charlat *et al.* 2003; Branca & Dupas 2006).

Biological control introductions are particularly relevant to investigate how populations change in a new environment (Yek & Slippers 2014). It is indeed estimated that only 20 % to 55 % of the introduced species establish (Orr & Lahiri 2014) and the causes of success/failure are still poorly understood. Among the common biological control agents, parasitoid wasps are of particular interest. They are generally haplodiploid, arrhenotokous species, which partly protects them from inbreeding depression because of the purge of deleterious alleles in haploid males (but see Henter 2003; Tortajada *et al.* 2009). They are often introduced in relatively low number, due to mass-rearing difficulties. Finally, several parasitoid species attack a small range of hosts and they are often reared on a substitute host species they do not usually parasitize. In addition to host-related variation, environmental changes can include rearing conditions in the laboratory, e.g. *ad libitum* food, high number of hosts of the suitable developmental stage, limited space, high densities, human-induced stress. Resulting selection pressures may lead to maladaptation of individuals when released in the field, a potential cause of failure of biological control programmes (van Lenteren 2003).

One feature of key importance for parasitoids that face a new host is its short-term evolvability of virulence, i.e. the ability to successfully parasitize the host. Dupas *et al.* (2013) evidenced both inter and intraspecific variation of virulence on different host species and strains in the *Leptopilina* genus, suggesting that virulence evolves rapidly. Besides, the levels

of virulence on different host species were sometimes not positively correlated, which means that some virulence factors are host specific. Rapid changes in virulence in response to symbiont-mediated host resistance were also reported in aphid parasitoids (Dion *et al.* 2011; Rouchet & Vorburger 2014). Results of Rouchet and Vorburger (2014) show a rapid evolution (5 generations) of *Lysiphlebus fabarum* virulence of against *Aphis fabae* lines harboring the defensive symbiont. The evolved virulence was specific of the symbiont strain, suggesting that it involves different specific factors.

Parasitoid virulence mainly relies on factors injected by the female at oviposition, the most studied being the Polydnviruses (associated with wasp groups of the Ichneumonoidea superfamily) and the venom (Poirié *et al.* 2009; Burke & Strand 2014). Parasitoid venom is composed of diverse proteinaceous components produced in a specialized gland. Most of them are demonstrated or potential virulence factors (Asgari 2012) that alter host immunity and regulate host metabolic cascades (Mrinalini *et al.* 2014). The occurrence of large differences in venom composition between closely related species and strains was first evidenced in *Leptopilina* wasps (Colinet *et al.* 2013a), suggesting a high evolvability of venom. Substantial venom variations between populations and individuals of both *Leptopilina* (Cynipidea) and *Psytalia* (Braconidae) wasps was further described (Colinet *et al.* 2013a; b). Whether venom variability is mainly due to standing genetic variation or plasticity and whether it is at least partly adaptive remains to be established.

This study was designed to test whether venom composition could rapidly evolve under new environmental conditions and whether it could be a relevant trait affecting population dynamics and extinctions. Comparison of venoms was performed between field-collected populations and long-term laboratory-reared populations of *P. lounsburyi*, a biological control agent of the olive fruit fly *Bactrocera oleae*. Moreover, experimental evolution was performed by creating and rearing laboratory experimental populations from *Psytalia* samples collected in Kenya and South Africa. These populations were monitored until their extinction. The populations faced at least two sudden environmental changes: a shift to laboratory conditions and a host-shift, because *P. lounsburyi* has a single described natural host (Daane *et al.* 2008; Malausa *et al.* 2010; Borowiec *et al.* 2012) but was reared in the laboratory on the substitution host *Ceratitis capitata*. This experiment enabled us to study (i) the short-term changes in venom composition, *Wolbachia* infections and genetic diversity, (ii) the effect of these characteristics and of the fitness of founders on the speed of population extinctions and (iii) the effect of founders' characteristics on their individual fitness. Results show that venom composition affects the fitness of individuals and that it is partly heritable.



They also evidence that venom changes over generations are not random and follow a common pattern across the various experimental populations. Finally, an effect of the initial venom composition and allelic richness on the time before extinction was detected.

## **Material and methods**

### ***1. Biological material***

#### *1.a. P. lounsburyi populations*

The four *P. lounsburyi* populations originate from samples collected in Kenya and South Africa. “Laboratory populations”, hereafter referred to as K<sub>L</sub> and SA<sub>L</sub>, were collected in 2003 and 2005, respectively. They had been reared on the substitute host *C. capitata* for approximately 150 and 120 generations at the time of the experiment. “Field populations”, hereafter referred to as SA<sub>F</sub> and K<sub>F</sub>, were obtained in 2012, SA<sub>F</sub> from a first sampling (February) in two close regions of South Africa (Jonkershoek and Stellenboch), K<sub>F</sub> from three samplings (April-June) in the forests Gataragwa, Sirimon, and Sirimon and Ontulili (mixed sample).

#### *1.b. Rearing*

Rearing was performed as described in Benvenuto *et al.* (2012) and Mathé-Hubert *et al.* (2013) except for parasitoid cages that were smaller (10 cm × 13 cm × 18 cm) and only contained 30 parasitoids, and for Parafilm containing host larvae that was wrapped around a glass marble instead of a ping-pong ball. Briefly, pools of *C. capitata* third-instar larvae were exposed to *P. lounsburyi* parasitism for seven hours and then transferred on fresh nutrient medium.

### ***2. Characterization of individuals and populations***

#### *2.a. Neutral markers: Microsatellite genotyping*

Genotyping was performed using 18 of the 21 microsatellite markers developed by Bon *et al.* (2008), combined in two multiplex PCR (see Table S1). DNA was extracted using prepGEM™ Insect kits and protocol except for the enzymatic digestion time (2 h at 75 °C). Both PCRs were carried out using QIAGEN Multiplex PCR kits (QIAGEN, Germany) in a 10 µL final volume (5µL PCR Master Mix, 2 µL of DNA, 0.04 to 1.2 µM of each primer; Table S1) with the following conditions: 15 min 95°C – 30 cycles [30 s 94°C, 90 s 58°C, 90 s 72 °C] – 30 min 60°C. PCR products were mixed with 8.75µl Hi-Di formamide and 0.25µl GeneScan 500 LIZ Size Standard (Applied Biosystems Inc.) and loaded on an ABI 3130 sequencer. Sample genotypes were scored using GeneMarker (version 1.75 SoftGenetics

LLC, USA).

Neutral differentiation between populations was tested using 13 microsatellite loci (selected on results of Hardy–Weinberg equilibrium and linkage disequilibrium tests as well as null alleles frequency; Table S1), with G test for Genotypic differentiation (genepop on the web version 4.2; Raymond & Rousset 1995). Population diversity was estimated using the standardized allelic richness ( $A_i$ ), equalized to a sample size of 10 genes using rarefaction (HP-RARE 1.0 software; Kalinowski 2005). At the individual level, homozygosity by locus (HL) (Aparicio *et al.* 2006) was estimated using the R package “genhet” (Coulon 2010).

### 2.b. *Wolbachia* typing

*Wolbachia* typing was performed with the same DNA extracts as microsatellite typing, based on amplification of the *ftsZ* [generalist primers, Dedeine *et al.* (2001)] and *wsp* genes in a multiplex PCR. We used three specific primers for *wsp* (Cheyppé-Buchmann *et al.*, 2011), the forward primer being common to the two *P. lounsburyi* *Wolbachia* types while the two reverse primers (*wspPsyR1* and *wspPsyR2*) were specific of *Wolbachia* type I and II, respectively. Note that *wspPsyR1* sequence is (5′-AGT YGT ATC AGT AT CCG CAG-3′) and not (5′-AGT YGT ATC AGT TAT CCG CAG-3′) as in Cheyppé-Buchmann *et al.* (2011). Discordant amplification of the two genes was treated as missing data (6% of samples). To reduce the number of variables in statistical models, and because almost all individuals were infected by Type I (table S2), variation of *Wolbachia* infection was estimated by the frequency of type II.

### 2.c. *Venom characterization: Sample preparation and analysis*

*P. lounsburyi* venom glands (N = 791) were dissected individually, treated as described in Mathé-Hubert *et al.* (submitted), and loaded on 58 1D SDS-PAGE gels (Any-kD Mini-PROTEAN® TGXTM, Bio-Rad). Following migration, gels were silver stained (Morrissey 1981) and photographed one to four times along the staining process (digital camera EOS-5D-MkII, Canon, Japan). The resulting high-resolution pictures (5626 × 3745 pixels; 16 bit; TIFF file) were then semi-automatically analyzed with a recently developed method based on the transformation of lanes into intensity profiles by Phoretix 1D (TotalLab, UK) and analysis of these profiles by R functions (details in Mathé-Hubert *et al.*, submitted). Analysis resulted in the choice of 35 “reference bands” (Fig. S1) of identified molecular weight, whose intensity in each lane was estimated with the following combination of parameters [“height” (maximal intensity between borders of reference band), “without background” (background removed in Phoretix-1D with a “rolling ball” of 10 000 pixels of radius), with quantiles normalization (Bolstad *et al.* 2003; Smyth 2005)]. These 35 reference bands are the variables describing

venom composition that were used to construct seven composite variables. Variable 1: “Total venom quantity”, estimated in each lane by the median intensity of reference bands, before the normalization steps. Variable 2 and 3:  $V_T$ , variance of the venom composition and  $V_{T\ inter}$ , proportion of venom variance due to inter-group differences. To handle multicollinearity, the computation of these two variables is based on the “total variance” [sum of eigenvalues i.e. the sum of variance of each uncorrelated dimension (Kirkpatrick 2009); details in Appendix S1]. The significance of venom differentiation (measured by  $V_{T\ inter}$ ) was tested with linear discriminant analyses (LDA) followed by randomization tests (ADE4; Dray & Dufour 2007). LDAs were also used to identify specific bands significantly correlated to LDA axes.

The last four variables summaries the variation of venom composition of field individuals. They correspond to the first principal components of a PCA (Principal Component Analysis) performed on venom of field individuals after removal of the variation between countries (separate centering of individuals from the two countries), which corresponds to a “within PCA” (implemented by the ADE4 R package). Descendants of these field individuals were projected as supplementary individuals on the PCA to obtain their coordinates on the first four principal components. These components, selected on the basis of the break on the scree plot (Fig. S2), summarizes 52% of the venom variation in the within PCA.

#### *2.d. Female fitness inference*

The number of offspring per female in each replicate was inferred from the kinship relationship among individuals across generations, estimated using microsatellite data with the Colony software (v2.0.5.0; Wang 2004). We used all the 18 loci (Table S1) since the gain of information associated with a higher number of markers can compensate for the loss of power due to violation of assumptions of linkage and Hardy-Weinberg equilibria (Wang 2004; Colony user manual). Details of the pedigree inference are in Appendix S2.

### **3. Long-term evolution: venom, neutral markers**

Long reared ( $K_L$  and  $SA_L$ ) and freshly collected ( $K_L$  and  $SA_L$ ) populations of the same origin (collection sites) were used to document microsatellite markers and venom composition changes having possibly occurred during more than 100 generations in drastically different environments. The four populations were compared with (i) pairwise  $F_{ST}$  and test of genotypic differentiation and (ii) pairwise venom differentiation measured with  $V_{T\ inter}$  and tested with LDA (see 2.c.). Venom differentiation was also analyzed with a LDA on the four groups to assess whether the same bands discriminate “field” and “laboratory” individuals from Kenya and South Africa. As the three Kenyan samples were not

discriminated, they were pooled to evaluate Kenyan – South African differentiation.

#### **4. Experimental evolution: venom, neutral markers, *Wolbachia* infection and fitness-related traits**

##### *4.a. Experimental design*

The experimental evolution was set-up to follow short-term changes in *P. lounsburyi* replicates, created from field-collected samples and reared under laboratory conditions that include the use of the substitute host *C. capitata*. The experiment began with 19 experimental populations (2 from South Africa, 17 from Kenya), each founded with 30 individuals (15 males and 15 females) emerged from field-collected *B. oleae*. See Figure S3.

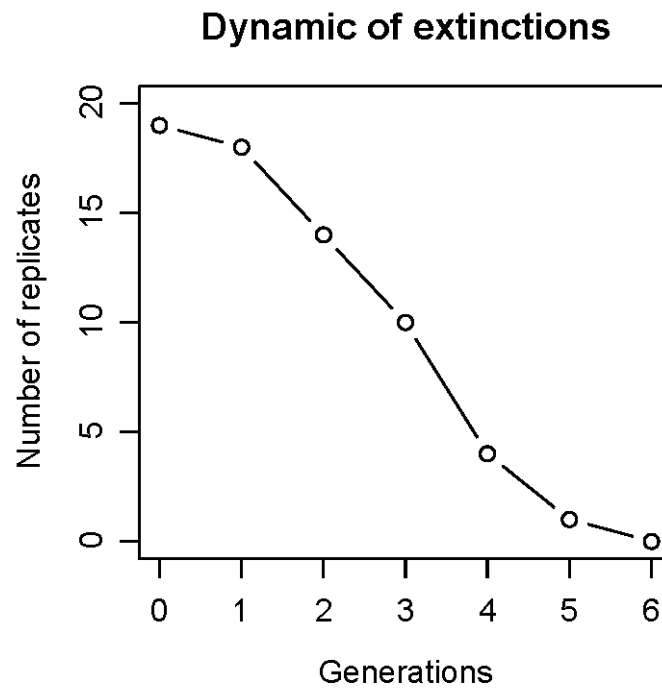
Each experimental population consisted in a separate cage, with founders as individuals of the first generation ( $G_0$ ). *C. capitata* larvae were provided at each generation, three times a week, during three weeks, before parasitoids were collected and stored at  $-80^\circ\text{C}$  for later analysis. All emerging individuals were mixed during the entire week following the emergence of the first female. The next generation was then created by randomly sampling 15 individuals of each sex. This helped reducing selection pressures on the developmental time. If less than 15 males or females were available, the population was completed with individuals emerging during an additional week. The population was considered as "complete" once 15 females and males were available or two weeks after emergence of the first female. *C. capitata* larvae were provided three days after the population was complete. This procedure was repeated until extinction of all populations (Fig S3). Among the 790 obtained individuals, about 200 could not be analyzed either because of dissection problems or due to a poor quality of protein profiles.

##### *4.b. Analysis of changes along the experiment*

Occurrence of changes in genetic markers and venom composition was assessed using  $F_{ST}$  (and test of genotypic differentiation) and  $V_{T\ inter}$  (and LDA), for each replicate and transition to the next generation, except when less than ten females were available at one of the two generations. We first characterized each population by the frequencies of microsatellite alleles and of the four types of *Wolbachia* infection (aposymbiotic, type I, type II and co-infection), as well as the median venom composition (median of intensities of the 35 reference bands) at  $G_0$ ,  $G_1$ ,  $G_2$  and  $G_3$ . Most replicates were indeed extinct at the fifth generation ( $G_4$ , Fig. 1).

The directionality of changes was then measured for each variable, replicate and generation ( $n$ ) with the inter-generation Delta:

$$\Delta_{G_n-G_{n+1}} = x_{n+1} - x_n$$



**Figure 1: Dynamic of extinctions during experimental evolution**

Description of the decrease in the number of replicates along the generations.

Where  $x_n$  is the value of the  $x$  variable in a given replicate at generation  $n$ . These  $\Delta$  were estimated for the generation transitions  $G_0 - G_1$ ,  $G_1 - G_2$  and  $G_2 - G_3$ .

#### 4.c. Repeatability between replicates and generations

To assess for repeatability of changes between replicates, we used a Wilcoxon signed rank test to test, for each variable and transition to the next generation, if the median of  $\Delta_{G_n-G_{n+1}}$  of all replicates differs from 0. All  $p$ -values were separately corrected for the false discovery rate (Benjamini & Yekutieli 2001), for each generation transition and each of the three sets of variables (frequencies of microsatellite alleles, frequencies of the types of *Wolbachia* infections, venom composition [35 bands]). To graphically represent the repeatability of venom changes, a PCA was performed for the three inter-generation changes with replicates as variables and reference bands as statistical individuals, and correlation circles were used to visualize the consistency of the repeatability.

Repeatability between generations was tested using a more global approach because of the low generation number. For each of the three set of variables and each replicate, we measured the correlation between the set of  $\Delta_{G_n-G_{n+1}}$  and the set of  $\Delta_{G_{n+1}-G_{n+2}}$  using Spearman correlation. A positive correlation was expected if the considered set of variables changed in the same direction during two successive generation transitions. For the three set of variables, we performed a Wilcoxon signed rank test with correlation coefficients obtained for each replicate and couple of generational changes to determine if the median of these correlations significantly differed from zero. This approach was used for correlations of  $\Delta_{G_0-G_1}$  with  $\Delta_{G_1-G_2}$ ,  $\Delta_{G_1-G_2}$  with  $\Delta_{G_2-G_3}$  and  $\Delta_{G_0-G_1}$  with  $\Delta_{G_2-G_3}$ .

#### *4.d. Heritability of venom variation*

Heritability of venom variation was tested using mother-daughter regressions, thanks to the inferred kinship links (Appendix S2). For each reference band, the median intensity in daughters was explained by the intensity in the mother as a fixed effect and the population as a random effect. Models were fitted with the lme4 R package (Bates *et al.* 2010) and the significance of the mother band intensity was tested with F-test performed with the anova function of the lmerTest package (Kuznetsova *et al.* 2014), with degrees of freedom calculated using the Satterthwaite's approximation (Schaalje *et al.* 2002). To satisfy the assumption of residues normality, the intensity of some of the bands was transformed with logarithm or square root functions. The global significance of the heritability of venom variation was tested using a Wilcoxon signed rank test to determine whether the median of the slopes of the mother-daughter regressions significantly differed from zero. This procedure was applied separately to G<sub>1</sub> and G<sub>2</sub> daughters.

### **5. Factors influencing individual fitness and time until extinction**

#### *5.1. Effect of individuals phenotypic/genotypic characteristics on their inferred fitness*

To check whether the effect of phenotypic/genotypic characteristics on the number of generations reached by the replicates could be explained by their effect on fitness, we used a Poisson GLMM model to explain the inferred number of offsprings of individual females by the homozygosity by locus (HL), the four principal components of the PCA, the total venom quantity, and the presence of *Wolbachia* type II infection. Populations (groups of 15 females) were used as a random effect, and an individual-level random effect was added to handle the overdispersion that was detected with the Pearson goodness-of-fit statistics (McCullagh & Nelder 1989). The model was fitted with the lme4 R package (Bates *et al.* 2014). As we did not consider interactions, we used the model averaging procedure implemented by the MuMIn package (Bartoń 2013) to test for fixed effects. To this end, models were ranked and weighted according to their AICc, and we used all models which Delta AICc was inferior to 10. This model averaging approach is preferred over classic variable selection (Burnham & Anderson 2004; Grueber *et al.* 2011), in particular in case of small data sets (Moeltner & Woodward 2008; Giudice *et al.* 2012).

For each significant phenotypic/genotypic characteristic, we approximated the effect of the naturally occurring variability on the fitness variability in laboratory conditions by the standard deviation of the predicted fitness of founders given their phenotypic/genotypic characteristics. Predictions were performed using the model of lowest AICc that only contains

the effects identified as significant by the model averaging procedure. This model was used for each significant founder characteristic, to predict fitness of hypothetical founders that would only vary for the considered characteristic (i.e. other characteristics were set to the mean of the values of founders). We then used the standard deviation of these predictions to summarize the effect of the naturally occurring variability on the fitness variability in laboratory conditions.

Confidence intervals of the effects of the naturally occurring variability on the fitness in laboratory were obtained by bootstrap (5000 replicates) and with the bias-corrected and accelerated (BCa) method to obtain confidence intervals (Efron 1987). Then, the same procedure was used to assess the effect of the global variability of venom composition, with variation of hypothetical founders allowed for all significant variables summarizing the venom composition (the “homozygosity by locus” variable only was set to its mean as this is the sole other significant variable).

### *5.2. Effects of phenotypic/genotypic characteristics of founders on time before extinction*

The effect of the phenotypic/genotypic characteristics of founders on the number of generations reached by a replicate was tested by fitting a saturated model explaining the number of generations reached by the country of origin as a random effect and the genotypic/phenotypic characteristics in founding populations (i.e. the standardized allelic richness, the frequency the *Wolbachia* type II among females, the variability of the venom composition ( $V_T$ ), the median of each of the four principal components of the PCA, and the median of the total venom quantity) as fixed effects. This saturated model was then analyzed by the same model averaging procedure as above, with a normal distribution of residuals.

A roughly similar procedure was used to test for the effect of the fitness of founders on the number of generations reached by the replicates. This corresponds to an indirect way to check for the impacts of venoms and other parameters on the extinction dynamics since their impact on individual fitness was already examined (section 5.1). In this analysis, the mean and variance of the inferred fitness as well as the frequency of *Wolbachia* type II among females founders were the fixed effects of the saturated model. It is indeed likely that variation of *Wolbachia* type II frequency among females at the first generation also impacted the frequency of CI at other generations.



## **Results**

Three main questions were addressed in this study: (i) do long-term changes in parasitoid venom composition occur under new environmental conditions, (ii) can we observe repeatable short-term changes in venom composition, and (iii) is venom, together with other population parameters, an important factor influencing the probability of extinction of small populations in a new environment. The first question was addressed by comparing field-collected and long-term reared populations at venom protein markers, while the second and third questions were addressed through the laboratory establishment and monitoring of 19 experimental populations.

### **1. Long term changes in venom composition**

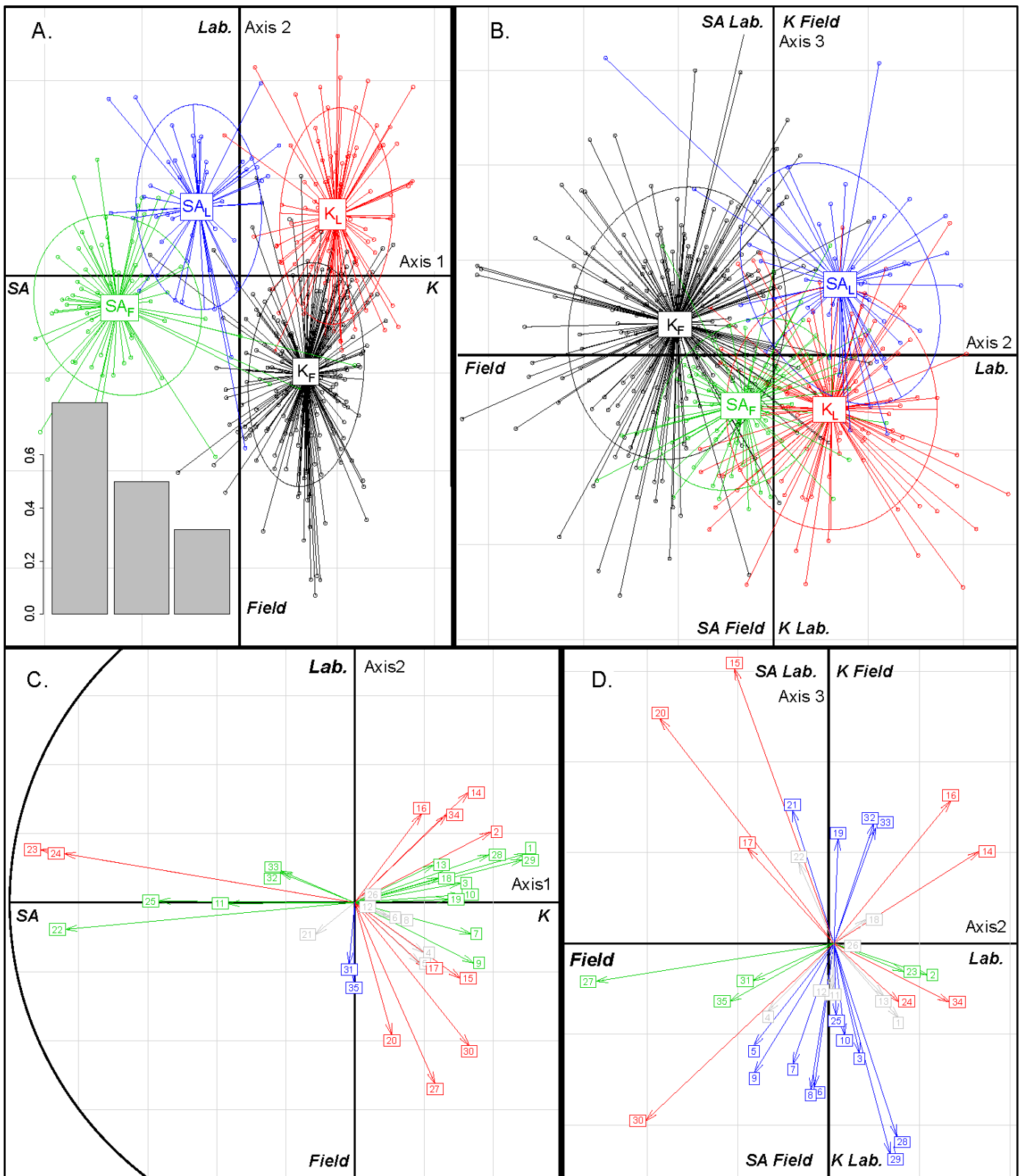
Field collected Kenyan and South African populations were characterized for microsatellite markers, venom composition, and *Wolbachia* infection. Significant differentiation was observed for Kenyan *versus* South African samples, both for neutral markers and venom composition (Table 1), while Kenyan samples were not discriminated. In Kenya, all individuals were infected with *Wolbachia* type I, 50% to 100% being also infected with type II, depending on the sample (Table S2). In South Africa, all infection types were observed (Table S2), which mainly contrasts from previous results (Cheyppé-Buchmann *et al.*, 2011) by the presence of type I. This may be due to a sampling effect and/or the progression of type I infection in South Africa.

Pairwise comparisons of “laboratory” ( $K_L$  and  $SA_L$ ) and “field” populations ( $K_F$  and  $SA_F$ ), evidenced a significant differentiation of all group pairs both for microsatellite markers and venom composition, showing that venom composition differed between laboratory and field populations. Overall, estimations of venom differentiation using  $V_{T\ inter}$  were much lower than  $F_{ST}$  (Table 1). However, the comparison is difficult since detection methods and estimated parameters strongly differ for these two kinds of markers. In addition, protein phenotypes that are determined by a rather low number of loci are predicted to have a high variance of dominance, which variance is expected to mainly decrease differentiation (Leinonen *et al.* 2013). Venom-based differentiation was more thoroughly studied by performing a Linear Discriminant Analysis on the four groups. The first axis discriminated Kenyan *versus* South-African populations. The second and third axes evidenced respectively the “field *vs.* laboratory” similar and opposite changes of venom composition in Kenyan and South-African populations (Fig. 2 A, B). Using correlation circle, we identified reference bands significantly correlated to these axes, after a Bonferroni correction for the number of bands ( $N = 35$ ). This notably showed that the high Kenyan *vs.* South-African differentiation mainly relied on a few reference bands, more intense in South-Africa (bands 22, 23 and 24; Fig. 2 C). Conservation of the venom-based Kenyan-African differentiation and of most of the discriminating bands after hundred generations of rearing suggests that a genetic basis to this discrimination. We indeed found that reference bands 22, 23 and 24 show significant heritability (see § 1.c.).

**Table 1: Neutral and venom-based differentiation.**

$F_{ST}$  and inter-group proportions of variance of venom composition ( $V_{T\ inter}$ ; Appendix S1) between Kenyan and South African laboratory strains and wild populations ( $K_L$ ,  $SA_L$ ,  $K_F$ ,  $SA_F$ ). Bold values indicate field – laboratory comparisons. All differentiations are highly significant.

	$SA_L$ (36) $F_{ST}$	$SA_F$ (24) $F_{ST}$	$K_F$ (227) $F_{ST}$	$SA_L$ (36) $V_{T\ inter}$	$SA_F$ (24) $V_{T\ inter}$	$K_F$ (227) $V_{T\ inter}$
$SA_F$ (24)	<b>0.27</b>			<b>0.05</b>		
$K_F$ (227)	0.22	0.23		0.09	0.16	
$K_L$ (63)	0.33	0.43	<b>0.16</b>	0.11	0.16	<b>0.02</b>



**Figure 2: Venom differentiation between Kenyan and South-African laboratory and field populations.** Results of a linear discriminant analysis on Kenyan and South-African laboratory and field populations (K<sub>L</sub>, SA<sub>L</sub>, K<sub>F</sub>, SA<sub>F</sub>). A and B: Position of individuals on discriminant axes. Bold italic indications at the extremities of the axis are the interpretation of the axis. A: First and second axes, as well as the scree plot; B: Second and third axes; C and D: Correlations of reference bands (variables) to the three discriminant axes. Correlations to the horizontal axis, the vertical axis, the two axes or none of the axes are indicated by green, blue, red and grey arrows, respectively.

## 2. Short-term evolution of experimental populations.

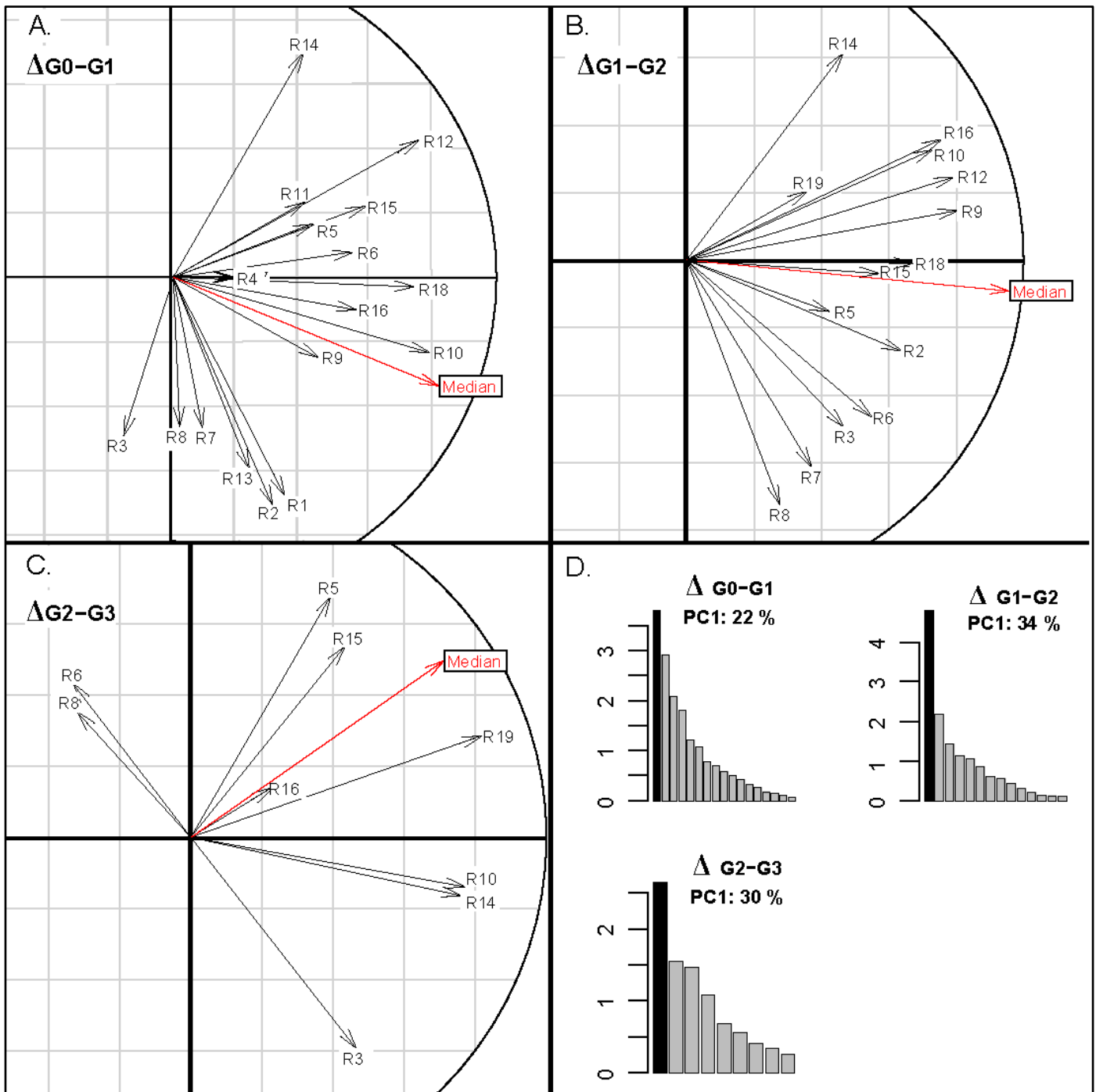
### 2.a. Overview of the experimental population dynamics

Extinctions occurred rapidly in the experiment and notably half the replicates were extinct at the  $G_3$  (Fig. 1). Prior to these extinction, populations endured a strong bottleneck leading to a rapid diminution of the observed heterozygosity, and a transient negative  $F_{IS}$  (Fig. S4 A. and B.).

### 2.b. Evolution of microsatellite markers, venom markers and *Wolbachia* infections

We observed a strong genetic differentiation between generations (mean  $F_{ST}$  of 0.1; Fig. S4), with 76% of  $F_{ST}$  values being significant. A lower inter-generation differentiation was found for venom composition, except for the  $G_1 - G_2$  comparison for which the mean  $V_{T\ inter}$  was 0.10. In addition, only one differentiation in one replicate was significant. This lower number of differences detected at the level of venom markers, when compared to microsatellites, may be partly caused by the limited power of the venom analysis method.

The repeatability of changes between replicates was characterized using the Delta between two generations for (i) microsatellite allelic frequencies, (ii) median venom composition (median for each reference band) and (iii) frequencies of the four types of *Wolbachia* infection. No repeatable change of microsatellite alleles or *Wolbachia* type frequency was observed among replicates. On the opposite, several venom reference bands changed repeatedly in different replicates. Between  $G_0$  and  $G_1$ , intensity of band 6, 8 and 35 increased, while that of band 16 decreased (corrected  $p$ -values were 0.037; 0.04; 0.037 and 0.04, respectively). Between  $G_1$  and  $G_2$ , intensity of reference bands 7, 9 and 10 decreased and that of bands 17, 18 and 19 increased (corrected  $p$ -values were 0.03; 0.03; 0.035; 0.027; 0.018 and 0.04 respectively). No significant repeatable change was detected between  $G_2$  and  $G_3$ , probably as a consequence of a lack of statistical power due to the high number of replicates that were extinct at  $G_3$ . In agreement with Wilcoxon test results, correlation circles evidenced a high consistency of repeatability between replicates at each generational change (Fig. 3), which was not observed for the other variable sets.

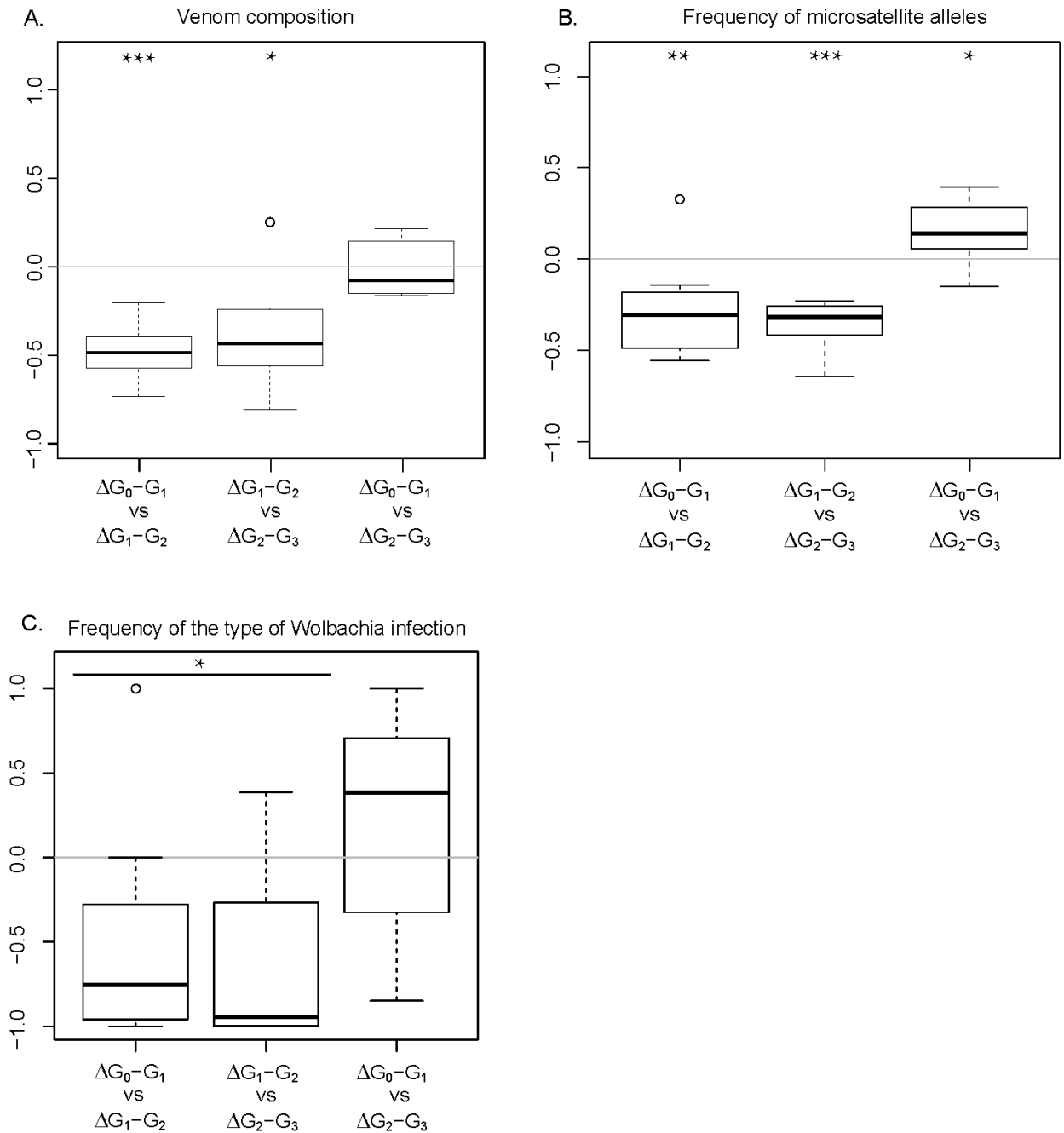


**Figure 3: Repeatability of venom changes between replicates.**

Correlations circle of the three PCA describing the venom change at the three studied generational changes (G<sub>0</sub> to G<sub>1</sub>; G<sub>1</sub> to G<sub>2</sub>; G<sub>2</sub> to G<sub>3</sub>). For each generational change and replicates, the change in reference bands intensities was characterized by Deltas. For each generational change, a PCA was performed on these Deltas, with reference bands as individuals and replicates as variables. A., B. and C. show the correlation circles. As they correspond to different PCA, they cannot be used to compare repeatability between generations. The red arrows correspond to the median change (median of Deltas for each reference bands); it was used in PCA as a supplementary variable.

A different approach was used to test the repeatability of changes between generations because of the low number of generations, and thus the very low number of Deltas per replicate per variable. We tested for each replicate and the three sets of variables if the corresponding sets of Delta values for a given generational change were correlated to those of other generational changes (three correlations between : G0-G1 and G1-G2; G0-G1 and G2-G3; G1-G2 and G2-G3). Unexpectedly, whatever the considered set of variables, correlations between consecutive generational changes were almost all negative (Fig. 4), indicating that variables changed in opposite directions in consecutive generation changes. This effect was significant for all comparisons except for *Wolbachia* (significant effects observed only when two sets of correlations between consecutive generational changes were pooled; Fig. 4C). Positive correlations were observed between Deltas G0-G1 and G2-G3 for microsatellites ( $P = 0.02$ ) and a similar trend was found for *Wolbachia*, ( $P = 0.14$ ; Fig 4 B, C). Overall, the strongest variable correlations were found for *Wolbachia* frequencies (Fig. 4.C.), likely because of the low number of values used to estimate the correlation coefficients (4 for *Wolbachia* infection compared to 35 and 211 for venom reference bands and microsatellite alleles, respectively). Despite this higher variability, correlations associated to *Wolbachia* frequencies tended to be much stronger than those associated with venom and microsatellites.

For the heritability of venom composition we found significant mother-daughter regression for reference bands 9, 16, 22, 23, 24 and 34, at G0-G1, as well as the reference band 21 at G1-G2. Interestingly, bands 9 and 16 were also identified as changing repeatedly during the experiment (see § 1.b.). The low number of heritable reference bands at G1-G2 is likely due to the loss of genetic variation illustrated by the decrease in observed heterozygosity (Fig S4). Distributions of coefficients of all mother-daughter regressions and significant mother-daughter regressions are shown Fig. S5.



**Figure 4: Negative repeatability of changes between generations.**

Correlations between Deltas of different generational changes are shown on the three boxplots corresponding to the three sets of variables. On each boxplot, the two first boxes correspond to correlations between Deltas of consecutive generational changes. Stars above boxes indicate the significance levels of Wilcoxon tests ( $H_0$ : median correlations equal to 0). Signif. codes: 0 ‘\*\*\*’ 0.001 ‘\*\*’ 0.01 ‘\*’ 0.05 ‘.’ 1

### *2.c. Influence of venom and other parameters on fitness and extinction*

Analysis of the Poisson GLMM model showed that the level of homozygosity (HL) negatively impacted the fitness (Table 2), while the presence of *Wolbachia* type II was not significant. This is likely because (i) the effect of *Wolbachia* depends on the frequencies of the four types of *Wolbachia* infection in the population, and (ii) in this haplodiploid species, incompatibility is expected to bias the sex-ratio, but not to decrease fitness.

Results observed for venom composition were as follows. PC<sub>3</sub> had a positive effect on fitness, while PC<sub>1</sub> had not significant effect, and PC<sub>2</sub> and PC<sub>4</sub> effects were highly significant but negative. The approximated effect of the naturally occurring variability on the fitness of founders is summarized in Table 4. Importantly, we detected a strong effect of the venom variability on the fitness of founders. Indeed, the standard deviation of the variability in the number of offspring due to the venom composition variability was 4.41 (95 % confidence interval: 2.74 – 6.41).

In addition, we detected a significant effect of the mean individual fitness in the founder populations on the number of generations before extinction ( $P = 7.10^{-3}$ ; Table 3).

### *2.d. Influence of venom and other parameters on the number of generations until extinction*

Analysis of models explaining extinction by phenotypic/genotypic characteristics was performed using a model averaging procedure. The most significant effects were the allelic richness and the frequency of *Wolbachia* type II that both positively influenced the number of generations reached by the replicates (Table 4). The first and third principal components (PC<sub>1</sub> and PC<sub>3</sub>) of the PCA that summarizes venom composition were also significant ( $P = 0.016$  and  $0.015$  respectively) suggesting that the number of generations before extinction also depends on venom composition.



**Table 2: Effect of individual phenotypic/genotypic variability on the individual fitness.**

Summary of the model averaging results. The last column corresponds to the approximation of the effect of the naturally occurring variability on the variability of fitness in laboratory conditions (see 4.3.2 of Material and methods).

N= 590 females	Sign of coeff.	Pr(> z )	Relative variable importance	Presence in the model of lowest AICc (1140)	Approximate effect of naturally occurring variability on the fitness variation in laboratory [95% CI]
Homozygosity (HL)	-	9.10 <sup>-3</sup> **	0.93	Yes	3.63 [ 1.29; 6.07 ]
Type II <i>Wolbachia</i>	+	0.53	0.3	-	4.41 [ 2.74; 6.41 ]
PC <sub>1</sub>	+	0.86	0.26	-	
PC <sub>2</sub>	-	2.10 <sup>-4</sup> ***	1	Yes	
PC <sub>3</sub>	+	0.036 *	0.77	Yes	
PC <sub>4</sub>	-	< 1.10 <sup>-4</sup> ***	1	Yes	
Total venom quantity	-	0.86	0.27	-	

**Table 3: Effect of the fitness of founders on the number of generations reached.**

Summary of the model averaging results.

N= 19 replicates	Sign of coefficients	Pr(> z )	Relative variable importance	Presence in the model of lowest AICc (57.6)
Mean fitness of founders	+	7.10 <sup>-3</sup> **	0.88	Yes
Variance of estimated fitness	+	0.9	0.19	-
Type II <i>Wolbachia</i> frequency	+	< 1.10 <sup>-4</sup> ***	0.99	Yes

**Table 4: Effect of phenotypic and genotypic characteristics of founders on the number of generations reached.** Summary of the model averaging results.

N= 19 replicates	Sign of coefficients	Pr(> z )	Relative variable importance	Presence in the model of lowest AICc (60.2)
<b>Allelic richness</b>	+	2.10 <sup>-3</sup> **	0.91	Yes
<b>Type II <i>Wolbachia</i> frequency</b>	+	3.10 <sup>-3</sup> **	0.89	Yes
<b>PC<sub>1</sub></b>	+	0.016 *	0.67	Yes
<b>PC<sub>2</sub></b>	-	0.47	0.08	-
<b>PC<sub>3</sub></b>	+	0.015 *	0.67	Yes
<b>PC<sub>4</sub></b>	-	0.39	0.08	-
<b>Total venom quantity</b>	-	0.85	0.06	-
<b>Venom variance (<math>V_T</math>)</b>	+	0.52	0.08	-

## Discussion

We have investigated here the short-term and long-term evolution of populations in a new environment, using the parasitoid *P. lounsburyi* imported to the laboratory for biological control purposes. The evolution of several characteristics (neutral markers, fitness-related traits, *Wolbachia* infections) was followed, with a main focus on venom composition which is likely a non-neutral trait.

A first interesting result was the occurrence of both long-term and short-term changes of venom composition in populations introduced in a drastically different environment (including a different host). Long-term evolution was evidenced by comparing populations maintained in laboratory conditions for more than 100 generations after their collection in Kenya and South Africa with field populations recently collected in the same sites. Short-term evolution was tested by monitoring venom changes in small experimental populations. Repeatable variation among populations was observed for venom but not for microsatellite markers that estimate neutral variation. This demonstrated that venom changes were not random and that venom was likely involved in adaptation of the introduced populations. A further argument was that 7 out of the 35 protein markers (reference bands) studied were detected as at least partially heritable, based on a significant mother-daughter regression. To our knowledge, this is the first demonstration of the heritability of parasitoid venom components. Some variation patterns were however difficult to explain. Notably, we observed that for each replicate, changes between  $G_0$ - $G_1$  were negatively correlated to changes between  $G_1$ - $G_2$ , themselves being negatively correlated to changes between  $G_2$ - $G_3$ . This challenged the interpretation that experimental results are due to selection on venom composition, since the direction of selection is not expected to change between generations. However, this unexpected pattern was also observed for microsatellite frequencies and *Wolbachia* infections. Several scenarii may explain this result, such as a strong heterogamy, an antagonistic selection between the two sexes, or an effect of *Wolbachia* that would explain the stronger pattern observed for this trait compared to microsatellites and venom. Two scenarii involving *Wolbachia* can be proposed based on bi- or unidirectional cytoplasmic incompatibilities. We describe a possible scenario involving *Wolbachia* and explaining these results in Appendix S3.

A second main result was that venom composition impacted the individual fitness in the introduced populations, which further supports the adaptive role of venom. Homozygosity at microsatellite loci also negatively impacted individual fitness, as expected from the

inbreeding depression occurring in the small experimental populations. These analyses also revealed that the naturally occurring venom variability induced a standard deviation of fitness in laboratory of approximately 4.4. This suggests either a high natural variability of fitness associated with the high variability of venom composition, or the occurrence of strong modifications of selection pressures on venom composition under laboratory conditions. This could have occurred in two ways. The optimal venom composition may have changed as a consequence of new selection pressures, hence making founders maladapted. Alternatively, the venom composition may have changed in the new environment, as a consequence of some plasticity, making it maladapted. Altogether, we show here that there is an important natural variation in the level of pre-adaptation to the studied environmental change.

A last result is that the fitness of the founder populations ( $G_0$ ), as well as their venom composition, *Wolbachia* infections and allelic richness were identified as factors affecting the time until population extinction. These combined effects of fitness of founders and venom composition (that also affect fitness) reveal that various level of pre-adaptation of venoms to the environmental change exist in the natural environment and is strong enough to affect extinctions dynamics. For *Wolbachia*, we detected a positive effect of the frequency of *Wolbachia* type II on the number of generations reached. As *Wolbachia* has no detected effect on the individual fitness, its impact on the extinction is likely due to cytoplasmic incompatibility (CI). *Wolbachia* type II frequency varied from 0 to 1 in founder populations which makes the expected frequencies of CI highly variable between replicates. CI might have increased inbreeding leading to faster extinction. The second most important variable was the allelic richness of founders that had a positive effect on the number of generations reached by the population. This effect of allelic richness either supports the hypothesis of inbreeding depression or that suggests that some adaptation may be required to reach a higher number of generations.

Finally, we also found a strong positive effect of the fitness of founder individuals on the time until extinction, confirming that the level of pre-adaptation is somewhat variable and that this affects the speed of extinction. All the results [venom composition and homozygosity impact the individual fitness; founder individual fitness as well as their characteristics (venom composition, allelic richness and *Wolbachia* infection) affect the time until extinction] are congruent and point towards an important role of the variability of parasitoid venom composition, which has never been described.

Although none of our experimental populations successfully established, we demonstrate here that the natural variability of parasitoid venom composition can influence parasitoids' success and establishment in new environments, an important feature in the context of global changes or host shift. Agosta *et al.* (2010) have underlined that parasite and parasitoid ability to shift to a new host should rely on some pre-adaptation to this host, which corresponds to the concept of ecological fitting (Janzen 1985; Harvey *et al.* 2012). Although our experimental design did not disentangle the effects of laboratory conditions and host shift, it revealed the occurrence of a large individual variability in terms of pre-adaptation of venom to the new environment, which is a prerequisite for natural selection. This suggests that the important evolvability of parasitoid virulence indeed relies, at least partly, on venom variability.

This evolutionary relevant venom variability has practical implications. For instance, the composition of venom should be an important trait to monitor along biological control programmes. It could also be used to evaluate the differentiation of populations during sampling of biological control agents, based on a non-neutral trait relevant for parasitoid efficiency. In addition, biological control may benefit from the selection of isofemale lines displaying the best venom composition for a given host or environment, for further mass-rearing and release. Finally, individuals released to the field can endure selection (e.g.: Phillips *et al.* 2008). A common practice in biological control programmes is to perform repeated releases which are probably useful to avoid Allee effect but can create migration load preventing adaptation to field conditions. In this context, comparison of venom composition of original individuals and recaptured individuals could be used to choose which parasitoid populations or isofemale lines to further release.

## BIBLIOGRAPHY

- Agosta SJ, Janz N, Brooks DR (2010) How specialists can be generalists: resolving the “parasite paradox” and implications for emerging infectious disease. *Zoologia*, **27**, 151–162.
- Aparicio JM, Ortego J, Cordero PJ (2006) What should we weigh to estimate heterozygosity, alleles or loci? *Molecular Ecology*, **15**, 4659–65.
- Asgari S (2012) Venoms from endoparasitoids. In *Parasitoid viruses: symbionts and pathogens*, Eds Nancy Beckage, Jean-Michel Drezen, pp. 217–231.
- Bartoń K (2013) MuMIn: Multi-model inference.
- Bates D, Maechler M, Bolker B, Walker S (2014) lme4: Linear mixed-effects models using Eigen and S4. R package version 1.1-7
- Benjamini Y, Yekutieli D (2001) The control of the false discovery rate in multiple testing under dependency. *Annals of Statistics*, **29**, 1165–1188.
- Benvenuto C, Cheyppé-Buchmann S, Bermond G, Ris N, Fauvergue X (2012) Intraspecific hybridization, life history strategies and potential invasion success in a parasitoid wasp. *Evolutionary Ecology*, **26**, 1311–1329.
- Bolstad BM, Irizarry R a, Astrand M, Speed TP (2003) A comparison of normalization methods for high density oligonucleotide array data based on variance and bias. *Bioinformatics (Oxford, England)*, **19**, 185–93.
- Bon MC, Jones W, Hurard C *et al.* (2008) Identification of 21 polymorphic microsatellites in the African parasitoid wasp, *Psytalia lounsburyi* (Silvestri) (Hymenoptera: Braconidae). *Molecular Ecology Resources*, **8**, 930–932.
- Borowiec N, Groussier-Bout G, Vercken E *et al.* (2012) Diversity and geographic distribution of the indigenous and exotic parasitoids of the olive fruit fly, *Bactrocera oleae* (Diptera: Tephritidae), in Southern France. *IOBC wprs Bulletin*, **79**, 71–78.
- Branca A, Dupas S (2006) A model for the study of *Wolbachia pipientis* Hertig (Rickettsiales: Rickettsiaceae)- induced cytoplasmic incompatibility in arrhenotokous haplodiploid populations: consequences for biological control. *Annales de la Société Entomologique de France*, **42**, 443–448.
- Burke GR, Strand MR (2014) Systematic analysis of a wasp parasitism arsenal. *Molecular Ecology*, **23**, 890–901.
- Burnham KP, Anderson DR (2004) Multimodel Inference. *Sociological Methods & Research*, **33**, 261–304.
- Charlat S, Hurst GDD, Merçot H (2003) Evolutionary consequences of *Wolbachia* infections. *Trends in Genetics*, **19**, 217–23.

- Cheyppe-Buchmann S, Bon MC, Warot S *et al.* (2011) Molecular characterization of *Psytalia lounsburyi*, a candidate biocontrol agent of the olive fruit fly, and its *Wolbachia* symbionts as a pre-requisite for future intraspecific hybridization. *BioControl*, **56**, 713–724.
- Colinet D, Deleury E, Anselme C *et al.* (2013a) Extensive inter- and intraspecific venom variation in closely related parasites targeting the same host: The case of *Leptopilina* parasitoids of *Drosophila*. *Insect Biochemistry and Molecular Biology*, **43**, 601–611.
- Colinet D, Mathé-Hubert H, Allemand R, Gatti JL, Poirié M (2013b) Variability of venom components in immune suppressive parasitoid wasps: from a phylogenetic to a population approach. *Journal of Insect Physiology*, **59**, 205–12.
- Le Corre V, Kremer A (2003) Genetic Variability at Neutral Markers, Quantitative Trait Loci and Trait in a Subdivided Population Under Selection. *Genetics*, **164**, 1205–1219.
- Coulon A (2010) genhet: an easy-to-use R function to estimate individual heterozygosity. *Molecular Ecology Resources*, **10**, 167–9.
- Daane KM, Sime KR, Wang X *et al.* (2008) *Psytalia lounsburyi* (Hymenoptera: Braconidae), potential biological control agent for the olive fruit fly in California. *Biological Control*, **44**, 79–89.
- Dedeine F, Vavre F, Fleury F *et al.* (2001) Removing symbiotic *Wolbachia* bacteria specifically inhibits oogenesis in a parasitic wasp. *Proceedings of the National Academy of Sciences USA*, **98**, 6247–52.
- Dion E, Zélé F, Simon J-C, Outreman Y (2011) Rapid evolution of parasitoids when faced with the symbiont-mediated resistance of their hosts. *Journal of Evolutionary Biology*, **24**, 741–50.
- Dray S, Dufour AB (2007) The ade4 Package: Implementing the Duality Diagram for Ecologists. *Journal of Statistical Software*, **22**, 1–18.
- Dupas S, Poirié M, Frey F, Carton Y (2013) Is parasitoid virulence against multiple hosts adaptive or constrained by phylogeny? A study of *Leptopilina* spp.(Hymenoptera: Figitidae)/*Drosophila* (Diptera: Drosophilidae) interactions. *Annales de la Société Entomologique de France*, **49**, 222–31.
- Efron B (1987) Better bootstrap confidence intervals. *Journal of the American Statistical Association*, **82**, 171–185.
- Engelstädter J, Hurst GDD (2009) The Ecology and Evolution of Microbes that Manipulate Host Reproduction. *Annual Review of Ecology, Evolution, and Systematics*, **40**, 127–149.
- Fauvergue X, Vercken E, Malausa T, Hufbauer R a (2012) The biology of small, introduced populations, with special reference to biological control. *Evolutionary applications*, **5**, 424–43.

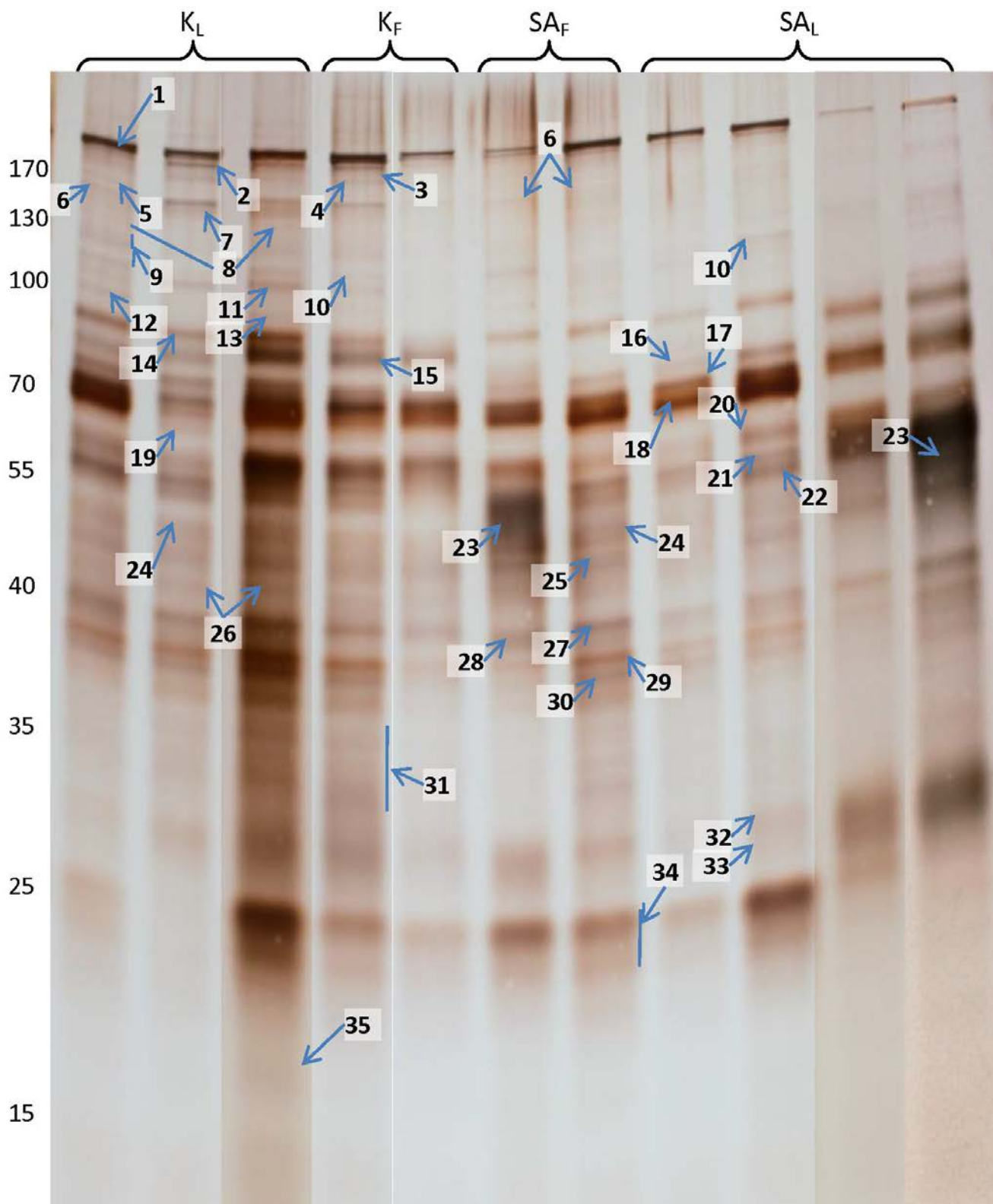
- Giudice JH, Fieberg JR, Lenarz MS (2012) Spending degrees of freedom in a poor economy: A case study of building a sightability model for moose in northeastern Minnesota. *The Journal of Wildlife Management*, **76**, 75–87.
- Grueber CE, Nakagawa S, Laws RJ, Jamieson IG (2011) Multimodel inference in ecology and evolution: challenges and solutions. *Journal of Evolutionary Biology*, **24**, 699–711.
- Harvey J a, Ximénez de Embún MG, Bukovinszky T, Gols R (2012) The roles of ecological fitting, phylogeny and physiological equivalence in understanding realized and fundamental host ranges in endoparasitoid wasps. *Journal of Evolutionary Biology*, **25**, 2139–48.
- Henter HJ (2003) Inbreeding depression and haplodiploidy: experimental measures in a parasitoid and comparisons across diploid and haplodiploid insect taxa. *Evolution*, **57**, 1793–803.
- Holderegger R, Kamm U, Gugerli F (2006) Adaptive vs. neutral genetic diversity: implications for landscape genetics. *Landscape Ecology*, **21**, 797–807.
- Janzen DH (1985) On Ecological Fitting. *OIKOS*, **45**, 308–310.
- Kalinowski ST (2005) Hp-Rare 1.0: a Computer Program for Performing Rarefaction on Measures of Allelic Richness. *Molecular Ecology Notes*, **5**, 187–189.
- Kirkpatrick M (2009) Patterns of quantitative genetic variation in multiple dimensions. *Genetica*, **136**, 271–284.
- Knopp T, Cano JM, Crochet P-A, Merilä J (2006) Contrasting Levels of Variation in Neutral and Quantitative Genetic Loci on Island Populations of Moor Frogs (*Rana arvalis*). *Conservation Genetics*, **8**, 45–56.
- Kuznetsova A, Bruun Brockhoff P, Haubo Bojesen Christensen R (2014) lmerTest: Tests for random and fixed effects for linear mixed effect models (lmer objects of lme4 package).
- Leinonen T, McCairns RJS, O'Hara RB, Merilä J (2013) QST–FST comparisons: evolutionary and ecological insights from genomic heterogeneity. *Nature Reviews Genetics*, **14**, 179–190
- Van Lenteren JC (2003) *Quality Control and Production of Biological Control Agents Theory and Testing Procedures* (JC van Lenteren, Ed.). CABI Publishing, Wageningen.
- Malausa J, Auguste-maros A, Cheyppé-buchmann S *et al.* (2010) Introductions of the African parasitoid *Psytalia lounsburyi* in South of France for classical biological control of *Bactrocera oleae*. *Integrated Protection of Olive Crops*, **59**, 163–170.
- Mathé-Hubert H, Gatti J-L, Poirié M, Malausa T (2013) A PCR-based method for estimating parasitism rates in the olive fly parasitoids *Psytalia concolor* and *P. lounsburyi* (Hymenoptera: Braconidae). *Biological Control*, **67**, 44–50.

- McCullagh P, Nelder JA (1989) *Generalized Linear Models, Second Edition (Monographs on Statistics and Applied Probability)*. Chapman & Hall/CRC.
- Moeltner K, Woodward R (2008) Meta-Functional Benefit Transfer for Wetland Valuation: Making the Most of Small Samples. *Environmental and Resource Economics*, **42**, 89–108.
- Morrissey JH (1981) Silver stain for proteins in polyacrylamide gels: a modified procedure with enhanced uniform sensitivity. *Analytical Biochemistry*, **117**, 307–10.
- Mrinalini, Aisha LS, Wright J *et al.* (2014) Parasitoid venom induces metabolic cascades in fly hosts. *Metabolomics*, 1–17.
- Orr D, Lahiri S (2014) Biological Control of Insect Pests in Crops. In: *Integrated Pest Management: Current Concepts and Ecological Perspective* , pp. 531–548. Elsevier Inc.
- Phillips CB, Baird DB, Iline II *et al.* (2008) East meets west: adaptive evolution of an insect introduced for biological control. *Journal of Applied Ecology*, **45**, 948–956.
- Poirié M, Carton Y, Dubuffet A (2009) Virulence strategies in parasitoid Hymenoptera as an example of adaptive diversity. *Comptes Rendus Biologie*, **332**, 311–320.
- Raymond M, Rousset F (1995) An exact test for population differentiation. *Evolution*, **49**, 1280–1283.
- Rouchet R, Vorburger C (2014) Experimental Evolution of Parasitoid Infectivity on Symbiont-Protected Hosts Leads To the Emergence of Genotype Specificity. *Evolution*, **68**, 1607–1616.
- Schaalje GB, McBride JB, Fellingham GW (2002) Adequacy of approximations to distributions of test statistics in complex mixed linear models. *Journal of Agricultural, Biological, and Environmental Statistics*, **7**, 512–524.
- Smyth GK (2005) Limma: linear models for microarray data. In: *Bioinformatics and Computational Biology Solutions Using R and Bioconductor* (ed Huber RG and VC and SD and RI and W), pp. 397–420. Springer, New York.
- Tortajada AM, Carmona MJ, Serra M (2009) Does haplodiploidy purge inbreeding depression in rotifer populations? *PloS One*, **4**, e8195.
- Vavre F, Fleury F, Varaldi J, Fouillet P, Boulétreau M (2000) Evidence for female mortality in Wolbachia-mediated cytoplasmic incompatibility in haplodiploid insects: epidemiologic and evolutionary consequences. *Evolution*, **54**, 191–200.
- Vercken E, Vincent F, Mailleret L *et al.* (2013) Time-lag in extinction dynamics in experimental populations: evidence for a genetic Allee effect? *The Journal of Animal Ecology*, **82**, 621–31.



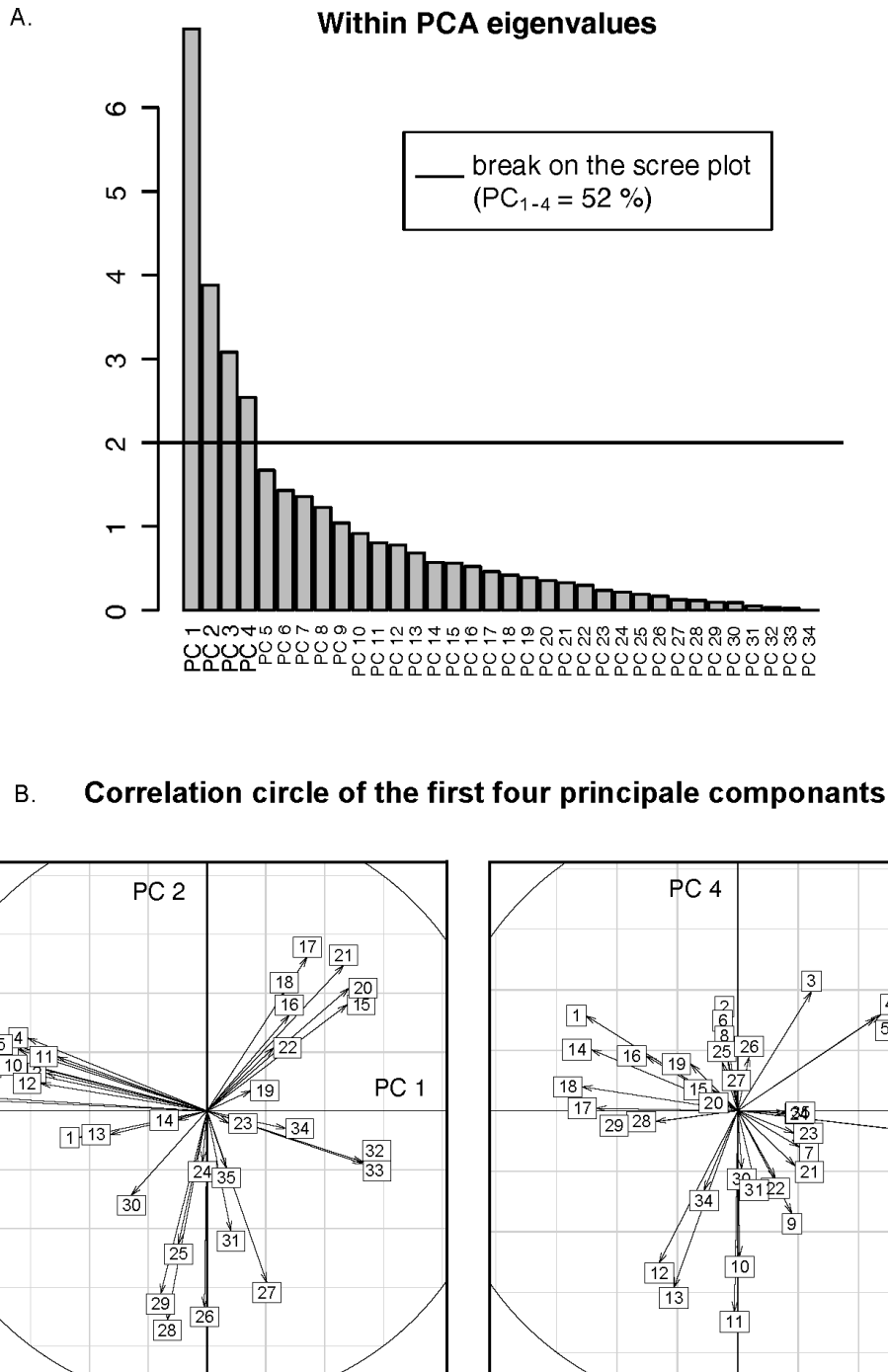
- Vander Wal E, Garant D, Festa-Bianchet M, Pelletier F (2013) Evolutionary rescue in vertebrates: evidence, applications and uncertainty. *Philosophical transactions of the Royal Society of London. Series B, Biological Sciences*, **368**, 20120090.
- Van Lenteren, J. C. (2003). Quality Control and Production of Biological Control Agents Theory and Testing Procedures. (J. C. van Lenteren, Ed.) (1st ed., pp. 1–341). Wageningen: CABI Publishing.
- Wang J (2004) Sibship reconstruction from genetic data with typing errors. *Genetics*, **166**, 1963–79.
- Williamson M, Fitter A (1996) The varying success of invaders. *Ecology*, **77**, 1661–1666.
- Yek SH, Slippers B (2014) Biocontrol opportunities to study microevolution in invasive populations. *Trends in Ecology & Evolution*, **29**, 429–30.

# Supplementary material



**Figure S1: Example of gels used to characterize the venom content.**

Arrows identify reference bands.



**Figure S2: Scree plot of the within PCA of the venom composition of founders.**

The venom variability of field sampled females (founders in the experimental evolution) was characterized by a within PCA (removal of the variability between countries). Part A. shows the scree plot. The horizontal line shows the break on the scree plot which was used to select the first four principal components for further analysis. These four principal components summarize 52 % of the variation of venom composition of founders. Part B. shows the correlation circles of these four principal components. Numbers at the end of arrows indicate the bands ID.

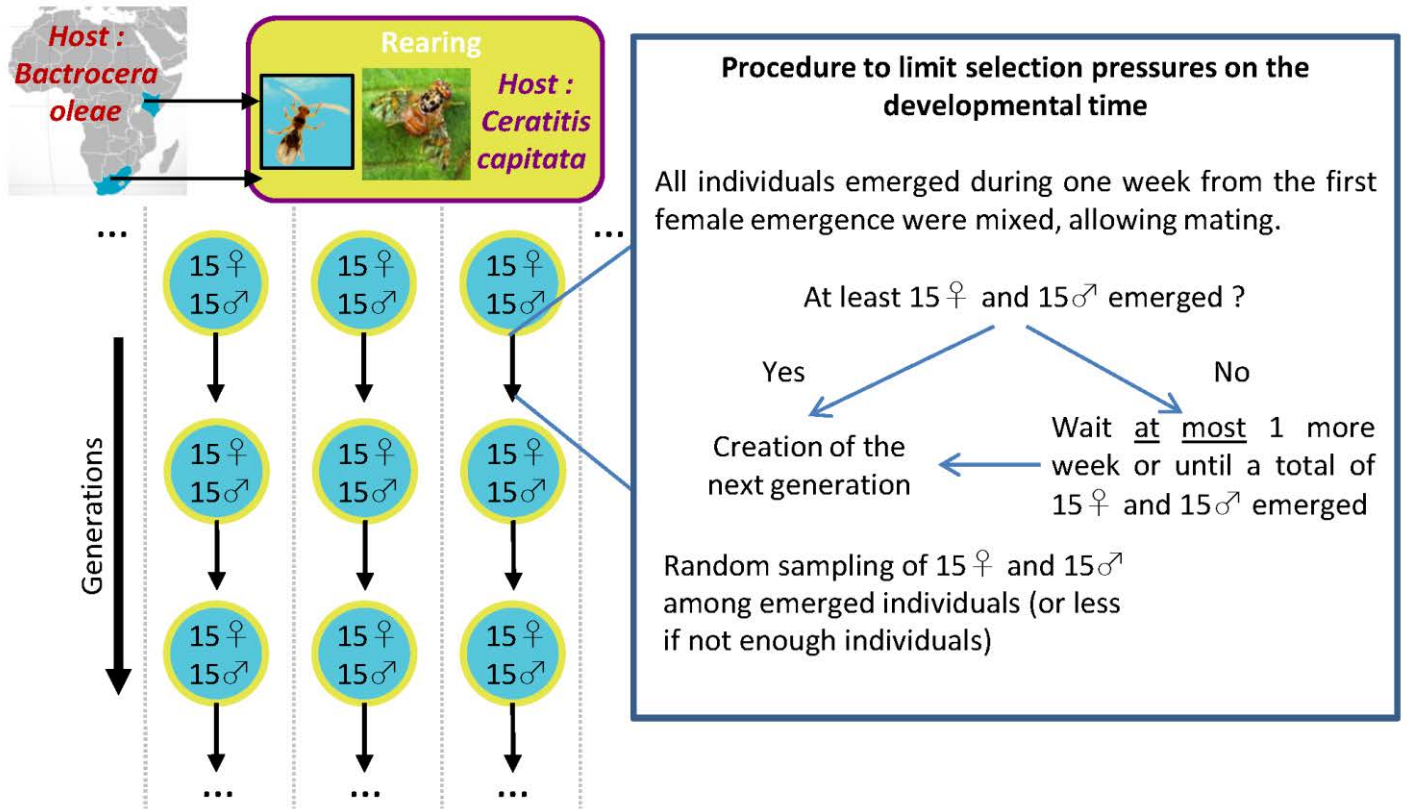
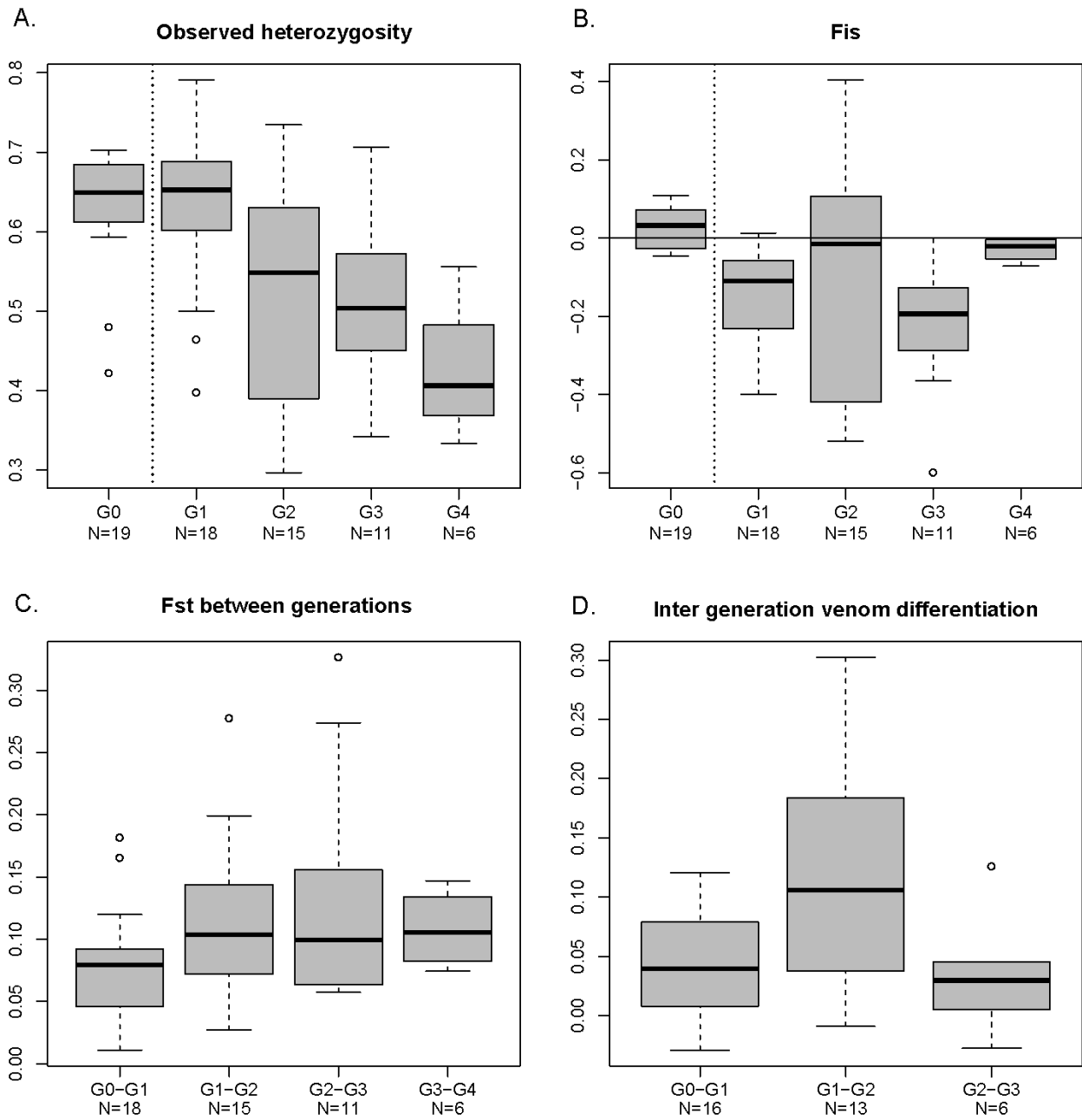


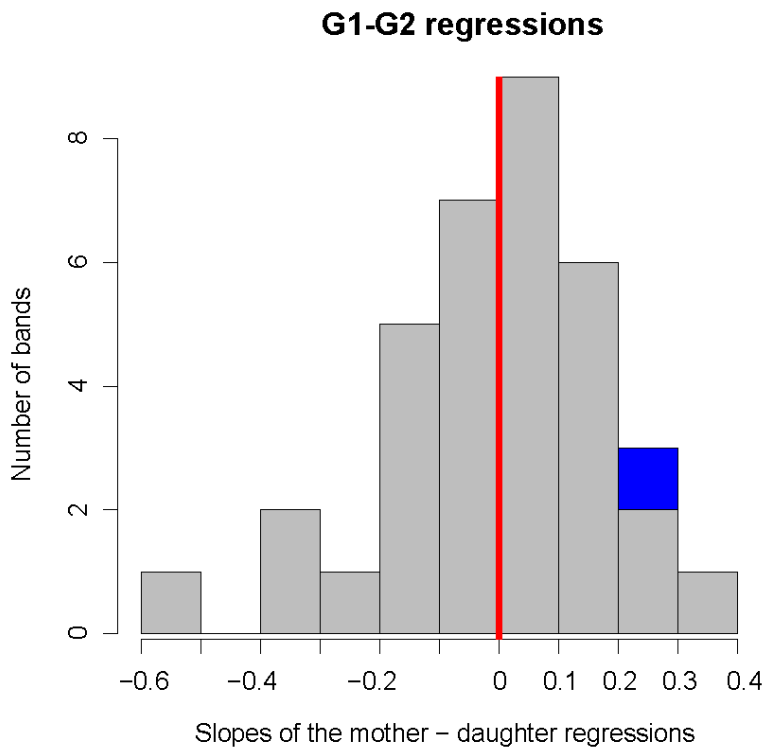
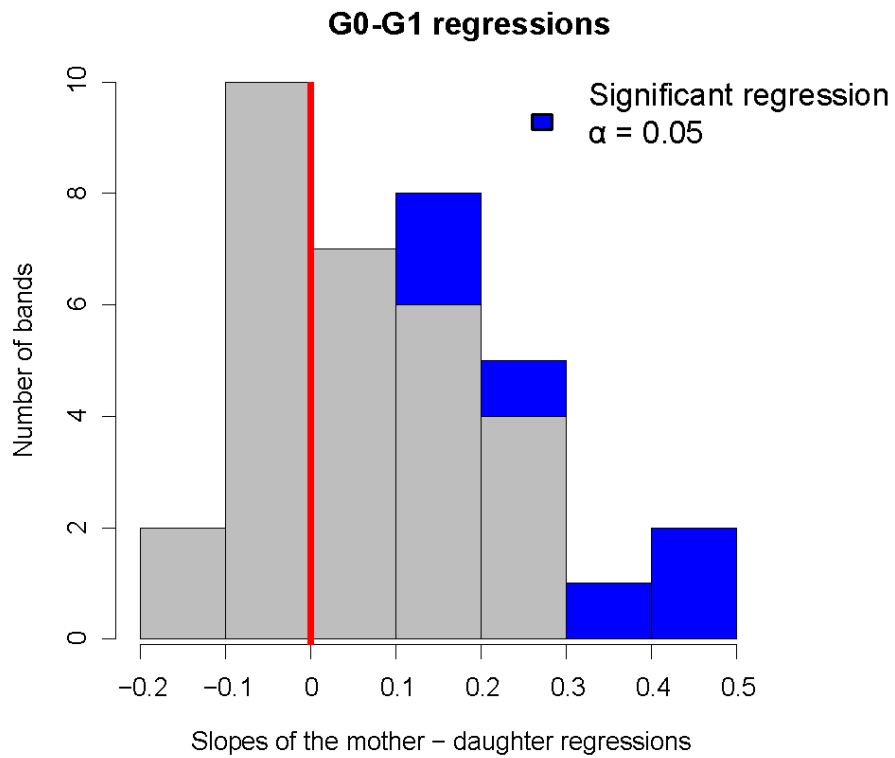
Figure S3: Experimental evolution design.



**Figure S4: Inter-generational genetic changes and differentiations.**

A. Evolution of the observed heterozygosity; B. Evolution of the  $F_{IS}$  estimated with Genepop on the web. Negative values indicate a heterozygote excess, which is the signature of a bottleneck. C. and D. show the inter-generational differentiation measured for microsatellites and venom, respectively.

A.

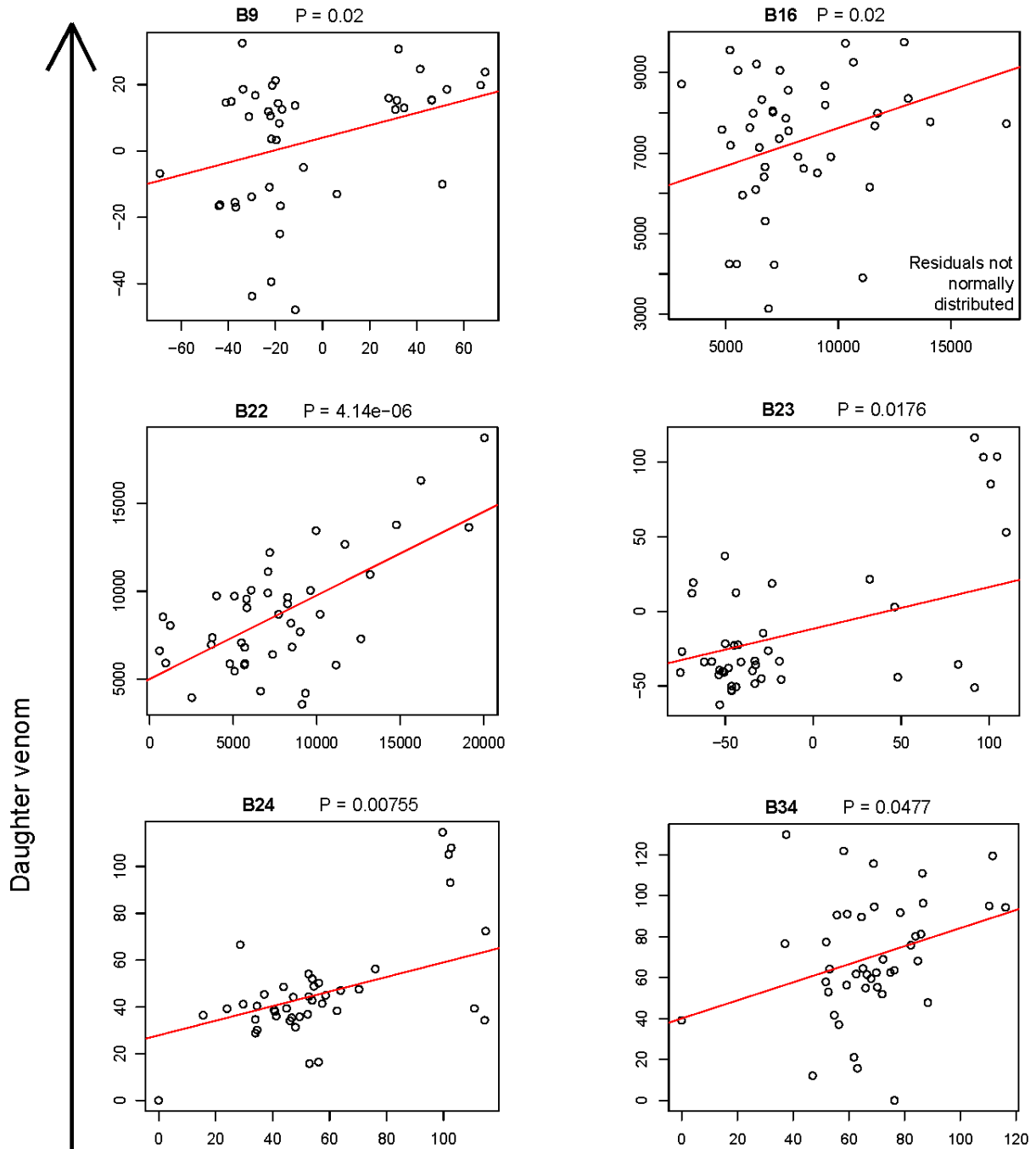


**Figure S5: Test of heritability of venom reference bands**

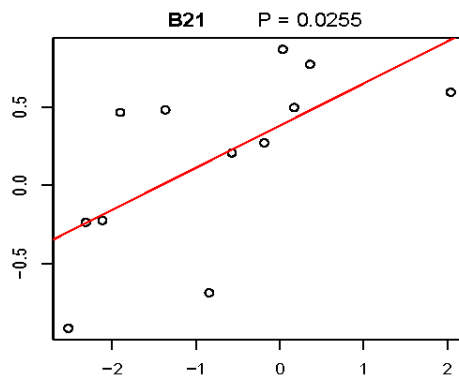
A. Distributions of coefficients of all mother-daughter regressions for the two studied generational changes. B. Significant mother-daughter regressions.

B.

Regressions G0-G1



Regressions G<sub>1</sub>-G<sub>2</sub>



— Model predictions



**Table S1: Characteristics of the 18 microsatellite loci in field-collected *Psytalia lounsburyi* females**

Conc. (μM)	Locus name	A	Ai				Significant deviation from HWE	Significant LD: Pop. and locus linked	Null allele freq.				Ho / He				Genotyping error rate (see § 6.a.)	
			SA (25)	K.G (10)	K.S (95)	K.SO (132)			SA (25)	K.G (10)	K.S (95)	K.SO (132)	SA (25)	K.G (10)	K.S (95)	K.SO (132)		
0.04	Plos4	9	2.2	3	3.6	3.67			0.02	0.04	0.19	0.14	0.28	0.33	0.42	0.70	0	
0.1	Plos3	26	4	4.8	3.9	4.5	SA; K.G K.S; K.SO	K.S Plos8 SA Plos10 SA Plos16	0.07	0.05	0.13	0	0.72	0.44	0.29	0.57	0.014	
0.2	Plos8	21	3.4	6.2	6.6	6.6		K.S Plos3 K.SO Plos2 SA Plos17	0.01	0.07	0	0	0.88	1.00	0.57	0.81	0.016	
0.04	Plos21	16	3.5	2.6	3.9	4.1		K.S Plos15 SA Plos6 SA Plos17	0.03	0.07	0	0.01	0.68	0.56	0.45	0.67	0.02	
Multiplex 1	0.04	Plos9	24	2	4	4.8	4.4	K.SO		0.09	0.25	0	0	0.28	0.67	0.37	0.42	0.02
	0.04	Plos18	7	1.9	4.4	3.8	3.6			0.21	0.53	0	0	0.48	0.78	0.41	0.36	0
	0.4	Plos15	26	3.6	6.1	6.7	6.5		K.S Plos21	0.02	0.05	0	0	0.64	0.89	0.60	0.84	0
	0.1	Plos2	12	1.7	4.7	4.5	4.4		K.SO Plos8	0.04	0.04	0	0.08	0.08	1.00	0.45	0.72	0.02
	0.2	Plos6	25	5.4	2.1	4.7	4.2		K.SO Plos12 SA Plos21 SA Plos7 SA Plos17	0.06	0.04	0	0	0.84	0.22	0.41	0.63	0
	0.04	Plos10	13	3.5	3.7	4.5	4.1		SA Plos3	0.10	0.16	0	0	0.72	0.67	0.41	0.57	0.03
	0.2	Plos7	22	6.5	2.6	3.5	3.5		SA Plos6	0.11	0.14	0.05	0.32	0.64	0.44	0.49	0.59	0
	0.1	Plos12	9	1	4	4.1	4.1	K.S	K.SO Plos6	0.39	0.14	0.65	0	0	0.11	0.21	0.29	0.12
Multiplex 2	0.2	Plos14	7	1.2	3.6	3.6	3.5			0.03	0.05	0	0	0.04	0.89	0.36	0.29	0
	0.1	Plos19	4	1.9	1	1.9	1.8		K.S Plos1	0	0.14	0	0.12	0.20	0	0.16	0.12	0
	0.2	Plos17	27	5	7.9	7.1	7.5		SA Plos8 SA Plos21 SA Plos6	0	0.04	0.06	0.02	0.76	0.78	0.53	0.46	0
	0.4	Plos5	9	1.2	3.5	3.5	3.9			0.02	0.05	0	0	0.04	1.00	0.38	0.36	0
	0.1	Plos16	17	2.9	5.3	6.6	6.2		SA Plos3	0.07	0.15	0.07	0	0.56	0.67	0.44	0.35	0
	1.2	Plos1	11	2.1	2.4	2.8	3.3		K.S Plos19	0.53	0.29	0.39	0.16	0.20	0.22	0.12	0.20	0
		Mean	16	2.9	4	4.4	4.4							0.45	0.59	0.39	0.50	0
		Total	285	53.5	72	80.1	79.8							0.46	0.60	0.70	0.70	0

From left to right: Primer concentration; Locus name (as in Bon *et al.* 2008); Number of alleles (A); Allelic richness (Ai; estimated as in El Mousadik & Petit (1996), implemented by

the R package PopGenReport (Adamack & Gruber 2014); Significant deviation from Hardy Weinberg (HWE) and linkage (LD) equilibria (both tested with genepop on the web version 4.2 (Raymond & Rousset 1995); Bonferroni corrected P-values); Null allele frequency (estimated with FreeNA; Chapuis & Estoup 2007); Observed and expected heterozygosities (HO / HE), Genotyping error rate. Grey loci have been removed from the analysis (except for pedigree reconstruction). Sample sizes (n) are provided in brackets in the title of each column. SA: South Africa; K.S. Kenya, Sirimon; K.G: Kenya, Gataragwa; K. SO: Kenya, Sirimon and Ontulili.

**Table S2: Field frequencies of Wolbachia infection types**

The frequency of infection types, estimated by PCR on sampled females, is indicated for each location. The number of tested females in indicated in brackets.

	Aposymbiotic	type I	type II	co-infected
SA (19)	32%	26%	32%	10%
K.G (8)				100%
K.S (39)		28%		72%
K.SO (123)		51%		49%

*Appendix S1: Details of the calculation of variance of the venom composition ( $V_T$ ), and the proportion of inter-group venom variance ( $V_{T\ inter}$ )*

The level of venom differentiation between a given set of groups was estimated by the proportion of inter-group variance. To compute this value, reference bands were standardized by their mean intensity, which was weighted to give the same weight to each group, whatever its size. The mean proportion of inter-group variance was not directly estimated by averaging this proportion over all bands because of multicollinearity. This would give more weight to dimensions to which many bands are correlated. We rather used the “total variance” to compute the “proportion of total inter-group variance” (hereafter  $V_T$  and  $V_{T\ inter}$ ). The “total variance” defined for the genetic covariance by Kirkpatrick (2009) was used here for covariance between protein bands. It corresponds to the sum of eigenvalues i.e. the sum of variances of each uncorrelated dimension.  $V_T$  is thus a good measure of the variance of a dataset of continuous variables. To compute  $V_{T\ inter}$ , we used the following formula:

$$V_{T\ inter} = 1 - \frac{\overline{V_{T\ intra}}}{V_{T\ all}} .$$

Where  $\overline{V_{T\ intra}}$  is the mean of the  $V_T$  of each group, and  $V_{T\ all}$  is the  $V_T$  estimated over all groups by weighting individuals to give the same weight to each group whatever its size. To compute  $V_{T\ all}$ , the weighted covariance matrix was obtained with the function “cov.wt” of the R package “stats”.

### *Appendix S2: Details of the pedigree inference*

This analysis was performed separately for each population and each generation (except G<sub>0</sub>) with genotypes of the previous generation as candidate parental genotypes.

The Colony software can handle null alleles and genotyping errors. Null allele frequencies at each locus were estimated separately for each population with FreeNA. To estimate the rate of genotyping errors, we used the following procedure: from the set of individuals genotyped twice because of the failure of the first amplification for several loci (32% of tested individuals), we selected 49 individuals (23 males and 26 females) which first and second amplification were both scored under GeneMarker by two different experimenters. This allowed estimation of the probability of error (due to amplification or data interpretation) for each locus (see Table S1). Null error rates were set up to 1% for Colony analyses.

Others Colony parameters used for all analyses were “updating allele frequencies” during runs, “dioecious” organisms, accounting for “inbreeding”, only one “very long” run, “full likelihood” method, estimated with a “very high precision”, with “co-dominant” markers, and a probability that candidate parents are included of 0.9 (see the Colony user manual for more details).

#### *Female offsprings*

Colony currently performs kinship inference for haplodiploids only with female offsprings and the two parental sexes. We thus performed two separate sets of analyses for female and male offsprings. For female offsprings, kinship relationship was inferred as described above, with two supplementary parameters: the system was considered “haplodiploid” and “polygamy” was allowed for both sexes.

#### *Male offspring*

In the haplodiploid system, Colony does not handle male offspring that are haploid. Thus, for male offspring, we considered a “diploid” system (homozygote male offsprings), with “monogamy” (brothers are always full-sib) and we only included female mothers as candidate parents. Although this approach is biologically irrelevant, it was expected to fit with our biological model since (i) kinship inference between haploid males and diploid mothers is a more straightforward problem than kinship inference in a diploid polygamous system, and (ii) we used this approach to infer kinship links at the most between 15 male offsprings and 15 candidate mothers using 18 microsatellite loci while Wang (2004) showed that sibships were

quite accurately inferred for haplodiploid species using only five microsatellite loci, with samples size ranging from 50 to 800.

#### *Validation of the approach*

A 95% confidence pedigree was reconstructed from kinship inference of male and female offspring (Marshall *et al.* 1998). This allowed us to infer (i) mother and father for respectively 53 % and 54 % of daughters (N = 621) and (ii) mother for 37 % of sons (N = 500). We could also identify paternal grandmother kinship links (that rely on kinship inference for both male and female offsprings) for a set of 14 granddaughters.

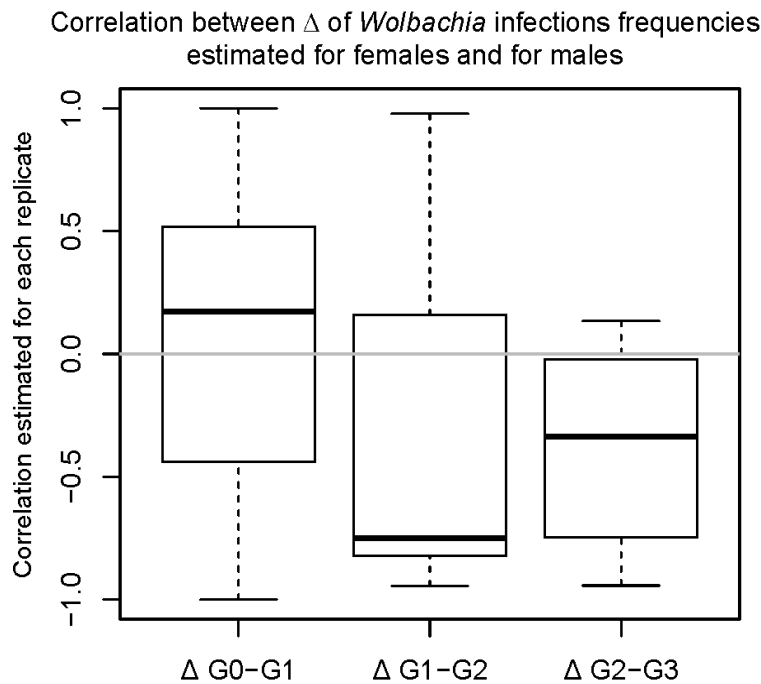
The reliability of the granddaughter – paternal grandmother kinship links was tested using a third pedigree inference with females only, based on the idea that in haplodiploids, males are the analogue of a male gamete in a monoecious hermaphrodite mating system without autogamy. Females of the (N – 1) generation were used as “candidate mothers” for daughters of the N generation while females of the (N – 2) generation were considered as “candidate fathers”. They indeed produce haploid sons of the (N – 1) generation by parthenogenesis. The system was considered as “diploid”, with “dioecious” polygamous parents. We choose the dioecious parameter because the colony output is easier to handle in this way. To make this analysis faster, we used only one “long run”, “pairwise-likelihood” method estimated with a “high precision” (see Colony user manual for details).

The two inference strategies led to the identification of the same 14 granddaughter – paternal grandmother kinship. The same analysis was performed with a confidence threshold of 70 %, allowing the inference of 32 granddaughters - paternal grand-mother kinship links, 81% being similar in the two inference strategies. This suggests that the inference performed for male offspring is valid.

*Appendix S3: Description of a scenario involving unidirectional incompatibilities.*

This scenario relies on either an energetic cost of *Wolbachia* or an imperfect vertical transmission rate. In this situation, in a population with only 50% of males and females infected, CI will increase the proportion of males among offspring of uninfected females. As a consequence, on the next generation, the proportion of infected females and the proportion of uninfected males will increase. Then, the increase of the proportion of uninfected males will make uninfected females less subject to CI. If in addition there is either an energetic cost induced by *Wolbachia* or an imperfect transmission rate, this will tend to re-equilibrate the proportions of infected and uninfected males and females making the population back toward the initial state. These fluctuations might reach a stable equilibrium, but in our system, drift may likely induce fluctuations from this hypothetical equilibrium state. Similar predictions can be derived for bi-directional incompatibilities.

According to these scenarios, at each generation, evolutions of *Wolbachia* frequencies in males and females should be negatively correlated. As shown in the figure bellow, this is what has been found for Deltas between  $G_1$ - $G_2$  and  $G_2$ - $G_3$ , but not for Deltas between  $G_0$ - $G_1$ .



Although, we did not find any publication that specifically describes this phenomenon, comparable patterns were observed in the two studies. The simulated frequency of artificially introduced *Wolbachia* first fluctuated before eventually stabilizing (Hancock *et al.*, 2011; Lines 1 of Figure 2). Hoffmann *et al.* (1998) observed strong fluctuations of *Wolbachia* frequencies in two out of the four studied populations of *Drosophila melanogaster*.

### **Bibliography of supplementary material**

- Adamack AT, Gruber B (2014) PopGenReport: simplifying basic population genetic analyses in R (S Dray, Ed.). *Methods in Ecology and Evolution*, **5**, 384–387.
- Bon MC, Jones W, Hurard C *et al.* (2008) Identification of 21 polymorphic microsatellites in the African parasitoid wasp, *Psytalia lounsburyi* (Silvestri) (Hymenoptera: Braconidae). *Molecular Ecology Resources*, **8**, 930–932.
- Chapuis M-P, Estoup A (2007) Microsatellite null alleles and estimation of population differentiation. *Molecular Biology and Evolution*, **24**, 621–31.
- Hancock P a, Sinkins SP, Godfray HCJ (2011) Population dynamic models of the spread of *Wolbachia*. *The American Naturalist*, **177**, 323–33.
- Hoffmann A, Hercus M, Dagher H (1998) Population dynamics of the *Wolbachia* infection causing cytoplasmic incompatibility in *Drosophila melanogaster*. *Genetics*, **148**, 221–231.
- Kirkpatrick M (2009) Patterns of quantitative genetic variation in multiple dimensions. *Genetica*, **136**, 271–284.
- Marshall TC, Slate J, Kruuk LE, Pemberton JM (1998) Statistical confidence for likelihood-based paternity inference in natural populations. *Molecular Ecology*, **7**, 639–55.
- El Mousadik A, Petit R (1996) High level of genetic differentiation for allelic richness among populations of the argan tree endemic to Morocco. *Theoretical and Applied Genetics*, **92**, 832–839.
- Raymond M, Rousset F (1995) An exact test for population differentiation. *Evolution*, **49**, 1280–1283.
- Wang J (2004) Sibship reconstruction from genetic data with typing errors. *Genetics*, **166**, 1963–79.

## ARTICLE 6

Comparative venomics of *Psytalia lounsburyi* and *P. concolor*, two olive fly parasitoid wasps, uncovers a new potential role for myrosinase.

En préparation

Colinet D., Mathé-Hubert H., et al. (co-premier auteurs)

*Caractérisation et comparaison de la composition des venins chez deux espèces proches du genre Psytalia. Comparaison avec d'autres espèces de Braconidae.*



## Présentation de l'article

L'article précédent a mis en évidence des changements rapides et répétables de l'intensité de certaines bandes protéiques de venin dans un nouvel environnement, ainsi que l'effet des variations d'intensité de certaines bandes sur la valeur sélective des individus au laboratoire.

Pour aller plus loin dans l'interprétation de ces résultats, il sera nécessaire d'identifier les protéines présentes dans les bandes détectées comme « évoluant » ou « ayant un effet sur la valeur sélective ». Il sera alors possible de chercher à comprendre le rôle de ces protéines dans l'interaction avec l'hôte et/ou l'environnement. Ce dernier travail n'était pas réalisable dans la période de thèse. En revanche, la caractérisation du contenu protéique global du venin a été entreprise pour deux espèces de *Psytalia* (*P. lounsburyi* et une espèce plus généraliste parasitant aussi *B. olea*, *P. concolor*) pour préparer cette étape. Cette caractérisation s'est appuyée sur une approche couplée de protéomique et de transcriptomique effectuée parallèlement aux expériences présentées précédemment. Elle a aussi permis de comparer le niveau de différence de composition du venin de ces deux espèces proches, *P. lounsburyi* et *P. concolor*, avec celui déjà observé entre deux espèces proches de *Leptopilina*.

Plusieurs résultats concernant les protéines présentes dans le venin de *Psytalia* sont intéressants. Ainsi, si un certain nombre ont déjà été retrouvé dans le venin d'autres parasitoïdes et si certaines (notamment des majeures) n'ont pas d'équivalent dans les bases de données ou de fonction définie, la présence d'une enzyme, la myrosinase, en grande quantité suggère pour la première fois une toxicité possible du venin sur l'hôte pouvant l'affaiblir via l'interaction de la myrosinase du parasitoïde avec les glucosinolates accumulés par l'hôte se nourrissant de tissus végétaux producteurs de glucosinolates. On observe aussi la présence d'une protéine à motif LRR, ayant un rôle potentiel dans la régulation de l'immunité (voie Toll), dont la forte variation d'intensité entre Afrique du Sud et Kenya constitue la principale différence entre ces deux populations de *Psytalia lounsburyi*.

Une apparente « redondance » du contenu du venin a été observée, avec plusieurs isoformes pour plusieurs des familles de protéines majeures, ce qui pourrait suggérer l'existence de mécanismes de maintien de la diversité fonctionnelle du venin, peut-être en réponse à la diversité physiologique des hôtes rencontrés.

Enfin, le niveau de divergence de composition du venin observé entre *Psytalia lounsburyi* et *Psytalia concolor* est inférieur à celui observé récemment entre les deux espèces de *Leptopilina* mais plus élevé que celui existant entre les souches virulente et avirulente de *L. boulandi* (ISm et ISy). Ceci pourrait indiquer une différence de variabilité du venin entre Braconidae et Cynipidae mais aussi être lié au temps écoulé depuis la divergence des deux espèces étudiées dans les deux taxa.

Le travail de mise en rapport des résultats de l'évolution expérimentale (Article 5) avec les résultats de cette approche vénomique est en cours mais n'était pas assez abouti pour être présentée dans ce manuscrit de thèse.

## **Comparative venomics of *Psytalia lounsburyi* and *P. concolor*, two olive fly parasitoid wasps, uncovers a new potential role for myrosinase.**

Colinet D, Mathé-Hubert H et al. (co-first authors)

En préparation

### **Introduction**

Hymenopteran parasitoids represent 10 to 20% of all insect species, being as such one of the largest group of venomous organisms. They develop on (ectoparasitoids) or inside (endoparasitoids) other arthropods, consuming their tissues and ultimately killing the host. They are thus important regulators of arthropod populations (Godfray, 1994; Quicke, 1997). One of the challenges faced by endoparasitoids is the immune response of the host that mainly consists in the formation of a multicellular, melanized capsule around the parasitoid egg (Carton *et al.*, 2008; Nappi, 2010). To ensure successful parasitism, endoparasitoids have thus evolved original strategies, the most common being the injection with the egg of various components that suppress host immunity and manipulate host physiology (i.e. metabolism, reproduction, molting) and behavior (i.e. movements, feeding habits). These components are often a complex mixture of ovarian and venom proteins (Asgari and Rivers, 2010; Colinet *et al.*, 2013a) but can also include virus-like particles (VLPs) (Gatti *et al.*, 2012) or wasp-specific polydnaviruses (PDVs) (Strand, 2012).

Broad studies involving transcriptomic and/or proteomic analyses have recently increased our knowledge of venom protein components in different parasitoid families (Burke and Strand, 2014; Colinet *et al.*, 2013b, 2014a; Crawford *et al.*, 2008; Dorémus *et al.*, 2013; Goeks *et al.*, 2013; de Graaf *et al.*, 2010; Parkinson *et al.*, 2003, 2004; Vincent *et al.*, 2010; Zhu *et al.*, 2010). The resulting picture evidences the diversity and complexity of parasitoid venom composition. Indeed, although some venom proteins, such as serine proteases and serine protease homologs, metalloproteases, acid phosphatases, or cystein-rich secretory proteins, are largely shared, others seems specific to a parasitoid group or species whereas some are only found in few phylogenetically distant species (Colinet *et al.*, 2013a). The large variation observed suggests a rapid evolution of parasitoid venom, based on mechanisms yet to be identified (Colinet *et al.*, 2013a).

The first large comparison of venom composition between closely related parasitoid species was only published recently (Colinet *et al.*, 2013b; Goeks *et al.*, 2013). Compared species were the *Drosophila* parasitoids *Leptopilina boulardi* and *L. heterotoma*

(Hymenoptera: Figitidae) which mainly differ in their host range, *L. heterotoma* being the more generalist (Fleury et al. 2009). Strikingly, these species had very few venom proteins in common and they did not share any abundant venom protein (Colinet et al., 2013b). In order to determine whether the variation of venom composition observed between *L. boulandi* and *L. heterotoma* reflects a venom diversity specific to this genus, or more generally to Figitid wasps, or similarly exists in other parasitoid taxa, we compared venom composition between the braconid wasps *Psytalia lounsburyi* and *P. concolor* that belong to the same complex of species in the Ichneumonoidea superfamily (Rugman-Jones et al. 2009). These species are biological control agents of the olive fruit fly *Bactrocera oleae* (Daane et al., 2011) that also differ in their host range. *P. lounsburyi* is rather specialized on *B. oleae* (Daane et al., 2011) whereas *P. concolor* successfully develops in at least 14 fruit fly species (Benelli et al., 2012). Since, no information was available on these species regarding virulence factors, we performed an in-depth venom analysis for *P. lounsburyi* and *P. concolor* using a combined transcriptomic and proteomic approach.

Comparison with large-scale venom data from other braconids, either associated with PDVs, *Chelonus inanitus* (Vincent et al., 2010) and *Microplitis demolitor* (Burke and Strand, 2014), or devoid of PDVs, such as *A. ervi* (Colinet et al., 2014a) was also expected to provide insights on how the use of various parasitism strategies may impact venom evolution and composition. This study will contribute to a better picture of the diversification of venom components at a short evolutionary scale, opening the way to the characterization of underlying mechanisms.

## **Material and methods**

### **1. Biological material**

*P. lounsburyi* (Pl) populations correspond to the South African (SA) and Kenyan (K) strains described by Benvenuto et al. (2012). They were reared on the *Ceratitis capitata* fruit fly under a 16:8h light/dark cycle at 22°C (Benvenuto et al., 2012). The *P. concolor* (Pc) population was collected in 2010 in Sicily (Italy) and reared for one generation on *C. capitata* before used in the study.

### **2. Light, fluorescence, and transmission electron microscopy**

For light and fluorescence microscopy, samples were examined using epifluorescent microscopes fitted with differential interference contrast (DIC) optics ("Imager.Z1", ZEISS, Germany). The "Axiocam MRm" black and white camera was used for acquisition of epifluorescent images and for black and white DIC images. Captured images were exported to

Adobe Photoshop for figure assembly and pseudocolorization. For transmission electron microscopy (TEM), TEM sample blocks were prepared from 10 ovaries or 10 venom glands per sample as follows. Immediately after dissection, samples were pooled into 100 µl of Ringer's saline (KCl 182 mM; NaCl 46 mM; CaCl<sub>2</sub> 3 mM; Tris-HCl 10 mM) into a centrifuge vial on ice. Following addition of the same volume of fixative (4% glutaraldehyde (Sigma) in 0.2 M sodium cacodylate buffer, pH 7.2), the vial was kept 24h at 4°C. Fixed samples were centrifuged (500g, 10 min) to pellet tissues and remove the fixative. Post-fixation was done with 2% osmium tetroxide in cacodylate buffer. Following dehydration in graded series of ethanol solutions, samples were embedded into Epon resin. Samples sections were cut with a diamond knife using a LKB ultramicrotome, mounted on copper grids, stained with uranyl acetate and lead citrate, and observed with a "Zeiss EM10CR" electron microscope at 80 kV.

### **3. Total RNA isolation and cDNA library construction**

The transcriptomic analysis was performed on 100 Pl and 100 Pc venom glands using Illumina RNA-Seq. To improve *de novo* assembly for Pl, we also generated Sanger sequences from 50 venom glands and 454 sequences from full insect bodies of 85 males and 85 females obtained from six siblings (Supplementary Figure 1). Pl and Pc venom glands were dissected in Ringer's saline and stored at -80°C. Total RNA was extracted using TRIzol Reagent (Invitrogen) according to manufacturer's instructions and its quality checked with an Agilent BioAnalyzer. cDNA library construction for Illumina RNA-Seq and 454 sequencing was performed by Beckman Coulter Genomics (USA). cDNA library used for Sanger sequencing was constructed from 1 µg of total RNA using the Creator SMART cDNA Library Construction Kit (Clontech). Ligation products were transformed into ElectroMax DH10 B *Escherichia coli* competent cells (Invitrogen).

### **4. Sequencing and assembly**

Illumina RNA-Seq sequencing (HiSeq 2000, 2x75pb), 454 sequencing (454 GS-FLX Titanium platform) and trimming were performed by Beckman Coulter Genomics. Quality of Illumina raw reads was controlled using FastQC software and reads were cleaned by removing low quality sequences and reads containing any N or adaptor sequences. For Sanger sequencing, a total of 2,000 clones were analysed by the Genoscope (CEA, EVRY, France) on an ABI sequencer using the standard M13 forward primer and BigDye terminator cycle sequencing kit (Applied Biosystems, Foster City, CA, USA). Sanger ESTs were then processed using SURF analysis pipeline tools as previously described (Colinet et al. 2013b).

For each species, we performed *de novo* transcriptome assembly using Velvet/Oases

assembler (Zerbino, 2010; Schulz et al., 2012) after the filtering process of illumina raw reads. The first assembly step used a multiple kmer approach with kmer size ranging from 45 to 65 (k=45, 55, 65 and coverage=2). A meta-assembly (kmeta=51, coverage=1) was then made using all previously obtained transcripts (minimum size of 100 bases) (Supplementary Figure 1). At both assembly steps, CD-HIT-EST was used to remove the shorter redundant transcripts that were entirely covered by other transcripts sharing more than 99% identity. Finally, a clustering of transcripts was performed using TIGR-TGICL. To improve the quality of the assembly for Pl, we included the cleaned 454 and Sanger sequences as long sequences (minimum size of 200 bases) or otherwise as short sequences, in addition to the short illumina reads.

## 5. Sequence annotation and analysis

To identify similarities with known proteins, the unisequences were compared to non-redundant NR (NCBI, 2014-07-07), UniProtKB/Swiss-Prot (SIB, 2014-01-22), insect predicted proteome databases (*Drosophila melanogaster* v5.46 and *Nasonia vitripennis* v1.2) and all braconid venom proteins found in UniProtKB, using blastx with a cut-off e-value of  $1e-7$ . Comparisons with previously published venom gland transcriptomes of *A. ervi* (Colinet et al. 2014a) and *Leptopilina* spp (Colinet et al. 2013) were performed using tblastx with a cut-off e-value of  $1e-7$ . Search for nudivirus/baculovirus-related specific genes was performed using tblastn with a cut-off e-value of  $1e-1$ .

ORF prediction and translation were performed using FrameDP software (Gouzy et al., 2009). Signal peptide prediction was obtained using SignalP (<http://www.cbs.dtu.dk/services/SignalP/>). Search for protein domains was achieved using PfamScan (<ftp://ftp.sanger.ac.uk/pub/databases/Pfam/Tools/>) and CD-Search against Conserved Domain Database (CDD) at NCBI (<http://www.ncbi.nlm.nih.gov/Structure/cdd/cdd.shtml>). Identification of leucine-rich repeats (LRR) in protein sequences was done using LRRfinder (<http://www.lrrfinder.com/>). Prediction of N-Glycosylation sites was achieved using NetNGlyc 1.0 Server (<http://www.cbs.dtu.dk/services/NetNGlyc/>). Multiple amino acid sequence alignments were obtained using MUSCLE (Edgar 2004).

Gene functions and GO terms were automatically assigned to the predicted proteins based on the identification of domains with PfamScan. Only the root domain of the hierarchical domain organization available from EBI was conserved. Comparison of GO terms between Pc and Pl unisequences and homogenization of the annotation level were performed using the GO slim.

## 6. Differential expression analysis

For each species, we used bowtie (Langmead et al. 2009) to map back all input trimmed Illumina raw reads (minimum size of 30 bases) to the assembled transcriptome with up to 3 nucleotides mismatches allowed. To compare the unisequence expression levels, the number of mapped raw reads for each transcript was normalized with the RPKM (reads per kilobase per million reads) method (Mortazavi et al. 2008) using the R package edgeR (Robinson et al. 2010).

## 7. SDS-polyacrylamide gel electrophoresis of venom and protein identification

The proteomic analysis was performed independently on Pc and Pl wasp venom (Supplementary Figure 1). Venom apparatus were dissected and glands collected in 25-50  $\mu$ l of Ringer's saline supplemented with a protease inhibitor cocktail (Sigma). Glands were opened to release the venom and centrifuged for 5 min at 500 g to remove residual tissues.

For isoelectric focusing (IEF), samples were prepared by boiling the protein solution for 5 min with 4% (v:v) of a denaturing solution (0.15 M dithioerythritol, 10% SDS). After cooling, the samples were mixed with an equal volume of a solution containing 9.2 M urea, 0.1 M dithioerythritol, and 2% CHAPS. IEF was performed using slab gel (modified from O'Farrell, 1975). Slab gels were made on glass tubes 14 cm in length (1.5 mm internal diameter) that were filled with 4% acrylamide, 9.2 M urea, 2% ampholytes (1% pH 3-10 [Pharmacia] and 1% pH 2-11 [Servalytes]), and 2% CHAPS. Isoelectric focusing was run in two steps: a first run at 20 mA, 0.1 W/tube, 700 V for a total of 10 000 V/h, followed by a second run at 20 mA, 0.1 W/tube, 3000 V for a total of 2000 V/h. For 1D gel electrophoresis, 6-16 % linear gradient SDS-PAGE was used. IEF gels were incubated with 4x Laemmli buffer containing  $\beta$ -mercaptoethanol and loaded on top of the SDS-PAGE. After separation, proteins were silver stained (Morrissey, 1981).

Identification of proteins by mass spectrometry was performed on 2D spots excised from the gels as previously described (Colinet et al. 2013; 2014a). MS/MS data analysis was performed with the Mascot software (<http://www.matrixscience.com>) licensed in house using the combined Pc and Pl unisequences and non-redundant NR (NCBI). Data validation criteria were (i) one peptide with individual ion score above 50 (Peptide score distribution. Ions score is  $-10\log(P)$ , where P is the probability that the observed match is a random event. Individual ions scores  $> 45$  indicate identity or extensive homology ( $p < 0.05$ )) or (ii) at least two peptides of individual ion score above 20 (corresponding to 1% probability that a peptide spectrum match is a random event). The mascot score was calculated as  $-10\log(P)$ . The calculated FDR (based on an automatic decoy database search) ranged from 0 to 1.4% depending of the

individual gel analysis. Mascot was searched with a fragment ion mass tolerance of 0.30 Da and a parent ion tolerance of 0.30 Da. Carbamidomethyl of cysteine was specified in Mascot as a fixed modification and Oxidation of methionine as a variable modification. The maximum missed cleavage authorized was 2.

## **Results and discussion**

### **1. Structure of the *Psytalia* venom apparatus**

The venom apparatus of braconids is typically composed of gland filaments (which secrete the venom), a venom reservoir, and a venom duct that extends into the ovipositor (Figure 1). Only a moderate degree of variation has been observed in the venom apparatus anatomy within the Opiinae (Quicke et al., 1997). The venom apparatus of *P. lounsburyi* and *P. concolor* are rather similar in structure, with a relatively large and multi-lobed venom gland, each lobe corresponding to an envelop limited by a thick layer of tissue, filled with a large volume of venom (Figure 1A, B, C). The gland lobes join together at their base where the ovoid shaped reservoir is laterally connected. The reservoir is composed of a large muscular layer surrounding a small internal volume of venom, suggesting it may serve mainly as a “pump” for injecting the venom at the time of oviposition and not as a storage organ. The reservoir also shows internal structures that form intricate spirals. These structures may serve to maintain the shape of the reservoir, like spiral springs, passively counteracting the muscular contraction. At the base of this apparatus, we also observed a "round gland" filled with large vesicles. This gland was previously described in both species (Quicke et al., 1997) and is more visible in *P. concolor* (Figure 1C) than in *P. lounsburyi* (perhaps because it may detach during dissection). Although its role is unknown, this gland may be the equivalent of the Dufour's gland present in Hymenopteran. Interestingly, we observed that both this gland and the intima spirals from the reservoir are highly autofluorescent (Figure 1D). This green emission suggests the presence of universal cellular fluorophores such as NAD(P)H and flavins, pigments or cuticular compounds that autofluoresce (Lee et al., 2009, and refs therein).

### **2. Comparison of electrophoretic profiles of *Psytalia* venom proteins**

The *P. lounsburyi* South-African (Pl<sub>SA</sub>) and Kenyan (Pl<sub>K</sub>) strains and *P. concolor* (Pc) venom samples were analyzed by 2D gel electrophoresis (Figures 2 and 3). Although venom was prepared from more than 50 individuals per gel, only 50 to 100 spots were clearly visible after silver staining. They range from 10 to more than 120 kDa and have a 4 to 8.5-9 pI (acidic from basic sides). Some close spots formed series or train representing polymorphic



forms of the same protein varying in their molecular mass and isoelectric point. The spots distribution was quite similar between  $PI_{SA}$  and  $PI_K$  (Figures 2A and 2B) although the gel separation was slightly different on the gel shown (as indicated by the molecular weight standards position). This probably explains why the large spots under 10 kDa, more or less intense in the  $PI_K$  gels, were not visible for the  $PI_{SA}$  strain. The largest difference between the two strains was the spot 10 at 55 kDa, present in all gels in  $PI_{SA}$  but totally absent from the  $PI_K$  strain. Although similar groups of spots were observed at low Mw, 55 kDa and around 90-100 kDa between the two species, differences could be observed as well, more particularly in the 25-35 kDa range where series of spots with different pIs spread throughout the Pc gel (Figures 2 and 3).

### **3. Comparison of transcriptomic and proteomics results between *Psytthalia* wasps**

All the major spots on 2D electrophoretic patterns of PI and Pc venom, as well as a number of minor ones (117 spots in total for PI and 57 for Pc, from at least three different 2D gels per species) were excised, and tryptic peptides were analyzed by LC-MS-MS. In parallel, a transcriptomic analysis of the PI and Pc venom glands was performed, based on Illumina sequencing completed with 454 and Sanger sequencing for PI (Supplementary Figure 1). The assembly yielded a total of 16,943 and 16,360 unisequences for PI and Pc respectively (Supplementary Table 1). Data produced from sequencing and assembly suggested a similar quality of the transcriptomes, based on general features and similarity searches (Supplementary Table 1) as well as GO terms comparison (Supplementary Figure 2).

The integrated analysis of transcriptomic and proteomic data resulted in 38 and 37 unisequences found in proteomics for PI and Pc, among which a putative function was found for 26 and 30 unisequences respectively (Supplementary Tables 2 and 3). No peptide signal was predicted for some of the unisequences found in proteomics, such as actin-5C or glyceraldehyde-3-phosphate dehydrogenase 2, although the sequence was complete (Supplementary Tables 2 and 3). Since their detection in proteomics likely resulted from cell damage during venom collection, we therefore only considered as putative venom proteins the unisequences (i) found in proteomics in venom and (ii) predicted to be secreted or for which secretion could not be predicted due to the incompleteness of the sequence. This resulted in a total of 31 and 29 putative venom proteins for PI and Pc respectively (Table 1).

Interestingly, although a proteomic analysis of the reservoir allowed detection of some of the putative venom proteins (data not shown), most of the identified proteins had a predicted muscular function, such as actin or paramyosin. This further supports the role of the reservoir in Braconidae in pumping and injecting venom during oviposition, as previously

suggested for *A. ervi* (Colinet et al., 2014a).

Based on the combined analyses, we then compared the venom protein content between the *Psytalia* species. 45% and 41% of the proteins identified in Pl and Pc were shared between the species, respectively (Table 1 and Figure 4A and B). In comparison, less than 20% of venom proteins were shared between *L. bouleari* and *L. heterotoma* (Colinet et al., 2013b). Moreover, none of the abundant unisequences were found in common between *Leptopilina* wasps (Colinet et al., 2013b), whereas respectively 8 and 7 of the 11 Pl and 12 Pc most abundant proteins (RPKM > 50 and Mascot matches > 10) were shared between *Psytalia* species (Figure 4C and Table 1). Finally, a total of 18 Pl and 19 Pc venom proteins were found in common with other Braconidae (Figure 4A) compared to only 6 and 4 Pl and Pc unisequences shared with the Figitidae *L. bouleari* or *L. heterotoma*, respectively (Figure 4B).

#### 4. Identified venom proteins common or not to the *Psytalia* wasps

Putative venom proteins were described below and classified in (i) proteins found in the venom of both *Psytalia* species, (ii) proteins found in the venom of *P. lounsburyi* and (iii) proteins found in the venom of *P. concolor* only. Several proteins with low RPKM values and for which the N-terminal sequence was not complete were not considered since they were typical cellular proteins and only a few number of Mascot matches were found (Table 1).

##### 4.1. Identified proteins found in the venom of both *Psytalia* species

*Proteins of unknown function.* The best ranked Pl unisequence (Pl\_004867) and its homolog in Pc (Pc\_009390), based on RPKM values, were detected in intense spots (Figures 2 and 3) and corresponded to a high number of matches, suggesting that they are abundant in venom. Although the sequences were complete and predicted to contain a signal peptide, no similarities were found in databases and no function could be proposed. Six other unisequences coding for proteins of unknown function were detected in the venom of both *Psytalia* species (Table 1 and Supplementary Tables 2 and 3). Among these, we identified a family of five related proteins that share similarities with venom proteins of the Braconidae *C. inanitus* (Vincent et al., 2012) and *Microctonus* sp. (Crawford et al., 2008). Some of these proteins were detected in rather intense spots, such as Pl\_010740 in Pl and Pc\_010911 in Pc, suggesting that they are abundant in both wasps venom (Figures 2 and 3).

*Leucine-rich repeat protein.* Two and four unisequences encoding leucine-rich repeat (LRR) proteins were found in Pl and Pc, respectively (Table 1 and Supplementary Tables 2 and 3). One of these sequences (Pl\_009581) was found in high abundance in *P. lounsburyi* SA only (rank 2) and corresponded to spot 10, of the most intense spots in the Pl<sub>SA</sub> strain

(Figure 2B). The unisequences that were complete contain a N-terminal signal peptide suggesting the secretion of the proteins. They also contain 9 to 19 canonical LRR motifs similar to the LRR motif in Toll Like Receptors (TLRs). However, *Psytallia* predicted proteins only contain the LRR domain in contrast to the majority of TLRs that are multidomain proteins.

*Neprilysin-like.* Neprilysin-like (NEP) proteins are zinc-dependent metalloproteases (ectopeptidases) belonging to the M13 peptidase family. They are involved in the degradation of a number of regulatory peptides in the nervous or immune system of mammals (Turner et al., 2001) and insects (Isaac et al., 2009). Although typically membrane-bound, ectopeptidases such as NEP may also be shed from the membrane through a proteolytic process and found in the surrounding fluid (Antczak et al., 2001). Three and two unisequences encoding NEP-like proteins were found in PI and Pc respectively (Table 1 and Supplementary Tables 2 and 3), one of which found in high abundance (rank 8 and 37 and 47 peptide matches in the PI and Pc venom glands, respectively). NEP-like proteins were detected in the venom of the Braconidae *A. ervi* (Colinet et al., 2014a), *Microctonus hyperodae* (Crawford et al., 2008) and *M. demolitor* (Burke and Strand, 2014), as well as of the Figitidae *L. bouvardi* (Colinet et al., 2013b) and they were also found associated with the VLPs produced in the ovary of *V. canescens* (Asgari et al., 2002). Although the role of soluble ectopeptidases is still not understood, NEP-like proteins have been hypothesized to modulate the host immune system by degrading immune-specific peptides (Asgari et al., 2002).

Another zinc-dependent metalloprotease was found in each *Psytallia* wasp, with a low similarity between their sequences. They appeared to be weakly related to the reprolysin-like proteins identified in venom of *P. hypochondriaca* (Parkinson et al., 2002) and *Eulophus pennicornis* (Price et al., 2009). However, the sequences were not complete and the number of matches detected in the venom was rather low (Table 1 and Supplementary Tables 2 and 3).

*Myrosinase.* Peptides from major 2D spots at 55-60 kDa (spots 8-9-10 in *P. lounsburyi* and 6 in *P. concolor*) matched with unisequences with high RPKM values, indicating that they are among the main expressed genes in the venom glands (Table 1 and Supplementary Tables 2 and 3). The corresponding proteins contain a glycosyl hydrolase family 1 domain and they share a high similarity with myrosinase ( $\beta$ -thioglucoside glucohydrolase, EC 3.2.1.147) sequences in databases. Myrosinases are a family of enzymes present from bacteria to mammals that catalyze the hydrolysis of a class of compounds called glucosinolates. They play a central role in the glucosinolate-myrosinase system, one of the best-studied activated

plant defense system (Bones and Rossiter, 1996; Hopkins et al., 2009). Interestingly, some insects have co-opted this system to defend themselves against predators by sequestering plant-derived glucosinolates and producing their own myrosinase (Kazana et al., 2007; Winde and Wittstock, 2011; Beran et al., 2014).

The Pl and Pc myrosinase sequences (Pc\_001157 vs Pl\_002819) shared 97% identity, the Pl sequence being shorter since the 15 N-term amino acids were missing (Supplementary Figure 3). The Pc sequence seems to be full-length, starting with a predicted signal peptide of 18 residues, the mature protein being predicted to be soluble. The theoretical Mw of the mature protein is 56.5 kDa, very close to the observed spot position on 2D gels, suggesting no or no massive glycosylations although N-glycosylation sites were predicted (Supplementary Figure 3). However, post-translational modification(s) likely occur, modifying the pI and leading to several isoforms, since the proteins correspond to several spots. An alignment was performed between the *Psytalia* sequences, the well-described plant myrosinases from *Arabidopsis thaliana*, *Brassica napus*, and *Sinapsis alba* (mustard) and one myrosinase from the aphid *Brevicoryne brassicae* (Figure 5). Two of these sequences have been crystallized and their enzymatic sites described in detail (Burmeister et al., 1997; Husebye et al., 2005). The critical residues were all conserved in both Pl and Pc sequences, thus suggesting that the *Psytalia* myrosinase is a functional enzyme (Figure 5). The main differences between aligned sequences were observed among the  $\beta$ -glucosidases aglycon binding sites involved in the specificity of binding (Tamaki et al., 2014). This suggests that the type of glucosinolates targeted by the *Psytalia* myrosinase might be specific. Interestingly, a myrosinase was found in the venom of *M. demolitor* (Burke and Strand, 2014) and detected, although in low quantity, in a proteomics study of the venom apparatus of *A. ervi* (Colinet et al., 2014a).

*Calreticulin*. A protein with similarities with calreticulin was found in the venom of both *Psytalia* species (Table 1 and Supplementary Tables 2 and 3), although the number of peptidic matches was low (1 and 3 matches for Pl and Pc, respectively). Calreticulin is a calcium (Ca<sup>2+</sup>)-binding protein with multifunctional properties including chaperone functions (Michalak et al., 1999). This venom protein was shown to inhibit host cell encapsulation in *Cotesia rubecula* (Zhang et al., 2006) and *Pteromalus puparum* (Wang et al., 2013) although the mechanism is still unclear. Calreticulin appears to be largely shared among parasitoids since it was also found in the venom of *Microctonus aethioides* and *M. hyperodae* (Crawford et al., 2008), *N. vitripennis* (de Graaf et al., 2010), *H. didymator* (Dorémus et al., 2013), *L. bouvardi* and *L. heterotoma* (Goecks et al., 2013).

*Heat shock protein 70*. Heat shock proteins 70 (Hsp70) are a family of chaperones

with distinct sub-cellular localization and function (Daugaard et al., 2007). Although they are normally intracellular, a protein with similarities with Hsp70 proteins was identified in the venom of both *Psytalia* species (Table 1 and Supplementary Tables 2 and 3). The *Psytalia* sequence contains the C-terminal KDEL motif that normally prevents secretion of ER-resident proteins. However, a high number of matches were found in venom proteomics (24 and 43 matches for Pl and Pc, respectively) suggesting that the detection of the Hsp70 did not result from cell contamination. Interestingly, a Hsp70 protein was found in the venom of the parasitoid, *P. puparum* (Zhu et al., 2010) and a related protein was associated with the *C. rubecula* PDV particles (Asgari et al., 2003). However, their role in the parasitoid-host interaction has not been investigated.

*Protein disulfide isomerase.* Two different unisequences coding for protein disulfide isomerases (PDI) were identified in the venom of both *Psytalia* species (Table 1 and Supplementary Tables 2 and 3). PDIs are enzymes involved in the folding and stabilizing of nascent polypeptides in the endoplasmic reticulum (ER) through catalysis of disulfide bond formation and isomerization (Wilkinson and Gilbert, 2004). Although this protein is normally recycled back to the ER from the Golgi via its C-terminal KDEL motif, secreted PDIs can escape this turnover mechanism (Terada et al., 1995). Among parasitoids, PDIs have only been detected in the venom gland of *A. ervi* (Colinet et al., 2014a). These enzymes have a broad substrates specificity and are involved in the folding of toxin peptides in different venomous organisms (di Luccio et al., 2001; Safavi-Hemami et al., 2012).

*Enolase.* A protein with similarities with enolase, a key enzyme in cell metabolism which is also associated with virulence of several pathogens (Ghosh and Jacobs-Lorena, 2011), was found in low abundance in the venom of both *Psytalia* species (Table 1 and Supplementary Tables 2 and 3). Interestingly, an extracellular enolase was recently described in oviposition injecta from *A. ervi* (Nguyen et al., 2013) and enolase is also released by teratocytes surrounding the *A. ervi* embryo (Falabella et al., 2009). It was suggested that this enzyme plays an important role in the host regulation and nutritional exploitation of the host (Falabella et al., 2009).

*Serpin.* Serpins (serine protease inhibitors) are a large family of functionally diverse protease inhibitors. They share a conserved structural architecture with an exposed reactive center loop (RCL) of about 20 amino acids, which acts as bait for target serine proteases (Huntington, 2011). Interestingly, the involvement of a *L. boulardi* venom serpin in suppressing host immunity was previously demonstrated. LbSPNy indeed prevents melanization in the *Drosophila* host through inhibition of PO activation (Colinet et al., 2009).

More recently, serpins were described in the venom of the Braconidae *A. ervi* (Colinet et al., 2014a) and *M. demolitor* (Burke and Strand, 2014) and the Ichneumonidae *H. didymator* (Dorémus et al., 2013) but their role in parasitism success remains unknown. One unisequence encoding a serpin was found in low abundance in the venom glands of both *Psytalia* species (Table 1 and Supplementary Tables 2 and 3). Although the two unisequences shared 94% identity, only the Pc serpin was complete, the Pl unisequence lacking the N- and C-termini (Supplementary Figure 4). The Pc serpin contains a signal peptide, suggesting secretion of the corresponding protein, as well as the consensus hinge sequence essential for the conformational change involving the RCL and necessary to inhibit the target protease (Supplementary Figure 4).

#### 4.2. Proteins detected in *P. lounsburyi* venom only

*Proteins of unknown function.* Five different unisequences encoding proteins of unknown function were detected in *P. lounsburyi* venom only (Table 1 and Supplementary Table 2). The two sequences with the best RPKM values (PI\_011877 and PI\_014442) were found in one of the most intense 2D spot (Figure 2), suggesting that the corresponding proteins are abundant in the venom. The small size of the spot was in agreement with the low molecular weight predicted from both amino acid sequences (less than 10 kDa). As expected, no matching spot was detected in 2D gels of *P. concolor* venom (Figure 3). Abundant transcripts encoding low molecular weight toxin-like peptides were previously identified from *A. ervi* venom (Colinet et al., 2014a) but no toxin-like signature was found for the *P. lounsburyi* small venom proteins of unknown function.

*Esterase/lipase-like.* Two esterase and/or lipase like proteins, one sharing similarities with pancreatic lipases, the other with carboxylesterases, were detected in *P. lounsburyi* venom, although in low abundance (Table 1 and Supplementary Table 2). Proteins belonging to the same functional class are largely shared since they were previously found in the venom of other Braconidae, such as *C. inanitus* (Vincent et al., 2010), *Microctonus* sp. (Crawford et al., 2008) or *M. demolitor* (Burke and Strand, 2014), but also in the venom of *H. didymator* (Dorémus et al., 2013), *Leptopilina* sp. (Goecks et al. 2013) and *N. vitripennis* (de Graaf et al., 2010). The functions of these hydrolase enzymes in host-parasitoid interactions have not been investigated.

*Endoplasmin.* Endoplasmin, which belongs to the heat shock protein 90 family, is a molecular chaperone located in the ER and involved in the final processing and export of secreted proteins (Marzek et al., 2012). It was found in low abundance in *P. lounsburyi* venom with only 8 matches detected (Table 1 and Supplementary Table 2) but in a high

abundance in the venom of *A. ervi* (Colinet et al., 2014a). The *P. lounsburyi* sequence contains the C-terminal HDEL motif that normally prevents secretion of ER-resident proteins. However, the retention in ER is not absolute (Takemoto et al., 1992), thus suggesting that endoplasmic reticulum was not released in the venom by cell damage during venom collection but was secreted via the normal secretory pathway. Interestingly, endoplasmic reticulum has been associated as a chaperone with the secretion of pancreatic lipases (see above) and their further internalization by intestinal cells in rat (Bruneau et al., 2000). Endoplasmic reticulum might thus play a role in the secretion of the *P. lounsburyi* venom proteins as well as their transport and targeting of host cells.

#### 4.3. Proteins detected in *P. concolor* venom only

*Proteins of unknown function.* Two different unisequences encoding proteins of unknown function (Pc\_015919 and Pc\_012023) were detected in *P. concolor* venom only (Table 1 and Supplementary Table 3). Pc\_012023, with rank 5 based on RPKM values, was found in one of the most intense 2D spots (Figure 3), suggesting that the corresponding protein is abundant in venom. The small size of the spot (less than 15 kDa) indicates that it has a low molecular weight. As expected, no matching spot was detected in the 2D analysis of *P. lounsburyi* venom (Figure 2). Although the other unisequence, Pc\_015919, was better ranked based on RPKM values, the corresponding spot was less intense (Figure 3) and the number of detected matches was lower (Table 1 and Supplementary Table 3), indicating that the protein was less abundant in the venom. For both unisequences, the sequence was not complete and the presence of a signal peptide could not be assessed.

*Phospholipase A2.* Secreted phospholipases A2 (PLA2s) are a family of relatively stable enzymes that are commonly found in snake venoms with neurotoxic and myotoxic effects (Montecucco et al., 2008). The abundance of PLA2 in the venom of *P. concolor* is low with only 3 matches detected (Table 1 and Supplementary Table 3) and a corresponding spot with low intensity (Figure 3). This enzyme was recently detected in the venom of *M. demolitor* as well (Burke and Strand, 2014), but its function in the host-parasitoid interaction is still unknown.

*Annexin.* A total of 16 matches were found in *P. concolor* venom for one unisequence sharing similarities with annexins and for which a signal peptide was predicted (Table 1 and Supplementary Table 3). Annexins constitute a family of Ca<sup>2+</sup>-dependent lipid binding proteins believed to be engaged in membrane transport processes, although recent work suggests a more complex set of functions. Annexins normally lack signal sequences for secretion, but some members of the family have been identified extracellularly where they can

act as receptors (Moss and Morgan, 2004). To our knowledge, annexins have never been described in the venom of parasitoids. However, some data suggest that different mammalian parasite clades possess annexins with unique properties that can be secreted and are likely involved in host-parasite interactions and host immune-modulation (Gao et al., 2006; Hofmann et al., 2010). Moreover, some parasitic nematodes secrete an annexin-like effector into host root cells that may mimic plant annexin function during the parasitic interaction (Patel et al., 2009). At last, it has been shown that annexins are also involved in the binding and internalization of toxins in eukaryotic cells (Somarajan et al., 2014).

*Serine carboxypeptidase.* A protein with similarities with a retinoid-inducible serine carboxypeptidases was found in low abundance in the venom of *P. concolor* (Table 1 and Supplementary Table 3). Although classical serine carboxypeptidases hydrolyze a peptide bond at the C-terminal end of peptides and proteins, a related enzyme (Scpep1) that do not show proteolytic activity but is involved in other functions has been described in mouse (Kollmann et al., 2009; Pan et al., 2014). To our knowledge, serine carboxypeptidase was only identified in the venom of *M. demolitor* until now (Burke and Strand, 2014). Interestingly, serine carboxypeptidases have also been described as candidate virulence factors in several pathogens (Alvarez et al., 2012).

## **5. No VLP or PDV in *Psytalia* wasps**

The presence of VLPs within the secretory cells of the venom gland of *P. concolor* (previously named *Opius concolor*; Jacas et al., 1997) and *O. caricivora* (Wan et al., 2006) had been previously suggested. We then performed an electron microscopy study on the *P. concolor* venom gland (Figure 6A) and ovaries of both species (Figure 6B, C, D). We did not observe any VLPs or vesicular material resembling VLPs in the venom, nor PDV particles in the *P. lounsburyi* and *P. concolor* ovarian fluid close to the eggs. This suggests that previous observations might correspond to small viruses infecting the reproductive tract of the observed samples, as reported in other Hymenoptera (Reineke and Asgari, 2005). Accordingly, no transcripts sharing similarities with genes specific of nudiviruses, a sister group of baculoviruses from which PDVs of braconid wasps derive (Bézier et al., 2009), were found in Pl or Pc transcriptomes (data not shown). Although the absence of VLPs and PDVs in ovaries must be confirmed since ovaries were not specifically studied in our transcriptomic analysis, this supports the importance of venom protein components in successful parasitism of *Psytalia* species.



## Conclusions

Our knowledge of the nature and diversity of the venom composition of parasitoids has increased these last years thanks to large scale transcriptomics and/or proteomics studies (Burke and Strand, 2014; Colinet *et al.*, 2013b, 2014a; Crawford *et al.*, 2008; Dorémus *et al.*, 2013; Goeks *et al.*, 2013; de Graaf *et al.*, 2010; Parkinson *et al.*, 2003, 2004; Vincent *et al.*, 2010; Zhu *et al.*, 2010). However, very few published studies aimed at evaluating how far closely-related parasitoid species differ in their venom composition. A comparative transcriptomic analysis of *Microctonus* sp. putative venom factors evidenced expression of a similar set of genes in venom glands of the Braconidae *M. hyperodae* and *M. aethiopoulos* (Crawford *et al.*, 2008). However, comparison was restricted to a small number of genes (less than 10) and proteomics was performed for *M. hyperodae* only. More recently, we evidenced a remarkable difference in venom composition between the closely-related Figitidae *L. boulandi* and *L. heterotoma* (Colinet *et al.*, 2013b) that differ in their host range and in several aspects of the virulence mechanisms used to suppress their hosts immune defense. Strikingly, very few venom proteins were common to the two species, none of them being considered as abundant (Colinet *et al.*, 2013b). We show here that the protein composition of the venom of *P. lounsburyi* and *P. concolor*, that also differ in their host range, is much more similar with a majority of the main venom proteins abundant in both species. Whether the diversity of venom is generally lower in Braconidae compared to Figitidae or the extensive venom variation between *L. boulandi* and *L. heterotoma* specific of these species thus remains an open and interesting question.

Unfortunately, a majority of the most abundant unisequences, either common or specific to each *Psytalia* species, had no predicted function. It is thus difficult to hypothesize on how *P. lounsburyi* and *P. concolor* counteract the immune defense of their hosts and regulate their physiology, and whether they use similar mechanisms. Nearly all venom proteins for which a function was predicted had already been identified in the venom of another parasitoid. A remarkable exception is the identification of a myrosinase as one of the most abundant protein in the venom of both *Psytalia* species. Myrosinase enzymes, that use glucosinolates as a substrate, play a central role in the production of the vast array of secondary metabolites involved in plant defense against herbivores and pathogens (Bones & Rossiter, 1996; Hopkins *et al.*, 2009). Within plants, myrosinase and glucosinolates are separated in different compartments but they come into contact upon tissue damage. This leads to the degradation of glucosinolates in a variety of toxic secondary compounds such as isothiocyanates, thiocyanates and nitriles, a reaction that has been described as a functional

“mustard oil bomb” (Matile, 1980; Lüthy and Matile, 1984). Several of these hydrolysis-products have been shown to be repellent or toxic to insects, nematodes, fungi and bacteria but they also serve as volatile attractants for specialist herbivores as well as their parasitoids (Winde & Wittstock, 2011). Interestingly, a number of herbivore insects have evolved different strategies to counteract this defense system, notably by sequestering the plant-produced glucosinolates to prevent their breakdown (Optiz and Müller, 1989; Bridges et al., 2002; Pentzold et al., 2014). The main *Psytalia* hosts *B. olea* and *C. capitata* oviposit in developing olive and fruits which are known to produce a large quantity of different glucosinolate compounds (Romero et al., 2002; Kanakis et al., 2013). It is thus possible that fruit flies larvae use a similar mechanism of sequestering of fruits-derived glucosinolates to survive and develop within the fruit. The introduction of myrosinase inside the host larva through injection of venom by *Psytalia* species might produce a burst in toxic compounds that could weaken the host defenses and improve the parasitoid probability of success.

Finally, several venom proteins containing repeats of a LRR motif similar to the one of Toll-like Receptors (TLRs) were identified in the venom of each *Psytalia* species. TLRs proteins, that play a central role in immunity (Matsushima et al., 2007), are normally multidomain proteins, but proteins identified in *Psytalia* venom only contain the LRR domain. Interestingly, related venom proteins that loss all but the LRR domain were also recently described in *A. ervi*. They were suggested to act as scavengers for the host TLRs, thus impairing the host immune response via the Toll pathway (Colinet et al., 2014a). Interestingly, nearly all the *Psytalia* LRR proteins were found in low abundance, the only exception being one of the most abundant venom protein in the South African strain of *P. lounsburyi*. Since this protein was not detected in the venom of the Kenyan strain, intraspecific variation may occur in venom composition of *P. lounsburyi*, although at a lesser extent than in *L. boulardi* (Colinet et al., 2013b).

Overall this comparative study is a further demonstration that parasitoid venoms are complex mixture of proteins some of which largely shared among wasps and others unique to strains or species. The occurrence of multigenic families of venom proteins also shed light on the quick evolution of venom components through processes such as duplication that may allow to evolve new molecular functions that remained to be deciphered such as in the case of LRR proteins. One main challenge will be now to decipher the biological function of the identified venom proteins and their role in the parasitism success of *Psytalia* wasps. This might be performed using the RNAi technique, as RNAi-mediated complete extinction of a venom protein was recently evidenced in an endoparasitoid wasp (Colinet et al., 2014b).

## References

- Alvarez VE, Niemirowicz, GT, Cazzulo, JJ (2012) The peptidases of *Trypanosoma cruzi*: Digestive enzymes, virulence factors, and mediators of autophagy and programmed cell death. *Biochim Biophys Acta* 1824: 195-206.
- Antczak C, De Meester I, Bauvois B (2001) Ectopeptidases in pathophysiology. *Bioessays* 23: 251–260.
- Asgari S, Reineke A, Beck M, Schmidt O (2002) Isolation and characterization of a neprilysin-like protein from *Venturia canescens* virus-like particles. *Insect Mol Biol* 11: 477–485.
- Asgari S, Zhang G, Schmidt O (2003) Polydnavirus particle proteins with similarities to molecular chaperones, heat-shock protein 70 and calreticulin. *J Gen Virol* 84: 1165–1171.
- Asgari S, Rivers DB (2010) Venom proteins from endoparasitoid wasps and their role in host-parasite interactions. *Annu Rev Entomol* 56: 313–335.
- Benelli G, Gennari G, Canale A (2012) Host discrimination ability in the tephritid parasitoid *Psytalia concolor* (Hymenoptera: Braconidae). *J Pest Sci* 86, 245–251.
- Benvenuto C, Cheyppé-Buchmann S, Bermond G, Ris N, Fauvergue, X (2012) Intraspecific hybridization, life history strategies and potential invasion success in a parasitoid wasp. *Evol Ecol* 26: 1311–1329.
- Beran F, Pauchet Y, Kunert G, Reichelt M, Wielsch N, Vogel H, Reinecke A, Svato A, Mewis I, Schmid D, et al. (2014) *Phyllotreta striolata* flea beetles use host plant defense compounds to create their own glucosinolate-myrosinase system. *Proc Natl Acad Sci USA* 111: 7349–7354.
- Bézier A, Annaheim M, Herbiniere J, Wetterwald C, Gyapay G, Bernard-Samain S, Wincker P, Roditi I, Heller M, Belghazi M, Pfister-Wilhelm R, Periquet G, Dupuy C, Huguet E, Volkoff AN, Lanzrein B, Drezen JM (2009) Polydnaviruses of braconid wasps derive from an ancestral nudivirus. *Science* 323: 926–930.
- Bones AM, Rossiter JT (1996) The myrosinase-glucosinolate system, its organisation and biochemistry. *Physiologia Plantarum* 97: 194–208.
- Burke GR, Strand MR (2014) Systematic analysis of a wasp parasitism arsenal. *Mol Ecol* 23: 890-901.

- Burmeister WP, Cottaz S, Driguez H, Iori R, Palmieri S, Henrissat B (1997) The crystal structures of *Sinapis alba* myrosinase and a covalent glycosyl-enzyme intermediate provide insights into the substrate recognition and active-site machinery of an S-glycosidase. *Structure* 5: 663–675.
- Bridges M, Jones AME, Bones AM, Hodgson C, Cole R, Bartlet E, Wallsgrove R, Karapapa VK, Watts N, Rossiter JT (2002) Spatial organization of the glucosinolate-myrosinase system in brassica specialist aphids is similar to that of the host plant. *Proc Biol Sci* 269, 187–191.
- Carton Y, Poirié M, Nappi AJ (2008) Insect immune resistance to parasitoids. *Insect Sci* 15: 67–87.
- Colinet D, Dubuffet A, Cazes D, Moreau S, Drezen JM, Poirié M (2009) A serpin from the parasitoid wasp *Leptopilina boulardi* targets the *Drosophila* phenoloxidase cascade. *Dev Comp Immunol* 33: 681–689.
- Colinet D, Mathé-Hubert H, Allemand R, Gatti J-L, Poirié M (2013a) Variability of venom components in immune suppressive parasitoid wasps: from a phylogenetic to a population approach. *J Insect Physiol* 59: 205–212.
- Colinet D, Deleury E, Anselme C, Cazes D, Poulain J, Azéma-Dossat C, Belghazi M, Gatti J-L, Poirié M (2013b) Extensive inter- and intraspecific venom variation in closely related parasites targeting the same host: The case of *Leptopilina* parasitoids of *Drosophila*. *Insect Biochem Mol Biol* 43: 601–611.
- Colinet D, Anselme C, Deleury E, Mancini D, Poulain J, Azéma-Dossat C, Belghazi M, Tares S, Pennacchio F, Poirié M, Gatti J-L (2014a) Identification of the main venom protein components of *Aphidius ervi*, a parasitoid wasp of the aphid model *Acyrtosiphon pisum*. *BMC Genomics* 15: 342.
- Colinet D, Kremmer L, Lemauf S, Rebuf C, Gatti JL, Poirié M (2014b) Development of RNAi in a *Drosophila* endoparasitoid wasp and demonstration of its efficiency in impairing venom protein production. *J Insect Physiol* 63: 56–61.
- Crawford AM, Brauning R, Smolenski G, Ferguson C, Barton D, Wheeler TT, McCulloch A (2008) The constituents of *Microctonus* sp. parasitoid venoms. *Insect Mol Biol* 17: 313–324.
- Daane KM, Johnson M, Pickett C, Sime K, Wang XG, Nadel H, Andrews JW, Hoelmer K (2011) Biological controls investigated to aid management of olive fruit fly in California. *Calif Agric* 65: 21–28.
- Daugaard M, Rohde M, Jäättelä M (2007) The heat shock protein 70 family: Highly

- homologous proteins with overlapping and distinct functions. *FEBS Lett* 581: 3702–3710.
- Dorémus T, Urbach S, Jouan V, Cousserans F, Ravallec M, Demettré E, Wajnberg E, Poulain J, Azéma-Dossat C, Darboux I, Escoubas JM, Colinet D, Gatti J-L, Poirié M, Volkoff AN (2013) Venom gland extract is not required for successful parasitism in the polydnavirus-associated endoparasitoid *Hyposoter didymator* (Hym. Ichneumonidae) despite the presence of numerous novel and conserved venom proteins. *Insect Biochem Mol Biol* 43: 292–307.
- Edgar RC (2004) MUSCLE: multiple sequence alignment with high accuracy and high throughput. *Nucleic Acids Res* 32: 1792–1797.
- Fleury F, Gibert P, Ris N, Allemand R (2009) Ecology and life history evolution of frugivorous *Drosophila* parasitoids. *Adv Parasitol* 70: 3–44.
- Gao YJ, Yan HL, Ding FX, Lu YM, Sun SH (2006) Annexin B1 at the host–parasite interface of the *Taenia solium* cysticercus: Secreted and associated with inflammatory reaction. *Acta Tropica* 101: 192–199.
- Gatti J-L, Schmitz A, Colinet D, Poirié M (2012) Diversity of virus-like particles in parasitoids' venom: viral or cellular origin? In: Beckage NE, Drezen J-M (Eds.), *Parasitoid Viruses*. Academic Press, London, pp. 181-192.
- Ghosh AK, Jacobs-Lorena M (2011) Surface-expressed enolases of *Plasmodium* and other pathogens. *Mem Inst Oswaldo Cruz* 106: 85-90.
- Godfray HCJ (1994) *Parasitoids: Behavioural and Evolutionary Ecology*. Princeton University Press, Princeton.
- Goecks J, Mortimer NT, Mobley JA, Bowersock GJ, Taylor J, Schlenke TA (2013) Integrative approach reveals composition of endoparasitoid wasp venoms. *PLoS One* 8: e64125.
- de Graaf DC, Aerts M, Brunain M, Desjardins CA, Jacobs FJ, Werren JH, Devreese B (2010) Insights into the venom composition of the ectoparasitoid wasp *Nasonia vitripennis* from bioinformatic and proteomic studies. *Insect Mol Biol* 19: 11–26.
- Hofmann A, Osman A, Leow CY, Driguez P, McManus DP, Jones MK (2010) Parasite annexins - New molecules with potential for drug and vaccine development. *Bioessays* 32: 967–976.
- Hopkins RJ, van Dam NM, van Loon JJA (2009) Role of glucosinolates in insect-plant relationships and multitrophic interactions. *Annu Rev Entomol* 54: 57–83.
- Huntington JA (2011) Serpin structure, function and dysfunction. *J Thromb Haemost* 9: 26–

34.

- Husebye H, Arzt S, Burmeister WP, Härtel FV, Brandt A, Rossiter JT, Bones AM (2005) Crystal structure at 1.1Å resolution of an insect myrosinase from *Brevicoryne brassicae* shows its close relationship to  $\beta$ -glucosidases. *Insect Biochem Mol Biol* 35: 1311–1320.
- Isaac RE, Bland ND, Shirras AD (2009) Neuropeptidases and the metabolic inactivation of insect neuropeptides. *Gen Comp Endocrinol* 162: 8–17.
- Jacas JA, Budia F, Rodriguez-Cerezo E, Vinuela E (1997) Virus-like particles in the poison gland of the parasitic wasp *Opius concolor*. *Ann Appl Biol* 130: 587–592.
- Kanakis P, Termentzi A, Michel T, Gikas E, Halabalaki M, Skaltsounis A-L (2013) From Olive Drupes to Olive Oil. An HPLC-Orbitrap-based Qualitative and Quantitative Exploration of Olive Key Metabolites. *Planta Med* 79, 1576–1587.
- Kazana E, Pope TW, Tibbles L, Bridges M, Pickett JA, Bones AM, Powell G, Rossiter JT (2007) The cabbage aphid: a walking mustard oil bomb. *Proc Biol Sci* 274: 2271–2277.
- Kollmann K, Damme M, Deuschl F, Kahle J, D’Hooge R, Lüllmann-Rauch R, Lübke T (2009) Molecular characterization and gene disruption of mouse lysosomal putative serine carboxypeptidase 1. *FEBS Journal* 276: 1356–1369.
- Langmead B, Trapnell C, Pop M, Salzberg SL (2009) Ultrafast and memory efficient alignment of short DNA sequences to the human genome. *Genome Biol* 10: R25.
- Lee S, Brown RL, and Monroe W (2009). Use of confocal laser scanning microscopy in systematics of insects with a comparison of fluorescence from different stains. *System Entomol* 34, 10–14.
- di Luccio E, Azulay DO, Regaya I, Fajloun Z, Sandoz G, Mansuelle P, Kharrat R, Fathallah M, Carrega L, Estève E, Rochat H, de Waard M, Sabatier JM (2001) Parameters affecting *in vitro* oxidation/folding of maurotoxin, a four-disulphide-bridged scorpion toxin. *Biochem J* 358: 681–692.
- Lüthy B, & Matile P. (1984) The mustard oil bomb: Rectified analysis of the subcellular organisation of the myrosinase system. *Biochemie Und Physiologie Der Pflanzen* 179, 5–12.
- Marzec M, Eletto D, Argon Y (2012) GRP94: An HSP90-like protein specialized for protein folding and quality control in the endoplasmic reticulum. *Biochim Biophys Acta* 1823: 774–787.
- Mathé-Hubert H, Gatti J-L, Poirié M, Malausa T (2013) A PCR-based method for estimating

- parasitism rates in the olive fly parasitoids *Psytalia concolor* and *P. lounsburyi* (Hymenoptera: Braconidae). *Biol Control* 67: 44–50.
- Matile P (1980) “The Mustard Oil Bom”: Compartmentation of the myrosinase system. *Biochimie Und Physiologie Der Pflanzen* 175, 722–731.
- Matsushima N, Tanaka T, Enkhbayar P, Mikami T, Taga M, Yamada K, Kuroki Y (2007): Comparative sequence analysis of leucine-rich repeats (LRRs) within vertebrate toll-like receptors. *BMC Genomics* 8: 124.
- Michalak M, Corbett EF, Mesaeli N, Nakamura K, Opas M (1999) Calreticulin: one protein, one gene, many functions. *Biochem J* 344: 281e292.
- Montecucco C, Gutiérrez JM, Lomonte B (2008) Cellular pathology induced by snake venom phospholipase A2 myotoxins and neurotoxins: common aspects of their mechanisms of action. *Cell Mol Life Sci* 65: 2897-2912.
- Morrissey JH (1981) Silver stain for proteins in polyacrylamide gels: a modified procedure with enhanced uniform sensitivity. *Anal Biochem* 117: 307e310.
- Mortazavi A, Williams BA, McCue K, Schaeffer L, Wold B (2008) Mapping and quantifying mammalian transcriptomes by RNA-Seq. *Nat Methods* 5: 621–628.
- Moss SE, Morgan RO (2004) The annexins. *Genome Biol* 5: 219.
- Nappi AJ (2010) Cellular immunity and pathogen strategies in combative interactions involving *Drosophila* hosts and their endoparasitic wasps. *Invertebrate Surviv J* 7: 198–210.
- Nguyen TTA, Magnoli I, Cloutier C, Michaud D, Muratori F, Hance T (2013) Early presence of an enolase in the oviposition injecta of the aphid parasitoid *Aphidius ervi* analyzed with chitosan beads as artificial hosts. *J Insect Physiol* 59: 11–18.
- O'Farrell PH (1975) High resolution two-dimensional electrophoresis of proteins. *J Biol Chem* 250: 4007-4021.
- Opitz SEW & Müller C (2009) Plant chemistry and insect sequestration. *Chemoecology* 19, 117–154.
- Pan X, Grigoryeva L, Seyrantepe V, Peng J, Kollmann K, Tremblay J, Lavoie JL, Hinek A, Lübke T, Pshezhetsky AV (2014) Serine carboxypeptidase SCPEP1 and cathepsin A play complementary roles in regulation of vasoconstriction via inactivation of endothelin-1. *PLoS Genet* 10: e1004146.
- Parkinson N, Conyers C, Smith I (2002) A venom protein from the endoparasitoid wasp *Pimpla hypochondriaca* is similar to snake venom reprolysin-type metalloproteases. *J Invertebr Pathol* 79: 129–131.

- Parkinson NM, Conyers CM, Keen JN, MacNicoll AD, Smith I, Weaver RJ (2003) cDNAs encoding large venom proteins from the parasitoid wasp *Pimpla hypochondriaca* identified by random sequence analysis. *Comp Biochem Physiol C* 134: 513–520.
- Parkinson NM, Conyers C, Keen J, MacNicoll A, Smith I, Audsley N, Weaver R (2004) Towards a comprehensive view of the primary structure of venom proteins from the parasitoid wasp *Pimpla hypochondriaca*. *Insect Biochem Mol Biol* 34: 565–571.
- Patel N, Hamamouch N, Li C, Hewezi T, Hussey RS, Baum TJ, Mitchum MG, Davis EL (2009) A nematode effector protein similar to annexins in host plants. *J Exp Bot* 61: 235–248.
- Pentzold S, Zagrobelny M, Roelsgaard PS, Møller BL, Bak S (2014) The multiple strategies of an insect herbivore to overcome plant cyanogenic glucoside defence. *PLoS ONE* 9, e91337.
- Price D, Bell H, Hinchliffe G, Fitches E, Weaver R, Gatehouse J (2009) A venom metalloproteinase from the parasitic wasp *Eulophus pennicornis* is toxic towards its host, tomato moth (*Lacanobia oleracae*). *Insect Mol Biol* 18: 195–202.
- Quicke DLJ (1997) *Parasitic Wasps*. Chapman & Hall, London.
- Quicke DL, Achterberg K, Godfray HCJ (1997) Comparative morphology of the venom gland and reservoir in opiine and alysiine braconid wasps (Insecta, Hymenoptera, Braconidae). *Zoologica Scripta* 26: 23–50.
- Reineke A, Asgari S (2005). Presence of a novel small RNA-containing virus in a laboratory culture of the endoparasitic wasp *Venturia canescens* (Hymenoptera: Ichneumonidae). *J Insect Physiol* 51: 127-135.
- Robinson MD, McCarthy DJ, Smyth GK (2010) edgeR: a Bioconductor package for differential expression analysis of digital gene expression data. *Bioinformatics*, 26: 139–140.
- Romero C, Brenes M, García P, Garrido A (2002) Hydroxytyrosol 4-β- d-Glucoside, an Important Phenolic Compound in Olive Fruits and Derived Products. *J Agric Food Chem* 50, 3835–3839.
- Rugman-Jones, PF, Wharton, R, Noort, TV & Stouthamer, R (2009) Molecular differentiation of the *Psytalia concolor* (Szépligeti) species complex (Hymenoptera: Braconidae) associated with olive fly, *Bactrocera oleae* (Rossi) (Diptera: Tephritidae), in Africa. *Biological Control* 49: 17–26.
- Safavi-Hemami H, Gorasia DG, Steiner AM, Williamson NA, Karas JA, Gajewiak J, Olivera BM, Bulaj G, Purcell AW (2012) Modulation of conotoxin structure and function is



- achieved through a multienzyme complex in the venom glands of cone snails. *J Biol Chem* 287: 34288–34303.
- Schulz MH, Zerbino DR, Vingron M, Birney E (2012) Oases: robust de novo RNA-seq assembly across the dynamic range of expression levels. *Bioinformatics* 28: 1086–1092.
- Somarajan SR, Al-Asadi F, Ramasamy K, Pandranki L, Baseman JB, Kannan TR (2014) Annexin A2 mediates *Mycoplasma pneumoniae* community-acquired respiratory distress syndrome toxin binding to eukaryotic cells. *MBio* 5: e01497-14.
- Strand MR (2012) Polydnavirus gene products that interact with the host immune system. In: Beckage NE, Drezen J-M (Eds.), *Parasitoid Viruses*. Academic Press, London, pp. 149-161.
- Takemoto H, Yoshimori T, Yamamoto A, Miyata Y, Yahara I, Inoue K, Tashiro Y (1992) Heavy chain binding protein (BiP/GRP78) and endoplasmic reticulum chaperonin are exported from the endoplasmic reticulum in rat exocrine pancreatic cells, similar to protein disulfide-isomerase. *Arch Biochem Biophys* 296: 129–136.
- Tamaki FK, Textor LC, Polikarpov I, Marana SR (2014) Sets of covariant residues modulate the activity and thermal stability of GH1  $\beta$ -glucosidases. *PLoS One* 9: e96627.
- Terada K, Manchikalapudi P, Noiva R, Jauregui HO, Stockert RJ, Schilsky ML (1995) Secretion, surface localization, turnover, and steady state expression of protein disulfide isomerase in rat hepatocytes. *J Biol Chem* 270: 20410–20416.
- Turner A, Isaac R, Coates D (2001) The neprilysin (NEP) family of zinc metalloendopeptidases: genomics and function. *BioEssays* 23: 261–269.
- Vincent B, Kaeslin M, Roth T, Heller M, Poulain J, Cousserans F, Schaller J, Poirié M, Lanzrein B, Drezen J-M, Moreau SJM (2010) The venom composition of the parasitic wasp *Chelonus inanitus* resolved by combined expressed sequence tags analysis and proteomic approach. *BMC Genomics* 11: 693.
- Wan Z-W, Wang H-Y, Chen X-X (2006) Venom apparatus of the endoparasitoid wasp *Opius caricivora* Fischer (Hymenoptera: Braconidae): morphology and ultrastructure. *Microsc Res Tech* 69: 820–825.
- Wang L, Fang Q, Qian C, Wang F, Yu XQ, Ye G (2013) Inhibition of host cell encapsulation through inhibiting immune gene expression by the parasitic wasp venom calreticulin. *Insect Biochem Mol Biol* 43: 936–946.
- Wilkinson B, Gilbert HF (2004) Protein disulfide isomerase. *Biochim Biophys Acta* 1699: 35–44.

- Winde I, Wittstock U (2011) Insect herbivore counteradaptations to the plant glucosinolate-myrosinase system. *Phytochemistry* 72, 1566–1575.
- Zerbino (2010) Using the Velvet de novo assembler for short-read sequencing technologies. *Curr Protoc Bioinformatics* 31: 11.5.1–11.5.12.
- Zhang G, Schmidt O, Asgari S (2006) A calreticulin-like protein from endoparasitoid venom fluid is involved in host hemocyte inactivation. *Dev Comp Immunol* 30: 756–764.
- Zhu JY, Fang Q, Wang L, Hu C, Ye GY (2010) Proteomic analysis of the venom from the endoparasitoid wasp *Pteromalus puparum* (Hymenoptera: Pteromalidae). *Arch Insect Biochem Physiol* 75: 28–44.

## Figure legends

**Figure 1:** Microscopy observations of the venom apparatus of *Psytalia* species. *Light microscopy observations:* A, *P. lounsburyi* female complete venom apparatus formed by the multi-lobed gland (G), the reservoir (R) and the long ovipositor (Ov); B ; *P. lounsburyi* dissected venom gland showing the thick envelop formed by the gland tissue and the lateral branching of the reservoir at the base of the gland. C, bright-field micrograph of a *P. concolor* venom gland and reservoir and D; the same, overlaid with a fluorescence micrograph showing the green autofluorescence of the reservoir intima spirals and of the small round gland at the base of the apparatus. Bars = 100  $\mu\text{m}$ .

**Figure 2:** 2D-SDS-PAGE separation of *P. lounsbury* venom. Venom from 50 Pl<sub>SA</sub> (A) and Pl<sub>K</sub> (B) females were separated by IEF followed by 6-16% SDS-PAGE. Following silver staining, the major protein spots (numbered) were cut and analyzed by LC-MS-MS. The identification obtained by Mascot is indicated on the right table, with putative function when available. Mw standard positions are indicated on the left.

**Figure 3:** 2D-SDS-PAGE separation of *P. concolor* venom. Venom from 50 Pc females were separated by IEF followed by 6-16% SDS-PAGE. Following silver staining, the major protein spots (numbered) were cut and analyzed by LC-MS-MS. The identification obtained by Mascot is indicated on the right table, with putative function when available. Mw standard positions are indicated on the left.

**Figure 4.** Venn diagrams. A and B, number of venom proteins shared between *P. lounsburyi*, *P. concolor* and other Braconidae (A) or the Figitidae *L. bouleardi* and *L. heterotoma* (B). C, number of abundant venom proteins (RPKM > 50 and Mascot matches > 10) shared between *P. lounsburyi* and *P. concolor*.

**Figure 5.** Multiple sequence alignment of myrosinases. The ligands of the Zn<sup>2+</sup> ion in myrosinase are shown in purple. Residues of myrosinase involved in glucose-ring recognition are printed in white on a black background and those involved in aglycon recognition are underlaid in yellow. The catalytic nucleophile is printed in red and the position of the general acid/base in related O-glycosidases is printed in white on a red background. Color codes are conserved from the crystal structures of *Sinapis alba* myrosinase (Burmeister, et al., 1997). MyrosinasePc from *P. concolor* Pc\_001157; myrosinasePl from *P. lounsburyi* Pl\_002819; *Arabidopsis thaliana* beta-thioglucoside glucohydrolase (ACO95141); *Brevicoryne brassicae* thioglucosidase (AAL25999); *Sinapis Alba* Chain M, Myrosinase (1E4M\_M); *Brassica napus* Myrosinase (Q9STD7).

**Figure 6:** Search for VLPs and PDVs in the venom and ovaries of *Psytalia* species using

microscopy. A, electron microscopy observation of a transversal cut through a gland lobe showing a cell cytoplasm very rich in rough endoplasmic reticulum and the venom fluid. The empty space is due to the venom retraction during dehydration. No vesicles are observed in the size range of VLPs (between 50 to 100 nm). B, wholemounts of ovaries of *P. concolor* female formed by the egg tubes (ET), the egg reservoir (OR), the calyx (C) that joined together in the oviduct. Bar = 500  $\mu$ m. C and D, TEM micrographs of sections through the ovary region of the *P. lounsburyi* (C) and *P. concolor* (D) calyx region showing the egg chorion (Ch), the ovarian fluid (Fl) and the calyx cells. No PDV particles have been observed in cells or in the fluid surrounding the egg chorion. Bar = 500 nm.

**Supplementary Figure 1.** Schematic representation of the combined large-scale transcriptomic and proteomic approach. Picture; venom apparatus of *P. lounsburyi*.

**Supplementary Figure 2.** Distribution of the number of unisequences associated with GO terms for Pl and Pc venom gland transcriptomes.

**Supplementary Figure 3.** Pairwise sequence alignment of *P. concolor* Pc\_001157 and *P. lounsburyi* Pl\_002819. The predicted signal peptide is shown in red. Predicted N-glycosylation sites are printed in white on a purple background. \* identical amino acids; : conserved amino acids; . different amino acids.

**Supplementary figure 4.** Multiple alignment of serpin sequences. The *P. lounsburyi* and *P. concolor* serpins were aligned with *A. ervi* (JAC59136 and JAC59130), *M. demolitor* (GANH01000239), *H. didymator* (Burke and Strand, 2014) and *L. bouleardi* (ACQ83466) venom serpin sequences. Residues identical or similar are highlighted in black and grey, respectively. The signal peptide and hinge region found in *P. concolor* serpin sequence region are underlined in blue and red respectively.

**Table 1.** Putative Pl and Pc venom proteins classified according to RPKM values.

**Supplementary Table 1.** General features of the Pl and Pc transcriptomes and results of similarity searches.

**Supplementary Table 2:** Unisequences found in proteomics in *P. lounsburyi*.

**Supplementary Table 3:** Unisequences found in proteomics in *P. concolor*.

**Table 1.** Putative Pl and Pc venom proteins classified according to RPKM values. Ae, *Aphidius ervi*. Ci, *Chelonus inanitus*. Md, *Microplitis demolitor*. Mh, *Microctonus hyperodae*.

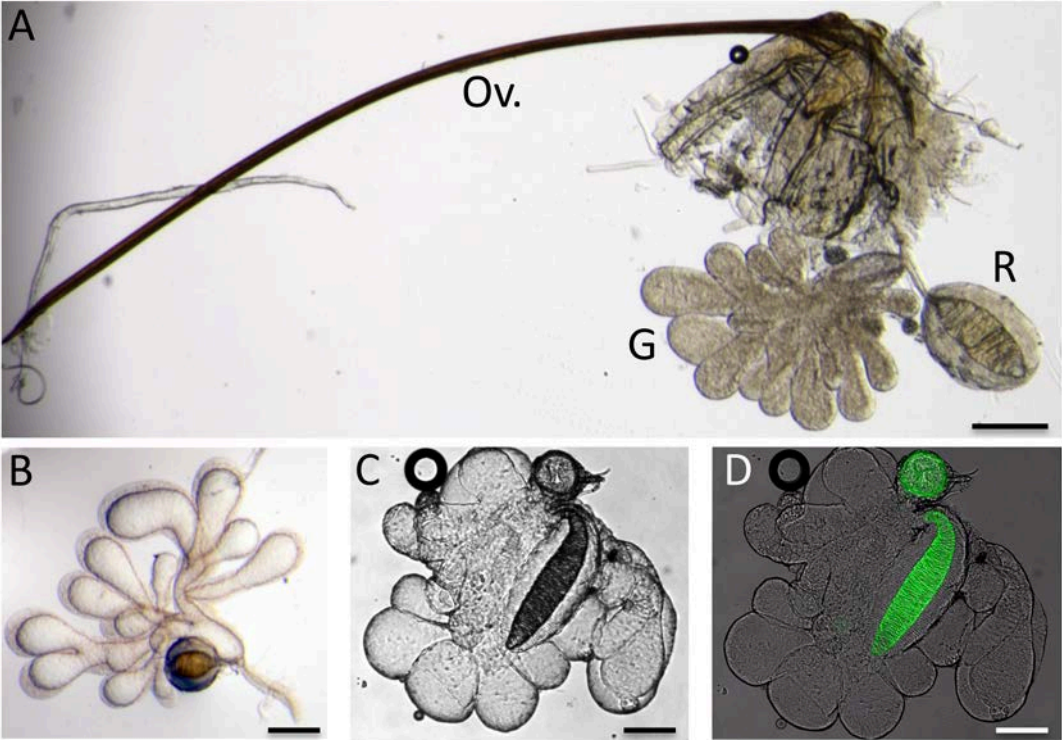
Rank	Sequence	RPKM	Mascot	Putative function	Signal peptide	Homolog in <i>P. concolor/lounsburyi</i>		Homolog in other Braconidae
						Sequence	Rank	
<i>P. lounsburyi</i>								
1	Pl_004867	1963.84	71		Yes	Pc_009390	3	
2	Pl_009581	1865.04	11	Leucine-rich repeat protein	Yes			Ae
3	Pl_011877	1538.27	54		Yes			
4	Pl_014442	816.50	10		?			
5	Pl_010740 <sup>a</sup>	738.87	104		Yes	Pc_014641	12	Ci, Mh
6	Pl_011340 <sup>a</sup>	691.22	37		Yes	Pc_010911	10	Ci, Md, Mh
7	Pl_002959	659.87	5		Yes			
8	Pl_006410	627.83	37	Neprilysin-like	Yes	Pc_006098	8	Mh
9	Pl_003816 <sup>a</sup>	574.51	33		Yes	Pc_013625	1	Ci, Mh
10	Pl_006199 <sup>a</sup>	476.04	153		Yes	Pc_014641	12	Ci, Mh
11	Pl_014571	360.78	93	Myrosinase	?	Pc_001157	7	Ae <sup>c</sup> , Md
12	Pl_010491	263.42	1	Calreticulin	?	Pc_015292	17	Mh
13	Pl_002333	242.50	90		Yes	Pc_006379	4	
14	Pl_014829	186.32	8	Zinc-dependent metalloprotease	?			
15	Pl_002212	143.39	3		Yes			
16	Pl_006057	135.90	1	Esterase/lipase-like	?			Ci, Md
17	Pl_013024	115.21	10	Neprilysin-like	?	Pc_006098	8	Mh
18	Pl_014734	85.45	24	Heat shock protein 70	?	Pc_008008	18	Ae <sup>c</sup>
19	Pl_002507	63.77	3	Protein disulfide-isomerase	Yes			Ae <sup>c</sup>
20	Pl_008373	40.85	8	Endoplasmic	Yes			Ae
21	Pl_003563 <sup>a</sup>	35.95	6		Yes			Ci, Md, Mh
22	Pl_011829	22.74	16	Protein disulfide-isomerase	Yes	Pc_010489	19	Ae <sup>c</sup>
23	Pl_001931	21.08	6	Puromycin-sensitive aminopeptidase <sup>b</sup>	?			
24	Pl_007984	17.02	2	Enolase	?	Pc_009146	21	
25	Pl_011015	6.13	5	Arginine kinase-like protein <sup>b</sup>	?			
26	Pl_010999	2.56	13		?			
27	Pl_009261	2.43	4	Esterase/lipase-like	?			
28	Pl_000063	2.28	14	Serpin	?	Pc_007867	24	Ae, Md
29	Pl_012461	2.02	6	Leucine rich repeat protein	?			Ae
30	Pl_013792	1.47	2	Neprilysin-like	Yes			Ae, Mh
31	Pl_004270	1.31	5	Glycogen phosphorylase <sup>b</sup>	?			
<i>P. concolor</i>								
1	Pc_013625 <sup>a</sup>	3110.46	59		Yes	Pl_003816	9	Ci, Md, Mh
2	Pc_015919	1626.40	12		?			
3	Pc_009390	1583.31	210		Yes	Pl_004867	1	
4	Pc_006379	1507.73	8		?	Pl_002333	13	
5	Pc_012023	1428.59	34		?			
6	Pc_012375	1326.30	8	Zinc-dependent metalloprotease	?			
7	Pc_001157	1196.52	84	Myrosinase	Yes	Pl_014571	11	Ae <sup>c</sup> , Md
8	Pc_006098	1178.46	47	Neprilysin-like	?	Pl_013024	17	Mh
9	Pc_014667 <sup>a</sup>	1152.41	9		Yes			Ci, Md, Mh
10	Pc_010911 <sup>a</sup>	947.92	71		Yes	Pl_011340	6	Ci, Md, Mh
11	Pc_002246	580.77	3	Phospholipase A2	?			Md
12	Pc_014641 <sup>a</sup>	441.52	57		Yes	Pl_006199	10	Ci, Mh
13	Pc_007330	360.78	16	Annexin	Yes			
14	Pc_009900	346.13	5	Serine carboxypeptidase	Yes			Md
15	Pc_014697	259.63	32	Protein disulfide-isomerase	Yes			Ae <sup>c</sup>
16	Pc_002889 <sup>a</sup>	243.19	2		Yes			Ci, Md, Mh
17	Pc_015292	236.32	3	Calreticulin	Yes	Pl_010491	12	Mh
18	Pc_008008	227.98	43	Heat shock protein 70	Yes	Pl_014734	18	Ae <sup>c</sup>
19	Pc_010489	199.42	13	Protein disulfide-isomerase	Yes	Pl_011829	22	Ae <sup>c</sup>
20	Pc_009911	102.94	1	Leucine-rich repeat protein	Yes			Ae
21	Pc_009146	53.51	9	Enolase	?	Pl_007984	24	
22	Pc_015675	39.64	3	Leucine-rich repeat protein	Yes			Ae
23	Pc_002924	36.88	3	Ezrin/radixin/moesin family <sup>b</sup>	?			
24	Pc_007867	32.85	12	Serpin	Yes	Pl_000063	28	Ae, Md
25	Pc_000616	29.37	5	Neprilysin-like	?			Mh
26	Pc_016110	12.69	4	Aldehyde dehydrogenase <sup>b</sup>	?			
27	Pc_005686	5.03	1	Leucine-rich repeat protein	?			Ae
28	Pc_007684	4.49	1	Leucine-rich repeat protein	?			Ae
29	Pc_009846	2.31	3	Adenosylhomocysteinase <sup>b</sup>	?			

<sup>a</sup> Related unisquences of unknown function found in both *Psytalia* wasps.

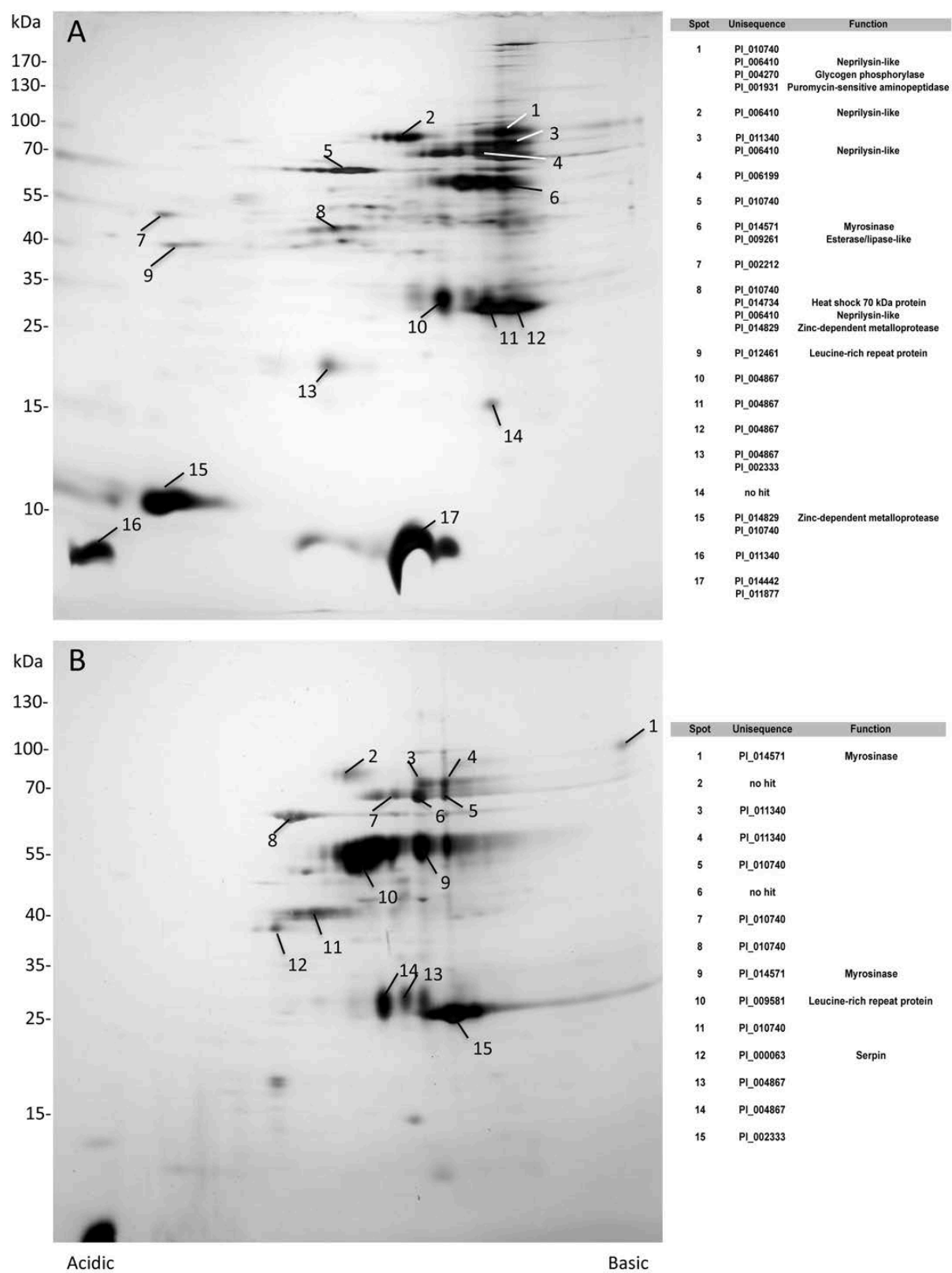
<sup>b</sup> Unisquences for which secretion could not be predicted and that are typical cellular proteins.

<sup>c</sup> Proteins identified in analysis of *A. ervi* venom apparatus but not considered as venom proteins due to a highly conservative approach.

Figure 1



**Figure 2**



**Figure 3**

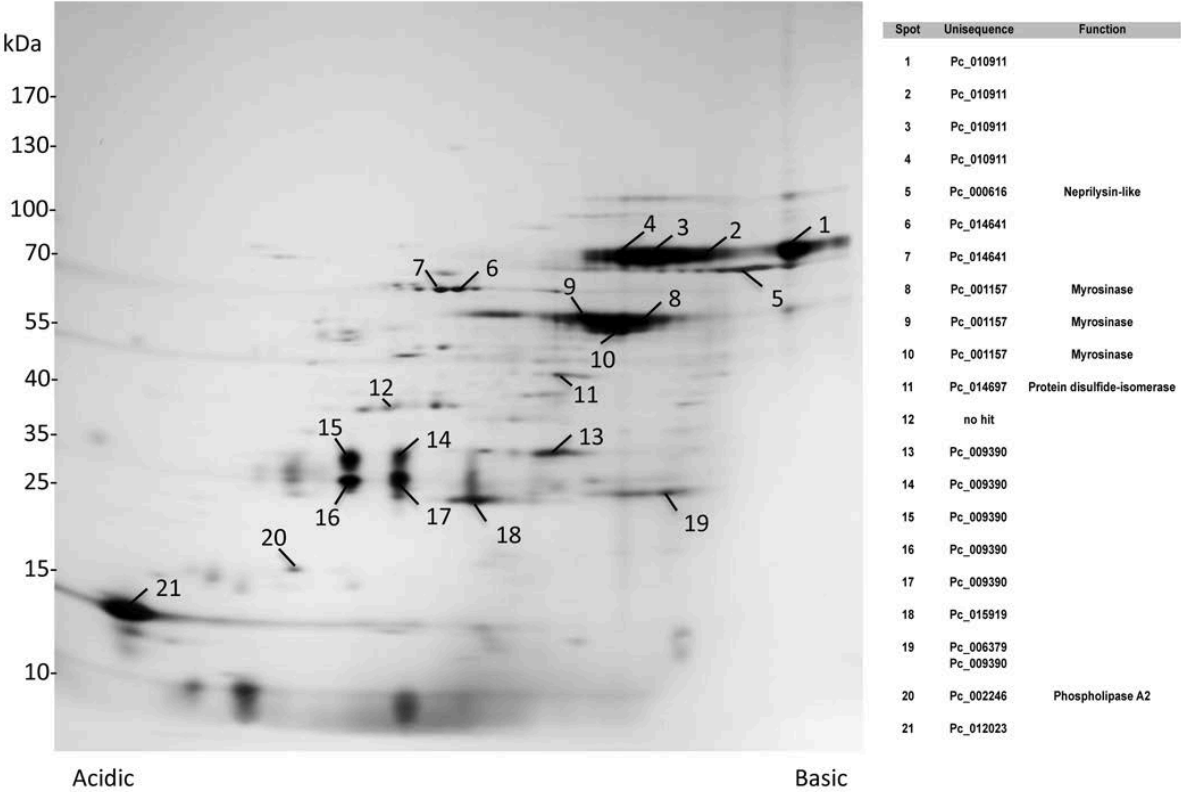




Figure 4

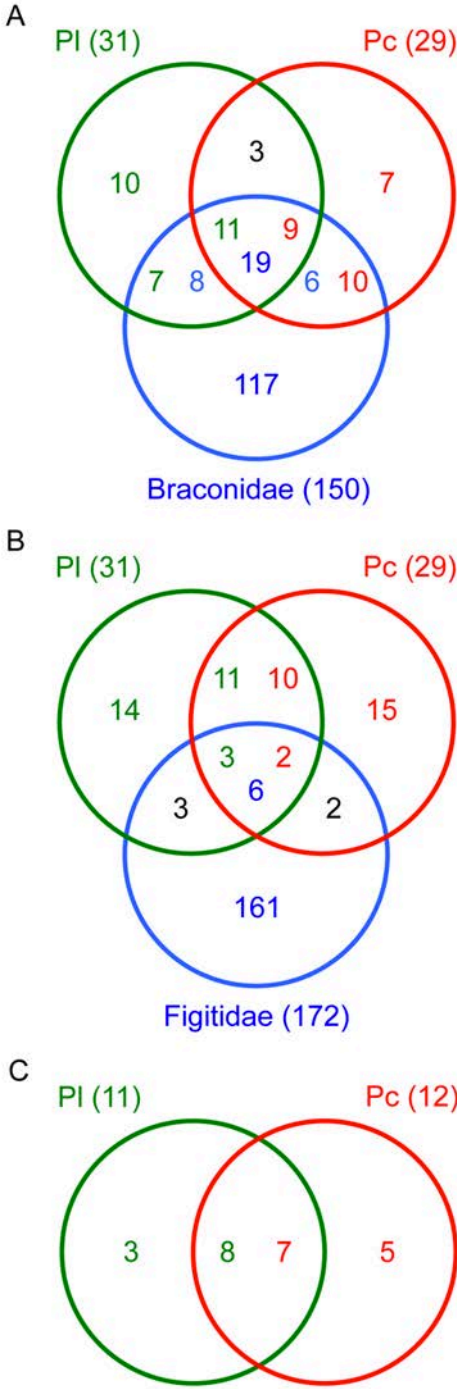


Figure 5

```

Arabidopsis MAIPKAHYSLAIIVVLFVAVRSRQKVCNPECKAKEPFNCDKTLAFNRNGFPNNFTFGAATS
Brassica ---MKHLGL-ILAFLLALATCKADEEITCEENLPFKCSQPDRLNSSSFEEKDFIFGVASS
Sinapis -----DEEITCQENLPFTCGNTDALNSSSFSDFIFGVASS
Brevicoryne -----MDYKFPKDFMFGTSTA
myrosinasePc ---MKILNVAALLTFV-----PVILA--NDDEYLKLPGLSIGAASA
myrosinaseP1 -----ILA--NDDKYLKLPGLSIGAASA
: : : * : : :

Arabidopsis AYQVEGA---AHRALNGWDYFTERYPERVS-DRSIGDPLACNSYDLYKDDVKLLKRMNVQA
Brassica AYQA-CC---LGRGLNVWDGFTERYPNKSGPDHNGDITCDSFSYWKQKIDVLDLDELNATG
Sinapis AYQIEGT---IGRGLNIWDGFTERYPNKSGPDHNGDITCDSFSYWKQKIDVLDLDELNATG
Brevicoryne SYQIEGGWNEDGKGENIWDRLVETSPEVIK-DGTNGDIACDSYHKYKEDVAIKDLNLKF
myrosinasePc AHQIEGAWNVSQKGLNVWDEFTRKPSMVD-NQTNAIDITSNSYKYYKEDIQIMKDIGLTH
myrosinaseP1 AHQIEGAWNVSQKGLNVWDEFTRKPSMVE-NQTNAIDITSNSYKYYKEDIQIMKDIGLTH
: : * : : * * * : * * : : * : : * : : * : : :

Arabidopsis YRFSIAWSRVLPKGRIGGVDENGITYNNLINELKANGIEPFVTIIEHWDVQPTELEDEYG
Brassica YRFSIAWSRIIPRGRSRGVNKGIDYHGLIDGLIDKGITPFVTLFHWDLQVLDQDEYE
Sinapis YRFSIAWSRIIPRGRSRGVNEKIDYHGLISGLIKKGITPFVTLFHWDLQVLDQDEYE
Brevicoryne YRFSISWARIAPSGVM-NSLEPKGIAYNNLINELIKNDIIPLVTVYHWDLPQVLDQ-LG
myrosinasePc YRFSLSWARILPTGFP-DKISQDGVQYKNIIDELKSKGIEPFVTIIEHWDHPALMGA-MG
myrosinaseP1 YRFSLSWARILPTGFP-DKISQDGVQYKNIIDEVKSKGIEPFVTIIEHWDHPALMGA-MG
*****: : * * : : * : : * : : * : : * : : * : :

Arabidopsis GFLSPRIVEDFKNYAELLQRFQDRVWFITLNPYSLAVKGYDGGYPPGRCTD----C
Brassica GFLDPQIIEHDFKHANLCQEFQGHKVNWLTINOLYTVPTRGYAGSDAPGRCSPTMVDVDS
Sinapis GFLDPQIIEHDFKHANLCQEFQGHKVNWLTINOLYTVPTRGYAGSDAPGRCSPTMVDVDS
Brevicoryne GWVNPIMSDYFKEYARVLFYFGDRVKKWITFNEPIAVCKGY-SIKAYAPNLNLKT----
myrosinasePc SWTNELMVEVFGHYARVVFREFGPKVKFWATVNEPEMYCKLTHGRNTYAPGLNSPL----
myrosinaseP1 SWTNELMVEVFAHYARVVFRELGPVKFWATVNEPEMYCKLTHGRNTYAPGLNSPL----
. : . : . * * * : * * * * * : . : . *

Arabidopsis EFGGDSGTEPYIVGHELLAHMEAVSLYRKRYQKFGGKIGTTLIGRWFIPLNETNDLKD
Brassica CYAGNSSTEPYIVAHNQLLAHATVVLDYLRKNYS-----IGPVMITRWFLPYNDTDPDSI
Sinapis CYAGNSSTEPYIVAHNQLLAHAKVVDYLRKNYT-HQGGKIGPTMIRWFLPYNDTDRHSI
Brevicoryne -----TGHYLAGHTQLIAHGKAYRLYEEMFKPTQNGKISISISGVFFMPKNAESDDDI
myrosinasePc -----FGEYICLHNLKKAHARAYQIYNDEFRADQGGKIGLVPLCFHHLLPA---SEDFT
myrosinaseP1 -----FGEYICLHNLKKAHARAYQIYNDEFRADQGGKIGLVPLCFHHLLPA---SEDFT
* : * * * * : : * : : : : * : :

Arabidopsis AAKREFDFSVGWFLDPLV--YGQYPKIMRMLG-----DRLPKFTPEQSALLKG
Brassica AATERMKEFFLGFWMGFLT--NGTYPQIMIDTVG-----ERLPSFSPEESNLVKG
Sinapis AATERMKEFFLGFWMGFLT--NGTYPQIMIDTVG-----ERLPSFSPEESNLVKG
Brevicoryne ETAERANQFERGWFGHPVY--KGDYPPIMKKVWDQKSKEGLPWSKLPKFTKEIKLLKG
myrosinasePc EAAEIAHQDFCGRTIHPFISKGDYPPIVKQRIRENSELEGLPFSRLEPFSPIWINLLRG
myrosinaseP1 EAAEIAHQDFCGRTIHPFISKGDYPPIVKQRIRENSELEGLPFSRLEPFSPIWINLLRG
: : : * * * * : : * * * : : : : : * * : : * : :

Arabidopsis SLDFLGLNYVTRYATYRPPMPPT-QHSLVTDSGVTIGFERN-GVSI-----GVKAP
Brassica SYDYLGLNYVVTQYQPSNPVHWANHTAMMDAGAKLTFRG-----NSDETK
Sinapis SYDYLGLNYVVTQYQPSNPVNSTHTAMMDAGAKLTYINASGHYIGLPEKDKADSTD
Brevicoryne TADFVALNHVSSRLVTFGSDPN-PN---FNPDASYVTSVDEA-----WLKPNETP
myrosinasePc SADYFGLNHVSTYLVEVPVWSNKTG---WYNDSGVRSFTDKN-----WAQ-SPAG
myrosinaseP1 SADYFGLNHVSTYLVEVPVWSNKTG---WYNDSGVRSFTDKN-----WAE-SPAG
: * : . * * * : . : * * * : : * : :

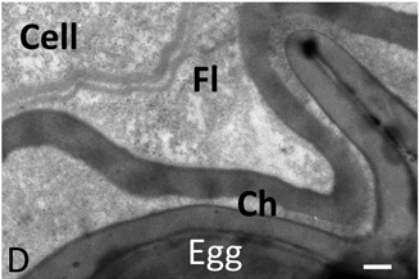
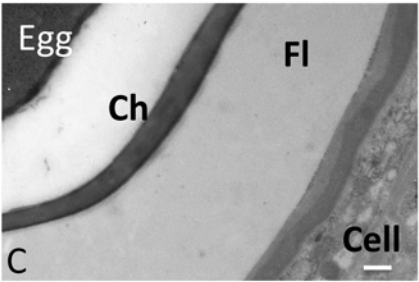
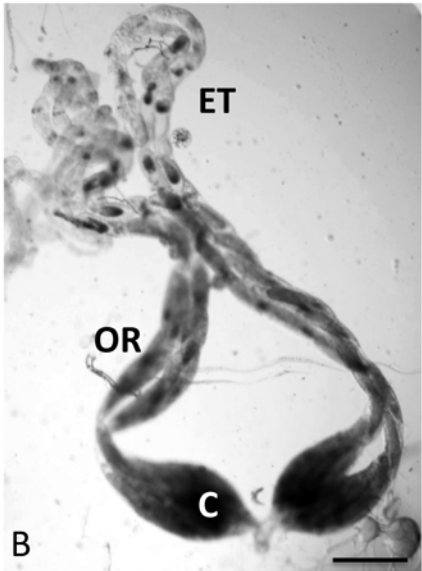
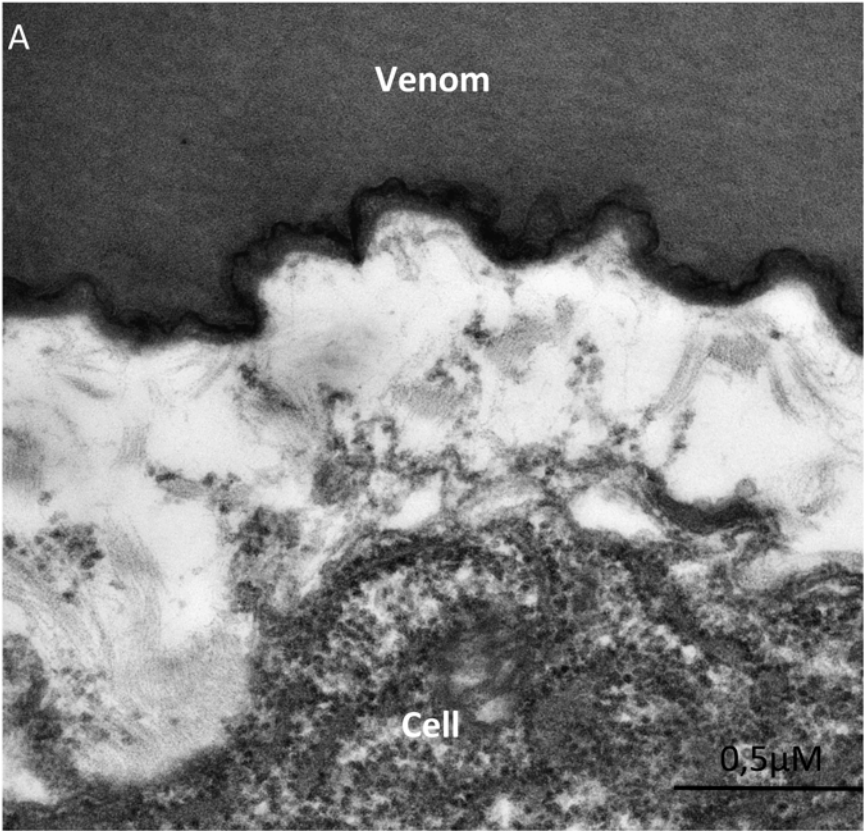
Arabidopsis SFSYPPGFRQILNHKKNYKNPLTYITENGVAADDFGNVTIANALADNGRIQFQCSHLS
Brassica NSYYYPKGIYYVMDYFKTKYINPLIYVTEINGISTP--GNETRDESMLHYKRIEYLSHLK
Sinapis NIYYYPKGIYSVMDFKKNYINPLIYVTEINGISTP--GDNERNQSMLDYTRIDYLSHLK
Brevicoryne YIIPVEGLRKLILWLKNEYGNPQLLITENGYGDD-----GQLDDFEKISYLNKYNL
myrosinasePc WLKIVPEGFGLRLRIKDKYGNPPVHVLENGIATY-----KGHEDYLRINYLHDMK
myrosinaseP1 WLKIVPEGFGLRLRIKDKYGNPPVHVLENGIATY-----IGHEDYLRINYLHDMK
* * : : : * * * : * * * : * * : : * : :

Arabidopsis CLKCAI-EDGCNVAGYFAWSLMDNYEFGNGYTLLRFGMNWVNFNTPADR-REKASGKWFSR
Brassica FLKSVIKEKHNKGYFAWSLGDNYEFDKGFVTRFGLSYIDWNNVTRD-DLKSQKGYQK
Sinapis FLNKVIEKEDVNVKGYLAWALGDNYEENKGFVTRFGLSYIDWNNVTRD-DLKSQKGYQK
Brevicoryne ATLQAMYEDKCNVIGYTVVWLLDNFEMFYGYSIHFLVKIDFNDPQRTRTKRESYTYFKN
myrosinasePc EMLVAINRDGCNVEVYTVVWLLDSEFWSRGEHRRFGLVEVDFDPSNRTTRPRLSTKWLRE
myrosinaseP1 EMLVAINRDGCNVEVYTVVWLLDSEFWSRGEHRRFGLVEVDFDPSNRTTRPRLSTKWLRE
. : . * * * * : * * * : : * : :

Arabidopsis FIAK-----
Brassica FISPAINPLKDFL-RSSLTFEKNKKFEDA
Sinapis FISP-----
Brevicoryne VVSTGKP-----
myrosinasePc ILAKRRLKLEPLKTTEFYKKSVDVADTSQGR--
myrosinaseP1 MLAKRRLKLEPLKTTEFYKKSVDVADTSQVR--
: :

```

Figure 6



**Supplementary Table 1.** General features of the Pl and Pc transcriptomes and results of similarity searches.

	<i>P. lounsburyi</i>	<i>P. concolor</i>
DATA		
Number of trimmed paired-end reads	88,793,008	41,603,068
Number of trimmed single-end reads	2,412,351	4,498,697
Number of trimmed 454	359,589	-
Number of trimmed Sanger	1,963	-
ASSEMBLY		
<b>Number of unisequences</b> (min size 100 bp)	<b>16,943</b>	<b>16,360</b>
Min sequence length	104	103
Average sequence length	1,663	983
Max sequence length	20,780	17,046

LIBRARY COMPARISONS		
<i>P. lounsburyi</i>	-	13,935
<i>P. concolor</i>	12,160	-

SIMILARITY SEARCHES		
With public databases		
NCBI NR	11,448	9,826
Swiss-Prot	9,162	7,365
With insect proteomes		
<i>Nasonia vitripennis</i>	10,830	9,134
<i>Drosophila melanogaster</i>	9,269	7,550
With parasitoid venom gland transcriptomes		
<i>Aphidius ervi</i>	1,779	1,187
<i>Leptopilina boulardi ISm</i>	1,616	1,043
<i>Leptopilina boulardi ISy</i>	1,574	1,101
<i>Leptopilina heterotoma</i>	2,115	1,398

TRANSLATION AND SECRETION		
Unisequences with ORF prediction	13,321	11,587
Predicted full length unisequences	3,130	1,990
Unisequences with signal peptide	905	744

**Supplementary Table 2:** Unisequences found in proteomics in *P. lounsburyi*

Unisequence	Putative function	RPKM	Mascot matches		Signal peptide
			PI SA	PI K	
PI_004867		1963,84	31	40	Yes
PI_009581	Leucine-rich repeat protein	1865,04	11		?
PI_011877		1538,27	18	36	?
PI_014442		816,50		10	?
PI_010740		738,87	28	76	?
PI_011340		691,22	9	28	?
PI_002959		659,87		5	Yes
PI_006410	Nepriylisin-like	627,83		37	?
PI_007365	Heat shock 70 kDa protein	612,54	2	16	No
PI_003816		574,51	2	33	?
PI_006199		476,04	38	115	Yes
PI_014571	Myrosinase	360,78	13	80	?
PI_010491	Calreticulin	263,42		1	?
PI_002333		242,50	3	87	?
PI_014829	Venom metalloproteinase	186,32		8	?
PI_002212		143,39		3	Yes
PI_006057	Pancreatic lipase-like	135,90		1	?
PI_013024	Nepriylisin-like	115,21		10	?
PI_014734	Heat shock 70 kDa protein	85,45	19	5	?
PI_002507	Protein disulfide-isomerase	63,77		3	Yes
PI_008373	Endoplasmin	40,85		8	Yes
PI_003563		35,95		6	Yes
PI_003140	Alpha-actinin	34,30		1	No
PI_004453	Actin 5C	26,49	4		No
PI_011829	Protein disulfide-isomerase	22,74	9	7	Yes
PI_001931	Puromycin-sensitive aminopeptidase	21,08		6	?
PI_007984	Enolase	17,02		2	?
PI_000005	Transitional endoplasmic reticulum ATPase TER94	16,71		2	No
PI_009978	threonine--tRNA ligase	12,91	1		No
PI_001568	Phosphoglucomutase-2	10,09		2	No
PI_011015	Arginine kinase-like protein	6,13		5	?
PI_010713	Phosphoglucomutase-1	4,42		1	No
PI_010999		2,56		13	?
PI_009261	Venom carboxylesterase	2,43		4	?
PI_000063	Serpin	2,28	10	4	?
PI_012461	Leucine-rich repeat protein	2,02		6	?
PI_013792	Nepriylisin-like	1,47		2	?
PI_004270	Glycogen phosphorylase	1,31		5	?

Blastx NR			Blastx SP
Best hit	Accession	E value	Best hit
PREDICTED: insulin-like growth factor-binding protein 3 [Cerapachys birchmanni]	XP_003427009.1	6,00E-19	Full=Leucine-rich repeat-containing G-protein coupled receptor 1; Short=LRR1
PREDICTED: uncharacterized protein LOC103580319 [Cerapachys birchmanni]	XP_008560277.1	8,00E-25	
hypothetical protein X777_02750 [Cerapachys birchmanni]	EZA56899.1	2,00E-62	
PREDICTED: membrane metallo-endopeptidase-like protein 1 [Cerapachys birchmanni]	XP_003491952.1	1,00E-126	Full=Nepriylisin-21 [Caenorhabditis elegans]
Heat shock 70 kDa protein cognate [Cerapachys birchmanni]	EZA53152.1	0.0	Full=Heat shock 70 kDa protein cognate 4; Short=HSP70
PREDICTED: uncharacterized protein LOC103574519 [Cerapachys birchmanni]	XP_008552186.1	2,00E-37	
PREDICTED: uncharacterized protein LOC103574219 [Cerapachys birchmanni]	XP_008551915.1	1,00E-35	
PREDICTED: myrosinase 1-like [Nasonia vitripennis]	XP_001601101.3	1,00E-95	Full=Myrosinase 1; AltName: Full=Beta-glucosidase
PREDICTED: calreticulin [Apis mellifera]	XP_006559569.1	3,00E-163	Full=Calreticulin; Flags: Precursor [Bombyx mori]
A disintegrin and metalloproteinase with thrombospondin type 1 motifs 1 [Cerapachys birchmanni]	EZA54032.1	2,00E-17	Full=Venom metalloproteinase 3; Short=EpMP3 [Bombyx mori]
PREDICTED: pancreatic triacylglycerol lipase-like [Cerapachys birchmanni]	XP_008557327.1	2,00E-50	Full=Pancreatic lipase-related protein 2; Short=PL-2
PREDICTED: membrane metallo-endopeptidase-like protein 1 [Cerapachys birchmanni]	XP_003701340.1	0.0	Full=Nepriylisin-11 [Caenorhabditis elegans]
Heat shock 70 kDa protein cognate 3 [Harpegnathos saltator]	EFN86831.1	0.0	Full=Heat shock 70 kDa protein cognate 3; AltName: Full=HSP70
PREDICTED: probable protein disulfide-isomerase [Cerapachys birchmanni]	XP_001602967.1	0.0	Full=Protein disulfide-isomerase A6; AltName: Full=PDIA6
PREDICTED: endoplasmin [Microplitis demolitor]	XP_008559868.1	0.0	Full=Endoplasmin; AltName: Full=94 kDa glucose-6-phosphate dehydrogenase
PREDICTED: hypothetical protein LOC100647415 [Cerapachys birchmanni]	XP_003394720.1	9,00E-67	
PREDICTED: alpha-actinin, sarcomeric isoform X1 [Drosophila melanogaster]	XP_008547897.1	0.0	Full=Alpha-actinin, sarcomeric; AltName: Full=F-actin
actin 5C, isoform B [Drosophila melanogaster]	NP_511052.1	0.0	Full=Actin-5C; Flags: Precursor [Drosophila melanogaster]
PREDICTED: protein disulfide-isomerase A3 [Microplitis demolitor]	XP_008544054.1	0.0	Full=Protein disulfide-isomerase A3; AltName: Full=PDIA3
PREDICTED: puromycin-sensitive aminopeptidase [Cerapachys birchmanni]	XP_008559138.1	0.0	Full=Puromycin-sensitive aminopeptidase; Short=PSA
PREDICTED: enolase isoform X1 [Microplitis demolitor]	XP_008547916.1	0.0	Full=Enolase; AltName: Full=2-phospho-D-glycerate kinase
PREDICTED: transitional endoplasmic reticulum ATPase [Cerapachys birchmanni]	XP_008549600.1	0.0	Full=Transitional endoplasmic reticulum ATPase TERA; Short=TERA
PREDICTED: threonine--tRNA ligase, cytoplasmic isoform 1 [Cerapachys birchmanni]	XP_008554535.1	0.0	Full=Threonine--tRNA ligase, cytoplasmic; AltName: Full=ThrRS
PREDICTED: phosphoglucomutase-2 [Nasonia vitripennis]	XP_001601687.1	0.0	Full=Phosphoglucomutase-2; Short=PGM 2; AltName: Full=PGM2
arginine kinase-like protein [Cyphononyx dorsalis]	BAF62631.1	1,00E-144	Full=Arginine kinase; Short=AK
PREDICTED: phosphoglucomutase isoform X3 [Apis mellifera]	XP_395366.2	0.0	Full=Phosphoglucomutase; Short=PGM; AltName: Full=PGM1
PREDICTED: venom carboxylesterase-6-like [Microplitis demolitor]	XP_008543575.1	0.0	Full=Venom carboxylesterase-6; AltName: Allergen
PREDICTED: uncharacterized protein LOC103574019 [Cerapachys birchmanni]	XP_008551598.1	9,00E-69	Full=Alaserpin; AltName: Full=Serp-1; Flags: Precursor
AGAP007060-PA-like protein [Anopheles sinensis]	KFB50469.1	2,00E-20	Full=Leucine-rich repeat-containing G-protein coupled receptor 1; Short=LRR1
PREDICTED: nepriylisin-like [Microplitis demolitor]	XP_008546803.1	0.0	Full=Nepriylisin-11 [Caenorhabditis elegans]
PREDICTED: glycogen phosphorylase [Microplitis demolitor]	XP_008555360.1	0.0	Full=Glycogen phosphorylase, muscle form; AltName: Full=PHO

		NCBI CDD		
Accession	E value	Best hit	Accession	E value
LGR4_XENTR	1,00E-17	Leucine rich repeat	pfam13855	1.16e-12
NPL21_CAEEL	5,00E-58	Peptidase family M13 includes neprilysin, endothel	cd08662	2.78e-103
HSP7D_MANSE	0.0	Nucleotide-Binding Domain of the sugar kinase/Hsp	cl17037	0.0
MYRO1_BREBR	4,00E-54	Beta-glucosidase/6-phospho-beta-glucosidase/beta	cl01046	3.14e-93
CALR_BOMMO	2,00E-143	Calreticulin family	pfam00262	6.85e-107
VMP03_EULPE	2,00E-10	Zinc-dependent metalloprotease. This super-famil	cl00064	1.37e-12
LIPR2_MYOCO	2,00E-31	Lipase. Lipases are esterases that can hydrolyze lo	cl14883	4.08e-67
NPL11_CAEEL	3,00E-133	Peptidase family M13 includes neprilysin, endothel	cd08662	0.0
HSP7C_DROME	0.0	Nucleotide-Binding Domain of the sugar kinase/Hsp	cl17037	0.0
PDIA6_RAT	5,00E-171	P5 family, C-terminal redox inactive TRX-like doma	cd02983	2.40e-65
ENPL_BOVIN	0.0	Hsp90 protein	cl20204	0.0
ACTN_DROME	0.0			
ACT1_DROME	0.0			
PDIA3_CHLAE	2,00E-141	protein disulfide isomerase, eukaryotic	TIGR01130	0.0
PSA_HUMAN	0.0	Peptidase M1 Aminopeptidase N family incudes tr	cd09601	0.0
ENO_DROME	0.0	Enolase: Enolases are homodimeric enzymes that	cd03313	0.0
TERA_DROME	0.0			
SYTC_MOUSE	0.0			
PGM2_HUMAN	0.0			
KARG_APIME	e-141	Phosphagen (guanidino) kinases such as arginine k	cd07932	1.75e-156
PGM_DROME	0.0			
EST6_APIME	2,00E-127	Carboxylesterase family	pfam00135	3.67e-109
SERA_MANSE	6,00E-32	SERine Proteinase INhibitors (serpins) exhibit conf	cl00137	1.26e-56
LGR5_BOVIN	7,00E-20	Leucine rich repeat	pfam13855	2.27e-12
NPL11_CAEEL	1,00E-77	Peptidase family M13 includes neprilysin, endothel	cd08662	3.26e-138
PYGM_MOUSE	0.0	This is a family of oligosaccharide phosphorylases.	cd04300	0.0

**Supplementary Table 3:** Unisequences found in proteomics in *P. concolor*.

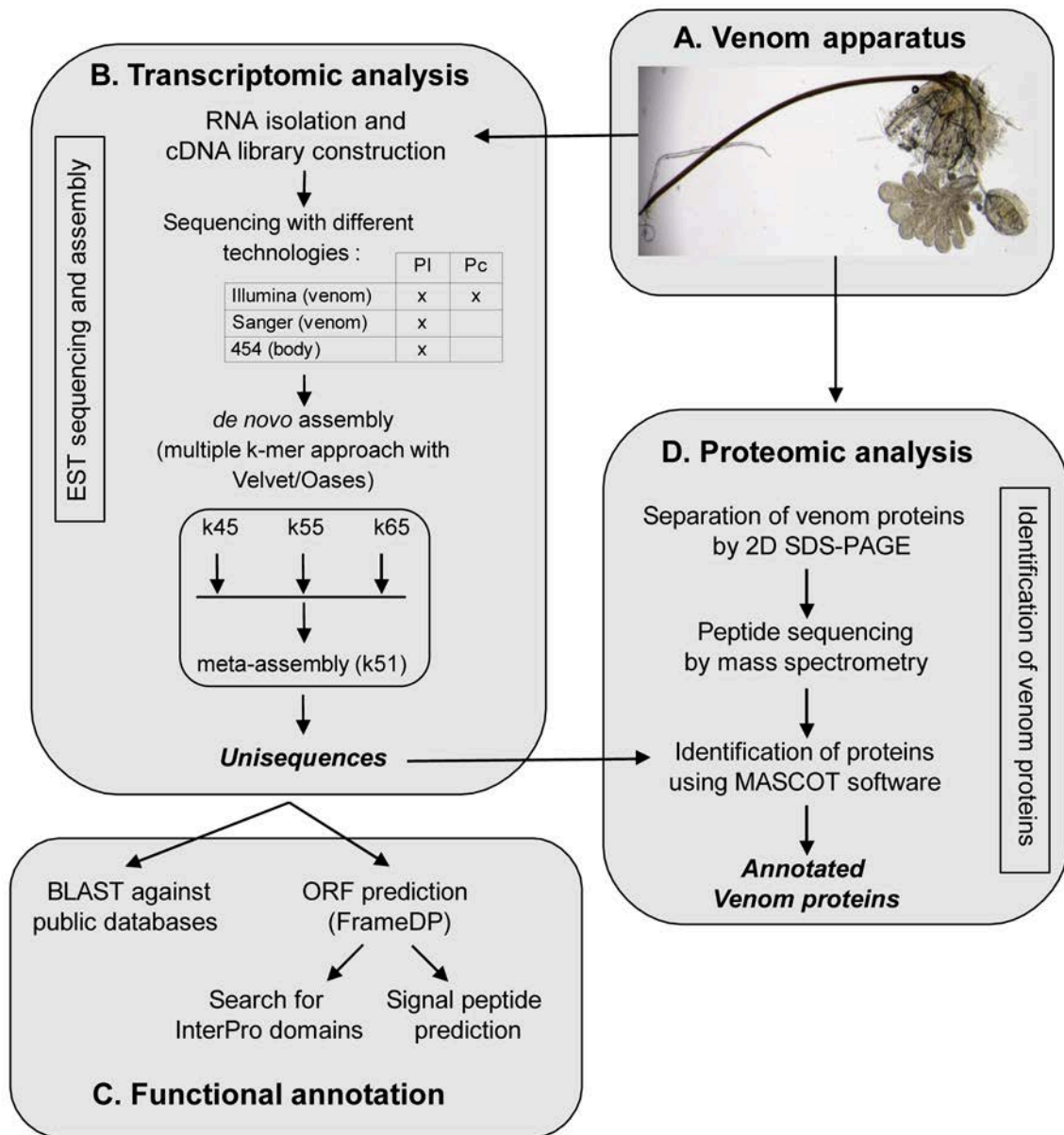
Unisequence	Putative function	RPKM	Mascot matches	Signal peptide
Pc_013625		3110,46	59	Yes
Pc_015919		1626,40	12	?
Pc_009390		1583,31	210	Yes
Pc_006379		1507,73	8	?
Pc_012023		1428,59	34	?
Pc_012375	Metalloprotease	1326,30	8	?
Pc_001157	Myrosinase	1196,52	84	Yes
Pc_006098	Neprilysin-like	1178,46	47	?
Pc_014667		1152,41	9	Yes
Pc_010911		947,92	71	Yes
Pc_005851	Heat shock 70 kDa protein	634,61	4	No
Pc_002246	Phospholipase A2	580,77	3	?
Pc_016344	Elongation factor 1-alpha 1	484,49	10	No
Pc_014641		441,52	57	Yes
Pc_007330	Annexin	360,78	16	Yes
Pc_009900	Serine carboxypeptidase	346,13	5	Yes
Pc_014697	Protein disulfide-isomerase	259,63	32	Yes
Pc_002889		243,19	2	Yes
Pc_015292	Calreticulin	236,32	3	Yes
Pc_008008	Heat shock 70 kDa protein	227,98	43	Yes
Pc_000224	Aldose reductase	202,13	1	No
Pc_010489	Protein disulfide-isomerase	199,42	13	Yes
Pc_000396	Actin-5C	103,71	10	No
Pc_009911	Leucine-rich repeat protein	102,94	1	Yes
Pc_012029	Glyceraldehyde-3-phosphate dehydrogenase	58,58	3	No
Pc_009146	Enolase	53,51	9	?
Pc_007703	14-3-3 protein zeta	51,74	4	No
Pc_015675	Leucine-rich repeat protein	39,64	3	Yes
Pc_006299	Rab GDP dissociation inhibitor alpha	37,69	2	No
Pc_002924	Ezrin/radixin/moesin family	36,88	3	?
Pc_007867	Serpin	32,85	12	Yes
Pc_000616	Neprilysin-like	29,37	5	?
Pc_005795	Transaldolase	18,50	1	No
Pc_011086	Lambda-crystallin homolog	13,21	4	No
Pc_016110	Aldehyde dehydrogenase	12,69	4	?
Pc_003971	FAM203 family protein	11,56	2	No
Pc_005686	Leucine-rich repeat protein	5,03	1	?
Pc_007684	Leucine-rich repeat protein	4,49	1	?
Pc_009846	Adenosylhomocysteinase	2,31	3	?



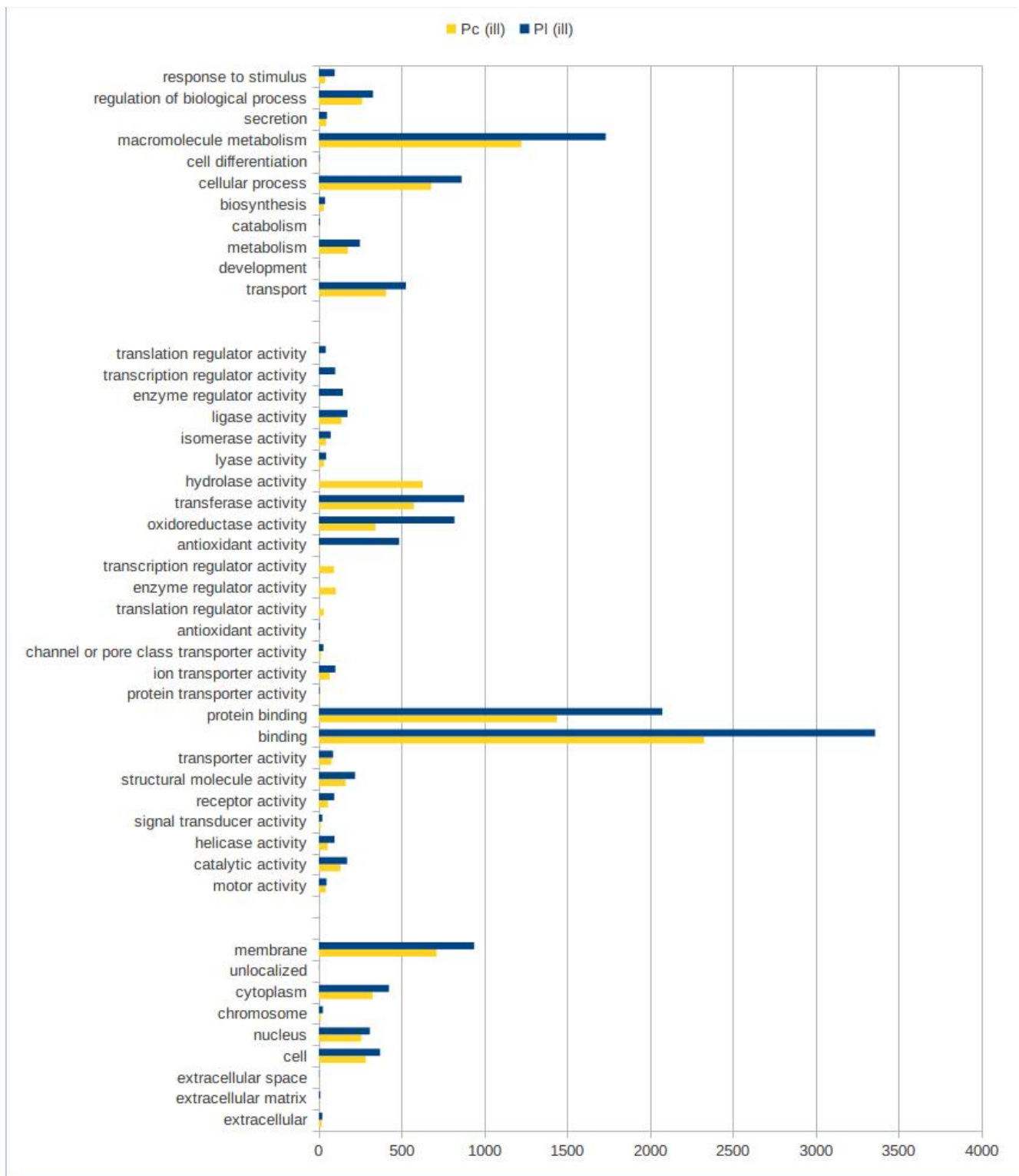
Blastx NR			Blastx SP
Best hit	Accession	E value	Best hit
PREDICTED: uncharacterized protein LOC1035745	XP_008552186.1	7,00E-55	
A disintegrin and metalloproteinase with thrombo	EGI57486.1	2,00E-19	
PREDICTED: myrosinase 1-like [Nasonia vitripennis]	XP_001601101.3	0.0	Full=Myrosinase 1; AltName: Full=Beta-glucosidas
PREDICTED: membrane metallo-endopeptidase-lik	XP_003701340.1	0.0	Full=Nepriylsin-11 [Caenorhabditis elegans]
PREDICTED: uncharacterized protein LOC1006796	XP_003424464.1	9,00E-54	
hypothetical protein EAG_09552 [Camponotus flo	EFN73534.1	3,00E-69	
Heat shock 70 kDa protein cognate [Cerapachys bi	EZA53152.1	0.0	Full=Heat shock 70 kDa protein cognate 4; Short=f
PREDICTED: phospholipase A2-like [Microplitis de	XP_008551155.1	3,00E-16	Full=Phospholipase A2 large subunit; Short=HfPLA
Elongation factor 1-alpha [Camponotus floridanus	EFN72500.1	0.0	Full=Elongation factor 1-alpha 1; Short=EF-1-alpha
hypothetical protein EAI_01992 [Harpegnathos sa	EFN89744.1	1,00E-33	
Annexin-B11 [Camponotus floridanus]	EFN74462.1	1,00E-24	Full=Annexin A1 isoform p35; AltName: Full=Anne
PREDICTED: retinoid-inducible serine carboxypept	XP_001605442.1	2,00E-126	Full=Retinoid-inducible serine carboxypeptidase; A
PREDICTED: protein disulfide-isomerase [Microplit	XP_008554924.1	0.0	Full=Protein disulfide-isomerase; Short=PDI; Short
PREDICTED: uncharacterized protein LOC1035745	XP_008552186.1	2,00E-84	
PREDICTED: calreticulin [Apis mellifera]	XP_006559569.1	0.0	Full=Calreticulin; Flags: Precursor [Bombyx mori]
Heat shock 70 kDa protein cognate 3 [Camponotu	EFN61604.1	0.0	Full=Heat shock 70 kDa protein cognate 3; AltNam
PREDICTED: aldose reductase-like [Bombus impati	XP_003484790.1	5,00E-159	Full=Aldose reductase; Short=AR; AltName: Full=2
PREDICTED: protein disulfide-isomerase A3 [Micro	XP_008544054.1	0.0	Full=Protein disulfide-isomerase A3; AltName: Full
actin 5C, isoform B [Drosophila melanogaster]	NP_511052.1	0.0	Full=Actin-5C; Flags: Precursor [Drosophila meland
PREDICTED: slit homolog 1 protein-like [Micropliti	XP_008549307.1	3,00E-51	Full=Leucine-rich alpha-2-glycoprotein; Short=LRG
Glyceraldehyde-3-phosphate dehydrogenase 2 [Aq	EGI66497.1	0.0	Full=Glyceraldehyde-3-phosphate dehydrogenase
PREDICTED: enolase isoform X1 [Microplitis demo	XP_008547916.1	0.0	Full=Enolase; AltName: Full=2-phospho-D-glycerat
PREDICTED: 14-3-3 protein zeta isoform X1 [Micro	XP_008543380.1	3,00E-166	Full=14-3-3 protein zeta
leucine-rich repeat-containing protein 1 [Anophele	ETN67512.1	2,00E-55	Full=Insulin-like growth factor-binding protein con
PREDICTED: rab GDP dissociation inhibitor alpha [	XP_008547480.1	0.0	Full=Rab GDP dissociation inhibitor alpha; Short=R
PREDICTED: moesin/ezrin/radixin homolog 1 [Micr	XP_008560453.1		Full=Moesin/ezrin/radixin homolog 1 [Drosophila
PREDICTED: uncharacterized protein LOC1035740	XP_008551598.1	2,00E-121	Full=Alpha-1-antiproteinase F; Short=APF; AltNam
PREDICTED: neprilysin 2 isoform X2 [Apis mellifera	XP_006566919.1	1,00E-37	Full=Nepriylsin-21 [Caenorhabditis elegans]
PREDICTED: transaldolase-like [Microplitis demoli	XP_008546484.1	0.0	Full=Transaldolase [Rattus norvegicus]
PREDICTED: lambda-crystallin homolog [Micropliti	XP_008551401.1	2,00E-177	Full=Lambda-crystallin homolog; AltName: Full=L-
PREDICTED: aldehyde dehydrogenase X, mitochon	XP_008555876.1	0.0	Full=Aldehyde dehydrogenase X, mitochondrial; A
PREDICTED: FAM203 family protein CG6073 [Micro	XP_008556985.1	9,00E-177	Full=FAM203 family protein CG6073 [Drosophila n
PREDICTED: slit homolog 1 protein-like [Micropliti	XP_008559334.1	4,00E-89	Full=Platelet glycoprotein V; Short=GPV; AltName:
AGAP007060-PA-like protein [Anopheles sinensis]	KFB50469.1	4,00E-15	Full=Insulin-like growth factor-binding protein con
Adenosylhomocysteinase [Harpegnathos saltator]	EFN84451.1	5,00E-51	Full=Adenosylhomocysteinase; Short=AdoHcyase;

		NCBI CDD		
Accession	E value	Best hit	Accession	E value
MYRO1_BREBR	6,00E-120	Glycosyl hydrolase family 1	pfam00232	1.31e-139
NPL11_CAEEL	5,00E-136	Peptidase family M13 includes neprilysin, endothel	cd08662	0.0
HSP7D_MANSE	0.0			
PA2_HETFU	9,00E-11	PLA2_like: Phospholipase A2, a super-family of ser	cl05417	1.46e-21
EF1A1_DROME	0.0			
ANX11_COLL1	0.03e-27	Annexin	pfam00191	2.74e-15
RISC_MOUSE	4,00E-77	Serine carboxypeptidase	pfam00450	4.68e-77
PDI_DROME	0.0	protein disulfide isomerase, eukaryotic	TIGR01130	4.73e-178
		Calreticulin family		
CALR_BOMMO	1,00E-164			
HSP7C_DROME	0.0	Nucleotide-binding domain of human HSPA5 and s	cd10241	0.0
ALDR_BOVIN	1,00E-101			
PDIA3_CHLAE	2,00E-149	protein disulfide isomerase, eukaryotic	TIGR01130	0.0
ACT1_DROME	0.0			
A2GL_HUMAN	4,00E-14	Leucine rich repeat	pfam13855	3.91e-09
G3P2_DROPS	0.0			
ENO_DROME	0.0	Enolase	cd03313	0.0
1433Z_BOMMO	2,00E-159			
ALS_PAPHA	7,00E-39	Leucine-rich repeats (LRRs), ribonuclease inhibitor	cd00116	1.41e-10
GDIA_BOVIN	0.0			
MOEH_DROPS	0.0	ERM family FERM domain C-lobe/F3	cd13194	5.86e-73
A1AF_RABIT	1,00E-53	SERine Proteinase INhibitors (serpins) exhibit conf	cd00172	4.20e-127
NPL21_CAEEL	1,00E-14			
TALDO_RAT	1,00E-163			
CRYL1_MOUSE	5,00E-103			
AL1B1_HUMAN	0.0	Peptidase family M13 includes neprilysin, endothel	cd08662	5.10e-30
FA203_DROME	1,00E-94			
GPV_MOUSE	8,00E-20	Leucine rich repeat	pfam13855	3.41e-09
ALS_RAT	1,00E-16	Leucine rich repeat	pfam13855	1.25e-09
SAHH_ANOGA	7,00E-47	Formate/glycerate dehydrogenases, D-specific 2-h	cl17240	2.45e-64

Supplementary Figure 1



## Supplementary Figure 2



### Supplementary Figure 3

```

Pc_001157      MKILNVAALLTFVPVILANDDEYLLKLPPLSIGAASAAHQIEGAWNVSDKGLNVWDEFTH
Pl_002819      -----ILANDDKYLKLPPLSIGAASAAHQIEGAWNVSDKGLNVWDEFTH
                *****:*****

Pc_001157      RKPSMVDNQTNADITSNSYYKYKEDIQIMKDIGLTHYRFSLSWARILPTGFPDKISQDGV
Pl_002819      RKPSMVENQTNADITSNSYYKYKEDIQIMKDIGLTHYRFSLSWARILPTGFPDKISQDGV
                *****:*****

Pc_001157      QYYKNIIDELKSKGIEPFVTIYHWDHPALMGAMGSWTNELMVEWFGHYARVVFREFGPKV
Pl_002819      QYYKNIIDEVKSKGIEPFVTLYHWDHPALMGAMGSWTNELMVEWFAHYARVVFRELGPKV
                *****:*****:*****:*****

Pc_001157      KFWATVNEPEMYCKLTHGRNTYAPGLNSPLFGEYICLHNLLKAHARAYQIYNDEFRADQG
Pl_002819      KFWATVNEPEMYCKLSHGRNTYAPGINSPLFGEYICLHNLLKAHARAYQIYNDEFRADQG
                *****:*****:*****:*****

Pc_001157      GKIGLVPLCFHHLPASEDFTEAAEIAHQFDCGRTIHPIFSKEGDYPPIVKQRIRENSELE
Pl_002819      GKVGLVPLCFHHLPASEDFTEAAEIAHQFDCGRTIHPIFSKGDYPPIVKQRIRENSELE
                **:*****:*****:*****

Pc_001157      GLPFSRLPEFSPYWINLLRGSADYFGLNHYSTYLVEPVPWSNKTGWYNDSGVRSFTDKNW
Pl_002819      GLPFSRLPEFSPYWINLLRGSADYFGLNHYSTYLVEPVPWSNKTGWYSDSGVRSFTDKNW
                *****:*****

Pc_001157      AQSPAGWLKIVPEFGSLLRLIKEKYGNPPVHVLengiATYKghEDYLrINylHDYMKEM
Pl_002819      AESPAGWLKIVPEFGSLLRLIKEKYGNPPVHVLengiATYIGHEDYLrINylHDYMKEM
                *:*****:***** *****

Pc_001157      LVAINRDGCNVEVYTVWSLLDSFEWSRGYEHFRGLVEVDFDSPNRRTRPRLSTKWLREIL
Pl_002819      LVAINRDGCNVEVYTVWSLLDSFEWSRGYEHFRGLVEVDFDSPNRRTRPRLSTKWLREML
                *****:*****

Pc_001157      AKRKLEPLKTTEFYKKSVVADTSDQGR
Pl_002819      AKRKLEPLKTTEFYKESVVADTSDQVR
                *****:*****

```

## Supplementary Figure 4

```

Pc_007867      1  MRVFLILGFAPLSSSWAMT-----VPEALRMVTRGMNLEAKKFKTKSVKDKD-DNFVMSFAGISIVTSM
Pl_000063     1  -----
Ae_CL18Contig1 1  MNFKFGVGLVAVSLLLASGNARKHSSKRHLDVLTNKARSFLMTVNTFTGKLVAAAFNKTKQ-DSYTCIPIIYWSMPTK
Ae_aar0aka8ya02 1  -----
Md_comp17591_c0 1  --MIKCSIVIVIIVTISVTNSSIYDDDDINMNGIIPAKPLQDFPSATNKKSKRFVSVLAEYES-DNLICFSLSVYVTFM
Hd-Ven390     1  ---MRFLLISIAVWCVS-----SSEAMAVQPAQSEGFQAVTKSTNAESPNFVKKHVAADTK-GNLICFSLSASMVISM
LbSPNy       1  -MMFTHLMSFFLIGTCSIYAVIAYGNVNYFSEELVQPLDFH---QALEKMNNDLHKNNAASNGSIQVLLSPLSINILDAI

Pc_007867     67  ASFGAGGTTTKTQIQTADNLE-TDDHTARSIGKSMMDQGRGLQSIELKMANKIFTTGVEMKPEFKEITRKTFSSEAQSMD
Pl_000063     1  -----
Ae_CL18Contig1 80  ISDLSGGQNKELQEDFLNW--KNTSWHRLGLASLYRRYHFKNMEVNSTGLIVIDKSVDLTDKNSDHLREI--KIVNVD
Ae_aar0aka8ya02 1  -----
Md_comp17591_c0 78  ASYGACGNTKROLLSADSSP-NDKITEREIQHLLYSLNMQGABVVKLVNKKIFATNKFQKPKFKTKITREYFGSEVKKVD
Hd-Ven390     70  VAYGARGNTAKQMRSVLALP-EKDELAKSGQAFVDSFKNYKQVDRRLANKVFLNEGKPKRAEFSSAMTRKGFSEAOQVN
LbSPNy       77  LAVGAGRTRSEIVTGINQELQSGAQLNLYKLMVENLNVTDVLEQMSNAIFVDHSIRLKKSFQDELFNYPKAHEFVSN

Pc_007867     146  FTKP-EAETINAWAAEKTNNKIQNLLQDDDK--DASVLANAVYFKGKMKPENAQMTMPKFFHMDDQASKDVPMMSK
Pl_000063     48  FTKP-EAETINAWGCREDEHKIQNLLQDDDK--DASVLANAVYFKGKMKPENAQMTMPKFFHMDDQASKDVPMMSK
Ae_CL18Contig1 155  FSKPDEAYNINIKRAEENSDDLNEIIPKGFKEK-DYRMVIANGGFIRGIVAVPEYPE-TSKTPEQLLDGKPKVDMMRA
Ae_aar0aka8ya02 1  -----
Md_comp17591_c0 157  FINVEKTVRTINNLCANESNNHTIDVVEPSDTE--GAEMILVSAIYFKGKNAEKKFKKWTNYPPEIDEKTKDVPMMFK
Hd-Ven390     149  FVKSAEAKTINDWCEAQTNNRIKDLIKPDDDA-STAMVLVNAVYFKGNVSDKEDPANTRKRPENVDATPKKDVPTMFR
LbSPNy       157  FKTPIPTVDRINIGKISEQTNKINMMLSTKIDRSTKVITNAIYFKGEM--KYKFAVNTLVVHDYHGQTKIVPTMFK

Pc_007867     223  MDNMFYAEI-PDMQAKIVELPYEREKDSPNKYVSMFIIVPNEVNGLDIEKNMETINMDMVRKKGSMRDVILDMPKFRME
Pl_000063     125  MDNMFYAEF-PDMQAKIVELPYEREKDSPNKYVSMFIIVPNEVNGLDIEKNMETINMDMVRKKGSMRDVILDMPSLR--
Ae_CL18Contig1 233  RGFIPPIGYLNPYSAKIIOLDY--LWLDNYNFAVNNYLVPEEDVGFDKVERLLYNFDFSNFE-VDEVANINLLMPFRLE
Ae_aar0aka8ya02 1  -----
Md_comp17591_c0 235  EAKFYWGYI-RAVKSRIKLPY--ESHGKETIEMTIIDPHNGVNIHDVNNINIKIDFTRLK--GSTMKMALHLPKFRLE
Hd-Ven390     228  SGSYFVGL-DLAKKRFVEIPY--KSEGPNDAMSFPVIVPDAVDGLAELEKNIKVSMDRLL-NSRKQDNLVLPKFRLE
LbSPNy       235  TGPYRVSGDTAIKARMIELPY--KGD---ELSMIIVIPYEMNGLDVDESSELRVNLNRNHKSLMPFVKNLPLKFRVE

Pc_007867     302  STNNLRPVMEEKMGMDMFSDKADFTGIDSPFLKISKAMQKAMIDVNEEGSE---AAAVTTMIAVPMSMPMPQELPVTLT
Pl_000063     202  -----
Ae_CL18Contig1 310  TSVELKKPLINDIGVTKIWSKESDLSGFSKN--TYVNEFPFKTCTIVDPPFNE---KTKSYIA-----PKGPVNVV
Ae_aar0aka8ya02 46  TKIDLKRHLKKKGINRAFRTNANFKGISGNQNVFNKVVQKAKIYVNDKGDADDHEAKIYGVDHILLKY-----MTIK
Md_comp17591_c0 310  SKFNLKPTLDVGIQMPKDTADFSGIKNTKLVKSKIIQKAPIEVNEEGTE---AAAVTGM---KMK-SRSSFLQFT
Hd-Ven390     304  SDIPLNAVLAKMGMDMFSDAADFTGIDSPRLAVSKVVQKAPIEVNEEGSE---AAAVTGM---KMK-SRSSFLQFT
LbSPNy       309  ATTDLYDALNKGINEAFQDIANSRIIDG-NLSVSKMMHKTLEVNENCAE---AAASVA---VLGFRSMKSDPEFNF

Pc_007867     379  IDRPFYFSIVIVNNELEGGQARTMLFTGRVMDPETS
Pl_000063     119  -----
Ae_CL18Contig1 376  VDRPFFWITVSDHG-----VVILFSRITNPAIQ
Ae_aar0aka8ya02 119  VDRPFLFVIATNNN-----ILFTGRVTPNLL
Md_comp17591_c0 381  VNRPFLLCVIVKSN-----NTPLFYARIMDPTAN
Hd-Ven390     380  VDRPAHFIIATKSN-----DQNAILFRGVSVDHPLAN
LbSPNy       382  ANHPFHYKIISIDK-----NNHVVLPAQNVRHQIQ

```

## ARTICLE 7

Evolution of the venom of the parasitoid wasp *Leptopilina boulardi* (Hymenoptera: Figitidae) in response to resistance of the *Drosophila melanogaster* host.

En préparation

Cavigliasso F., Mathé-Hubert H., et al. (co-premier auteurs)

*Evolution expérimentale du venin de Leptopilina boulardi en fonction de la résistance de l'hôte Drosophila melanogaster.*

## Présentation de l'article

Afin de d'étudier spécifiquement l'effet de l'hôte sur la composition du venin, nous avons choisi un paramètre important, sa résistance vis à vis du parasitoïde. Il a en effet été montré récemment que la virulence des parasitoïdes pouvait être sélectionnée en réponse à la résistance symbiotique de l'hôte (Dion *et al.* 2011; Rouchet & Vorburger 2014) et ce de façon spécifique à la souche de symbiote induisant la résistance. Nous avons ici utilisé un modèle bien caractérisé, l'interaction entre *Leptopilina boulardi* et *Drosophila melanogaster*.

L'expérience d'évolution expérimentale a été menée à partir d'individus F1 produits par le croisement de deux lignées de parasitoïdes différant par leur réussite parasitaire sur la souche hôte résistante utilisée (succès vs échec) (Dubuffet *et al.* 2009), ainsi que par la composition de leur venin. Les deux souches hôtes, sensible et résistante, diffèrent uniquement par une partie du chromosome 2 contenant le gène de résistance majeur identifié (Poirié *et al.* 2000; Dubuffet *et al.* 2009).

Les individus F1 ont été répartis en deux groupes d'une dizaine d'individus, maintenus pendant 10 générations, l'un sur hôte sensible, l'autre sur hôte résistant. Le venin d'une dizaine d'individus par réplicat a ensuite été caractérisé à différentes générations afin de tester l'évolution de la composition du venin sur chacun des deux hôtes. Cette caractérisation a été réalisée par deux approches : (i) globalement, à l'aide de la méthode d'analyse des gels développée dans la partie 1 de ma thèse (Article 2) et (ii) de façon spécifique, à l'aide d'anticorps ciblant des protéines spécifiques suspectées ou connues pour être nécessaires au succès parasitaire (sur hôte résistant ou sensible). Grâce aux données disponibles sur la composition du venin de *L. boulardi*, une liste de protéines ayant potentiellement « évoluées » sur chaque hôte a pu être établie.

Cette expérience a permis de montrer que le venin de *L. boulardi* peut évoluer rapidement en réponse à la résistance de l'hôte. Les résultats de l'approche globale (analyse digitale des gels) et spécifique (anticorps) concordent. Ceci confirme la fiabilité de la méthode d'analyse et de son interprétation. Le nombre de bandes détectées comme « évoluant » significativement sur au moins un hôte est élevé (17 bandes sur 34). Par ailleurs, les bandes dont l'intensité diminue sur un hôte ont tendance à augmenter sur l'autre hôte. Ceci montre clairement qu'une sélection différente s'exerce sur chacune des souches hôtes et suggère un coût à la production ou à la présence de certaines protéines. Enfin, des protéines connues ou suspectées comme



impliquées dans la virulence sur hôte résistant ou sensible ont été retrouvées dans la liste des protéines « évoluant », en accord avec leur rôle prédit.

Evolution of the venom composition in the parasitoid wasp  
*L. bouleardi* (Hymenoptera: Figitidae) in response to the resistance  
of the *Drosophila melanogaster* host

Cavigliasso F., Mathé-Hubert H., et al.  
(co-premier auteurs)

## Introduction

Variations observed in parasite virulence and host resistance are often considered as a result of coevolutionary processes. Indeed, a rapid evolution of these traits is predicted under strong selective pressures. Such evolution has notably been documented for *Drosophila*-parasitoid interactions, using population cage experiments (Dupas and Boscaro, 1999; Fellowes et al., 1998; Green et al., 2000; Kraaijeveld et al., 2001). More recently, experimental evolution results demonstrated that aphid parasitoids virulence rapidly evolves in response to host resistance driven by the *Hamiltonella* symbiont (Dion et al., 2011). Rouchet and Vorburger (2014) confirmed these results and further evidenced that this adaptation can be partly specific to the symbiont isolate, suggesting it possibly involves different specific virulence factors.

Strikingly, the mechanisms underlying evolution of resistance or virulence in selected strains or populations are still little understood. Kraaijeveld et al. (2001) reported an increase in the number of hemocytes in lines selected for resistance to *A. tabida*. *Drosophila melanogaster* resistance to *A. tabida* was also explored by Wertheim et al. (2011) that surveyed transcriptional changes in an artificially selected strain and Jalving et al. (2014) that uses whole-genome sequencing on selected lines, revealing multiple, highly localized genomic changes. Finally, studies of naturally occurring *D. melanogaster* resistance to the *L. bouleardi* parasitoid (ISy line) evidenced the implication of a single diallelic major gene, Rlb, located on chromosome 2 (labelled as Rst(2)Lb in Flybase; ID number: FBgn0016729) (Carton et al. 1992; Benassi et al. 1998; Poirié et al. 2000). Genetic experiments then led to characterization of the involved region and identification of a few candidates loci for this gene (Hita et al., 1999; Hita et al., 2006). To our knowledge, no physiological or molecular trait possibly evolved in response to selection for parasitoid virulence have ever been identified.

Venom has been demonstrated as a key factor in the virulence of many parasitoid species, being often necessary to ensure successful development at the surface or inside the host (Kitano 1986; Wago & Tanaka 1989; Asgari 2012) and to increase the host nutritional value (Mrinalini *et al.* 2014). Its composition varies between more or less related parasitoid taxa but also at the intraspecific level, as shown in the *Leptopilina* (Hymenoptera: Figitidae) parasitoid genus (Colinet *et al.* 2013a; b).

Colinet *et al.* (2013a) used an approach combining transcriptomics and proteomics to characterize and compare venom composition between *L. heterotoma* and two lines of *L. bouvardi* (ISm and ISy) that differ in their virulence properties. Strikingly, results indicate that *L. heterotoma* and *L. bouvardi* do not share any abundant venom protein while the two *L. bouvardi* lines only share 56% of the abundant proteins. This is in agreement with results of Dupas *et al.* (2013) that evidenced both inter and intraspecific variation of virulence on different host species and lines in this genus. Besides, the levels of virulence on different host species were sometimes not positively correlated, which means that some virulence factors are host specific. Finally, variation of venom content among *L. bouvardi* individuals was also recently evidenced (Colinet *et al.* 2013b; unpublished data). This high level of variability suggests that parasitoid venom has a high evolvability. This raised the question of the possible involvement of venom in the rapid and sometimes highly specific evolution of parasitoid virulence.

The *Leptopilina* – *Drosophila* model is particularly well-suited to address these questions. In particular, the well-characterized *L. boulardi* isofemale lines ISm and ISy (Gif stock, no. 431 and 486, respectively) can be useful in experimental settings. ISm, which originates from the Nasrallah oasis (Tunisia), is highly virulent against *D. melanogaster* but is always encapsulated in the tropical species *D. yakuba*, as a result of the immune defence. In contrast, ISy, which comes from Brazzaville (Congo) can be successful in both host species but depending on their resistance/susceptible phenotype (Dupas *et al.* 2003; Dubuffet *et al.* 2008). This difference is likely due to the presence of a larger number of *Drosophila* host species in the tropical area. Resistance to ISy in *D. melanogaster* is determined by the major locus Rlb (see above). Two highly inbred strains, R and S (Gif n° 1088 and 1089, respectively), are available that only differ by part of their chromosome 2, involving the Rlb locus. This system has been considered as a „gene for gene“ interaction, encapsulation occurring only when an “avirulent” wasp (ISy) parasites a resistant *D. melanogaster* fly (Fig. 1).





		<i>Drosophila melanogaster</i>	
		Susceptible	Resistant
<i>Leptopilina boulardi</i>	ISy	 Success	 Failure
	ISm	 Success	 Success

Figure 1: Interactions between the *D. melanogaster* and *L. boulardi* strains. Resistance is only observed toward the ISy strain of *L. boulardi*.

Some venom proteins of the ISm and ISy strains, that largely differ in venom composition, were previously characterized and demonstrated to be involved in immune suppression of the host defense (Dubuffet *et al.* 2009). Their qualitative or quantitative variation may explain the difference of virulence observed between these lines. Among these proteins, a RhoGAP domain-containing protein, LbGAP, required for parasitism success on the resistant *D. melanogaster* strain was found to be much more abundant in ISm compared to ISy venom (Colinet *et al.* 2010). This protein targets Rac1 and Rac2 inside the *D. melanogaster* host

hemocytes, inducing changes in their morphology and preventing encapsulation of the eggs (Labrosse *et al.* 2005a, b; Colinet *et al.* 2007; Williams *et al.* 2005). The extensive study of Colinet *et al.* (2013a) revealed the presence in venom of eight other RhoGAP domain-containing proteins that were all mutated on their catalytic site, making them likely not active as “classical” RhoGAPs. Among these additional proteins, the most closely related to LbGAP, LbGAP2 (39% amino acid sequence identity; Colinet *et al.* 2013a), is also one of the most abundant protein in the ISm venom. The venom of the two lines also contains high amounts of a serine protease inhibitor of the serpin superfamily (SPN). Serpins in the two lines (ISm: SPNm ; ISy: SPNy) differ by their molecular weight but they likely correspond to alleles of a same gene. SPNy was shown to inhibit the activation of the prophenoloxidase enzyme and is thus likely involved in the melanization process (i.e.: the immune reaction; Colinet *et al.* 2009). Although sequences of SPNm and SPNy are very similar, they display some important differences in the catalytic site, suggesting that they may have different targets (Colinet *et al.* 2009).

In this study, we performed an experimental evolution aimed at testing and characterizing the evolution of the venom composition of hybrids of the two *L. boucardi* lines raised on the resistant or the susceptible *D. melanogaster* strain. The venom composition of individuals from the F2, F6 and F10 generations was analyzed using two different approaches, performed on the same individual. The global approach was based on the analysis of pictures of 1D electrophoresis gels of venom reservoir contents. Gel pictures were then analyzed with a method that allows measuring and comparing intensities of protein bands, 34 in this analysis (Mathé-Hubert, submitted). We then used proteomic and transcriptomic data from Colinet *et al.* (2013a) to identify the proteins contained in the bands that were shown to evolve. This approach is without *a priori* and it provided global information on the evolution of venom composition. The specific approach was based on Western blots analysis of the venom reservoir contents, and tests for the presence of the LbGAP protein, the quantity of LbGAP2 and genotype for the serpin. Being more specific, it is also more accurate and allows easier interpretation of the results. Data obtained with these two approaches are compared and results are discussed in the light of our knowledge on *L. boucardi* virulence.

## Material and methods

### *Biological material*

The origin of the *L. bouleari* ISy (Gif stock number 486) and ISm (Gif stock number 431) isofemale lines has been previously described (Dupas *et al.* 1998). Briefly, ISy derives from a single female collected in Brazzaville (Congo) while ISy originate from a single female collected in Nasrallah (Tunisia). The two lines were reared on a susceptible *D. melanogaster* strain (Gif stock number 1333) at 25°C. After emergence, adults were kept at 20°C on agar medium with honey.

The *D. melanogaster* R strain (Gif number 1088) S strain (1089) both originate from isofemale lines established from a population collected in Brazzaville. They have been used to obtain susceptible and resistant flies to the sympatric ISy *L. bouleari* line. The R and S strains are long-inbred strains that have the genetic background of the original isofemale line susceptible to the ISy parasitoid (Gif strain n° 22). The resistant strain was given the second chromosome of the fly strain created with isofemales lines selected for high resistance to ISy (resulting strain 940 ; Carton and Nappi, 1997).

### *Venom analysis and data acquisition*

Venom reservoirs were dissected individually in 15 µl of insect Ringer solution supplemented with protease inhibitors cocktail (PI; Roche). Residual tissues were removed by centrifugation (500g, 5 min), and 10 µl of supernatant were mixed with an equivalent volume of Laemmli reducing buffer and heated (95°C, 5 min). These individual protein samples were then spitted in two, one part being used for the global analysis, the other for the specific analysis. For both analyses, protein separation was done by 1D SDS-PAGE electrophoresis using commercial gels (Any-kD Mini-PROTEAN® TGX™, Bio-Rad) for homogeneity.

Global analysis: For the global analysis, we used the method described by Mathé-Hubert *et al.* (submitted). To this end, following migration, gels were silver stained (Morrissey 1981) and photographed three to four times along the staining process (digital camera EOS-5D-MkII, Canon, Japan). The resulting high-resolution pictures (5626 × 3745 pixels; 16 bit; TIFF file) were then semi-automatically analyzed with the developed method based on the transformation of lanes into intensity profiles by Phoretix 1D (TotalLab, UK) and analysis of these profiles by R functions. Analysis resulted in the choice of 34 “reference bands” of identified molecular weight, whose intensity in each lane was estimated with the following combination of parameters [“height” (maximal intensity between borders of reference band),

“with background” (background removed in Phoretix-1D with a “rolling ball” of 10 000 pixels of radius), with quantiles normalization (Bolstad *et al.* 2003; Smyth 2005)]. The intensity of the 34 reference bands are the variables describing venom composition that were used for statistical analyses.

Western-blot: For the specific analysis, gels were blotted onto a nitrocellulose membrane (120 V for 1 h ; Whatman, GE Healthcare). The membrane was incubated one hour in 2% milk in TBS - Tween (20 mM Tris-HCl pH 7,3, 150 mM NaCl, 0,2% Tween 20) and then overnight at 4°C with a mix of antibodies against LbGAP (1:10000), LbGAP2 (1:2000) and LbSPN (1:2000). LbGAP and LbGAP2 were produced using an *E. coli* recombinant protein while LbSPN was an anti-peptide antibody. Following three washes of 20 min in TBS – Tween, the membrane was incubated with a secondary antibody coupled to peroxylase (1:10000) in 2% milk in TBS – Tween, washed three times 20 min in TBS – Tween, and then revealed with a luminescent substrat (Luminata TM Crescendo Western HRP Substrate Millipore). Signal was acquired with a cooled CCD camera (Andor iKon-M, Andor Solis Imaging and Spectrograph).

Data were then acquired as follows. For each individual, we recorded i) for LbGAP, the presence or absence of signal ii) for LbGAP2, the relative quantity (ratio between the LbGAP2 signal intensity and the total intensity of the corresponding lane) iii) for SPN, the presence of one or two bands of known molecular weight. The detection of a 45 Kda band indicates the presence of LbSPNm only, while that of a 54 Kda band the presence of LbSPNy only. The detection of the two bands signals an heterozygote individual.

### *Experimental design*

The experiment was designed to follow and characterize the evolution of the venom composition of hybrids between the ISm and ISy lines of *L. bouleari* on either the susceptible (S) of the resistant (R) strain of *D. melanogaster*. ISm is virulent on both R and S strains while Isy only succeeds on the S strain. For each of the eight replicates, the offspring of one individual cross (ISm female x ISy male) was used to create two groups of 10 females and 5 males that were separately maintained on resistant or susceptible *D. melanogaster* strains. At each generation, 10 females and 5 males were randomly chosen to create the next generation. The 16 populations were maintained on their respective host for 10 generations.

Since parasitoid wasps are haplodiploids, all F1 females were heterozygote (with an ISm and an ISy allele) while males are of the ISy type. F<sub>2</sub> is thus the first generation with different

genotypes for male and females and thus the first generation that can respond to selection. Also, because the genetic background of ISm is more present than the ISy one in the first generations, our experiment is statistically much more powerful to detect evolution toward the ISy type of the venom than toward the ISm type.

### *Statistical analysis*

For the global analysis of venom, we used a MANOVA to test for the significance of the venom evolution and the specificity of this evolution toward the host genotype (resistant vs. susceptible). Then, we characterized the changes that occurred in venom composition using a discriminant analysis.

Because band intensities are not normally distributed, we used the non parametric MANOVA implemented by the “adonis” R function of the “vegan” package (Dixon 2003) with 999 permutations and Euclidean distances to explain bands intensity with the host resistance, the generation, the (host resistance x generation) interaction and the replicates as fixed effect. Linear discriminant analysis was performed with the individual venom composition as continuous variables with the combination of host resistance and generation as a factor (ADE4; Dray & Dufour 2007). Bands correlations to the first two discriminant axes were tested with Spearman rank correlations. Then, because the position of individuals on the first and the second axis were clearly interpretable as “venom evolution on the susceptible host” and “venom evolution on the resistant host”, we tested how bands correlation to these two axis were distributed, using a linear regression. Finally, to determine if bands evolved on the susceptible or the resistant host, we tested if they were significantly correlated, to the first or the second axis, respectively. To handle multicollinearity between bands, the correlation to discriminant axes of each band was tested using partial correlations accounting for the variation of other bands correlated to the considered band (at least with a correlation of 0.4). This was performed with the function “partial.cor” of the package “Rcmdr”. All *p*-values were Bonferroni corrected for the number of bands ( $N = 34$ ).

For the specific analysis, we tested if each of the three considered proteins evolved (i) randomly and (ii) differentially on the two hosts. Because the three variables describing these proteins are of different types (presence/absence for LbGAP, categorical for LbSPN with three genotypes, continuous for LbGAP2 with the relative quantity), we used a different test for each protein. For LbGAP and LbGAP2, we fitted mixed models with the host level of resistance, the generation and the (host level of resistance x generation) interaction as fixed effects and the replicate as random effect with a binomial distribution for LbGAP (GLMM)



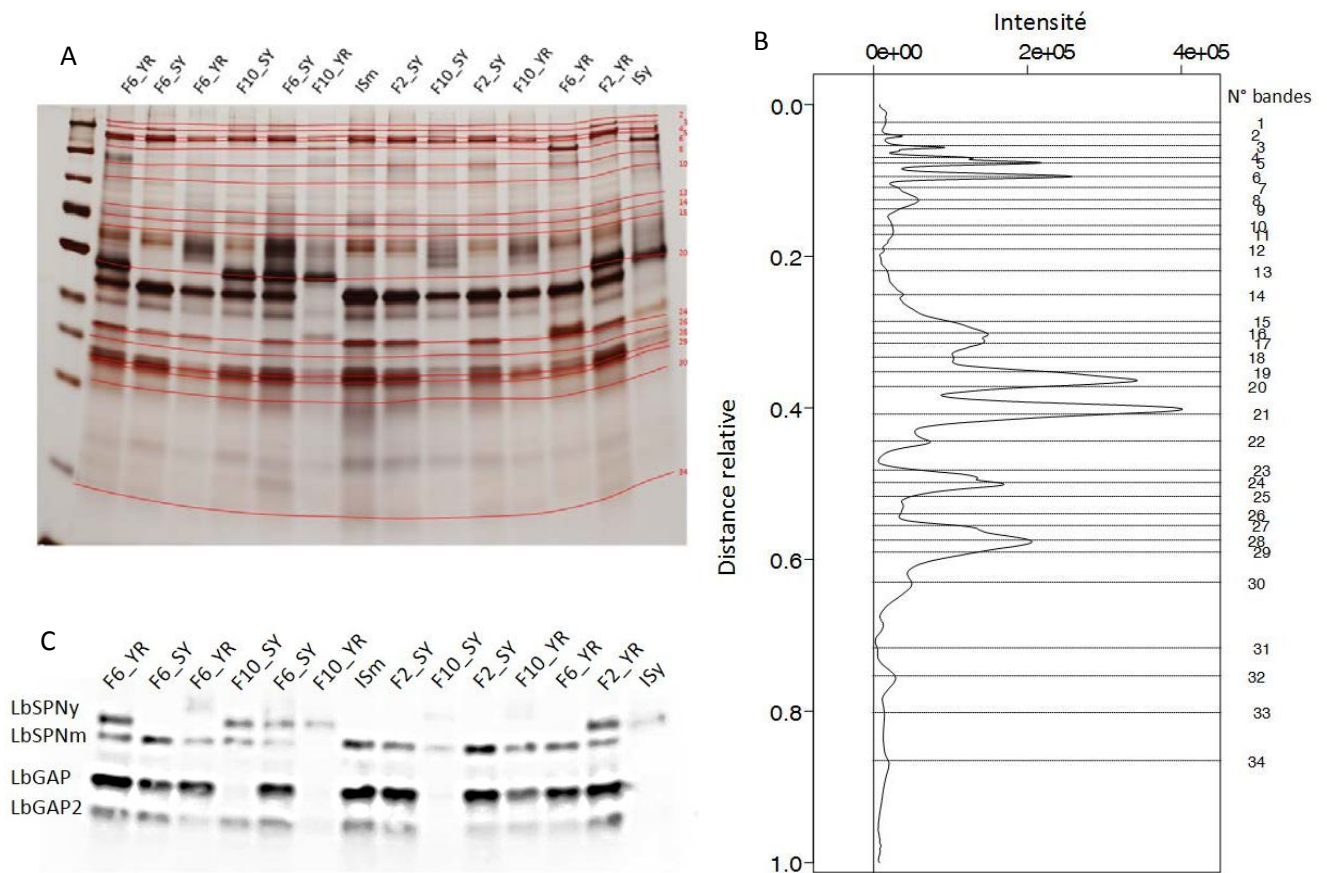
and a log transformation for LbGAP2 (LMM). From these saturated models, variables were selected on the basis of the AIC and selected variables were tested with a Wald test. Models were fitted with the lme4 R package (Bates *et al.* 2010). As all F2 individuals have the LbGAP protein, the test was performed both with and without F2 individuals.

For LbSPN, we used a separate chi-square test for evolution on the two hosts, as well as for F6 and F10 individuals. Specifically, we tested if the observed genotypic frequencies differed from the frequencies expected under the assumption that (i) allelic frequencies were the same as in the F2 generation F2 and (ii) Hardy-Weinberg equilibrium.

## **Results**

### *Host specific evolution of individual venom composition evidenced by a global approach*

Characterisation of the individual venom composition was performed based on the analysis of the intensities of 1D SDS-PAGE reference bands (see Figure 2, upper and right parts). The non-parametric MANOVA revealed a highly significant effect of the interaction between the host phenotype (resistant or susceptible) and the generation on the venom composition (Table 1), demonstrating that venom composition evolved in a different way on the two hosts.



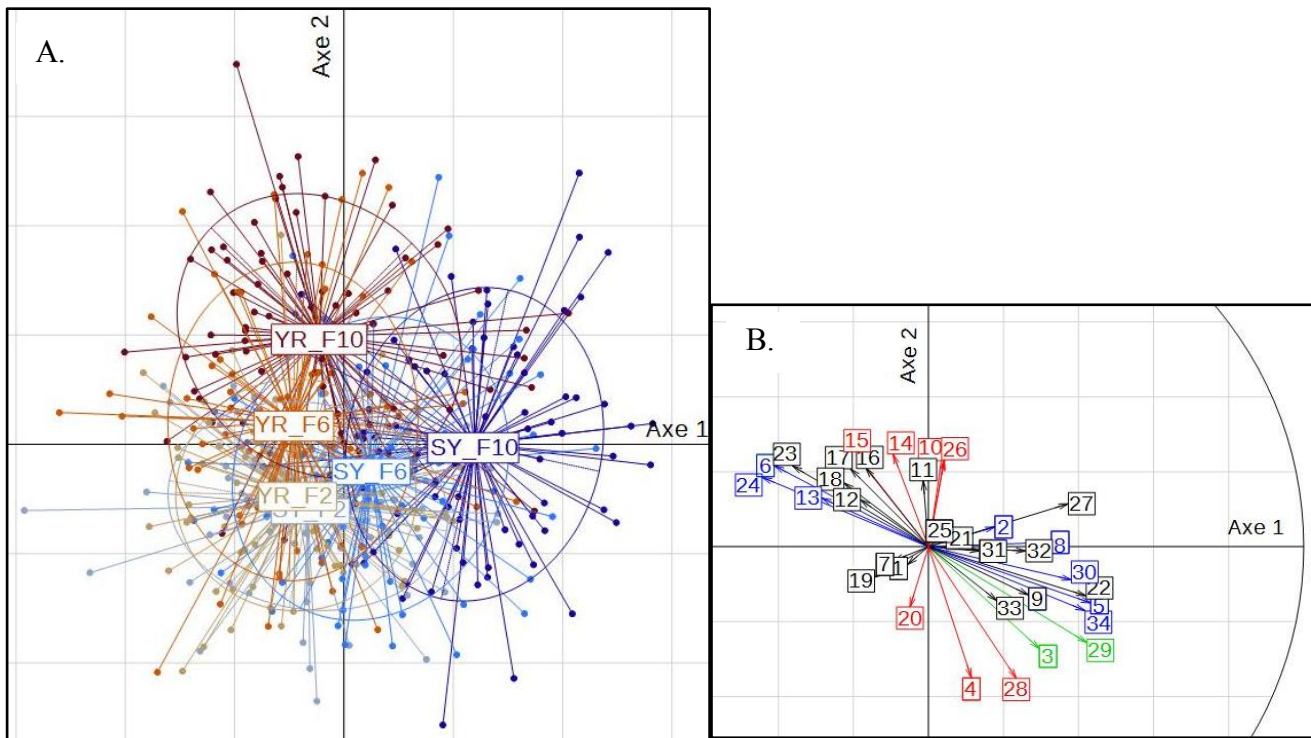
**Figure 2:** Global analysis of the individual venom protein contents.

A. Example of 1D SDS-PAGE, silver stained, individual profiles. F2, F6 and F10: *L. boulandi* individuals from the F2, F6 and F10 generations of the experimental selection. SY and YR: individuals raised on the *D. melanogaster* SY and YR strain, respectively. ISm and ISy: control individuals from the ISm and ISy lines. Red lines correspond to the bands that were shown to evolve. Numbers on the right are the band numbers. B. Intensity curve of the mean profile obtained from analyses of the individual profiles with Phoretix 1D and R. Horizontal lines are the positions of the bands. Relative distance: distance from the top of the gel relative to the height of the gel. Intensity: sum of the pixels and their intensities. C. Western blot corresponding to the gel with detection of the LbGAP, LbGAP2 and SPN proteins on the same individuals.

**Table 1:** Results of the non-parametric MANOVA Df : degree of freedom. Sums Of Sqs: sum of squares. MeanSqs: sum of squares by degree of freedom. F: F statistics. R2: partial R-squared. Pr(>F) *p*-value based on 999 permutations.

	Df	Sums Of Sqs	Mean Sqs	F	R2	Pr(>F)
Generation	2	0.03	0.016	2.94	0.011	0.0044 **
Host	1	0.07	0.07	13.9	0.026	<1.10 <sup>-4</sup> ***
Replicate	7	0.26	0.038	7.03	0.091	<1.10 <sup>-4</sup> ***
Generation × host	2	0.05	0.026	4.85	0.018	<1.10 <sup>-4</sup> ***
Residuals	461	2.46	0.005	0.85		
Total	473	2.88	1.00			

To better characterize the host specific evolution of venom composition, we then performed a linear discriminant analysis on the venom composition. The position of individuals from the six groups (the F<sub>2</sub>, F<sub>6</sub> and F<sub>10</sub> generations on the two hosts) on the first and the second axis clearly show that these two axes can be interpreted as “venom evolution on the susceptible host” and “venom evolution on the resistant host”, respectively (Fig. 3). This confirms that the venom composition evolved differently on the two hosts. It also evolved rather rapidly since changes were already detected in F<sub>6</sub>, after 4 generations of selection. In addition, no variation was observed among F<sub>2</sub> individuals raised on the different strains, which means that there was no evidence of plasticity of venom composition depending on the host strain.



**Figure 3:** Part A. positions of individuals (points) on discriminant axes. Individuals are grouped and colored according to the host strain (respectively YR and SY for the resistant and susceptible host) and generation. Part B: correlation circle indicating correlations of bands to discriminant axes. Colors indicate the significance of correlations estimated with partial correlations. Green: correlation to the two axes; blue: correlation to the horizontal axis; red: correlation to the vertical axis; black: no correlation.

We then identified bands that significantly evolved using partial correlations. This revealed that 17 out of the 34 protein bands were significantly correlated to one of the two LDA axes i.e. evolved in response to the host strain, resistant or susceptible. Among these bands, three and five bands were positively and negatively selected on the susceptible host, four and three bands were positively and negatively selected on the resistant host, and finally, two bands were both positively and negatively selected, on the susceptible and the resistant host, respectively. Interestingly, a negative correlation was observed for the position of bands on the two discriminant axes (Spearman correlation test,  $R_s = -0.6812$ ,  $p\text{-value} = 1.5e-05$ ), showing that the majority of bands evolved in opposite directions on resistant and susceptible hosts.

The identification of proteins contained in the bands that evolved was performed by manually matching reference bands of this analysis with bands of 1D electrophoresis gels used for proteomic analysis of *L. bouhardi* venom in Colinet *et al.* (2013a). The proteomics

had led to characterization of a number of peptides for each analysed band, allowing identification of the number of matches of each peptide to unisequences previously identified through transcriptomics. These numbers of matches, which describe the contents of electrophoretic gel bands, are provided in Table 2 for evolving bands.

This approach allowed identifying at least one abundant protein (more than ten matches) for the 9 bands that were detected as evolving by the global approach (Table 2). A protein was considered as responsible for the evolution of the band if the number of matches was clearly higher than the number observed for the other proteins of the band. Identified abundant proteins were a Glucose-Methanol-Choline (GMC) oxidoreductase and a RhoGAP (LbGAPy4) that were positively selected on the resistant host; the serpine LbSPNy that was counter-selected on the resistant host; LbGAP that was counter-selected on the susceptible host; LbGAP2 that was selected on the susceptible host and counter-selected on the resistant host.

**Table 2:** Correspondence between evolving bands and their protein content.

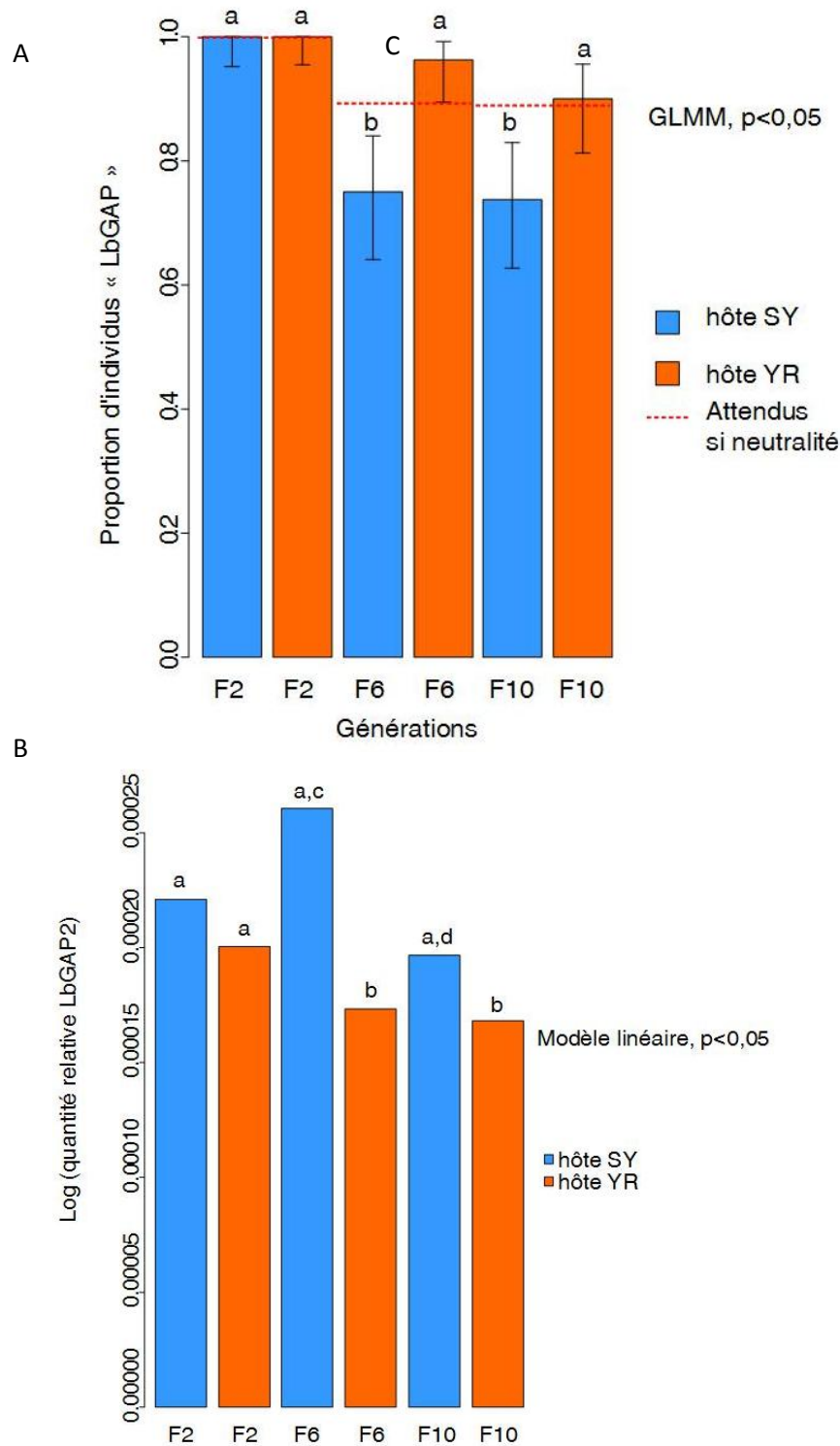
The number of proteins found in the band, the predicted function of each of these proteins, and the number of matches to unisequences identified in transcriptomics are provided. + and – indicates a positive or a negative evolution of the corresponding host train, respectively. Proteins evidenced as the more abundant in the protein band are in bold.

Reference band	Proteins number in the band	Functions	Number of matches	Evolution on R strain	Evolution on S strain
13	1	Unknown	11		-
<b>14</b>	1	<b>GMC oxidoreductase</b>	40	+	
15	3	3 Unknown	39, 36, 28	+	
<b>20</b>	1	<b>Serpin (LbSPNy)</b>	81	-	
<b>24</b>	5	<b>RhoGAP (LbGAP)</b>	52		-
		1 Unknown	21		
		Serpin (LbSPNm)	17		
		2 Unknown	12, 11		
<b>26</b>	1	<b>RhoGAP (LbGAPy4)</b>	24	+	
<b>28</b>	3	<b>RhoGAP (LbGAP2)</b>	43	-	
		RhoGAP (LbGAP1)	23		
		Serpine (LbSPNm)	15		
<b>29</b>	4	<b>RhoGAP (LbGAP2)</b>	68	-	+
		Unknown	21		
		RhoGAP (LbGAPy2)	19		
		Unknown	11		
30	2	Unknown	18		+
		RhoGAP (LbGAP2)	12		

*Host specific evolution of individual venom composition evidenced by a specific approach*

Three different proteins were chosen for the specific analysis: two venomous RhoGAP, LbGAP and LbGAP2, and the venom serpin SPN. Individuals raised on the R or S strains were analyzed at the three generations F2, F6 and F10, using specific antibodies. LbGAP is detected as an intense band in ISm venom and is not detected in ISy venom. It was then analyzed as present/absent. The presence of LbGAP was affected both by the generation (Fig. 4A,  $p < 0.01$ ) and the level of resistance (Fig. 3A,  $p < 0.001$ ). When the test was performed without the F<sub>2</sub> individuals, we only observed a strong effect of the resistance level (Fig. 4A,  $p < 0.001$ ). This suggests that the evolution of LbGAP mainly occurs between the F2 and F6 generations. No evolution was observed on the resistant host ( $\text{Chi}^2$ ,  $p = 0.13$  in F6 and  $p = 1$  in F10) while negative selection occurred on the susceptible host ( $\text{Chi}^2$ ,  $p = 0.04$  in F6 and  $p =$

0.025 in F10). The quantity of the LbGAP2 protein was rather variable and it was then analyzed based on the signal intensity level. Significant effects were observed for the host resistance level ( $p = 0.02$ ) and the generation ( $p = 0.03$ ) but only when F<sub>2</sub> individuals were removed from the analysis (Fig. 4B). LbGAP2 quantity was significantly lower on the resistant host compared to the susceptible host ( $p < 0.001$  in F6 and  $p < 0.05$  in F10). The serpin SPN shows a qualitative variation between ISm and ISy parasitoids with two different forms (SPNy in ISy and SPNm in ISm) and the frequency of the three genotypes was analyzed. We did not detect any effect of the generation nor the host.



**Figure 4: Evolution of the specific proteins LbGAP and LbGAP2.** Host strains SY et YR: individuals reared on the susceptible and resistant strain, respectively. A. Proportion of LbGAP individuals depending of the host strain and generation. The red lines indicate the expected proportion. B. Relative quantity of LbGAP2 (logarithm) depending on the host and the generation.



## Discussion

Parasitoids virulence has been shown to evolve very rapidly in response to the host resistance, whether genetically-based or symbiotic, and several studies suggest that this evolution may be specific to the parasitized host (Dupas *et al.* 2013; Rouchet & Vorburger 2014). This suggests that some “virulence factors” should be highly evolvable and should be host specific. One good candidate, shared by most parasitoid species and commonly necessary for parasitism success was the venom injected into the host together with the eggs.

Here, we have tested this hypothesis by characterizing the evolution of parasitoid venom composition in response to the host resistance or susceptibility. Venom composition was characterized by two parallel approaches performed on the same individual: a global approach based on the analysis of bands intensity on pictures of 1D electrophoresis gels of individual venom reservoirs, and a specific approach (focused on the two well-characterized venom proteins LbGAP and LbSPN, and the abundant protein LbGAP2, another RhoGAP mutated on the active site). Results of the two approaches were congruent and they evidenced evolution of venom composition.

The global approach revealed that a large amount of bands (17 out of 34) evolved at least on one of the two hosts. This seems surprising since the difference of resistance between the two strains was shown to involve a single gene, *Rlb* (Carton *et al.* 1992; Benassi *et al.* 1998; Poirié *et al.* 2000; Hita *et al.*, 1999, 2006). However, the R and S strains also differ at other loci on chromosome 2, so that phenotypic differences other than resistance could be partly responsible for the observed selection on parasitoid venom. Also, the *Rlb* gene is likely to be involved in a key signalisation pathway and the two alleles (R/S) may thus induce large cellular differences (Hita *et al.*, 2006). It is thus possible that many virulence factors are needed to overcome the resistance induced by this gene. Finally, a large part of the observed selection events corresponded to counter-selection and some of these evolving protein bands contained the same major protein (e.g. LbGAP2).

The observed evolution of venom composition was very rapid as it was detectable after only four generations of selection. Interestingly, this corresponds to the number of generations required for evolution of parasitoid counter-resistance (Dion *et al.* 2011; Rouchet & Vorburger 2014), suggesting that venom components may possibly be involved. Interestingly, results of the specific approach suggest that the time for evolution can differ between venom proteins (LbGAP and LbGAP2), probably in relation with different strengths of selection.

The global approach also evidenced a negative correlation of evolution of most of the evolving bands on the two host strains. Proteins that were positively selected on one host were often counter-selected on the other host. The same trend, although not significant, was observed in the specific approach, with an opposite selection on the two hosts. Results thus suggest that venom proteins are often costly, the cost being overcome when they are “useful” i.e. increase the parasitoid fitness. This is in agreement with data of Dupas & Boscaro (1999) showing that virulence of the ISy *L. boulardi* line against *D. yakuba* decreases when it is reared on *D. melanogaster*. It also supports the idea that venom components can be specific to the host strain.

The observed effect, a largely shared trend, was significant for the protein band #29 which was positively selected on the susceptible host and counter-selected on the resistant host. Based on the comparison with “omics” data of Colinet *et al.* (2013a), this band contains two unknown proteins as well as two RhoGAP proteins, the most abundant of all being **LbGAP2**, that was also identified as counter-selected on the resistant strain in the specific approach.

Several other proteins with a known function or predicted function were detected as predominant proteins in a band that evolved. Unfortunately, many proteins were found that have no predicted function nor homologies in databanks. This indicates that our picture of venom factors involved in the *L. boulardi* success on *D. melanogaster* remains largely incomplete.

**LbGAP** is the most abundant protein in the band #24. It is produced in large quantity in the ISm line, but not in ISy, and it is known to play an important role in virulence against the resistant *D. melanogaster* strain (Colinet *et al.* 2010). Band #24 was counter-selected on the susceptible host but, surprisingly, it did not appear as selected on the resistant host. This is likely due to the fact that LbGAP (ISm allele) is dominant and that it was in a high frequency at the beginning of the experiment. Indeed, F1 hybrids are offspring of ISm females and ISy males, and the ISm LbGAP allele thus represents 2/3 of the alleles. In these conditions, selection is weak and statistically difficult to detect whereas counter-selection can be easily observed. Data thus suggest that the LbGAP production (or effect) is costly when the parasitoid is reared on the susceptible host strain.

A third RhoGAP protein, **LbGAPy4**, mutated on its catalytic site as **LbGAP2**, was predominant in the band #26 that was found to be selected on the resistant host. This protein was identified from the ISy line, suggesting that it is not sufficient *per se* to allow parasitoid

success on the the resistant strain. It may nevertheless increase the parasitoid fitness on this host, either alone or due to its association with other proteins.

The global analysis suggests that the **LbSPNy** protein is counter-selected on the resistant host. This protein is involved in the ISy immune suppression of the host via the inhibition of the phenoloxidase cascade activation (Colinet *et al.* 2009). As the ISy line does not succeed on the host resistant strain, its counter-selection on this host is expected if the presence of the protein is costly.

*[Results of the specific analysis for SPN were not significant, but for several reasons, the chi-squared test used to analyze this protein was not appropriate and a different approach will be used before final publication].*

Finally, the band #14 that mainly contains a GMC oxydoreductase (identified from the ISm line) was detected as selected on the resistant host. Interestingly, the injection of the proteins eluted from a gel electrophoresis band containing this protein has been shown to reduce the encapsulation rate of the ISy line in the *D. melanogaster* resistant strain of (Labrosse *et al.* 2005b; protein band "P1"). In addition, GMC oxydoreductase proteins were shown to be involved in the silkworm resistance to pathogens (Sun *et al.* 2012).

Our experiment was designed to create as much variability as possible by crossing two parasitoid lines whose virulence properties and venom composition largely differed. Variable bands are thus mainly those that these lines do not share. New combinations of factors have then been created as a large panel for selection. The ISm and ISy *L. boulardi* lines also differ by their virulence properties on the *D. yakuba* host since the ISy but not ISm can succeed on this species. It is then possible that parts of the venom proteins that differ between the lines are adapted to another host species than *D. melanogaster*.

In conclusion, our results demonstrate that venom composition can evolve rapidly and specifically on strains differing by their resistance capacities. Moreover, they evidence that parasitoid venom components can be costly. The nature of this cost remains to be investigated. Finally, this experiment confirms that venom proteins of unknown function may have an important role in parasitoid virulence, thus allowing to identify some new potential virulence factors.

## Bibliography

- Asgari S (2012) Venoms from endoparasitoids. In: *Parasitoid viruses: symbionts and pathogens*, Eds Nancy Beckage and Jean-Michel Drezen, pp. 217–231.
- Bates D, Maechler M, Bolker B (2010) lme4: Linear mixed-effects models using Eigen and syntax. R package version 0.999375-39.
- Benassi V, Frey F, Carton Y (1998) A new specific gene for wasp cellular immune resistance in *Drosophila*. *Heredity*, **80**, 347–52.
- Bolstad BM, Irizarry R a, Astrand M, Speed TP (2003) A comparison of normalization methods for high density oligonucleotide array data based on variance and bias. *Bioinformatics (Oxford, England)*, **19**, 185–93.
- Carton Y, Frey F, Nappi A (1992) Genetic determinism of the cellular immune reaction in *Drosophila melanogaster*. *Heredity*, **69**, 393–9.
- Carton, Y., & Nappi, A. (1997). *Drosophila* cellular immunity against parasitoids. *Parasitology Today*, **13**, 2245–51.
- Colinet D, Deleury E, Anselme C *et al.* (2013a) Extensive inter- and intraspecific venom variation in closely related parasites targeting the same host: The case of *Leptopilina* parasitoids of *Drosophila*. *Insect Biochemistry and Molecular Biology*, **43**, 601–611.
- Colinet D, Dubuff et A, Cazes D *et al.* (2009) A serpin from the parasitoid wasp *Leptopilina boulardi* targets the *Drosophila* phenoloxidase cascade. *Developmental and Comparative Immunology*, **33**, 681–689.
- Colinet D, Kremmer L, Lemauf S *et al.* (2014) Development of RNAi in a *Drosophila* endoparasitoid wasp and demonstration of its efficiency in impairing venom protein production. *Journal of Insect Physiology*, **63**, 56–61.
- Colinet D, Math e-Hubert H, Allemand R, Gatti JL, Poiri e M (2013b) Variability of venom components in immune suppressive parasitoid wasps: from a phylogenetic to a population approach. *Journal of Insect Physiology*, **59**, 205–12.
- Colinet D, Schmitz A, Cazes D, Gatti J (2010) The Origin of Intraspecific Variation of Virulence in an Eukaryotic Immune Suppressive Parasite. *PLoS Pathogens*, **6**, 1–11.
- Colinet D, Schmitz A, Depoix D, Crochard D, Poiri e M (2007) Convergent use of RhoGAP toxins by eukaryotic parasites and bacterial pathogens. *PLoS Pathogens*, **3**, e203.
- Dion E, Z el e F, Simon J-C, Outreman Y (2011) Rapid evolution of parasitoids when faced with the symbiont-mediated resistance of their hosts. *Journal of Evolutionary Biology*, **24**, 741–50.
- Dixon P (2003) VEGAN, a package of R functions for community ecology. *Journal of Vegetation Science*, **14**, 927–930.

- Dray S, Dufour AB (2007) The ade4 Package: Implementing the Duality Diagram for Ecologists. *Journal Of Statistical Software*, **22**, 1–18.
- Dubuffet A, Colinet D, Anselme C *et al.* (2009) Variation of *Leptopilina boulardi* success in *Drosophila* hosts: what is inside the black box? *Advances in Parasitology*, **70**, 147–188.
- Dubuffet A, Doury G, Labrousse C *et al.* (2008) Variation of success of *Leptopilina boulardi* in *Drosophila yakuba*: the mechanisms explored. *Developmental and Comparative Immunology*, **32**, 597–602.
- Dupas S, Boscaro M (1999) Geographic Variation and Evolution of Immunosuppressive Genes in a *Drosophila* Parasitoid Geographic variation and evolution of immunosuppressive genes in a *Drosophila* parasitoid. *Ecography*, **22**, 284–291.
- Dupas S, Carton Y, Poirié M (2003) Genetic dimension of the coevolution of virulence-resistance in *Drosophila* - parasitoid wasp relationships. *Heredity*, **90**, 84–89.
- Dupas S, Frey F, Carton Y (1998) A single parasitoid segregating factor controls immune suppression in *Drosophila*. *The Journal of Heredity*, **89**, 306–11.
- Dupas S, Poirié M, Frey F, Carton Y (2013) Is parasitoid virulence against multiple hosts adaptive or constrained by phylogeny? A study of *Leptopilina* spp.(Hymenoptera: Figitidae)/*Drosophila* (Diptera: Drosophilidae) interactions. *Annales de la Société Entomologique de France*, **49**, 222–31.
- Fellowes, M. D., Kraaijeveld, a R., & Godfray, H. C. (1998). Trade-off associated with selection for increased ability to resist parasitoid attack in *Drosophila melanogaster*. *Proceedings of the Royal Society of London, B*, **265**, 1553–8.
- Gibert P, Allemand R, Henri H, Huey RB (2010) Local adaptation and evolution of parasitoid interactions in an invasive species, *Drosophila subobscura*. *Evolutionary Ecology Research*, **12**, 873–883.
- Green, D. M., Kraaijeveld, a R., & Godfray, H. C. (2000). Evolutionary interactions between *Drosophila melanogaster* and its parasitoid *Asobara tabida*. *Heredity*, **85**, 450–458.
- Hita, M., Espagne, E., Lemeunier, F., Pascual, L., Carton, Y., Periquet, G., & Poirié, M. (2006). Mapping candidate genes for *Drosophila melanogaster* resistance to the parasitoid wasp *Leptopilina boulardi*. *Genetical Research*, **87**, 1–11.
- Hita, M. T., Poirié, M., Leblanc, N., Lemeunier, F., Lutcher, F., Frey, F., ... Carton, Y. (1999). Genetic localization of a *Drosophila melanogaster* resistance gene to a parasitoid wasp and physical mapping of the region. *Genome Research*, **9**, 471–81.
- Jalvingh, K. M., Chang, P. L., Nuzhdin, S.V., Wertheim, B. (2014). Genomic changes under rapid evolution: selection for parasitoid resistance. *Proceedings of the Royal Society of London, B*, **281**, 20132303.
- Kitano H (1986) The role of *Apanteles glomeratus* venom in the defensive response of its host, *Pieris rapae crucivora*. *Journal of Insect Physiology*, **32**, 369–375.

- Kraaijeveld, A., & Godfray, H. (2001). Is there local adaptation in *Drosophila*-parasitoid interactions? *Evolutionary Ecology Research*, **3**, 107–16.
- Labrosse C, Eslin P, Doury G, Drezen JM, Poirié M (2005a) Haemocyte changes in *D. melanogaster* in response to long gland components of the parasitoid wasp *Leptopilina boulardi*: a Rho-GAP protein as an important factor. *Journal of Insect Physiology*, **51**, 161–170.
- Labrosse C, Stasiak K, Lesobre J *et al.* (2005b) A RhoGAP protein as a main immune suppressive factor in the *Leptopilina boulardi* (Hymenoptera, Figitidae)-*Drosophila melanogaster* interaction. *Insect Biochemistry and Molecular Biology*, **35**, 93–103.
- Morrissey JH (1981) Silver stain for proteins in polyacrylamide gels: a modified procedure with enhanced uniform sensitivity. *Analytical Biochemistry*, **117**, 307–10.
- Mrinalini, Aisha LS, Wright J *et al.* (2014) Parasitoid venom induces metabolic cascades in fly hosts. *Metabolomics*, 1–17.
- Poirié M, Frey F, Hita M *et al.* (2000) *Drosophila* resistance genes to parasitoids: chromosomal location and linkage analysis. *Proceedings of the Royal Society of London, B*, **267**, 1417–21.
- Rouchet R, Vorburger C (2014) Experimental Evolution of Parasitoid Infectivity on Symbiont-Protected Hosts Leads To the Emergence of Genotype Specificity. *Evolution*, **68**, 1607–1616.
- Smyth GK (2005) Limma: linear models for microarray data. In: *Bioinformatics and Computational Biology Solutions Using R and Bioconductor* (ed Huber RG and VC and SD and RI and W), pp. 397–420. Springer, NewYork.
- Sun W, Shen Y-H, Yang W-J *et al.* (2012) Expansion of the silkworm GMC oxidoreductase genes is associated with immunity. *Insect Biochemistry and Molecular Biology*, **42**, 935–45.
- Wago A, Tanaka T (1989) Synergistic Effects of Calyx Fluid and Venom of *Apanteles kariyai* Watanabe (Hymenoptera: Braconidae) on the Granular Cells of *Pseudaletia separata* Walker (Lepidoptera: Noctuidae). *Zoological Science*, **6**, 691–696.
- Wertheim, B., Kraaijeveld, A. R., Hopkins, M. G., Walther Boer, M., & Godfray, H. C. J. (2011). Functional genomics of the evolution of increased resistance to parasitism in *Drosophila*. *Molecular Ecology*, **20**, 932–49.
- Williams MJ, Ando I, Hultmark D (2005) *Drosophila melanogaster* Rac2 is necessary for a proper cellular immune response. *Genes to cells*, **10**, 813–23.

## V. SYNTHESE DES PRINCIPAUX RESULTATS

L'objectif de cette thèse était de caractériser la variabilité et le potentiel adaptatif du contenu du venin de guêpes parasitoïdes, souvent utilisées comme auxiliaires en lutte biologique. Une première étape a consisté à vérifier l'existence d'une variabilité inter-individuelle de la composition de ce venin (Article 1). Afin d'étudier globalement cette variabilité, j'ai ensuite développé une méthode permettant de comparer statistiquement la composition protéique d'un grand nombre d'échantillons (Article 2). Elle a tout d'abord été utilisée pour caractériser la structuration de la composition du venin des parasitoïdes *Leptopilina bouvardi* et *L. heterotoma* selon un gradient Nord-Sud dans la vallée du Rhône (Article 3). Ceci a montré pour la première fois qu'il est possible de discriminer des populations locales d'un parasitoïde via la composition du venin. Une différence importante a été observée entre les deux espèces, les populations de *L. bouvardi* étant beaucoup moins différenciées que celles de *L. heterotoma*.

Ensuite, deux principales expériences ont été menées pour comprendre la nature de la variabilité du venin observée et tester ses effets et son potentiel adaptatif en réponse à de nouveaux environnements tels qu'un nouvel hôte.

Sur le modèle de lutte biologique *Psytalia lounsburyi*, j'ai tout d'abord développé une méthode moléculaire facilitant l'évaluation de la performance des populations au laboratoire ou sur le terrain et pouvant notamment être couplée à des analyses de type « DNA barcoding » (Article 4). J'ai ensuite mis en place l'expérience majeure de ma thèse (Article 5) : des individus échantillonnés sur le terrain ont été utilisés pour initier une évolution expérimentale visant à analyser les changements de composition du venin suite à un brusque changement environnemental : la mise en élevage en conditions de laboratoire et l'utilisation d'un hôte de substitution. Cette expérience a mis en évidence que (i) la composition du venin est partiellement héritable, (ii) elle peut changer très rapidement (une génération) et de façon répétable entre populations expérimentales, (iii) elle a un fort impact sur la valeur sélective des femelles et (iv) sur la dynamique d'extinction de petites populations, ce qui est vraisemblablement lié à son effet sur la valeur sélective des femelles. La méthode développée pour analyser la variation inter-individuelle du venin permet d'identifier les bandes protéiques « qui structurent » ou qui « évoluent ». Ensuite, pour identifier ces protéines, plusieurs approches peuvent être utilisées comme par exemple la caractérisation

globale du contenu protéique du venin à l'aide d'une approche combinée de protéomique et transcriptomique. Cette approche a été utilisée parallèlement aux expérimentations décrites ci-dessus, pour caractériser mais aussi comparer le contenu global du venin de *Psytalia lounsburyi* et de *P. concolor* (Article 6). Une autre approche moins exhaustive mais plus précise pour identifier les protéines contenues dans les bandes sélectionnées sera discutée par ailleurs (fin § **IV.2.**). Une interprétation « mécanistique » des résultats pourra donc être proposée en s'appuyant sur les fonctions connues ou supposées des protéines contenues dans ces bandes.

Parallèlement, une autre expérience d'évolution expérimentale a été menée sur le modèle *L. bouvardi*, bien mieux caractérisé que *Psytalia*, pour étudier le potentiel adaptatif du venin en réponse au niveau de résistance de l'hôte. Pour cette expérience, des parasitoïdes issus de l'hybridation de deux souches différant par leur niveau de virulence sur une souche hôte résistante ont été maintenus pendant 10 générations soit sur cet hôte résistant soit sur un hôte sensible. Les résultats montrent que la composition du venin peut s'adapter rapidement à l'hôte parasité et que les changements observés diffèrent selon la résistance de l'hôte (Article 7).



## VI. DISCUSSION ET PERSPECTIVES

La base de ce projet vient de la combinaison de plusieurs constats et éléments de contexte : tout d'abord, le taux de diversification extrêmement élevé des guêpes parasitoïdes conduit souvent à un continuum entre populations structurées et espèces cryptiques. En effet, les outils moléculaires révèlent souvent l'existence de complexes d'espèces (Li *et al.* 2004; Pennacchio & Strand 2006; Poulin & Keeney 2008; Rugman-Jones *et al.* 2009). Ce taux élevé de diversification est souvent considéré comme résultant en grande partie de la dynamique coévolutive entre hôte et parasitoïde (Dupas *et al.* 2009) qui peut conduire à de nombreuses adaptations locales. Des études montrent en effet que la virulence peut évoluer très vite en réponse à la résistance symbiotique de l'hôte (et de façon spécifique par rapport à la souche de symbiote conférant la résistance ; Dion *et al.* 2011; Rouchet & Vorburger 2014).

Ensuite, une grande partie des facteurs de virulence de parasitoïdes connus ou supposés sont des protéines de venin injectées dans l'hôte par la mère en même temps que l'œuf. Il devrait donc être possible de déterminer si ces protéines de venin sont à l'origine du potentiel évolutif à court terme de la virulence.

En termes de faisabilité, les protéines de venin sont stockées dans un appareil à venin ce qui en facilite l'étude. Par ailleurs, le laboratoire disposait de deux modèles d'étude intéressants: un modèle de terrain, le parasitoïde *Psytalia lounsburyi*, importé en France dans le cadre de la lutte biologique contre la mouche de l'olive, donnant l'opportunité de décrire l'évolution des protéines du venin face à un brusque changement environnemental (conditions de laboratoire et changement d'hôte) ; le modèle de laboratoire bien caractérisé « *Leptopilina boulardi* – *Drosophila melanogaster* ».

La question de la variabilité et du potentiel évolutif de la composition protéique des venins de parasitoïde n'avait jamais été abordée. En effet, la plupart des caractérisations de contenu protéique du venin ont été réalisées sur des espèces éloignées rendant la comparaison moins intéressante d'un point de vue évolutif. Néanmoins, certaines études avaient montré de larges différences dans la composition du venin entre espèces proches (Crawford *et al.* 2008; Colinet *et al.* 2013) suggérant que le venin peut évoluer rapidement.

Une forte évolvabilité étant généralement liée à une forte variabilité intraspécifique (Barrett & Schluter 2007; Welch & Jiggins 2014), le point d'entrée de ma thèse a été de vérifier l'existence de cette variabilité, puis de développer et utiliser une méthode permettant de l'étudier. Une part conséquente de la thèse ayant été consacrée à cet aspect, j'ai choisi

d'aborder ce thème de la variation individuelle du venin dans une première partie de cette discussion.

Ce travail de thèse ayant notamment eu pour but de combiner des approches populationnelles et de protéomique, je terminerai par une discussion sur l'intérêt des approches mêlant écologie évolutive et protéomique et les contraintes associées.

## **VI.1. La variabilité individuelle du venin**

### **Impact de la variabilité du venin : valeur sélective, extinction, et évolvabilité**

Chez les parasitoïdes, il semble exister une forte variabilité du venin entre espèces, populations et individus. Nous l'avons en tous cas observée dans deux modèles (*Leptopilina* et *Psytalia*) appartenant à deux taxa phylogénétiquement éloignés (Cynipidae et Ichneumonidae), représentant chacun un grand nombre d'espèces. L'étude de ces deux modèles permet de « généraliser » dans une certaine mesure (et en restant prudent) les résultats observés dans cette thèse.

J'ai montré ensuite qu'il est possible de quantifier et analyser statistiquement cette variabilité, puis étudié son effet sur la réponse à un nouvel environnement et/ou un nouveau type d'hôte.

Du fait de la difficulté d'élever au laboratoire l'hôte naturel de *P. lounsburyi*, la mouche de l'olive, le design de l'évolution expérimentale confond l'effet de l'élevage au laboratoire et l'effet du changement d'hôte. Néanmoins, cette expérience a fourni plusieurs résultats importants pour la compréhension de l'effet de la variabilité du venin. Tout d'abord, une partie de la variabilité individuelle est héritable et donc susceptible de répondre à la sélection. Ensuite, une part de la variabilité du venin a eu un fort effet sur la valeur sélective des femelles ce qui pourrait expliquer le second effet observé, à savoir que la composition du venin affecte aussi la dynamique d'extinction des populations.

Le fait que la composition du venin soit héritable et affecte la valeur sélective des individus suggère que chez *Psytalia lounsburyi*, elle devrait évoluer en réponse à la sélection suite à l'arrivée au laboratoire. Ceci a aussi été testé – c'était d'ailleurs le but initial de cette expérience. L'observation de changements de la composition du venin, répétables entre de populations expérimentales, suggère que le venin a effectivement évolué en réponse à la sélection. Toutefois, l'interprétation de ce dernier résultat est compliquée par l'existence d'une répétabilité négative entre générations, les réplicats qui évoluent dans une direction

donnée à une génération évoluent dans la direction opposée à la génération suivante. Bien que plusieurs hypothèses aient été proposées pour expliquer cette observation, nous n'avons pas eu la possibilité de les tester avec les données de cette expérience. Par ailleurs, quelle que soit la cause de cette répétabilité négative entre générations, elle a de toute évidence empêché la sélection d'agir de façon pérenne. Si une adaptation était nécessaire pour « éviter l'extinction » (sauvetage évolutif), il n'est pas surprenant que les populations expérimentales se soient éteintes.

Les résultats de l'évolution expérimentale réalisée sur le modèle de laboratoire *Leptopilina bouvardi* – *Drosophila melanogaster* sont plus simples à interpréter. Cette étude, menée dans le cadre des stages de Laurent Kremmer et de Fanny Cavigliasso (2014), s'appuie sur l'utilisation de deux souches hôtes qui diffèrent par leur niveau de résistance à la souche ISy de *L. bouvardi*, l'une étant « résistante » et l'autre « sensible » mais sont toutes deux sensibles à la souche ISm. La résistance à ISy est monogénique et seule une partie du chromosome 2 contenant le gène de résistance est différente entre les deux souches hôtes. Par ailleurs, les souches ISm et ISy du parasitoïde présentent une différence importante, essentiellement quantitative, de composition de leur venin (Colinet *et al.* 2013) et des facteurs de virulence différents ont été identifiés dans les deux souches.

Pour initier cette évolution expérimentale, nous avons créé une variabilité « maximale » du venin en croisant les souches ISy et ISm. Les descendants de ce croisement ont ensuite été élevés soit sur la souche hôte « résistante », soit sur la souche « sensible ». Les résultats montrent qu'une large proportion des composants du venin répond rapidement à la sélection, sur chacun des deux hôtes, et ce de façon différente sur les hôtes sensible et résistant. Ceci est d'autant plus étonnant que les deux hôtes ne diffèrent *a priori* que pour une partie de leur génome.

Il semble en tous les cas que cette différence incluant un gène majeur de résistance ait suffi à exercer une sélection détectable sur de nombreux composants du venin. Le fait que cette sélection soit souvent négative (diminution d'intensité de la bande protéique considérée) et en accord avec les prédictions réalisées pour les protéines connues pour être importantes (e.g. diminution sur la souche sensible pour un facteur impliqué dans la résistance) suggère également l'existence d'un coût à la présence de certains facteurs du venin sur certains hôtes (coût à la production ou du à l'effet de ce facteur). Par ailleurs, il faut noter que suite au croisement de ISm et ISy, de nombreuses combinaisons de facteurs du venin ont été créées,

permettant de détecter facilement les évènements de sélection.

Il est intéressant de replacer ce résultat par rapport à celui publié par Rouchet & Vorburger (2014). Il montre que la virulence des parasitoïdes de puceron évolue rapidement (cinq générations) en réponse au type du symbiote *Hamiltonella* induisant la résistance du puceron au parasitoïde. On observe dans les deux cas chez un parasitoïde une évolution rapide, soit de la virulence, soit d'un trait associé à la virulence (la composition du venin), en réponse à la résistance de l'hôte. Par ailleurs, dans les deux cas, l'évolution est spécifique à la résistance de l'hôte que cette résistance soit déterminée génétiquement ou par des souches différentes de symbiotes. La question intéressante du rôle possible du venin des parasitoïdes de puceron dans la virulence contre des hôtes montrant une résistance symbiotique pourra être abordée de façon similaire à celle utilisée dans cette thèse.

Dans le milieu naturel, une faible variabilité des pressions de sélection exercées (conditions stables, hôte peu variable) pourrait amener à une réduction voire une disparition de la variabilité du venin. Or, ce n'est pas ce que l'on observe, pour les deux modèles étudiés. Ceci pose la question de l'existence de mécanismes de maintien de cette variabilité.

### **Maintien de la variabilité du venin dans les populations naturelles**

On peut imaginer que la variabilité du venin n'existe pas ou peu dans les populations naturelles. La variabilité observée au laboratoire correspondrait alors à une variabilité de la norme de réaction dans les conditions de laboratoire. Ce type de phénomène d'augmentation de la variabilité phénotypique « en réponse » à une situation de stress a déjà été observé, principalement dans le cadre d'études sur le développement (West-Eberhard 2003; Badyaev 2005). Cependant, il ne semble pas parcimonieux d'envisager que l'ensemble de la variabilité observée soit due à ce phénomène, notamment parce que certains individus utilisés (pour lesquels une forte variabilité du venin a été observée) n'ont jamais été élevés au laboratoire. Les adultes ont cependant émergé au laboratoire (d'olives récoltées sur le terrain) et on ne peut donc pas exclure un certain effet des conditions de laboratoire.

### *Le coût de l'existence ... et l'existence du coût*

Si une part importante de la variabilité observée existe dans les populations naturelles, elle pourrait n'avoir que peu d'effet sur la valeur sélective en milieu naturel. Cependant, ceci est également improbable car la production de venin a probablement un coût énergétique important. A ma connaissance, aucune étude n'a mesuré ce coût chez les parasitoïdes.

Chez les serpents et les scorpions, la production de venin a un coût énergétique étonnamment élevé par rapport à la masse de protéines produite (McCue 2006; Nisani *et al.* 2007, 2012). Par ailleurs, le rôle du venin dans le succès parasitaire a été largement démontré dans différentes espèces de parasitoïdes, même s'il pourrait être moins essentiel dans celles qui produisent des polydnavirus. Ainsi, Dorémus *et al.* (2013) suggèrent que le venin d'*Hyposoter didymator* pourrait ne pas avoir d'effet protecteur, tout au moins vis-à-vis d'un de ses hôtes, cependant le venin de ce parasitoïde a une composition complexe et importante en terme de quantité de protéines et peptides. Ensuite, le coût lié à la production et l'injection de venin n'est pas forcément qu'énergétique, par exemple, du point de vue de l'interaction hôte – parasitoïde, le venin peut parfois induire une mortalité précoce de l'hôte empêchant ainsi le développement du parasitoïde. Enfin, il peut être reconnu comme un corps étranger et déclencher/augmenter la réaction immunitaire de l'hôte (e.g.: Labrosse *et al.* 2005), ce qui pourrait accroître le risque de mortalité du parasitoïde. Par ailleurs, bien que le mécanisme n'est pas été identifié, Dupas & Boscaro (1999) ont montrés que la virulence de la souche ISy de *L. boulandi* sur *D. yakuba* est « couteuse » car elle est contre-sélectionnée lorsque la souche ISy est élevée sur *D. melanogaster*.

Le modèle développé par Fellowes & Travis (2000) suggère que la dynamique évolutive hôte-parasitoïde est fortement influencée par les coûts de la résistance et de la virulence. Notamment, de rapides cycles coévolutifs sont prédits lorsque des coûts intermédiaires à la résistance et à la virulence sont considérés. Un coût à la résistance a été montré chez certaines espèces hôtes (Kraaijeveld & Godfray 2003; Vijendravarma *et al.* 2009; Niogret *et al.* 2009). Chez le parasitoïde, j'ai montré que de nombreux composants du venin apparaissent contre-sélectionnés au cours de l'évolution expérimentale de *L. boulandi*, suggérant également l'existence de coûts.

*Par la coévolution ...*

Plusieurs hypothèses permettant d'expliquer le maintien de variabilité sont spécifiques aux traits impliqués dans les interactions antagonistes, tels que le venin. On peut citer le scénario de « polymorphisme co-évolutif » et la « course aux armements » (voir l'introduction générale § « L'antagonisme évolutif » pour plus de détails). Ces deux scénarios reposent sur l'hypothèse d'une dynamique coévolutive hôte – parasitoïde, qui nécessite une importante diversité géographique et/ou locale des deux partenaires. Dans le cas du modèle *Bactrocera oleae* – *Psytalia lounsburyi*, *B. oleae* n'est que très faiblement structurée géographiquement, seules des différenciations intercontinentales ayant été mises en évidence (Nardi *et al.* 2005). En revanche, ces deux espèces semblent avoir une diversité génétique non négligeable, avec une hétérozygotie attendue de 0,50 pour *B. oleae*, au Kenya comme en Afrique du sud (Nardi *et al.* 2005), et de 0,60 et 0,24 pour *P. lounsburyi* respectivement au Kenya et en Afrique du sud (Cheyppé-Buchmann *et al.* 2011). Ceci rend envisageable l'existence d'une dynamique coévolutive.

Pour *L. heterotoma*, de fortes différenciations de la composition du venin ont été observées, particulièrement entre Vence et les populations de la vallée du Rhône, mais aussi entre ces dernières populations. La faible structuration observée pour les marqueurs neutres chez cette espèce dans la même région (Ris, 2003) suggère un phénomène d'adaptation locale (par exemple à l'hôte parasité) comme le plus probable pour expliquer la structuration de composition du venin. Cependant, ceci ne signifie pas qu'il y ait une dynamique de coévolution. En effet, une des hypothèses envisagées est liée à la présence plus ou moins ancienne de *L. bouvardi*, qui pourrait restreindre la gamme d'hôtes disponibles pour *L. heterotoma* en raison de sa forte compétitivité. Cette restriction de la gamme d'hôte pourrait induire une modification des pressions de sélection sur le venin.

Bien que des différenciations significatives aient aussi été détectées entre populations proches, elles sont globalement faibles pour *L. bouvardi* dans la vallée du Rhône. Plus largement, le phénotype résistant (à la souche ISy provenant d'Afrique tropicale) utilisé dans l'évolution expérimentale est retrouvé dans de nombreuses régions du monde avec le maintien d'un polymorphisme résistant/sensible (Dupas *et al.* 2003). Même si ce polymorphisme n'entraîne pas de différence de succès parasitaire (en termes immunitaire) ailleurs qu'en Afrique tropicale, il pourrait générer une spécialisation du parasitoïde et ainsi permettre le maintien de la diversité. Ceci correspondrait au scénario de « polymorphisme co-évolutif » mentionné précédemment.

Pour tester ce scénario, il serait intéressant de déterminer si le venin d'individus virulents provenant du terrain (qui réussissent sur les deux types d'hôte) montre une évolution sur hôte résistant ou sensible. Ceci suggérerait qu'en dehors du phénotype majeur observé (succès ou non sur la souche résistante), il existe des différences subtiles de physiologie des drosophiles résistantes et sensibles qui pourraient permettre le maintien de la variation de composition du venin.

Les changements de composition du venin pourraient être plus importants et/ou encore plus rapides lors d'un changement d'espèce hôte qu'en fonction d'une souche hôte. Ceci sera testé par l'équipe selon le même principe d'évolution expérimentale en utilisant le fait que la souche ISy réussit sur *D. yakuba* contrairement à la souche ISm. Les F1 seront maintenues parallèlement sur chacune des espèces hôtes. Une évolution du venin suggérerait fortement que l'utilisation d'hôtes de substitution dans l'élevage de masse des auxiliaires de lutte biologique ne serait pas sans conséquence sur leur phénotype.

... *Sans coévolution*

Les hypothèses plus générales permettant d'expliquer le maintien de la variabilité sont principalement la compétition, les compromis ou la variabilité des pressions de sélection. La compétition peut augmenter la diversité génétique en induisant une diversification des stratégies via une « spécialisation individuelle » (Bolnick 2007; Araújo *et al.* 2011). Par exemple, dans le cadre du venin et des interactions hôte – parasitoïde, il est envisageable que la compétition intraspécifique conduise à une diversification des stratégies de parasitisme comme par exemple le fait de parasiter des stades d'hôtes différents et finalement à une spécialisation du venin sur les différents stades d'hôtes. Une interaction venin × stade d'hôte a déjà été mise en évidence, par exemple chez *Chelonus near curvimaculatus* dont le venin est dégradé lorsqu'il est pondu dans des hôtes trop âgés (Asgari 2012). On peut imaginer des parasitoïdes puissent s'adapter au parasitisme de larves plus âgées, évitant ainsi la compétition, voire se spécialisent sur ce stade.

Les compromis peuvent être de nombreux types. Un exemple de compromis est « l'antagonisme sexuel » qui apparaît lorsqu'un trait est codé par les mêmes gènes chez les mâles et les femelles et que la valeur optimale du trait chez les mâles et les femelles n'est pas la même. Il semblerait que ces « antagonismes sexuels » soient en fait extrêmement fréquents. Connallon *et al.* (2010) ont estimé à partir d'une méta-analyse sur des espèces animales que 26% à 54% des traits, selon les composantes de valeurs sélectives utilisées, seraient affectés par la sélection sexe-spécifique. Il est envisageable que ce soit aussi le cas de la composition

du venin, par exemple si les parasitoïdes mâles et femelles ont des besoins nutritionnels différents lors de leur développement. En effet, le venin est connu pour affecter la physiologie de l'hôte, notamment pour augmenter sa valeur nutritionnelle (Mrinalini *et al.* 2014). Le venin pourrait être sujet à de l'antagonisme sexuel si son effet sur la valeur nutritionnelle de l'hôte ne peut être optimal à la fois pour les mâles et les femelles. Ainsi, il a été montré que les femelles parasitoïdes résistent mieux que les mâles à la toxicité de l'alcool produit par la fermentation des fruits en décomposition (Bouletreau & David 1981). Récemment, Punzalan *et al.* (2014) ont mesuré l'antagonisme sexuel chez *Drosophila serrata* sur différentes plantes hôtes et montré qu'il varie beaucoup d'une plante à l'autre, suggérant que l'antagonisme sexuel peut être fortement affecté par le changement d'environnement et en particulier, le changement d'hôte. Il est donc aussi possible que l'antagonisme sexuel ait pu affecter la composition du venin au cours des évolution expérimentales.

La variabilité des pressions de sélection dans l'espace ou dans le temps peut aussi être source de maintien de la variabilité. On sait par exemple que les proportions des différentes espèces d'hôtes (drosophiles) et de parasitoïdes varient géographiquement et au cours de la saison dans la vallée du Rhône (Fleury *et al.* 2004, 2009).

## **VI.2. Apports méthodologiques de cette thèse pour combiner les approches d'écologie évolutive et de protéomique**

Après avoir identifié des bandes contenant une ou plusieurs protéines dont la quantité covarie avec un paramètre d'intérêt, la question qui suit est que sont ces protéines ? Dans le cas de *Leptopilina boulardi*, les résultats de l'évolution expérimentale ont été croisés avec les données de Colinet *et al.* (2013). Certaines des bandes ayant évolué ont pu ainsi être reliées à une protéine de fonction connue et notamment à des protéines déjà décrites comme impliquées dans la virulence, ce qui a permis de confirmer la fiabilité de la méthode d'analyse globale développée. Pour ces protéines, les résultats vont généralement dans le sens attendu et ont pu être confirmés avec une analyse spécifique. Le fait que la majeure partie des bandes « ayant évoluée » n'ait pas de fonction prédite montre que de nombreux facteurs intervenant dans la virulence restent à identifier chez *L. boulardi*, bien que ce modèle soit probablement le mieux connu aujourd'hui.

Certaines protéines qui n'étaient pas connues en tant que facteur de virulence ont été détectées comme sélectionnées sur hôte résistant. C'est notamment le cas d'une des protéines



RhoGAP : **LbGAPy4**. Un des facteurs de virulence majeur de *L. bouleari* est LbGAP, une protéine RhoGAP qui a été montrée comme altérant le cytosquelette des lamellocytes, des cellules immunitaires de l'hôte (Colinet *et al.* 2007). La caractérisation de la composition du venin de *L. bouleari* a révélé qu'il contient huit autres protéines RhoGAPs, toutes mutées sur leur site actif ce qui les rends *a priori* inopérantes pour l'inactivation de leur cible. L'une d'entre elles est **LbGAPy4** qui pourrait donc être active malgré ses mutations ou posséder une autre fonction que celle normalement associée à cette famille de protéines.

Pour *Psytalia*, l'étude comparative des protéines du venin dans les deux espèces *P. lounsburyi* et *P. concolor* (Ichneumonoidea : Braconidae) a mis en évidence certaines différences quantitatives et/ou en termes d'isoformes. Cependant, les venins de ces deux espèces sont plus proches que ceux de *L. bouleari* et *L. heterotoma* (Cynipoidea : Figitidae) qui présentent de fortes différences quantitatives et ne partagent aucune des protéines majeures du venin. Ce résultat pourrait être dû à une séparation plus récente des deux espèces de *Psytalia* par rapport aux espèces de *L. heterotoma*. Il pourrait aussi révéler une variabilité plus importante (et peut-être une évolution plus rapide) du venin chez les Figitidae que chez les Braconidae.

Chez *P. lounsburyi*, la différenciation entre les populations d'Afrique du Sud et du Kenya est principalement due à trois bandes protéiques groupées de poids moléculaire proche. L'analyse croisée des gels individuels et de l'analyse de protéomique a permis de montrer que cette différenciation est vraisemblablement liée à une protéine contenant des domaines LRR (Leucine Rich Repeat) présente en beaucoup plus grande quantité dans le venin des *P. lounsburyi* d'Afrique du Sud que du Kenya. Cette protéine contient des motifs LRRs classiques des « Toll Like Receptor » et pourrait donc être impliquée dans l'inhibition de la voie Toll, une des composantes majeures de l'immunité des insectes.

La différenciation des populations d'Afrique du Sud et du Kenya par rapport à cette protéine peut sembler surprenante car les populations de l'hôte *Bactrocera oleae* (Nardi *et al.* 2005) ne sont pas différenciées au niveau des marqueurs neutres. On ne peut toutefois pas exclure une adaptation locale de *B. oleae* qui n'ait pas été détectée (Landguth & Balkenhol 2012). Une autre explication possible serait la nature des oliviers au Kenya et en Afrique du sud. En effet, alors qu'au Kenya il n'y a que des oliviers sauvages (comme *Olea europaea ssp. africana*), on trouve aussi en Afrique du Sud des oliviers cultivés d'origine européenne (*Olea europaea subsp. europaea*) pour la production d'huile d'olive (en faible quantité toutefois). De plus, les sous-espèces d'oliviers sauvages et cultivars ne sont pas forcément les mêmes au

Kenya et en Afrique du sud (Besnard *et al.* 2009) tout comme les olives produites qui ont des qualités nutritionnelles différentes (entre oliviers sauvages mais aussi entre les cultivars d'oliviers exploités). Les olives pourraient en particulier avoir une composition différente en glucosides et dérivés phénoliques variés (Esti *et al.* 1998) qui pourraient affecter les capacités immunitaires de la mouche *B. oleae* (plasticité). Ce type d'interaction qualité des plantes × capacité immunitaire de l'hôte herbivore a notamment été montré chez des lépidoptères (Klemola *et al.* 2007). Un scénario possible est donc que la différenciation observée au niveau du venin de *P. lounsburyi* soit une adaptation locale aux capacités immunitaires de *B. oleae* dont la variation viendrait de facteurs environnementaux comme le type d'olivier.

#### *Du point de vue de la protéomique*

De manière plus générale, l'étude des questions d'écologie évolutive à cette échelle de déterminisme est bénéfique aux deux disciplines. Du point de vue de la protéomique, les approches d'écologie évolutive permettent de comprendre les forces environnementales et sélectives agissant sur l'expression des protéines, ce qui est nécessaire pour comprendre leurs rôles « ultimes ». Par ailleurs, une approche courante en protéomique consiste à identifier les protéines potentiellement intéressantes en se basant sur leur annotation fonctionnelle. Des analyses spécifiques permettent ensuite de tester l'intérêt de la protéine sélectionnée par rapport à la question étudiée. Il est cependant très fréquent de ne trouver aucune similarité avec des protéines de fonction connue. Ainsi, des familles entières de protéines n'ont aucune fonction prédite. En 2013, 20% des domaines protéiques identifiés et détectés comme conservés, n'avaient pas de fonction connue (Goodacre *et al.* 2014). Par ailleurs, l'annotation fonctionnelle ne fait que des prédictions quant aux fonctions des protéines, ce qui est dans la majorité des cas très informatif, mais reste putatif sans études spécifiques.

Cette situation est largement observée dans le cas des protéines du venin des parasitoïdes, notamment vis-à-vis des protéines abondantes, ce qui suggère que les fonctions de nombreuses protéines importantes pour les interactions hôte – parasitoïde ne sont pas encore connues. La caractérisation d'une protéine de fonction inconnue étant complexe et représentant un travail conséquent, initier l'étude d'une protéine de fonction inconnue sur la seule base de son abondance est particulièrement risqué. Dans ce contexte, l'analyse sans *a priori* effectuée avec la méthode développée (qui permet d'étudier la variabilité d'expression de nombreuses protéines simultanément) peut permettre d'identifier certaines protéines impliquées dans un phénotype particulier qui pourront alors être choisies pour une étude plus détaillée.

La démonstration du rôle d'une protéine dans un trait donné nécessitera toujours des expériences fonctionnelles comme l'inactivation du gène correspondant par ARN interférence. Cette technique a été récemment développée pour les endoparasitoïdes (Colinet *et al.* 2014 pour les Leptopilina).

#### *Du point de vue de l'écologie évolutive*

De nombreuses interactions intra- et inter-spécifiques mettent en jeu des « échanges moléculaires » qui peuvent être importants en terme écologique. Par exemple, un mécanisme de défense contre les herbivores, largement répandu chez les Brassicacées, consiste à produire des glucosinolates et une enzyme, la myrosinase, dans des cellules adjacentes, mais séparées. Leur mélange mécanique lors de l'attaque d'un herbivore permet à la myrosinase de convertir les glucosinolates en toxines telles que les isothiocyanates (Winde & Wittstock 2011). Les herbivores ont évolué de nombreux mécanismes permettant de contourner cette défense et certains utilisent même ces composés pour leur propre défense. Il a par exemple été montré que le puceron *Brevicoryne brassicae* accumule des glucosinolates produits par les choux sur lesquels il se nourrit et produit sa propre myrosinase, ce qui lui permet de résister à certains prédateurs (Pratt *et al.* 2008). De façon surprenante, l'analyse « omique » des venins de *P. lounsburyi* de *P. concolor* a montré qu'ils contiennent une importante quantité de myrosinase dont le rôle pourrait être, une fois injectée, de convertir les glucosinolates ingérés par l'hôte en produits toxiques affaiblissant ainsi celui-ci.

Au niveau évolutif, l'expression protéique est une des premières étapes de la construction d'un phénotype (Diz *et al.* 2012). Caractériser les mécanismes protéiques qui sous-tendent un changement phénotypique, devrait améliorer notre compréhension des contraintes s'exerçant sur les phénotypes. Par exemple, ce type d'étude peut permettre d'analyser quels mécanismes moléculaires rendent un phénotype polygénique plus ou moins robuste aux mutations. Dans le cadre de la virulence et du venin, on peut imaginer qu'une forte redondance fonctionnelle dans la composition de certains types de venin (Morgenstern & King 2013) rende la virulence plutôt robuste aux mutations de ces composants. Cette robustesse aux mutations est importante en écologie évolutive car elle peut permettre de comprendre d'où vient le maintien du potentiel adaptatif du trait polygénique considéré (Wagner 2012).

*En résumé,*

La méthode développée vient compléter une panoplie d'approches qui comprend par exemple les approches « omiques » avec l'annotation fonctionnelle et l'étude de protéines spécifiques à l'aide d'outils tels que l'ARN interférence ou les tests d'activités.

Une des difficultés liée à son utilisation est l'identification des protéines d'intérêt. La plupart des bandes contiennent plusieurs protéines et il n'est pas toujours facile d'identifier celles qui sont responsables de la variabilité observée. Une approche intéressante pourrait être de n'analyser individuellement qu'une moitié d'échantillon pour chaque individu. Après analyse des données individuelles et choix des bandes présentant une variation intéressante, les moitiés d'échantillons conservées et dont les profils protéiques sont de même type pourraient être regroupés pour identifier les protéines impliquées. Par exemple, le développement de techniques plus poussées en protéomique, telles que l'orbitrap permet d'envisager la possibilité d'utiliser les moitiés d'échantillon pour obtenir de l'information sur la nature des protéines contenues dans une bande d'intérêt. Cependant, ceci ne peut être réalisé que si l'on dispose des séquences génomique et/ou transcriptomique pour l'espèce considérée.

### **VI.3. Apport de la vénomique des populations pour la lutte biologique**

Les résultats de cette thèse ont plusieurs implications pour la lutte biologique. Tout d'abord, le fait que la composition du venin varie beaucoup et qu'il semble être sujet à de l'adaptation locale, signifie que des individus échantillonnés dans des zones différentes risquent de ne pas avoir la même composition de venin. Or, comme je l'ai montré, la composition du venin affecte fortement la valeur sélective des femelles. Tester différentes populations d'auxiliaires semble donc indispensable pour optimiser les résultats.

L'intérêt de l'utilisation de différentes populations d'auxiliaires est déjà partiellement pris en compte en lutte biologique puisque la plupart des campagnes de lutte essaient de maintenir un haut niveau de variation génétique des auxiliaires utilisés sur le terrain. Ceci a deux buts : (i) permettre de minimiser le risque de dépression de consanguinité et (ii) permettre les adaptations éventuellement nécessaires à l'établissement de l'auxiliaire. Cette thèse a permis de révéler que le venin est un trait important dans le cadre de l'établissement dans un nouvel environnement. Or la variabilité neutre ne reflète pas forcément la variabilité de caractères soumis à la sélection, ce qui conduit Landguth & Balkenhol (2012) à conseiller de prendre aussi en compte la diversité génétique non neutre.

Dans le cadre de l'adaptation à l'environnement dans lequel le parasitoïde est lâché, il est important de considérer une pratique courante en lutte biologique qui consiste à effectuer des lâchers répétés. Elle vise à éviter que la population d'auxiliaires lâchée ne rentre dans une dynamique d'extinction du fait d'effets Allee (diminution du taux d'accroissement, voire disparition, liée à la faible taille de la population). Paradoxalement, cette procédure peut aussi empêcher l'adaptation à l'environnement ciblé par la lutte biologique si la plupart des individus lâchés régulièrement sont relativement mal adaptés. Ce phénomène correspond au fardeau de migration (« migration load »). Dans ce contexte, une application de la méthode développée pourrait être de comparer la composition du venin des individus lâchés et des individus éventuellement recapturés afin de choisir le type d'individus à lâcher. Un tel choix, guidé par les profils de venins, permettrait de garder le bénéfice d'introductions répétées en termes de démographie, tout en diminuant le risque de perturber l'adaptation des populations. Cette méthode pourra aussi permettre d'établir un « contrôle qualité » en vérifiant qu'après un certain temps d'élevage la population présente toujours le type de profil de venin attendu.

## **VII. CONCLUSIONS**

Au début de ma thèse, la très large majorité des études sur le venin des parasitoïdes ne s'intéressaient qu'au niveau interspécifique. Son rôle primordial dans le succès parasitaire de certaines espèces de parasitoïde avait été démontré et les rares études qui avaient posé la question de la variabilité intraspécifique n'avaient été réalisées que sur quelques espèces, en ne considérant que quelques protéines candidates.

Le but de ma thèse était d'analyser la variabilité globale de la composition du venin.

Après de nombreux essais étalés sur plusieurs mois, j'ai fini par accepter que le logiciel d'analyse des gels d'électrophorèse qui devait être utilisé n'était pas adapté à l'analyse d'un très grand nombre d'individus. J'ai donc développé une méthode (basée sur ce logiciel) permettant d'étudier facilement la variabilité de la composition protéique d'échantillons sans les *a priori* qui sont classiquement faits à partir des fonctions supposées des protéines.

Le développement de cette méthode n'a pas été simple. Après avoir plus ou moins reproduit sous R ce que fait le logiciel d'analyse de gel sans faire mieux... la solution est venue, probablement comme souvent, d'une discussion (merci à Thibaut Malausa et Nicolas Ris !).

Le principal atout de cette méthode est sa simplicité : il n'y a pas besoin de détecter les bandes sur chacune des pistes des gels pour décrire la variabilité de ces mêmes bandes ! Oui, on peut décrire assez précisément la variabilité d'un objet que l'on n'est pas capable de détecter correctement de façon systématique... Encore fallait-il y penser !

Ensuite, le but était d'étudier l'évolution du venin d'auxiliaires de lutte biologique en réponse à un changement d'environnement (arrivée au laboratoire sur un hôte de substitution). Pour cela, il a été nécessaire d'obtenir des individus du terrain. L'organisation des échantillonnages n'a pas été simple non plus, car elle dépend notamment de la présence de personnes sur le terrain et de la présence du parasitoïde. Cette étape a été retardée plusieurs fois. Avant ma thèse, je n'avais jamais fait d'élevage. Je me suis rattrapé ! Maintenir un élevage d'une vingtaine de populations expérimentales pendant 10 mois, sur ce type d'espèce, c'est un travail à plein temps. Heureusement, nous nous y sommes mis à plusieurs.

Une question qui s'est posée pour cette expérience est « enlève-t-on la bactérie endosymbiotique *Wolbachia* avant de démarrer l'expérience » ? Cette question a été très rapidement résolue puisque retirer *Wolbachia* prend 2 générations et crée un important goulot d'étranglement. Au vu des résultats, on peut quand même se demander si c'était la bonne solution car il est possible que les tendances difficiles à expliquer (corrélations négatives entre générations successives des variations des marqueurs du venin, des marqueurs neutres et des infections par *Wolbachia*) soient la conséquence de la présence de *Wolbachia*...

Malgré tout, cette expérience et celle réalisée sur *L. boulandi* ont permis de montrer que la variabilité intra-spécifique du venin a des effets sur la valeur sélective des individus et qu'elle peut évoluer en réponse à la sélection. Ceci pose de nombreuses questions quant au maintien de cette variabilité et à son effet sur la biologie des parasitoïdes.

Ensuite, un résultat très surprenant de l'évolution expérimentale de *Psytalia* est l'effet de la composition du venin sur la vitesse des extinctions. Il serait amusant de mettre ce résultat en relation (i) avec les dynamiques de métapopulation des hôtes et parasitoïdes, avec les extinctions – recolonisations fréquentes chez certaines espèces, et (ii) avec la diversité des types d'hôtes présente sur le terrain (diversité qui a été montrée comme pouvant faire évoluer la composition du venin).

Tout ceci ouvre des portes à de nombreuses études : faisables techniquement grâce à la méthode développée, motivantes parce qu'on sait à présent que la variabilité du venin est un facteur important. De plus, savoir quelles bandes changent en fonction du paramètre étudié

permet de cibler les études sur les protéines intéressantes pour une question donnée. Ceci peut par exemple permettre de décortiquer la complexité du venin, en le décomposant en groupes de protéines : groupes paraissant varier de façon aléatoire, groupes ayant un effet sur un ou quelques caractères phénotypiques, groupes présentant des effets pléiotropiques sur différents types de traits, etc.

# BIBLIOGRAPHIE GENERALE

- Abdel-latif M, Hilker M (2008) Innate immunity: eggs of *Manduca sexta* are able to respond to parasitism by *Trichogramma evanescens*. *Insect Biochemistry and Molecular Biology*, **38**, 136–45.
- Agosta S (2006) On ecological fitting, plant–insect associations, herbivore host shifts, and host plant selection. *Oikos*, **3**.
- Agosta SJ, Janz N, Brooks DR (2010) How specialists can be generalists: resolving the “parasite paradox” and implications for emerging infectious disease. *Zoologia*, **27**, 151–162.
- Alavanja M, Hoppin J, Kamel F (2004) Health Effects of Chronic Pesticide Exposure: Cancer and Neurotoxicity. *Annual Review of Public Health*, **25**, 155–97.
- Allemand R, Lemaitre C (2002) Phylogeny of six African Leptopilina species (Hymenoptera: Cynipoidea, Figitidae), parasitoids of *Drosophila*, with description of three new species. *Annales de la Société Entomologique de France*, **38**, 319–332.
- Antia R, Regoes RR, Koella JC, Bergstrom CT (2003) The role of evolution in the emergence of infectious diseases. *Nature*, **426**, 658–61.
- Arakaki N, Wakamura S, Yasuda T (1996) Phoretic egg parasitoid, *Telenomus euproctidis* (Hymenoptera: Scelionidae), uses sex pheromone of tussock moth *Euproctis taiwana* (Lepidoptera: Lymantriidae) as a. *Journal of Chemical Ecology*, **22**, 1079–85.
- Araújo MS, Bolnick DI, Layman C a (2011) The ecological causes of individual specialisation. *Ecology Letters*, **14**, 948–58.
- Asgari S (2012) Venoms from endoparasitoids. In: *Parasitoid viruses: symbionts and pathogens* (ed Drezen J-M), pp. 217–231. Eds Nancy Beckage.
- Badyaev A V (2005) Role of stress in evolution: from individual adaptability to evolutionary adaptation. In: *Variation: a central concept in biology* (eds Benedikt H, Hall B), pp. 277–302.
- Barrett RDH, Schluter D (2007) Adaptation from standing genetic variation. *Cell*, **23**, 38–44.
- Beckage N, Drezen J (2012) *Parasitoid viruses: symbionts and pathogens*.
- Beketov M a, Kefford BJ, Schäfer RB, Liess M (2013) Pesticides reduce regional biodiversity of stream invertebrates. *Proceedings of the National Academy of Sciences of the United States of America*, **110**, 11039–43.
- Besnard G, Rubio de Casas R, Christin P-A, Vargas P (2009) Phylogenetics of *Olea* (Oleaceae) based on plastid and nuclear ribosomal DNA sequences: tertiary climatic shifts and lineage differentiation times. *Annals of Botany*, **104**, 143–60.
- Boller E (1972) Behavioral aspects of mass-rearing of insects. *BioControl*, **17**, 9–25.
- Bolnick DI (2007) Behavioural Genetics: Evolutionary Fingerprint of the “Invisible Hand.” *Current Biology*, **17**, R594–6.
- Bouletreau M, David J (1981) Sexually dimorphic response to host habitat toxicity in *Drosophila* parasitic wasps. *Evolution*, **35**, 395–99.
- Britten R, Davidson E (1971) Repetitive and non-repetitive DNA sequences and a speculation on the origins of evolutionary novelty. *Quarterly Review of Biology*, **46**, 111–38.
- Bukovinszky T, Gols R, Smid HM *et al.* (2012) Consequences of constitutive and induced variation in the host’s food plant quality for parasitoid larval development. *Journal of Insect Physiology*, **58**, 367–75.
- Burke GR, Strand MR (2014) Systematic analysis of a wasp parasitism arsenal. *Molecular Ecology*, **23**, 890–901.



- Cai W, Yan Y, Li L (2005) The earliest records of insect parasitoids in China. *Biological Control*, **32**, 8–11.
- Canale A, Benelli G (2012) Impact of mass-rearing on the host seeking behaviour and parasitism by the fruit fly parasitoid *Psytalia concolor* (Szépligeti) (Hymenoptera: Braconidae). *Journal of Pest Science*, **85**, 65–74.
- Carton Y, Frey F, Nappi A (1992) Genetic determinism of the cellular immune reaction in *Drosophila melanogaster*. *Heredity*, **69**, 393–9.
- Carton Y, Poirié M, Nappi AJ (2008) Insect immune resistance to parasitoids. *Insect Science*, **15**, 67–87.
- Cheyppe-Buchmann S, Bon MC, Warot S *et al.* (2011) Molecular characterization of *Psytalia lounsburyi*, a candidate biocontrol agent of the olive fruit fly, and its *Wolbachia* symbionts as a pre-requisite for future intraspecific hybridization. *BioControl*, **56**, 713–24.
- Clercq P, Mason PG, Babendreier D (2011) Benefits and risks of exotic biological control agents. *BioControl*, **56**, 681–98.
- Colinet D, Cazes D, Belghazi M, Gatti J-L, Poirié M (2011) Extracellular superoxide dismutase in insects: characterization, function, and interspecific variation in parasitoid wasp venom. *The Journal of Biological Chemistry*, **286**, 40110–21.
- Colinet D, Deleury E, Anselme C *et al.* (2013a) Extensive inter- and intraspecific venom variation in closely related parasites targeting the same host: The case of *Leptopilina* parasitoids of *Drosophila*. *Insect Biochemistry and Molecular Biology*, **43**, 601–11.
- Colinet D, Dubuffet A, Cazes D *et al.* (2009) A serpin from the parasitoid wasp *Leptopilina boulardi* targets the *Drosophila* phenoloxidase cascade. *Developmental and Comparative Immunology*, **33**, 681–9.
- Colinet D, Mathé-Hubert H, Allemand R, Gatti JL, Poirié M (2013b) Variability of venom components in immune suppressive parasitoid wasps: from a phylogenetic to a population approach. *Journal of Insect Physiology*, **59**, 205–12.
- Colinet D, Schmitz A, Depoix D, Crochard D, Poirié M (2007) Convergent use of RhoGAP toxins by eukaryotic parasites and bacterial pathogens. *PLoS pathogens*, **3**, e203.
- Connallon T, Cox R, Calsbeek R (2010) Fitness consequences of sex-specific selection. *Evolution*, **64**, 1671–82.
- Conrad DF, Pinto D, Redon R *et al.* (2010) Origins and functional impact of copy number variation in the human genome. *Nature*, **464**, 704–12.
- Crawford A, Brauning R, Smolenski G *et al.* (2008) The constituents of *Microctonus* sp. parasitoid venoms. *Insect Molecular Biology*, **17**, 313–24.
- Crisp M, Cook L (2012) Phylogenetic niche conservatism: what are the underlying evolutionary and ecological causes? *New Phytologist*, 681–94.
- Daane KM, Johnson M, Pickett C *et al.* (2011) Biological controls investigated to aid management of olive fruit fly in California. *California Agriculture*, **65**, 21–8.
- Dahlman DL (1991) Teratocytes and host/parasitoid interactions. *Biological Control*, **1**, 118–26.
- Damalas C a, Eleftherohorinos IG (2011) Pesticide exposure, safety issues, and risk assessment indicators. *International Journal of Environmental Research and Public Health*, **8**, 1402–19.
- Desneux N, Blahnik R, Delebecque CJ, Heimpel GE (2012) Host phylogeny and specialisation in parasitoids. *Ecology Letters*, **15**, 453–60.
- Digilio M, Isidoro N, Tremblay E, Pennacchio F (2000) Host castration by *Aphidius ervi* venom proteins. *Journal of Insect Physiology*, **46**, 1041–50.

- Dion E, Zélé F, Simon J-C, Outreman Y (2011) Rapid evolution of parasitoids when faced with the symbiont-mediated resistance of their hosts. *Journal of Evolutionary Biology*, **24**, 741–50.
- Diz AP, Martínez-Fernández M, Rolán-Alvarez E (2012) Proteomics in evolutionary ecology: linking the genotype with the phenotype. *Molecular Ecology*, **21**, 1060–80.
- Dorémus T, Urbach S, Jouan V *et al.* (2013) Venom gland extract is not required for successful parasitism in the polydnavirus-associated endoparasitoid *Hyposoter didymator* (Hym. Ichneumonidae) despite the presence of numerous novel and conserved venom proteins. *Insect Biochemistry and Molecular Biology*, **43**, 292–307.
- Dupas S, Boscaro M (1999) Geographic variation and evolution of immunosuppressive genes in a *Drosophila* parasitoid. *Ecography*, **22**, 284–91.
- Dupas S, Carton Y (1999) Two non-linked genes for specific virulence of *Leptopilina boulardi* against *Drosophila melanogaster* and *D. yakuba*. *Evolutionary Ecology*, **13**, 211–20.
- Dupas S, Carton Y, Poirié M (2003) Genetic dimension of the coevolution of virulence-resistance in *Drosophila* - parasitoid wasp relationships. *Heredity*, **90**, 84–9.
- Dupas S, Dubuffet A, Carton Y, Poirié M (2009) Local, geographic and phylogenetic scales of coevolution in *Drosophila*-parasitoid interactions. In: *Advances in parasitology, Volume 70* (ed Prévost G), pp. 281–95.
- Dupas S, Poirié M, Frey F, Carton Y (2013) Is parasitoid virulence against multiple hosts adaptive or constrained by phylogeny? A study of *Leptopilina* spp. (Hymenoptera: Figitidae)/*Drosophila* (Diptera: Drosophilidae) interactions. *Annales de la Société Entomologique de France*, **49**, 222–31.
- Eggleton P, Gaston K (1990) “Parasitoid” Species and Assemblages: Convenient Definitions or Misleading Compromises? *Oikos*, 417–20.
- Eilenberg J, Hajek A, Lomer C (2001) Suggestions for unifying the terminology in biological control. *BioControl*, 387–400.
- Eslin P, Doury G (2006) The fly *Drosophila subobscura*: a natural case of innate immunity deficiency. *Developmental and Comparative Immunology*, **30**, 977–83.
- Eslin P, Giordanengo P, Fourdrain Y, Prévost G (1996) Avoidance of encapsulation in the absence of VLP by a braconid parasitoid of *Drosophila* larvae: an ultrastructural study. *Canadian Journal of Zoology*, **74**, 2193–8.
- Espinosa-Soto C, Martin OC, Wagner A (2011) Phenotypic plasticity can facilitate adaptive evolution in gene regulatory circuits. *BMC Evolutionary Biology*, **11**, 5.
- Esti M, Cinquanta L, La Notte E (1998) Phenolic Compounds in Different Olive Varieties. *Journal of Agricultural and Food Chemistry*, **46**, 32–35.
- Fanciulli M, Petretto E, Aitman TJ (2010) Gene copy number variation and common human disease. *Clinical Genetics*, **77**, 201–13.
- Fatouros NE, Huigens ME (2011) Phoresy in the field: natural occurrence of *Trichogramma* egg parasitoids on butterflies and moths. *BioControl*, **57**, 493–502.
- Fay JC, Wittkopp PJ (2008) Evaluating the role of natural selection in the evolution of gene regulation. *Heredity*, **100**, 191–9.
- Fellowes M, Travis J (2000) Linking the coevolutionary and population dynamics of host–parasitoid interactions. *Population Ecology*, **42**, 195–203.
- Ferrari J, Muller CB, Kraaijeveld R, Godfray HC (2001) Clonal variation and covariation in aphid resistance to parasitoids and a pathogen. *Evolution*, **55**, 1805–14.
- Ffrench-Constant R (1994) The molecular and population genetics of cyclodiene insecticide resistance. *Insect Biochemistry and Molecular Biology*, **24**, 335–45.

- Fleury F, Gibert P, Ris N, Allemand R (2009) Ecology and life history evolution of frugivorous *Drosophila* parasitoids. In: *Advances in parasitology, Volume 70* , pp. 3–44.
- Fleury F, Ris N, Allemand R *et al.* (2004) Ecological and genetic interactions in *Drosophila*-parasitoids communities: a case study with *D. melanogaster*, *D. simulans* and their common *Leptopilina* parasitoids in south-eastern France. *Genetica*, **120**, 181–94.
- Forde S, Thompson J, Bohannan B (2004) Adaptation varies through space and time in a coevolving host–parasitoid interaction. *Nature*, 841–4.
- Forister ML, Dyer L a, Singer MS, Stireman JO, Lill JT (2012) Revisiting the evolution of ecological specialization, with emphasis on insect–plant interactions. *Ecology*, **93**, 981–91.
- Fry J (1996) The evolution of host specialization: are trade-offs overrated? *American Naturalist*, **148**, S84–S107.
- Futuyma D, Moreno G (1988) The evolution of ecological specialization. *Annual Review of Ecology and Evolution*, **19**, 207–33.
- García-Robledo C, Horvitz CC (2012) Jack of all trades masters novel host plants: positive genetic correlations in specialist and generalist insect herbivores expanding their diets to novel hosts. *Journal of Evolutionary Biology*, **25**, 38–53.
- Gatti J, Schmitz A, Colinet D, Poirié M (2012) Diversity of Virus-Like Particles in Parasitoids' Venom: Viral or Cellular Origin? In: *Parasitoid viruses: symbionts and pathogens* , pp. 181–92.
- Gibson G (2008) The environmental contribution to gene expression profiles. *Nature reviews. Genetics*, **9**, 575–81.
- Ginzburg L, Taneyhill D (1994) Population cycles of forest Lepidoptera: a maternal effect hypothesis. *Journal of Animal Ecology*, **63**, 79–92.
- Gokcumen O, Babb PL, Iskow RC *et al.* (2011) Refinement of primate copy number variation hotspots identifies candidate genomic regions evolving under positive selection. *Genome Biology*, **12**, R52.
- Gómez-Gutiérrez J, Peterson WT, De Robertis A, Brodeur RD (2003) Mass mortality of krill caused by parasitoid ciliates. *Science (New York, N.Y.)*, **301**, 339.
- Goodacre NF, Gerloff DL, Uetz P (2014) Protein domains of unknown function are essential in bacteria. *American Society for Microbiology*, **5**, e00744–13.
- Gressel J (2009) Evolving understanding of the evolution of herbicide resistance. *Pest management science*, **65**, 1164–73.
- Harvey J a. (2005) Factors affecting the evolution of development strategies in parasitoid wasps: the importance of functional constraints and incorporating complexity. *Entomologia Experimentalis et Applicata*, **117**, 1–13.
- Hassell MP (2000) Host-parasitoid population dynamics\*. *Journal of Animal Ecology*, **69**, 543–66.
- Hochberg M, Hassell M, May R (1990) The dynamics of host-parasitoid-pathogen interactions. *The American Naturalist*, **135**, 74–94.
- Hodgins-Davis A, Townsend JP (2009) Evolving gene expression: from G to E to GxE. *Trends in Ecology & Evolution*, **24**, 649–58.
- Hopper K, Roush R, Powell W (1993) Management of genetics of biological-control introductions. *Annual review of Entomology*, **38**, 27–51.
- Howarth FG (1991) Environmental Impacts Of Classical Biological Control. *Annual Review of Entomology*, **36**, 485–509.
- Janzen DH (1985) On Ecological Fitting. *Oikos*, **45**, 308–10.

- Johnson KP, Malenke JR, Clayton DH (2009) Competition promotes the evolution of host generalists in obligate parasites. *Proceedings. Biological Sciences / The Royal Society*, **276**, 3921–6.
- Joshi A, Thompson J (1995) Trade-offs and the evolution of host specialization. *Evolutionary Ecology*, **9**, 82–92.
- Kacsoh BZ, Schlenke T a (2012) High hemocyte load is associated with increased resistance against parasitoids in *Drosophila suzukii*, a relative of *D. melanogaster*. *PloS one*, **7**, e34721.
- Kaeslin M, Reinhard M, Bühler D *et al.* (2010) Venom of the egg-larval parasitoid *Chelonus inanitus* is a complex mixture and has multiple biological effects. *Journal of Insect Physiology*, **56**, 686–94.
- Kakani EG, Sagri E, Omirou M, Ioannides IM, Mathiopoulos KD (2013) Detection and geographical distribution of the organophosphate resistance-associated  $\Delta 3Q$  ace mutation in the olive fruit fly, *Bactrocera oleae* (Rossi). *Pest Management Science*, **70**, 743–50.
- Kakani EG, Zygouridis NE, Tsoumani KT *et al.* (2010) Spinosad resistance development in wild olive fruit fly *Bactrocera oleae* (Diptera: Tephritidae) populations in California. *Pest Management Science*, **66**, 447–53.
- Kawecki TJ (1994) Accumulation of Deleterious Mutations and the Evolutionary Cost of Being a Generalist. *The American Naturalist*, **144**, 833–8.
- Kimani-Njogu S, Trostle MK, Wharton RA, Woolley JB, Raspi A (2001) Biosystematics of the *Psytalia concolor* Species Complex (Hymenoptera: Braconidae: Opiinae): The Identity of Populations Attacking *Ceratitis capitata* (Diptera: Tephritidae) in Coffee in Kenya. *Biological Control*, **20**, 167–74.
- Kitano H (1986) The role of *Apanteles glomeratus* venom in the defensive response of its host, *Pieris rapae crucivora*. *Journal of Insect Physiology*, **32**, 369–75.
- Klemola N, Andersson T, Ruohomäki K, Klemola T (2010) Experimental test of parasitism hypothesis for population cycles of a forest lepidopteran. *Ecology*, **91**, 2506–13.
- Klemola N, Klemola T, Rantala MJ, Ruuhola T (2007) Natural host-plant quality affects immune defence of an insect herbivore. *Entomologia Experimentalis et Applicata*, **123**, 167–76.
- Kon R, Takeuchi Y (2001) The effect of evolution on host-parasitoid systems. *Journal of Theoretical Biology*, **209**, 287–302.
- Kraaijeveld A, Godfray H (2003) Potential life-history costs of parasitoid avoidance in *Drosophila melanogaster*. *Evolutionary Ecology Research*, **5**, 1251–61.
- Kunert G, Reinhold C, Gershenson J (2010) Constitutive emission of the aphid alarm pheromone, (E)- $\beta$ -farnesene, from plants does not serve as a direct defense against aphids. *BMC Ecology*, **10**, 23.
- Labrosse C, Eslin P, Doury G, Drezen JM, Poirié M (2005) Haemocyte changes in *D. Melanogaster* in response to long gland components of the parasitoid wasp *Leptopilina boulardi*: a Rho-GAP protein as an important factor. *Journal of Insect Physiology*, **51**, 161–70.
- Landguth EL, Balkenhol N (2012) Relative sensitivity of neutral versus adaptive genetic data for assessing population differentiation. *Conservation Genetics*, **13**, 1421–6.
- Lapchin L (2002) Host-parasitoid association and diffuse coevolution: when to be a generalist? *The American Naturalist*, **160**, 245–54.
- Lapchin L, Guillemaud T (2005) Asymmetry in host and parasitoid diffuse coevolution: when the red queen has to keep a finger in more than one pie. *Frontiers in Zoology*, **2**, 4.
- Lavandero B, Tylianakis JM (2013) Genotype matching in a parasitoid-host genotypic food web: an approach for measuring effects of environmental change. *Molecular Ecology*, **22**, 229–38.
- Lavine MD, Strand MR (2002) Insect hemocytes and their role in immunity. *Insect Biochemistry and Molecular Biology*, **32**, 1295–309.

- Van Lenteren JC (2003) *Quality Control and Production of Biological Control Agents Theory and Testing Procedures* (JC van Lenteren, Ed.). CABI Publishing, Wageningen.
- Li Y, Alvarez OA, Gutteling EW *et al.* (2006) Mapping determinants of gene expression plasticity by genetical genomics in *C. elegans*. *PLoS genetics*, **2**, e222.
- Li S, Falabella P, Giannantonio S *et al.* (2002) Pea aphid clonal resistance to the endophagous parasitoid *Aphidius ervi*. *Journal of Insect Physiology*, **48**, 971–80.
- Li Z, Zheng L, Shen Z (2004) Internally transcribed spacer 2 sequences to re-examine the taxonomic status of several cryptic species of *Trichogramma* (Hymenoptera: Trichogrammatidae). *European Journal of Entomology*, **86**, 347–58.
- Mackauer M (1971) Genetic aspects of insect production (\*). *Entomophaga*, **17**, 27–48.
- Mackauer M (1976) Genetic problems in the production of biological control agents. *Annual review of Entomology*, **21**, 369–85.
- Maure F, Brodeur J, Ponlet N *et al.* (2011) The cost of a bodyguard. *Biology Letters*, **7**, 843–6.
- McCue MD (2006) Cost of Producing Venom in Three North American Pitviper Species (R Mason, Ed.). *Copeia*, **2006**, 818–25.
- Melián C, Vilas C, Baldó F (2011) Eco-evolutionary dynamics of individual-based food webs. In: *Advances in Ecological Research, Vol 45: The Role of Body Size in Multispecies Systems*, pp. 225–68.
- Mendlová M, Šimková A (2014) Evolution of host specificity in monogeneans parasitizing African cichlid fish. *Parasites & Vectors*, **7**, 69.
- Messing R, Wright M (2006) Biological control of invasive species: solution or pollution? *Frontiers in Ecology and the Environment*, **4**, 132–40.
- Mohamed S a., Overholt W a., Lux S a., Wharton R a., Eltoun EM (2007) Acceptability and suitability of six fruit fly species (Diptera: Tephritidae) for Kenyan strains of *Psytalia concolor* (Hymenoptera: Braconidae). *Biocontrol Science and Technology*, **17**, 247–59.
- Moran N, Russell J (2005) Evolutionary Relationships of Three New Species of Enterobacteriaceae Living as Symbionts of Aphids and Other Insects. *Applied and Environmental Microbiology*, **71**, 3302–10.
- Morgenstern D, King GF (2013) The venom optimization hypothesis revisited. *Toxicology : official journal of the International Society on Toxinology*, **63**, 120–8.
- Mostafalou S, Abdollahi M (2013) Pesticides and human chronic diseases: evidences, mechanisms, and perspectives. *Toxicology and Applied Pharmacology*, **268**, 157–77.
- Mouillot D, Krasnov BR, Shenbrot GI, Gaston KJ, Poulin R (2006) Conservatism of host specificity in parasites. *Ecography*, **29**, 596–602.
- Mrinalini, Aisha LS, Wright J *et al.* (2014) Parasitoid venom induces metabolic cascades in fly hosts. *Metabolomics*, 1–17.
- Nardi F, Carapelli A, Dallai R, Roderick GK, Frati F (2005) Population structure and colonization history of the olive fly, *Bactrocera oleae* (Diptera, Tephritidae). *Molecular Ecology*, **14**, 2729–38.
- Nesse RM (2006) The Smoke Detector Principle. Natural Selection and the Regulation of Defensive Responses. *Annals of the New York Academy of Sciences*, **935**, 75–85.
- Niogret J, Sait SM, Rohani P (2009) Parasitism and constitutive defence costs to host life-history traits in a parasitoid-host interaction. *Ecological Entomology*, **34**, 763–71.

- Nisani Z, Boskovic DS, Dunbar SG, Kelln W, Hayes WK (2012) Investigating the chemical profile of regenerated scorpion (*Parabuthus transvaalicus*) venom in relation to metabolic cost and toxicity. *Toxicon: official journal of the International Society on Toxinology*, **60**, 315–23.
- Nisani Z, Dunbar SG, Hayes WK (2007) Cost of venom regeneration in *Parabuthus transvaalicus* (Arachnida: Buthidae). *Comparative Biochemistry and Physiology. Part A, Molecular & integrative physiology*, **147**, 509–13.
- Oerke E-C (2006) Crop losses to pests. *The Journal of Agricultural Science*, **144**, 31–43.
- Oliver KM, Russell J a, Moran N a, Hunter MS (2003) Facultative bacterial symbionts in aphids confer resistance to parasitic wasps. *Proceedings of the National Academy of Sciences of the United States of America*, **100**, 1803–7.
- Orr D (2009) *Integrated Pest Management: Innovation-Development Process* (R Peshin, AK Dhawan, Eds.). Springer Netherlands, Dordrecht.
- Orr D, Lahiri S (2014) Biological Control of Insect Pests in Crops. In: *Integrated Pest Management: Current Concepts and Ecological Perspective* , pp. 531–48. Elsevier Inc.
- Ostrowski E, Ofria C, Lenski R (2007) Ecological specialization and adaptive decay in digital organisms. *The American Naturalist*, **169**, E1–E20.
- Palaima A (2007) The fitness cost of generalization: present limitations and future possible solutions. *Biological Journal of the Linnean Society*, **90**, 583–90.
- Pennacchio F, Strand MR (2006) Evolution of developmental strategies in parasitic hymenoptera. *Annual Review of Entomology*, **51**, 233–58.
- Poirié M, Carton Y, Dubuffet A (2009) Virulence strategies in parasitoid Hymenoptera as an example of adaptive diversity. *Comptes Rendus Biologies*, **332**, 311–20.
- Poulin R, Keeney DB (2008) Host specificity under molecular and experimental scrutiny. *Trends in Parasitology*, **24**, 24–8.
- Pratt C, Pope T, Powell G, Rossiter J (2008) Accumulation of glucosinolates by the cabbage aphid *Brevicoryne brassicae* as a defense against two coccinellid species. *Journal of Chemical Ecology*, **34**, 323–29.
- Punzalan D, Delcourt M, Rundle HD (2014) Comparing the intersex genetic correlation for fitness across novel environments in the fruit fly, *Drosophila serrata*. *Heredity*, **112**, 143–48.
- Quicke DL (1997) *Parasitic Wasps* (Springer, Ed.). Springer, London.
- Ravigné V, Dieckmann U, Olivieri I (2009) Live where you thrive: joint evolution of habitat choice and local adaptation facilitates specialization and promotes diversity. *The American Naturalist*, **174**, E141–69.
- Redon R, Ishikawa S, Fitch KR *et al.* (2006) Global variation in copy number in the human genome. *Nature*, **444**, 444–54.
- Reed D a., Luhring K a., Stafford C a. *et al.* (2007) Host defensive response against an egg parasitoid involves cellular encapsulation and melanization. *Biological Control*, **41**, 214–22.
- Ris N (2003) Hétérogénéité spatiale, plasticité phénotypique et trade-off environnementaux: Rôle de l'espèce hôte et de la température dans la différenciation génétique des populations du parasitoïde *Leptopilina heterotoma* (Hymenoptera).
- Rouchet R, Vorburger C (2014) Experimental Evolution of Parasitoid Infectivity on Symbiont-Protected Hosts Leads To the Emergence of Genotype Specificity. *Evolution*, **68**, 1607–16.
- Rugman-Jones PF, Wharton R, Noort T V, Stouthamer R (2009) Molecular differentiation of the *Psytalia concolor* (Szépligeti) species complex (Hymenoptera: Braconidae) associated with olive fly, *Bactrocera oleae* (Rossi) (Diptera: Tephritidae), in Africa. *Biological Control*, **49**, 17–26.

- Salt G (1968) The resistance of insect parasitoids to the defence reactions of their hosts. *Biological Reviews*, **43**, 200–32.
- Salt G (1971) Teratocytes as a means of resistance to cellular defence reactions. *Nature*, **232**, 1971.
- Schmidt O, Theopold U, Strand M (2001) Innate immunity and its evasion and suppression by hymenopteran endoparasitoids. *BioEssays*, **23**, 344–51.
- Schrider DR, Hahn MW (2010) Gene copy-number polymorphism in nature. *Proceedings. Biological sciences / The Royal Society*, **277**, 3213–21.
- Slansky FJ (1986) Nutritional ecology of endoparasitic insects and their hosts: an overview. *Journal of Insect Physiology*, **32**, 255–61.
- Soller M, Lanzrein B (1996) Polydnavirus and venom of the egg-larval parasitoid *Chelonus inanitus* (Braconidae) induce developmental arrest in the prepupa of its host *Spodoptera littoralis* (Noctuidae). *Journal of Insect Physiology*, **42**, 471–81.
- Stireman JO (2005) The evolution of generalization? Parasitoid flies and the perils of inferring host range evolution from phylogenies. *Journal of Evolutionary Biology*, **18**, 325–36.
- Strand M, Casas J (2008) Parasitoid and host nutritional physiology in behavioral ecology. In: *Behavioral Ecology of Insect Parasitoids*, pp. 113–28. Blackwell Publishing Ltd.
- Strand MR, Pech LL (1995) Immunological basis for compatibility in parasitoid-host relationships. *Annual review of entomology*, **40**, 31–56.
- Talaei R (2009) Influences of plant species on life history traits of *Cotesia rubecula* (Hymenoptera: Braconidae) and its host *Pieris rapae* (Lepidoptera: Pieridae). *Biological Control*, **51**, 72–5.
- Tayeh A, Estoup A, Laugier G *et al.* (2012) Evolution in biocontrol strains: insight from the harlequin ladybird *Harmonia axyridis*. *Evolutionary Applications*, **5**, 481–88.
- Tremblay E, Pennacchio F, Digilio MC (1998) Host regulation effects of ovary fluid and venom of *Aphidius ervi* (Hymenoptera: Braconidae). *Journal of Insect Physiology*, **44**, 779–84.
- Trimmer PC, Marshall J a. R, Fromhage L, McNamara JM, Houston AI (2013) Understanding the placebo effect from an evolutionary perspective. *Evolution and Human Behavior*, **34**, 8–15.
- Tripp E a, Manos PS (2008) Is floral specialization an evolutionary dead-end? Pollination system transitions in *Ruellia* (Acanthaceae). *Evolution*, **62**, 1712–37.
- Trostle Duke MK (2005) Classical biological control of mediterranean fruit fly, *ceratitis capitata* (wiedemann), (diptera: tephritidae): natural enemy exploration and nontarget testing.
- Tuda M, Shimada M (2005) Complexity, evolution, and persistence in host-parasitoid experimental systems with *Callosobruchus* beetles as the host. *Advances in Ecological Research*, **37**, 37–75.
- Vienne D (2013) Cospeciation vs host-shift speciation: methods for testing, evidence from natural associations and relation to coevolution. *New Phytologist*, **198**, 347–85.
- Vijendravarma RK, Kraaijeveld AR, Godfray HCJ (2009) Experimental evolution shows *Drosophila melanogaster* resistance to a microsporidian pathogen has fitness costs. *Evolution*, **63**, 104–14.
- Wagner A (2012) The role of robustness in phenotypic adaptation and innovation. *Proceedings. Biological sciences / The Royal Society*, **279**, 1249–58.
- Wago A, Tanaka T (1989) Synergistic Effects of Calyx Fluid and Venom of *Apanteles kariyai* Watanabe (Hymenoptera: Braconidae) on the Granular Cells of *Pseudaletia separata* WALKER (Lepidoptera: Noctuidae). *Zoological Science*, **6**, 691–6.
- Weichenthal S, Moase C, Chan P (2010) A review of pesticide exposure and cancer incidence in the Agricultural Health Study cohort. *Environmental Health Perspectives*, **8**, 1117–25.
- Welch JJ, Jiggins CD (2014) Standing and flowing: the complex origins of adaptive variation. *Molecular Ecology*, **23**, 3935–7.

- Weldon SR, Strand MR, Oliver KM (2013) Phage loss and the breakdown of a defensive symbiosis in aphids. *Proceedings. Biological sciences / The Royal Society*, **280**, 20122103.
- West-Eberhard MJ (2003) *Developmental plasticity and evolution*. Oxford University Press, New York.
- Whitlock M (1996) The red queen beats the jack-of-all-trades: the limitations on the evolution of phenotypic plasticity and niche breadth. *American Naturalist*, **148**, S65–S77.
- Williamson M, Fitter A (1996) The varying success of invaders. *Ecology*, **77**, 1661–1666.
- Winde I, Wittstock U (2011) Insect herbivore counteradaptations to the plant glucosinolate-myrosinase system. *Phytochemistry*, **72**, 1566–75.
- Xu C, Boyce MS (2005) Dynamic complexities in a mutual interference host–parasitoid model. *Chaos, Solitons & Fractals*, **24**, 175–182.
- Zheng W, Gianoulis TA, Karczewski KJ, Zhao H, Snyder M (2011) Regulatory variation within and between species. *Annual Review of Genomics and Human Genetics*, **12**, 327–46.