



**HAL**  
open science

# Runtime testing of dynamically adaptable and distributed component based Systems

Mariam Lahami

► **To cite this version:**

Mariam Lahami. Runtime testing of dynamically adaptable and distributed component based Systems. Computer Science [cs]. Ecole Nationale d'Ingénieurs de Sfax, 2017. English. NNT : . tel-02469999

**HAL Id: tel-02469999**

**<https://hal.science/tel-02469999>**

Submitted on 6 Feb 2020

**HAL** is a multi-disciplinary open access archive for the deposit and dissemination of scientific research documents, whether they are published or not. The documents may come from teaching and research institutions in France or abroad, or from public or private research centers.

L'archive ouverte pluridisciplinaire **HAL**, est destinée au dépôt et à la diffusion de documents scientifiques de niveau recherche, publiés ou non, émanant des établissements d'enseignement et de recherche français ou étrangers, des laboratoires publics ou privés.

Ministère de l'Enseignement  
Supérieur,  
Et de la Recherche Scientifique

Université de Sfax  
École Nationale d'Ingénieurs de Sfax



Ecole Doctorale  
Sciences et Technologies

Thèse de DOCTORAT  
Ingénierie des Systèmes  
Informatiques

N° d'ordre: 2017-156/16

---

# THESE

*présenté à*

**l'École Nationale d'Ingénieurs de Sfax**

*en vue de l'obtention de*

**DOCTORAT**

Dans la discipline *Informatique*  
*Ingénierie des systèmes informatiques*

*par*

**Mariam LAHAMI**

(Mastère Systèmes d'Information et Nouvelles Technologies )

---

## **Runtime Testing of Dynamically Adaptable and Distributed Component-based Systems**

---

*soutenu le 29 Avril 2017, devant le jury composé de :*

|  |                           |
|--|---------------------------|
| M. Maher BEN JEMAA (Professeur)        | <i>Président</i>          |
| M. Mohamed MOSBAH (Professeur)         | <i>Rapporteur</i>         |
| Mme. Leila JEMNI (Professeur)          | <i>Rapporteur</i>         |
| M. Kais HADDAR (Maître de conférences) | <i>Examineur</i>          |
| M. Mohamed JMAIEL (Professeur)         | <i>Directeur de thèse</i> |

*To the memory of my dad Youssef,  
Who gave me the drive and the desire to accomplish this thesis.  
“Ya Pa”, I know that your dream was to call me “Doctor”.  
Now, we are so close to fulfill our dream !*

# *Acknowledgments*

It is not an easy task to acknowledge all the people who made this Ph.D. thesis possible with a few words. However, I will try to do my best to extend my great appreciation to everyone who helped me scientifically and emotionally throughout this study.

First, I would like to express a deep gratitude to my thesis supervisor Prof. Mohamed Jmaiel for taking me under his wing and guiding me since the moment I entered the National School of Engineers of Sfax. I greatly appreciate his patience, motivation, and immense knowledge. His guidance helped me in all the time of research and writing of this thesis. I feel very privileged to have worked with an outstanding professor and a superb person like him.

Second, I would like to thank my thesis co-supervisor Dr. Moez Krichen, Associate Professor at the University of Baha, KSA, as he shared with me his knowledge and his research experience.

Many thanks go to the rest of the jury panel: Prof. Maher Ben Jemaa (Professor at the University of Sfax, Tunisia), Prof. Kais Haddar (Professor at the University of Sfax, Tunisia), especially Prof. Mohamed Mosbah (Professor at the University of Bordeaux 1, France) and Prof. Leila Jemni Ben Ayed (Professor at the University of Manouba, Tunisia) for accepting the review of my thesis report.

I would also like to convey my sincere and deep gratitude to my family for both believing in me and suffering with me through this long and arduous process.

A very special thank to my mother Fekria for the unconditional support and understanding that she has given to me. I am indebted to her more than she knows and I owe to her what I am today. Everyday and every moment, I thank God for enlightening my life with your presence “Ya Ma”.

I also owe many thanks and gratitude to my dearest husband Faker for his support and encouragement. Thank you for sharing my wish to reach the goal of completing this thesis and for bearing an overworked wife during thirteen years of marriage.

No words could express how much I am indebted to my lovely children Aziz, Youssef and Khadija who have always stood by me and dealt with all my absence and my stressful times with simply a smile. Aziz has grown up watching me study and juggle with family and work. I know that especially the last two years were a burden for you as you stay all day long in the school. Youssef, thank you for being a constant source of love and tenderness at home. By simply looking at your eyes, I felt and I will feel the presence of my father by my side, and indirectly you give me the strength to make this dream a reality. Khadija, the little one, who always tries

to do everything to make her presence felt. You have always told me to stop studying! Mommy's Ph.D. studies will be ended soon! I hope that I have been a good mother and that I have not lost too much during the tenure of this thesis.

Special and profound thanks goes to my sisters Islem, Salma and Yasmin. Your devotion, unconditional love and support, sense of humor, patience, optimism and advice were more valuable than you could ever imagine.

Furthermore, I would like to express my sincere thanks to my aunt Soumaya, my uncle Hedi and also my family-in-law for their support and their prayers.

Distinctive thanks go to my closest friends Raja, Meriam, Afef J., Afef M., Maissa, Faten, Ines, and Nabiha for their invaluable support and encouragement during the difficult moments of this thesis. Specially, I owe a debt of gratitude to Afef M. for reading my thesis report and providing useful suggestions.

Finally, I owe special thanks to all ReDCAD Laboratory members, especially Amina, Imene, Fatma, Nesrine, Wafa, Rahma, Amal G., Amal G. and Salma for the great environment inside our lab. We were not only able to support each other by deliberating over our problems and findings, but also by talking happily about things other than just our papers.

*I dedicate this work to you all.*

# *Abstract*

This thesis deals with runtime validation of dynamically adaptable and distributed component-based systems. With the aim of ensuring its correctness after each dynamic adaptation, *Runtime Testing* is adopted as an online validation technique which is carried out in the final execution environment of a system while it is performing its normal work. In spite of its ability to detect adaptation faults at runtime, this technique expects additional processing time and computational resources. Therefore, it is required to design and implement a test framework that alleviates its cost and burden while increasing its fault-finding capabilities.

Our proposal, called *Runtime Testing Framework for Adaptable and Distributed Systems* (RTF4ADS), covers the runtime testing process from the test generation to the test execution while supporting structural and behavioral adaptations.

The first part of this thesis is devoted to the validation of dynamic structural adaptations. To this end, RTF4ADS ensures the selection of a minimal set of tests and their distribution while respecting resource and connectivity constraints of the execution environment. At the test execution phase, the proposed test system executes runtime tests written in a standardized test notation based on the *Testing and Test Control Notation Language Version 3* (TTCN-3) standard. It also extends the TTCN-3 test system with a test isolation layer that reduces the risk of interference between testing processes and business processes in the final execution environment.

In the second part of this thesis, we focus on handling test suite evolution after dynamic behavioral adaptations. A selective test generation method from a formal specification based on timed automata is proposed. Taking the old specification, the evolved one, and the old test suite as inputs, our approach identifies new tests to be generated, existing tests to rerun, the existing tests to modify, and the obsolete tests to remove. Finally, our method produces a new test suite that will be automatically mapped to the TTCN-3 notation.

Through several experiments, we show the efficiency of RTF4ADS in reducing the cost of runtime testing and we present the tolerated overhead that it introduces in case of dynamic structural or behavioral adaptations.

# Résumé

Ce travail de thèse s'inscrit dans le cadre de la validation d'exécution des systèmes à base de composants logiciels distribués et dynamiquement adaptables. Afin de maintenir la sûreté de fonctionnement de ces systèmes après chaque adaptation dynamique, nous adoptons le *Test d'exécution*. Cependant, cette technique se caractérise essentiellement par sa consommation en termes de ressources et de temps d'exécution. D'où, nous notons le besoin de mettre en place un Framework de test d'exécution capable de réduire son coût et d'augmenter son efficacité à révéler des fautes d'adaptation.

Notre proposition, dite *Runtime Testing Framework for Adaptable and Distributed Systems* (RTF4ADS), assure le test d'exécution dès la génération jusqu'à l'exécution tout en supportant des adaptations dynamiques à la fois structurelles et comportementales.

La première partie de cette thèse est consacrée à la validation des adaptations structurelles. Pour ce faire, RTF4ADS assure la sélection d'un ensemble minimal de tests à distribuer tout en respectant des contraintes de ressources et de connectivité de l'environnement d'exécution. Durant la phase d'exécution, nous avons proposé un système de test ayant pour rôle l'exécution des tests rédigés selon un standard de test appelé *Testing and Test Control Notation Language Version 3* (TTCN-3). De plus, il étend le système de test de TTCN-3 par une couche d'isolation des tests afin d'éviter le risque d'interférence entre les processus de test et les processus métiers dans l'environnement d'exécution final.

Dans la deuxième partie de cette thèse, nous nous sommes focalisés à étudier le test d'exécution lorsque des adaptations comportementales aient lieu. Une méthode de génération sélective des tests à partir d'une spécification formelle basée sur les automates temporisés a été définie afin de réduire le coût de la génération de tests. Prenant en entrée l'ancienne spécification, la nouvelle obtenue suite à une adaptation dynamique et l'ancienne suite de tests, elle identifie les nouveaux tests à générer, les tests existants à ré-exécuter, les tests existants à modifier ainsi que les tests obsolètes à supprimer. Finalement, notre méthode produit une nouvelle suite de tests qui sera automatiquement transformée vers la notation générique du standard TTCN-3.

Des expérimentations sont menées afin de montrer l'efficacité de RTF4ADS à réduire le coût du test d'exécution tout en assurant la qualité du système évolutif.

---

## Contents

---

|          |   |           |
|----------|---|-----------|
| <b>1</b> | <b>Introduction</b>                             | <b>1</b>  |
| 1.1      | Research context and motivation . . . . .       | 1         |
| 1.2      | Problem statement . . . . .                     | 2         |
| 1.3      | Contributions . . . . .                         | 4         |
| 1.4      | Thesis outline . . . . .                        | 6         |
| <b>I</b> | <b>Background and Related Work</b>              | <b>8</b>  |
| <b>2</b> | <b>Background Materials</b>                     | <b>9</b>  |
| 2.1      | Introduction . . . . .                          | 9         |
| 2.2      | Dynamically adaptable systems . . . . .         | 9         |
| 2.3      | Software testing fundamentals . . . . .         | 13        |
| 2.4      | Testing dynamically adaptable systems . . . . . | 18        |
| 2.5      | Summary . . . . .                               | 23        |
| <b>3</b> | <b>State Of The Art</b>                         | <b>24</b> |
| 3.1      | Introduction . . . . .                          | 24        |
| 3.2      | Related work on regression testing . . . . .    | 25        |
| 3.3      | Related work on runtime testing . . . . .       | 28        |
| 3.4      | Summary . . . . .                               | 36        |



|            |   |           |
|------------|---|-----------|
| <b>II</b>  | <b>Design of Runtime Testing Approach</b>                         | <b>37</b> |
| <b>4</b>   | <b>Runtime Testing of Structural Adaptations</b>                  | <b>38</b> |
| 4.1        | Introduction . . . . .  | 38        |
| 4.2        | The Approach in a nutshell . . . . .                              | 39        |
| 4.3        | Online dependency analysis . . . . .                              | 40        |
| 4.4        | Online test case selection . . . . .                              | 43        |
| 4.5        | Constrained test component placement . . . . .                    | 45        |
| 4.6        | Test isolation and execution support . . . . .                    | 50        |
| 4.7        | Summary . . . . .   | 56        |
| <b>5</b>   | <b>Runtime Testing of Behavioral Adaptations</b>                  | <b>57</b> |
| 5.1        | Introduction . . . . .  | 57        |
| 5.2        | The approach in a nutshell . . . . .                              | 58        |
| 5.3        | Prerequisites . . . . .   | 59        |
| 5.4        | Differencing between behavioral models . . . . .                  | 65        |
| 5.5        | Old test suite classification . . . . .                           | 70        |
| 5.6        | Test generation and recomputation . . . . .                       | 72        |
| 5.7        | Test case concretization . . . . .                                | 74        |
| 5.8        | Summary . . . . .   | 79        |
| <b>III</b> | <b>Prototype Implementation and Case Studies</b>                  | <b>80</b> |
| <b>6</b>   | <b>Prototype Implementation</b>                                   | <b>81</b> |
| 6.1        | Introduction . . . . .  | 81        |
| 6.2        | RTF4ADS overview . . . . .  | 81        |
| 6.3        | Test selection and distribution GUI . . . . .                     | 82        |
| 6.4        | Test isolation and execution GUI . . . . .                        | 88        |
| 6.5        | Selective Test Generation GUI . . . . .                           | 91        |
| 6.6        | Summary . . . . .   | 94        |
| <b>7</b>   | <b>Application of RTF4ADS After Structural Adaptations</b>        | <b>95</b> |
| 7.1        | Introduction . . . . .  | 95        |
| 7.2        | Case study: Teleservices and Remote Medical Care System . . . . . | 95        |
| 7.3        | TRMCS test specification . . . . .                                | 98        |
| 7.4        | Checking TRMCS correctness after structural adaptations . . . . . | 103       |

|          |   |            |
|----------|---|------------|
| 7.5      | Evaluation and overhead estimation . . . . .                                  | 106        |
| 7.6      | Synthesis . . . . .   | 109        |
| 7.7      | Summary . . . . .   | 110        |
| <b>8</b> | <b>Application of RTF4ADS After Behavioral Adaptations</b>                    | <b>112</b> |
| 8.1      | Introduction . . . . .  | 112        |
| 8.2      | Case study: Toast architecture . . . . .                                      | 112        |
| 8.3      | Dynamic Toast evolution . . . . .   | 114        |
| 8.4      | Applying the selective test generation method after Toast evolution . . . . . | 119        |
| 8.5      | Test distribution and execution . . . . .                                     | 123        |
| 8.6      | Evaluation and overhead estimation . . . . .                                  | 123        |
| 8.7      | Summary . . . . .   | 126        |
| <b>9</b> | <b>Conclusion</b>   | <b>127</b> |
| 9.1      | Summary . . . . .   | 127        |
| 9.2      | Limitations and Future Work . . . . .   | 128        |
|          | <b>Author's Publications</b>  | <b>129</b> |
|          | <b>Bibliography</b>   | <b>132</b> |
| <b>A</b> | <b>Background Material on The TTCN-3 Standard</b>                             | <b>146</b> |
| A.1      | TTCN-3 core language . . . . .  | 146        |
| A.2      | TTCN-3 reference architecture . . . . .                                       | 148        |
| A.3      | Distributed testing with TTCN-3 . . . . .                                     | 149        |
| <b>B</b> | <b>Dependency Analysis Algorithms</b>   | <b>150</b> |
| B.1      | Adding a new component and its connections . . . . .                          | 150        |
| B.2      | Deleting an existing component and its connections . . . . .                  | 152        |
| B.3      | Replacing a component by another version . . . . .                            | 152        |
| B.4      | Adding/Deleting a dependency between two components . . . . .                 | 153        |
| B.5      | Identification of affected component compositions . . . . .                   | 154        |
| <b>C</b> | <b>Background of the Knapsack Problem</b>                                     | <b>156</b> |
| C.1      | The Knapsack Problem (KP) . . . . .   | 156        |
| C.2      | The Multi-Dimensional Knapsack Problem (MDKP) . . . . .                       | 157        |
| C.3      | The 0-1 Multiple Knapsack Problem (0-1 MKP) . . . . .                         | 157        |

|  |            |
|--|------------|
| <b>D Test Case Generation Algorithms</b>                             | <b>158</b> |
| D.1 Test case generation with satisfying test properties . . . . .   | 158        |
| D.2 Test case generation with satisfying coverage criteria . . . . . | 159        |

---

## List of Figures

---

|      |  |    |
|------|--|----|
| 2.1  | Distributed component-based architecture. . . . .  | 10 |
| 2.2  | Basic structural reconfiguration actions. . . . .  | 10 |
| 2.3  | Different kinds of testing [1]. . . . .  | 13 |
| 2.4  | Tester view. . . . .   | 16 |
| 2.5  | TTCN-3 test configuration [2]. . . . .   | 17 |
| 2.6  | Test classification. . . . .   | 19 |
|      | (a) Old test suite. . . . .  | 19 |
|      | (b) New test suite in corrective regression testing. . . . .   | 19 |
|      | (c) New test suite in progressive regression testing. . . . .  | 19 |
| 2.7  | The runtime level in the software life cycle. . . . .  | 19 |
| 2.8  | A component with a test interface. . . . .   | 21 |
| 2.9  | Illustration of the tagging strategy. . . . .  | 21 |
| 2.10 | Example of the deep clone strategy. . . . .  | 22 |
| 4.1  | Runtime testing process for the validation of structural adaptations. . . . .  | 39 |
| 4.2  | Dependency relationship. . . . .   | 41 |
| 4.3  | A CDG and its CDM representing direct dependencies. . . . .  | 42 |
| 4.4  | An adjacency matrix representing direct and indirect dependencies produced by<br>the Roy-Warshall algorithm. . . . . | 42 |
| 4.5  | Illustrative example of dependence path computation. . . . .   | 44 |
| 4.6  | TTCN-3 test configuration for unit and integration testing. . . . .  | 45 |
|      | (a) Unit test configuration. . . . .   | 45 |
|      | (b) Integration test configuration. . . . .  | 45 |

|      |   |     |
|------|---|-----|
| 4.7  | Illustration of connectivity problems during testing. . . . .                     | 47  |
| 4.8  | Illustrative example for profit calculation. . . . .                              | 48  |
| 4.9  | XML schema of the Resource Aware Test Plan. . . . .                               | 50  |
| 4.10 | Supported layers of TT4RT. . . . .  | 51  |
| 4.11 | Internal interactions in the TT4RT system. . . . .                                | 52  |
| 4.12 | Test isolation policy. . . . .  | 54  |
| 4.13 | The distributed test execution platform. . . . .                                  | 56  |
| 5.1  | TestGenApp: Selective test case generation approach. . . . .                      | 58  |
| 5.2  | An example of a network of timed automata [3]. . . . .                            | 61  |
| 5.3  | UPPAAL timed automata XML schema. . . . .   | 62  |
| 5.4  | Edge coverage observer presented in both textual and graphical notations. . . . . | 64  |
| 5.5  | An example of initial and evolved models. . . . .                                 | 67  |
|      | (a) The initial model. . . . .  | 67  |
|      | (b) The evolved model. . . . .  | 67  |
| 5.6  | Output of the transitionDiff procedure. . . . .                                   | 67  |
| 5.7  | Output of the locationDiff procedure. . . . .                                     | 68  |
| 5.8  | Output of the model differencing algorithm. . . . .                               | 70  |
| 6.1  | RTF4ADS prototype. . . . .  | 82  |
| 6.2  | Screenshot of the test selection and distribution GUI. . . . .                    | 83  |
| 6.3  | XML schema of the system dependency graph. . . . .                                | 83  |
| 6.4  | Online dependency analysis inputs and outputs. . . . .                            | 84  |
| 6.5  | Online test case selection module inputs and outputs. . . . .                     | 84  |
| 6.6  | XML schema of the test case repository descriptor. . . . .                        | 84  |
| 6.7  | Constrained test component placement module inputs and outputs. . . . .           | 85  |
| 6.8  | XML schema of the execution environment descriptor. . . . .                       | 85  |
| 6.9  | Screenshot of the test isolation and execution GUI. . . . .                       | 88  |
| 6.10 | TT4RT instance inputs and outputs. . . . .  | 89  |
| 6.11 | Screenshot of the selective test generation GUI. . . . .                          | 91  |
| 6.12 | UPPAAL CO $\sqrt$ ER setup. . . . .   | 93  |
| 7.1  | The basic configuration of TRMCS. . . . .   | 96  |
| 7.2  | TRMCS bundles running on Felix. . . . .   | 97  |
| 7.3  | The dependency graph of the studied scenario. . . . .                             | 103 |
| 7.4  | Screenshot of the RATP XML file content. . . . .                                  | 104 |

|      |   |     |
|------|---|-----|
| 7.5  | An example of interactions between TTCN-3 test components and SUT. . . . .  | 105 |
| 7.6  | The adopted testbed. . . . .  | 106 |
| 7.7  | Execution time required by each step in the RTF4ADS framework. . . . .  | 107 |
|      | (a) Execution time of the dependency analysis step. . . . .   | 107 |
|      | (b) Execution time of the test selection step. . . . .  | 107 |
|      | (c) Execution time of the constrained test component placement step. . . . .  | 107 |
|      | (d) Centralized vs distributed runtime tests. . . . .   | 107 |
| 7.8  | Memory usage for one TT4RT instance while varying the number of test cases. . .   | 108 |
| 7.9  | Memory usage for one TT4RT instance while varying the number of PTCs. . . .   | 108 |
| 7.10 | The impact of resource and connectivity awareness on test results. . . . .  | 109 |
| 7.11 | The overhead of the whole runtime testing process while searching for an optimal<br>solution in step 3. . . . .             | 110 |
| 7.12 | Assessing the overhead of the whole runtime testing process while searching for a<br>satisfying solution in step 3. . . . . | 110 |
| 8.1  | The initial Toast architecture. . . . .   | 113 |
| 8.2  | Toast behavioral models. . . . .  | 114 |
|      | (a) The initial GPS model. . . . .  | 114 |
|      | (b) The environment model. . . . .  | 114 |
|      | (c) The initial Emergency Monitor model. . . . .  | 114 |
| 8.3  | The evolved GPS model in Case 1. . . . .  | 115 |
| 8.4  | The evolved GPS model in Case 2. . . . .  | 116 |
| 8.5  | The evolved GPS model in Case 3. . . . .  | 116 |
| 8.6  | The addition of a Back End server to the Toast architecture (Case 4). . . . .   | 117 |
|      | (a) The new Toast architecture. . . . .   | 117 |
|      | (b) The new Back End model. . . . .   | 117 |
|      | (c) The ENV model. . . . .  | 117 |
| 8.7  | The addition of the Tracking Monitor to the Toast architecture (Case 5). . . . .  | 118 |
| 8.8  | The new timed automata of the Tracking Monitor. . . . .   | 118 |
| 8.9  | New templates in Case 6. . . . .  | 118 |
|      | (a) The Climate Monitor. . . . .  | 118 |
|      | (b) The Climate Controller. . . . .   | 118 |
| 8.10 | The $GPS_{diff}$ model from Case 0 to Case 1. . . . .   | 119 |
| 8.11 | The $GPS_{diff}$ model from Case 2 to Case 3. . . . .   | 121 |
| 8.12 | Comparison between TestGenApp and Regenerate All approaches. . . . .  | 124 |

|      |   |     |
|------|---|-----|
| (a)  | The number of generated traces. . . . .                   | 124 |
| (b)  | Execution time for test evolution. . . . .                | 124 |
| 8.13 | The overhead of the TestGenApp modules. . . . .           | 125 |
| A.1  | Core elements in the TTCN-3 module. . . . .               | 147 |
| A.2  | TTCN-3 reference architecture. . . . .                    | 148 |
| A.3  | Architecture of a distributed TTCN-3 test system. . . . . | 149 |

---

## List of Tables

---

|     |  |     |
|-----|--|-----|
| 2.1 | Limitations of the test isolation strategies. . . . .                          | 22  |
| 3.1 | Survey of regression testing approaches. . . . .                               | 28  |
| 3.2 | Survey of runtime testing approaches. . . . .                                  | 35  |
| 5.1 | TTCN-3 transformation rules. . . . .   | 76  |
| 7.1 | Supporting several configurations of the TRMCS application. . . . .            | 98  |
| 7.2 | Supported test scenarios. . . . .  | 99  |
| 7.3 | Test scenario 1 (TS-1). . . . .  | 99  |
| 7.4 | Test scenario 2 (TS-2). . . . .  | 100 |
| 7.5 | Test scenario 3 (TS-3). . . . .  | 101 |
| 7.6 | Test scenario 4 (TS-4). . . . .  | 102 |
| 7.7 | Reusable test cases. . . . .   | 104 |
| 8.1 | Several studied Toast evolutions. . . . .                                      | 115 |
| 8.2 | Comparison between Regenerate All, Retest All and TestGenApp strategies. . . . | 124 |



---

## List of Listings

---

|     |   |     |
|-----|---|-----|
| 5.1 | Customized edge coverage criterion. . . . .                         | 73  |
| 5.2 | TTCN-3 module structure. . . . .                                    | 76  |
| 5.3 | Component and port definitions. . . . .                             | 77  |
| 5.4 | A generated TTCN-3 function for a single test behavior. . . . .     | 77  |
| 5.5 | A generated test case for an abstract test sequence. . . . .        | 78  |
| 5.6 | The generated module control part. . . . .                          | 78  |
| 6.1 | Mapping of the MMKP formulation to the Choco-based code. . . . .    | 86  |
| 6.2 | A code snippet of the proposed variable selector heuristic. . . . . | 87  |
| 6.3 | Remote interface of TT4RT instance. . . . .                         | 89  |
| 6.4 | Test isolation instance based on AOP code. . . . .                  | 90  |
| 6.5 | Test classification code snippet. . . . .                           | 92  |
| 7.1 | A sample of test case for TS-1. . . . .                             | 99  |
| 7.2 | A sample of test case for TS-2. . . . .                             | 100 |
| 7.3 | A sample of test case for TS-3. . . . .                             | 101 |
| 7.4 | A sample of test case for TS-4. . . . .                             | 102 |
| 7.5 | The test configuration in TTCN-3 notation. . . . .                  | 105 |
| 8.1 | A snippet TTCN-3 code for testing the new Climate Monitor. . . . .  | 122 |
| A.1 | TTCN-3 code snippet. . . . .  | 147 |

---

## List of Algorithms

---

|     |   |     |
|-----|---|-----|
| 4.1 | Resolution of MMKP problem. . . . .   | 50  |
| -   | Procedure transitionDiff(in <i>list_T1</i> , <i>list_T2</i> , out <i>list_Colored_T</i> ). . . . .    | 66  |
| -   | Procedure locationDiff(in <i>list_L1</i> , <i>list_L2</i> , out <i>list_Colored_L</i> ). . . . .      | 68  |
| 5.1 | Model differencing algorithm. . . . .   | 69  |
| 5.2 | Test classification algorithm. . . . .  | 71  |
| 5.3 | Test recomputation algorithm. . . . .   | 74  |
| B.1 | Affected components by the “add Component” action. . . . .  | 151 |
| B.2 | Affected components by the “delete Component” action. . . . .   | 152 |
| B.3 | Affected components by the “replace Component” action. . . . .  | 153 |
| B.4 | Affected components by the “add Dependency” (respectively by the “delete Dependency”) action. . . . . | 154 |
| B.5 | Affected component compositions by a dynamic change. . . . .  | 155 |
| D.1 | A standard reachability analysis algorithm [4]. . . . .   | 159 |
| D.2 | A breadth-first search exploration algorithm for test case generation [5]. . . . .                    | 160 |

**AOP** Aspect Oriented Programming

**BIT** Built-In Test

**BPEL** Business Process Execution Language

**CD** Coding/Decoding

**CDG** Component Dependency Graph

**CDM** Component Dependency Matrix

**CFG** Control Flow Graph

**CH** Component Handling

**CPU** Central Processing Unit

**CSP** Constraint Satisfaction Problem

**CUT** Component Under Test

**EFSM** Extended Finite State Machine

**FSM** Finite State Machine

**GraphML** Graph Markup Language

**GUI** Graphical User Interface

**IDE** Integrated Development Environment

**JAR** Java ARchive

**LTS** Labeled Transition System

**M@RT** Model@runtime

**MAPE** Monitor-Analyse-Plan-Execute

**MBT** Model Based Testing

**MMKP** Multiple Multidimensional Knapsack Problem

**MORABIT** Mobile Resource-Aware Built-In-Test

**MTC** Main Test Component

**OCL** Object Constraint Language

**OSGi** Open Service Gateway initiative

**PA** Platform Adapter

**PTC** Parallel Test Component

**QoS** Quality of Services

**RATP** Resouce Aware Test Plan

**RTF4ADS** Runtime Testing Framework for Adaptable and Distributed Systems

**SA** System Adapter

**SUT** System Under Test

**TA** Timed Automata

**TCI** TTCN-3 Control Interface

**TCP** Transmission Control Protocol

**TE** TTCN-3 Executable

**TestGenApp** Test Generation Approach

**TM** Test Management

**TRI** TTCN-3 Runtime Interface

**TRMCS** Teleservices and Remote Medical Care System

**TS** Test System

**TSC** Test System Coordinator

**TT4RT** TTCN-3 Test System for Runtime Testing

**TTCN-3** Testing and Test Control Notation Version 3

**U2TP** UML 2.0 Test Profile

**UDP** User Datagram Packet

**UML** Unified Modeling Language

**WSDL** Web Services Description Language

**XML** eXtensible Markup Language

### 1.1 Research context and motivation

Nowadays, distributed component-based systems tend to evolve dynamically without stopping their execution. In general, such evolution is required to provide more dependable systems, to remove identified deficiencies, or to handle the rapid evolution of user requirements and the increased variability of the execution context (e.g., mobility of devices hosting components, *Quality of Services* (QoS) degradation, node crash, etc.). Known as *Dynamically Adaptable and Distributed Systems*, these systems are currently playing an important role in society's services. Indeed, the growing demand for such systems is obvious in several application domains such as crisis management (i.e., helping to identify, assess, and handle a crisis situation like natural disasters, accidents, etc.) [6], medical monitoring (i.e., offering assistance to patients suffering from chronic health problems)[7, 8], fleet management (i.e., helping to manage and control vehicle fleet such as speed management, maintenance, tracking, etc.) [9], etc. This demand is stressed by the complex, mobile and critical nature of these applications that also need to continue meeting their functional and non-functional requirements and to support advanced properties such as context awareness and mobility. To do so, the runtime evolution, commonly referred to as *Dynamic Adaptation*, is performed either by dynamically modifying the architecture of the software system (i.e., structural adaptations) or by modifying its behavior (i.e., behavioral adaptations).

Nevertheless, dynamic adaptations of component-based systems may generate new risks of bugs, unpredicted interactions (e.g., connections going down), unintended operation modes and

performance degradation. This may cause system malfunctions and guide its execution to an unsafe state. For instance, a required functionality may be removed by mistake when a component leaves the system or an undesired cycle may be introduced in new interactions between components. Such unexpected failures can have costly results especially for safety-critical systems such as patient monitoring systems, fleet management systems, etc. Therefore, guaranteeing their high quality and their trustworthiness remains a crucial requirement to be considered.

As one of the key methods to get confidence in these evolved systems, software testing captured researchers' interest for a long time. It has often been applied to check functional and non-functional requirements at design stage of the software development life cycle. Its ultimate goal is to detect the presence of faults (e.g., programming errors, specification mismatches) in the *System Under Test* (SUT). In this respect, the literature comprises a myriad of techniques and methods (i.e., covering test generation, test selection, test execution, etc.) for efficiently testing several kinds of software systems (e.g., *Component-based Systems*, *Service-based Applications*, *Publish/Subscribe Systems*, etc.). However, these approaches are not suitable for validating dynamically adaptable systems since they are conceived for static systems and they are performed at the design level.

One of the most promising ways of testing dynamic systems is the use of an emerging technique, called *Runtime Testing*. It is defined in [10] as any testing method (i.e., unit testing, regression testing, conformance testing, etc.) that is carried out in the final execution environment during the operation time of a system. In spite of its ability to detect faults at runtime and to provide valuable means of system assurance, runtime testing may impose a relative impact on the running SUT and on its execution environment. For instance, performing runtime testing activities requires additional execution time, extra resource consumption, and/or unexpected changes to the system behavior. Consequently, it is necessary to apply runtime testing carefully with the purpose of avoiding its undesired side effects.

This thesis addresses the design, the implementation, and the evaluation of a novel approach that reduces the impact of the runtime testing on both the SUT and its execution environment while increasing its fault-detection capabilities.

## 1.2 Problem statement

Similar to any testing method, runtime testing requires additional resources (e.g., memory consumption) and extra processing time to check the correctness of software systems after dynamic adaptations. Since runtime tests are executed in the final execution environment, such overhead may have an effect on the running SUT (i.e., performance degradation) and on the execution

environment (i.e., burden execution nodes).

Several studies have considered runtime testing in various software domains. In fact, we distinguish approaches dealing with runtime testing of Java applications [11], ubiquitous software systems [12], component-based systems [13, 14, 15], service oriented systems [16, 17, 18], publish/subscribe systems [19] and autonomic systems [20, 21, 22]. We have noticed that most of them adopt a centralized test architecture in which a given *Test System* (TS) communicates with all parts of the distributed SUT. Such an architecture may considerably load the execution environment and may intensively consume computational resources. Also, most of the studied approaches propose platform-dependent test systems tightly coupled with the SUT. They assume that test cases are available (i.e., generally embedded in components under test or stored in a test repository). Despite the effort to apply an effective runtime testing process, it remains one of the most challenging validation techniques. Consequently, several problems are fixed and detailed afterwards.

*How to obtain the adequate test cases to execute when the system evolves at runtime?*

This question is rarely tackled in the literature. It raises two main challenges while identifying a subset of test cases to run after the occurrence of dynamic adaptations. In the case of structural adaptations, system behaviors are preserved and only system architectures are evolved at runtime. Therefore, tests, usually generated at design time, are still valid. Hence, a test selection strategy is required with the purpose of identifying a minimal set of test cases to rerun. The latter must cover affected parts of the system by this dynamic change. In the case of behavioral adaptations, the old test suite becomes irrelevant because some obsolete behaviors are omitted from the system, new emergent ones are added and some existing ones are modified. Regenerating all tests from the evolved behavioral model of the SUT is a costly activity and must be avoided. Therefore, a selective test case generation method is required with the intention of avoiding the regeneration of full test suites and reducing the amount of tests to rerun.

*How to reduce the burden of execution nodes while executing runtime tests?*

As already mentioned, software testing is known by its intense resource consumption. This fact is emphasized notably when this activity is applied online, in a shared environment with the SUT, and in a centralized manner. Several risks may happen and undermine SUT quality and may even cause software and hardware failures such as SUT delays, memory and CPU overload, node crash, etc. Such risks may impact also the Test System itself, which can produce faulty test results. As a solution, supporting test distribution over the network may alleviate considerably the test workload at runtime. Moreover, it is highly demanded to provide a resource-aware and distributed test system that meets resource availability and fits connectivity constraints in order



to have a high confidence in the validity of test results as well as to reduce their associated burden and cost on the running SUT.

*Does runtime testing affect the running system behavior?*

Remember that runtime testing is usually applied in the final execution environment while the SUT is operational. This means that business and test processes are executed concurrently. As a result, SUT behaviors may be seriously influenced by some test input data. In the worst case, the obtained side effects are difficult to control or impossible to recover from (e.g., flattening an airbag due to the test execution, firing a missile while testing a part of a military unit system, etc.). Therefore, test isolation mechanisms are needed in order to counter the problem of testing sensitive components (i.e., including some behaviors that cannot be safely tested at runtime) and to prevent interference between test and business processes.

*How to reduce the effort of runtime testing in heterogeneous environments?*

Due to the trend towards service-oriented applications and the widespread use of components off the shelf, software systems are more and more heterogeneous regarding the programming language of components or regarding the underlying component model such as Fractal [15] and the Open Service Gateway initiative (OSGi) [17]. For instance, a software system may evolve dynamically by changing a service implementation (e.g., written in Java language) by another service implementation (e.g., written in C++ language) while keeping the same behavior. In this case, existing tests (e.g., written in JUnit<sup>1</sup>) are not understandable by the new version. Hence, the generation of new tests for the new version (e.g., written in CppUnit<sup>2</sup>) is required. For the purpose of reducing this test development burden and improving the reuse of existing tests, using a unified and platform-independent notation such as the *Testing and Test Control Notation Language Version* (TTCN-3) language for the test specification greatly helps especially when heterogeneous software components from different providers may join and leave the application at runtime.

### 1.3 Contributions

In this thesis, the different problems expressed above are considered in order to find a trade-off between runtime testing, SUT quality and resource consumption. The main goal to achieve consists in performing runtime testing activity while reducing its sides effects and its high cost, either after the occurrence of dynamic structural adaptations or behavioral ones. To that aim, several contributions are outlined as follows :

---

<sup>1</sup><http://junit.org/>

<sup>2</sup>[http://cppunit.sourceforge.net/doc/cvs/cppunit\\_cookbook.html](http://cppunit.sourceforge.net/doc/cvs/cppunit_cookbook.html)

- The first contribution focuses on selecting and distributing efficiently runtime tests in the final execution environment without overloading execution nodes when structural adaptations take place. Regarding the test selection perspective, a dependency analysis approach is used in order to detect affected parts of the system by the dynamic change [23]. Based on the obtained results, we conceive an algorithm that selects a minimal subset of test cases to rerun covering the impacted parts of the SUT. Concerning the test distribution perspective, a novel idea is introduced to efficiently distribute the selected test cases and to assign their corresponding test components to execution nodes while respecting resource and connectivity constraints [24]. The *Knapsack Problem* model is used to formalize this test component placement problem. A well-known solver in the constraint programming area, namely Choco [25], is applied to compute either an optimal or a satisfying solution.
- The second contribution consists in designing a standard-based test execution platform, called *TTCN-3 test system for Runtime Testing (TT4RT)* [26]. This proposal affords a platform-independent test system for isolating and executing runtime tests that are specified in a unified and standardized notation. The choice of TTCN-3 standard [2] as a test specification language is justified by its platform independence and by its ability to build dynamic test configurations that evolve when the SUT evolves. The particularity of TT4RT is that it extends the original *TTCN-3 Reference Architecture* [27, 28] by a new test isolation layer capable of reducing interference risks between test and business processes at runtime. This layer supports different test isolation strategies in order to handle heterogeneous systems made up of testable components (i.e., components that can be tested at runtime) and untestable ones (i.e., components that cannot be tested at runtime) [29].
- The third contribution proposes a *Selective Test Generation Approach (TestGenApp)* that produces relevant test cases covering either modified or newly added behaviors at runtime [30]. By merging model-based testing [1] and selective regression testing [31] principles, the presented method avoids the regeneration of the full test suite by covering only the affected parts of the SUT behavioral model. To model the initial SUT behavior and its evolved version, we employ the UPPAAL Timed Automata formalism [3] due to its expressiveness and its convenience. Several algorithms are newly conceived to firstly deal with model differencing and marking difference and similarities between the initial and the evolved models. Next, a novel test classification algorithm is proposed to select valid tests from the old test suite and detect either obsolete tests (i.e., tests covering removed items in the evolved model) or aborted ones (i.e., tests that cannot be animated on the evolved

model anymore due to some modified items). Then, the test generation tool UPPAAL CO $\sqrt$ ER is customized to generate effectively new tests. Based on the *Observer Language*, we express a new coverage criteria that is used by the UPPAAL CO $\sqrt$ ER for the efficient test generation purpose. Also, we propose a test recomputation algorithm that adapts invalid tests (i.e., obsolete and aborted tests) while avoiding test redundancy. At the end, the evolved abstract test suite is mapped to the TTCN-3 notation.

- The fourth contribution consists in implementing the *Runtime Testing Framework for Adaptable and Distributed Systems (RTF4ADS)* [32]. This Java-based prototype gathers the achievement of the previous contributions. In addition to that, we demonstrate the feasibility of our proposal by means of two case studies, one in the healthcare domain and the other in the fleet management domain. Through several experiments [33], we show also the efficiency of the proposed framework and the tolerated cost that it introduces in case of structural and behavioral adaptations.

## 1.4 Thesis outline

This dissertation is structured in three parts as follows :

- Part I, named *Background and Related Work*, includes the following two chapters :

**Chapter 2** presents the background material related to this thesis. This includes the main characteristics of dynamically adaptable systems, software testing fundamentals and test languages. Moreover, two well-known testing techniques usually used to test evolved software systems are introduced, namely regression testing and runtime testing.

**Chapter 3** describes existing approaches in the literature according to two research lines. The first line deals with approaches relying on regression testing with the aim of testing evolved systems at design time. The second line introduces approaches that are based on runtime testing to test evolved systems at runtime. This chapter ends with a synthesis highlighting the main objectives of this thesis.

- Part II, named *Runtime Testing Approach*, includes the following two chapters :

**Chapter 4** details the approach we propose to handle structural adaptations at runtime. Our findings in efficiently selecting and distributing test cases is outlined in the first part of this chapter. In the second part, we focus on presenting our TTCN-3 based test system, especially we pinpoint the afforded test isolation layer and the distributed test architecture that it is relying on.

**Chapter 5** introduces our proposal to handle behavioral adaptations at runtime. In the beginning, background materials on the UPPAAL model checker, timed automata, and observer automata are given. Next, a method for selective test case generation is proposed. The evolved test suite is then mapped to the TTCN-3 notation with the aim of obtaining concrete tests.

- Part III, named *Prototype Implementation and Case Studies*, includes the following three chapters:

**Chapter 6** presents the prototype implementation of the RTF4ADS framework.

**Chapter 7** deals with the application of this framework to validate structural adaptations. A case study in the healthcare field, called *Teleservices and Remote Medical Care System* (TRMCS) is used for this purpose. Also, several experiments are conducted to assess the overhead of the proposed framework.

**Chapter 8** outlines the use of RTF4ADS to support runtime validation of behavioral adaptations. A second case study, called Toast architecture, is used in this stage to show the feasibility of our selective test generation method. Several experiments demonstrate the low cost introduced by this framework compared to typical solutions in the literature.

Finally, **Chapter 9** summarizes the contributions and the obtained results of this Ph.D. work. It also outlines several directions for future research.

# Part I

---

## Background and Related Work

---

### 2.1 Introduction

This chapter is dedicated to present the background material required to understand our contributions in this Ph.D. thesis. In Section 2.2, we start by giving the main characteristics of adaptable and distributed component-based systems and we discuss the challenges that we face after the occurrence of dynamic adaptations. Key concepts on software testing is outlined in Section 2.3. It includes a software testing definition, test kinds, the well-known test implementation techniques and test architectures. In Section 2.4, some testing techniques commonly used to validate modifications introduced in software systems are presented, namely regression and runtime testing. Finally, Section 2.5 concludes this chapter.

### 2.2 Dynamically adaptable systems

#### 2.2.1 Main characteristics

Dynamically adaptable systems in the sense of this thesis consist of a set of interconnected software components<sup>1</sup> that may leave and join the system at any time during runtime. In fact, a component is a software module that encapsulates a set of functions or data. Seen as black-boxes, components offer functionalities that are expressed by clearly defined interfaces. These interfaces are usually required to connect components for communication and to compose

---

<sup>1</sup>Even though the thesis context deals with component-based architectures, it can be easily extended to the case of service-oriented architectures.

them in order to provide complex functionalities. As highlighted in Figure 2.1, components are capable of exposing these functionalities as provided interfaces to other components or using other functionalities from other components by their required interfaces. Due to the increasing needs of computational resources, these components are distributed among different execution nodes and they coordinate and synchronize their execution via remote connections.

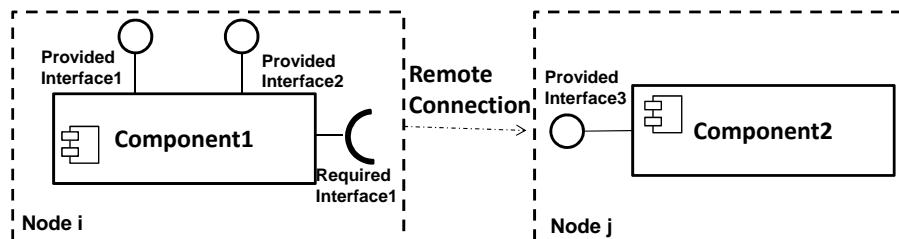

Figure 2.1: Distributed component-based architecture.

### 2.2.2 Dynamic adaptation: kinds and goals

To guarantee their high availability at runtime, dynamically adaptable systems are designed to accommodate new features even after the design and deployment stages. They need to dynamically adapt and evolve at runtime in order to achieve new requirements and avoid failures without service interrupting. In fact, dynamic adaptation, known also as dynamic reconfiguration, is defined in [34] as the ability to modify and extend a system while it is running.

Several changes, whether structural or behavioral, can be made. For the case of structural changes, only the system architecture is modified at runtime. Figure 2.2 depicts different kinds of structural reconfiguration actions, namely, adding or deleting components, adding or deleting connections and replacing a component by a new version.

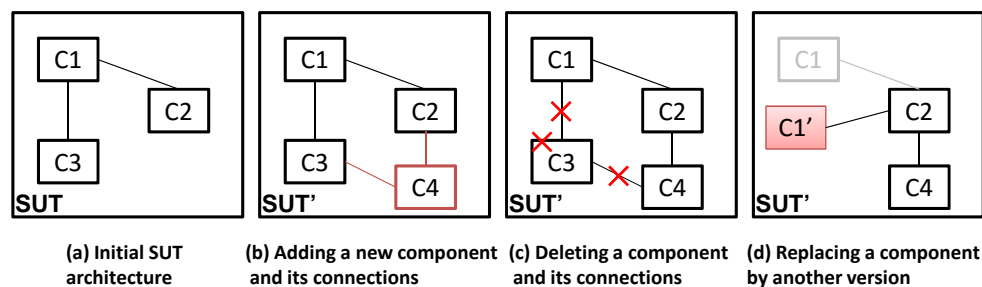

Figure 2.2: Basic structural reconfiguration actions.

For the case of behavioral changes, the system behavior is modified by changing the implementation of its components or by changing its interfaces (i.e., adding or deleting interfaces).

Four major purposes of dynamic adaptation are defined in [35] :

**Corrective adaptation.** It removes the faulty behavior of a running component by re-

placing it with a new version that provides exactly the same functionality. For instance, if a component misses its specified deadline, it must be replaced with a correct one able to continue the same tasks of the faulty component.

**Extending adaptation.** It extends the system by adding either new components or new functionalities in their implementation to satisfy new emerging requirements.

**Perfective adaptation.** It aims to improve the system performance even if it runs correctly. For example, we may replace a component with a new one that has a more optimized implementation. Moreover, the overhead of a component may be reduced by deploying another one performing some of its tasks.

**Adaptive adaptation.** It allows adapting the working system to a new running environment like a new operating system, a new database or even new hardware components.

In the literature, several research approaches have been proposed to support the establishment of dynamic and distributed systems. They vary according to the underlying component or service model or according to the programming language. We discern approaches dealing with Fractal [36], OSGi [37], Web services [38], etc.

Without loss of generality, we use in this thesis the OSGi [39] platform as a basis to build dynamic systems. Within OSGi, components provide and require services. That is, all their interactions occur via services. Hence, this platform combines service-oriented and component-oriented concepts to build a service-oriented component model. The latter guarantees the construction of component-based applications that are capable of autonomously adapting at runtime due to the dynamic availability of services provided by their constituent components.

### 2.2.3 Challenges

By evolving dynamically the structure or/and the behavior of a distributed component-based system, several faults<sup>2</sup> may arise at runtime. We distinguish:

**Functional faults.** For instance, a defect at the software level, for example in the new version of a software component implementation, can lead to an integration fault caused by interface or data format mismatches with its consumers. Moreover, a defect at the hardware level (i.e., node overload or crash, node connections going down, etc.) may cause service unavailability or service shutdown.

**Non-functional faults.** For instance, migrating a software component from one node to another can lead to performance degradation and missing deadlines (i.e., timing constraints are not respected, user requests are delayed, etc.).

---

<sup>2</sup>A fault is a physical defect, imperfection or mistake that occurs in hardware or software.



Such faults originally cause errors<sup>3</sup> that can lead to observable failures<sup>4</sup> [40]. Moreover, the failure of one component can trigger the failure of every component which is directly or indirectly linked to it. Also, all composite components that contain the faulty one may be subject to a failure. Such series of cascading failures are commonly called in the literature the *domino effect* issue [15].

In these situations, it is crucial to investigate ways to validate these systems at runtime with the aim of avoiding system failures and reaching confidence in their ability to deliver services in accordance with their specification. Therefore, applying *Validation and Verification* (V&V) techniques is highly required to ensure the system quality and trustworthiness after the occurrence of dynamic adaptations.

In the literature, two recent surveys address this issue [41, 42] and stress the need for the development of techniques and methods that allow continuous assurance of dynamic software, especially at service-time. This need comes from the fact that dynamically adaptable systems may introduce unpredictable behaviors in response to unforeseen context and requirement changes. Therefore, several V&V techniques can be used with the aim of checking unanticipated evolutions such as:

**Model checking.** Based on a formal model and a set of properties expressed in a formal logic, model checking has been widely used to verify either hardware or software systems satisfying desired properties. At runtime, model checking is used either for ensuring the fulfillment of system requirements or for re-certifying system properties after dynamic adaptations. To this end, this technique exploits research done in the *Models at Run-Time* (M@RT) community [43, 42] in order to have an up-to-date representation of the evolved system. Called in the literature *Model Evolution*, the latter is still a challenging issue since it is highly demanded to preserve coherence between runtime models and the running system [41, 44].

**Monitoring and analysis of system executions.** Monitoring consists in observing passively the system's executions during its use in the field. To do so, *Monitors* are required to collect relevant context information from the execution environment and from the target system. We can distinguish between *assurance monitors* that monitor the system itself and *adaptation monitors* that monitor the adaptation process [42]. The gathered data are then analyzed with the aim of detecting inconsistencies introduced after dynamic adaptations.

**Software Testing.** To address the weakness imposed by the passive nature of monitoring, software testing was introduced as one of the most promising V&V techniques. It consists in

---

<sup>3</sup>An error is a part of the system's state that may cause a failure.

<sup>4</sup>A failure happens when an error attains the service interface and the delivered service deviates from its intended behavior.

stimulating the system with a set of test inputs and comparing the obtained outputs with a set of expected ones. Providing runtime assurance of dynamically adaptable systems can be achieved by a new emerging kind of software testing, called *Runtime Testing* [10]. Its ultimate goal is to verify that the evolved system still behaves as expected.

The latter technique is adopted in this thesis as one of the most effective V&V techniques. In the following, basic concepts related to software testing and its variants are deeply discussed.

## 2.3 Software testing fundamentals

### 2.3.1 Definition, levels and objectives

One of the most important activities for proper software development is the testing activity. In fact, it is defined in [45] as the process of validating and ensuring the quality of a System Under Test, SUT. It is usually performed with the aim of assessing the compliance of a system to its intended specifications. To accomplish this task, test designers define a test suite composed of a finite set of test cases. A test case is a sequence of input data and expected outputs in the case of deterministic reactive systems. It is seen as a tree in the case of non-deterministic reactive systems. It exercises the SUT and checks whether an erroneous behavior occurs.

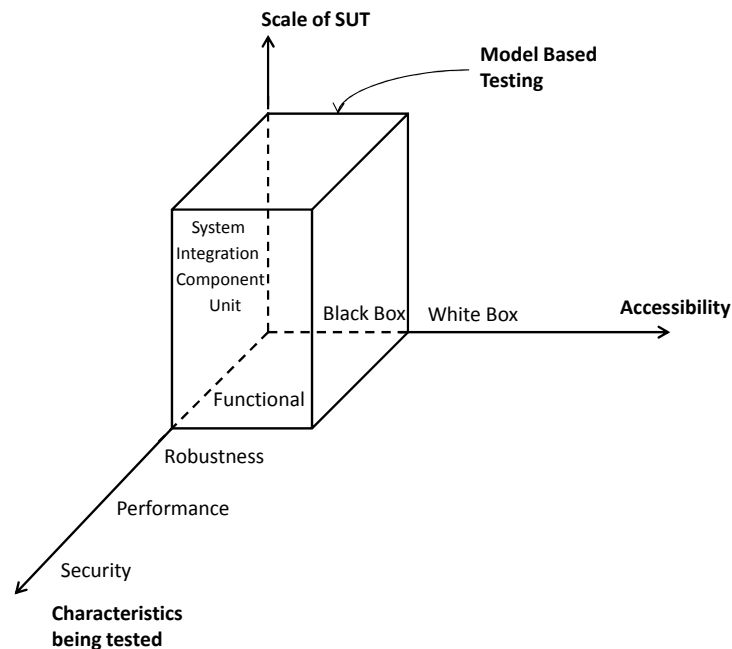

Figure 2.3: Different kinds of testing [1].

As outlined in Figure 2.3, software testing is usually performed at different levels along the development and maintenance processes :

- *Unit testing* in which individual units (functions, classes, components, services, etc.) are

tested in isolation,

- *Integration testing* in which subsystems formed by integrating individually tested components are tested as an entity and
- *System testing* in which the system formed from tested subsystems is tested as an entity.

It should be pointed out that *Component testing* and *Component integration testing* are adopted in our context. The first one is a sort of unit testing, and the second one is performed to expose defects in the interfaces and interaction between integrated components.

Testing can be conducted to fulfill a specific objective. It can be used to verify different properties either functional or non-functional. For instance, test cases can be designed to validate whether the observed behavior of the tested software conforms to its specifications or not. This is mostly referred to in the literature as *Conformance testing*. Non-functional requirements, such as reliability, performance and security requirements, can be also validated by means of testing. For instance,

- *Performance testing* is seen as a testing activity that specifically aims at verifying that the software meets the specified performance requirements (such as capacity and response time) [46],
- *Security testing* is a type of testing activity that intends to check the security properties of a software (such as confidentiality, integrity and authentication),
- *Reliability testing* is a testing activity that aims at determining the reliability of a software.

Our main objective in this work consists in using *Regression testing* for checking dynamically adaptable systems. This testing activity aims at ensuring that the modified system still behaves as intended. It is usually applied in static environments at design time. Conversely, we require to test the modified system at runtime.

### 2.3.2 Test techniques

It is hard to find a common way for classifying all available test techniques. The one used here is based on how tests are generated. We distinguish mainly three categories: specification-based, model-based and code-based techniques.

In specification-based testing, formal SUT specifications (e.g., based on the Z specification language [47]) or object-oriented specifications (e.g., based on Object-Z notation [48]), are used for automatic derivation of functional test cases without requiring the knowledge of the internal structure of the program.

In *Model-Based Testing* (MBT), test cases are derived from formal test models like *Unified Modeling Language* (UML) diagrams [49, 50] and *Finite State Machine* (FSM) models [1, 51]. MBT methods have recently gained increased attention because maintaining and adapting test cases can be facilitated and also automated [1]. Therefore, MBT can be suitably applied in the context of adaptable systems where test cases have to evolve automatically and efficiently to follow the system changes.

In *code-based testing*, several approaches are proposed to extract test cases from the source code of a program. The obtained test cases allow to find inconsistencies in the control flow or data flow that may lead to unwanted system behavior. For instance, approaches in combinatorial testing [52], mutation testing [53], and symbolic execution [54] are seen as code-based test generation techniques.

### 2.3.3 Test implementation techniques

In the literature, we identify several test specification and test implementation techniques, including the *Java Unit*<sup>5</sup> (JUnit) framework and the TTCN-3 standard [2].

As the name indicates, JUnit is designed for the Java programming language. This framework is considered more established than various xUnit tools such as CUnit for C programs, NUnit for .Net applications, etc. It is applied by Java developers in order to test individual methods, classes or even complex components. JUnit exploits a set of assertion methods useful for writing self-checking tests. Compared to its old version (version 3), JUnit 4 makes use of annotations which provide more flexibility and simplicity in specifying unit tests. For instance, some annotations give information about which methods are going to run before and after test methods. JUnit is fully integrated in many *Integrated Development Environments* (IDE) such as Eclipse<sup>6</sup>. It supplies a *Graphical User Interface* (GUI) which simplifies testing and gives valuable information about executed tests, occurred errors, and reported failures. For instance, a colored bar indicates the success of the test (i.e., with a green color) or its failure (i.e., with a red color) and a text field provides information about the reasons of failure.

As for TTCN-3, it is known in the research community as the only internationally standardized testing language by the *European Telecommunications Standards Institute* (ETSI). It is designed to satisfy many testing needs and to be applied to different types of testing, either combined hardware/software components or pure software components. Similar to a traditional programming language, TTCN-3 is built upon a well-defined syntax and a modular language that encapsulates a great number of concepts related to test cases, verdicts, concurrent test

---

<sup>5</sup><http://junit.org/>

<sup>6</sup><https://eclipse.org/>

behavior and test components.

The strength of TTCN-3 relies on its platform independence. By adopting TTCN-3 as a test language, testers focus only on the test specification while the complexity of the underlying platform, e.g., operating system, hardware configuration, is left behind the scenes. They can work more naturally at the abstract level by hiding technical and implementation details. This makes the use of TTCN-3 more appropriate in the case of heterogeneous systems and allows it to address a wide range of applications running in different platforms. In contrast to various testing and modeling languages, TTCN-3 does not comprise only a test language, but also a test system architecture for the test execution phase. In fact, this TTCN-3 test system comprises interacting entities that manage test execution, interpret or execute compiled TTCN-3 code and establish real communication with the SUT.

Due to all these features (i.e., a standardized, abstract, and platform-independent test language), we consider TTCN-3 as a convenient test notation and test execution support for validating dynamic and distributed systems. For more details about the TTCN-3 language and the TTCN-3 reference architecture, we refer readers to Appendix A.

### 2.3.4 Test architectures for distributed systems

A test architecture is composed of a set of test components also called *Testers*. As described in [55], the tester is an entity that interacts with the SUT to execute the available test cases and to observe its response related to this excitation. A test case can be defined as a set of input values, execution preconditions, execution post-conditions and expected results developed generally in order to verify the conformance of a system to its requirements.

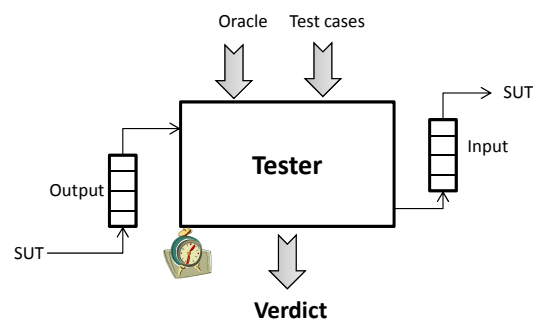

Figure 2.4: Tester view.

As depicted in Figure 2.4, the main role of a tester consists of (1) stimulating the SUT with input values, (2) comparing the obtained output data with the expected results (also called oracle) and (3) generating the final verdict. The latter can be *pass*, *fail* or *inconclusive*. A pass verdict is obtained when the observed results are valid with respect to the expected ones. A

fail verdict is obtained when at least one of the observed results is invalid with respect to the expected one. Finally, an inconclusive verdict is obtained when neither a pass or a fail verdict can be given.

Proposing test architectures for managing distributed systems is carried out in several research works. They offer either centralized [56, 57] or distributed [58, 59, 57] test architectures for static environments. The centralized architecture presented in [56] consists of a single tester that communicates with the different ports of the system under test. It considers that the SUT is distributed among several sites and contains a port in each of its sites. This architecture is enhanced in [59] by associating a local tester and a local clock to each port. Following the same principles, [57] proposes two testing architectures. The centralized one is made up of a synchronizer which embeds internal small testers and one global clock. The role of the synchronizer is to execute test suites on the SUT and to return a verdict about its conformance to its specification. The issue of conformance testing was considered in [58], as well. This work proposes a distributed test architecture consisting of a set of *Timed Input-Output Automata* each of which represents the specification of each SUT component and a distributed tester that contains a set of coordinating testers. Each tester is dedicated to test a single SUT component.

A standardized test architecture has been proposed by TTCN-3 [2]. The afforded test configuration is made up of a set of interconnected test components with well-defined communication ports and an explicit test system interface (see Figure 2.5).

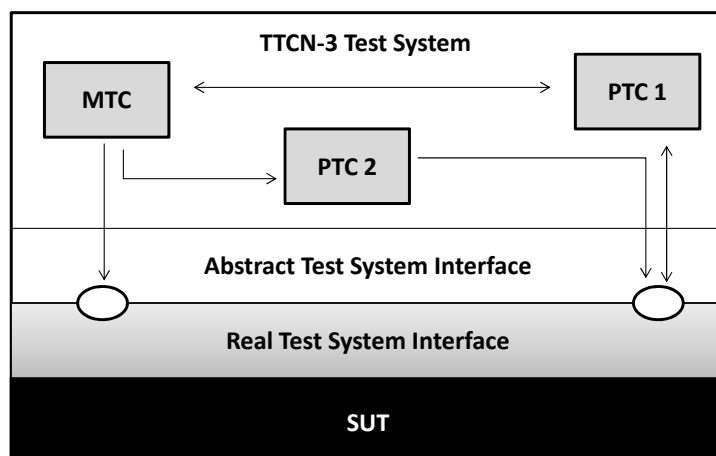

Figure 2.5: TTCN-3 test configuration [2].

Within each configuration, a *Main Test Component* (MTC) is created. This MTC component is dedicated to start the test process, create test components called *Parallel Test Component* (PTC) if needed and generate the final verdict. This test architecture can be distributed among different nodes in the network as proposed in [46].

## 2.4 Testing dynamically adaptable systems

Several modifications may be applied to a software system either at design time or at service time. In the literature, two well-known testing techniques are usually performed to check the correctness of an evolved software system. Regression tests are executed after the occurrence of each modification at design time whereas runtime tests are performed at service time. In the following, these testing techniques are detailed and their main characteristics are highlighted.

### 2.4.1 Regression testing

Regression testing, as quoted from [60], “attempts to validate modified software and ensure that no errors are introduced into previously tested code”. This technique guarantees that the modified program is still working according to its specification and it maintains its level of reliability. It is commonly applied during the development phase and not at runtime. When the program code is modified (i.e., behavioral changes), code-based regression testing techniques can be advocated, as in [61]. In the context of model based testing, such a modification is translated into the model level and a test generation method is usually applied to regenerate all tests from the new version of the model. Nevertheless, when we deal with large industrial case studies, this *Regenerate All* strategy can be costly. Another possibility is to reuse old tests issued from the original model, namely *Retest All* strategy [62]. The latter consists in re-executing all old tests and generating new tests that cover new added behaviors. However, such a strategy may reveal faults introduced by executing tests covering deleted behaviors. Therefore, *Selective Test Generation* approaches are proposed with the aim of using regression testing techniques in a cost effective manner [63, 64, 65, 66]. The objective is to avoid the complete regeneration of tests by selecting a subset of valid tests from the old test suite and generating new tests covering new behaviors.

According to Leung et al. [31], old tests can be classified into three kinds of tests (see Figure 2.6a):

- Reusable tests : valid tests that cover the unmodified parts of the SUT.
- Retestable tests : still valid tests that cover modified parts of the SUT.
- Obsolete tests : invalid tests that cover deleted parts of the SUT.

Leung et al. identify two types of regression testing. In the progressive regression testing, the SUT specification can be modified by reflecting some enhancements or some new requirements added in the SUT. In the corrective regression testing, only the SUT code is modified by altering

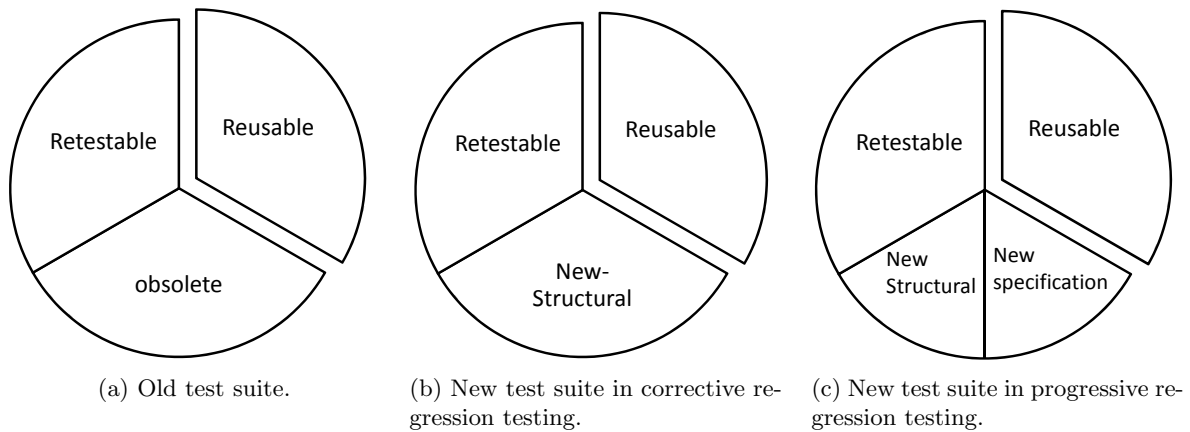

Figure 2.6: Test classification.

some instructions in the program whereas the specification does not change. Thus, new tests can be classified into two classes (see Figure 2.6b and Figure 2.6c):

- New specification tests : include new test cases generated from the modified parts of the specification.
- New structural tests : include structural-based test cases that test altered program instructions.

Although regression testing techniques are not dedicated for dynamically adaptable systems, research done in this area is useful to obtain in a cost effective manner a relevant test suite validating behavioral changes. Therefore, a detailed overview of regression testing approaches is presented in Section 3.2 of Chapter 3.

### 2.4.2 Runtime testing

The runtime testing activity is defined in [10] as any testing method (i.e., unit testing, regression testing, conformance testing, etc.) that is carried out on the final execution environment of a system when the system or a part of it is operational.

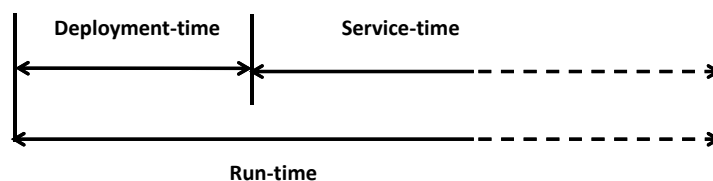

Figure 2.7: The runtime level in the software life cycle.

As outlined in Figure 2.7, it can be performed either at deployment-time or at service-time. The deployment-time testing serves to verify and validate the assembled system in its runtime



environment while it is deployed for the first time. For systems whose architectures remain constant after their initial installation, there is obviously no need to retest the system when it has been placed in-service. On the contrary, if the execution environment or the system behavior or its architecture has changed, service-time testing becomes a necessity to verify and validate the new system in the new situation.

### 2.4.3 Runtime testability

According to IEEE std. 610.12 [67], the testability is defined as the degree to which a system or a component facilitates the performance of tests to determine whether a requirement is met. Another definition can be rephrased as follows : the testability is an indicator of the effort needed to test a software.

When we deal with the runtime testability, the definition becomes : the runtime testability is an indicator of the effort needed to test the running software without affecting its functionalities or its environment. More concretely, the runtime testability is seen as an important measurement that characterizes a system under test. In this direction, some approaches, such as [68], have focused on proposing mathematical methods for its assessment. Furthermore, we notice that the runtime testability varies according to two main characteristics of the system under test : *Test Sensitivity* and *Test Isolation*.

#### 2.4.3.1 Test sensitivity

It is a component property that indicates whether the component under test can be tested without unwanted side-effects. In particular, a component is called test sensitive when it includes some behaviors or operations that cannot be safely tested at runtime. In this case, the component is called untestable whereas a testable component is characterized by the ability to test its execution environment and to be tested by it.

#### 2.4.3.2 Test isolation

This solution is applied by test engineers in order to counter the test sensitivity problem and to prevent test processes from interfering with business processes. Many test isolation techniques are available to fulfill such aim. The well-known test isolation strategies in the literature are briefly introduced.

**Built-In Test approach.** The *Built-In Test* (BIT) paradigm consists in building testable components. To do so, components are equipped with a test interface (see Figure 2.8). The latter provides operations ensuring that the test data and business data are not mixed during

the test process [69, 70].

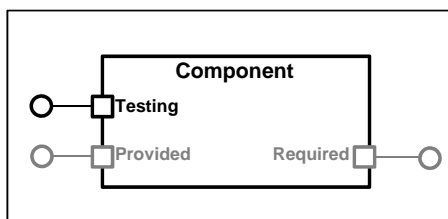

Figure 2.8: A component with a test interface.

However, test cases may occupy a lot of space in the component especially with the growth of built-in test code. This might lead to the rise of component size and complexity which could make the component sometimes hard to manage. Also, some of these tests may not be required in the context where the component is deployed on.

**Aspect-based approach.** This technique uses *Aspect Oriented Programming* (AOP) to build testable components. Conversely to the BIT approach that embeds test cases into components, the aspect-based approach integrates such test scripts into a separate module, i.e., aspect. As a result, the modularization of testability concerns<sup>7</sup> that cut across the implementation of a component is achieved. Thus, the maintainability of the component and its capacity to check itself is improved. In addition, this approach may provide facilities for fault location and for tracing the component behavior [71].

**Tagging components.** This technique consists in marking the test data with a special flag in order to discriminate it from business data [19]. The component is then called *test aware*. Figure 2.9 shows the use of flags during testing after the occurrence of a reconfiguration action. The latter deals with updating an existing component C by another version C'. We remark here that components A, B and D are test aware. Thus, they can easily discriminate between test inputs and business inputs. The principal advantage of this method is that one component can receive production as well as testing data simultaneously.

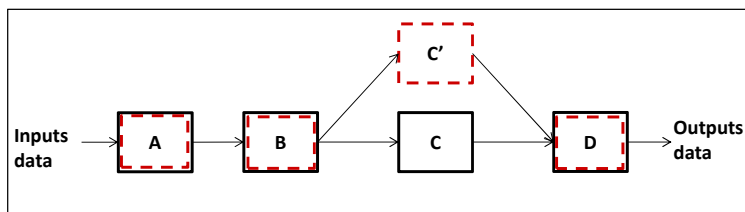

Figure 2.9: Illustration of the tagging strategy.

<sup>7</sup>AOP is one of the most appropriate solutions that provide the separation of crosscutting concerns (i.e., including logging, monitoring, testing, persistence, etc.) from the functional code of a software system.

**Cloning components.** This mechanism consists in cloning the component under test before the start of the test activity. Thus, test processes are performed by the clone while business processes are performed by the original component. To clone components efficiently, we must also duplicate their dependencies, known as *Deep clone strategy* [72] (see Figure 2.10).

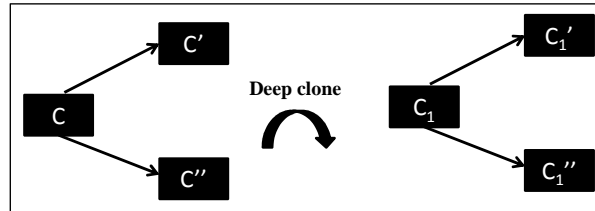

Figure 2.10: Example of the deep clone strategy.

This option can be very expensive and resource consuming when the number of needed clones becomes very large. If the physical resources are not limited, cloning components can be a feasible test isolation solution. Also, this technique can be applied partially for testing only sensitive components and not for all the system under test.

**Blocking components.** In case of untestable components, a blocking strategy can be adopted as a test isolation technique. In fact, it consists in interrupting the activity of component sources for a lapse of time representing the duration of the test. Thus, all business requests are interrupted and delayed until the end of the test. Once the test has been achieved, the component under test resumes its original state. Also, all the source components are unlocked and the delayed requests are treated.

**Synthesis.** To sum up, we note that the listed test isolation techniques suffer from some weaknesses as illustrated in Table 2.1. First of all, the cloning strategy is very costly in terms of resources especially when the number of needed clones increases. Besides, BIT, tagging and aspect-based techniques have an additional development burden. Regarding the blocking option, it may affect the performance of the whole system, especially its responsiveness in case of real-time systems.

Table 2.1: Limitations of the test isolation strategies.

| Mechanisms | Intense resource consumption | SUT delay | Development burden |
|------------|------------------------------|-----------|--------------------|
| BIT        |                              |           | ×                  |
| Aspect     |                              |           | ×                  |
| Tagging    |                              |           | ×                  |
| Blocking   |                              | ×         |                    |
| Cloning    | ×                            |           |                    |

## 2.5 Summary

This chapter addressed the fundamentals related to runtime validation of dynamically adaptable systems. It was mainly dedicated to give an overview of the most common concepts frequently used in the field of software testing, especially while testing evolvable systems. In this context, two well-known techniques, namely regression testing and runtime testing were introduced. The next chapter surveys the state of art of these two techniques.

### 3.1 Introduction

Verification and Validation (V&V) activities aim at getting confidence in software products throughout their lifecycle. This is achieved by satisfying user needs and by meeting their expected functionalities. For systems running on stable execution environments and well-known execution conditions, several V&V methods and tools are applied at design time. However, in case of dynamically adaptable systems, runtime V&V techniques are highly required for guaranteeing the achievement of adaptation goals and fitting the expected quality attributes.

As introduced in Chapter 2, a wide spectrum of V&V techniques already exist in the literature [41]. Among these techniques, we focus our interest essentially on *Software testing*. In this context, two research lines are studied. In the first one, we deal with selective regression testing as a V&V technique usually applied at design time to ensure the validity of the modified software systems. In this respect, Section 3.2 outlines research work done mainly on test selection and test generation issues. In the second research area, we focus on runtime testing as an active runtime V&V technique. The surveyed approaches in Section 3.3 are studied from different perspectives such as resource consumption, interference risks, test distribution, test execution and dynamic test evolution and generation. Finally, Section 3.4 summarizes the chapter and draws the objectives of this thesis. Parts of this chapter have been published in [33].

## 3.2 Related work on regression testing

In the literature, many researchers have investigated regression testing techniques to reestablish confidence in modified software systems. Their research spans a wide variety of topics, namely test selection, test prioritization, efficient test generation, etc. The existing approaches are classified into : code-based regression testing [63, 61, 73], model-based regression testing [74, 64, 75, 76, 65, 66] and software architecture-based regression testing [77, 78].

### 3.2.1 Code-based regression testing approaches

Regenerating all tests, when a program change occurs, may consume inordinate time and resources. Therefore, many researchers handle this issue by proposing selective regression testing techniques. Commonly, these techniques update the old test suite by maintaining valid tests and by generating new tests covering only new added behaviors. In this respect, Rothermel et al. [61] construct control flow graphs from a program and its modified version and then use the elaborated graphs to select all non obsolete tests from the old test suite. The obtained set of tests is still valid and covers the changed code.

Similarly, Granja et al. [63] deal with identifying program modifications and selecting attributes required for regression testing. Based on data flow analysis, these authors use the obtained elements to select retestable tests. In accordance with the metrics defined in Rothermel et al. [79], they show that their approach has a good precision (i.e., ignores non relevant tests), and a high generality (i.e., can be applied even in the case of complex modifications) but entails further work to reach inclusiveness (i.e., the degree of selecting modification revealing tests) and efficiency (i.e., the extent to be more economical in terms of space and time requirements). Test generation features to produce new tests covering new behaviors are not discussed in this work.

Regarding the work of [73], it applies a regression test selection and prioritization approach based on code coverage to a popular Web browser engine. This method analyzes the source code with the purpose of identifying the modified procedures without using any program representations. The obtained results show the efficiency of the proposed implementation to reveal defects, to reduce the test set and the test time. Nevertheless, this approach is specific to C++ programming language and it is based on C++ specific tools to identify changes made to the source code. Moreover, it is tightly related to the system under test and cannot be easily applied to others systems.

### 3.2.2 Model-based regression testing approaches

Brian et al. [65] introduce a UML-based regression test selection strategy. They support changes in actions of sequence diagrams and in variables, operations, relationships and classes. Following these modifications, the proposed approach automatically classifies tests issued from the initial behavioral models as obsolete, reusable and retestable tests. Identifying parts of the system that require additional tests to generate has not been tackled by this approach.

Similarly, the work of [66] deals with minimizing the impact of test case evolution by avoiding the regeneration of full test suites from UML diagrams. In this context, the proposed technique selects reusable tests, discards obsolete ones and generates only new ones. A point in favor of this work is the enhancement of the test classification already proposed by Leung et al. [31]. In fact, the authors define a more precise test status based on the model dependence analysis. Notably, retestable tests are animated on the model and can be classified into re-executed (i.e., can be animated on the evolved model and produces the same output), updated (i.e., can be animated on the evolved model but produces a different output), or failed tests (i.e., cannot be animated on the evolved model).

Pilskalns et al. [75] present a new technique that reduces the complexity of identifying the modification impact from various UML diagrams. This proposal is based on an integrated model called *Object Method Directed Acyclic Graph* built from class and sequence diagrams as well as *Object Constraint Language* (OCL) expressions. The authors consider several design changes (e.g., the addition of a message in a sequence diagram) which are classified according to whether they create, modify, or delete elements in the diagram. Also, they assume that when a path in the graph changes, it may affect one or more test cases. Thus, they define rules to categorize test cases as obsolete, retestable, and reusable.

Chen et al. [76] propose a safe regression technique relying on *Extended Finite State Machine* (EFSM) as a behavioral model and a dependence analysis approach. The latter is used to look for the effects of three types of Elementary Modifications (EM) of the machine : addition, deletion and modification of a transition. For this given set of EMs, a regression test suite reduction method is defined with the aim of capturing essentially the effects of the model on the EMs, the effects of the EMs on the model, and the side-effects caused by the EMs on the unmodified parts of the model.

Similar to [76], Korel et al. [80] support only elementary modifications, namely the addition and the deletion of a transition. In this context, they present two kinds of model-based test prioritization methods : selective test prioritization and model dependence-based test prioritization. In the first case, the authors classify tests into high and low priority sets. A high priority

is assigned to tests that execute modified transitions in the modified model. A low priority is attributed to tests that do not exercise any modified transition. In the second case, data and control dependences are applied to identify interactions between added/deleted transitions and the remaining parts of the model. The obtained information is then used to prioritize high priority tests.

### 3.2.3 Software architecture-based regression testing

Initially, Harrold et al. [77] introduced the use of the formal architecture specification instead of the source code in order to reduce the cost of regression testing and analysis.

This idea has been explored later by Muccini et al. [78]. The authors propose an effective and well-implemented approach called *Software Architecture-based Regression Testing*. They apply regression testing at both code and architecture levels whenever the system implementation or its architecture evolve. For the first case, they check the conformance of a modified implementation to a given software architecture. For the second case, they verify the implementation conformance to the new software architecture. *Labeled Transition Systems* (LTS) are used to model software architecture specifications. The authors propose a SAdiff algorithm that compares the two behavioral models corresponding to the initial architecture and the evolved one. The main goal of this algorithm is to identify similarities and differences at the model level. This technique was used later to identify tests to rerun covering the affected paths.

### 3.2.4 Discussion

Two major questions are identified when several regression testing approaches are studied (see Table 3.1). The first one is how to select a relevant and a minimal subset of tests from the original test suite. The second one is how to generate new tests covering only new behaviors. Responding to these challenging questions requires both test selection and generation capabilities. In this respect, we notice that some approaches focus only on the test selection activity at the code level [61, 63] or at the model level [65] whereas the work of [76] deals only with model-based test generation issue. Addressing both activities as in [64, 66, 75, 78] is highly demanded in order to reduce their cost especially in terms of number of tests and time required for their execution.

Up to our knowledge, no previous work has dealt with the use of regression testing approaches at runtime. Therefore, we aim to handle test selection and test generation activities at a higher abstract level without code source access while the SUT is operational. Consequently, adjusting regression testing to be applied at runtime requires more effort to obtain a runtime behavioral model of the target system and to select and derive the adequate test cases to run in the final



Table 3.1: Survey of regression testing approaches.

| Approaches            | Supported techniques | Behavioral models  | Supported changes   | Testing activities              |
|-----------------------|----------------------|--|---|---------------------------------|
| Rothermel et al. [61] | Code-based           | Control Flow Graph (CFG)                                     | All types of program changes  | Test selection                  |
| Korel et al. [74, 64] | Model-based          | Extended Finite State Machines (EFSEM)                       | Addition and deletion of a transition                                 | Test generation, test selection |
| Granja et al. [63]    | Code-based           | Control Flow Graph (CFG)                                     | Data and control flow changes   | Test selection                  |
| Muccini et al. [78]   | SA-based, Code-based | Labeled Transition systems (LTS)                             | Topological and behavioral changes                                    | Test selection, test execution  |
| Pilskalns et al. [75] | Model-based          | UML (Class and sequence diagrams, OCL expressions)           | Addition, deletion and modification of supported diagram elements     | Test generation, test selection |
| Chen et al. [76]      | Model-based          | Extended Finite State Machines (EFSEM)                       | Elementary changes (addition, deletion, modification of a transition) | Test generation                 |
| Briand et al. [65]    | Model-based          | UML (Class, sequence and use case diagrams, OCL expressions) | Addition, deletion and modification of supported diagram elements     | Test selection                  |
| Fournier et al. [66]  | Model-based          | UML (Statechart diagrams and OCL constraints)                | Changes on data and control dependences                               | Test selection, test generation |
| Beszedes et al. [73]  | Code-based           | —  | Modified procedures   | Test selection                  |

execution environment.

### 3.3 Related work on runtime testing

Recently, there has been a spate of interest in how to use runtime testing to verify and validate dynamically adaptable systems. This technique has been adopted in several software domains in order to ensure that the target system complies with its functional or non-functional requirements in spite of predictable and unpredictable evolved user requirements and context variations. Moreover, we identify several approaches supporting only the runtime testing of structural adaptations [12, 15, 11, 13, 14, 17]. The work presented in [20] deals only with behavioral adaptations. The approaches in [16, 18, 21] take into account both structural and behavioral adaptations while performing runtime tests.

As discussed in Chapter 2, a trade-off must be made between the confidence gained from runtime testing and the computational resources used in this kind of testing. To that aim, there are several arduous challenges that have to be handled while executing runtime tests [41, 81]. Therefore, existent runtime testing approaches are discussed from various perspectives (see Table 3.2). We look for their capabilities to :

- avoid interference risks between test processes and business processes by supporting test

isolation strategies;

- alleviate the test workload by considering the test distribution over the network;
- provide relevant test suites by handling test selection and evolution at runtime;
- supply loosely coupled test systems by providing platform-independent ones;
- reduce the impact on the final execution environment by supporting test resource awareness.

### 3.3.1 Supporting test isolation strategies

As stated before, runtime tests are executed while the system under test is operational. In this case, some component instances are shared between the test configuration and the working configuration. Consequently, interference risks between test processes and business processes may happen. This can impact the intended behaviors of the running SUT and lead to other effects outside the SUT (i.e., its clients, other subsystems), as well. More concretely, we assume that a component is stimulated by some test input data during its operation. Such test data may influence its behavior and affect its internal state. For example, it is unsafe to store in a medical database, monitored sensor values generated by the test execution process. In the worst case, the obtained side effects are out of control, e.g., delivering an ordered book by an online book seller or flattening an airbag due to the test execution.

In the literature, we have noticed that several research approaches, such as [10, 18, 21, 15, 14, 17, 19, 20], have a strong tendency to investigate test isolation concept in order to reduce this interference risk. The majority accommodates the Built-In Test paradigm for this purpose [10, 15, 19]. Accordingly, test isolation facilities have been already introduced and integrated into components by software developers. Similarly to this strategy, the approaches introduced in [18] and [14] deal with putting all the involved components into a testing mode before the execution of runtime tests. However, these strategies cannot be always adopted, especially due to the trend towards service-oriented applications and the widespread use of *Components Off The Shelf*. In that case, the source code of some components and their testability options are seldom available.

We have identified some approaches that deal with runtime testing of untestable components. They afford other test isolation strategies such as *Safe Validation with Adaptation* [20], which is equivalent to the blocking strategy already introduced in Chapter 2. Similar to cloning components, the *Replication with Validation* strategy has been proposed by [21] as a means of

test isolation. Furthermore, instantiating services at runtime and using new service instances for runtime testing purposes is proposed by [17].

Up to our best knowledge, only the *Mobile Resource-Aware Built-In-Test* (MORABIT) framework introduced in [12] has addressed the runtime testing of heterogeneous software systems composed of testable and untestable components. This framework supports two test isolation strategies : cloning if components under test are untestable and the BIT paradigm otherwise.

### 3.3.2 Handling test distribution

The test distribution over the network has been rarely addressed by runtime testing approaches. Most of the studied works assume that tests are integrated into components under test. Thus, managing test case assignment to test components and also managing their deployment in execution nodes has not been required for them. We have identified only two approaches that shed light on this issue.

In the first study [82, 16], the authors introduce a light-weight framework for adaptive testing called *Multi Agent-based Service Testing* in which runtime tests are executed in a coordinated and distributed environment. This framework encompasses the main test activities including test generation, test planing and test execution. Notably, the last step defines a coordination architecture that facilitates mainly test agent deployment and distribution over the execution nodes and test case assignment to the adequate agents. Unfortunately, this framework suffers from a dearth of test isolation concerns.

In the second study [11], a distributed in vivo testing approach is introduced. This proposal defines the notion of *Perpetual Testing* which suggests the proceeding of software analysis and testing throughout the entire lifetime of an application : from the design phase until the in-service phase. In this context, it conducts unit tests while the application is running in the deployment environment. The main contribution of this work consists in distributing the test load in order to attenuate the workload and improve the SUT performance by decreasing the number of tests to run.

Thus, the proposed framework called *Invite* is characterized by its client-server architecture. Each application under test encompasses an Invite client. Regarding the Invite server, it runs on a separate machine and it is in charge of assigning test suites to the Invite clients, coordinating their execution and managing test results, as well. Under the assumptions that only minor modifications may happen, the same unit tests applied during the development phase are performed by the Invite framework at the deployment phase and throughout the entire lifetime of the ap-

plication. Hence, this framework does not handle the occurrence of behavioral adaptations and supports only the cloning strategy for test isolation.

### 3.3.3 Handling test selection and evolution

Under the assumption that some test cases generated during the development phases can be re-executed when structural adaptations occur, the test selection issue has to be addressed seriously with the aim of reducing the amount of tests to rerun. One of the potential solutions that tackle this issue is introduced in [19]. The proposed approach uses dependency analysis to find the affected components by the change. Regarding the set of affected components, it determines a subset of test cases to rerun in order to ensure that the affected parts of the system still function as intended after the occurrence of structural changes.

Executing the same test cases when behavior adaptations occur seems to be meaningless. These test cases should be updated or even removed and sometimes new ones have to be generated. For instance, if a dynamic adaptation introduces a new behavior, new test cases should be generated to cover it. Similarly, if some behaviors are omitted, some test cases may no longer be applicable, or adequate for testing. Therefore, a dynamic evolution of tests is required in order to cover all the new requirements with the purpose of validating new behavioral changes.

In the literature, we distinguish the *ATLAS* framework [15], which affords a test case evolution through an *Acceptance Testing Interface*. Thus, dynamic addition and removal of test cases that the component under test may use to check the context it is deployed on are guaranteed. This strategy ensures that tests are not built in components permanently and can evolve when the system under test evolves, too. The major limitation of this approach is the lack of automated test generation since tests are not generated automatically from components' models and specification. Conversely, the authors of [82] and [18] address this last issue. Both methods regenerate all test cases from new service specifications (*Web Services Description Language* (WSDL) for individual services, *Business Process Execution Language* (BPEL) for composite services) when dynamic behavioral adaptations occur. However, regenerating all tests can be costly and is considered as an inefficient solution, especially in the case of large scale models.

To overcome these limitations, recent approaches dealing with test case adaptation at runtime [83, 22] are identified. For instance, Akour et al. [83] propose a model-driven approach for updating regression tests after dynamic adaptations. Called *Test Information Propagation*, this proposal consists in synchronizing component models and test models at runtime. It basically deals with reductive changes (i.e., removing existing component interfaces or implementations). Thus, the unit tests associated with the component targeted for removal can be deleted from

the test suite. Moreover, the integration tests that validate its behaviors with its callees can be removed, as well. Since the removal of a component may affect its caller components, updating unit and integration tests used to validate these caller components is also highly demanded. Nevertheless, additive changes (i.e., adding new component interfaces or implementations) have not yet been included and dynamic test case generation in this case has not been studied.

In the same context, Fredericks et al. [22] propose an approach called *Veritas* that adapts test cases at runtime with the aim of ensuring that the evolved SUT continues its execution safely and correctly when environmental conditions are adapted. Based on the MAPE-T<sup>1</sup> feedback loop [81], *Veritas* monitors the execution environment. Then, it identifies relevant test cases for the current conditions. Next, it executes the test plan and analyzes the results to check the validity of the executed test cases. In the case of invalid tests, test adaptations are required at runtime. Nevertheless, this work can only adapt test case parameters at runtime and it is not intended to dynamically add or remove test cases.

#### 3.3.4 Affording platform independent test systems

The major test systems, that have been surveyed, have been implemented in a tightly coupled manner to various platforms. In general, this variety relates to the programming language of components or to the underlying component model such as Fractal [15] and OSGi [17]. We have distinguished other approaches that have proposed their own research component models like the one called *Dynamic Adaptive System Infrastructure* (DAiSI) component model in [14] and the MORABIT component model in [85]. Another approach presented in [11] affords a Java-based framework that has been implemented without imposing any restrictions on the design of the software application. Furthermore, the majority uses the JUnit framework to specify test cases and also to execute them. Regardless of all the features provided by these test systems, we have noticed that they are strongly related to the system under test. Their applicability to other component models might be a complex and tedious task even though some of them affirm this possibility as [15] does for example.

To handle this complexity, Deussen et al. [86] stress the importance of using the TTCN-3 standard to build an online validation platform for internet services. Active tests, which are specified in an abstract and platform-independent notation, are performed to analyze the system behavior in its current context. However, this work neglects the test isolation issue which is a fundamental step in order to avoid interference between test and business processes.

It is worthy to note that various test systems are built based on the TTCN-3 standard. We

---

<sup>1</sup>Similar to the MAPE-K feedback loop [84] that manages the design and the execution of autonomic systems, MAPE-T provides a support for monitoring, analyzing, planning and executing runtime test adaptations.

distinguish research for testing protocol-based applications [87, 88], Web applications [46, 89, 90], Web services [91, 92] and also real-time and embedded systems [93, 94]. All these approaches benefit from the strengths of the TTCN-3 standard as a platform independent language for specifying tests even for heterogeneous systems. Nevertheless, they address testing issues at design time and not at runtime.

### 3.3.5 Supporting test resource awareness

As discussed before, runtime testing is a resource-consuming activity, which is often performed concurrently with the system under test in its final execution environment. In fact, computational resources are used for generating tests if needed, instantiating test components charged with test execution and finally starting them and evaluating the obtained results. Notably, the bigger the number of test cases is, the more resources such as CPU load, memory consumption are used. Hence, we note that the intensive use of these computational resources during the test execution has an impact not only on the SUT but also on the test system itself. When such a situation is encountered, the test results can be wrong and can lead to an erroneous evaluation of the SUT responses.

To the best of our knowledge, this problem has been studied only by Merdes'work [12]. Aiming at adapting the testing behavior to the given resource situation, it provides a resource-aware infrastructure that keeps track of the current resource states. To do this, a set of resource monitors are implemented to observe the respective values for processor load, main memory, battery charge, network bandwidth, etc. According to resource availability, the proposed framework is able to balance in an intelligent manner between testing and the core functionalities of the components. It provides in a novel way a number of test strategies for resource aware test management. Among these strategies, we can mention, for example, *Threshold Strategy* under which tests are performed only if the amount of used resources does not exceed thresholds.

### 3.3.6 Discussion

Despite the emergence of runtime testing as a validation technique in many software domains, this testing activity has to be handled under carefully-controlled conditions. Otherwise, risks of affecting SUT dependability might happen. Therefore, we have classified the surveyed runtime testing approaches based on the most relevant features needed to be supported, as outlined in Table 3.2. First of all, both structural and behavioral adaptations have been studied only by [16, 18, 21]. Furthermore, we have noticed a quasi-absence of approaches offering platform independent test systems based on the TTCN-3 standard. Except Deussen et al. [86], most of

previous studies use a specific test framework like JUnit to define test cases and execute them. In addition, they support homogenous systems-under test made up of only testable or only untestable components. Thus, they afford at most one test isolation strategy for reducing interference risks. We have identified only one work [12] that deals with combining two test isolation strategies for the testing of testable and untestable components : BIT and cloning. Moreover, only the latter approach has tackled the issue of resource limitations and time restriction during runtime testing.

Regarding test evolution and generation at runtime, the existing approaches did not deal efficiently with this challenging issue. Indeed, we identified works [82, 18] that regenerate all test cases from the new specifications when dynamic behavioral adaptations occur. The work of [22] tries to reduce this cost by adapting exiting test cases to the evolved environmental conditions but without generating new tests covering new behaviors or removing obsolete ones. To partially overcome this limitation, [83] supports only reductive changes (e.g., removing existing components) and then adapts the test suite by removing obsolete tests and by updating the set of retestable tests. Thus, we conclude that dynamic test case generation when additive changes (e.g., adding new components) take place is still an open issue.

In summary, this study on runtime testing approaches reveals a dearth in the provision of a platform-independent support for test generation and execution which considers resource limitations and time restriction. To surmount this major lack, our ultimate goal is to conceive a safe and efficient framework that minimizes the cost of checking a running system after each dynamic adaptation either structural or behavioral. From the test execution perspective, setting up a TTCN-3 test system for the distribution, isolation and execution of a minimal set of test cases identified after the occurrence of structural adaptations is strongly required.

Table 3.2: Survey of runtime testing approaches.

| Approaches             | Software Domain                   | Adaptation Kinds          | Test Levels                    | Test Distribution | Test Isolation                  | Test Evolution | Platform-Independent Test System                    | Test Resource Awareness |
|------------------------|-----------------------------------|---------------------------|--------------------------------|-------------------|---------------------------------|----------------|---|-------------------------|
| Deussen et al. [86]    | Internet services                 | Not supported             | Unit and integration testing   | No                | Not supported                   | No             | TTCN-3 Test System                                  | No                      |
| Merdes et al. [12]     | Ubiquitous Systems                | Structural                | Unit testing                   | No                | BIT and Cloning                 | Not stated     | MORABIT-based Test System (JUnit tests)             | Yes                     |
| Bai et al. [16]        | Service-based systems             | Structural and Behavioral | Unit and integration testing   | Yes               | Not stated                      | Yes            | Agent-based Test System                             | No                      |
| Gonzalez et al. [15]   | Systems of systems                | Structural                | Integration testing            | No                | BIT                             | No             | Fractal-based Test System (JUnit tests)             | No                      |
| Ramirez et al. [21]    | Autonomous systems                | Structural and Behavioral | Integration and system testing | No                | Replication with validation     | No             | Autonomic Component-based Test System (JUnit tests) | No                      |
| Hielscher et al. [18]  | Service-based systems             | Structural and Behavioral | Unit and integration testing   | No                | Test mode                       | Yes            | Not stated  | No                      |
| Murphy et al. [11]     | Java-based systems                | Structural                | Unit testing                   | Yes               | Cloning                         | No             | Java-based Test System (JUnit tests)                | No                      |
| Niebuhr et al. [14]    | Component-based systems           | Structural                | Integration testing            | No                | Test mode                       | No             | DAiSI-based Test System                             | No                      |
| Piel et al. [95] [19]  | Component and Event-based systems | Structural                | Integration testing            | No                | Tagging or BIT                  | Not stated     | Platform dependent (JUnit tests)                    | No                      |
| Greiler et al. [17]    | Service-based systems             | Structural                | Integration testing            | No                | Service Instantiating           | No             | OSGi-based Test System (JUnit tests)                | No                      |
| King et al. [20]       | Autonomous systems                | Behavioral                | Integration and system testing | No                | Safe adaptation with validation | No             | Autonomic Component-based Test System (JUnit tests) | No                      |
| Fredericks et al. [22] | Autonomous systems                | Structural and Behavioral | System testing                 | No                | Not stated                      | Yes            | Not stated  | No                      |



---

From the test generation perspective, proposing a selective test case generation method that derives test cases efficiently from the affected parts of the SUT behavioral model and selects relevant tests from the old test suite should be investigated.

## 3.4 Summary

In this chapter, we discussed the state of art of testing modified systems. Research done in the area of regression testing as well as runtime testing were analyzed. Based on this study, we identified several requirements that should be achieved by this thesis.

The next chapter describes in depth our runtime testing approach and how it is able to face the weakness identified in the literature, notably when structural adaptations take place.

## Part II

---

### Design of Runtime Testing Approach

---

---

## Runtime Testing of Structural Adaptations

---

### 4.1 Introduction

Testing at design-time or even at deployment-time usually demonstrates that the System Under Test, SUT, satisfies its functional and non-functional requirements. However, its applicability becomes limited and irrelevant when this system is adapted at runtime according to evolving requirements and environmental conditions that were not explicitly specified at design-time. For this reason, runtime testing is strongly required to extend assurance from design-time to runtime.

As stated in Chapter 3, this runtime V&V method is considered resource consuming and should be applied carefully in the final execution environment of a running system. Therefore, a trade-off must be made between the confidence gained from applying runtime testing and the computational resources used for it. To that aim, we introduce in the present chapter our solution that executes runtime tests while reducing their side-effects and their cost.

In Section 4.2, a brief overview of the overall runtime testing process is given. First of all, the timing cost is reduced by executing only a minimal subset of test cases that validates the affected parts of the system by dynamic changes. In this respect, Sections 4.3 and 4.4 introduce the use of the dependency analysis technique to identify the affected parts of the dynamically adaptable system and their corresponding test cases. Secondly, Section 4.5 introduces the method we use to effectively distribute the obtained tests over the network with the aim of alleviating runtime testing load and not disturbing SUT performance. Thirdly, Section 4.6 presents the standard-based test execution platform that we have designed for test isolation and execution purposes. It

relies on the TTCN-3 standard not only on its test specification language but also on its reference test architecture [27, 28]. The latter is extended to supply a test isolation layer that reduces the interference risk between test processes and business processes. Ultimately, this chapter is concluded in Section 4.7. Parts of this chapter have been published in [26, 29, 24, 32, 96, 33].

## 4.2 The Approach in a nutshell

The process depicted in Figure 4.1 spans the different steps to fulfill with the aim of executing runtime tests when structural reconfiguration actions are triggered, as follows :

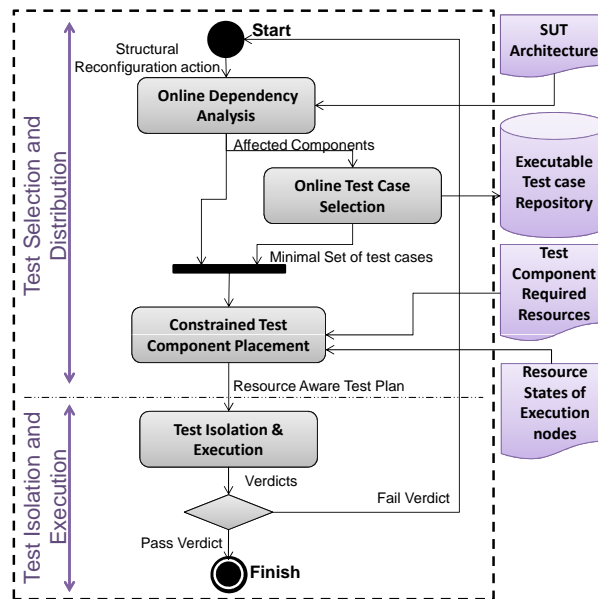

Figure 4.1: Runtime testing process for the validation of structural adaptations.

**Online Dependency Analysis.** In this step, we focus on identifying the affected components and compositions by a structural reconfiguration action. To do so, looking for runtime dependencies between components is required. This information may reduce the test activity burden through checking only the parts affected by a dynamic change and not the whole system. In that case, the number of test components to deploy and test cases to rerun is decreased, which permits a lower test execution time and accordingly the reduction of resource consumption.

**Online Test Case Selection.** Once the affected parts of the system are identified, we look for their corresponding test cases that are stored in the *Executable Test Case Repository*. We assume in this stage that these test cases have been already written manually or generated automatically in an abstract format (TTCN-3 language) and compiled to obtain the executable ones.

**Constrained Test Component Placement.** For each selected test case, we have at least one test component to deploy, known in the TTCN-3 standard as the main test component,

MTC. With the purpose of reducing the test burden on the shared execution environment between the SUT and the TS, these test components have to be assigned to the appropriate execution node while fitting resource and connectivity constraints. In this step, the placement solution is generated and saved as a *Resource Aware Test Plan* (RATP). This plan contains mainly test cases to execute and the deployment host of each test component to deploy according to each affected component to validate.

**Test Isolation and Execution.** The final step in the former process is the test isolation and execution phase. Before executing the selected tests at runtime, a test isolation layer has to be set up with the aim of avoiding test interference with the normal behavior of the SUT. Then, test components are dynamically created and assigned to their appropriate execution nodes. Afterwards, test cases are started concurrently, test case verdicts are computed and finally the global verdict is deduced. If a pass verdict is produced then the end of the runtime testing process is reached. Otherwise, another dynamic reconfiguration action has to be enacted in order to handle such a failure.

The proposed methods and tools used in the test selection and distribution phase as well as in the test isolation and execution phase are detailed in the following sections.

### 4.3 Online dependency analysis

To reduce the time cost and the resource burden of the runtime testing process, the key idea is to avoid the re-execution of all tests at runtime when structural adaptations occur. Thus, we use the dependency analysis approach with the aim of determining the parts of the system impacted by dynamic evolutions and then computing a minimal set of tests to rerun. In fact, the dependency analysis technique is widely used in various software engineering activities including testing [97], maintenance and evolution [98, 99]. A definition of this concept is given in the following. Then, we present the model used to capture direct and indirect dependencies. The application of this technique on test case selection is also discussed.

#### 4.3.1 Definition

Dependencies between components is defined in [98] as “the reliance of a component on other(s) to support a specific functionality”. It is also considered as a binary relation between two components :  $A$  and  $B$  as illustrated in Figure 4.2.

- Antecedent : a component  $A$  is an antecedent to another component  $B$  if its data or functionalities are utilized by  $B$ .



Figure 4.2: Dependency relationship.

- **Dependent** : a component  $B$  is a dependent on another component  $A$  if it utilizes data or functionalities of  $A$ .

Formally, the relation  $\rightarrow$  called “*Depends on*” is defined in [100] where  $B \rightarrow A$  means that the component  $B$  depends on the component  $A$ . The set of all dependencies in a component-based system is defined as :

$\mathcal{D} = \{(C_i, C_j) : C_i, C_j \in \mathcal{S} \wedge C_i \rightarrow C_j\}$  where  $\mathcal{S}$  is the set of components in the system. Accordingly, the current system configuration is a set of components and its dependencies  $Con = (\mathcal{S}, \mathcal{D})$ .

Dependencies in component-based systems are caused by interacting, cooperating and communicating components. Several forms of dependencies are identified in the literature [97]. For instance, we mention data dependency (i.e., data defined in one component are used in another component), control dependency (i.e., caused by sending a message from one component to another component), etc. The main dependency form that we support in this thesis is the interface dependency, which means that a component requires (respectively provides) a service from (respectively to) another component. With the purpose of managing and analyzing such dependencies in a good way, the traditional graph theory is used.

### 4.3.2 Dependency representation

To represent and analyze component dependencies, two formalisms are generally described : a *Component Dependency Graph* (CDG) and a *Component Dependency Matrix* (CDM). These two concepts are formally defined as follows.

**Definition 1 : Component Dependency Graph.** A CDG is a directed graph denoted by  $\mathcal{G} = (\mathcal{S}, \mathcal{D})$  where:

- $\mathcal{S}$  is a finite nonempty set of vertices representing system’s components and
- $\mathcal{D}$  is a set of edges between two vertices,  $\mathcal{D} \subseteq (\mathcal{S} \times \mathcal{S})$ . For instance,  $(a, b) \in \mathcal{D}$  means  $a \rightarrow b$ .

**Definition 2 : Component Dependency Matrix.** A CDM is defined as a 0-1 Adjacency Matrix  $\mathcal{AM}_{n \times n}$ , that represents direct dependencies in a component-based system. Figure

4.3 shows an example of dependency graph and its corresponding adjacency matrix. In this matrix, each component is represented by a column and a row. If a component  $C_i$  depends on a component  $C_j$  then  $d_{ij} = 1$  otherwise  $d_{ij} = 0$ . More formally, the values of all elements in  $\mathcal{AM}_{n \times n} = (d_{ij})_{n \times n}$  are defined as follows :

$$d_{ij} = \begin{cases} 1 & \text{if } C_i \rightarrow C_j \\ 0 & \text{otherwise} \end{cases}$$

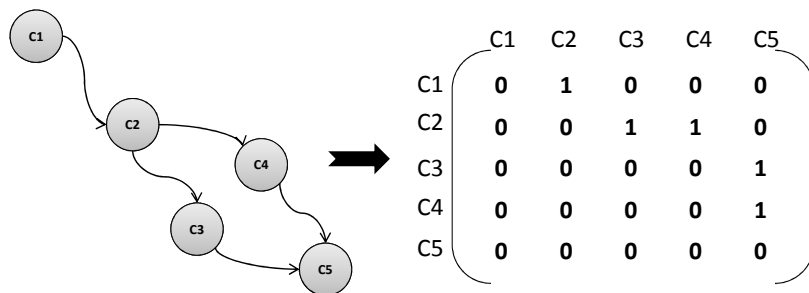

Figure 4.3: A CDG and its CDM representing direct dependencies.

Initially,  $\mathcal{D}$  represents only direct dependencies between components. In order to gather all indirect dependencies in the component-based system, the transitive closure of the graph has to be calculated. Several transitive closure algorithms have been widely studied in the literature such as the Roy-Warshall algorithm and its modification proposed by Warren [101]. In the worst case, both algorithms compute the transitive closure on  $\theta(n^3)$  times where  $n$  is the number of vertices of the graph. This complexity has been enhanced in [102] by proposing an algorithm computing the transitive closure only for cycle-free graphs on better than  $\theta(mn)$  times where  $m$  is the number of edges of the graph. In our context, we adopt the Roy-Warshall algorithm because of its sufficiency in computing transitive closure of any graph and its acceptable complexity (see Figure 4.4).

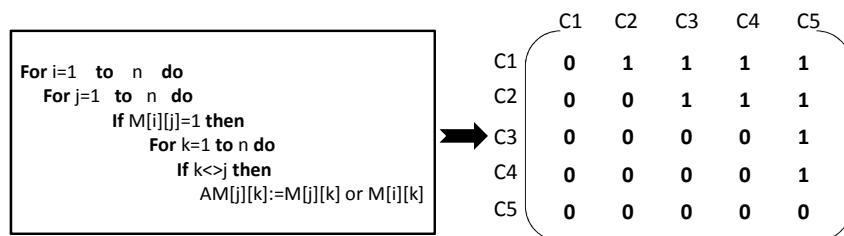

Figure 4.4: An adjacency matrix representing direct and indirect dependencies produced by the Roy-Warshall algorithm.

It is worthy to note that the CDG can be derived from the system's runtime architecture even when the source code is not available. To do so, components, their provided and required

interfaces must be explicitly defined. Such information is considered sufficient to build the CDG. Systems that require the source code availability in order to detect implicit dependencies cannot be handled in our context.

### 4.3.3 Computation of affected components and compositions by dynamic structural changes

Different algorithms for computing affected components with response to the dynamic evolution of the system are detailed in Appendix B. The obtained set depends on the triggered reconfiguration action.

**Case 1 : Adding a component and its connections.** The set *AffectedC\_By\_Add* contains components that directly or indirectly depend on the new component  $C_{new}$  and components that  $C_{new}$  depends on (see Algorithm B.1).

**Case 2 : Deleting a component and its connections.** The set *AffectedC\_By\_Del* comprises components that directly or indirectly depend on the removed component  $C_{removed}$  (see Algorithm B.2).

**Case 3 : Replacing a component by another version.** Replace action can be seen as a set of adding and deleting actions. Thus, the set  $AffectedC\_By\_Rep = AffectedC\_By\_Add \cup AffectedC\_By\_Del$  (see Algorithm B.3).

**Case 4 : Modifying dependencies between two components.** The set *AffectedC\_By\_AddDep* (respectively *AffectedC\_By\_DelDep*) includes components that are directly or indirectly affected by adding a new dependency (respectively by deleting an old dependency) (see Algorithm B.4).

An affected composition is seen as a dependence path in the CDG that contains at least one affected component. These dependence paths are derived by traversing the CDG and then combined to create test execution paths (see Algorithm B.5). Such information can be afterwards interpreted to select a subset of test cases that cover the identified test execution paths. For the sake of simplicity, the computation of all affected dependent paths is done under the assumptions that hierarchical compositions are not supported by our work and also CDG does not contain cycles. Moreover, we use the term affected composition hereafter instead of affected dependence path.

## 4.4 Online test case selection

The main question to be tackled in this section is how to identify a minimal set of test cases that must be rerun after the occurrence of dynamic changes. This concern has been extensively studied in the literature. In fact, various regression test selection techniques have been proposed



with the purpose of identifying a subset of valid test cases from an initial test suite that tests the affected parts of a program. These techniques usually select regression tests based on data and control dependency analysis [79]. They indicate that source code access is required in order to compute such kinds of dependencies. Therefore, they may not be effective in our context as we adopt interface dependency analysis. Moreover, we suppose that the source code is not available and only the system architecture description is given (i.e., dependencies between provided and required interfaces).

Two kinds of tests are considered after the occurrence of dynamic adaptations. On the one hand, unit tests are executed to validate individual affected components. On the other hand, integration tests are performed to check interactions and interoperability between components. In order to facilitate their lookup, a naming convention technique is applied. The latter consists in including component names as well as dependence paths into test case names. Formally, units and integration test names are expressed as follows:

- Unit tests :  $\mathcal{UT} = \{UTC_i\}$  where  $C_i$  is a newly added or replaced component.
- Integration tests :  $\mathcal{IT} = \{ITP_j, \forall P_j \in \text{affPaths}\}$  where each  $P_j$  is a dependence path in the CDG of length  $l$  that covers at least an affected component by the change. It can be seen as a graph  $P = (\mathcal{C}_p, \mathcal{D}_p)$ , where  $\mathcal{C}_p = \{C_1, C_2, \dots, C_l\}$  and  $\mathcal{D}_p = \{\{C_1, C_2\}, \{C_2, C_3\}, \dots, \{C_{l-1}, C_l\}\}$  with  $C_i \rightarrow C_{i+1}, \forall i \in \{1..l-1\}$ .

Let us take an example with four components and a dependency graph that looks like Figure 4.5. Assume that  $C_2$  is replaced with a new version. Thus, two dependence paths are identified:  $C_1 \rightarrow C_2 \rightarrow C_3$  and  $C_1 \rightarrow C_2 \rightarrow C_4$ . As a result, the mapping to integration tests produces:  $ITC1C2C3$  and  $ITC1C2C4$  have to be rerun.

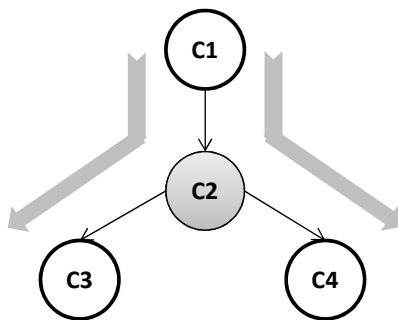

Figure 4.5: Illustrative example of dependence path computation.

Recall that tests are written in the TTCN-3 notation and are executed by TTCN-3 test components. As depicted in Figure 4.6a, an MTC component is only charged with executing a unit test. It shares this responsibility with other PTC components when an integration test is

executed (see Figure 4.6b). Each PTC is created to simulate a test call from a component to another at lower hierarchy in the dependence path. The following subsection copes with test case distribution and more precisely with main test components assignment to execution nodes.

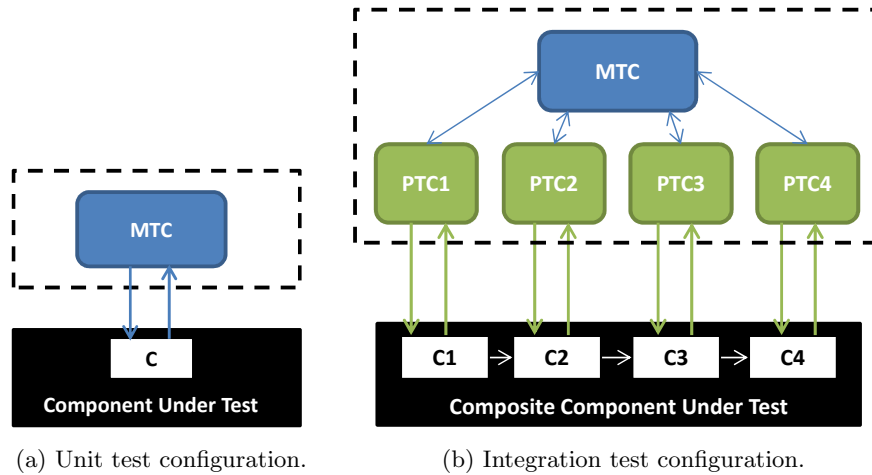

Figure 4.6: TTCN-3 test configuration for unit and integration testing.

## 4.5 Constrained test component placement

Distributing test cases over the network and assigning their corresponding test components efficiently to execution nodes, seems to be an optional step. Especially, when the execution environment under which the SUT is running is not resource constrained, this step may be skipped. Nevertheless, we strongly believe that test case distribution with respect to some resource and connectivity constraints may alleviate considerably the test workload. This is crucial not only for the SUT performance and its execution environment but also for the test system performance and for gaining confidence in the obtained test results.

In the following subsections, we discuss how to formalize resource and connectivity constraints and finally how to find the adequate deployment host for each test involved in the runtime testing process.

### 4.5.1 Resource allocation issue

In general, runtime testing is seen as a resource consuming activity that has to be performed carefully in resource constrained environments. In order to preserve the QoS of dynamically adaptable component-based systems, the consideration of resource allocation during test distribution is applied.

For each node in the execution environment, three resources are monitored during the SUT

execution : the available memory, the current CPU load and the battery level. The value of each resource can be directly captured on each node through the use of internal monitors. These values are measured after the runtime reconfiguration and before starting the testing activity. For each test component, we introduce the memory size (i.e., the memory occupation needed by a test component during its execution), the CPU load and the battery consumption properties. We suppose that these values are provided by the test manager. It is also worth noting that some techniques are available in the literature for obtaining the resources required by test components. For example in [46], the authors propose a preliminary test to learn about some required resources such as the amount of memory allocated by a test component, the time needed to execute the test behavior, etc.

Formally, provided resources of  $m$  execution nodes are represented through three vectors :  $C$  that contains the CPU load,  $R$  that provides the available RAM and  $B$  that introduces the battery level.

$$C = \begin{pmatrix} c_1 \\ c_2 \\ \vdots \\ c_m \end{pmatrix} \quad R = \begin{pmatrix} r_1 \\ r_2 \\ \vdots \\ r_m \end{pmatrix} \quad B = \begin{pmatrix} b_1 \\ b_2 \\ \vdots \\ b_m \end{pmatrix}$$

The resources required by the  $n$  test components are initially computed at the deployment time after a preliminary test run. Similarly, they are formalized over three vectors :  $D_c$  that contains the required CPU,  $D_r$  that introduces the required RAM and  $D_b$  that contains the required battery by each test.

$$D_c = \begin{pmatrix} dc_1 \\ dc_2 \\ \vdots \\ dc_n \end{pmatrix} \quad D_r = \begin{pmatrix} dr_1 \\ dr_2 \\ \vdots \\ dr_n \end{pmatrix} \quad D_b = \begin{pmatrix} db_1 \\ db_2 \\ \vdots \\ db_n \end{pmatrix}$$

As the proposed framework is resource aware, checking resource availability during test distribution is usually performed before starting the runtime testing process. Thus, the overall resources required by  $n$  test components must not exceed the available resources in  $m$  nodes. This rule is formalized through three constraints to fit as outlined in (4.1) where the two dimensional variable  $x_{ij}$  can be equal to 1 if the corresponding test component  $i$  is assigned to the node  $j$ , 0 otherwise.

$$\begin{cases} \sum_{i=1}^n x_{ij} dc_i \leq c_j & \forall j \in \{1, \dots, m\} \\ \sum_{i=1}^n x_{ij} dr_i \leq r_j & \forall j \in \{1, \dots, m\} \\ \sum_{i=1}^n x_{ij} db_i \leq b_j & \forall j \in \{1, \dots, m\} \end{cases} \quad (4.1)$$

#### 4.5.2 Connectivity issue

Dynamic environments are characterized by frequent and unpredictable changes in connectivity caused by firewalls, non-routing networks, node mobility, etc. For this reason, we have to pay attention when assigning a test component to a host computer by finding at least one route in the network to communicate with the component under test.

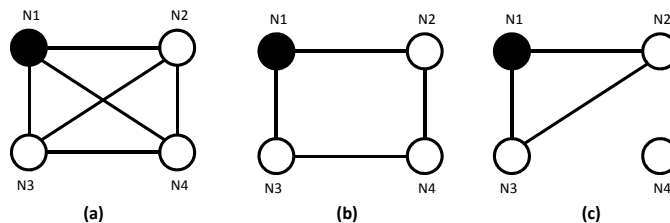

Figure 4.7: Illustration of connectivity problems during testing.

Such a constraint can be ignored when all nodes are connected together. In this context, the execution environment is seen as a strongly connected graph in which every pair of nodes are connected together. As depicted in Figure 4.7 case (a), the node under test<sup>1</sup> N1 is colored in black, thus its corresponding test component can be deployed on any host in the execution environment. Similarly, in case (b) we can find a path between the black node and any node in the network. Thus, the test component can find a way to communicate with its corresponding component under test. However, if there is no such a path between these end-nodes, the testing process cannot take place. Case (c) outlines a disconnection between the node N4 and the remaining nodes in the network. Consequently, the corresponding test component cannot be deployed on N4. The latter is considered as a forbidden node.

More generally, we pinpoint, for each test component, a set of forbidden nodes to discard during the constrained test component placement step. From a technical perspective, either Depth-First Search<sup>2</sup> or Breadth-First Search<sup>3</sup> algorithms can be used to firstly identify connected execution nodes in the network and secondly to compute a set of forbidden nodes for each test

<sup>1</sup>The node hosting the component under test

<sup>2</sup>[http://en.wikipedia.org/wiki/Depth-first\\_search](http://en.wikipedia.org/wiki/Depth-first_search)

<sup>3</sup>[http://en.wikipedia.org/wiki/Breadth-first\\_search](http://en.wikipedia.org/wiki/Breadth-first_search)

component involved in the test process. This connectivity constraint is denoted as follows:

$$x_{ij} = 0 \quad \forall j \in \text{forbiddenNodeSet}(i) \quad (4.2)$$

where the  $\text{forbiddenNodeSet}(i)$  function returns a set of forbidden nodes for a test component  $i$ .

Finding a satisfying test placement solution is merely achieved by fitting the former constraints (4.1) and (4.2). At this stage, the constrained test component placement module is formalized as a *Constraint Satisfaction Problem* (CSP)<sup>4</sup> [103].

### 4.5.3 Optimizing the test component placement problem

Looking for an optimal test placement solution consists in identifying the best node to host the concerned test component in response with two criteria : its distance from the node under test and its link bandwidth capacity. To do so, we are asked to attribute a profit value  $p_{ij}$  for assigning the test component  $i$  to a node  $j$ . For this aim, a matrix  $\mathcal{P}_{n \times m}$  is computed as follows:

$$p_{ij} = \begin{cases} 0 & \text{if } j \in \text{forbiddenNodeSet}(i) \\ \text{maxP} - k \times \text{step}_p & \text{otherwise} \end{cases} \quad (4.3)$$

where  $\text{maxP}$  is constant,  $\text{step}_p = \frac{\text{maxP}}{m}$ ,  $k$  corresponds to the index of a node  $j$  in a *Rank Vector* that is computed for each node under test. This vector corresponds to a classification of the connected nodes according to both criteria : their distance far from the node under test [24] and their link bandwidth capacities.

Consider an execution environment made up of four nodes ( $N1$ ,  $N2$ ,  $N3$ , and  $N4$ ) as illustrated in Figure 4.8.

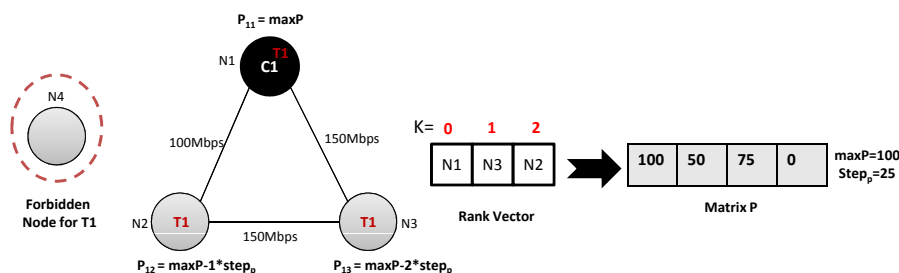

Figure 4.8: Illustrative example for profit calculation.

We look for the best test component placement solution for a test component  $T1$  charged

<sup>4</sup>A CSP is a problem composed of a finite set of variables each of which has a finite domain of values and a set of constraints. The goal is to find an assignment of a value for each variable in such a way that the assignments satisfy all the constraints.

with testing a component under test  $C1$  running on an execution node  $N1$ . First of all, the node  $N4$  is discarded from the test component placement process because the link with the node under test  $N1$  is broken. Second, we compute the *Rank Vector* for the rest of the connected nodes and we deduce the matrix profit. We note here that the profit  $p_{ij}$  is maximal if the test component  $T1$  is assigned to the node  $N1$  because assigning a test component to its corresponding node under test and performing local tests reduces the network communication cost. This profit decreases with respect to the node index in the *Rank Vector*. For instance,  $N3$  is considered a better target for  $T1$  than  $N2$  although they have the same distance far from the node under test because the link bandwidth between  $N3$  and  $N1$  is greater than the link bandwidth between  $N2$  and  $N1$ .

As a result, the constrained test component placement module generates the best deployment host for each test component involved in the runtime testing process by maximizing the total profit value while fitting the former resource and connectivity constraints. Thus, it is formalized as a variant of the Knapsack Problem, called *Multiple Multidimensional Knapsack Problem* (MMKP). In Appendix C, readers can find more in-depth information about knapsack variants.

$$MMKP = \begin{cases} \text{maximize } \mathcal{Z} = \sum_{i=1}^n \sum_{j=1}^m p_{ij} x_{ij} & (4.4) \\ \text{subject to (4.1) and (4.2)} & \\ \sum_{j=1}^m x_{ij} = 1 \quad \forall i \in \{1, \dots, n\} & (4.5) \\ x_{ij} \in \{0, 1\} \quad \forall i \in \{1, \dots, n\} \quad \text{and} \quad \forall j \in \{1, \dots, m\} & \end{cases}$$

Constraint (4.4) corresponds to the objective function that maximizes test component profits while satisfying resource (4.1) and connectivity (4.2) constraints. Constraint (4.5) indicates that each test component has to be assigned to at most one node.

Algorithm 4.1 displays the main instructions to solve this MMKP problem. First of all, resource constraints have to be defined (see lines 2-4). Second, forbidden nodes for each test component are identified and then connectivity constraints are deduced (see lines 5-7). Then, an objective function is calculated (see line 8) and then maximized (see line 9) to obtain an

optimal solution.

---

**Algorithm 4.1:** Resolution of MMKP problem.

---

**Input:** The matrix profit  $\mathcal{P}_{n \times m}$ ,

The provided resources by  $m$  nodes  $R, C, B$ ,

The required resources by  $n$  tests  $D_r, D_c, D_b$ .

**Output:** The two dimensional value  $x$ .

```

1 begin
2   Constraint ram[] = defineResourceConstraint( $x, R, D_r$ );
3   Constraint cpu[] = defineResourceConstraint( $x, C, D_c$ );
4   Constraint bat[] = defineResourceConstraint( $x, B, D_b$ );
5   Constraint connectivity;
6   for  $i = 1$  to  $n$  do
7     |  $connectivity.add(defineConnectivityConstraint(x, forbiddenNodeSet(i)))$ ;
8   end
9    $Z = defineObjectiveFunction(x, \mathcal{P})$ ;
10   $x = maximize(Z, ram, cpu, bat, connectivity)$ ;
11  return  $x$ ;
12 end

```

---

The returned  $x$  value is used to produce the RATP file. As depicted in Figure 4.9, it contains mainly the adequate deployment host for each test case and its associated Main Test Component involved in the runtime testing process. Further information can be included in this file such as affected components or compositions as well as their main characteristics (e.g., required and provided interfaces, testability options, deployment hosts, etc.). It is used next in the test isolation and execution step.

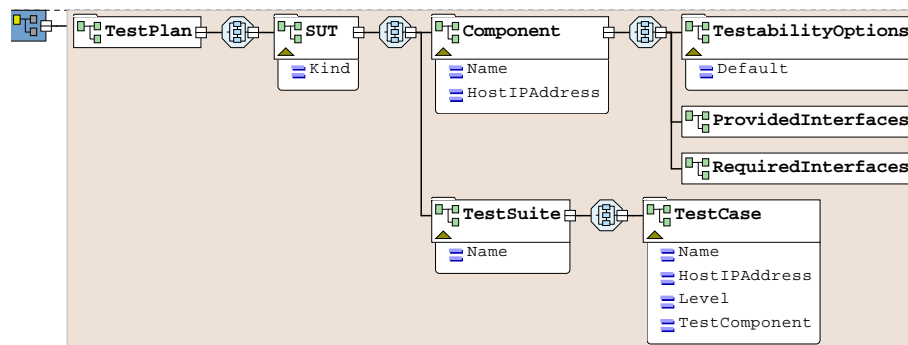

Figure 4.9: XML schema of the Resource Aware Test Plan.

## 4.6 Test isolation and execution support

With the purpose of alleviating the complexity of testing adaptable and distributed systems, we propose a test system called, *TTCN-3 test system for Runtime Testing* (TT4RT) [26]. The

key idea is to reuse the classical TTCN-3 test system, already introduced in Appendix A, more precisely in Section A.2. As illustrated in Figure A.2, this test system is composed of a set of interacting entities which are mainly responsible for managing test execution, executing compiled TTCN-3 tests, establishing communication with the SUT, etc. Due to all these features and especially its platform independence, it is retained at this stage.

#### 4.6.1 TT4RT as a local test execution support

As depicted in Figure 4.10, TT4RT includes two new layers: a *Test Management Layer* and a *Test Isolation Layer*.

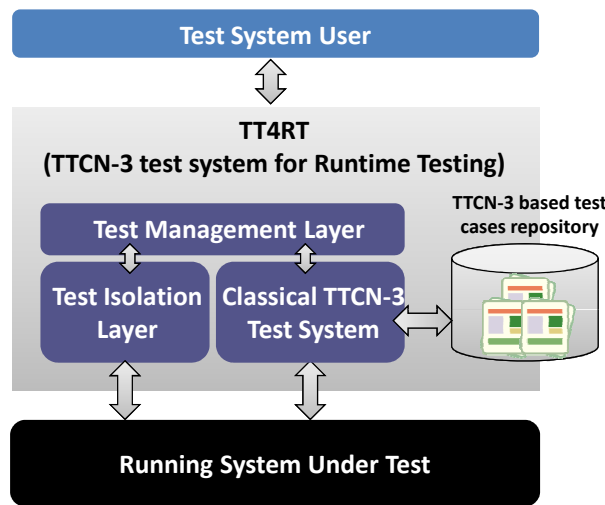

Figure 4.10: Supported layers of TT4RT.

Since this standardized test system is designed to apply essentially black box conformance testing at design time and does not support runtime testing, we extend it with test isolation capabilities in order to perform safely and efficiently runtime tests. These enhancements are highlighted in the following paragraphs.

**Test management layer :** This layer intends to manage locally the execution of selected test cases at runtime. It extends the Test Management (TM) entity (i.e., offered by the classical TTCN-3 test system to manage and monitor the whole test execution process) with a GUI component (namely *TTmanGUI*). The latter is responsible mainly for starting and stopping test cases and also collecting local verdicts from test components in order to compute the global verdict. It has as input the RATP file already introduced in the previous section.

**Test isolation layer :** In Chapter 2 Section 2.4, several test isolation techniques have been discussed and the need to support heterogeneous systems made up of testable and untestable



components has been pointed out, as well. Such techniques aim to reduce the interference risk between test data and business data when testing is performed at runtime. For this reason, TT4RT includes a test isolation layer, which is able to choose the most suitable test isolation technique for each component under test.

#### 4.6.2 Detailed interactions of TT4RT components

As mentioned before, TT4RT relies on the classical TTCN-3 test system. Thus, it reuses all its constituents, namely Test Management (TM), TTCN-3 Executable (TE), Component Handling (CH), Coding and Decoding (CD), System Adapter (SA) and Platform Adapter (PA). These entities are briefly introduced below. For more details, readers can refer to Appendix A. As depicted in Figure 4.11, a new *Generic Test Isolation Component* is added to the TTCN-3 reference architecture with the aim of handling test isolation concerns. The next steps define the different components of TT4RT and their internal interactions:

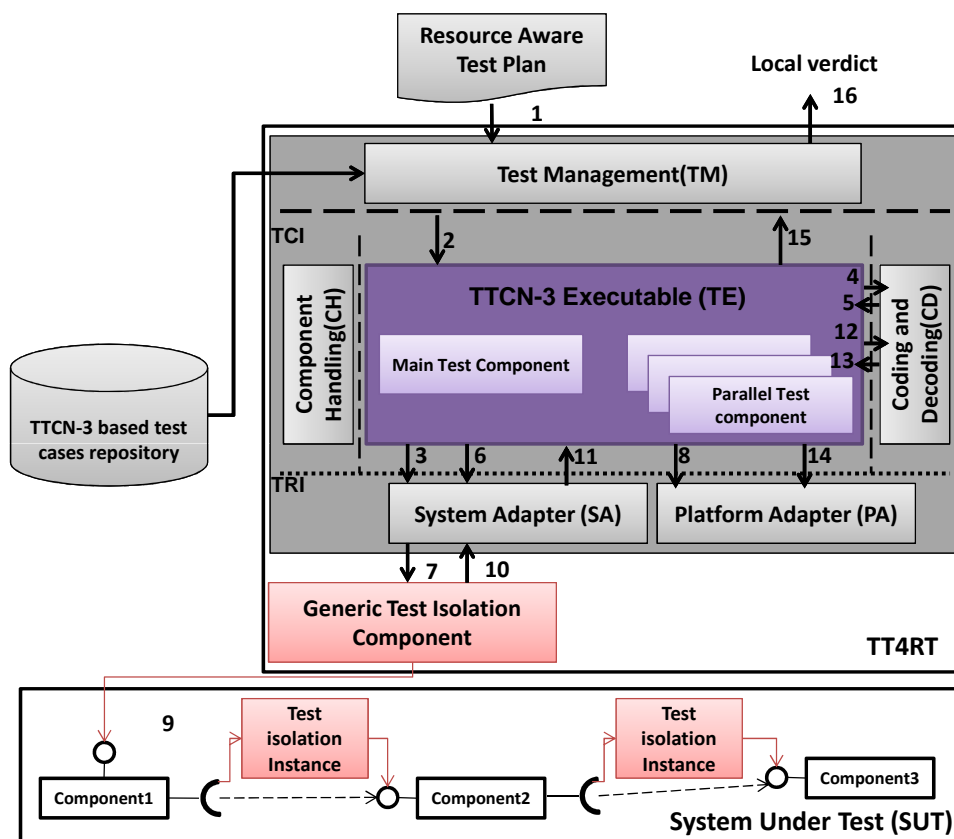

Figure 4.11: Internal interactions in the TT4RT system.

- When a reconfiguration action is triggered, the RATP file is generated and it is considered as an input to the TT4RT test system (Step 1).
- The test execution is initiated by the TM entity which is charged with starting and stopping

runtime tests (Step **2**).

- Once the test process is started, the TE entity (i.e., which is responsible of executing the compiled TTCN-3 code) creates the involved test components and informs the SA entity (i.e., which is charged with propagating test requests from TE to SUT) with this start up in order to set up its communication facilities (Step **3**).
- Next, TE invokes the CD entity in order to encode the test data from a structured TTCN-3 value into a form that will be accepted by the SUT (Step **4**).
- The encoded test data is passed back to the TE entity as a binary string and forwarded to the SUT via the SA entity (Steps **5-6-7**).
- After the test data is sent, a timer can be started (Step **8**).
- The Generic Test isolation Component, implementing test isolation facilities, intercepts the test request, identifies the component under test and its supported test isolation technique and prepares the test environment (Steps **7-9**).
- Different test isolation instances are automatically created to perform test isolation inter-component invocations (Step **9**).
- The SUT response is forwarded to the SA entity through the Generic Test Isolation Component. The given response is an encoded value that has to be decoded in order to be understandable by the TTCN-3 test system (Step **10**).
- For this purpose, the SA entity forwards the encoded test data to the TE entity (Step **11**).
- The TE entity transmits the encoded response to the CD entity with the intention of decoding it into a structured TTCN-3 value (Step **12**).
- The decoded response is passed back to the TE that stops the running timer and finally computes a verdict (pass, fail or inconclusive) for the current test case (Steps **13-14-15**).
- Finally, a local verdict is computed depending on the obtained verdicts for test cases executed by the current TT4RT instance (Step **16**).

The main behavior of the Generic Test isolation Component and its different instances is discussed in the following subsection.

### 4.6.3 Overview of the Generic Test Isolation Component

To perform a safe runtime testing activity, it is required to set up an adequate test environment with test isolation capabilities. For this aim, the Generic Test Isolation Component as well as several test isolation instances required for inter-component invocations are proposed. We make use of the *Aspect Oriented Programming* (AOP) capabilities with the purpose of enforcing the separation of testability concerns from the implementation of the system. The key idea is to implement an aspect-based test isolation policy that automatically intercepts the test request and selects the adequate test isolation technique to apply for each component under test or composite component under test<sup>5</sup>.

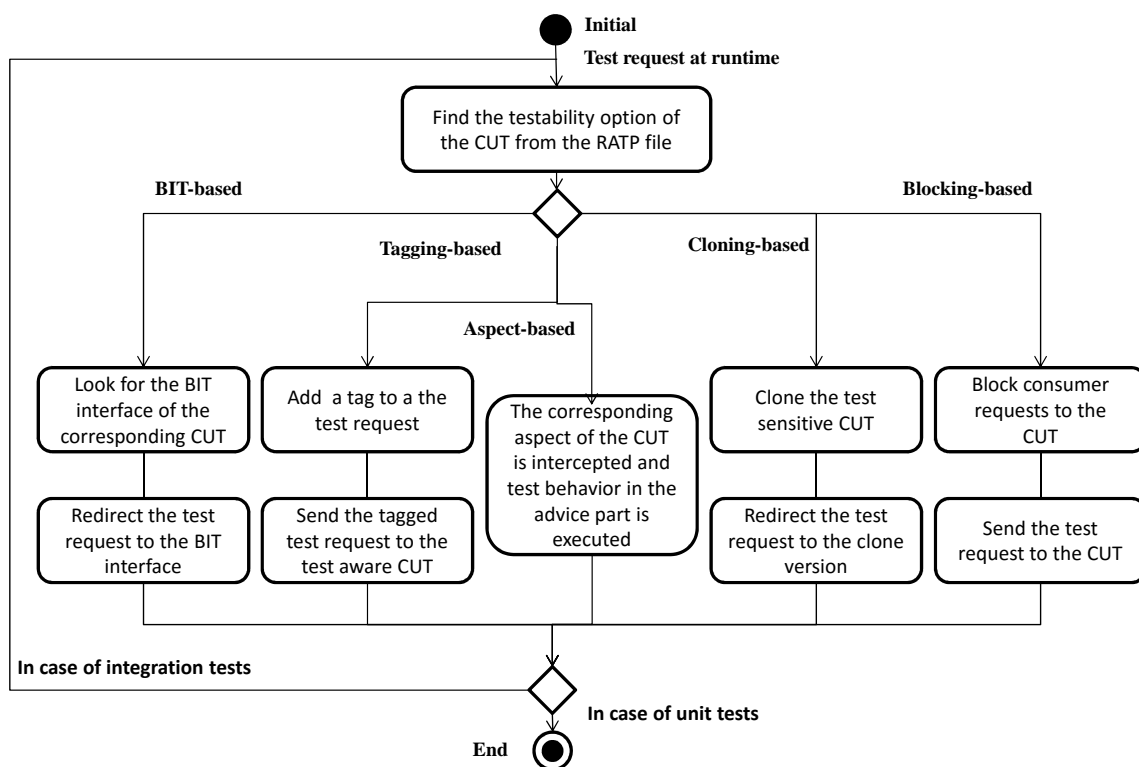

Figure 4.12: Test isolation policy.

As outlined in Figure 4.12, the proposed policy is executed while a test request is intercepted from the System Adapter entity. Five strategies can be applied in response to the testability degree of a Component Under Test (CUT). On the assumption that the CUT is testable, the test request can be redirected to one or more test operations provided by its corresponding test interface or its associated aspect (particularly in the advice part) when the aspect-based technique is used. If the component under test is test aware, the tagging technique is applied and the CUT is invoked by tagging the input test data with a flag to discriminate them from

<sup>5</sup>We note here that the testability capability of each component is required and has to be supplied by system designers.

business data. If we deal with untestable components, either cloning or blocking techniques can be performed. For a test sensitive component, a clone is created and the test request is redirected to it. Regarding the blocking strategy, it consists in interrupting the activity of the component under test consumers for a lapse of time that corresponds to the test duration. During this period, all business requests are delayed until the end of the test. Once the test is achieved, the component under test consumers are unlocked and the delayed requests are treated.

Note that this process is executed only once if a single component is under test. Otherwise, in the case of a composite component under test, the test isolation instances already introduced have to be instantiated with the aim of executing safely the test request.

From a technical perspective, each instance is implemented as an aspect (i.e., the unit of modularity proposed by the AOP paradigm) and it is associated for each provided interface by the CUT. Within this aspect, a set of execution points, called *join points*, has to be defined which correspond in our context to method calls. At each joint point, the test isolation policy behavior is defined within *an advice*. Once a test request is intercepted, the advice code is automatically executed and then the suitable test isolation technique is set.

Thanks to the AOP paradigm, our solution provides more flexibility and allows the dynamic selection of the most appropriate test isolation technique. Moreover, the defined aspects are automatically integrated within the functional code to produce a final application which is safely testable at runtime.

#### 4.6.4 The adopted distributed architecture

As explained before, the TTCN-3 standard offers concepts related to test configurations, test components, their communicating ports between each other and with the SUT, their execution and their termination only at an abstract level. Nevertheless, the means to control the distributed execution of these test components are not explicitly defined in the current specification. Regarding this issue, we propose our own test architecture that relies on a *Test System Coordinator* (TSC) and several TT4RT instances.

As outlined in Figure 4.13, TSC is mainly charged with distributing selected test cases to re-run and assigning their corresponding test components to the execution nodes. Several TT4RT instances are installed within the host computers involved in the final execution environment. They can be seen as test containers that hold test components (i.e., either MTC or PTC components) deployment and execution. Each instance controls the execution of a subset of selected test cases.

As described in the former workflow, test isolation concerns have to be applied in each

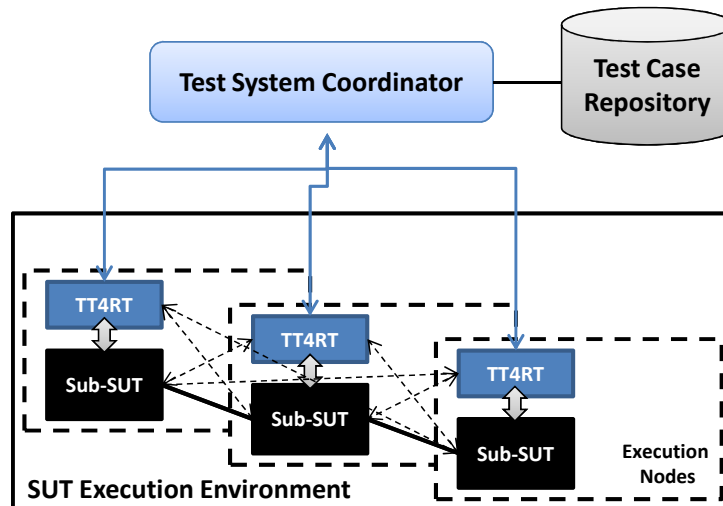

Figure 4.13: The distributed test execution platform.

TT4RT instance before the startup of the runtime testing process. During the test execution, test components are created, connected to the SUT and started in order to detect SUT malfunctions. When the test execution is done, the test processes are stopped, the communication channels with SUT are closed and the allocated memory is released. Then, a local verdict is generated and is sent to TSC with the aim of computing the final global verdict.

## 4.7 Summary

In this chapter, we applied the runtime testing process to validate component-based systems after the occurrence of dynamic structural adaptations. For this aim, we proposed a generic and resource aware test execution platform that covers essentially two phases. The first phase deals with test selection and distribution concerns. The main issue tackled in this first part is alleviating test burden, cost and resource consumption. This goal is achieved by reducing the amount of test cases to rerun and by assigning efficiently their associated test components to execution nodes while fitting resource and connectivity constraints. The second phase handles test isolation and execution concerns. Based on the TTCN-3 standard, we proposed a test system, TT4RT, which performs tests written in a standardized notation. Accordingly, we gained in terms of using the same notation for all types of tests and using a generic and flexible test harness. Furthermore, TT4RT afforded a test isolation infrastructure supporting components with various testability options (i.e., testable, test aware, untestable, etc.).

To illustrate the usefulness of the proposed approach, Chapter 7 introduces the runtime testing of an OSGi-based application in the context of the healthcare domain. The next chapter defines the method we propose to validate dynamic behavioral adaptations.

---

## Runtime Testing of Behavioral Adaptations

---

### 5.1 Introduction

Running old test suites on dynamic software systems, in which not only the structure evolves but also the behavior may change, seems to be meaningless. Therefore, it is highly required to evolve test suites in a cost effective manner as long as the software system is changing to fulfill new requirements. In this chapter, we address this issue by merging model-based testing and selective regression testing capabilities. As stated in Chapter 2, MBT is considered as a well-established technique for generating automatically test cases from formal specifications while selective regression testing is usually applied to select a subset of valid tests from the existing test suite. Based on these two techniques, our major aim is to produce a relevant and fault revealing test suite without full regeneration.

To do so, we propose a Selective Test Generation Approach, called TestGenApp. The latter is briefly outlined in Section 5.2. It consists of : (1) a model differencing module that detects similarities and differences between the initial and the evolved behavioral models, expressed on timed automata, (2) an old test classification module that distinguishes reusable and retestable tests from the old test suite, discards obsolete ones and detects some tests that cannot be animated on the evolved behavioral model (called aborted tests), (3) a test recomputation and generation module that includes facilities to adapt aborted and obsolete tests as well as to generate new tests covering new behaviors and finally (4) a TTCN-3 transformation module that derives TTCN-3 test cases from the new abstract test suite.

Before detailing these modules, background materials on timed automata, UPPAAL for-

malism and observer automata are presented in Section 5.3. Then, we introduce the model differencing algorithm in Section 5.4. The output of this module is then used in Section 5.5 to perform an old test classification. Section 5.6 handles the test coverage customization that we propose in order to generate efficiently new tests. Moreover, it presents the algorithm that we propose to adapt either aborted or obsolete tests. Once abstract test sequences are obtained, their mapping to the TTCN-3 notation is discussed in Section 5.7. Finally, this chapter is concluded in Section 5.8. Several parts of this chapter have been already published in [30].

## 5.2 The approach in a nutshell

As illustrated in Figure 5.1, our Selective Test Generation Approach is composed of four modules:

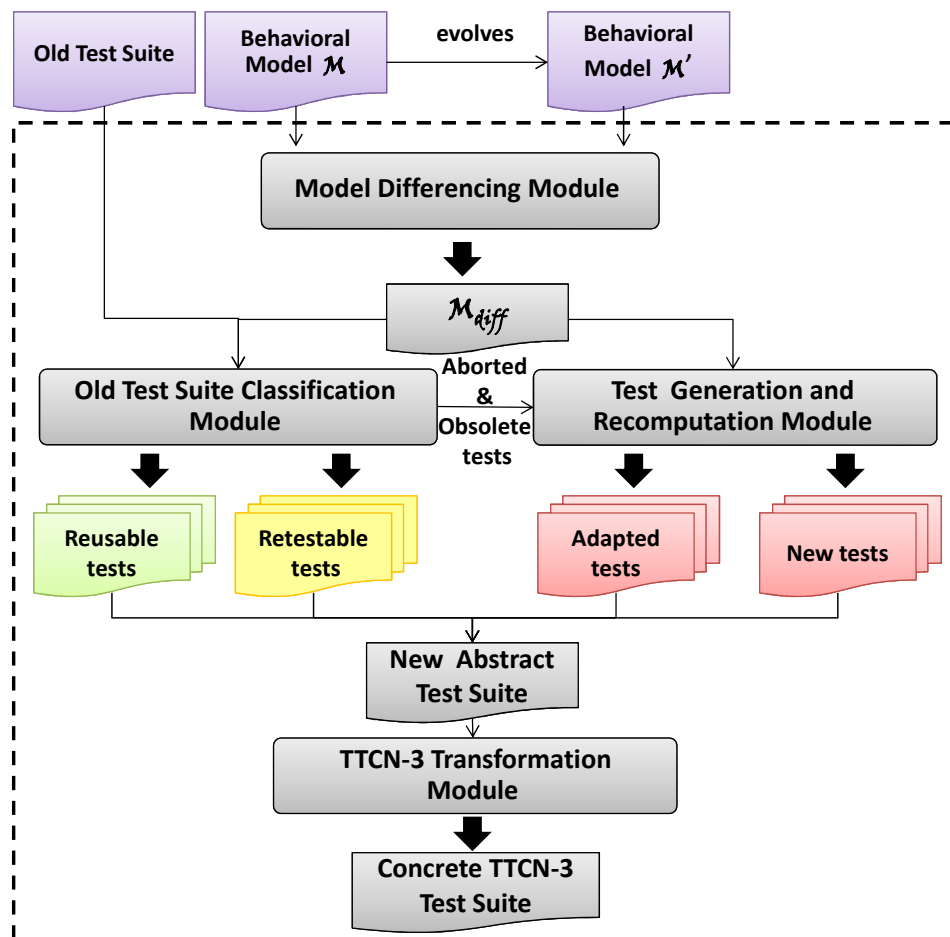

Figure 5.1: TestGenApp: Selective test case generation approach.

**Model Differencing Module.** It is proposed to concisely capture correspondences and differences between two behavioral models in terms of added, removed or modified locations and transitions. As a result, it produces a new model called  $\mathcal{M}_{diff}$  that highlights changed and

unchanged elements.

**Old Test Suite Classification Module.** It is charged with classifying the old test suite issued from the original model  $\mathcal{M}$  into *reusable*, *retestable*, *aborted* and *obsolete* tests. A test is reusable if it covers unimpacted parts of the  $\mathcal{M}_{diff}$  model by the change. It is considered obsolete if it traverses deleted elements. It is retestable if it is still valid and can be animated on the evolved model otherwise it is called an aborted test.

**Test Generation and Recomputation Module.** Regarding the test generation issue, it is based on a model-checking technique which takes as inputs the evolved behavioral model and coverage criteria encoded as observer automata. It generates essentially new abstract test sequences covering newly added behaviors. Regarding the test recomputation issue, it adapts aborted and obsolete tests that fail during their animation on the new behavioral model while avoiding test redundancy.

**TTCN-3 Transformation Module.** It is used to transform the abstract test sequences, obtained in the last step, into the TTCN-3 code. To do so, several rules are defined and then implemented in order to automate the mapping to TTCN-3. The obtained TTCN-3 test cases are then compiled and can be executed within our TT4RT test system already described in Chapter 4.

## 5.3 Prerequisites

This section gives an overview of the background knowledge involved in our TestGenApp approach. On the one hand, we present the variant of timed automata that we consider. On the other hand, the reachability analysis as well as observer automata used for specifying the coverage criteria are introduced.

### 5.3.1 UPPAAL Timed Automata

In order to specify the behavioral models of evolved systems, *Timed Automata* (TA) is chosen for the reason that it is a widespread formalism usually used for modeling behaviors of critical and real-time systems. More precisely, we opt for the particular UPPAAL style of timed automata because UPPAAL is a well-established verification tool. It is made up of a system editor that allows users to edit easily timed automata, a simulator that visualizes the possible dynamic execution of a given system and a verifier that is charged with verifying a given model w.r.t. a formally expressed requirement specification.

Within UPPAAL timed automata, a system is modeled as a network of timed automata, called processes. A timed automaton, is an extended finite-state machine equipped with a set of



clock-variables that track the progress of time and that can guard when transitions are allowed. In the following, we give the syntax definition and semantics for the basic timed automata. For additional information about the richer UPPAAL language, i.e., with integer variables and the extensions of urgent channels and committed locations, readers should refer to the UPPAAL documentation [3].

### 5.3.1.1 Timed Automata : Definitions

#### Definition 1 : Timed automaton

Let  $\mathcal{C}$  be a set of variables called clocks, and  $\mathcal{Act} = \mathcal{I} \cup \mathcal{O} \cup \{\tau\}$  with  $\mathcal{I}$  a set of input actions,  $\mathcal{O}$  a set of output actions (denoted  $a?$  and  $a!$ )<sup>1</sup>, and the non-synchronizing action (denoted  $\tau$ ). Let  $\mathcal{G}(\mathcal{C})$  denote the set of guards on clocks being conjunctions of constraints of the form  $c \bowtie n$ , where  $c \in \mathcal{C}$ ,  $n \in \mathbb{N}$ , and  $\bowtie \in \{\leq, <, =, \geq, >\}$ . Moreover, let  $\mathcal{U}(\mathcal{C})$  denotes the set of updates of clocks corresponding to sequences of statements of the form  $c := n$ .

A timed automaton over  $(\mathcal{Act}, \mathcal{C})$  is a tuple  $(L, l_0, \mathcal{Act}, \mathcal{C}, I, E)$ , where :

- $L$  is a set of locations,  $l_0 \in L$  is an initial location.
- $I : L \mapsto \mathcal{G}(\mathcal{C})$  a function that assigns to each location an invariant.
- $E$  is a set of edges such that  $E \subseteq L \times \mathcal{G}(\mathcal{C}) \times \mathcal{Act}_\tau \times \mathcal{U}(\mathcal{C}) \times L$

We shall write  $l \xrightarrow{g, \alpha, u} l'$  when  $\langle l, g, \alpha, u, l' \rangle \in E$ .

#### Definition 2 : Semantics of TA

Let  $(L, l_0, \mathcal{Act}, \mathcal{C}, I, E)$  be a timed automaton. The semantics of  $TA$  is defined in terms of a timed transition system over states in the form  $(l, \sigma)$  where  $l$  is a location and  $\sigma \in \mathbb{R}_{\geq 0}^{\mathcal{C}}$  is a clock valuation satisfying the invariant of  $l$ . The initial state  $(l_0, \sigma_0)$  is a state where  $l_0$  is the initial location of the automaton and  $\sigma_0$  is the initial mapping where  $\forall c \in \mathcal{C}, c = 0$ . Indeed, there are two kinds of transitions :

- Delay transitions,  $(l, \sigma) \xrightarrow{d} (l, \sigma + d)$ , in which all clock values of the automaton are incremented with the amount of the delay, denoted  $\sigma + d$ . In such a case, the automaton may stay in a location  $l$  as long as its invariant remains true.
- Discrete transitions,  $(l, \sigma) \xrightarrow{\alpha} (l', \sigma')$ , correspond to the execution of edges  $(l, g, \alpha, u, l')$  for which the guard  $g$  is satisfied by  $\sigma$ . The clock valuation  $\sigma'$  of the target state is obtained by modifying  $\sigma$  according to updates  $u$ .

---

<sup>1</sup>Hereafter, each input action is suffixed with “?”, and each output action is suffixed with “!”. An internal action has no suffix.

**Definition 3 :** A run of  $TA$

A run of timed automaton  $(L, l_0, \mathcal{Act}, \mathcal{C}, I, E)$  is a sequence of transitions  $(l_0, \sigma_0) \xrightarrow{d_1} \alpha_1 \rightarrow (l_1, \sigma_1) \xrightarrow{d_2} \alpha_2 \rightarrow \dots \xrightarrow{d_n} \alpha_n \rightarrow (l_n, \sigma_n)$ , with  $\sigma_i \in \mathbb{R}_{\geq 0}^{\mathcal{C}}$ ,  $d_i \in \mathbb{R}_{\geq 0}$  and  $\alpha_i \in \mathcal{Act}$ .

**Definition 4 :** Networks of  $TA$

A network of timed automata,  $TA_1 \parallel \dots \parallel TA_n$  over  $(\mathcal{Act}, \mathcal{C})$  is modeled as a timed transition system obtained by the parallel composition of  $n$   $TA$  over  $(\mathcal{Act}, \mathcal{C})$ . Synchronous communication between the timed automata is performed by hand-shake synchronization using input and output actions (e.g.,  $a!$  and  $a?$ ).

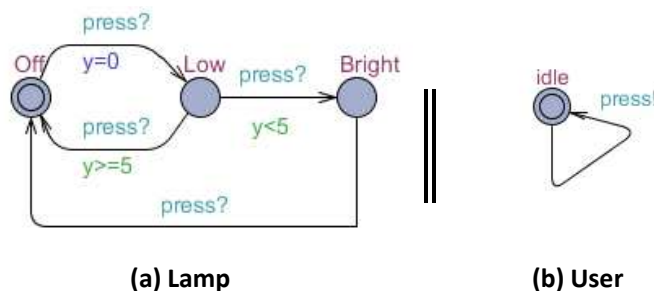

Figure 5.2: An example of a network of timed automata [3].

Figure 5.2 shows a network of timed automata modeling the behavior of a simple lamp and its user. They communicate using the label *press*. As outlined in Figure 5.2 (a), the lamp has three locations : *Off*, *Low*, and *Bright*. Its clock  $y$  is used to record time and to detect if the user was fast ( $y < 5$ ) or slow ( $y \geq 5$ ) while pressing the button. Indeed, the user model is shown in Figure 5.2 (b). If the user presses a button slowly, then the lamp is turned on. If the user presses the button again, the lamp is turned off. However, if the user is fast and rapidly presses the button twice, the lamp is turned on and becomes bright.

It is worthy to note that a system model is a network of TA. It often consists of a controller part, specifying the behavior of the system under test, and an environment part specifying the components surrounding the controller. The controller part might be also a network of timed automata. Each involved component in the software system is modeled as a timed automaton. A specific variant of timed automata are required for the controller part [104]. They have to be *Deterministic Input Enabled Output Urgent Timed Automata* (DIEOU-TA). For short, these restrictions mean that: (i) an input or a delay from one semantic state leads only to one semantic state, (ii) no delay can be done when an input is offered, (iii) if an output is enabled, no conflicting input, output, or delay is allowed.

## 5.3.1.2 UPPAAL timed automata XML schema

It is important to describe the structure of a UPPAAL file as we make use of such a file next in the model differencing module in order to detect similarities and differences between the initial and the evolved behavioral models. In this respect, the UPPAAL model-checker saves a SUT model (i.e., network of timed automata) as an XML file. Its corresponding XML schema is outlined in Figure 5.3.

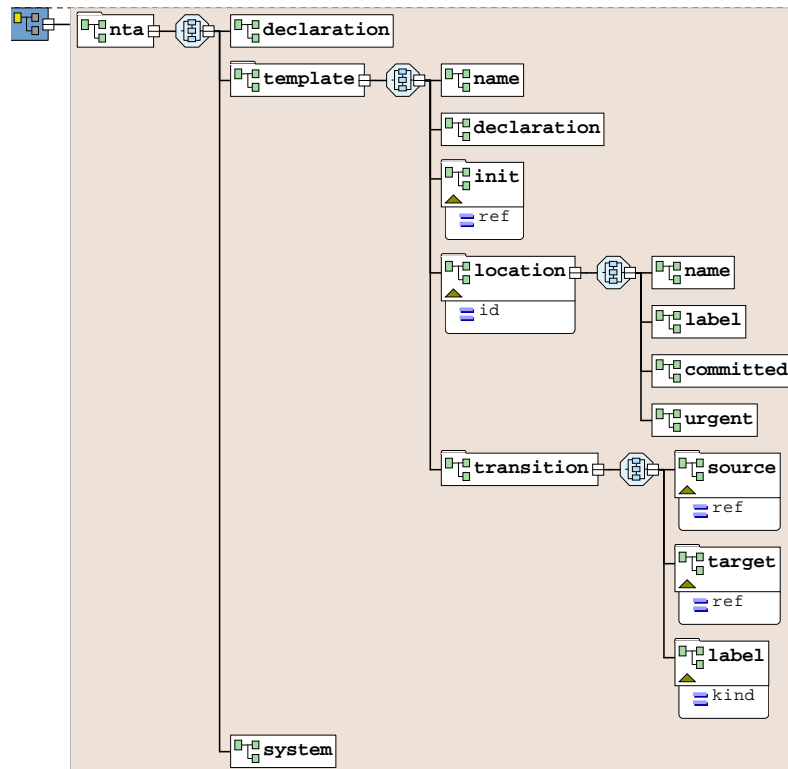

Figure 5.3: UPPAAL timed automata XML schema.

As discussed before, a model is made up of several templates  $\langle template \rangle$ . Each template denotes a single timed automaton. It is characterized by a name, a set of local variables (specified in the  $\langle declaration \rangle$  element), an initial location  $\langle init \rangle$  identified by the  $ref$  attribute, several locations and transitions. Each location has necessarily an  $id$ , a  $name$  and may contain an  $invariant$  specified in the element  $\langle label \rangle$ . Also, it can be  $urgent$  or  $committed$ . A transition has a more informative structure : a source location and a target location which are identified by their corresponding  $id$  in the  $ref$  attribute as well as one or more  $\langle label \rangle$  elements. The latter can be a  $guard$ , an  $assignment$  or a  $synchronization$ .

### 5.3.2 UPPAAL reachability analysis

The UPPAAL model-checker can be used for an offline test generation by model-checking. The main idea here is to formulate the test case generation problem as a reachability problem. To do so, UPPAAL performs a reachability analysis of the timed automata network to look for reachable states. A state is considered reachable if it can be reached from the initial state by zero or more transitions while a property is satisfied. This can be achieved by adding boolean auxiliary variables and formulating a property in which a state is reached if all variables are true [105]. For instance, the edge coverage criterion requires the definition of an auxiliary variable  $e_i$  for each edge, initially equal to false. Then, the assignment of  $e_i := true$  for each edge is also added to the model. To cover all edges in the model, the reachability property, all  $e_i$  variables are evaluated to true, is formulated as  $e_0 == true \wedge e_1 == true \wedge \dots \wedge e_n == true$ , and it must hold.

As a result, UPPAAL produces a *diagnostic trace* that satisfies the corresponding reachability property called also *witness trace*. Indeed, it supports three options for diagnostic trace generation:

- any trace leading to a state in which a property holds.
- the shortest trace leading to the goal state with the shortest path (i.e., the minimum number of transitions).
- the fastest trace leading to the goal state with the shortest execution time delay.

In these three cases, the obtained timed trace has the form

$$(S_0, E_0) \xrightarrow{\chi_0} (S_1, E_1) \xrightarrow{\chi_1} (S_2, E_2) \dots \xrightarrow{\chi_{n-1}} (S_n, E_n)$$

where  $S_i$  and  $E_i$  are respectively states of the SUT and ENV,  $\chi_i$  correspond to the synchronization actions or the time delays. As described in [104], it is possible to obtain a test sequence which is an alternating sequence of observable actions and delays from the diagnostic trace. This can be done by simply projecting the trace to the ENV part while removing invisible transitions, and summing adjacent delay actions.

### 5.3.3 Observer automata

In this section, observer automata [5], used generally to specify coverage criteria, are introduced. A coverage criterion consists of a list of items that should be “covered”. An item to be traversed or visited is called a coverage item. For example, the coverage criterion *Edge Coverage* requires

that a test case should visit all the edges of a given timed automaton. Similarly, *Location Coverage* consists in looking for a test case covering all the locations of a given automaton. Thus, an observer is mainly able to observe the execution of a test case and to report the acceptance when the coverage item is covered by the test case.

Formally, an observer automaton is a quadruple  $(\mathcal{Q}, q_0, \mathcal{Q}_f, \mathcal{B})$  where:

- $\mathcal{Q}$  is a finite set of observer locations.
- $q_0$  is the initial observer location.
- $\mathcal{Q}_f \subset \mathcal{Q}$  is a set of accepting observer locations.
- $\mathcal{B}$  is a set of edges, each of the form  $q \xrightarrow{b} q'$  where  $b$  is a predicate based on attributes of timed automata as locations, edges, variables, etc.

*Parametrization* of observers is also retained to enable the specification of several coverage criteria. In this context, a *parametrized observer* is an observer in which parameters are defined in locations or edges. Its main advantage is its great flexibility since the same observer can be used on several timed automata without making any modification on the timed automata or the observer.

Figure 5.4 outlines a parametrized observer for the coverage criterion “all edges coverage” that is presented in two notations : graphical and textual. From the graphical perspective, an observer is composed of locations and edges. Locations are labeled with a name and optional variables, and edges are labeled with predicates. We distinguish two special types of locations : the initial location represented by a black filled circle, and the accepting location represented by a double circle. Moreover, an observer has only one initial location but it can reach several accepting locations.

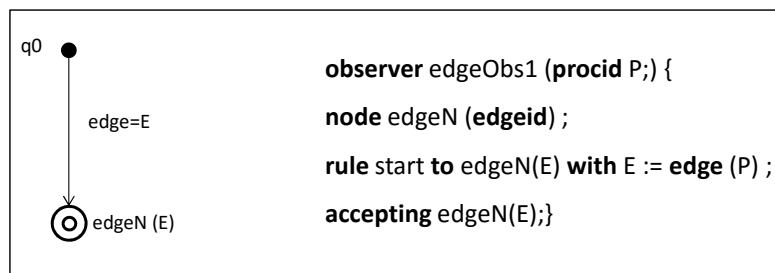

Figure 5.4: Edge coverage observer presented in both textual and graphical notations.

From the textual perspective, the observer language is introduced. As shown in Figure 5.4, the observer, named **edgeObs1**, takes as argument a set of process instances **P**. It has an initial location **start** and an accepting location **edgeN(E)** where **E** is a parameter that ranges over

edges. Note that observer parameters are represented with capital letters. They can refer to edges, locations, variables, etc. In such a case, the observer looks for collecting edges that satisfy the assignment  $\mathbf{E} := \mathbf{edge}(\mathbf{P})$ . The operation  $\mathbf{edge}(\mathbf{P})$  returns an edge of the active automaton if the automaton is a member of the set of processes  $\mathbf{P}$ . For a complete description of the observer language, we refer readers to [5].

Using this simple and general mechanism, we are able to specify the most popular coverage criteria in the literature such as “all edges”, “all locations”, “all-definition use-pairs”<sup>2</sup>[105]. Moreover, it is possible to tailor existing ones to specific features of a particular SUT.

The next sections deal with the possibility of specifying our own coverage criteria and then generating the corresponding witness traces covering new behaviors in the context of dynamically adaptable systems.

## 5.4 Differencing between behavioral models

Recall that our main objective is to produce efficiently fault revealing tests based on the evolved behavioral model and the old test suite issued from the original one. Accordingly, it is essential to identify impacted and unimpacted elements in the new model and then to change the test suite by generating new tests and adapting not only aborted tests that cannot be animated on the new model but even obsolete ones. To do so, a model differencing technique should be applied in order to capture differences and similarities between the original model and the evolved one. In this context, we have identified in the literature several approaches dealing with this issue. They have focused essentially on comparing UML diagrams [106] and finite state models [107, 108].

In this respect, we introduce a novel *Differencing Algorithm* that concisely captures differences and similarities between networks of timed automata. In such a case, two main elements are compared: locations and transitions. Firstly, we apply the code snippet depicted in the Procedure **transitionDiff** to differentiate automata at the transition level. Hence, the two transitions  $T_i$  in the initial  $\mathcal{TA}$  and  $T_j$  in the evolved  $\mathcal{TA}'$  are considered similar if the following conditions are met :

- a.  $T_i$  and  $T_j$  have the same source and target locations, and
- b. they have the same values in the guard, assignment and synchronization fields.

The procedure takes as input two array lists including transitions of two timed automata :  $\mathcal{TA}$  and  $\mathcal{TA}'$ . For each transition in the initial automaton, we firstly check its presence within

---

<sup>2</sup>It is a data flow criterion which looks for definition-clear paths from the definition to the use of individual variables.

the evolved one (see line 3). From a technical point of view, this condition is checked by looking for an equivalent transition in the evolved model having similar source location  $id$  and target location  $id^3$ . As long as this condition is satisfied, we look for meeting conditions defined above meaning that they have the same source and target locations (i.e., name, label, committed, and urgent) and unchanged transition labels (i.e., guard, assignment and synchronization).

---

**Procedure** TRANSITIONDIFF(IN  $list\_T1$ ,  $list\_T2$ , OUT  $list\_Colored\_T$ ).

---

```

1 begin
2   foreach transition in list_T1 do
3     if (exists(transition, list_T2) then
4       if (getSource(transition,  $\mathcal{TA}$ )==getSource(transition,  $\mathcal{TA}'$ ) and
5         getTarget(transition,  $\mathcal{TA}$ )==getTarget(transition,  $\mathcal{TA}'$ ) and
6         getlabel(transition,  $\mathcal{TA}$ )==getlabel(transition,  $\mathcal{TA}'$ ) then
7           transition.color=Green;
8         add (transition, list_Colored_T);
9       else
10          transition.color=Yellow;
11        add (transition, list_Colored_T);
12      end
13    end
14  end
15  foreach transition in list_T2 and not in list_T1 do
16    transition.color=Red;
17    add (transition, list_Colored_T) ;
18  end
19 end

```

---

As a result, the transition is considered unmodified and it is marked in Green (see lines 5-6). If at least one condition is not respected, the transition is considered modified and it is marked in Yellow (see lines 8-9). New transitions which exist only in the evolved model are finally marked in Red (see lines 13-16). If a transition in  $\mathcal{TA}$  does not have an equivalent in the new timed automaton  $\mathcal{TA}'$ , then this transition is not copied in the final array list because it is considered as a removed transition. The output of this procedure is an array list containing all marked transitions (unmodified, modified and new ones).

Hereafter, we consider a simple example of the initial and the evolved models shown in Figure 5.5 with the aim of illustrating all the given procedures and algorithms. At the beginning, we apply the Procedure **transitionDiff** to the above models. As a result, we obtain colored transitions illustrated within the model in Figure 5.6 in which the new transitions (i.e., T9, T10

---

<sup>3</sup>Within UPPAAL, each location is identified by a unique  $id$ . We assume here that each transition is identified by a couple items : its source  $id$  and its target  $id$ .

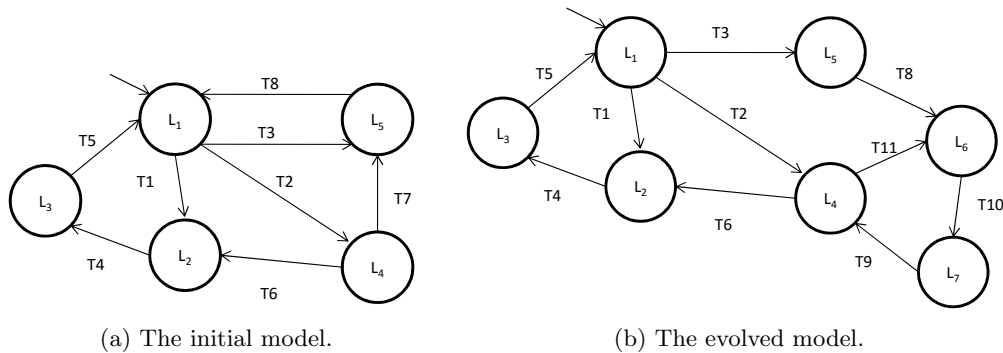

Figure 5.5: An example of initial and evolved models.

and T11) are marked in Red, the modified transition T8 (i.e., its target location is changed) is colored in Yellow and the preserved transitions like T1, T2, T3, T4, T5 and T6 are colored in Green. Finally, we notice that T7 is removed as depicted in the evolved model (see Figure 5.5b).

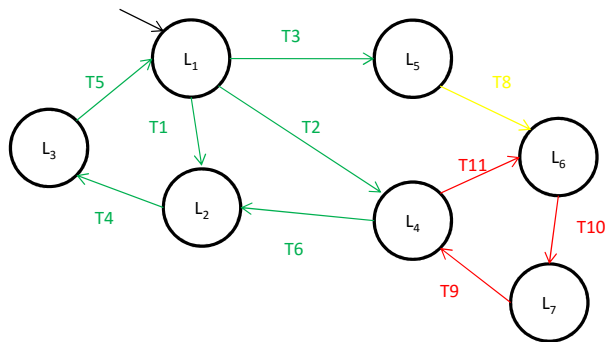

Figure 5.6: Output of the transitionDiff procedure.

Following the same logic, we compare locations in both models by applying Procedure **locationDiff**. Two locations  $l_i$  in  $\mathcal{TA}$  and  $l_j$  in  $\mathcal{TA}'$  are considered similar if the following conditions are satisfied :

- a.  $l_i$  and  $l_j$  have the same name and the same identifier,
- b. they have the same incoming and outgoing transitions, and
- c. they have the same invariant expression.

Whenever these conditions hold as expressed in line 4, the location is copied in *list\_Colored\_L* and colored in Green (see lines 5-6). The location is marked as changed and colored in Yellow if at least one of these conditions are not met (see lines 8-9). If an old location has no equivalent one in the new model, then this location is not copied in the final array list as it is considered as a removed location. On the contrary, if a location in the new model does not have equivalent location in the initial model then it has to be added to *list\_Colored\_L* and marked in Red (see



lines 13-16).

---

```

Procedure LOCATIONDIFF(IN list_L1, list_L2, OUT list_Colored_L).

---

1 begin
2   foreach location in list_L1 do
3     if (exists(location, list_L2)) then
4       if (getTranIN(location, TA)==getTransIN(location, TA') and
5         getTransOUT(location, TA)==getTransOUT(location, TA') and
6         getNameID(location, TA)==getNameID(location, TA') and
7         getlabel(location, TA)==getlabel(location, TA')) then
8           location.color=Green;
9           add (location, list_Colored_L);
10        else
11          location.color=Yellow;
12          add (location, list_Colored_L);
13        end
14      end
15    end
16  foreach location in list_L2 not in list_L1 do
17    location.color=Red;
18    add (location, list_Colored_L);
19  end

```

---

The result of applying this procedure to the example already introduced is depicted in Figure 5.7. New locations like L6 and L7 are marked in Red. Locations L1, L2 and L3 are unchanged and colored in Green. Since the incoming and outgoing transitions are changed, locations L4 and L5 are modified and then colored in Yellow.

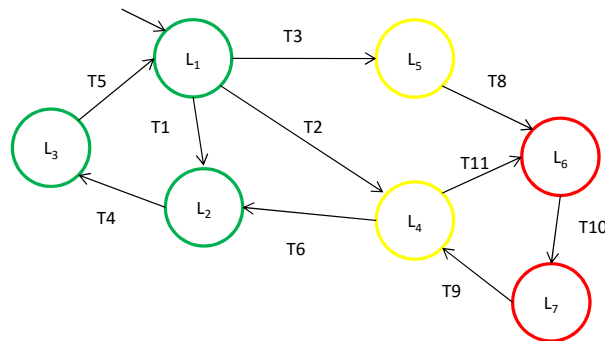

Figure 5.7: Output of the locationDiff procedure.

Remember that the SUT is generally modeled by a network of timed automata. Thus, it is necessary to apply these procedures for each timed automaton in the network. In this context, Algorithm 5.1 is introduced with the purpose of discovering similarities and differences among each  $\mathcal{TA}$  (i.e., template with the UPPAAL notation) in the initial and the evolved mod-

els. Accordingly, it produces a new model called  $\mathcal{M}_{diff}$  that pinpoints changed and unchanged elements.

---

**Algorithm 5.1:** Model differencing algorithm.

---

**Input:**  $\mathcal{M}$  and  $\mathcal{M}'$  : UPPAAL XML files

**Output:**  $\mathcal{M}_{diff}$  : UPPAAL XML file highlighting changed and unchanged elements.

```

1 begin
2   foreach template in  $\mathcal{M}'$  do
3     get_transitions_locations(template, list_T2, list_L2);
4     if exist(template,  $\mathcal{M}$ ) then
5       get_transitions_locations(template, list_T1, list_L1);
6       // Identification of template similarities and differences
7       transitionDiff(list_T1, list_T2, list_Colored_T);
8       locationDiff(list_L1, list_L2, list_Colored_L);
9     else
10      // It corresponds to a new template in the new model  $\mathcal{M}'$ 
11      newTemplate(template, list_Colored_L, list_Colored_T);
12    end
13    int col=1;
14    // update the col variable with response to transition and location
15    status
16    foreach transition in list_Colored_T do
17      if transition.color==Green and transition.source.color==Green and
18      transition.target.color== Green then
19        addAssignement(transition, col:=col*1);
20      else if transition.color== Red or transition.source.color==Red or
21      transition.target.color== Red then
22        addAssignement(transition, col:=col*0);
23      else
24        addAssignement(transition, col:=col*2);
25      end
26    end
27    Tempdiff=ColoredTemplate(list_Colored_L, list_Colored_T);
28    addTemplate(Tempdiff,  $\mathcal{M}_{diff}$ );
29  end
30 end

```

---

From line 2 to line 7, Procedures **transitionDiff** and **locationDiff** are called for each template that exists in both models. If the template exists only in  $\mathcal{M}'$ , all locations and transitions are considered new and they are marked in Red (see line 9). The colored model includes a new variable called *col* initially equal to 1. This variable is updated in response to the performed modification and it is required for delimiting critical zones in the model (i.e., new and modified elements). If the target and the source locations as well as the transition labels are marked in

Green, the  $col$  variable associated with this transition is multiplied by one (i.e.,  $col := col * 1$ ), see lines 13-14. Similarly, if the transition labels, the source or the target location are colored in Yellow, the  $col$  variable is multiplied by two (i.e.,  $col := col * 2$ ), see line 18. Otherwise, they are newly added and then colored in Red. Consequently, the  $col$  variable is multiplied by zero (i.e.,  $col := col * 0$ ), see lines 15-16. An illustration of applying the model differencing algorithm on the running example is given in Figure 5.8.

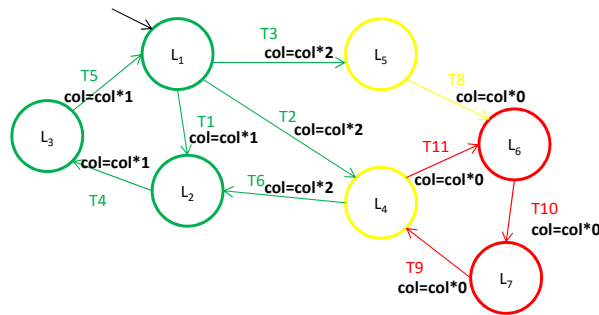

Figure 5.8: Output of the model differencing algorithm.

## 5.5 Old test suite classification

Inspired from the test classification proposed by Leung et al. [31], we introduce in this section a new test classification algorithm in which the old test suite generated from the original model  $\mathcal{M}$  is analyzed and then partitioned into :

- Reusable test set  $T_{Ru}$  : valid traces that traverse unimpacted items by the change.
- Retestable test set  $T_{Rt}$  : valid traces that traverse impacted items by the change.
- Aborted test set  $T_{Ab}$  : invalid traces that cannot be animated on the new model because they cannot traverse modified items.
- Obsolete test set  $T_{Ob}$  : invalid traces that cannot be animated on the new model because they traverse removed items.

For that aim, each trace in the  $\mathcal{TR}$  set should be animated on the  $\mathcal{M}_{diff}$  model and its covered items should be identified, as depicted in Algorithm 5.2. Two scenarios are then tackled. On the one hand, the test animation on the new model is achieved successfully, see line 4. If the *trace* traverses unchanged items (locations and transitions marked in Green), it is classified as a *reusable test*, see lines 5-6. Otherwise, it is classified as a *retestable test* (i.e., in case of modified items, colored in Yellow), see lines 7-8.

On the other hand, the test animation on the new model is abandoned, see line 10. If this abort is due to some removed items which are no longer available in the new model, the *trace* is seen as an obsolete test and it should be automatically discarded from the new test suite, see lines 11-12. Otherwise, this abort can be due to a modified transition which cannot be reached any more. In such a case, the *trace* is classified as an *aborted test*.

---

**Algorithm 5.2:** Test classification algorithm.

---

**Input:** Old test traces  $\mathcal{TR}$  and  $\mathcal{M}_{diff}$ .

**Output:**  $T_{Ru}$ ,  $T_{Rt}$ ,  $T_{Ab}$  and  $T_{Ob}$ .

```

1 begin
2   foreach trace in  $\mathcal{TR}$  do
3     coveredItemsList = get_CoveredItems(trace);
4     if isExercisedPath(coveredItemsList)=true then
5       // Test animation on the  $\mathcal{M}_{diff}$  succeeds
6       if VerifColor(coveredItemsList)= Green then
7         | trace  $\in T_{Ru}$  ;
8       else
9         | trace  $\in T_{Rt}$  ;
10      end
11    else
12      // Test animation on the  $\mathcal{M}_{diff}$  fails
13      if not exist(coveredItemsList,  $\mathcal{M}_{diff}$ ) then
14        | trace  $\in T_{Ob}$  ;
15      else
16        | trace  $\in T_{Ab}$ 
17      end
18    end
19  end
20 end

```

---

Consider the example already introduced in Section 5.4. We assume that the old test suite, issued from the initial model illustrated in Figure 5.5a, is available. For instance, a test covering transitions T1, T4 and T5 is classified as a reusable test because it covers unimpacted parts of the model. Moreover, a test covering, for example, transitions T3 and T8 can be classified as retestable test if it can be animated on the evolved model. Otherwise, it is seen as an aborted test. Since T7 is removed from the evolved model, the old test covering transitions T2, T7 and T8 is considered obsolete. Finally, we conclude that some new tests have to be generated especially those that cover critical regions in the new model (i.e., Red locations and transitions). This issue is tackled in the next section.

## 5.6 Test generation and recomputation

Our approach identifies critical regions in the evolved model not only by marking added locations and transitions in Red but also by detecting old traces that cannot be animated on the new model. Consequently, the  $\mathcal{M}_{diff}$  is used in this stage to generate new tests and adapt aborted and obsolete ones in a cost effective manner.

### 5.6.1 Test generation

To generate new tests covering newly added behaviors, we are based on the findings of Blom et al. [5], which express coverage criteria by using observer automata with parameters and formulate the test generation problem as a search exploration problem. Instead of adding auxiliary variables to enable the expression of a coverage criterion as a reachability property using UPPAAL, the superposition of an observer onto timed automata is supported.

Formally, this superposition of an observer  $(\mathcal{Q}, q_0, \mathcal{Q}_f, \mathcal{B})$  onto a timed automaton  $(L, l_0, \text{Act}, \mathcal{C}, I, E)$  is defined as follows :

- States have the form of  $\langle (l, \sigma) \mid \mathcal{Q} \rangle$  where  $(l, \sigma)$  is a state of the timed automaton, and  $\mathcal{Q}$  is a set of locations of the observer.
- The initial state is denoted by  $\langle (l_0, \sigma_0) \mid q_0 \rangle$  where  $(l_0, \sigma_0)$  corresponds to the initial state in the automaton and  $q_0$  is the initial location of the observer.
- The computation step is defined as follows :  $\langle (l, \sigma) \mid \mathcal{Q} \rangle \rightsquigarrow \alpha \langle (l', \sigma') \mid \mathcal{Q}' \rangle$  if  $(l, \sigma) \xrightarrow{\alpha} (l', \sigma')$  and  $\mathcal{Q}' = \{q' \mid q \xrightarrow{b} q' \text{ and } q \in \mathcal{Q} \text{ and } (l, \sigma) \xrightarrow{\alpha} (l', \sigma') \models b\}$ , where  $b$  is a predicate on the observer edge satisfied by the timed automaton transition  $(l, \sigma) \xrightarrow{\alpha} (l', \sigma')$ .
- A state  $\langle (l, \sigma) \mid \mathcal{Q} \rangle$  of the superposition covers the coverage item  $q_f \in \mathcal{Q}_f$  if  $q_f \in \mathcal{Q}$ .

Based on this technique, Blom et al. consider the issue of covering a coverage item  $q_f \in \mathcal{Q}$  as the problem of finding a trace having the following form :

$$tr = \langle (l_0, \sigma_0) \mid q_0 \rangle \xrightarrow{\alpha} \dots \xrightarrow{\alpha'} \langle (l, \sigma) \mid \mathcal{Q} \rangle \text{ with } q_f \in \mathcal{Q}$$

They propose an abstract breadth-first search exploration algorithm (see Algorithm D.2 in Appendix D) that produces the word of the trace  $tr$ :  $w(tr) = \alpha \dots \alpha'$ . Note that the obtained trace covers a maximum number of accepting locations of the observer.

The test generation tool UPPAAL CO $\sqrt$ ER [109] supports the concept of observers and the test case generation algorithm [110]. This efficient test suite generator is adopted in this thesis

to realize a selective test generation approach when behavioral adaptations occur. The key idea is to formulate an observer that monitors only new regions in the evolved model.

Listing 5.1 highlights the use of the formal specification language of observer automata to express a customized edge coverage criterion. The latter, named **Obs**, takes two arguments: process instances having **procid** as type and a **varid** variable from the model. In line 2, we define the location **edgeN** with the type of its variable. Then, we define the edges and their associated guards (see line 3). Based on two predefined macros used as guards on edges (i.e., **edge(procid)** and **eval(varid)**), the proposed observer monitors all different edges  $E$  from the set of processes  $P$  while the assignment  $E:=\mathbf{edge}(P)$  is evaluated to *true* and the variable *col* is evaluated to 0. Finally, the last line indicates that the location **edgeN** is considered as an accepting location.

```

1 observer Obs (procid P;varid col;) {
2   node edgeN (edgeid, varid) ;
3   rule start to edgeN(E, col) with E:=edge(P), eval(col)==0 ;
4   accepting edgeN;
5 }

```

Listing 5.1: Customized edge coverage criterion.

A test sequence satisfies this coverage criterion if when executed on the model it traverses at least one new edge where the *col* variable is updated to zero.

## 5.6.2 Test recomputation

At this stage, the new test suite  $\mathcal{N}\mathcal{T}\mathcal{S}$  contains reusable, retestable and new tests.

$$\mathcal{N}\mathcal{T}\mathcal{S} = T_{Ru} \cup T_{Rt} \cup T_{New}$$

With the aim of enhancing the overall coverage rate and obtaining valid tests covering critical regions on the evolved model, the Algorithm 5.3, which adapts either aborted or obsolete tests, is introduced. As mentioned before, the test animation on the evolved model may not be achieved due to some removed or modified items (i.e., locations or transitions) that cannot be traversed anymore. The key idea here consists in starting the test recomputation not from the initial state of the evolved model but from the last reachable state detected during the test animation. To do so, it takes as inputs the current test suite  $\mathcal{N}\mathcal{T}\mathcal{S}$ , the evolved model  $\mathcal{M}_{diff}$ , the valid sub-trace  $\mathcal{T}\mathcal{R}$  from a given aborted trace (respectively obsolete trace) and the last reached state. Next, it looks for the adjacency matrix of each timed automaton in  $\mathcal{M}_{diff}$  (see line 2). Then, it explores the state space while generating all sub-paths that start from the given state and reach the

initial one (see line 3). For each sub-path, an adapted trace is obtained and added to the  $\mathcal{N}\mathcal{T}\mathcal{S}$  test suite while verifying that the test redundancy is avoided (see lines 3-9).

---

**Algorithm 5.3:** Test recomputation algorithm.

---

**Input:**  $\mathcal{M}_{diff}$ : the evolved model,  $\mathcal{T}\mathcal{R}$ : the valid sub-trace from a given aborted/obsolete trace,  $state$ : the last reached state,  $\mathcal{N}\mathcal{T}\mathcal{S}$ : the new test suite.

**Output:**  $\mathcal{N}\mathcal{T}\mathcal{S}$ : the new test suite.

```

1 begin
2    $\mathcal{A}$  = lookForAdjacencyMatrix( $\mathcal{M}_{diff}$ );
   // get all sub-paths that start from the given state and reach the
   // initial state.
3   ArrayList sub-paths = explore( $\mathcal{A}$ , state, init);
4   foreach path in sub-path do
5     adaptedT =  $\mathcal{T}\mathcal{R} \cup path$ ;
6     if VerifRedundancy(adaptedT,  $\mathcal{N}\mathcal{T}\mathcal{S}$ ) then
7       |  $\mathcal{N}\mathcal{T}\mathcal{S} \cup adaptedT$ ;
8     end
9   end
10  return  $\mathcal{N}\mathcal{T}\mathcal{S}$ ;
11 end
```

---

The greatest added value of this technique is not only the decrease of the test generation cost but also its ability to create a test suite based on the kind of change (i.e., made up of reusable, retestable, new and adapted tests).

$$\mathcal{N}\mathcal{T}\mathcal{S} = T_{Ru} \cup T_{Rt} \cup T_{New} \cup T_{Ad}$$

If the obtained test suite is still large, a test prioritization strategy can be adopted. In that case, a high priority should be attributed to tests that cover critical zones on the evolved model such as new and adapted tests.

## 5.7 Test case concretization

Before introducing our proposed transformation rules that we use to derive TTCN-3 test cases from the abstract test sequences which have been newly generated from UPPAAL CO $\sqrt$ ER, we give a brief overview of exiting research dealing with this issue.

### 5.7.1 Related work on transforming abstract tests to TTCN-3 notation

In the last decade, several researchers have paid more attention to automatic test case generation, more particularly to the concretization and the execution of abstract test suites

[111, 112, 113, 114, 115, 116]. We can mention, for instance, the approach in [115] which describes the generation of TTCN-3 test suites specifically for the *Session Initiation Protocol* without using formal specifications. The obtained test case generator is included in a commercial tool developed by Ericsson.

Deriving executable tests from UML 2.0 models was proposed by [114]. Based on a commercial tool<sup>4</sup> usually used for interoperability testing of healthcare applications, this work generates TTCN-3 test behaviors from UML sequence diagrams whereas TTCN-3 test data are generated from two eHealth standards, namely *Health Level 7* which is generally used for data representation and *Integrating Healthcare Enterprise* which is used for describing interactions between medical devices. Similarly, the approach in [112] shows the translation of *Message Sequence Charts* elements to the TTCN-3 notation.

Following the same principles of model-driven engineering, [117] proposes an approach that deals with the model transformation of *UML 2.0 Test Profile (U2TP)*<sup>5</sup> elements into an executable test code. Within this work, U2TP is adopted as a modeling language for the test case specification. Then, the models are transformed to the TTCN-3 language.

To our best knowledge, only the works in [113, 116] handle the derivation of TTCN-3 test cases from abstract test sequences which are generated from finite state machines. In this context, authors in [113] make use of another variant of UPPAAL called UPPAAL CORA<sup>6</sup>. Similar to our approach, they obtain witness traces from extended finite state machines and perform their derivation to TTCN-3 notation. Also, the approach presented in [116] is close to our proposal as it deals with a variant of timed automata called *Labeled-Ports Timed Input/Output Automata*. The latter formalism is used to model the different port behaviors in a given multi-port system. Then, a test generation algorithm is proposed and the obtained test cases are transformed into TTCN-3 language.

Since there are no available tools which are able to realize automatically the mapping of test sequences, generated from formal specifications based on timed automata, to the TTCN-3 notation, we have to develop our own transformation rules as outlined in the following subsection.

### 5.7.2 Transformation rules from abstract test sequences to TTCN-3

At this stage, we define several rules to derive TTCN-3 test cases from abstract test sequences (see Table 5.1) [118]. First of all, we assume that for each test suite, a TTCN-3 module should be generated (**R1**).

---

<sup>4</sup><https://www.seppmed.de/produkte/mbtsuite.html>

<sup>5</sup>U2TP is an extension of UML 2.0 with test specific concepts such as test components, test behaviors, etc.

<sup>6</sup><http://people.cs.aau.dk/adavid/cora/>



Table 5.1: TTCN-3 transformation rules.

| Rules     | Abstract concepts                                   | TTCN-3 concepts        |
|-----------|---|------------------------|
| <b>R1</b> | a test suite  | a TTCN-3 module        |
| <b>R2</b> | a single trace                                      | a TTCN-3 test case     |
| <b>R3</b> | Time dependent behavior                             | a timer definition     |
| <b>R4</b> | a test sequence in the form of input! delay output? | a TTCN-3 test behavior |
| <b>R5</b> | each involved TA                                    | a PTC component        |
| <b>R6</b> | each channel  | a template             |

Recall that within the TTCN-3 standard, the module concept is used as a top-level structure. As highlighted in Listing 5.2, it is divided into a definition part and a control part. The first part includes definitions of test data, templates, test components, functions, communication ports, test cases and so on. The second part is usually used to describe the execution sequence of test cases<sup>7</sup>.

```

1 module MyModuleName {
2     //Module definition part
3 }
4 control{
5     //Module control part
6 }

```

Listing 5.2: TTCN-3 module structure.

Next, we deal with the generation of the TTCN-3 test configuration which is composed of several test components with well-defined communication ports and an abstract test system interface (see Figure 4.6). A test component can be either a Main Test Component (MTC) or a Parallel Test Component (PTC). Remember that the MTC is charged with creating PTC components and executing TTCN-3 test cases. To do so, a port must be defined in order to specify a *Point of Control and Observation* via which the test component can interact with other components and with the SUT. To specify time delays, TTCN-3 supports a timer mechanism (**R3**). Timers can be declared in component type definitions, the module control part, test cases, functions and altsteps. The channels declared in the UPPAAL XML file are transformed into TTCN-3 templates<sup>8</sup> (**R6**).

Listing 5.3 describes the definitions that we generate for several kinds of components. From line 4 to 13, an MTC component type and a PTC component type are declared. In each declaration, a port instance is defined. For simplicity reasons, we define a single port type for

<sup>7</sup>For further details about the TTCN-3 core language, see Appendix A

<sup>8</sup>A TTCN-3 template is a special kind of data structure that declares test data to be sent or received over the test ports.

both MTC and PTC components (see lines 1-3). The **message** keyword declares that the port is used for message-based communication<sup>9</sup>. In this context, we assume that several incoming and outgoing messages are allowed by using the keyword **inout all**. However, it should be noted that the restriction of message direction is supported by the TTCN-3 standard (for instance by using keywords like **in** or **out**). Moreover, an abstract test system interface is defined similarly to a component definition. It includes a list of all possible communication ports through which the test system is connected to the SUT (see lines 14-17).

```

1  type port myPortName message {
2      inout all;
3  }
4  type component MyMTCType
5  {
6      port myPortName mtcPort;
7      timer T; // in case of time-dependent behavior
8  }
9  type component MyPTCType
10 {
11     port myPortName ptcPort;
12     timer T; // in case of time-dependent behavior
13 }
14 type component MySystemType
15 {
16     port myPortName systemPort;
17 }

```

Listing 5.3: Component and port definitions.

Once the test configuration is generated, we look for the mapping of the abstract test sequences to test cases. As stated in Table 5.1, for each test behavior in the form of *input! delay output?*<sup>10</sup> a TTCN-3 function is derived (**R4**). As shown in Listing 5.4, the timer is initialized with a delay value (see line 2). After emitting the input, the timer is started (see lines 3-4). If the test component receives the expected output without exceeding the maximum delay, a pass verdict is produced (see lines 6-8). Otherwise, a fail verdict is obtained (see lines 9-14).

```

1  function f_tci() runs on MyPTCType {
2      T:=delay;
3      ptcPort.send(inputi)
4      T.start;
5      alt{
6          [] mtcPort.receive(outputi){

```

<sup>9</sup>Note that the procedure-based communications is also allowed by TTCN-3 standard but it is out the scope of this thesis.

<sup>10</sup>We write *input!* and *output?* (instead of *input?* and *output!*) since, with respect to the tester, an input is emitted to the SUT and then an output is received from the SUT.

```

7     setverdict (pass);
8     }
9     [] mtcPort.receive {
10    setverdict (fail);stop;
11    }
12    [] T.timeout{
13    setverdict (fail);stop;
14    }
15 }}

```

Listing 5.4: A generated TTCN-3 function for a single test behavior.

Moreover, for a single trace (i.e., an abstract test sequence), a test case is generated (**R2**). As shown in Listing 5.5, its execution is handled by an MTC component which creates the involved PTC components (see lines 4, 10 and 14). Then, the communication is established between the PTC ports and the System ports (see lines 6, 11 and 15). Finally, a sequence of calls to the already generated TTCN-3 functions is performed (see lines 8, 12 and 16).

```

1 testcase tc_1() runs on MyMTCType system systemType {
2 var MyPTCType ptc1,..., ptc_i,..., ptc_n;
3 // create the PTCs
4 ptc1:= MyPTCType.create("ptc1");
5 //map the PTCs to the system port
6 map(ptc1:ptcPort, system:systemPort);
7 //start the PTC's behavior
8 ptc1.start(f_tc1()); ptc1.done;
9 ...
10 ptc_i:= MyPTCType.create("ptc_i");
11 map(ptc_i:ptcPort, system:systemPort);
12 ptc_i.start(f_ptc_i()); ptc_i.done;
13 ...
14 ptc_n:= MyPTCType.create("ptc_n");
15 map(ptc_n:ptcPort, system:systemPort);
16 ptc_n.start(f_tc_n()); ptc_n.done;
17 }

```

Listing 5.5: A generated test case for an abstract test sequence.

With the aim of executing all generated test cases, the module control part includes the call of each one as depicted in Listing 5.6.

```

1 control{
2     execute (tc_1());
3     ...
4     execute (tc_n());
5 }

```

Listing 5.6: The generated module control part.

To compile the obtained test cases, the TThree compiler [119] is used. It transforms the *Abstract Test Suite* into an *Executable Test Suite*. Then, our TT4RT test system can be used for test isolation and execution purposes.

## 5.8 Summary

The contributions presented in this chapter are many-fold. First, we defined a model differencing algorithm that highlights similarities and differences between an original behavioral model and the evolved one, generally obtained after behavioral adaptations. Second, we provided a test classification algorithm that selects efficiently reusable and retestable tests, identifies aborted tests and discards obsolete ones. These two steps are responsible for identifying critical regions in the evolved model that need to be covered by newly generated tests. For this purpose, we specified our own coverage criteria based on the observer automata language and we used the well-established tool UPPAAL model-checker and its extension UPPAAL CO $\sqrt$ ER for generating new tests. Also, a test recomputation algorithm was introduced with the aim of adapting aborted and obsolete tests. Finally, the mapping of the abstract test sequences to the TTCN-3 notation was handled.

To demonstrate the feasibility of these contributions, the next chapters are devoted to show their implementation details and their applications to two case studies.

## Part III

---

### Prototype Implementation and Case Studies

---

---

## Prototype Implementation

---

### 6.1 Introduction

The runtime validation approach introduced in Chapter 4 and Chapter 5 helps test engineers to automate the runtime testing process from the test generation phase until the test execution and evaluation phase. As discussed before, the main concern of this thesis consists in reducing the side effects of runtime testing on the running system, on its performance and also on its execution environment. To demonstrate the achievement of this objective, this chapter deals with the implementation details of the proposed approach either when structural adaptations or behavioral adaptations take place. To this end, we provide a *Runtime Testing Framework for Adaptable and Distributed Systems* (RTF4ADS) that gathers the different modules already introduced in Section 4.2 and Section 5.2. Thus, Section 6.2 summarizes from a technical point of view the different constituents of RTF4ADS. Next, each implemented graphical user interface is illustrated in Sections 6.3, 6.4 and 6.5. Finally, Section 6.6 summarizes the chapter. Parts of this chapter have been published in [30, 33].

### 6.2 RTF4ADS overview

Getting confidence in dynamic and distributed software systems can be reached by using RTF4ADS as a resource aware and platform independent test support. On the one hand, resource awareness is achieved by distributing selected tests according to available resources and connectivity constraints of the final execution nodes. On the other hand, platform indepen-

dence is reached using the TTCN-3 standard. Remember that this test standard provides a text-based language that inherits the most important programming features and includes some specific concepts related to the testing domain. Its strength lies essentially in its reference test architecture that automates test execution and more particularly in its test adaptation layer. The latter comprises Coding-Decoding entity, Test Adapter entity and Platform Adapter entity that supply means to adapt the communication and the time handling between the SUT and the test system in a loosely-coupled manner.

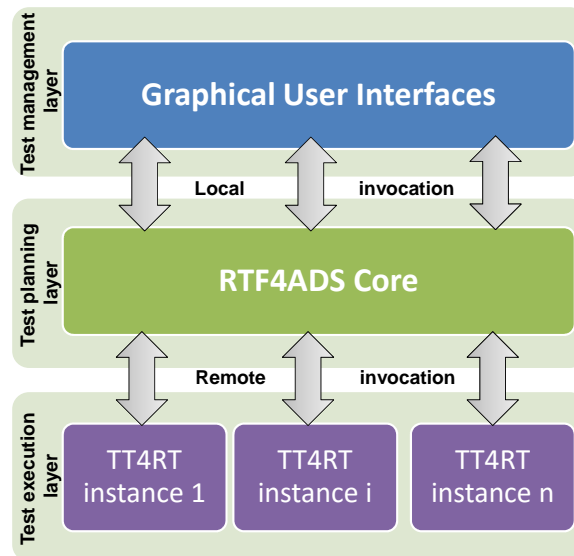

Figure 6.1: RTF4ADS prototype.

As depicted in Figure 6.1, this Java-based framework comprises three layers :

- At the test management layer, Graphical User Interfaces (GUI) are provided to handle automatically the different phases of the runtime testing process.
- At the test planning layer, the RTF4ADS core includes modules that contribute efficiently to the test generation, the test selection and the test distribution steps.
- At the test execution layer, several TT4RT instances are deployed and charged with first applying test isolation mechanisms and second executing runtime tests.

In the following, we introduce each GUI while presenting its corresponding involved modules.

### 6.3 Test selection and distribution GUI

The GUI component, illustrated in Figure 6.2, is used by the Test System Coordinator<sup>1</sup> to plan the execution of runtime tests in a cost effective manner. It is responsible for analyzing SUT

<sup>1</sup>Recall that TSC is a test manager charged with starting the runtime testing process after the occurrence of a dynamic reconfiguration action.

dependencies, selecting test cases to rerun and looking for a test component placement solution for the involved main test components while fitting resource and connectivity constraints.

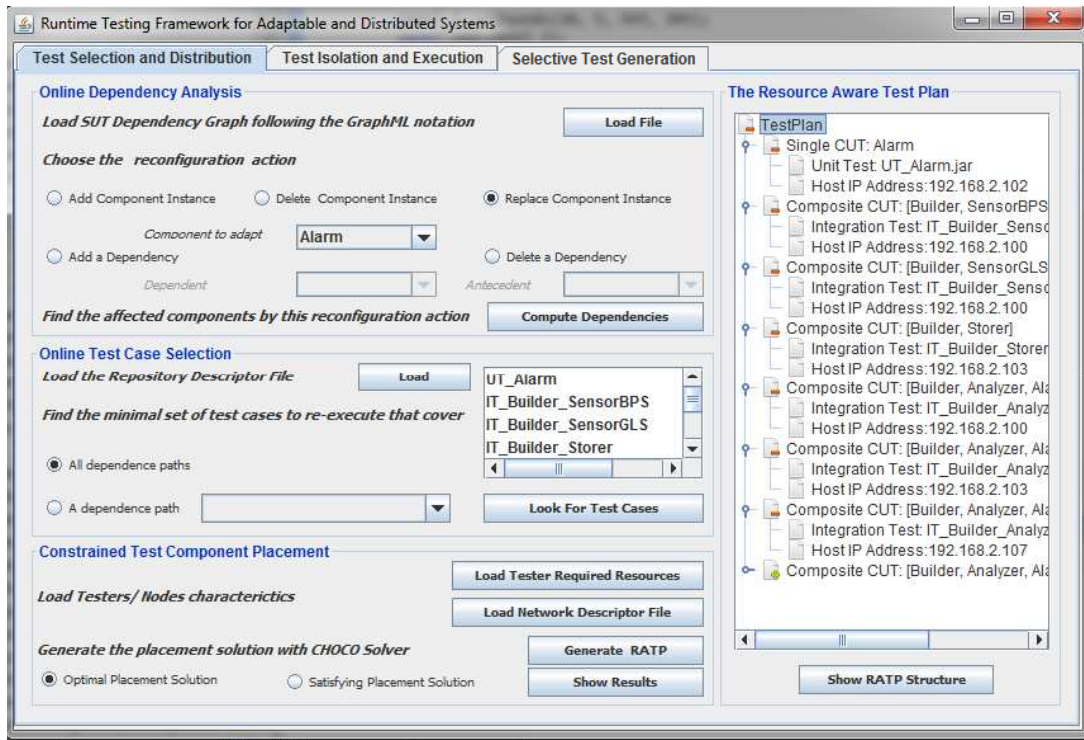

Figure 6.2: Screenshot of the test selection and distribution GUI.

The first panel shows the implementation of the online dependency analysis module. It takes as inputs the performed reconfiguration action and a file that describes the system dependency graph. The latter is expressed in the *Graph Markup Language* (GraphML). Indeed, GraphML notation [120] is an XML-based file format for graphs. It consists of a language core to describe the structural properties of a graph and a flexible extension mechanism to add application-specific data.

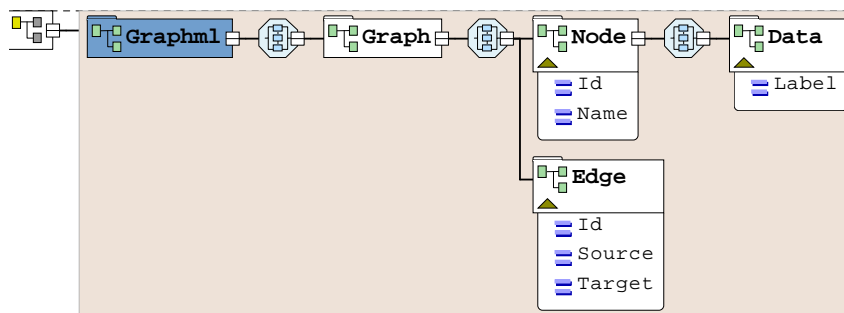

Figure 6.3: XML schema of the system dependency graph.

Figure 6.3 illustrates the XML schema of the GraphML file which is basically composed of a GraphML element and a variety of sub-elements such as graph, node and edge. In our context, nodes represent components and edges represent component dependencies. As illustrated in



Figure 6.4, this module generates the affected parts of the system that have to be validated (i.e., single components, composite components).

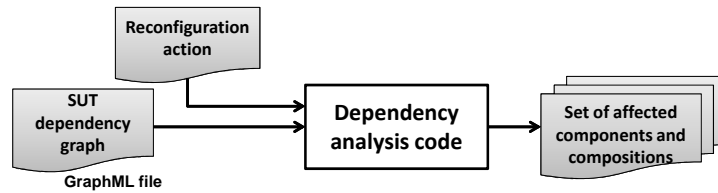

Figure 6.4: Online dependency analysis inputs and outputs.

The second panel corresponds to the implementation of the test case selection module which requires two major inputs, as depicted in Figure 6.5.

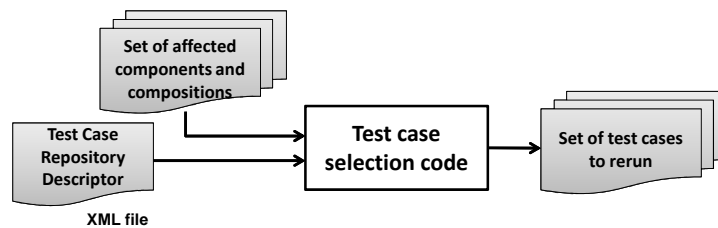

Figure 6.5: Online test case selection module inputs and outputs.

The first input is the *Test Case Repository Descriptor* that expresses, for each test stored in the repository, data like identifiers, names, artifacts, MTC components, required resources, etc. Its XML schema is outlined in Figure 6.6. The second one is the set of affected components and compositions obtained from the last step. Remember that the main goal at this stage is to look for a minimal set of test cases to run following the already defined naming convention between test names and component/composition names (See Chapter 4 Section 4.4).

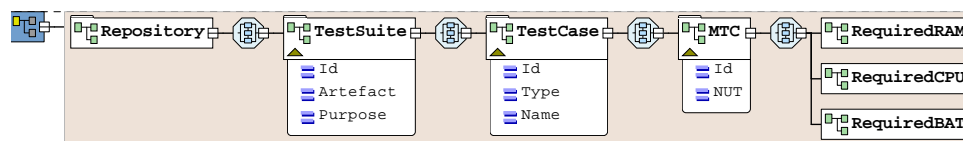

Figure 6.6: XML schema of the test case repository descriptor.

The third panel is used to distribute TTCN-3 tests and their corresponding MTC components to the execution nodes while respecting already defined resource and connectivity constraints. To solve such a problem, the outputs generated from the last steps such as single components under test (respectively composite components under test), their associated unit tests (respectively integration tests), their main test components and their required resources are given as input (see Figure 6.7).

The *Execution Environment Descriptor* that includes the network topology, especially the

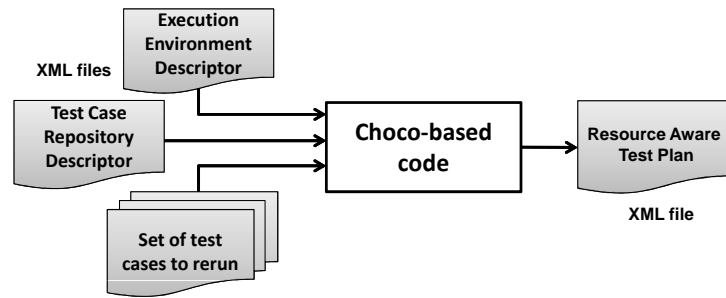

Figure 6.7: Constrained test component placement module inputs and outputs.

node and the link characteristics (i.e., identifier, name, device, provided resources, bandwidth, etc.), is involved in this step, as well. An XML schema of this file is illustrated in Figure 6.8.

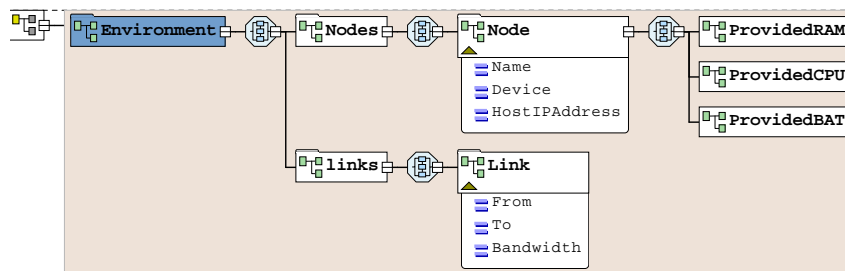

Figure 6.8: XML schema of the execution environment descriptor.

The core of the last module is based on the Choco Java library which is an open source software offering a problem modeler and a constraint programming solver [25]. Among several existing solvers like GeCoDe<sup>2</sup> and CPLEX<sup>3</sup>, Choco is selected because it is one of the most popular within the research community. Also, it offers a reliable and stable open source Java library widely used in the literature to solve combinatorial optimization problems [121, 122].

Due to all these features, Choco is retained in this thesis to model and to solve the test placement problem while fitting several resource and connectivity constraints. First, we make use of the Choco Java library to translate the mathematical representation of the test placement problem into the Choco-based code. Second, we use it to solve this problem in both modes : in a satisfaction mode by computing a feasible solution or in an optimization mode by looking for the optimal solution.

As shown in Listing 6.1, we create a *Constraint Programming Model* (CPModel) instance which is one of the basic elements in a Choco program (see line 2). Then, we declare the variables of the problem, generally unknown. Lines 4-7 show the declaration of the  $x_{ij}$  variable and its domain. Moreover, we display in line 9 the declaration of the objective function that maximizes the profit of test components placement.

<sup>2</sup><http://www.gecode.org/>

<sup>3</sup><http://www-03.ibm.com/software/products/fr/ibmilogcpleoptistud>

```

1 //Model declaration
2 CPMModel model = new CPMModel();
3 // Variables declaration
4 IntegerVariable[][] X = new IntegerVariable[n][m];
5 for (int i = 0; i < n; i++) {
6   for (int j = 0; j < m; j++) {
7     X[i][j] = Choco.makeIntVar("X" + i+j, 0, 1);}
8 //Objective variable declaration
9 IntegerVariable Z = Choco.makeIntVar("gain", 1, n*maxp,Options.V_OBJECTIVE);
10 //Modelling knapsack constraints
11 IntegerVariable[][] XDual = new IntegerVariable[m][n];
12 for (int i = 0; i < m; i++) {
13   for (int j = 0; j < n; j++) {
14     XDual[i][j] = X[j][i];}
15 Constraint[] cols_ram = new Constraint[m];
16 Constraint[] cols_cpu = new Constraint[m];
17 Constraint[] cols_bat = new Constraint[m];
18 for (int j = 0; j < m; j++) {
19   cols_ram[j] = Choco.leq(Choco.scalar(Dr,XDual[j]),R[j]);
20   cols_cpu[j] = Choco.leq(Choco.scalar(Dc,XDual[j]),C[j]);
21   cols_bat[j] = Choco.leq(Choco.scalar(Db,XDual[j]),B[j]);}
22 model.addConstraints(cols_ram);
23 model.addConstraints(cols_cpu);
24 model.addConstraints(cols_bat);
25 //adding a constraint for each forbidden node, l is the number of forbidden nodes
26 Constraint[] forbidden_nodes = new Constraint[l]; int k=0;
27   for (int i = 0; i < n; i++)
28     for (int j = 0; j < m; j++) {
29       if(P[i][j]==0){
30         forbidden_nodes[k] = Choco.eq(X[i][j],0); k++;}
31     }
32 model.addConstraints(forbidden_nodes);
33 //Objective function
34 IntegerExpressionVariable []exp1=new IntegerExpressionVariable [n];
35 for (int i = 0; i < n; i++)
36   exp1[i]=Choco.scalar(P[i], X[i]);
37 model.addConstraint(Choco.eq(Choco.sum(exp1),Z));
38 //Create the solver
39 Solver s = new CPSolver();
40 s.read(model);
41 //Variable and value selection heuristics
42 s.setVarIntSelector(new MyFinalVarSelector(s));
43 s.setValIntIterator(new DecreasingDomain());
44 //Solve the problem
45 s.maximize(s.getVar(Z), false);

```

Listing 6.1: Mapping of the MMKP formulation to the Choco-based code.

Recall that for each assignment of a test component  $i$  to a node  $j$  a profit value  $p_{ij}$  is computed according to two criteria : the distance of node  $j$  from the node under test and the link bandwidth capacities. In lines 15-24, the resource constraints to be satisfied are expressed and added to the model. For each forbidden node, the constraint  $x_{ij} = 0$  is also defined (see lines 26-32). Once, the model is designed, we aim next to solve it by building a solver object as outlined in line 39.

We override the default search strategy<sup>4</sup> offered initially by Choco with the aim of improving the efficiency of the model. To do so, we use a value selector heuristic (see line 43) that it iterates over decreasing values of every domain variable. In addition, we implement our own variable selector strategy that selects the next variable to instantiate in a decreasing order of interest (see line 42).

To show really how this selection strategy is performed, a snippet code of *MyFinalVarSelector.java* is highlighted in Listing 6.2.

```

1 public static IntDomainVar selectNextVar() {
2     IntDomainVar bestVar = null;
3     double bestRate = -Double.MAX_VALUE;
4     for (int n = 0; n < MainTest.n; n++) {
5         for (int k = 0; k < MainTest.m; k++) {
6             IntDomainVar thatVar = MainTest.s.getVar(MainTest.X[n][k]);
7             if (thatVar.isInstantiated()) {
8                 continue;
9             }
10            // Remaining residual capacity of each resource in the node K
11            double remRAMCapa = evalRemainderRAMCapa(k);
12            double remCPUCapa = evalRemainderCPUCapa(k);
13            double remBATCapa = evalRemainderBATCapa(k);
14            // Compute the benefit rate of each test component
15            double thatRate = MainTest.P[n][k]/max(MainTest.Dr.get(n)/remRAMCapa,
16            MainTest.Dc.get(n)/remCPUCapa, MainTest.Db.get(n)/remBATCapa);
17            if (thatRate > bestRate) {
18                bestVar = thatVar;
19                bestRate = thatRate;
20            }
21        }
22    }return bestVar;
23 }

```

Listing 6.2: A code snippet of the proposed variable selector heuristic.

This class looks for the best variable to instantiate dynamically. A given variable  $X[n][k]$  is considered *bestVar* for a given node  $k$  if its resource (i.e., CPU, RAM and BAT) consumption is

<sup>4</sup>The default branching heuristic used by Choco is to choose the variable with current minimum domain size first (i.e., `MinDomain(Solver s)`) and to take its values in an increasing order (i.e., `IncreasingDomain()`)

low whereas its profit value is high. Thus, the benefit rate of each test component is computed as a function of its associated profit  $P[n][k]$  and each required resource divided by its remaining residual capacity.

Finally, this constrained test placement step produces the Resource Aware Test Plan. Its XML schema has been already introduced in Chapter 4 (see Figure 4.9). Remember that this file contains the affected components or compositions as well as their main characteristics (e.g., required and provided interfaces, testability options, deployment hosts, etc.) and their associated test cases. This file nests the adequate deployment host for each test component involved in the runtime testing process. It is used next in the test isolation and execution module.

## 6.4 Test isolation and execution GUI

The second component GUI, depicted in Figure 6.9, is used by the Test System Coordinator to start remotely one or several tests. For this purpose, it communicates with several TT4RT instances by using the *Remote Method Invocation* (RMI) technology. It also displays the global verdict, local verdicts collected from each involved host in the runtime testing process and some logging data.

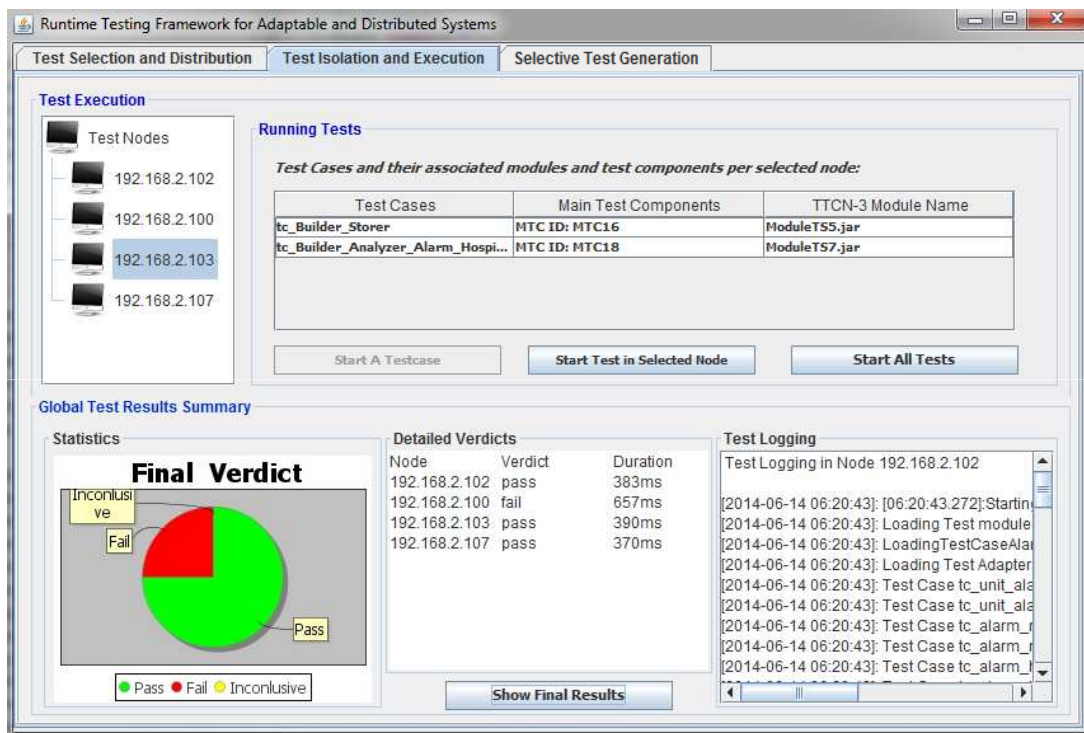

Figure 6.9: Screenshot of the test isolation and execution GUI.

The first JTree panel outlines the involved nodes in the test execution process. In each one, a TT4RT instance is installed and started. Two majors input elements are required by TT4RT :

selected Executable TTCN-3 test cases from the repository as JAR files and the Resource Aware Test Plan (see Figure 6.10).

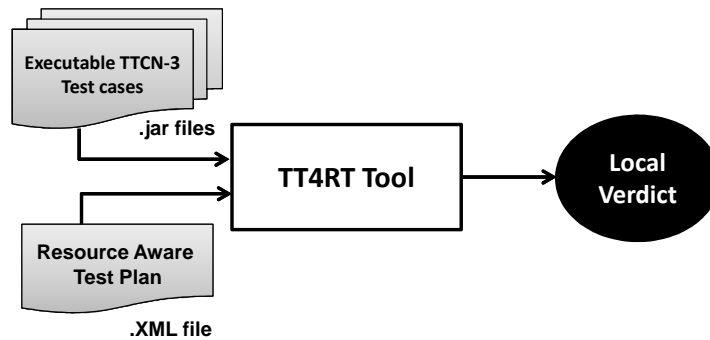

Figure 6.10: TT4RT instance inputs and outputs.

The centered *JTable* describes test cases assigned to the selected node as well as their main characteristics (i.e., test case name, TTCN-3 module name and MTC identifier). Several buttons are proposed to efficiently manage the test execution. Consequently, we can start a selected test case, all tests in a selected node or even all tests on their corresponding nodes. In that case, each TT4RT instance is designed as a remote server object which implements a remote interface offering three methods as illustrated in Listing 6.3. The method *start\_testCase(...)* starts a single test case from a specified module; the method *start\_testmodule* starts all test cases contained in the specified module and finally the method *get\_FinalVerdict()* returns the local verdict calculated by the TT4RT instance.

```

1 public interface RemoteTestInterface extends java.rmi.Remote
2 {
3     public void start_testCase( String module, String testcase) throws RemoteException;
4     public void start_testmodule( String module) throws RemoteException;
5     public String get_FinalVerdict() throws RemoteException;
6 }
  
```

Listing 6.3: Remote interface of TT4RT instance.

The *Generic Test Isolation Component*, which represents the test isolation layer in TT4RT, implements a *User Datagram Packet* (UDP) port listener function which runs an infinite loop listening for test data in the form of UDP packets from the UDP test adapter. It can intercept either local test requests sent by a local test adapter or remote test requests sent by a remote test adapter. It is worth noticing that in the current implementation of RTF4ADS, not only a UDP test adapter was implemented but also a *Transmission Control Protocol* (TCP) test adapter was encoded. The latter can be easily integrated if required. These two possible implementations can be used to establish communication through sockets between our TS and any kind of SUT.

This component uses AOP facilities to automate the test isolation of components under test before the execution of runtime tests. In fact, we associate for each provided interface a test isolation instance, designed as an AOP advice, which is automatically launched if at least one of its methods is called by a test component. This test isolation instance is charged with looking for the testability option of the component under test and then proceeds to the test execution. To realize such an implementation, we use the most popular and stable AOP language, namely AspectJ [123]. Indeed, the latter extends the Java language with new features to support the aspect concepts. Listing 6.2 illustrates an AspectJ-based code of the test isolation instance.

```

1 public aspect TestIsolationInstance {
2     pointcut asp(String Patient_ID,String HelpKind, String HelpCenter_Name ):execution
3     (public void HelpCenterAmbulatoryImpl.send_help(String,String,String))
4     && args(Patient_ID,HelpKind,HelpCenter_Name);
5     void around(String Patient_ID,String HelpKind, String HelpCenter_Name)
6     throws InvalidSyntaxException: asp(Patient_ID,HelpKind,HelpCenter_Name){
7         // Test isolation instance is started
8         ReadTestPlanFile tp = new ReadTestPlanFile("RATP.XML");
9         //Look for the testability option of the invoked component from the RATP file
10        String testOpt = tp.Read_TestOpt_CUT(HelpCenter_Name);
11        // This function returns 0 for BIT, 1 for tagging, 2 for aspect, 3 for blocking and 4 for cloning
12        int opt=testOpt_to_int(testOpt);
13        if(opt==0){
14            //BIT strategy is applied and the test service is discovered from the registry
15            ...
16        } else if (opt==1) {
17            //Tagging strategy is applied
18            String id_p_tag=Patient_ID +"#";
19            String help_kind_tag=HelpKind +"#";
20            String helpcenter_name_tag=HelpCenter_Name+"#";
21            proceed (id_p_tag,help_kind_tag,helpcenter_name_tag);
22        } else if (opt==4){
23            // Aspect based strategy is applied
24            ...
25        }else if (opt==3){
26            // Blocking strategy is applied
27            ...
28        }else if (opt==2){
29            // Cloning strategy is applied
30            ...
31        }else{
32            //Business behavior is proceeded
33            proceed (Patient_ID,HelpCenter_Name,HelpKind);
34        }}}

```

Listing 6.4: Test isolation instance based on AOP code.

First of all, a pointcut called *asp* is defined to capture for example the call of the method *send\_help(String Patient\_ID, String helpKind, String HelpCenter\_Name)*<sup>5</sup> belonging to the class *HelpCenterAmbulatoryImpl* (see lines 2-4). Then, the around advice captures the execution call and takes the decision to allow the execution of the corresponding method in case of business request (i.e., the operation will be normally executed by calling the keyword *proceed* (see line 33)). Otherwise, it prohibits the execution and sets up the appropriate test isolation technique before performing a test request. To do so, the testability options of each component under test are obtained from the RATP file (see lines 8-10). Given a test aware component under test, the input parameters are tagged with a special flag (see lines 18-20), for instance with “#”. In this case, this component is able to discriminate test data (i.e., tagged with “#”) from business data. Thus, the method is called with the new tagged parameters by using the keyword *proceed* (see line 21).

## 6.5 Selective Test Generation GUI

The RTF4ADS framework includes a selective test generation GUI to build automatically a new test suite after the occurrence of behavioral adaptations.

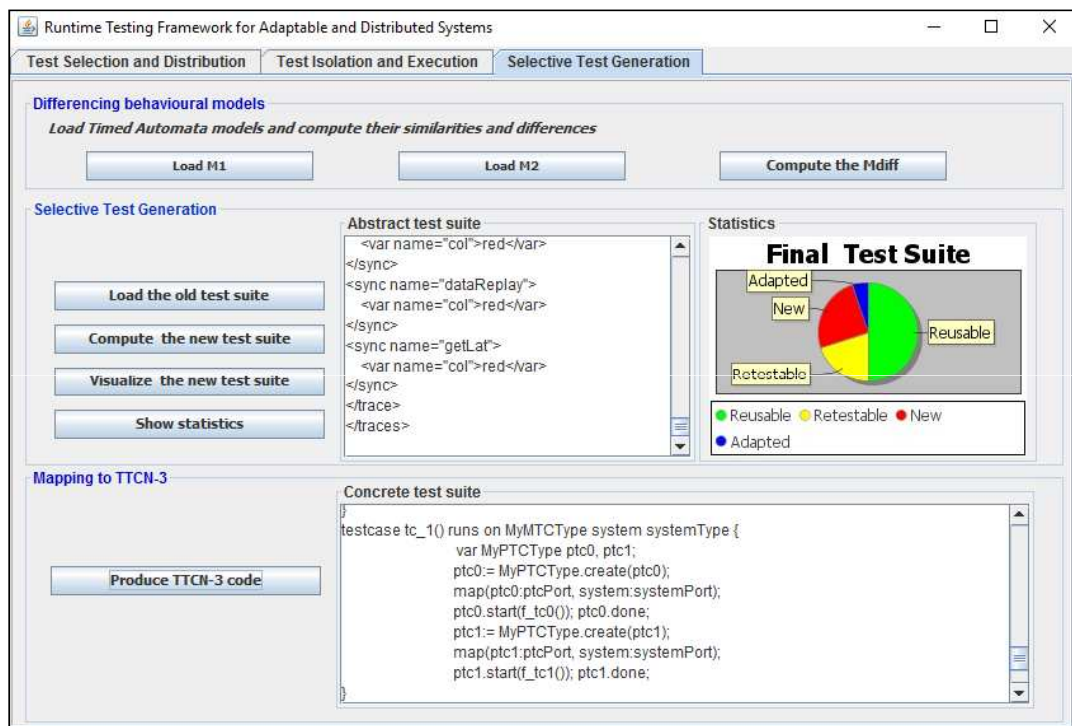

Figure 6.11: Screenshot of the selective test generation GUI.

The new test suite is composed of reusable and retestable tests, selected from the old test

<sup>5</sup>This scenario belongs to an e-Health application in which an alarm component sends a help request to a help center, e.g., *Ambulatory* component, in case of emergencies.



suite, new tests generated from the evolved behavioral model by UPPAAL CO $\sqrt$ ER (version 1.4) [109] and some adapted ones obtained by test recomputation. Once the new test suite is evolved, it is mapped to the TTCN-3 notation.

The first panel illustrated in Figure 6.11 deals with the model differencing step. Indeed, the initial behavioral model and the evolved one are loaded, and then an  $M_{diff}$  model highlighting their similarities and their differences is computed. The next step consists in loading the old test suite and performing a test classification.

```

1 // Load the old trace
2 ExtractXMLTraces XMLTR=new ExtractXMLTraces();
3 Vector<Trace> traces=XMLTR.extract("OldTraceXML.xml");
4 // Read the SUT and ENV timed automata
5 TA_automata SUTdiff=algo.readModel("SUT");
6 TA_automata ENVdiff=algo.readModel("ENV");
7 ArrayList<state> SUTstates=SUTdiff.getStates();
8 ArrayList<state> ENVstates=ENVdiff.getStates();
9 for (int i=0;i<traces.size();i++)
10 {
11     Trace TR=null;
12     state SUT_l0=algo.lookupState(SUTdiff.getInit(), SUTstates);
13     state ENV_l0=algo.lookupState(ENVdiff.getInit(), ENVstates);
14     for (int j=0;j<traces.get(i).sync.size();j++)
15     {
16         if (algo.IstransitionReached(traces.get(i).sync.get(j), SUT_l0,ENV_l0))
17         {
18             SymbolicState symb=algo.NextReachedState(...); // Look for the next reached state
19             SUT_l0=symb.getSi();
20             ENV_l0= symb.getEi();
21         }else{
22             invalide=true;
23             if (algo.findOldTransition(...) // the transition already exists in the old model
24                 TR=new Trace(traces.get(i).sync, "aborted");break;
25             else
26                 TR=new Trace(traces.get(i).sync, "obsolete");break;}
27         }
28         if (!invalide){
29             if (algo.VerifColor(traces.get(i).sync, SUTdiff.getTransitions()))
30                 // All the covered items are colored in Green
31                 TR=new Trace(traces.get(i).sync, "reusable");
32             else
33                 TR=new Trace(traces.get(i).sync, "retestable");
34         } OldTestSuite.add(TR);
35     }

```

Listing 6.5: Test classification code snippet.

Listing 6.5 shows a Java code snippet of the old test classification module. Indeed, the old test

suite is made up of several traces in the XML format (see lines 1-3). Each trace is animated on the SUT and ENV models. Since a given synchronization action (i.e.,  $traces.get(i).sync.get(j)$ ) in the old trace cannot be traversed, the test animation is abandoned (see line 21). At line 23, we check the existence of the corresponding transition in the evolved model. In such a case, the trace is classified as an aborted trace (see line 24). Otherwise, it is considered obsolete (see line 26). In lines 28-32, we classify valid traces into reusable or retestable traces.

Finally, we compute the new test suite by launching the UPPAAL CO $\sqrt$ ER tool to generate new tests, in a cost effective manner, by adapting obsolete and aborted tests and by including reusable and retestable tests.

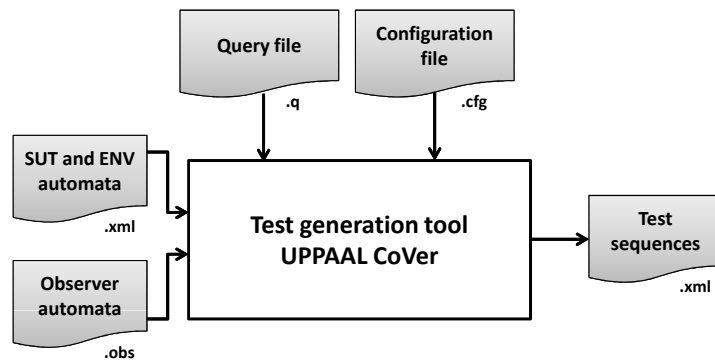

Figure 6.12: UPPAAL CO $\sqrt$ ER setup.

As shown in Figure 6.12, the UPPAAL CO $\sqrt$ ER tool takes mainly as inputs :

- the  $M_{diff}$  model (.xml), which is composed of a system part (SUT) and an environment part (ENV),
- the observer (.obs), which expresses the adopted coverage criteria,
- a query file (.q) that is used to specify from which timed automaton or timed automata of the  $M_{diff}$  the test suite is generated, and
- a configuration file (.cfg) that is used to format the generated traces to contain desired information in the XML format.

The last panel is dedicated to perform the mapping of abstract test traces to the TTCN-notation. Once TTCN-3 test cases are compiled to be executable, test distribution, test isolation and test execution are performed as in the case of structural adaptations.

## 6.6 Summary

The achievement of a well-implemented prototype for runtime testing of dynamic adaptations was pinpointed in the present chapter. The obtained framework includes the realization of both approaches proposed to check structural and behavioral adaptations. Implementation details in terms of input files, output results and used tools required for each module were presented.

In the next chapters, we employ RTF4ADS to check the correctness of two critical case studies after the occurrence of either dynamic structural or behavioral adaptations. On the one hand, we illustrate the efficient execution of runtime tests in case of dynamically adapting the structure of an e-Health case study (see Chapter 7). On the other hand, RTF4ADS is used to evolve test suites when behavioral adaptations take place in the case of telematic application (see Chapter 8).

---

## Application of RTF4ADS After Structural Adaptations

---

### 7.1 Introduction

This chapter is mainly dedicated to show the relevance of our framework in case of structural adaptation occurrence. To do so, a remote medical care system is introduced and its implementation details are highlighted in Section 7.2. In Section 7.3, several test scenarios are specified for the adopted case study. Their mapping to the TTCN-3 notation is also presented. Section 7.4 shows the applicability of RTF4ADS to check the case study correctness after structural adaptations. At the end, several experiments have been conducted in Section 7.5 to assess the overhead introduced by RTF4ADS as well as to show its efficiency to reveal adaptation faults. The last section summarizes this chapter. Parts of this chapter have been published in [32, 96, 33].

### 7.2 Case study: Teleservices and Remote Medical Care System

#### 7.2.1 General overview

*Teleservices and Remote Medical Care Systems* (TRMCS) were introduced in the literature for more than a decade ago [124]. They were designed initially to provide monitoring and assistance to patients suffering from chronic health problems. Thus, they send emergency signals to the medical staff (such as doctors, nurses, etc.) to inform them with the critical state of a patient. Recently, both the architecture and the behaviors of such medical care systems are evolved and enhanced by more elaborated functionalities (for instance, the acquisition, the analysis and the storage of biomedical data) and sophisticated technologies [125, 126, 7, 8].

New components and features can be installed at runtime during system operation in order to fulfill new requirements such as adding new health care services, updating the existing ones in order to support performance improvements, etc. Such adaptability is essential to ensure that the healthcare system remains within the functional requirements defined by application designers, and also maintains its performance, security and safety properties.

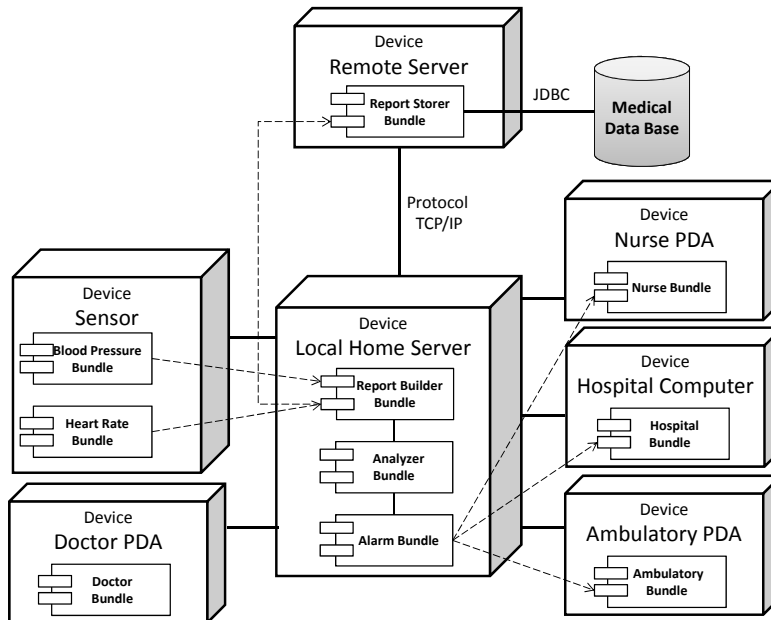

Figure 7.1: The basic configuration of TRMCS.

Following these directions, we provide our own architecture of the TRMCS application which is inspired mainly from [126]. Its main architecture is highlighted through a UML deployment diagram depicted in Figure 7.1. We assume that initially a given patient is suffering from chronic high blood pressure. Thus, he is equipped with a *Blood Pressure Sensor* and a *Heart Rate Sensor* that measure respectively his arterial blood pressure and his heart-rate beats per minute. Periodic reports are built and stored in the medical database. They are also accessible for consultation from the medical staff. The *Analyzer* component is charged with analyzing the monitored data in order to detect whether some thresholds are exceeded. In that case, an *Alarm* component is invoked with the aim of sending help requests to the medical staff.

### 7.2.2 TRMCS implementation

The TRMCS is fully implemented as an OSGi application. Developed by OSGi Alliance [39], the OSGi specification describes how to build service-oriented and loosely coupled systems. This standardized technology defines a lightweight framework based on Java Runtime Environment and a set of installed *bundles*. Bundles are software components, packed in JAR files. A *bundle* is

designed as a minimal deliverable application in OSGi that is composed of cooperating services, which are discovered after being published in the OSGi service registry. It is capable of either exporting Java packages and exposing functionalities as services to other bundles or importing Java packages or services from other bundles [127, 128].

To efficiently manage the bundles' life cycle, the OSGi framework offers management functionalities that include installing, activating, deactivating, updating, and removing services. Consequently, it provides dynamic mechanisms for deploying, starting and removing services at runtime in order to meet, for instance, changing business demands. Furthermore, the OSGi platform supports various execution environments, networks and technologies [128]. Hence, the bundles may be deployed on multiple devices such as mobile computing devices, digital TV set top boxes, game consoles, etc.

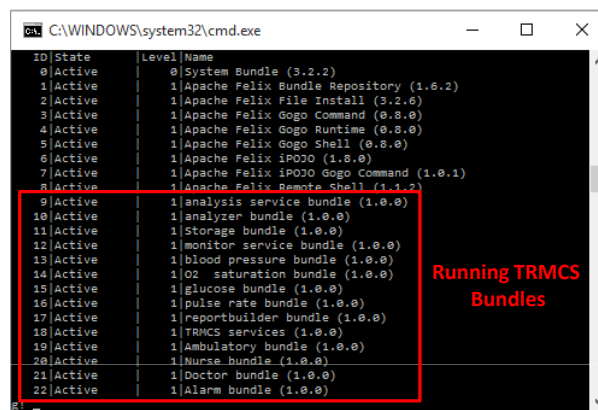

```

C:\WINDOWS\system32\cmd.exe
10 State      Level Name
0 Active     0 System Bundle (3.2.2)
1 Active     1 Apache Felix Bundle Repository (1.6.2)
2 Active     1 Apache Felix File Install (3.2.6)
3 Active     1 Apache Felix Gogo Command (0.8.0)
4 Active     1 Apache Felix Gogo Runtime (0.8.0)
5 Active     1 Apache Felix Gogo Shell (0.8.0)
6 Active     1 Apache Felix IPOJO (1.8.0)
7 Active     1 Apache Felix IPOJO Gogo Command (1.0.1)
8 Active     1 Apache Felix Remote Shell (1.1.2)
9 Active     1 analysis service bundle (1.0.0)
10 Active    1 analyzer bundle (1.0.0)
11 Active    1 Storage bundle (1.0.0)
12 Active    1 monitor service bundle (1.0.0)
13 Active    1 blood pressure bundle (1.0.0)
14 Active    1 O2 saturation bundle (1.0.0)
15 Active    1 glucose bundle (1.0.0)
16 Active    1 pulse rate bundle (1.0.0)
17 Active    1 reportbuilder bundle (1.0.0)
18 Active    1 TRMCS services (1.0.0)
19 Active    1 Ambulatory bundle (1.0.0)
20 Active    1 Nurse bundle (1.0.0)
21 Active    1 Doctor bundle (1.0.0)
22 Active    1 Alarm bundle (1.0.0)
  
```

Running TRMCS Bundles

Figure 7.2: TRMCS bundles running on Felix.

Due to these major benefits (i.e., dynamism, extensibility and application interoperability), OSGi is retained in our context to build TRMCS components. A wide number of implementations of the OSGi specification exist. The one we are using is Apache Felix<sup>1</sup>. Figure 7.2 shows the deployment and the start up of TRMCS bundles on this OSGi container.

### 7.2.3 TRMCS configurations

For experimental purposes, we vary the TRMCS architecture. Thus, different configurations of this case study are implemented. The system evolves from one configuration to another by installing and starting bundles or by stopping and uninstalling them. A brief overview of the related bundles as well as the main characteristics of each configuration in terms of number of hosts in the execution environment and number of stored test cases in the repository is summarized in Table 7.1.

<sup>1</sup><http://felix.apache.org/site/index.html>

Table 7.1: Supporting several configurations of the TRMCS application.

| Configurations        | Number of bundles | Number of hosts | Number of Stored TCs | Bundle names   |
|-----------------------|-------------------|-----------------|----------------------|--|
| <i>Conf 1</i>         | 5                 | 5               | 9                    | Alarm + Hospital + Doctor + Nurse + Ambulatory   |
| <i>Conf 2</i> (Basic) | 10                | 7               | 24                   | Bundles depicted in Figure 7.1   |
| <i>Conf 3</i>         | 15                | 8               | 48                   | Bundles in <i>Conf 2</i> + SMS + Call + EmergencyCenter + SensorT + SensorGLS                          |
| <i>Conf 4</i>         | 20                | 8               | 58                   | Bundles in <i>Conf 3</i> + PPS + ECG + GSR + AirS + SPO2   |
| <i>Conf 5</i>         | 25                | 13              | 72                   | Bundles in <i>Conf 4</i> + LaboratoryCenter + RadiographyCenter + Different instances of doctor bundle |

For instance, in *Conf 3*, TRMCS supports three kinds of help requests: generating call, sms or alarm signals. Moreover, another help center can be used, *Emergency Center*. The patient is also equipped with new sensors to measure the body temperature and the blood glucose level. *Conf 4* includes more medical device sensors such as:

- Patient Positioning Sensor (PPS) that detects the patient body position,
- Electrocardiogram (ECG) sensor that assesses the electrical and muscular heart functions,
- Galvanic Skin Response (GSR) sensor that measures the electrical conductance of the skin,
- Airflow Sensor (AirS) that detects low airflow levels to provide efficient oxygen delivery for patients and
- Percutaneous arterial oxygen Saturation (SPO2) sensor that measures the blood oxygen saturation level.

In *Conf 5*, we extend the TRMCS application by adding bundles like the *Laboratory Center*, the *Radiography Center* and different instances of doctor bundles.

Due to the dynamic nature of the TRMCS application, medical errors and degradation of QoS parameters can occur. Therefore, runtime testing is required to validate dynamic changes on the TRMCS application with the aim of early detection of undesirable behaviors. Next, various test scenarios are specified in the TTCN-3 notation and later performed at runtime for testing the TRMCS application and checking either its functional or non-functional requirements.

### 7.3 TRMCS test specification

To show the high expressiveness of the TTCN-3 language in supporting various testing levels (i.e., unit and/or integration tests) and different testing purposes (i.e., functional tests, load tests, availability tests, etc.), some test scenarios are studied for the former case study and their

mapping to the TTCN-3 notation is given afterwards. Table 7.2 summarizes tests supported by the proposed test platform when structural adaptations occur.

Table 7.2: Supported test scenarios.

| Test kinds         | Testing issues   |
|--------------------|--|
| Functional tests   | Check the compliance of a system or a component with its specified behavior by sending stimulus and analyzing outputs. |
| Timing tests       | Check the temporal constraints under which the SUT shall operate.  |
| Availability tests | Check the availability of a service after dynamic adaptations.   |
| Load tests         | Check system responsiveness under normal and heavy load.   |

Given that the entire test scenarios are too lengthy to describe, four examples are provided to highlight the most common types of test scenarios. First of all, these scenarios are introduced in a descriptive way then their mapping to the TTCN-3 code is given.

**Guarantee of help service delivery.** This scenario can be used to test the situation in which the analysis of monitored critical events are triggered or threshold conditions are reached (i.e., when the heart rate exceeds a certain level of tolerance). In this context, emergency signals are sent to the appropriate medical staff. Table 7.3 provides a concise description of this scenario.

Table 7.3: Test scenario 1 (TS-1).

| Test Scenario 1 TS-1   |  |
|------------------------|--|
| <b>Test objective</b>  | To ensure that an urgent notification is sent to the medical staff when a threshold is exceeded.   |
| <b>Pre-Conditions</b>  | <ul style="list-style-type: none"> <li>a. The appropriate test isolation strategies have to be set up for all the components involved in this test.</li> <li>b. Test data greater than the threshold is sent to the SUT.</li> <li>c. No packet loss in the communication network<sup>2</sup>.</li> </ul> |
| <b>Action</b>          | Start the test system and inject test data into the SUT.   |
| <b>Post-Conditions</b> | A notification should be sent to the involved medical staff.   |

**Mapping of TS-1 to TTCN-3.** As depicted in Listing 7.1, a help request is sent to the *Alarm* component via an MTC component (see line 4). If the test component receives the adequate output as mentioned in line 7, a pass verdict is generated (see line 8). Otherwise, a fail verdict is generated (see line 10).

```

1 testcase tc_CheckAlarm() runs on mtcType system systemType{
2   map (mtc: mtcPort, system: systemPort);
3   timer localtimer := 15.0;
4   mtcPort.send(msg_to_alarm);

```

<sup>2</sup>This pre-condition is proposed with the aim of avoiding inconclusive verdicts.



```

5 localtimer.start;
6 alt {
7     [] mtcPort.receive("Service invoked Successfully")
8     {setverdict (pass, "Test service alarm successfully");}
9     [] mtcPort.receive
10    {setverdict (fail, "Something else received");}
11    [] localtimer.timeout
12    { setverdict (fail, "Timeout");}
13    localtimer.stop;}}}

```

Listing 7.1: A sample of test case for TS-1.

**Achievement of timing constraints.** This scenario is used to check that the *Alarm* component must send the help request to the *Nurse* component in a duration that does not exceed 15 time units. Table 7.4 provides a concise tabular description of this scenario.

Table 7.4: Test scenario 2 (TS-2).

| Test Scenario 2 TS-2   |   |
|------------------------|---|
| <b>Test objective</b>  | To ensure that the <i>Alarm</i> component respects its timing constraints.  |
| <b>Pre-Conditions</b>  | <ul style="list-style-type: none"> <li>a. The appropriate test isolation strategies have to be set up for all the components involved in this test.</li> <li>b. No packet loss in the communication network.</li> </ul> |
| <b>Action</b>          | Invoke the Help Service in the <i>Alarm</i> component and measure the response time.  |
| <b>Post-Conditions</b> | The <i>Alarm</i> component should send the emergency request while fitting the predefined timing constraints.   |

**Mapping of TS-2 To TTCN-3.** Listing 7.2 depicts an example of testing timing constraints.

```

1 testcase tc_time_Constraint() runs on mtcType system systemType{
2   var float sendTime, receiveTime;
3   map (mtc: mtcPort, system: systemPort);
4   mtcPort.send(msg_ALARM_NURSE)->timestamp sendTime;
5   mtcPort.receive -> timestamp receiveTime;
6   if(receiveTime-sendTime<15)
7   {
8     setverdict (pass, "Time Constraint respected");}
9   else{
10    setverdict (fail, "Time Constraint not respected");}

```

Listing 7.2: A sample of test case for TS-2.

In this situation, we assume that the *Alarm* component has to transmit the help request to the *Nurse* component in a time lapse that does not exceed 15 time units. Therefore, the

test component sends test data to the concerned component composition (made up of *Alarm* and *Nurse* components) (see line 4). The send time of the message is recorded by means of the redirection operator `- > timestamp` [129] and is assigned to the given variable `sendTime`. Similarly, the arrival time of the receive message is retrieved and assigned to the `receiveTime` variable. As illustrated in lines 6-10, if this deadline is respected, a pass verdict is generated; otherwise, a fail verdict is computed.

**Availability of a component.** This scenario serves to check component availability after the occurrence of dynamic reconfigurations (i.e., adding, updating or migrating components). For instance, in case of patient mobility in and out of the local server's range, we have to check that wearable medical sensors are accessible and can be invoked from components deployed on the local server (like the *Report Builder* component, the *Analyzer* component, etc.). Table 7.5 provides a concise description of this scenario.

Table 7.5: Test scenario 3 (TS-3).

| Test Scenario 3 TS-3   |   |
|------------------------|---|
| <b>Test objective</b>  | To ensure the availability of the new or modified or mobile component.  |
| <b>Pre-Conditions</b>  | <ul style="list-style-type: none"> <li>a. The appropriate test isolation strategies have to be set up for all the components involved in this test.</li> <li>b. No packet loss in the communication network.</li> </ul> |
| <b>Action</b>          | Send a test request to the component under test and check its availability.   |
| <b>Post-Conditions</b> | The component should receive the test request and send a response to the test system.   |

**Mapping of TS-3 to TTCN-3.** Listing 7.3 gives an example for testing the availability of a medical sensor. This kind of test can be applied when a new medical service is added at runtime to the TRMCS application or when the patient wearing this device is mobile.

```

1 testcase tc_Availability() runs on mtcType system systemType {
2   map (mtc: mtcPort, system: systemPort);
3   timer localtimer := 15.0;
4   mtcPort.send (msg_to_sensor);
5   localtimer.start;
6   alt {
7     [] mtcPort.receive("Sensor invoked Successfully")
8     {setverdict (pass,"The sensor is available");}
9     [] mtcPort.receive
10    {setverdict (fail,"The sensor is not available");}
11    [] localtimer.timeout
12    { setverdict (fail, "Timeout");}
13    localtimer.stop;}}}
```

Listing 7.3: A sample of test case for TS-3.

**Concurrent test requests.** This scenario is used to simulate the situation in which multiple users request the service under test at the same time. The dynamic creation of PTCs in TTCN-3 standard enables our framework to create a number of virtual users that send multiple test requests concurrently and perform load testing on the SUT. Table 7.6 provides a concise description of this scenario.

Table 7.6: Test scenario 4 (TS-4).

| Test Scenario 4 TS-4   |   |
|------------------------|---|
| <b>Test objective</b>  | To ensure that the SUT operates correctly under different workloads.  |
| <b>Pre-Conditions</b>  | <ul style="list-style-type: none"> <li>a. The appropriate test isolation strategies have to be set up for all components involved in this test.</li> <li>b. Fix the number of parallel test components used by the test system to load the SUT.</li> <li>c. No packet loss in the communication network.</li> </ul> |
| <b>Action</b>          | Start the test system and monitor the response time of the SUT under this heavy load.   |
| <b>Post-Conditions</b> | SUT performance varies according to the increasing number of PTCs.  |

**Mapping of TS-4 to TTCN-3.** Listing 7.4 gives an example for load testing the *Alarm* component.

```

1  function ptc_time_constraint() runs on ptcType {
2      var integer duration;
3      ptcPort.send (msg_ALARM_NURSE);
4      ptcPort.receive (integer:?) -> value duration;
5      if(duration<15)
6          {setverdict (pass, "Time Constraint respected");}
7      else
8          {setverdict (fail, "Time Constraint not respected");}
9      }
10 testcase LoadTest() runs on mtcType system systemType {
11     var ptcType ptcArray[NUMBER_OF_PTCS];
12     var integer i := 0;
13     for (i := 0; i < NUMBER_OF_PTCS; i := i + 1) {
14         // create the PTCs
15         ptcArray[i] := ptcType.create;
16         map(ptcArray[i]:ptcPort, system:systemPort);
17         ptcArray[i].start(ptc_time_constraint());
18         ptcArray[i].done;} }

```

Listing 7.4: A sample of test case for TS-4.

This test case creates an arbitrary number of PTCs components that will execute the test behavior described from line 1 to line 10. In line 11, we declare an array named *ptcArray* of

size equal to the constant *NUMBER\_OF\_PTCS*. Each test component is created, mapped to the system and then started (see lines 15-17). The aim here is to check that under heavy load timing constraints under which the *Alarm* component is running are still respected.

In order to edit and compile the specified tests, we use respectively the *TTCN-3 Core Language Editor* (CL Editor) and the *TThree Compiler* that are included in the TTworkbench basic tool<sup>3</sup>. The generated Jars are stored in the Test Case Repository for further use and can be dynamically loaded during the runtime test execution to check dynamic changes.

## 7.4 Checking TRMCS correctness after structural adaptations

At present, we study the evolution of the basic configuration illustrated in Figure 7.1. Indeed, it comes a moment when this system dynamically evolves to fulfill new requirements. For instance, the *Alarm* component is updated with a new version in order to increase SUT responsiveness. The new version sends the help request to the medical staff in a duration that does not exceed 15 time units instead of 30 time units for the old version. Once this reconfiguration is achieved, the new component and all the affected parts of the system have to be validated.

To perform efficiently the runtime testing of the studied scenario, we begin with the computation of the affected components and compositions by this dynamic change. Figure 7.3 illustrates the system dependencies in this scenario and the affected parts of the system are delimited by a red square.

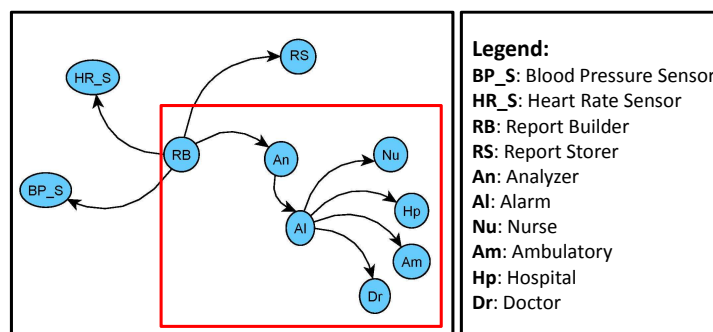

Figure 7.3: The dependency graph of the studied scenario.

In the second step, a subset of test cases covering the impacted parts of the TRCMS application is identified. Table 7.7 shows the constituents of the new test suite to run. Recall that the unit tests are prefixed by “*UT*” whereas the integration tests are prefixed by “*IT*”.

Once the test cases are identified, the constrained test component placement module is called in this stage in order to look for a suitable solution that satisfies predefined resource and

<sup>3</sup><http://www.testingtech.com/products/ttworkbench.php>

Table 7.7: Reusable test cases.

| Selected test cases.                      |
|---|
| UT_Alarm.jar                              |
| IT_RBUILDER_SensorBPS.jar                 |
| IT_RBUILDER_SensorHRS.jar                 |
| IT_RBUILDER_Storer.jar                    |
| IT_RBUILDER_Analyzer_Alarm_Nurse.jar      |
| IT_RBUILDER_Analyzer_Alarm_Hospital.jar   |
| IT_RBUILDER_Analyzer_Alarm_Ambulatory.jar |
| IT_RBUILDER_Analyzer_Alarm_Doctor.jar     |

connectivity constraints. For instance, an optimal solution is computed in which four test nodes<sup>4</sup> are chosen : the local home server, the hospital computer, the remote server and the nurse PDA. Then, the selected test cases are distributed over these four nodes. Notice that this solution may change especially when we vary the node provided resources and the network connectivity.

As mentioned before, affected components as well as their main characteristics (e.g., required and provided interfaces, testability options, etc.), their associated test components and their deployment hosts are included in the RATP file. Figure 7.4 shows a screenshot of this file and describes mainly the new *Alarm* component and its main features. Especially, it pinpoints the deployment host where the Alarm unit test case will be run on (i.e., the host having 192.168.2.102 as IP address).

| Node               | Content  |
|--------------------|--|
| xml                | version="1.0" encoding="UTF-8" standalone="no" |
| TestPlan           |  |
| SUT                |  |
| Kind               | Single   |
| Component          |  |
| ID                 | n03  |
| Name               | Alarm  |
| TestabilityOptions | BIT  |
| TestSuite          |  |
| TestCase           |  |
| HostIPAddress      | 192.168.2.102                                  |
| Level              | Unit   |
| Name               | UT_Alarm.jar                                   |
| TestComponent      | MTC1   |

Figure 7.4: Screenshot of the RATP XML file content.

The RATP file is used in the next step that copes with the test isolation and execution. Indeed, the preparation of the test isolation layer is done in accordance with the testability options of each component under test. In the current scenario, we have different components with various testability features. The *Report Builder* is testable and it is equipped with a test interface ensuring that the test data and the business data are not mixed during the runtime testing process. The other components involved in this test process are considered test aware.

<sup>4</sup>Nodes holding test execution.

This means that they differentiate between test data and business data by using a test tag.

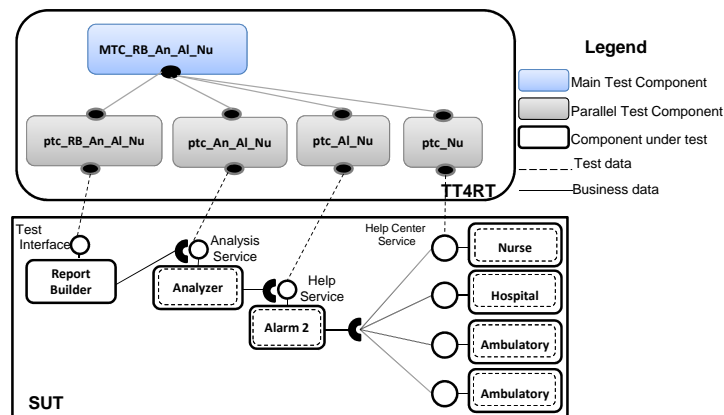

Figure 7.5: An example of interactions between TTCN-3 test components and SUT.

Figure 7.5 sketches interactions between the SUT and our test system TT4RT when an executable test *IT\_RBUILDER\_Analyzer\_Alarm\_Nurse.jar* is loaded and performed at runtime. Based on the bottom up integration testing strategy, the lowest level in the dependence path is tested first (e.g., *Nurse*) then components that rely on it are tested. For this aim, different PTC components playing the role of test drivers (e.g., *ptc\_Nu*, *ptc\_Al\_Nu*, etc.) are created in each test case. They perform this integration test under the control of an MTC component called *MTC\_RB\_An\_Al\_Nu*.

```

1  testcase tc_RB_An_Al_Nu() runs on mtcType system systemType {
2  var ptcType2 ptc_Nu, ptc_Al_Nu, ptc_An_Al_Nu, ptc_RB_An_Al_Nu;
3  // create the PTCs
4    ptc_Nu := ptcType.create("ptc_Nu");
5  //map the PTCs to the system port
6    map(ptc_Nu:ptcPort, system:systemPort);
7  //start the PTC's behaviour
8    ptc_Nu.start(ptcBehaviour_Nu()); ptc_Nu.done;
9    ptc_Al_Nu:= ptcType.create("ptc_Al_Nu");
10   ...
11   ptc_An_Al_Nu:= ptcType.create("ptc_An_Al_Nu");
12   ...
13   ptc_RB_An_Al_Nu:= ptcType.create("ptc_RB_An_Al_Nu");
14   ... }

```

Listing 7.5: The test configuration in TTCN-3 notation.

Listing 7.5 outlines how to specify this test configuration with the TTCN-3 notation. Each involved PTC is created and then its test behavior is started. For instance, line 4 outlines the creation of the test component *ptc\_Nu* charged with testing of the *Nurse* component (see line 8). The PTC behavior (*ptcBehavior\_Nu()*) is a TTCN-3 function similar to the one previously

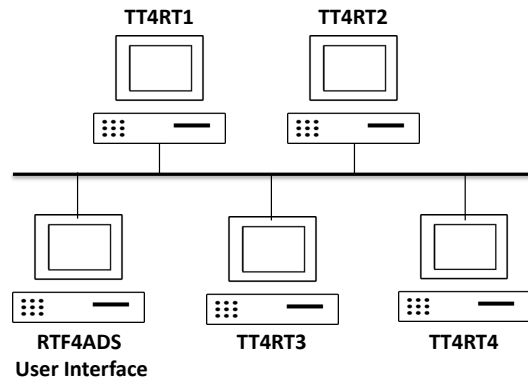

Figure 7.6: The adopted testbed.

defined in Listing 7.4.

The use of the TTCN-3 language here ensures the specification of abstract and platform-independent test suites. Furthermore, adopting TTCN-3 test components for the execution of these tests allows building a generic test architecture loosely coupled with the system under test. In this way, the test design is separated from the test implementation and execution.

## 7.5 Evaluation and overhead estimation

We carried out some experiments to measure the overhead introduced by the use of the RTF4ADS framework when structural adaptations take place. Thus, the main objective is to estimate the dependency analysis, the test selection, the constrained test component placement and the test execution overheads and to determine which parameters have a significant effect on each of them.

Thereby, we deployed our distributed test system as well as the TRMCS application on five machines: a PC with Intel Core 2 Duo CPU and 2 GO of main memory, another PC with Intel Core i7 and 8 GB of main memory and three virtual machines having each 2.30 GHz CPU and 512 MB of main memory. Using this experimental setting, we deployed four TT4RT instances on the involved test nodes identified during the test component placement step. RTF4ADS user interfaces were deployed on a separate host (see Figure 7.6). Moreover, we have to note that each experiment was conducted ten times to derive the precise average value of execution time.

As outlined in Figure 7.7, four experiments were conducted to measure the execution time required by each step in the runtime testing process. The first experiment (see Figure 7.7a) shows that the execution time needed to compute the affected parts of the system after the occurrence of a dynamic change increases at the same time as the number of involved components increases. For instance, whereas the system is made of 25 bundles (*Conf 5*) running together, the time spent for the dependency analysis does not exceed 70 ms.

The overhead of test case selection depends mainly on the number of test cases stored in the repository. In order to estimate the influence of the repository size, we varied the number of stored tests and we measured the execution time required for the repository exploration. As depicted in Figure 7.7b, the time required for the test case lookup increases while the number of stored test cases in the repository increases too.

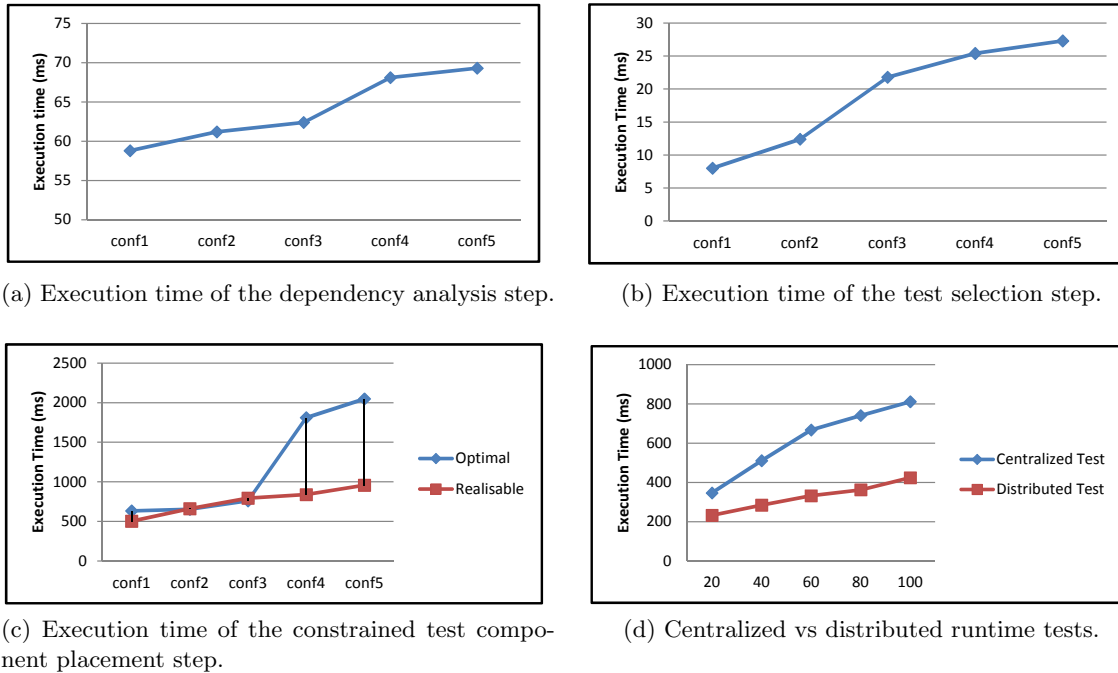

Figure 7.7: Execution time required by each step in the RTF4ADS framework.

The third experiment was conducted to evaluate the execution time needed for the test placement phase. Thus, two cases were studied. Two parameters influence the time required for computing an optimal or a satisfying solution : the number of test components to deploy and the number of host nodes in the execution environment. As depicted in Figure 7.7c, the first curve shows the average execution time required by the Choco solver to compute an optimal solution. The analysis of the results indicates that the average time required for assigning test components to execution nodes increases with the increase of the number of test components and nodes. Due to the significant time spent for calculating an optimal solution, this technique can be adopted when the dynamic changes do not occur frequently. Thus, we have enough time to validate them.

This amount of time decreases considerably when we look for a satisfying solution as illustrated in the second curve. For instance, the time required to find a satisfying solution for 5 test components in an execution environment made up of 5 nodes (see *Conf 1*) decreases by 20.5%. Similarly, assigning 21 test components in an execution environment made up of 13 nodes (see



*Conf 5*) decreases by 53.2%. Thus, we notice that the proposed solver may resolve this  $\mathcal{NP}$ -hard problem in a reasonable amount of time while the number of test components and nodes does not exceed some dozens. Such a solution can be sufficient especially when a very constrained part of the whole system, in terms of components as well as in terms of execution nodes, are affected by the modification.

The experiment, outlined in Figure 7.7d, evaluated the overhead of our test execution platform, notably while increasing the number of test cases. Hence, we recorded the execution time for an example of test by varying the number of test cases from 20 up to 100 (i.e., from 20 up to 100 MTC components). The first curve corresponds to the evolution of the execution time while one TT4RT instance is deployed (i.e., this is a centralized test). It is evident that the average time required for performing tests increases with the increase of the number of test cases. Indeed, the time consumed to create locally 20 test components, to execute tests and to generate the final verdict is around 300ms while it increases to attain approximately 800ms for 100 tests. The second curve shows a decrease in the execution time after distributing tests over four TT4RT instances. Such a decrease reaches 32.85% for running 20 tests and attains 47.78% for running 100 tests.

Moreover, we performed some experiments with and without a TT4RT instance in order to measure the introduced overhead in each node. For this purpose, we monitored the memory usage during the test execution based on the JConsole tool. We compared three cases when test cases are equal to 10, 50 and 100 (see Figure 7.8). In the first case, the memory overhead is around 4 MB. As expected, when the number of test cases increases, the memory consumption rises, too, and attains approximately 4.5 MB for running 100 test cases. Similarly, whereas the PTC components involved in a test case increase significantly in number, the memory consumption rises, too (see Figure 7.9). Therefore, we conclude that minimizing the set of test cases to re-execute leads to a reduction of the involved test components. Hence, the distribution of the runtime tests can be seen as a relevant solution for reducing the overhead of runtime tests in terms of memory usage and execution time .

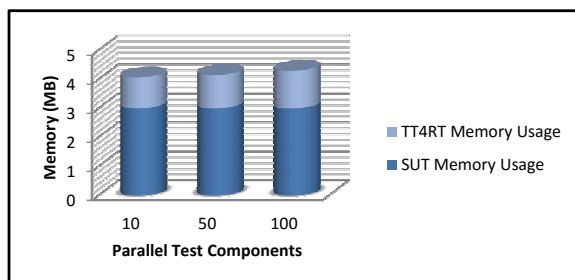
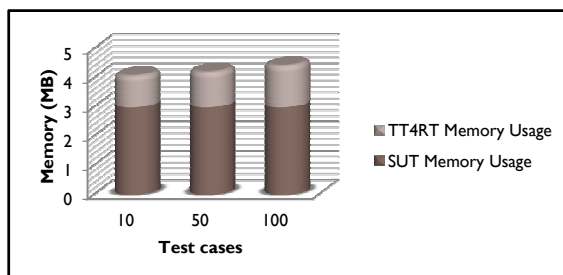

Figure 7.8: Memory usage for one TT4RT instance while varying the number of test cases. Figure 7.9: Memory usage for one TT4RT instance while varying the number of PTCs.

## 7.6 Synthesis

The different experiments that we carried out show that the runtime testing cost in terms of execution time and memory consumption increases significantly while the amount of tests to run or the number of test components to deploy rises. Compared to one of the traditional test selection strategy, the *Retest All* strategy [62], which re-executes all available tests, our proposal seems to be more efficient as it reduces the number of tests to rerun. In addition, the adopted test selection technique does not require much time to identify the unit and integration tests involved in the runtime testing process. Even in the worst case, when the whole system is affected by the dynamic change, we reduce the impact of the runtime testing on the system under test and on its environment by distributing test cases and their corresponding test components while fitting the resource and connectivity constraints.

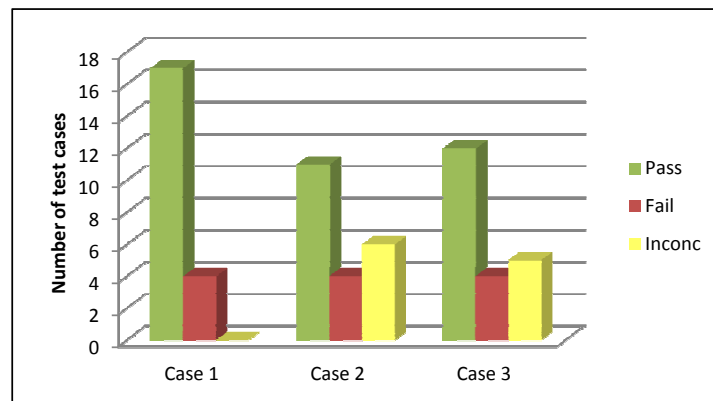

Figure 7.10: The impact of resource and connectivity awareness on test results.

The experiment outlined in Figure 7.10 shows the importance of the constraint test component placement module and its impact on the final test results. In the following, three cases of test results are obtained while executing twenty one selected tests as requested in *Conf 5*.

- In the first case, our test placement module was used to identify the adequate test hosts and our test system was run to perform the selected tests. The seeded faults were detected and thus we obtained **seventeen** Pass and **four** Fail verdicts.
- In the second case, we assume that the hospital computer is disconnected from the network. However, this connectivity problem was not taken into consideration during the testing process. As a result, six test requests were sent from their corresponding test components without receiving any response. In this situation, neither a Pass nor a Fail verdict can be assigned and thus **six** inconclusive verdicts are obtained.
- The third case shows the test results obtained while executing the twenty one tests on

some overloaded nodes. As in Case 2, the tests results are influenced by the execution environment state and consequently several verdicts were set to inconclusive. Such test results were obtained due to the timeout occurrence during the test execution.

To sum up, runtime testing may affect not only the SUT performance and responsiveness but also the test system itself could be impacted. Thus, resource and connectivity awareness appears to be a solution in order to have a high confidence in the validity of the test results as well as to reduce their associated cost.

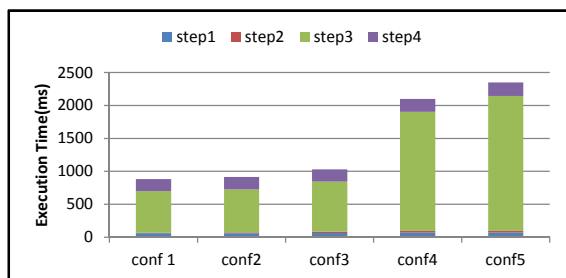

Figure 7.11: The overhead of the whole runtime testing process while searching for an optimal runtime testing process while searching for a satisfying solution in step 3.

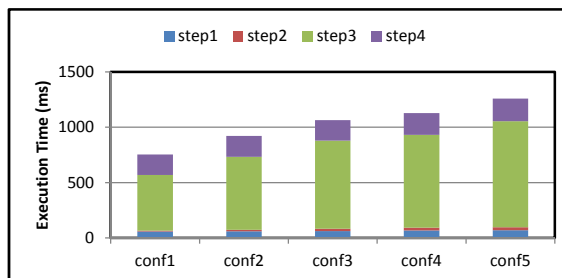

Figure 7.12: Assessing the overhead of the whole testing process while searching for a satisfying solution in step 3.

The experiments presented in Figure 7.11 and Figure 7.12 show that the different overheads introduced by our runtime testing support are relatively low. In fact, we find out that the sum of all overheads including the dependency analysis (step 1), the test selection (step 2), the test placement (step 3) and the test execution (step 4) overheads does not exceed 2.5 seconds in the worst case (i.e., when we are looking for an optimal solution in step 3). This cost can be justified by the use of exact methods in the current version of the constrained test component module. It is obvious that this resolution technique is one of the most costly ways to find the best solution from all feasible solutions.

As illustrated in Figure 7.12, this cost decreases when we simply look for a feasible solution of test component placement. In this case, our test framework requires less than 1.5 seconds for checking *Conf 5*. With the aim of guaranteeing the scalability of RTF4ADS, we recommend to make do with generating the satisfying solution as it consumes less time when the numbers of test components and host nodes increase. We believe that such a solution is sufficient because it respects both the resource and connectivity constraints of the execution environment.

## 7.7 Summary

In this chapter, we applied RTF4ADS to execute in a cost effective manner runtime tests after the occurrence of dynamic structural adaptations. Our contributions were illustrated via the

---

TRMCS case study that was implemented using the OSGi platform. Several test scenarios were presented and were mapped to the TTCN-3 notation in order to demonstrate the expressiveness of this standard. At the end, several experiments were conducted to estimate the RTF4DAS overhead. They pointed out the efficiency of the proposed framework and the tolerated cost that it introduced while varying SUT architecture, execution environment topology and the number of involved tests.

In the following chapter, we show the application of RTF4ADS to evolve test suites when dynamic behavioral adaptations take place.

---

## Application of RTF4ADS After Behavioral Adaptations

---

### 8.1 Introduction

The present chapter outlines the usefulness of the selective test generation part of RTF4ADS in case of behavioral adaptation occurrence and how it is able to efficiently evolve test suites. Therefore, we describe the application of the presented approach on a case study in the telematics<sup>1</sup> and fleet management<sup>2</sup> domain, called *Toast*. The latter is firstly introduced in Section 8.2. As the dynamic behavior is one of the main hallmarks of this case study, several *Toast* evolutions are discussed in Section 8.3 while giving their corresponding behavioral models. Section 8.4 deals with the application of our selective test generation method in order to evolve efficiently the old test suite. In Section 8.6, we evaluate the proposed method by assessing its overhead while the model scale rises and by comparing it to the classical *Regenerate All* and *Retest All* approaches. The last section summarizes the chapter. Parts of this chapter have been published in [30].

### 8.2 Case study: Toast architecture

The interest in telematics and fleet management systems has witnessed an increase during the last decade. The first generation of these systems provides simple functionalities such as vehicle tracking systems. The latter include but they are not limited to the *Global Positioning System* (GPS) technology integrated with other advanced sensors and the mobile communication

---

<sup>1</sup>Telematics is the combination of word telecommunication and informatics. This new technology consists in sending, receiving and storing information by using telecommunication devices.

<sup>2</sup>Fleet management includes a wide range of functions to manage and control vehicles (such as vehicle tracking, vehicle maintenance, speed management, etc.)

technology.

Currently, fleet management systems are more and more mature and highly developed. Consequently, they involve sophisticated functions such as the supervision of the use and the maintenance of vehicles, the monitoring and the accident investigation capabilities, and so on. Moreover, the flexibility and the dynamic adaptability have become important attributes of a fleet management system with the aim of adapting its behavior to the changing needs of the industry and the increasing evolution in the automotive area.

Seeing all these features, a sample case study in this emergent domain is retained to show the feasibility of our selective test generation approach after the occurrence of behavioral adaptations. As introduced in [130], Toast is a typical fleet telematics system used to demonstrate a wide range of EclipseRT technologies. As an OSGi-based application, it provides means to manage and to interact with vehicle devices at runtime. Initially, we start with a simple scenario that covers the case of emergency notification. In this situation, the vehicle comprises three devices : an Airbag, a GPS and a Console. If the airbag deploys, an Emergency Monitor is notified. The monitor asks the GPS for the vehicle position and speed (see Figure 8.1) and displays the obtained data on the vehicle console.

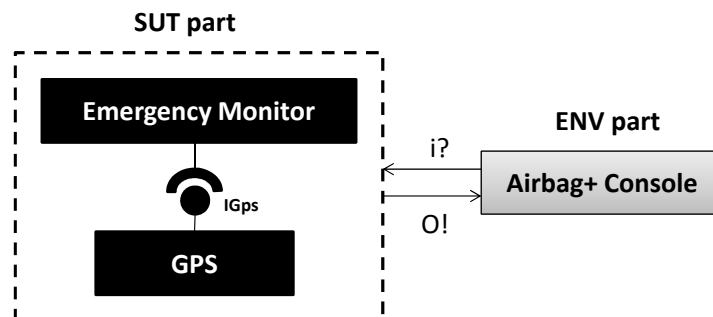

Figure 8.1: The initial Toast architecture.

In the following, we consider the Airbag and the Console components as a part of the environment. Our system under test is made up of GPS and Emergency Monitor components. SUT and ENV parts are modeled by a network of UPPAAL timed automata as shown in Figure 8.2. At the beginning, timing constraints are not considered and we focus mainly on the synchronization of input and output signals between the Toast components.

When the Airbag is deployed (via the action *deploy*), the Emergency Monitor interacts with the GPS to get the vehicle's latitude, longitude, heading and speed. Once this information is obtained, it is displayed on the console with an emergency message (modeled by the action *displayData*).

By applying UPPAAL CO $\sqrt$ ER at this stage, we generate the initial test suite which consists

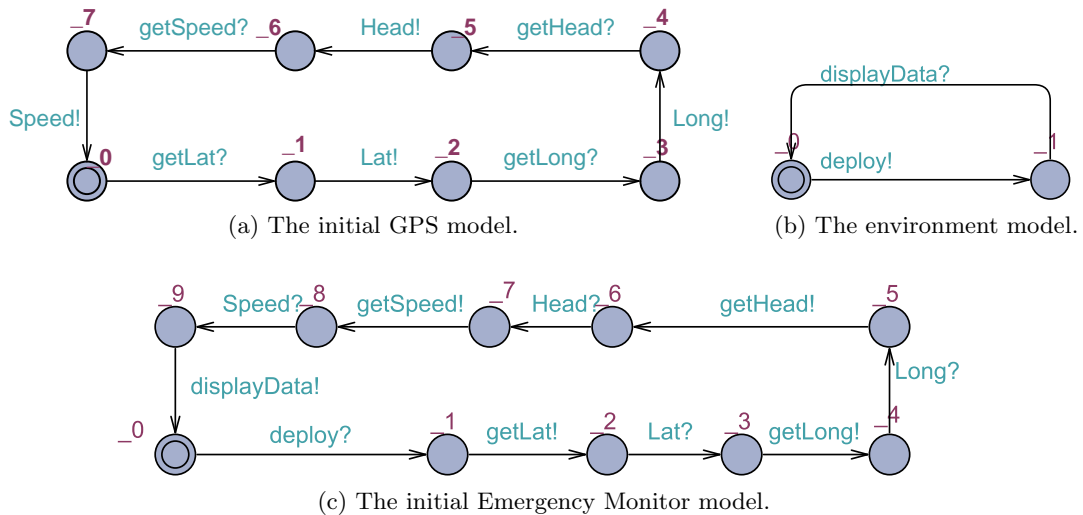

Figure 8.2: Toast behavioral models.

of :

- a unit test for the GPS component : getLat! Lat? getLong! Long? getHead! Head? getSpeed! Speed?
- a unit test for the Emergency Monitor component: deploy! getLat? Lat! getLong? Long! getHead? Head! getSpeed? Speed! displayData?
- an integration test for the composite composition: deploy! displayData?

Throughout this chapter, we turn this basic system into a dynamic and fully functional fleet management application in order to prove the feasibility of our approach and its efficiency in reducing the number of generated tests.

## 8.3 Dynamic Toast evolution

Starting from the basic configuration introduced in the previous section, new components and features can be installed at run-time during the system execution. For instance, we can add a new application that tracks the vehicle's location and periodically reports to the control center. A support for climate control can be integrated, as well. As illustrated in Table 8.1, six cases of behavioral adaptations are discussed and deeply studied in the following subsections.

### 8.3.1 GPS with new behaviors (Case 1)

The initial Toast architecture is maintained whereas GPS behavior is evolved in order to log other pieces of information like altitude (i.e., vertical distance between the vehicle and the local surface of the earth), time, passenger status (i.e., with/without passengers). Figure 8.3 outlines

Table 8.1: Several studied Toast evolutions.

| Scenarios | Evolution description                                      | Kind of the evolution                        | SUT templates   | Locations                     | Transitions                    |
|-----------|--|--|---|-------------------------------|--------------------------------|
| Case 0    | Initial Toast configuration                                | ——   | GPS<br>Emergency  | 8<br>10                       | 8<br>10                        |
| Case 1    | Updated GPS behavior                                       | Complex (adding locations and transitions)   | GPS<br>Emergency  | 13<br>15                      | 15<br>17                       |
| Case 2    | Error support in GPS data transmission                     | Complex (adding locations and transitions)   | GPS<br>Emergency  | 27<br>29                      | 36<br>38                       |
| Case 3    | Removal some behaviors within the GPS                      | Complex (removing locations and transitions) | GPS<br>Emergency  | 23<br>25                      | 31<br>33                       |
| Case 4    | Addition of the Back End Server                            | Complex (adding a new template)              | GPS<br>Emergency<br>Back End  | 23<br>26<br>3                 | 31<br>34<br>3                  |
| Case 5    | Addition of the Tracking Monitor                           | Complex (adding a new template)              | GPS<br>Emergency<br>Tracking<br>Back End  | 23<br>26<br>11<br>6           | 31<br>34<br>11<br>6            |
| Case 6    | Addition of the Climate Controller and the Climate Monitor | Complex (adding two new templates)           | GPS<br>Emergency<br>Tracking<br>Back End<br>Climate Monitor<br>Climate Controller | 23<br>26<br>11<br>6<br>9<br>6 | 31<br>34<br>11<br>6<br>12<br>9 |

the updated GPS behavioral model with new transition labels : *getAlt*, *Alt*, *getTime*, *Time*, *getStatus* and *Status*. Similarly, the Emergency Monitor behavior evolves too with the aim of supporting these changes.

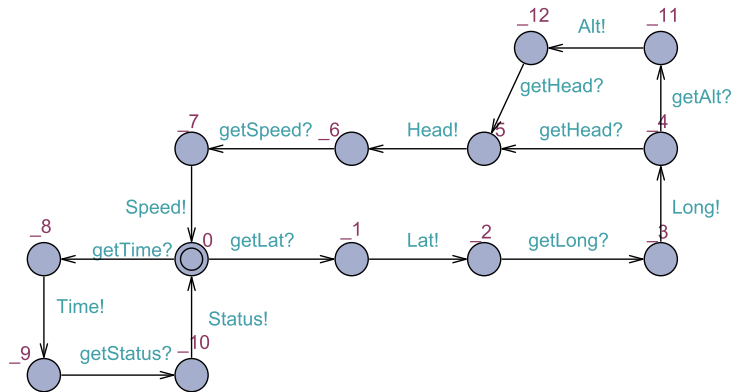

Figure 8.3: The evolved GPS model in Case 1.

### 8.3.2 Error support in GPS data transmission (Case 2)

The evolved GPS behavior, outlined in Figure 8.4, is improved by taking into account errors during data transmission to the Emergency Monitor. To do so, the evolved version of the GPS component sends the vehicle information again in case of error occurrence. This modification introduces new locations and transitions both in the GPS and the Emergency Monitor models.



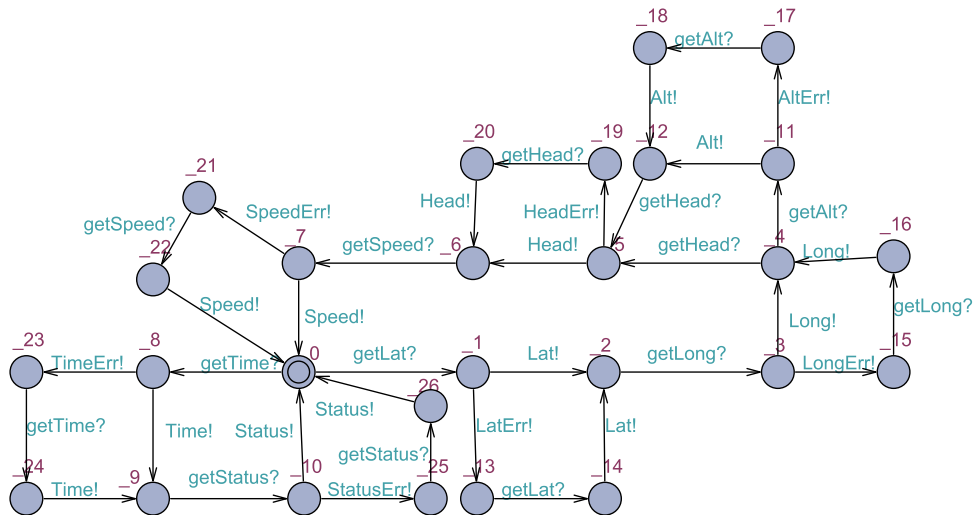

Figure 8.4: The evolved GPS model in Case 2.

### 8.3.3 GPS with some removed and modified behaviors (Case 3)

With the aim of illustrating the case of reductive changes, we assume that the GPS component evolves by removing some behaviors such as passenger status logging. Moreover, instead of recording the altitude, the GPS logs the Elevation (i.e., vertical distance between the local surface of the Earth and global sea level.) and hence the old transition labels are replaced by *getElev*, *Elev* and *ElevErr* as outlined in Figure 8.5.

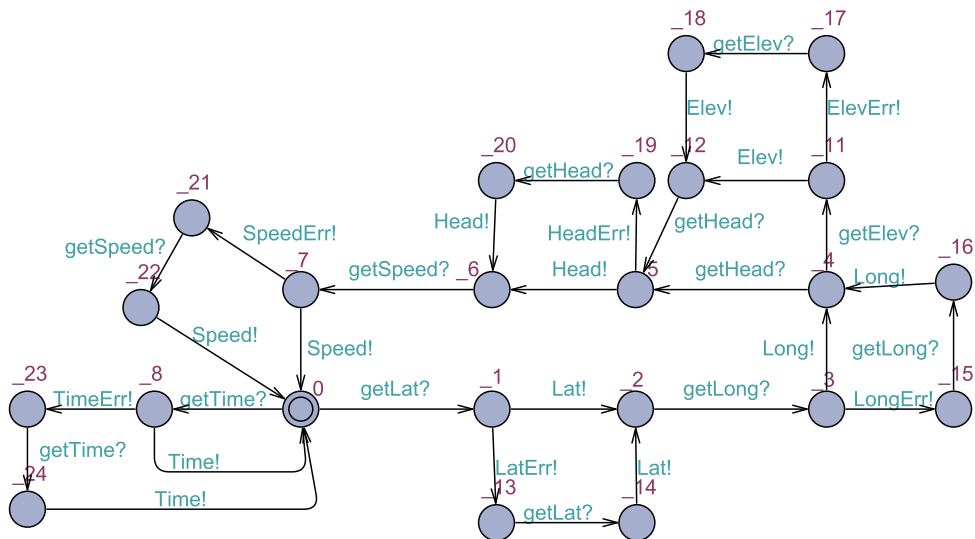

Figure 8.5: The evolved GPS model in Case 3.

### 8.3.4 Adding the Back End component (Case 4)

At this stage, the Toast architecture still operates as a stand-alone application. However, it is required to report emergencies to a remote emergency station in order to notify for example

police and medical services. To do so, the Toast application evolves in order to include a new component in the server side, called *Back End* [131]. The latter is a server running entirely on a separate computer and it is charged with collecting information from the Emergency Monitor and reporting these emergencies. The obtained architecture is outlined in Figure 8.6a.

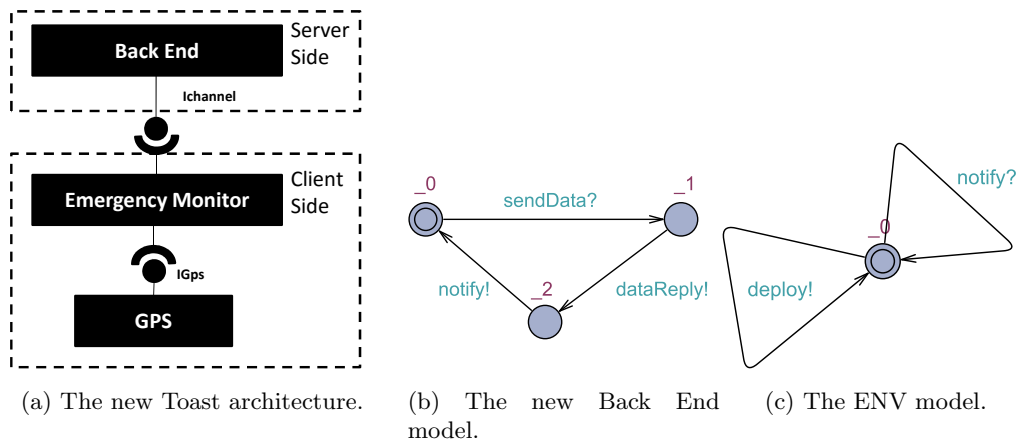

Figure 8.6: The addition of a Back End server to the Toast architecture (Case 4).

The overall Toast behavior is changed and a new template for the Back End component is introduced as shown in Figure 8.6b. Regarding the Emergency Monitor behavior, instead of simply printing the emergency message to the console (via the action *displayData*), it collects readings from the GPS and sends it to the Back End (via the action *sendData*). In turn, this server component notifies the involved participants (such as fire departments, hospitals, police office, etc.) to handle possible crisis situations (via the action *notify*). Note that these participants are considered as a part of the environment in which the Toast application is running.

### 8.3.5 Adding the vehicle tracking feature (Case 5)

In this section, we add a new feature to the Toast application that consists in tracking the vehicle's location. Such a scenario is very interesting, especially for car rental agencies, trucking companies, and even parents of teenagers that are looking for the location of their vehicles. Indeed, Figure 8.7 highlights the Toast tracking scenario that consists in fetching the vehicle location by polling the GPS component every two minutes and then reporting the readings to the Back End server.

The most significant change in this scenario is the new template of the Tracking Monitor (see Figure 8.8). In this timed automaton, a clock  $x$  is defined in order to control the periodic behavior of this component. In each state, an invariant constraint is added in order to limit the waiting time and to force the time progress. The Back End component is evolved too in order

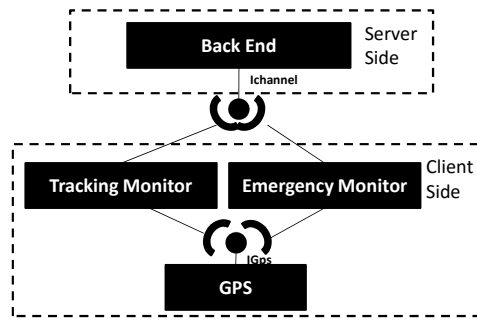

Figure 8.7: The addition of the Tracking Monitor to the Toast architecture (Case 5).

to handle this new interaction with the Tracking Monitor (via the action *storeData*).

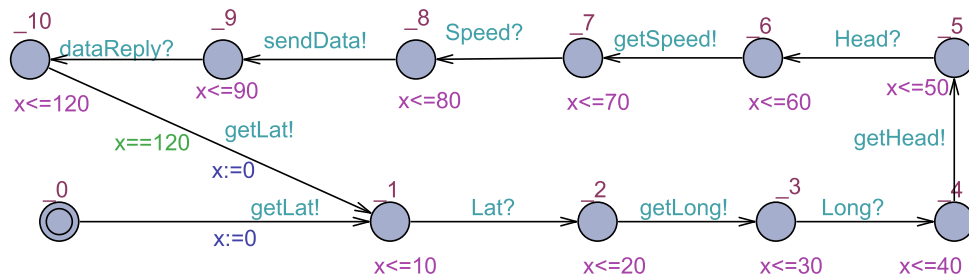

Figure 8.8: The new timed automata of the Tracking Monitor.

### 8.3.6 Adding the vehicle climate control feature (Case 6)

At this level, the Toast architecture is evolved in order to support the vehicle climate control.

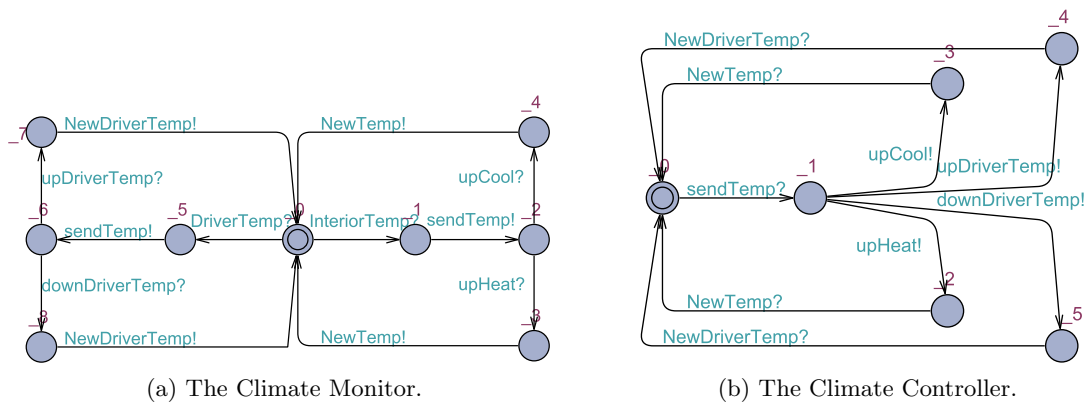

Figure 8.9: New templates in Case 6.

In this scenario, a new component called Climate Controller is deployed on the server side in order to increase or decrease the temperature in response to the current vehicle temperature. For that aim, it communicates with a Climate Monitor. The latter collects the inside temperature and the driver temperature from sensors installed in the vehicle, then the collected data are reported to the Monitor Controller. The latter commands the monitor to heat or to cool either

the driver's seat or the vehicle's inside climate. The behavioral models of these components are illustrated in Figure 8.9.

## 8.4 Applying the selective test generation method after Toast evolution

To check the correctness of the evolved Toast application in a cost effective manner, we have to evolve the test suites by making use of the TestGenApp module. As introduced in Chapter 5, the first step in this module consists in comparing the initial behavioral model and the evolved one. As output, it generates an  $M_{diff}$  model that highlights the similarities and difference between timed automata. It is worthy to note that several cases of evolution are studied in the following. For each case, the obtained  $M_{diff}$  model is automatically exported from the UPPAAL model checker. For that reason, transition and location colors are not observable.

Let us take the example in which the Toast evolves from Case 0 to Case 1. Here, we focus on comparing the old GPS model outlined in Figure 8.2a and the evolved one depicted in Figure 8.3. Applying the model differencing step (see Algorithm 5.1, in Chapter 5), transitions labeled by  $getTime$ ,  $Time$ ,  $getStatus$ ,  $Status$ ,  $getAlt$  and  $Alt$  are marked as new transitions and their corresponding locations are marked as new locations, as well. The obtained  $GPS_{diff}$  model is highlighted in Figure 8.10.

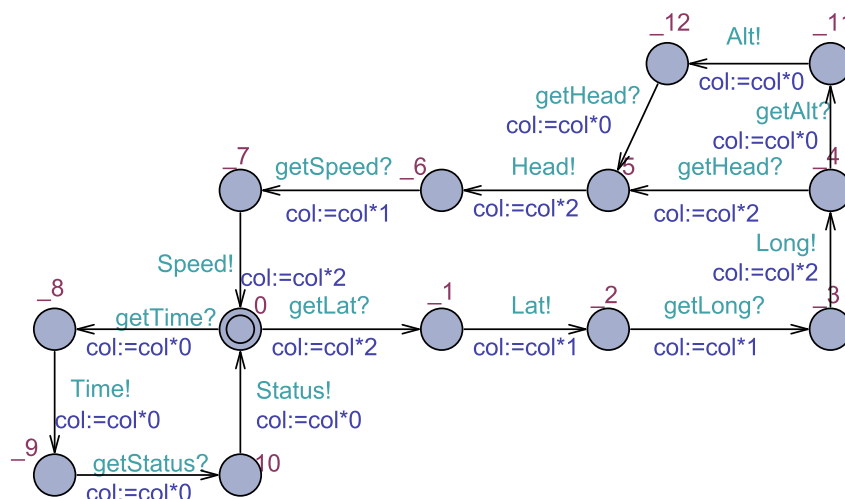

Figure 8.10: The  $GPS_{diff}$  model from Case 0 to Case 1.

It points out that :

- for each new transition (i.e., colored in Red), the assignment  $col := col * 0$  is added;
- for each unchanged transition (i.e., transition labels as well as their source and target locations are colored in Green), the assignment  $col := col * 1$  is added;

- for each changed transition (i.e., at least its source location or its target location or its labels are colored in Yellow), the assignment  $col := col * 2$  is added.

Once the model differencing algorithm is applied to each template in the SUT, we look for the old test suite classification. As already mentioned, the old test suite, which is issued from the initial Toast behavioral models, contains three traces. The latter are classified as follows :

- A reusable trace (i.e., covers unimpacted elements in the SUT): `deploy! displayData?;`
- Two retestable traces (i.e., may cover the impacted elements in the SUT) :
  - `getLat! Lat? getLong! Long? getHead! Head? getSpeed! Speed?;`
  - `deploy! getLat? Lat! getLong? Long! getHead? Head! getSpeed? Speed! displayData?;`

Four new traces are generated by the UPPAAL CO $\sqrt$ ER tool while using our proposed observer automaton that covers edges in which the  $col$  variable is evaluated to zero :

New unit tests for the GPS under test are generated :

- `getTime! Time? getStatus! Status?;`
- `getLat! Lat? getLong! Long? getAlt! Alt?;`

New unit tests for the Emergency Monitor under test are generated :

- `deploy! getTime? Time! getStatus? Status!;`
- `deploy! getLat? Lat! getLong? Long! getAlt? Alt!;`

Let us study now the evolution from Case 2 to Case 3 while focusing essentially on the GPS component. Tests issued from the old GPS model already illustrated in Figure 8.4 are the following :

- `getTime! TimeErr? getTime! Time?;`
- `getLat! LatErr? getLat! Lat?;`
- `getTime! Time? getStatus! StatusErr? getStatus! Status?;`
- `getLat! Lat? getLong! LongErr? getLong! Long?;`
- `getLat! Lat? getLong! Long? getAlt! Alt?;`
- `getLat! Lat? getLong! Long? getAlt! AltErr? getAlt! Alt?;`

g. getLat! Lat? getLong! Long? getHead! HeadErr? getHead! Head?;

h. getLat! Lat? getLong! Long? getHead! Head? getSpeed! SpeedErr? getSpeed! Speed?;

As outlined in Figure 8.11, the output of the model differencing module is given in which transitions labeled with *Status* and *getStatus* are removed. Moreover, several transition labels are changed since we consider in this case the elevation logging instead of the altitude. Consequently, the transitions impacted by these changes are marked with the assignment  $col := col * 2$ .

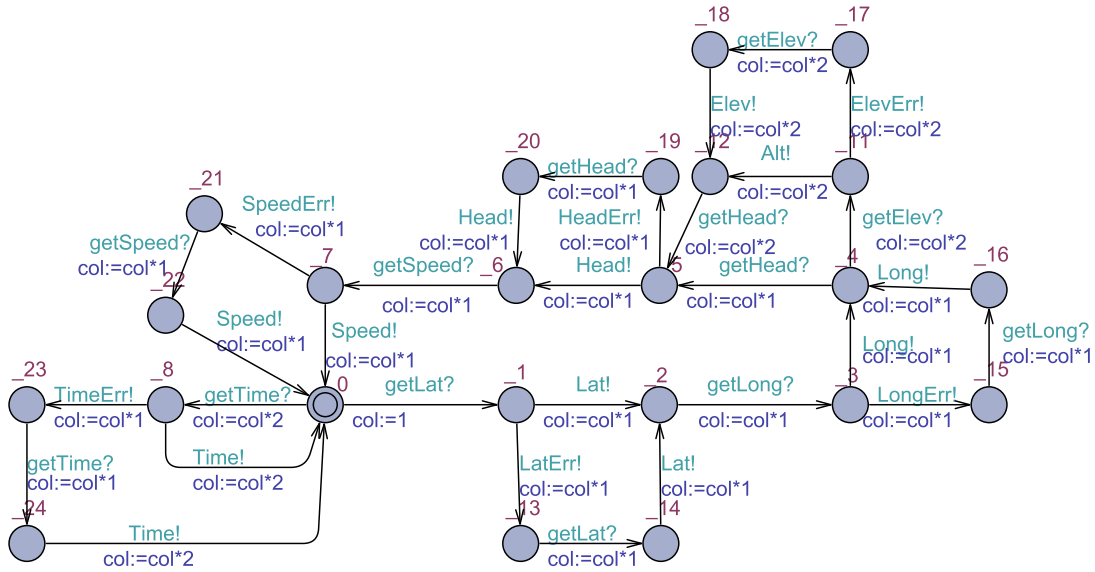

Figure 8.11: The  $GPS_{diff}$  model from Case 2 to Case 3.

At this stage, the old test classification module is executed. First, it detects an obsolete test that covers deleted transitions like *getStatus* and *Status* (i.e.,  $T_{Ob} = \{c\}$ ). Then, it identifies some reusable tests which are still valid and unimpacted by these reductive changes (i.e.,  $T_{Ru} = \{a, b, d, g, h\}$ ). Moreover, it distinguishes other tests that cannot be animated on the new GPS model. These tests are classified as aborted (i.e.,  $T_{Ab} = \{e, f\}$ ) and need to be adapted as follows:

- getLat! Lat? getLong! Long? getElev! Elev?;
- getLat! Lat? getLong! Long? getElev! ElevErr? getElev! Elev?;

Consider now the evolution from Case 3 to Case 4. In this scenario, the template Back End is newly added to the Toast architecture. Thus, all transitions in the Back End model are marked as new transitions. Consequently, for each one, the assignment  $col := col * 0$  is added.

It is worthy to note that the GPS component maintains the same behavior illustrated in Case 3. However, the Emergency Monitor is modified in order to send the measured data to the

Back End Component. Therefore, several locations and transitions are newly added and others are impacted by these changes.

Recall that the old test suite issued from the models in Case 3 consists of unit tests for the GPS component, unit tests for the Emergency Monitor and an integration test for their composition. Old tests for the GPS are unimpacted by the change and are automatically classified as reusable tests. Regarding the Emergency Monitor, its old tests are classified as retestable tests except an obsolete one. A new trace is generated by UPPAAL CO $\sqrt$ ER as follows:

```
deploy! getLat? Lat! getLong? Long! getHead? Head! getSpeed? Speed! sendData?
dataReply!
```

Once the test generation process is achieved, the transformation of the abstract test sequences to concrete tests should be performed. Following the transformation rules already discussed in Chapter 5 Section 5.7, we illustrate the mapping of a sample unit test case of the Climate Monitor (i.e., *InteriorTemp! sendTemp? upHeat! NewTemp?*) via the Listing 8.1.

```

1  ...
2  template float InteriorTemp:={data:=5.0}
3  template float NewTemp:={data:=?}
4  function f_tc0() runs on MyPTCType {
5      mtcPort.send(InteriorTemp);
6      alt{
7          [] mtcPort.receive(sendTemp) {
8              setverdict(pass);}
9          [] mtcPort.receive {
10             setverdict (fail); stop
11         }}}
12 function f_tc1() runs on MyPTCType {
13     mtcPort.send(upHeat);
14     alt {
15         [] mtcPort.receive(Newtemp) {
16             setverdict (pass);}
17         [] mtcPort.receive {
18             setverdict (fail); stop
19         }}}
20 testcase tc_1() runs on MyMTCType system systemType {
21     var MyPTCType ptc0, ptc1;
22     ptc0:= MyPTCType.create(ptc0);
23     map(ptc0:ptcPort, system:systemPort);
24     ptc0.start(f_tc0()); ptc0.done;
25     ptc1:= MyPTCType.create(ptc1);
26     map(ptc1:ptcPort, system:systemPort);
27     ptc1.start(f_tc1()); ptc1.done;
28 }
29 ...

```

Listing 8.1: A snippet TTCN-3 code for testing the new Climate Monitor.

It should be noted that the required data structure for the *send* messages (i.e., actions in the trace defined with “!”) and the expected one for the *receive* messages (i.e., actions in the trace defined with “?”) are declared as a TTCN-3 template. For example, a concrete definition of the send template *InteriorTemp* is illustrated in line 2. Another definition of the receive template *NewTemp* is given using the matching symbol “?” where the latter may be any float value (see line 3).

## 8.5 Test distribution and execution

At this stage, the new abstract test suite is computed after the occurrence of behavioral adaptations. In addition, its mapping to the TTCN-3 notation is achieved with the aim of obtaining concrete tests. Once the latter are compiled by using the TTthree compiler, executable TTCN-3 tests are ultimately produced.

To execute the obtained tests, RTF4ADS is called, more concretely its constraint test placement module as well as its test isolation and execution module. Recall that the first one is required to distribute the involved tests efficiently over the network while fitting resource and connectivity constraints. The second one, TT4RT, is used to set up the test isolation layer and then to perform the test execution.

Since these modules are deeply illustrated in Chapter 7 through the TRMCS case study and they are also evaluated, we focus in the next section on evaluating and estimating the overhead of only the TestGenApp module.

## 8.6 Evaluation and overhead estimation

In this section, we carried out some experiments to measure the overhead introduced by the use of TestGenApp module when different scenarios of behavioral evolutions take place. Thus, the main objective is to compute the number of generated traces after each evolution and estimate the execution time required for the model differencing step, the test classification step and ultimately for the test generation step with UPPAAL CO<sub>√</sub>ER.

Table 8.2 illustrates the studied Toast evolution scenarios and pinpoints the comparison between our proposal TestGenApp and two well-known regression testing strategies : the *Regenerate All* and the *Retest All* approaches. Recall that the first one consists in generating all tests from the new evolved model. The second approach deals with re-executing all tests in the old test suite issued from the old behavioral model and generating new tests that cover only new added behaviors.



Table 8.2: Comparison between Regenerate All, Retest All and TestGenApp strategies.

| Scenario | Case study evolutions | Regenerate All | Retest All |     | TestGenApp |     |            |         |
|----------|-----------------------|----------------|------------|-----|------------|-----|------------|---------|
|          |                       |                | Old        | New | Reusable   | New | Retestable | Adapted |
| 1        | From Case 0 to Case 1 | 7 traces       | 3          | 4   | 1          | 4   | 2          | 0       |
| 2        | From Case 1 to Case 2 | 18 traces      | 7          | 14  | 1          | 14  | 6          | 0       |
| 3        | From Case 2 to Case 3 | 14 traces      | 18         | 0   | 1          | 0   | 11         | 4       |
| 4        | From Case 3 to Case 4 | 17 traces      | 14         | 2   | 7          | 2   | 7          | 0       |
| 5        | From Case 4 to Case 5 | 19 traces      | 17         | 2   | 17         | 2   | 0          | 0       |
| 6        | From Case 5 to Case 6 | 28traces       | 19         | 9   | 19         | 9   | 0          | 0       |

Compared to the Regenerate All technique, our proposal reduces the number of generated traces as shown in Table 8.2. For instance, the evolution from Case 0 to Case 1 requires the generation of **seven** traces with the Regenerate All strategy. The application of TestGenApp produces the selection of **one** trace as a reusable test that covers the unimpacted parts of the model. Moreover, **two** old traces are classified as retestable tests. Only **four** traces are newly generated to cover the newly-added transitions in both the GPS and the Emergency models.

Similarly, instead of generating the full test suite (**fourteen** traces here) when the Toast architecture evolves from Case 2 to Case 3, only **four** traces are adapted in order to cover the modified transitions in the SUT models. **Eleven** old traces are still valid and can be re-executed to prove that these reductive changes have no side effects on the unimpacted parts of the model. Moreover, **one** trace is considered as a reusable test.

Concerning the Retest All strategy, we notice that this strategy does not make any analysis before re-executing tests. Its main limitation consists in re-executing obsolete tests which are no longer valid. For example, when the Toast evolves from Case 2 to Case 3, **four** traces from the old test suite cannot be animated on the new model and then they may cause failure during test execution. This failure is not caused by a faulty behavior in the system but it is due to the execution of invalid tests. Consequently, we conclude that selecting valid and relevant tests to run is highly recommended because it provides a high degree of confidence in the evolved system without rerunning the overall test suite.

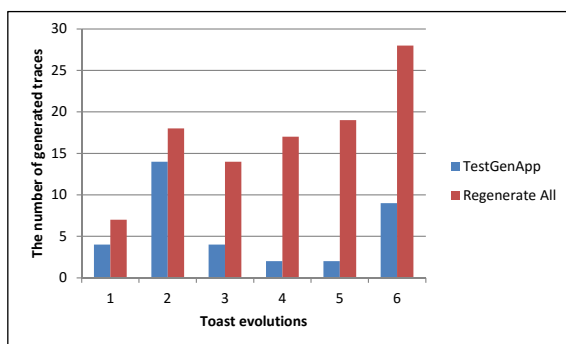

(a) The number of generated traces.

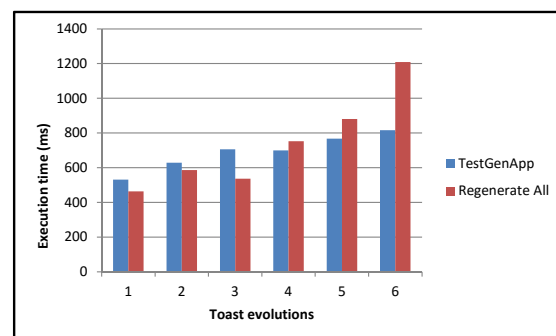

(b) Execution time for test evolution.

Figure 8.12: Comparison between TestGenApp and Regenerate All approaches.

Figure 8.12 outlines two experiments that we conducted on a machine with Intel Core i7 and 8 GB of main memory. They show that TestGenApp and Regenerate All approaches depend highly on the model scale either in terms of generation time or generated traces.

Regarding the number of generated traces after each evolution, we notice that an increase in the number of involved templates, locations and transitions causes an increase in the test suite size. As depicted in Figure 8.12a, it is obvious that the TestGenApp produces less traces than the Regenerate All strategy since it focuses only on covering new behaviors in the evolved model.

Regarding the generation time, Figure 8.12b shows that this measure follows the model scale, as well. In case of small systems (e.g., Toast scenarios in Case 1, Case 2 and Case 3), TestGenApp overhead in terms of test generation time is greater than Regenerate All as it performs several tasks : model differencing, test classification and test generation (see Figure 8.13). When we deal with large systems, we notice that the cost of generating the complete test suite is higher than generating only new behaviors.

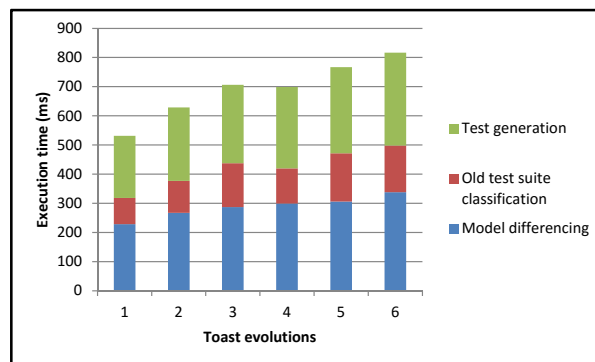

Figure 8.13: The overhead of the TestGenApp modules.

Such experiments show the clear benefits of the TestGenApp especially in case of large scale models and elementary modifications (i.e., Adding/removing/modifying a location and/or a transition). It is easier to generate a minimal set of tests from the part of the model impacted by the dynamic change rather than performing a full regeneration.

Compared to the typical solutions such as Regenerate All and Retest all, TestGenApp gives an important information about the obtained tests and which parts of the SUT they cover. As a result, test prioritization can be easily applied in our context and tests covering critical zones have the priority to be executed first.

## 8.7 Summary

This chapter outlined the application of the RTF4ADS framework, more specifically the TestGenApp module, through the dynamic Toast architecture. Several scenarios were studied with the aim of highlighting the benefits of TestGenApp not only on reducing the number of generated tests but also on providing a significant status (i.e., reusable, retestable, new and adapted) for each test in the new test suite. Moreover, the conducted experiments illustrated the merit of TestGenApp compared to the Retest All as well as the Regenerate All strategies. The next chapter summarizes the contributions of this thesis, the main results which were obtained, and outlines areas for future research.

The present chapter concludes firstly this dissertation and summarizes the presented contributions. Secondly, it discusses some limitations of our work and it proposes some future research lines to explore.

## 9.1 Summary

In this thesis, we proposed a runtime testing support that performs platform-independent tests safely while the SUT is operational in order to check its correctness after dynamic adaptations. In this respect, we presented several contributions, namely (i.) a dependency analysis approach for test case selection (ii.) a constrained test component placement method that looks for a satisfying solution of test component assignment to execution nodes with respect to resource availability and network connectivity (iii.) a test isolation infrastructure that supports heterogeneous components under test in terms of testability options, (iv.) a TTCN-3-based test system for executing TTCN-3 based tests at runtime (v.) a selective test generation method that produces relevant test cases covering either modified or newly-added behaviors at runtime and finally maps the generated abstract test sequences to the TTCN-3 language. The use of the TTCN-3 standard as a test specification language and as a runtime test execution platform makes the proposed test system easier to be extended for new systems under test, new component models, etc. The RTF4ADS framework, gathering all these provided features was also introduced.

These contributions were illustrated through two critical and distributed case studies, namely

the Teleservices and Remote Medical Care System (TRMCS) and the Toast application. The first case study was applied to illustrate the applicability of RTF4ADS, more precisely TT4RT instances for executing safely and efficiently runtime tests in a distributed and resource aware environment after the occurrence of dynamic structural adaptations. The second case study was served to empirically validate the feasibility of the selective test generation method, TestGenApp, when behavioral adaptations take place.

Several experiments were conducted to show the benefits of the RTF4ADS framework and its components. On the one hand, the experimental results pointed out the efficiency of the proposed framework and the tolerated cost that it introduced while varying the TRMCS architecture, the execution environment characteristics (i.e., topology, connectivity, resource availability) and the number of involved tests. On the other hand, several experiments were carried out to evaluate our TestGenApp module, and its cost-effective test generation capabilities. For that aim, it was compared to the classical regression testing techniques namely the Retest All and the Regenerate All strategies. The results of these experiments indicate that our proposal avoids the re-execution of obsolete tests, reduces the number newly-generated tests and also provides a significant status (i.e., reusable, retestable, new and adapted) for each test in the evolved test suite.

## 9.2 Limitations and Future Work

In spite of the mentioned advantages, this thesis has some limitations which should be addressed. The remainder of this section outlines some ongoing and future works that will be investigated in the following order.

### 9.2.1 Meta-heuristic techniques for the constrained test placement problem

The major problem that we faced while applying RTF4ADS on large-scale environments comes from the constrained test placement module. Since this module solves the test placement problem, which is formalized by *0-1 Multiple Knapsack Problem* (MKP), by using the Choco solver, more specifically by an exact approach (i.e., Branch and Bound). This tool requires a long time to compute an optimal solution fitting the resource and connectivity constraints. Therefore, we investigate efforts in enhancing the proposed method by using the *Tabu Search* (TS) meta-heuristic as a resolution algorithm and performing a parallel exploration of the solution domain. Due to its notable efficiency in solving large scale size 0-1 MKP, the TS approach may generate a good approximation of the test placement solution while reducing the execution time and the memory consumption required for this computation.

### 9.2.2 Extension of the distributed TTCN-3 Test System

The current version of RTF4ADS, more precisely its TT4RT module, focused only on distributing TTCN-3 test cases. Each one was managed by a *Main Test Component* (MTC) and may create several Parallel Test Components in order to execute integration tests. In this case, only MTC components are involved in the test placement process. To gain more performance and to alleviate the test workload on the execution environment, it might be interesting to distribute also PTC Components over the execution nodes. To that aim, we plan to extend TT4RT in order to avoid the communication overhead introduced by the centralized execution of several PTCs [88].

### 9.2.3 Runtime testing of autonomous systems

We dealt in this thesis with dynamically adaptable systems in which dynamic adaptation actions are done manually by an external adaptation manager. It is highly recommended to enhance our test framework in order to support autonomous systems which are able to manage themselves by forming emergent behaviors in response to changing environmental conditions. To do so, we should include our test system into *Monitor-Analyze-Plan-Execute* (MAPE-K) loops with the purpose of automating not only the adaptation process but also the runtime testing process. In this respect, we plan to adjust RTF4ADS in order to test functional and non-functional requirements of recent and emergent applications like the smart energy grid [132] and the IoT<sup>1</sup>-based eHealth applications [133].

### 9.2.4 Test generation based on probabilistic model-checking

An emergent research line, which is still in progress, consists in using probabilistic models during test generation. The key idea here is to apply runtime testing before the occurrence of dynamic proactive adaptations which consist in making predictions of how the environment or the system is going to evolve in the near future. To do so, tests have to be generated from behavioral models that are augmented with probabilities to describe the unpredictable system's behavior. Formalisms like *Probabilistic Timed Automata* (PTAs) can be used to specify the system behavior. In this context, providing a model-based testing approach that generates runtime tests from PTAs models while maximizing an utility function should be investigated [134].

---

<sup>1</sup>Internet of Things

### Journal publications

- 1) **Mariam Lahami**, Moez Krichen, and Mohamed Jmaiel. Safe and Efficient Runtime Testing Framework Applied in Dynamic and Distributed Systems, *Science of Computer Programming (SCP)*, vol. 122, no. C, pp.1-28, 2016.
- 2) **Mariam Lahami**, Moez Krichen, and Mohamed Jmaiel. Runtime Testing Approach of Structural Adaptations for Dynamic and Distributed Systems in *the International Journal of Computer Applications in Technology (IJCAT)*, vol. 51, no. 4, pp. 259-272, 2015.
- 3) **Mariam Lahami**, Moez Krichen, and Mohamed Jmaiel. A distributed Test Architecture For Adaptable and Distributed Real-Time Systems, *dans la Revue Nouvelles Technnologies d'Information (RNTI)*, L6 CAL'2011, 2012.

### Conference publications

- 4) **Mariam Lahami**, Moez Krichen, Hajer Barhoumi and Mohamed Jmaiel. Selective Test Generation Approach for Testing Dynamic Behavioral Adaptations, in *Proceedings of the 27th IFIP International Testing Software and Systems Conference (ICTSS)*, pp. 224-239, Sharjah-Dubai, UAE, November 2015. Lecture Notes in Computer science, Springer.
- 5) **Mariam Lahami**, Moez Krichen, and Mohamed Jmaiel. Runtime testing framework for improving quality in dynamic service-based systems, in *Proceedings of the second International Workshop on Quality Assurance for Service-based Applications (QASBA)*, in conjunction with ISSSTA 2013, July 15-20, Lugano, Switzerland.

- 6) **Mariam Lahami** and Moez Krichen. Test Isolation Policy for Safe Runtime Validation of Evolvable Software Systems, in *Proceedings of the 22nd IEEE International Conference on Enabling Technologies: Infrastructure for Collaborative Enterprises (WETICE)* Hammamet, Tunisia, June 2013. IEEE Computer Society.
- 7) **Mariam Lahami**, Fairouz Fakhfakh, Moez Krichen, and Mohamed Jmaiel. Towards a TTCN-3 Test System for Runtime Testing of Adaptable and Distributed Systems, in *Proceedings of the 24th IFIP International Testing Software and Systems Conference (ICTSS)*, pp. 71-86, Aalborg, Denmark, November 2012. Lecture Notes in Computer science, Springer.
- 8) **Mariam Lahami**, Moez Krichen, Mariam Bouchakwa and Mohamed Jmaiel. Using Knapsack Problem Model to Design a Resource Aware Test Architecture for Adaptable and Distributed systems, in *Proceedings of the 24th IFIP International Testing Software and Systems Conference (ICTSS)*, pp. 103-118, Aalborg, Denmark, November 2012. Lecture Notes in Computer science, Springer.



---

## Bibliography

---

- [1] M. Utting and B. Legeard, *Practical Model-Based Testing: A Tools Approach*. Morgan Kaufmann Publishers Inc., 2006.
- [2] ETSI, “Methods for Testing and Specification (MTS), The Testing and Test Control Notation version 3, Part 1: TTCN-3 Core Language,” 2005.
- [3] G. Behrmann, A. David, and K. G. Larsen, “A Tutorial on UPPAAL,” in *Proceeding of the International School on Formal Methods for the Design of Computer, Communication, and Software Systems (SFM-RT’04)*, vol. 3185, 2004, pp. 200–237.
- [4] F. Stenh, “Extending a Real-Time Model-Checker to a Test-Case Generation Tool Using libCoverage,” Master’s thesis, UPPSALA University, 2008.
- [5] J. Blom, A. Hessel, B. Jonsson, and P. Pettersson, “Specifying and Generating Test Cases Using Observer Automata,” in *Proceeding of the 5th International Workshop on Formal Approaches to Software Testing (FATES’05)*, 2005, pp. 125–139.
- [6] J. Kienzle, N. Guelfi, and S. Mustafiz, *Transactions on Aspect-Oriented Software Development VII: A Common Case Study for Aspect-Oriented Modeling*. Springer Berlin Heidelberg, 2010, ch. Crisis Management Systems: A Case Study for Aspect-Oriented Modeling, pp. 1–22.
- [7] I.-Y. Chen and C.-H. Tsai, “Pervasive Digital Monitoring and Transmission of Pre-Care Patient Biostatistics with an OSGi, MOM and SOA Based Remote Health Care System,” in *Proceeding of the 6th Annual IEEE International Conference on Pervasive Computing and Communications (PerCom’06)*, 2008, pp. 704–709.

- [8] U. Varshney, "Pervasive Healthcare and Wireless Health Monitoring," *Mobile Networks and Applications*, vol. 12, no. 2-3, pp. 113–127, 2007.
- [9] S. T. S. Thong, C. T. Han, and T. A. Rahman, "Intelligent Fleet Management System with Concurrent GPS GSM Real-Time Positioning Technology," in *Proceeding of the 7th International Conference on Intelligent Transport Systems Telecommunications (ITST'07)*, 2007, pp. 1–6.
- [10] D. Brenner, C. Atkinson, R. Malaka, M. Merdes, B. Paech, and D. Suliman, "Reducing Verification Effort in Component-based Software Engineering Through Built-In Testing," *Information Systems Frontiers*, vol. 9, no. 2-3, pp. 151–162, 2007.
- [11] C. Murphy, G. Kaiser, I. Vo, and M. Chu, "Quality Assurance of Software Applications Using the In Vivo Testing Approach," in *Proceedings of the 2nd International Conference on Software Testing Verification and Validation (ICST'09)*, 2009, pp. 111–120.
- [12] M. Merdes, R. Malaka, D. Suliman, B. Paech, D. Brenner, and C. Atkinson, "Ubiquitous RATs: How Resource-Aware Run-Time Tests Can Improve Ubiquitous Software Systems," in *Proceedings of the 6th International Workshop on Software Engineering and Middleware (SEM'06)*, 2006, pp. 55–62.
- [13] É. Piel and A. González-Sánchez, "Data-flow Integration Testing Adapted to Runtime Evolution in Component-Based Systems," in *Proceedings of the ESEC/FSE Workshop on Software Integration and Evolution@runtime*, 2009, pp. 3–10.
- [14] D. Niebuhr and A. Rausch, "Guaranteeing Correctness of Component Bindings in Dynamic Adaptive Systems Based on Runtime Testing," in *Proceedings of the 4th International Workshop on Services Integration in Pervasive Environments (SIPE'09)*, 2009, pp. 7–12.
- [15] A. González-Sánchez, É. Piel, and H.-G. Gross, "Architecture Support for Runtime Integration and Verification of Component-based Systems of Systems," in *Proceeding of the Automated Software Engineering - Workshops, (ASE Workshops'08)*, 2008, pp. 41–48.
- [16] X. Bai, D. Xu, G. Dai, W.-T. Tsai, and Y. Chen, "Dynamic Reconfigurable Testing of Service-Oriented Architecture," in *Proceeding of the 31st Annual International Computer Software and Applications Conference (COMPSAC'07)*, 2007, pp. 368–378.
- [17] M. Greiler, H.-G. Gross, and A. van Deursen, "Evaluation of Online Testing for Services – A Case Study," in *Proceeding of the 2nd International Workshop on Principles of Engineering Service-Oriented System*, 2010, pp. 36–42.

- [18] J. Hielscher, R. Kazhamiakin, A. Metzger, and M. Pistore, “A Framework for Proactive Self-adaptation of Service-Based Applications Based on Online Testing,” in *Proceedings of the 1st European Conference on Towards a Service-Based Internet (ServiceWave’08)*, 2008, pp. 122–133.
- [19] É. Piel, A. González-Sánchez, and H.-G. Groß, “Automating Integration Testing of Large-Scale Publish/Subscribe Systems,” in *Principles and Applications of Distributed Event-Based Systems*, 2010, pp. 140–163.
- [20] T. M. King, A. A. Allen, R. Cruz, and P. J. Clarke, “Safe Runtime Validation of Behavioral Adaptations in Autonomic Software,” in *Proceedings of the 8th International Conference on Autonomic and Trusted Computing (ATC’11)*, 2011, pp. 31–46.
- [21] A. E. Ramirez, B. Morales, and T. M. King, “A Self-Testing Autonomic Job Scheduler,” in *Proceedings of the 46th Annual Southeast Regional Conference on XX (ACM-SE’08)*, 2008, pp. 304–309.
- [22] E. M. Fredericks, B. DeVries, and B. H. C. Cheng, “Towards Run-time Adaptation of Test Cases for Self-adaptive Systems in the Face of Uncertainty,” in *Proceedings of the 9th International Symposium on Software Engineering for Adaptive and Self-Managing Systems (SEAMS’14)*, 2014, pp. 17–26.
- [23] M. Lahami, M. Krichen, and M. Jmaïel, “A distributed Test Architecture For Adaptable and Distributed Real-Time Systems,” *Dans la revue Nouvelles Technologies d’Information (RNTI), L6 CAL’2011*, 2012.
- [24] M. Lahami, M. Krichen, M. Bouchakwa, and M. Jmaïel, “Using Knapsack Problem Model to Design a Resource Aware Test Architecture for Adaptable and Distributed Systems,” in *Proceedings of the 24th IFIP WG 6.1 International Conference Testing Software and Systems (ICTSS’12)*, 2012, pp. 103–118.
- [25] N. Jussien, G. Rochart, and X. Lorca, “Choco: an Open Source Java Constraint Programming Library,” in *Proceeding of the Workshop on Open-Source Software for Integer and Constraint Programming (OSSICP’08)*, 2008, pp. 1–10.
- [26] M. Lahami, F. Fakhfakh, M. Krichen, and M. Jmaïel, “Towards a TTCN-3 Test System for Runtime Testing of Adaptable and Distributed Systems,” in *Proceedings of the 24th IFIP WG 6.1 International Conference Testing Software and Systems (ICTSS’12)*, 2012, pp. 71–86.

- [27] ETSI, “Methods for Testing and Specification (MTS), The Testing and Test Control Notation version 3, Part 5: TTCN-3 Runtime Interface (TRI),” 2005.
- [28] —, “Methods for Testing and Specification (MTS), The Testing and Test Control Notation version 3, Part 6: TTCN-3 Control Interface (TCI),” 2005.
- [29] M. Lahami and M. Krichen, “Test Isolation Policy for Safe Runtime Validation of Evolvable Software Systems,” in *Proceedings of the 22nd IEEE International Conference on Enabling Technologies: Infrastructure for Collaborative Enterprises (WETICE’13)*, 2013, pp. 377–382.
- [30] M. Lahami, M. Krichen, H. Barhoumi, and M. Jmaïel, “Selective Test Generation Approach for Testing Dynamic Behavioral Adaptations,” in *Proceedings of the 27th IFIP WG 6.1 International Conference on Testing Software and Systems (ICTSS’15)*, 2015, pp. 224–239.
- [31] H. Leung and L. White, “Insights into regression testing [software testing],” in *Proceedings of the International Conference on Software Maintenance (ICSM’89)*, 1989, pp. 60–69.
- [32] M. Lahami, M. Krichen, and M. Jmaïel, “Runtime Testing Framework for Improving Quality in Dynamic Service-based Systems,” in *Proceedings of the 2nd International Workshop on Quality Assurance for Service-based Applications (QASBA’13), in conjunction with (ISSTA’13)*, 2013, pp. 17–24.
- [33] —, “Safe and Efficient Runtime Testing Framework Applied in Dynamic and Distributed Systems,” *Science of Computer Programming (SCP)*, vol. 122, no. C, pp. 1–28, 2016.
- [34] J. Kramer and J. Magee, “Dynamic Configuration for Distributed Systems,” *IEEE Transactions on Software Engineering (TSE)*, vol. 11, no. 4, pp. 424–436, 1985.
- [35] A. Ketfi, N. Belkhatir, and P. yves Cunin, “Dynamic Updating of Component-Based Applications,” in *Proceeding of the International Conference on Software Engineering Research and Practice (SERP’02)*, 2002.
- [36] E. Bruneton, T. Coupaye, M. Leclercq, V. Quéma, and J.-B. Stefani, “An Open Component Model and Its Support in Java,” in *Proceeding of the 7th International International ACM Sigsoft Symposium on Component-Based Software Engineering (CBSE’04)*, 2004, pp. 7–22.
- [37] T. Chaari and K. Fakhfakh, “Semantic Modeling and Reasoning at Runtime for Autonomous Systems Engineering,” in *Proceeding of the 9th International Conference on*

- Ubiquitous Intelligence Computing and Autonomic Trusted Computing (UIC/ATC'12)*, 2012, pp. 415–422.
- [38] E. Mezghani and R. B. Halima, “DRF4SOA: A Dynamic Reconfigurable Framework for Designing Autonomic Application Based on SOA,” in *Proceeding of the 21st IEEE International Conference on Enabling Technologies: Infrastructure for Collaborative Enterprises (WETICE'12)*, 2012, pp. 95–97.
- [39] *OSGi service gateway specification, Release 4*, Open Services Gateway Initiative, 2005.
- [40] J. C. Laprie, A. Avizienis, and H. Kopetz, Eds., *Dependability: Basic Concepts and Terminology*. Springer-Verlag New York, Inc., 1992.
- [41] G. Tamura, N. Villegas, H. Müller, J. Sousa, B. Becker, G. Karsai, S. Mankovskii, M. Pezzè, W. Schäfer, L. Tahvildari, and K. Wong, “Towards Practical Runtime Verification and Validation of Self-Adaptive Software Systems,” in *Software Engineering for Self-Adaptive Systems II*, 2013, pp. 108–132.
- [42] B. Cheng, K. Eder, M. Gogolla, L. Grunske, M. Litoiu, H. Müller, P. Pelliccione, A. Perini, N. Qureshi, B. Rumpe, D. Schneider, F. Trollmann, and N. Villegas, “Using Models at Runtime to Address Assurance for Self-Adaptive Systems,” in *Models@run.time*, 2014, pp. 101–136.
- [43] B. Morin, O. Barais, J.-M. Jezequel, F. Fleurey, and A. Solberg, “Models@Runtime to Support Dynamic Adaptation,” *Computer*, vol. 42, no. 10, pp. 44–51, 2009.
- [44] P. Inverardi and M. Mori, “Model Checking Requirements at Run-time in Adaptive Systems,” in *Proceedings of the 8th Workshop on Assurances for Self-adaptive Systems (ASAS'11)*, 2011, pp. 5–9.
- [45] R. Freedman, “Testability of Software Components,” *IEEE Transactions on Software Engineering*, vol. 17, no. 6, pp. 553–564, 1991.
- [46] G. Din, S. Tolea, and I. Schieferdecker, “Distributed Load Tests with TTCN-3,” in *Proceedings of the 18th IFIP TC6/WG6.1 International Conference for Testing of Communicating Systems (TestCom'06)*, 2006, pp. 177–196.
- [47] P. Stocks and D. Carrington, “A Framework for Specification-Based Testing,” *IEEE Transactions on Software Engineering (TSE)*, vol. 22, no. 11, pp. 777–793, 1996.

- [48] L. Liu, H. Miao, and X. Zhan, “A Framework for Specification-Based Class Testing,” in *Proceeding of the 8th International Conference on Engineering of Complex Computer Systems (ICECCS’02)*, 2002, pp. 153–162.
- [49] M. Sarma, D. Kundu, and R. Mall, “Automatic Test Case Generation from UML Sequence Diagram,” in *International Conference on Advanced Computing and Communications (ADCOM’07)*, 2007, pp. 60–67.
- [50] S. K. Swain and D. P. Mohapatra, “Test Case Generation from Behavioral UML Models,” *International Journal of Computer Applications*, vol. 6, no. 8, pp. 5–11, 2010.
- [51] A. J. Maâlej, M. Krichen, and M. Jmaïel, “Model-Based Conformance Testing of WS-BPEL Compositions,” in *Proceeding of the 4th IEEE International Workshop on Software Test Automation (STA’12) in conjunction with (COMPSAC ’12)*, 2012, pp. 452–457.
- [52] A. Calvagna and A. Gargantini, “A Logic-based Approach to Combinatorial Testing With Constraints,” in *Proceedings of the 2nd International Conference on Tests and Proofs (TAP’08)*, 2008, pp. 66–83.
- [53] L. Zhang, T. Xie, L. Zhang, N. Tillmann, J. De Halleux, and H. Mei, “Test Generation via Dynamic Symbolic Execution for Mutation Testing,” in *Proceeding of the 26th IEEE International Conference on Software Maintenance (ICSM’10)*, 2010, pp. 1–10.
- [54] S. Khurshid, C. S. Păsăreanu, and W. Visser, “Generalized Symbolic Execution for Model Checking and Testing,” in *Proceedings of the 9th International Conference on Tools and Algorithms for the Construction and Analysis of Systems (TACAS’03)*, 2003, pp. 553–568.
- [55] M. Krichen, “A Formal Framework for Conformance Testing of Distributed Real-Time Systems,” in *Proceedings of the 14th International Conference On Principles Of Distributed Systems, (OPODIS’10)*, 2010.
- [56] A. Khoumsi, “Testing Distributed Real Time Systems Using a Distributed Test Architecture,” in *Proceeding of the IEEE Symposium on Computers and Communications (ISCC’01)*, 2001, pp. 648–654.
- [57] S. Siddiquee and A. En-Nouaary, “Two Architectures for Testing Distributed Real-Time Systems,” in *Proceeding of the 2nd Information and Communication Technologies (ICTTA’06)*, vol. 2, 2006, pp. 3388–3393.

- [58] A. Tarhini and H. Fouchal, “Conformance Testing of Real-Time Component Based Systems,” in *Proceeding of the International School and Symposium on Advanced Distributed Systems (ISSADS’05)*, 2005, pp. 167–181.
- [59] A. Khoumsi, “Testing Distributed Real-Time reactive Systems Using a centralized Test Architecture,” in *Proceeding of the North Atlantic Test Workshop (NATW)*, 2001, pp. 648–654.
- [60] M. J. Harrold, “Testing: a roadmap,” in *Proceedings of the 16th IEEE Conference on The Future of Software Engineering (ICSE’00)*, 2000, pp. 61–72.
- [61] G. Rothermel and M. J. Harrold, “A Safe, Efficient Regression Test Selection Technique,” *ACM Transactions on Software Engineering and Methodology*, vol. 6, pp. 173–210, 1997.
- [62] T. L. Graves, M. J. Harrold, J.-M. Kim, A. Porter, and G. Rothermel, “An Empirical Study of Regression Test Selection Techniques,” *ACM Transactions on Software Engineering and Methodology (TOSEM)*, vol. 10, no. 2, pp. 184–208, 2001.
- [63] I. Granja and M. Jino, “Techniques for Regression Testing: Selecting Test Case Sets Tailored to Possibly Modified Functionalities,” in *Proceedings of the 3rd European Conference on Software Maintenance and Reengineering (CSMR’99)*, 1999, pp. 2–22.
- [64] B. Korel, L. Tahat, and B. Vaysburg, “Model Based Regression Test Reduction Using Dependence Analysis,” in *Proceedings of the 18th IEEE International Conference on Software Maintenance (ICSM’02)*, 2002, pp. 214–223.
- [65] L. C. Briand, Y. Labiche, and S. He, “Automating Regression Test Selection Based on UML Designs,” *Information & Software Technology*, vol. 51, no. 1, pp. 16–30, 2009.
- [66] E. Fourneret, F. Bouquet, F. Dadeau, and S. Debricon, “Selective Test Generation Method for Evolving Critical Systems,” in *Proceedings of the 2011 IEEE 4th International Conference on Software Testing, Verification and Validation Workshops (ICSTW’11)*, 2011, pp. 125–134.
- [67] IEEE, “IEEE Standard Glossary of Software Engineering Terminology,” 1990.
- [68] A. González, E. Piel, and H.-G. Gross, “A Model for the Measurement of the Runtime Testability of Component-Based Systems,” in *Proceedings of the IEEE International Conference on Software Testing, Verification, and Validation Workshops (ICSTW’09)*, 2009, pp. 19–28.

- [69] Y. Wang, G. King, D. Patel, S. Patel, and A. Dorling, "On Coping With Real-time Software Dynamic Inconsistency by Built-In Tests," *Annals of Software Engineering*, vol. 7, no. 1-4, pp. 283–296, 1999.
- [70] J. Vincent, G. King, P. Lay, and J. Kinghorn, "Principles of Built-In-Test for Run-Time-Testability in Component-Based Software Systems," *Software Quality Control*, vol. 10, no. 2, pp. 115–133, 2002.
- [71] C. Mao, "AOP-based Testability Improvement for Component-based Software," in *Proceedings of the 31st Annual International Computer Software and Applications Conference (COMPSAC '07)*, 2007, pp. 547–552.
- [72] L. Chu, K. Shen, H. Tang, T. Yang, and J. Zhou, "Dependency Isolation for Thread-based Multi-tier Internet Services," in *Proceeding of the 24th Annual Joint Conference of the IEEE Computer and Communications Societies (INFOCOM'05)*, 2005, pp. 796–806.
- [73] A. Beszedes, T. Gergely, L. Schrettnner, J. Jasz, L. Lango, and T. Gyimothy, "Code Coverage-Based Regression Test Selection and Prioritization in WebKit," in *Proceeding of the 28th IEEE International Conference on Software Maintenance (ICSM'12)*, 2012, pp. 46–55.
- [74] B. Korel and A. M. Al-Yami, "Automated Regression Test Generation," *ACM SIGSOFT Software Engineering Notes*, vol. 23, no. 2, pp. 143–152, 1998.
- [75] O. Pilskalns, G. Uyan, and A. Andrews, "Regression Testing UML Designs," in *Proceedings of the 22nd IEEE International Conference on Software Maintenance (ICSM'06)*, 2006, pp. 254–264.
- [76] Y. Chen, R. L. Probert, and H. Ural, "Model-based Regression Test Suite Generation Using Dependence Analysis," in *Proceedings of the 3rd International Workshop on Advances in Model-based Testing (A-MOST'07)*, 2007, pp. 54–62.
- [77] M. J. Harrold, "Architecture-Based Regression Testing of Evolving Systems," in *Proceeding of the International Workshop on the Role of Software Architecture in Testing and Analysis (ROSATEA '98)*, 1998, pp. 73–77.
- [78] H. Muccini, M. S. Dias, and D. J. Richardson, "Software Architecture-Based Regression Testing," *Journal of Systems and Software*, vol. 79, no. 10, pp. 1379–1396, 2006.
- [79] G. Rothermel and M. Harrold, "Analyzing Regression Test Selection Techniques," *IEEE Transactions on Software Engineering*, vol. 22, no. 8, pp. 529–551, 1996.



- [80] B. Korel, L. Tahat, and M. Harman, "Test Prioritization Using System Models," in *Proceedings of the 21st IEEE International Conference on Software Maintenance(ICSMA'05)*, 2005, pp. 559–568.
- [81] E. M. Fredericks, A. J. Ramirez, and B. H. C. Cheng, "Towards Run-time Testing of Dynamic Adaptive Systems," in *Proceedings of the 8th International Symposium on Software Engineering for Adaptive and Self-Managing Systems (SEAMS'13)*, 2013, pp. 169–174.
- [82] X. Bai, G. Dai, D. Xu, and W.-T. Tsai, "A Multi-Agent Based Framework for Collaborative Testing on Web Services," in *Proceedings of the 4th IEEE Workshop on Software Technologies for Future Embedded and Ubiquitous Systems, and the 2nd International Workshop on Collaborative Computing, Integration, and Assurance (SEUS-WCCIA'06)*, 2006, pp. 205–210.
- [83] M. Akour, A. Jaidev, and T. M. King, "Towards Change Propagating Test Models in Autonomic and Adaptive Systems," in *Proceedings of the 18th IEEE International Conference and Workshops on Engineering of Computer-Based Systems (ECBS'11)*, 2011, pp. 89–96.
- [84] J. O. Kephart and D. M. Chess, "The Vision of Autonomic Computing," *Computer*, vol. 36, no. 1, pp. 41–50, 2003.
- [85] D. Suliman, B. Paech, L. Borner, C. Atkinson, D. Brenner, M. Merdes, and R. Malaka, "The MORABIT Approach to Runtime Component Testing," in *Proceedings of the 30th Annual International Computer Software and Applications Conference (COMPSAC '06)*, 2006, pp. 171–176.
- [86] P. H. Deussen, G. Din, and I. Schieferdecker, "A TTCN-3 Based Online Test and Validation Platform for Internet Services," in *Proceedings of the 6th International Symposium on Autonomous Decentralized Systems (ISADS'03)*, 2003.
- [87] S. Schulz and T. Vassiliou-Gioles, "Implementation of TTCN-3 Test Systems using the TRI," in *Proceedings of the IFIP 14th International Conference on Testing Communicating Systems (TestCom'02)*, 2002, pp. 425–442.
- [88] I. Schieferdecker and T. Vassiliou-Gioles, "Realizing Distributed TTCN-3 Test Systems With TCI," in *Proceedings of the 15th IFIP International Conference on Testing of Communicating Systems (TestCom'03)*, 2003.

- [89] B. Stepien, L. Peyton, and P. Xiong, “Framework Testing of Web Applications Using TTCN-3,” *International Journal on Software Tools for Technology Transfer (STTT)*, vol. 10, no. 4, pp. 371–381, 2008.
- [90] Q. L. Ying Li, “Research on Web Application Software Load Test Using Technology of TTCN-3,” *American Journal of Engineering and Technology Research*, vol. 11, pp. 3686–3690, 2011.
- [91] I. Schieferdecker, G. Din, and D. Apostolidis, “Distributed Functional and Load Tests for Web Services,” *International Journal on Software Tools for Technology Transfer (STTT)*, vol. 7, pp. 351–360, 2005.
- [92] C. Rentea, I. Schieferdecker, and V. Cristea, “Ensuring Quality of Web Applications by Client-side Testing Using TTCN-3,” in *Proceeding of the 21th IFIP International Conference on Testing of Communicating Systems joint with 9th International Workshop on Formal Approaches to Testing of Software (TestCom/Fates’09)*, 2009.
- [93] J. C. Okika, A. P. Ravn, Z. Liu, and L. Siddalingaiah, “Developing a TTCN-3 Test Harness for Legacy Software,” in *Proceedings of the International Workshop on Automation of Software Test*, 2006, pp. 104–110.
- [94] D. A. Serbanescu, V. Molovata, G. Din, I. Schieferdecker, and I. Radusch, “Real-Time Testing with TTCN-3,” in *Proceeding of the 20th IFIP International Conference on Testing of Communicating Systems joint with 8th International Workshop on Formal Approaches to Testing of Software (TestCom/Fates’08)*, 2008, pp. 283–301.
- [95] E. Piel, A. Gonzalez-Sanchez, and H.-G. Gross, “Built-in Data-Flow Integration Testing in Large-Scale Component-Based Systems,” in *Proceedings of the 22nd IFIP WG 6.1 International Conference on Testing Software and Systems (ICTSS’10)*, 2010, pp. 79–94.
- [96] M. Lahami, M. Krichen, and M. Jmaïel, “Runtime Testing Approach of Structural Adaptations for Dynamic and Distributed Systems,” *International Journal of Computer Applications in Technology (IJCAT)*, vol. 51, no. 4, pp. 259–272, 2015.
- [97] B. Li, Y. Zhou, Y. Wang, and J. Mo, “Matrix-based Component Dependence Representation and Its Applications in Software Quality Assurance,” *ACM SIGPLAN Notices*, vol. 40, no. 11, pp. 29–36, 2005.

- [98] S. Alhazbi and A. Jantan, “Dependencies Management in Dynamically Updateable Component-Based Systems,” *Journal of Computer Science*, vol. 3, no. 7, pp. 499–505, 2007.
- [99] B. Qu, Q. Liu, and Y. Lu, “A Framework for Dynamic Analysis Dependency in Component-Based System,” in *the 2nd International Conference on Computer Engineering and Technology (ICCET’10)*, 2010, pp. 250–254.
- [100] M. Larsson and I. Crnkovic, “Configuration Management for Component-Based Systems,” in *Proceeding of the 10th International Workshop on Software configuration Management (SCM’01)*, 2001.
- [101] Y. E. Ioannidis and R. Rantakrishnan, “Efficient Transitive Closure Algorithms,” in *Proceedings of the 14th International Conference on Very Large Databases (VLDB’88)*, 1988.
- [102] B. Jaumard and M. Minoux, “An Efficient Algorithm for The Transitive Closure and a Linear Worst-case Complexity Result for a Class of Sparse Graphs,” *Information Processing Letters*, vol. 22, no. 4, pp. 163–169, 1986.
- [103] K. Ghédira and B. Dubuisson, *Constraint Satisfaction Problems*. John Wiley & Sons, Inc., 2013, ch. Foundations of CSP, pp. 1–28.
- [104] A. Hessel, K. G. Larsen, B. Nielsen, P. Pettersson, and A. Skou, “Time-Optimal Real-Time Test Case Generation Using UPPAAL,” in *Proceeding of the 3rd International Workshop on Formal Approaches to Testing of Software, (FATES’03)*, 2003, pp. 114–130.
- [105] A. Hessel, K. G. Larsen, M. Mikucionis, B. Nielsen, P. Pettersson, and A. Skou, “Testing Real-time Systems Using UPPAAL,” in *Formal Methods and Testing*, 2008, pp. 77–117.
- [106] U. Kelter, J. Wehren, and J. Niere, “A Generic Difference Algorithm for UML Models,” in *Proceeding of the Software Engineering 2005, Fachtagung des GI-Fachbereichs Softwaretechnik*, 2005, pp. 105–116.
- [107] H. Muccini, “Using Model Differencing for Architecture-level Regression Testing,” in *Proceeding of the 33rd EUROMICRO Conference on Software Engineering and Advanced Applications*, 2007, pp. 59–66.
- [108] K. Bogdanov and N. Walkinshaw, “Computing the Structural Difference between State-Based Models,” in *Proceeding of the 16th Working Conference on Reverse Engineering*, 2009, pp. 177–186.

- [109] A. Hessel and P. Pettersson, “COVER– A Real-Time Test Case Generation Tool,” in *Proceeding of the 7th International Workshop on Formal Approaches to Testing of Software (FATES’07)*, 2007.
- [110] —, “A global algorithm for model-based test suite generation,” *Electronic Notes in Theoretical Computer Science*, vol. 190, no. 2, pp. 47–59, 2007.
- [111] M. Beyer, W. Dulz, and F. Zhen, “Automated TTCN-3 Test Case Generation by Means of UML Sequence Diagrams and Markov Chains,” in *Proceeding of the 12th Asian Test Symposium (ATS’03)*, 2003, pp. 102–105.
- [112] M. Ebner, “TTCN-3 Test Case Generation from Message Sequence Charts,” in *Proceeding of the Workshop on Integrated-reliability with Telecommunications and UML Languages (WITUL’04)*, 2004.
- [113] J. P. Ernits, A. Kull, K. Raiend, and J. Vain, “Generating TTCN-3 Test Cases from EFSM Models of Reactive Software Using Model Checking,” in *Informatik 2006 - Informatik für Menschen, Band 2, Beiträge der 36. Jahrestagung der Gesellschaft für Informatik e.V. (GI), 2.-6*, 2006, pp. 241–248.
- [114] D. E. Vega, G. Din, and I. Schieferdecker, “Application of TTCN-3 Test Language to Testing Information Systems in eHealth Domain,” in *Proceeding of the International Conference on Multimedia Computing and Information Technology (MCIT’10)*, 2010, pp. 21–24.
- [115] N. Katanić, T. Nenadić, S. Dešić, and L. Skorin-Kapov, “Automated Generation of TTCN-3 Test Scripts for SIP-based Calls,” in *Proceedings of the 33rd International Convention on Information and Communication Technology, Electronics and Microelectronics (MIPRO’10)*, 2010, pp. 423–427.
- [116] X. Zhao and W. Zheng, “Research and Application on MBT and TTCN-3 Based Automatic Testing Approach,” in *Proceeding of the International Conference on Computer Application and System Modeling (ICCAASM’10)*, vol. 1, 2010, pp. 481–485.
- [117] J. Zander, Z. R. Dai, I. Schieferdecker, and G. Din, “From u2tp models to executable tests with ttcn-3 - an approach to model driven testing -,” in *Proceedings of 17th IFIP TC6/WG 6.1 International Conference for Testing Communicating Systems (TestCom’05)*, 2005, pp. 289–303.
- [118] T. V. Axel Rennoch, Claude Desroches and I. Schieferdecker, “TTCN-3 Quick Reference Card,” 2016.

- [119] T. Technologies, “TTthree - Compile TTCN-3 modules into test executables,” <http://www.testingtech.com/products/>, 2008.
- [120] U. Brandes, M. Eiglsperger, I. Herman, M. Himsolt, and M. S. Marshall, “GraphML Progress Report,” in *Proceeding of the International Symposium on Graph Drawing (GD’01)*, 2001, p. 501–512.
- [121] D. Pizzocaro, S. Chalmers, and A. Preece, “Sensor Assignment In Virtual Environments Using Constraint Programming,” in *Proceedings of the 27th SGAI International Conference on Innovative Techniques and Applications of Artificial Intelligence (AI’07)*, 2007, pp. 333–338.
- [122] F. Hermenier, A. Lebre, and J. Menaud, “Cluster-Wide Context Switch of Virtualized Jobs,” in *Proceedings of the 19th ACM International Symposium on High Performance Distributed Computing, (HPDC’10)*, 2010, pp. 658–666.
- [123] G. Kiczales, E. Hilsdale, J. Hugunin, M. Kersten, J. Palm, and W. G. Griswold, “An Overview of AspectJ,” in *Proceedings of the 15th European Conference on Object-Oriented Programming (ECOOP’01)*, 2001, pp. 327–353.
- [124] P. Inverardi, C. Mangano, F. Russo, and S. Balsamo, “Performance Evaluation of a Software Architecture: a Case Study,” in *Proceedings of the 9th International Workshop on Software Specification and Design*, 1998, pp. 116–125.
- [125] M. Zouari, C. Diop, and E. Exposito, “Multilevel and Coordinated Self-management in Autonomic Systems based on Service Bus,” *Journal of Universal Computer Science (UCS)*, vol. 20, no. 3, pp. 431–460, 2014.
- [126] J. Bourcier, “Auto-Home: une plate-forme pour la gestion autonome d’applications pervasives,” Ph.D. dissertation, Université Joseph Fourier, 2008.
- [127] T. Gu, H. Pung, and D. Zhang, “Toward an OSGi-based Infrastructure for Context-Aware Applications,” *IEEE Pervasive Computing*, vol. 3, no. 4, pp. 66–74, 2004.
- [128] D. Tkachenko, N. Kornet, E. Andrievsky, A. Lagunov, D. Kravtsov, and A. Kurbanow, “Management of IEEE 1394 Video Devices in OSGi Networks,” in *Proceeding of the 10th IEEE International Symposium on Consumer Electronics (ISCE’06)*, 2006, pp. 1–6.
- [129] ETSI, “Methods for Testing and Specification (MTS), The Testing and Test Control Notation version 3, TTCN-3 Language Extensions: TTCN-3 Performance and Real Time Testing,” 2015.

- [130] J. McAffer, P. VanderLei, and S. Archer, *OSGi and Equinox : Creating Highly Modular Java Systems*. Addison-Wesley, 2010.
- [131] F. D. Angelis, M. R. D. Berardini, H. Muccini, and A. Polini, “CASSANDRA : An Online Failure Prediction Strategy for Dynamically Evolving Systems,” in *Proceedings of the 16th International Conference on Formal Engineering Methods (ICFEM’14)*, 2014, pp. 107–122.
- [132] B. Eberhardinger, “Testing Self-organizing, Adaptive Systems,” in *Proceedings of the IEEE International Conference on Self-Adaptive and Self-Organizing Systems Workshops (SASOW’15)*, 2015, pp. 140–145.
- [133] A. B. Torjusen, H. Abie, E. Paintsil, D. Trcek, and A. Skomedal, “Towards Run-Time Verification of Adaptive Security for IoT in eHealth,” in *Proceedings of the 8th European Conference on Software Architecture Workshops (ECSAW’14)*, 2014, pp. 1–8.
- [134] G. A. Moreno, J. Cámara, D. Garlan, and B. Schmerl, “Proactive Self-adaptation Under Uncertainty: A Probabilistic Model Checking Approach,” in *Proceedings of the 10th Joint Meeting on Foundations of Software Engineering*, 2015, pp. 1–12.
- [135] ETSI, “Methods for Testing and Specification (MTS), The Testing and Test Control Notation version 3, Part 2: TTCN-3 Tabular presentation Format (TFT),” 2005.
- [136] —, “Methods for Testing and Specification (MTS), The Testing and Test Control Notation version 3, Part 3: TTCN-3 Graphical presentation Format (GFT),” 2005.
- [137] C. Cotta and J. Troya, “A Hybrid Genetic Algorithm for The 0-1 Multiple Knapsack Problem,” *Artificial Neural Nets and Genetic Algorithms*, vol. 3, pp. 251–255, 1998.
- [138] P. Pospíchal, J. Schwarz, and J. Jaroš, “Parallel Genetic Algorithm Solving 0/1 Knapsack Problem Running on the GPU,” in *Proceeding of the 16th International Conference on Soft Computing Systems (ICSCS’10)*, 2010, pp. 64–70.
- [139] J. Puchinger, G. R. Raidl, and U. Pferschy, “The Core Concept for the Multidimensional Knapsack Problem,” in *Proceeding of the 6th European Conference on Evolutionary Computation in Combinatorial Optimization (EvoCOP’06)*, 2006, pp. 195–208.
- [140] S. Martello and P. Toth, “Solution of The Zero-One Multiple Knapsack Problem,” *European Journal of Operational Research*, vol. 4, no. 4, pp. 276–283, 1980.
- [141] K. Jansen, “Parametrized Approximation Scheme for The Multiple Knapsack Problem,” in *Proceedings of the 20th Annual ACM-SIAM Symposium on Discrete Algorithms (SODA’09)*, 2009, pp. 665–674.

---

## Background Material on The TTCN-3 Standard

---

TTCN-3 is a test-specification language which is usually used for black-box testing of distributed or even centralized reactive systems. It supports three different presentation formats, namely: the textual core language [2], the tabular presentation format [135] and the graphical presentation format [136] for test suite specification. Throughout this thesis, the textual notation is adopted.

### A.1 TTCN-3 core language

This section is devoted to give an insight into TTCN-3 core language [2]. As outlined in Figure A.1, a module is a top-level unit of TTCN-3. It can be compiled or interpreted, it may include a single or several test cases, and it can be used as a library by other modules.

Each module comprises a definition part and a control part. The definition part includes definitions of data types<sup>1</sup>, constants, test data templates, test components, communication ports, functions, test cases, etc. From a test configuration perspective, TTCN-3 allows the definition of several test components with well-defined communication ports and an explicit test system interface. Each test component is an instance of a component type definition. It can be a Main Test component (MTC) or Parallel Test Component (PTC). An MTC is the basis of a test case and is created and started automatically at the beginning of each test case execution. It is responsible for managing the overall test process. Consequently, it handles the creation and the startup of PTC components.

---

<sup>1</sup>TTCN-3 has a number of pre-defined basic data types (e.g., integer, float, etc.) as well as structured types

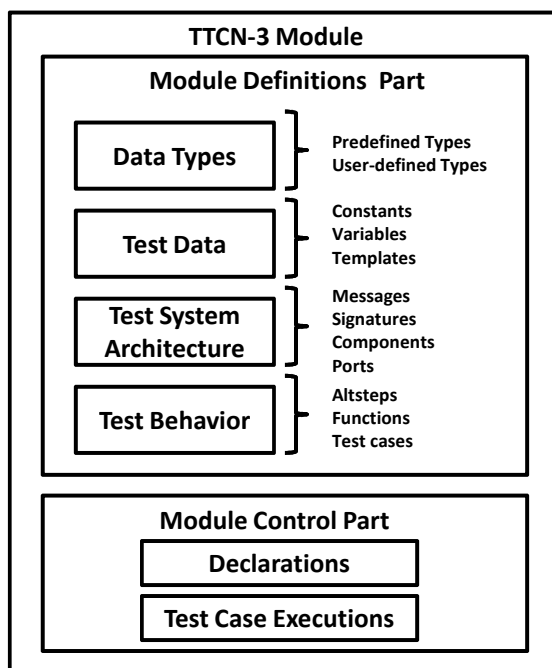

Figure A.1: Core elements in the TTCN-3 module.

Several forms of test behaviors are executed by these components. They can be defined within functions, altsteps<sup>2</sup> and test cases. The control part is considered as “the main function” of the module. It describes the execution sequence of test cases. It gathers verdicts delivered by test cases and according to them can decide the next execution steps.

Listing A.1 presents a code snippet of the module definition *MyModule*, which is saved in a file called *MyModule.ttcn*:

```

module MyModule{
// Definitions part
import from OtherModule all;
type integer MyPosInt (0 .. infinity);
testcase tc_myFirstCase() runs on MyComponent system MyTsi
{
...
}
// Control part
control
{
execute(tc_myFirstCase(), 10.0); //Maximum execution time 10.0 seconds
execute(tc_mySecondCase()); //No maximum execution time
}}

```

Listing A.1: TTCN-3 code snippet.

such as records, sets, unions, enumerated types and arrays.

<sup>2</sup>Altsteps are a special kind of function that allow to structure alternative behavior.



## A.2 TTCN-3 reference architecture

The structure of a TTCN-3 Reference Architecture is depicted in Figure A.2. It is made up of a set of interacting entities where each one corresponds to a specific functionality involved in the test system implementation. These entities interact together through two major interfaces: the *TTCN-3 Control Interface* (TCI) [28] and the *TTCN-3 Runtime Interface* (TRI) [27].

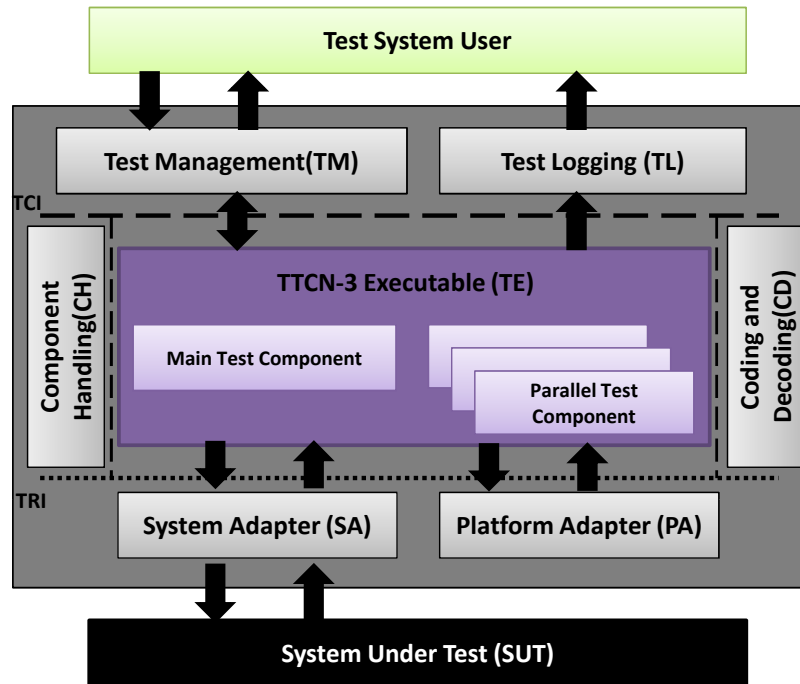

Figure A.2: TTCN-3 reference architecture.

These core elements in the TTCN-3 runtime environment are briefly described as follows:

**The Test Management (TM).** It defines the operations to manage tests and administers the execution parameters and the external constants. The main TM functionality provides means to start/stop a test case and to monitor the whole test execution process.

**The Test Logging (TL).** It is responsible for maintaining test logs and presenting them to the TS user. It provides information about the test execution such as which test components have been created, started and terminated, which data is sent to the SUT, received from the SUT, etc.

**The TTCN-3 Executable (TE).** It interprets or executes the compiled TTCN-3 code. This component manages different test elements such as control, behavior, component, type, value and queues, which are the basic constructors for the executable code.

**The Coding/Decoding (CD).** It encodes and decodes data associated with message-based or procedure-based communication within the TE. Indeed, to send data to SUT, a coder

is needed to serialize the data into SUT understandable messages. A decoder is also required to make the inverse process to transform the SUT message into TS understandable messages.

**The Component Handling (CH).** It handles the communication between test components. The CH API contains operations to create, start, stop parallel test components, to establish the connection between test components (i.e., connect), to handle the communication operations (i.e., send, receive, call and reply) and to manage verdicts (i.e., setverdict).

**The System Adapter (SA).** It mediates between the SUT and the TTCN-3 Executable. It is in charge of propagating test requests from the TE to the SUT and to notify it of any received test events from the SUT.

**The Platform Adapter (PA).** It implements external functions as well as explicit and implicit timers. The latter are platform-specific elements and have to be implemented outside the TS.

### A.3 Distributed testing with TTCN-3

To alleviate the test workload, a distributed TTCN-3 Test System is proposed by [88]. In fact, the proposed test system is distributed over several test nodes and various test behaviors can be performed at the same time. As outlined in Figure A.3, an instance of TE associated with its own CD, SA and PA is created on each test node. The entities CH, TM and TL supply the test management, test logging and test component handling between the TEs on each host. Note that a special TE is required in this distributed test architecture to start a test case and to calculate its final verdict.

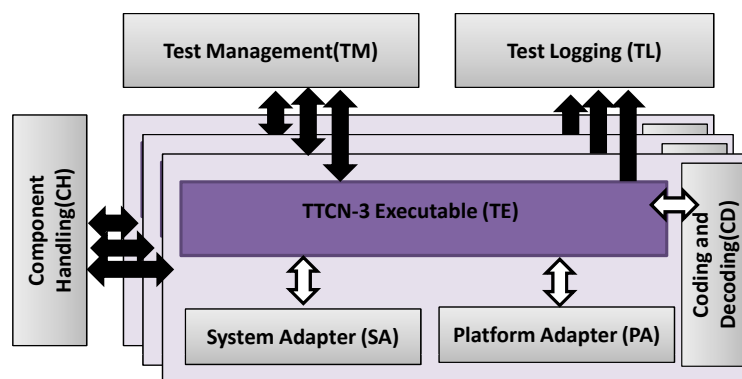

Figure A.3: Architecture of a distributed TTCN-3 test system.

---

## Dependency Analysis Algorithms

---

Analyzing component dependencies and computing the affected parts of the SUT after each dynamic change is introduced. We focus especially on four kinds of structural reconfiguration actions : adding a new component and its connections, deleting an existing component and its connections, replacing a component by another version and changing dependencies between components.

### B.1 Adding a new component and its connections

Dynamically adding a new component to the SUT architecture might affect not only its direct dependents but also indirect ones. As a result, the adjacency matrix has to be modified by adding new rows and columns representing direct dependencies between the new component and the old ones. Indirect dependencies are obtained as mentioned before transitively by applying the Warshall's algorithm in order to generate an adjacency matrix defining direct and indirect dependencies. The current system configuration is then modified  $New\_Con = (New\_S, New\_D)$  with:

- $New\_S = S \cup C_{new}$  and
- $New\_D = D \cup \{(C_{new}, C) : C_{new} \rightarrow C\} \cup \{(C, C_{new}) : C \rightarrow C_{new}\}$

---

**Algorithm B.1:** Affected components by the “add Component” action.

---

**Input:** A new component  $C_{new}$ , the new configuration  $New\_Con = (New\_S, New\_D)$ , and the new adjacency matrix  $\mathcal{AM}$ .

**Output:**  $AffectedC\_By\_Add$ : an array that contains components affected by the “add Component” action.

```

1 begin
2    $Col$  : The column index in  $\mathcal{AM}$  that represents the component  $C_{new}$  to add;
3    $Lig$  : The row index in  $\mathcal{AM}$  that represents the component  $C_{new}$  to add;
4    $k = 0$  ;
   // Find the column and the row number of the  $C_{new}$  component in the
   //  $\mathcal{AM}$ .
5    $Col = identify\_column(C_{new}, \mathcal{AM})$ ;
6    $Lig = identify\_row(C_{new}, \mathcal{AM})$ ;
   // Find components that depend on  $C_{new}$ .
7   for  $j = 0$  to  $New\_Con.New\_S.size - 1$  do
8     if  $\mathcal{AM}[j][Col] = 1$  then
9        $AffectedC\_By\_Add[k] = New\_Con.New\_S[j]$ ;
10       $k = k + 1$ ;
11    end
12  end
   // Find components that  $C_{new}$  depends on.
13  for  $j = 0$  to  $New\_Con.New\_S.size - 1$  do
14    if  $\mathcal{AM}[Lig][j] = 1$  then
15       $AffectedC\_By\_Add[k] = New\_Con.New\_S[j]$ ;
16       $k = k + 1$ ;
17    end
18  end
19  return  $AffectedC\_By\_Add$ ;
20 end
```

---

Algorithm B.1 defines how to obtain all the affected components by the “add Component” action. It has as inputs the component to add, the new configuration and the new adjacency matrix describing direct and indirect dependencies. All components that depend on  $C_{new}$  and  $C_{new}$  depends on are affected by this action. To calculate them, we have to search first in the adjacency matrix for the non-zero elements in the column corresponding to  $C_{new}$  (see lines 7-12). The non-zero elements indicate that the corresponding components depend on  $C_{new}$ . Second, we look for the non-zero elements in the row corresponding to  $C_{new}$ . These elements indicate that  $C_{new}$  depends on the corresponding components (see lines 15-18).

## B.2 Deleting an existing component and its connections

Dynamically deleting a component from the SUT architecture might affect its direct and indirect dependents which must be tested and validated. The current system configuration is modified  $New\_Con = (New\_S, New\_D)$  with:

- $New\_S = S \setminus C_{removed}$  and
- $New\_D = D \setminus \{(C, C_{removed}) : C \rightarrow C_{removed}\}$

---

**Algorithm B.2:** Affected components by the “delete Component” action.

---

**Input:** A component  $C_{removed}$ , the old configuration  $Con = (S, D)$ , and the adjacency matrix  $\mathcal{AM}$ .

**Output:**  $AffectedC\_By\_Del$ : an array that contains components affected by the “delete Component” action.

```

1 begin
2    $Col$  : The column index in  $\mathcal{AM}$  that represents the component  $C_{removed}$  to delete;
3    $K = 0$ ;
4   // Find the column number of the  $C_{removed}$  component in the  $\mathcal{AM}$ 
5    $Col = identify\_column(C_{removed}, \mathcal{AM})$ ;
6   for  $j = 0$  to  $Con.S.size - 1$  do
7     if  $\mathcal{AM}[j][Col] = 1$  then
8        $AffectedC\_By\_Del[k] = Con.S[j]$ ;
9        $k = k + 1$ ;
10    end
11  end
12 return  $AffectedC\_By\_Del$ ;
13 end

```

---

Algorithm B.2 has as inputs the component to delete, the old configuration and the old adjacency matrix describing direct and indirect dependencies. As output, it computes the affected components set by this “delete Component” action. To do so, we use the adjacency matrix  $\mathcal{AM}$  by searching for the non-zero elements in the column corresponding to  $C_{removed}$ . These non-zero elements indicate the direct and indirect dependent components on  $C_{removed}$  which are affected by this change (see lines 5-10).

## B.3 Replacing a component by another version

The “replace Component” action can be seen as a set of adding and removing components. In fact, replacing an old component  $C_i$  by a new component  $C'_i$  is done by calling:

- The “delete Component” action that deletes the old component  $C_i$  and all its dependencies and

- The “add Component” action that adds the new component  $C'_i$  and all its dependencies.

Therefore, we use the already defined algorithms as illustrated in Algorithm B.3 to identify the affected components by the “replace Component” action.

---

**Algorithm B.3:** Affected components by the “replace Component” action.

---

**Input:** The old component  $C_{old}$ , the new component  $C_{new}$ , the old configuration  $Con = (S, D)$ , and the new configuration  $New\_Con = (New\_S, New\_D)$ .

**Output:**  $AffectedC\_By\_Rep$ : an array that contains components affected by the “replace Component” action.

```

1 begin
2    $\mathcal{AM}$ : the adjacency matrix;
3    $\mathcal{AM}$  = lookForAM( $Con$ );
4    $AffectedC\_By\_Del$  = callAlgorithm2( $C_{old}$ ,  $Con$ ,  $\mathcal{AM}$ );
5    $\mathcal{AM}$  = lookForAM( $New\_Con$ );
6    $AffectedC\_By\_Add$  = callAlgorithm1( $C_{new}$ ,  $New\_Con$ ,  $\mathcal{AM}$ );
7    $AffectedC\_By\_Rep$  =  $AffectedC\_By\_Del \cup AffectedC\_By\_Add$ ;
8   return  $AffectedC\_By\_Rep$ ;
9 end
```

---

## B.4 Adding/Deleting a dependency between two components

When either the “add Dependency” action or the “delete Dependency” is triggered, the adjacent matrix  $\mathcal{AM}$  is modified in order to reflect this change in the dependency structure. Also, using the Warshall’s algorithm, the matrix is updated in response to the newly added or deleted dependency. The affected components in both cases are those which depend on the dependent component in the new dependency (respectively in the dependency to remove) and which

correspond to non-zero elements in the matrix as outlined in Algorithm B.4.

---

**Algorithm B.4:** Affected components by the “add Dependency” (respectively by the “delete Dependency”) action.

---

**Input:** The dependent component *dependent*, the configuration  $Con = (S, D)$ , and the adjacency matrix  $\mathcal{AM}$ .

**Output:** *AffectedC\_By\_AddDep* (respectively *AffectedC\_By\_DelDep*): an array that contains affected components by the “add Dependency” action (respectively by the “delete Dependency” action).

```

1 begin
2     // Find the column number of the dependent component
3     Col = identify_column(dependent, AM);
4     k = 0;
5     // Find components that depend on dependent component
6     for i = 0 to Con.S.size - 1 do
7         if AM[j][col] = 1 then
8             AffectedC_By_AddDep[k]=Con.S[j] (respectively
9             AffectedC_By_DelDep = Con.S[j]);
10            k = k + 1;
11        end
12    end
13    return AffectedC_By_AddDep (respectively AffectedC_By_DelDep);
14 end

```

---

## B.5 Identification of affected component compositions

The Algorithm B.5 illustrates a pseudocode used to identify component compositions affected by dynamic adaptation actions. In fact, the adjacency matrix  $\mathcal{AM}$  is updated in response to the adaptation action. For example, when a new component is instantiated, new rows and columns representing direct dependencies between the new component and the old ones are added (line 9). Indirect dependencies are obtained as mentioned before transitively by applying the Warshall’s algorithm in order to generate another adjacency matrix  $\mathcal{AM}'$  defining direct and indirect dependencies. Afterward, a set of affected components is generated depending on the executed adaptation action (line 10). A composite component, seen as a dependence path in the CDG, is affected if it contains at least one affected component. Thus, we derive all dependence

paths traversing components affected by the adaptation action (line 18).

---

**Algorithm B.5:** Affected component compositions by a dynamic change.

---

**Input:** The adaptation action *adaptAction* and the adjacency matrix  $\mathcal{AM}$

**Output:** *affPaths*: a set of affected component compositions

```

1 begin
2   if adaptAction = "add Dependency" then
3     new_AM = updateAddDep( $\mathcal{AM}$ );
4      $\mathcal{AM}'$  = warshall(new_AM);
5     AffectC = AffectedC_by_addDep( $\mathcal{AM}'$ , Dependent, Antecedent);
6   else if adaptAction = "delete Dependency" then
7     new_AM = updateDelDep( $\mathcal{AM}$ );
8      $\mathcal{AM}'$  = warshall(new_AM);
9     AffectC = AffectedC_by_delDep( $\mathcal{AM}'$ , Dependent, Antecedent);
10  else if adaptAction = "add Component" then
11    new_AM = updateAddComp( $\mathcal{AM}$ );
12     $\mathcal{AM}'$  = warshall(new_AM);
13    AffectC = AffectedC_by_addComp( $\mathcal{AM}'$ , ComptoAdd);
14  else if adaptAction = "delete Component" then
15    new_AM = updateDelComp( $\mathcal{AM}$ );
16     $\mathcal{AM}'$  = warshall(new_AM);
17    AffectC = AffectedC_by_delComp( $\mathcal{AM}'$ , ComptoDel);
18  else
19    new_AM = updateRep( $\mathcal{AM}$ );
20     $\mathcal{AM}'$  = warshall(new_AM);
21    AffectC = AffectedC_by_replace( $\mathcal{AM}'$ , ComptoReplace);
22  end
23  affPaths = findPathforAllAffectedComponent(AffectC, new_AM);
24  return affPaths;
25 end
```

---



---

## Background of the Knapsack Problem

---

The *Knapsack Problem* (KP) is a well-studied, strongly  $\mathcal{NP}$ -hard combinatorial optimization problem. It has been used to model different applications for instance in computer science and financial management. In the literature, we find many variants of this problem [137, 138, 139]. We describe in details the basic one and the two models used in our context.

### C.1 The Knapsack Problem (KP)

The most basic form of KP is formulated as follows:

$$KP = \begin{cases} \text{maximize} & z = \sum_{j=1}^n p_j x_j \\ \text{subject to} & \sum_{j=1}^n w_j x_j \leq W \\ & x_j \in \{0, 1\} \quad \forall j \in \{1, \dots, n\} \end{cases}$$

It considers a set of  $n$  objects  $O = o_1, \dots, o_n$  and a knapsack of capacity  $W$ . Each object  $o_j$  has an associated profit  $p_j$  and weight  $w_j$ . The objective is to find a subset  $S \subseteq O$  in such a way that the weight sum over the objects in  $S$  does not exceed the knapsack capacity and yields a maximum profit.

## C.2 The Multi-Dimensional Knapsack Problem (MDKP)

It is also called the Multiply constrained Knapsack Problem or the  $m$ -dimensional knapsack problem. It can be viewed as a resource allocation model and can be modeled as follows:

$$MDKP = \begin{cases} \text{maximize} & z = \sum_{j=1}^n p_j x_j \\ \text{subject to} & \sum_{j=1}^n w_{ij} x_j \leq c_i \quad \forall i \in \{1, \dots, m\} \\ & x_j \in \{0, 1\} \quad \forall j \in \{1, \dots, n\} \end{cases}$$

where a set of  $n$  items with profits  $p_j > 0$  and  $m$  resources with capacities  $c_i > 0$  are given. Each item  $j$  consumes an amount  $w_{ij} \geq 0$  from each resource  $i$ . The 0-1 decision variables  $x_j$  indicate which items are selected. The main purpose is to choose a subset of items with maximum total profit. the selected items must not exceed the resource capacities. This is expressed by the knapsack constraints [139]. Obviously, the KP is a special case of the multidimensional knapsack problem with  $m = 1$ .

## C.3 The 0-1 Multiple Knapsack Problem (0-1 MKP)

It is the problem of assigning a subset of  $n$  items to  $m$  distinct knapsacks having different capacities  $W_i$ . It is also referenced as the 0-1 integer programming problem or the 0-1 linear programming problem [140, 141]. More formally, an MKP is stated as follows:

$$MKP = \begin{cases} \text{maximize} & z = \sum_{i=1}^m \sum_{j=1}^n p_j x_{ij} \\ \text{subject to} & \sum_{j=1}^n w_j x_{ij} \leq W_i \quad \forall i \in \{1, \dots, m\} \\ & \sum_{i=1}^m x_{ij} \leq 1 \quad \forall j \in \{1, \dots, n\} \\ & x_{ij} \in \{0, 1\} \quad \forall j \in \{1, \dots, n\} \quad \text{and} \quad \forall i \in \{1, \dots, m\} \end{cases}$$

where each item  $j$  has a profit  $p_j$  and a size  $w_j$ , and each knapsack  $i$  has a capacity  $W_i$ . The goal is to find a subset of items of maximum profit in such a way that they have a feasible packing in the knapsacks. When  $m = 1$ , the MKP reduces the 0-1 KP considered in Section C.1.

---

## Test Case Generation Algorithms

---

Generating test suites by reachability analysis has been widely studied in the literature, e.g., [5, 104, 4, 110]. In fact, the proposed algorithms explore the state space of a given model to find a set of traces that satisfies a given property or follows a given coverage criterion. In what follows, we introduce test case generation algorithms inspired by reachability analysis used in the model-checker UPPAAL and its extension UPPAAL CO $\sqrt$ ER, as well.

### D.1 Test case generation with satisfying test properties

Algorithm D.1 highlights a standard reachability algorithm that computes on-the-fly state space. Two data structures *WAIT* and *PASS* are used. The first one keeps track of the states waiting to be examined. The second one stores states already examined. Initially, *PASS* is empty and *WAIT* holds the initial state  $\{(l_0, \sigma_0)\}$ . While the *WAIT* list is not empty, a state  $(l, \sigma)$  is selected. If the test property is held in the state  $(l, \sigma)$ , then the algorithm terminates and returns **true** (see lines 6-8). Otherwise, the algorithm looks for the current state in the *PASS* list. The state  $(l, \sigma)$  can be ignored if it exists in the *PASS* list. In the other case, the state is added to *PASS*, all its successors are computed and added to *WAIT* if they are not already in

the list (see lines 10-16). Then, the while loop starts again.

---

**Algorithm D.1:** A standard reachability analysis algorithm [4].

---

```

1 begin
2   PASS := ∅ ;
3   WAIT := {(l0, σ0)};
4   while WAIT ≠ ∅ do
5     select (l, σ) from WAIT;
6     if testProperty((l, σ)) then
7       return true;
8     end
9     if σ ⊈ σ' forall (l, σ') ∈ PASS then
10      insert(l, σ) in PASS ;
11      forall (l', σ') such that (l, σ) → (l', σ') do
12        if σ' ⊈ σ'' forall (l', σ'') ∈ WAIT then
13          insert (l, σ) in WAIT;
14        end
15      end
16    end
17  end
18  return False;
19 end

```

---

## D.2 Test case generation with satisfying coverage criteria

Algorithm D.2 has been implemented in the UPPAAL CO<sub>✓</sub>ER tool with the aim of producing a trace  $w_{max}$  that covers the maximum number of coverage items  $MAX$ . Similar to Algorithm D.1, the two data structures *WAIT* and *PASS* are defined and initialized as follows: the *PASS* set is empty and the *WAIT* set includes the initial extended state  $\{\langle(l_0, \sigma_0) \mid \{q_0\}\rangle, w_0\}$  where  $w_0$  is an empty trace. Lines 4 to 14 are repeated until the *WAIT* set becomes empty. At line 5, a state  $\langle(l, \sigma) \mid \mathcal{Q}\rangle$  is taken from *WAIT*. If it is included in a state  $\langle(l, \sigma) \mid \mathcal{Q}'\rangle$  in *PASS* then the state  $\langle(l, \sigma) \mid \mathcal{Q}\rangle$  does not need to be further explored. Otherwise, all its successors are generated and they are put on *WAIT* as shown in lines 11-13.

The global integer variable  $MAX$  is initialized with 0 and the variable  $w_{max}$  is set to empty trace. They are updated whenever an extended state, found in *WAIT*, covers more items than the current value of  $MAX$  (see lines 6-8). Note that  $wt$  denotes the trace  $w$  extended with the

transition  $t$ , where  $\langle (l, \sigma) \mid \mathcal{Q} \rangle \xrightarrow{t} \langle (l', \sigma') \mid \mathcal{Q}' \rangle$ .

---

**Algorithm D.2:** A breadth-first search exploration algorithm for test case generation [5].

---

```

1 begin
2    $PASS := \emptyset$ ;  $MAX := 0$ ;  $w_{max} := w_0$  ;
3    $WAIT := \{ \langle (l_0, \sigma_0) \mid \{q_0\} \rangle, w_0 \}$ ;
4   while  $WAIT \neq \emptyset$  do
5     select  $(\langle (l, \sigma) \mid \mathcal{Q} \rangle, w)$  from  $WAIT$ ;
6     if  $|\mathcal{Q}_f \cap \mathcal{Q}| > MAX$  then
7        $w_{max} := w$ ,  $MAX := |\mathcal{Q}_f \cap \mathcal{Q}|$  ;
8     end
9     if forall  $\langle (l, \sigma) \mid \mathcal{Q}' \rangle$  in  $PASS$ :  $\mathcal{Q} \not\subseteq \mathcal{Q}'$  then
10      add  $\langle (l, \sigma) \mid \mathcal{Q} \rangle$  to  $PASS$  ;
11      forall  $\langle (l'', \sigma'') \mid \mathcal{Q}'' \rangle$  such that  $\langle (l, \sigma) \mid \mathcal{Q} \rangle \xrightarrow{t} \langle (l'', \sigma'') \mid \mathcal{Q}'' \rangle$  do
12        add  $\{ \langle (l'', \sigma'') \mid \mathcal{Q}'' \rangle, wt \}$  to  $WAIT$ ;
13      end
14    end
15  end
16  return  $w_{max}$  and  $MAX$  ;
17 end

```

---

---

---

# Runtime Testing of Dynamically Adaptable and Distributed Component-based Systems

---

---

Mariam LAHAMI

---

---

**الخلاصة :** اختبار المنظومات البرمجية الموزعة و القابلة للتكيف أصبح ضرورة من أجل المحافظة على سلامتها التشغيلية بعد كل تكيف ديناميكي. لكن هذه التقنية تتميز بكثرة استهلاك الموارد و تأثيرها على وقت التنفيذ. وبالتالي فإن هدفنا هو تصميم إطار اختبار وقت التشغيل قادر على التقليل من كلفة هذه التقنية و زيادة كفاءتها في الكشف عن أخطاء التكيف. مساهمتنا تشمل الاختبار وقت التشغيل من الحصول على الاختبارات حتى تنفيذها بعد التعديلات الهيكلية والسلوكية. من ناحية نقتراح أداة اختبار موحد الذي ينفذ بأمان وكفاءة الاختبارات وقت التشغيل مع احترام توفر الموارد. من ناحية أخرى، نقدم منهج لتطوير الاختبارات القديمة بعد كل تكيف سلوكي. وقد أثبتت التجارب فعالية المنهج المقترح لخفض تكلفة تنفيذ الاختبار وقت التشغيل مع ضمان جودة المنظومة.

**المفاتيح :** الاختبار وقت التشغيل، التكيف ديناميكي، معيار TTCN-3، تنفيذ و تطوير الاختبارات

**Résumé :** Le test d'exécution des systèmes à base de composants logiciels distribués et dynamiquement adaptables devient une nécessité afin de maintenir leur sûreté de fonctionnement après chaque adaptation dynamique. Cependant, cette technique se caractérise par sa grande consommation de ressources et de temps d'exécution. D'où, notre objectif consiste à concevoir un Framework de test capable de réduire son coût et d'augmenter son efficacité à révéler des fautes d'adaptation. Notre contribution assure le test d'exécution dès la génération jusqu'à l'exécution tout en supportant des adaptations dynamiques à la fois structurelles et comportementales. D'une part, nous proposons une plateforme standardisée pour l'exécution des tests tout en respectant les contraintes de ressources et de connectivité de l'environnement d'exécution. D'autre part, une méthode de génération sélective des tests a été définie afin d'évoluer la suite de tests après des adaptations comportementales. Des expérimentations ont montré l'efficacité de l'approche proposée à réduire le coût du test d'exécution tout en assurant la qualité du système évolutif.

**Mots clés :** Test d'exécution, adaptation dynamique, sensibilité aux ressources, TTCN-3, exécution et évolution des tests

**Abstract :** Runtime testing of dynamically adaptable and distributed systems is currently highly demanded to ensure their correctness and trustworthiness. However, this runtime validation technique expects additional processing time and computational resources. Therefore, our objective is to conceive and implement an efficient runtime testing framework that alleviates its cost and burden while increasing its fault-finding capabilities. Our main contribution consists in covering the runtime testing process from the test generation to the test execution while supporting structural and behavioral adaptations. On the one hand, we propose a standardized test execution platform that executes safely and efficiently runtime tests while respecting resource availability and node connectivity. On the other hand, we introduce a selective test generation approach that evolves the old test suite after behavioral adaptations. Through several experiments, we show the efficiency of our proposal and the tolerated overhead that it introduces in case of dynamic structural or behavioral adaptations.

**Key-words :** Runtime testing, dynamic adaptation, resource awareness, TTCN-3, test execution and evolution