



HAL
open science

A multi-agent system for the reactive fleet maintenance support planning of a fleet of mobile cyber-physical systems: application to rail transport industry

John William Mbuli

► To cite this version:

John William Mbuli. A multi-agent system for the reactive fleet maintenance support planning of a fleet of mobile cyber-physical systems: application to rail transport industry. Artificial Intelligence [cs.AI]. Université Polytechnique Hauts-de-France, 2019. English. NNT : 2019UPHF0027 . tel-02468233v2

HAL Id: tel-02468233

<https://hal.science/tel-02468233v2>

Submitted on 5 Feb 2020

HAL is a multi-disciplinary open access archive for the deposit and dissemination of scientific research documents, whether they are published or not. The documents may come from teaching and research institutions in France or abroad, or from public or private research centers.

L'archive ouverte pluridisciplinaire **HAL**, est destinée au dépôt et à la diffusion de documents scientifiques de niveau recherche, publiés ou non, émanant des établissements d'enseignement et de recherche français ou étrangers, des laboratoires publics ou privés.

**Thesis submitted for the degree of Doctor of Philosophy from
the POLYTECHNIC UNIVERSITY OF HAUTS-DE-FRANCE**

Specialization in Automatic Control and Computer Engineering

**Submitted and defended by JOHN WILLIAM MBULI
22nd November 2019, Valenciennes, FRANCE**

Doctoral School:

Sciences Pour l'ingénieur (ED SPI 072)

Laboratory and research team:

Laboratoire d'Automatique, de Mécanique et d'Informatique Industrielles et Humaines (LAMIH – UMR 8201)

A multi-agent system for the reactive fleet maintenance support planning of a fleet of mobile cyber-physical systems: Application to rail transport industry

JURY

JURY PRESIDENT

Hind EL HAOUZI, Professor at the University of Lorraine, France

REVIEWERS

Noureddine ZERHOUNI, Professor at the University of Franche-Comté, France

Bernard GRABOT, Professor at Ecole Nationale d'Ingénieur de Tarbes, France

EXAMINERS

Hind EL HAOUZI, Professor at the University of Lorraine, France

Ali SIADAT, Professor at Ecole Nationale Supérieure d'Arts et Métiers, France

DISSERTATION ADVISOR

Damien TRENTESAUX, Professor at the Polytechnic University of Hauts-de-France, France

INVITED MEMBERS

Thierry DAILLY, Bombardier Transportation France

Bertrand DELEVAL, Bombardier Transportation France

Thèse de doctorat pour obtenir le grade de Docteur de l'UNIVERSITÉ POLYTECHNIQUE HAUTS-DE-FRANCE

Spécialité Automatique et Génie Informatique

**Présentée et soutenue par JOHN WILLIAM MBULI
22 Novembre 2019, à Valenciennes, FRANCE**

École doctorale :

Sciences Pour l'ingénieur (ED SPI 072)

Équipe de recherche et Laboratoire :

Laboratoire d'Automatique, de Mécanique et d'Informatique Industrielles et Humaines (LAMIH – UMR 8201)

Proposition d'un système multi-agent pour la planification réactive des opérations de maintenance d'une flotte de systèmes cyber-physiques mobiles : Application au domaine ferroviaire

JURY

PRESIDENT DU JURY

Hind EL HAOUZI, Professeur, Université de Lorraine, France

RAPPORTEURS

Noureddine ZERHOUNI, Professeur, Université de Franche-Comté, France

Bernard GRABOT, Professeur, Ecole Nationale d'Ingénieur de Tarbes, France

EXAMINATEURS

Hind EL HAOUZI, Professeur, Université de Lorraine, France

Ali SIADAT, Professeur, Ecole Nationale Supérieure d'Arts et Métiers, France

DIRECTEUR DE THÈSE

Damien TRENTESAUX, Professeur, Université Polytechnique Hauts-de-France, France

MEMBRES INVITÉS

Thierry DAILLY, Bombardier Transport France

Bertrand DELEVAL, Bombardier Transport France

Acknowledgements

I would like to express my profound gratitude to all those who have contributed in one way or another to facilitate the completion of this research work including family, friends and colleagues.

First of all, I would like to express my deepest appreciation to Professor Damien Trentesaux, the director of this research work, for his scientific and technical assistance without which the successful completion of this work would not have been possible.

I would also like to acknowledge the support of my advisors and colleagues at Bombardier Transportation France for their technical support, swift feedback and constructive evaluations. I would particularly like to thank, Christophe Augustyniak, Bertrand Deleval, Thierry Dailly, Louis Esquerre, Damien Baert, Fabien Malca and Oussama Yennoune.

My acknowledgements also go to the members of the jury for their acceptance in reviewing and examining this manuscript as well as their participation in the defence of this research work. I sincerely would like to thank, professors Nouredine ZERHOUNI, Hind EL HAOUZI, Bernard GRABOT and Ali SIADAT.

I would further like to express my gratitude to the region of Hauts-de-France and the European union for funding SurferLab, hence this research work. I would equally thank all the members of SurferLab and LAMIH, particularly from the departments of Automatic Control and computer science. During this research work, I have had the pleasure of making acquaintances to exceptional researchers with whom I have shared unforgettable experiences. I would particularly thank, Tarik Chargui, with whom the mathematical model in this work has been formulated. Others include, Maroua Nouri, Abdelghani Bekrar, Adoum Fadil, Barbara Lafarge, Corentin Gely, Vivien Basselot, Ayush Jain, Bruno Mateus, Rebecca and all others.

Finally, I would like to acknowledge the support of my family and friends from Tanzania, Germany and Poland for their emotional support in the years during which this research work was carried out. First of all, my parents, William and Victoria and others in no particular order: Anna Nowak and her family, Lola Froehlich and her family and all others without exceptions.

Foreword

The presented research work has been carried out in the course of three years at SurferLab ([weblink](#)). SurferLab is a research laboratory within LAMIH laboratory which facilitates collaborative projects among three partners, namely, the Polytechnic University of Hauts-de-France, Bombardier Transportation France and Prosys. This research work, was particularly motivated by the technical and scientific challenges and needs expressed by Bombardier Transportation France as it establishes itself around the concept of servitization, i.e. selling products (fleet of trains) and services (maintenance services). My personal motivations for joining the research activities at SurferLab are briefly expressed hereinafter.

In September 2016, after having completed my master's degree in Aerospace engineering from the University of Paris Saclay, I became increasingly interested in the notion of maintenance management and systems' reliability, in particular, the maintenance of cyber-physical systems (CPSs) at the fleet level. This interest together with the growing research opportunities in CPSs and the quality of research activities at SurferLab and LAMIH on the maintenance of transportation systems pushed further my motivations to join SurferLab in late 2016 as a research engineer and a doctoral candidate. After commencing this project, I divided my working time between SurferLab and Bombardier Transportation France in Crespin, France.

During these research years at SurferLab and Bombardier Transportation France, apart from widening my research network through international conferences, seminars and workshops, I have also been able to profoundly develop my skills and interests on a lot of subjects associated with the maintenance of cyber-physical fleets such as, the assets' maintenance management, diagnosis methodologies, prognosis and health management, maintenance planning and other associated concepts and their applications in the rail transport industry. To this end, after having compiled this work, I would continue working as a fleet maintenance and commissioning engineer at Bombardier Transportation France.

John William Mbuli
Fleet Maintenance and Commissioning Engineer
Bombardier Transportation France

Abstract

The manufacturers and the operators of the fleets of cyber-physical systems (CPSs) are subjected to huge expectations expressed in terms of the availability and reliability of the provided products and services during the exploitation of these fleets in dynamic environments. These expectations foster the fleet manufacturers, particularly in the transportation sector, to develop effective mechanisms as far as the reactive planning of the maintenance operations at the fleet level is concerned. In this research work, a multi-agent system (MAS) for the reactive maintenance planning of a fleet of CPSs is proposed. The proposed MAS is conceived by using the ANEMONA design methodology and it aims at optimizing the fleet maintenance planning decisions to meet the specified objectives. The experiments carried out in the course of this work demonstrate the ability of the proposed MAS in planning the fleet maintenance effectively (i.e. satisfying the fleet's availability and reliability requirements in a static environment) and reactively (i.e. being able to adapt/modify the fleet maintenance planning decisions following perturbations). The effectiveness of the MAS model is validated by a mathematical programming model and its reactivity is tested by using simulated perturbations. An application in rail transport industry to the fleet of trains at Bombardier Transportation France is proposed. The proposed MAS is integrated in a decision support system called "MainFleet". The development of MainFleet at Bombardier is ongoing.

Résumé

Les industriels et les opérateurs des flottes de systèmes cyber-physiques (CPS) sont soumis à de fortes exigences exprimées en termes de disponibilité, fiabilité des produits et des services fournis lors de l'exploitation de ces flottes dans des environnements dynamiques. Ces attentes incitent les industriels, et notamment dans le secteur du transport, à développer des mécanismes efficaces de planification réactive des opérations de maintenance au niveau de la flotte. Dans cette thèse, un système multi-agent (SMA) pour la planification réactive de la maintenance d'une flotte de CPS est proposé. Ce SMA est construit en utilisant la méthode de conception ANEMONA et a pour objectif d'optimiser la planification de la maintenance au niveau flotte afin de répondre aux exigences spécifiées. Les expériences réalisées au cours de ces travaux démontrent la capacité de ce SMA à planifier la maintenance de la flotte de manière efficace (c'est-à-dire satisfaire les exigences de disponibilité et de fiabilité de la flotte dans un environnement statique) et de manière réactive (c'est-à-dire être capable d'adapter/de modifier les décisions de planification de la maintenance à la suite des perturbations). L'efficacité de ce modèle SMA est validée par un modèle mathématique et sa réactivité est testée par simulation de perturbations. Une application dans le domaine ferroviaire au sein de Bombardier Transport France est proposée. Le SMA est intégré à un système d'aide à la décision dénommé « MainFleet ». Le développement de MainFleet est en cours.

TABLE OF CONTENTS

GENERAL INTRODUCTION	10
Chapter I State of art on the maintenance support planning of mobile cyber-physical fleets.....	12
I.1 The context of the study	12
I.2 Boundaries of the thesis and the addressed research question.....	17
I.3 Cyber-physical systems and fleets of cyber-physical systems	19
I.3.1 Definition.....	19
I.3.2 Fleets of CPSs.....	20
I.4 Literature review	20
I.4.1 FMSP background and evolution.....	21
I.4.2 Contributions to the FMSP: A framework analysis	21
I.4.3 Contributions to the FMSP: Approaches, models and tools in decision-making	36
I.5 Summary	42
Chapter II Specifying a reactive CPSs fleet maintenance support planning system	45
II.1 Specifying the scientific issues	45
II.2 CPSs FMSP problem formulation	47
II.2.1 Problem boundaries and working assumptions.....	47
II.2.2 FMSP problem modelling assumptions and data requirements.....	52
II.2.3 Parameters, notations and indexes.....	53
II.3 Specifying the aid provided by the reactive CPSs FMSP	56
II.3.1 Background: the fleet supervisor decisional context	56
II.3.2 Adopting a decision support approach	56
II.3.3 Human-centred design of the DSS	57
II.3.4 Dataflow specification in the DSS layers	60
II.4 Summary	62
Chapter III A multi-agent system for the reactive CPSs fleet maintenance support planning	65
III.1 The choice of the modelling approach.....	65
III.2 Proposed MAS for the reactive CPSs FMSP.....	67
III.2.1 The agent view	68
III.2.2 The organization view	72
III.2.3 The interaction view.....	80
III.3 Summary	83
Chapter IV Numerical implementations: MAS Simulations in static and dynamic environments....	85

Table of contents

IV.1	MAS implementation description	85
IV.1.1	MAS implementation framework.....	86
IV.1.2	MAS implementation logic and structure	87
IV.2	MAS simulation in a static environment	91
IV.2.1	MILP model: Context and boundaries.....	92
IV.2.2	MILP model formulation	92
IV.2.3	Simulation settings	95
IV.2.4	Results in a static environment and evaluation	96
IV.3	MAS simulation in a dynamic environment	98
IV.3.1	Scenarios for perturbations.....	98
IV.3.2	MAS results in the considered perturbative scenario	99
IV.4	Illustrative example	100
IV.4.1	FMSP in a static environment by the MAS model.....	100
IV.4.2	FMSP in a dynamic environment by the MAS model.....	102
IV.5	Limitations of the proposed MAS model	107
IV.6	Summary	107
Chapter V Application to rail transport.....		109
V.1	The context of the application	109
V.1.1	Surferlab context.....	109
V.1.2	The rail transport industry: Contributions and challenges.....	110
V.2	Reactive CPSs FMSP system at Bombardier Transportation France	111
V.2.1	Fleet of trains.....	113
V.2.2	Fleet operators	115
V.2.3	Maintenance depots	116
V.2.4	Perturbations.....	119
V.2.5	MainFleet.....	120
V.3	Evaluations and industrial expectations.....	129
V.4	Summary	130
CONCLUSIONS AND FUTURE WORKS		133
REFERENCES		135
APPENDICES		157

LIST OF FIGURES

Figure I-1: Management of fleets in the transportation sector: The context	13
Figure I-2 : Maintenance management process in a fleet of CPSs (Adapted from [31])	15
Figure I-3: Inputs and outputs in a decision-maker's context.....	18
Figure I-4: CPSs concept map [44].....	20
Figure I-5: Maintenance support planning decision-making in a fleet of mobile CPSs: a framework ..	23
Figure I-6: Maintenance-centred manufacturing [66]	24
Figure I-7: MIMOSA architecture [105]	27
Figure I-8: Strategic analysis and the influences of its environment [107].....	28
Figure I-9: Maintenance taxonomy [107].....	32
Figure I-10: An enterprise view of E-maintenance [86]	33
Figure I-11: MCDM classification [157]	38
Figure II-1: Reduced context of the FMSP framework	47
Figure II-2: Fleet supervisor's decisional context	52
Figure II-3: fleet supervisor decisional complexity induced by the context.....	56
Figure II-4: Reactive CPSs FMSP in a DSS for decision aid to the fleet supervisor	59
Figure II-5: Design layers in the DSS	62
Figure III-1: Agents workflow within horizons	71
Figure III-2: The three phases in the proposed MAS.....	72
Figure III-3: Categorizing phase	74
Figure III-4: Selection process for corrective maintenance.....	77
Figure III-5: Verification and scheduling.....	77
Figure III-6: Selection process for CBM	78
Figure III-7: Coordination and supervision phase	80
Figure III-8: Solution to conflictual interaction	82
Figure III-9: Cooperative interactions.....	83
Figure IV-1: Abstract class and interfaces	88
Figure IV-2: Example of Agent classes.....	90
Figure IV-3: Classes relations in the implementation of the proposed MAS	91
Figure IV-4: Simulation of the MAS model in a static environment.....	96
Figure IV-5: CPAs set for CBM interventions before and after unanticipated breakdowns	100
Figure IV-6: Health status groups and maintenance actions needed	101
Figure IV-7: Identification of the maintenance resources.....	101
Figure IV-8: Maintenance resources verification in the maintenance depots.....	104
Figure IV-9: Maintenance planning before perturbations	105
Figure IV-10: Reactive maintenance planning following a perturbation	106
Figure V-1: Reactive CPSs FMSP system at Bombardier Transportation France.....	112
Figure V-2: Technical design characteristics of Omneo trains in R2N fleet [376].....	113
Figure V-3: Energy consumption optimization in Omneo train [376].....	114
Figure V-4: The maintenance depots for R2N fleet.....	117
Figure V-5: Maintenance intervention details in maintenance depot in Lille.....	118
Figure V-6: Train groups computed by SuperFlo for R2N fleet in Occitanie	123
Figure V-7: FMSP planning in R2N fleet in Toulouse.....	124
Figure V-8: Geolocations of the trains and the maintenance depots	126
Figure V-9: Fleet's availability analysis in every maintenance depot.....	127
Figure V-10: Details on groups 2 and 3 trains' maintenance requirements in TER Hauts-de-France.	128

List of figures

Figure V-11: Prognosis approaches classification [283] 160
Figure V-12: Series and parallel hybrid prognosis [235] 161
Figure V-13: Roadmap of the ASPECS process (phases/activities and their goals) [429] 163
Figure V-14: Overview of the first three core workflows of ADELFE [432] 164
Figure V-15: ANEMONA development process [323] 165

LIST OF TABLES

Table I-1: Description of tasks involved in FMSP.....	15
Table I-2: FMSP sustainability objectives	25
Table I-3: Overview of reactive maintenance practices [107]	28
Table I-4: Overview of Pre-determinative maintenance [107]	29
Table I-5: Overview of Proactive maintenance [107].....	30
Table I-6: Overview of Predictive maintenance [107].....	31
Table I-7: Characterization of the selected literature works on fleet maintenance support planning.	34
Table II-1: Reduced context in FMSP framework.....	63
Table III-1: Negotiations in CNP.....	81
Table IV-1: Methods from Agent abstract class	87
Table IV-2: Methods from Perturbation abstract class	88
Table IV-3: Individual agent classes.....	89
Table IV-4: MAS and MILP simulations in a static environment	97
Table IV-5: MAS model under perturbations (unanticipated CPAs breakdowns after allocation)	99
Table V-1: Objectives of Surferlab [361]	109
Table V-2: R2N operators and the routes	115
Table V-3: Data processing tools	158

ABBREVIATIONS

ABM	Avoidance-based maintenance
ACM	Availability centred maintenance
AGM	Age-based maintenance
AI	Artificial intelligence
BBM	Block-based maintenance
BCM	Business centred maintenance
CBM	Condition-based maintenance
CIM	Constant interval maintenance
CNP	Contract net protocol
CPA	Cyber-physical fleet agent
CPS	Cyber-physical system
DBM	Detective-based maintenance
DOM	Design-out maintenance
DRM	Deferred reactive maintenance
DSS	Decision support system
EMU	Electric multiple units
FBM	Failure-based maintenance

Abbreviations

FIPA	Foundation for Intelligent Physical Agents
FMSP	Fleet maintenance support planning
FSA	Fleet supervisor agent
FTM	Fixed time maintenance
GOFAI	Good old-fashioned AI
HMC	Human-machine cooperation
HMI	Human-machine interface
HVAC	Heating, Ventilation and Air-Conditioning
IBM	Inspection-based maintenance
ICT	Information and communication technologies
IDSS	Intelligent decision support system
IRM	Immediate reactive maintenance
JADE	Java Agent Development Framework
KPI	Key performance indicator
LBM	Life-based maintenance
MA	Maintenance depots agents
MAS	Multi-agent system
MCA	Mission coordination agent

Abbreviations

MCDM	Multiple-criteria decision-making
MILP	Mixed-integer linear programming
MMTR	Mean maintenance time to repair
MODM	Multi-objective Decision Making
MOSO	Multi-objective simulation optimization
OSA-CBM	Open System Architecture for Condition-Based Maintenance
OTF	Operate to failure
PHM	Prognostic and health management
PLM	Product lifecycle management
PPM	Planned preventive maintenance
R2N	Regio 2N
RBM	Risk-based maintenance
RCM	Reliability-centred maintenance
RUL	Remaining useful life
SA	Supervision agent
SNCB	Société nationale des chemins de fer belges
SNCF	Société nationale des chemins de fer français
SRM	Scheduled reactive maintenance

Abbreviations

SURFER	Surveillance active Ferroviarie
TAT	Turnaround time
TBM	Time-based maintenance
TCPS	Transportation cyber-physical system
TIA	Temporary information handling agent
TPM	Total productive maintenance
UBM	Use-based maintenance
UI	User interface
UML	Unified modelling language

GENERAL INTRODUCTION

In the wake of recessions, over-increasing global competition and falling consumer demands, manufacturers of fleets of mobile cyber-physical systems (CPSs) have shown trends of shifting from providing only goods to providing goods and services to their clients (the fleet operators). This shift has been referred to as servitization [1] and not only has it helped to fill in the loophole between the fleet manufacturers and the fleet operators but it has also helped in generating necessary revenue for survival. However, both the fleet manufacturers and operators are still faced with huge expectations from the end consumers in terms of the availability and reliability of the provided goods and services. This happens during the fleets' exploitations in the over-increasing dynamic environments. These expectations foster the fleet manufacturers to develop reactive maintenance planning, availability and reliability optimization, maintenance resource management and maintenance decision support mechanisms as far as the maintenance of the fleets of CPSs is concerned. These functions constitute the fleet maintenance support planning (FMSP). Therefore, exploring the development of a reactive FMSP system for the fleet of CPSs is thus the motivation behind this research work.

This research work was carried out in the course of three years at Surferlab [2] which is a partnership scientific laboratory officially created in October 2016 by the Polytechnic University of Hauts-de-France [3], Bombardier Transportation France [4] and Prosys [5]. Since its founding, Surferlab has centred its research themes around three main axes, namely:

- Axis 1: Connected maintenance. This axis principally deals with deployment of the and optimization of the maintenance models developed in SURFER project.
- Axis 2: Artificial intelligence models. This axis was initiated following the industrial needs identified by Bombardier Transportation France vis-à-vis its clients.
- Axis 3: Conception and integration/Product lifecycle.

This research work intersects concepts from axes 1 and 2. The following is an overview of the organization of the work:

Chapter I: State of art on the maintenance support planning of mobile cyber-physical fleets. In the first part of this chapter, a detailed description of the background and the context of this research work will be presented. This part will also explore the associated notions around the fleets of CPSs such as the industry 4.0 and big data and pose the research question. The second part of this chapter will explore the literature review on the fleet maintenance support planning (FMSP) vis-à-vis the research question in two-fold, firstly, the FMSP frameworks and their aspects. Secondly, the approaches, models and tools used in FMSP decision-making as presented by the existing literature works. Lastly, the recommendations following the limitations of the literature works in answering the research question will be presented.

Chapter II: Specifying a reactive CPSs fleet maintenance support planning system. Following the recommendations provided in chapter I, this chapter will formalize the FMSP problem as well as presenting the specifications for the reactive CPSs FMSP system. The context of the FMSP framework will be reduced in order to fix the boundaries of the research. A decision approach to the fleet supervisor by the reactive CPSs FMSP system will be adopted hence a specification of a decision support system (DSS).

Chapter III: A multi-agent system for the reactive CPSs fleet maintenance support planning. This chapter will present a reactive CPSs FMSP model to be integrated in the DSS specified in chapter II. To do so, a multi-agent system (MAS) approach is used. The presented model should be affective in satisfying the fleet's availability and reliability expectations and reactive in mitigating the effects of perturbations as far as the FMSP is concerned.

Chapter IV: Numerical implementations: MAS Simulations in static and dynamic environments. The objective of this chapter is to validate the effectiveness and the reactivity of the MAS model presented in the previous chapter. To do so, the MAS model will be firstly, simulated in a static environment in order to test its effectiveness. In this environment, the MAS model will be compared to an equivalent mixed-integer linear programming (MILP) model. Secondly, the MAS will be put under simulated perturbations in order to test its reactivity (i.e. simulation of the MAS model in a dynamic environment).

Chapter V: Application to rail transport. The objective of this chapter is to study the applicability and the impact of the proposed reactive CPSs FMSP system in the rail transport industry. For that purpose, Firstly, the context of the application is defined. Then the implementation of the reactive CPSs FMSP system to a fleet of trains at Bombardier Transportation France is presented. The industrial implications of the implemented system are presented in the last part of this chapter.

Following the last chapter of this thesis, the conclusions of the research will be presented as well as the short and long-term perspectives of the presented work.

Chapter I STATE OF ART ON THE MAINTENANCE SUPPORT PLANNING OF MOBILE CYBER-PHYSICAL FLEETS

The principle objective of this chapter is to define and position maintenance support planning decision-making as a key research topic as far as the maintenance of the fleets of mobile CPSs is concerned. In doing so, a thorough background review of literary and practical works in the maintenance of cyber-physical fleets and the associated aspects is provided, through which the position, novelty, motivation and contribution of this work can be established.

The rest of this chapter is organized as follows, section I.1 will provide the context of the study, set the precise boundaries of the work and provide the addressed research question. Moreover, as the fleet entities considered in this research work are CPSs, section I.3 that follows will focus on CPSs as well as their composing fleets in the context of the fleet maintenance support planning. Section I.4 will provide a detailed literature review on the fleet maintenance support planning based on two points of view, namely, the FMSP framework and the approaches, models and tools used in fleet maintenance support planning decision-making. Furthermore, this section will analyse the limitations on these literature works as far as the research question is concerned hence the motivation of this research work. Section 5 will conclude this chapter by summarizing the discussed concepts and by giving recommendations following the identified research gaps.

I.1 THE CONTEXT OF THE STUDY

The transportation sector, including logistics, translates to important societal, economic and environmental stakes ([6],[7], [8]). Several aspects that complicate the managing of these stakes characterize this sector as shown in Figure I-1. The first of these aspects is related to the complexity of the transportation systems themselves, being trains, cars, planes, busses, ships, etc. These complex systems compose the fleets of systems and they must be managed throughout their lifecycles. The transportation systems can therefore be characterized as complex cyber-physical systems (CPSs). Deka et al. [9] refers to the CPSs in transportation domain as Transportation cyber-physical systems (TCPSs). In the general sense, CPSs merge the physical and the digital worlds, with limited reliability, often moving in open and uncontrolled large environments and interact with an infrastructure that is also complex and costly to develop and maintain [10]. The second complexity is related to the diversity of actors and legal responsibilities involved, either as constructors, integrators, suppliers, fleet operators, maintenance operators, politicians, end consumers, etc. The last aspect is the fierce global competition that

fosters industrialists to always be a step ahead of their competitors by constantly searching to provide new products, new innovations and services ([1], [11]).

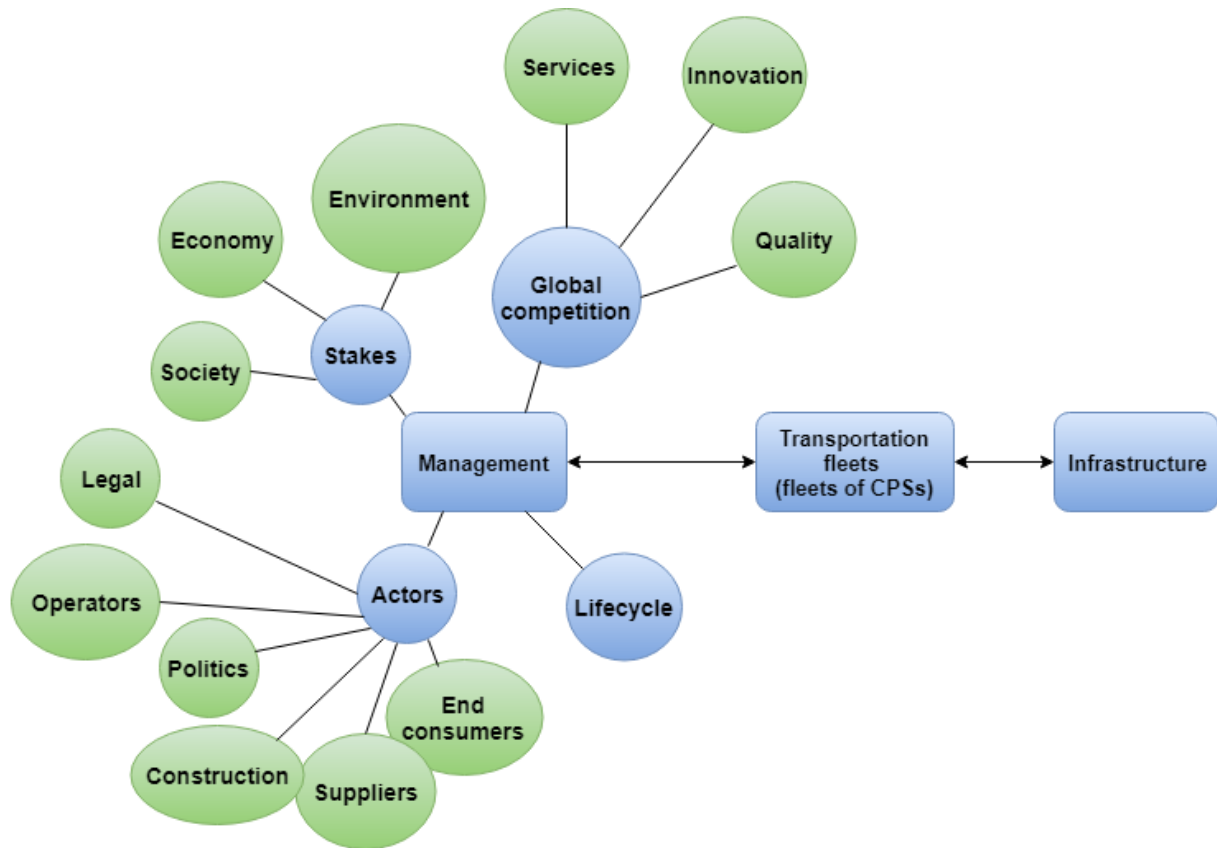

FIGURE I-1: MANAGEMENT OF FLEETS IN THE TRANSPORTATION SECTOR: THE CONTEXT

Lifecycle management as far as the fleets of CPSs are concerned, is crucial to all actors and stakes involved (c.f. Figure I-1) because it helps in managing and minimizing the fleets' operational risks and costs [12]. Some of these risks and costs include, schedule delays, cost overruns, accidents, excessive operating costs (e.g. maintenance costs) and premature product failures. In recent years to address the challenges brought about by these risks and costs, product lifecycle management (PLM) is proposed as a business approach to manage the complete life cycle of a product [13]. According to Romero et al. [14], Maintenance is a big part of PLM and arguably, the later could be used to improve the quality of maintenance services and reduce the associated costs since *"it enables the collaborative creation, management, dissemination, use, maintenance and repair of products and its operational process information across the entire life of products from market concept to product retirement"*.

The maintenance aspect in the management of the fleets of CPSs in the transportation is the global context of this research work. This aspect is critical due to several reasons. First and foremost, Many studies have concluded that, maintenance in complex systems accounts for 60 to 75 percent of their overall lifecycle costs [15]. But more recent studies and trends indicate that, good maintenance practices do not only increase the reliability of the maintained systems but also reduce enormously the operating costs of the concerned systems ([16], [17], [18], [19]). This link between the maintenance and operational costs reduction is of uttermost importance because in today's global economy and world-wide competition, controlling the way of doing business is essential for survival as pointed out by Tousley [20]. Moreover, due to improved reliability, maintenance interventions improve systems' overall availability. System availability is the readiness of the later to undertake operations. According to the Committee on analysis of research directions and needs in US manufacturing and technical systems [21], reducing mean time between systems failures increases the systems' availability by 30 percent. Furthermore, systems' safety is another aspect in which manufacturers, stakeholders, regulators as well as other actors seek to improve. Recent trends maintenance practices such as predictive analytics make it possible to control repairs, downtime and data which means increased safety, productivity and profits [22].

On the other side, maintenance of fleets of CPSs is a complex activity to be managed by the decision-makers regardless of the level addressed (i.e. from strategic fleet level maintenance policies to maintenance tasks operation). These decision-makers are faced with huge expectations from several parts such as, the fleet operators (for example, requiring a minimum level of fleet availability), the end users (demanding a correct transportation service in due time), governmental regulation bodies (paying attention to safety, energy, carbon footprint performances) and others in a highly dynamic environment. These expectations foster the fleet manufacturers to develop fleet maintenance models that can satisfy the concerned expectations during the exploitation of the CPSs composing the fleet.

Fleet maintenance is not a new concept [23] and recently, it has regained a lot of attention, especially in sectors such as the aviation and the military, for example, see [24], [25], [26] and [27]. From the existing literature works, fleet maintenance has been treated as a specific function of the "more global" fleet management function (for example, [26], [28], [29], and [30]). From these works, we can deduce the definition of the maintenance of cyber-physical fleets as, "*the process of identifying the required maintenance tasks, scheduling and allocating resources to the identified maintenance tasks (repair, replacement, preventive maintenance), the execution of those tasks and the assessment of the executed tasks associated with a fleet of CPSs*". The global maintenance process of a fleet is composed of the following phases according to Candell et al. [31]: Maintenance Management, Maintenance Support Planning, Maintenance Preparation, Maintenance Execution, Maintenance Assessment and Maintenance Improvement. Feedback processes enable these phases to be handled reactively, according to real time events occurring in the fleet. Figure I-2 inspired by an example of a maintenance process in the aircraft industry found in Candell et al. [31], depicts a general maintenance process in a fleet of CPSs as well as the associated data flows.

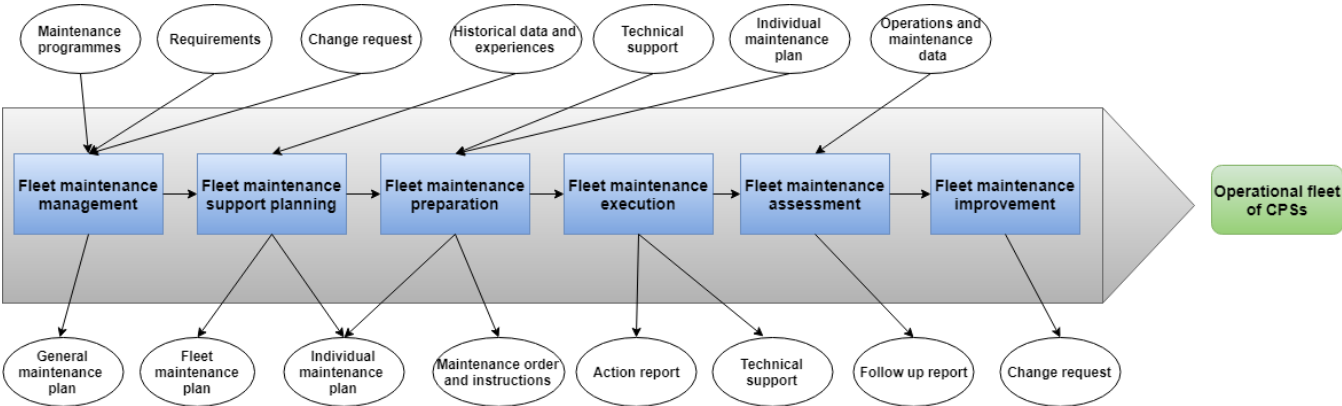

FIGURE I-2 : MAINTENANCE MANAGEMENT PROCESS IN A FLEET OF CPSS (ADAPTED FROM [31])

This research work deals more precisely with the *fleet maintenance support planning* (FMSP) phase. This phase corresponds to the O-level described in Sheng et al. [32] where it is suggested that, fleet maintenance is organized into three levels: organization- (O-), intermediate- (I-) and depot-level (D-). The FMSP phase mainly aims to establish reactive fleet-level plan for the maintenance of CPS fleet. A more precise description of the tasks involved in the FMSP is provided in Table I-1.

TABLE I-1: DESCRIPTION OF TASKS INVOLVED IN FMSP

Task	Description
CPSs’ maintenance planning.	The arrangement and planning of the CPSs fleet maintenance process.
Fleet’s availability and reliability optimization.	<ul style="list-style-type: none"> ➤ Respect the requirements from fleets operators. ➤ Maintenance decision-making based on the current and future CPSs’ health status.
Management of maintenance resources.	<ul style="list-style-type: none"> ➤ Optimized allocation of maintenance resources.

	<ul style="list-style-type: none"> ➤ Minimization of the maintenance costs associated with resources mismanagement [27].
Decision support.	<ul style="list-style-type: none"> ➤ To help a human decision-maker (fleet supervisor) in decision-making based on the suggestions proposed by the FMSP

There are several actors involved in the FMSP phase. Firstly, the fleet operator is a key actor in charge of defining the fleet’s operational requirements such as the minimum number of CPSs required for fleet operations (fleet availability). Another key actor involved in this phase is the FMSP decision-maker. The FMSP decision-maker is primarily in charge of the monitoring of the fleet tasks execution [33]. Beyond this monitoring, the decision-maker is also in charge of reporting fleet’s key performance indicators (KPIs) to the fleet operators and managing fleet maintenance plans in a reactive way. These KPIs are for example, expressed in terms of fleet availability, reliability, security and maintenance costs [34]. Concretely, this decision-maker typically makes fleet’s CPSs FMSP decisions. Moreover, the maintenance operators are the other actors involved in the FMSP phase. In the context of this work, the maintenance operators are augmented to maintenance depots through which the CPSs in the fleet undergo their maintenance interventions. These actors contribute to the availability of the maintenance resources such as the maintenance teams (with appropriate maintenance skills), the maintenance infrastructure (for example, railway tracks, hangars, etc.) and the replacement parts.

The FMSP phase is crucial due to the following reasons. Firstly, through FMSP, the overall fleet’s availability and reliability aspects are improved ([35],[36]). This is because, while the FMSP seeks to intervene on the health status of the fleet’s CPSs correctively or predictively, it does so by ensuring the availability in order to satisfy fleet operations as required by the fleet operator. Nevertheless, through FMSP, the maintenance resources management problem can be addressed. The maintenance planning in FMSP is constrained by the availability of the maintenance resources such as the labor, infrastructure and stocks of the replacement parts [37]. This brings about the need of efficient maintenance resources handling and management schemes in order to attain not only effective FMSP but also the reductions of the costs associated with mismanagement of those resources [38]. Furthermore, through FMSP models, the occurrences of unexpected events as far as the maintenance planning is concerned can be addressed. Maintenance planning has to take considerations of the random nature of the fleet CPSs’ events, environment through which these CPSs operate as well as the infrastructure ([39], [40]). Uncertainties in maintenance planning can be mitigated because FMSP deals with maintenance.

I.2 BOUNDARIES OF THE THESIS AND THE ADDRESSED RESEARCH QUESTION

Considering the aforementioned need of developing reactive CPSs FMSP system (operational in a dynamic environment) to aid in the fleet maintenance decision-making, the main research question of this doctoral dissertation is:

Which kind of maintenance support planning system for the fleet of mobile CPSs could be developed in order to aid a human decision-maker in satisfying the fleet's sustainability expectations (Economic, social and environmental expectations) considering various financial, technical and operational constraints in a perturbed environment ?

This research question raises the following concerns:

1. How does one define and gauge economic, social and environmental expectations in developing a reactive CPSs FMSP system?
2. How is the human decision-maker aided by the developed reactive CPSs FMSP system (i.e. the interactions between the human decision-maker and the reactive CPSs FMSP system)?

In this research work, we assume that, the context of the decision-maker is aligned with the approach adopted by our team as follows: The fleet entities are CPSs merged in a fleet of CPSs. Each entity is embedded with intelligent algorithms capable of establishing its current and future health indicators (diagnostic and prognostic and health management (PHM) key performances indicators (KPIs) are considered as important inputs in this research work but are out of the scope of the presented research). Diagnostic health-indicators seek to detect the current abnormalities occurring in the underlying industrial systems [41]. According to Lamoureux et al. [42], PHM has two subprocesses, namely, extraction process (linking PHM to the monitored system by introducing health indicators) and the supervision process (linking PHM to maintenance by forecasting the health indicators). Furthermore, KPIs are needed to validate the two subprocesses in PHM. Using this information as well as the information on the availability of the maintenance resources (maintenance teams, infrastructure, replacement parts, etc.) and the fleet operator's requirements (CPSs needed to complete fleet operations), the decision-maker must decide on the appropriate maintenance policy and its schedule for a concerned CPS in a fleet with an objective of meeting the fleet's sustainability expectations as defined in this research. This decisional context by the decision-maker is shown in Figure I-3.

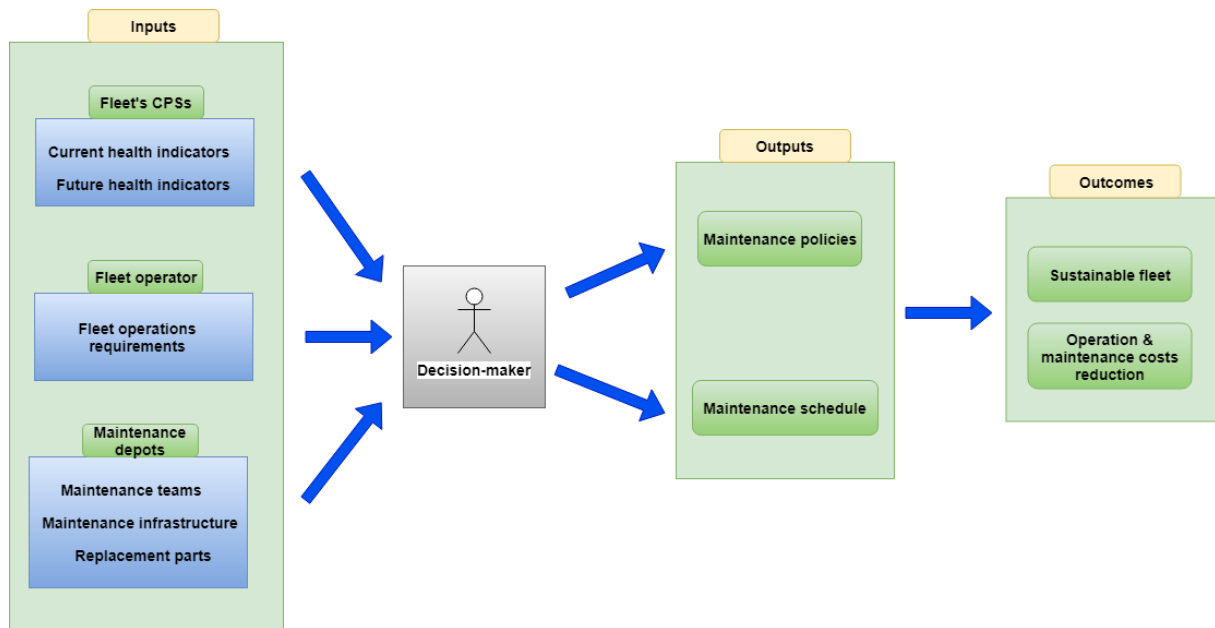

FIGURE I-3: INPUTS AND OUTPUTS IN A DECISION-MAKER'S CONTEXT

As far as the application is concerned, this research work will use the rail transport industry as a case study. As such, a fleet of trains at Bombardier Transportation France will be considered where:

- Trains are the CPSs composing the fleet. For that purpose, they provide their current as well as future health indicators to the decision-maker.
- The fleet operators are the regions through which the considered fleet operates. They provide the fleet operational requirements to the decision-maker.
- The maintenance depots are maintenance centers in the regions where the considered fleet operates. They provide the availabilities of the maintenance resources such as the replacement parts, the labor and the infrastructure to the decision-maker.
- The decision-maker is the fleet supervisor who must use the provided information to make FMSP decisions on the appropriate maintenance policies and the maintenance schedule.

As mentioned, the fleet is assumed to be composed of CPSs. As CPSs are vital in this research work, it is thus important to discuss them in more details. Consequently, the section that follows gives a detailed view of the concept of CPSs, fleet of CPSs and the associated aspects in the context of FMSP.

I.3 CYBER-PHYSICAL SYSTEMS AND FLEETS OF CYBER-PHYSICAL SYSTEMS

I.3.1 DEFINITION

There have been many variations on the definitions of cyber-physical systems (CPSs), mostly due to varying contexts. Despite these variations, most of those definitions tend to agree that CPSs merge the physical and digital worlds through a network of sensors and actuators to perform different tasks, including but not limited to measurements, data treatment, computation, supervision and protection [10]. CPSs involve the integrations of computation, networking and physical processes and they englobe characteristics such as, real-time capabilities, reactivity, control, software and physical resources [43]. The authors in [44] detail a connection between the cyber and the physical worlds that, embedded computing units monitor and control physical processes while the physical processes affect the computations via feedback loops. This feedback mechanism between the cyber and the physical worlds is further elaborated by the author in [45] who argues that, CPSs consist of two main functional components, firstly, the advanced connectivity for the real-time data acquisition from the physical world and the information feedback from the cyberworld as corroborated by. Secondly, intelligent data management, analytics and computational capability which are the foundations of the cyber world. Figure I-4 depicts a concept map of the CPSs that federates the main aspects relevant to CPSs.

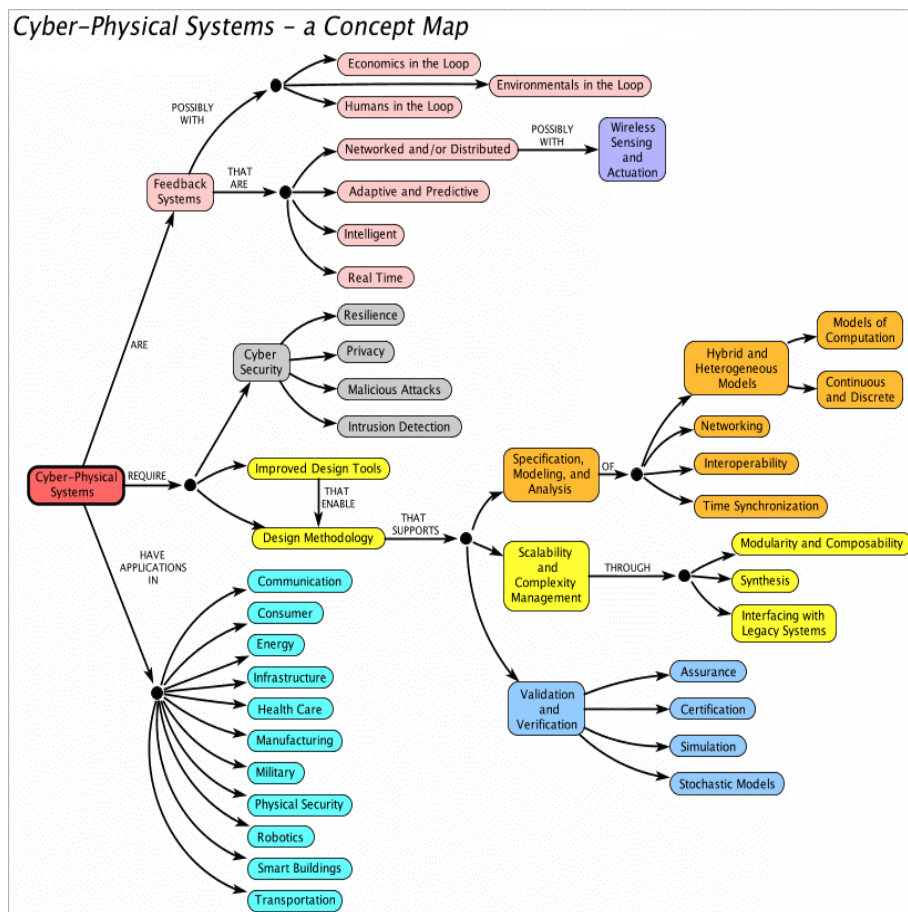

FIGURE I-4: CPSs CONCEPT MAP [44]

According to [46], developing CPSs requires the need of engineering tools capable of supporting distributed systems and that the developing process is coupled with a major shift in emphasis from traditional monolithic, specialism-based, isolated engineering tools and methods toward integrated, cloud-based tool and system infrastructures based around an Internet of Services and associated data. Current trends in manufacturing always associate CPSs with industry 4.0 and big data analytics [47]. [48] argues that, there are two main functional components to handle CPSs big data concerns in industry 4.0 namely, systems infrastructure and data analytics. The subsection that follows gives a view on the fleets of CPSs.

I.3.2 FLEETS OF CPSs

Fleets of CPSs are composed of several CPSs in which each CPS is comprised of similar types of subsystems or equipment [49]. In the literature and in practical applications, fleet approach consists of managing and handling the entities at fleet level as opposed to individual entities ([50], [51]). In recent applications, the fleet approach towards the handling of mobile systems is deemed the best practice because, it improves the overall management of the mobile assets and specifically in acquisition, diagnosis, prognosis, maintenance scheduling, resources allocation and operations management functions ([49], [52], [53]). According to Billhardt et al. [54], the advances in cyber-physical approaches and the associated methodologies further facilitate the fleet approach in managing mobile systems by “*conceiving Fleet Management Systems in terms of Cyber-Physical Systems, and putting forward the notion of Cyber Fleets*”.

As far as the transportation sector is concerned, the fleets of CPSs offer a new approach to the application of information technology to improve the performance of the former [55]. With this approach the transportation systems have better abilities to detect malfunctions, to enhance life-cycle management and to minimize operational costs than before ([56], [47]). This has led to the birth of another sub-domain of CPSs referred to as Transportation Cyber-Physical Systems (TCPs) ([56], [9], [57]).

I.4 LITERATURE REVIEW

The literature review carried out under this section is well aligned with the formulated research question in the sense that, it investigates to what extent have the existing FMSP works satisfied the fleets’ sustainability expectations. Given the previous definitions and the contextual, the literature review is going to be realized based on two complementary points of view. Firstly, different aspects that authors deal with when addressing the FMSP such as the objectives and constraints were studied and for that purpose a framework analysis is suggested, helping us to position different kinds of contributions, which will enable us to point out the limits of the state-of-the-art. Secondly, using a transversal view, a consideration was put on different modeling and solving approaches that are used to solve the FMSP problems, with a specific focus on decisional aspects. Before aboding the two literature contribution views in FMSP, the section that follows gives a brief background and evolution of the FMSP.

I.4.1 FMSP BACKGROUND AND EVOLUTION

It is beyond a reasonable doubt that the current practices in FMSP framework would not have been available had it not been for the state-of-the-art advances in computing technologies. Nevertheless, to better comprehend the current state of affairs in the FMSP, a brief historical background is necessary.

Data processing in fleet management functions, including the FMSP function can be traced as far back as 1950s with the use of unit record equipment [58] which used punched cards [59]. Given the standards of the 1950s, the unit record equipment were efficient and could process large volumes of data (up to 2000 punched cards per minute) [60]. However, with the introduction of mainframe computers [61] by IBM in the late 1950s, most of the fleet management industries transitioned from the unit record equipment to mainframe computers in the 1960s. For example, Wheels and PHH installed their first IBM mainframe computers in 1959 [60]. Moreover, the 1960s saw more innovative discoveries for the fleet maintenance industry such as the 'dumb' terminal [62] and the teleprinter or the teletype [63].

Furthermore, the introduction of electronic vehicle ordering services and the massive expansion of the use of personal computers in the 1970s and 1980s respectively ushered a new direction in the FMSP framework towards ubiquitous accessibility of fleet data. For example according to [60], by 1980s, fleet managers could access fleet data by logging in directly into the fleet management company's mainframe computer (online access) or by transferring the data to their personal computers (offline access).

The internet revolution of the 1990s paved a way into the emergence of fleet management companies that were more and more web enabled. The use of servers became a common practise as more fleet management companies used personal computers to provide the services which were formerly hosted on their mainframe computers [60]. When the boom of smart mobile devices happened in the 2000s, the trend shifted again towards mobile FMSP applications development.

The subsections that follow give a detailed description of the associated concepts in FMSP framework as established in Figure I-5.

I.4.2 CONTRIBUTIONS TO THE FMSP: A FRAMEWORK ANALYSIS

A survey of the existing literature has been realized with a specific focus on different aspects dealt with by the contributions to the FMSP. From this survey, an analysis framework has been built as depicted in Figure I-5. In this figure, the focus is set on decision-making vis-à-vis the maintenance of the CPSs composing the respective fleet. These decisions depend on several factors such as, the maintenance policies, the fleet's availability (requirement from fleet's operators), fleet reliability (current and future health status), resources' availability (maintenance depots, manpower, costs), etc. Thus, from the literature review, FMSP is characterized by the following main elements:

- The objective: To establish sustainable FMSP decisions based on

- Economic aspects: Availability (from fleet operators), reliability and reactivity (Occurrences of unexpected events, operating in a dynamic environment).
- Social aspects: Security and connectivity.
- Environmental aspects: Energy and carbon footprint.
- The constraints (the resources) such as:
 - Financial aspects.
 - Time resources.
 - Manpower.
 - Maintenance depots:
 - Availability of the replacement parts.
 - Availability of the maintenance teams (with appropriate skills).
 - Availability of the maintenance infrastructure (for example, maintenance tracks, hangars).
- Establish appropriate maintenance policy (for example, condition-based, corrective, etc...).
- When discussed, the decision support to the human decision-maker (e.g., the fleet supervisor, etc.).

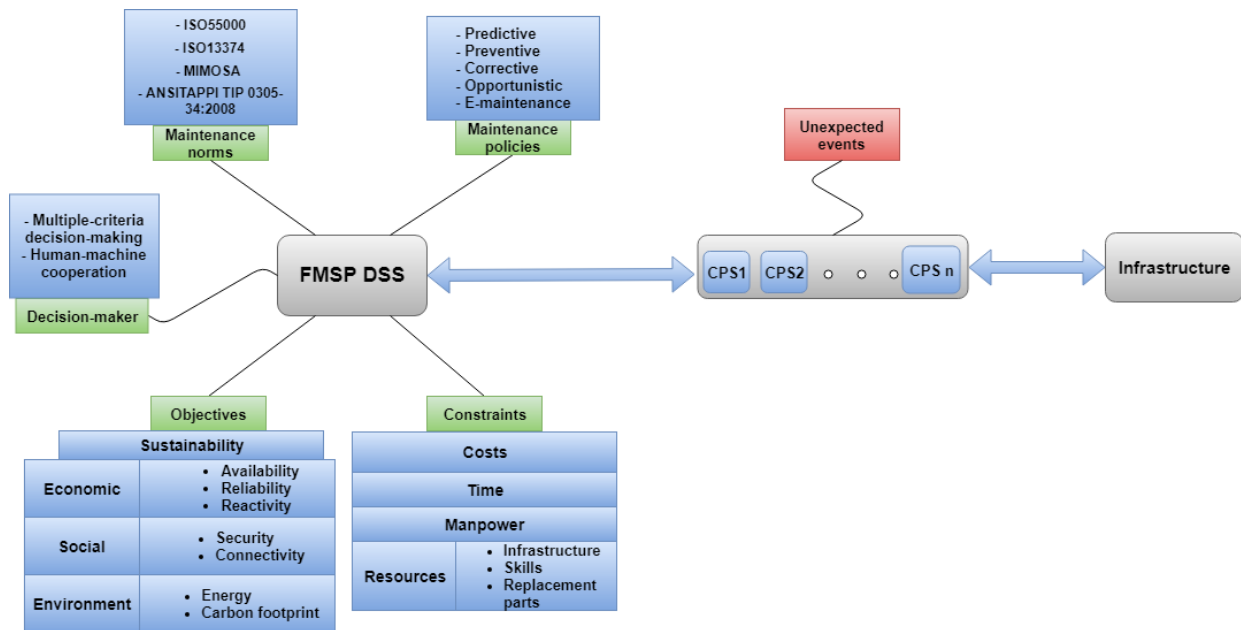

FIGURE I-5: MAINTENANCE SUPPORT PLANNING DECISION-MAKING IN A FLEET OF MOBILE CPSS: A FRAMEWORK

The subsections that follows give a detailed discussion on the aspects of the FMSP framework.

I.4.2.1 FMSP OBJECTIVES: SUSTAINABLE EXPECTATIONS

“Creating a sustainable fleet is much more than about seeking environmentally friendly, or ‘green’ practices. In fact, that’s just one of the three fundamentals of sustainability, which are economic, environmental and social, or more easily remembered as people, planet & profits.”

- Lindsey Hall [64]

According to [65], the role of maintenance has changed to *“Life cycle maintenance”* as the result of the need to optimize maintenance costs since the later became much higher than acquisition and operation costs. It is therefore a way of entertaining a profit vision of maintenance leading to the increase of the number of stakeholders in maintenance by expecting results on the three sustainability pillars from the deployment of concepts such as *“lean maintenance”*, *“green maintenance”* and *“maintenance-centred circular manufacturing”* [65] as shown in Figure I-6.

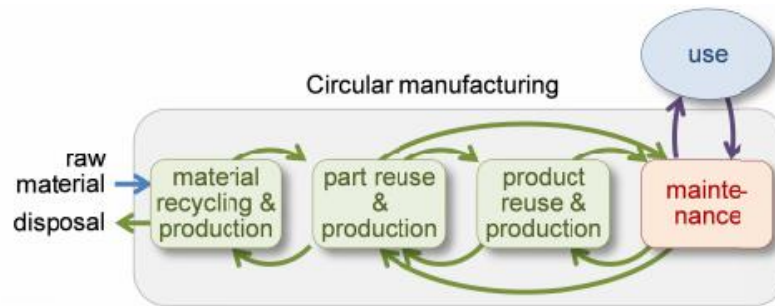

FIGURE I-6: MAINTENANCE-CENTRED MANUFACTURING [66]

The subsections that follow will give a detailed view of the FMSP sustainability objectives, namely, economic, social and environmental.

I.4.2.1.1 ECONOMIC OBJECTIVES

I.4.2.1.1.1 *FLEET AVAILABILITY*

Fleet availability problem has been widely discussed in the literature, especially in the aviation industry (see [67], [68]) and it has been expressed in several ways, such as, the number of CPSs available for service during pick hours [69], the number of CPSs instantaneously present for fleet operations [70] and the average percentage of availability per period for all the CPSs composing a fleet ([71], [72], [73]). In the context of FMSP, many of the literary works define fleet availability as the minimum number of CPSs required to carry out the planned fleet operations [74]. This is in most cases a requirement from the fleet operators who are in charge of defining the fleets' operations hence the need CPSs to carry out these operations [25]. In the context of this work, the FMSP should respect this requirement from the fleet operator in order to satisfy the fleet's availability expectations.

I.4.2.1.1.2 *FLEET RELIABILITY*

According to Schneider et al. [75], the fleet's reliability is defined as the probability that all systems successfully complete their mission. More precisely, it is the capability of the associated fleet to provide services (to carry out its operations) timely and safely ([76], [77], [78]). This depends highly on the health status of the CPSs composing the fleet. Thus, in the context of this research work, the FMSP should satisfy the fleet's reliability expectations by taking account of the CPSs' current (diagnosis) and future (prognosis) health status.

I.4.2.1.1.3 *REACTIVITY OF THE FMSP SYSTEM*

In the context of this research, reactivity is the ability of the FMSP system to handle the occurrences of unplanned events as far as the fleet's maintenance planning is concerned. This constitutes situation awareness in face of dynamic and random environment by the reactive FMSP system [79]. An example of a scenario of unplanned events in maintenance planning is the occurrences of unexpected breakdowns among the fleet's CPSs leading to failures in meeting the fleet's availability requirements.

I.4.2.1.2 SOCIAL OBJECTIVES

According to Liyanage et al. [80], in order to assess the FMSP social objectives, one should question of the social impact arising from effective fleet maintenance planning practices. Some of these impacts as discussed in the literature are the fleet’s security as discussed in [81], [82] and [83]. The other impact is the fleet’s connectivity ([84], [85]) which involves connecting different actors involved in FMSP functions. In recent practices in FMSP, the fleet’s connectivity has been associated with a trend referred to as the E-maintenance ([86], [87]).

I.4.2.1.3 ENVIRONMENTAL OBJECTIVES

Environmental objectives in FMSP analyses the environmental objectives of the fleet maintenance planning activities [80]. Contrary to classical maintenance practices in FMSP such as reactive and preventive which regard mostly financial aspects, sustainable FMSP schemes seek to find an equilibrium with other aspects such as environmental (green) aspects. Some of the most considered environmental aspects in literary works and in practical applications include energy aspect as discussed in ([88], [89]) and carbon footprints as discussed in ([90], [91], [92]).

I.4.2.1.4 SUMMARY

The Table I-2 below summarizes the FMSP sustainability objectives.

TABLE I-2: FMSP SUSTAINABILITY OBJECTIVES

FMSP Sustainability objectives	Aspects of the objectives
Economic	<ul style="list-style-type: none"> • Fleet availability [93], [25] • Fleet reliability [25] • Reactivity [79]
Social	<ul style="list-style-type: none"> • Fleet security [81], [82], [83] • Fleet connectivity [84], [85] • E-maintenance [87], [86]
Environmental	<ul style="list-style-type: none"> • Energy [88], [89] • Carbon footprint [90], [91], [92]

I.4.2.2 FMSP CONSTRAINTS

There are several constraints as far as the FMSP framework is concerned. First of all, many works give a considerable importance to the maintenance resources. These are, firstly and foremostly the availability of the maintenance depots. This is a major constraint to FMSP decision-making problem ([94], [75]). Disorganization and chaos in maintenance resources management will have a direct impact on the reliability, availability and safety of the CPSs composing the fleet [95]. This has made maintenance resource management an important field of research as far as the FMSP is concerned ([96], [97], [98]). For example, in aviation sector, there is a growing interest in Maintenance Resource Management (MRM) training, (also known as “Maintenance Human Factors training) [99]. In the context of this research work, we consider maintenance resources in the FMSP problem as the availability of the maintenance depots in terms of the availability of the manpower (the maintenance teams with required skills and expertise), the availability of the maintenance infrastructure and the availability of the replacement parts needed to carry out the maintenance interventions as demonstrated in Figure I-5.

Moreover, the maintenance time is another constraint considered by the literature works on FMSP. Traditional research works on maintenance practices have focused on Turnaround time (TAT) of the fleets’ assets in order to guarantee that the later are timely and reliably dispatched [24]. According to Feng et al. [27], the optimization of the fleet’s maintenance time does not only improve the fleet’s availability but it also reduces the maintenance consumption and the mission risks. Other research trends around the fleets’ CPSs maintenance time have focused around the mean maintenance time to repair (MMTR) [100] for different maintenance strategies (for example, the mean maintenance time to preventive maintenance [101]).

Furthermore, the maintenance costs are inevitable constraints not only in the FMSP context but in all contexts involving physical assets that need to be maintained to a defined acceptable standard. According to El-Haram and Horner [102], maintenance costs are the costs associated with day-to-day repair, preventive or improvement tasks of the assets. These costs might be directly associated to the cost of the maintenance activities (e.g. the manpower, replacement parts and the maintenance infrastructure) or indirectly (e.g. penalties due to assets unavailability, management, administrative etc.)

I.4.2.3 MAINTENANCE NORMS IN FMSP

Maintenance norms are standards organized by various standardization committees as a source of documentation on the terminologies, methods and techniques to facilitate the communication between the maintenance professionals and the stakeholders [103]. There are many norms and standards as far as the maintenance activities are concerned but according to [104], there are five most important maintenance standards, namely:

- **ISO 55000 Asset Management Standards:** This norm deals with the coordination and optimization of the physical assets’ management throughout their lifecycle. This norm is comprised of three standards:
 - ISO 55000: The terms and definitions of the standards.

- ISO 55001: Requirement for integrated and effective assets' management.
- ISO 55002: Implementation guidelines for assets' management.
- **ISO 13374 on Condition monitoring and diagnostics of machines:** Efficient data sharing and distribution in the maintenance systems and processes, Condition-based, preventive and predictive.
- **MIMOSA Open Information Standards:** This norm is comprised of a wide range of standards covering all aspects of data exchange and integration in operations and maintenance. For example, OSA-CBM which facilitates the practices of CBM, see Figure I-7.
- **ANSI TAPPI TIP 0305-34:2008:** Provides guidelines for creating maintenance checklists.
- **Industrial Internet Consortium Reference Architecture:** Defines the structuring principles that drive the integration of Industrial Internet applications, as part of the emerging digitization of the industry.

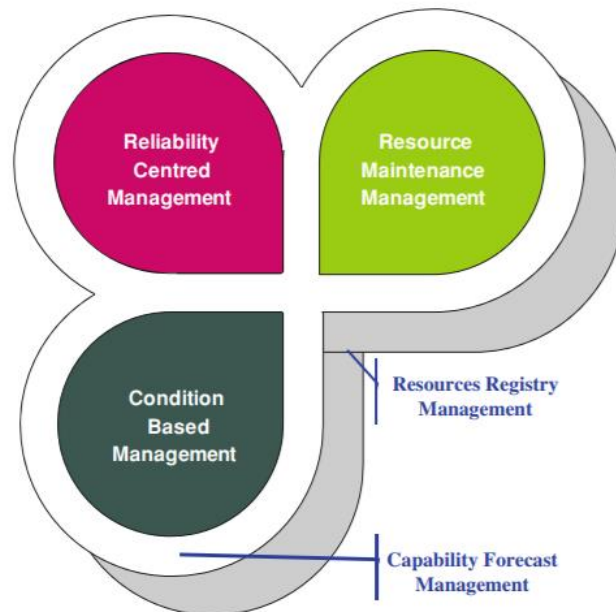

FIGURE I-7: MIMOSA ARCHITECTURE [105]

I.4.2.4 MAINTENANCE POLICIES IN FMSP

In Europe, the definition and the classification of maintenance is based on the norm EN 13306 [106]. However the authors from [107] have considered maintenance classification on another perspective based on strategies, policies and tactics as demonstrated in Figure I-8. Based on these terms, maintenance can be classified into two categories namely, reactive and preventive. However, apart from this traditional classification, there seems to be an emergence of other intelligent maintenance practices due to the advances in sophisticated embedded systems and intelligent machines. The subsections that follow will present the classification according to these two points of views.

I.4.2.4.1 TRADITIONAL CLASSIFICATION

Traditional classification of the maintenance strategies, policies and tactics puts forward two maintenance categories, namely, reactive and preventive. In reactive maintenance the maintenance activities are triggered by an occurrence of a failure [107]. This type of maintenance is described as a fire-fighting approach to maintenance [108]. Moreover, this category is broken down into corrective maintenance ([109], [110], [111]) and prospective maintenance (opportunistic maintenance) [112] practices. Further classification of these practices results in immediate reactive maintenance (IRM), scheduled reactive maintenance (SRM), deferred reactive maintenance (DRM), failure-based maintenance (FBM) and operate to failure (OTF) as shown in Table I-3.

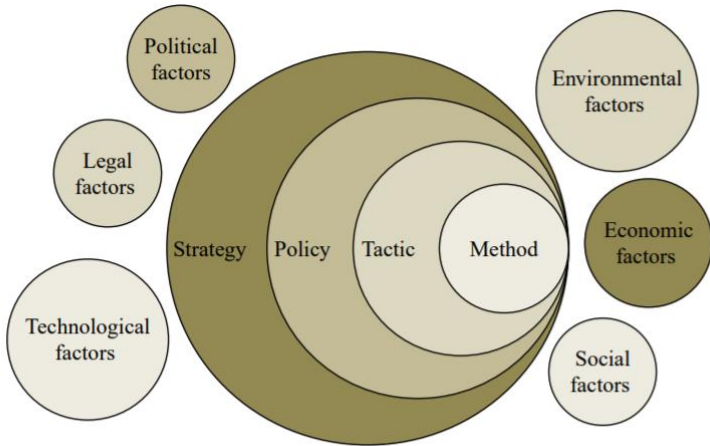

FIGURE I-8: STRATEGIC ANALYSIS AND THE INFLUENCES OF ITS ENVIRONMENT [107]

TABLE I-3: OVERVIEW OF REACTIVE MAINTENANCE PRACTICES [107]

Type	Abbreviation	Description
Immediate reactive maintenance	IRM	Maintenance is immediately done after a machinery breakdown. All the necessary resources have to be available right after a failure happens
Scheduled reactive maintenance	SRM	Maintenance is planned and scheduled when a machine is broken down. This provides a more flexible and efficient use of resources

Deferred reactive maintenance	DRM	Maintenance is postponed or deferred for a broken-down machine due to lack or unavailability of resources in case of an unimportant failure
Failure-based maintenance	FBM	Maintenance is undertaken when one or more failure modes of un-maintained machinery have been observed, thus after a breakdown
Operate to failure	OTF	Maintenance is done when a machine is failed. There is no endeavour to trim down the number of failures

The second category in the classification of maintenance is preventive maintenance. This category has three major practices, namely, Pre-determinative maintenance, Proactive maintenance and Predictive maintenance. These practices are further classified and described in Table I-4, Table I-5 and Table I-6 respectively. The taxonomy of maintenance practices is shown in Figure I-9.

TABLE I-4: OVERVIEW OF PRE-DETERMINATIVE MAINTENANCE [107]

Type	Abbreviation	Description
Age-based maintenance	AGM	Maintenance is based on age renewal of machine, which is preventively maintained till a certain number of time periods without a failure
Block-based maintenance	BBM	Maintenance is taken place preventively at definite time intervals that may have different lengths
Constant interval maintenance	CIM	Maintenance is taken place preventively at definite time intervals that have fixed and constant lengths

Fixed time maintenance	FTM	Maintenance attempts to reduce the number of failures by replacing, repairing or servicing the tool after a planned and pre-set time period
Inspection-based maintenance	IBM	Maintenance through which condition of components subjected to technical and visual inspections is often evaluated on a discrete scale
Life-based maintenance	LBM	Maintenance centres on the machinery lifespan and undertakes preventive scheduled maintenance based on it
Planned preventive maintenance	PPM	Maintenance is regular, repetitive work done to keep equipment in good working order and to optimize its efficiency and accuracy
Time-based maintenance	TBM	Maintenance is performed at fixed time gaps, whether a problem is apparent or not, to shun failure of the items while the system operates
Use-based maintenance	UBM	Maintenance is carried out after a specific and definite amount of time through which the component or machine was used

TABLE I-5: OVERVIEW OF PROACTIVE MAINTENANCE [107]

Type	Abbreviation	Description
Availability centred maintenance	ACM	Maintenance accentuates three actions of mechanical service,

		repair and replacement based on availability
Business centred maintenance	BCM	Maintenance is based on the identification of the business objectives, which are then translated into maintenance objectives
Design-out maintenance	DOM	Maintenance is centred on design change due to recurrent faults of the same type occurring after a system is commissioned
Risk-based maintenance	RBM	Maintenance is based on an approach to minimize the risk resulting from the breakdowns or failures
Reliability-centred maintenance	RCM	Maintenance is centred on the idea that all equipment in a facility are not of equal importance to either the process or facility safety
Total productive maintenance	TPM	Maintenance focuses on process and people, and deterioration prevention aspires to prevent any kind of slack before occurrence

TABLE I-6: OVERVIEW OF PREDICTIVE MAINTENANCE [107]

Type	Abbreviation	Description
Avoidance-based maintenance	ABM	Maintenance is focused on the avoidance of a failure rather than detection of it. Failure is prevented by act of refraining from it

Condition-based maintenance	CBM	Maintenance relies on the fact that the majority of failures do not occur instantaneously, and they can be predicted by condition monitoring
Detective-based maintenance	DBM	Maintenance is undertaken as a consequence of condition monitoring done only by the human senses

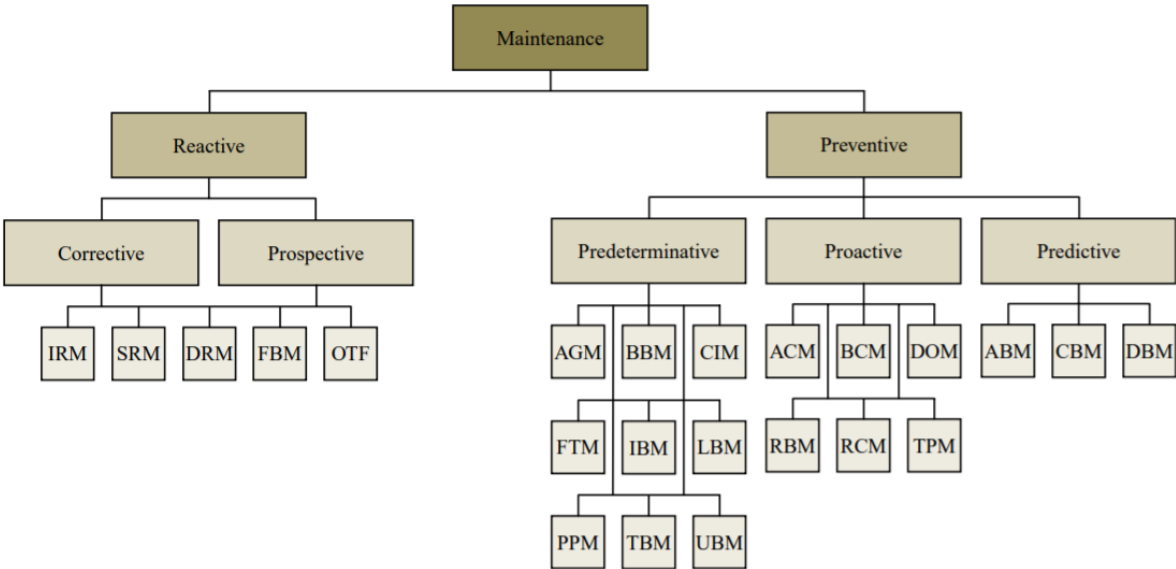

FIGURE I-9: MAINTENANCE TAXONOMY [107]

I.4.2.4.2 CURRENT MAINTENANCE TRENDS

“When smart machines are networked and remotely monitored, and when their data is modelled and continually analysed with sophisticated embedded systems, it is possible to go beyond mere ‘predictive maintenance’ to ‘intelligent prognostics’.”

- Lee et al. [87]

Lee et al. [87] provided the insights towards the concept of intelligent prognostics as a way of continually tracking the health degradation of an asset and predicting the risks of the behaviour associated with this degradation over time. When this continuous tracking is synchronized with fleet operations and the FMSP constraints (such as the maintenance resources), the concept of *E-maintenance* is born. Muller et al. [86] put forward a more general definition of E-maintenance as the integration of information and communication technologies (ICT) [113] within a maintenance strategy. E-maintenance is further categorized as a maintenance plan, maintenance strategy, maintenance type and maintenance support as demonstrated in Figure I-10.

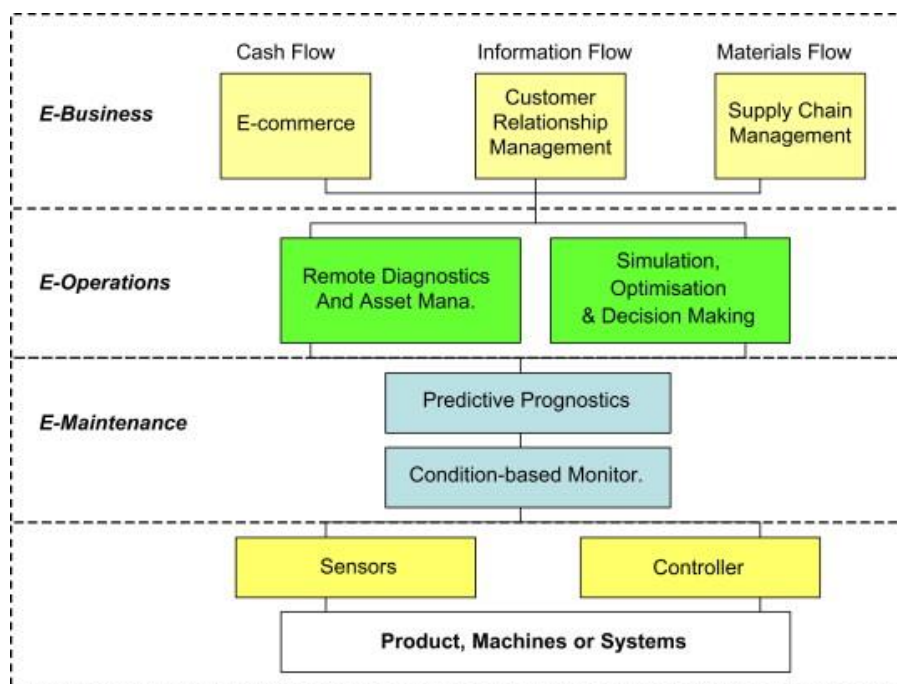

FIGURE I-10: AN ENTERPRISE VIEW OF E-MAINTENANCE [86]

I.4.2.5 CHARACTERIZATION OF THE LITERATURE AND LIMITATIONS

A review table positioning the literature has been established using the FMSP framework, see Table I-7. The main conclusions of our study are provided hereinafter.

Most of the works in FMSP literature address the question of the management of the maintenance resources (spare parts, labour and maintenance infrastructure). This is a major constraint as far as the FMSP is concerned ([94], [75]). Proper management of these resources will lead to the management of other constraints such as the associated maintenance costs and time as addressed in ([114], [24], [25], [27]).

Reliability is another important aspect dealt with by the works on the FMSP literature. Reliability has been linked to improved systems' availability on long-term basis, for example, according to [21], reducing mean time between systems failures increases the systems' availability by 30 percent. For a good portion of the works analysed in Table I-7, reliability has been practically addressed through predictive maintenance practices such as the CBM (for example, [26], [27]).

Moreover, it is also worth noting that, several of the works in FMSP literature positioned their studies not only on the economic dimension of the sustainability but also social dimension. These works considered aspects such as the security, the connectivity and the E-maintenance (for example, [32], [115], [116]).

Meanwhile, some limitations have been identified. First of all, even if reactivity is an important aspect in FMSP, few contributions really addressed this aspect. The majority of the works in FMSP literature do not sufficiently address the random nature of fleet events when designing fleet maintenance models, hence making a gap between research and practical needs.

Secondly, various works in the context of the FMSP are specific when addressing sustainability and other aspects (c.f. Figure I-5). This means, there exist some works which address some sustainability aspects but no other aspects such as the maintenance resources and vice-versa. This contributes to the lack of general cyber-physical FMSP framework that would address fleet sustainability, the management of the maintenance resources as well as the integration of the human maintenance decision-maker in the FMSP model (for example, through a decision support system (DSS) as in [26], [117]).

TABLE I-7: CHARACTERIZATION OF THE SELECTED LITERATURE WORKS ON FLEET MAINTENANCE SUPPORT PLANNING

Sustainability						Resources			Decision-maker interactivity	
Economic			Social		Environment					
Availability	Reliability	Reactivity	Connectivity	Security	E-maintenance	Energy	Carbon footprint	Time, costs		Manpower/Skills availability

Kozanidis et al [67]	•	•								•	•		
Joo et al. [114]		•								•	•	•	
Papakostas et al. [24]		•								•	•	•	
Feng et al. [25]		•								•		•	
Feng et al. [27]	•	•								•		•	
Lin et al. [26]	•	•								•		•	•
Sheng et al [32]	•	•		•						•			
Rawat et al [118]	•									•		•	
Stålhane et al [119]	•	•				•				•		•	
Schneider et al [120]	•	•								•	•	•	
Dožić et al [121]	•									•			
Gutierrez-Alcoba et al [122]			•										
Yang et al [28]	•	•								•	•	•	
Verhagen et al [123]	•	•								•	•	•	
Wijk et al [29]	•									•		•	
Mehar et al. [116]	•	•		•		•	•			•			
Vujanović et al. [124]	•	•				•				•			
Kumar et al. [125]		•	•			•				•			
Jasiulewicz-Kaczmarek et al. [115]	•	•		•		•				•	•	•	
Jasiulewicz-Kaczmarek et al. [126]	•	•		•		•				•			
Shi et al. [127]	•	•		•			•			•	•		
Uhlmann et al. [128]		•		•		•				•		•	
Jasiulewicz-Kaczmarek et al. [129]	•	•		•		•				•			
Iung et al. [65]	•	•		•		•				•	•	•	
Jasiulewicz-Kaczmarek et al. [130]	•	•		•		•				•	•	•	
Cai et al. [131]		•	•			•				•		•	

Sénéchal[132]	•	•					•		•		•	•
Sriram et al. [133]	•								•		•	

I.4.3 CONTRIBUTIONS TO THE FMSP: APPROACHES, MODELS AND TOOLS IN DECISION-MAKING

The second transversal view of the literature is on the approaches, models and tools used in the FMSP. This point of view is important because this research work focuses on the decisional aspects of the FMSP and thus, the models, approaches and tools used in the FMSP decision-making context. Exploring this point of view will help us in identifying the best modeling approach to adopt in our theoretical developments. The subsections that follows give an in-depth view of these aspects.

I.4.3.1 APPROACHES

One can identify several approaches in formulating FMSP decisions in for maintenance decision-making. In [25], the authors identified four main methods: “mathematical programming”, “heuristic algorithm”, “system simulation” and “knowledge-based approach”. Similarly, in [27], four approaches have been pointed out, namely: “mathematical programming”, “heuristic algorithm”, “system modelling and simulation” and “other methods”. A more general classification has been provided in [134] where the approaches in formulating FMSP have been identified as, the “exact approaches” and “heuristics-based approaches”. While exact methods guarantee the optimal point [135], the heuristics guarantee good solutions (not necessarily optimal) within reasonable computing time [136].

Exact approaches are sometimes referred to as mathematical programming approaches in the literature. These are the approaches that ensure the search in a whole space and solve an optimization problem to optimality with an exception of $P = NP$ (problems that can both be solved and verified in polynomial time) [137] and [138].

Heuristic approaches are used to find solutions more quickly when classical methods are too slow or fail to find any optimal solution [139]. According to [140], heuristic approaches rank alternatives in a search space into branches and based on the available information, they provide decisions on which branch to follow in a stepwise manner. Heuristics are the foundation of the whole field of artificial intelligence and computer simulation as they might be specifically used in situations where there are no known solutions [141]. Furthermore, unresolved problems in computer science such as NP-hardness make heuristics the only viable solutions.

The literature indicates that, simulation-based approaches have widely been used in the fleet maintenance context. In these approaches, the behaviour of the system is reproduced by using computer systems to simulate the outcomes of the mathematical model of the respective system [142]. Most of

these approaches consist of two phases, the mathematical modelling of the system and the simulation of the said system. For example, in [143], the authors used a simulation-based approach named multi-objective simulation optimization (MOSO). This approach consisted of two phases namely, mathematical optimization and decision support respectively. Further uses of simulation-based approaches are demonstrated in [144], [145], [146], [147], [148] and [149].

Furthermore, through Knowledge-based techniques, the knowledge on the maintenance planning activities is stored in the databases and the solutions to different maintenance scenarios can be provided based on the rules associated with the stored knowledge [25]. Examples demonstrating the uses of knowledge-based techniques are found in [124] and [150]. The subsections that follow give a detailed review on the models used in FMSP decision-making.

I.4.3.2 FMSP MODELS FOR DECISION MAKING: A LITERATURE REVIEW

I.4.3.2.1 MIXED-INTEGER LINEAR PROGRAMMING

As far as the exact optimization approaches are concerned in formulating FMSP decisions, mathematical programming models are widely used. These models have been deployed to solve various decision-making problems such as planning and scheduling problems [151]. Mixed-integer linear programming models (MILP) are linear programming techniques that make the use of binary, integer and continuous variables for the explicit modelling of FMSP decisions to be made [152]. An example of such models in formulating FMSP is demonstrated in [27], where the problem is considered as a two-dimensional knapsack problem with respect to maintenance time and mission risk and exploits the measurement of the remaining useful life (RUL) of assets to optimize the total maintenance cost [153]. The further use of the mathematical optimization models is presented in [154].

I.4.3.2.2 MULTIPLE-CRITERIA DECISION ANALYSIS

Despite the usefulness of mathematical programming models (for example, MILP) in solving FMSP decision-making problems, the former might not always be efficient in solving FMSP problems which integrate many interdependent factors (criteria) and cluster (dimensions) [155]. In such situations, multiple-criteria decision-making (MCDM) models can be successfully deployed [156]. MCDM is a collection of methodologies to compare, select, or rank alternatives where multiple and conflicting criteria involving both tangible and intangible factors are considered [157]. MCDM can be categorized into two types, namely, Multi-objective Decision Making (MODM) and Multi-Attribute Decision-Making (MADM) methods ([158], [159]). Figure I-11 below details the classification of MCDM methods.

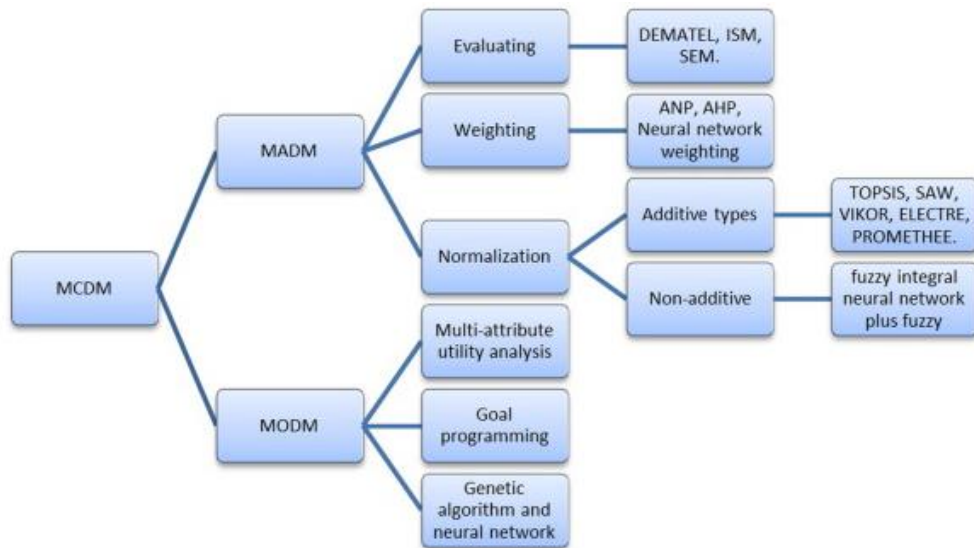

FIGURE I-11: MCDM CLASSIFICATION [157]

In multi-objective FMSP problems, a decision-maker has to make certain trade-offs to gain the value from one performance aspect (e.g. reliability) on the cost of another (e.g. owner cost) [160]. It is therefore often true that no dominant alternative will exist that is better than all other alternatives in terms of all objectives [161]. In this sense, MCDM provides effective decision-making in such cases where it is not easy to find an alternative that would best meet a wide variety of considered criteria [162].

I.4.3.2.3 MULTI-AGENT SYSTEMS

I.4.3.2.3.1 BACKGROUND

“In recent years, some AI pioneers such as John McCarthy and Nils J. Nilsson have expressed their discontent on existing AI technology. Under the logo no more idiot savants, it is claimed that it is important to distinguish between intelligent programs and the special performance systems, that is, tools, that they use. Building the tools is important - no question. But working on the tools alone does not move us closer to AI's original goal. The challenge of the new millennium in AI is, therefore, to go back to good old-fashioned AI (GOFAI) and build general intelligent systems. These systems should be capable of flexible autonomous action in dynamic, unpredictable domains. That is precisely what some AI people have been doing in the last decade: Building agents”

- Eduardo Alonso, 1998 [163]

Multi-agent system (MAS) consists of heterogeneous subsystems and computing nodes also known as agents [164]. According to [165], an agent is any physical or virtual entity that can perceive its environment and act on it using sensors and effectors respectively. However, the definition in [166], asserts that an agent must have certain characteristics such as autonomy and computational objectives or goals. As modelling and computation in complex systems become laborious and difficult to handle using centralized methods [167], distributed systems become more and more popular. In a distributed

system, two or more agents form a multi-agent system (MAS). MAS is a network of agents that work with each other to solve problems that could not otherwise be solved by an individual agent [168].

As insinuated in [169], agent-based research and development owes its origins to the evolution of artificial intelligence, object-oriented programming, object-based systems and human-computer interface design fields. By 1980s agent-based systems were quite popular (owing to Thomas Schelling's 1971 segregation model [170]) in solving complex problems in various domains [171]. However, new challenges such as scalability, versatility, reusability, brittleness and inconsistency became major concerns. This was partially due to the increase in systems' sizes and complexities. To counteract these concerns, a new 'divide and conquer' technique which relied on the distribution of the system's tasks among different agents [163] was devised. This was the birth of the MASs era.

I.4.3.2.3.2 MULTI-AGENT SYSTEMS IN FMSP

Notwithstanding the fact that, in formulating FMSP decisions in the fleets of mobile systems, various heuristic-based approaches such as game theory and Petri nets models have been experimented with (see [32], [27] and [25]), multi-agent FMSP models are quickly emerging and becoming suitable techniques partly due to decentralized, distributed and dynamic nature of the fleets in transportation domain [152]. Mobile transportation systems are complex engineering systems [172] and modelling these systems is not trivial. Therefore, using MASs, different units in the transportation systems could be configured and represented by agents to support active monitoring and surveillance to detect any changes related to data [173] hence the anticipation of these uncertainties. These agents may also be used for competition and cooperation to dynamically find near optimal and balanced solutions [174] as far as the FMSP is concerned. Further uses of intelligent agents in maintenance support planning in industrial plants are widely deployed, see for example [175], [176], and [177] where non-mobile industrial equipment like, DC induction motors and a component-Handling Platform are explored.

I.4.3.3 DECISION SUPPORT SYSTEMS

"We seem to be on the verge of another 'era' in the relentless advancement of computer-based information systems in organizations. Designated by the term Decision Support Systems (DSS), these systems are receiving reactions ranging from 'a major breakthrough' to just another 'buzz word'."

- Ralph H. Sprague, Jr 1980.

In an era were the use of industrial personal computers (PCs) was just starting to take shape (1980s), Ralph H. Sprague gave an overview and perspectives for the decision support systems (DSSs) [178]. In his paper, Sprague gave a more complete definition and properties of DSSs as:

- DSS tends to be aimed at the less well structured, underspecified problem that upper level managers typically face.

- DSS attempts to combine the use of models or analytic techniques with traditional data access and retrieval functions.
- DSS specifically focuses on features which make them easy to use by non-computer-proficient people in an interactive mode.
- DSS emphasizes flexibility and adaptability to accommodate changes in the environment and the decision-making approach of the user.

DSS concept was coined long before the emergence of PCs [179], nevertheless, DSSs represent the role of computers within the decision-making process [180]. This fact implies the parallelism between the evolution of DSSs and the advances in the information technologies [181]. According to [181], DSSs' evolution has been through four generations:

- Data intensive DSSs [182], [183] and [184]
- User interface ('dialog') DSSs [185], [186] and [187]
- Model based DSSs [188], [189], [190], [191], [192] and [193]
- Next generation web-based DSSs [194]

Technologies associated with DSSs (for example, artificial intelligence, communication systems) are growing very fast hence the fast evolution of the current trends in DSSs as corroborated by the research works and industrial practices. Modern DSSs facilitate a wide range of services, some of which are; information gathering, information analysis, model building, sensitivity analysis, collaboration, alternative evaluation and decision implementation [194]. [195] argues that, "the concept of Decision Support Systems is an almost established concept, but which is still growing due to the integration (incorporation) of several individual and relatively newer technologies (object orientation, expert systems, advanced communications), from which it extracts new valences and strengths".

I.4.3.3.1 DSS IN FMSP

In recent years, due to the dwindling profitability in transportation industry (for example [196]), companies operating fleets of mobile CPSs seek to utilize costs-saving techniques such as the optimization and rationalization of their decision-making processes [197]. This has pushed for the efforts to develop computer-based decision aiding tools which are reliable, efficient and user-friendly [197]. These DSSs offer services in several aspects of fleet management functions such as routing, operations scheduling, service portfolio optimization and maintenance support planning ([197], [24], [117]) and integrate cutting-edge methodologies developed in various scientific fields such as, operations research, decision sciences, decision aid and artificial intelligence ([197], [198]).

I.4.3.3.2 HUMAN-MACHINE COOPERATION

The interactions between the decision-makers and the maintenance management models integrated in the DSSs (for example, FMSP models) constitute human-machine interactions and in such contexts, the DSSs interfaces could be referred to as human-machine interfaces (HMIs) (see definition in [199]). However, in recent trends, some of the models integrated in such DSSs are reactive (i.e. they have been designed to take considerations of the random nature of the environment through which they operate) [200] and have powerful decisional capabilities. These situations make the role of human decision-makers in automated systems ambiguous [201] and as such, a human-machine cooperation (HMC) approach is necessary in designing the DSSs as opposed to the classical human-machine interactions (HMIs) [202]. HMC entails three important aspects, namely, sufficient know-how for solving problems in an autonomous way, know-how-to-cooperate and adequate organizational structure integrating human and machine ([203], [204], [205]).

I.4.3.4 SCIENTIFIC LIMITATIONS

I.4.3.4.1 LIMITATIONS OF THE FMSP MODELS FOR DECISION-MAKING

Despite the tremendous evolution of the FMSP models in design and applications, present-day FMSP frameworks are still faced with several challenges and limitations. The following are some of these challenges and limitations as highlighted by the discussions from the literature.

Lack of reactivity and dynamism. This challenge can be characterised as a lack of situation awareness when dealing with complex and dynamic environment [79]. Most FMSP models lack reactivity because the dynamic aspects depend on the factors which are outside the scope of design of such models [206]. However, there have been some efforts to make the FMSP models more dynamic through human-like DSSs. This phenomenon has given birth to another term ‘intelligent decision support systems’ (IDSSs) thought to have been coined by Clyde Holsapple and Andrew Whiston [207]. Today, the integration of artificial intelligence techniques in FMSP models is picking up especially through the use of ‘*intelligent agents*’ embedded in DSSs which have cognitive capabilities [208].

Lack of reliable data. Effective FMSP decision-making depends on the availability of reliable data from various actors such as the fleet entities (the CPSs), the maintenance depots and the fleet operators. Thus, there is a need of developing accurate models and tools which will ensure a reliable computation of information from those actors for effective FMSP decision-making. Taking the fleet’s CPSs as an example, there is a need to develop more precise and accurate models capable of getting a correct picture of the current (diagnosis) and future (prognosis) health-status (refer to [209], [210], [211], [49] and [212]) for effective fleet maintenance management.

Limitations on the interactions with decision-makers. Even though in most FMSP models, the interactions with the maintenance decision-makers are achieved through a DSS, most of such DSSs have failed to integrate/incorporate the results of the interactions between them and the decision-makers (users) in their computational algorithms [213]. Poor quality of input information or parameters will lead to poor calculated results by such DSSs [214] and the lack of communication with a decision-maker for correction or completion [195] makes this problem worse. However, this seems to be a design

problem, as Mbuli et al. [117] argues that, if DSSs are designed to share intelligence with decision-makers, not only could the results be improved but also the user experience.

Limitations in resources. Most of FMSP models, weather they are integrated in DSSs or not, will be limited by the computer systems from which they are running [215]. Hence important aspects of these computer systems such as their designs, computing capabilities and security will have a direct impact on FMSP models.

I.4.3.4.2 LIMITATIONS OF THE DECISION AID TOOLS

Despite the sophistication and the state-of-the-art advances of the modern-day DSSs, the later are still faced with several shortcomings as far as fleet maintenance is concerned. One of those limitations is that most developed DSSs are domain specific. [195] points out that, for efficiency and effectiveness, DSSs need to be designed for a specific field of use and for a specific type of decision-making problems. However, this prevents the generalized use of DSSs in multiple decision-making contexts [215]. Another common limitation of modern DSSs is the lack of human characteristics. Some of these characteristics or traits are identified in [216] as creativity, intuition, imagination and the instinct of self-preservation. In this respect, most DSSs are incapable of making assumptions [217] hence not very efficient in handling uncertainties like humans. Nonetheless there have been tremendous efforts to make DSSs behave like human assistants through the development of intelligent decision support systems (IDSSs). Other prominent limitations range from limited interactions between DSSs and human decision makers ([213], [214], [195], [117]) to limitations in computational resources ([215], [195]).

I.5 SUMMARY

This chapter has explored the state of the art on the fleet maintenance support planning (FMSP) of mobile cyber-physical fleets. It has offered a detailed view and background of the concepts associated with the fleets of mobile CPSs. The advances in cyber-physical fleets maintenance support planning frameworks have been prompted by several reasons, firstly, the state-of-the-art evolution of the closely related concepts such as CPSs and their constituting fleets (see section I.3). Secondly, the advances in fleet management methodologies. This research specifically deals with the maintenance support planning function of the fleet management and the associated methodologies have been exhaustively discussed in section I.4. The third reason is due to the advances in the associated in ICT which prompted positive changes not only to the FMSP decision support tools (subsection I.4.3.3) but also to the fleet management industry in general. The evolution of FMSP practises vis-à-vis the ICT has been covered in subsection I.4.1.

Nevertheless, despite the outlined swift evolutions and impressive current trends, FMSP frameworks seem to be a work in progress due to the limitations presented by the associated FMSP frameworks as well as the approaches, models and tools used to solve the FMSP decision-making problems as discussed in subsections I.4.2.5 and I.4.3.4 respectively.

Considering the identified needs and the limitations of the solutions offered by the existing works in the literature on the FMSP of cyber-physical fleets, this research, proposes the following recommendations:

A need to develop a reactive CPSs FMSP system basing on the dynamism of the environment through which the fleets of CPSs operate (i.e. occurrences of unplanned events). The system should be able to modify/adjust the FMSP decisions at the occurrences of unplanned events.

The next chapter will formalise the FMSP problem as well as providing specifications for a reactive CPS FMSP system as recommended this chapter.

Chapter II SPECIFYING A REACTIVE CPSs FLEET MAINTENANCE SUPPORT PLANNING SYSTEM

In the previous chapter, the principal needs towards formulating a reactive CPSs fleet maintenance support planning (FMSP) system were identified. Literature works were explored to see how they respond to the addressed research question by considering two points of views, firstly, the FMSP frameworks and their different aspects such as the objectives (e.g. sustainability), the constraints (e.g. the maintenance resources, maintenance time) etc. as discussed by the works found in the literature. The second point of view considered the approaches, models and tools used in the literature in solving FMSP decision-making problems. The literature limitations vis-à-vis these two points of views were outlined.

As discussed in chapter I, the elaboration of such a reactive FMSP system is a complex process due to various reasons, the first being the complexity of the fleet of CPSs as far as its management is concerned. The second aspect is the random/dynamic nature of the environment through which different elements in the FMSP framework operate (for example, even the static fleet maintenance planning is known to be an NP-hard combinatorial problem [27], [94]). The third complicating aspect dwells on how the human decision-maker is aided by such a reactive FMSP system (i.e. decision aid to the human decision-maker).

The aim of this chapter is to formalize the FMSP problem and provide specifications for a reactive CPSs FMSP system. These specifications will serve as a basis for the development of a possible reactive FMSP model developed in chapter III. The rest of this chapter is organized as follows, section II.1 will give the specifications of the scientific issues associated with the fleets of CPSs vis-à-vis the FMSP problem. Section II.2 will provide the specifications of the CPSs FMSP system through, first of all, providing boundaries to the FMSP framework (i.e. objectives, constraints, etc.). Secondly, the FMSP problem modelling assumptions and data requirements will be provided. Lastly, the FMSP problem parameters and indexes will be presented in this section. Section II.3, will present the decision aid context to the human decision-maker. In this section, a decision support approach will be adopted. Lastly, section II.4 will conclude the chapter and give perspectives of the coming chapters.

II.1 SPECIFYING THE SCIENTIFIC ISSUES

The scientific issues specified under this section concern the targeted class of entities composing the fleet and which are subjected to exploitation and maintenance. These issues will serve as references for the specification of the reactive CPSs FMSP system. The addressed assumptions on the targeted CPSs are as follows:

Assumption 1:	In our work, the considered entities of the fleet are CPSs, they are therefore ‘intelligent’ in the sense that, they have processing and communication capabilities. These are among the capabilities of CPSs in transportation systems ([9], [9], [47]).
Assumption 2:	As far as the processing capabilities of the considered fleet’s CPSs are concerned, each CPSs has sensors embedded to its subsystems for raw data acquisition ([218], [219]). Moreover, the CPSs have also embedded diagnostic and prognostic functions, models and algorithms enabling the establishment of the health status indicators (including time stamped fault-detection events), and CBM (condition-based maintenance) indicators. This constitutes on-board processing capability of the CPSs ([220], [221], [222]).
Assumption 3:	The considered CPSs are moving complex systems (e.g. trains, planes, trucks, etc.) which are operating within various environmental situations (for example, with limited communication bandwidth [223], with weather condition issues [224], etc.). They are also often geographically scattered in large areas and the fleet is often composed of hundreds of CPSs ([225], [117], [49]).

Vis-à-vis these specifications, the contributions of the research team through which this work was carried out to the global research question introduced in chapter I is twofold:

First of all, how to get a correct and real-time picture of the current health states (monitoring and diagnostic related issues) and future states (prognostic, supervision, remaining useful life) of each of the supervised CPS.

Secondly, how to make effective (e.g., considering availability and reliability expectations), efficient (e.g., cost) and reactive (e.g., unexpected events) CPSs FMSP decisions based on the picture generated by the first issue.

This research work focuses on the problems associated with the second issue. While the first issue is out of the scope of this work, more information on the latter can be obtained by referring to [209], [210] and [212]. Reaching effectiveness and reactivity leads to conflictual situations. For example, the fleet operator may impose that the fleet supervisor ensures a minimum level of fleet availability (e.g. a minimal number of CPSs simultaneously in use [27]) while at the same time, the fleet supervisor must decide maintenance interventions for some of the CPSs in the fleet, a decision which reduces consequently the real fleet availability level [93]. This will motivate us to adopt a decision aid approach in our applications.

II.2 CPSs FMSP PROBLEM FORMULATION

In chapter I, an FMSP framework was proposed as the results of a survey on the existing literature works contributing to the FMSP problem. Based on this global framework, this section has an objective of specifying and formalizing the CPSs FMSP problem. It will start by fixing the boundaries on the reactive CPSs FMSP framework presented in chapter I (subsection II.2.1). After having defined the considered context, this section will present the modelling assumptions and the required data as far as the reduced CPSs FMSP context is concerned (section II.2.2). Lastly, in order to formalize the CPSs FMSP problem, this section will present the problem’s parameters, notations and indexes used throughout this research work (section II.2.3).

II.2.1 PROBLEM BOUNDARIES AND WORKING ASSUMPTIONS

There are many ways to address the scientific issues pointed out. As a consequence, working assumptions must be made. These assumptions are the results of the reduced context of the FMSP framework discussed in chapter I. This reduced FMSP framework is thus used to present and organize them, as shown in Figure II-1.

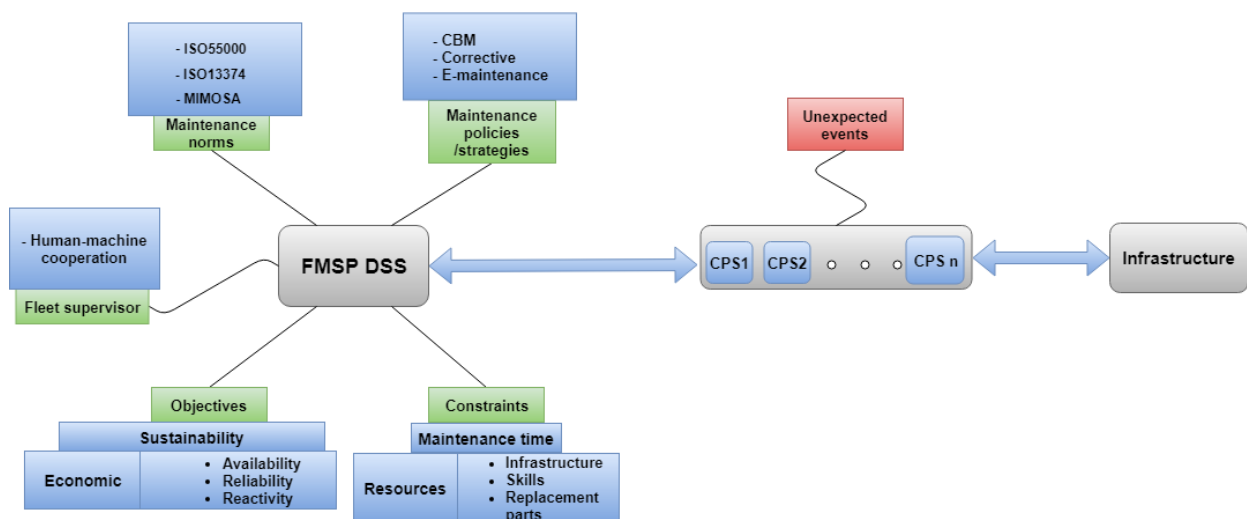

FIGURE II-1: REDUCED CONTEXT OF THE FMSP FRAMEWORK

II.2.1.1 SPECIFIED OBJECTIVES

The objectives and requirements of the FMSP system are reduced to the technical and economic aspects of the fleet sustainability as defined in the FMSP framework in chapter 1 (i.e. fleet’s availability, fleet’s reliability and the FMSP reactivity). The specified FMSP system should therefore not only satisfy the mobile cyber-physical fleet’s effectiveness but should also be able to operate in a dynamic environment where there is a presence of unplanned events. In our work, and from our review, we chose to describe effectiveness as a function of availability and reliability performances objectives. In the previous chapter, different definitions for these objectives could be found in the literature and we had to set which definition we adopt and how we quantify them. Consequently, the precise definitions of these objectives we adopted are provided hereinafter:

Effectiveness

➤ Fleet availability:

It can be defined and measured in a number of ways. Sarma et al. [226], defined fleet availability as the average fraction of fleet entities fit for use at a given instance. According to Feng et al. [74], it is the minimum number of fleet's CPSs required to accomplish the planned fleet operations within a specified horizon. Other quantification methods exist such as, the average percentage of availability per period for all the CPSs composing a fleet (refer to Chapter I), but they are out of scope of this research, thus, this work will consider the Feng et al. definition.

➤ Fleet reliability:

It is defined as the probability of no failure at all for a given number of entities in the respective fleet ([227], [228]). Efforts in finding ways to improving assets' reliability has been the focus of PHM community for the past few decades ([229], [230],[231]). These efforts are based on the trends in predictive maintenance practices such as the CBM ([25], [232], [27]). In the context of this work, in order to fix the specifications for the fleet's reliability, increasing the fleet's reliability is equated to increasing CBM interventions on the fleet's CPSs because evidence from the literature works suggests that, CBM not only reduces the assets' operating costs but also increases their reliability ([233], [234], [235], [236], [237]). Despite this being a major factor to increasing the fleet's reliability, it is not the only one. Other factors such as other preventive maintenance techniques (e.g. proactive and predeterminative – see chapter I) and improving equipment safety norms exist but are out of scope of this research work.

Reactivity	<ul style="list-style-type: none">➤ FMSP system reactivity: This is defined as the of the ability of the CPSs FMSP system to adapt or modify the CPSs' maintenance planning decisions according to the occurrences of unexpected events in real-time (e.g. delayed maintenance operation, bad estimation of maintenance operation duration, unanticipated breakdown of an equipment of a CPS currently in use, etc.) [79]. Though system's reactivity is hard to quantify, in this research work, it can be considered as the number of CPSs FMSP system's reactions following perturbations/unanticipated events in the system similar to systems' reactions after disruptions problems discussed by Hajibabai et al. [238] and Hu et al. [239].
-------------------	--

II.2.1.2 SPECIFIED MAINTENANCE CONSTRAINTS

From the FMSP framework presented in chapter I, different constraints to the FMSP were explored. The constraints included, the maintenance resources, the maintenance time and the maintenance costs. In the context of this specification, the constraints will be confined within the maintenance resources and the maintenance time as they are the most important constraints suggested by many works in the FMSP literature ([94], [75]). The maintenance resources in this context will consider the availability of the maintenance depots in terms of the labour, replacement parts and the maintenance infrastructure ([74], [120], [75], [23], [240]). Based on these works, the description of the specified constraints is provided hereinafter:

<ul style="list-style-type: none">➤ Maintenance time:	According to Liao et al. [241], maintenance time is the time required to perform a maintenance intervention on an asset. This time can be calculated by a number of ways. Most literature works consider mean time to repair (MTTR), which is the mean time required to repair a faulty asset, thus a measure of maintainability of the respective asset ([242], [100], [243]). The maintenance time for a task can also be measured through the turnaround time (TAT) [244].
<ul style="list-style-type: none">➤ Maintenance teams:	According to Chang et al. [245], maintenance teams' availability is the most important of the maintenance resources and it could contribute as high as 80% of the total maintenance costs. Do et al. [246] raises three concerns vis-à-vis maintenance teams as major maintenance resources: <ul style="list-style-type: none">○ Maintenance teams are limited resources○ Their availability vary over time

	<ul style="list-style-type: none">○ Maintenance team allocation as an NP-hard problem
➤ Replacement parts:	Vaughan T.S [247] discusses an inventory policies for spare parts. He argues that, while it is costly to keep spare parts in inventory, the former must be available when needed for maintenance interventions. This contradiction between the cost and availability forms a basis for the modern trends in the modelling of replacement parts inventory policies ([248], [249], [250], [251]).
➤ Maintenance infrastructure:	The management of maintenance infrastructure has been widely discussed in aviation domain. These are known as aircraft maintenance hangars ([252], [253], [254]). However, the maintenance infrastructure is as important in other transportation domains too, for example, maintenance depots in rail transport which contain the maintenance railway tracks and garages in automobile.

II.2.1.3 MAINTENANCE NORMS AND POLICIES

The maintenance needs arising from the specified CPSs FMSP objectives (i.e. availability, reliability and reactivity – subsection II.2.1.1) pushes for considerations for corrective maintenance (due to the presence of unanticipated events), CBM (in order to improve the fleet’s reliability) and E-maintenance (the fleet entities being CPSs) practices. Along with these maintenance practices, the considered standards and norms are ISO 13374 on condition monitoring, ISO 55000 on assets’ lifecycle management and OSA-CBM which is part of MIMOSA. More details on these specified maintenance policies and norms are provided hereinafter.

➤ Corrective maintenance:	Include a group of maintenance practices done as a result of unanticipated system failures ([255]). These practices are always associated with systems’ downtime costs ([256]) as the results of breakdowns of the latter.
---------------------------	---

- CBM: This is a maintenance practice done as a result of condition monitoring ([117], [49], [212], [209]) with the aim of increasing the assets reliability and reducing their operating costs.
- E-maintenance: This is the result of the integration of ICTs in maintenance practices. Recent ICT advances and trends such as the CPSs, the Industry 4.0 have brought a wide range of solutions and improvements in digitalization as far as the maintenance practices are concerned ([257], [258]).
- OSA-CBM: This is a standardization for CBM architecture that facilitates the entire range of CBM functions from data acquisition to maintenance actions recommendations ([259], [260]).
- ISO 13374: This is the norm that defines assets' condition monitoring and diagnostics. In the context of this work, it guides the CBM practices through condition monitoring guidelines and the corrective maintenance practices through machine diagnostics guidelines ([261]).
- ISO 55000: This norm provides guidelines for assets' lifecycle management [261]. According to Ma et al. [262], the economic efficiency of enterprises managing physical assets can be significantly improved by focusing on the whole lifecycle of those assets through ISO 55000 standard.

II.2.1.4 FLEET SUPERVISOR

In the context of this research, the human decision-maker is referred to as the “*fleet supervisor*”. The fleet supervisor is primarily in charge of monitoring the fleet’s tasks execution [33]. Beyond this monitoring, the fleet supervisor is also in charge of reporting fleet’s key performance indicators (KPIs) to fleet operators and managing fleet maintenance plans dynamically. In this research work, these KPIs have been expressed in terms of the fleet availability and reliability expectations [34] (see subsection II.2.1.1). Concretely, the fleet supervisor makes fleet’s entities maintenance decisions based on the fleet’s availability (requirement from fleet’s operators), reliability (current and future health status) and resources’ availability (maintenance depots), etc. which is a complex decisional problem ([27], [74]) (see Figure II-2).

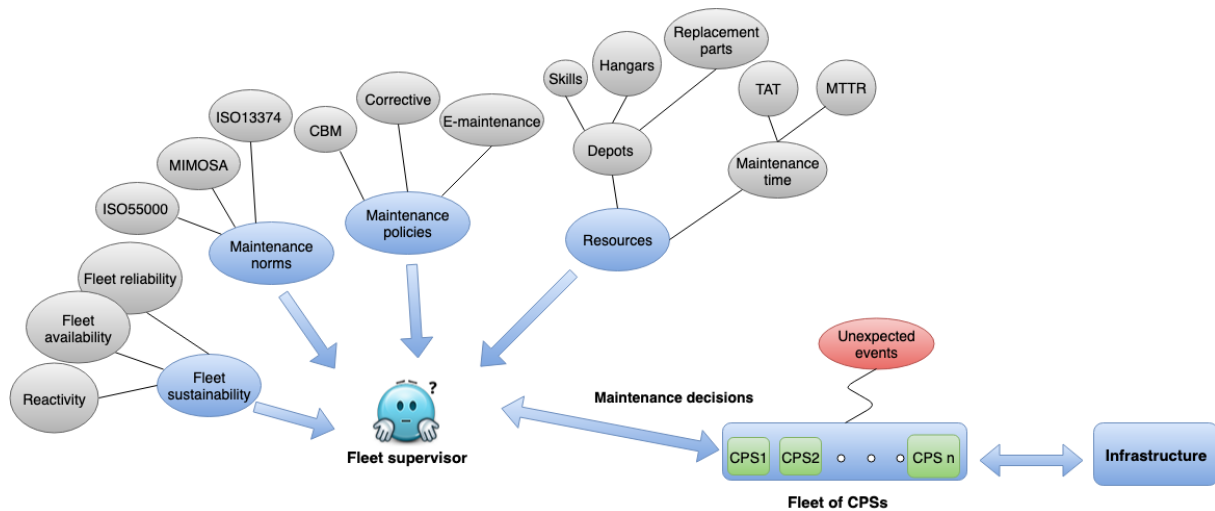

FIGURE II-2: FLEET SUPERVISOR'S DECISIONAL CONTEXT

II.2.2 FMSP PROBLEM MODELLING ASSUMPTIONS AND DATA REQUIREMENTS

After having defined the FMSP problem boundaries in the previous subsection, this subsection will define the FMSP problem assumptions and the requirements for the input data in a detailed context. There are several assumptions associated with the modelling of the considered scientific problem and the set of data that is needed as inputs in the specified work. These assumptions are presented hereinafter:

- In order to organize the fleet's CPSs in terms of their health status, the first modelling assumption divides the fleet into three health status groups similar to the problem discussed by Feng et al. [74]. The first group (group 1) of CPSs contains the CPSs which do not require any maintenance interventions. The CPSs in group 2, require preventive measures from the information provided by the CBM indicators. The third group of CPSs (group 3), contains the CPSs which require corrective maintenance interventions. These CPSs cannot be deployed for fleet operations without undergoing the concerned corrective measures.
- Secondly, CBM indicators referred to in the first assumption are equations on the changes in the systems' characteristics [263]. This makes it possible to estimate the remain useful life (RUL) of an equipment ([264], [265], [266], [267] and [268]). In the context of this work, it is referred to as "the gravity of a CBM indicator", denoted gi_CBM , which is the estimated time until the next breakdown.
- Thirdly, it is supposed that the MMTR of a CPS in need of a maintenance intervention is known or can be estimated by the maintenance teams similar to the problems discussed by Liao et al. [241], Feng at al. [74], and Wohl [269]. By this assumption, the repair time of a CPS can be approximated thus the CPSs needing long or short time can be identified for maintenance priorities depending on the fleet's availability level (Feng et al. [74]).

- The fourth modeling assumption is that each CPS in the fleet has a mission to realize and is assumed to be attached primarily to a specific maintenance depot (similar to the context of Integrated Support Stations in the military sector, see [153]) in which its maintenance needs will be taken care of. Meanwhile, it is assumed that, in the case of emergencies, a CPS involved can go to any maintenance depot and this becomes a decision to be taken by the fleet supervisor. This situation is quite common in the transportation sector [27].
- The fifth modeling assumption is that, the list of operations of all the CPSs in the fleet that are scheduled within a given time horizon is assumed to be available (this list is often provided by the fleet operator [270]). In the context of this work, the tracking of the fleet availability is realized using an availability threshold can that help to verify whether the fleet's availability is low or high similar to the problems described by Kozanidis et al. [271] and Sarma et al. [226]. Such availability threshold is assumed to be provided by the fleet supervisor and is to be compared with the difference between the CPSs which are available and the CPSs which are needed by the fleet operator to complete the planned fleet operations within a specified horizon.
- Last modeling assumption, the maintenance depots are assumed to have the knowledge on the availability of the maintenance resources. In the context of this work, such maintenance resources are Maintenance teams (with the required maintenance skills), replacement parts (refer to [73], [272]) and the maintenance infrastructure (for example, the maintenance hangars in aviation, maintenance railway tracks in the railway industry) refer to ([273], [274]).

II.2.3 PARAMETERS, NOTATIONS AND INDEXES

With boundaries, input data and working and modeling assumptions set, the whole set of parameters, notations and indexes that will be used in this work are presented hereinafter.

In the context of this work, a fleet with f CPSs is considered. The number of maintenance depots is considered to be d . Usually $d \leq f$, which is a quite common situation as discussed by Feng et al. [27]. In this context, the introduced minimum number of CPSs required to accomplish the planned fleet operations within a specified horizon is denoted as ϵ . The fleet availability threshold is denoted μ .

The complete list of the indices and parameters used in the remainder of the document are given hereinafter.

i : Index of CPSs ($i = 1 \dots f$), with f number of CPSs in the fleet

j : Index of maintenance depots ($j = 1 \dots d$), with d number of maintenance depots

k : Index of Manpower ($k = 1 \dots K$), with K number of maintenance teams based on manpower per depot

t : Index of time periods ($t = 1...T$), with T being the time horizon

h : Index of depot hangars ($h = 1...H$), with H number of maintenance hangars (tracks) per maintenance depot

ε : Minimum number of CPSs in a fleet required to complete the fleet operations (availability level imposed by the fleet operator)

μ : Fleet availability threshold

$MMTR_i$: Estimated mean maintenance time to recover of a CPS

g_{i_CBM} : CBM gravity indicator of a subsystem in a CPS

M : A positive number

Moreover, α_i , β_i and γ_i are the initial states of the CPSs in the fleet such that:

$$\alpha_i = \begin{cases} 1, & \text{if CPS } i \text{ does not require a maintenance} \\ & \text{(group 1)} \\ 0, & \text{Otherwise} \end{cases} \quad (1)$$

$$\beta_i = \begin{cases} 1, & \text{if CPS } i \text{ requires a CBM} \\ & \text{(group 2)} \\ 0, & \text{Otherwise} \end{cases} \quad (2)$$

$$\gamma_i = \begin{cases} 1, & \text{if CPS } i \text{ requires a corrective maintenance} \\ & \text{(group 3)} \\ 0, & \text{Otherwise} \end{cases} \quad (3)$$

Initially from the equation (1), α_i is a CPS which does not require any maintenance intervention, it can therefore carry out the fleet operations and this CPS belongs to the group 1. From the equation (2), β_i is a CPS which requires preventive actions due to the indications by the CBM indicators. This CPS belongs to the group 2. Equation (3) has γ_i , which is a CPS which requires corrective maintenance interventions. This CPS cannot carry out the planned fleet operations before these corrective measures. This CPS belongs to the group 3.

$$S_{ik} = \begin{cases} 1, & \text{if CPS } i \text{ needs maintenance skill } k \\ & \text{when under maintenance (group 3)} \\ 0, & \text{Otherwise} \end{cases} \quad (4)$$

$$D_{ij} = \begin{cases} 1, & \text{if CPS } i \text{ belongs to maintenance depot } j \\ 0, & \text{Otherwise} \end{cases} \quad (5)$$

$$F_{kt} = \begin{cases} 1, & \text{if skill } k \text{ is available at time } t \\ 0, & \text{Otherwise} \end{cases} \quad (6)$$

$$Q_{kt} = \begin{cases} 1, & \text{if the parts needed for skill } k \text{ are} \\ & \text{available at time } t \\ 0, & \text{Otherwise} \end{cases} \quad (7)$$

Equation (4) expresses a parameter which describes a CPS in need of a particular maintenance skill/expertise as far as the maintenance teams are concerned. Equation (5) expresses a parameter where a concerned CPS is in the maintenance depot. Equations (6) and (7) express the availabilities of the maintenance teams with appropriate skills and the replacement parts respectively.

II.3 SPECIFYING THE AID PROVIDED BY THE REACTIVE CPSs FMSP

II.3.1 BACKGROUND: THE FLEET SUPERVISOR DECISIONAL CONTEXT

Considering the aforementioned specification boundaries, input data and the working and modelling assumptions, the objective of the fleet supervisor will be to maximize the number of CBM interventions (maximizing the fleet’s reliability expectations – see the specification, subsection II.2.1.1) while ensuring that there enough CPSs to satisfy the planned fleet operations (satisfying the fleet’s availability expectations). Moreover, this objective should be satisfied in a dynamic environment (i.e. presence of perturbations) as shown in Figure II-3. From this decisional context, there are two complicating aspects. The first complexity arises from the contradiction in the objective in the sense that, increasing CBM interventions will decrease the fleet’s availability level. The second complicating aspect is the presence of perturbations. The role of the reactive FMSP system will be to aid the fleet supervisor in reaching the objective and overcoming these complexities. This clearly pushes for the adoption of a decision support approach.

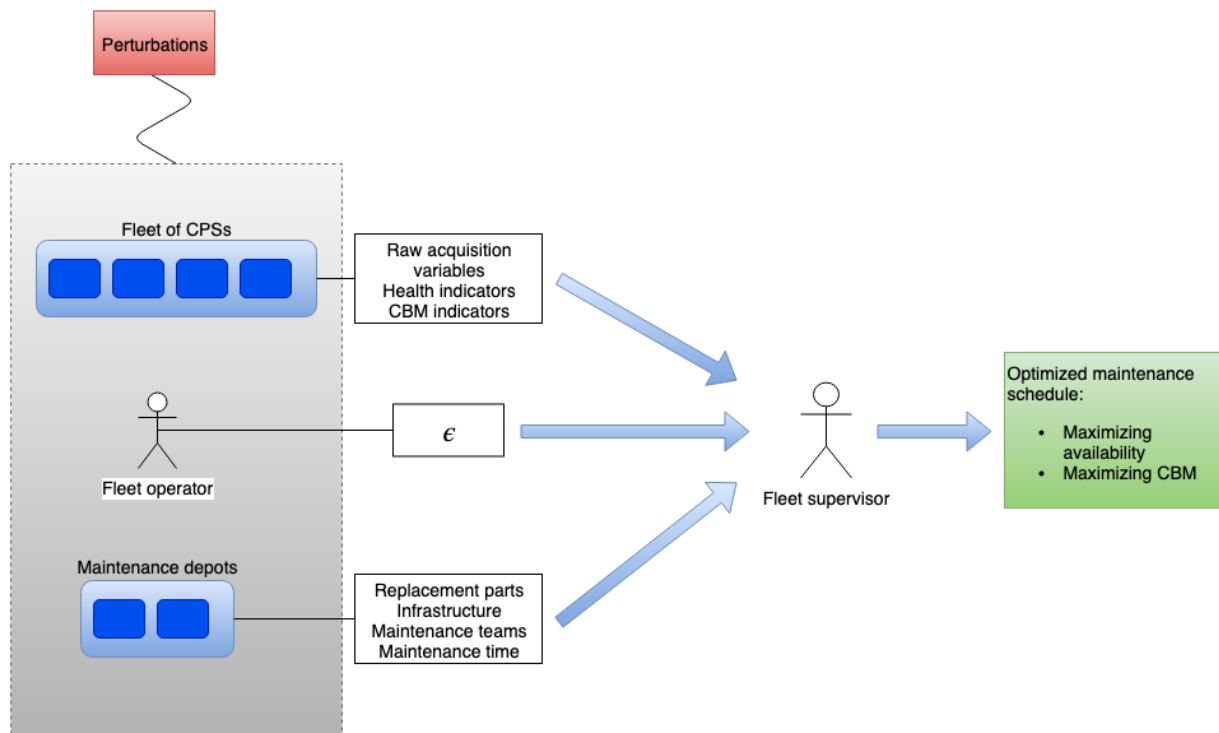

FIGURE II-3: FLEET SUPERVISOR DECISIONAL COMPLEXITY INDUCED BY THE CONTEXT

II.3.2 ADOPTING A DECISION SUPPORT APPROACH

In this research work, the decision support approach to the fleet supervisor through the development of a decision support system (DSS) is adopted. This approach is desirable in this context because DSSs in FMSP do not only offer user-friendly means to decision-making but also optimized, rational, reliable and efficient FMSP decisions (ref. Chapter I). According to that view, the fleet supervisor is then aided by the reactive FMSP model integrated in a DSS in order to attain the FMSP objectives: the FMSP model

in a DSS suggests decisions that the fleet supervisor may validate or not. Since the FMSP model integrated in the DSS is reactive, the interactions between the DSS and the fleet supervisor through the user interface (UI) are not merely Human–computer interactions (HCIs) but constitute a human-machine cooperation (HMC) as defined in chapter I. Typically, HMC addresses important aspects of the DSS such as the cooperation mechanisms with the fleet supervisor [117].

Nevertheless, it is important to underline that, this work relies on a decision support to help the fleet supervisor and it does not, in any way, add any scientific contributions to the scientific field of DSS or closely related fields like HCI and HMC. Meanwhile, to be compatible with the principles of a decision support system, our contribution must be specified in a consistent way with these principles, which is the topic of this section. Therefore, using the classical DSS design architecture by Sprague ([178], [184]), Sprague et al. ([191], [180]), a possible generic architecture of such a DSS to which our contribution must be aligned with, is depicted in Figure II-4. This architecture shows three layers of the DSS, namely, the data layer, the model layer and the presentation layer. The inputs, namely, the fleet’s data (i.e. the CPSs’ acquisition data, the current and future health status), the fleet’s operator data and the data from the maintenance depots feed the data layer of the DSS. These inputs are associated with uncertainty events (perturbations). The data is then processed in the model layer of the DSS. This model layer contains the reactive FMSP model. In this sense, the specified DSS is a **model driven DSS** according to Sprague ([180]). The output of the DSS is presented to the fleet supervisor through the presentation layer which contains a UI.

II.3.3 HUMAN-CENTRED DESIGN OF THE DSS

In the context of this work, the conceptual design of a DSS proposed by Sprague ([178],[191]) can gain from being complemented by a human-centred design (HCD) [275]. In this sense, the DSS development process takes consideration of the fleet supervisor’s perspective in attaining the objectives ([276], [277]). Norman [278], offers basic HCD principles, namely:

- Easy determination of the course of actions and possibilities at any instance
- There should be a visibility for: The conceptual model of the system, the alternative course of actions and the results of those actions
- Evaluation of the current state of the system should be made easy to evaluate
- The design should follow the natural mappings between:
 - Intentions and the required actions
 - The actions and the resulting effects
 - Visible information and the interpretation of the system state

These principles would place a human (the fleet supervisor in this context) at the centre of the design of the DSS [279]. Chapter V of this thesis contains the description of an application aligned with these specifications and illustrates how our contribution can be integrated into such a DSS. The following sections details the specifications to comply with in more details.

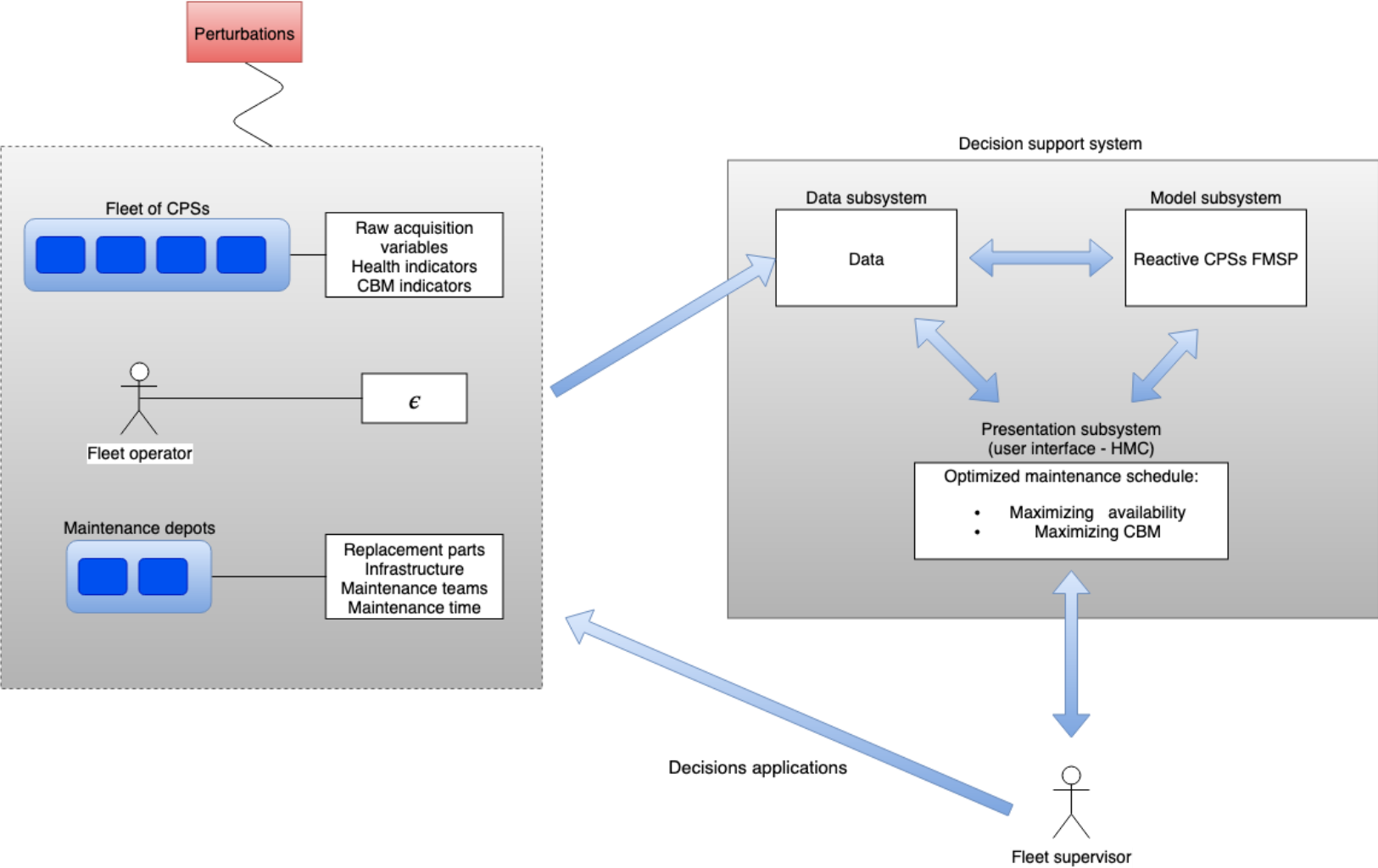

FIGURE II-4: REACTIVE CPSs FMSP IN A DSS FOR DECISION AID TO THE FLEET SUPERVISOR

II.3.4 DATAFLOW SPECIFICATION IN THE DSS LAYERS

This subsection gives a detailed description of the three layers of the DSS identified in the previous subsection, namely, the data layer, the model layer and the presentation layer as shown in Figure II-5.

II.3.4.1 DATA LAYER

This layer consists of the data from the internal and external data sources ([178], [280]). The external data sources constitute the raw acquired data by the embedded sensors in the CPSs subsystems, the health status indicators (obtained as the results of the raw acquisition data processing) showing the current health status of the CPSs (ref. to diagnosis [281], [282], [237]). Moreover, due to the presence of CBM indicators in the CPSs, the external data sources consist of the data indicating the future possible health status of the respective CPSs (ref. to prognosis [236], [266], [283], [17], [284], [234], [285]). Furthermore, the external data sources constitute the information from the fleet operator on the number of CPSs needed to satisfy the fleet operations as well as the information from the maintenance depots on the availability of the maintenance resources such as the maintenance teams, maintenance infrastructure and replacement parts. As far as the internal data sources are concerned, this layer consists of the data from the model layer and the presentation layers as detailed in the coming subsections.

II.3.4.2 MODEL LAYER

This layer consists of the reactive FMSP model. The reactive FMSP model in the model layer carries out the following operations:

- The computation of the CPSs groups (no maintenance required group, CBM group and corrective maintenance group). These groups are calculated using acquired raw variables, health indicators and CBM indicators of the CPSs.
- The verification of the fleet's availability level. This is computed using the number of CPSs required for fleet operations (ϵ , indicated by the fleet operator), the number of CPSs which are mission ready (in terms of CPSs' health status) and the fleet's availability threshold (μ) as indicated by the fleet supervisor.
- Verifications of the maintenance resources availability. The verifications have to be made vis-à-vis the maintenance depots information data handled in the data layer. The maintenance resources in this context considers the maintenance teams, the maintenance infrastructure and the replacement parts.
- Reactive maintenance planning of the CPSs in terms of their health, fleet availability and the availability of the maintenance resources.

Chapter III will present a detail description of the reactive FMSP model integrated in this layer, which constitutes the core scientific contribution of our research.

II.3.4.3 PRESENTATION LAYER

This layer consists of a UI delaying information between other layers (data layer and model layer) and the fleet supervisor. In this sense, the fleet supervisor becomes an important component in the design of the DSS ([286], [287]). In the context of this work, the presentation layer brings about the following requirements:

- Fleet information
 - Current and future CPSs' health status
 - CPSs' geolocations
- Maintenance depots information
 - Maintenance teams
 - Replacement parts
 - Infrastructure
 - Geolocations
- Fleet operator information
 - Required fleet availability
- Optimized maintenance planning
- Interactions between the fleet supervisor and the DSS. This is discussed in detail by Sprague [178] and Keen [288]. The approach to these interactions can be for example by Natural language processing (NLP) technique ([289], [290], [291] and [292]).

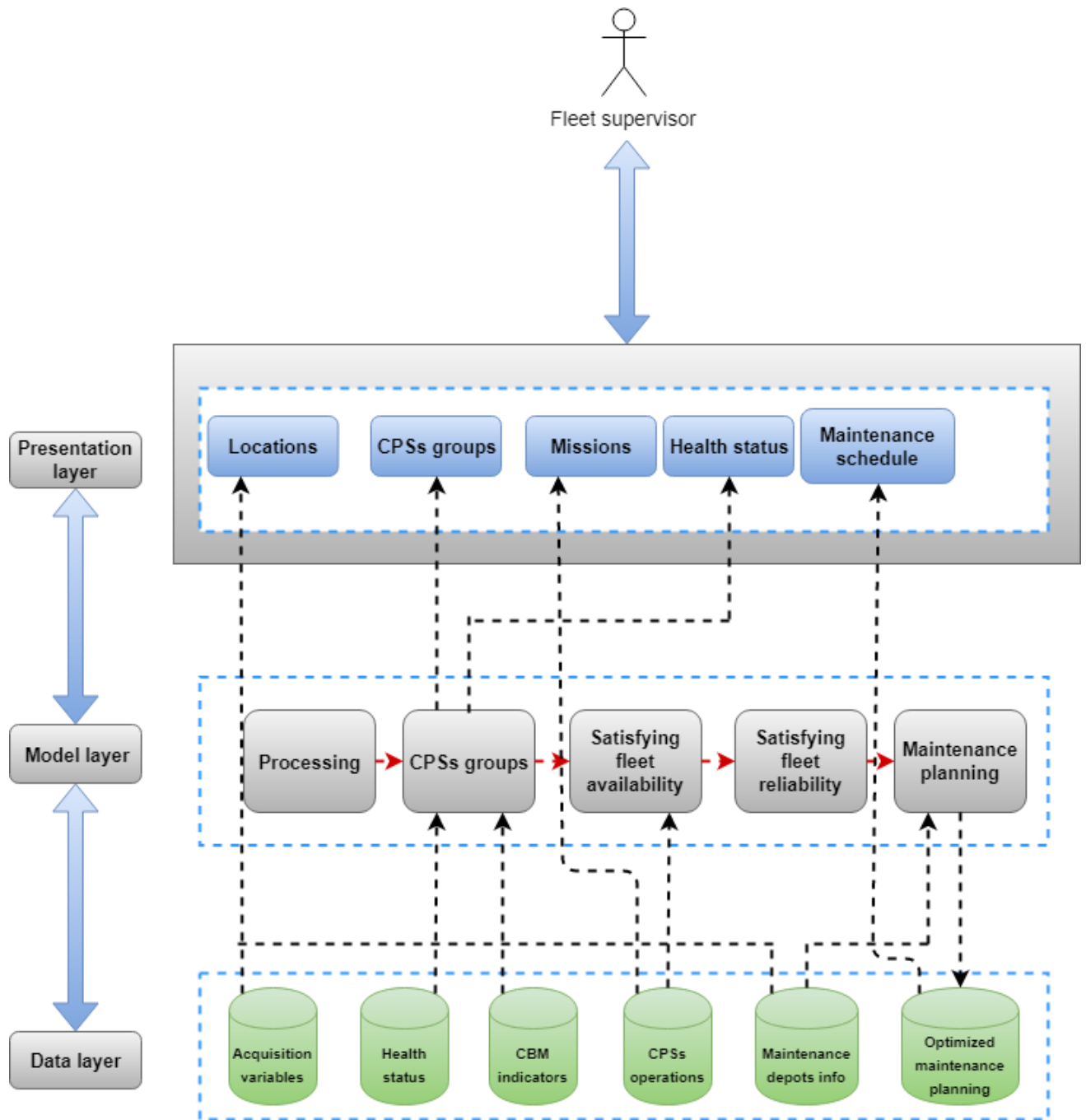

FIGURE II-5: DESIGN LAYERS IN THE DSS

II.4 SUMMARY

This chapter has first provided a set of specifications regarding the design of a reactive CPSs FMSP system with an objective of satisfying the fleet’s availability and reliability expectations in a dynamic environment (i.e. presence of perturbations). For that purpose, several assumptions had to be set to

narrow the scope of the work. These assumptions reduced the FMSP framework defined in chapter 1 as shown in Table II-1 as follows:

TABLE II-1: REDUCED CONTEXT IN FMSP FRAMEWORK

FMSP framework aspects (Chapter I)	Reduced aspects
<p>Objectives: Sustainability</p> <ul style="list-style-type: none"> • Economic: <ul style="list-style-type: none"> ○ Availability ○ Reliability ○ Reactivity • Social: <ul style="list-style-type: none"> ○ Security ○ Connectivity • Environment: <ul style="list-style-type: none"> ○ Energy ○ Environment 	<p>Objective: Sustainability</p> <ul style="list-style-type: none"> • Economic: <ul style="list-style-type: none"> ○ Availability ○ Reliability ○ Reactivity
<p>Constraints: Maintenance resources</p> <ul style="list-style-type: none"> • Maintenance depots: <ul style="list-style-type: none"> ○ Maintenance teams ○ Maintenance infrastructure ○ Replacement parts • Maintenance costs • Maintenance time 	<p>Constraints: Maintenance resources</p> <ul style="list-style-type: none"> • Maintenance depots: <ul style="list-style-type: none"> ○ Maintenance teams ○ Maintenance infrastructure ○ Replacement parts • Maintenance time
<p>Maintenance norms:</p> <ul style="list-style-type: none"> • ISO 55000 <ul style="list-style-type: none"> ○ ISO 55000 ○ ISO 55001 ○ ISO 55002 • ISO 13374 • MIMOSA (e.g. OSA-CBM) 	<ul style="list-style-type: none"> • ISO 55000 <ul style="list-style-type: none"> ○ ISO 55000 ○ ISO 55001 ○ ISO 55002 • ISO 13374 • OSA-CBM

<ul style="list-style-type: none"> • ANSI TAPPI TIP 0305-34:2008 • Industrial Internet Consortium Reference Architecture 	
<p>Maintenance policies: Reactive and preventive techniques. (Further classification in chapter 1)</p>	<ul style="list-style-type: none"> • CBM • Corrective • E-maintenance

Subsequently, after having defined the boundaries of the specification context, the FMSP problem modelling assumptions and data requirements were laid out. Through these assumptions and requirements, the FMSP problem was bounded (subsections II.2.2 and II.2.3 respectively). Moreover, to aid the human decision-maker (referred to as the fleet supervisor), in attaining the specified objectives (availability, reliability and reactivity), a decision support approach was adopted. A DSS that could integrate our contribution was therefore specified (section II.3). In this sense, a reactive FMSP model is to be integrated in the model layer of the specified DSS.

Following the CPSs FMSP system specifications provided in this chapter, the principle interest that follows is the design of the reactive FMSP model integrated in the model layer of the DSS presented in this chapter. In the coming chapter, this reactive FMSP model is formulated using a multi-agent system (MAS) approach.

Chapter III A MULTI-AGENT SYSTEM FOR THE REACTIVE CPSs FLEET MAINTENANCE SUPPORT PLANNING

Chapter II specified the design of a reactive CPSs FMSP system. The objective of this chapter is to develop a possible reactive CPSs FMSP decision-making model integrated in the model layer of the DSS specified in the previous chapter. The remainder of this chapter is organized as follows, section III.1 will present the choice of the modelling approach. In this section, a multi-agent system (MAS) approach is chosen. The justifications for the MAS modelling approach as well the limitations and drawbacks of the latter are provided in this section. In section III.2, the reactive MAS for CPSs FMSP decision-making is proposed, using the ANEMONA MAS design methodology. The section III.3 will conclude the chapter by giving the summary and the perspectives for the next chapter.

III.1 THE CHOICE OF THE MODELLING APPROACH

There are various approaches in modelling CPSs FMSP decision-making problems as explored by the literature review in chapter I. In the context of this research work, the multi-agent system (MAS) approach is used ([166], [165], [167], [168]). The choice of MAS is justified by the several reasons presented hereinafter:

- Firstly, by using the MAS approach, it is possible to model the behavior of the fleet's CPSs and other involved actors (for example, the maintenance depots, the fleet operator, etc.) with a desired degree of precision ([293], [294], [295]). As there is communication among the actors involved, the MAS modelling approach can imitate and facilitate the communication and cooperation among agents which model these actors in order to attain the identified objectives ([74], [296]). This is described as a "natural description of the system" capability of the MAS approach [297].
- Secondly, dedicated agents can be easily interfaced with the human decision-makers (fleet supervisors), facilitating the interaction process through a DSS ([208], [298], [299], [300]). In this sense, once the presented MAS is integrated into a DSS (as specified in Chapter II), the agents modelling different actors (e.g. fleet's CPSs, maintenance depots, etc.) can be modelled to interact directly or indirectly with the human decision-makers.

- Thirdly, intelligent agents as far as agent-based and multi-agent systems theories are concerned, should display various degrees of cognitive sense thus, they are reactive by nature ([301], [302]). This sense can facilitate the satisfaction of some of the objectives such as the reaction to perturbations (occurrences of unplanned events) during the fleet's maintenance planning as specified in chapter II.
- Lastly, in MAS designing, one can mirror the reality where agents, as a kind of digital twin (see [303], [304], [305]), mirror the behavior of each of the CPSs composing the fleet [174]. This supports, during simulations or during real exploitation of the fleet of CPSs, the agents' ability to be intelligent, that is, to generate and treat events ([306], [307]). It is also useful, for example, the simulation of the whole fleet to test maintenance strategies and "what-if" scenarios ([308], [309], [310]). Besides, it facilitates the mirroring of the same fleet during its real exploitation to organize data collection and state monitoring in real-time (facilitating the handling of diagnostic and prognostic issues) ([311], [74]). Moreover, and aligned with the perspective of a real industrial application as seek in this research work, the iterative replacement of simulated agents with their real counterparts is eased. This is for example, a fully simulated CPS can be replaced by a companion agent or an avatar in charge of data exchange with the physical part of the CPS (e.g. by virtual commissioning [312]).

Despite the suitability of the MAS approach in modelling the CPSs FMSP decision-making problem, the former presents some limitations. However, since the MAS is a relatively recent domain [313], these limitations and drawbacks may be considered temporary as new research fields in MAS. These limitations and the possible ways to mitigate them are outlined hereinafter.

- MASs are often seen as a kind of heuristic approach ([74], [314], [315]), the major cause for concern is on the accuracy of the solutions reached by the agents as far as the FMSP decisions are concerned. As pointed out in chapter I, while heuristics are fast, they tend to give good solutions but not necessarily optimal. The possible way to mitigate this concern will be by validating the solutions reached by the MAS by exact algorithms (see chapter I).

- MASs are also very domain-specific systems. The MAS models have to be built to the right level of description [316]. This makes it difficult to have general purpose models in MASs.
- According to Bonisoli [317], despite privacy related issues being among the principle reasons for adopting distributed systems approaches, privacy is not well defined among MASs architectures. This refers to the protocols and standards on what the agent should keep private, how it should abstract the information or share the information with other agents to fulfill the objectives. There have been several efforts to mitigate this, for example, by distinguishing between public and private agents' actions as discussed by Brafman et al. [318].
- Another limitation concerns the lack of general and efficient platforms for developing MASs. Such platforms will define important aspects in MASs development such as the design standards, protocols, programming language and the means of evaluation. To tackle this challenge, there have been efforts to develop standards such as the foundation for intelligent agents (FIPA) [319], which oversees the standards for heterogenous and interacting agents and some platforms for MASs development such as JADE [320], NetLogo [321] and Repast [322].

The MAS developed in this chapter will take considerations of these limitations and drawbacks and try to mitigate them as much as possible. The section that follows presents the proposed MAS.

III.2 PROPOSED MAS FOR THE REACTIVE CPSS FMSP

There are several methodologies as far as the design of MASs is concerned. A comparative study on these design methodologies will be provided in the annex of this research work. In the context of this work, the proposed MAS for the reactive CPSs FMSP decision-making model to be integrated in a model layer of the DSS is designed using ANEMONA design methodology ([323], [324], [325])¹. This is because ANEMONA is described as one of the most complete MAS design methodologies [325]. This design methodology is based on views or models. The MAS design in this chapter is therefore organized into views namely, the agent view, the organization view and the interaction view as detailed in the subsections that follow.

¹ Refer to the MASs design methodologies in the annex of this research work

III.2.1 THE AGENT VIEW

Different aspects and actors of the described CPSs FMSP system (see Chapter I and Chapter II) are modelled as agents similar to the problem discussed by Feng et al. [74]. Thus, the resulting MAS has the following types of agents along with their multiplicity:

- Cyber-physical fleet agents (CPA): *Number (CPA) = f*
- Supervision agent (SA): *Single*
- Fleet supervisor agent (FSA): *Single*
- Maintenance depots agents (MA) : *Number (MA) = d*
- Mission coordination agent (MCA): *Single*
- Temporary information handling agent (TIA): *Single*

Under the subsections below, a detailed description of these agents and their role is provided. The global workflow of these agents is illustrated in Figure III-1. This workflow is activated repeatedly at the beginning of each time horizon T as demonstrated in this figure.

III.2.1.1 CYBER-PHYSICAL FLEET AGENTS (CPAS)

CPAs are agents that mirror individual CPSs in the fleet. These agents were specified in chapter II, they also mirror the sensing and the processing capabilities of the fleet's CPSs. The roles and the properties of the CPAs are described below:

- The CPAs send the variables acquired by the embedded sensors and/or computed from their previous fleet missions to the SA, these include time-stamped fault detection events.
- The CPAs process the raw acquired variables to establish systems' health indicators and send this information to the SA.

- The CPAs are embedded with CBM indicators to determine the possible future health status of the systems. This information is equally transmitted to the SA.
- CPAs presenting abnormalities send requests to be repaired as soon as possible.

III.2.1.2 MAINTENANCE DEPOTS AGENTS (MA)

MAs mirror the maintenance depots in which the CPAs in the fleet are to be repaired. They send the information on their availabilities to the SA. As specified in chapter II, the availability of maintenance depots here is defined in terms of:

- Availability of the replacement parts.
- Availability of the maintenance teams.
- Availability of the maintenance hangars inside depots.

Moreover, as specified in chapter II, these agents also have the capability of estimating the MMTR of each CPA to be repaired. These agents are modelled to have the urge to repair as many CPAs in the fleet needing maintenance as possible within the horizon, depending on the availability of the maintenance resources.

III.2.1.3 MISSION COORDINATION AGENT (MCA)

The MCA mirrors the fleet operator and as specified in chapter II, defines the missions and operations of the fleet's CPAs. The MCA therefore determines the minimum number of CPAs required to satisfy the fleet operations in the horizon (T). The behaviour of this agent is modelled in such a way that, it wants to maximize the number of mission ready CPAs (fleet's availability).

III.2.1.4 SUPERVISION AGENT (SA)

The SA oversees the computation and suggests the CPSs FMSP decisions to the FSA. To do so, the SA uses the information from the CPAs on their current health status (through raw variables, health indicators) and their possible future health status (CBM indicators). Through this information, the SA is able to categorize whether a CPA requires no maintenance action, corrective maintenance interventions or CBM interventions (see the specifications in chapter II). Furthermore, the SA uses the information from the MCA (on the fleet operations requirements) and the information from the MAs on the availability of the maintenance resources (labour, replacement parts and infrastructure) in the maintenance depots and the estimates of the MTTRs of the concerned CPAs. With this information, the SA determines the optimized CPAs allocations for the fleet operations and the optimized maintenance planning for CPAs to be repaired. However, these allocations and maintenance planning decisions have to be validated by the fleet supervisor (the FSA) in order to be final decisions.

III.2.1.5 FLEET SUPERVISOR AGENT (FSA)

The FSA mirrors the human fleet supervisor in the simulation (it is to be removed and replaced by him/her when implementing the system on a real fleet). The role of the FSA agent is to confirm or not the allocation and maintenance planning decisions computed and suggested by the SA.

For instance, if the FSA does not confirm a maintenance planning decision for a particular CPA, a reason to justify this action must be provided and the respective CPA will be handled by the TIA to be considered in the next maintenance planning with a relative higher maintenance priority.

III.2.1.6 TEMPORARY INFORMATION HANDLING AGENT (TIA)

The TIA handles unconfirmed maintenance planning suggestions between horizons. This signifies that, when the FSA does not confirm/validate the maintenance planning suggestions by the SA for a particular reason, the TIA will register that action and it will be considered when the planning in the next horizon takes places.

III.2.1.7 THE MAS'S ARCHITECTURE

The architecture of the proposed MAS is depicted on Figure III-1. This architecture shows the agents' workflow within the horizons and how the information is passed between horizons by the TIA. After the SA receives information from the CPAs, the MAs and the MCA, it calculates the optimized fleet allocations as well as the maintenance planning decisions and suggests them to the FSA. The FMSP decisions which were not carried out within the horizon for various reasons such as the non-validations by the FSA and the lack of the maintenance resources are handled by the TIA to be considered in the next planning with relatively higher maintenance priorities as shown in the figure.

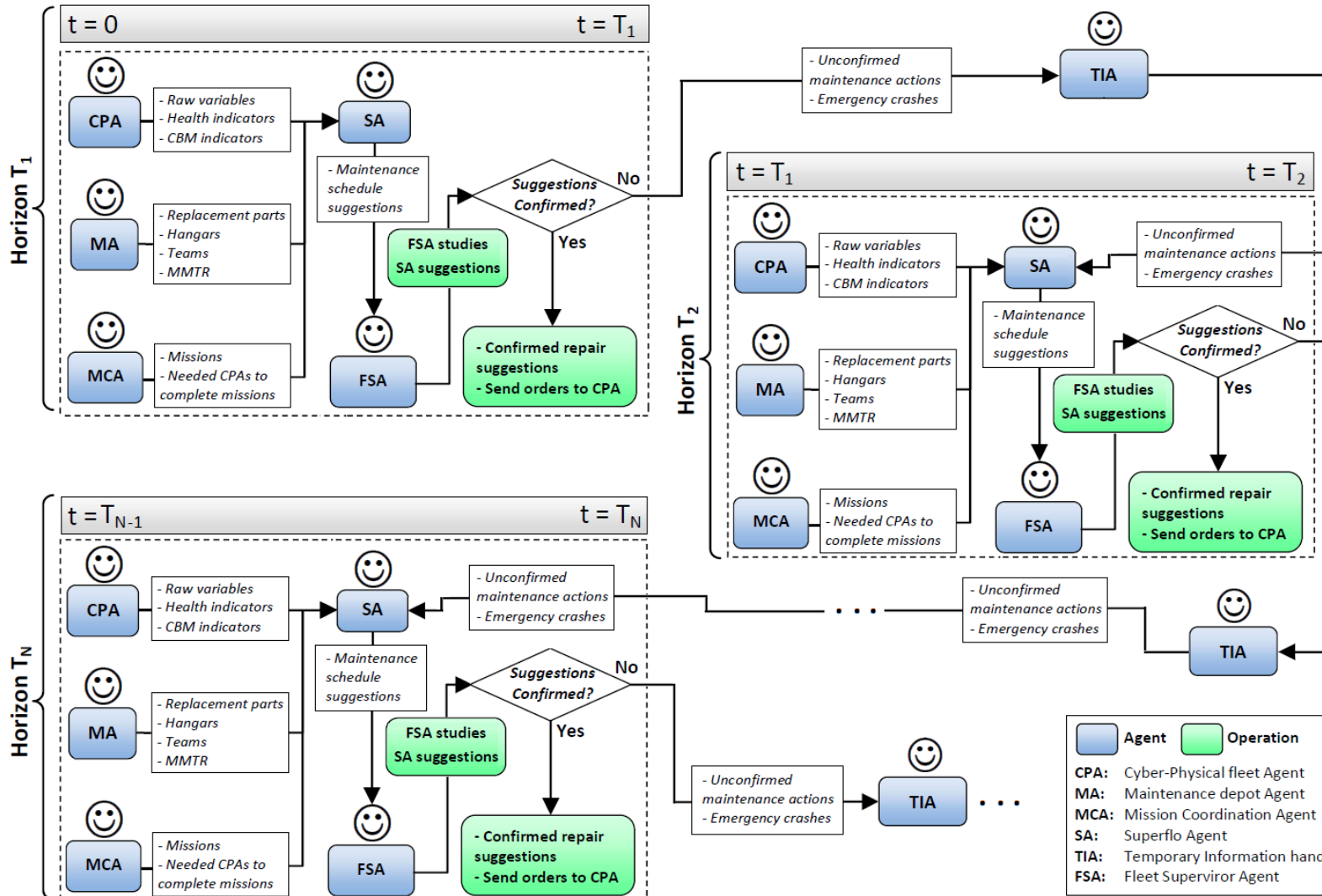

FIGURE III-1: AGENTS WORKFLOW WITHIN HORIZONS

III.2.2 THE ORGANIZATION VIEW

After the description of the agents and the overall architecture of the proposed MAS in the previous subsection (the agent view), the purpose of the organization view in this subsection is to explicitly describe the proposed MAS model. The proposed MAS model is organized into three iterative phases, namely, categorizing phase, selection phase and coordination phase. Each of these phases is associated with one or several operations. The categorizing phase is associated with the grouping of CPAs into health status groups (as specified in chapter II). The selection phase takes place in the maintenance depots and it is associated with the fleet’s availability level verifications as well as the scheduling of the fleet’s maintenance interventions (c.f. the specifications in chapter II). The coordination and supervision phase is associated with the verifications of the requirements from the fleet operator and the status of the fleet (health status) in order to make optimized allocations and maintenance planning decisions. These phases as well as their associated operations are shown in Figure III-2.

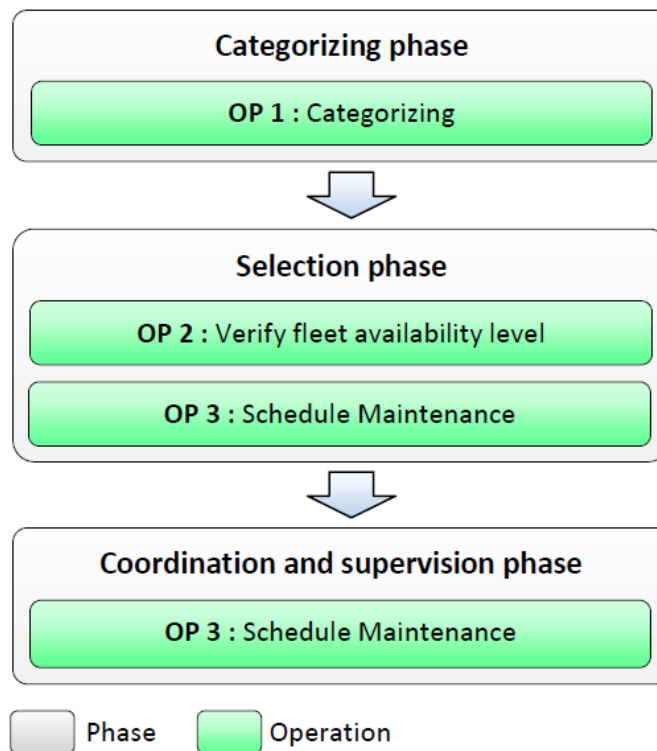

FIGURE III-2: THE THREE PHASES IN THE PROPOSED MAS

The subsections that follow give a detailed description of the three phases.

III.2.2.1 THE categorizing PHASE

The objective of this phase is to assign each CPA to one of the three health groups, namely “no maintenance action group – (group 1)”, “CBM action group – (group 2)” and “corrective maintenance action group – (group 3)” as specified in chapter II in the modelling assumptions. For that purpose, the SA first sends a bid to CPAs requesting their health status and CPAs counter the bid by sending their raw

acquired systems' variables, health indicators and CBM indicators. Using this information, the SA groups the CPAs into three main categories in accordance to their maintenance needs as follows:

- No maintenance actions needed group (group 1) - This is a group of CPAs in which no necessary maintenance is required. More precisely, these CPAs are mission ready.
 - The number of CPAs in this group is f_1 .

- CBM actions group (group 2) - This is a group in which the CPAs do not require immediate maintenance actions but due to the indications from the CBM indicators, they could profit from preventive maintenance actions before breakdowns occur in the near future. These CPAs are available to carry out the fleet operations even before the required CBM interventions are done.
 - The number of CPAs in this group is f_2 .

- Corrective maintenance actions group (group 3) - These are the CPAs which are not mission ready due to malfunctions in their systems. These CPAs cannot be deployed to carry out the fleet operations before the needed corrective maintenance actions are done.
 - The number of CPAs in this group is f_3 .

Figure III-3 Shows the graphical representation of this phase.

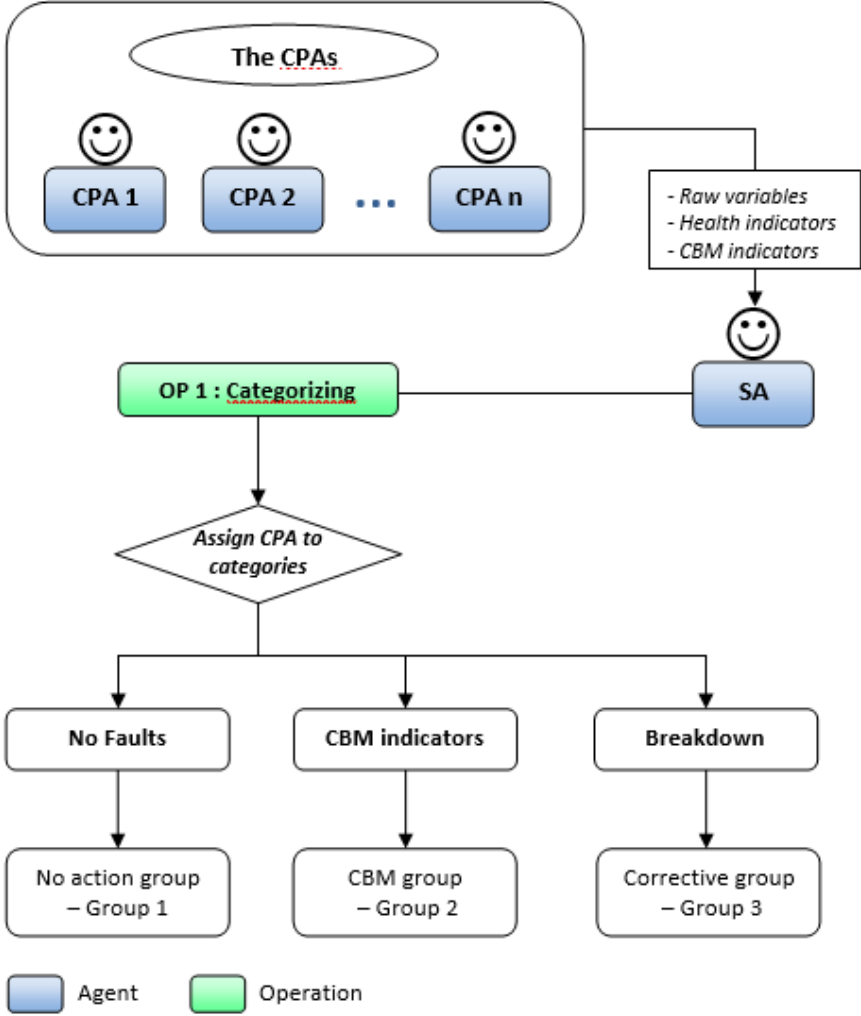

FIGURE III-3: CATEGORIZING PHASE

III.2.2.2 SELECTION PHASE

The objective of this phase is to establish the maintenance priorities for the CPAs in the maintenance depots. As specified in chapter II, the fleet’s availability threshold (μ) is used to determine if the fleet’s availability is high or low. Mathematically, this is done as follows:

- $(f_1 + f_2) - \epsilon > \mu$: The fleet availability is high.
- $(f_1 + f_2) - \epsilon \leq \mu$: The fleet availability is low.

This phase is divided in two subphases, namely, the selection process for corrective maintenance and the selection for CBM as detailed in the following subsections.

III.2.2.2.1 SELECTION PROCESS FOR CORRECTIVE MAINTENANCE

In this subphase, the SA considers the CPAs belonging to the group 3. The SA verifies the fleet availability level using the fleet availability threshold (μ) as illustrated in Figure III-4. As previously introduced, the fleet availability can be high or low:

- If the fleet availability is low $((f_1 + f_2) - \epsilon \leq \mu)$:
 - The SA introduces the priorities for the CPAs according to their estimated MMTR. The CPAs with lower MMTR will have higher priorities than the CPAs with higher MMTR. Once the priority lists are established in each maintenance depot, the SA uses the table shown in Figure III-5 to perform a verification and planning operation (OP 3) for each maintenance depot. This table can be extended or adapted based on the applicative cases. Its role is to find placement for the maintenance of CPAs in the depots within the horizon whereby the resources such as the maintenance teams, the maintenance infrastructure and the replacement parts are available. For example, in Figure III-5, for a particular maintenance requirement, such placement is found in H2 and H4. In this operation, the SA verifies the availability and finds the earliest placement possible for each CPA starting with the CPAs with higher priorities. If there is a possibility to schedule a maintenance for a CPA, the SA suggests this planning to the FSA. If the maintenance of a particular CPA cannot be scheduled due to resource unavailability, then a CPA is handled by TIA as indicated in Figure III-4. These CPAs will have the higher maintenance priorities in the next planning. The repaired CPAs are then put in group 1.

- If the availability is high ($(f_1 + f_2) - \varepsilon > \mu$):
 - The SA establishes the priorities for the CPAs requiring maintenance interventions according to their MMTR such that, the CPAs with heavy maintenance tasks (with high MMTR) have high priorities. Once the maintenance priorities for the concerned CPAs are established in each maintenance depot, the SA uses the table shown in Figure III-5 to perform verification and planning operation (OP 3) in each maintenance depot. In this operation, the SA verifies the availabilities of the maintenance resources and finds the earliest placement possible for each CPA starting with the CPAs with high priorities. If there is a possibility to schedule a maintenance for a CPA, the SA suggests this planning to the fleet supervisor (FSA). If the maintenance of a particular CPA cannot be scheduled due to resource unavailability, then a CPA is handled by TIA as indicated in Figure III-4. These CPAs will have the higher maintenance priorities in the next planning. The repaired CPAs are then put in group 1.

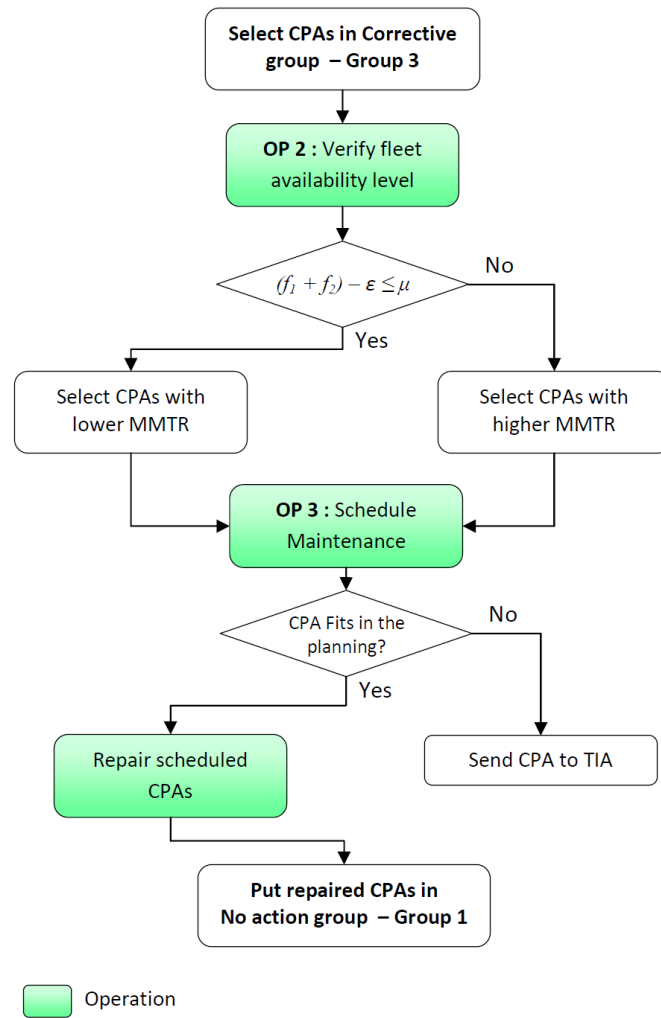

FIGURE III-4: SELECTION PROCESS FOR CORRECTIVE MAINTENANCE

OP 3

Hours	H1	H2	H3	H4	H5	H6	H7
Tracks	✓	✓	✓	✓	✗	✗	✗
Maintenance teams availability	✗	✓	✗	✓	✗	✗	✗
Replacement parts available	✓	✓	✓	✓	✓	✓	✓
Replacement parts in delivery	NA	NA	NA	NA	NA	NA	NA

FIGURE III-5: VERIFICATION AND SCHEDULING

III.2.2.2.2 SELECTION PROCESS FOR CBM

This subphase is depicted in Figure III-6. In this process, the SA takes the CPAs in group 2 and establishes a list of priorities based on the gravity of the CBM indicators (g_{i_CBM}). As specified in chapter II,

this means, the longer the estimated time to the next breakdown, the less the gravity. Once the priority list is established, the SA uses the table shown in Figure III-5 to perform verification and planning operation (OP 3). The approach used in this research is such that, the planning (assignment of CBM interventions for the CPAs) is done in an optimized way, as such to avoid idleness of the maintenance team within the horizon. For example, a CPA_i needing x hours for maintenance will not necessarily be scheduled as soon as possible but rather on the convenient time within the horizon where the resources are available for x hours.

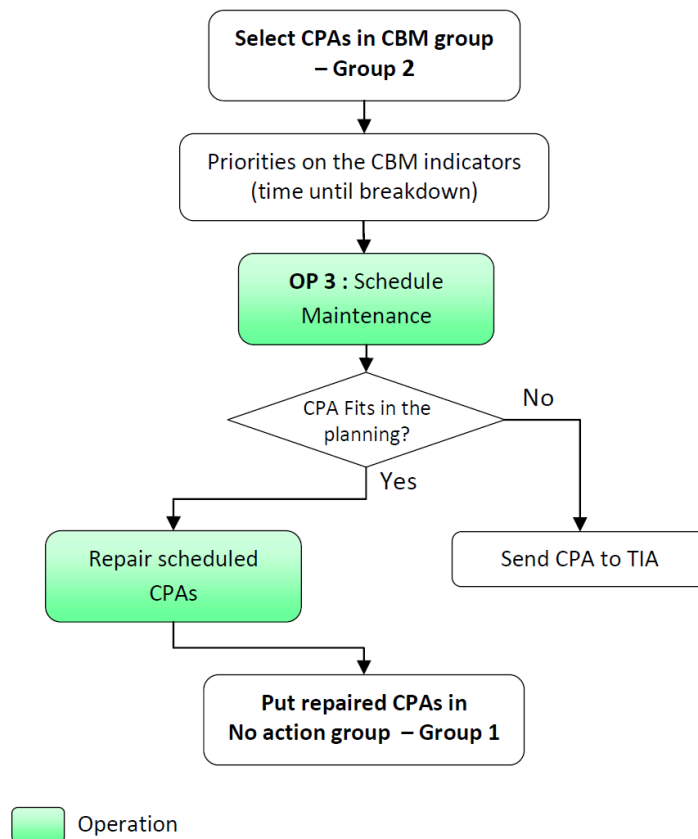

FIGURE III-6: SELECTION PROCESS FOR CBM

III.2.2.3 COORDINATION AND SUPERVISION PHASE

This phase aims to guarantee that there are enough CPAs for the planned fleet operations while allocating maintenance tasks in an optimized way. For that purpose, and from the MCA, the SA gets the information on the planned fleet operations as well as the number of CPAs needed to carry out those operations (ϵ) as shown in figure 9. Using this information as well as the number of CPAs in the categories created in the categorizing phase, the SA tries to find the best compromise between increasing the fleet availability and allocating maintenance tasks for CPAs (fleet's reliability). This SA's compromising effort results in four heuristic rules as follows:

- If the minimum number of CPAs needed to complete planned fleet operations is less than or equal to the number of CPAs that require no maintenance actions ($\epsilon \leq f_1$) then:
 - The CPAs in group 1 are deployed to carry out the fleet operations. Then the CPAs in group 3 are repaired with priorities depending on the fleet availability level (OP 2). When this is done, the CPAs in group 2 are repaired with priorities depending on the fleet availability level (OP 2).
- If the number of CPAs needed to complete the planned fleet operations (ϵ) is greater than the number of CPAs requiring no actions but less than or equal to the sum of CPAs needing no maintenance action and the CPAs needing CBM actions ($f_1 < \epsilon \leq f_1 + f_2$) then:
 - All the CPAs in group 1 are deployed to carry out fleet operations. A part of CPAs in group 2 with low maintenance priorities is also deployed to complement the fleet operations. The CPAs in group 3 are repaired according to OP 2. Then the remaining part of the CPAs in group 2 (with high maintenance priorities are repaired) according to OP 2.
- If the number of CPAs needed to complete planned fleet operations (ϵ) is greater than the sum of the CPAs needing no actions and the CPAs needing CBM actions, but is less than or equal to the sum of the CPAs needing no action, the CPAs needing CBM actions and the repaired CPAs ($f_1 + f_2 < \epsilon \leq f_1 + f_2 + \text{Repaired}$) then:
 - The CPAs in group 1 and 2 are deployed for fleet operations. In this case, the CPAs in group 1 will include the repaired CPAs. Then the CPAs in group 3 are repaired according to OP 2.
- If the number of CPAs needed to complete planned fleet operations (ϵ) is greater the sum of the CPAs needing no action, the CPAs needing CBM actions and the repaired CPAs ($f_1 + f_2 + \text{Repaired} < \epsilon$) then:
 - There is no solution. In such a situation, SA proposes alternative solutions such as delaying some scheduled operations while prioritizing the maintenance of the CPAs in group 3 with low MTTR.

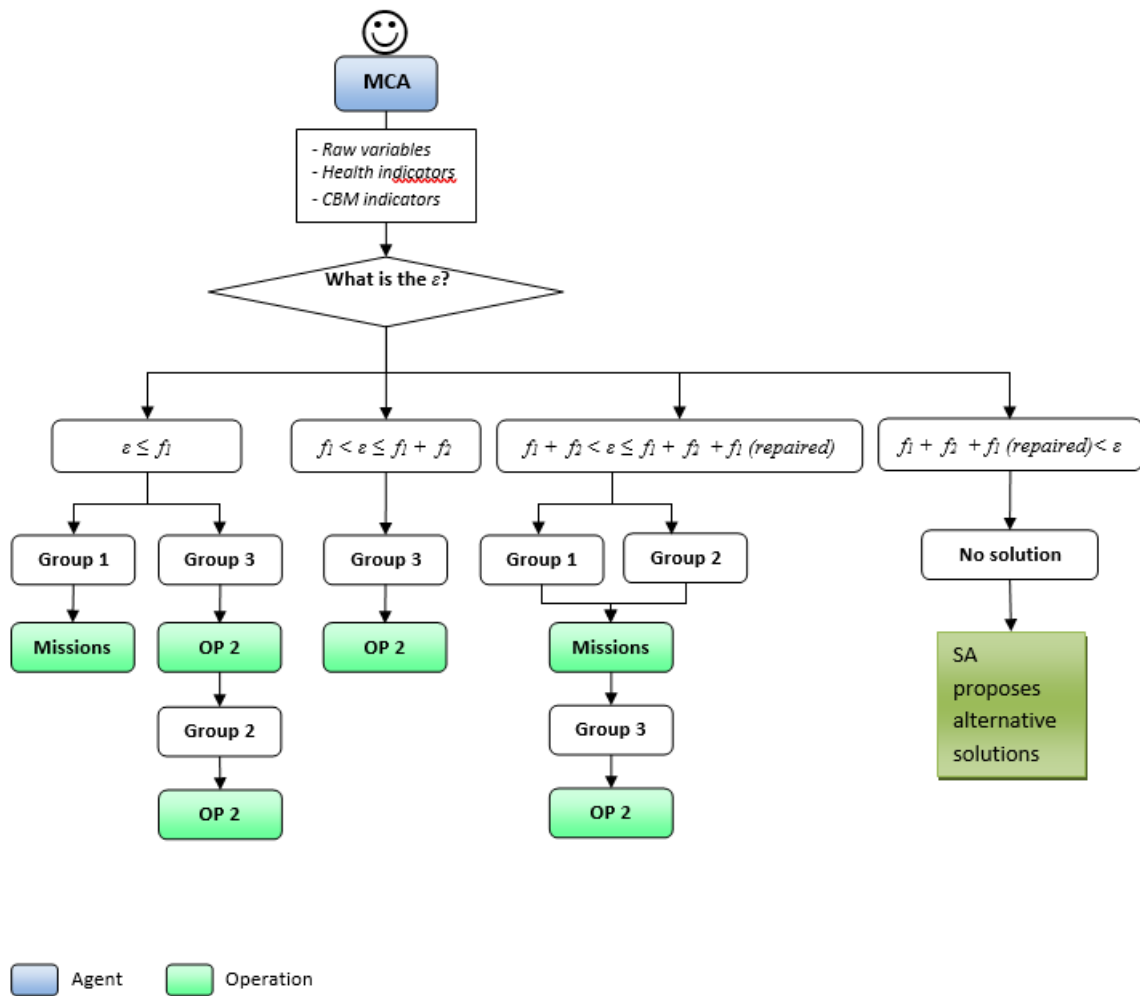

FIGURE III-7: COORDINATION AND SUPERVISION PHASE

III.2.3 THE INTERACTION VIEW

In this research work, the agents exhibit two types of interactions, namely, conflictual and cooperative interactions. In MASs these interactions are often modelled through the contract net protocol (CNP) for agents' negotiations and communications([326], [327]) as is the case in this work.

The subsections that follow will give a detailed description of the CNP before demonstrating the two types of the agents' interactions in this work using the CNP.

III.2.3.1 THE CONTRACT NET PROTOCOL

As introduced above, the CNP is an approach to cooperation, coordination and task-sharing in multi-agent systems [328]. This approach is inspired by a market-like model whereby the system consists of nodes or software agents and each node on the network can, at different times or for different tasks, be a manager or a contractor [326]. According to Davis et al. [329], the CNP is not merely a means of

transferring bits from one node to another but it rather provides a description of the content of the transmitted information. The negotiations in CNP happen in five stages [328] as indicated in Table III-1.

TABLE III-1: NEGOTIATIONS IN CNP

Stage	Description
Recognition	<p>This is the stage whereby the agents recognizes that it wants help with achieving its goal because:</p> <ul style="list-style-type: none"> ○ It does not have the capabilities to achieve it. ○ It does not want to achieve it in isolation. ○ It wants to achieve the goal swiftly etc.
Announcement	<p>In this stage the agent sends out the goal described in recognition stage, its specifications, constraints and meta-tasks.</p>
Bidding	<p>Other agents that receive the task decide whether they should bid for it depending on their capabilities and the constraints attached to the task.</p>
Awarding	<p>The agent that sent the announcement must decide, upon receiving the bids, which agent to award the contract to.</p>
Expediting	<p>This stage involves the possibility of other sub-contracts in order to complete the contracted task.</p>

III.2.3.2 CONFLICTING INTERACTION IN THE PROPOSED MAS

In conflicting interactions, agents have conflicting goals [74]. In the context of this research, the conflicting situation occurs when the SA wants to repair the maximum number of CPAs in CBM group (group 2) while the MCA wants to ensure that enough CPAs are available to carry out the planned fleet

operations within the specified horizon. These goals are conflicting because repairing many CPAs in group 2 might leave insufficient CPAs for the fleet operations during those CBM interventions. Hence the SA will try to find the best compromise between satisfying the fleet operations and at the same time deploying CBM to the remaining CPAs in group 2. Figure III-8 depicts the conflict resolution using a unified modelling language (UML) sequence diagram.

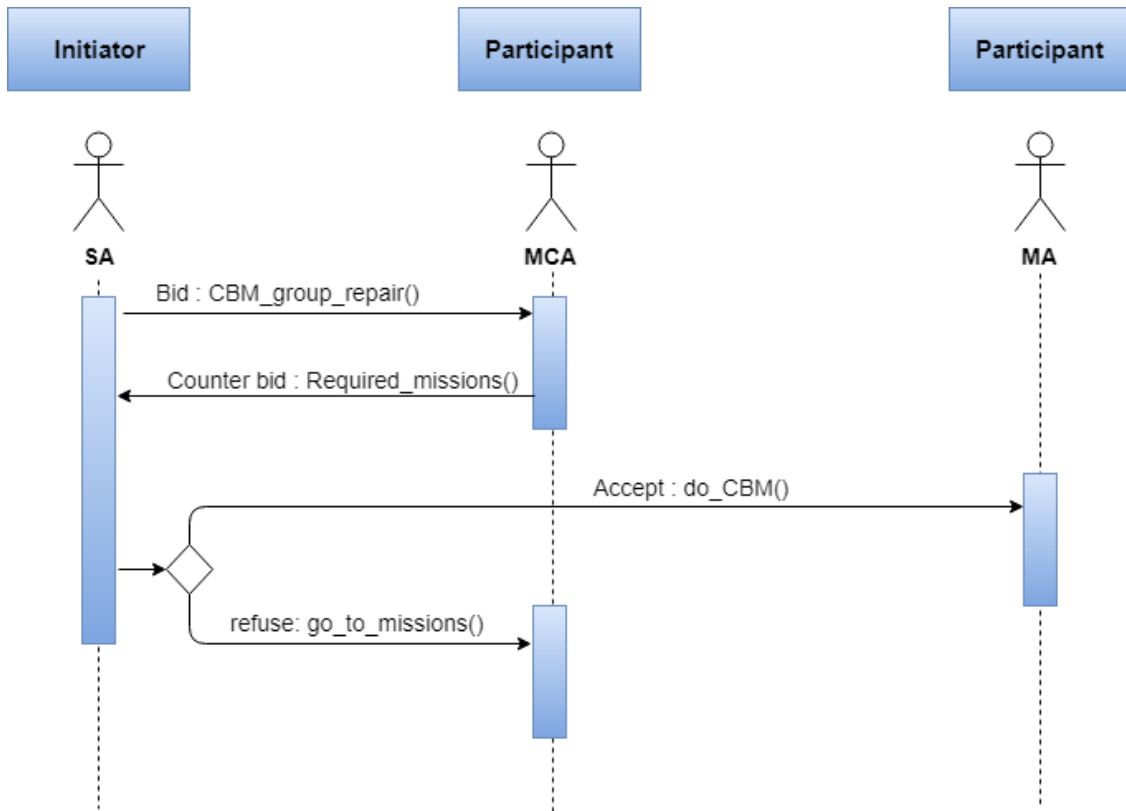

FIGURE III-8: SOLUTION TO CONFLICTUAL INTERACTION

III.2.3.3 COOPERATIVE INTERACTIONS IN THE PROPOSED MAS

These are the interactions among agents to reach a common goal [74]. Four cooperative interactions are identified in this research work as follows:

- Between the SA and the CPAs: With the objective of calculating the groups of CPAs as well as the maintenance priorities in the maintenance depots.
- Between the SA and the MCA: To verify the number of CPAs needed to satisfy the planned fleet operations within a given horizon (T).
- Between the SA and the MA: To verify the depots availability (i.e. the availability of the maintenance resources – Maintenance teams, infrastructure and the replacement parts).

- Between the SA and the FSA: For confirmation of the proposed maintenance decisions.

The sequence diagram detailing these four cooperative interactions is depicted in Figure III-9.

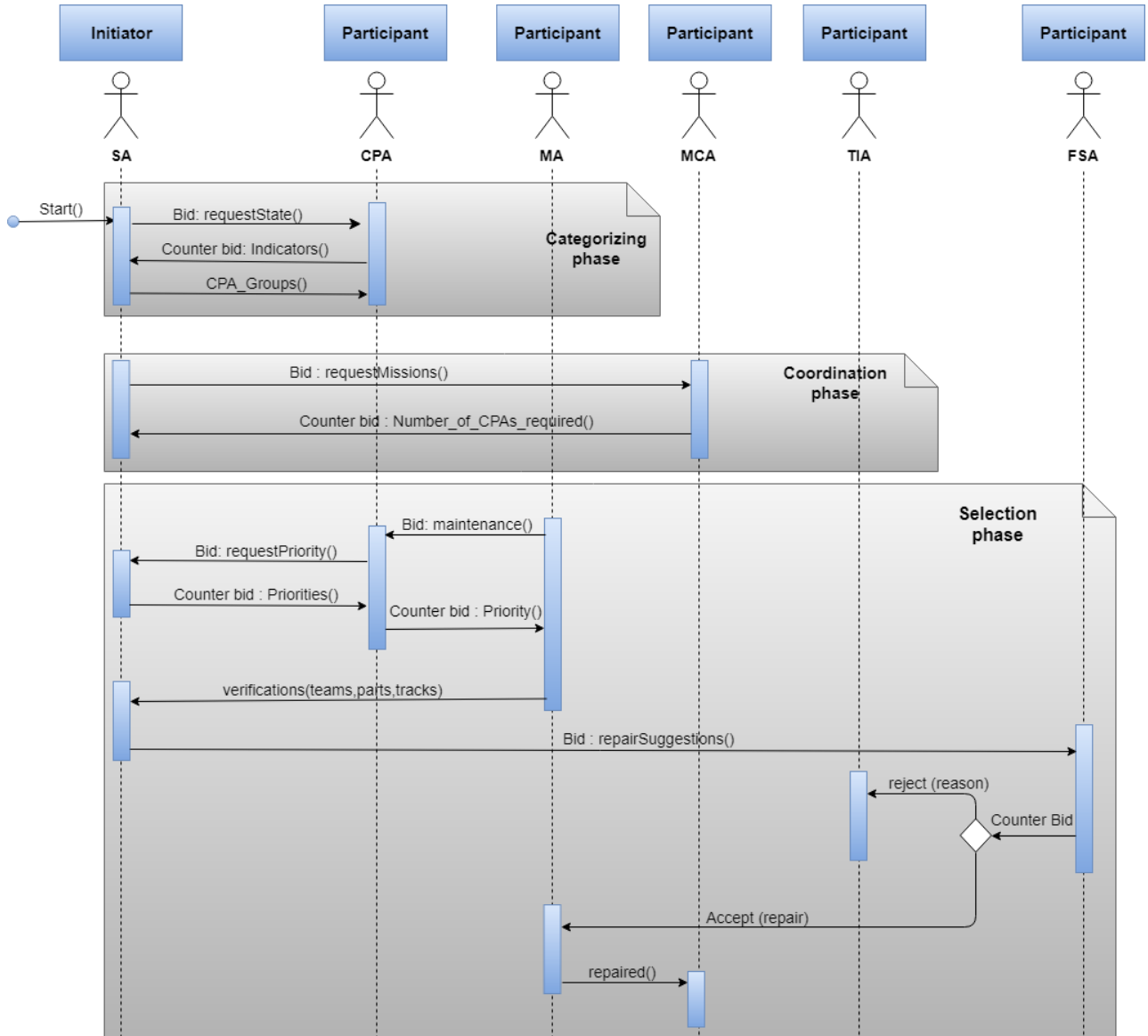

FIGURE III-9: COOPERATIVE INTERACTIONS

III.3 SUMMARY

In this chapter a reactive CPSs FMSP model to be integrated in the model layer of the DSS specified in chapter II has been proposed. The formulation of this model is done using a multi-agent system (MAS) modelling approach. This MAS has been designed using ANEMONA design methodology which organizes the systems' components into views or models. Through the proposed MAS approach, the aspects of the CPSs FMSP framework described in the previous chapter such as the CPSs, the maintenance

depots, the fleet operator and the human-maintenance decision-maker (fleet supervisor) have been modelled as agents interacting with each other to achieve the model's objectives. The interactions among these agents were handled by using the contract net protocol (CNP) which is inspired by market-like model.

The formulation of the MAS-based reactive CPSs FMSP model proposed in this chapter brings up the following interests and questions:

- Is the proposed MAS effective in satisfying the fleet's availability and reliability expectations as specified in chapter II? This question is also related to the primary concern on the limitations of heuristic-based MASs as pointed out in the section III.1.
- Is the proposed MAS operational in a dynamic environment? In other words, Is the proposed MAS reactive vis-à-vis the occurrences of unexpected events? Due to the domain-specific nature of MASs (as pointed out in the limitations of MASs in the section III.1), the definition of perturbative scenarios (unexpected events) in a dynamic environment, depends on the applicative case.

In the coming chapter, this research work will use numerical implementations and simulations to address the raised questions and the associated concerns following the proposition of the MAS for the reactive CPs FMSP in this chapter.

Chapter IV NUMERICAL IMPLEMENTATIONS: MAS SIMULATIONS IN STATIC AND DYNAMIC ENVIRONMENTS

The previous chapter presented a model for the reactive CPSs FMSP decision-making to be integrated in the model layer of the DSS specified in chapter II. To design this model, a MAS modelling approach was chosen. The presented MAS mirrored different actors of the specified FMSP framework as cooperating agents to reach the specified objectives (i.e. availability, reliability and reactivity).

The objective of this chapter is to simulate and provide the numerical implementations of the proposed MAS in order to answer the key questions raised in the previous chapter, namely, is the proposed MAS effective (capable of satisfying the fleet's availability and reliability expectations)? Is the proposed MAS reactive in adapting the FMSP decisions after the occurrences of unexpected events? Meanwhile, since the presented MAS is fundamentally a heuristic-based approach, i.e. it is based on heuristic rules on the agents' interactions ([330], [331], [332]), its overall effectiveness must be carefully studied and validated by more powerful and exact approaches but static optimization mechanisms ([333], [334], [137]), like mathematical programming ([335], [336]). This is especially true in the context of FMSP where performance expectations from different actors are high and must be ensured as much as possible ([27], [74], [25]). Thus, in the context of this research, to validate the effectiveness of the proposed MAS in a static environment (i.e. absence of unexpected events), we formulate a mixed-integer linear programming (MILP) model ([337], [338]) and compare its solutions to those proposed by the MAS.

The remainder of this chapter is organized as follows, section IV.1 will present the framework used to implement the proposed MAS. Section IV.2 will present the simulation of the MAS in a static environment. Moreover, a MILP model will be formulated in this section in order to validate the MAS model. Section IV.3 will present the simulations of the MAS in a dynamic environment. In this section, the MAS will be put under simulated perturbations and observations will be made on how it reacts to mitigate these perturbations. A considered scenario for perturbations will be discussed in this section. In section IV.4, an illustrative example to demonstrate the capabilities of the MAS model in both static and dynamic environments will be presented. Section IV.5 will put forward the limitations of the proposed MAS model. The last section will give the summaries and the conclusions drawn from this chapter as well as the perspectives.

IV.1 MAS IMPLEMENTATION DESCRIPTION

Under this section, the implementation of the MAS model presented in the previous chapter is described. This section is organized as follows, subsection IV.1.1 will present a framework through which the proposed MAS in this research work has been implemented on. This subsection will first of all analyze the popular MAS development frameworks and point out their limitations and drawbacks in the context of FMSP hence the motivations for the used framework. Subsection IV.1.2 will describe the implementation structure by presenting some of the classes used in the implementation framework.

IV.1.1 MAS IMPLEMENTATION FRAMEWORK

There are several frameworks as far as the development of MASs is concerned. Some of these frameworks are JADE, NetLogo and Repast (c.f. previous chapter) with JADE being the most popular among them ([339], [340], [341]). The reasons for the popularity of these MASs development frameworks are analyzed hereinafter:

- These frameworks provide middleware for the expression of the functionalities independently of the specific application hence simplification in describing distributed systems [340].
- According to Wooldridge et al. [342], through these frameworks, it is easier to exploit the level of agent abstraction provided by the MASs.
- Implementation of abstractions over very well-known object-oriented programming languages. For example, according to Sandita et al. [339], JADE implements the abstraction over Java programming language which is a very popular.
- Most of these frameworks come with built-in agents' communication protocols making it easier to model the interactions between agents in MASs.

Despite the advantages of these popular MASs frameworks in quick and relatively precise MASs development, they come with some drawbacks as pointed out below:

- The most significant drawback is the **overhead** in the deployment. This happens even in the implementation of a simple project. According to Leitão et al. [343], although JADE is quite popular, it struggles a lot with performance issues. As far as the FMSP is concerned in this research work, with the real industrial application, this limitation is not tolerable.
- Scalability impairment is another major drawback of these popular MASs development frameworks [344]. This is because these frameworks use single message queuing mechanisms in communications creating a linear list of many messages affecting the scalability.
- Since in these frameworks there is some form of **centralized** description for the agents, e.g. the Global agent descriptor table (GADT) in JADE, the robustness could potentially be hindered on these platforms especially as far as the fault tolerance is concerned [344].

After having observed these limitations, we have chosen to implement our own framework to develop the proposed MAS similar to the work done by Ettienne et al. [345]. Our framework is based on Python programming language and it integrates the FIPA- based CNP for agents' communications (c.f. CNP modelling in chapter III). Apart from these limitations, other motivations for implementing our own framework in Python include:

- To have more control on all aspects of the MAS implementation.
- The FMSP scenario and objectives are complex (c.f. MAS model for the CPSs FMSP described in the previous chapter).

- Requirements for supporting framework implementations are easy to satisfy and are not overwhelming, hence, easy to implement our own framework.
- Suitability of Python programming language not only in data processing (strong data science libraries) but also because it supports multiple paradigms.

IV.1.2 MAS IMPLEMENTATION LOGIC AND STRUCTURE

As discussed in the previous subsection, the Python language is used to implement the agents' abstraction and communications in the proposed MAS. In this section, the class diagrams are used to illustrate the proposed MAS implementation structure.

IV.1.2.1 ABSTRACT CLASS AND INTERFACES

To facilitate the object-oriented programming for the framework reusability, for the moment there is an abstract class (Agent) which implements two interfaces, namely, ContractNetProtocol and Perturbation respectively. Agent class contains all the properties and the description of the agents in the proposed MAS. All the defined agents in this work (c.f. chapter III) will inherit the properties of this class. Some of the most important attributes and methods of this Agent class are explained in Table IV-1.

TABLE IV-1: METHODS FROM AGENT ABSTRACT CLASS

<code>requestHealthStatus()</code>	Requesting the CPAs' health status
<code>requestDepotsAvailability()</code>	Requesting the maintenance resources availability.
<code>requestOperationRequirements()</code>	Requesting the fleet operations requirements (availability requirements).
<code>respondHealthStatus()</code>	Returns the raw variables, health indicators and the CBM indicators of the CPAs.
<code>respondDepotsAvailability()</code>	Returns the availability of the maintenance resources (manpower, replacement parts and maintenance infrastructure) in the maintenance depots.
<code>respondOperationalRequirements()</code>	Returns the number of CPAs required to satisfy the fleet operations.

Perturbation is an interface containing a set of methods which define the simulated disturbances meant to test the reactivity of the MAS model. Currently, this interface has three methods (corresponding to the considered possible scenarios for perturbations) as explained in Table IV-2.

TABLE IV-2: METHODS FROM PERTURBATION ABSTRACT CLASS

breakAvailableCPA():	Which induces a fault to one or several CPAs and forces them to go to group 3.
replacementPartsDelay():	Which delays the delivery of the replacement parts after the maintenance has been planned.
messageLost():	Which blocks the messages between the agents when it is called.

These methods are meant to induce disruptions. More discussion on these perturbative scenarios is presented in the subsection IV.3.1.

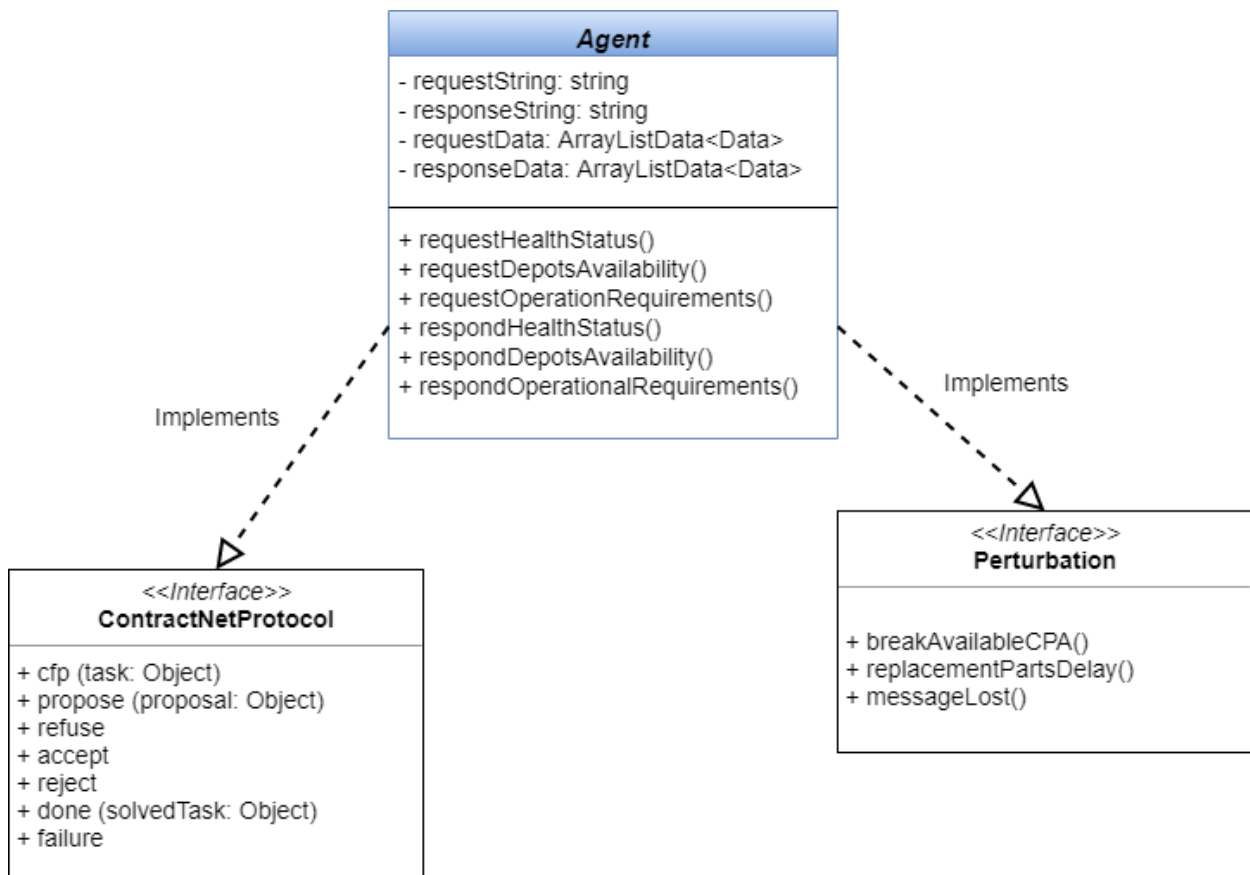

FIGURE IV-1: ABSTRACT CLASS AND INTERFACES

ContractNetProtocol interface contains some methods of the FIPA-based CNP which are implemented in our FMSP scenario. In the context of this work, much focus was given on the communication and interaction aspects of the protocol and less on the hierarchical and organizational aspects similar to the scenarios set in ([346], [347], [348]).

IV.1.2.2 AGENT CLASSES

The agent classes present the attributes and the properties of the agents in the proposed MAS. These classes inherit from Agent class presented in the previous subsection. Figure IV-2 below demonstrates some of these classes with extra attributes and properties apart from the inherited ones. These properties are explained in Table IV-3.

TABLE IV-3: INDIVIDUAL AGENT CLASSES

SA	calculateCPAsGroups()	Calculate the 3 health status groups of the CPAs
	maintenancePlanning()	Plans the maintenance interventions for the CPAs in groups 2 and 3.
	operationsAllocations()	Deploys available CPAs for fleet operations.
	sendFMSPtoFSA()	Sends the FMSP decisions to the FSA for validation.
	replanningAfterPertubations()	Recalculates the FMSP decisions after the perturbations.
CPA	calculateHealthIndicators()	Transforms raw acquisition variables into health indicators.
	calculateRUL()	Calculates the gravity of the CBM indicators.
FSA	validateOperationsAllocations()	FSA validates the allocations decisions for fleet operations.
	validateMaintenancePlanning()	FSA validates the fleet maintenance planning decisions.

This figure also demonstrates a composite relationship between CPA class and FleetCPAs class, more precisely, this is a relationship between an entity and a fleet of entities. Composite relationship also exists between the class MA and MAs (one maintenance depot and a group of maintenance depots) as shown in Figure IV-3.

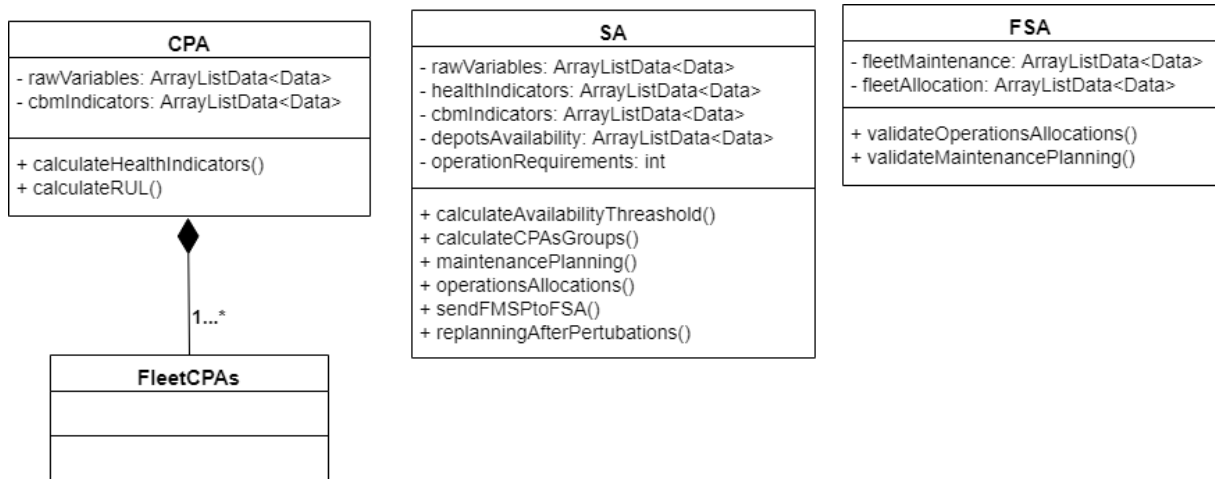

FIGURE IV-2: EXAMPLE OF AGENT CLASSES

IV.1.2.3 MAS CLASS RELATIONS

Figure IV-3 below demonstrates the relationships between the implemented classes in the proposed MAS. Apart from the inheritance (from Agent class), composition (e.g. a CPA and a fleet of CPAs) and implementation (Agent to the interfaces) discussed in the previous subsections, this figure illustrates associative relations between parent and child classes. For example, SA is a child class to CPAs, MAs and MCA (parents). Through the information from these classes, SA is able to calculate the FMSP decisions (allocations to fleet operations and fleet maintenance planning). FSA is associated to its parent class SA through which the FMSP decisions are validated. Lastly, FSA is a child class to TIA, in this case, if the FMSP decisions are not validated, then the information is handled by the TIA as discussed in the previous chapter.

The sections that follow will provide the experimental simulations of the proposed MAS model in static and dynamic environments.

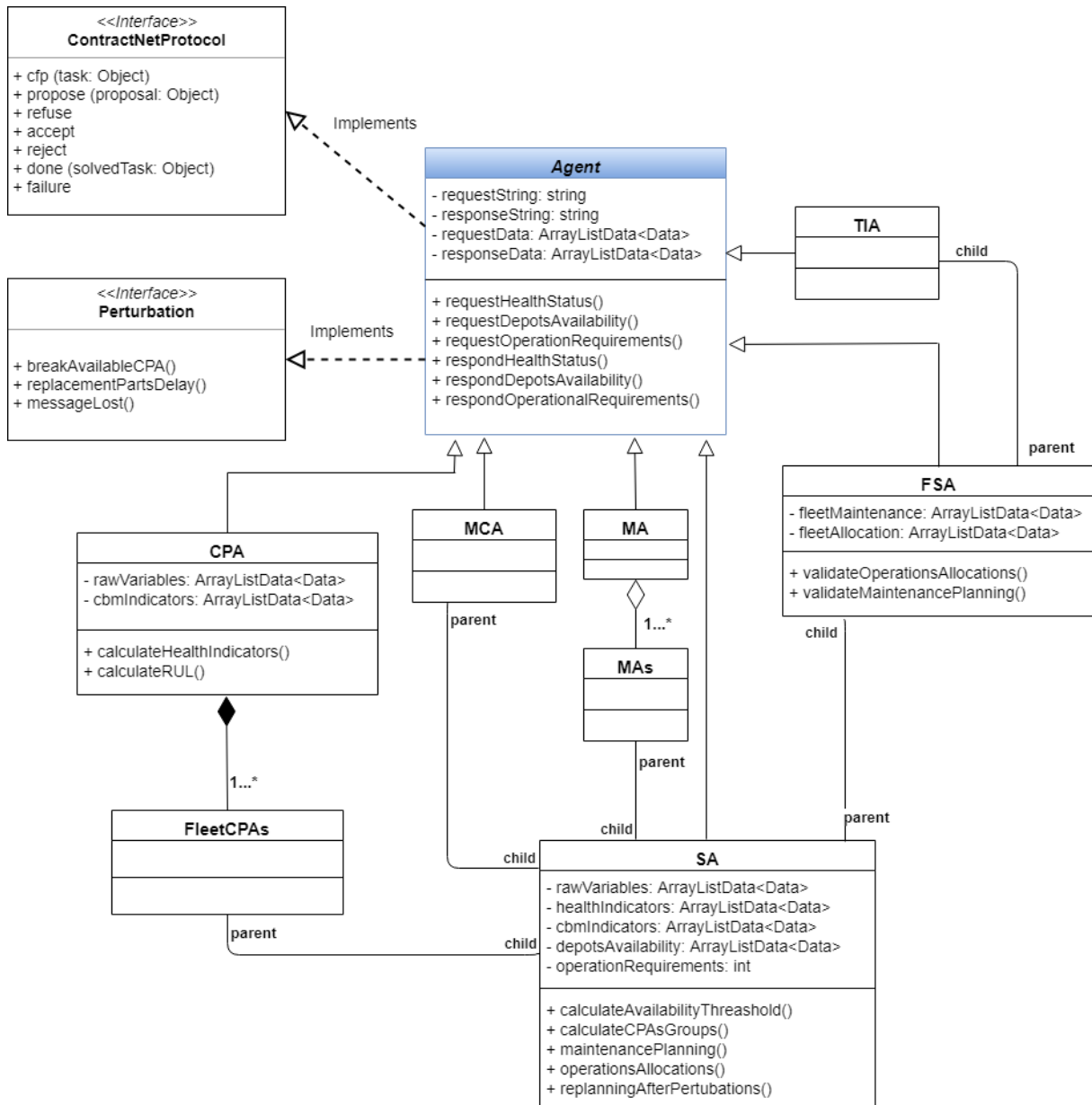

FIGURE IV-3: CLASSES RELATIONS IN THE IMPLEMENTATION OF THE PROPOSED MAS

IV.2 MAS SIMULATION IN A STATIC ENVIRONMENT

Under this section, the proposed MAS is simulated in a static environment. In the context of this research work, a static environment signifies the absence of unplanned events as far as the FMSP is concerned (i.e. absence of perturbations) ([349], [350], [351]). The MAS model will be tested for its effectiveness as defined in this research work (c.f. specifications in chapter II). In order to validate the solutions reached by the MAS in this static environment, a MILP model will be formulated, and its solutions will be compared to the MAS's solutions.

This section is organized as follows, subsections IV.2.1 and IV.2.2 will present the MILP model which will be used to validate the MAS model proposed in this research work. In these subsections, the

context, the objective function as well as the constraints of the MILP model will be presented. Subsection IV.2.3 will present the simulation settings for the MAS and MILP models respectively. Lastly, subsection IV.2.4 will present the simulation results of the two models in a static environment as well as their evaluations.

IV.2.1 MILP MODEL: CONTEXT AND BOUNDARIES

The aim of the MILP model formulated in this subsection will be not only to get a formal reference of the problem, but also and mainly to validate the solutions reached by the MAS in a static environment. The MILP model uses mathematical approach to model the FMSP decision-making problem (refer to the mathematical approaches in chapter I). Since, the CPSs FMSP framework is not a deterministic process ([352], [353]), the mathematical modelling of such process is not so trivial thus, in this context, the MILP model is associated with a set of assumptions as follows:

- Assumption 1: The formulated MILP model does not calculate the groups of CPSs in terms of their health status but rather supposes that these groups are given as an input to this model. These groups are calculated by the SA in the categorizing phase (the first phase) of the MAS presented in chapter III.
- Assumption 2: The MILP model validates the results obtained from the two last phases of the MAS (i.e. the selection phase and the coordination and supervision phase).
- Assumption 3: The objective of the MAS and the MILP is the same: Maximizing the number of fleet's CBM interventions (maximizing reliability) while ensuring that there are enough fleet's CPSs to satisfy the missions defined within the horizon (ensuring the fleet's availability).

The details of the MILP are provided in the subsections that follow, where decision variables are first presented, followed by the presentation of the objective function and the constraints to be respected.

IV.2.2 MILP MODEL FORMULATION

IV.2.2.1 DECISION VARIABLES

The following equations represent the decision variables in the MILP model:

$$x_{it} = \begin{cases} 1, & \text{if a CPS } i \text{ requires no maintenance at time } t \in T \\ 0, & \text{Otherwise} \end{cases} \quad (1)$$

$$y_{it} = \begin{cases} 1, & \text{if a CPS } i \text{ is undergoing CBM at time } t \in T \\ 0, & \text{Otherwise} \end{cases} \quad (2)$$

$$z_{it} = \begin{cases} 1, & \text{if a CPS } i \text{ is in corrective maintenance} \\ & \text{at time } t \in T \\ 0, & \text{Otherwise} \end{cases} \quad (3)$$

$$v_{ijt} = \begin{cases} 1, & \text{if a CPS } i \text{ in depot } j \text{ at time } t \text{ for CBM or} \\ & \text{corrective maintenance within } T \\ 0, & \text{Otherwise} \end{cases} \quad (4)$$

$$w_i = \begin{cases} 1, & \text{if a CPS } i \text{ is scheduled to undergo CBM} \\ & \text{within } T \\ 0, & \text{Otherwise} \end{cases} \quad (5)$$

Equation (1) represents a Boolean variable in which a CPS in a fleet belongs to the group 1 (no maintenance required group). Equations (2) and (3) indicate CPSs undergoing CBM and corrective maintenance interventions respectively. Equation (4) describes a CPS being in a certain maintenance depot for CBM or corrective maintenance action. Lastly, the equation (5) describes a CPS scheduled to undergo CBM intervention in a certain time interval.

IV.2.2.2 OBJECTIVE FUNCTION

The objective function of the proposed MILP model is to maximize the CPSs undergoing CBM as follows:

$$\textbf{Maximize:} \quad \sum_{i=1}^f w_i g_{i_CBM} \quad (6)$$

IV.2.2.3 CONSTRAINTS

The MILP model has the following set of constraints:

$$w_i \leq \sum_{t=1}^T y_{it} \quad (\forall i = 1 \dots f) \quad (7)$$

$$\sum_{i=1}^f w_i \leq f_2 - \varepsilon + f_1 \quad (\forall t = 1 \dots T) \quad (8)$$

$$\sum_{i=1}^f x_{it} \geq \varepsilon \quad (\forall t = 1 \dots T) \quad (9)$$

$$x_{it} + y_{it} + z_{it} \leq 1 \quad (\forall i = 1 \dots f, \forall t = 1 \dots T) \quad (10)$$

$$\sum_{t=1}^T x_{it} \leq M(1 - \gamma_i) \quad (\forall i = 1 \dots f) \quad (11)$$

$$\sum_{t=1}^T z_{it} \geq MMTR_i - M(1 - \gamma_i) \quad (\forall i = 1 \dots f) \quad (12)$$

$$u - t + 1 \leq MMTR_i + M(2 - (z_{it} + z_{iu})) \quad (\forall i = 1 \dots f, \forall t, u = 1 \dots T, u > t) \quad (13)$$

$$\sum_{t=1}^T y_{it} = MMTR_i w_i \quad (\forall i = 1 \dots f) \quad (14)$$

$$\sum_{t=1}^T y_{it} \leq M(1 - \alpha_i) \quad (\forall i = 1 \dots f) \quad (15)$$

$$\sum_{t=1}^T y_{it} \leq M(1 - \gamma_i) \quad (\forall i = 1 \dots f) \quad (16)$$

$$u - t + 1 \leq MMTR_i + M(2 - (y_{it} + y_{iu})) \quad (17)$$

$$(\forall i = 1 \dots f, \forall t, u = 1 \dots T, u > t)$$

$$y_{it} \beta_i S_{ik} \leq F_{kt} Q_{kt} \quad (\forall i = 1 \dots f, \forall k = 1 \dots K, \forall t = 1 \dots T) \quad (18)$$

$$z_{it} \gamma_i S_{ik} \leq F_{kt} Q_{kt} \quad (\forall i = 1 \dots f, \forall k = 1 \dots K, \forall t = 1 \dots T) \quad (19)$$

$$\sum_{i=1}^f v_{ijt} \leq H \quad (\forall j = 1 \dots d, \forall t = 1 \dots T) \quad (20)$$

$$D_{ij} y_{it} = \beta_i v_{ijt} \quad (\forall i = 1 \dots f, \forall j = 1 \dots d, \forall t = 1 \dots T) \quad (21)$$

$$D_{ij} z_{it} = \gamma_i v_{ijt} \quad (\forall i = 1 \dots f, \forall j = 1 \dots d, \forall t = 1 \dots T) \quad (22)$$

$$u - t + 1 \leq MMTR_i + M(2 - (v_{ijt} + v_{iju})) \quad (23)$$

$$(\forall i = 1 \dots f, \forall j = 1 \dots d, \forall t, u = 1 \dots T, u > t)$$

$$x_{it}, y_{it}, z_{it}, v_{iju}, w_i \in \{0, 1\} \quad (24)$$

$$(\forall i = 1 \dots f, \forall j = 1 \dots d, \forall t = 1 \dots T)$$

IV.2.2.4 DESCRIPTION OF THE CONSTRAINTS

Constraint (7) sets the Boolean variable w_i to zero if the CPS i is not undergoing CBM maintenance. Constraint (8) ensures that the CPSs undergoing CBM does not affect the total requested availability ϵ . Constraint (9) ensures that there is at least a minimum number of mission-ready CPSs (ϵ) available, and it includes both the CPSs that do not need maintenance actions (group 1) and the CPSs in CBM group (group 2). In constraint (10), a CPS must be only in one group at a time, either no maintenance action, CBM or corrective maintenance group. Constraint (11) ensures that the available CPSs do not include the ones that need corrective maintenance. Constraints (12) and (14) calculate the MMTR of the CBM and the corrective maintenance interventions respectively. Constraint (13) ensures that the corrective maintenance is performed without pre-emption. Constraints (15) and (16) exclude the available CPSs and corrective maintenance CPSs from preventive maintenance. Constraint (17) ensures that the CBM maintenance is performed without pre-emption. Constraints (18) and (19) check the availability of the replacement parts and the maintenance skills for CBM and corrective maintenance respectively. Constraint (20) ensures that the number of CPSs assigned to a maintenance depot at a time t does not exceed the number of available hangars in that depot. Constraints (21) and (22) assign the CBM and corrective maintenance to their corresponding depots respectively. Constraint (23) ensures that there is no interruption while a CPS is in CBM and corrective maintenance. Constraint (24) ensures that the variables x_{it} , y_{it} , z_{it} , v_{ijt} and w_i are binary.

IV.2.3 SIMULATION SETTINGS

The proposed MAS and the equivalent MILP model were run on a Windows computer with an Intel Core i5-6300U processor and 8GB of RAM. For the visualization, the data from these agents was imported in Matlab Simulink [354] as shown in Figure IV-4. This figure shows one instance with 10 CPAs as the fleet size. The equivalent MILP model was constructed in IBM CPLEX [355].

The effectiveness of the MAS was tested by using several instances (indicating the fleet sizes). These are f and ϵ which indicate the fleet size and the minimum required CPAs by the fleet operator respectively. For the MAS, these simulation instances are generated randomly. Using these instances, the SA in the MAS calculates f_1, f_2, f_3 , the number of CBM interventions and the fleet availability respectively. For the MILP model, all the instances f and ϵ (generated randomly) together with the instances f_1, f_2 , and f_3 (calculated by the SA in the MAS) are taken as inputs into the model. Using these inputs and the defined constraints, the MILP model calculates the optimal number of CBM interventions and the fleet availability.

The only purpose of the MILP model is to therefore verify the results reached by the MAS in terms of the number of CBM interventions (reliability) and the number of CPAs available for missions (fleet operations) in a static environment.

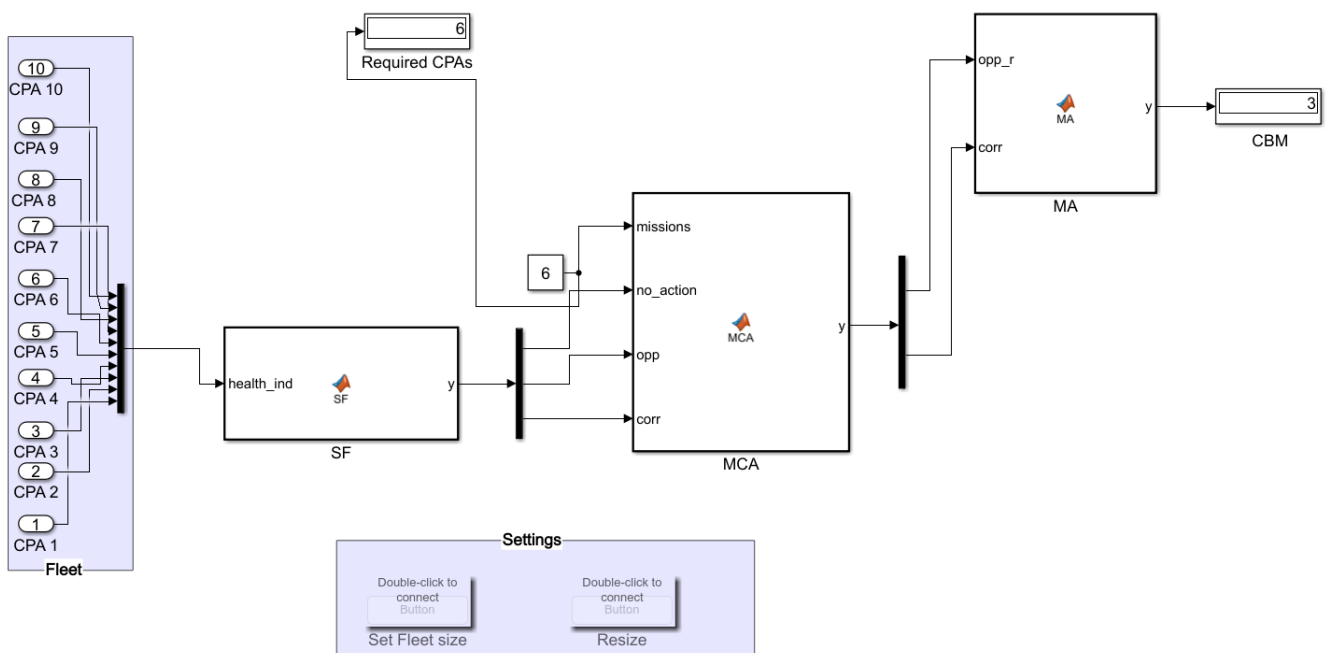

FIGURE IV-4: SIMULATION OF THE MAS MODEL IN A STATIC ENVIRONMENT

IV.2.4 RESULTS IN A STATIC ENVIRONMENT AND EVALUATION

Table IV-4 contains the results reached by the proposed MAS model in a static environment (i.e. absence of uncertainties – unplanned events). The formulated MILP model (subsection IV.2.2) was used to validate these results. This was done by comparing the number of CPAs available for missions (fleet operations) and the number of CPAs put in the maintenance depots for CBM interventions for both models. Table IV-4 indicates that results reached by the proposed MAS are coherent with those by MILP model. In some instances where the number of available CPAs was less than ϵ , the MILP model reached no results while the MAS model, deployed the available CPAs for the planned operations while delaying some planned operations in waiting for the maintenance of unavailable CPAs.

TABLE IV-4: MAS AND MILP SIMULATIONS IN A STATIC ENVIRONMENT

Instances					Number CPAs sent to fleet operations		Number of CPAs set to undergo CBM interventions	
f	ϵ	f_1	f_2	f_3	MAS	MILP	MAS	MILP
7	3	3	3	1	3	3	3	3
10	5	2	6	2	5	5	3	3
15	7	3	10	2	7	7	6	6
20	16	5	14	1	16	16	3	3
25	11	8	12	5	11	11	9	9
30	15	12	14	4	15	15	11	11
35	18	15	17	3	18	18	14	14
40	20	16	19	5	20	20	15	15
45	23	18	22	5	23	23	17	17
50	35	10	30	10	35	35	5	5
55	23	12	36	7	23	23	25	25
60	19	15	40	5	19	19	36	36
65	21	10	45	10	21	21	34	34
70	50	5	19	46	24	No solution	0	0
75	50	15	20	40	35	No solution	0	0
80	50	10	60	10	50	50	20	20
85	45	20	50	15	45	45	25	25
90	70	10	58	22	68	No solution	0	0
100	70	20	60	20	70	70	10	10
150	100	50	80	20	100	100	30	30
200	150	60	80	60	140	No solution	0	0

IV.3 MAS SIMULATION IN A DYNAMIC ENVIRONMENT

Under this section, the proposed MAS will be simulated in a dynamic environment. In the context of this work, the dynamic environment signifies the presence of uncertainties as far as the FMSP is concerned ([349], [356]). In this environment, the MAS will be tested for its reactivity vis-à-vis simulated perturbations as defined in this research work. In order to validate the results, analysis of the MAS's solutions before and after the perturbations is performed. To do so, the subsection that follows will give more details of the considered scenario for perturbations as discussed in this work and subsection IV.3.2 will give the results following the simulations on the considered perturbative scenario.

IV.3.1 SCENARIOS FOR PERTURBATIONS

This research work makes the use of simulated perturbations in order to test the reactivity of the proposed MAS for the FMSP decision-making. In the context of the FMSP, perturbations can occur under various pretexts. Some of these pretexts are described hereinafter.

- | | |
|---|---|
| ➤ Unanticipated breakdowns: | These are unexpected breakdowns [357] of the CPSs which affect the fleet's availability in a way that the fleet's operations are no longer satisfied [358]. |
| ➤ Delays in replacement parts delivery: | If the FMSP decisions were based upon the availability of a replacement part, then if the delivery of such a part delays, there will be perturbations vis-à-vis the maintenance planning ([247], [359]). |
| ➤ Maintenance time estimations: | Bad estimations in the MTTR of the fleet's CPSs could constitute perturbations as far as the FMSP is concerned. This is especially true in the context of this work where the MTTR is used to establish the maintenance priorities of the CPSs in the maintenance depots [360]. |
| ➤ Miscommunications: | Miscommunications among various actors (agents) in the FMSP framework can be another source of perturbations. This for example, can occur in the cases where the messages are lost in between agents' communications in MASs. |

In the context of this work, in order to test the MAS's reactivity, the unanticipated breakdowns scenario is considered because this is by far the commonest uncertainty as far as the FMSP is concerned ([79], [239]). In this scenario, the CPAs breakdowns occur after the FMSP decisions have been made in such a way that, the fleet's availability is no longer satisfied (c.f. the definition above). From the results in Table IV-4, the number of CPAs allocated to fleet operations is equal to the number of CPAs required by the fleet operator for fleet operations (ϵ) in MAS. If there is one or more CPAs breakdowns in this allocated group, then fleet operations will no longer be satisfied hence the MAS model should make adjustments to guarantee the fleet's availability after these breakdowns.

IV.3.2 MAS RESULTS IN THE CONSIDERED PERTURBATIVE SCENARIO

below demonstrates the adjustments made by the MAS model following the unanticipated breakdowns in order to satisfy the fleet operations requirements (fleet availability) from the fleet operator. The results on the table indicate that the number of available CPAs (fleet availability) remains the same before and after the perturbations.

TABLE IV-5: MAS MODEL UNDER PERTURBATIONS (UNANTICIPATED CPAs BREAKDOWNS AFTER ALLOCATION)

Before perturbation					CPAs Available	CPAs for CBM	Perturbations	CPAs break-downs	After perturbation					CPAs Available	CPAs for CBM
Instances									Instances						
f	ϵ	f_1	f_2	f_3					f	ϵ	f_1	f_2	f_3		
7	3	3	3	1	3	3	1	7	3	2	3	2	3	3	2
10	5	2	6	2	5	3	1	10	5	2	5	3	5	5	2
15	7	3	10	2	7	6	3	15	7	3	7	5	7	7	3
20	16	5	14	1	16	3	1	20	16	4	14	2	16	16	2
25	11	8	12	5	11	9	2	25	11	8	10	7	11	11	7
30	15	12	14	4	15	11	4	30	15	10	12	8	15	15	7
35	18	15	17	3	18	14	4	35	18	13	15	7	18	18	10
40	20	16	19	5	20	15	5	40	20	11	19	10	20	20	10
45	23	18	22	5	23	17	1	45	23	17	22	6	23	23	16
50	35	10	30	10	35	5	3	50	35	9	28	13	35	35	2
55	23	12	36	7	23	25	5	55	23	7	36	12	23	23	20
60	19	15	40	5	19	36	10	60	19	15	30	15	19	19	26
65	21	10	45	10	21	34	5	65	21	5	45	15	21	21	29
80	50	10	60	10	50	20	10	80	50	5	55	20	50	50	10
100	70	20	60	20	70	10	5	100	70	20	55	25	70	70	5

In each case, when the breakdowns occur, the MAS model mitigated the situation by replacing the broken-down CPAs by the CPAs set to undergo CBM interventions and by which those respective CBM

interventions have not started. While this delays/decreases the number of CBM interventions, the fleet availability is maintained (satisfaction in fleet’s availability) and the number CBM interventions remain satisfactory as demonstrated by the graph in Figure IV-5.



FIGURE IV-5: CPAs SET FOR CBM INTERVENTIONS BEFORE AND AFTER UNANTICIPATED BREAKDOWNS

IV.4 ILLUSTRATIVE EXAMPLE

In this section, an instance of the MAS model will be presented and discussed to illustrate the capabilities of the latter in satisfying the fleet’s availability and reliability expectations in both static and dynamic environments. For that purpose, the first instance of the simulation (from Table IV-4 and Table IV-5) is considered. From this instance, 3 CPAs require no particular maintenance actions, 3 CPAs require CBM measures and one CPA requires corrective measures. Moreover, the MCA requires 3 CPAs for the planned fleet operations (i.e. $\varepsilon=3$). Furthermore, in this instance the CPAs are attached to two maintenance depots (c.f. specifications in chapter II), namely, the CPAs 1, 3, 5 and 7 are attached to the maintenance depot 1 (depot 1) and the CPAs 2, 4 and 6 are attached to the maintenance depot 2 (depot 2). The subsections that follow will illustrate how the MAS model makes the FMSP decisions in this scenario both in static and dynamic environments.

IV.4.1 FMSP IN A STATIC ENVIRONMENT BY THE MAS MODEL

First of all, the SA receives the raw acquisition variables, health status indicators and the CBM indicators from the CPAs. This information will not only permit the SA to group the CPAs in the health status groups but also will enable the SA to identify the needed maintenance actions associated with the CPAs in the fleet as shown in Figure IV-6. This figure shows the groups of CPAs as well as the maintenance actions needed.

Agent	Groups	CPAs	Maintenance actions	
SF	Group 1	CPA 1	No fault	
		CPA 2	No fault	
		CPA 3	No fault	
	Group 2	CPA 4	CBM actions {1, 2}	
		CPA 5	CBM actions {1, 2, 3}	
		CPA 6	CBM actions {2, 3}	
	Group 3	CPA 7	Corrective action { 1 }	

FIGURE IV-6: HEALTH STATUS GROUPS AND MAINTENANCE ACTIONS NEEDED

Secondly, from the list of the maintenance actions needed (i.e. both corrective and CBM interventions), the SA is able to identify the maintenance resources required to carry out these interventions. These resources are identified in terms of the replacement parts needed, maintenance teams (with the needed skills) and the maintenance infrastructure as shown in Figure IV-7.

	Maintenance Teams	Teams with skills for corrective action 1 - TC1
		Teams with skills for CBM action 1 - TCBM1
		Teams with skills for CBM action 2 - TCBM2
		Teams with skills for CBM action 3 - TCBM3
Resources	Replacement parts	Parts for corrective action 1 - PC1
		Parts for CBM action 1 - PCBM1
		Parts for CBM action 2 - PCBM2
		Parts for CBM action 3 - PCBM3
	Infrastructure	Maintenance hangar (corrective action 1)
		Maintenance hangar (preventive action 1)
		Maintenance hangar (preventive action 2)
		Maintenance hangar (preventive action 3)

FIGURE IV-7: IDENTIFICATION OF THE MAINTENANCE RESOURCES

Thirdly, the SA receives the information from the two MAs (maintenance depot 1 and depot 2 respectively) on the maintenance resources available in these depots. Using this information, the SA verifies if the needed resources for the maintenance of the CPAs in group 2 and group 3 respectively are available and when are they available. This verification is illustrated in Figure IV-8.

Lastly, the SA suggests optimized CPAs allocation for the fleet operations as well as optimized maintenance planning for the CPAs in groups 3 and 2 respectively (corrective maintenance and CBM) by

considering the fleet's availability and the availability of the maintenance resources. This is demonstrated in Figure IV-9. Since the MCA requires 3 CPAs for the fleet operations, the SA sends the 3 CPAs in group 1 (CPA 1, CPA 2 and CPA 3) to carry out the fleet operations. Following the maintenance resources availabilities in Figure IV-8, the maintenance planning for the CPAs in groups 3 and 2 are planned as follows:

- On Monday:
 - CBM action {1} (CBM 1) is planned for the CPAs 4 between 1000 hours and 1600 hours.
 - CBM action {2} (CBM 2) is planned for the CPA 5 between 0800 hours and 1400 hours.
 - CBM action {2} (CBM 2) is planned for the CPA 6 between 1000 hours and 1700 hours.
- On Tuesday:
 - The start of CBM action {3} (CBM 3) for the CPA 5 at 1000 hours
 - The start of corrective action {1} (corrective 1) for the CPA 7 at 1400 hours.
 - The start of CBM action {2} (CBM 2) for the CPA 4 at 1500 hours.
- On Wednesday:
 - The start of CBM action {1} (CBM 1) for the CPA 5 at 1400 hours.
 - The start of CBM action {3} (CBM 3) for the CPA 6 at 1500 hours.
 - The winding up of CBM action {2} (CBM 2) for the CPA 4 at 1600 hours.
- On Thursday:
 - The winding up of CBM action {1} (CBM 1) for the CPA 5 at 1400 hours.
 - The winding up of corrective action {1} (corrective 1) for the CPA 7 at 1400 hours.
 - The winding up of CBM action {3} (CBM 3) for the CPA 6 at 1700 hours.

IV.4.2 FMSP IN A DYNAMIC ENVIRONMENT BY THE MAS MODEL

After the planning suggested by the SA in the previous subsection (Figure IV-9), on Wednesday, at 1000 hours, the CPA 3 breaks down and it is automatically placed in group 3 (it is no longer available for fleet operations). This makes the number of available CPAs (2 CPAs) less than the number of required CPAs (3 CPAs). To counteract this breakdown and in order to satisfy the fleet's availability, the CBM action {3} intervention (CBM 3) of CPA 6 is delayed as shown in Figure IV-10 in order to **temporarily** make this CPA available. The CPA 6 is then made available to replace the broken-down CPA (CPA 3) on Wednesday between 1100 hours and 1700 hours until CPA 4 completes the necessary repairs and can

permanently replace the CPA 3 on Thursday at 0800 hours as shown in Figure IV-10. Nevertheless, the SA has to plan for the corrective maintenance of the CPA 3 depending on the availability of the maintenance resources. This illustrates the reactivity of the MAS model vis-à-vis the FMSP decision-making in mitigating unexpected events.

Days		Monday							Tuesday							Wednesday							Thursday							Friday											
Hours		8	9	10	11	12	14	15	16	8	9	10	11	12	14	15	16	8	9	10	11	12	14	15	16	8	9	10	11	12	14	15	16	8	9	10	11	12	14	15	16
Depot 1	Teams	TCBM1, TCBM2, TCBM3							TCBM1, TCBM2, TCBM3, TC1							TCBM1, TC1																									
	Replacement parts	PCBM2		PCBM2, PCBM3					PCBM1, PCBM2, PCBM3, PC1																																
	Infrastructure	Hangar 1, Hangar 2, Hangar 3																																							
Depot 2	Teams	TCBM1, TCBM2, TCBM3							TCBM2, TCBM3																																
	Replacement parts	PCBM1, PCBM2														PCBM1, PCBM2, PCBM3																									
	Infrastructure	Hangar 1, Hangar 2																																							

FIGURE IV-8: MAINTENANCE RESOURCES VERIFICATION IN THE MAINTENANCE DEPOTS

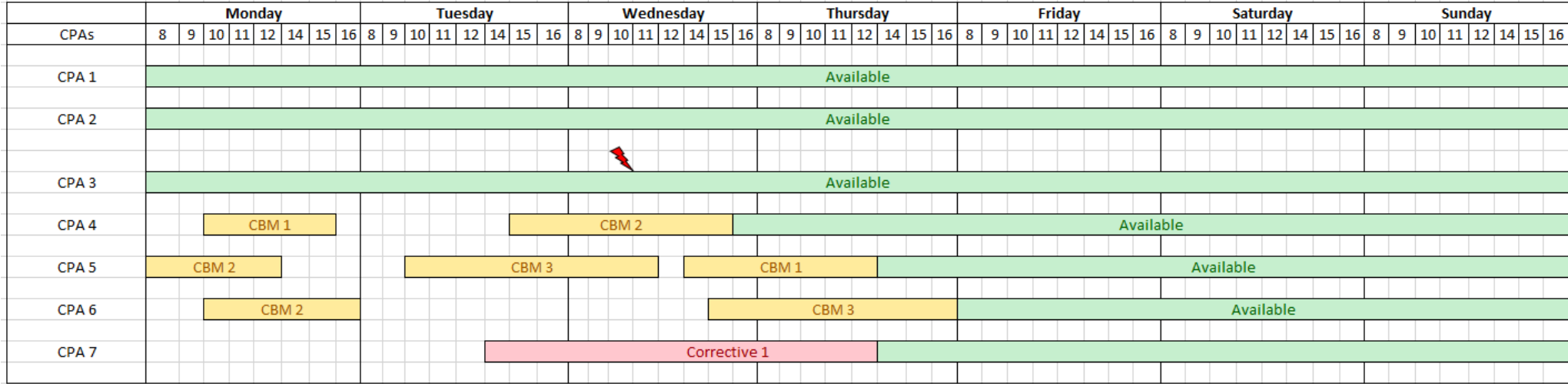

FIGURE IV-9: MAINTENANCE PLANNING BEFORE PERTURBATIONS

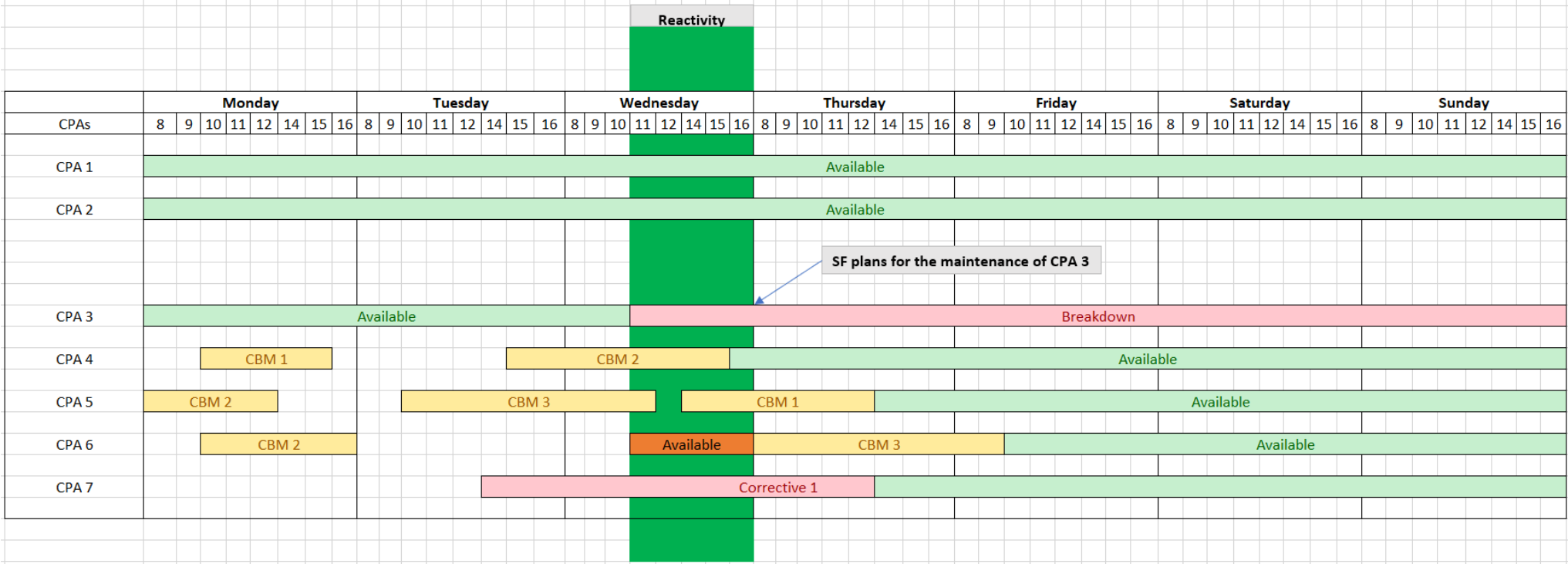

FIGURE IV-10: REACTIVE MAINTENANCE PLANNING FOLLOWING A PERTURBATION

IV.5 LIMITATIONS OF THE PROPOSED MAS MODEL

Despite the effectiveness and the reactivity of the proposed MAS model as illustrated in the previous subsections, there are several limitations and vulnerabilities associated with the latter. The major limitation is the lack of generalization as far as the MAS's effective and reactive capabilities are concerned. This limitation is described hereinafter.

As stated earlier in this work, the notions of asset reliability and the occurrences of perturbations in FMSP can be expressed under numerous pretexts. In order to set the boundaries and fix the context, the reliability expectations (increasing CBM interventions) and the perturbative the scenarios described and tested in this research work (see subsection IV.3.1) are very specific. The experimental results obtained from these contexts are, therefore, not sufficient to describe the overall/general effectiveness (when considering reliability aspects) and the reactivity of the proposed model. There is a need of defining and testing more perturbative scenarios as well as reliability aspects in order to render the proposed MAS model more general.

Moreover, as pointed out under the general limitations of the MASs (subsection III.1), there is a need of defining formal protocols and standards to address the question of privacy in the MAS proposed in this research work. To mitigate the lack of formal privacy standards and protocols, all agents' actions (methods) and properties (variables) in the proposed MAS have been defined as public or private depending on what a specific agent wants to share with other agents as suggested in the literature (Brafman et al. [318]). Nevertheless, standard protocols for the privacy issues in MASs would provide the means to address these issues in a formal manner.

IV.6 SUMMARY

In this chapter, numerical implementations and simulations of the proposed MAS model for the reactive FMSP decision-making have been proposed. The objectives of the simulations presented in this chapter were, firstly to verify if the proposed MAS model was effective in FMSP decision-making (i.e. Do the FMSP decisions reached by the MAS model satisfy the fleet's availability and reliability expectations?). The second objective was to verify if the proposed MAS model was reactive as far as the occurrences of unplanned events in the FMSP are concerned (i.e. Can the MAS model adapt the FMSP decisions in order to meet availability and reliability expectations in an uncertainty environment?). To do so, first of all, the MAS implementation framework was presented. Then, the simulations of the MAS model were done in static and dynamic environments. In a static environment (absence of unplanned events), the solutions reached by the MAS model in terms of availability (i.e. the number of CPAs allocated to fleet operation) and reliability (i.e. the number of CPAs set to undergo CBM interventions) were validated by the MILP model. The comparison of the two models indicated that, the results given by MAS were coherent with those by MILP hence the effectiveness of the proposed MAS model in satisfying the availability and reliability expectations.

To test the reactivity of the proposed MAS model, the latter was put under simulated perturbations. Different scenarios for perturbations were pointed out whereby one scenario (the occurrences of unanticipated breakdowns after the fleet maintenance planning) was considered. The results of the MAS model simulations in this environment indicated that, the MAS model made adjustments following the

perturbative breakdowns in order to satisfy primarily, the fleet's availability expectations and the reliability expectations as well (as presented in section IV.3). The MAS model is thus reactive in mitigating the occurrences of unanticipated breakdowns. However, as far as the reactivity is concerned, there is a need to test more perturbative scenarios such as the miscommunications between various actors involved in the FMSP, delays in replacement parts delivery among others in order to analyze the overall reactivity of the MAS models in an uncertain environment.

Since the presented MAS model in the context of this work has illustrated to be both effective and reactive, in the coming chapter, the implementation of the model in the railway industry will be presented. The MAS model will be integrated in a DSS named "MainFleet" in order to aid a fleet supervisor in making effective and reactive FMSP decisions.

Chapter V APPLICATION TO RAIL TRANSPORT

In the previous chapter, numerical implementations and simulations of the proposed MAS model for the FMSP decision-making were carried out in static and dynamic environments. The objective of these simulations was to test the effectiveness (i.e. capability of satisfying the fleet's availability and reliability expectations) and the reactivity of the proposed MAS model. The analysis of the simulation results indicated that, the proposed MAS model is not only effective but also capable of adapting the FMSP decisions following the perturbations (i.e. reactive).

The objective of this chapter is to present and study the applicability of the reactive CPSs FMSP system in the rail transport industry in order to assess the impact of the former. The rest of the chapter is organized as follows, section V.1 will present the context of the application in two-fold, namely, the research context of the entity through which this work was carried out and the context of the rail transport industry in general. Section V.2 will present the application of the reactive CPSs FMSP system in the rail transport industry at Bombardier Transportation France. The application evaluations and the anticipated industrial gains vis-à-vis the presented system will be discussed in section V.3. The last section will give the summary of the chapter and present the perspectives of the coming chapter.

V.1 THE CONTEXT OF THE APPLICATION

V.1.1 SURFERLAB CONTEXT

Surferlab [361] is a joint laboratory founded by Bombardier Transportation France [4], Prosys [5] and the Université Polytechnique de Hauts-de-France [3]. It is a continuation of the SURFER (active rail monitoring) project which took place between 2009 and 2013 ([362], [211], [210]). The objectives of Surferlab are scientifically and strategically summarized by the Table V-1 below.

TABLE V-1: OBJECTIVES OF SURFERLAB [361]

Scientific objectives	Strategic objectives
<ul style="list-style-type: none"> ➤ Contribution to both design phase and operational phase: <ul style="list-style-type: none"> ○ Design phase: Cost-oriented design, Human-centred design. ○ Operational phase: Improvement of RAMS (reliability, availability, maintainability and security) in rail transport. 	<ul style="list-style-type: none"> ➤ Business plan for the projects as well as technologies developed by Surferlab partners.
<ul style="list-style-type: none"> ➤ Contribution to the improvement of the infrastructure in the rail transport. 	<ul style="list-style-type: none"> ➤ To consolidate sustainability in rail transport industry.

<ul style="list-style-type: none"> ➤ To analyse the impacts of the production phase on RAMS. 	<ul style="list-style-type: none"> ➤ To deploy R&D expertise in the region and elsewhere.
	<ul style="list-style-type: none"> ➤ To anticipate future developments in rail transport vis-à-vis digital factory, ICT and industry 4.0

V.1.2 THE RAIL TRANSPORT INDUSTRY: CONTRIBUTIONS AND CHALLENGES

The rail transport industry is among the fastest growing. According to a report on rail transport global markets (2016-2025) [363], there has been an observation on the positive growth rates in freight, passenger and urban segments since 2005. According to Altran [364], There has been a transformation in rail transport towards a single transport system that is more automated, more connected and more environmentally friendly in terms of the products and the services [365]. The same transformative efforts are manifested by the current trends in various research works in rail transport such as the autonomous train ([366], [367], [368]) among others. The actors involved in this sector have invested heavily in innovation which is the backbone of the said transformation. Bombardier Transportation France [4], points out 5 innovative trends today as far as the rail transport is concerned, namely, connected mobility, green transportation, industry 4.0, virtual reality and driver’s assistance (obstacle detection assistance system) [369]. Moreover, the rail transport industry is also very important to the energy sector and the environment [370]. The international energy agency (IEA) [371] affirms the following facts vis-à -vis the rail transport sector today:

- Rail transport is among the most energy efficient in the sense that, the rail sector carries 8% of the world passengers and 7% of the global freight but contributes only to 2% of the global energy demand.
- Rail transport is the most electrified mode of transport with three quarters of trains running on electricity.
- While rail transport is among the most energy efficient mode of transport, its importance is often neglected in public debates on environmental pollution and energy crisis.

Nevertheless, like all the sectors in the transportation industry, the rail transport sector is faced with several challenges. According to a report done by the Railway-Technology [372] on the major challenges facing the rail operators, maintainers, owners and the role of ICT [373] indicates that, the major challenges on railway transport today are on the operational and maintenance costs. More precisely, these challenges arise from the over-increasing expectations from the operators and the manufacturers in this sector in terms of the fleet availability and reliability in the over-increasing dynamic environments.

These challenges have been the key motivations of this research work which focused on the transportation sector in general (c.f. chapter I) and for which a MAS model for the effective and reactive FMSP decision-making has been proposed (c.f. chapters III and IV). Furthermore, conforming to the

specifications posed in chapter II, a decision support approach is adopted in the sense that, the fleet supervisor is aided in making effective and reactive FMSP decisions by the proposed model. Thus, in this chapter, we present the application of the reactive CPSS FMSP system to the fleet of trains at Bombardier Transportation France using a decision support context to the fleet supervisor. This implementation is presented in the section that follows.

V.2 REACTIVE CPSS FMSP SYSTEM AT BOMBARDIER TRANSPORTATION FRANCE

Under this section, the proposed reactive CPSS FMSP system is applied to a fleet of trains at Bombardier Transportation France. Figure V-1 below shows the architecture of the implemented system. Conforming to the specifications fixed by this research work, a DSS is developed for the decision aid to the fleet supervisor. In this context, this DSS is named “MainFleet” as depicted in this figure. Different aspects of this implementation will be discussed in detail in the subsections that follow.

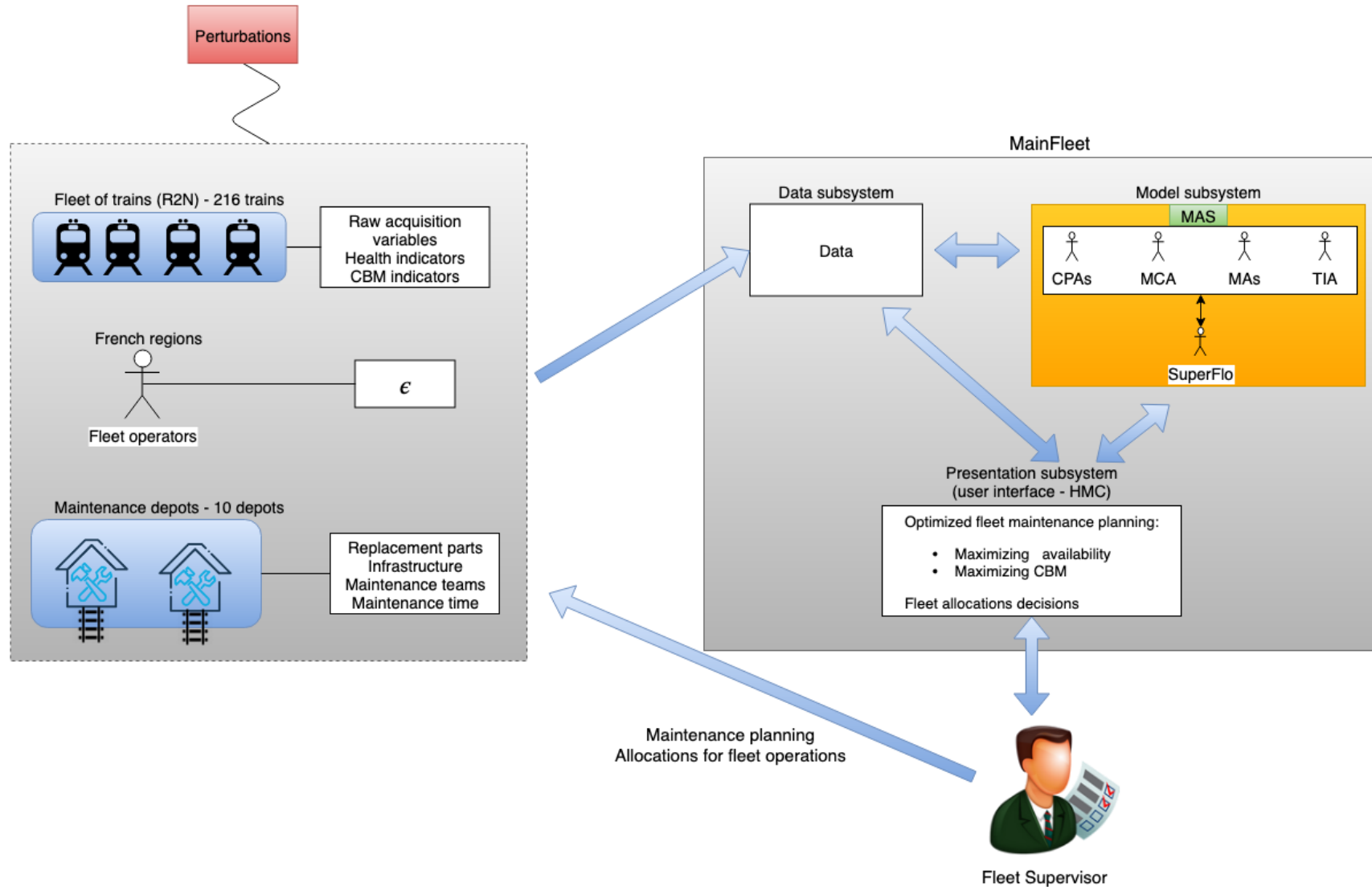

FIGURE V-1: REACTIVE CPSS FMSP SYSTEM AT BOMBARDIER TRANSPORTATION FRANCE

V.2.1 FLEET OF TRAINS

The considered fleet of trains at Bombardier Transportation France is named Regio 2N (R2N) and it consists of 216 trains (i.e. $f = 216$) which are operational throughout France. The R2N fleet constitutes Bombardier Omneo trains, which is a family of electric multiple units (EMU) [374] built by Bombardier Transportation France following the request by the SNCF (Société nationale des chemins de fer français) [375] for regional EMUs. The technical design characteristics of these trains are depicted in Figure V-2.

OMNEO train for France Technical characteristics	Short	Medium	Long	Extra Long	V200 Intercity
Multiple Unit Operation	UM3	UM3	UM3	UM3	UM3
Gauge	UIC 505-1	UIC 505-1	UIC 505-1	UIC 505-1	UIC 505-1
Length between couplers (m)	80.9 to 84.5*	93.2 to 95*	108.2 to 109.9*	133.6 to 135.4*	109.9
Height (m)	4.32	4.32	4.32	4.32	4.32
Width of single deck vehicles (m)	3.05	3.05	3.05	3.05	3.05
Width of double-deck vehicles (m)	2.99	2.99	2.99	2.99	2.99
Power at rail (MW)	2.4	2.4	2.4 or 3.2	2.4 or 3.2	2.55
Top speed (km/h)	160	160	160	160	200
Level entrance from platform height of (mm)	550 / 760 / 920	550 / 760 / 920	550 / 760 / 920	550 / 760 / 920	550 / 760 / 920
Number of doors/side	6	6	8	10	8
Door width (m)	1.6	1.6	1.6	1.6	1.6
Seated capacity incl. tip-up 2+2 / 2+3 seating	360 to 390* / 410 to 450*	435 to 450* / 500 to 520*	515 to 530* / 595 to 615*	650 to 670* / 760 to 780*	485 / -
Total capacity (4 pass/m ²) 2+2 / 2+3	680 to 730* / 720 to 775*	800 to 825* / 850 to 880*	955 to 980* / 1,020 to 1,050*	1,210 to 1,230* / 1,290 to 1,320*	- / -
Number of toilets (incl. 1 for wheelchair user)	3	3	4	5	7
Axle load CNO / CN4 / CE (t)	17.5 / 19 / 20	17.5 / 19 / 20	17.5 / 19 / 20	17.5 / 19 / 20	17.5 / 19 / 20

FIGURE V-2: TECHNICAL DESIGN CHARACTERISTICS OF OMNEO TRAINS IN R2N FLEET [376]

Conforming to our specification assumptions, these trains in R2N fleet are CPSs ([49], [212], [376]) since they are embedded with sensors monitoring various train systems such as the HVAC (Heating, Ventilation and Air-Conditioning), the pantographs, the doors, the batteries, etc. Moreover, these trains have embedded diagnostic algorithms capable of transforming the raw acquisition variables into the systems' health indicators for the respective train systems. Furthermore, the trains in the fleet are also embedded with the prognosis algorithms which establish the CBM indicators (c.f. specifications in chapter II).

Figure V-3 below shows other characteristics of the trains in the R2N fleet as far as the energy consumption is concerned.

eco⁴

The Climate is Right for Trains

The OMNEO train concept, combined with the Bombardier portfolio of environmental technologies allows operators to achieve a step-change in efficient passenger transportation.

MITRAC Permanent Magnet motor

The BOMBARDIER MITRAC Permanent Magnet Motor saves energy directly with increased motor efficiency as well as indirectly with reduced vehicle weight. Further environmental benefits are achieved as a larger proportion of the braking is performed electrically, resulting in reduced energy consumption and noise emission. Moreover, the OMNEO train offers single stage gear boxes, further reducing losses in the traction chain.

EBI Drive 50 Driver Assistance System

BOMBARDIER EBI Drive 50 is a tool intelligently combining the goals of punctuality and energy saving. It generates recommendations to the driver for optimised speed and traction force. EBI Drive 50 uses real-time remote data transfer on actual position, track information, speed and time compared to timetable. Traction energy savings of up to 15% have been proven in various test trials with customers in different countries. Smoother operation also results in reduced wear of wheelsets, engines, brakes and tracks.



High Power Regenerative Braking

AeroEfficient Optimised Train Shaping

EBI Drive 50 Driver Assistance System

Lightest Train per Passenger

Energy Management Control System

ThermoEfficient Climatisation System

Energy Management Control System

"If you cannot measure it, you cannot improve it". Energy management is an end-to-end concept, ensuring an integrated approach: from data logging and file transmission, via data analysis and report. It includes smart management of auxiliary loads in the train.

AeroEfficient

State-of-the-art aerodynamic computer modelling used to optimise the BOMBARDIER ZEFIRO 380 very high-speed train also supported aerodynamic improvements on the OMNEO train concept.

ThermoEfficient

After traction, HVAC has the highest energy consumption on a train. The ThermoEfficient climatisation system not only offers significant energy savings, it also optimises passenger comfort through variable fresh air rate and even temperature levels.

High Efficiency Gear

MITRAC Permanent Magnet Motor

FIGURE V-3: ENERGY CONSUMPTION OPTIMIZATION IN OMNEO TRAIN [376]

V.2.2 FLEET OPERATORS

As specified in chapter II, the fleet operator is in charge of defining the fleet operational requirements such as the number of trains required for the planned fleet operations (i.e. the availability expectations). For Bombardier Transportation France, the fleet operators have been traditionally affiliated with its clients such as the SNCF and the SNCB (Société nationale des chemins de fer belges) [377] among others. These operators own the fleets of trains and hence define the associated operations. In turn, Bombardier Transportation France sells goods (e.g. trains) and services (e.g. maintenance services) to these entities.

In the context of the R2N fleet, the fleet operators are the regions through which the trains in this fleet operate. The Table V-2 below shows the operators of the R2N fleet throughout France as well as the routes of those operators.

TABLE V-2: R2N OPERATORS AND THE ROUTES

Operator	Routes
TER Auvergne-Rhône-Alpes	<ul style="list-style-type: none"> ➤ Mâcon-Ville → Villefranche-sur-Saône → Lyon-Perrache → Vienne → Valence-Ville ➤ Saint-Étienne-Châteaueux → Lyon-Part-Dieu → Ambérieu-en-Bugey ➤ Firminy → Saint-Étienne-Châteaueux → Givors-Ville → Lyon-Perrache ➤ Lyon-Perrache → Saint-André-le-Gaz
TER Brittany	<ul style="list-style-type: none"> ➤ Rennes → Saint-Malo ➤ Rennes → Brest ➤ Rennes → Quimper
TER Center-Loire Valley	<ul style="list-style-type: none"> ➤ Paris-Montparnasse → Le Mans ➤ Le Croisic → Nantes → Angers → Tours → Orléans
TER Pays de la Loire	<p>(Since June, 9 2018)</p> <ul style="list-style-type: none"> ➤ Le Croisic/Nantes → Orléans
TER Hauts-de-France	<ul style="list-style-type: none"> ➤ Paris-Nord → Creil → Compiègne ➤ Lille-Flandres → Valenciennes ➤ Lille-Flandres → Libercourt → Lens
TER New Aquitaine	<ul style="list-style-type: none"> ➤ Bordeaux-Saint-Jean → Arcachon

	<ul style="list-style-type: none"> ➤ Bordeaux-Saint-Jean → Agen ➤ Bordeaux-Saint-Jean → Libourne → Angoulême
TER Occitanie	<ul style="list-style-type: none"> ➤ Toulouse-Matabiau → Agen ➤ Toulouse-Matabiau → Montauban-Ville-Bourbon ➤ Toulouse-Matabiau → Narbonne ➤ Toulouse-Matabiau → Tarbes
TER Provence-Alpes-Côte d'Azur	<ul style="list-style-type: none"> ➤ Marseille-Saint-Charles → Toulon → Hyères ➤ Marseille-Saint-Charles → Cannes → Nice-Ville → Monaco-Monte-Carlo → Menton → Vintimille
Transilien R	<ul style="list-style-type: none"> ➤ Melun → Montereau via Héricy ➤ Paris-Gare-de-Lyon → Montereau via Moret

V.2.3 MAINTENANCE DEPOTS

The trains in the R2N fleet which present abnormalities or possible future abnormalities (prognosis) in their systems are repaired in the 10 maintenance depots (i.e. $d = 10$). These maintenance depots are scattered evenly throughout the regions which are the operators of the R2N fleet. This conforms to the specifications defined in chapter II that each train in the fleet is attached to a certain maintenance depot through which all its maintenance requirements are carried out. This has an exception in cases of emergencies where a train can be repaired in any maintenance depot within proximities (c.f. chapter II). The interface showing these maintenance depots along with the number of maintenance interventions carried out is depicted in Figure V-4. The zoom view of the interface in Figure V-4 with more details on maintenance depot in Lille is depicted in Figure V-5 where the reparation records of train Z5500509 – T6 are shown.

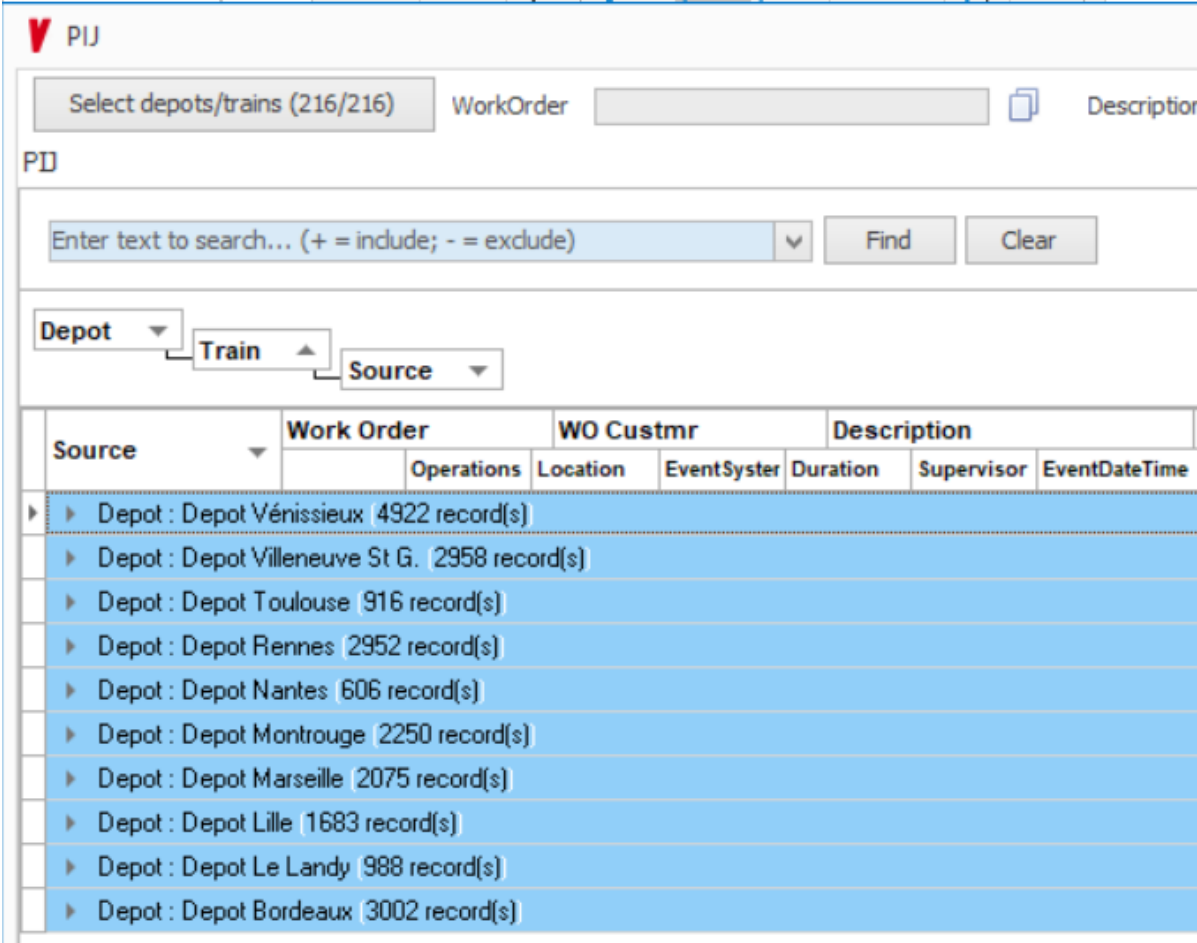

FIGURE V-4: THE MAINTENANCE DEPOTS FOR R2N FLEET

Chapter V: Application to rail transport

PIJ

Select depots/trains (216/216) WorkOrder Description

PD

Enter text to search... (+ = include; - = exclude) Find Clear

Depot Train Source

Source	Work Order	WO Custmr	Description	Type	EventStat	Prior	Plan	VisitCount
Operations	Location	EventSystem	Duration	Supervisor	EventDateTime	Comments	Visits	Exec
▶ Depot : Depot Marseille (2075 record(s))								
▲ Depot : Depot Lille (1683 record(s))								
▲ Train : R005M - [HG] Z5500509 - T6 (130 record(s))								
▲ Source : Maxim (130 record(s))								
Maxim	505559	17-885	bute aimante manquant sur	CM	WMATL	4	0	0
o		N/V13/AV/P	GDISTEFA	00:00:00	GDISTEFA	01/02/2017 01:18:25		0
Maxim	1018237	493	FMI PPC ER-002752	MOD	APPR	2	0	0
o		PIC0830215	N/V20/PR/M	PPC	07:00:00	PPC	01/02/2019 09:24:54	0
Maxim	1018243	493	FMI PPC ER-002752	MOD	APPR	2	0	0
o		PIC0830215	N/V20/PR/M	PPC	07:00:00	PPC	01/02/2019 09:24:54	0
Maxim	1047677		P2/E/interference DILAC &	MOD	WMATL	2	0	0
o		C0836383	N	PIRETROFI	05:00:00	PIRETROFI	01/04/2019 12:21:19	0
Maxim	786919		P2/E/CAIS/Filtre RC IDF/CDC	MOD	WMATL	3	0	0
o		C0836190	N	PIRETROFI	04:00:00	PIRETROFI	01/06/2018 09:07:25	0
Maxim	889649	18-4711	probleme reglage barre	CM	WSUPPL	3	0	0
o		N/V13/AV/P	GDISTEFA	00:00:00	GDISTEFA	02/01/2019 15:21:33		0
Maxim	504285	17-699	cable mvb et wtb a proximite	CM	INPRG	3	0	0
o		N/V11/TC	GDISTEFA	00:00:00	GDISTEFA	02/10/2018 05:21:51		0
Maxim	906922	18-4707	oxydation dans combles	CM	WSUPPL	3	0	0
o		N/V11/AV/C	GDISTEFA	00:00:00	GDISTEFA	03/01/2019 08:44:39		0
Maxim	879734	18-4510	Probleme TFP	CM	WAGREE	2	0	0
o		N/V11/EE/T	GDISTEFA	00:00:00	GDISTEFA	04/02/2018 08:50:58		0

Create Visit Close

FIGURE V-5: MAINTENANCE INTERVENTION DETAILS IN MAINTENANCE DEPOT IN LILLE

V.2.4 PERTURBATIONS

These are the disturbances occurring in such a way that the FMSP objectives (e.g. the availability expectations) are not met. These disturbances have the most effects when the FMSP decisions are already validated by the fleet supervisor. As seen in chapter IV, these disturbances can occur under various pretexts. Some of these pretexts specific to the application of the reactive CPSs FMSP system in R2N fleet at Bombardier Transportation France are detailed hereinafter.

Immobilizing breakdowns:

These are unexpected breakdowns in the train subsystems which will cause the mission-ready trains after the FMSP decisions are validated to be immobilized and as such, not meeting the availability expectations and causing perturbations. At Bombardier Transportation France, an example of these unexpectedly occurring breakdowns is, the door which does not close when the train starts moving.

Delays in the delivery of replacement parts:

In the context of the application of the reactive CPSs FMSP system at Bombardier Transportation France and conforming to the specifications of this research work (c.f. chapter II), the fleet maintenance activities within a horizon are planned based on the availability or the anticipated delivery of the required replacement parts. Delays in the delivery of these parts is considered as a disturbance to the systems and hence the CPSs FMSP system needs to adapt the FMSP decisions to counter such disturbances.

Bad estimations in trains' repair time:

In the context of this application, a possible scenario caused by this perturbation can be for example, considering a low fleet availability level (c.f. fleet availability threshold in chapter II), the SA will prioritize the maintenance of the trains with tasks requiring less repair time in order to rapidly increase the number of mission-ready trains. The priorities will therefore be introduced depending on the estimations of the MTTR of the concerned trains by the expertise from the maintenance depots. Huge misestimations in the MTTR will cause the misappropriations in the maintenance priorities hence constituting disturbance as far as the FMSP decision-making is concerned.

V.2.5 MAINFLEET

MainFleet in this context has an objective of aiding the fleet supervisor in making effective and reactive FMSP decisions as far as the R2N fleet at Bombardier Transportation France is concerned. As specified in chapter II, the design of MainFleet follows the approach by Sprague ([178], [184]) with three subsystems layers, namely, the data subsystem, the model subsystem and the presentation subsystem as shown in Figure V-1. The composition of these layers is detailed hereinafter.

V.2.5.1 THE DATA SUBSYSTEM

All the data necessary in aiding the fleet supervisor in FMSP decision-making is stored in the data subsystem of MainFleet. The contents of the data subsystem are not only from the real physical systems in the FMSP framework (e.g. trains, depots, etc...) but are also from the computations done by the agents mirroring these physical systems (e.g. the SA, the MAs, etc...). In this application, the content of this data is described hereinafter.

Data from	Content
Omneo trains in R2N fleet	<ul style="list-style-type: none">➤ The raw acquisition subsystems variables from the embedded sensors➤ Subsystems' health indicators➤ CBM indicators
Maintenance depots	<ul style="list-style-type: none">➤ Replacement parts stocks➤ The schedules of the maintenance teams➤ The schedules of the maintenance rail tracks
Fleet operators	<ul style="list-style-type: none">➤ The fleet operations requirements (i.e. number of trains required to carry out the planned operations)
MAs	<ul style="list-style-type: none">➤ The estimated MTTR of the trains to be repaired➤ The lists of maintenance priorities

TIA	➤ The FMSP decisions which are not validated by the fleet supervisor
SA	➤ The fleet maintenance planning decisions ➤ The allocation decisions for the fleet operations

V.2.5.2 THE MODEL SUBSYSTEM

The MAS proposed in chapter III and simulated in chapter IV is integrated in the model layer of MainFleet. The approach of this research work consists of replacing the agents in the proposed MAS in MainFleet by avatars connected to the real systems, e.g. CPSs-trains, fleet operator and maintenance depots (contrary to virtual agents simulating these real systems as presented in chapter IV).

The correspondence between the agents simulated in chapter IV and the real systems considered in this chapter is described hereinafter.

Agent	Real system	Parameters
➤ CPAs:	These cyber-physical agents are replaced by the avatars connected to the Omneo trains in the R2N fleet.	$f = 216$
➤ MAs:	These agents are replaced by the avatars connected to the maintenance depots responsible for the trains in R2N fleet. They facilitate the following: <ul style="list-style-type: none"> ○ The management of the replacement parts inventories in the maintenance depots ○ Manage the schedules of the maintenance teams ○ Manage the schedules of the maintenance infrastructures: Maintenance railway tracks ○ The management of the maintenance time (MTTR) of the trains. ○ The introduction of the maintenance priorities in terms of the MTTR depending on the fleet’s availability threshold 	$d = 10$
➤ SA:	This agent remains to be a virtual supervisor agent. In this context, this agent is referred to as “SuperFlo”. SuperFlo	f_1, f_2 and f_3 – Based on the

	<p>cooperates with other agents to produce optimized FMSP decisions which satisfy the availability, reliability and reactivity expectations. SuperFlo relays these decisions to the human fleet supervisor through MainFleet's UI. Moreover, the fleet supervisor can have information on different aspects of the fleet (such as the health status of a particular train, the health status of a particular system, etc.) by requesting SuperFlo. The prototype showing the communication between the fleet supervisor and SuperFlo is demonstrated here².</p>	trains' health status
➤ FSA:	<p>This agent is replaced by the human fleet supervisor. The fleet supervisor has to validate the suggestions proposed by SuperFlo.</p>	μ - based on the fleet operational requirements
➤ MCA:	<p>This agent is replaced by an avatar connected to the fleet operators. As discussed previously, in this context, the operators are the French regions through which the trains in the R2N fleet operate. These operators define the fleet operations in a horizon hence the number of trains necessary to accomplish those operations.</p>	ε – based on the fleet operational requirements in the regions
➤ TIA:	<p>This is a virtual agent which handles the FMSP decisions which have not been validated by the fleet supervisor.</p>	

V.2.5.2.1 ILLUSTRATIVE MAS EXAMPLE FOR THE FMSP IN R2N FLEET IN OCCITANIE REGION

In this illustrative example we consider the R2N trains operating in the region of Occitanie from 17/09/2018 to 23/09/2018. In total there were 14 trains operating in this region during this interval of time. Following the information from the CPAs connected to these trains, SuperFlo categorized these trains into 3 health status groups (c.f. Chapters II, III and IV) as demonstrated in Figure V-6.

² Video showing communications between SuperFlo and the fleet supervisor

Agent	Groups	Trains	Maintenance actions
		R426Cm	
		R428Cm	
		R429Cm	
	Group 1	R430Cm	No fault
		R431Cm	
		R433Cm	
SuperFlo		R434Cm	
		R436Cm	
		R437Cm	
		R438Cm	
	Group 2	R432Cm	Degraded CCUS communication
		R425Cm	LCB opened due to regeneration inhibit
	Group 3	R427Cm	Fault in quai detection (Laser GA 9022 fault)
		R435Cm	Traction fault - Fault in tension measuring bus (DC AMC2)

FIGURE V-6: TRAIN GROUPS COMPUTED BY SUPERFLO FOR R2N FLEET IN OCCITANIE

To avoid the discussion on the fleet operations schedule in this region (the train schedules being confidential information), we deduce that, the operator in this region (TER Occitanie) wants to maintain not less than 12 mission-ready trains within the horizon (17/09/2018 to 23/09/2018). After having categorized the trains in their respective health status groups, SuperFlo uses the information on the availability of the maintenance resources in the maintenance depot in this region and the fleet availability requirements from the operator to propose the maintenance planning and fleet allocations for the planned operations in order to carry out the identified CBM and corrective interventions but also to maintain the fleet availability of not less than 12 trains within the horizon. The proposed FMSP planning in this context is depicted in Figure V-7. In turn the fleet supervisor must validate these proposed planning decisions. In cases of perturbations (not present in this case), the MAS model will readjust the planning in order to satisfy the required fleet availability and at the same time addressing the CBM and corrective maintenance requirements.

Chapter V: Application to rail transport

	Monday 17/09/2018							Tuesday 18/09/2018							Wednesday 19/09/2018							Thursday 20/09/2018							Friday 21/09/2018							Saturday 22/09/2018							Sunday 23/09/2018																					
Trains	8	9	10	11	12	14	15	16	8	9	10	11	12	14	15	16	8	9	10	11	12	14	15	16	8	9	10	11	12	14	15	16	8	9	10	11	12	14	15	16	8	9	10	11	12	14	15	16	8	9	10	11	12	14	15	16	8	9	10	11	12	14	15	16
R426Cm	Available																																																															
R428Cm	Available																																																															
R429Cm	Available																																																															
R430Cm	Available																																																															
R431Cm	Available																																																															
R433Cm	Available																																																															
R434Cm	Available																																																															
R436Cm	Available																																																															
R437Cm	Available																																																															
R438Cm	Available																																																															
R432Cm	Available							CCUS comm							Available																																																	
R425Cm	Available														LCB intervention							Availabe																																										
R427Cm	Laser GA 9022 repair							Available																																																								
R435Cm															Tension bus DC AMC2 repair																																																	

FIGURE V-7: FMSP PLANNING IN R2N FLEET IN TOULOUSE

V.2.5.3 THE PRESENTATION SUBSYSTEM

The presentation subsystem of MainFleet handles the UI through which the fleet supervisor is aided by the effective and reactive MAS model. Even though the development of MainFleet at Bombardier transportation France is ongoing, all the subsystems of MainFleet are already structured and implemented. Currently, with all the research and industrial partners, we are at the phase of finalizing and testing the development of the MCA, the MAs and the TIA agents in the model subsystem of MainFleet. In this layer, the development of other agents such as the CPAs and SuperFlo is already completed and these agents are already functional.

Under this subsection, we are going to demonstrate some of the functionalities which are currently available to aid the fleet supervisor through the MainFleet's UI in its presentation subsystem.

V.2.5.3.1 THE GEOLOCATIONS

The trains through the CPAs agents and the maintenance depots through MAs constantly update their geolocations to the SA agent (SuperFlo). This allows the fleet supervisor to trace the locations of the trains, a very important parameter in order to validate the proposed FMSP decisions. The geolocations of the trains (in green) and the maintenance depots (in red) are displayed on the UI of MainFleet as shown in Figure V-8. In this figure, the avatar of SuperFlo is displayed on the right side of the geolocation window through which the fleet supervisor can interact with by speech or text to get the fleet information.

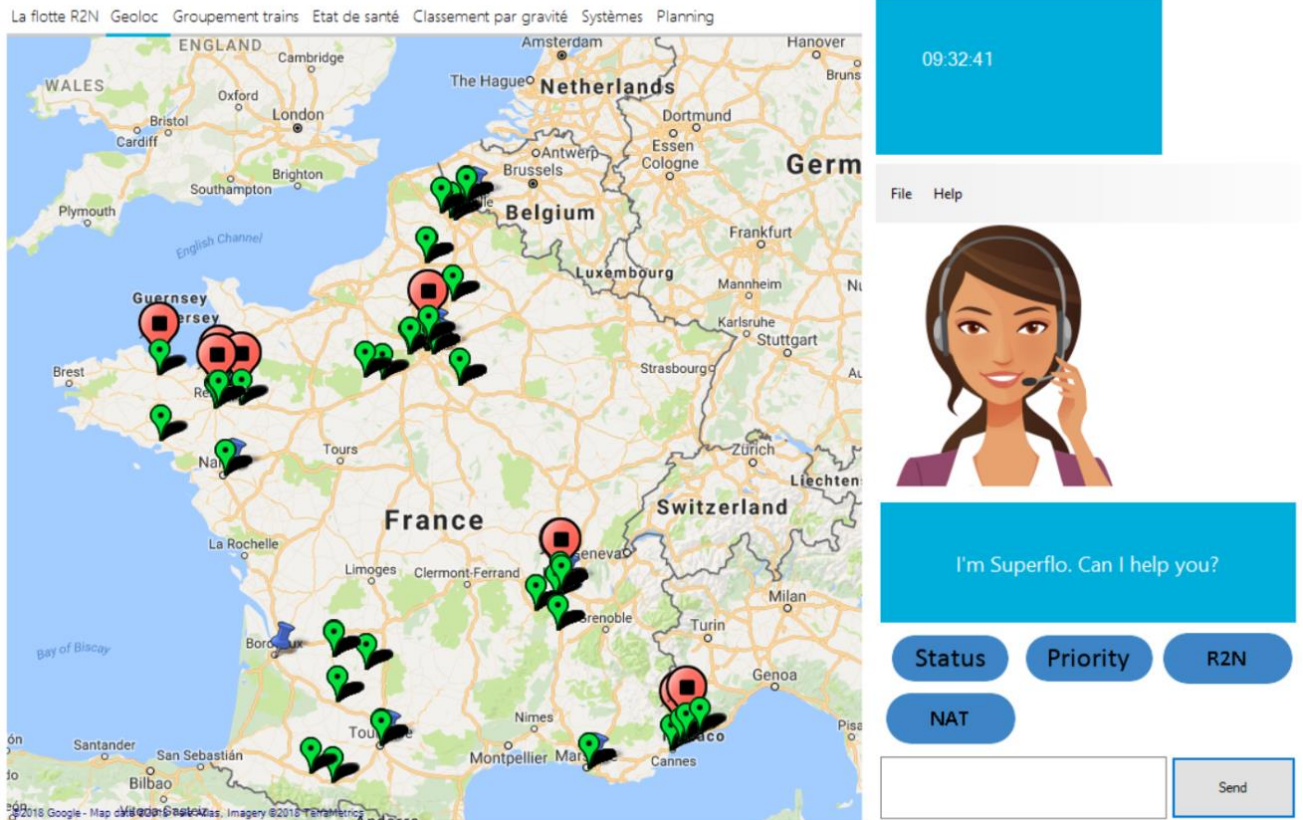

FIGURE V-8: GEOLOCATIONS OF THE TRAINS AND THE MAINTENANCE DEPOTS

V.2.5.3.2 FMSP: R2N FLEET AVAILABILITY, TRAIN GROUPS AND THE HEALTH STATUS

As mentioned before, the industrial implementation of the CPAs and the SA (SuperFlo) is already functional, the trains in the R2N fleet send their raw variables, health indicators and the CBM indicators to SuperFlo and in turn SuperFlo groups the trains in three health status groups. Conforming to the research specifications posed in this work, these groups are, group 1 (mission ready trains with no faults or maintenance needs), group 2 (trains requiring CBM interventions) and group 3 (the trains requiring corrective interventions). This information is presented to the fleet supervisor through the UI as demonstrated in Figure V-9. In this figure, the groups are presented by pie charts. Moreover, the fleet supervisor can get more details on the trains in groups 2 and 3, for example, in Hauts-de-France region, the problems associated with the trains in these groups are detailed in Figure V-10.

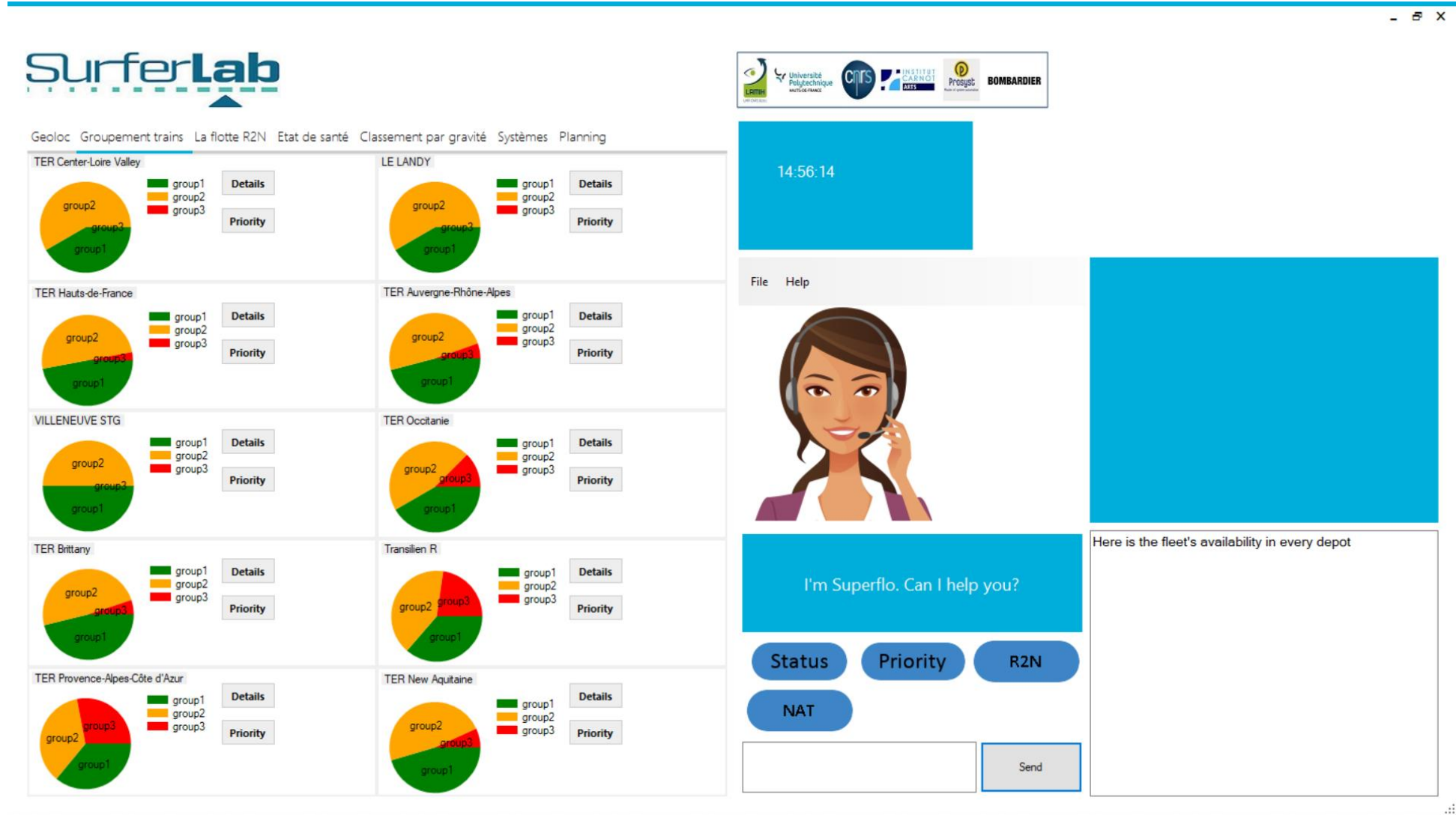

FIGURE V-9: FLEET'S AVAILABILITY ANALYSIS IN EVERY MAINTENANCE DEPOT



FIGURE V-10: DETAILS ON GROUPS 2 AND 3 TRAINS' MAINTENANCE REQUIREMENTS IN TER HAUTS-DE-FRANCE

V.3 EVALUATIONS AND INDUSTRIAL EXPECTATIONS

As previously stated, the development of MainFleet for industrial implementation at Bombardier transportation France is ongoing, the first full-size experimentations are expected in months to come in order to evaluate the impact of the whole reactive CPSs FMSP system in making effective and reactive FMSP decisions. To describe the expected industrial gains of the proposed system, it is vital to understand the penalties and the financial constraints that these penalties are causing at Bombardier transportation France. Altogether, there are three types of penalties facing Bombardier based on the unanticipated breakdowns from the fleet operators as follows:

Breakdown	Penalties
Breakdown A (Immobilizing breakdowns):	They correspond to a lot of hours of delay at the terminus. The penalties are between 200,000 and 360,000 euros (depending on the type of fleet).
Breakdown B:	They correspond to between 5 and 1 hours of delay at the terminus. The penalties are between 40,000 and 60,000 euros.
Breakdown C:	They correspond to other breakdowns which have no impact to the operations. These penalties are between 2,000 and 1,000 euros.

These penalties are based on Failure per million kilometers (FPMK) [378] and they take effect as long as the trains are under guarantee. The average monthly FPMK rate for the three types of breakdowns in the first half of 2017 for the R2N fleet is summarized as follows:

Month	Breakdowns		
	Breakdown A	Breakdown B	Breakdown C
January 2017	1.63	12	288
February 2017	1.63	12.1	288
March 2017	1.63	21.1	289

April 2017	1.63	21.1	288
May 2017	1.63	12	286
June 2017	1.63	11.9	284
July 2017	1.62	11.9	283
August 2017	1.62	11.9	283
September 2017	1.62	11.7	278
October 2017	1.60	11.2	264
November 2017	1.60	11.2	264

Based on these records, Bombardier Transportation France Incurred approximately more than **17 million Euros** between January and November 2017 due to the lack of a reactive system capable of mitigating the effects of these unanticipated breakdowns such as the operational delays. To assess the capabilities of the proposed reactive CPSs FMSP system developed in the course of this work in mitigating the effects of the penalties due to operational delays in the terminus (i.e. the breakdowns of types A and B), the following consideration is given: If MainFleet could mitigate 80 % of the delay penalties due to the Breakdowns of types A and B only without considering the costs associated with type C breakdowns, nearly **9 million Euros** would have been saved between January and November 2017. These estimations have been carried out in cooperation with our industrial partners in order to analyze the potential impact of this research work.

V.4 SUMMARY

This chapter presented the application of the reactive CPSs FMSP system to the rail transport industry. To do so, the context of the application was presented in two parts, firstly, the context of the laboratory in which this work was carried out. Secondly, the context of the rail transport industry in general in terms of the contributions, needs and challenges was presented. Following the propositions presented in the preceding chapters as well as the set context, different aspects of the reactive CPSs FMSP system have been translated for application to the R2N fleet of trains at Bombardier Transportation France. Conforming to the decision support approach to the fleet supervisor as specified in chapter II, a DSS named “MainFleet” was presented. The contents of the main components of MainFleet, namely, the data, model and presentation subsystems were developed as follows:

The Data subsystem:	The data from the connected physical components (trains in R2N fleet, maintenance depots, regional fleet operators, etc..) as well as the data calculated by the agents in the integrated MAS model (SuperFlo, CPAs, etc...) are handled by this subsystem.
The model subsystem:	The MAS model (c.f. chapter III) was integrated in this subsystem of MainFleet. The agents in the MAS model were replaced by the avatars connected to the real physical systems at Bombardier Transportation France (e.g. the trains, the train operators, the maintenance depots, etc...).
The presentation subsystem:	The fleet supervisor uses the UI handled by this subsystem for FMSP decision support.

Furthermore, this chapter presented the anticipated industrial implications vis-à-vis the proposed reactive CPSs FMSP system as far as unexpected faults are concerned. The industrial partners esteem that, the capabilities of the presented system in mitigating the effects of the unexpected breakdowns will help in reducing the associated penalties which present huge operational costs.

The last chapter of this research will give a summary of the work as well as pointing to the possible future directions as far as the FMSP in the fleets of CPSs is concerned.

CONCLUSIONS AND FUTURE WORKS

The research work carried out in this thesis focused on the proposition of a reactive CPSs FMSP system to satisfy the fleet's availability and reliability expectations (i.e. effective FMSP decisions) in both static and dynamic environments. To do so, a MAS model for effective and reactive FMSP decision-making was proposed. Moreover, to help the fleet supervisor in making these "effective and reactive" FMSP decisions by using the proposed MAS model, a decision support approach to the fleet supervisor was adopted. This was followed by the design of a DSS which integrated the formulated MAS model. The overall research work was carried out in the following phases.

First of all, a thorough literature review on FMSP was conducted. This literature review was done in two parts, namely, the FMSP framework and the models and approaches used in solving the FMSP problems. As far as the first part is concerned, the FMSP framework considered different aspects of the FMSP such as the objectives, the constraints, maintenance norms and policies. The literature review in this part specifically dealt with the practices, the evolutions, the current trends of these aspects as well as the limitations of the FMSP frameworks. In the second part of the FMSP literature review, a consideration was given to the approaches, models and tools and their limitations as far as the FMSP decision-making is concerned. Following this literature review, a need to develop a sustainable CPSs FMSP system was identified.

Following the recommendations after the literature review, the formal description of the FMSP in the context of this research work and the specifications for the reactive CPSs FMSP system were provided. To narrow down and fix the scope of this research work, several assumptions were proposed in order to reduce the FMSP framework discussed previously. For example, the sustainability objectives of the FMSP framework were reduced to the economic aspects such as the availability and reliability expectations and the reactivity of the CPSs FMSP system. Moreover, a decision approach to the fleet supervisor was specified in this phase with the specification of a DSS which will integrate a reactive FMSP model in its model subsystem.

The next phase focused on the formulation of the reactive FMSP model to be integrated in the DSS proposed in the previous phase. For this purpose, a MAS approach was used. In this approach different actors of the FMSP framework were modelled as agents cooperating among each other in order to accomplish the specified objectives (effectiveness and reactivity).

In order to evaluate the MAS model presented in the previous phase in both static environment (i.e. without perturbations) and dynamic environment (i.e. with perturbations), the MAS modelled was simulated. To validate the effectiveness of the MAS model in satisfying the availability and reliability expectations, an equivalent MILP model was formulated, and its solutions were compared to those of MAS in terms of the number of CPSs available in the fleet and the number of CBM interventions performed. To validate the reactivity of the MAS model, the latter was put under simulated perturbations to observe how it modifies the FMSP decisions following the disturbances. The analysis of the results showed that, the MAS model was effective and reactive.

Conclusions and future works

The last phase consisted of implementing the proposed reactive CPSs FMSP system to a fleet of trains at Bombardier Transportation France. To conform to the adopted decision support approach, a DSS named “MainFleet” was designed and the reactive MAS model was integrated in its model subsystem. The agents in the MAS were replaced by the avatars connected to the real systems (such as the trains and the maintenance depots among others) at Bombardier Transportation France. The anticipated industrial gains at Bombardier Transportation France brought about by the proposed system were also analyzed.

The perspectives and the future directions of this research work are put forward in two terms, namely, the short-term prospects and the long-term prospects.

As far as the short-term prospects are concerned, we anticipate addressing the following: Firstly, the need to model and test more perturbative scenarios in order to validate the reactivity of the proposed CPSs FMSP system in a large scale. This perspective will help in addressing practical recurring issues as far as the FMSP in the fleet of CPSs is concerned. One of such issues is the ability of the reactive CPSs FMSP system to deal with missing data. This scenario can manifest itself in various cases such as sensor malfunctions, agent communication problems in MAS, etc. among others. Secondly, cybersecurity aspects vis-à-vis the data in the reactive CPSs FMSP system should be addressed. This issue is important as the model involves numerous data movements, for example, between communicating agents in the MAS.

As far as the long-term prospects are concerned, the first perspective is relevant to the reliability of the data used. This refers to the need of developing more precise, accurate models and tools capable of getting a correct picture of the CPSs’ health-status from the raw acquisition variables (diagnosis) which in turn will help in establishing their precise prognosis (e.g. establishing the remaining useful life (RUL) - expressed as g_i_CBM in this work). This is highly crucial as the data from the diagnosis and prognosis are important part of the FMSP decision-making in the proposed reactive CPSs FMSP system.

The second long-term prospective is the development of models, method and tools enabling the replacement of simulated agents (e.g. CPAs and others) by avatars in charge of data exchange among the real actors involved (CPSs, maintenance depots, etc.). In the context of the implementation of the reactive CPSs FMSP system at Bombardier Transportation France, this is expected to be done in a user-transparent way, inspired by the virtual commissioning approach. The idea under development is that, MainFleet (and the fleet supervisor) do not know (unless asking) if agents are fully virtual (i.e. emulating physical processes) or are in fact avatars really connected with physical systems and equipment. This challenging prospect is currently under study with our industrial partners and will help us in proposing a deployment method in other transportation domains apart from the rail transport such as, the energy, the construction and the manufacturing sectors.

Lastly, other long-term perspectives are aligned with the limitations of the proposed MAS model as discussed in the section IV.5. This refers to the following, firstly, the need to define and test more reliability as well as perturbative scenarios in order to provide a description of the system that is effective and reactive not only in specific contexts but in a general sense. Secondly, there is a need of revisiting and defining protocols and standards for the formal description of the privacy-related issues.

References

- [1] N. F. Ayala, C. A. Paslauskis, A. Ghezzi, and A. G. Frank, 'Knowledge sharing dynamics in service suppliers' involvement for servitization of manufacturing companies', *Int. J. Prod. Econ.*, vol. 193, pp. 538–553, 2017.
- [2] Surferlab, 'Accueil | SurferLab : laboratoire en intelligence distribuée pour les systèmes de transport'. [Online]. Available: <http://www.surferlab.fr/>. [Accessed: 10-Jan-2019].
- [3] UPHF, 'Université Polytechnique Hauts-de-France'. [Online]. Available: <https://www.uphf.fr/>. [Accessed: 10-Jan-2019].
- [4] BT, 'Bombardier France'. [Online]. Available: <https://rail.bombardier.com/en/about-us/worldwide-presence/france/en.html>. [Accessed: 10-Jan-2019].
- [5] 'PROSYST :: Produits & Systèmes industriels': [Online]. Available: <http://www.prosynt.fr/index.html>. [Accessed: 10-Jan-2019].
- [6] A. Emadi, 'Transportation 2.0', *IEEE Power Energy Mag.*, vol. 9, no. 4, pp. 18–29, Jul. 2011.
- [7] W. R. Black, 'Sustainable transportation: a US perspective', *J. Transp. Geogr.*, vol. 4, no. 3, pp. 151–159, Sep. 1996.
- [8] H. Haghshenas and M. Vaziri, 'Urban sustainable transportation indicators for global comparison', *Ecol. Indic.*, vol. 15, no. 1, pp. 115–121, Apr. 2012.
- [9] L. Deka, S. M. Khan, M. Chowdhury, and N. Ayres, '1 - Transportation Cyber-Physical System and its importance for future mobility', in *Transportation Cyber-Physical Systems*, L. Deka and M. Chowdhury, Eds. Elsevier, 2018, pp. 1–20.
- [10] E. Molina and E. Jacob, 'Software-defined networking in cyber-physical systems: A survey', *Comput. Electr. Eng.*, vol. 66, pp. 407–419, 2018.
- [11] A. Diaz and D. Trentesaux, 'Servitization in Train Transportation', in *Service Orientation in Holonic and Multi-Agent Manufacturing, Studies in computational intelligence, Springer*, 2019, vol. 803, pp. 273–284.
- [12] W. P. Hall, G. Richards, C. Sarelius, and B. Kilpatrick, 'Organisational management of project and technical knowledge over fleet lifecycles', *Aust. J. Mech. Eng.*, vol. 5, no. 2, pp. 81–95, Jan. 2008.
- [13] S. G. Lee, Y.-S. Ma, G. L. Thimm, and J. Verstraeten, 'Product lifecycle management in aviation maintenance, repair and overhaul', *Comput. Ind.*, vol. 59, no. 2, pp. 296–303, Mar. 2008.
- [14] A. Romero and D. R. Vieira, 'Using the Product Lifecycle Management Systems to Improve Maintenance, Repair and Overhaul Practices: The Case of Aeronautical Industry', in *Product Lifecycle Management for a Global Market*, Springer, 2014, pp. 159–168.
- [15] B. S. Dhillon, *Engineering Maintainability:: How to Design for Reliability and Easy Maintenance*. Gulf Professional Publishing, 1999.
- [16] C. M. F. Lapa, C. M. N. A. Pereira, and M. P. de Barros, 'A model for preventive maintenance planning by genetic algorithms based in cost and reliability', *Reliab. Eng. Syst. Saf.*, vol. 91, no. 2, pp. 233–240, Feb. 2006.
- [17] A. K. S. Jardine and A. H. C. Tsang, *Maintenance, replacement, and reliability: theory and applications*, Second edition. Boca Raton: CRC Press, Taylor & Francis, 2013.
- [18] R.-C. Leou, 'A new method for unit maintenance scheduling considering reliability and operation expense', *Int. J. Electr. Power Energy Syst.*, vol. 28, no. 7, pp. 471–481, Sep. 2006.
- [19] K. Bouvard, S. Artus, C. Bérenguer, and V. Cocquempot, 'Condition-based dynamic maintenance operations planning & grouping. Application to commercial heavy vehicles', *Reliab. Eng. Syst. Saf.*, vol. 96, no. 6, pp. 601–610, Jun. 2011.
- [20] P. C. Tousley, 'Maintain it and save Why We Need Maintenance Management Programs', *Energy Eng.*, vol. 107, no. 5, pp. 64–75, Aug. 2010.
- [21] Committee on analysis of research directions and needs in US manufacturing and technical systems, *The Competitive Edge: Research Priorities for U.S. Manufacturing*. Washington: National Academies Press, 1991.

References

- [22] scanimetrics, 'Predictive maintenance increases productivity, profits and safety'. [Online]. Available: <https://www.scanimetrics.com/index.php/scanimetrics-news-menu-item/11-improving-productivity/225-predictive-maintenance-increases-productivity-profitsa-and-safety>. [Accessed: 20-Mar-2019].
- [23] C. R. Cassady, W. P. Murdock, J. A. Nachlas, and E. A. Pohl, 'Comprehensive fleet maintenance management', in *SMC'98 Conference Proceedings. 1998 IEEE International Conference on Systems, Man, and Cybernetics (Cat. No.98CH36218)*, San Diego, CA, USA, 1998, vol. 5, pp. 4665–4669.
- [24] N. Papakostas, P. Papachatzakis, V. Xanthakis, D. Mourtzis, and G. Chryssolouris, 'An approach to operational aircraft maintenance planning', *Decis. Support Syst.*, vol. 48, no. 4, pp. 604–612, Mar. 2010.
- [25] Q. Feng, W. Bi, Y. Chen, Y. Ren, and D. Yang, 'Cooperative game approach based on agent learning for fleet maintenance oriented to mission reliability', *Comput. Ind. Eng.*, vol. 112, pp. 221–230, Oct. 2017.
- [26] L. Lin, B. Luo, and S. Zhong, 'Development and application of maintenance decision-making support system for aircraft fleet', *Adv. Eng. Softw.*, vol. 114, pp. 192–207, 2017.
- [27] Q. Feng, X. Bi, X. Zhao, Y. Chen, and B. Sun, 'Heuristic hybrid game approach for fleet condition-based maintenance planning', *Reliab. Eng. Syst. Saf.*, vol. 157, pp. 166–176, 2017.
- [28] D. Yang, H. Wang, Q. Feng, Y. Ren, B. Sun, and Z. Wang, 'Fleet-level selective maintenance problem under a phased mission scheme with short breaks: A heuristic sequential game approach', *Comput. Ind. Eng.*, vol. 119, pp. 404–415, May 2018.
- [29] O. Wijk, P. Andersson, J. Block, and T. Righard, 'Phase-out maintenance optimization for an aircraft fleet', *Int. J. Prod. Econ.*, vol. 188, pp. 105–115, 2017.
- [30] C. Nakousi, R. Pascual, A. Anani, F. Kristjanpoller, and P. Lillo, 'An asset-management oriented methodology for mine haul-fleet usage scheduling', *Reliab. Eng. Syst. Saf.*, vol. 180, pp. 336–344, Dec. 2018.
- [31] O. Candell and R. K. and A. Parida, 'Development of Information System for e-Maintenance Solutions within the Aerospace Industry', *Int. J. Perform. Eng.*, vol. 7, no. 6, pp. 583–592, Nov. 2011.
- [32] J. Sheng and D. Prescott, 'A hierarchical coloured Petri net model of fleet maintenance with cannibalisation', *Reliab. Eng. Syst. Saf.*, vol. 168, pp. 290–305, Dec. 2017.
- [33] J. Conesa-Munoz, M. Gonzalez-de-Soto, P. Gonzalez-de-Santos, and A. Ribeiro, 'Distributed Multi-Level Supervision to Effectively Monitor the Operations of a Fleet of Autonomous Vehicles in Agricultural Tasks', *Sensors*, vol. 15, no. 3, pp. 5402–5428, 2015.
- [34] C. Dumitrache, O. Kherbash, and M. L. Mocan, 'Improving Key Performance Indicators in Romanian Large Transport Companies', *Procedia - Soc. Behav. Sci.*, vol. 221, pp. 211–217, Jun. 2016.
- [35] M. Vivaldini, S. R. I. Pires, and F. B. de Souza, 'Improving logistics services through the technology used in fleet management', *JISTEM - J. Inf. Syst. Technol. Manag.*, vol. 9, no. 3, pp. 541–562, Dec. 2012.
- [36] C. Jones and J. Sedor, 'Improving the Reliability of Freight Travel', *Public Roads*, vol. 70, no. 1, Jul. 2006.
- [37] G. L. Giacco, A. D'Ariano, and D. Pacciarelli, 'Rolling Stock Rostering Optimization Under Maintenance Constraints', *J. Intell. Transp. Syst.*, vol. 18, no. 1, pp. 95–105, Jan. 2014.
- [38] P. Y. L. Tu, R. Yam, P. Tse, and A. O. Sun, 'An Integrated Maintenance Management System for an Advanced Manufacturing Company', *Int. J. Adv. Manuf. Technol.*, vol. 17, no. 9, pp. 692–703, May 2001.
- [39] J. Arts, D. Tönissen, and Z.-J. Shen, 'Maintenance location routing for rolling stock under line and fleet planning uncertainty', *Transp. Sci.*, Vol. 53, pp 1252-1270, Aug. 2019.
- [40] G. F. List *et al.*, 'Robust optimization for fleet planning under uncertainty', *Transp. Res. Part E Logist. Transp. Rev.*, vol. 39, no. 3, pp. 209–227, May 2003.
- [41] S. Yin, X. Zhu, and O. Kaynak, 'Improved PLS Focused on Key-Performance-Indicator-Related Fault Diagnosis', *IEEE Trans. Ind. Electron.*, vol. 62, no. 3, pp. 1651–1658, Mar. 2015.

References

- [42] B. Lamoureux, N. Mechbal, and J. Masse, 'Numerical key performance indicators for the validation of phm health indicators with application to a hydraulic actuation system', *Chem. Eng. Trans.*, vol. 33, pp. 43–48, Jul. 2013.
- [43] S. C. Suh, U. J. Tanik, J. N. Carbone, and A. Eroglu, Eds., *Applied Cyber-Physical Systems*. New York, NY: Springer New York, 2014.
- [44] 'Cyber-Physical Systems - a Concept Map'. [Online]. Available: <https://ptolemy.berkeley.edu/projects/cps/>. [Accessed: 10-Jan-2019].
- [45] H. Chen, 'Applications of Cyber-Physical System: A Literature Review', *J. Ind. Integr. Manag.*, vol. 02, no. 03, pp. 1-28, Sep. 2017.
- [46] R. Harrison, D. Vera, and B. Ahmad, 'Engineering Methods and Tools for Cyber-Physical Automation Systems', *Proc. IEEE*, vol. 104, no. 5, pp. 973–985, May 2016.
- [47] J. Barbosa, P. Leita, D. Trentesaux, A. W. Colombo, and S. Karnouskos, 'Cross benefits from cyber-physical systems and intelligent products for future smart industries', in *2016 IEEE 14th International Conference on Industrial Informatics (INDIN)*, Poitiers, France, 2016, pp. 504–509.
- [48] L. D. Xu and L. Duan, 'Big data for cyber physical systems in industry 4.0: a survey', *Enterp. Inf. Syst.*, vol. 13, no. 2, pp. 148–169, Feb. 2019.
- [49] J. Mbuli, D. Trentesaux, J. Clarhaut, and G. Branger, 'Decision support in condition-based maintenance of a fleet of cyber-physical systems: a fuzzy logic approach', in *IEEE Intelligent Systems Conference (IntelliSys)*, 2017, pp. 82–89.
- [50] PricewaterhouseCoopers, 'The fleet effect: The economic benefits of adopting a fleet approach to nuclear new build in the UK', *PwC*. [Online]. Available: <https://www.pwc.co.uk/industries/nuclear/insights/the-economic-benefits-of-adopting-a-fleet-approach-to-nuclear-new-build-in-the-uk.html>. [Accessed: 27-Mar-2019].
- [51] 'Fleet management approach design', *Arthur D. Little France*, 26-May-2017. [Online]. Available: <http://www.adlittle.fr/en/career/case-studies/fleet-management-approach-design-0>. [Accessed: 27-Mar-2019].
- [52] D. Trentesaux, T. Knothe, G. Branger, and K. Fischer, 'Planning and control of maintenance, repair and overhaul operations of a fleet of complex transportation systems: a cyber-physical system approach', in *Service Orientation in Holonic and Multi-agent Manufacturing*, vol. 594, Springer International Publishing, studies in computational intelligence, 2015, pp. 175–186.
- [53] A. Fadil, D. Trentesaux, and G. Branger, 'Event management architecture for the monitoring and diagnosis of a fleet of trains: a case study', *J. Mod. Transp.*, Vol. 27, pp. 169-187, Apr. 2019.
- [54] H. Billhardt *et al.*, 'Dynamic Coordination in Fleet Management Systems: Toward Smart Cyber Fleets', *IEEE Intell. Syst.*, vol. 29, no. 3, pp. 70–76, May 2014.
- [55] D. P. F. Möller and H. Vakilzadian, 'Cyber-physical systems in smart transportation', in *2016 IEEE International Conference on Electro Information Technology (EIT)*, 2016, pp. 0776–0781.
- [56] X. Liu, W. He, and L. Zheng, 'Transportation Cyber-Physical Systems: Reliability Modeling and Analysis Framework', in *Proceedings at the National Workshop for Research on High-Confidence Transportation Cyber-Physical Systems. Automot. Aviation. Rail*, 2008, pp. 18–20.
- [57] M. Han, Z. Duan, and Y. Li, 'Privacy Issues for Transportation Cyber Physical Systems', in *Secure and Trustworthy Transportation Cyber-Physical Systems*, Y. Sun and H. Song, Eds. Singapore: Springer Singapore, 2017, pp. 67–86.
- [58] 'Unit record equipment', *Wikipedia*. 07-Jan-2019.
- [59] 'Punched card', *Wikipedia*. 07-Jan-2019.
- [60] M. Antich, 'The History of Computers in Fleet Management'. [Online]. Available: <http://www.automotive-fleet.com/148366/the-history-of-computers-in-fleet-management>. [Accessed: 10-Jan-2019].
- [61] 'Mainframe computer', *Wikipedia*. 06-Jan-2019.
- [62] 'Computer terminal', *Wikipedia*. 09-Dec-2018.
- [63] 'Teleprinter', *Wikipedia*. 29-Dec-2018.
- [64] L. Hall, 'How fleet managers can create a culture of sustainability', *FleetCarma*, 15-Jun-2018. .

References

- [65] B. lung and E. Levrat, 'Advanced Maintenance Services for Promoting Sustainability', *Procedia CIRP*, vol. 22, pp. 15–22, 2014.
- [66] S. Takata, 'Maintenance-centered Circular Manufacturing', *Procedia CIRP*, vol. 11, pp. 23–31, 2013.
- [67] G. Kozanidis, G. Liberopoulos, and C. Pitsilkas, 'Flight and Maintenance Planning of Military Aircraft for Maximum Fleet Availability', *Mil. Oper. Res.*, vol. 15, no. 1, pp. 53–73, 2010.
- [68] A. Gavranis and G. Kozanidis, 'An exact solution algorithm for maximizing the fleet availability of a unit of aircraft subject to flight and maintenance requirements', *Eur. J. Oper. Res.*, vol. 242, no. 2, pp. 631–643, Apr. 2015.
- [69] 'Vehicle Availability'. [Online]. Available: <https://ppiaf.org/sites/ppiaf.org/files/documents/toolkits/UrbanBusToolkit/assets/1/1c/1c8.html>. [Accessed: 13-Jul-2019].
- [70] 'Reliability Basics: Availability and the Different Ways to Calculate It'. [Online]. Available: <https://www.weibull.com/hotwire/issue79/relbasics79.htm>. [Accessed: 13-Jul-2019].
- [71] F. Cordova and V. Olivares, 'Design of drone fleet management model in a production system of customized products', in *2016 6th International Conference on Computers Communications and Control (ICCCC)*, 2016, pp. 165–172.
- [72] H. L. Barden, 'Maintainability, reliability and availability.', air force institute of tech wright-patterson school of engineering, gre/math/65-1, Dec. 1965.
- [73] H. F. de Castro and K. L. Cavalca, 'Maintenance resources optimization applied to a manufacturing system', *Reliab. Eng. Syst. Saf.*, vol. 91, no. 4, pp. 413–420, Apr. 2006.
- [74] Q. Feng, S. Li, and B. Sun, 'An intelligent fleet condition-based maintenance decision making method based on multi-agent', *Int. J. Progn. Health Manag.*, vol. 110, 2012.
- [75] K. Schneider and C. R. Cassady, 'Fleet performance under selective maintenance', in *Annual Symposium Reliability and Maintainability, 2004 - RAMS, 2004*, pp. 571–576.
- [76] C. ReVelle and V. Marianov, 'A probabilistic FLEET model with individual vehicle reliability requirements', *Eur. J. Oper. Res.*, vol. 53, no. 1, pp. 93–105, Jul. 1991.
- [77] U. Kumar, B. Klefsjö, and S. Granholm, 'Reliability investigation for a fleet of load haul dump machines in a Swedish mine', *Reliab. Eng. Syst. Saf.*, vol. 26, no. 4, pp. 341–361, Jan. 1989.
- [78] E. S. Tzannatos, 'Technical reliability of the Greek coastal passenger fleet', *Mar. Policy*, vol. 29, no. 1, pp. 85–92, Jan. 2005.
- [79] G. D'Aniello, V. Loia, and F. Orciuoli, 'Adaptive Goal Selection for improving Situation Awareness: the Fleet Management case study', *8th Int. Conf. Ambient Syst. Netw. Technol. ANT-2017 7th Int. Conf. Sustain. Energy Inf. Technol. SEIT 2017 16-19 May 2017 Madeira Port.*, vol. 109, pp. 529–536, Jan. 2017.
- [80] J. P. Liyanage, F. Badurdeen, and R. M. C. Ratnayake, 'Industrial Asset Maintenance and Sustainability Performance: Economical, Environmental, and Societal Implications', in *Handbook of Maintenance Management and Engineering*, M. Ben-Daya, S. O. Duffuaa, A. Raouf, J. Knezevic, and D. Ait-Kadi, Eds. London: Springer London, 2009, pp. 665–693.
- [81] D. A. Borugian, 'Vehicle security and maintenance', US6701231B1, 02-Mar-2004.
- [82] R. Blanchet and M.-A. Beliveau, 'Vehicle fleet security system', US7808371B2, 05-Oct-2010.
- [83] M. Montanari, R. H. Campbell, K. Sampigethaya, and M. Li, 'A security policy framework for eEnabled fleets and airports', in *2011 Aerospace Conference*, 2011, pp. 1–11.
- [84] J. Y. Kim and Y. Park, 'Connectivity analysis of transshipments at a cargo hub airport', *J. Air Transp. Manag.*, vol. 18, no. 1, pp. 12–15, Jan. 2012.
- [85] G. Danoy, M. R. Brust, and P. Bouvry, 'Connectivity Stability in Autonomous Multi-level UAV Swarms for Wide Area Monitoring', in *Proceedings of the 5th ACM Symposium on Development and Analysis of Intelligent Vehicular Networks and Applications*, New York, NY, USA, 2015, pp. 1–8.
- [86] A. Muller, A. Crespo Marquez, and B. lung, 'On the concept of e-maintenance: Review and current research', *Reliab. Eng. Syst. Saf.*, vol. 93, no. 8, pp. 1165–1187, Aug. 2008.
- [87] J. Lee, J. Ni, D. Djurdjanovic, H. Qiu, and H. Liao, 'Intelligent prognostics tools and e-maintenance', *Comput. Ind.*, vol. 57, no. 6, pp. 476–489, Aug. 2006.

References

- [88] M. D'Agosto and S. K. Ribeiro, 'Eco-efficiency management program (EEMP)—a model for road fleet operation', *Transp. Res. Part Transp. Environ.*, vol. 9, no. 6, pp. 497–511, Nov. 2004.
- [89] W. G. Colella, M. Z. Jacobson, and D. M. Golden, 'Switching to a U.S. hydrogen fuel cell vehicle fleet: The resultant change in emissions, energy use, and greenhouse gases', *J. Power Sources*, vol. 150, pp. 150–181, Oct. 2005.
- [90] M. E. Iacob, M. J. van Sinderen, M. Steenwijk, and P. Verkroost, 'Towards a reference architecture for fuel-based carbon management systems in the logistics industry', *Inf. Syst. Front.*, vol. 15, no. 5, pp. 725–745, Nov. 2013.
- [91] H. Hilpert, L. Thoroe, and M. Schumann, 'Real-Time Data Collection for Product Carbon Footprints in Transportation Processes Based on OBD2 and Smartphones', in *2011 44th Hawaii International Conference on System Sciences*, 2011, pp. 1–10.
- [92] M. I. Pieczyk and A. C. McKinnon, 'Forecasting the carbon footprint of road freight transport in 2020', *Int. J. Prod. Econ.*, vol. 128, no. 1, pp. 31–42, Nov. 2010.
- [93] D. Trentesaux and G. Branger, 'Data Management Architectures for the Improvement of the Availability and Maintainability of a Fleet of Complex Transportation Systems: A State-of-the-Art Review', in *Service Orientation in Holonic and Multi-Agent Manufacturing: Proceedings of SOHOMA 2017, studies in computational intelligence*, Springer, vol. 762, T. Borangiu, D. Trentesaux, A. Thomas, and O. Cardin, Eds. Cham: Springer International Publishing, 2018, pp. 93–110.
- [94] W. E. Moudani and F. Mora-Camino, 'A dynamic approach for aircraft assignment and maintenance scheduling by airlines', *J. Air Transp. Manag.*, vol. 6, no. 4, pp. 233–237, Oct. 2000.
- [95] H. H. Y. Lee and D. Scott, 'Overview of maintenance strategy, acceptable maintenance standard and resources from a building maintenance operation perspective', *J. Build. Apprais.*, vol. 4, no. 4, pp. 269–278, Mar. 2009.
- [96] J. Taylor and T. Christensen, 'Airline Maintenance Resource Management: Improving Communication', in *Airline Maintenance Resource Management: Improving Communication*, SAE, 1998, pp. 1–15.
- [97] F. P. Frisina, 'Computer software for maintenance resource management', US6385621B1, 07-May-2002.
- [98] B. Sian, M. Robertson, and J. Watson, *Maintenance Resource Management Handbook*. Washington, DC: Federal Aviation Administration Office of Aviation Medicine, 1996.
- [99] J. C. Taylor, 'Reliability and validity of the Maintenance Resources Management/Technical Operations Questionnaire', *Int. J. Ind. Ergon.*, vol. 26, no. 2, pp. 217–230, Aug. 2000.
- [100] J. Wakiru, L. Pintelon, P. Muchiri, and P. Chemweno, 'Maintenance Optimization: Application of Remanufacturing and Repair Strategies', *Procedia CIRP*, vol. 69, pp. 899–904, 2018.
- [101] S. H. Sim and J. Endrenyi, 'Optimal preventive maintenance with repair', *IEEE Trans. Reliab.*, vol. 37, no. 1, pp. 92–96, Apr. 1988.
- [102] M. A. El-Haram and M. W. Horner, 'Factors affecting housing maintenance cost', *J. Qual. Maint. Eng.*, vol. 8, no. 2, pp. 115–123, Jun. 2002.
- [103] A. Despujols, 'Normes de maintenance européennes et internationales', *Ref: Tip095web - 'Maintenance'*, 10-Oct-2015. [Online]. Available: <https://www.techniques-ingenieur.fr/base-documentaire/genie-industriel-th6/soutien-de-maintenance-42637210/normes-de-maintenance-europeennes-et-internationales-mt9181/>. [Accessed: 14-Mar-2019].
- [104] J. Soldatos, '5 important Standards Maintenance Professionals should be aware of'. [Online]. Available: <https://www.solufy.com/blog/five-standards-maintenance-professionals>. [Accessed: 14-Mar-2019].
- [105] J. F. G. Fernández and A. C. Márquez, 'International Standards, Best Practices and Maintenance Management Models as Reference', in *Maintenance Management in Network Utilities: Framework and Practical Implementation*, J. F. Gómez Fernández and A. Crespo Márquez, Eds. London: Springer London, 2012, pp. 33–59.
- [106] 'CEN - EN 13306 - Maintenance - Maintenance terminology | Engineering360'. [Online]. Available: <https://standards.globalspec.com/std/10272557/en-13306>. [Accessed: 15-Jan-2019].

References

- [107] K. Khazraei and J. Deuse, 'A strategic standpoint on maintenance taxonomy', *J. Facil. Manag.*, vol. 9, pp. 96–113, May 2011.
- [108] L. Swanson, 'Linking maintenance strategies to performance', *Int. J. Prod. Econ.*, vol. 70, no. 3, pp. 237–244, Apr. 2001.
- [109] M. Kajko-Mattsson, 'Problem management maturity within corrective maintenance', *J. Softw. Maint.*, vol. 14, pp. 197–227, May 2002.
- [110] O. Maurine, 'Corrective Maintenance Practices and Operational Performance of Manufacturing Firms Listed in the Nairobi Securities Exchange', p. 66.
- [111] M. j. Alvarez, E. Viles, F. Alonso, and D. Puente, 'Improving the corrective maintenance of an electronic system for trains', *J. Qual. Maint. Eng.*, vol. 13, no. 1, pp. 75–87, Apr. 2007.
- [112] D. J. Sherwin, 'Age-based opportunity maintenance', *J. Qual. Maint. Eng.*, vol. 5, no. 3, pp. 221–235, Sep. 1999.
- [113] D. Trentesaux, T. Borangiu, and A. Thomas, 'Emerging ICT concepts for smart, safe and sustainable industrial systems', *Comput. Ind.*, vol. 81, pp. 1–10, Sep. 2016.
- [114] S. J. Joo, R. R. Levary, and M. E. Ferris, 'Planning Preventive Maintenance for a Fleet of Police Vehicles Using Simulation', *Simulation*, vol. 68, no. 2, pp. 93–99, Feb. 1997.
- [115] M. Jasiulewicz-Kaczmarek, 'Sustainability: Orientation in Maintenance Management—Theoretical Background', in *EcoProduction and Logistics: Emerging Trends and Business Practices*, P. Golinska, Ed. Berlin, Heidelberg: Springer Berlin Heidelberg, 2013, pp. 117–134.
- [116] S. Mehar, S. Zeadally, G. Rémy, and S. M. Senouci, 'Sustainable Transportation Management System for a Fleet of Electric Vehicles', *IEEE Trans. Intell. Transp. Syst.*, vol. 16, no. 3, pp. 1401–1414, Jun. 2015.
- [117] J. Mbuli, D. Trentesaux, and T. Dailly, 'Specifying a Condition-Based Maintenance Decision Support System of a Fleet of Cyber-Physical Systems', in *Service Orientation in Holonic and Multi-Agent Manufacturing, studies in computational intelligence*, Springer, 2019, vol. 803, pp. 285–294.
- [118] M. Rawat and B. K. Lad, 'Novel approach for machine tool maintenance modelling and optimization using fleet system architecture', *Comput. Ind. Eng.*, vol. 126, pp. 47–62, Dec. 2018.
- [119] M. Stålhane, E. E. Halvorsen-Weare, L. M. Nonås, and G. Pantuso, 'Optimizing vessel fleet size and mix to support maintenance operations at offshore wind farms', *Eur. J. Oper. Res.*, Jan. 2019.
- [120] K. Schneider and C. R. Cassady, 'Evaluation and comparison of alternative fleet-level selective maintenance models', *Reliab. Eng. Syst. Saf.*, vol. 134, pp. 178–187, 2015.
- [121] S. Dožić, A. Jelović, M. Kalić, and M. Čangalović, 'Variable Neighborhood Search to solve an airline fleet sizing and fleet assignment problem', *Transp. Res. Procedia*, vol. 37, pp. 258–265, 2019.
- [122] A. Gutierrez-Alcoba, G. Ortega, E. M. T. Hendrix, E. E. Halvorsen-Weare, and D. Haugland, 'A model for optimal fleet composition of vessels for offshore wind farm maintenance', *Procedia Comput. Sci.*, vol. 108, pp. 1512–1521, 2017.
- [123] W. J. C. Verhagen and L. W. M. De Boer, 'Predictive maintenance for aircraft components using proportional hazard models', *J. Ind. Inf. Integr.*, vol. 12, pp. 23–30, Dec. 2018.
- [124] D. Vujanović, V. Momčilović, N. Bojović, and V. Papić, 'Evaluation of vehicle fleet maintenance management indicators by application of DEMATEL and ANP', *Expert Syst. Appl.*, vol. 39, no. 12, pp. 10552–10563, Sep. 2012.
- [125] A. Kumar, R. Shankar, and L. S. Thakur, 'A big data driven sustainable manufacturing framework for condition-based maintenance prediction', *J. Comput. Sci.*, vol. 27, pp. 428–439, Jul. 2018.
- [126] M. Jasiulewicz-Kaczmarek and P. Drożyner, 'Social Dimension of Sustainable Development – Safety and Ergonomics in Maintenance Activities', in *Universal Access in Human-Computer Interaction. Design Methods, Tools, and Interaction Techniques for eInclusion*, 2013, pp. 175–184.
- [127] X. Shi, D. Veneziano, N. Xie, and J. Gong, 'Use of chloride-based ice control products for sustainable winter maintenance: A balanced perspective', *Cold Reg. Sci. Technol.*, vol. 86, pp. 104–112, Feb. 2013.
- [128] E. Uhlmann, M. Bilz, and J. Baumgarten, 'MRO – Challenge and Chance for Sustainable Enterprises', *Procedia CIRP*, vol. 11, pp. 239–244, 2013.

References

- [129] M. Jasiulewicz-Kaczmarek, 'The role and contribution of maintenance in sustainable manufacturing', *IFAC Proc. Vol.*, vol. 46, no. 9, pp. 1146–1151, 2013.
- [130] M. Jasiulewicz-Kaczmarek and P. Drożyner, 'The Role of Maintenance in Reducing the Negative Impact of a Business on the Environment', in *Sustainability Appraisal: Quantitative Methods and Mathematical Techniques for Environmental Performance Evaluation*, M. G. Erechchoukova, P. A. Khaiteer, and P. Golinska, Eds. Berlin, Heidelberg: Springer Berlin Heidelberg, 2013, pp. 141–166.
- [131] Y. P. Cai, G. H. Huang, Q. G. Lin, X. H. Nie, and Q. Tan, 'An optimization-model-based interactive decision support system for regional energy management systems planning under uncertainty', *Expert Syst. Appl.*, vol. 36, no. 2, pp. 3470–3482, Mar. 2009.
- [132] O. Sénéchal, 'Maintenance decision support for sustainable performance: problems and research directions at the crossroads of health management and eco-design', *IFAC-Pap.*, vol. 49, no. 28, pp. 85–90, 2016.
- [133] C. Sriram and A. Haghani, 'An optimization model for aircraft maintenance scheduling and re-assignment', *Transp. Res. Part Policy Pract.*, vol. 37, no. 1, pp. 29–48, Jan. 2003.
- [134] F. Tonelli *et al.*, 'Assessment of mathematical programming and agent-based modelling for off-line scheduling: application to energy aware manufacturing', *CIRP Ann.*, vol. 65, no. 1, pp. 405–408, 2016.
- [135] Y. Zhou, A. Rossi, and J.-K. Hao, 'Towards effective exact methods for the Maximum Balanced Biclique Problem in bipartite graphs', *Eur. J. Oper. Res.*, vol. 269, no. 3, pp. 834–843, 2018.
- [136] I. Hinostroza, L. Pradenas, and V. Parada, 'Board cutting from logs: Optimal and heuristic approaches for the problem of packing rectangles in a circle', *Int. J. Prod. Econ.*, vol. 145, no. 2, pp. 541–546, 2013.
- [137] F. V. Fomin and P. Kaski, 'Exact exponential algorithms', *Commun. ACM*, vol. 56, no. 3, pp. 80–88, Mar. 2013.
- [138] F. V. Fomin and D. Kratsch, *Exact exponential algorithms*. Berlin: Springer, 2010.
- [139] M. Moshref-Javadi, 'Heuristic Design and Optimization'. [Online]. Available: <http://www.mit.edu/~moshref/Heuristics.html>. [Accessed: 04-Mar-2019].
- [140] J. Pearl, *Heuristics: Intelligent search strategies for computer problem solving*. 1984.
- [141] M. J. Apter, *The computer simulation of behaviour*. London: Hutchinson, 1970.
- [142] A.-T. Nguyen, S. Reiter, and P. Rigo, 'A review on simulation-based optimization methods applied to building performance analysis', *Appl. Energy*, vol. 113, pp. 1043–1058, Jan. 2014.
- [143] V. Mattila and K. Virtanen, 'Maintenance scheduling of a fleet of fighter aircraft through multi-objective simulation-optimization', *Simulation*, vol. 90, no. 9, pp. 1023–1040, Sep. 2014.
- [144] M. J. Dupuy, D. E. Wesely, and C. S. Jenkins, 'Airline fleet maintenance: Trade-off analysis of alternate aircraft maintenance approaches', in *2011 IEEE Systems and Information Engineering Design Symposium*, Charlottesville, VA, USA, 2011, pp. 29–34.
- [145] E. Bivona and G. B. Montemaggiore, 'Evaluating Fleet and Maintenance Management Strategies through System Dynamics Model in a City Bus Company', presented at the The 23rd International Conference of the System Dynamics Society, Boston, USA, 2005.
- [146] H. B. E. Haouzi, A. Thomas, and P. Charpentier, 'Toward adaptive modelling & simulation for IMS: The Adaptive Capability Maturity Model and future challenges', *IFAC Proc. Vol.*, vol. 46, no. 7, pp. 174–179, May 2013.
- [147] H. El Haouzi, R. Pannequin, and A. Thomas, 'Génération automatique de plateformes de simulation pour des systèmes organisés en flux tirés', in *7e Congrès International de Génie Industriel*, Trois Rivières, Canada, 2007, p. CDR0M.
- [148] H. El Haouzi, J.-F. Petin, and A. Thomas, 'Simulation as a support of design and validation of a product driven control system', *IFAC Proc. Vol.*, vol. 41, no. 2, pp. 10540–10545, Jan. 2008.
- [149] A. Gruber, S. Yanovski, and I. Ben-Gal, 'Condition-Based Maintenance via Simulation and a Targeted Bayesian Network Metamodel', *Qual. Eng.*, vol. 25, no. 4, pp. 370–384, Oct. 2013.
- [150] X. Li *et al.*, 'A decision support system for strategic maintenance planning in offshore wind farms', *Renew. Energy*, vol. 99, pp. 784–799, Dec. 2016.

References

- [151] S. M. Sinha, 'Chapter 1 - Introduction', in *Mathematical Programming*, Burlington: Elsevier Science, 2006, pp. 1–9.
- [152] C. A. Méndez, I. E. Grossmann, I. Harjunkski, and P. Kaboré, 'A simultaneous optimization approach for off-line blending and scheduling of oil-refinery operations', *Comput. Chem. Eng.*, vol. 30, no. 4, pp. 614–634, 2006.
- [153] Q. Feng, Y. Chen, B. Sun, and S. Li, 'An Optimization Method for Condition Based Maintenance of Aircraft Fleet Considering Prognostics Uncertainty', *Sci. World J.*, vol. 2014, pp. 1–8, 2014.
- [154] I. E. Grossmann, S. V. den Heever, and I. Harjunkski, 'Discrete Optimization Methods and their Role in the Integration of Planning and Scheduling', in *Computers & Chemical Engineering*, Vol. 326, pp. 150-168, 2002.
- [155] D. Vujanovic, V. Momcilovic, and M. Vasic, 'A hybrid multi-criteria decision making model for the vehicle service center selection with the aim to increase the vehicle fleet energy efficiency', *Therm. Sci.*, vol. 22, no. 3, pp. 1549–1561, 2018.
- [156] V. Gopalaswamy, J. A. Rice, and F. G. Miller, 'Transit Vehicle Component Maintenance Policy via Multiple Criteria Decision Making Methods', *J. Oper. Res. Soc.*, vol. 44, no. 1, pp. 37–50, 1993.
- [157] D. M. Castro and F. S. Parreiras, 'A review on multi-criteria decision-making for energy efficiency in automotive engineering', *Appl. Comput. Inform.*, Apr. 2018.
- [158] S. D. Pohekar and M. Ramachandran, 'Application of multi-criteria decision making to sustainable energy planning—A review', *Renew. Sustain. Energy Rev.*, vol. 8, no. 4, pp. 365–381, Aug. 2004.
- [159] R. Z. Farahani, M. SteadieSeifi, and N. Asgari, 'Multiple criteria facility location problems: A survey', *Appl. Math. Model.*, vol. 34, no. 7, pp. 1689–1709, Jul. 2010.
- [160] Z. A. Bukhsh, I. Stipanovic, G. Klanker, A. O. Connor, and A. G. Doree, 'Network level bridges maintenance planning using Multi-Attribute Utility Theory', *Struct. Infrastruct. Eng.*, vol. 15, no. 7, pp. 1–14, Jan. 2018.
- [161] R. L. Keeney and H. Raiffa, *Decisions with Multiple Objectives: Preferences and Value Trade-Offs*. Cambridge: Cambridge University Press, 1993.
- [162] A. Mardani, E. K. Zavadskas, Z. Khalifah, A. Jusoh, and K. M. Nor, 'Multiple Criteria Decision-Making Techniques in Transportation Systems: A Systematic Review Of The State Of The Art Literature', *Transport*, vol. 31, no. 3, pp. 359–385, Dec. 2015.
- [163] E. Alonso, 'From Artificial Intelligence to Multi-Agent Systems: Some Historical and Computational Remarks', *Artif. Intell. Rev.*, vol. 21, no. 1, pp. 3–24, 1998.
- [164] I. Ali and S. Bagchi, 'Designing hybrid graph model and algorithmic analysis of workflow decomposition in mobile distributed systems', *Future Gener. Comput. Syst.*, vol. 86, pp. 145–161, 2018.
- [165] S. J. Russell and P. Norvig, *Artificial Intelligence: A Modern Approach*, 2nd ed. Pearson Education, 2003.
- [166] P. Maes, 'Artificial Life Meets Entertainment: Lifelike Autonomous Agents', *Commun ACM*, vol. 38, no. 11, pp. 108–114, Nov. 1995.
- [167] J. Xie and C.-C. Liu, 'Multi-agent systems and their applications', *J. Int. Counc. Electr. Eng.*, vol. 7, no. 1, pp. 188–197, Jan. 2017.
- [168] P. Stone and M. Veloso, 'Multiagent Systems: A survey from a machine learning perspective', *Auton. Robots*, vol. 8, no. 3, pp. 345–383, Jul. 2000.
- [169] N. R. Jennings, K. Sycara, and M. Wooldridge, 'A Roadmap of Agent Research and Development', *Auton. Agents Multi-Agent Syst.*, vol. 1, no. 1, pp. 7–38, Mar. 1998.
- [170] T. C. Schelling, 'Dynamic models of segregation+', *J. Math. Sociol.*, vol. 1, no. 2, pp. 143–186, Jul. 1971.
- [171] R. M. Axelrod, *The complexity of cooperation: agent-based models of competition and collaboration*. Princeton, N.J: Princeton University Press, 1997.
- [172] D. McFarlane and R. Cuthbert, 'Modelling information requirements in complex engineering services', *Comput. Ind.*, vol. 63, no. 4, pp. 349–360, May 2012.

References

- [173] T. Pirttioja, A. Halme, A. Pakonen, I. Seilonen, and K. Koskinen, 'Multi-Agent System Enhanced Supervision of Process Automation', pp. 151–156, 2006.
- [174] H.-J. Bürkert, K. Fischer, and G. Vierke, 'Holonc transport scheduling with teletruck', *Appl. Artif. Intell.*, vol. 14, no. 7, pp. 697–725, 2000.
- [175] H. Vermaak and J. Kinyua, 'Multi-Agent Systems based Intelligent Maintenance Management for a Component-Handling Platform', in *2007 IEEE International Conference on Automation Science and Engineering*, Scottsdale, AZ, USA, 2007, pp. 1057–1062.
- [176] J. Lee, M. Lee, S. Lee, S. Oh, and J. R. Jang, 'A Multi-agent based Facility Maintenance Planning and Monitoring System: A Case Study', Korea, pp.110-116, 2012.
- [177] D. V. Weppenaar, H. Vermaak, and J. Kinyua, 'Utilising multi-agent systems to develop an intelligent maintenance management system based on the Drools-Planner', *J. New Gener. Sci.*, vol. 10, no. 1, pp. 170–190, Jan. 2012.
- [178] R. H. Sprague, 'A Framework for the Development of Decision Support Systems', *MIS Q.*, vol. 4, no. 4, p. 1, Dec. 1980.
- [179] S. Alter, 'A work system view of DSS in its fourth decade', *Decis. Support Syst.*, vol. 38, no. 3, pp. 319–327, Dec. 2004.
- [180] G. Fick and R. H. Sprague, *Decision Support Systems: Issues and Challenges: Proceedings of an International Task Force Meeting June 23-25, 1980*. Elsevier, 2013.
- [181] A. Aggarwal, 'A Taxonomy of Sequential Decision Support Systems', presented at the 2001 Informing Science Conference, 2001.
- [182] L. R. Medsker, 'An interactive decision support system for energy policy analysis', *Commun. ACM*, vol. 27, no. 11, pp. 1122–1128, Nov. 1984.
- [183] E. W. Robak, 'Toward a Microcomputer-Based DSS for Planning Forest Operations', *Interfaces*, vol. 14, no. 5, pp. 105–111, Oct. 1984.
- [184] R. H. Sprague, 'DSS in context', *Decis. Support Syst.*, vol. 3, no. 3, pp. 197–202, Sep. 1987.
- [185] I. Benbasat and A. S. Dexter, 'An Experimental Evaluation of Graphical and Color-Enhanced Information Presentation', *Manag. Sci.*, vol. 31, no. 11, pp. 1348–1364, Nov. 1985.
- [186] G. W. Dickson, G. DeSanctis, and D. J. McBride, 'Understanding the effectiveness of computer graphics for decision support: a cumulative experimental approach', *Commun. ACM*, vol. 29, no. 1, pp. 40–47, Jan. 1986.
- [187] H. C. Lucas, 'An Experimental Investigation of the Use of Computer-Based Graphics in Decision Making', *Manag. Sci.*, vol. 27, no. 7, pp. 757–768, Jul. 1981.
- [188] A. K. Aggarwal, 'Simulation as a DSS modelling technique', *Inf. Manage.*, vol. 19, no. 5, pp. 295–305, Dec. 1990.
- [189] A. K. Aggarwal, R. R. Vemuganti, and W. Fetner, 'A model-based decision support system for scheduling lumber drying operations', *Prod. Oper. Manag.*, vol. 1, no. 3, pp. 320–328, Jan. 2009.
- [190] R. H. Bonczek, C. W. Holsapple, and A. B. Whinston, 'The evolving roles of models in decision support systems', *Decis. Sci.*, vol. 11, no. 2, pp. 337–356, Apr. 1980.
- [191] R. H. Sprague and H. J. Watson, *Decision support systems: putting theory into practice*. Englewood Cliffs: Prentice Hall, 1993.
- [192] S. A. Floyd, C. F. Turner, and K. Roscoe Davis, 'Model-based decision support systems: An effective implementation framework', *Comput. Oper. Res.*, vol. 16, no. 5, pp. 481–491, Jan. 1989.
- [193] H. S. Weigel and S. P. Wilcox, 'The Army's personnel decision support system', *Decis. Support Syst.*, vol. 9, no. 3, pp. 281–306, Apr. 1993.
- [194] H. K. Bhargava, D. J. Power, and D. Sun, 'Progress in Web-based decision support technologies', *Decis. Support Syst.*, vol. 43, no. 4, pp. 1083–1095, Aug. 2007.
- [195] M. Cioca and L.-I. Cioc, 'Decision Support Systems used in Disaster Management', in *Decision Support Systems*, C. S., Ed. InTech, 2010.
- [196] A. Hoffmann, 'How profitable is European Road Transport?', 15-Mar-2018. [Online]. Available: <https://www.tnx-logistics.com/blog/2018/03/15/how-profitable-is-european-road-transport.html>. [Accessed: 01-Mar-2019].

References

- [197] J. Zak, 'Decision Support Systems in Transportation', in *Handbook on Decision Making: Vol 1: Techniques and Applications*, L. C. Jain and C. P. Lim, Eds. Berlin, Heidelberg: Springer Berlin Heidelberg, 2010, pp. 249–294.
- [198] J. B. Michael *et al.*, 'Integrated Diagnostic System (IDS) for Aircraft Fleet Maintenance', in *Proceedings of the AAAI/IAAI*, Providence, Rhode Island, 1998.
- [199] P. Juneja, 'Designing a Decision Support System User Interface'. [Online]. Available: <https://www.managementstudyguide.com/designing-decision-support-system-user-interface.htm>. [Accessed: 21-Mar-2019].
- [200] J. M. Hoc, 'From human-machine interaction to human-machine cooperation', *Ergonomics*, vol. 43, no. 7, pp. 833–843, Jul. 2000.
- [201] P. Millot and G. Boy, 'Human-machine cooperation: a solution for life-critical Systems?', *Work*, no. Supplement 1, pp. 4552–4559, 2012.
- [202] C. Kolski, Ed., 'From Human-Machine Interaction to Cooperation: Towards the Integrated Copilot', in *Human-Computer Interactions in Transport*, Hoboken, NJ, USA: John Wiley & Sons, Inc, 2013, pp. 129–155.
- [203] M.-P. Pacaux, S. A. D. Godin, B. Rajaonah, F. Anceaux, and F. Vanderhaegen, 'Levels of automation and human-machine cooperation: Application to human-robot interaction', *IFAC Proc. Vol.*, vol. 44, no. 1, pp. 6484–6492, Jan. 2011.
- [204] M. Pacaux-Lemoine, D. Trentesaux, and G. Z. Rey, 'Human-machine cooperation to design Intelligent Manufacturing Systems', in *IECON 2016 - 42nd Annual Conference of the IEEE Industrial Electronics Society*, 2016, pp. 5904–5909.
- [205] P. Millot and M. P. Lemoine, 'An attempt for generic concepts toward human-machine cooperation', in *SMC'98 Conference Proceedings. 1998 IEEE International Conference on Systems, Man, and Cybernetics (Cat. No.98CH36218)*, 1998, vol. 1, pp. 1044–1049 vol.1.
- [206] V. Zeimpekis, *Dynamic fleet management concepts, systems, algorithms & case studies*. New York: Springer, 2007.
- [207] C. W. Holsapple and A. B. Whinston, *Business expert systems*. Homewood, Ill: Irwin, 1987.
- [208] T. Bui and J. Lee, 'An agent-based framework for building decision support systems', *Decis. Support Syst.*, vol. 25, no. 3, pp. 225–237, Apr. 1999.
- [209] D. Trentesaux and G. Branger, 'Foundation of the Surfer Data Management Architecture and Its Application to Train Transportation', in *Service Orientation in Holonic and Multi-Agent Manufacturing: Proceedings of SOHOMA 2017*, T. Borangiu, D. Trentesaux, A. Thomas, and O. Cardin, Eds. Cham: Springer International Publishing, 2018, vol. 762, pp. 111–125.
- [210] G. Branger *et al.*, 'System and method for the asset management of railway trains', Patent WO2017211593, 2016.
- [211] A. Le Mortellec, J. Clarhaut, Y. Sallez, T. Berger, and D. Trentesaux, 'Embedded holonic fault diagnosis of complex transportation systems', *Eng. Appl. Artif. Intell.*, vol. 26, no. 1, pp. 227–240, Jan. 2013.
- [212] A. Fadil, J. Clarhaut, G. Branger, and D. Trentesaux, 'Smart Condition Based Maintenance (S-CBM) for a Fleet of Mobile Entities', in *Service Orientation in Holonic and Multi-Agent Manufacturing, Studies in computational intelligence, Springer*, 2017, vol. 694, pp. 115–123.
- [213] C. Ramos, 'Limitations of decision support for intelligent manufacturing: The need for a new generation of decision support systems', *IFAC Proc. Vol.*, vol. 33, no. 20, pp. 167–171, Jul. 2000.
- [214] J. C. Day, 'Use and limitations of decision support systems/tools', 26-Jul-2016. [Online]. Available: <https://panorama.solutions/en/building-block/use-and-limitations-decision-support-systemstools>. [Accessed: 10-Jan-2019].
- [215] Z. S. Arora, 'Limitations of DSS', *Scribd*. [Online]. Available: <https://fr.scribd.com/doc/52046194/Limitations-of-DSS>. [Accessed: 10-Jan-2019].
- [216] F. G. Filip, *Sisteme suport pentru decizii*. București: Editura Tehnică, 2007.
- [217] P. Juneja, 'Limitations & Disadvantages of Decision Support Systems'. [Online]. Available: <https://www.managementstudyguide.com/limitations-and-disadvantages-of-decision-support-systems.htm>. [Accessed: 10-Jan-2019].

References

- [218] K. N. Qureshi and A. H. Abdullah, 'A Survey on Intelligent Transportation Systems', *Middle-East J. Sci. Res.*, vol. 15, no. 5, pp. 629–642, 2013.
- [219] G. M. Siddesh, G. C. Deka, K. G. Srinivasa, and L. M. Patnaik, *Cyber-Physical Systems: A Computational Perspective*. CRC Press, 2015.
- [220] J. M. Bradley and E. M. Atkins, 'Optimization and Control of Cyber-Physical Vehicle Systems', *Sensors*, vol. 15, no. 9, pp. 23020–23049, Sep. 2015.
- [221] J. M. Bradley and E. M. Atkins, 'Cyber-Physical Optimization for Unmanned Aircraft Systems', *J. Aerosp. Inf. Syst.*, vol. 11, no. 1, pp. 48–60, 2014.
- [222] M. Z. A. Bhuiyan, J. Wu, G. Wang, and J. Cao, 'Sensing and Decision Making in Cyber-Physical Systems: The Case of Structural Event Monitoring', *IEEE Trans. Ind. Inform.*, vol. 12, no. 6, pp. 2103–2114, Dec. 2016.
- [223] S. Ali, S. B. Qaisar, H. Saeed, M. Farhan Khan, M. Naeem, and A. Anpalagan, 'Network Challenges for Cyber Physical Systems with Tiny Wireless Devices: A Case Study on Reliable Pipeline Condition Monitoring', *Sensors*, vol. 15, no. 4, pp. 7172–7205, Mar. 2015.
- [224] T. Noack and I. Schmitt, 'Monitoring mobile cyber-physical systems by means of a knowledge discovery cycle', in *IEEE 7th International Conference on Research Challenges in Information Science (RCIS)*, 2013, pp. 1–12.
- [225] N. Chen *et al.*, 'Cyber-Physical Geographical Information Service-Enabled Control of Diverse In-Situ Sensors', *Sensors*, vol. 15, no. 2, pp. 2565–2592, Jan. 2015.
- [226] V. V. S. Sarma, K. Ramchand, and A. K. Rao, 'Queuing Models for Estimating Aircraft Fleet Availability', *IEEE Trans. Reliab.*, vol. R-26, no. 4, pp. 253–256, Oct. 1977.
- [227] J. N. YANG and W. J. TRAPP, 'Reliability Analysis of Aircraft Structures under Random Loading and Periodic Inspection', *AIAA J.*, vol. 12, no. 12, pp. 1623–1630, 1974.
- [228] J. Halpin, K. Jerina, and T. Johnson, 'Characterization of Composites for the Purpose of Reliability Evaluation', in *Analysis of the Test Methods for High Modulus Fibers and Composites*, J. Whitney, Ed. 100 Barr Harbor Drive, PO Box C700, West Conshohocken, PA 19428-2959: ASTM International, 1973, pp. 5-5–60.
- [229] B. lung, 'Overview on E-maintenance facilities addressing PHM vs. CBM+ requirements', in *International Conference on Prognostics and Health Management, IEEE PHM 2012*, Beijing, China, 2012.
- [230] K. Le Son, M. Fouladirad, A. Barros, E. Levrat, and B. lung, 'Remaining useful life estimation based on stochastic deterioration models: A comparative study', *Reliab. Eng. Syst. Saf.*, vol. 112, pp. 165–175, Apr. 2013.
- [231] A. Hoang, P. Do, and B. lung, 'Prognostics on energy efficiency performance for maintenance decision-making: Application to industrial platform TĒLMA', in *2015 Prognostics and System Health Management Conference (PHM)*, 2015, pp. 1–7.
- [232] Ź. Marušić, B. Galović, and O. Pita, 'Optimizing Maintenance Reliability Program for Small Fleets', *Transport*, vol. 22, no. 3, pp. 174–177, Sep. 2007.
- [233] Y. Peng, M. Dong, and M. J. Zuo, 'Current status of machine prognostics in condition-based maintenance: a review', *Int. J. Adv. Manuf. Technol.*, vol. 50, no. 1, pp. 297–313, Sep. 2010.
- [234] O. E. Dragomir, R. Gouriveau, F. Dragomir, E. Minca, and N. Zerhouni, 'Review of prognostic problem in condition-based maintenance', in *2009 European Control Conference (ECC)*, Budapest, 2009, pp. 1587–1592.
- [235] K. Javed, R. Gouriveau, and N. Zerhouni, 'State of the art and taxonomy of prognostics approaches, trends of prognostics applications and open issues towards maturity at different technology readiness levels', *Mech. Syst. Signal Process.*, vol. 94, pp. 214–236, Sep. 2017.
- [236] K. Goebel, M. Daigle, A. Saxena, S. Sankararaman, I. Roychoudhury, and J. Celaya, *Prognostics*. Wrocław: Amazon Fulfillment, 2017.
- [237] A. K. S. Jardine, D. Lin, and D. Banjevic, 'A review on machinery diagnostics and prognostics implementing condition-based maintenance', *Mechanical Systems and Signal Processing*, vol. 20, no. 7, pp. 1483-1510, Oct. 2006.

References

- [238] L. Hajibabai and Y. Ouyang, 'Dynamic Snow Plow Fleet Management Under Uncertain Demand and Service Disruption', *IEEE Trans. Intell. Transp. Syst.*, vol. 17, no. 9, pp. 2574–2582, Sep. 2016.
- [239] Y. Hu, B. Xu, J. F. Bard, H. Chi, and M. Gao, 'Optimization of multi-fleet aircraft routing considering passenger transiting under airline disruption', *Comput. Ind. Eng.*, vol. 80, pp. 132–144, Feb. 2015.
- [240] G. R. Weckman, J. H. Marvel, and R. L. Shell, 'Decision Support Approach to Fleet Maintenance Requirements in the Aviation Industry', *J. Aircr.*, vol. 43, no. 5, pp. 1352–1360, 2006.
- [241] H. Liao, E. A. Elsayed, and L.-Y. Chan, 'Maintenance of continuously monitored degrading systems', *Eur. J. Oper. Res.*, vol. 175, no. 2, pp. 821–835, Dec. 2006.
- [242] A. E. Stavale, 'Reducing Reliability Incidents And Improving Meantime Between Repair', in *24th Int. Pump Users Symp.*, 2008, pp. 21–24.
- [243] P. A. Kullstam, 'Availability, MTBF and MTRR for Repairable M out of N System', *IEEE Trans. Reliab.*, vol. R-30, no. 4, pp. 393–394, Oct. 1981.
- [244] N. Wang, M. Li, B. Xiao, and L. Ma, 'Availability analysis of a general time distribution system with the consideration of maintenance and spares', *Reliab. Eng. Syst. Saf.*, pp. 1–9, Jul. 2018.
- [245] Q. Chang, J. Ni, P. Bandyopadhyay, S. Biller, and G. Xiao, 'Maintenance staffing management', *J. Intell. Manuf.*, vol. 18, no. 3, pp. 351–360, Jun. 2007.
- [246] P. Do, H. C. Vu, A. Barros, and C. Bérenguer, 'Maintenance grouping for multi-component systems with availability constraints and limited maintenance teams', *Reliab. Eng. Syst. Saf.*, vol. 142, pp. 56–67, Oct. 2015.
- [247] T. S. Vaughan, 'Failure replacement and preventive maintenance spare parts ordering policy', *Eur. J. Oper. Res.*, vol. 161, no. 1, pp. 183–190, Feb. 2005.
- [248] A. H. Elwany and N. Z. Gebraeel, 'Sensor-driven prognostic models for equipment replacement and spare parts inventory', *IIE Trans.*, vol. 40, no. 7, pp. 629–639, Apr. 2008.
- [249] M. A. Ilgin and S. Tunali, 'Joint optimization of spare parts inventory and maintenance policies using genetic algorithms', *Int. J. Adv. Manuf. Technol.*, vol. 34, no. 5, pp. 594–604, Sep. 2007.
- [250] W. Wang, 'A stochastic model for joint spare parts inventory and planned maintenance optimisation', *Eur. J. Oper. Res.*, vol. 216, no. 1, pp. 127–139, Jan. 2012.
- [251] A. Van Horenbeek, J. Buré, D. Cattrysse, L. Pintelon, and P. Vansteenwegen, 'Joint maintenance and inventory optimization systems: A review', *Int. J. Prod. Econ.*, vol. 143, no. 2, pp. 499–508, Jun. 2013.
- [252] L. Marrero, 'Aircraft maintenance apparatus and method of maintaining aircraft', Patent US6477730B1, 12-Nov-2002.
- [253] H. A. Kinnison and T. Siddiqui, *Aviation Maintenance Management*. McGraw-Hill, 2012.
- [254] M. Choquet, R. Héon, C. Padioleau, P. Bouchard, C. Néron, and J.-P. Monchalain, 'Laser-Ultrasonic Inspection of the Composite Structure of an Aircraft in a Maintenance Hangar', in *Review of Progress in Quantitative Nondestructive Evaluation: Volume 14*, D. O. Thompson and D. E. Chimenti, Eds. Boston, MA: Springer US, 1995, pp. 545–552.
- [255] C. Gundegjerde, I. B. Halvorsen, E. E. Halvorsen-Weare, L. M. Hvattum, and L. M. Nonås, 'A stochastic fleet size and mix model for maintenance operations at offshore wind farms', *Transp. Res. Part C Emerg. Technol.*, vol. 52, pp. 74–92, Mar. 2015.
- [256] M. Stålhane, H. Vefsnmo, E. E. Halvorsen-Weare, L. M. Hvattum, and L. M. Nonås, 'Vessel Fleet Optimization for Maintenance Operations at Offshore Wind Farms Under Uncertainty', *Energy Procedia*, vol. 94, pp. 357–366, Sep. 2016.
- [257] J. Karlton, 'Cyber-Physical System for maintenance in industry 4.0', Report, Jonkoping University PAPER WITHIN Production Systems, 2016.
- [258] M. Aljumaili, K. Wandt, R. Karim, and P. Tretten, 'eMaintenance ontologies for data quality support', *J. Qual. Maint. Eng.*, vol. 21, no. 3, pp. 358–374, Aug. 2015.
- [259] M. Lebold and K. Reichard, 'OSA-CBM Architecture Development with Emphasis on XML Implementations', in *Maintenance and reliability conference*, 2002, pp. 1–16.

References

- [260] 'How an Open Standard Development Process Led to an MDA-like Solution | Object Management Group'. [Online]. Available: https://www.omg.org/mda/mda_files/OSACBM.htm. [Accessed: 21-May-2019].
- [261] 14:00-17:00, 'ISO 13374-3:2012', ISO. [Online]. Available: <http://www.iso.org/cms/render/live/en/sites/isoorg/contents/data/standard/03/76/37611.html>. [Accessed: 21-May-2019].
- [262] Z. Ma, L. Zhou, and W. Sheng, 'Analysis of the new asset management standard ISO 55000 and PAS 55', in *2014 China International Conference on Electricity Distribution (CICED)*, 2014, pp. 1668–1674.
- [263] W. R. Wessels and F. C. Sautter, 'Reliability analysis required to determine CBM condition indicators', in *2009 Annual Reliability and Maintainability Symposium*, 2009, pp. 454–459.
- [264] N. Beganovic and D. Söffker, 'Remaining lifetime modeling using State-of-Health estimation', *Mech. Syst. Signal Process.*, vol. 92, pp. 107–123, 2017.
- [265] G. Walter and S. D. Flapper, 'Condition-based maintenance for complex systems based on current component status and Bayesian updating of component reliability', *Reliab. Eng. Syst. Saf.*, vol. 168, pp. 227–239, 2017.
- [266] C. Okoh, R. Roy, J. Mehnen, and L. Redding, 'Overview of Remaining Useful Life Prediction Techniques in Through-life Engineering Services', *Procedia CIRP*, vol. 16, pp. 158–163, 2014.
- [267] C. I. Ossai, 'Remaining useful life estimation for repairable multi-state components subjected to multiple maintenance actions', *Reliab. Eng. Syst. Saf.*, vol. 182, pp. 142–151, Feb. 2019.
- [268] B. Zhang, Y. Sui, Q. Bu, and X. He, 'Remaining useful life estimation for micro switches of railway vehicles', *Control Eng. Pract.*, vol. 84, pp. 82–91, Mar. 2019.
- [269] J. G. Wohl, 'Maintainability Prediction Revisited: Diagnostic Behavior, System Complexity, and Repair Time', *IEEE Trans. Syst. Man Cybern.*, vol. 12, no. 3, pp. 241–250, May 1982.
- [270] J. D. Fitzsimmons *et al.*, 'Simulation of an electric vehicle fleet to forecast availability of grid balancing resources', in *2016 IEEE Systems and Information Engineering Design Symposium (SIEDS)*, 2016, pp. 205–210.
- [271] G. Kozanidis and A. Skipis, 'Flight and maintenance planning of military aircraft for maximum fleet availability: a biobjective model', in *International Conference on Multiple Criteria Decision Making*, 2006, pp. 1–11.
- [272] S. Martorell, M. Villamizar, S. Carlos, and A. Sánchez, 'Maintenance modeling and optimization integrating human and material resources', *Reliab. Eng. Syst. Saf.*, vol. 95, no. 12, pp. 1293–1299, Dec. 2010.
- [273] Y. Qin, Z. X. Wang, F. T. S. Chan, S. H. Chung, and T. Qu, 'A mathematical model and algorithms for the aircraft hangar maintenance scheduling problem', *Appl. Math. Model.*, vol. 67, pp. 491–509, Mar. 2019.
- [274] A. Ceruti, P. Marzocca, A. Liverani, and C. Bil, 'Maintenance in Aeronautics in an Industry 4.0 Context: The Role of Augmented Reality and Additive Manufacturing', *J. Comput. Des. Eng.*, Feb. 2019.
- [275] M. Cooley, 'Human-centred Systems', in *Designing Human-centred Technology: A Cross-disciplinary Project in Computer-aided Manufacturing*, H. Rosenbrock, Ed. London: Springer London, 1989, pp. 133–143.
- [276] D. McDonnell, N. Balfe, S. Al-Dahidi, and G. O'Donnell, 'Designing for Human-Centred Decision Support Systems in PHM', in *Second European Conference of the Prognostics and Health Management Society*, 2014, vol. 5, pp. 1–16.
- [277] S. Lepreux, M. Abed, and C. Kolski, 'A human-centred methodology applied to decision support system design and evaluation in a railway network context', *Cogn. Technol. Work*, vol. 5, no. 4, pp. 248–271, Dec. 2003.
- [278] D. A. Norman, *The Psychology of Everyday Things*. Basic Books, 1988.
- [279] C. Abras, D. Maloney-krichmar, and J. Preece, 'User-Centered Design', in *In Bainbridge, W. Encyclopedia of Human-Computer Interaction. Thousand Oaks: Sage Publications, 2004.*

References

- [280] E. B. Schlünz, P. M. Bokov, and J. H. van Vuuren, 'An optimisation-based decision support system framework for multi-objective in-core fuel management of nuclear reactor cores', *South Afr. J. Ind. Eng.*, vol. 27, no. 3, pp. 201–209, Nov. 2016.
- [281] K. Tidriri, N. Chatti, S. Verron, and T. Tiplica, 'Bridging data-driven and model-based approaches for process fault diagnosis and health monitoring: A review of researches and future challenges', *Annu. Rev. Control*, vol. 42, pp. 63–81, 2016.
- [282] R. Isermann, 'Model-based fault-detection and diagnosis – status and applications', *Annu. Rev. Control*, vol. 29, no. 1, pp. 71–85, Jan. 2005.
- [283] F. Peysson, M. Ouladsine, H. Noura, J.-B. Leger, and C. Allemand, 'New Approach to Prognostic System Failures', *IFAC Proc. Vol.*, vol. 41, no. 2, pp. 12861–12866, 2008.
- [284] R. Gouriveau, K. Medjaher, and N. Zerhouni, *From Prognostics and Health Systems Management to Predictive Maintenance 1: Monitoring and Prognostics*. John Wiley & Sons, 2016.
- [285] D. A. Tobon-Mejia, K. Medjaher, N. Zerhouni, and G. Tripot, 'A Data-Driven Failure Prognostics Method Based on Mixture of Gaussians Hidden Markov Models', *IEEE Trans. Reliab.*, vol. 61, no. 2, pp. 491–503, Jun. 2012.
- [286] G. M. Marakas, *Decision support systems in the 21st century*, 2nd ed. Upper Saddle River, N.J. ; [London] : Prentice Hall, 2003.
- [287] A. Gachet, R. Gachet, and P. Haettenschwiler, 'Developing Intelligent Decision Support Systems: A Bipartite Approach', in *International Conference on Knowledge-Based and Intelligent Information and Engineering Systems*, 2003, vol. 2774, pp. 87–93.
- [288] P. G. W. KEEN, *Decision Support Systems: A research perspective*. Cambridge: Center for Information Systems Research, Alfred P. Sloan School of Management, 2016.
- [289] I. Zeroual and A. Lakhouaja, 'Data science in light of natural language processing: An overview', *Procedia Comput. Sci.*, vol. 127, pp. 82–91, 2018.
- [290] Y.-M. Huang, R. Shadiev, and W.-Y. Hwang, 'Investigating the effectiveness of speech-to-text recognition applications on learning performance and cognitive load', *Comput. Educ.*, vol. 101, pp. 15–28, 2016.
- [291] V. R. Reddy and K. S. Rao, 'Prosody modeling for syllable based text-to-speech synthesis using feedforward neural networks', *Neurocomputing*, vol. 171, pp. 1323–1334, 2016.
- [292] 'LUIS (Language Understanding) – Cognitive Services – Microsoft Azure'. [Online]. Available: <https://www.luis.ai/home>. [Accessed: 04-Feb-2019].
- [293] D. Teodorovic, 'Transport modeling by multi-agent systems: a swarm intelligence approach', *Transp. Plan. Technol.*, vol. 26, no. 4, pp. 289–312, Aug. 2003.
- [294] M. Balmer, 'Travel demand modeling for multi-agent transport simulations: Algorithms and systems', Thesis ETH Zurich, 2007.
- [295] P. Davidsson, L. Henesey, L. Ramstedt, J. Törnquist, and F. Wernstedt, 'An analysis of agent-based approaches to transport logistics', *Transp. Res. Part C Emerg. Technol.*, vol. 13, no. 4, pp. 255–271, Aug. 2005.
- [296] G. Zhang and Y. Li, 'Agent-based Modeling and Simulation for Open Complex Systems', in *Proceedings of the 2Nd International Asia Conference on Informatics in Control, Automation and Robotics - Volume 1*, Piscataway, NJ, USA, 2010, pp. 504–507.
- [297] E. Bonabeau, 'Agent-based modeling: Methods and techniques for simulating human systems', *Proc. Natl. Acad. Sci.*, vol. 99, no. suppl 3, pp. 7280–7287, May 2002.
- [298] V. Robu, H. Noot, H. La Poutré, and W.-J. van Schijndel, 'A multi-agent platform for auction-based allocation of loads in transportation logistics', *Expert Syst. Appl.*, vol. 38, no. 4, pp. 3483–3491, Apr. 2011.
- [299] J. Himoff, G. Rzevski, and P. Skobelev, 'Magenta Technology Multi-agent Logistics i-Scheduler for Road Transportation', in *Proceedings of the Fifth International Joint Conference on Autonomous Agents and Multiagent Systems*, New York, NY, USA, 2006, pp. 1514–1521.
- [300] B. Fayech, S. Maouche, S. Hammadi, and P. Borne, 'Multi-agent decision-support system for an urban transportation network', in *Proceedings of the 5th Biannual World Automation Congress*, 2002, vol. 14, pp. 27–32.

References

- [301] J.-L. Koning and C. X. Ling, 'Cognitive agents and multiagent interaction', *Cogn. Syst. Res.*, vol. 4, no. 3, pp. 167–168, Sep. 2003.
- [302] A. Olaru and A. M. Florea, 'Emergence in Cognitive Multi-Agent Systems', in *CSCS17, the 17th International Conference on Control Systems and Computer Science, MASTS Workshop*, Bucarest, Romania, 2009, pp. 515–522.
- [303] W. Kritzinger, M. Karner, G. Traar, J. Henjes, and W. Sihn, 'Digital Twin in manufacturing: A categorical literature review and classification', *IFAC-Pap.*, vol. 51, no. 11, pp. 1016–1022, Jan. 2018.
- [304] S. Kaewunruen and N. Xu, 'Digital Twin for Sustainability Evaluation of Railway Station Buildings', *Front. Built Environ.*, vol. 4, 2018.
- [305] M. Holler, F. Uebernickel, and W. Brenner, 'Digital Twin Concepts in Manufacturing Industries - A Literature Review and Avenues for Further Research', in *Proceedings of the 18th International Conference on Industrial Engineering (IJIE)*, Korean Institute of Industrial Engineers, 2016.
- [306] F. Balbo and S. Pinson, 'Using intelligent agents for Transportation Regulation Support System design', *Transp. Res. Part C Emerg. Technol.*, vol. 18, no. 1, pp. 140–156, Feb. 2010.
- [307] Yan Li, Lu Chun, and A. N. Y. Ching, 'An agent-based platform for Web-enabled equipment predictive maintenance', in *IEEE/WIC/ACM International Conference on Intelligent Agent Technology*, 2005, pp. 132–135.
- [308] A. Stranjak, P. S. Dutta, M. Ebdem, A. Rogers, and P. Vytelingum, 'A Multi-agent Simulation System for Prediction and Scheduling of Aero Engine Overhaul', in *Proceedings of the 7th International Joint Conference on Autonomous Agents and Multiagent Systems: Industrial Track*, Richland, SC, 2008, pp. 81–88.
- [309] P. Davidsson, J. Holmgren, J. A. Persson, and L. Ramstedt, 'Multi Agent Based Simulation of Transport Chains', in *Proceedings of the 7th International Joint Conference on Autonomous Agents and Multiagent Systems - Volume 2*, Richland, SC, 2008, pp. 1153–1160.
- [310] M. Maciejewski and K. Nagel, 'Towards Multi-Agent Simulation of the Dynamic Vehicle Routing Problem in MATSim', in *Parallel Processing and Applied Mathematics*, 2012, pp. 551–560.
- [311] P. Arpaia, G. Lucariello, and A. Zanesco, 'Multi-Agent Remote Predictive Diagnosis of Dangerous Good Transports', in *2005 IEEE Instrumentation and Measurement Technology Conference Proceedings*, 2005, vol. 3, pp. 1685–1690.
- [312] T. Berger, D. Deneux, T. Bonte, E. Cocquebert, and D. Trentesaux, 'Arezzo-flexible manufacturing system: A generic flexible manufacturing system shop floor emulator approach for high-level control virtual commissioning', *Concurr. Eng.*, vol. 23, no. 4, pp. 333–342, Dec. 2015.
- [313] A. Dorri, S. S. Kanhere, and R. Jurdak, 'Multi-Agent Systems: A Survey', *IEEE Access*, vol. 6, pp. 28573–28593, 2018.
- [314] M. Paletta and P. Herrero, 'A MAS-Based Negotiation Mechanism to Deal with Service Collaboration in Cloud Computing', in *2009 International Conference on Intelligent Networking and Collaborative Systems*, 2009, pp. 147–153.
- [315] J. S. Heo and K. Y. Lee, 'A Multi-Agent System-Based Intelligent Heuristic Optimal Control System for A Large-Scale Power Plant', in *2006 IEEE International Conference on Evolutionary Computation*, 2006, pp. 1544–1551.
- [316] A. Bazghandi, 'Techniques, Advantages and Problems of Agent Based Modeling for Traffic Simulation', *IJCSI Int. J. Comput. Sci. Issues*, vol. 9, no. 1, pp. 115–119, 2012.
- [317] A. Bonisoli, 'Distributed and Multi-Agent Planning: Challenges and Open Issues', An Official Workshop of the 13th International Conference of the Italian Association for Artificial Intelligence, vol. 1126, p. 41-45, 2013.
- [318] R. I. Brafman and C. Domshlak, 'From One to Many: Planning for Loosely Coupled Multi-Agent Systems', in *International Conference on Automated Planning and Scheduling*, 2008, pp. 28–35.
- [319] S. Poslad, 'Specifying Protocols for Multi-agent Systems Interaction', *ACM Trans Auton Adapt Syst*, vol. 2, no. 4, Nov. 2007.
- [320] 'Java Agent Development Framework', *Wikipedia*. 24-Nov-2018.

References

- [321] 'NetLogo Home Page'. [Online]. Available: <https://ccl.northwestern.edu/netlogo/>. [Accessed: 09-Jun-2019].
- [322] 'Repast Suite Documentation'. [Online]. Available: <https://repast.github.io/>. [Accessed: 09-Jun-2019].
- [323] A. Giret and M. A. Salido, 'Extending ANEMONA with NDT Phases', *Procedia CIRP*, vol. 11, pp. 120–123, 2013.
- [324] A. Giret and V. Botti, 'Engineering Holonic Manufacturing Systems', *Comput. Ind.*, vol. 60, no. 6, pp. 428–440, Aug. 2009.
- [325] A. Giret, D. Trentesaux, M. A. Salido, E. Garcia, and E. Adam, 'A holonic multi-agent methodology to design sustainable intelligent manufacturing control systems', *J. Clean. Prod.*, vol. 167, pp. 1370–1386, Nov. 2017.
- [326] 'Contract Net Protocol', *Wikipedia*. 04-Nov-2013.
- [327] R. G. Smith, 'The Contract Net Protocol: High-Level Communication and Control in a Distributed Problem Solver', *IEEE Trans. Comput.*, no. 12, p. 10, 1980.
- [328] X. Li, S. Dang, N. Hao, and K. Li, 'An extension to Contract Net Protocol for military agents interactions', in *2010 5th International Conference on Computer Science Education*, 2010, pp. 1506–1511.
- [329] R. Davis and R. G. Smith, 'Negotiation as a metaphor for distributed problem solving', *Artif. Intell.*, vol. 20, no. 1, pp. 63–109, 1983.
- [330] G. Manzo and D. Baldassarri, 'Heuristics, Interactions, and Status Hierarchies: An Agent-based Model of Deference Exchange', *Sociol. Methods Res.*, vol. 44, no. 2, pp. 329–387, May 2015.
- [331] N. Magnenat-Thalmann, J. Yuan, D. Thalmann, and B.-J. You, *Context Aware Human-Robot and Human-Agent Interaction*. Springer, 2015.
- [332] Strömbom Daniel *et al.*, 'Solving the shepherding problem: heuristics for herding autonomous, interacting agents', *J. R. Soc. Interface*, vol. 11, no. 100, p. 20140719, Nov. 2014.
- [333] E. W. Davis and J. H. Patterson, 'A Comparison of Heuristic and Optimum Solutions in Resource-Constrained Project Scheduling', *Manag. Sci.*, vol. 21, no. 8, pp. 944–955, Apr. 1975.
- [334] P. Bettinger, J. Sessions, and K. Boston, 'A review of the status and use of validation procedures for heuristics used in forest planning', *Math. Comput. For. Nat.-Resour. Sci. MCFNS*, vol. 1, no. 1, pp. 26–37 (12), Feb. 2009.
- [335] 'Mathematical optimization', *Wikipedia*. 23-May-2019.
- [336] M. E. El-Hawary and G. S. Christensen, Eds., 'Chapter 3 >Mathematical Optimization Techniques', in *Mathematics in Science and Engineering*, vol. 142, Elsevier, 1979, pp. 59–123.
- [337] 'Integer programming', *Wikipedia*. 17-Apr-2019.
- [338] V. Gazzaneo, J. C. Carrasco, and F. V. Lima, 'An MILP-based Operability Approach for Process Intensification and Design of Modular Energy Systems', in *Computer Aided Chemical Engineering*, vol. 44, M. R. Eden, M. G. Ierapetritou, and G. P. Towler, Eds. Elsevier, 2018, pp. 2371–2376.
- [339] A. V. Sandita and C. I. Popirlan, 'Developing A Multi-Agent System in JADE for Information Management in Educational Competence Domains', *Procedia Econ. Finance*, vol. 23, pp. 478–486, 2015.
- [340] F. Bellifemine, G. Caire, and D. Greenwood, 'Developing Multi-agent Systems with JADE', *Dev. Multi-Agent Syst. JADE*, pp. 1–286, Feb. 2007.
- [341] F. Bergenti and G. Petrosino, 'Overview of a Scripting Language for JADE-Based Multi-Agent Systems', in *In Proc. 19th Workshop "From Objects to Agents" (CEUR Workshop Proceedings)*, RWTH Aachen, vol. 2215, pp. 57–62.
- [342] M. Wooldridge, N. R. Jennings, and D. Kinny, 'The Gaia Methodology for Agent-Oriented Analysis and Design', *Auton. Agents Multi-Agent Syst.*, vol. 3, no. 3, pp. 285–312, Sep. 2000.
- [343] P. Leitão and S. Karnouskos, *Industrial Agents: Emerging Applications of Software Agents in Industry*. Morgan Kaufmann, 2015.
- [344] F. Bellifemine, A. Poggi, and G. Rimassa, 'Developing multi-agent systems with a FIPA-compliant agent framework', *Softw. Pract. Exp.*, vol. 31, no. 2, pp. 103–128, 2001.

References

- [345] M. B. Ettienne, S. Vester, and J. Villadsen, 'Implementing a Multi-Agent System in Python with an Auction-Based Agreement Approach', in *Programming Multi-Agent Systems*, vol. 7217, L. Denis, O. Boissier, and R. H. Bordini, Eds. Berlin, Heidelberg: Springer Berlin Heidelberg, 2012, pp. 185–196.
- [346] A. Vatankhah Barenji and R. Barenji, 'Improving multi-agent manufacturing control system by indirect communication based on ant agents', *Proc. Inst. Mech. Eng. Part J. Syst. Control Eng.*, vol. 231, p. 447-458, May 2017.
- [347] D. Der Technischen Wissenschaften and M. Hauswirth, 'Internet-Scale Push Systems for Information Distribution - Architecture, Components, and Communication', Thesis Technische Universität Berlin, Fraunhofer FOKUS, 1999.
- [348] M. Baldoni, C. Baroglio, and F. Capuzzimati, '2COMM: A commitment-based MAS architecture', presented at the CEUR Workshop Proceedings, 2013, vol. 1099.
- [349] 'Environments'. [Online]. Available: <https://www.doc.ic.ac.uk/project/examples/2005/163/g0516302/environments/environments.html>. [Accessed: 27-May-2019].
- [350] N. Miyata, J. Ota, T. Arai, and H. Asama, 'Cooperative transport by multiple mobile robots in unknown static environments associated with real-time task assignment', *IEEE Trans. Robot. Autom.*, vol. 18, no. 5, pp. 769–780, Oct. 2002.
- [351] R. B. Duncan, 'Characteristics of Organizational Environments and Perceived Environmental Uncertainty', *Adm. Sci. Q.*, vol. 17, no. 3, pp. 313–327, 1972.
- [352] 'Deterministic system', *Wikipedia*. 01-Apr-2019.
- [353] A. Lasota and M. C. Mackey, *Probabilistic Properties of Deterministic Systems*. Cambridge University Press, 1985.
- [354] *MATLAB Optimization Toolbox*. 2016.
- [355] Ibm, *IBM ILOG CPLEX Optimization Studio CPLEX User's Manual*. 2011.
- [356] R. K, 'Agents and Environment Part 1: The Nature of The Environment', *Medium*, 10-Jul-2018.
- [357] W.-M. A. Tshibangu, 'Impact of Machine Reliability on Key Lean Performance Measures: The Case of a Flexible Manufacturing System (FMS)', in *Proceedings of the 13th International Conference on Informatics in Control, Automation and Robotics*, Portugal, 2016, pp. 567–575.
- [358] A. Chaudhuri, 'Predictive Maintenance for Industrial IoT of Vehicle Fleets using Hierarchical Modified Fuzzy Support Vector Machine', *ArXiv180609612 Cs*, Jun. 2018.
- [359] W. Wang and A. A. Syntetos, 'Spare parts demand: Linking forecasting to equipment maintenance', *Transp. Res. Part E Logist. Transp. Rev.*, vol. 47, no. 6, pp. 1194–1209, Nov. 2011.
- [360] J. Stearley, 'Defining and Measuring Supercomputer Reliability, Availability, and Serviceability (RAS)', in *Proceedings of the Linux clusters institute Conference*, 2005, pp. 1–15.
- [361] 'Accueil | SurferLab : laboratoire en intelligence distribuée pour les systèmes de transport'. [Online]. Available: <http://www.surferlab.fr/>. [Accessed: 10-Jan-2019].
- [362] A. Le Mortellec, 'Proposition d'une architecture de surveillance "active" à base d'agents intelligents pour l'aide à la maintenance de systèmes mobiles - Application au domaine ferroviaire'. Université de Valenciennes et du Hainaut-Cambresis, 2014.
- [363] 'Rail Transport Markets - Global Market Trends 2016-2025'. [Online]. Available: https://www.sci.de/en/document/news/rail-transport-markets-global-market-trends-2016-2025/?no_cache=1&tx_news_pi1%5Bcontroller%5D=News&tx_news_pi1%5Baction%5D=detail&cHash=a875e6986234d6c9ede70a2d40a989c2. [Accessed: 19-May-2019].
- [364] 'Découvrez Altran, leader mondial en solutions d'ingénierie et innovation', *Altran France*. [Online]. Available: <https://www.altran.com/fr/fr/>. [Accessed: 28-May-2019].
- [365] 'Railway industry, transport system and infrastructure - Altran', *Altran United States*. [Online]. Available: <https://www.altran.com/us/en/industries/rail-infrastructure-transportation/>. [Accessed: 28-May-2019].
- [366] R. Rault and D. Trentesaux, 'Artificial Intelligence, Autonomous Systems and Robotics: Legal Innovations', in *Service Orientation in Holonic and Multi-Agent Manufacturing: Proceedings of SOHOMA 2017, studies in computational intelligence*, Springer, vol. 762, T. Borangiu, D.

References

- Trentesaux, A. Thomas, and O. Cardin, Eds. Cham: Springer International Publishing, 2018, pp. 1–9.
- [367] D. Trentesaux and R. Rault, ‘Designing Ethical Cyber-Physical Industrial Systems’, *IFAC-Pap.*, vol. 50, no. 1, pp. 14934–14939, Jul. 2017.
- [368] D. Trentesaux *et al.*, ‘The Autonomous Train’, in *IEEE 2018 13th Annual Conference on System of Systems Engineering (SoSE)*, 2018, pp. 514–520.
- [369] ‘Top 5 Rail Industry trends to watch in 2018’. [Online]. Available: <https://www.bombardier.com/en/media/articles/top-5-rail-industry-trends-to-watch-in-2018.html>. [Accessed: 28-May-2019].
- [370] ‘The Future of Rail’. [Online]. Available: <https://www.iea.org/futureofrail/>. [Accessed: 28-May-2019].
- [371] ‘International Energy Agency’. [Online]. Available: <https://www.iea.org/>. [Accessed: 28-May-2019].
- [372] ‘Railway Technology | Rail & Train News & Views Updated Daily’, *Railway Technology*. [Online]. Available: <https://www.railway-technology.com/>. [Accessed: 28-May-2019].
- [373] ‘Major Challenges Facing Rail Operators, Maintainers, Owners and the Role of ICT - Railway Technology’. [Online]. Available: <https://www.railway-technology.com/downloads/whitepapers/operation/major-challenges-facing-rail-operators/>. [Accessed: 19-Jun-2019].
- [374] ‘Electric multiple unit’, *Wikipedia*. 21-Jun-2019.
- [375] ‘SNCF – Horaire, Train, Info Trafic, Services et Groupe International’, *SNCF*. [Online]. Available: <https://www.sncf.com/fr>. [Accessed: 19-Jun-2019].
- [376] ‘OMNEO: The ultimate breakthrough for high capacity comfort’, p. 7.
- [377] ‘SNCB Site Officiel - Achetez votre billet de train en ligne’. [Online]. Available: <https://www.belgiantrain.be:443/fr>. [Accessed: 19-Jun-2019].
- [378] *Practical E-Manufacturing and Supply Chain Management*. Elsevier, 2004.
- [379] N. Dadashi, J. R. Wilson, S. Sharples, D. Golightly, and T. Clarke, ‘A framework of data processing for decision making in railway intelligent infrastructure’, in *2011 IEEE International Multi-Disciplinary Conference on Cognitive Methods in Situation Awareness and Decision Support (CogSIMA)*, Miami Beach, FL, USA, 2011, pp. 276–283.
- [380] R. Kour, P. Tretten, and R. Karim, ‘eMaintenance solution through online data analysis for railway maintenance decision-making’, *J. Qual. Maint. Eng.*, vol. 20, no. 3, pp. 262–275, Aug. 2014.
- [381] K. Efthymiou, N. Papakostas, D. Mourtzis, and G. Chryssolouris, ‘On a Predictive Maintenance Platform for Production Systems’, *Procedia CIRP*, vol. 3, pp. 221–226, 2012.
- [382] V. Fedorenko, I. Fedorenko, A. Sukmanov, V. Samoylenko, D. Shlaev, and I. Atanov, ‘Modeling of data acquisition systems using the queueing theory’, *AEU - Int. J. Electron. Commun.*, vol. 74, pp. 83–87, Apr. 2017.
- [383] H. Austerlitz, ‘Introduction to Data Acquisition’, in *Data Acquisition Techniques Using PCs*, Howard Austerlitz, 2003, pp. 1–5.
- [384] N. V. Kirianaki, N. O. Shpak, and V. P. Deynega, *Data acquisition and signal processing for smart sensors*, vol. 13. 2002.
- [385] M. Maadooliat, J. Z. Huang, and J. Hu, ‘Integrating Data Transformation in Principal Components Analysis’, *J. Comput. Graph. Stat. Jt. Publ. Am. Stat. Assoc. Inst. Math. Stat. Interface Found. N. Am.*, vol. 24, no. 1, pp. 84–103, Jan. 2015.
- [386] D. R. Lewin and Y. Harmaty, ‘Predictive Maintenance using PCA’, *IFAC Proc. Vol.*, vol. 27, no. 2, pp. 439–444, May 1994.
- [387] J. Wang and C.- Chang, ‘Applications of Independent Component Analysis in Endmember Extraction and Abundance Quantification for Hyperspectral Imagery’, *IEEE Trans. Geosci. Remote Sens.*, vol. 44, no. 9, pp. 2601–2616, Sep. 2006.
- [388] E. Bechhoefer and M. Kingsley, ‘A Review of Time Synchronous Average Algorithms’, in *Annual Conference of the Prognostics and Health Management Society*, San Diego, CA, 2009, vol. 23, pp. 1–10.

References

- [389] S. S. Patil and J. A. Gaikwad, 'Vibration analysis of electrical rotating machines using FFT: A method of predictive maintenance', in *2013 Fourth International Conference on Computing, Communications and Networking Technologies (ICCCNT)*, Tiruchengode, 2013, pp. 1–6.
- [390] C. Mateo and J. A. Talavera, 'Short-Time Fourier Transform with the Window Size Fixed in the Frequency Domain (STFT-FD): Implementation', *SoftwareX*, vol. 8, pp. 5–8, Jul. 2018.
- [391] M. S. Safizadeh, A. A. Lakis, and M. Thomas, 'USING SHORT-TIME FOURIER TRANSFORM IN MACHINERY DIAGNOSIS', in *ESPOCO'05 Proceedings of the 4th WSEAS International Conference on Electronic, Signal Processing and Control*, Rio de Janeiro, Brazil, 2005, vol. 20, pp. 1–7.
- [392] Y. Zhang, C. Bingham, M. Gallimore, and S. Maleki, 'Operational pattern analysis for predictive maintenance scheduling of industrial systems', in *2015 IEEE International Conference on Computational Intelligence and Virtual Environments for Measurement Systems and Applications (CIVEMSA)*, Shenzhen, China, 2015, pp. 1–5.
- [393] B. Boashash and P. Black, 'An efficient real-time implementation of the Wigner-Ville distribution', *IEEE Trans. Acoust. Speech Signal Process.*, vol. 35, no. 11, pp. 1611–1618, Nov. 1987.
- [394] S. Bourenane, J. Marot, C. Fossati, A. Bouridane, and K. Spinnler, 'Multidimensional Signal Processing and Applications', *Sci. World J.*, vol. 2014, pp. 1–2, 2014.
- [395] H. Xiao, D. Huang, Y. Pan, Y. Liu, and K. Song, 'Fault diagnosis and prognosis of waste water processes with incomplete data by the auto-associative neural networks and ARMA model', *Chemom. Intell. Lab. Syst.*, vol. 161, pp. 96–107, 2017.
- [396] M. J. Roemer, C. Hong, and S. H. Hesler, 'Machine health monitoring and life management using finite element-based neural networks', *J. Eng. Gas Turbines Power—Transactions ASME*, vol. 118, pp. 830–835, 1996.
- [397] C. H. Hansen, R. K. Autar, and J. M. Pickles, 'Expert systems for machine fault diagnosis', *Acoust. Aust.*, vol. 22, pp. 85–90, 1994.
- [398] Y. Zhi-Ling, W. Bin, D. Xing-Hui, and L. Hao, 'Expert System of Fault Diagnosis for Gear Box in Wind Turbine', *Syst. Eng. Procedia*, vol. 4, pp. 189–195, 2012.
- [399] H. Merabet, T. Bahi, and N. Halem, 'Condition Monitoring and Fault Detection in Wind Turbine Based on {DFIG} by the Fuzzy Logic', *Energy Procedia*, vol. 74, pp. 518–528, 2015.
- [400] C. K. Mechefsk, 'Objective machinery fault diagnosis using fuzzy logic', *Mech. Syst. Signal Process*, vol. 12, pp. 855–86, 1998.
- [401] A. Widodo and B.-S. Yang, 'Support vector machine in machine condition monitoring and fault diagnosis', *Mech. Syst. Signal Process.*, vol. 21, no. 6, pp. 2560–2574, 2007.
- [402] M. Artes, L. D. Castillo, and J. Perez, 'Failure prevention and diagnosis in machine elements using cluster', *Proc. Tenth Int. Congr. Sound Vib. Stockh. Swed.*, pp. 1197–1203, 2003.
- [403] V. A. Skormin, L. J. Popyack, V. I. Gorodetski, M. L. Araiza, and J. D. Michel, 'Applications of cluster analysis in diagnostics-related problems', *Proc. 1999 IEEE Aerosp. Conf.*, vol. 3, pp. 161–168, 1999.
- [404] R. J. Elliott, L. Aggoun, and J. B. Moore, *Hidden Markov Models: Estimation and Control*. Springer, New York, 1995.
- [405] M. Hutter, 'Extreme state aggregation beyond Markov decision processes', *Theor. Comput. Sci.*, vol. 650, pp. 73–91, 2016.
- [406] M. L. Fugate, H. Sohn, and C. R. Farrar, 'Vibration-based damage detection using statistical process control', *Mech. Syst. Signal Process.*, vol. 15, pp. 707–721, 2001.
- [407] A. S. Sekha, 'Model-based identification of two cracks in a rotor system', *Mech. Syst. Signal Process.*, vol. 18, pp. 977–983, 2004.
- [408] S. Simani, C. Fantuzzi, and R. J. Patton, *Model-based Fault Diagnosis in Dynamic Systems Using Identification Techniques*. Springer, London, 2003.
- [409] A. Chahmi and A. Djoudi, 'Diagnosis of the induction machine by the Kalman filter', in *2017 5th International Conference on Electrical Engineering - Boumerdes (ICEE-B)*, Boumerdes, 2017, pp. 1–7.
- [410] L. C. K. Reuben and D. Mba, 'Diagnostics and prognostics using switching Kalman filters', *Struct. Health Monit. Int. J.*, vol. 13, no. 3, pp. 296–306, May 2014.

References

- [411] D. Lin and V. Makis, 'Recursive filters for a partially observable system subject to random failure', *Adv. Appl. Probab.*, vol. 35, pp. 207–227, 2003.
- [412] C. R. Farrar, F. Hemez, G. Park, A. N. Robertson, H. Sohn, and T. O. Williams, 'coupled approach to developing damage prognosis solutions', *He Fifth Int. Conf. Damage Assess. Struct. DAMAS 2003 Southampt. UK*, 2003.
- [413] M. Pecht and R. Jaai, 'A prognostics and health management roadmap for information and electronics-rich systems', *Microelectron. Reliab.*, vol. 50, no. 3, pp. 317–323, 2010.
- [414] M. Gašperin, Đ. Juričić, P. Boškovski, and J. Vižintin, 'Model-based prognostics of gear health using stochastic dynamical models', *Mech. Syst. Signal Process.*, vol. 25, no. 2, pp. 537–548, Feb. 2011.
- [415] E. I. Robinson, J. Marzat, and T. Raissi, 'Model-based prognosis of fatigue crack growth under variable amplitude loading', *IFAC-Pap.*, vol. 51, no. 24, pp. 176–183, 2018.
- [416] J. Wei, G. Dong, and Z. Chen, 'Lyapunov-based state of charge diagnosis and health prognosis for lithium-ion batteries', *J. Power Sources*, vol. 397, pp. 352–360, Sep. 2018.
- [417] M. Pecht and Jie Gu, 'Physics-of-failure-based prognostics for electronic products', *Trans. Inst. Meas. Control*, vol. 31, no. 3–4, pp. 309–322, Jun. 2009.
- [418] M. Pecht, 'Prognostics and Health Management of Electronics', in *Encyclopedia of Structural Health Monitoring*, C. Boller, F.-K. Chang, and Y. Fujino, Eds. Chichester, UK: John Wiley & Sons, Ltd, 2008.
- [419] Ö. Eker, F. Camci, and I. K. Jennions, 'Major Challenges in Prognostics: Study on Benchmarking Prognostics Datasets', in *Proceedings of the PHM*, Dresden, 2012, vol. 3, pp. 1–8.
- [420] R. L. Penha, J. Hines, and B. Upadhyaya, 'Monitoring And Diagnosis Of A Heat Exchanger Using Hybrid System Modeling', U.S. Department of Energy NEER Program, Research report, Jun. 2003.
- [421] A. Saxena, J. R. Celaya, I. Roychoudhury, S. Saha, B. Saha, and K. Goebel, 'Designing Data-Driven Battery Prognostic Approaches for Variable Loading Profiles: Some Lessons Learned', European Conference of Prognostics & Health Management p. 1-11, 2012.
- [422] F. MANGILI, 'Development of advanced computational methods for prognostics and health management in energy components and systems', 26-Mar-2013. [Online]. Available: <https://www.politesi.polimi.it/handle/10589/74461>. [Accessed: 15-Jan-2019].
- [423] M. L. Thompson and M. A. Kramer, 'Modeling chemical processes using prior knowledge and neural networks', *AIChE J.*, vol. 40, no. 8, pp. 1328–1340, Aug. 1994.
- [424] S. Park and V. Sugumaran, 'Designing multi-agent systems: a framework and application', *Expert Syst. Appl.*, vol. 28, no. 2, pp. 259–271, Feb. 2005.
- [425] M. Cossentino and C. Potts, '(PDF) A CASE tool supported methodology for the design of multi-agent systems', *ResearchGate*. [Online]. Available: https://www.researchgate.net/publication/2524911_A_CASE_tool_supported_methodology_for_the_design_of_multi-agent_systems. [Accessed: 25-Mar-2019].
- [426] P. Gauthier, 'Méthodologie de développement de systèmes multi-agents adaptatifs et conception de logiciels à fonctionnalité émergente', Université Paul Sabatier Toulouse III, Toulouse, 2004.
- [427] V. Hilaire, A. Koukam, and S. Rodriguez, 'An Adaptative Agent Architecture for Holonic Multi-agent Systems', *ACM Trans Auton Adapt Syst*, vol. 3, no. 1, pp. 2:1–2:24, Mar. 2008.
- [428] C. Y. Baldwin and K. B. Clark, 'Modularity in the Design of Complex Engineering Systems', in *In Complex engineered systems*, 2006, pp. 175–205.
- [429] M. Cossentino, N. Gaud, V. Hilaire, S. Galland, and A. Koukam, 'ASPECS: an agent-oriented software process for engineering complex systems: How to design agent societies under a holonic perspective', *Auton. Agents Multi-Agent Syst.*, vol. 20, no. 2, pp. 260–304, Mar. 2010.
- [430] N. Gaud, S. Galland, V. Hilaire, and A. Koukam, 'An Organisational Platform for Holonic and Multiagent Systems', in *Programming Multi-Agent Systems*, 2009, pp. 104–119.
- [431] 'Adelfe | Site de l'équipe SMAC'. [Online]. Available: <https://www.irit.fr/smac/en/adelfe>. [Accessed: 25-Mar-2019].
- [432] C. Bernon, M.-P. Gleizes, S. Peyruqueou, and G. Picard, 'ADELFE: A Methodology for Adaptive Multi-agent Systems Engineering', in *Engineering Societies in the Agents World III*, vol. 2577, P.

References

- Petta, R. Tolksdorf, and F. Zambonelli, Eds. Berlin, Heidelberg: Springer Berlin Heidelberg, 2003, pp. 156–169.
- [433] H. Van Brussel, J. Wyns, P. Valckenaers, L. Bongaerts, and P. Peeters, 'Reference architecture for holonic manufacturing systems: PROSA', *Comput. Ind.*, vol. 37, no. 3, pp. 255–274, Nov. 1998.

APPENDICES

FLEET MAINTENANCE: DATA ACQUISITION, DIAGNOSIS AND PROGNOSIS

Introduction

Generally speaking, different maintenance programs are organized into three steps namely, data acquisition, data processing and maintenance decision-making (refer to [379], [380], [381]). Data acquisition step deals with raw data collection from the targeted system through embedded sensors [382]. The data processing step deals with the analysis of the data collected during the acquisition in order to extract relevant data (information) for better understanding and interpretation [237]. Lastly, the maintenance decision-making deals mainly with the course of action recommendation following the data processing steps. This step can further be categorized into diagnosis and prognosis [237]. According to [379], the maintenance decision-making steps provides the decision-makers with the diagnostic and prognostic information for decision support. In the subsections that follow, a detailed view of these steps is provided.

Data acquisition

Data acquisition is a process of collecting, storing and analysing information from the physical world [383]. Recent trends and advances in information and communication technologies (IC) [384] have enabled the automation of the data acquisition process. [383] argues that, this automation has resulted in the collection of more data in less time and with fewer errors.

In the context of fleet maintenance, the data collected during the acquisition can be categorized into two types [237], namely, event data and condition monitoring data. While event data points out to what happened and what was done to the fleet entities, condition monitoring data is related to the measurement of the health status of the respective entities. [237] points out that, both event data and condition-monitoring data are equally important as far as the maintenance planning is concerned.

Data processing

In [237], the authors have provided an exhaustive review on data processing in the maintenance context. In the review, data processing is divided into two sub-steps, namely, data cleaning and data analysis. While the data cleaning step has the objective of ensuring error-free data for both event data (errors are frequently present due to manual entering of data) and condition monitoring data (errors from sensor faults), data analysis deals with the interpretation of the data. Tools and algorithms used in data analysis are classified depending on the type of the collected data as explained in Table V-3.

TABLE V-3: DATA PROCESSING TOOLS

Data type	Definition	Tools used in analysis
Value type data	Data collected at a specific instance of condition monitoring with one value per condition monitoring variable. For example, oil analysis.	<ul style="list-style-type: none"> ➤ Principal component analysis (PCA) [385], [386]. ➤ Independent component analysis (ICA) [387].
Waveform data	A time series of data for condition monitoring variable. For example, vibration data.	<ul style="list-style-type: none"> ➤ Time-domain analysis <ul style="list-style-type: none"> ○ Time synchronous average (TSA) [388] ➤ Frequency-domain analysis <ul style="list-style-type: none"> ○ Fast Fourier transform (FFT) [389] ➤ Time-frequency analysis <ul style="list-style-type: none"> ○ Short-time Fourier transform (STFT) [390], [391] ○ spectrogram (the power of STFT) [392]

		<ul style="list-style-type: none"> ○ Wigner–Ville distribution [393]
Multidimensional data	Data collected at a specific instance for condition monitoring are multidimensional. For example, Thermographs and X-ray imaging	<ul style="list-style-type: none"> ➤ Image processing [394]

Diagnostic methodologies

Diagnosis refers to fault detection, isolation and identification. According to [237], fault diagnosis consists of a pattern recognition or a mapping between measured values in a measurement space and faults in a fault space. There are two types of approaches associated with fault diagnosis, namely, data-based approaches and model-based approaches.

According [281], data-based diagnostic approaches treat diagnosis as a classification problem which can be supervised or unsupervised. [237] further classifies data-based diagnostic approaches into two groups of methods, namely, artificial intelligence methods and statistical methods. Artificial intelligence techniques make the use of training data for modelling. Some of these techniques in the context of maintenance are, artificial neural networks (ANNs) – ([237], [395],[396]), expert systems ([397], [398]), fuzzy logic ([49], [399], [400]) and support vector machine (SVM) - [401]. Statistical methods obtain the monitoring without information intrusive techniques. Some of these methods are, clustering techniques ([402], [403]), hidden Markov model ([404], [405]) and statistical process control [406].

Model-based diagnostic approaches perform the detection of faults in processes, actuators and sensors by using dependencies between different measurable signals expressed by mathematical process models [282]. These techniques make the use of differential equations to represent real systems. While these approaches are very effective if the models are realistic and correct, it is often very difficult to model real complex systems [237]. Some of these techniques as applied in the maintenance are, system identification ([407], [408]), Kalman filtering ([409], [410]).

Prognosis and health monitoring

Prognosis is a science of making failure prediction of engineering systems [236]. According to [237], prognosis has two main fields, the first field consists of predicting how much time is left before a failure occurs, commonly referred to as remaining useful life (RUL) ([266], [268], [267]). The second field consists of calculating the probability of operation without failure up to a certain point ([411], [412]). Despite the fact that, most of the literature classifies the approaches in prognosis into three groups (for

example see [235], [413]), namely, physics/model based approaches, data based approaches and hybrid approaches, [283] classifies prognosis approaches based on their applicability and relative costs as experience-based prognosis, data-driven prognosis and model-based prognosis as shown on *Figure V-11*.

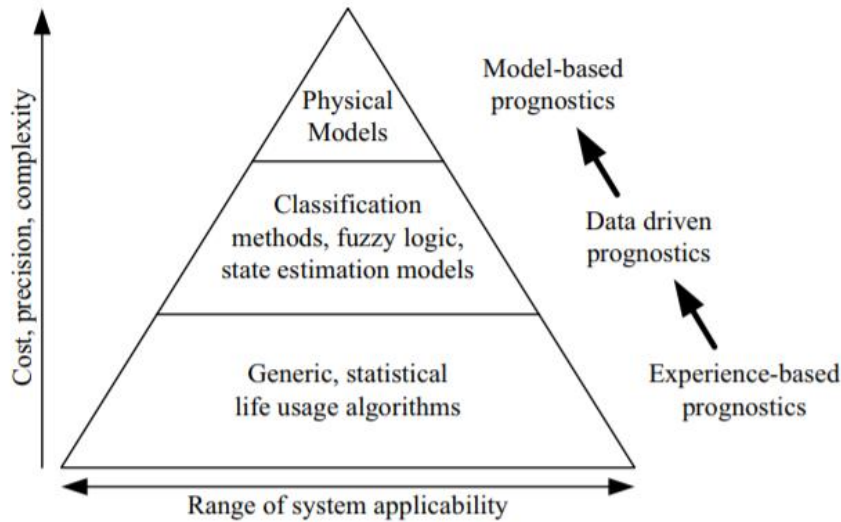

FIGURE V-11: PROGNOSIS APPROACHES CLASSIFICATION [283]

Similar to diagnostic model-based approaches, physics/model-based prognosis uses mathematical representations to describe a system [413]. This approach is further divided into two domains, namely, system modelling ([414], [415], [416]) and physics of failure (PoF) ([417], [418]). While system modelling uses mathematical functions to represent a system, PoF uses the knowledge from the system’s lifecycle, geometrical and material properties to estimate potential failure and estimate RUL [413].

Data-based prognosis approaches make the use of data for learning in order to provide intelligent decision-making [413]. These approaches make the use of black box models to learn system’s behaviour from condition monitoring [235]. Similar to data-based approaches in diagnosis, most of the literature classify these approaches in two groups, namely, artificial intelligence and statistical techniques ([233], [419], [234]). However, the authors in [283] classify data-based prognosis into, evolutionary/feature-based prognosis, artificial intelligence prognosis and state estimator prognosis.

Hybrid prognostic approaches are combinations of physics-based and data-driven approaches [235]. The said combination maybe either in parallel or in series (grey box/semi-mechanistic modelling) [420] as shown on *Figure V-12 a* and *b* respectively.

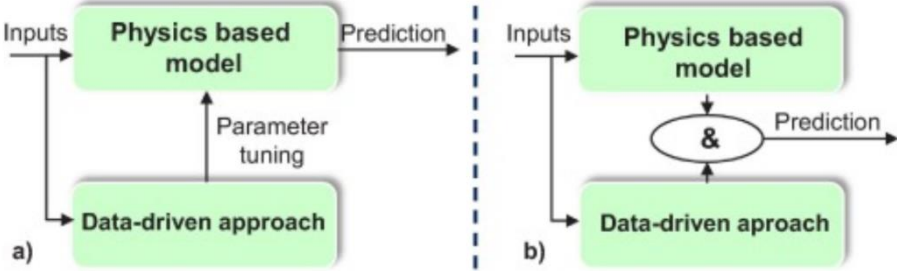

FIGURE V-12: SERIES AND PARALLEL HYBRID PROGNOSIS [235]

While series hybrid approach uses a physics-based model with initial knowledge and a data-based model which acts as an online parameter estimator to update or tune the model ([413], [283], [421]), in parallel hybrid approach the data-based model does not use the knowledge from the physics-based model ([422], [423]).

MULTI-AGENT SYSTEMS DESIGN METHODOLOGIES

The process of designing MASs is different from designing classical software solutions ([297], [424]). This is because MAS integrate the notions of agents' intelligence, autonomy, ontology, communications, mobility and other agents' characteristics ([166], [165]). For this reason, the MAS design must take inspiration from the classical design approaches but also go a step further in order to take account of these characteristics [425]. There are several design methodologies associated with MAS as discussed in [426] and [325]. The subsections that follow give detailed descriptions of some of the most prominent MAS design methodologies found in the literature.

ASPECS design methodology

ASPECS is a holonic-based ([427]) MAS design methodology for complex engineering systems [428]. This methodology is based on a holonic organisational metamodel and provides a step-by-step guide from requirements to code allowing the modelling of a system at different levels of details using a suite of refinement methods [325] (see Figure V-13). ASPECS design methodology distinguishes itself from other design methodologies in that, instead of considering agents as atomic entities, it intuitively considers the hierarchical organization and agents as the composing entities of the organization [429]. The design of MAS with ASPECS uses a specific platform referred to as JANUS [430].

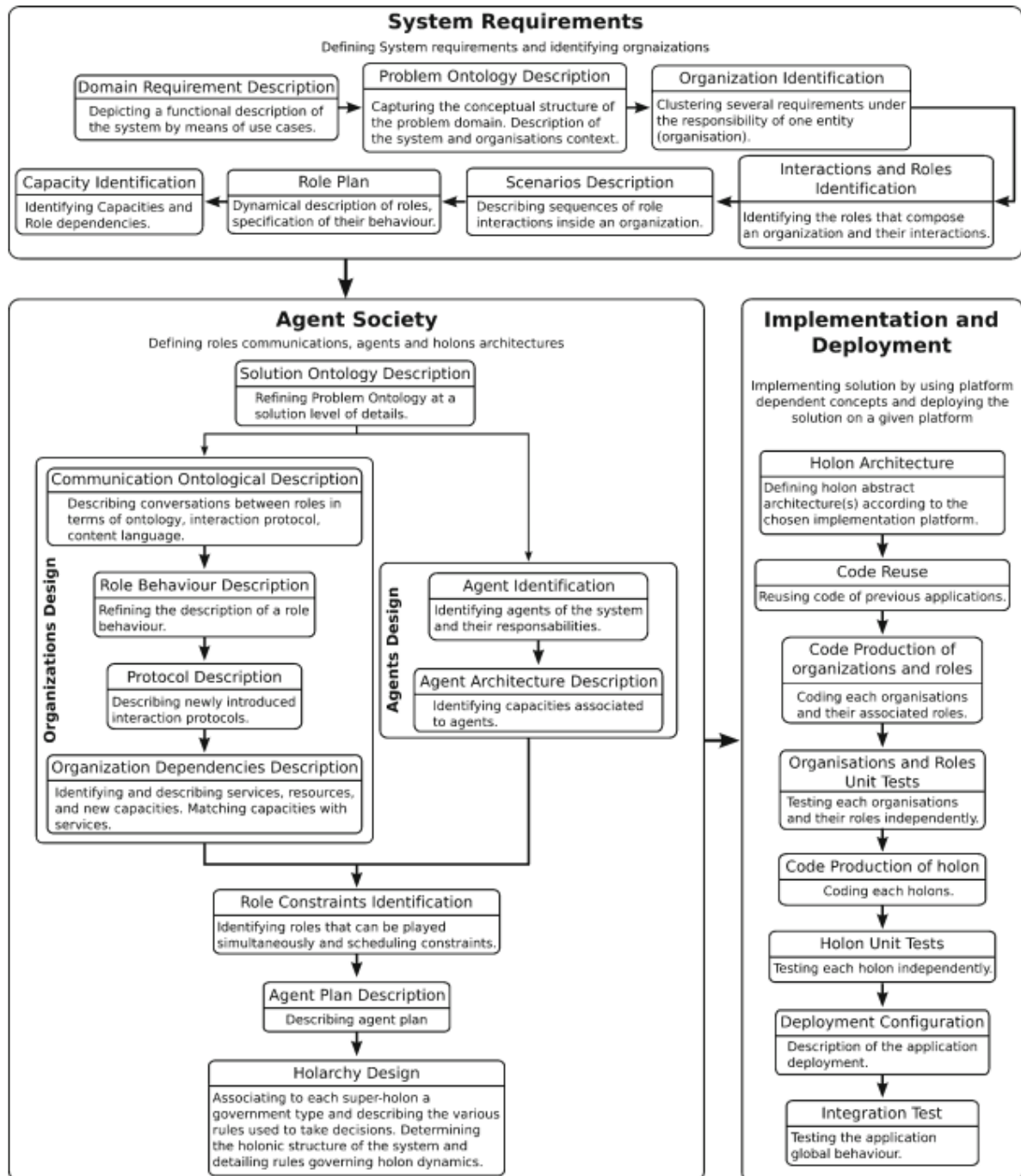

FIGURE V-13: ROADMAP OF THE ASPECS PROCESS (PHASES/ACTIVITIES AND THEIR GOALS) [429]

ADELFE design methodology

ADELFE is a design methodology used to facilitate the design of adaptive multi-agent systems (AMAS) based on cooperative self-adaptation [325]. ADELFE project was initiated in France in December 2000 by the French ministry of Economy, Finance and Industry and it has several partners such as the University of Toulouse, University of La Rochelle, ARTAL and TNI [431]. According to [432], the ADELFE methodology is based on the object-oriented methodologies and it utilizes the Rational Unified Process (RUP) and Unified Modelling Language (UML). According to Giret et al. [325], by using ADELFE, an agent is cooperative if :

1. It interprets the message it receives without ambiguity (Perceptive cooperation).
2. It takes action on the received message (Decisive cooperation).
3. The action it takes is profitable for the global system (cooperation in action).

Figure V-14 Shows the first three workflows of the ADELFE methodologies as well as their functional characteristics.

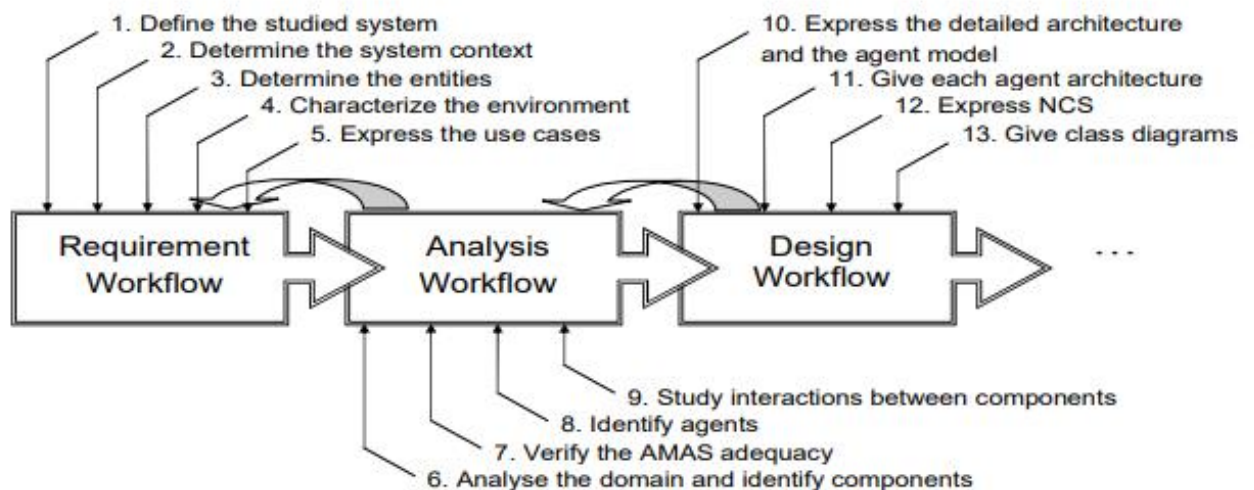

FIGURE V-14: OVERVIEW OF THE FIRST THREE CORE WORKFLOWS OF ADELFE [432]

ANEMONA design methodology

ANEMONA is a design methodology based on the PROSA holons [433] in which the *top-down* approach is adopted for the analysis and specification phase while the *bottom-up* approach is adopted in design phase [325]. In ANEMONA, the designed system is divided into specific characteristics which form models or views [323] in order to identify the components of the designed system and the relations among those components. Figure V-15 demonstrates the development process using ANEMONA methodology.

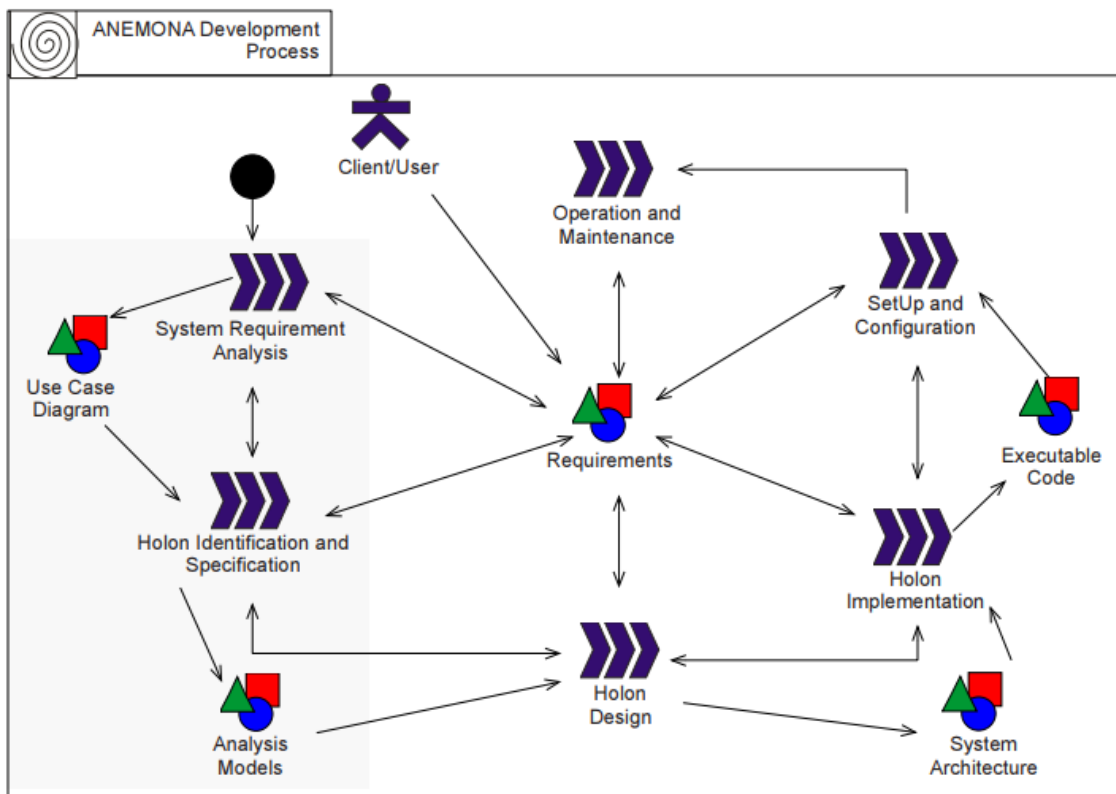

FIGURE V-15: ANEMONA DEVELOPMENT PROCESS [323]

ANEMONA design methodology is comprised of five views or models as follows:

- The agent view: This view describes the functions (i.e. Responsibilities and capabilities) of each agent.
- The organization view: This view describes how the system is grouped into agents, resources and applications.

- The interaction view: This view describes the exchange of information among agents. The interaction view is the principal view of the ANEMONA methodology as it expresses the cooperation in modelling dynamic behaviours.
- The environment view: This view describes the non-autonomous entities with which the agents interact.
- The task/goal view: This view describes the relations among the individual agents' goals.

Giret et al. [325] describes ANEMONA as one of the most complete design methodology as far as the MAS design in manufacturing is concerned. Thus, in the context of this research, the proposed MAS is designed by ANEMONA.

JOHN WILLIAM MBULI

A reactive fleet maintenance support planning system for a fleet of mobile cyber-physical systems:
Application to the rail transport industry

Thesis director: Professor Damien Trentesaux, Polytechnic University Hauts-de-France

Specialization: Automatic control and computer engineering

Abstract: The manufacturers and the operators of the fleets of cyber-physical systems (CPSs) are subjected to huge expectations expressed in terms of the availability and reliability of the provided products and services during the exploitation of these fleets in dynamic environments. These expectations foster the fleet manufacturers, particularly in the transportation sector, to develop effective mechanisms as far as the reactive planning of the maintenance operations at the fleet level is concerned. In this research work, a multi-agent system (MAS) for the reactive maintenance planning of a fleet of CPSs is proposed. The proposed MAS is conceived by using the ANEMONA design methodology and it aims at optimizing the fleet maintenance planning decisions to meet the specified objectives. The experiments carried out in the course of this work demonstrate the ability of the proposed MAS in planning the fleet maintenance effectively (i.e. satisfying the fleet's availability and reliability requirements in a static environment) and reactively (i.e. being able to adapt/modify the fleet maintenance planning decisions following perturbations). The effectiveness of the MAS model is validated by a mathematical programming model and its reactivity is tested by using simulated perturbations. An application in rail transport industry to the fleet of trains at Bombardier Transportation France is proposed. The proposed MAS is integrated in a decision support system called "MainFleet". The development of MainFleet at Bombardier is ongoing.

Keywords: Fleet maintenance support planning, Multi-agent systems, cyber-physical systems, condition-based maintenance, mathematical programming, fleet supervision, train transportation.

Résumé : Les industriels et les opérateurs des flottes de systèmes cyber-physiques (CPS) sont soumis à de fortes exigences exprimées en termes de disponibilité, fiabilité des produits et des services fournis lors de l'exploitation de ces flottes dans des environnements dynamiques. Ces attentes incitent les industriels, et notamment dans le secteur du transport, à développer des mécanismes efficaces de planification réactive des opérations de maintenance au niveau de la flotte. Dans cette thèse, un système multi-agent (SMA) pour la planification réactive de la maintenance d'une flotte de CPS est proposé. Ce SMA est construit en utilisant la méthode de conception ANEMONA et a pour objectif d'optimiser la planification de la maintenance au niveau flotte afin de répondre aux exigences spécifiées. Les expériences réalisées au cours de ces travaux démontrent la capacité de ce SMA à planifier la maintenance de la flotte de manière efficace (c'est-à-dire satisfaire les exigences de disponibilité et de fiabilité de la flotte dans un environnement statique) et de manière réactive (c'est-à-dire être capable d'adapter/de modifier les décisions de planification de la maintenance à la suite des perturbations). L'efficacité de ce modèle SMA est validée par un modèle mathématique et sa réactivité est testée par simulation de perturbations. Une application dans le domaine ferroviaire au sein de Bombardier Transport

France est proposée. Le SMA est intégré à un système d'aide à la décision dénommé « MainFleet ». Le développement de MainFleet est en cours.

Mots-clés : Planification de maintenance, systèmes cyber-physiques, systèmes multi-agents, maintenance conditionnelle, programmation mathématique, supervision de flotte, systèmes de transport ferroviaire.