



HAL
open science

Digital Ecosystem for Better Management of Power Systems: An Application on Microgrids

Khouloud Salameh

► **To cite this version:**

Khouloud Salameh. Digital Ecosystem for Better Management of Power Systems: An Application on Microgrids. Computer Science [cs]. Université de Pau et des pays de l'Adour; Universidad del País Vasco. Facultad de ciencias, 2017. English. NNT: . tel-02403468

HAL Id: tel-02403468

<https://hal.science/tel-02403468>

Submitted on 11 Dec 2019

HAL is a multi-disciplinary open access archive for the deposit and dissemination of scientific research documents, whether they are published or not. The documents may come from teaching and research institutions in France or abroad, or from public or private research centers.

L'archive ouverte pluridisciplinaire **HAL**, est destinée au dépôt et à la diffusion de documents scientifiques de niveau recherche, publiés ou non, émanant des établissements d'enseignement et de recherche français ou étrangers, des laboratoires publics ou privés.

Digital Ecosystem for Better Management of Power Systems: An Application on Microgrids



Khouloud SALAMEH

Advisors: Prof. **Richard CHBEIR** University of Pau and Adour Countries, France
Prof. **Haritza CAMBLONG** University of Basque Country, Spain

Reviewers: Prof. **Kokou YETONGNON** University of Dijon, France
Prof. **Ernesto DAMIANI** University of Milano, Italy
Prof. **Abderrafiaa KOUKAM** University of Belfort, France

Examiners: Prof. **Yudith CARDINALE** University of Simone Bolivar, Venezuela
Dr. **Aitor MILO** IK4-IKERLAN Research Alliance, Spain
Prof. **Ionel VECHIU** Estia Institute of Technology, France

*A thesis submitted for the degree of Doctor of
Philosophy in Systems Engineering and Automation*

7/7/2017

To my parents...

Acknowledgements

Foremost, I am so grateful to Prof. Kokou YETONGNON, Prof. Ernesto DAMIANI, and Prof. Abderrafiaa KOUKAM for dedicating their time to read and report my thesis. I would also like to thank Prof. Yudith Cardinale, Prof. Ionel VECHIU, and Dr. Aitor MILO for being members of my jury.

Undertaking this PhD has been a truly life-changing experience for me and it would not have been possible to do without the support and guidance that I received from many people.

I would like to express my sincere gratitude to my advisors Prof. Richard CHBEIR of the University of Pau, as well as, Prof. Haritza CAMBLONG of the University of Basque Country. I am deeply thankful to Prof. Richard for his patience, motivation, enthusiasm, and immense knowledge. His guidance and presence raised me up when I was down. It could have never been the same without him. I would also like to thank Prof. Haritza for his invaluable guidance, support, comprehension, encouragement, trust, help and valuable advices. It is a pleasure to have known them and a privilege to have worked with them.

I would also like to thank all the technical and administrative staff of the IUT de Bayonne for the warm and convivial atmosphere and their sympathy. Thanks to Philippe ANIORTE and Philippe LOPISTEGUY for their kindness, advices, and support.

Thanks to Joe TEKLI for his confidence, support and professionalism.

I am thankful for my friends in Lebanon and France for their unconditional support and availability in the hard moments. Thank you, Eliana,

Nathalie, Lara, Elio, Fawzi, Solomon, Gauthier-Charbel, Elias, Cecile and all the members of the lab.

Thank you Mom, Dad and sisters, without the inspiration, drive, and support that you have given me, I might not be the person I am today. I hope that you are proud of me.

My deepest gratitude and love goes to God who filled me with strength, patience and perseverance to finish this work.

Abstract

Over the past decade, new concepts have emerged in the electricity field, including the Smart Grids, the Distributed Generation and the Microgrids (MGs). In this thesis, we will be mainly focusing on the study of the MGs. An MG is a small-scale power system, consisting of local power generation, local loads and energy storage systems. Thanks to their numerous economical, ecological and operational benefits, the MGs are expected to hold the promise of becoming a major ingredient in the implementation of the future power systems. However, there are several significant challenges to overcome in order to achieve its expected benefits, namely: the cyber-attacks, the mobility aspect, the interoperability, the non-cooperation, and the demand-side management. Three main contributions are developed. First, we present OntoMG, an ontology-based data model, capable of representing the heterogeneous components of the MG and their properties, while being compliant with existing models and information standards (i.e., IEC 61970 and IEC 61850) and coping with the interoperability issues and the multi-objective aspect of MG. Secondly, we introduce DECF, a cooperative model for the optimization of the electricity exchange in the MG, offering several advantages over existing approaches, in particular: 1) its generic in that it considers all heterogeneous components of MG, 2) it is a cooperative model that reduces the technical, ecological and economic costs and encourages the local power exchange, and 3) it is user-oriented in that it gives the user the possibility to fine-tune the weight of each objective aspect. Finally, we introduce MOCSF, a multi-objective cooperative scheduler designed to schedule the power production, consumption and storage in the MG, while taking into account the preferences of MG components. Illustrative examples are provided after each step to facilitate understanding of each module. Then, a number of simulations are made to show the effectiveness of our approaches to solve our challenges in relation to the existing approaches.

Resumen

Capítulo 1

Introducción

Durante la última década, han surgido nuevos conceptos en el campo de la electricidad, en particular las Smart Grids, la generación distribuida y las Microrredes (Microgrids, MGs). En esta tesis, nos centramos principalmente en el estudio de MGs. Según las previsiones de los expertos en la materia, las MGs deberían tomar un papel cada vez mayor en los sistemas eléctricos en el futuro. Pero para ello necesitan ser mejor gestionados. Una mejor gestión requiere la resolución de ciertos problemas importantes y la consideración de aspectos que todavía no están tomados en cuenta hoy en día:

1. Identificación: con la amplificación de su digitalización, las MG son más vulnerables a los ataques cibernéticos. Estos ataques podrían, por ejemplo, llevar a la extinción voluntaria de los operadores de la MG, lo que causaría problemas en cascada en la red. Por lo tanto, uno de los principales retos para la gestión de MGs es asegurar una identificación fiable de los componentes para la autenticación y trazabilidad adecuada.
2. Movilidad: hoy en día, ciertos componentes de una MG (por ejemplo, vehículos eléctricos, barcos, etc.) tienen la capacidad de moverse y por lo tanto de cambiar su ubicación dentro de una MG, o incluso de cambiar de MG. Las MGs deben tener en cuenta esta movilidad y adaptarse a nuevas situaciones de dichos componentes.
3. Aspecto multi-papel: otro aspecto también debe ser considerado en la MG, la ‘Prosomación’. Se refiere a la capacidad de algunos dispositivos para producir y consumir energía al mismo tiempo. Una MG debe aprovechar esta capacidad de algunos de sus componentes para mejorar la gestión de la energía.

4. Interoperabilidad: una MG por lo general consta de varios elementos heterogéneos: generadores eléctricos, sistemas de almacenamiento de energía y cargas eléctricas. Esta heterogeneidad debe ser tomada en cuenta, en particular en la comunicación entre los diferentes componentes.
5. Falta de cooperación: un entorno poco cooperativo tiene efectos negativos significativos desde el punto de vista del funcionamiento, la económica y el impacto sobre el medioambiente de la MG, de ahí la necesidad de un entorno de colaboración que permita el intercambio entre los componentes que tienen interés en trabajar juntos.
6. La planificación de la oferta y la demanda de energía eléctrica: muchas consideraciones deben ser tomadas en cuenta para proporcionar una planificación optimizada en función de las preferencias de todos los componentes y para lograr los objetivos económicos y ambientales.

Para resolver estos problemas, se propone un marco / una estructura dedicada compuesto por 3 capas: 1) física, 2) de conocimiento y 3) de gestión. En esta tesis, nos centramos en las capas de conocimiento y de gestión.

Capítulo 2

OntoMG: Un modelo de información basado en la ontología para las MGs

En esta ‘era renovable’, la atención de muchos investigadores es atraída por las MGs, especialmente para mejorar su gestión mediante el aprovechamiento de todos los activos que poseen. Sin embargo, como con cualquier nueva tecnología, la aplicación de MGs se acompaña de barreras que impiden una operación inteligente, flexible y autónoma. En este capítulo, se abordan dos conceptos importantes relacionados con estos obstáculos: la interoperabilidad y el aspecto multi-objetivo de la gestión de las MGs. Por un lado, una MG consiste en una serie de componentes heterogéneos (fuentes de energía, sistemas de almacenamiento de energía y cargas eléctricas). Por lo tanto, es necesario establecer una interoperabilidad semántica entre componentes heterogéneos, que les permita garantizar una comunicación fluida y transparente. Por otra parte, una MG tiene varias características y diferentes objetivos operativos, económicos y ecológicos. Contiene además componentes especiales, incluyendo 1)

los ‘prosumidores’, que son componentes que tienen la capacidad de producir y consumir electricidad simultáneamente, y 2) los componentes móviles, como el “vehículo eléctrico”, que tienen la capacidad de moverse dentro o fuera de la MG. Es por esto que es tan importante modelar, desde el punto de vista de la comunicación y la información, todos los parámetros relacionados con los servicios prestados por la MG. Teniendo en cuenta todo esto, como indicado en el primer capítulo, ofrecemos un marco de sistema de gestión de MG que se compone de tres capas, la física, la de información / conocimiento y la de gestión. La piedra angular de este marco es OntoMG, un modelo ontológico de datos, basado en las normas IEC 61970 e IEC 61580, complementado por una serie de parámetros adicionales que permitan a la MG alcanzar todos sus objetivos. En comparación con los modelos existentes en la literatura y presentados en detalle en este capítulo, varias contribuciones son realizadas por OntoMG, en particular:

1. El cumplimiento y la alineación de la ontología con los modelos de información existentes.
2. La capacidad para resolver el problema de la interoperabilidad entre todas las capas.
3. La ventaja de integrar las habilidades de pensamiento y las características necesarias de forma inteligente.
4. La consideración del aspecto multi-objetivo en la gestión de la MG.

Varias pruebas y evaluaciones han sido llevadas a cabo para validar el marco propuesto y destacar la importancia y utilidad de OntoMG en el campo de la electricidad. Los resultados obtenidos son satisfactorios y tienen varias perspectivas prometedoras.

Capítulo 3

DECF: Modelo cooperativo para la optimización del intercambio de electricidad en las MGs

El mundo se vuelve cada vez más digital y la digitalización conduce a una mayor conectividad y una mayor interacción entre los sistemas. Esto ha dado lugar a un nuevo paradigma: el ecosistema digital. Un ecosistema digital es un entorno de colaboración, que consiste en una serie de componentes heterogéneos que trabajan/colaboran juntos sobre la base de intereses y beneficios mutuos. En esta tesis, una MG es visto como

un ecosistema digital, ya que es un sistema de potencia distribuido que consiste en un número de componentes heterogéneos (generadores de energía, cargas eléctricas y sistemas de almacenamiento de energía) que tienen impactos directos / indirectos los unos sobre los otros y sobre el medio ambiente. Teniendo en cuenta la importancia del aspecto de colaboración en la MG, después de un estudio detallado de lo existente, se propone un algoritmo de agrupamiento para reunir a los componentes que tienen intereses mutuos. Para ello, proponemos en esta sección un modelo cooperativo para la gestión de MGs que incluye dos componentes principales: 1) la ‘Alliances Builder’ y 2) el ‘Seller2Buyer Matcher’. El generador de alianzas ‘Alianzas Builder’ proporciona un algoritmo de agrupamiento apropiado para reunir a todos los componentes heterogéneos de la MG con necesidades y preferencias similares. Una vez estas alianzas hechas, el módulo ‘Seller2Buyer’ se aplica dentro de cada grupo y entre grupos, apuntando a un mejor intercambio dentro de la MG y generando un número de asociaciones vendedor-comprador. Nuestro enfoque tiene varias ventajas sobre los enfoques existentes, en particular:

1. Es genérico. Toma en cuenta todos los componentes heterogéneos de la MG y se puede aplicar a otros ecosistemas digitales (por ejemplo, de comercio electrónico web, banca electrónica, etc.).
2. Se basa en OntoMG, lo que permite el intercambio de datos de conformidad con las normas existentes (por ejemplo, IEC, IEEE, etc.).
3. Permite la intervención humana, dando la oportunidad al usuario de refinar/ajustar el peso de cada objetivo.
4. Se trata de un modelo cooperativo que reduce los costes técnicos, ecológicos y económicos y fomenta el intercambio de energía local.

La aplicación de los algoritmos a las MGs ha permitido destacar ventajas tri-dimensionales: económicos con la reducción de costes, ambientales reduciendo las emisiones de gases tóxicos y operacionales minimizando las pérdidas de energía.

Capítulo 4

MOCSF: Planificación cooperativa multi-objetivo de la energía eléctrica en las MGs

Con el crecimiento de las MGs, la importancia de la planificación de la producción, el consumo y el almacenamiento de electricidad aumenta. Una planificación adecuada

para la producción, el consumo y el almacenamiento de la electricidad debe garantizar la fiabilidad de la MG y extender la vida útil de sus unidades constituyentes. Además, la planificación también debe tener en cuenta los objetivos económicos y ecológicos. Para ello, proponemos en esta sección una planificación multi-objetivo cooperativo, aplicada después de la herramienta presentada en el capítulo anterior (DECF). Se compone de dos módulos principales: 1) el ‘Preference-based Compromise Builder’ y 2) el ‘Multi-objective Scheduler’. El ‘Preference-based Compromise Builder’ pretende ofrecer el mejor equilibrio, o lo que llamamos ”compromiso” entre las preferencias de los compradores y vendedores que pertenecen a la misma asociación vendedor-comprador resultante del DECF. Una vez esta tarea completada, el planificador multi-objetivo tiene como objetivo proporcionar una planificación del intercambio de electricidad en cada asociación, con el fin de alcanzar objetivos tridimensionales: económicos con la reducción de los costes de la electricidad, medioambientales con la reducción de emisiones tóxicas y operacionales mediante la reducción de la carga máxima de la MG y sus componentes, y tomando en consideración las preferencias de estos componentes. Nuestro enfoque tiene varias ventajas sobre los enfoques existentes en la literatura, en particular:

1. Permite la planificación del consumo, la producción y el almacenamiento de la electricidad en la MG.
2. Considera a varias fuentes de energía a diferencia de los enfoques existentes que tienen en cuenta la interacción de los consumidores con una sola fuente de energía.
3. Tiene en cuenta todas las preferencias de los componentes de la MG (en términos de tiempo de arranque, tiempo de parada, y vinculada a la cantidad deseada de la electricidad) en contraste con los enfoques existentes que tienen en cuenta a estas preferencias sólo en parte.

Los experimentos realizados han demostrado que los algoritmos propuestos proporcionan resultados convincentes, que demuestran la capacidad de nuestros algoritmos para encontrar el equilibrio óptimo entre los precios de la electricidad, las cargas máximas y las emisiones, y para tomar en cuenta las preferencias de los componentes.

Capítulo 5

Conclusiones

El trabajo presentado en esta tesis se dirige principalmente al modelado de datos y la optimización de la gestión energética en las MGs. En resumen, se han presentado tres contribuciones principales. En primer lugar, hemos presentado OntoMG, nuestro modelo ontológico de datos, capaz de representar los componentes heterogéneos de la MG y sus propiedades, sin dejar de ser compatible con los modelos de información existentes y las normas (por ejemplo, IEC 61970 e IEC 61850), y haciendo frente a la interoperabilidad y el aspecto multi-objetivo de la MG. En segundo lugar, hemos introducido DECF, un modelo cooperativo para optimizar el intercambio de electricidad en las MGs, con varias ventajas sobre los enfoques existentes, incluyendo: 1) la naturaleza genérica de esta herramienta que permite tomar en consideración todos los componentes heterogéneos de la MG, y 2) la cooperación que reduce los costes técnicos, medioambientales y económicos, fomenta el intercambio de energía local, y proporciona la posibilidad de intervención humana dando al usuario la posibilidad de refinar/ajustar el peso de cada objetivo. Por ltimo, hemos presentado MOCSF, un planificador cooperativo multi-objetivo, diseñado para planificar la producción, el consumo y el almacenamiento de energía eléctrica en la MG, teniendo en cuenta las preferencias de los componentes de la MG. Se han proporcionado ejemplos ilustrativos después de cada paso para facilitar la comprensión de cada módulo. A continuación, se han llevado a cabo simulaciones para demostrar la eficacia de nuestro enfoque en comparación con los enfoques existentes.

El trabajo presentado en este informe es sólo el comienzo de una obra que debe ser completada y mejorada con el fin de tener una metodología integral que se pueda aplicar a todas las MGs. Para ello, quedan varios puntos a estudiar y completar. En primer lugar, queremos mejorar la manipulación de datos visual de OntoMG por medio de ciertas técnicas de procesamiento del lenguaje natural (NLP), para permitir que los no expertos en informática puedan escribir consultas, insertar, actualizar y borrar conceptos de una manera simplificada. Además, tenemos la intención de mejorar la capacidad de pensamiento de OntoMG, mediante la definición de reglas y restricciones dedicadas, para permitir que los componentes de la MG reaccionen y tomen decisiones de manera independiente. Por último, la confidencialidad de la información intercambiada en la MG sigue siendo un problema crítico en los sistemas eléctricos de hoy en día. Por lo tanto, queremos hacer un control de privacidad

para proteger la confidencialidad de los componentes, preservando las características avanzadas de control y monitoreo.

Contents

1	Introduction	1
1.1	Traditional Grid	1
1.2	Traditional grid improvements	3
1.3	Microgrid	4
1.3.1	Microgrid benefits	4
1.3.1.1	Operational/technical Benefits of a Microgrid	5
1.3.1.2	Ecological Benefits of a Microgrid	6
1.3.1.3	Economical Benefits of a Microgrid	6
1.3.2	Microgrid Challenges	7
1.3.2.1	Autonomy	7
1.3.2.2	Integrating renewable energy sources	8
1.3.2.3	Compatibility	8
1.3.2.4	Scalability	8
1.3.2.5	Decentralized control	8
1.3.2.6	Security	8
1.3.3	Microgrid as a Cyber-physical system	9
1.3.3.1	Cyber-Physical Microgrid Challenges	10
1.3.3.1.1	Identification	10
1.3.3.1.2	Mobility	11
1.3.3.1.3	Multi-roles	11
1.3.3.1.4	Interoperability	11
1.3.3.1.4.1	Cooperation	11
1.3.3.1.4.2	Demand-side management	12
1.4	Contributions	12
1.4.1	<i>OntoMG</i> : An Ontology-Based Information Model for Microgrids	14
1.4.2	Digital Ecosystem Cooperative Model for Microgrids	14
1.4.3	Multi-objective Alliances-based Scheduling for Microgrids	15
1.5	Publications	15

1.5.1	Conference Papers	15
1.5.2	Journal Papers	16
1.5.3	Oral Presentation	16
1.6	Report Organization	16
2	<i>OntoMG: An Ontology-Based Information Model for Microgrids</i>	18
2.1	Introduction	19
2.2	Related Work	20
2.2.1	Syntactic Based Models	21
2.2.1.1	Common Information Model	21
2.2.1.2	MIRABEL FlexEnergy Data Model	21
2.2.1.3	Facility Smart Grid Information Model	23
2.2.1.4	OASIS Energy Interoperation	23
2.2.2	Semantic Approaches	24
2.2.2.1	Facility Ontology	24
2.2.2.2	Prosumer Ontology	26
2.2.2.3	Upper Ontology for power engineering application	27
2.2.3	Summary	28
2.2.3.1	Interoperability aspect	28
2.2.3.2	Multi-objective aspect	29
2.3	Microgrid Management framework	30
2.4	<i>OntoMG</i> Ontology	32
2.4.1	Why ‘Ontologies are appropriate’ means for semantic approaches?	32
2.4.1.1	Ontology as a Shared Knowledge	32
2.4.1.2	Ontology as a better means for Information Retrieval	33
2.4.1.3	Ontology as a Reasoning Strategy	33
2.4.2	<i>OntoMG</i> Overview	33
2.4.3	<i>OntoMG</i> Basic structure	35
2.4.3.1	Distributed Energy Source (DES) Branch	36
2.4.3.2	Energy Storage (ES) Branch	36
2.4.3.3	Electrical Load (EL) branch	38
2.4.4	<i>OntoMG</i> Extended Structure	38
2.4.4.1	Identification Concept	39
2.4.4.2	Economic Concept	40
2.4.4.3	Operation Concept	40
2.4.4.4	Ecology Concept	40

2.4.4.5	Mobility Concept	41
2.4.4.6	Multi-roles Concept	42
2.5	Experiments	43
2.5.1	Evaluation criteria	43
2.5.2	Evaluation Context	44
2.5.2.1	Ontology layers	44
2.5.2.2	Evaluation metrics	45
2.5.2.3	Tests and Testers	45
2.5.3	Comprehensibility Results	45
2.5.3.1	Correctness	46
2.5.3.2	Consistency	49
2.5.3.3	Discussion	52
2.5.4	Domain coverage Results	52
2.5.4.1	Integrating <i>OntoMG</i> in HIT2GAP	53
2.5.4.2	Aligning <i>OntoMG</i> with ISare	56
2.5.4.3	Discussion	58
2.6	Conclusion	58
3	Digital Ecosystem Cooperative Model for Microgrids	59
3.1	Introduction	60
3.2	Related work	62
3.2.1	Game-theory approaches	62
3.2.2	Agent-based approaches	65
3.2.3	Discussion	66
3.3	Digital Ecosystem Cooperative Framework	68
3.3.1	Alliance Builder	69
3.3.1.1	Classification Module	77
3.3.1.2	Start Couple Selection Module	77
3.3.1.3	Candidate Alliances Selection Module	77
3.3.1.4	Final Alliance Selection Module	78
3.3.1.5	Alliances Builder Properties	83
3.3.2	Seller-to-buyer matcher	84
3.3.2.1	Alliances Internal matcher	85
3.3.2.2	Microgrid Internal matcher	86
3.3.2.3	Microgrid External matcher	87
3.4	Complexity Analysis	88

3.4.1	Time Complexity	88
3.4.2	Space Complexity	90
3.5	Experiments	91
3.5.1	Experimental Context	91
3.5.2	Experimental Metrics and Results	92
3.5.2.1	Alliance Builder impact on the <i>MG</i> operation	92
3.5.2.2	Alliance Builder Performance	94
3.5.2.3	Seller2Buyer matcher impact on the <i>MG</i> operation	94
3.6	Conclusion	95
4	Multi-objective Cooperative Scheduling for Microgrids	97
4.1	Introduction	98
4.2	Related work	100
4.2.1	Semi-automatic Schedulers	101
4.2.2	Automatic Schedulers	103
4.2.3	Discussion	105
4.3	Multi-objective Cooperative Scheduling	106
4.3.1	Preference-based compromise builder	107
4.3.1.1	Candidate components' prescheduling	113
4.3.1.2	Final components' prescheduling	113
4.3.1.3	Compromise prescheduling	114
4.3.1.4	Preference-based compromise builder illustration	115
4.3.2	Multi-objective Scheduler	119
4.3.2.1	Particle Swarm Optimization	119
4.4	Experiments	120
4.4.1	Experimental Context	120
4.4.2	Experimental Metrics and Results	121
4.4.2.1	Preferences-based compromise builder effectiveness	121
4.4.2.2	Preferences-based compromise builder performance	121
4.4.2.3	Multi-objective scheduler impact on the <i>MG</i>	122
4.5	Conclusion	124
5	Conclusion	125
5.1	Recap	125
5.2	Futur Works	126
5.2.1	<i>OntoMG</i> ontology improvements	127
5.2.1.1	<i>OntoMG</i> non-experts manipulation	127

5.2.1.2	<i>OntoMG</i> reasoning capabilities	127
5.2.1.3	<i>OntoMG</i> deep learning	127
5.2.2	127
5.2.2.1	Real use cases applications	127
5.2.2.2	Auction games integration	128
5.2.3	<i>MOCSE</i> improvements	128
5.2.3.1	Information privacy	128
5.2.3.2	Strategy-proof techniques integration	128

Bibliography		129
---------------------	--	------------

List of Figures

1.1	World electrical energy consumptions	2
1.2	Major historical power outages	3
1.3	Estimated Shares of global toxic gas emissions	6
1.4	World primary energy supply	7
1.5	5C Architecture for Cyber-Physical Systems	9
1.6	<i>DEMG</i> Management System Framework	13
2.1	Microgrid Architecture Example	19
2.2	Extract of the Common Information Model (CIM)	22
2.3	Extract of the MIRABEL information model	23
2.4	Extract of FSGIM information model	24
2.5	Extract of the OASIS information model	25
2.6	Extract of the Facility Ontology	26
2.7	Extract of the Prosumer Ontology	27
2.8	Extract of the upper ontology for power engineering applications	28
2.9	<i>OntoMG</i> structure	34
2.10	Extract of the <i>OntoMG</i> skeleton structure	35
2.11	Extract of the DES Branch	36
2.12	Extract of the Photovoltaic Branch package	37
2.13	Extract of the Wind Power Branch	37
2.14	Extract of the Energy Storage Branch	38
2.15	Extract of the Electrical load Branch	38
2.16	Basic and extended structure of <i>OntoMG</i>	39
2.17	Multi-role Concept	43
2.18	Extract of the Ambiguity Test Used to Evaluate the Correctness	46
2.19	Ambiguity Rate for the Computer Scientists (Non-Experts)	47
2.20	Ambiguity Rate for the Electrical Engineers	48
2.21	Ambiguity Rate for the Electronic Engineers	48
2.22	Extract of the QCM test used to evaluate the consistency	50

2.23	Precision and Recall of the Computer Scientists (Non-Experts)	51
2.24	Precision and recall of the Electric domain experts	51
2.25	Precision and recall of the Electronic Engineers	52
2.26	The architecture of <i>HIT2GAP</i> platform	54
2.27	Extract of HIT2GAP Data Model	55
2.28	ISare Framework Architecture	57
3.1	Our <i>DECF</i> framework	69
3.2	A simplified activity diagram of Alliance Builder	75
3.3	Visual representation of the <i>MG</i> components after the Classification module	80
3.4	Visual representation of the <i>MG</i> components' clustering status after each step	81
3.5	Seller-to-buyer matcher framework	85
3.6	Application of Vogel's Solution	88
3.7	Average Alliances Cost with respect to the number of <i>MG</i> components while considering the operational aspect only	93
3.8	Average Alliances Cost with respect to the number of <i>MG</i> components while integrating the three aspects	94
3.9	Isolated components with respect to the number of <i>MG</i> components	94
3.10	Time performance with respect to the number of <i>MG</i> components . .	95
3.11	Power Exchange Total Cost with respect to the number of <i>MG</i> components	95
4.1	CPSO Configuration and Operation	102
4.2	Multi-objective Cooperative Scheduling Framework	107
4.3	Preferences-based Compromise Builder Framework	112
4.4	Purchase Graph Illustration	115
4.5	Compromise Similarity w.r.t the number of <i>MG</i> Components	121
4.6	Time performance w.r.t the number of <i>MG</i> Components	122
4.7	Time-varying electricity price	123
4.8	Non-cooperative electricity load result	123
4.9	MOCSF electricity load result	124

List of Tables

2.1	Comparison of existing power system information models with respect to the interoperability aspect	29
2.2	Comparing existing power system information models regarding the <i>MG</i> multi-aspect	30
2.3	Identification Concept	39
2.4	Economic Concept	40
2.5	DER Operation Concept	41
2.6	ES Operation Concept	41
2.7	EL Operation Concept	42
2.8	Ecology Concept	42
2.9	Time tracking Concept	42
2.10	Location tracking Concept	42
2.11	Multi-roles Concept	43
3.1	Comparing existing Power Exchange optimization approaches	66
3.2	Example of 9 components of an <i>MG</i>	80
3.3	Resulting components after of the Classification module	80
3.4	Cost matrix of the couples	81
3.5	Example of the Start Couple Selection algorithm execution	82
3.6	Updated Cost matrix of the remaining couples	82
3.7	Candidate Alliance Selection algorithm Execution example	83
3.8	Vogel Problem Parameters	87
4.1	Comparing existing DSM approaches	105

Chapter 1

Introduction

“We forget just how painful dim the world was before electricity.
A candle, a good candle, provides barely a hundredth of illumination of a single
100-watt light bulb...”
- Bill Bryson

1.1 Traditional Grid

Electric grid is a network that consists of electrical components, deployed to generate electric power and supply it to the consumers. In 1882, the Edison Electric Light Company, developed the first steam powered electric power station on Pearl Street in New York City. This was the beginning of a power-dependent society, where electric-power remains a vital source to ensure necessities of life. In 2016, the International Energy Outlook 2016 (IEO2016) Reference case¹ projects significant growth in world-wide energy demand over the 28-year period from 2012 to 2040. In addition, the total world consumption of marketed energy is expected to expand from 549 quadrillion British thermal units (Btu) ² in 2012 to 629 quadrillion Btu in 2020 and to 815 quadrillion Btu in 2040, a 48% increase from 2012 to 2040 (cf. Figure 1.1). Note that the grid has been hailed by the National Academy of Engineering as the most beneficial innovation to our civilization in the 20th century [3].

All that emphasizes the need of upgrading the existing grid to meet the rising demand. However, despite the improvements that have been made on the existing grid [22, 27], it still operates the way it did almost 100 years ago. The problems related to the existing grid are several: 1) the existing grid is aged and centralized, in a way to carry the power from a central generator (mainly based on non-renewable

¹[https://www.eia.gov/outlooks/ieo/pdf/0484\(2016\).pdf](https://www.eia.gov/outlooks/ieo/pdf/0484(2016).pdf)

²1 BTU = 0.000293 kWh

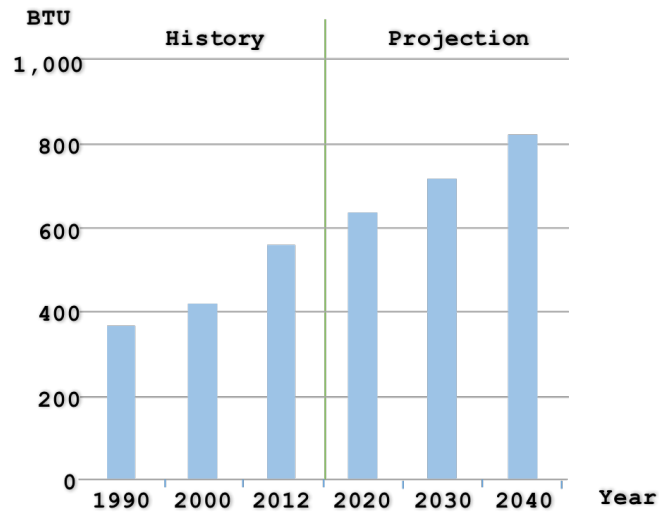

Figure 1.1: World electrical energy consumptions

resources such as petroleum, natural gas, etc.) to a large number of consumers, 2) it has a one-way communication infrastructure (from the grid to the consumer), in that the consumer is passive, and cannot fully express his needs and preferences nor inject power into the grid, and 3) it is equipped with few sensors and monitors which reduce its capabilities of monitoring and detecting problems. The result is a vulnerable and inefficient grid, which increases the risks of having failures and blackouts. It is worthy to note that the world witnessed several major power outages that caused extremely bad effects on the economical and social situations of the countries (cf. Figure 1.2). To mention few recent examples:

- On August 29th 2015, a powerful wind storm knocked out power to 710,000 people on Vancouver Island and Vancouver's lower mainland. 705,000 people had power restored within 72 hours of the storm.
- On March 31st 2015, because of technical problems, over 90% of Turkey (about 70 million people) went without power. Unaffected regions were Van and Hakkari provinces which are fed by electricity from Iran.
- On September 21st, 2016, a full grid collapse occurred on the island of Puerto Rico affecting its 3.5 million people. The power outage, popularly referred to as the "Apagón" (translated as 'super outage') has been labeled as the largest in Puerto Rico history not caused by an atmospheric event. The outage occurred after a failure of two transmission lines, with power running up to 230,000 volts and lasted 24 hours.

- On March 8th, 2017, high winds at 60 mph struck Southeast Michigan and left over 800,000 people without power for 36 hours.

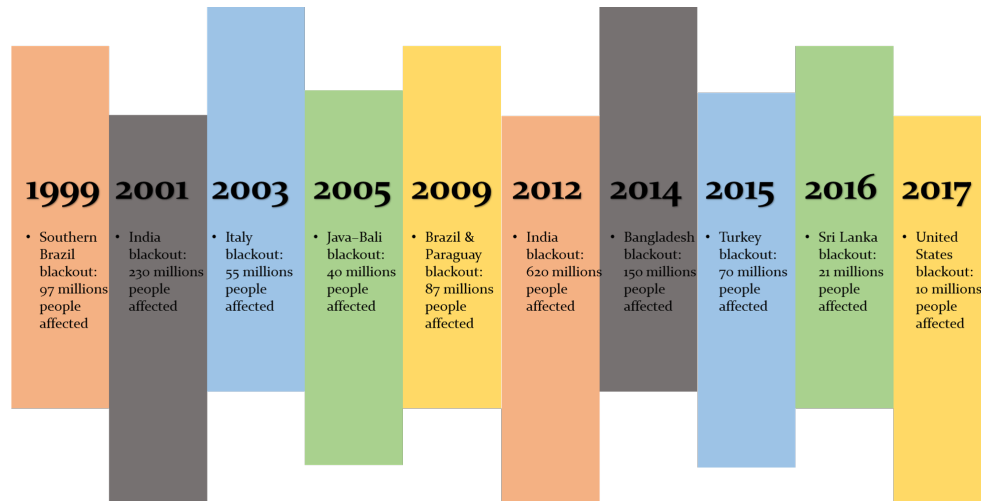

Figure 1.2: Major historical power outages

Hence, significant investments would be needed to upgrade the existing grid to support power demand growth and economical growth without environmental harm. According to the International Energy Agency³, global investments required in the energy sector over the period 2003-2030 are estimated at 16 trillion dollars.

1.2 Traditional grid improvements

In order to provide reliable energy supplies, new services and opportunities have been emerging in the electricity domain. First, the development of information and communication technologies (ICT) gave birth to a new vision of the electrical grid called: the ‘Smart Grid’ or SG. An SG is an electrical grid that uses digital technologies to provide better reliability and monitoring of the power system. It is based on a two-way communication infrastructure, enabling a real-time information exchange between the electrical components. The SGs make the grid more flexible and intelligent, with a significant improvement of efficiency, cost and adaptability. Secondly, the ‘Distributed Generation’ or DG, loosely defined as small-scale electricity generation, is a new concept that contributes to the evolution of the grid. The DG represents decentralized low power generators, often fed by renewable energy sources, but also from fossil fuels. The DG main advantage is that it employs small-scale technologies

³<http://www.worldenergyoutlook.org/media/weowebsite/2008-1994/weo2003.pdf>

to produce electricity close to the consumers. Thirdly comes the ‘Microgrid’ or MG, a new organization of the grid making it more robust and reliable while facilitating the integration of the DG. In this report, we will be mainly focusing on the study of the MGs, their opportunities, issues and solutions.

1.3 Microgrid

An *MG* is a potential host solution conceived to address the aforementioned challenges facing the traditional grid. The U.S. Department of Energy (DOE) and the California Energy Commission (CEC) jointly came up with a report from Navigant Consulting in 2005 ⁴ that defines the *MG* as follows:

‘An *MG* consists of interconnected distributed energy resources capable of providing sufficient and continuous energy to a significant portion of internal load demand (the power demand inside the *MG*). It possesses independent controls, and intentional islanding takes place with minimal service interruption (seamless transition from grid-parallel to islanded operation)’.

In a simpler way, an *MG* is a small-scale power system consisting of renewable and non-renewable energy sources, such as micro-turbines, photovoltaic arrays and fuel cells, together with electrical consumption loads and storage systems such as batteries, super capacitors and flywheels. An *MG* is controlled and monitored via an ‘*MG* Central Controller’ or MGCC, which includes functions like SCADA (Supervisory Control and Data Acquisition), grid health monitoring, energy management and other functions. The key feature that distinguishes an *MG* from a traditional grid is its control capabilities allowing it to operate in off-grid (islanded) or on-grid (connected) mode by changing the grid connection status. In grid connected mode, the *MG* is connected to the main grid at a point of common coupling that maintains the same voltage level as the grid unless there is any problem. So, the switch separates the *MG* from the main grid. In islanded mode, the *MG* is disconnected from the main grid which forces the distributed generators to power the local grid, without any dependency on the main grid.

1.3.1 Microgrid benefits

Thanks to the use of distributed generation that ensures reliable power supply and the ability to self-generate power when islanded, the *MG* can provide a large variety of multi-objective benefits: operational/technical, economical and ecological benefits.

⁴<https://goo.gl/l4ocFR>

1.3.1.1 Operational/technical Benefits of a Microgrid

An *MG* can likely enhance the technical performance of the grid mainly in the following aspects.

- **Power quality:** The term ‘power quality’ refers to the voltage quality in a certain area, which essentially depends on the transmission and distribution infrastructure of the grid in this area. Today’s main grid is suffering from a low power quality caused by the lack of investments in the grid that leads to voltage imbalance, power frequency variation, and voltage fluctuation, etc. Here comes the importance of the *MG* that can disconnect from the main grid, in case of power quality issues, and ensure a normal power supply. Depending on the electrical loads installed in the *MG*, power quality needs may differ inside the *MG*. For instance, in highly critical premises (e.g., hospitals, military bases, etc.), a high-power quality is necessary.
- **Transmission and distribution losses:** Power generated from the main grid pass through a complex network [66] consisting of a big number of cables, transformers and other equipment before reaching its end destination (the consumer). Hence, some percentage of the power generated is lost in the grid. The International Energy Agency (IEA) estimates that electricity transmission and distribution losses average about 8.163% of the electricity that is transmitted and distributed annually in the world⁵. An *MG* can significantly reduce the power losses by satisfying its internal power needs using its own power generation without the need to import power from the main grid and thanks to its ability to be installed near the consumers.
- **Reliability:** According to the North American Electric Reliability Corporation (NERC), the term ‘reliability’ refers to the grid ability to meet the power needs, even when sudden disturbances happen⁶. It represents the capability of a grid to face unexpected disturbances or unanticipated losses in grid components, by ensuring adequate service on an almost continuous basis, with few ruptures over a long time. Knowing that the main grid faces hundreds of disturbances every day, mainly caused by natural incidents (e.g., rainy days, lightning, arc flashes, snow storms toppling trees over the transmissions lines, etc.), a grid should have certain reliability to avoid significant power blackouts. An *MG* is

⁵<https://www.iea.org/Textbase/npsum/WEO2015SUM.pdf>

⁶<http://www.electricity.ca/industry-issues/economic/reliability.php>

a perfect reliable solution thanks to its capability to automatically disconnect from the main grid [91, 55].

1.3.1.2 Ecological Benefits of a Microgrid

According to the International Energy Agency (IEA) report delivered in 2016 ⁷, the use of energy (resulting from production, processes, transmission, storage and use of fuels) constitutes the largest contributor in the worlds toxic gas emissions ratio (cf. Figure 1.3).

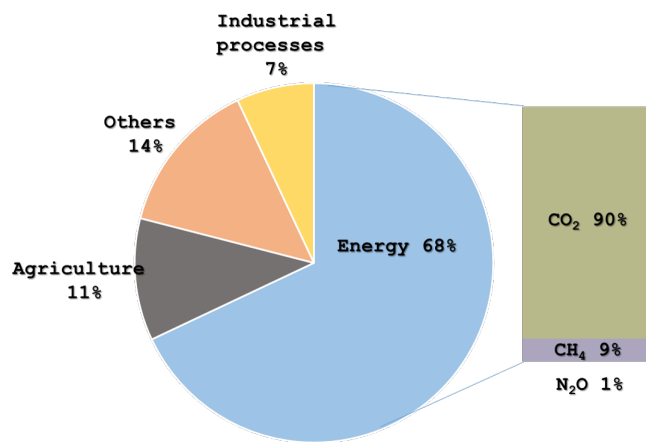

Figure 1.3: Estimated Shares of global toxic gas emissions

This comes to the fact that due to the increasing worldwide power demand, the global total primary energy supply (TPES) increased by almost 150% between 1971 and 2014, but still mainly relies on fossil fuels (cf. Figure 1.4).

Hence, an *MG* can contribute positively in the reduction of the toxic gas emissions due to the integration and the increasing reliance of the renewable energy sources. Besides, even if the *MG* consists of non-renewable energy sources, the ecological bad effects will be very limited since an *MG* is a small-scale grid, and thus, its gas emissions level will be rather small.

1.3.1.3 Economical Benefits of a Microgrid

An *MG* acts as a local energy market[84, 47] able to establish a local power exchange between the energy sources, energy storages systems and the consumers constituting the *MG*. This can ensure an energy costs reduction for the consumers willing to buy power from the *MG* power sources at prices lower than the retail level (instead

⁷https://www.iea.org/publications/freepublications/publication/Global_EV_Outlook_2016.pdf

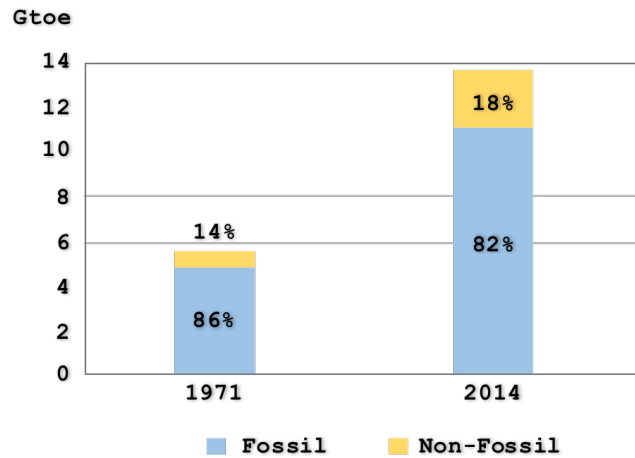

Figure 1.4: World primary energy supply

of buying at higher prices from the main grid) and a benefit increase for the power sources willing to sell power to the main grid at prices higher than the prices at wholesale level.

1.3.2 Microgrid Challenges

MGs are expected to hold the promise of becoming a major ingredient in the implementation of the future power systems. However, as it is the case with most new technologies, there are several significant challenges to overcome in order to achieve its expected benefits. In the following, we will briefly mention the main challenges facing the *MG*.

1.3.2.1 Autonomy

An *MG* consists of power generation, energy storage and electrical loads. An efficient *MG* should be able to operate autonomously in grid-connected and islanded mode [68]. In the grid-connected mode, an *MG* should independently optimize its own power generation and consumption while considering the grid economy such as buying or selling decisions (whether it is more beneficial to sell or to buy power to/from the main grid). In both modes, the *MG* should reduce toxic gas emissions by maximizing renewable energy consumption and minimizing fossil based generation. In islanded mode, the grid should be able to balance the power generation and the consumption.

1.3.2.2 Integrating renewable energy sources

Despite their positive contribution on the environment, the integration of the renewable energy sources are facing several challenges [24], mainly: 1) they suffer of operating constraints such as variable power supply related to their weather dependency, and 2) they are less predictable than non-renewable energy sources.

1.3.2.3 Compatibility

An *MG* is the key building block of future grids [78]. Hence, it should be completely compatible with the existing grids [45], supporting their growth in an economical and environmentally friendly way.

1.3.2.4 Scalability

An *MG* can grow through the installation of additional energy sources, storage systems and electrical loads. Such an extension should be done easily without the need of a new configuration of the *MG* and in a parallel and modular manner so to reach higher generation and consumption levels [40].

1.3.2.5 Decentralized control

An *MG* is currently controlled via an *MG* Central Controller or MGCC. This centralized control increases the failure risks and weakens the monitoring capabilities of the *MG* since the minor problem in the MGCC can cause disturbances and instability in the grid. Thus, an *MG* should support a peer-to-peer model for operation, control and energy trade [92].

1.3.2.6 Security

An *MG* could face hundreds of disturbances every day, not only caused by natural incidents such as rainy days and lightning, but also by non-natural incidents such as terrorist attacks and human errors. Thus, an *MG* should meet security requirements allowing it to react appropriately to coming disturbances without interruption of the power supply [4].

To sum up, there is a serious need to improve today's *MG* infrastructures to meet the tomorrow expectations by allowing them become smarter, decentralized, scalable and secured. Our choice to reach that is to put together three disciplines: energy, telecommunications, and Information technologies, so to create a wiser *MG*.

1.3.3 Microgrid as a Cyber-physical system

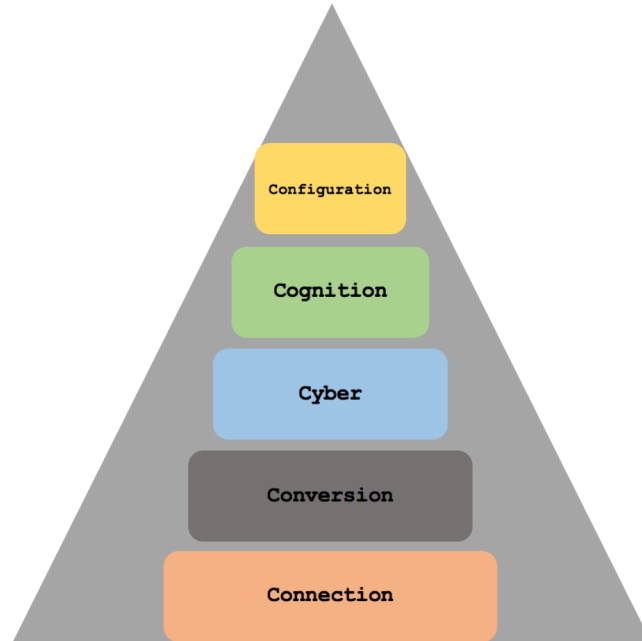

Figure 1.5: 5C Architecture for Cyber-Physical Systems

With the advancements of smart technologies such as the Internet of Things (IoT) and Information and Communication Technologies (ICT), a new paradigm emerged called ‘Cyber-Physical Systems’ or CPS. A CPS refers to a new generation of systems which integrate computational and physical capabilities [6], in order to improve the autonomy, efficiency and reliability of the systems. The key to success of the CPS is the ‘Information’. In [53], the authors have defined a 5C architecture (cf. Figure 1.5) for designing and deploying the CPS. The architecture is pyramid-shaped to represent the way data is changing; by increasing the level, the size of the data becomes smaller, however, the value of the information rises:

- In the ‘Connection level’, the data generated by the self-connected devices is gathered and pushed up to the next level.
- In the ‘Conversion level’, the collected data is converted to information using dedicated algorithms. For instance, consider raw data extracted from an alarm device. The raw data carries no useful information about the status of the system. But an alarm processing algorithm can extract pertinent features and can provide warning signals in case of dangerous situations.

- In the ‘Cyber level’, information from the conversion level is received and used to create additional value after applying complex analysis. It might seem that both conversion and cyber levels are similar. However, the main difference between them is that the conversion level is more focused on the individual assets while the cyber level deals with the information provided from the entire system to infer additional knowledge.
- In the ‘Cognition level’, the system uses specific prediction algorithms to diagnose its own potential failure and estimate the time to reach certain kinds of failures. Besides, it ensures a remote visualization for human interaction and an integrated simulation and synthesis.
- In the ‘Configuration level’, the system ensures a self-optimize for disturbances and a self-configure for resilience. It can defend itself from difficulties by changing its own behaviors using the health monitoring information.

CPS realized significant achievements in several domains, such as robotics, transportation, health care, etc. But most importantly, CPS made a revolution in the electricity domain and especially in *MGs*.

1.3.3.1 Cyber-Physical Microgrid Challenges

Relying on the CPS architecture, several issues have been seriously improved giving the *MG* the ability to: 1) integrate a big number of devices without additional infrastructure changes via the plug and play technology [52], 2) monitor the status of the whole equipment in a better and faster way, 3) remotely control several devices, 4) sense more data (and not only technical data), and 4) be integrated seamlessly into existing grid. However, several challenges remain still.

1.3.3.1.1 Identification The integration of CPS has weakened the *MG* from different perspectives, mainly from security perspective. In essence, with the digitalization of *MG*, cyber-attacks have become easier, creating some breaches such as intentionally remote-switching off of the *MG* operators, conducting to cause cascade damages on the grid. Hence, one of the key challenges to be revolved by the *MG* is to ensure a reliable identification of the components (for appropriate authentication and better traceability) aiming at reducing the grid intrusions.

1.3.3.1.2 Mobility Nowadays, a device has the ability to move during its lifetime inside the same *MG* and/or between different ones. For example, this is the case of electric vehicles and boats [49]. The *MG* needs to cope with this mobility and trace it properly.

1.3.3.1.3 Multi-roles Another aspect needs to be considered as well in the *MG*: ‘Prosuming’ [35, 71]. It refers to the ability of some devices to PROduce and CONSUME power at the same time. An *MG* needs to take advantage of their capabilities as a support to its energy management.

1.3.3.1.4 Interoperability An *MG* usually consists of several heterogeneous components such as power generation, storage systems and electrical loads, build and supplied by different organizations with different purposes and protocols. In addition, the heterogeneity of the *MG* would arise further from the internal and external communication between the components within the *MG* and with the main grid. All that highlights the communication issues and emphasizes the need to ensure a seamless information exchange between the components. The main building block in resolving the communication issue is to develop a information modeling that aims at providing dedicated semantic interoperability between components. However, none of the current information models [60, 69, 19, 85, 32, 16] fully provides such semantic interoperability since they mainly rely on modeling the technical data sensed from equipment (without coping with its semantics).

1.3.3.1.4.1 Cooperation As mentioned previously, the integration of ICT into the power systems allowed better cooperation between components thanks to reliable communication protocols. Thus, smarter cooperation can be easily adopted by the *MG*. It is to be noted that most of current approaches are only providing non-cooperative environments [59, 73, 57]. A non-cooperative environment has significant bad effects on the operational, economical and ecological benefits of the *MG*. From operational perspective, a non-cooperative *MG* would increase the transmission and distribution losses by allowing sometimes the power exchange between far away components instead of promoting close exchange between near components. From economical perspective, a non-cooperative *MG* would cause an increase of the power costs since *MG* components may sell/buy power to/from the main grid instead of exchanging power locally inside the *MG*. From ecological perspective, a non-cooperative *MG* may accept any power exchange (between the electrical loads

and the non-renewable energy sources) instead of fostering the renewable sources. While few existing approaches foster cooperative models [72, 5, 46], they also don't take into account the three mutual perspectives and only consider the cooperation as a classical optimization problem. They also ignore the end-user needs which can evolve.

1.3.3.1.4.2 Demand-side management The ICT allowed power systems to move from a one way to a two-way communication system enabling a real-time information exchange between its components. This makes the consumers more active and able to express their needs and preferences in the *MG*, leading to the emergence of Demand-Side Management (DSM). DSM consists of planning and monitoring activities of electric components in order to encourage consumers to modify their level and pattern of electricity usage and reduce their electricity bills. While the consumers are enjoying their reduced electricity bills when shifting their consumption from on-peak to off-peak periods, they may encounter discomfort costs related to the delay time of receiving their desired power. This means that many considerations need to be taken into account in order to provide a successful DSM. Current DSM approaches [63, 90, 56] provide pretty nice solutions to schedule the consumption. However, they don't consider the production scheduling, which plays an essential role in shaping the peak load, in reducing the electricity bills, and in minimizing the gas emissions effects. Furthermore, all the existing approaches lack in considering multiple energy sources, since they take into account the interaction with only one utility grid. Thus, an *MG* power scheduling should include the consumption, the production and the storage in a way to reduce peak hours while minimizing the electricity bills and preserving the components comfort as much as possible.

1.4 Contributions

In order to provide a wiser *MG*, while relying on CPS, we propose in this thesis a Digital Ecosystem (DE) based *MG* or *DEMG* to overcome the challenges aforementioned. The concept of DE has been adopted as a natural way to represent the *MG* since it is a collaborative environment consisting of several heterogeneous, interconnected and interrelated components that need to cooperate in a mutual way while advising local and global objectives [13, 17, 65].

In order to give our *DEMG* requested features and tools, we propose a 3-layered management framework as shown in Figure 1.6:

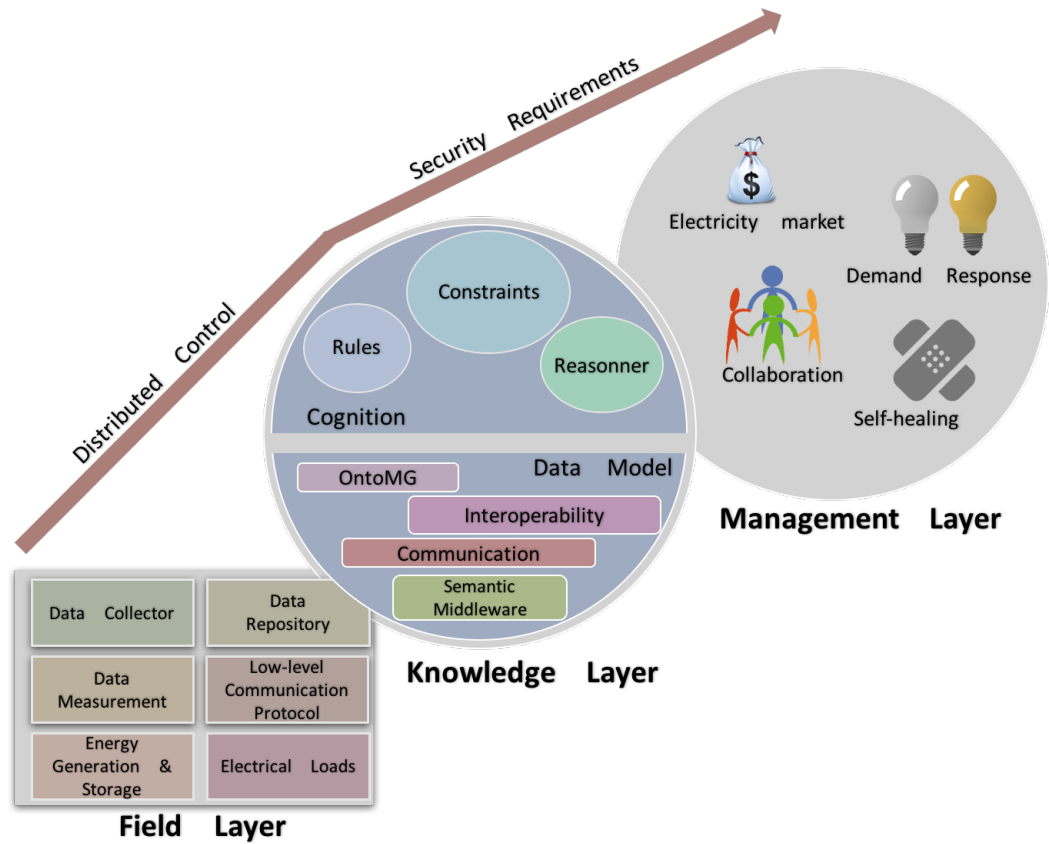

Figure 1.6: *DEMG* Management System Framework

Our information model considers the 5C architecture of cyber-physical systems (Connection, Conversion, Cyber, Cognition and Configuration) and the ICT infrastructure, complemented with additional modules specific to the objectives of the *MG* (e.g., Electricity market, Demand Response, Collaboration, etc.). The three layers will be briefly described in what follows.

- **Field Layer (FL):** Via this layer, the data collector gathers all data exchanged between components via a low-level communication environment [79] relying on standardized protocols (e.g., BACnet [50], Modbus [67], etc.). Once gathered, those data are stored in a low-level data repository and pushed up to the next layers.
- **Knowledge Layer (KL):** In order to resolve the interoperability issues and open up the possibility to model the new trends in today's energy systems (i.e., prosumers, electric vehicle, etc.), it is essential to capture and understand the semantics of exchanged data to ensure a seamless communication between the

components within the *DEMG*. Through this layer, the semantic middle-ware insures the semantic translation of the collected data using our ontology-based information model called *OntoMG* [74]. Furthermore, the reasoner is responsible of processing information and using it to infer additional value thanks to many rules and constraints defined in this layer.

- **Management Layer (ML):** In this layer, a collaborative diagnostics, a self-optimization for disturbance, and a remote visualization for the users (via an integrated simulation and synthesis) are provided. Besides, the information extracted from the knowledge layer is processed in order to achieve the objectives of the *DEMG*. To do so, a battery of advanced management services (e.g., Demand side management, minimization of transmission losses, etc.) is designed.

In this report, we will be focusing on the knowledge and the management layers. The main contributions of this thesis can be summarized as follows:

1.4.1 *OntoMG*: An Ontology-Based Information Model for Microgrids

First, we introduce *OntoMG*, an ontology-based information model that aims at 1) resolving interoperability issues encountered in the *DEMG* and 2) achieving its functionalities and objectives (not fully covered in the existing information models as mentioned previously). Our model is based on the CIM and the IEC 61850 standards, integrating 6 main concepts each related to a specific aspect involved in the achievement of the *DEMG* objectives, namely, 1) identification concept related to the components' unique identity in the system, 2) operation concept related to the components' operating, 3) mobility concept related to the components displacements during their lifetime, 4) economical concept related to the components' participation in the Energy Market, 5) ecology concept related to the components' participation and effects in/on the environment, and 6) the multi-roles concept, related to the component roles during its activities in the system.

1.4.2 Digital Ecosystem Cooperative Model for Microgrids

We propose a Cooperative Framework *DECF* for a better management of the *MG* (at the management layer). *DECF* is based on two main modules: 1) the alliances

builder and 2) the Seller2Buyer matcher. The first module is a novel clustering algorithm consisting of gathering the *MG* components into ‘alliances’. Each alliance contains a number of components, having mutual interests. Their interests is expressed by an objective function, taking into account three-dimensional *MG* objectives: operational, economical and ecological. The second module comes down to establish a power exchange, consisting of exchanging power between the components forming each alliance, between the remaining components that couldn’t form new alliances, as well as between the remaining components and the main grid. The result is a set of seller-to-buyer associations, each composed of the seller and the buyer that have the biggest interest in working together.

1.4.3 Multi-objective Alliances-based Scheduling for Microgrids

After identifying the best components’ associations to exchange power, a Multi-Objective Cooperative Scheduling framework *MOCSF* designed for scheduling the production, consumption and storage in the *MG*, and more specifically the seller-to-buyer associations resulting from the *DECF*. The scheduling an association maintains the cooperation aspect of the *MG* by preserving the power exchange between the sellers and the buyers that achieve the highest benefits when working together. *MOCSF* consists of two main modules: the **Preference-based Compromise Builder**, providing the best balance between the desired schedulers of the sellers and the buyers given as an input, and the **Multi-objective Scheduler**, providing seller-to-buyer associations scheduling aiming at ensuring the economical, ecological and operational satisfactions.

1.5 Publications

1.5.1 Conference Papers

1. Khoulood Salameh, Richard Chbeir, Haritza Camblong, Gilbert Tekli, and Ionel Vechiu. A generic ontology-based information model for better management of microgrids. In *Artificial Intelligence Applications and Innovations*, pages 451 - 466. Springer, 2015.
2. Vanea Chiprianov, Laurent Gallon, Khoulood Salameh, Manuel Munier, and Jamal El Hachem. Towards security software engineering the smart grid as a

system of systems. In System of Systems Engineering Conference (SoSE), 2015 10th, pages 77 - 82. IEEE, 2015.

3. Khoulood Salameh, Richard Chbeir, Haritza Camblong, and Ionel Vechiu. Microgrid Components Clustering in a Digital Ecosystem Cooperative Framework. In Knowledge-Based and Intelligent Information and Engineering Systems (KES), Procedia Computer Science, 2017 - Accepted.

1.5.2 Journal Papers

1. Khoulood Salameh, Richard Chbeir, Haritza Camblong, and Ionel Vechiu. A Digital Ecosystem Cooperative Model for better Management of Microgrids. In IEEE Transactions on Sustainable Computing, IEEE, 2017 - Accepted.
2. Khoulood Salameh, Richard Chbeir, Haritza Camblong, and Ionel Vechiu. SSG: An Ontology-Based Information model for Smart Grids. In IEEE Transactions on Smart Grids, IEEE - Submitted.

1.5.3 Oral Presentation

1. Khoulood Salameh, Richard Chbeir, Haritza Camblong, and Ionel Vechiu. Digital Ecosystem for better Management of Microgrids. In ACM Conference on Management of Digital EcoSystems (MEDES), 2016.

1.6 Report Organization

The rest of this report is organized as follows.

Chapter 2 describes our ontology-based information model: *OntoMG*. We present a review related to the existing power systems information models. Then, we introduce the *MG* information architecture, detailing its three-layer architecture aiming at better locating our proposed information model (in the knowledge layer). After that, we detail the *OntoMG* ontology, through its main concepts, highlighting its importance in resolving the multi-objectives aspects of an *MG* and to cope with the interoperability layers. Finally, we describe the evaluation methodology and results of our proposed framework and ontology.

Chapter 3 introduces our digital ecosystem cooperative model: *DECF*. We provide a detailed analysis of the existing power exchange optimization techniques and their drawbacks with respect to the requested needs. Then, we detail the two main components of *DECF*: The Alliances builder and the Seller2Buyer Matcher. The first aiming at gathering the components having interests in working together into alliances and the second aiming at establishing a seller to buyer matching inside the resulting alliances. An illustrative example is provided after each step to ease the understanding of each module. Finally, we show the set of experiments elaborated to demonstrate the efficiency of our technique.

Chapter 4 presents our multi-objective alliances-based scheduling for *MGs*: *DECSF*. We first present current scheduling approaches. Then, we detail our scheduling framework consisting of two main modules: The Preferences-based associations prescheduling and the Associations scheduler. Our scheduler allows to schedule the power consumption production and storage while considering the components preferences. Finally, we show the results of the experiments conducted to validate our approach.

Chapter 5 concludes this study and presents several future research directions that we identified through our study and that will be explored afterwards.

Chapter 2

OntoMG: An Ontology-Based Information Model for Microgrids

“The purpose of models is not to fit the data but to sharpen the question...”

- Samuel Karlin

In this ‘renewable era’, researchers’ eyes are diverted to the *MGs* to exploit their functionalities in order to improve today’s power systems. This work addresses two main challenges encountered in the management of such an *MG*: 1) the semantic interoperability needed between its heterogeneous components in order to ensure a seamless communication and integration, and 2) a means to consider its various objectives from economical, ecological, and operational perspectives, to mention some. In this chapter, we propose a three-layered *MG* management framework, aiming at resolving these two issues. The backbone of the framework is *OntoMG*, a generic ontology-based model, is detailed here. It aims at modeling¹ the *MG* components, their features and properties, allowing the achievement of the *MG* objectives. Several evaluations have been conducted in order to validate our proposed framework and emphasize the *OntoMG* importance and utility in the electricity domain. Obtained results are satisfactory and draw several promising perspectives.

¹Note that, in our work we are focusing on the data modeling of the *MG*

2.1 Introduction

In the era of new technologies and with the growing need for reliable ecological energy supplies [29], current electrical grids have to be upgraded in order to be smarter, more flexible and able to operate, monitor and heal themselves autonomously. Here comes the *MG* as one of the main contributor in the power systems update. However, as mentioned in the Introduction of this thesis, several challenges have to be solved before. One of the most important challenges is related to heterogeneity. In essence, *MGs* consists of a number of heterogeneous components (cf. Figure 2.1) (built and supplied by different companies, for different purposes, and using various protocols [42] such as local generation units, energy storage systems, electrical loads, electric vehicles as well as technologies still to be invented). In addition, the heterogeneity of such power systems would arise further from the internal and external interactions of their components as well as with the external environment. All this underlines the need of an appropriate semantic interoperability ensuring a seamless information exchange between components within three layers as discussed in [37, 38] : Field Layer, Knowledge Layer, and Management Layer (cf. Fig. 1.6).

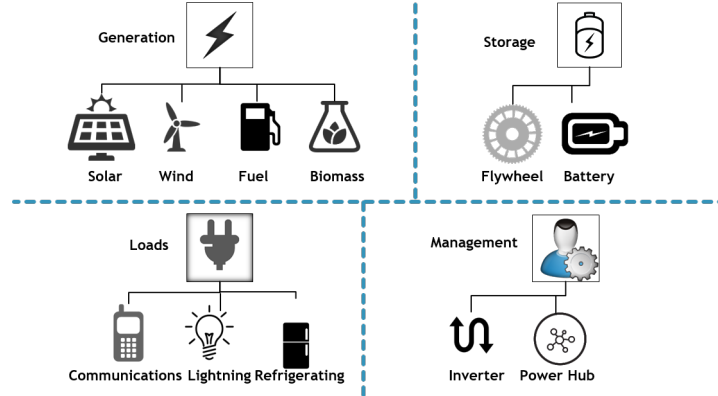

Figure 2.1: Microgrid Architecture Example

In addition to the operational aspect related to the components operating, the *MG* needs to ensure several services each targeting a different objective. First, an *MG* aims at providing reliable and secured identification when incorporating heterogeneous components. In today’s digital world, cyber-attacks [54, 61], such as intentionally switching off the *MG* operators, could cause cascade damages on the grid. Hence, it is important to provide such an identification for the components helping in reducing the grid intrusions. Second, each component can play multiple roles, participating in the emergence of a new paradigm known as ‘Prosumer’ [71, 35], referring to the

components able to **PRO**duce power and **conSUME** energy at the same time. Hence, an *MG* can be seen as a multi-objective system that depends on a potential interaction among different stakeholders (i.e., energy sources, energy consumption loads, etc.), having each its objectives, which emphasizes the need of taking into account all the aspects involved in the achievement of the *MG* objectives. Third, the *MG* needs to cope with the mobility of the several components (e.g., electric vehicles, boats, etc.) during their lifetime. Fourth, an *MG* would become an important player in the electricity market relying on its components participation in the environment.

The goal of this study is to address the above issues and challenges by providing an appropriate information modeling for *MGs*. In this chapter, we present a dedicated framework for better management of *MG* driven by adapted tools and services. We also detail here our ontology-based *MG* model called *OntoMG*, capable of:

1. Being compliant and aligned with existing information models,
2. Coping with the interoperability between all the layers,
3. Providing the reasoning capabilities and smart features needed, as well as
4. Solving the multi-objective aspect of the *MG*.

To the best of our knowledge, this is the first attempt to provide an ontological data model to represent *MGs* and to consider their specificities.

The rest of this chapter is organized as follows. Section 2.2 presents the state of the art of existing power systems information models. Section 2.3 describes the proposed *MG* architecture. Section 2.4 presents our *OntoMG* ontology through its main concepts. Section 2.5 describes the evaluation methodology and results of the proposed framework and ontology. Section 2.6 concludes the chapter.

2.2 Related Work

Knowing that the *MG* is a new paradigm in the electricity domain, most of the existing information models provided in the literature addressed the problem of ‘Power system information modeling’ and not specifically the ‘Microgrid information modeling’ with the exception of very few models (more details will be provided in the following). They can be categorized into syntactic-based and semantic-based approaches. The syntactic-based models are intended to provide a standard way to

represent the data of the system. The semantic-based models are ontology-based information models, aiming at providing a richer and complex knowledge representation about the entities and relations between them.

2.2.1 Syntactic Based Models

2.2.1.1 Common Information Model

The Common Information Model (CIM) [60] is a widely accepted electricity information model being part of the IEC 61970 standards. Its main objective is to develop a platform independent data model for enabling better grid interoperability. This model includes the exchange between market participants and market operators as well as communication between market operators. Figure 2.2 shows an extract of the CIM represented in UML model. It shows that the *PowerSystemResource* concept is composed of the *Equipment* concept that contains the components of a power system that are physical devices, electronic or mechanical. Two types of equipment exist: 1) *ConductingEquipment* and 2) *Powertransformer*. A *ConductingEquipment* concept, represents the parts of the power system that are designed to carry current. A *Powertransformer* is an electrical device, allowing a mutual coupling between electric circuits.

From the multi-objective perspective, the CIM model [60] does not fully describe all the operational properties of the distributed energy sources and the storage systems. In addition, it covers partially the ecological aspect (using the *EmissionType* parameter) and the economical aspect (using the *CostPerEnergyUnit* and *CostPerHour* parameters). The identification aspect is limited to only two parameters: *Id*, *Name*. However, the mobility and the multi-role aspects were totally absent in the model.

From the interoperability perspective, the CIM model does not cover completely the field layer. In addition, since it is an UML based model, this impoverishes the semantic relations between the concepts, which limits its knowledge coverage. In addition, as mentioned before, since there is a lack in representing all the objective aspects of a power system, this also affects negatively the management layer.

2.2.1.2 MIRABEL FlexEnergy Data Model

The MIRABEL smart grid system [85] comes to hand over the flexibility in energy demand and supply. It incorporates the power profile concept which associates a consumption/production schedule for each branch.

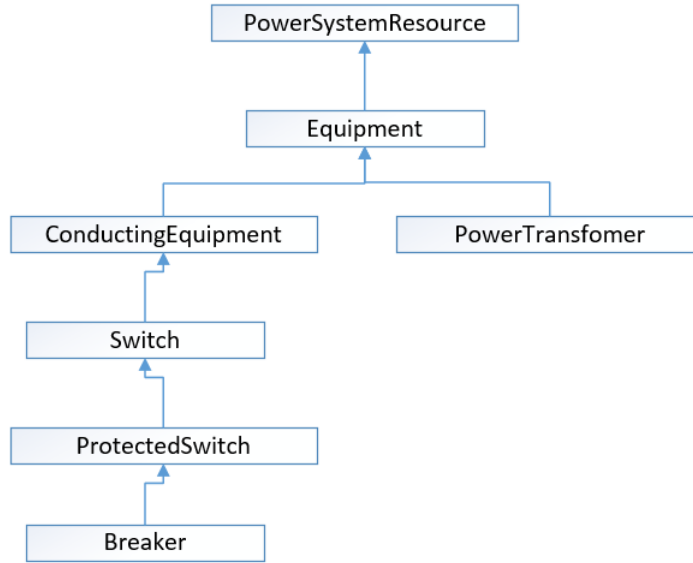

Figure 2.2: Extract of the Common Information Model (CIM)

In order to achieve such flexibility in energy demand and supply in the power grid, a data model has been developed in [85] consisting of five main classes (cf. Figure 2.3): *branch*, *actor*, *energyprofile*, *constraint* and *flex-offer*. A *branch* is an energy consumer or producer that has a specific energy load over a certain time span (called *energyprofile*). An *actor* has minimum or maximum demands (called *constraints*) on their energy load, price and time. These constraints are issued (by an actor) toward the branches owned by the actor. The *flex-offer* class defines two types of demands: flexible demand and non-flexible demand. Flexible demand can often be shifted from the peak demand times to lower demand times, while non-flexible demand should be satisfied immediately without time delay.

From the multi-objective perspective, the model in [85] provides a high economical aspect representation and a slighter representation of the operational and identification aspects, since it is dedicated to conceive a flexible market power exchange. However, the ecological, mobility and multi-roles aspects are absent in it.

From the interoperability perspective, the MIRABEL model does not cover completely the field layer. Similarly to the CIM model, Mirabel is an UML based model, which impoverishes its semantic expressiveness and the knowledge coverage. In addition, as mentioned before, since there is a lack in representing all the objective aspects, affecting negatively the management layer.

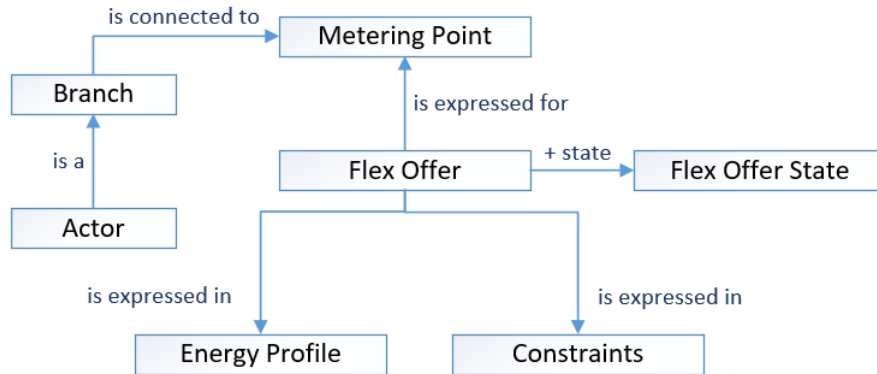

Figure 2.3: Extract of the MIRABEL information model

2.2.1.3 Facility Smart Grid Information Model

The Facility Smart Grid Information Model (FSGIM) [69] is developed with the aim of enabling energy consuming branches and control systems in the customer premises so to manage electrical loads and energy sources in response to communications with the smart grid. To achieve this, an object-oriented information model (cf. Figure 2.4) is defined to support a wide range of energy management applications and electrical service provider interactions. The proposed information model [69] provides a common basis to describe, manage, and communicate information on aggregate electrical energy consumption and forecasts.

From the multi-objective perspective, the FSGIM model covers almost all the components of a power system, except the storage devices (only the thermal storage systems are modeled). However, the model takes fully into account the economical and identification aspects. Concerning the ecological aspect, it is partially covered in the model (using *Emission* parameter). The multi-role aspect is completely absent in the model.

From the interoperability perspective, the FSGIM model does not cover completely the field layer. In addition, since it is an object-oriented model, it has a limited means to express the semantic relations between the components and the reasoning capabilities of the system. All this causes a partial management layer coverage.

2.2.1.4 OASIS Energy Interoperation

OASIS Energy Interoperation [19] enables collaborative use of energy in a power network. It defines XML-based vocabularies for the interoperable and standard exchange

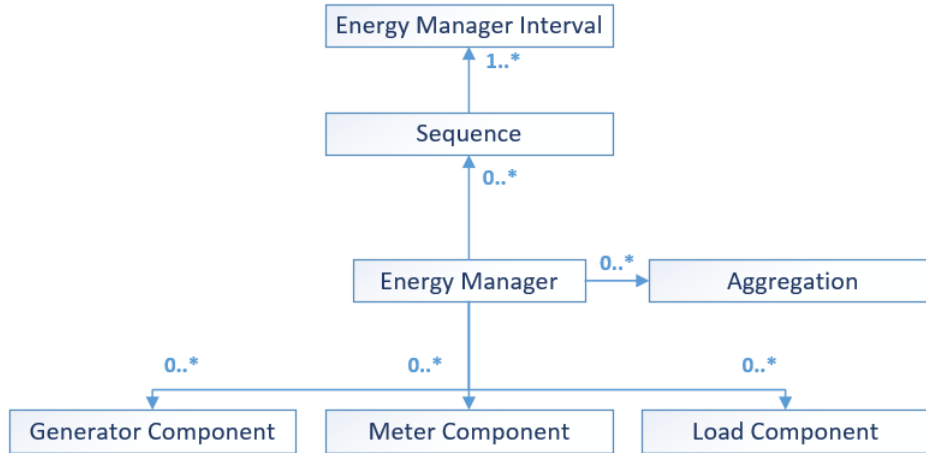

Figure 2.4: Extract of FSGIM information model

of information related to energy prices and bids (demand and response), network reliability, emergency signals and the prediction of loads consumption (cf. Figure 2.5). This information relies on the *WS – Calendar* [20] and *EMIX* (electricity market Information Exchange Specification) [18]. The first defines how to specify and communicate the duration and time of a schedule, while the later specifies the semantics (i.e., definition of price and products) in electricity markets.

From the multi-objective perspective, the OASIS model covers completely the economic aspect since it targets the electricity market information model. However, it neglects the remaining aspects.

From the interoperability perspective, the OASIS model covers partially the three layers, since it does not cover completely all the components and operational parameters, without taking into account all the semantic relations between the components.

2.2.2 Semantic Approaches

2.2.2.1 Facility Ontology

The Facility Ontology [81] aims at conceiving a standard nomenclature for the power systems, by providing a representation of its components and their control parameters. Complying with the Suggested Upper Merged Ontology (SUMO), the proposed ontology aims to classify the power system in two main concepts: the *Physical* and the *Abstract* concepts (as shown in Figure 2.6). The *Physical* concept serves for describing the physical components of the power system (i.e., production unit, storage unit, consumption unit and conversion unit) with a set of related properties. Concerning the *Abstract* concept, two concepts are introduced: the *Management*

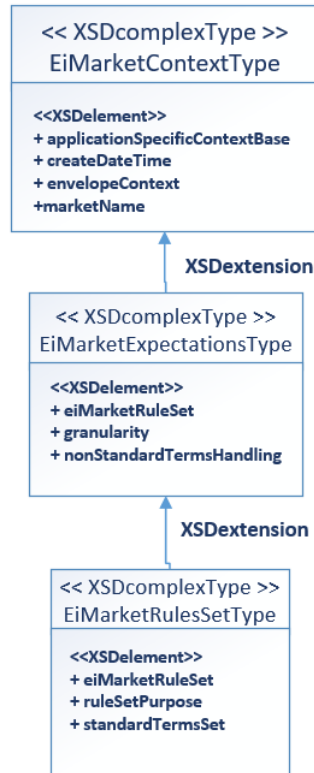

Figure 2.5: Extract of the OASIS information model

concept, and the *Policy* concept. The *Management* concept consists of four sub concepts: i) the *Energy_trading*, ii) the *Lc_operation*, iii) the *Mgcc_operation* and iv) the *Operational_modes*. The *Lc_operation* and *Mgcc_operation* concepts contain all the information related to the load and central controllers. The *Energy_trading* concept represents the information related to the power exchanged in the grid, such as the power prices, the minimum and the maximum power quantity. And finally, the *Policy* concept, refers to the information related to the constitution (*Design* concept), the operation (*Operation* class) and interface (*integration* concept) of the power system.

From the multi-objective perspective, the ontology shows a high efficiency in representing the operational aspect, by modeling all the components of the power system. Similarly to the operational aspect, the economical one was taken into account via the *Energy_trading* concept. The identification aspect was limited to the definition of the *ID*, *Mode* and *Manufacturer* parameters. However, the mobility, the ecological and the multi-role aspects were totally absent in the ontology.

From the interoperability perspective, the Facility Ontology covers completely

the field layer. However, it is poor in representing the semantic relations between the components (limited to the "hasSubClass" relations), which limits its knowledge coverage. In addition, as mentioned before, there is a lack in representing all the objective aspects of a power system which affects negatively the management layer.

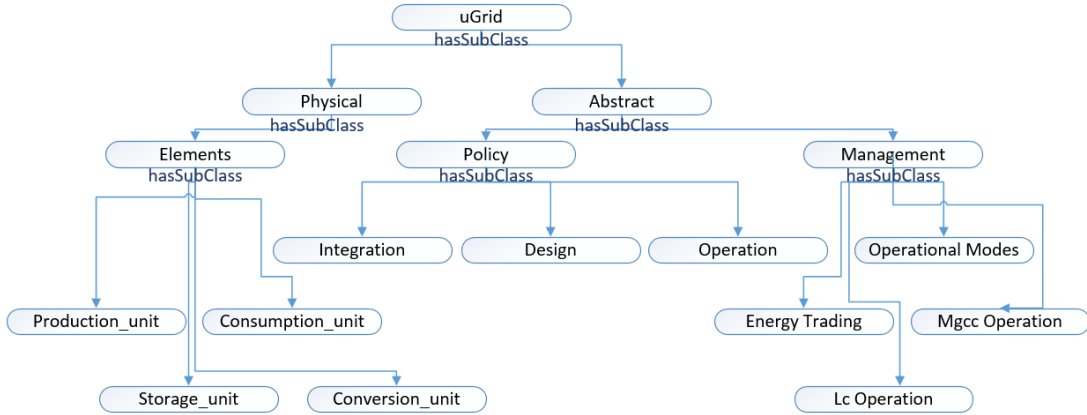

Figure 2.6: Extract of the Facility Ontology

2.2.2.2 Prosumer Ontology

In [32], the authors propose a classification of the power system components using several predefined scenarios (cf. Figure 2.7). Based on the UK property classification [ref], five power consumption patterns are identified, namely: 1) *commercial premises* consisting of the consumers having varying operating times, 2) *business related premises* consisting of the consumers having fixed operating times (e.g., office times), 3) *residential premises* consisting of the houses consumption, 4) *non – residential premises* consisting of non-residential premises (e.g., hospitals, schools, etc.) having more critical power needs, and 5) *industrial premises* consisting of the factories consumption having uninterrupted power needs. Concerning the energy sources classification, two categories were also introduced in [32]: *renewable* and *non – renewable* energy sources, while three energy storage systems categories were identified, according to the type, produced power and charge and discharge efficiency, namely: 1) *energy management*, 2) *power quality*, and 3) *bridging power*. In addition, the *component connectivity* focuses on enabling the exact connectivity relationships between the producers and the consumers. And finally, the *Service Contracts* comes to describe the information exchanged between the producers and the consumers in a competitive market. It contains the Start/End Date” of the contract, the type of payment and the charges per units of power.

From the multi-objective perspective, the ontology in [32] shows a lack in the operational aspect, since it is limited to modeling the main components of a power system, without taking into account their operational parameters. When it comes to the economic aspect, it is partially taken into account by modeling the contracts between producers and the consumers. The ecological aspect is partially modeled by distinguishing the renewable and non-renewable energy sources. The remaining aspects are totally absent in this model [32].

From the interoperability perspective, the Prosumer ontology covers partially the field layer. This affects directly the knowledge layer modeling. Here again, the management layer can partially be addressed due to the lacks in the multi-objective aspect modeling.

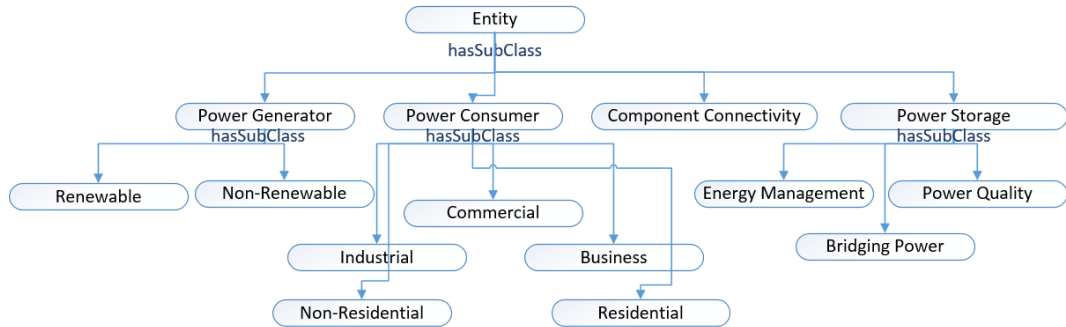

Figure 2.7: Extract of the Prosumer Ontology

2.2.2.3 Upper Ontology for power engineering application

Based on the Common Information Model (CIM) [60], the authors in [16] propose an ontology that mainly aims at monitoring the health status of the power systems. Figure 2.8 shows an extract of the upper ontology. The concept *Measurement* represents anything that can be measured, including data taken from sensors and historical data. In addition, anything that is extracted from raw data is represented as an *Interpreted Data*, and specifically as a *Summary Interpretation* or a *Detailed Interpretation*. Moreover, the components' operations in the system are represented via the *Agent Action*. This model supports the exchange of messages between agents, but not explicitly defined. Although adopted by several applications, the upper ontology usually needs to be enriched with additional concepts to cover all the required information.

From the multi-objective perspective, and since this model [16] is based on the CIM [60], this leads to inherit the same objective aspects coverage. Hence, the upper

ontology covers partially the operational, identification, economical and ecological aspects, but does not take into account the mobility and multi-roles aspects.

From the interoperability perspective, the upper ontology covers partially the field layer. In addition, it neglects the semantic relations between the components, which makes the knowledge layer incomplete. All this causes a lack in the management layer.

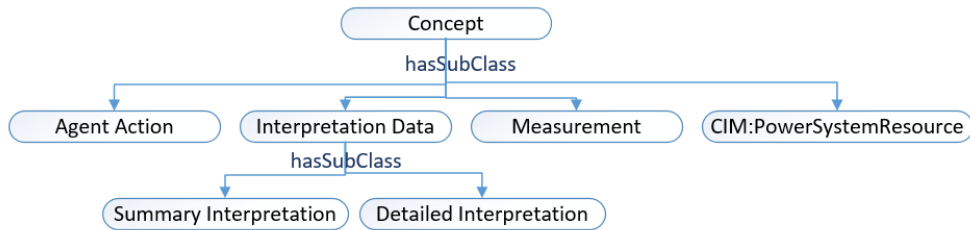

Figure 2.8: Extract of the upper ontology for power engineering applications

2.2.3 Summary

In this section, we present a comparison summary between the existing approaches, highlighting their strengths and drawbacks with respect to their ability to resolve the interoperability issue within a power system, and the integration of the necessary aspects allowing the achievement of related services. Three symbols for comparison will be used in what follows:

- ”-” to express the low capabilities of an approach in covering a feature,
- ”partial” when an approach has middle coverage capabilities, and
- ”+” to express the high coverage capabilities of an approach.

2.2.3.1 Interoperability aspect

Table 2.1 shows the ability of the existing approaches to cope with the interoperability issue. In short, most of them cover the modeling of the field layer, which contains the physical components of the power systems. Concerning the Knowledge/Information layer, the semantic-based approaches show a better potential in the knowledge modeling, compared to the syntactic-based ones, represented by the classification and the categorizing of the power systems components, but lack in fully modeling the relationships between them. Table 2.1 also shows that existing approaches cannot provide

an appropriate modeling of the management layer, since they are mostly limited to modeling the electricity market information.

Table 2.1: Comparison of existing power system information models with respect to the interoperability aspect

	Interoperability Layers		
	Field Layer	Knowledge/Information Layer	Management Layer
CIM [60]	Partial	Partial	Partial
FSGIM [69]	+	Partial	Partial
OASIS [19]	-	-	-
MIRABEL [85]	-	-	-
Prosumer [32]	Partial	Partial	Partial
Facility Ontology [81]	+	Partial	Partial
Upper ontology [16]	Partial	Partial	Partial

2.2.3.2 Multi-objective aspect

Table 2.2 summarizes the main commonalities and differences between existing approaches with respect to the six categories of aspects used in the achievement of the Power Systems objectives. In short, few take properly into account the identification aspect. In contrast, the operational aspect is the core of most of the existing models, whose aim was to standardize the technical vocabulary in the power systems, except MIRABEL system which mainly focuses on the electricity market modeling. Clearly, as the comparison table shows, the economical aspect is highly modeled since most of the existing models aim at conceiving a market power exchange. Moreover, the ecological aspect is merely modeled through a small set of properties related to the gas emission of the components. However, two aspects are almost absent in the existing information models, namely: 1) the mobility aspect representing the shifts of the components in the system, and 2) the multi-roles aspect, representing the roles played by a component during its lifetime according to a certain context.

To sum up, none of the existing approaches completely addresses the interoperability and the multi-objective aspect of the power system. In the following section, we provide our *MG* Management System framework, aiming at resolving interoperability issues from the information perspective by integrating all the power system aspects related to its objectives.

Table 2.2: Comparing existing power system information models regarding the *MG* multi-aspect

	MG Objective aspect					
	Identification	Operational	Mobility	Economical	Ecological	Multi-Roles
CIM [60]	Partial	Partial	-	Partial	Partial	-
FCGIM [69]	+	Partial	Partial	Partial	+	Partial
OASIS [19]	-	-	-	+	-	-
MIRABEL [85]	Partial	Partial	-	+	-	-
Prosumer [32]	-	Partial	-	-	Partial	-
Facility Ontology [81]	Partial	+	-	+	-	-
Upper Ontology [16]	Partial	Partial	-	Partial	Partial	-

2.3 Microgrid Management framework

In order to give *MG* requested features and tools, we propose our *MG* Management System framework consisting of three main modules (cf. Figure 1.6).

- **Field Layer (FL):** it directly focuses on the digital exchange of data between the physical equipment of a power system and the establishment of a reliable low-level communication environment. This is achieved by using several standardized protocols such as BACnet [15] and Modbus [30] to transform communications to TCP/IP packets. Note that, the data exchanged between the components at this layer (e.g., voltage, frequency level, etc.) could be stored in different data storage repositories depending on the technologies used.
- **Knowledge Layer (KL):** Since, it is not sufficient to understand the syntax or the grammar of the data exchanged to ensure a seamless communication between the components, it is a must to capture its semantics and to model it. Thus, this layer encompasses the semantic translation of the data coming from the low-level data repositories. The translated data plays an essential role in facilitating the interoperation and opens up the possibility to model the new trends in today's and tomorrow's energy systems (i.e., prosumers, power plants, electric vehicle, etc.). *OntoMG*, an ontological data model is proposed here in order to represent all the *MG* components and their relations.
- **Management Layer (ML):** it uses the information extracted from the KL in order to provide advanced management and control services and functionalities. It consists of applying artificial intelligence techniques, aiming to achieve the power system services and to meet expectations in resolving interoperability issues and multi-objective aspect. Six services' categories are proposed:

- *Identification Services*: the main identification services are the *Authentication* and the *Registration*. In the aim of establishing a secure access to the power system, an *Authentication* service is required. It verifies the identity of any component wishing to access the *MG*. The *Registration* service, is the process of registering the components in the power system using a set of parameters defined in the information/knowledge layer.
- *Operational Services*: the main operational services are 1) the *Voltage and frequency regulation*, 2) the *Fault detection*, 3) the *Power loss minimization*, and 4) the *Peak power reduction*. The *Voltage and frequency regulation* consists of maintaining a balanced output of the voltage and frequency of the grid, done despite the systems' disturbances and the load variations. The *Fault detection* consists of detecting power system errors as fast as possible, so that an appropriate action can be immediately taken before major problems can happen. The *Power loss minimization* consists of ensuring the power exchange between the components in a way to reduce the power transmission losses. The *Peak power reduction* consists of reducing the maximum power consumption (for instance, by applying prediction techniques of electrical consumption [34] and demand-side management techniques).
- *Economical Services*: they consist of managing the impact of the components on the electricity market. They play an essential role in delegating the cheapest component that should be launched or implemented to satisfy a certain need. For instance, one main economical service is the *electricity market management* which consists of establishing auction algorithms in order to find the optimal power prices and to maximize the net benefit of the components.
- *Ecological Services*: they consist of managing the participation of the components in the environment. The main ecological service is the *Green decisions management*. It consists of ensuring a cooperation in the power system by gathering the components that have mutual benefits, in order to make green decisions (e.g., putting up consumers having high power needs with the renewable energy sources in the aim of reducing the pollution ratio).
- *Mobility Services*: they are related to the components movements [49] in the power system. The main mobility service is the *Components location*

tracking. It consists of determining and tracking the precise location of a component at any time. It is also used by the *Fault detection* service by facilitating the detection of the location of any problem in order to fix it more rapidly.

- *Multi-roles Services*: they are related to the components which are able to execute many roles during their lifetime in the *MG*. The main multi-roles service is the *Role forcing* which forces a component to play a certain role (i.e., produce, consume or store power) when there is an essential need in the *MG*.

2.4 *OntoMG* Ontology

As seen in our related work study, semantic-based models showed a higher expressive power in dealing with interoperability issues and to some extent with the multi-objective aspect of the *MGs*. Thus, this drove us to adopt a semantic-based approach called *OntoMG*, a generic ontology-based model, aiming at modeling the *MG* components, their parameters and additional properties allowing the achievement of its objectives.

2.4.1 Why ‘Ontologies are appropriate’ means for semantic approaches?

In the recent years, ontologies gained a huge success in the representation of the domain specific knowledge and resolving interoperability issues [76], in various domains. Due to its importance [36] in information systems and artificial intelligence, an ontology-based *MG* information model would provide a shared knowledge conceptualization allowing an easier system interaction and manipulation, especially for non-computer scientists, while giving the grid reasoning capabilities and autonomy.

2.4.1.1 Ontology as a Shared Knowledge

Since an *MG* consists of a number of heterogeneous components, it is important to define a shared representation of the exchanged information. In addition, each component has a direct/indirect impact on the other components and on the overall grid. Hence, it is necessary to have a shared collective representation allowing the study of the local and the global impact of each component in the *MG*. Furthermore, knowing that there are several existing power system information models,

an ontology would form the knowledge core of the system, by providing enrichment and semantic expressiveness to the information but also allowing the description of specific situations, integration and alignment with multiple specific ontologies. Note that, a shared knowledge is primordial for the information exchange between the *MG* and the electricity market that should speak the same language.

2.4.1.2 Ontology as a better means for Information Retrieval

Since a power system is usually managed by non-computer-scientists, an ontology would help them interact and manipulate the system in an easier and more intuitive way. Besides, an ontology would provide a structure that is flexible, and that naturally organizes the information in multidimensional ways like finding more general/specific classes (e.g., a wind turbine *isA* renewable energy source, and this latter *isA* distributed energy resource). As well, an ontology would allow a more sophisticated information retrieval, for instance, ‘retrieving the distributed energy sources that are renewable energy sources but are neither wind power nor solar power’.

2.4.1.3 Ontology as a Reasoning Strategy

Due to the intermittent aspect [21] of the renewable energy sources and the exposure of the power system to predictable and non-predictable events (power system anomalies, storms, etc.), an ontology becomes essential since it can also represent beliefs, goals, hypotheses, and predictions. These latter will give the components the ability to act and react autonomously or collectively according to a certain event or goal. For example, thanks to the reasoning capabilities provided by an ontology, a diesel generator should easily stop working automatically when the renewable energy sources are able to satisfy all the loads power demands. In addition, a system can advise a component to adjust its production/consumption according to another component with better profile.

For all these reasons, we believe that modeling a *MG* using an ontology is a suitable choice allowing the resolving of the interoperability issues in a complex system consisting of numerous heterogeneous components, and the modeling of all its objective aspects.

2.4.2 *OntoMG* Overview

While conceiving an ontology, the main target is to settle a shared terminology describing the power system. Several steps were conducted while developing our on-

tology [83]. In the aim of being compliant with existing standards, the first step was to identify the well-known and most adopted standards in the power domain. Two important standards have been identified: the CIM / IEC 61790 model (already detailed in the related work section), and the IEC 61850-7-420 related to the basic communication structure for distributed energy resources logical nodes. The second step consisted of grouping the concepts into categories in order to check the coverage of the ontology regarding the needed aspects. And finally, the refinement phase consisted of establishing the semantic relations between the defined concepts. Thus, to cope with the interoperability issues, the skeleton structure of the *MG* (called the **basic structure**) is mainly based on the CIM standard and the multi-objective aspect (called **extended structure**) is based on the IEC 61850 standard and completed with a set of additional properties (cf. Figure 2.9).

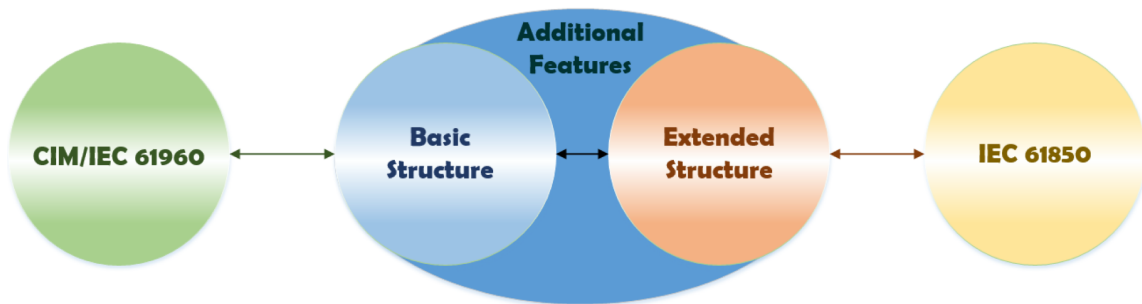

Figure 2.9: *OntoMG* structure

Our ontology, called *OntoMG*, is a graph representing a collection of subject-relation-object triples, where:

- Nodes designate subjects, objects, or subject/object properties representing:
 - *MG* branches and components (e.g., EnergyStorageBranch, WindTurbine, etc.), and
 - Corresponding property values (e.g., panelWidth, totalCost, etc.)
- Edges connecting source/destination nodes, designate relations representing:
 - Relations between components (e.g., WindTurbine isA DistributedEnergySource, etc.), and
 - Property and value relations (e.g., windTurbine HasSpeed 50, solarPanel HasCost 7500, etc.)

The property values and edges in *OntoMG* are mainly classified into five categories: identification, mobility, operation, economic, and ecology. Details are provided in what follows.

2.4.3 *OntoMG* Basic structure

To cope with the interoperability issues, our *OntoMG* basic structure is a semantic translation of the CIM extension proposed in [88]. Knowing that the CIM is not dedicated to cover specifically the *MG* components modeling, the authors in [88] proposed additional features (e.g., solar power, wind power, etc.). Here comes the importance of our ontology that represents in a simple and clean way, each branch structure which contains the set of the equipment that composes it. Figure 2.10 shows the ‘Microgrid’ concept, inheriting from the “CIM:SubControlArea”, which describes relative information of the power system operation and allows the creation of several connected power systems instances. Based on the branch concept defined in [88], four main branches are added here: 1) Distributed energy source branch, 2) Energy storage branch, 3) Electrical load branch, and 4) Infrastructure Branch, where each has its own Branch Switch and Branch Controller. The Branch Switch is responsible of turning on/off the branch, and the Branch controller is the manager of the branch operations. All concepts borrowed from CIM have been prefixed with “CIM:” in the following figures of the provided ontology.

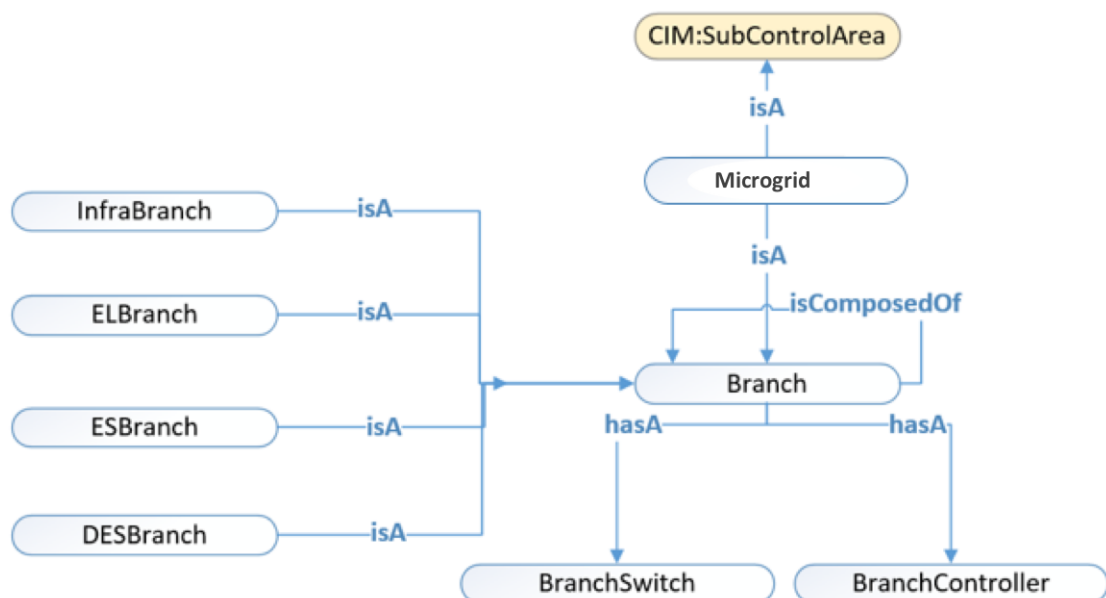

Figure 2.10: Extract of the *OntoMG* skeleton structure

2.4.3.1 Distributed Energy Source (DES) Branch

The distributed energy resource branch consists of renewable or non-renewable energy sources. Figure 2.11 shows the DES branch concept, consisting of a Solar Power Branch, Wind Power Branch, Combined Heat Power Branch and Fuel Power Branch.

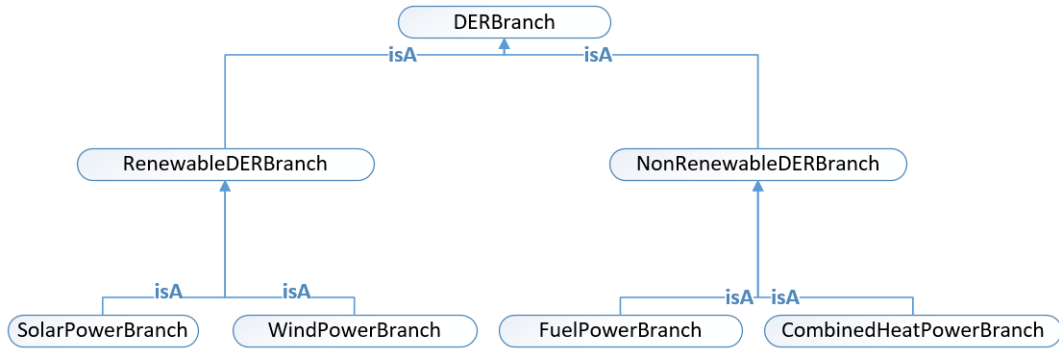

Figure 2.11: Extract of the DES Branch

Note that a branch is a combination of several equipment, when working together, they accomplish a specific function in the *MG* (e.g., a Solar Cell and a Converter are two main equipment constituting the Solar Power branch and allowing its functioning in the power system). In more details, a Solar Power branch (cf. Figure 2.12) consists mainly of a Solar Cell a converter. The Solar Cell is an electrical device that converts the energy of light directly into electricity by the photovoltaic effect, which is a physical and chemical phenomenon. The converter is a branch for altering the nature of an electric current or signal, especially from AC to DC (Ac/Dc Converter) or vice versa (commonly called Inverter). This latter can be a Monophasic inverter or a Triphasic inverter.

Figure 2.13 depicts the wind power branch. It includes mainly, the wind turbine and the converter. The wind turbine generates electricity from the kinetic power of the wind. The wind turns two or three propeller-like blades around a rotor. The rotor is connected to the main shaft, which spins a generator to create electricity. Similarly to the photovoltaic branch, the converter consists an essential component in the wind power structure.

2.4.3.2 Energy Storage (ES) Branch

Recently, the energy storage systems start to have a great potential in radically transforming the global energy landscape, helping to solve key issues in the integration of

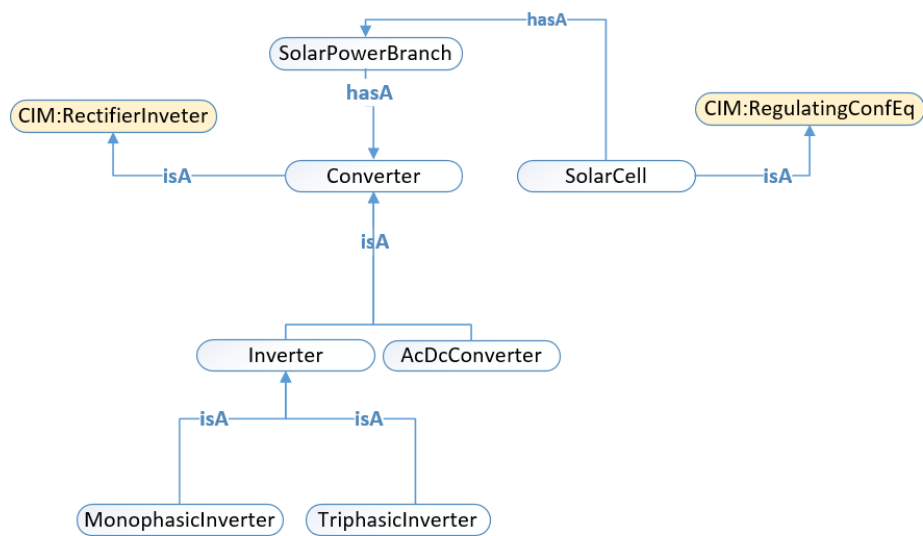

Figure 2.12: Extract of the Photovoltaic Branch package

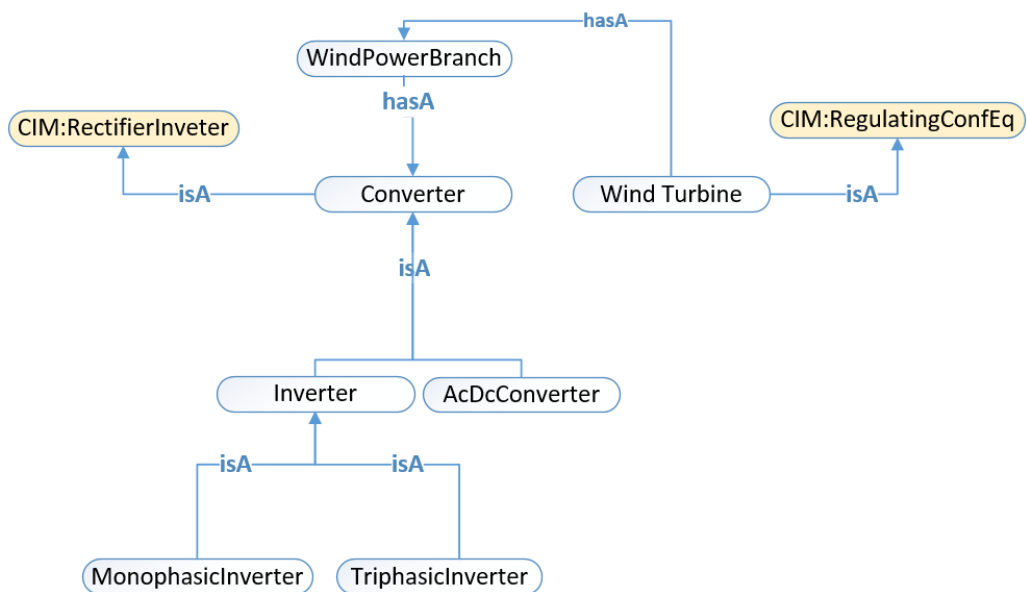

Figure 2.13: Extract of the Wind Power Branch

renewable energy systems. Energy storage systems play an essential role in stabilizing the *MG*, improving the quality of power supply, and achieving power peak shaving. The energy storage branch consists mainly of the energy storage device (e.g., Pumped-Storage Hydroelectricity (PSH), batteries, etc.) and a converter (cf. Figure 2.14).

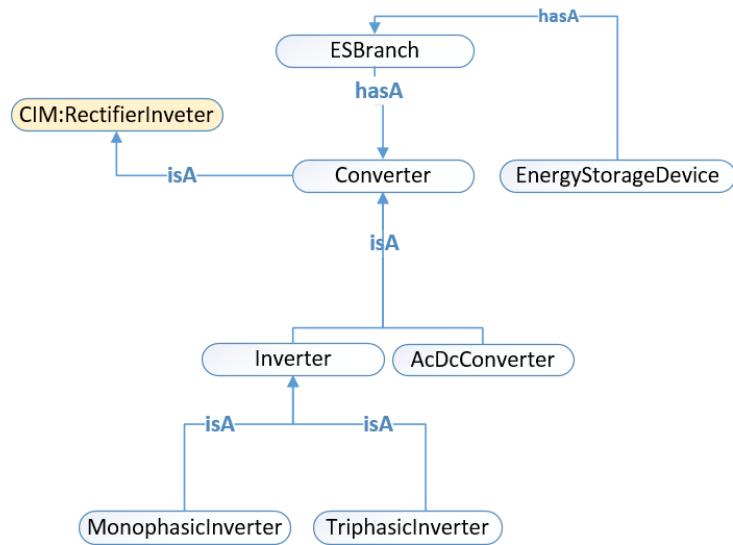

Figure 2.14: Extract of the Energy Storage Branch

2.4.3.3 Electrical Load (EL) branch

An electrical Load is an electrical component or branch that consumes electric power. It is mainly consisting of the electrical appliance components (cf. Figure 2.15).

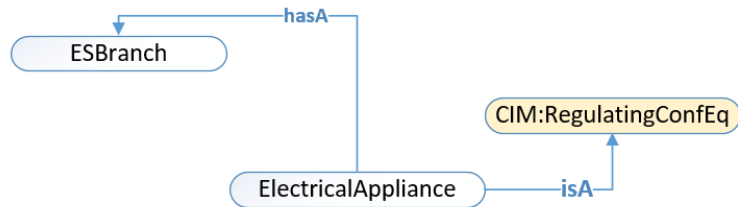

Figure 2.15: Extract of the Electrical load Branch

2.4.4 *OntoMG* Extended Structure

To cope with the multi-objective aspect of an *MG*, *OntoMG* aims to model all the aspects/functionalities participating in the achievement of its objectives. Hence, six concepts are defined, each covering an objective aspect, namely: 1) identification, 2) economical, 3) operation, 4) mobility, 5) ecological and 6) multi-roles. Those concepts are the key for conceiving an *MG* able to reason and act autonomously. It is worth

noting here, that a big number of the *OntoMG* concepts mentioned below will be used in our *DECF* and *MOCS* modules explained in the coming chapters.

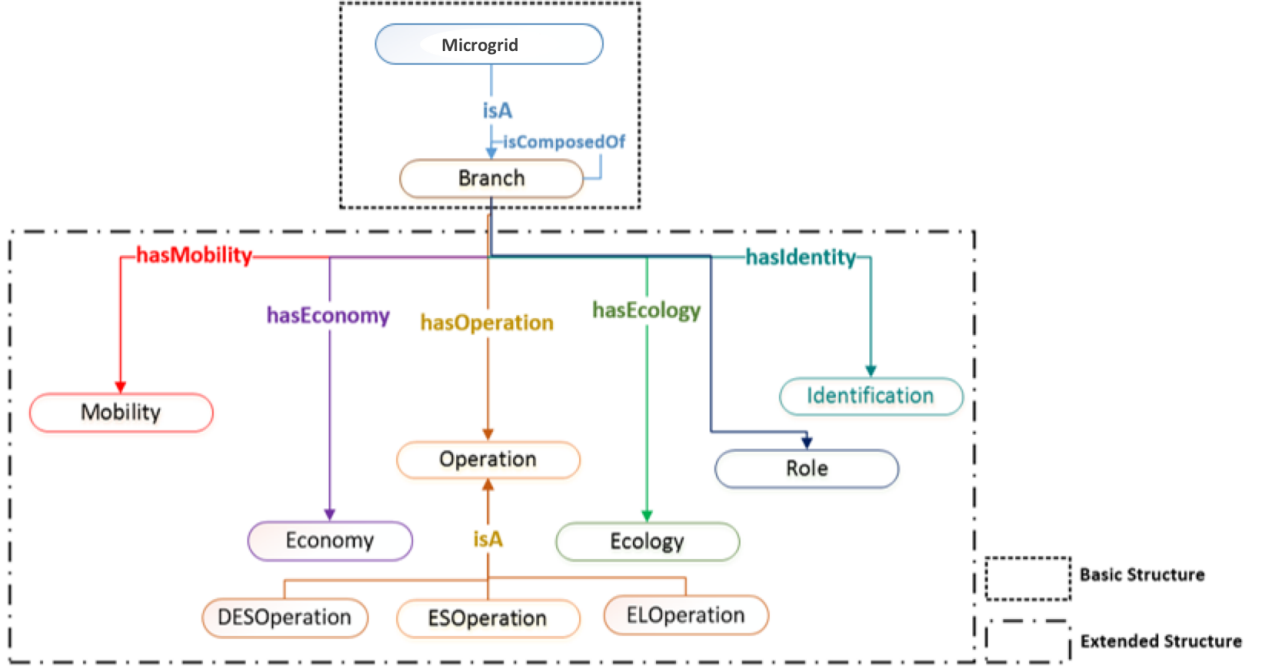

Figure 2.16: Basic and extended structure of *OntoMG*

2.4.4.1 Identification Concept

An *MG* consists of several heterogeneous branches, each having its own characteristics and operation modes during its lifetime. Thus, when joining an *MG*, each branch is associated, through an identification service, with an ‘identity’ consisting of a number of properties distinguishing it from the others and giving it the possibility to be automatically recognized. The identification concept consists of a number of properties (cf. Table 2.3): the serial number which is a unique value, the type, brand and model designating a certain provider.

<i>Name</i>	<i>Description</i>	<i>Type</i>
<i>Serial#</i>	Unique identifier of a component within the system	String
<i>Type</i>	Type to which a component belongs	String
<i>Brand</i>	Feature that distinguishes one seller’s component from those of others	String
<i>Model</i>	Style or design of a particular component	String

Table 2.3: Identification Concept

2.4.4.2 Economic Concept

Due to the importance of the *MG* from economic perspective, it is essential to consider related properties of its components. Those properties imply several features related to the *MG* participation in the electricity market. Table 2.4 shows the main properties of the economic aspect consisting of: the maintenance cost, the total cost, the start up cost, the stop cost, the installation cost, the equipment cost and the operating cost. Two additional properties are only assigned to the branches being able to sell their produced/stored power are the power price per KWh, the power price per hour, and the power cost.

<i>Name</i>	<i>Description</i>	<i>Type</i>
<i>EqCost</i>	Equipment cost of a component	Number
<i>MaintenanceCost</i>	Maintenance cost of a component	Number
<i>InstallCost</i>	Installation cost of a component	Number
<i>OpCost</i>	Operating cost of a component	Number
<i>TotalCost</i>	Total cost of a component	Number
<i>StrCost</i>	Start up cost of a component	Number
<i>StopCost</i>	Stop cost of a component	Number
<i>PwrKWhPrice</i>	Power price vector per KWh	Number
<i>PwrhPrice</i>	Power price vector per hour	Number
<i>PwrCost</i>	Production power cost vector	Number
<i>CptBill</i>	Consumption bill vector	Number

Table 2.4: Economic Concept

2.4.4.3 Operation Concept

The operation concept encompasses the technical properties related to the components functioning during their lifetime in the power system. Since our model is based on the IEC 61850 in its extended structure, this eases the exchanges of the technical information between the *MG* components.

Tables 2.5, 2.6 and 2.7 show the list of the distributed energy source (DES), energy storage (ES) and electrical load (EL) operation properties, respectively.

2.4.4.4 Ecology Concept

Knowing the importance of the *MG* in the integration of green energy production, it becomes essential to take into account the components contribution in the environment. This participation is modeled through ecology concept (cf. Table 2.8) using several properties, such as the carbon emission ratio, the Ethylene emission ratio,

<i>Name</i>	<i>Description</i>	<i>Type</i>
<i>IEC : VRtg</i>	Voltage level rating	Number
<i>IEC : ARtg</i>	Current rating under nominal voltage under nominal power factor	Number
<i>IEC : HzRtg</i>	Nominal frequency	Number
<i>IEC : TmpRtg</i>	Max temperature rating	Number
<i>IEC : VARTg</i>	Max volt-amps rating	Number
<i>IEC : WRtg</i>	Max watt rating	Number
<i>IEC : Vartg</i>	Max var rating	Number
<i>IEC : MaxWOut</i>	Max watt output - continuous	Number
<i>IEC : WRtg</i>	Rated Watts	Number
<i>IEC : MinWOut</i>	Min watt output - continuous	Number
<i>IEC : EffRtgPct</i>	Efficiency at rated capacity as percent	Number
<i>LaunchCount</i>	Number of time the components is launched during an interval of time	Number
<i>Penalty</i>	Waiting time penalty of launching the component	Number
<i>SInit</i>	Desired schedule of the component	Double
<i>SOp</i>	Operational schedule of the component	Double

Table 2.5: DER Operation Concept

<i>Name</i>	<i>Description</i>	<i>Type</i>
<i>IEC : AhrRtg</i>	Amp-hour capacity rating	Number
<i>IEC : BatVNom</i>	Nominal voltage of battery	Number
<i>IEC : BatSerCnt</i>	Number of cells in series	Number
<i>IEC : BatParCnt</i>	Number of cells in parallel	Number
<i>IEC : DisChaCnt</i>	Discharge curve	Number
<i>IEC : DisChaTim</i>	Discharge curve by time	Number
<i>IEC : DisChaRte</i>	Self discharge rate	Number
<i>IEC : EffRtgPct</i>	Efficiency at rated capacity as percent	Number
<i>IEC : SOCPct</i>	Battery level as percent	Number
<i>IEC : SOHPct</i>	Battery lifetime as percent	Number
<i>LaunchCount</i>	Number of time the components is launched during an interval of time	Number
<i>Penalty</i>	Waiting time penalty of launching the component	Number
<i>SInit</i>	Desired schedule of the component	Double
<i>SOp</i>	Operational schedule of the component	Double

Table 2.6: ES Operation Concept

and others gas emissions ratios, expressed in g/Kg. In addition, the pollution costs related to the toxic emissions are modeled using several properties: Carbon Emission Cost, Etyl Emission Cost.

2.4.4.5 Mobility Concept

In order to model the components ability to move during their lifetime in the *MG*, a two-dimensional tracking is represented through two concepts : ‘Time tracking’ and ‘Position tracking’. Each concept has a set of properties allowing a fine-grained tracking (cf. Tables 2.9 and 2.10).

<i>Name</i>	<i>Description</i>	<i>Type</i>
<i>ActhAm</i>	A.m active hours	Number
<i>ActhPm</i>	P.m active hours	Number
<i>Cpt</i>	Current consumption	Number
<i>MaxCpt</i>	Maximum consumption	Number
<i>MinCpt</i>	Minimum consumption	Number
<i>MinStrTim</i>	Minimum start time consumption	DateTimeStamp
<i>MaxStrTim</i>	Maximum start time consumption	DateTimeStamp
<i>StrTim</i>	Start time consumption	DateTimeStamp
<i>MinStopTim</i>	Minimum stop time consumption	DateTimeStamp
<i>MaxStopTim</i>	Maximum stop time consumption	DateTimeStamp
<i>StopTim</i>	Stop time consumption	DateTimeStamp
<i>isPrimary</i>	Designates a critical load	Boolean
<i>isSecondary</i>	Designates a non-critical load	Boolean
<i>isShiftable</i>	Designates a shiftable load	Boolean
<i>LaunchCount</i>	Number of time the components is launched during an interval of time	Number
<i>Penalty</i>	Waiting time penalty of launching the component	Number
<i>SInit</i>	Desired schedule of the component	Double
<i>SOp</i>	Operational schedule of the component	Double

Table 2.7: EL Operation Concept

<i>Name</i>	<i>Description</i>	<i>Type</i>
<i>CarbEss</i>	Carbon emission ratio	Number
<i>EthylEss</i>	Ethyl emission ratio	Number
<i>HeatEss</i>	Heat emission ratio	Number
<i>CarbEssCost</i>	Carbon emission Cost	Number
<i>EthylEssCost</i>	Ethyl emission Cost	Number
<i>HeatEssCost</i>	Heat emission Cost	Number

Table 2.8: Ecology Concept

<i>Name</i>	<i>Description</i>	<i>Type</i>
<i>DepTim</i>	Departure Time of a mobile component	DateTimeStamp
<i>ArrTim</i>	Arrival Time of a mobile component	DateTimeStamp

Table 2.9: Time tracking Concept

<i>Name</i>	<i>Description</i>	<i>Type</i>
<i>Ctry</i>	Country	String
<i>Lat</i>	Latitude	Double
<i>Long</i>	Longitude	Double
<i>PosInMG</i>	Position in the <i>MG</i>	String

Table 2.10: Location tracking Concept

2.4.4.6 Multi-roles Concept

Future *MG* are going through comprehensive changes, especially due to the integration of the Prosumers, where an entity can consume and produce simultaneously in

a complete paradigm shift [35].



Figure 2.17: Multi-role Concept

Figure 2.17 shows the ‘Role’ concept defined to model the different roles that a component can play during their lifetime in the grid. Besides, three additional properties are defined (cf. Figure 2.11): the ‘RoleCondition’, the ‘RoleStartTime’ and the ‘Duration’.

<i>Name</i>	<i>Description</i>	<i>Type</i>
<i>RoleCondition</i>	Required Condition to play a specific role	String
<i>RoleStartTime</i>	Start Time of a specific role	DateTimeStamp
<i>Duration</i>	Play duration of a specific role	Double

Table 2.11: Multi-roles Concept

2.5 Experiments

We conducted several experiments in order to validate our proposed framework and emphasize the *OntoMG* importance and utility in the electricity domain. Before detailing the conducted tests, it is important to quickly describe the *OntoMG* design process. We developed *OntoMG* after exploring the current standards in power domain. In essence, we designed it iteratively by:

- exploring and comparing the current standards in power domain,
- presenting our observations and conclusions to several experts,
- considering their feedback regarding their future needs and expectations.

This iterative process has taken almost two years long in order to come up with a stable version.

2.5.1 Evaluation criteria

It is worthy to note that there is no unique methodology for developing and evaluating ontologies. Developing ontology is usually an iterative process that can start with a rough first pass at the ontology and then revise and refine the evolving ontology.

This process of iterative design will likely continue through the entire lifecycle of the ontology. In our study, we adopted two main quality criteria provided in [33] to evaluate *OntoMG*:

- **Comprehensibility:** it refers to how easily the language can be understood by technical actors (agents, engineers, etc.). Important aspects are the support of abstraction mechanisms (hiding details), uniform constructs, and a reasonable number of concepts. Reasoning is also important here.
- **Domain coverage:** it refers to the ability of the ontology to capture and cover the domain knowledge. It is related to the structure of the provided representation (concepts and relationships) and is the most important aspect of the ontology evaluation

2.5.2 Evaluation Context

Although automatic or semi-automatic evaluation techniques are attracting more and more interests, manual evaluation or what is called ‘human assessment evaluation’ remains commonly adopted in the literature when addressing ontology evaluation [14]. Thus, we conducted manual evaluations to validate the core of *OntoMG*. We also deployed *OntoMG* into two projects. Before detailing the obtained results, we detail in what follows: 1) the ontology layers that has been evaluated, 2) corresponding evaluation metrics, and 3) the testers’ profiles.

2.5.2.1 Ontology layers

Three main ontology layers have been evaluated in our experiments:

- The *syntactic layer* includes respectively the ABox (concepts/classes) and the TBox (instances) of *OntoMG*
- The *semantic layer* encompasses the semantic relations between concepts (e.g., isA, hasPart, etc.), shaping the structure of the ontology
- The *context layer* includes the additional properties related to the *MG* needs, which are here reflected by its multi-objective aspects.

2.5.2.2 Evaluation metrics

In order to correctly evaluate the ontology, three evaluation metrics have been used (the 3Cs requirements [94]):

- The *Correctness* aims at evaluating the clarity of the vocabulary and data of the syntactic layer of the ontology. It is used in our experiments to mainly measure the comprehensibility criteria,
- The *Consistency* targets the evaluation of the semantic layer of an ontology. It is also used to measure the comprehensibility,
- The *Completeness* targets the evaluation of the syntactic and context layers. It aims at evaluating the domain coverage criteria with the services that a *MG* must deal with.

2.5.2.3 Tests and Testers

Three tests were conducted, each targeting a specific evaluation metric: an ambiguity test, a quiz test, and a real use case scenario to evaluate the correctness, consistency and completeness, respectively. The first two tests were conducted by:

- 80 experts in electrical engineering (45 participants) and electronics (35 participants),
- 45 non-experts in electrical engineering and electronics (mainly computer scientists).

The choice of having computer scientists in our tests is related to the fact that we believe that future power systems will be multidisciplinary and would require some expertise in Information Technologies in order to understand how things are working together. In what follows, a detailed explanation of each evaluation is presented.

2.5.3 Comprehensibility Results

In what follows, we show the results obtained with the two metrics of Correctness and Consistency to measure the comprehensibility criteria.

2.5.3.1 Correctness

A first ‘semantic ambiguity test’ was done to evaluate the ontology correctness that targets the *syntactic* layer evaluation (cf. Figure 2.18). A semantic ambiguity refers to the ambiguity of a word to be used in different contexts in order to express different meanings. In this test, the participants were asked to rate the ambiguity degree (if the word is clear/understandable or not) of a list of 60 items on a scale of 0 to 4 (4 expresses a very clear concept with no ambiguity, and 0 expresses a high ambiguity). Those items are categorized into two main categories: the low-level and the high-level items. The low-level items, target the technical data related to the power system structure and branches (i.e., the basic structure). However, the high-level items target the semantic data extracted related to the identification, ecological, economical, operational and mobility concepts (i.e., the extended structure). The obtained results are as follows:

Basic Structure

RATING VALUES :

4 = very clear, no ambiguity
3 = low ambiguity
2 = medium ambiguity
1 = high ambiguity
0 = very high ambiguity

Microgrid *

4
 3
 2
 1
 0

If Rating Value = 0 or 1, tell us why?

Figure 2.18: Extract of the Ambiguity Test Used to Evaluate the Correctness

- For non experts: Figure 2.19 shows the results of the tests conducted by the 45 testers in computer science. The ambiguity rates vary from 2.66 (Basic

structure) to 3.25 (Mobility concept), which can be considered as a very good result for non-experts in the electricity domain. A closer look to the rates led us to conclude that the hardest part was related to the evaluation of the low-level items, driving an ambiguity rate of 2.66. However, it was easier for them to understand the high-level items, resulting an ambiguity rate that varies from 2.85 (Economic concept) to 3.25 (Mobility concept). This is explained by the fact that the computer scientists are less familiar with the technical vocabulary related to the power systems (e.g., solar cell, flywheel, etc.), yet they are globally aware about the high-level concepts related to the electricity market (e.g., Power Price, etc.), ecology (e.g., Gas Emission, etc.), identification (e.g., Serial Number, etc.), and mobility (e.g., Component Position, etc.).

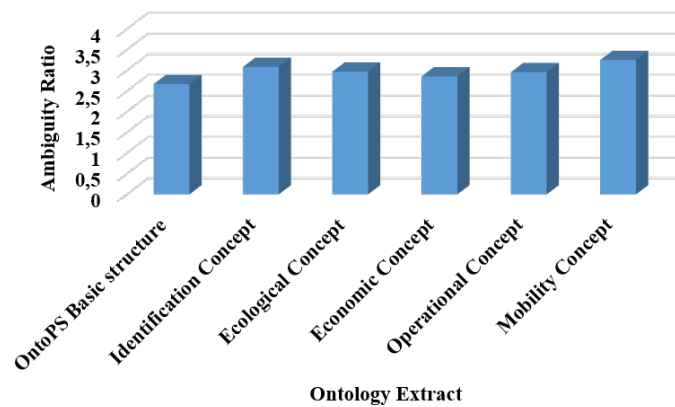

Figure 2.19: Ambiguity Rate for the Computer Scientists (Non-Experts)

- For electrical engineers: Figure 2.20 shows the results of the 45 testers in the electrical domain. The ambiguity rates vary from 2.35 (Identification concept) to 3.6 (Operational concept), which is very satisfactory. We observed that the easiest part for electrical experts, contrarily to non-experts, was to evaluate the ambiguity of the technical part, leading to an ambiguity rate of 3.6 (Operation concept). However, it was more difficult for them to understand the high-level items, resulting an ambiguity rate that varies between 2.35 (Identification concept) and 2.975 (Ecology concept).
- For electronic engineers: Figure 2.21 shows the results of the remaining 35 testers (most of them are students). The ambiguity rates vary between 2.58

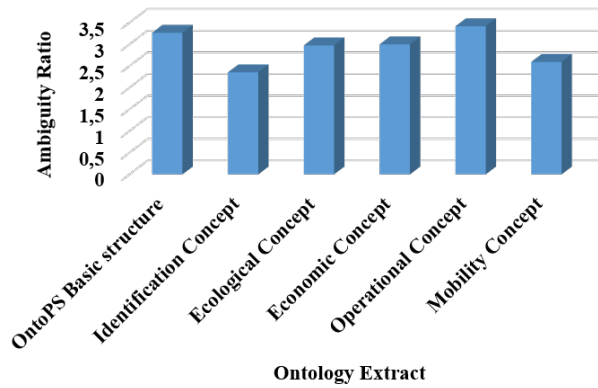

Figure 2.20: Ambiguity Rate for the Electrical Engineers

(Mobility concept) and 3.25 (Operation concept). A closer look to the rates led us to conclude that the results were not converging, since the lowest ambiguity rate is 2.58 for the mobility concept which is related to the high-level terms, while the highest ambiguity rate is 3.25 for the technical terms. Hence, this will require new tests to be conducted with additional 'confirmed' testers (with similar profiles) so to know if this is related to the background of the testers or to some concepts in our ontology. Also, this will allow in the future to measure and compare the **Learning load** of an expert and a non-expert in order to master the proposed vocabulary.

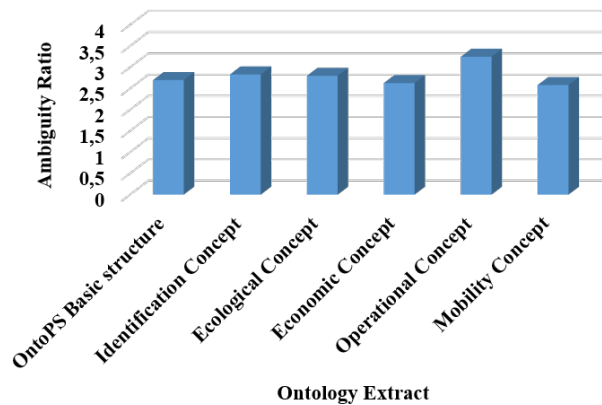

Figure 2.21: Ambiguity Rate for the Electronic Engineers

2.5.3.2 Consistency

A second test was conducted to evaluate the ontology consistency. In this test, the testers were kindly requested to choose the adequate relations between the concepts in a given ontology extract (cf. Figure 2.22). Similarly to correctness, the list of 6 ontology extracts (each related to an ontology structure and concept) is categorized into two main categories: the low-level and the high-level extracts. The low-level one targets the technical data related to the *OntoMG* basic structure, while the high-level category targets the semantic data related to the identification, ecology, economic, operation and mobility concepts. For this evaluation, we adopted the precision and recall metrics commonly adopted in Information Retrieval since they meet our needs in evaluating whether the relations between the concepts are relevant or not. Please note that Precision (PR) computes the ratio of the number of correct answers w.r.t. the total number of answers (correct and false), while Recall (R) underlines the number of correctly identified answers w.r.t. the total number of correct answers, including those not answered by the user. Formally:

$$Precision = \frac{A}{A + B} \quad (2.1)$$

$$Recall = \frac{A}{A + C} \quad (2.2)$$

Where:

A the number of correct answers;

B the number of wrong answers;

C the number of correct answers not identified by the tester.

The obtained results are as follows:

- For non experts: Figure 2.23 shows that the highest precision obtained by the computer scientists was reached when dealing with the mobility concept (of 1). This comes from the intuitiveness of the answers (which are the concepts in the ontology such as Country, Latitude and Longitude) that do not need an expertise in the power domain.

However, the lowest precision (of 0.74) was reached when dealing with the basic structure. This comes from the specificity of the answers related to the different basic components that compose the power system. On the other hand, Figure 2.23 shows that the highest recall (of 1) is reached when dealing with the basic

OntoMG Basic Structure

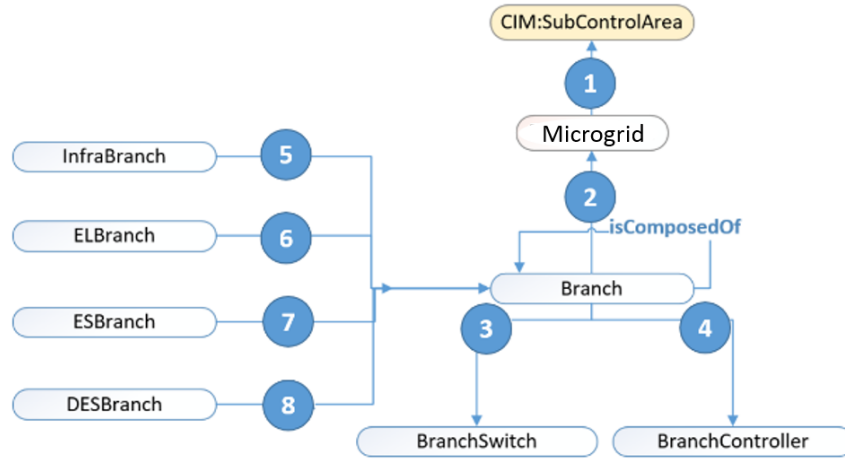

isA

(i.e., it relates a more specific term to a more general term, sub-group, sub-domain or type)

- 1
- 2
- 3
- 4
- 5
- 6
- 7
- 8

Figure 2.22: Extract of the QCM test used to evaluate the consistency

structure. This comes from the fact that since the testers are not experts in the power domain, they chose multiple answers, which increased sometimes the percentage of the correct answers. However, the lowest precision (of 0.658) was reached when dealing with the operation concept. This result confirms our expectation regarding *OntoMG*.

- For electrical engineers: Figure 2.24 shows that the highest precision (of 1) obtained by the electrical scientists was reached when dealing with the mobility concept (similarly to the computer scientists). However, the lowest precision (of 0.78) was reached when dealing with the identification concept. This comes from the fact that this concept is brand new for the testers who were assuming that some technical information (e.g., nominal active power, etc.) is enough to provide component identification. In addition, those details were modeled in the operation concept and were not linked to the identification one. After

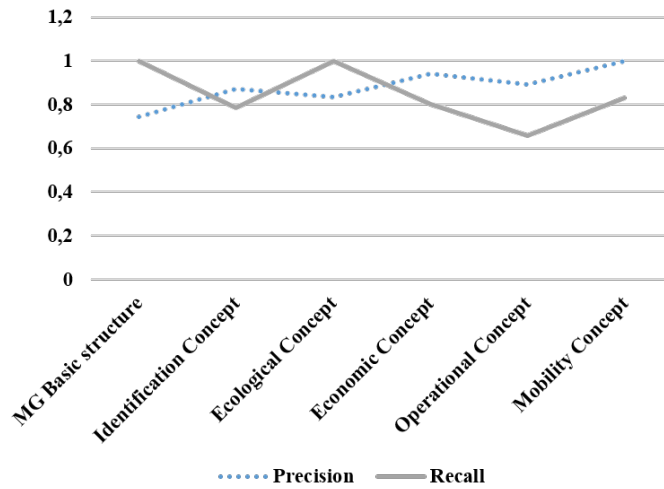

Figure 2.23: Precision and Recall of the Computer Scientists (Non-Experts)

discussion with them, they understood the identification risks and agreed about the limitations of only considering the technical details. Figure 2.24 shows also the highest recall (1) reached when dealing with the basic structure. This comes from the fact that our testers are experts in the power domain, hence they all chose the correct answers without forgetting any correct one. However, the lowest precision (of 0.575) was reached when dealing with the economic aspect, because some answered by choosing operational aspect parameters, since they considered that they are also related to the economic aspect.

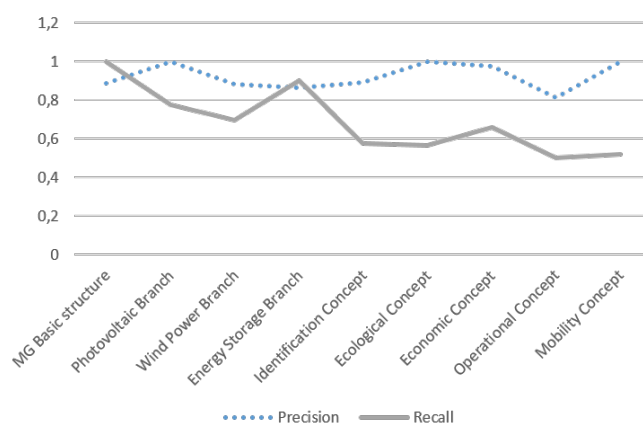

Figure 2.24: Precision and recall of the Electric domain experts

- For electronic engineers: Figure 2.25 shows that the highest precision (of 1) obtained by our testers is also reached when dealing with the mobility aspect

branch. However, the lowest precision (0.81) was reached when dealing with the operational aspect. This comes from the fact that the electricians are not all familiar with the operational and technical concepts of a power system. Figure 2.25 shows that the highest recall (of 1) is reached when dealing with the basic structure. This comes from the fact that most of them were not aware of all the details in the power system domain. Hence, they chose almost all the proposed answers to avoid forgetting any correct one. However, the lowest precision (of 0.5) was reached when dealing with the operational aspect. This comes from the numerous correct answers, since testers focused on what they considered the most pertinent ones.

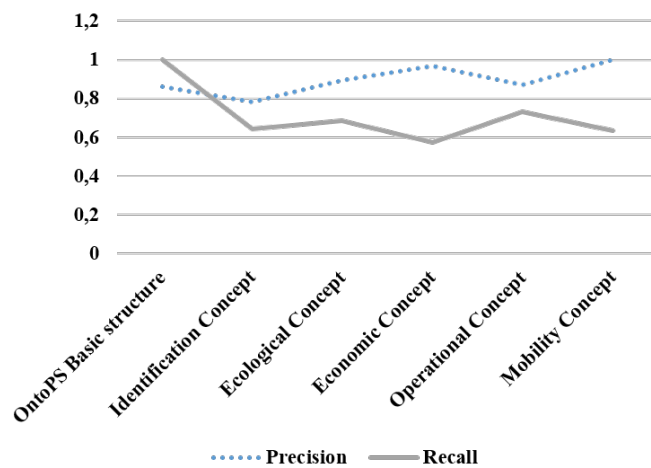

Figure 2.25: Precision and recall of the Electronic Engineers

2.5.3.3 Discussion

Those results show that our ontology provides promising results in term of correctness and consistency, reflecting the comprehensibility and the clarity of our ontology concepts and relations for the experts and non-experts.

2.5.4 Domain coverage Results

The domain coverage criterion comes down to evaluate the context layer of *OntoMG*. This latter targets the ontology capability of modeling the properties allowing the power system to meet the end-users needs by executing corresponding services. Hence, in order to evaluate it, *OntoMG* has been deployed into two main projects: HIT2GAP

and ISare as detailed below. *OntoMG* has been serialized into RDF/OWL and posted online ².

2.5.4.1 Integrating *OntoMG* in HIT2GAP

The *HIT2GAP*³ is an European joint collaboration research project (EU/H2020 Grant Agreement No:680708) for developing a next generation building control tool for optimizing energy usage. The main objective of this project is to propose a new paradigm of an energy management platform for smart buildings. The project consortium is composed of 22 partners from 10 European countries. The *HIT2GAP* platform relies on an ontology allowing different partners to query data so to extract some information and events (through a set of services) from a smart building data. The architecture of the *HIT2GAP* platform is given in Figure 2.26. Figure 2.27 shows an extract of the ontological data model used for modeling and storing data within the platform. It shows its alignment with several main standards:

- IFC ⁴: to represent the building related concepts,
- SSN ⁵: to represent the data acquired from the sensors, and
- *OntoMG*: to represent all the power system equipment since a smart building can be considered as an *MG*.

Related concepts are prefixed with `ifc:`, `ssn:`, and `OntoMG:`.

As one can see, *OntoMG* is integrated as a backbone of the information model of HIT2GAP platform.

The following concepts have been aligned with *HIT2GAP* ontology as follows:

1. *OntoMG:DESBranch* is aligned with `ifc:DistributionSystem` in order to extend the IFC with the distributed energy sources and their corresponding parameters,
2. *OntoMG:ESBranch* is aligned with `ifc:DistributionElement` in order to extend the IFC with the energy storage systems and their corresponding parameters,

²<http://spider.sigappfr.org/research-projects/ontomg/>

³<http://www.hit2gap.eu>

⁴<http://www.buildingsmart-tech.org/specifications/ifc-overview>

⁵<https://www.w3.org/2005/Incubator/ssn/ssnx/ssn>

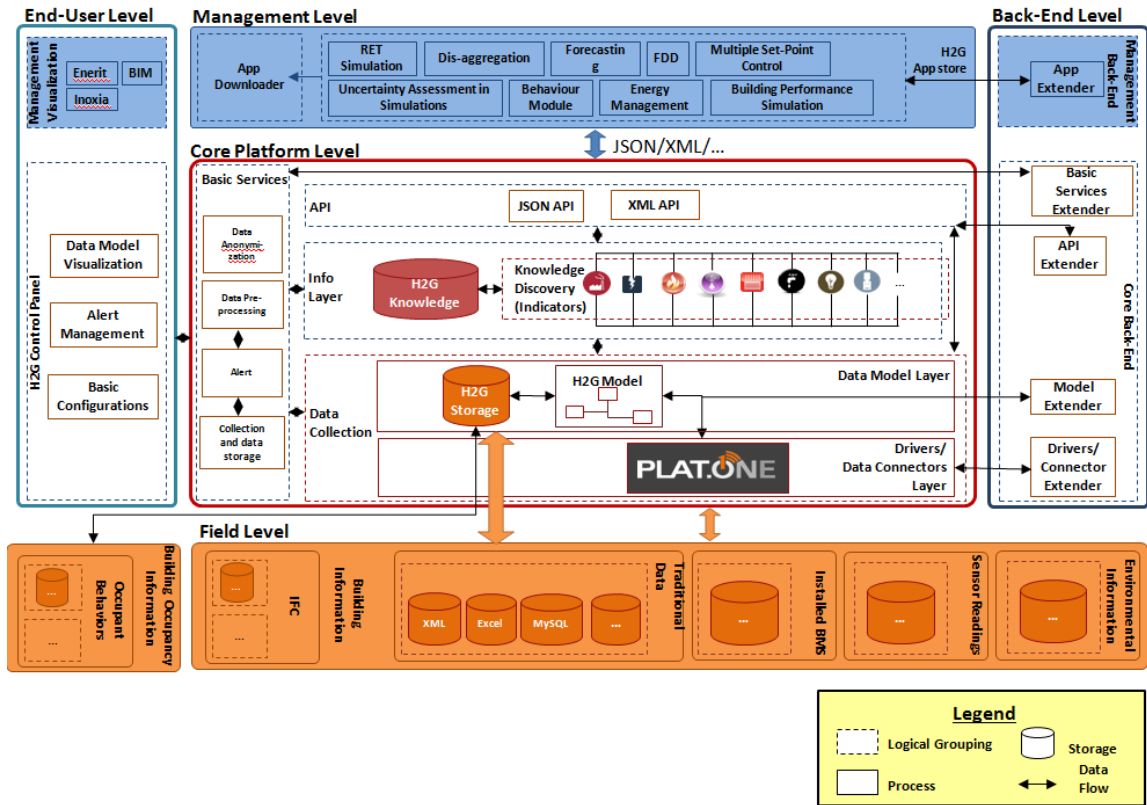

Figure 2.26: The architecture of *HIT2GAP* platform

- OntoMG:ELBranch* is aligned with `ifc:DistributionElement` in order to extend the IFC with the electrical loads and their corresponding parameters,
- OntoMG:InfraBranch* is aligned with `ifc:DistributionCircuit` in order to extend the IFC with the infrastructure equipment (e.g, cables, fiber optic, etc.) and their corresponding parameters,
- OntoMG:BranchController* is aligned with `ifc:Controller` in order to extend the IFC with the DES, ES, EL, Infrastructure controllers, and their corresponding parameters.

This alignment proves two main points:

- OntoMG* is completely included in the HIT2GAP ontology since it allows to cover an important domain related to smart buildings: power domain. This will allow building actors to count on the expressiveness of *OntoMG* in order to represent/extract data and reason on it.

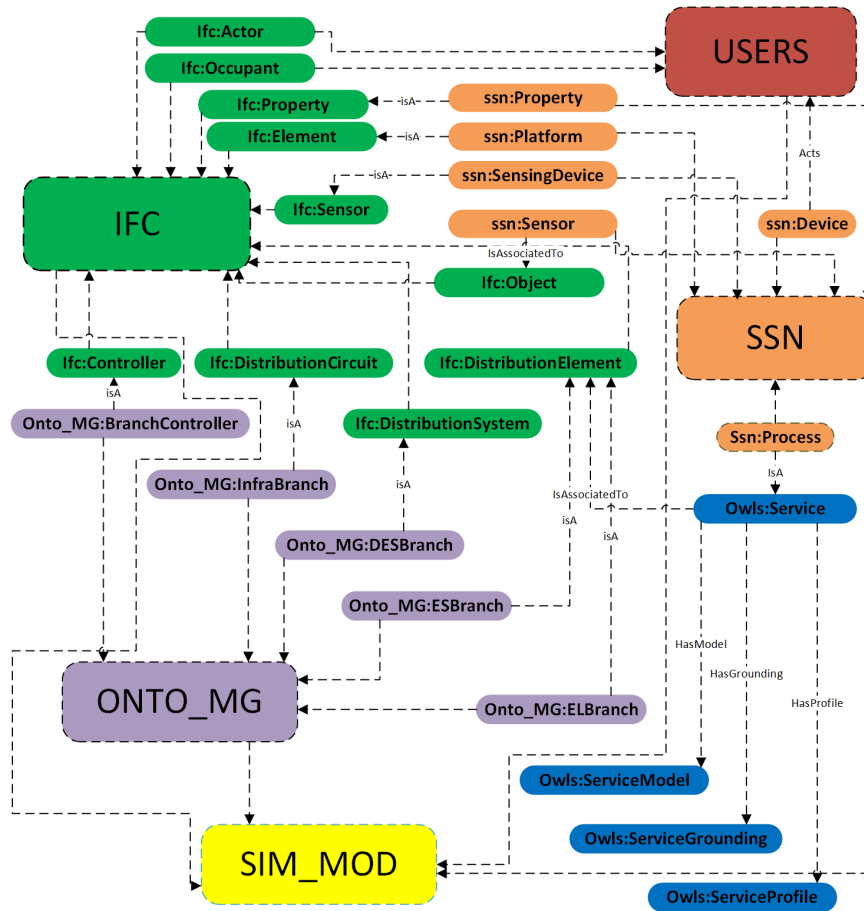

Figure 2.27: Extract of HIT2GAP Data Model

- *OntoMG* extends IFC which is the standard in building modelling that mainly focuses on the representation of the building equipment and constituents (e.g., floor, stair, wall, etc.), while neglecting the full coverage of the power related concepts in its vocabulary. This may weaken the building modeling since each equipment in the building can be considered as an energy source, storage or consumer, which highlights the importance of the *OntoMG* extension of the IFC.

It is to be noted that the *HIT2GAP* project is currently on-going. Hence, we have not had any feedback yet regarding the domain coverage of *OntoMG*. The feedback of partners are expected to be received by the end of 2018 and will be posted online on the project website⁶.

⁶<http://www.hit2gap.eu>

2.5.4.2 Aligning *OntoMG* with ISare

In collaboration of Jema Irizar Group, leader of the ISare Microgrid (MG) project, we fully implemented *OntoMG* in it in order to highlight the potential of the ontology in answering the needs and objectives. ISare MG is installed in San Sebastian-Spain and electrifies 12 offices. The generation system comprises 10 kW of solar generation, a nominal 53 kWh battery bank, 105 kW of wind generation and a 120 kW diesel genset. A second solar array of about 15 kW, mounted on the roof of the control system building, is connected to an SMA inverter and a 70 kWh of gas turbine to provide power for monitoring and communication. In addition, 50 kW of electric vehicle charger were installed, equipped with a protection system, to ensure a mobile power when needed. The ISare MG has been modeled using our *OntoMG*, resulting the *ISare-OntoMG model*⁷.

As a power system, the ISare MG has several needs. ISare MG needs to be modeled via an interoperable structure, that enables the integration and the validation of the various new heterogeneous renewable distributed generation systems and various storage technologies. In order to enable ISare MG managers to have intuitive data querying and management, we developed a dedicated framework with an easy-to-use pool of predefined services so to achieve the objectives.

The *ISare-OntoMG model* has been implemented (cf. Figure 2.28) as an OWL graph, on a central entity. Queries are executed through an SPARQL querying interface. Note that, SPARQL is a query language, that is, a semantic query language, able to retrieve and manipulate data stored in Web Ontology Language (OWL). Then, a reasoning process has been added in order to interfere new knowledge and to allow the autonomous behavior of the MG. This process has not been tested yet.

In order to highlight the advantages provided by our *ISare-OntoMG*, three scenarios are presented in the following for illustration.

- Scenario 1: If an end-user needs to identify the consumer having the highest power consumption bill and advise him/her about the energy sources and storage systems that should be implemented in order to satisfy the demands at a lower cost, several concepts need to be used in the search engine from *ISare-OntoMG*⁸. The basic-structure concepts are: ELBranch, ESBranch and

⁷The *ISare-OntoMG model* won't be detailed further

⁸We don't provide here the corresponding SPARQL queries in order to ease the identification of related concepts within the ontology

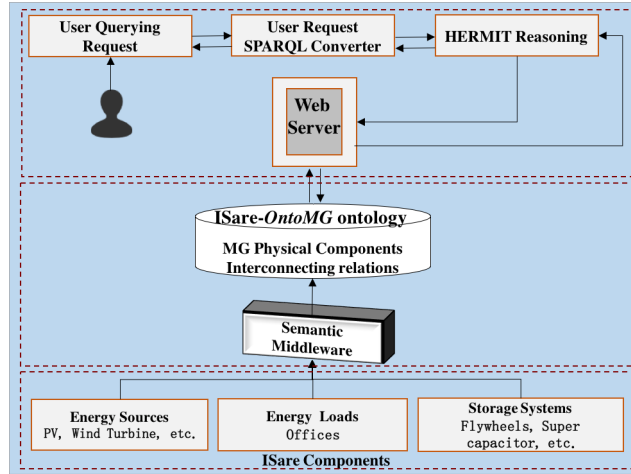

Figure 2.28: ISare Framework Architecture

DESBranch. Those of the Extended Structure are: Operation and Economic, with the following properties: *CptBill*, *EqCost*, *MaintenanceCost*, *InstallCost*, *OpCost*, *TotalCost*, *StrCost*, *StopCost*, *PwrKWhPrice*, *PwrhPrice* and *PwrCost*

- Scenario 2: If an end-user needs to determine the most environmental friendly energy source, able to satisfy a consumer’s power need at a certain weather condition, two basic-structure concepts are to be used (ELBranch and DESBranch) with other extended-structure concepts such as: Operation and ecology, with the following properties: *Cpt*, *CarbEss*, *EthylEss*, *HeatEss*
- Scenario 3: If an end-user wants to visualize the type, brand and model of the most implemented renewable energy sources (e.g., solar plant, wind plant, etc.) in the power system, his/her query will include the following basic-structure concepts: ELBranch, DESBranch, ESBranch and InfraBranch. It will also include one extended concept: Identification and all its properties (i.e., *Serial#*, *Type*, *Brand* and *Model*).

The usage of our framework within ISare project has been aligned with the needs of end-users. The major difficulty that end-users were facing when writing queries in the current version of the prototype is related to the complexity of SPARQL (since they are not computer scientists). Currently, we are working on another alternative related to providing them a visual retrieval interface coupled with some natural language processing (NLP) techniques to allow end-users write queries in a more intuitive way.

2.5.4.3 Discussion

Those two applications show that our ontology provides a promising solid base for a better sharing of knowledge leading to a seamless communication between the components of the system (whether it is a smart building or a power system). In addition, it allows a better information querying and retrieval, and participates in increasing the reasoning capability of the system giving its components the possibility to take decisions and act autonomously.

2.6 Conclusion

This chapter introduces *OntoMG*, an ontology-based information model for *MGs*. To the best of our knowledge, it is the first attempt to design such an ontological information model for *MGs* while being compliant with the CIM and the IEC 61850 standards. The contributions of our work are four-folded: 1) it allows to resolve interoperability issues (syntactic and semantic) encountered between *MG* components, 2) it helps *MG* to represent and consider their (economical, ecological and operational) objectives directly in the information model (which is not the case of existing models) and allows to provide reasoning features to reach the fixed objectives, and 3) it allows to consider mobility and diversity of roles that can have each component involved in the *MGs*, and 4) it provides an evolutionary solution able to be extended easily to cover future needs. Several evaluations have been conducted to evaluate *OntoMG*. Some of them were done manually with several testers in order to evaluate the ontology consistency and correctness. We have also integrated *OntoMG* in two projects, HIT2GAP and ISare Microgrid, as a backbone data modeling to show to which extend *OntoMG* is able to represent the power systems components.

Chapter 3

Digital Ecosystem Cooperative Model for Microgrids

“Unity is strength when there is teamwork and collaboration,
wonderful things can be achieved...”
- Mattie J.T. Stepanek

The world is becoming digital and this digitization has been leading to greater connectivity and interaction between separate systems, and thus gave birth to a new paradigm: the digital ecosystem (DE). A DE is a collaborative environment, consisting of a number of heterogeneous components collaborating together on the basis of mutual interests and benefits. A MicroGrid (*MG*) is an example of the DE, since it is a distributed power system consisting of a number of heterogeneous components (energy sources, electrical loads and energy storage systems) having direct/indirect impacts on each other and consequently on the entire environment. In order to provide an appropriate collaborative model, it is essential to conceive a dedicated clustering algorithm aiming at gathering the components that have mutual benefits. To do so, we propose in this chapter a DE cooperative model for *MG* management, that consists of two main modules: 1) the **Alliances Builder** and 2) the **Seller2Buyer matcher**. The **Alliances Builder** provides an appropriate clustering algorithm, aiming at gathering all the DE heterogeneous components, having similar needs and preferences. Once done, the **Seller2Buyer matcher** is applied inside each cluster and between clusters, targeting a better collaboration inside the *MG*. Conducted simulations showed that the proposed algorithms yield significant results. Applying our algorithms on *MGs* also showed three-dimensional benefits: economical by reducing the costs, ecological by reducing the toxic gas emissions, and operational by minimizing the power losses (that also has ecological and economical benefits).

3.1 Introduction

Nowadays, researchers' eyes are diverted to the MicroGrid (*MG*), to exploit its functionalities to improve today's power systems [52]. Like current grids, it consists of a number of heterogeneous components: power generation, electrical loads and storage systems all within a controlled network. As mentioned in the Introduction of this thesis, an *MG* is capable of operating in parallel with, or independently from, the main grid.

The main idea behind conceiving the first *MG* was to enhance power reliability due to the local power generation and the ability to island the *MG* from the main grid. Thus, blackouts and power disturbances are significantly minimized. Besides reliability, the *MGs* benefits are represented through a three dimensional axis, each representing an *MG* objective: economical, ecological and technical. Economically, an *MG* can significantly reduce costs paid by consumers when having power outages, since they have to find an alternative power source, which is usually very expensive. In addition, it can also generate revenues by selling its power surplus to the main grid (when not islanded). Ecologically, an *MG* can reduce the greenhouse gas (GHG) emissions since it mainly relies on the integration of renewable energy sources (non-polluting). Technically, it can optimize the network operations by minimizing the transmission power losses and maintaining a power balance between the generation and the consumption (which is difficult nowadays, since the DG is rarely implemented).

Similar to several applications, such as the e-banks and e-commerce websites, the *MG* can be seen as a Digital Ecosystem (DE). A DE is a collaborative cyber-physical environment which consists of several heterogeneous, interconnected and interrelated components having mutual benefits. A DE is a new paradigm and as it is the case of the most of the new technologies, there are many challenges to be addressed, in order to provide an optimal/efficient operation of the DE.

In addition to the *MG* interoperability problem [74] addressed in the previous chapter, an important challenge emerges: the power exchange between *MG* components. As mentioned before, an *MG* is a distributed power system that consists of a number of heterogeneous components, each having a direct/indirect impact on the other components and consequently on the entire environment. All this emphasizes the need of establishing an internal *MG* cooperation addressing the problem of power exchange optimization from three perspectives: technical [72], ecological [46] and economical [63].

From technical perspectives, a promising cooperative method is proposed in [72] aiming at balancing the power exchanged among the interconnected *MGs*. The cooperation in [46] allows the minimization of the transmission and distribution losses by allowing the power exchange between the nearby *MG* components. Economically, a cooperative *MG* model is proposed in [63] aiming at shifting the high-power appliances to off-peak hours (when power demand is less) and thus minimizing the power prices increased during the peak hours (when power demand reaches its maximum). Ecologically, the *MG* cooperation, would be environmentally beneficial, if it allows the prioritization of the power exchange between the consumers and the renewable energy sources (when it comes to the "Tertiary Control" [70] of the *MG*), instead of acquiring power from polluting non-renewable sources.

However, to the best of our knowledge, none of the current approaches [72, 82, 62, 59, 46, 63] seems to keep the pace since they do not consider the three perspectives (i.e., ecological, economical and technical) at the same time nor allow the end-users to fine-tune the importance of each one of them according to their preferences.

In this work, we introduce *DECF*, a 'Digital Ecosystem Cooperative Framework' designed for optimizing the *MG* power exchange while addressing the previous challenges, mainly: 1) the multi-objective aspect of the *MG*, 2) the cooperation between the *MG* components, 3) the user intervention in fine-tuning the importance of the ecological, economical and operational aspect and the multi-type compliance, in that the approach should take into account all types of components (generation, consumption and storage). *DECF* contains two main components: 1) the **Alliances Builder** provides an appropriate clustering algorithm aiming at gathering all the DE heterogeneous components having similar needs and preferences, and 2) the Seller2Buyer matcher is applied inside each cluster and between clusters, targeting a better collaboration inside the *MG*.

- **Alliance Builder:** designed to gather all the *MG* components having some interest in working together. The interest is expressed by a combined objective function that takes into account the economical, ecological and technical objective aspects of an *MG*.
- **Seller2Buyer Matcher:** allows to provide better power exchange matching between, on one hand, *MG* components, and, on the other, between *MG* and the main grid while reducing the power costs in the *MG*.

Our approach presents several advantages over existing approaches, namely:

1. It is generic in that it can process on all the heterogeneous *MG* components and it can be applied to other DE (e.g., e-commerce websites, e-banks, etc.),
2. It is based on an ontological data representation model [74] allowing the semantic-based data search while being compliant with the existing standards (e.g., IEC, IEEE, etc.),
3. It is user-oriented in that it gives the user the possibility to fine-tune the weight of each objective aspect,
4. It is a cooperative model that reduces the technical, ecological and economic costs and encourages the local power exchange.

The rest of this chapter is organized as follows. Section 3.2 provides details about existing power exchange optimization techniques and their drawbacks. Section 3.3 details the ‘DECF’ modules. An illustrative example is provided after each step to ease the understanding of each module. In Section 3.5.2, the experiments conducted to validate our approach and the main results obtained are presented. Section 3.6 concludes the chapter.

3.2 Related work

Many approaches have been proposed in the literature to solve the optimization problem of the power exchange. However and to the best of our knowledge, none of them has been able to solve all the challenges presented and illustrated previously. Current approaches can be categorized into two main groups: game-theory based [72, 59] and agent-based [5, 46, 57].

3.2.1 Game-theory approaches

In [72], the main goal was to develop an *MG* power exchange model which incorporates several energy sources (considered as Microgrids), allowing them to reduce the power load on the main grid and to minimize the transmission power losses over the distribution lines. To do so, the authors considered a distribution network connected to a main grid and to a group of n nodes (*MGs*). Each node i is able to generate a total power G_i and must satisfy the total power need D_i . Two scenarios were proposed: one is non-cooperative and one is cooperative. The first scenario is non-cooperative and assumes that each node i exchanges its surplus or need with the main grid only.

Thus, the non-cooperative payoff of any node i is defined as the total transmission power losses due to the power exchange between the MGs and the main grid:

$$U(i) = -w_i \cdot Ploss_{i0} \quad (3.1)$$

where w_i is the price paid by a node i per unit of power loss $Ploss_{i0}$ with the main grid (i0). The other scenario in [72] is cooperative and proposed to avoid the full reliance on the main grid. Here, the MGs can decide to form cooperative groups called ‘coalitions’ and exchange power locally with a little reliance on the main grid. By doing so, the power transmission losses are reduced due to the fact that the MGs are located closer to each other than to the main grid and subsequently they can reduce the loads on this latter. For any coalition S , let TS be the set of orderings over the buyers in S . Then, given an order $\pi \in TS$, the total power losses over the distribution lines incurred by the power transfers to or from the members of S are given by:

$$U(S, \pi) = - \sum_{i=0}^n w_i \cdot Ploss_{ij} + \sum_{i=0}^n w_i \cdot Ploss_{i0} + \sum_{j=0}^m w_j \cdot Ploss_{j0} \quad (3.2)$$

where $Ploss_{i0}$ and $Ploss_{j0}$ are the power losses during the power exchange between the seller i and the buyer j of a coalition S and the main grid, respectively. $Ploss_{ij}$ is the transmission power lost during the power exchange, inside S , between a seller i and a buyer j .

Based on the coalition payoffs defined in (3.2), a clustering algorithm is defined, aiming at grouping together the MGs that allow the minimization of the power losses. To do so, the authors used the ‘coalition game theory’ [8] based on applying the Pareto order. The main idea is that a group of MGs prefers to be part of a coalition A rather than a coalition B , if at least one MG is able to improve its payoff when the coalition changes from A to B . Once the coalitions are formed, a simple sellers-to-buyers matching is proposed here, relying on the preferences of the buyers inside the coalition (by exchanging power with the seller that minimizes the power lost). A simulation conducted on a number of MGs showed that the cooperative scenario yields a significant transmission power losses reduction in the distribution network [72].

In [59], the authors developed an approach that enables to determine the optimal operation of a solar-powered MG with respect to the consumers demands. The

adopted scenario is a multiple sellers/buyers scenario, consisting of a village generating enough power and able to satisfy the demands (homes needs). The objective of the proposed approach is to make the village be at least cost-neutral in power. Moreover, it aims at improving the revenue of the producers by comparing the uniform and discriminatory bidding. Firstly, an algorithm for predicting power demand is proposed, taking into account the load profiles for a year. Once the power demand prediction is done, an auction algorithm [59] is then applied, aiming at increasing the consumers revenues, using single-bid and double-bid market. The idea behind the single-bid pricing is that all bids are priced at the marginal cost of that power. Hence, all the sellers receive a fixed market price for the power that are willing to sell. As per the double-bid market, every seller (or buyer) with a winning bid pays (or is paid) at the price of his bid. A computational analysis has shown that the single-bid pricing leads to a power bills reduction bigger than the use of double-bid pricing. This comes to the fact that, under single-bid pricing, the bidders perform better, providing a revenue equivalence, and they can reach the profit-maximized revenues without any risk of being dominated by the main market grid which keeps the prices high. In contrast, under discriminatory pricing, the bidders are not able to reach the profit-maximized revenues without the risk of being dominated.

In [73], the authors developed a non-cooperative model within which the Plug-in Hybrid Electric Vehicles (PHEV) can decide on the amount of energy they want to sell to the main grid. In addition, the authors proposed a scheme for determining the trading price of the power exchanged between the PHEVs and the main grid. In this regard, a non-cooperative game was conceived to model the competitive situation that arises between the PHEVs that are interested in selling energy surplus. Considering a number K of consumers, requiring to satisfy their power needs by buying energy from n groups of PHEVs, having a power surplus. The strategy of each PHEV group is to select the maximum amount of energy surplus to be sold while maximizing a utility function. The payoff of each PHEV group i when choosing the strategy a_i is defined as follows:

$$U_i(a_i, a_{-i}) = \sum_{k \in K} (p_{ik}(a) - s_i) \cdot q_{ik}(a) - f\left(\sum_{k \in K} q_{ik}(a)\right) \quad (3.3)$$

where a is the $N \times 1$ vector of all strategy choices, $a_{-i} = [a_1, a_2, \dots, a_{i-1}, a_{i+1}, \dots, a_n]$ is the vector of strategies chosen by all the PHEVs groups excepting the group i , $p_{ik}(a)$ is the trading price between seller i and buyer k , q_{ik} is the amount of energy sold from

seller i to buyer k , and $f(\sum_{k \in K} q_{ik}(a))$ is a function that represents the cost of selling power (i.e., the cost of discharging the storage devices or the PHEVs batteries). After defining the utility function, a trading price computation was done by adopting a strategy-proof double auction approach. This was adopted to ensure that no seller nor buyer has an incentive to cheat about its reservation price. By applying the double auction mechanism, (3.3) becomes:

$$U_i(a_i, a_{-i}) = (\bar{p}(a) - s_i)Q_i(a) - \delta_i \cdot Q_i^2(a) \quad (3.4)$$

where $Q_i(a)$ is the total power sold by i , δ_i is a pricing factor that determines the costs paid by the PHEV group i during the power selling process, and $\bar{p}(a)$ is the trading price. Here, the energy trading was done, using the Nash equilibrium [86] strategies. So both sellers and buyers can exchange power and collect their profits. Simulation results have shown that the proposed approach enables the PHEV groups to act rationally while improving their utility function.

3.2.2 Agent-based approaches

The literature is rich with examples of agent-based *MGs* optimization applications. [5, 46, 57]. In most of these approaches [57], the *MG* is designed as a distributed power network comprising various distributed agents (generators, storage and controllable loads, etc.) that are operated in interconnected or islanded mode. To do so, JADE framework is commonly adopted for agents' modeling [7].

In this subsection, we will focus on only two main approaches that particularly focused on the power exchange optimization in the *MG*.

In [46], the authors developed a multi-agent system that aims to minimize *MG's* photovoltaic (PV) operating costs and the toxic pollutants emissions while maximizing the output of the energy sources. To do so, six agent types were defined including PV agent (Photovoltaic), WT (Wind Turbine) agent, MT (Micro turbine) agent, FC (Fuel Cell) agent, and BAT (battery) agent. An objective function was also defined to capture the output of the micro sources, the operational costs and the toxic gas emissions, as follows:

$$Min(\lambda_1 C_F(P_{ij}) + \lambda_2 C_E(P_{ij})) \quad (3.5)$$

where $C_F(P_{ij})$ represents the operational costs of the micro source, taking into account the active power output of the j^{st} micro source of the i^{st} type. It considered also ecological costs of the micro source $C_E(P_{ij})$ consisting of the multiplication

of the number of the atmospheric pollutants, the emission rate of the atmospheric pollutants and their corresponding financial penalty. Note that, λ_1 and λ_2 are the weights assigned to the operational and ecological costs respectively. After defining the objective function, one or more control strategies were defined for each agent of the multi-agent system in order to achieve the aforementioned objectives. Simulation experiments have shown the flexibility and the efficiency of the approach by measuring the hourly output of the different micro sources.

In [5], a decentralized control architecture for *MG* was presented, aiming at maximizing the use of renewable energy sources and minimizing the use of conventional generators. The proposed control architecture contains different types of agents (such as Photovoltaic agent, Fuel cell agent, Distributed Generator agent, Power Converter Building Block agent, Hybrid Energy Storage System agent and Load agent), where each represents a major component in the *MG*. A dedicated algorithm was proposed to manage the use of renewable and non-renewable energy sources in both grid-connected and islanded *MG* operation modes. Simulation studies have demonstrated that the control system can manage the power of each micro source and load. In addition, it has proved that the proposed control system was able to fulfill real time management of an *MG*.

3.2.3 Discussion

In this section, a comparison between the existing approaches is presented, highlighting their strengths and drawbacks with respect to the challenges addressed in our study (cf. Table 4.1).

Table 3.1: Comparing existing Power Exchange optimization approaches

	Multi-Objective	Multi-Type	User-Oriented	Cooperative
Saad et al [72]	Partial	-	-	+
Maity et al [59]	Partial	-	-	-
Saad et al [73]	Partial	-	-	-
Jia et al [5]	Partial	+	-	+
Aung et al [46]	Partial	-	+	+
Logenth-iran et al [57]	Partial	+	-	-
Our Approach	+	+	+	+

The study in [72] addresses the problem of resource collaboration in the *MGs*. However, several limitations are identified with respect to our challenges. In [72], the goal was mainly to minimize the transmission power losses (technical aspect), without

capturing the ecological and economical factors. In addition, the authors proposed a "simple scheme for matching" sellers to buyers (as they called it), without minimizing the power costs exchanges and prioritizing the internal coalitions exchanges. Besides, the study lacks in integrating the impact of the storage systems on the outcome of the local energy exchange as well as the cooperative model. And finally, the proposed approach does not capture the instantaneous changes in renewable energy generation and consumer loads.

Concerning [59], the study is based on an auction algorithm that only takes into account the energy prices (economical aspect). Further, it does not consider the cooperation aspect in the *MG* while neglecting ecological and operational aspects. In addition, it targets one type of power generation: the solar-power *MG*.

Similarly to [59], the study in [73] targets the competition raised between the PHEVs trying to increase their revenues. Since their objective function consider solely the trading and selling power costs, the approach does not consider the ecological and operational factors.

In [5], a weighted summation of two objective factors is presented (the ecological and the operational), disregarding the economical aspect and the power market. Besides, the cooperative aspect of the *MG* is completely absent in this study.

The study in [57] presents an algorithm aiming at prioritizing the usage of the renewable energy sources instead of conventional sources. Hence, this work mainly targets the ecological aspect of the *MG* without considering any objective function nor cooperation model.

To summarize:

- *Multi-objective aspect*: The common drawback of all of the existing approaches, is that they do not cope with the three objective aspects of an *MG* [41]. For instance, in [72], the goal was mainly to minimize the transmission power losses (technical aspect), disregarding the economic and ecological aspects. The same aspect was addressed in [5], where the aim was to establish a power equilibrium (technical aspect). However, in [59, 73, 57], the authors focused on establishing a stable power market (economic aspect), while neglecting the other aspects. In [46], the authors aimed at maximizing the power input (operational aspect) while taking into account the minimization of the toxic gas emissions (ecological aspect),
- *Multi-type compliance*: The agent-based approaches [5, 46, 57] showed an efficiency in modeling all types of components, each represented by an agent. This

is not the case of game-theory approaches [72, 59, 73] which target solely the optimization of one type of *MG* components,

- *User-oriented*: This aspect was almost absent in the existing approaches, with the exception of [46] where the user has the possibility to fine-tune the parameters of the objective function,
- *Interoperability*: The data exchanged between the components, was not modeled in dedicated information models, except in [57], where an ontology describing the power market was used. The absence of a solid information model induces an unstable communication and interoperability between *MG* components,
- *Cooperation*: Concerning the cooperative aspect, the authors proposed in [72] a cooperative model by ensuring a power exchange between the energy sources allowing to minimize the transmission losses. In [5, 46], the cooperation is done by forcing the components to maximize the same objective function. Contrariwise to [59, 73, 57] where the cooperation is totally ignored.

All these limitations lead us to develop a new cooperative generic and scalable *MG* model, based on a solid information model, taking into account the three dimensional objective aspects of an *MG* while allowing the user to assign each aspect with an appropriate importance.

3.3 Digital Ecosystem Cooperative Framework

In this study, we address the problem of power exchange optimization of an *MG*. As shown in Figure 3.1, our Digital Ecosystem Cooperative Framework or *DECF* consists of two main modules, **Alliance Builder** and detailed in the following subsections. It is to note that in our study the *MG* components are heterogeneous (e.g., consumer, producer, etc.). They are called nR, standing for ‘n Roles’, since they can play different roles.

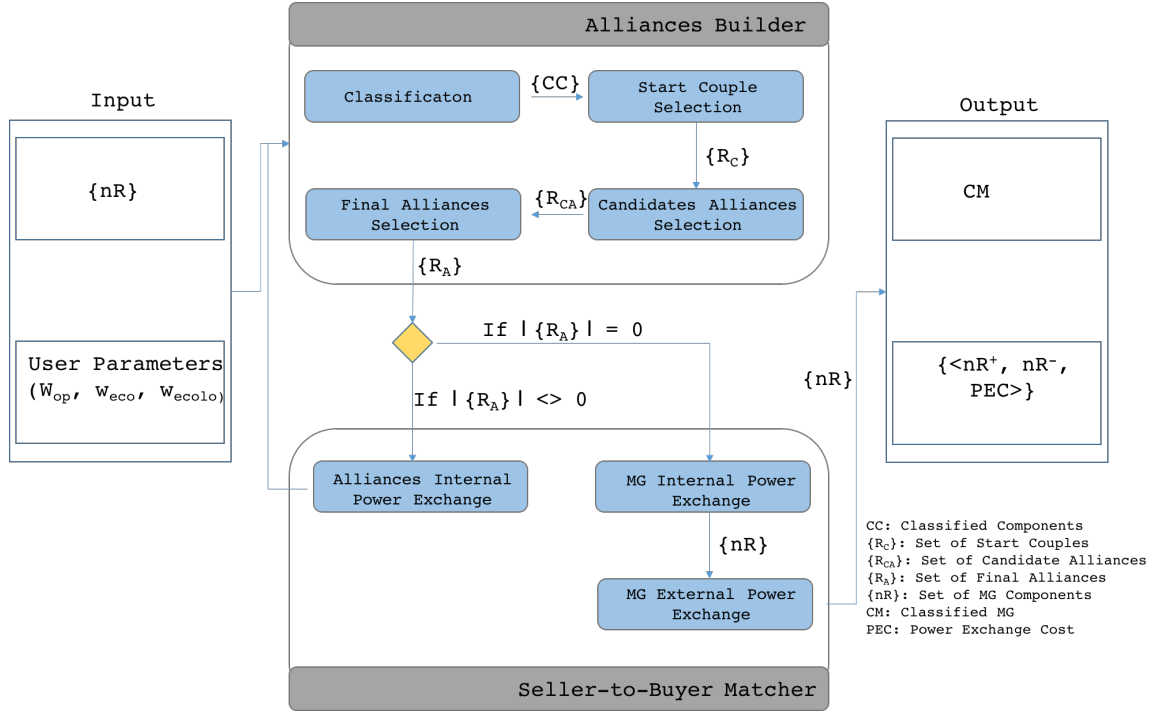

Figure 3.1: Our *DECF* framework

3.3.1 Alliance Builder

As in [72], based on the assumption that it is more beneficial to promote an *MG* internal power exchange rather than relying on the main grid, our Alliance Builder has been designed to gather, into a set of alliances, components having some interest to cooperate and exchange power in *MG* while taking into account the three dimensional aspects (technical, ecological and economical). In other words, an alliance consists of a number of *MG* components aiming at reducing the transmission power losses wasted over the distribution lines and maintaining a power balance (between the generation and the consumption). In addition, it minimizes Seller2Buyer Matcher, the environmental impact due to the conventional energy sources, and ensures a stable energy trading via a cost reduction.

After a close study of existing clustering techniques [39, 44, 9, 10, 48], we observed that they are inappropriate to be adopted in our work to cluster the *MG* components due to two main limitations:

- They consider that all the components to be clustered belong to the same type,
- They use an objective function that can be calculated between any two components (since they belong to the same type), which is meaningless when having

different component types.

All this, prompt us to develop our own algorithm. Before detailing the process, it is essential to present some formal definitions used in our study. Let us consider an *MG* consisting of K components.

Definition 1 (MG Component $[nR]$). *An MG component is an MG constituent, that has the possibility to play one or several roles during its lifetime (i.e., produce, consume and store power). Formally:*

*An nR component is represented as $nR:\prec Id, Eco, Ecolo, Op, Geo, T \succ$ where *Id, Eco, Ecolo, Op, Geo* represent its identification, economic, ecological, operational and geographical property sets respectively at a time $T \in [1, \dots, H] / H = 24$, since we are studying the behavior of the *MG* in an interval of one hour \blacklozenge*

Definition 2 (Power Gap $[G]$). *A power gap defines the power surplus, need or satisfaction of a component or a set of components. Formally:*

A power gap of a component or a set of components \mathcal{R} , denoted as G , designates its gap between power generation, demand and storage. It is defined as:

$$G(\mathcal{R}) = \sum_{i=1}^{|\mathcal{R}|} (nR_i.Op.g - nR_i.Op.d + nR_i.Op.s) \quad (3.6)$$

where $nR_i \in \mathcal{R}$, and g , d , and s are respectively the component power generation, demand, and storage \blacklozenge

Definition 3 (Seller $[nR^+]$). *A seller is an MG component that has a power surplus. Formally:*

An nR is called Seller, denoted as nR^+ , if its $G(nR) > 0$ \blacklozenge

Definition 4 (Buyer $[nR^-]$). *A buyer is an MG component that has a power need. Formally:*

An nR is called Buyer, denoted as nR^- , if its $G(nR) < 0$ \blacklozenge

Definition 5 (Self-satisfied $[nR^0]$). *A self-satisfied is an MG component that has a power satisfaction, in other words, it hasn't any power surplus or need. Formally: An nR is called Self-satisfied, denoted as nR^0 , if its $G(nR) = 0$. \blacklozenge*

Definition 6 (ClassifiedComponents $[CC]$). *A ClassifiedComponents is the set of MG components, classified into three sets of sellers, buyers and self-satisfied components.*

Formally, $\mathcal{CC} \prec \mathcal{R}^+, \mathcal{R}^-, \mathcal{R}^0 \succ$ where $\mathcal{R}^+ = \left(\bigcup_{i=1}^n \{nR_i^+\}\right)$, $\mathcal{R}^- = \left(\bigcup_{j=1}^m \{nR_j^-\}\right)$, $\mathcal{R}^0 = \left(\bigcup_{k=1}^l \{nR_k^0\}\right)$ and $(n + m + l) = K$. A function called $\mathcal{CC}()$ is used to return the *ClassifiedComponents* set \mathcal{CC} . \blacklozenge

Definition 7 (Alliance [A]). An Alliance is a set of MG sellers and buyers, having a mutual interest in working together. Formally:

An Alliance \mathcal{A} is defined as a set of at least one seller and one buyer. Formally, $\mathcal{A} \prec \mathcal{R}^+, \mathcal{R}^- \succ$ where $\mathcal{R}^+ = \left(\bigcup_{i=1}^n \{nR_i^+\}\right)$, $\mathcal{R}^- = \left(\bigcup_{j=1}^m \{nR_j^-\}\right)$ and $(n + m) \leq K$, $n \geq 1$, and $m \geq 1$ \blacklozenge

Definition 8 (Couple [C]). A couple \mathcal{C} is a special case of an alliance composed of only one buyer and one seller. Formally:

$\mathcal{C} \prec \mathcal{R}^+, \mathcal{R}^- \succ$ where $\mathcal{R}^+ = \{nR^+\}$ and $\mathcal{R}^- = \{nR^-\}$ \blacklozenge

Definition 9 (Cost [P]). The cost of one or several components \mathcal{R} is defined according to the costs related to its operational, economic, and ecological properties. It represents the transmission power losses costs (operational), the power generation costs (economic) and the environmental impact costs (ecological) of the MG components during their functioning. Although it can be defined using different aggregation functions (e.g., maximum, average, etc.), we adopted the weighted sum function to combine the different objective aspects costs, allowing the user to tune the weight of each criterion in accordance with her priorities. Formally:

$$P(\mathcal{R}, W) = W.w_{op} \times P_{op}(\mathcal{R}) + W.w_{eco} \times P_{eco}(\mathcal{R}) + W.w_{ecolo} \times P_{ecolo}(\mathcal{R}) \quad (3.7)$$

where:

- $P_{op}(\mathcal{R})$ represents the operational cost of \mathcal{R} ,
- $P_{eco}(\mathcal{R})$ represents the economic cost of \mathcal{R} ,
- $P_{ecolo}(\mathcal{R})$ represents the ecological cost of \mathcal{R} , and
- W is a set of three weights, denoted as $\prec w_{op}, w_{eco}, w_{ecolo} \succ$, $w_{op} + w_{eco} + w_{ecolo} = 1$ and $(w_{op}, w_{eco}, w_{ecolo}) \geq 0$ \blacklozenge

It is worthy to note here, that in this study, the cost P does not consider the power exchange cost. This latter is taken into account in the seller-to-buyer module. The main reason behind this choice, is building stable alliances based on reducing the ecological, economical and operational costs independently from any market tariffs

changes. In addition, in this way we are prioritizing the alliances formation based on the three-dimensional factors without any market influence. For instance, let us consider a consumer $C1$ having a need of 200 KW, and two producers both able to satisfy the need of $C1$: a solar-powered system $S1$ with a tariff of 50 euros and a diesel generator $S2$ with a tariff of 25 euros. In our case, $C1$ and $S1$ will belong to the same alliance since we are privileging the ecological aspect on the market tariffs. However, while integrating the market prices, $C1$ and $S2$ will belong to the same alliance neglecting the ecological aspect.

Definition 10 (Operational Cost $[P_{op}]$). *The operational or technical cost of one or several components \mathcal{R} , denoted $P_{op}(\mathcal{R})$, is defined as:*

$$P_{op}(\mathcal{R}) = MG.Op.PWLossCost \times \sum_{i=0, j=0}^{n, m} (MG.Op.PWLoss_{i,j}) + MG.Op.PWasteCost \times (|G(\mathcal{R}) - \sum_{i,j}^{n, m} (MG.Op.PWLoss_{i,j})|) \quad (3.8)$$

where $\forall i$ and j , nR_i^+ and $nR_j^- \in \mathcal{R}$, and $n + m = |\mathcal{R}|$. The technical cost depends on various parameters such as the power losses $PWLoss(nR_i^+, nR_j^-)$ between the seller nR_i^+ and the buyer nR_j^- , and the fixed price $PWLossCost$ paid by the buyer nR_j^- per unit of power loss (e.g., 0.5 euro /watt). In addition, the wasted power is calculated by subtracting the power lost in \mathcal{R} from its gap $G(\mathcal{R})$, and is multiplied by the fixed price $PWasteCost$ paid per unit of power wasted (e.g., 1 euro /watt).

Note that the power loss $PWLoss$ between two components is defined as follows:

$$PWLoss_{i,j} = R_{ij} \times I^2 + \beta \times Q_i \quad (3.9)$$

where R_{ij} is the resistance of the distribution line between the two components i and j , β is the fraction of power lost, I is the current flowing over the distribution line and Q_i represents the power flowing between the two components. \blacklozenge

Definition 11 (Economical Cost $[P_{eco}]$). *The economical cost of one or several components \mathcal{R} , denoted $P_{eco}(\mathcal{R})$, is defined as:*

$$P_{eco}(\mathcal{R}) = \sum_{i=0}^{|\mathcal{R}|} (nR_i.Eco.SUCost + nR_i.Eco.SDCost) + \sum_{j=0}^n (nR_j^+.Eco.PWCost \times nR_j^+.Op.g) \quad (3.10)$$

where $\forall i, nR_i \in \mathcal{R}$, and $\forall j, nR_j^+ \in \mathcal{R}$, and $n \leq |\mathcal{R}|$. The economic cost depends on several factors such as the startup cost $SUCost$ and the shutdown cost $SDCost$ of each MG component nR_i in $|\mathcal{R}|$. In addition, it considers the production cost $PWCost$ paid by the seller nR_j^+ per unit of power production. \blacklozenge

Definition 12 (Ecological Cost $[P_{ecolo}]$). The ecological cost of one or several components \mathcal{R} , denoted $P_{ecolo}(\mathcal{R})$, is defined as:

$$P_{ecolo}(\mathcal{R}) = MG.Op.GasEssCost \times \sum_{i=0}^n (nR_i^+.Ecolo.GasEss \times nR_i^+.Op.g) \quad (3.11)$$

if $\forall i, nR_i^+ \in \mathcal{R}$, and $n \leq |\mathcal{R}|$. The ecological cost depends on the toxic gas emissions $GasEss$ evolved during the power production, and the cost $GasEssCost$ per unit of gas emission. \blacklozenge

Definition 13 (Isolated $[\mathcal{I}]$). An MG component nR is called isolated $R_{\mathcal{I}}$ if adding it to any existing alliance increases the cost of the alliance. Formally:

An $nR \in R_{\mathcal{I}}$ if $P(\mathcal{A}' \cup \{nR\}) > P(\mathcal{A}') \forall \mathcal{A}' \in \left(\bigcup_{i=1}^L \mathcal{A}_i \right)$ where L is the number of created Alliances \blacklozenge

Definition 14 (ClassifiedMG $[\mathcal{CM}]$). A ClassifiedMG is the set of MG components, classified into three separate sets of alliances, isolated and self-satisfied components.

Formally, $\mathcal{CM} :< \mathcal{R}_{\mathcal{A}}, \mathcal{R}_{\mathcal{I}}, \mathcal{R}^0 >$ where $\mathcal{R}_{\mathcal{A}}$, $\mathcal{R}_{\mathcal{I}}$ and \mathcal{R}^0 are the created alliances, isolated and self-satisfied sets respectively, defined by: $\mathcal{R}_{\mathcal{A}} = (\bigcup \{\mathcal{R}_{\mathcal{A}_i}\})$, $\mathcal{R}_{\mathcal{I}} = (\bigcup \{\mathcal{R}_{\mathcal{I}_j}\})$ and $\mathcal{R}^0 = (\bigcup \{nR_k^0\})$ \blacklozenge

Definition 15 (Neighborhood $[\mathcal{V}]$). The neighborhood of a couple \mathcal{C} , denoted $\mathcal{V}(\mathcal{C})$, is the set of one or more sellers or buyers, allowing the initial couple \mathcal{C} to maintain its cost $P(\mathcal{C})$ after its/their integration. Formally,

$$\mathcal{V}(\mathcal{C}) = \left(\bigcup \{nR_i\} \right) \quad (3.12)$$

if $\forall nR_i$:

$$P(\mathcal{C}) = \begin{cases} P(\{\mathcal{C}.nR^+\} \cup \{nR_i\}) & \text{where } nR_i \in \left\{ \bigcup_{j=1}^m nR^+ \right\} \\ P(\{\mathcal{C}.nR^-\} \cup \{nR_i\}) & \text{where } nR_i \in \left\{ \bigcup_{k=1}^n nR^- \right\} \end{cases} \quad \text{where } n \text{ is the number of}$$

Sellers and m is the number of Buyers. \blacklozenge

Definition 16 (MinCostCouple $[MCC]$). The MinCostCouple of one or several couples $\mathcal{R}_{\mathcal{C}}$ is the subset of couples having the smallest cost. Formally:

$$MCC(\mathcal{R}_{\mathcal{C}}) = \left(\bigcup \mathcal{C}_i \right) / P(\mathcal{C}_i) \leq P(\mathcal{C}_{-i}) \quad (3.13)$$

$\forall \mathcal{C}_{-i} \in \mathcal{R}_{\mathcal{C}}$ and $\mathcal{C}_{-i} \neq \mathcal{C}_i$ \blacklozenge

Definition 17 (MinGapCouple [MGC]). *The MinGapCouple of one or several couples $\mathcal{R}_{\mathcal{C}}$ is the subset of couples having the smallest gap. Formally:*

$$MGC(\mathcal{R}_{\mathcal{C}}) = \left(\bigcup \mathcal{C}_i \right) / \text{Gap}(\mathcal{C}_i) \leq \text{Gap}(\mathcal{C}_{-i}) \quad (3.14)$$

$\forall \mathcal{C}_{-i} \in \mathcal{R}_{\mathcal{C}}$ and $\mathcal{C}_{-i} \neq \mathcal{C}_i$ \blacklozenge

Definition 18 (MaxNeighborCouple [MNC]). *The MaxNeighborCouple of one or several couples $\mathcal{R}_{\mathcal{C}}$ is the subset of couples having the biggest number of neighbors gap. Formally:*

$$MNC(\mathcal{R}_{\mathcal{C}}) = \left(\bigcup \mathcal{C}_i \right) / |(\mathcal{V}(\mathcal{C}_i))| \leq |(\mathcal{V}_{\mathcal{C}_{-i}})| \quad (3.15)$$

$\forall \mathcal{C}_{-i} \in \mathcal{R}_{\mathcal{C}}$ and $\mathcal{C}_{-i} \neq \mathcal{C}_i$ \blacklozenge

Definition 19 (Candidate Alliance Benefit [CAB]). *The candidate Alliance Benefit is the difference between the alliance cost before and after adding in it either an MG component or a couple. Formally:*

$$CAB(\mathcal{A} \cup h) = P(\mathcal{A}) - P(\mathcal{A} \cup h) \quad (3.16)$$

$\forall h \in \{nR^+, nR^-, \mathcal{C}\}$ and $h \notin \mathcal{A}$ \blacklozenge

Definition 20 (MaxCandidateAllianceBenefit [MCAB]). *The MaxCandidateAllianceBenefit of one or several alliances $\mathcal{R}_{\mathcal{A}}$ is the subset of alliances having the biggest Candidate Alliance Benefit (CAB). Formally:*

$$MCAB(\mathcal{R}_{\mathcal{A}}) = \left(\bigcup \mathcal{A}_i \right) / CAB(\mathcal{A}_i \cup h) \leq CAB(\mathcal{A}_{-i} \cup h) \quad (3.17)$$

$\forall \mathcal{A}_{-i} \in \mathcal{R}_{\mathcal{A}}$ and $\mathcal{A}_{-i} \neq \mathcal{A}_i$ \blacklozenge

Definition 21 (ADD [ADD]). *The ADD of two sets \mathcal{R} and \mathcal{R}' each consisting of one or several components is to add the components of the set \mathcal{R}' to the set \mathcal{R} . Formally:*

$$ADD(\mathcal{R}, \mathcal{R}') = \left(\bigcup_{i=1}^{|\mathcal{R}|} \{nR_i\} \right) \cup A \quad (3.18)$$

where $A = \mathcal{R}'$, if A is a set of components
and $A = \{nR'\}$, if A is a single component

$\forall i, nR_i \in \mathcal{R}$. \blacklozenge

Definition 22 (REMOVE [REMOVE]). The REMOVE of two sets \mathcal{R} and \mathcal{R}' each consisting of one or several components is to remove the components of the set \mathcal{R}' from the set \mathcal{R} . Formally:

$$REMOVE(\mathcal{R}, \mathcal{R}') = \left(\bigcup_{i=1}^{|\mathcal{R}|-|\mathcal{R}'|} \{nR_i\} \right) \quad (3.19)$$

where $\forall i, nR_i \in \mathcal{R}$ and $nR_i \notin \mathcal{R}'$ \blacklozenge

An overview of our Alliance Builder module is shown in Figure 3.2. The idea implies that an *MG* component (a seller or a buyer) should join an alliance *A* rather than *B*, if it is able to decrease the cost of *A*, $C(A)$, more than the cost of *B*, $C(B)$. In other words, a component should be beneficial to the alliance, in that it should reduce its ecological, economical and operational cost to the maximum while reducing the wasted power into the alliance. To ensure that we are forming alliances with minimum costs, we start by selecting the couple (the seller and the buyer) having the minimum cost, and adding in the components that can reduce this cost. Once done, we move to the next couple having the next minimum. The complete process is explained in details in what follows.

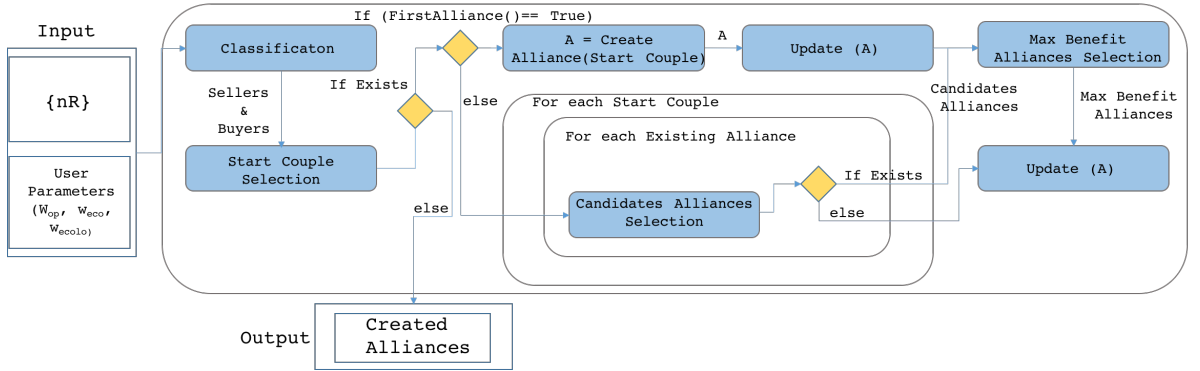

Figure 3.2: A simplified activity diagram of Alliance Builder

It consists of 4 main components: *i*) Components Classification, *ii*) Start Couple Selection *iii*) Candidate Alliances Selection, and *iv*) Final Alliance Selection.

When an input of K components of an *MG* is available for the *MGCC*, this module is executed automatically every hour of the day.

The pseudo-code of the global **Alliances Builder** algorithm is provided in Algorithm 1. In short, the first phase of the process (lines 1-4) consists of taking away the self-satisfied components that have no need to sell or buy power in the *MG*. Then, a classification is done aiming at identifying the sellers and the buyers that are

willing to enter the power exchange process. After this classification, a ‘start couple selection’ is initiated (line 9), resulting in one or more couples having the minimum cost, minimum gap and maximum number of neighbors. In the aim of encouraging the *MG* components cooperation, a compatibility test (line 15) is applied between the resulting start couple(s) and the existing alliances called ‘Candidate Alliances Selection’. It consists of selecting all the existing alliances that can reduce their costs

Algorithm 1: Global Algorithm

```

Input:  $nR[]$ ,  $W[]$  // Set of MG components and weights (operational, economical and ecological)
Output:  $\mathcal{CM}$  // The classification of the Micogrid
1  $CC \leftarrow CC()$  // Retrieve the ClassifiedComponents
2  $nR^+[] \leftarrow CC.\mathcal{R}^+$  // Retrieve the Sellers
3  $nR^-[] \leftarrow CC.\mathcal{R}^-$  // Retrieve the Buyers
4  $nR^0[] \leftarrow CC.\mathcal{R}^0$  // Retrieve the Self-satisfied
5  $\mathcal{R}_A[] \leftarrow []$  // Initialize a list of Alliances
6  $\mathcal{R}_C[] \leftarrow []$  // Initialize a list of Couples
7  $\mathcal{R}_I[] \leftarrow []$  // Initialize a list of Isolated
8  $\mathcal{R}_{CA}[] \leftarrow []$  // Initialize a list of candidate alliances
9 while  $|nR^+[]| > 0 \ \& \ |nR^-[]| > 0$  do
10  $\mathcal{R}_C[] \leftarrow StartCoupleSelection(nR^+[], nR^-[], \mathcal{R}_A[], W[])$ 
11 if  $|\mathcal{R}_A[]| = 0$  then
12  $Couple \leftarrow RND(\mathcal{R}_C[])$ 
13  $Alliance \leftarrow UPDATE(nR^+[], nR^-[], Couple, W[])$   $\mathcal{R}_A[] \leftarrow ADD(\mathcal{R}_A[], Alliance)$ 
14 else
15  $\mathcal{R}_{CA}[] \leftarrow CandidateAllianceSelection(nR^+[], nR^-[], \mathcal{R}_C[], W[])$ 
16 if  $|\mathcal{R}_{CA}[]| > 0$  then
17  $\mathcal{R}_A[] \leftarrow FinalAllianceSelection(nR^+[], nR^-[], \mathcal{R}_{CA}[], W[])$ 
18 else
19  $Couple \leftarrow RND(\mathcal{R}_C[])$ 
20  $Alliance \leftarrow UPDATE(nR^+[], nR^-[], Couple, W[])$ 
21  $\mathcal{R}_A[] \leftarrow ADD(\mathcal{R}_A[], Alliance)$ 
22 for each  $nR_i^+ \in nR^+[]$  do
23  $\mathcal{R}_I[] \leftarrow ADD(\mathcal{R}_I[], nR_i^+)$  // This allows to add the isolated sellers to the isolated list
24  $nR^+[] \leftarrow REMOVE(nR^+[], nR_i^+)$  // This allows to remove the isolated sellers from the sellers list
25 for each  $nR_i^- \in nR^-+[]$  do
26  $\mathcal{R}_I[] \leftarrow ADD(\mathcal{R}_I[], nR_i^-)$  // This allows to add the isolated buyers to the isolated list
27  $nR^-[] \leftarrow REMOVE(nR^-[], nR_i^-)$  // This allows to remove the isolated buyers from the buyers list
28  $\mathcal{CM}.\mathcal{R}_A \leftarrow \mathcal{R}_A[]$ 
29  $\mathcal{CM}.\mathcal{R}_I \leftarrow \mathcal{R}_I[]$ 
30  $\mathcal{CM}.\mathcal{R}^0 \leftarrow nR^0[]$ 
31 return  $\mathcal{CM}$ 

```

by adding the start couples’ seller, buyer or the whole couple. When there is no resulting candidate alliance, we create a new alliance formed by the start couple. Then, a ‘Final candidate alliance’ (line 17) is achieved, consisting of creating an alliance formed by the candidate alliance having the biggest benefit by adding the start couple. After the creation of the alliance, this latter is updated by adding its neighbors able to reduce its costs. If none exists, a new ‘start couple selection’ is launched. The whole process is repeated until there is no more start couple. In the following, the **Alliances Builder** modules will be detailed.

3.3.1.1 Classification Module

This module consists of classifying the MG components into three separate sets of sellers ($\{nR^+\}$), buyers ($\{nR^-\}$) and self-satisfied components ($\{nR^0\}$).

3.3.1.2 Start Couple Selection Module

The aim of this module is to select the starting couple(s) in each iteration of the power exchange process. The pseudo-code of the Start Couple Selection algorithm is provided in Algorithm 2. We start by selecting the couples having the minimum cost (line 1). If many resulting couples exist, the couple having the minimum gap is selected (lines 2-3). If many exist, the couple having the biggest number of neighbors is selected (lines 4-5). If many exist and if there is no existing alliance, the start couple is randomly chosen from the list of start couples (lines 6-7). Otherwise, if there is at least one existing alliance, the start couple will be a list of the couples having the biggest number of neighbors.

Algorithm 2: Start Couple Selection

```

Input:  $nR^+[]$ ,  $nR^-[]$ ,  $\mathcal{R}_A[]$ ,  $W[]$  // Set of Sellers, Buyers, Created Alliances and weights (operational, economical and ecological)
Output:  $\mathcal{R}_C[]$  // Set of Start Couples
1  $\mathcal{R}_C[] \leftarrow MCC(nR^+[], nR^-[], W[])$  // Select the couples having the minimum Cost
2 if  $|\mathcal{R}_C[]| > 1$  then
3    $\mathcal{R}_C[] \leftarrow MGC(\mathcal{R}_C[])$  // Select the couples having the minimum Gap
4 if  $|\mathcal{R}_C[]| > 1$  then
5    $\mathcal{R}_C[] \leftarrow MNC(\mathcal{R}_C[])$  // Select the couples having the maximum number of neighbors
6 if  $|\mathcal{R}_A[]| = 0$  then
7    $\mathcal{R}_C[] \leftarrow RND(\mathcal{R}_C[])$  // If many exist, choose a random start couple
8 return  $\mathcal{R}_C[]$ 

```

3.3.1.3 Candidate Alliances Selection Module

The goal of this module is to select the existing alliances, that are able to decrease their costs by integrating any of the start couples' seller, buyer or both. The pseudo-code of the Candidate Alliances Selection algorithm is provided in Algorithm 3. If there is no existing alliance, an alliance is created by a random start couple and then updated with the function Update in the aim of testing the possibility to add its neighbors to the alliance (lines 2-5). Otherwise, for each existing alliance having a $Gap > 0$ and for each start couple, we calculate the alliances costs after adding the start couple buyer and the whole couple (since it is unnecessary to add a seller to an alliance that already has a surplus of power). Here, if the new cost is less than the initial alliance cost, the new alliance is added to the list of candidate alliances (lines

Algorithm 3: Candidate Alliances Selection

```

Input:  $nR^+$  [],  $nR^-$  [],  $\mathcal{R}_C$  [],  $\mathcal{R}_A$  [],  $W$  [] // Set of Sellers, Buyers, Start Couples, Created Alliances and weights
           (operational, economical and ecological)
Output:  $\mathcal{R}_{CA}$  [] // Set of Candidate Alliances
1  $\mathcal{R}_{CA}$  []  $\leftarrow$  []
2 if  $|\mathcal{R}_A| = 0$  then
3    $C \leftarrow RND(\mathcal{R}_C)$  // If many exist, choose a random start couple
4    $nR^+ \leftarrow REMOVE(nR^+, C, \mathcal{R}^+)$ 
5    $nR^- \leftarrow REMOVE(nR^-, C, \mathcal{R}^-)$ 
6    $\mathcal{A} \leftarrow UPDATE(nR^+, nR^-, C)$  // Test if we can add in any start couple neighbor
7    $\mathcal{R}_A \leftarrow ADD(\mathcal{R}_A, \mathcal{A})$  // Add the new alliance to the created alliances set
8 else
9   for each  $C_i \in \mathcal{R}_C$  do
10    for each  $\mathcal{A}_j \in \mathcal{R}_A$  do
11      if  $Gap(\mathcal{A}_j) > 0$  // If  $\mathcal{A}_j$  needs a buyer
12        then
13           $\mathcal{A}_k \leftarrow ADD(\mathcal{A}_j, C_i, \mathcal{R}^-)$ 
14          if  $P(\mathcal{A}_k, W) \leq P(\mathcal{A}_j, W)$  // If the couple's buyer  $C_i, \mathcal{R}^-$  reduces the cost of  $\mathcal{A}_j$ 
15            then
16               $\mathcal{A}_j \leftarrow \mathcal{A}_k$  // Add the buyer  $C_i, \mathcal{R}^-$  to the alliance  $\mathcal{A}_j$ 
17               $\mathcal{R}_{CA} \leftarrow ADD(\mathcal{R}_{CA}, \mathcal{A}_j)$  // Add the alliance  $\mathcal{A}_j$  to the set of candidate alliances  $\mathcal{R}_{CA}$ 
18            else if  $P(ADD(\mathcal{A}_k, C_i, \mathcal{R}^+, W)) \leq P(\mathcal{A}_j, W)$  // If the couple's buyer  $C_i, \mathcal{R}^-$  and the couple's
19              seller  $C_i, \mathcal{R}^+$  reduce the cost of  $\mathcal{A}_j$ 
20              then
21                 $\mathcal{A}_j \leftarrow ADD(\mathcal{A}_k, C_i, \mathcal{R}^+)$  // Add the seller  $C_i, \mathcal{R}^+$  to the alliance  $\mathcal{A}_j$ 
22                 $\mathcal{R}_{CA} \leftarrow ADD(\mathcal{R}_{CA}, \mathcal{A}_j)$  // Add the alliance  $\mathcal{A}_j$  to the set of candidate alliances  $\mathcal{R}_{CA}$ 
23            else if  $Gap(\mathcal{A}_j) < 0$  // If  $\mathcal{A}_j$  needs a seller
24              then
25                 $\mathcal{A}_k \leftarrow ADD(\mathcal{A}_j, C_i, nR^+)$ 
26                if  $P(\mathcal{A}_k, W) \leq P(\mathcal{A}_j, W)$  // If the couple's seller  $C_i, nR^+$  reduces the cost of  $\mathcal{A}_j$ 
27                  then
28                     $\mathcal{A}_j \leftarrow \mathcal{A}_k$  // Add the seller  $C_i, nR^+$  to the alliance  $\mathcal{A}_j$ 
29                     $\mathcal{R}_{CA} \leftarrow ADD(\mathcal{R}_{CA}, \mathcal{A}_j)$  // Add the alliance  $\mathcal{A}_j$  to the set of candidate alliances  $\mathcal{R}_{CA}$ 
30                  else if  $P(ADD(\mathcal{A}_k, C_i, \mathcal{R}^-, W)) \leq P(\mathcal{A}_j, W)$  // If the couple's buyer  $C_i, \mathcal{R}^-$  and the couple's
31                    seller  $C_i, \mathcal{R}^+$  reduce the cost of  $\mathcal{A}_j$ 
32                    then
33                       $\mathcal{A}_j \leftarrow ADD(\mathcal{A}_k, C_i, \mathcal{R}^-)$  // Add the buyer  $C_i, \mathcal{R}^-$  to the alliance  $\mathcal{A}_j$ 
34                       $\mathcal{R}_{CA} \leftarrow ADD(\mathcal{R}_{CA}, \mathcal{A}_j)$  // Add the alliance  $\mathcal{A}_j$  to the set of candidate alliances  $\mathcal{R}_{CA}$ 
35    return  $\mathcal{R}_{CA}$ 

```

9-19). The same test is done on the alliances having a $Gap < 0$, by testing the new alliances costs after adding the start couple's seller or the whole couple (lines 20-30).

Algorithm 4 shows the pseudo-code of the update function algorithm.

3.3.1.4 Final Alliance Selection Module

The goal of this module is to select the final candidate alliance which has the biggest cost reduction when adding the start couple seller, buyer or the whole couple. The pseudo-code of the Final Alliance Selection algorithm is provided in Algorithm 5. For each candidate alliance resulting from the 'Candidate Alliances Selection' module, we select the alliances having the maximum benefit (line 2). If there is no resulting alliance, a new alliance is created formed by a random start couple (lines 3-6). Otherwise, only one will be chosen randomly (lines 8-9). Then a selection of a new start couple selection is done.

The whole same process will be repeated until there is no more start couples.

Algorithm 4: Update

```

Input:  $nR^+$  [],  $nR^-$  [],  $C$ ,  $W$ [] // Set of Sellers, Buyers, the Couple to be updated and the set of weights (operational,
      economical and ecological)
Output:  $\mathcal{A}$  // The resulting alliance
1 Alliance  $\mathcal{A}$ 
2 Set of candidate Alliance  $\mathcal{R}_{CA}$ []
3 Set of final Alliance  $\mathcal{R}_{FA}$ []
4  $V_C \leftarrow \mathcal{V}(C)$ 
5 if  $|V_C| \geq 1$  // If  $C$  has neighbors
6 then
7   if  $Gap(C) > 0$  // If  $C$  needs a buyer
8   then
9     for each  $nR_i \in V_C$  do
10       $R[] \leftarrow Add(C, nR_i)$ 
11      if  $Gap(nR_i) < 0$  &  $P(R[], W[]) \leq P(C)$  // If  $nR_i$  is a buyer and reduces the cost of  $C$ 
12      then
13         $\mathcal{A} \leftarrow ADD(C, nR_i)$  // Creating an alliance  $\mathcal{A}$  resulting from adding the neighbor  $nR_i$  to the couple  $C$ 
14         $nR^-[] \leftarrow REMOVE(nR^-[], nR_i)$   $\mathcal{R}_{CA}[] \leftarrow ADD(\mathcal{R}_{CA}[], \mathcal{A})$  // Add the alliance  $\mathcal{A}$  to the set of
          candidate alliances  $\mathcal{R}_{CA}[]$ 
15       $\mathcal{R}_{FA}[] \leftarrow MCAB(\mathcal{R}_{CA}[])$  // Select the alliances having the biggest benefit
16      if  $|\mathcal{R}_{FA}[]| > 1$  then
17         $\mathcal{A} \leftarrow RND(\mathcal{R}_{FA}[])$ 
18 if  $Gap(C) < 0$  // If  $C$  needs a seller
19 then
20   for each  $nR_i \in V_C$  do
21       $R[] \leftarrow Add(C, nR_i)$ 
22      if  $Gap(nR_i) > 0$  &  $P(R[], W[]) \leq P(C)$  // If  $nR_i$  is a seller and reduces the cost of  $C$ 
23      then
24         $\mathcal{A} \leftarrow ADD(C, nR_i)$  // Creating an alliance  $\mathcal{A}$  resulting from adding the neighbor  $nR_i$  to the couple  $C$ 
25         $nR^+[] \leftarrow REMOVE(nR^+[], nR_i)$   $\mathcal{R}_{CA}[] \leftarrow ADD(\mathcal{R}_{CA}[], \mathcal{A})$  // Add the alliance  $\mathcal{A}$  to the set of
          candidate alliances  $\mathcal{R}_{CA}[]$ 
26       $\mathcal{R}_{FA}[] \leftarrow MCAB(\mathcal{R}_{CA}[])$  // Select the alliances having the biggest benefit
27      if  $|\mathcal{R}_{FA}[]| > 1$  then
28         $\mathcal{A} \leftarrow RND(\mathcal{R}_{FA}[])$ 
29 return  $\mathcal{A}$ 

```

Algorithm 5: Final Alliance Selection

```

Input:  $nR^+$  [],  $nR^-$  [],  $\mathcal{R}_C$  [],  $\mathcal{R}_{CA}$  [],  $W$ [] // Set of Sellers, Buyers, Start Couples, Candidate Alliances and weights
      (operational, economical and ecological)
Output:  $\mathcal{R}_A$ [] // Set of Created Alliances
1 Set of Alliances  $\mathcal{R}_{FA}$ []
2  $\mathcal{R}_{FA}[] \leftarrow MCAB(\mathcal{R}_{CA}[])$  // Select the alliances having the biggest benefit
3 if  $|\mathcal{R}_{FA}[]| = 0$  then
4    $C \leftarrow RND(\mathcal{R}_C[])$ 
5    $nR^+[] \leftarrow REMOVE(nR^+[], C.\mathcal{R}^+)$ 
6    $nR^-[] \leftarrow REMOVE(nR^-[], C.\mathcal{R}^-)$ 
7    $\mathcal{A} \leftarrow UPDATE(nR^+[], nR^-[], C, W[])$  // Update the created alliance
8    $\mathcal{R}_A[] \leftarrow ADD(\mathcal{R}_A[], \mathcal{A})$  // Add the alliance to the existing alliances
9 else
10   $\mathcal{A} \leftarrow RND(\mathcal{R}_{FA}[])$ 
11   $\mathcal{R}_A[] \leftarrow ADD(\mathcal{R}_A[], \mathcal{A})$  // Add the alliance to the existing alliances
12 return  $\mathcal{R}_A[]$ 

```

Alliances Builder Illustration

The aim of this subsection is to illustrate our **Alliance Builder** module. An example will be used to illustrate every step of the module. Let us consider an *MG* consisting of 9 components having the power generation (*g*), demand (*d*) and storage (*s*) as shown in Table 3.2.

	Generation (g)	Demand (d)	Storage (s)
nR_1	17	0	0
nR_2	2	35	1
nR_3	4	10	1
nR_4	20	0	5
nR_5	5	5	0
nR_6	0	0	3
nR_7	6	20	0
nR_8	5	3	1
nR_9	10	20	5

Table 3.2: Example of 9 components of an MG

- Classification module: After classifying the MG components, they will be put into three main categories: the sellers willing to sell their power surplus ($nR_1 \rightarrow nR_1^+$, $nR_4 \rightarrow nR_2^+$, $nR_6 \rightarrow nR_3^+$, $nR_8 \rightarrow nR_4^+$), the buyers willing to buy their power needs ($nR_2 \rightarrow nR_1^-$, $nR_3 \rightarrow nR_2^-$, $nR_5 \rightarrow nR_3^-$, $nR_9 \rightarrow nR_4^-$), and the self-satisfied components ($nR_5 \rightarrow nR_1^0$) (cf. Table 3.3). Figure 3.3 shows the visual representation of the sellers represented by ‘ ∇ ’ and the buyers by ‘ ∇ ’.

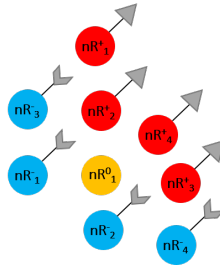

Figure 3.3: Visual representation of the MG components after the Classification module

Component	Generation (g)	Demand (d)	Storage (s)	Gap (G)
nR_1 (nR_1^+)	17	0	0	+17
nR_2 (nR_1^-)	2	35	1	-32
nR_3 (nR_2^-)	4	10	1	-5
nR_4 (nR_2^+)	20	0	5	+25
nR_5 (nR_1^0)	5	5	0	0
nR_6 (nR_3^+)	0	0	3	+3
nR_7 (nR_3^-)	6	20	0	-14
nR_8 (nR_4^+)	5	3	1	+3
nR_9 (nR_4^-)	10	20	5	-5

Table 3.3: Resulting components after of the Classification module

- Start Couple Selection module: After classifying the MG components, a start couple selection should be done. Table 3.4 shows the costs matrix of all the couples.

	nR_1^-	nR_2^-	nR_3^-	nR_4^-
nR_1^+	7.5	6	1.5	6
nR_2^+	3.5	10	5.5	10
nR_3^+	14.5	1	5.5	1
nR_4^+	14.5	1	5.5	1

Table 3.4: Cost matrix of the couples

Table 3.5 shows the execution result of the Start Couple Selection algorithm. We start by selecting the couples having the minimum cost (line 1). Since there are several resulting couples having $Cost = 2$ (line 2), the couple having the minimum gap is selected (line 3). In this example, there are many resulting couples having the same gap $Gap = 2$ (line 4), hence, the couple having the maximum number of neighbors is selected (line 5). Also here, several couples have the same number of neighbors $|\mathcal{V}(\mathcal{C})| = 2$, thus, a random couple is selected; let it be the couple $\mathcal{C}_1 = \langle nR_2^-, nR_3^+ \rangle$. As a result, a new alliance A_1 is created consisting of the seller and the buyer of the start couple, $A_1 = \langle \{nR_2^-\}, \{nR_3^+\} \rangle$. An illustration of this phase is shown in Figure 3.4-1.

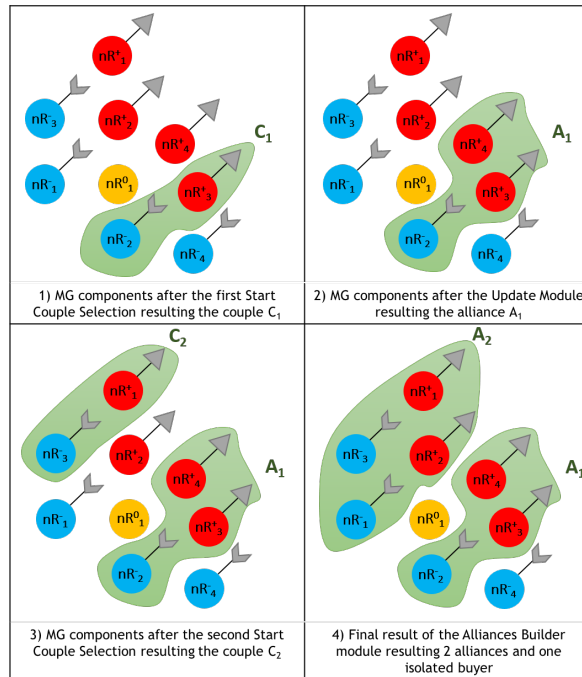

Figure 3.4: Visual representation of the MG components' clustering status after each step

Line	Result
Line 1	$\mathcal{R}_C = \{ \langle nR_2^-, nR_3^+ \rangle, \langle nR_4^-, nR_3^+ \rangle, \langle nR_1^-, nR_4^+ \rangle, \langle nR_4^-, nR_4^+ \rangle \}$
Line 2	True
Line 3	$\mathcal{R}_C = \{ \langle nR_2^-, nR_3^+ \rangle, \langle nR_4^-, nR_3^+ \rangle, \langle nR_1^-, nR_4^+ \rangle, \langle nR_4^-, nR_4^+ \rangle \}$
Line 4	True
Line 5	$\mathcal{R}_C = \{ \langle nR_2^-, nR_3^+ \rangle, \langle nR_4^-, nR_3^+ \rangle, \langle nR_1^-, nR_4^+ \rangle, \langle nR_4^-, nR_4^+ \rangle \}$
Line 6	True
Line 7	$\mathcal{R}_C = \langle nR_2^-, nR_3^+ \rangle$

Table 3.5: Example of the Start Couple Selection algorithm execution

- Update Module: After creating the first alliance $A_1 = \langle \{nR_2^-\}, \{nR_3^+\} \rangle$, the update module is called to test the possibility of adding any of its neighbors as long as it reduces the alliance cost. $\mathcal{V}(A_1) = \{nR_4^+\}$ and $\mathcal{C}(ADD(A_1, nR_4^+)) < \mathcal{C}(A_1)$, hence the alliance should be updated by adding the seller nR_4^+ resulting $A_1 = \langle \{nR_2^-\}, \{nR_3^+, nR_4^+\} \rangle$ as shown in Figure 3.4-2.
- Candidate Alliance Selection Module: After creating the first alliance $A_1 = \langle \{nR_2^-\}, \{nR_3^+, nR_4^+\} \rangle$, consisting of 2 sellers and one buyer, we update the costs matrix by removing the buyers and the sellers being part of existing alliances (cf. Table 3.6). Here, a new start couple selection is done, and resulting the couple $\mathcal{C}_2 : \langle nR_3^-, nR_1^+ \rangle$ as shown in Figure 3.4-3.

	nR_1^-	nR_3^-	nR_4^-
nR_1^+	7.5	1.5	6
nR_2^+	3.5	5.5	10

Table 3.6: Updated Cost matrix of the remaining couples

Before creating a new alliance with the resulting start couple, we check the possibility of adding any of the couple's seller, the buyer or both to the existing alliance A_1 (cf. Table 3.7). Our example shows the impossibility of adding the buyer nR_3^- or the seller nR_1^+ or the whole couple (line 10) to the existing alliance (line 11) $A_1 = \langle \{nR_2^-\}, \{nR_3^+, nR_4^+\} \rangle$, since once added to A_1 , they would increase its cost (lines 27-33). Hence, a new alliance $A_2 = \langle \{nR_3^-\}, \{nR_1^+\} \rangle$ is created. Here, a new start couple selection is done, since this alliance A_2 has no neighbors to check the possibility of adding it.

Line	Result
Line 2	False
Line 9	$\langle nR_3^-, nR_1^+ \rangle$
Line 10	$\langle nR_2^-, nR_3^+, nR_4^+ \rangle$
Line 11	False
Line 22	True
Line 27	False
Line 29	False
Line 33	$\mathcal{R}_{CA} = \square$

Table 3.7: Candidate Alliance Selection algorithm Execution example

A new start couple selection is done resulting the couple $\mathcal{C}_3 : \langle nR_1^-, nR_2^+ \rangle$. Before creating a new alliance with the resulting start couple, we check again the possibility of adding any of the couple's seller, buyer or both to the existing two alliances A_1 and A_2 . Our example shows that by adding the seller and the buyer of the couple to the alliance A_2 , the cost of this latter is decreased. Hence, the alliance A_2 will be updated and becomes $A_2 = \langle \{nR_1^+, nR_2^+\}, \{nR_3^-, nR_1^-\} \rangle$. Here, the only one remaining component, nR_4^- , will be an isolated since it is impossible to add it to the existing alliances as it increases their costs once added as shown in Figure 3.4-4.

3.3.1.5 Alliances Builder Properties

Our approach verifies the following properties characterizing the quality of the alliances builder process. It is to note that $\forall nR_i \in MG$, if $nR_i \in \{nR^0\} \Rightarrow nR_i$ belongs to the output of Alliances Builder algorithm since we include all the self-contained components without any processing.

Property 1 (Completeness). Our algorithm is said to be complete if all the input MG components are preserved in the output without any losses. Formally: $\forall nR_i \in MG \Rightarrow nR_i \in \mathcal{A} \cup \mathcal{I} \cup \{nR^0\}$

Proof. if $nR_i \notin \mathcal{A} \cup \mathcal{I} \cup \{nR^0\}$
 $\Rightarrow nR_i \notin \mathcal{A} \ \& \ nR_i \notin \mathcal{I}$
 $\Rightarrow nR_i \notin \{nR^+\} \ \& \ nR_i \notin \{nR^-\}$
 $\Rightarrow nR_i \in \{\mathcal{I}\}$ which is impossible. □

Property 2 (Minimality). Our algorithm is said to be minimal since a component cannot figure in two alliances at the same time. Formally: $\forall nR_i \in \mathcal{A}_j \Rightarrow nR_i \notin \mathcal{A}_k$

Proof. if $nR_i \in \mathcal{A}_j \cap \mathcal{A}_k$
 \Rightarrow if $nR_i \in \mathcal{A}_j \Rightarrow \mathcal{P}(\mathcal{A}_j, nR_i) \leq \mathcal{P}(\mathcal{A}_j)$ and

if $nR_i \in \mathcal{A}_k \Rightarrow \mathcal{P}(\mathcal{A}_k, nR_i) \leq \mathcal{P}(\mathcal{A}_k)$ then three cases are possible:

if $\mathcal{P}(\mathcal{A}_j, nR_i) - \mathcal{P}(\mathcal{A}_j) > \mathcal{P}(\mathcal{A}_k, nR_i) - \mathcal{P}(\mathcal{A}_k) \Rightarrow nR_i \in \mathcal{A}_j$

if $\mathcal{P}(\mathcal{A}_j, nR_i) - \mathcal{P}(\mathcal{A}_j) < \mathcal{P}(\mathcal{A}_k, nR_i) - \mathcal{P}(\mathcal{A}_k) \Rightarrow nR_i \in \mathcal{A}_k$

if $\mathcal{P}(\mathcal{A}_j, nR_i) - \mathcal{P}(\mathcal{A}_j) = \mathcal{P}(\mathcal{A}_k, nR_i) - \mathcal{P}(\mathcal{A}_k) \Rightarrow nR_i \in \mathcal{A}_j \parallel \mathcal{A}_k \quad \square$

Property 3 (Correctness). Our algorithm is said to be correct since it provides an optimal output. For instance, having multiple candidate alliances a component joins the one where its cost is reduced the most after the joint.

Formally: $\forall nR_i \in \mathcal{A}_j \Rightarrow \mathcal{P}(nR_i, \mathcal{A}_j \cup \mathcal{A}_k) > \mathcal{P}(\mathcal{A}_k)$

where $\forall \mathcal{A}_k \in \{\mathcal{A}\}$

Proof. if $\mathcal{P}(nR_i, \mathcal{A}_j \cup \mathcal{A}_k) \leq \mathcal{P}(\mathcal{A}_k)$

$\Rightarrow nR_i \in \mathcal{A}_k$ which is impossible since $\forall nR_i \in \mathcal{A}_j \Rightarrow nR_i \notin \mathcal{A}_k$ (Minimality)

\square

3.3.2 Seller-to-buyer matcher

The goal of the Seller-to-buyer Matcher (cf. Figure 3.5) is to ensure firstly a local power exchange inside each alliance, secondly between alliances, and finally with the main grid. It goes into establishing the power exchange between the *MG* components by prioritizing the *MG* internal exchange over the external exchange with the main grid.

It consists of three main modules: *i)* Alliances internal matcher, *ii)* *MG* internal matcher, and *iii)* *MG* external matcher. They are detailed below.

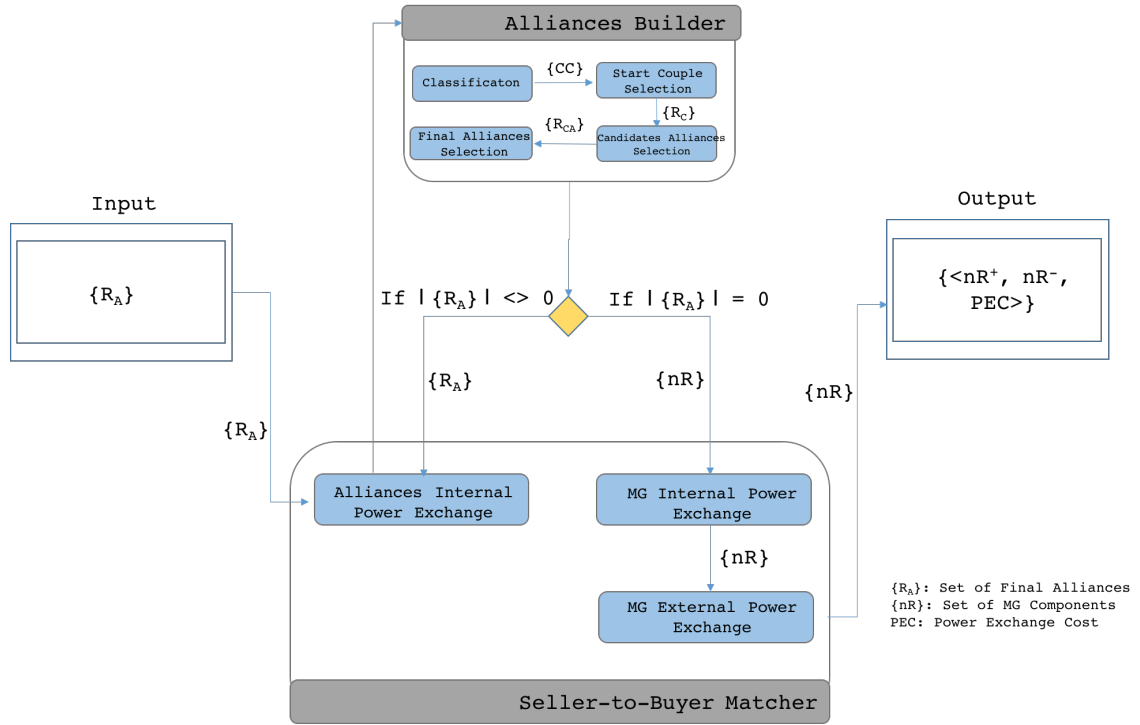

Figure 3.5: Seller-to-buyer matcher framework

3.3.2.1 Alliances Internal matcher

Based on the assumption that it is cheaper to exchange power inside an alliance than to exchange with the Main Grid, the first module of the seller-to-buyer matcher consists of establishing an internal alliances matching. It aims at exchanging power locally inside the alliances, in a way to reduce the costs paid by the buyers (nR^-) as much as possible. To do so, we adopted one of the well-known matching methods in linear programming, known as ‘Vogel Approximation Method’ [77]. We chose it since it suits our needs; having several buyers (nR^-) and several sellers (nR^+) trying to minimize the power costs exchanged between them. The Vogel Approximation Method is an improved version of the Minimum Cell Cost Method and the Northwest Corner Method that in general produces better initial basic feasible solution, which are understood as basic feasible solutions that report a minimization in the objective function of a Problem (*sum of the supply = sum of the demand*).

Vogel Approximation Problem parameters are (as illustrated in our study in Table 3.8):

- The K components of an *MG*

- The ‘Dummy’ component used to balance the demand and the supply in the *MG*
- The power surplus of each seller, shown in the Supply column
- The power need of each buyer, shown in the Demand row
- The unit power price of the power exchanged between i^{th} seller and j^{th} buyer, shown in the cell
- The penalty cost, which is the difference between the lowest two cells in all the rows and columns, shown in the last row and the last column respectively.

The first step of Vogel algorithm consists of calculating the penalty costs of all the rows and columns. Then, the row or column with the highest penalty cost is selected. Then, the cell (couple) with the lowest power price is selected and allocated to the maximum. Here, the row or the column whose having supply or demand = 0 is crossed. The process is stopped when all the rows and columns are crossed. Otherwise, the penalty costs are calculated for all the remaining rows and columns. Any row and column with zero supply or demand should not be used in calculating further penalties. Once the power exchange in all the alliances is established (using Vogel algorithm), a new alliance formation is done with the remaining buyers and sellers, that couldn’t satisfy their needs inside the alliance. Here again, a new internal alliances matching is done in the new created alliances. This process is repeated until there is no possibility to create new alliances.

Vogel algorithm is a well-known methods that has several interesting properties, mainly : 1) the simplicity, 2) the efficiency and the 3) optimality. A detailed study can be provided in [?].

3.3.2.2 Microgrid Internal matcher

The *MG* internal matcher consists of establishing a power exchange between the *MG* components remaining from the Alliances Internal Matcher module. This process is beneficial in that it ensures an internal *MG* power exchange instead of relying on the Main Grid. To do so, Vogel Approximation Method is also applied on the remaining components (the sellers and the buyers that cannot create new alliances anymore).

3.3.2.3 Microgrid External matcher

The third module is the ‘*MG* external power exchange’ which consists of establishing the power exchange between the remaining components of the *MG* internal matcher. Note that, those components must have the same type (sellers or buyers), reflecting the impossibility to make any power exchange between them. In other words, it shows whether the *MG* has a need to sell or buy power from the Main Grid without having the possibility to satisfy it internally.

S2B Matcher Illustration

Back to our previous example, two alliances and one isolated buyer are resulting from the **Alliances Builder** module, as follows:

$$A_1 = \langle \{nR_3^+, nR_4^+\}, \{nR_2^-\} \rangle$$

$$A_2 = \langle \{nR_1^+, nR_2^+\}, \{nR_3^-, nR_1^-\} \rangle$$

$$\mathcal{I}_1 = \langle nR_4^- \rangle$$

Let us start with the A_1 internal matching. In Figure 3.6-1, we show that all the buyers could buy their power need (since $G(A_2) = 1$, which means that it has a power surplus). However, the seller nR_4^+ couldn’t sell all his power, and still have a surplus of 1 *KW*.

	nR_1^-	nR_3^-	Supply	Penalty Cost
nR_1^+	7	1	17	6
nR_2^+	3	5	25	2
Dummy	0	0	4	0
Demand	32	14		
Penalty Cost	3	1		

Table 3.8: Vogel Problem Parameters

Table 3.8 represents the A_2 Vogel solution format. In Figure 3.6-2, we see that all the sellers could sell their power surplus (since $G(A_1) < 0 = -4$, which means that it has a power need of 4 *KW*). The visual representation of the matching is done between the buyer symbol (\wedge) and the seller one (∇), annotated by the exchanged power quantity.

As a result, two sellers and one buyer are remaining: nR_1^- having ($G(nR_1^-) = -4kW$), the remaining buyer of A_1 , nR_4^+ having ($G(nR_4^+) = +1kW$), the remaining seller of A_2 and the isolated buyer having nR_4^- ($G(nR_4^-) = -5kW$). Since there is no possibility to form new alliances from those remaining sellers and buyers, the *MG* internal matcher module is launched. This latter consists of applying Vogel method on the components that have no possibility to form new alliances. Figure 3.6-3 shows

that nR_4^+ can sell all its power surplus (which is normal since $G(MG) < 0$, which means that it has a power need). However, nR_4^- and nR_1^- couldn't satisfy, and still have a need of -3 KW and -5 KW .

Hence, two resulting buyers will move to the third component 'MG external matcher'. Those two components will be responsible of buying their need from the Main Grid.

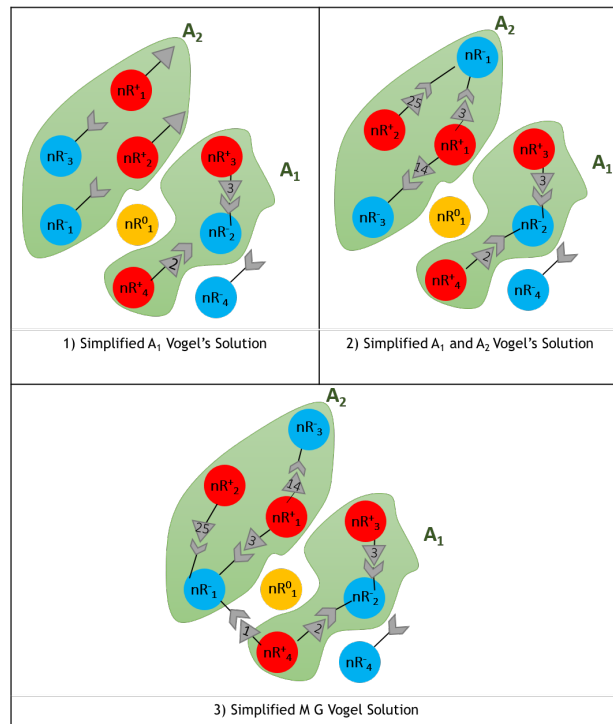

Figure 3.6: Application of Vogel's Solution

3.4 Complexity Analysis

3.4.1 Time Complexity

The computational complexity of our **Alliances Builder** module simplifies to a complexity of $O(N^3)$.

Let:

- N be the number of components in the MG considered (i.e., cardinality/size of MG),
- N^+ the number of sellers in the MG considered,

- N^- the number of buyers in the MG considered,
- N_C the number of couples in the MG considered,
- N_A the number of alliances in the MG considered

It is computed as follows:

- *Classification module* is of average linear complexity and simplifies to $O(N)$ since it parses all the components of MG in order to classify them into three categories (seller, buyer, and auto-satisfied)

- *Start Couple Selection module*, is of $O(N^+ \times N^- + 2 \times N_C + k)$ complexity, since:
 - 1- MCC module calls the components in worst case scenario $N^+ \times N^-$ times.
 - 2- MGC and MNC modules call the couples in worst case scenario N_C times,
 - 3- RND can be executed in a constant time k .

Thus, the time complexity of this module comes down to $O(N^2)$.

- *Update module*, is of $O(N^+ \times N^- + N_C \times N + N_A)$ complexity since:
 - 1- \mathcal{V} module calls the components in worst case ($N^+ \times N^- - 2$)
 - 2- ADD calls the components k times in worst case scenario,
 - 3- REMOVE calls the components N times in worst case scenario,
 - 4- MCAB module calls the components in worst case scenario N_A times

Thus, the time complexity of this module comes down to $O(N^2)$.

- *Candidate Alliances Selection module* is of $O(N_C \times N_A \times k)$ since the ADD module can be executed in a constant time k nested into two "for" loops having respectively a complexity of N_C and N_A .

Thus, the time complexity of this module comes down to $O(N^2)$.

- *Final Alliance Selection module* is of $O(N_A + N^2 + N)$ since:
 - 1- MCAB module call the components in worst case scenario N_A times
 - 2- ADD calls the components k times in worst case scenario,
 - 3- REMOVE calls the components N times in worst case scenario,
 - 4- Update module calls the components $O(N^2)$ times.

Thus, the time complexity of this module comes down to $O(N^2)$.

The computational complexity of the **Vogel approximation** module is of $O(N^3)$. It has been demonstrated in [25] and won't be detailed further in this study.

Hence, the overall time complexity of our model comes down to $O(N^3) + O(N^3) = O(N^3)$.

3.4.2 Space Complexity

As for memory usage, our approach requires RAM space to store the component sets/lists being compared. It simplifies to a linear complexity of $O(N^2)$ space as:

- *Classification module* requires an $O(2 \times N)$ space since it parses all the components of MG and stores them into three new lists (seller, buyer, and auto-satisfied). Thus, the space complexity of this module comes down to $O(N)$.
- *MCC, MGC and MNC algorithms* require in worst case scenario $O(N + N_C)$ space for storing all the components (N) and the resulting couples N_C . Thus, the space complexity of this module comes down to $O(N)$.
- *MCAB algorithm* requires also in worst case scenario $O(N + N_A)$ space for storing all the components (N) of the resulting alliances. Thus, the space complexity of this module comes down to $O(N)$.
- *UPDATE algorithm* requires in worst case scenario $O(N + 3 \times (N_C) + N_A)$, since:
 - 1- \mathcal{V} requires in worst case scenario $(N + 2 + (N_C - 1))$ space
 - 2- ADD and REMOVE require N in worst case scenario,
 - 3- MCAB algorithm requires also in worst case scenario $O(N)$ space.
 Thus, the complexity of this module comes down to $O(N)$.
- *Candidate Alliances Selection module* is of $O(N + N_C \times N_A + N_A)$ space complexity since in a worst case scenario, it parses for each start couple (N_C), all the existing alliances (N_A), resulting in a worst case scenario N_A alliances. Thus, the space complexity of this module comes down to $O(N^2)$.
- *Final Alliance Selection module* is of $O(N_A + N^2 + N)$ since:
 - 1- MCAB algorithm requires also in worst case scenario $O(N)$ space
 - 2- ADD and REMOVE require N space in worst case scenario,
 - 3- Update module requires N space.

4- Candidate Alliances Selection module requires N^2 space.

Thus, the space complexity of this module comes down to $O(N^2)$.

As for the time complexity, the space complexity of the **Vogel approximation** module is studied in [25] and is of $O(N^2)$.

Hence, the overall space complexity of our model comes down to $O(N^2)+O(N^2) = O(N^2)$.

3.5 Experiments

We have developed a prototype to validate our *DECM* framework. A set of experimental tests have been conducted as explained below.

3.5.1 Experimental Context

The prototype is implemented using Java, developed on the NetBeans 8.0.2 platform, carried out on a PC with an Intel Core i7-3630 QM CPU, 2.40 GHz processor with 8 GB RAM. It includes the following functionalities: 1) the *MG* components management (while taking the transmission lines and their characteristics) 2) the **Alliances Builder**, and 3) the **Seller2buyer matcher**.

The user can add the components of the *MG* to be managed. She can also upload a list of *MG* components with their properties from an external source. Once the components are defined, the user can execute the ‘**Alliances Builder module**’. This latter generates a list of alliances with their according costs. Once done, the user can execute the ‘**S2B Power Matcher module**’, producing a list of matched components (sellers and buyers) with their computing power exchange costs.

Since the *MG* is relatively a recent concept in the power systems area, there is a lack of a current Benchmark to be based on. Hence, we carried out our experimental scenario inspired by the one provided in [72] but adapted to fit better the scope of our study. Here, we set up an *MG* within an area of $10 \text{ km} \times 10 \text{ km}$ with:

- the main grid located
- the *MG* components randomly located within this area

The power gap (G) of any *MG* component nR : $10 \text{ MW} \leq G(nR) \leq 316 \text{ MW}$. Note that, the exchange cost between an *MG* component and the Main Grid is set to 10.

3.5.2 Experimental Metrics and Results

The main criteria used to evaluate the effectiveness of our approach are:

- the alliances formation impact on the *MG* operation,
- the time needed to generate the alliances, as well as
- the sellers to buyers matching impact on the cost reduction.

The results are detailed below.

3.5.2.1 Alliance Builder impact on the *MG* operation

The cooperation aspect is the key factor that led us to conceive the alliances builder module. Hence, we propose to measure the average of the alliances costs per *MG*, where we vary the number of components from 2 to 50 components, in an average of 10 times. The reason behind choosing this range is that the *MGs* are small scale distribution networks which consist of a limited number of components [26]. Note that, the highest number of components used in the literature was 30 components [72].

In this test, four different scenarios were considered:

1. a non-cooperative one, consisting of calculating the average cost of the *MG* components exchange with the Main grid,
2. a random one, consisting of calculating the costs average of a random alliances formation,
3. the cooperative model presented in [72], and
4. our cooperative one.

As mentioned before, the work in [72] takes only into account the operational aspect of the *MG*. Hence, in order to be able to compare their approach with ours, we considered only the operational aspect in our cost calculation (by assigning 1 to the operational aspect weight and 0 to the others, i.e., $w_{op} = 1$ and $w_{eco} = w_{ecolo} = 0$).

Figure 3.7 shows that the worst case scenario is the non-cooperative one, with a constant value of 10. This result reflects our initial assumption that it is more beneficial to ensure a local *MG* cooperation instead of relying on the Main Grid. In addition, it shows that as the number of components increases, the resulting alliances

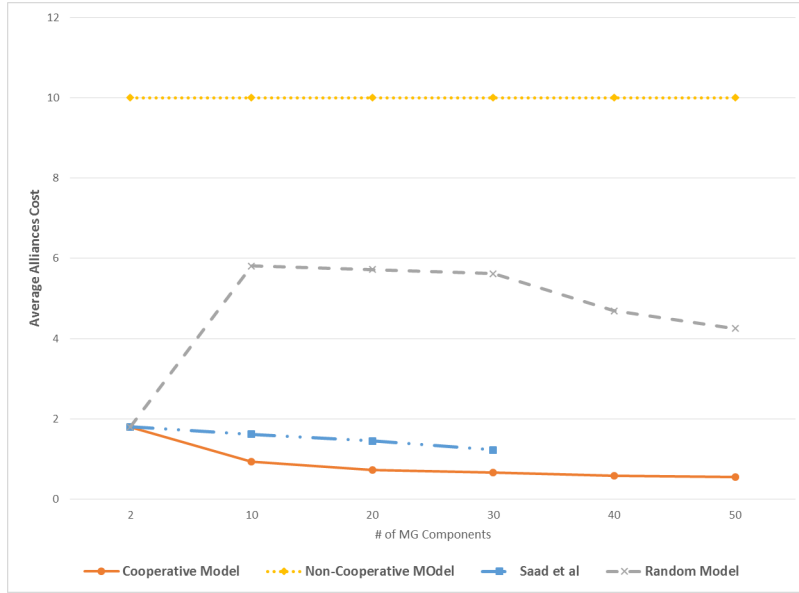

Figure 3.7: Average Alliances Cost with respect to the number of MG components while considering the operational aspect only

average cost decreases more the random scheme averages. This is due to the fact that, for our cooperative algorithm, as N increases, it becomes easier for the MG components to find cooperating components with which they can cooperate in a beneficial way in order to decrease the alliances costs and therefore increase the performance of the MG . In addition, it is clear that, compared to the random scenario, our proposed method has a significant performance improvement, in terms of average alliances cost, which is increasing with N and reaching up to 40% of cost reduction (at $N = 50$) relative to the random scenario. Comparing to the existing approach in [72], results show that our approach ensures better results reaching up to 30% of cost reduction (at $N = 30$). Note also that, in their approach, the maximum number of components was limited to $N = 30$.

For the rest of the tests, we reconsider the three aspects of the MG equally ($w_{op} = w_{eco} = w_{ecolo} = 3.33$). In Figure 3.8, we show the same test conducted while integrating all the aspects in the cost computation. The result shows that our method is better than the other approaches as well.

A new test was conducted to calculate the resulting noise of the alliance builder module. It consists of calculating the number of the generated isolated components in the Classified Microgrid (\mathcal{CM}). Figure 3.9 shows that the biggest number of isolated comes down to "4", which can be considered as a very promising result and fully satisfies our initial goal in conceiving a cooperative environment.

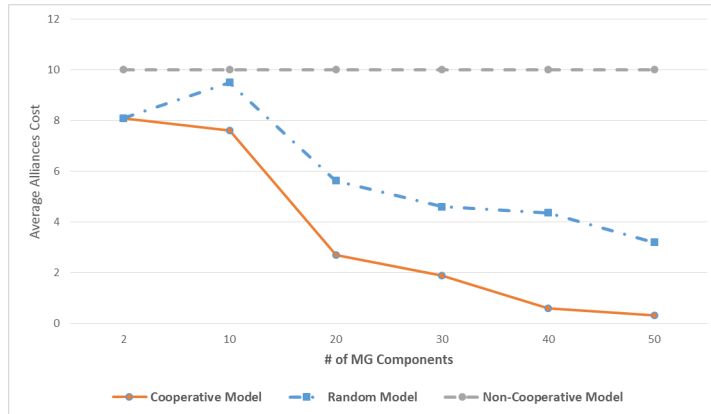

Figure 3.8: Average Alliances Cost with respect to the number of MG components while integrating the three aspects

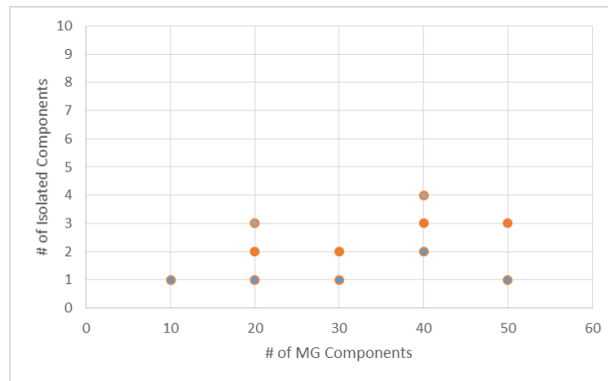

Figure 3.9: Isolated components with respect to the number of MG components

3.5.2.2 Alliance Builder Performance

In addition to testing the effectiveness of our approach in reducing alliances costs, we evaluated its time performance. This test consisted of measuring the necessary time to build the alliances while varying the number of MG components. Figure 3.10 shows that the time needed to create alliances grows in an almost linear fashion (since N is small) with respect to the number of components. This is quite normal since every component is a part of the alliances builder algorithm input and therefore it should be parsed in order to associate it the adequate alliance.

3.5.2.3 Seller2Buyer matcher impact on the MG operation

Similarly to the **Alliances Builder** evaluation, two scenarios are proposed in order to evaluate the effectiveness of the **Seller2Buyer module**. A first cooperative one consists of measuring the power exchange total cost of the resulted alliances using our

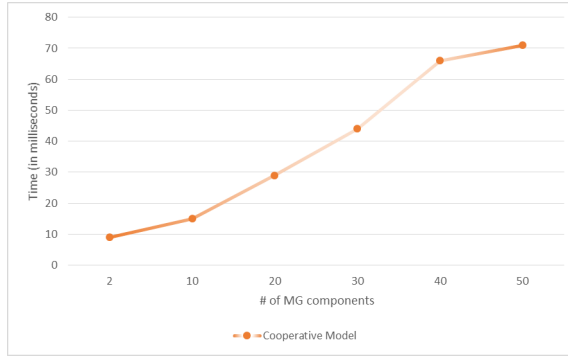

Figure 3.10: Time performance with respect to the number of MG components

proposed S2B matcher, and a second one consists of measuring the power exchange total cost of the resulted alliances using a random matching between the sellers and the buyers.

Figure 3.11 shows a significant performance improvement, in terms of total power exchange cost, which is increasing with N and reaching up to 22% of total power cost reduction (at $N = 50$) relative to the random scenario.

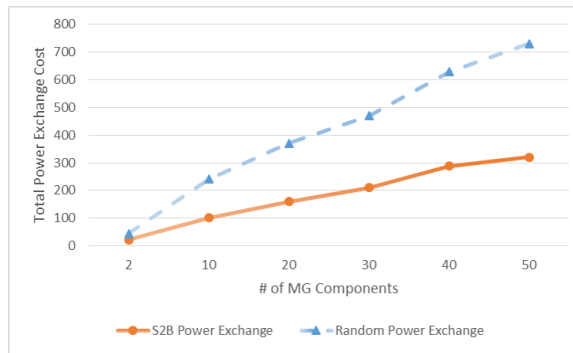

Figure 3.11: Power Exchange Total Cost with respect to the number of MG components

3.6 Conclusion

In this work, we have proposed a digital ecosystem cooperative model for MG distribution network. The proposed approach is based on two main modules: 1) the alliances builder and 2) the Seller2Buyer matcher. The first module is a novel clustering algorithm consisting of gathering the MG components into ‘alliances’. Each alliance contains a number of MG components, having mutual interests. Their interests are expressed through an objective function, taking into account three-dimensional MG

aims: operational, economical and ecological. Once done, the second module comes down to firstly, establish an alliance internal power exchange, consisting of exchanging power between the components forming each alliance, secondly, an *MG* internal power exchange is done between the remaining components that couldn't form new alliances. And Finally, an *MG* external power exchange is done between the remaining components and the Main Grid. Simulation results show that the proposed cooperative module yields a significant reduction in the three-dimensional cost and a minimization in the total power exchange cost in the *MG*.

Chapter 4

Multi-objective Cooperative Scheduling for Microgrids

“When I was young, I was scared of the dark.
Now when I see my electricity bill I am scared the lights”
- The minions

As the size of an *MG* grows, the economic significance of power generation, consumption and storage scheduling becomes more and more apparent. A proper scheduling for electricity generation, consumption and storage will also ensure the reliability of the *MG* and extend the operational lives of its constituent units. Besides, it can achieve economical and ecological benefits for the *MG*. To do so, we propose in this chapter a multi-objective cooperative scheduling based on the output of the *DECF* presented in the previous chapter. It consists of two main modules: 1) the **Preference-based Compromise Builder** and 2) the **Multi-objective Scheduler**. The **Preference-based Compromise Builder** aims at generating the best balance or what we called ‘the compromise’ between the preferences of the sellers and the buyers belonging to the same seller-to-buyer association, resulting from the *DECF*. Once done, the **Multi-objective Scheduler** aims at proposing a power schedule for the associations, in order to achieve three-dimensional benefits: economical by reducing the electricity costs, ecological by minimizing the toxic gas emissions, and operational by reducing the peak load of the *MG* and its components, and by increasing their comfort. Conducted experiments showed that the proposed algorithms provide convincing results.

4.1 Introduction

The Information and Communication technologies (ICT) represent unprecedented opportunities to move the *MGs* into a new era of reliability and efficiency that will contribute to operational, economical and ecological improvements. During this transition period, it will be essential to implement adequate techniques allowing to ensure that the benefits envisioned from the smart *MG* become a reality. The Demand-Side Management (DSM) [31, 80] is commonly considered as a key mechanism towards a more efficient and cost effective *MG*. DSM refers to the planning and implementation of the utility companies' programs¹ designed to directly or indirectly influence the consumers consumption in the aim of reducing the system peak load and electricity costs. It leads to achieve several objectives, but mainly [12]:

1. From the operational perspective, DSM aims at reducing the number of black-outs and increasing the *MG* reliability. This can be done by reducing on-peak periods while encouraging less power usage during off-peak periods
2. From the economical perspective, DSM aims at reducing electricity bills. This can be done by shifting loads to periods of lower electricity prices such as night time.
3. From the ecological perspective, DSM contributes to achieve environmental benefits by reducing the simultaneous power production from pollutants energy sources leading to reduced greenhouse gas emissions.

DSM techniques can be mainly gathered in two main categories:

- The *load shifting* [64] which involves shifting the power consumption from on-peak to off-peak periods
- The *energy efficiency and conservation* [2] which encourages consumers to reduce their consumption in order to reduce their electricity bills and the peak load.

In our study, we focus on the load shifting category, and more specifically on the power scheduling, since it has been shown that it is easier to motivate users to reschedule their needs rather than asking them to reduce their consumption [64].

¹A utility company is a company that engages in the generation and the distribution of electricity for sale generally in a regulated market

Several approaches have been provided in the literature to address the power scheduling problem [63, 93, 75, 1, 28, 87]. However, and to the best of our knowledge, none of the them seems to keep the pace since they don't fully address the following challenges:

- **Operational Challenges:** Several issues can be mentioned here:
 1. **The consumer discomfort:** while the consumers are enjoying their reduced electricity bills when shifting their consumption from on-peak to off-peak periods, they might risk discomfort related to the delay time of receiving their desired power. For instance, recharging a consumer electric vehicle at 7:15 a.m. instead of 7:00 a.m. before going to work (at 7:30 a.m.) will cause a lack in the battery charging, and increases the risk of the disruption of the vehicle on his way to work
 2. **The local peaks:** while trying to reduce the whole *MG* peak load, it is essential to consider the individual *MG* components peak loads as well. This would conduct to increase the reliability of the components and decrease the local failures risks. Note that, this matter has not considered yet in the existing DSM scheduling approaches [63, 93, 75, 1, 28, 87]
 3. **The consumption wise:** the current shifting programs [63, 93, 75, 28] provide consumption scheduling without considering the production nor the storage scheduling (with the exception of few approaches [1, 87]) which negatively impact their efficiency in shaping the peak load, reducing the electricity bills and minimizing the gas emissions effects.
- **Economical Challenges:** Knowing that the electricity price relies on the demand and supply over a specific period [58], an adequate scheduling should be established to shift loads during periods of high market prices (peak hours) and consequently minimize the electricity costs.
- **Ecological Challenges:** A significant power production from pollutants energy sources leads to a significant toxic gas emissions. Hence, it is essential to provide a power production scheduling allowing to reduce the bad emissions and effects on the environment by reducing the simultaneous toxic power production. Note that, to the best of our knowledge, none of the existing scheduling approaches [63, 93, 75, 1, 28, 87] considered the ecological aspect.

Here, we introduce *MOCSF*, a ‘Multi-Objective Cooperative Scheduling Framework’ designed for the power scheduling in the *MG*, while overcoming the aforementioned challenges. More precisely, our framework aims at scheduling the seller-to-buyer associations resulting from the *DECF* to ensure better reduction of the economical, operational and ecological costs and impacts within the *MG*. In addition, our approach presents several advantages over existing approaches, namely:

1. It provides a scheduling coverage in that it allows the scheduling of all of the power consumption, production and storage of the *MG*,
2. It considers multiple energy sources unlike existing approaches [63, 93, 75, 1, 28, 87] that studied the interaction of the consumers with only one energy source: the main grid,
3. It takes into account the *MG* components’ preferences (in terms of start-time, end-time, and related needed power) unlike current approaches [93, 1, 87] that consider them partially.

The rest of this chapter is organized as follows. Section 4.2 provides details about existing power scheduling techniques and their drawbacks regarding aforementioned challenges. Section 4.3 details the ‘MOCSF’ modules. An illustrative example is provided after each step to ease the understanding of each module. In Section 4.4, the experiments conducted to validate our approach and the main results obtained are presented. Section 4.5 concludes the chapter.

4.2 Related work

Many approaches have been proposed in the literature to solve the power scheduling problem. Current approaches can be categorized into two main groups [43]: semi-automatic schedulers [63, 93, 28] and automatic schedulers [87, 75, 1] schedulers. In the semi-automatic schedulers, the consumers inject their desired preferences (e.g., desired temperature, appliances start time preferences, etc.) during the scheduling, contrary to the automatic schedulers where there is no human intervention. In our work, we will be focusing on six scheduling approaches, that vary in their scheduler, optimization problem type, appliances types and objectives.

4.2.1 Semi-automatic Schedulers

In [63], the authors developed a distributed power consumption scheduling algorithm aiming at reducing the electricity bills and balancing the total power demand when multiple consumers share a single energy source. To do so, the authors formulated a game-theory technique, where the players are the consumers and the strategies are their corresponding power consumption schedules (represented as vectors). The objective function of each consumer n when choosing the strategy x_n is defined as follows:

$$\text{Min} \sum_{h=1}^H C_h \left(\sum_{n \in N} \sum_{a \in A_n} x_{n,a}^h \right) \quad (4.1)$$

Where C_h is the cost function, assumed to be strictly convex for each $h \in H$, and $H = 24$. $x_{n,a}^h$ is the schedule of the appliance a , owned by the player n , at hour h . The pseudo-code of the distributed algorithm proposed is provided in cf. Algorithm 6.

Algorithm 6: Executed by each consumer $n \in N$

```

1 Randomly initialize  $x_n$  and  $x_{-n}$ 
2 repeat
3   At random time instances Do
4     Solve the objective function using IPM
5     if  $x_n$  changes compared to current schedule then
6       Update  $x_n$  according to the new schedule
7       Broadcast a control message to announce  $l_n$  to the other consumers
8     if a control message is received then
9       Update  $l_n$  accordingly
10 until no new schedule is announced

```

For each player $n \in N$, the power consumption scheduling is generated randomly. The intuition behind this choice is that the authors considered that, at the beginning, a player n has no prior information about others players. Then, a loop is executed until the algorithm converges. Within the loop, the objective function is resolved using an IPM algorithm [11], resulting a new schedule for each player. The same process is repeated until there is no new announced schedule for all the players. Simulations results showed that the proposed distributed algorithm can reduce the electricity bills and the peak of average ratio.

In [93], the authors developed a meta-heuristic scheduling algorithm, aiming at reducing the dissatisfaction and the energy cost of a set of homes in a district, and the variance of the grid. To do so, the authors divided the home appliances into two categories: power-shiftable and time-shiftable appliances. The objective function is formulated as follows:

$$\begin{aligned}
& \text{Min} \sum_{t=1}^T \sum_{j=1}^S [I_{ij}(t) * U_{ij}(t) + \alpha * (\gamma(t) * \sum_{j=1}^S P_{ij}(t))] \\
& + \beta * (\sum_{t=1}^T \sum_{j=1}^S * P_{ij}(t) - 1/|T| * \sum_{i=1}^N \sum_{t=1}^T \sum_{j=1}^S P_{ij}(t))^2]
\end{aligned} \tag{4.2}$$

Where T is the set of time interval, N is the set of households, S is the set of electric appliances, $I_{ij}(t)$ is a binary variable denoting the working status of the appliance j in the household i at time t , $U_{ij}(t)$ is the dissatisfaction caused by operating the appliance i in the household i at time t , $\gamma(t)$ is the electricity sale price at time t , and $P_{ij}(t)$ is the working power of the appliance j in the household i at time t .

The dissatisfaction function $U_{ij}(t)$ represents the difference between the desired temperature and the actual indoor temperature for the space heater at time t , and the difference between the desired hot water temperature and the actual hot water temperature for the water heater at time t .

The authors used the Cooperative Particle Swarm Optimization (CPSO) (cf. Figure 4.1) to find the optimal scheduling of the appliances. Experimental results showed the positive impact of the households coordination in decreasing the peak loads and reducing the power costs.

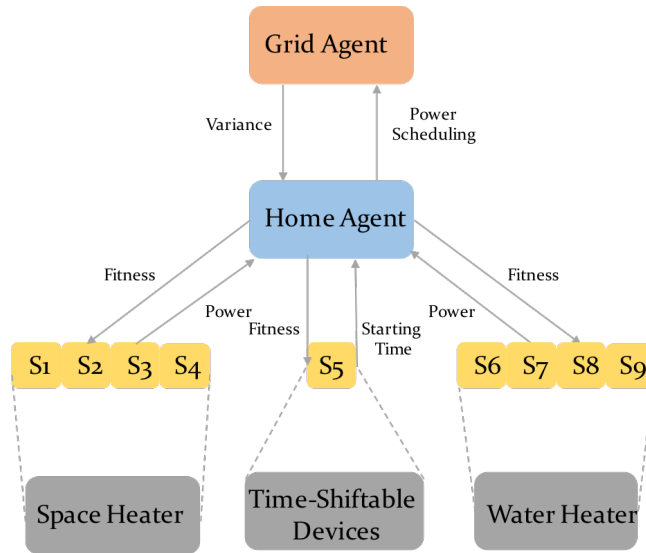

Figure 4.1: CPSO Configuration and Operation

In [28], the authors developed a power consumption scheduling aiming at reducing the electricity bills of the consumers with a minimum impact on their consumption

preferences. The authors considered that the scheduler needs to determine the consumption vector $X_i = [x_{i,1}, x_{i,1}, \dots, x_{i,H}]$ for each unit i in the determined zone horizon H , where H consists of M segments comprised of m time intervals, i.e., $H = M * m$. Then, a shrinking horizon optimization problem [23] has been defined as follows:

$$\mathcal{S}^{(j)}(H) = \sum_{h=jm-m+1}^{jm} \mathcal{S}(t_h) + \sum_{h=jm+1}^{jm} \hat{\mathcal{S}}(t_h) \quad (4.3)$$

Where $\mathcal{S}^{(j)}(H)$ is the total electricity cost in the j^{th} optimization step, $\sum_{h=jm-m+1}^{jm} \mathcal{S}(t_h)$ is the energy cost for m intervals in the j th time segment based on actual electricity prices, and $\sum_{h=jm+1}^{jm} \hat{\mathcal{S}}(t_h)$ is the estimated energy cost based on the forecasted electricity prices for subsequent time intervals. Note that the user preferences are considered by including the time intervals where energy scheduling is performed for unit i . Without giving details about the obtained results, the authors assume that the proposed model can minimize the electricity consumption costs while including the consumers' preferences.

4.2.2 Automatic Schedulers

In [75], the authors formulated an optimization model for households power scheduling, aiming at reducing the electricity costs and the peak load of the grid. To do so, the authors integrated the incentive and inconvenience concepts. The incentive is offered to the users during peak times to encourage them to reduce their consumption, while the inconvenience seeks to reduce the difference between the baseline and the optimal appliances schedule. The objective function is defined as follows:

$$Min \sum_{t=1}^T \sum_{j=1}^I [P_i(\gamma_t * U_{i,t}^{opt} - \beta_t * \delta(U_{i,t}^{bl} - U_{i,t}^{opt})) * \Delta.t + (U_{i,t}^{bl} - U_{i,t}^{opt})^2] \quad (4.4)$$

Where P_i is the rated power of the appliance i , $U_{i,t}^{opt}$ is the new on/off status of the appliance i at time t , $U_{i,t}^{bl}$ is the baseline on/off status of the appliance i at time t , $I = 10$, $T = 144$, $\delta(U_{i,t}^{bl} - U_{i,t}^{opt}) = 1$ if $(U_{i,t}^{bl} - U_{i,t}^{opt}) > 0$ and $\delta(U_{i,t}^{bl} - U_{i,t}^{opt}) = 0$ if $(U_{i,t}^{bl} - U_{i,t}^{opt}) < 0$. The formulated model is solved using the MINLP algorithm, which utilizes the Mixed Integer Programming (MIP) [89] and the Non-Linear Programming (NLP) [11]. Simulations results showed that using this model, the consumers realized 25% of electricity cost reduction. Noting that this percentage is affected by several factors, such as the number of shiftable appliances and the prices of the on-peak and off-peak times.

In [87], the authors developed a power storage scheduling algorithm aiming at managing the storage in the grid in a way of saving energy and reducing the reliance on the non-renewable energy sources. To do so, the authors formulated a game-theorist technique, where the players are the consumers and the strategies are their storage schedule vectors. The objective function of each player i when choosing the strategy s_i is defined as follows:

$$P_i(s_i, s_{-i}) \sum_{h=1}^H (s_i^h + l_i^h) \quad (4.5)$$

Where s_i is the storage schedule vector of all the players expect i , $P_i(s_i, s_{-i})$ is the power price determined using a continuous and supply curve, and l_i^h is the amount of power required by the player i at time h . The Nash equilibrium of the game correspond to the storage schedule s_i that minimizes the global generator costs given by $\sum_{H}^{h=1} \int_0^{q_h} b_h(x) dx$, where $b_h()$ is the supply curve and q_h is the the total amount of power traded by all the players at time h . Simulation results showed that it is possible to realize an electricity bill saving of 13% per consumer with a storage capacity of 4KW.

Similar to [75], the authors in [1] proposed an energy storage and loads scheduling algorithms aiming at reducing the electricity costs and the peak load hours. In this study, the electricity load analysis is done by grouping the day periods into three time zones each representing a cluster. Each cluster represents the loads expected to be launched during a given period. The cost required to satisfy the power needs of a given cluster j , consisting of K appliances is given by:

$$C_j = \sum_{m=1}^K \sum_{h \in T_j} \{(E_{h,m} + B_{h,m}^c - B_{h,m}^d) * r_h\} \quad (4.6)$$

Where $E_{h,m}$ is the power purchased from the utility grid by a consumer m to meet its electrical appliances' power needs at period h , $B_{h,m}^c$ and $B_{h,m}^d$ are the charging and discharging power profiles of the consumer m for the same period h , and r_h is the market power price at a period h . An optimal load and storage scheduling should satisfy the consumers' requirements at the lowest cost in each period without harming the grid stability. To do so, the objective function has been defined as follows:

$$Min \sum_{j=1}^3 (C_j) \quad (4.7)$$

Here, linear programming was applied in resolving the optimization problem. Simulation results showed a 20% of peak load reduction and a 17% of costs savings.

4.2.3 Discussion

In this section, a comparison between the existing DSM approaches is presented, highlighting their strengths and drawbacks with respect to the aforementioned challenges (cf. Table 4.1):

Table 4.1: Comparing existing DSM approaches

	Multi-type Scheduling	Satisfaction	Multiple Energy Sources	Multi-objective
Rad et al [63]	Partial	-	-	Partial
Koukam et al [93]	Partial	Partial	-	Partial
Ditiro et al [75]	Partial	+	-	Partial
Peruknishnen et al [87]	Partial	Partial	-	Partial
Christopher et al [1]	Partial	-	-	Partial
Amin et al [28]	Partial	+	-	Partial
Our Approach	+	+	+	+

- **Scheduling coverage:** All the existing DSM approaches [63, 93, 75, 1, 28, 87], focused on the power consumption scheduling, with the exception of [1, 87] that addressed the storage scheduling as well. However, the common drawback of all the existing approaches [63, 93, 75, 1, 28, 87] is that they do not cover the power production scheduling.
- **Consumer satisfaction:** Few approaches [1, 87, 93] took into account the consumers' satisfaction. In [93], the consumers' comfort is ensured by reducing the gap between the desired and the actual hot water, and between the desired and the actual indoor temperature. However, in [1, 87], the satisfaction is measured by the delay time between the desired start time and the real operation of its household appliances. Contrariwise to [63, 75, 28], where this aspect is completely absent.
- **Multiple energy sources:** To the best of our knowledge, all the DSM approaches [63, 93, 75, 1, 28, 87] target the interaction of the consumers while assuming having only one utility grid and consequently one energy source (i.e., the main grid).
- **Restricted goal:** Another limitation of all the existing approaches, is that they do not cope with the three objectives of a successful DSM. In almost all

the approaches [63, 93, 75, 1, 28, 87], the goal was mainly to reduce the electricity costs (economical aspect). In [63, 93], the peak load reduction (operational aspect) is addressed aiming at reducing the peak hours in the power grid. However, none of the approaches considers the gas emission minimization (ecological aspect).

All these limitations lead us to develop a new DSM cooperative model, allowing the scheduling of the power production, consumption and storage while considering the three-objective aspect of the DSM and the components' preferences.

4.3 Multi-objective Cooperative Scheduling

In this section, we detail our dedicated power scheduling method *MOCSF* aiming at reducing electricity bills, peak loads and environmental bad effects, while enhancing the comfort of the *MG* components. *MOCSF* takes as input a set of associations of the sellers and buyers with their desired schedules reflecting their operational preferences in terms of: start time, end time and power quantity (to sell or to buy). It produces a seller-to-buyer associations' schedule that minimizes the ecological, economical and operational costs. Our study is based on DECF (detailed in the previous chapter). The main reason behind this choice relies on the fact that we do not want to schedule the sellers and the buyers randomly but we rather want to maintain the power exchange between the sellers and the buyers belonging to the same alliance, having the biggest interest in working together.

In the following subsections, we will illustrate the scheduling steps using the same illustrative example provided in the previous chapter. Please note the following seller-to-buyer associations that have been generated from the DECF:

$$\left\{ \begin{array}{l} \textit{Association 1} : (nR_1^+, nR_3^-) - nR_1^+ \text{ should sell } nR_3^- \text{ a quantity of } 14 \text{ kW} \\ \textit{Association 2} : (nR_1^+, nR_1^-) - nR_1^+ \text{ should sell } nR_1^- \text{ a quantity of } 3 \text{ kW} \\ \textit{Association 3} : (nR_4^+, nR_1^-) - nR_4^+ \text{ should sell } nR_1^- \text{ a quantity of } 1 \text{ kW} \\ \textit{Association 4} : (nR_4^+, nR_2^-) - nR_4^+ \text{ should sell } nR_2^- \text{ a quantity of } 2 \text{ kW} \end{array} \right.$$

As shown in Figure 4.2, *MOCSF* consists of two main modules: **Preference-based compromise builder** and **Multi-objective Scheduler** detailed in what follows.

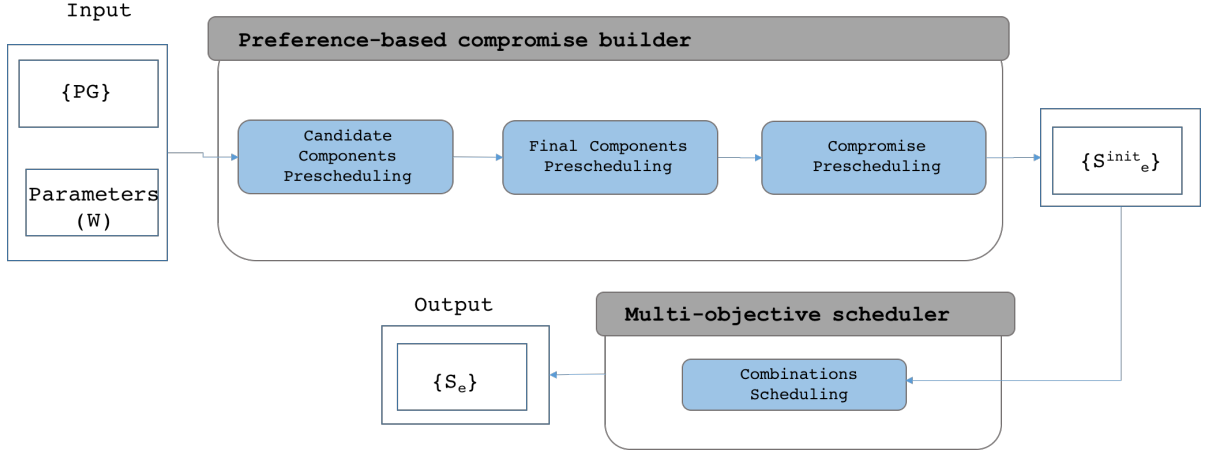

Figure 4.2: Multi-objective Cooperative Scheduling Framework

4.3.1 Preference-based compromise builder

As mentioned before, the result of the DECF is a set of seller-to-buyer associations, each composed of a seller and a buyer. Note that, each seller or buyer might belong to one or several associations. While sellers and buyers of the same association have to exchange power, each one of them has its own preferences to be respected so to establish a successful cooperative *MG*. Hence, the first step towards the associations scheduling is to find the best balance or what we call the compromise, between the preferences of the sellers and buyers belonging to the same association. Let us consider the first association (nR_1^+, nR_3^-) of the illustrative example. nR_1^+ and nR_3^- should be scheduled together, however nR_1^+ may have several preferences that are different from nR_3^- 's: for instance, this latter prefers to buy power at 7:00 am, while nR_1^+ prefers to sell its surplus at 8:00 am. Hence, our goal is to find the trade-off between the sellers and the buyers preferences. The problem becomes more and more complicated when each seller and buyer exchanges power with several components (since each can belong to several associations). For instance, nR_1^+ belongs to another association as well, (nR_1^+, nR_1^-) , where nR_1^- prefers also to buy power at 7:00 am. Hence, our module should propose an optimal distribution of the sellers' available power at each time t , in that it can meet its preferences and the buyers preferences, as well. Note that, for privacy reasons, a component has no prior information with whom he will exchange power, he can only precise the quantity he needs to sell or buy at each time t .

Before detailing the process, we present first some definitions used in our study.

Each component nR^2 , could be a seller nR^+ or a buyer nR^- having respectively power surplus and power need.

Definition 23 (Schedule [s]). A schedule S consists of the power exchanged vector $s_{\mathcal{R}} = [s_{\mathcal{R}}^1, s_{\mathcal{R}}^2, \dots, s_{\mathcal{R}}^T]$, where $s_{\mathcal{R}}^t$ denotes the corresponding power quantity (in KW) that an entity R is willing to exchange, at a time t over a period T ♦

Definition 24. [PurchaseGraph [PG]] A PurchaseGraph PG is an oriented graph (V, E, S, EV) consisting of representing power scheduling of vertices v_i and associations e_i^j where each vertice $v_i \in V = \{nR^+\} \cup \{nR^-\}$ represents a component, each edge e_i^j connects a seller $v_i \in \{nR^+\}$ to a buyer $v_j \in \{nR^-\}$ with the total power quantity in EV exchanged between them, and each vertice v_i or edge e_i^j is associated to one desired schedule, denoted $s^{init} \in S$, and one operational schedule $s^{op} \in S$. The desired schedule designates the component operational preferences expressing its willing power quantity to exchange at each time t within a period T . The operational schedule designates the proposed schedule (provided by our algorithm). Note that, $\forall nR \in \{PG_k\} \Rightarrow nR \notin \{PG_{\neq k}\}$. To simplify in what follows,

- $e.nR^+$ designates the edge seller,
- $e.nR^-$ designates the edge buyer,
- $e.EV$ designates the edge total power quantity,
- s_{nR}^{init} designates the component desired schedule,
- s_{nR}^{op} designates the component operational schedule,
- s_e^{init} designates the edge desired schedule, and
- s_e^{op} designates the edge operational schedule.

♦

Definition 25. [Satisfaction [S(e,W)]]. The satisfaction of an edge e is defined according to the operational, economical, and ecological satisfactions of its vertices (its connected seller and buyer). It considers the sellers and buyers' comfort (operational), the power peak load (operational), the electricity bills (economical) and the environmental impacts (ecological). Although it can be defined using different aggregation functions (e.g., maximum, average, etc.), we adopted the weighted sum function

²Self-satisfied components are not included here

to combine the different objective aspects costs, allowing the user to tune the weight of each criterion. Formally:

$$S(e, W) = W.w_{op} \times S_{op}(e) + W.w_{eco} \times S_{eco}(e) + W.w_{ecolo} \times S_{ecolo}(e) \quad (4.8)$$

where:

- $S_{op}(e)$ represents the operational satisfaction of e ,
- $S_{eco}(e)$ represents the economic satisfaction of e ,
- $S_{ecolo}(e)$ represents the ecological satisfaction of e , and
- W is a set of three weights, denoted as $:\prec w_{op}, w_{eco}, w_{ecolo} \succ, w_{op} + w_{eco} + w_{ecolo} = 1$ and $(w_{op}, w_{eco}, w_{ecolo}) \geq 0$

◆

Thus, the satisfaction of a PG consisting of M edges is defined as follows:

$$S(PG, W) = \sum_{i=0}^M S(e_i, W) \quad (4.9)$$

Similarly, the satisfaction of an MG consisting of N number of PG is defined as follows:

$$S(MG, W) = \sum_{i=0}^N S(PG_i, W) \quad (4.10)$$

Note that, in our study, we are aiming to minimize the operational, ecological and economical dissatisfactions (Dis) as follows:

$$\begin{aligned} Dis(e, W) &= \frac{1}{1 + S(e, W)} \in [0, 1] \\ Dis(PG, W) &= \frac{1}{1 + S(PG, W)} \in [0, 1] \\ Dis(MG, W) &= \frac{1}{1 + S(MG, W)} \in [0, 1] \end{aligned} \quad (4.11)$$

where, the lower is the dissatisfaction (tends to 0), the higher is the satisfaction.

Definition 26 (Operational Satisfaction $[S_{op}]$). The operational satisfaction of an edge e , denoted $S_{op}(e, W)$, is defined as:

$$S_{op}(e, W) = W.w_{\alpha} \times Comfort(e) + W.w_{\beta} \times Variance(e) + W.w_{\gamma} \times Variance(PG) \quad (4.12)$$

where W is a set of three weights, denoted as $:\prec w_{\alpha}, w_{\beta}, w_{\gamma} \succ, w_{\alpha} + w_{\beta} + w_{\gamma} = 1$ and $(w_{\alpha}, w_{\beta}, w_{\gamma}) \geq 0$, and PG is the PurchaseGraph to which e belongs. ◆

Thus, the operational satisfaction of a PG consisting of M edges is defined as follows:

$$S_{op}(PG, W) = \sum_{i=0}^M S_{op}(e_i, W) \quad (4.13)$$

Similarly, the operational satisfaction of an MG consisting of N number of PG is defined as follows:

$$S_{op}(MG, W) = \sum_{i=0}^N S_{op}(PG_i, W) \quad (4.14)$$

Note that, the operational dissatisfactions (Dis_{op}) is defined as follows:

$$\begin{aligned} Dis_{op}(e, W) &= \frac{1}{1 + S_{op}(e, W)} \in [0, 1] \\ Dis_{op}(PG, W) &= \frac{1}{1 + S_{op}(PG, W)} \in [0, 1] \\ Dis_{op}(MG, W) &= \frac{1}{1 + S_{op}(MG, W)} \in [0, 1] \end{aligned} \quad (4.15)$$

where, the lower is the operational dissatisfaction (tends to 0), the higher is the operational satisfaction.

Definition 27 (Comfort [Comfort(e)]). *The comfort of an edge e , is the waiting time penalization of its vertices, defined as:*

$$\begin{aligned} Comfort(e) &= \sum_{t=1}^T Avg(e.nR^+.Op.Penalty \times |s_e^{op}[t] - s_{e.nR^+}^{init}[t]| \\ &\quad + e.nR^-.Op.Penalty \times |s_e^{op}[t] - s_{e.nR^-}^{init}[t]|) \end{aligned} \quad (4.16)$$

where $Penalty$ is the waiting time penalty of the seller nR^+ and the buyer nR^- , $|s_e^{op}[t] - s_{e.nR^+}^{init}[t]|$ is the difference between the initial desired schedule and the real operation of the seller nR^+ , and $|s_e^{op}[t] - s_{e.nR^-}^{init}[t]|$ is the difference between the initial desired schedule and the real operation of the buyer nR^- . \blacklozenge

Note that, the penalty is a positive weighting factor, which represents the waiting time flexibility of the component. If the penalty is zero, this means that the component does not penalize the delay between its desired and operational schedule. The highest is the penalty, the most the component is delay time constraining.

Definition 28 (Variance \mathbf{e} [Variance(e)]). *The variance of an edge e , denoted Variance(e) is the peak load ratio of its vertices, defined as:*

$$Variance(e) = \sum_{t=1}^T \left(s_e^{op}[t] - \frac{\sum_{t=1}^T s_e^{op}[t]}{|T|} \right)^2 \quad (4.17)$$

\blacklozenge

Note that, the variance is a positive value reflecting the power load dispersion all along T. The highest is the variance, the higher are the peak loads probabilities.

Definition 29 (Variance PG [VariancePG]). The variance of a PG, denoted $Variance(PG)$ is the peak load ratio of its edges, defined as:

$$Variance(PG) = \sum_{t=0}^T \left(\sum_{i=0}^M S_e^{op}[t] - \frac{\sum_{t=0}^T \sum_{i=0}^M S_e^{op}[t]}{|T|} \right)^2 \quad (4.18)$$

where M is the number of e in PG \blacklozenge

Definition 30 (Variance MG [Variance(MG)]). The variance of an MG, denoted $Variance(MG)$ is the peak load ratio of the PGs forming the MG, defined as:

$$Variance(MG) = \sum_{t=1}^T \sum_{j=1}^N \left(\sum_{i=1}^M PG_j \cdot s_{e_i}^{op}[t] - \frac{\sum_{t=1}^T \sum_{i=1}^M PG_j \cdot s_{e_i}^{op}[t]}{|T|} \right)^2 \quad (4.19)$$

where N is the number of PG in MG and M is the number of e in PG \blacklozenge

Definition 31 (Economical Satisfaction [S_{eco}]). The economical satisfaction of an edge e , denoted $S_{eco}(e)$, is defined as:

$$\begin{aligned} S_{eco}(e) = & \sum_{t=1}^T Avg(s_e^{op}[t] \times MG.Op.PwrCost[t] \\ & + e.nR^+.Op.LaunchCount \times (e.nR^+.Eco.SUCost + e.nR^+.Eco.SDCost) \\ & + e.nR^-.Op.LaunchCount \times (e.nR^-.Eco.SUCost + e.nR^+.Eco.SDCost)) \end{aligned} \quad (4.20)$$

where $PwrCost[t]$ is the electricity price at a time t and $LaunchCount$ is the number of launches of the sellers and buyers belonging to e , during T . Note that, all these parameters are represented in our *OntoMG*. \blacklozenge

Similarly,

$$\begin{aligned} Dis_{eco}(e) &= \frac{1}{1 + S_{eco}(e)} \in [0, 1] \\ Dis_{eco}(PG) &= \frac{1}{1 + S_{eco}(PG)} \in [0, 1] \\ Dis_{eco}(MG) &= \frac{1}{1 + S_{eco}(MG)} \in [0, 1] \end{aligned} \quad (4.21)$$

where, the lower is the economical dissatisfaction (tends to 0), the higher is the economical satisfaction.

Definition 32 (Ecological Satisfaction [S_{ecolo}]). The ecological satisfaction of an edge e , denoted $S_{ecolo}(e)$, is defined as:

$$S_{ecolo}(e) = \sum_{t=1}^T s_e^{op}[t] \times e.nR^+.Ecolo.GasEss \times MG.Op.GasEssCost \quad (4.22)$$

The ecological satisfaction depends on the toxic gas emissions $GasEss$ emitted during the power production, and the cost $GasEssCost$ per unit of gas emission. Note that, all these parameters are modeled in our *OntoMG* ontology. \blacklozenge

Thus, the ecological satisfaction of a PG consisting of M edges is defined as follows:

$$S_{ecolo}(PG) = \sum_{i=0}^M S_{ecolo}(PG) \quad (4.23)$$

Similarly, the ecological satisfaction of an MG consisting of N number of PG is defined as follows:

$$S_{ecolo}(MG) = \sum_{i=0}^N S_{ecolo}S_{ecolo}(MG) \quad (4.24)$$

Note that, the ecological dissatisfactions (Dis_{ecolo}) is defined as follows:

$$\begin{aligned} Dis_{ecolo}(e) &= \frac{1}{1 + S_{ecolo}(e)} \in [0, 1] \\ Dis_{ecolo}(PG) &= \frac{1}{1 + S_{ecolo}(PG)} \in [0, 1] \\ Dis_{ecolo}(MG) &= \frac{1}{1 + S_{ecolo}(MG)} \in [0, 1] \end{aligned} \quad (4.25)$$

where, the lower is the ecological dissatisfaction (tends to 0), the higher is the ecological satisfaction.

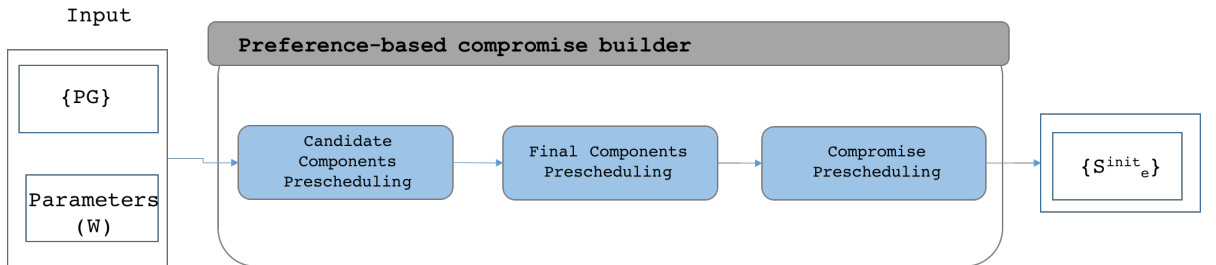

Figure 4.3: Preferences-based Compromise Builder Framework

An overview of our Preferences-based Compromise Builder module is shown in Figure 4.3. It consists of three main components: 1) Candidate components' prescheduling, 2) Final components' prescheduling, and 3) Compromise prescheduling. They are detailed below.

4.3.1.1 Candidate components' prescheduling

The aim of this module is to dissociate the desired schedule of each seller/buyer, so as to distribute the power quantity at each time t (its capacity of selling/buying) between the components with which, it must exchange, without exceeding nor being inferior of its desired capacity at t . The pseudo-code of the candidate components' prescheduling is provided in Algorithm 7. For each seller/buyer, we retrieve the list of edges to which the seller/buyer belongs. Then, we generate the list of permuted lists of the retrieved edges (Lines 7-16). For each permuted list of edges in each list of permuted lists of edges at a time t , we verify if the seller/buyer has enough power to sell/to buy to the buyer/from the seller of the same edge (Line 17). If there is enough power (Lines 18-20), we fill the schedule with the quantity to buy/to sell and recall the process by the next seller/buyer. If not, we fill the schedule with the quantity to buy/sell, reduce the quantity to sell/to buy, and verify the quantity to sell/buy to the next buyer/from the next seller of the next edge (Lines 21-25).

Algorithm 7: Candidate Components' Prescheduling

```

Input:  $PG[]$  // Set of  $PG$  forming the  $MG$ 
Output:  $PG[]$  // Set of  $MG$  components updated with their candidate preschedules
1  $S.CS = new\ int\ [][]$  // Initialize a candidate Solution  $S$  having a candidate Schedule  $CS$ 
2  $S.e = new\ Edge\ []$  // Initialize a candidate Solution  $S$  having a list of edges  $e$ 
3  $int\ RPL$ 
4 for  $int\ i = 0; i < |MG.PG[]|; i++$  // For each PurchaseGraph in the Microgrid
5 do
6    $E[] = GLE(MG.PG[i].e.nR)$  // Retrieve the list of edges to which the seller/buyer of the edge belongs
7    $PE[] = Permutate(E[])$  // Retrieve the possible permutation of the list of edges
8   for each  $e[] \in PE[]$  // For each list of permuted lists of edges
9   do
10     $S.CS = new\ int\ []\ [e[]][T]$  // Initialize a candidate schedule  $CS$  for a solution  $S$ 
11     $S.Ce = new\ Couple\ []\ [e[]]$  // Initialize a set of edges  $Ce$  for a solution  $S$ 
12     $RP[] = \sum_{t=1}^T S_{MG.PG[i].e.nR}^{init}[t]$  // Initialize the remaining production to sell/buy to the desired selling/buying
    vector
13    for  $int\ j = 0, j < |e[]|, j++$  // For each edge in the pemutated list of edges
14    do
15       $RPL = e[j].EV$  // Initialize the remaining production to buy/sell (of the linked component) with the valued
    exchanged of the couple
16      for  $int\ k = 0; k < T; k++$  // For each time  $k$ 
17      do
18        if  $RP[k] \geq RPL$  // If there is sufficient power to sell
19        /buy then
20           $S.CS[j][k] = RPL$  // Fill the schedule with the quantity to buy/sell
21           $RPL = 0$  // No more power need to buy/sell
22        else
23           $S.CS[j][k] = RP[k]$  // Fill the schedule with the quantity to buy/sell
24           $RPL -= RP[k]$  // Reduce the quantity to buy/sell
25           $RP[k] -= S.CS[j][k]$  // Reduce the quantity to sell/buy
26     $MG.PG[i].e.nR.S.Add(S)$  // Add  $S$  as a candidate solution of the seller/buyer

```

4.3.1.2 Final components' prescheduling

The aim of this module is to select the candidate components' schedules that guarantee that each edge is provided with its exchanged value (EV) at T (e.g., at the end of the day, where $T = 24h$). In other words, for each edge, the sum of the power

quantity exchanged between its sellers and the buyers at T , should be equal to their exchanged value (EV) in the PG . So, the sellers sell all their power surplus and the buyers satisfy all their needs. The pseudo-code of the final components' schedules is provided in Algorithm 8. For each candidate schedule of each seller (Line 2-9) and for each time t of the day, we calculate the sum of the energy exchanged of the edges to which the seller/buyer belongs during the day. The schedule is accepted if the sum is equal to the exchanged value of the edge (Line 12-13). If the equality is verified for all the edges, we added the candidate schedule to the final components' schedules (Line 13-16).

Algorithm 8: Final Components' Prescheduling

```

Input:  $PG[]$ 
Output:  $PG[]$ 
1 for  $int\ i = 0; i < |MG.PG[]|; i++$ 
2 do
3   for each  $s \in MG.PG[i].e.nR.S$ 
4   do
5      $bool\ isAcceptedSolution = true$ 
6     for  $int\ j = 0; j < |s.CS[0]||; j++$ 
7     do
8        $int\ sev = 0$ 
9       for  $int\ k = 0; k < T; k++$ 
10      do
11         $sev += s.CS[j][k]$ 
12         $isAcceptedSolution = sev.Equals(s.Cs[j].EV)$ 
13      if  $isAcceptedSolution$ 
14      then
15         $MG.PG[i].e.nR.S.Add(S)$ 

```

// Set of PG forming the MG
// Set of MG components updated with their final preschedules
// For each PurchaseGraph in the Microgrid
// For each possible solution of the seller/buyer
// For each candidate schedule of the seller/buyer
// Initialize the sum of the exchange value with zero
// For each time k
// Calculate the sum of the energy exchanged during T of the edge
// The solution is accepted if the sum is equal to the value
exchanged of the edge
// If the equality is verified for all the edges
// Add S as an accepted solution of the seller/buyer

4.3.1.3 Compromise prescheduling

The aim of this module is to generate the seller-to-buyer associations (edges) desired schedules. It consists of selecting the best combination between the final preschedules of the sellers and buyers. This can be done by selecting the combination that ensures the minimum gap between the desired schedules of the sellers and buyers and the proposed compromise desired schedule. In our work, we adopted the cosine measure to calculate the similarity between the proposed and the desired schedules. Since there are more values that are in common between two schedules, it is useless to use the other methods of calculating similarities (e.g., the Euclidean Distance, the Pearson Correlation Coefficient, etc.). The pseudo-code of the final components' schedules is provided in Algorithm 9. First, we generate the combinations between the final preschedules of the sellers and the buyers (Lines 1-3). Then, for each seller/buyer of each combination, we calculate the power quantity for each edge in each candidate schedule for all combinations at a time t and fill it into a new vector ($FinalQuantity$) (Lines 4-17). After that, a similarity computation of the resulting vector and the

initial desired schedule (vector) of each seller/buyer is done using the cosine similarity measure (Line 18). Finally, the combination vector having the biggest similarity or what we call it here ‘minimum delay will be retrieved (Lines 19-27).

Algorithm 9: Compromise Prescheduling

```

Input:  $PG[]$  // Set of  $PG$  forming the  $MG$ 
Output:  $S_e^{init}[]$  // Edges desired schedule
1 for int  $i = 0; i < |MG.PG[]|; i++$  // For each PurchaseGraph in the Microgrid
2 do
3    $Comb[] = Combination(MG.PG[i].e.nR^+.S[], MG.PG[i].e.nR^-.S[])$  // Retrieve the possible combinations of the
   final sellers and buyers preschedules
4 for int  $i = 0; i < |Comb[]|; i++$  // For each combination
5 do
6   for int  $j = 0; j < |MG.PG[]|; j++$  // For each PurchaseGraph in the Microgrid
7   do
8     for int  $k = 0; k < |Comb[i].Ce|; k++$  // For each set of edges of the selected combination
9     do
10      if  $Comb[i].Ce[k].nR == MG.PG[j].nR$  // Check if we are verifying the schedules of the same seller/buyer
11      then
12        for int  $l = 0; l < |Comb[i].CS|; l++$  // For each set of candidate schedules of the selected
13        combination
14        do
15           $Comb[i].FinalQuantityPerHour[j][l] += Comb[i].CS[k][l]$  // Sum the power quantity for each
16          edge in each candidate schedule of each combination
17        for int  $x = 0; x < |Comb[i].CS|; x++$  // For each set of candidate schedules of the selected combination
18        do
19           $FinalQuantity[x] = Comb[i].FinalQuantityPerHour[j][x]$  // Calculate the combination's power
20          quantity for each seller/buyer
21         $Comb[i].TotalDelay += 1 - Cosinus(S_{MG.PG[j].nR}^{init}, FinalQuantity)$  // Calculate the similarity between
22        the desired schedule of the seller/buyer and the combination's schedule
23
24  $minDelay = Comb[0].TotalDelay$ 
25 for int  $i = 0; i < |Comb[]|; i++$  // Retrieve the minimum delay
26 do
27   if  $Comb[i].TotalDelay < minDelay$  then
28      $minDelay = Comb[i].TotalDelay$ 
29
30 for int  $i = 0; i < |Comb[]|; i++$  // Retrieve the combination having the minimum delay
31 do
32   if  $Comb[i].TotalDelay == minDelay$  then
33      $S_e^{init}[] = Comb[i]$ 

```

4.3.1.4 Preference-based compromise builder illustration

In our previous illustration, all the buyers and sellers are connected, forming one purchase graph (cf. Figure 4.4).

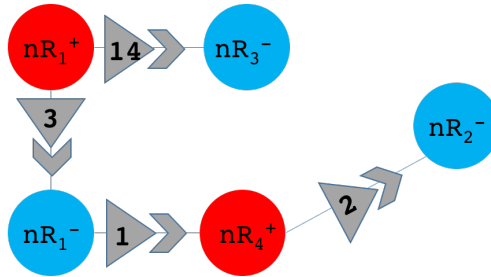

Figure 4.4: Purchase Graph Illustration

As an input, each seller and buyer proposes its desired schedule. Note that, we

will consider that $T=4$.

$$\begin{cases} S_{nR_1^+}^{init} = [3, 14, 0, 0] \\ S_{nR_4^+}^{init} = [0, 0, 1, 2] \\ S_{nR_1^-}^{init} = [3, 0, 1, 0] \\ S_{nR_2^-}^{init} = [0, 0, 0, 2] \\ S_{nR_3^-}^{init} = [0, 14, 0, 0] \end{cases}$$

The aim of applying the Preference-based compromise builder is to find the desired schedule of the resulting linked couples (nR_1^+, nR_3^-) , (nR_1^+, nR_1^-) , (nR_4^+, nR_1^-) and (nR_4^+, nR_2^-) : $S_{nR_1^+, nR_3^-}^{init}$, $S_{nR_1^+, nR_1^-}^{init}$, $S_{nR_4^+, nR_1^-}^{init}$ and $S_{nR_4^+, nR_2^-}^{init}$, respectively.

- Candidate components' prescheduling:

The output of the candidate components' prescheduling is as follows:

Candidate nR_1^+ prescheduling:

There are two possible solutions:

$$\begin{aligned} \text{Solution1} & \begin{cases} S_{nR_1^+, nR_3^-}^{init} = [3, 11, 0, 0] \\ S_{nR_1^+, nR_3^-}^{init} = [0, 3, 0, 0] \end{cases} \\ \text{Solution2} & \begin{cases} S_{nR_1^+, nR_3^-}^{init} = [3, 0, 0, 0] \\ S_{nR_1^+, nR_3^-}^{init} = [0, 14, 0, 0] \end{cases} \end{aligned}$$

Those solutions were selected since the sum of the selling power at each time t is equal to the desired power quantity given as an input (3 kw at $t=1$ and 14 kw at $t=2$)

Candidate nR_4^+ prescheduling:

There are two possible solutions:

$$\begin{aligned} \text{Solution1} & \begin{cases} S_{nR_4^+, nR_1^-}^{init} = [0, 0, 1, 0] \\ S_{nR_4^+, nR_2^-}^{init} = [0, 0, 0, 2] \end{cases} \\ \text{Solution2} & \begin{cases} S_{nR_4^+, nR_1^-}^{init} = [0, 0, 0, 1] \\ S_{nR_4^+, nR_2^-}^{init} = [0, 0, 1, 1] \end{cases} \end{aligned}$$

Those solutions were selected since the sum of the selling power at each time t is equal to the desired power quantity given as an input (1 kw at $t=3$ and 2 kw at $t=4$)

Candidate nR_1^- prescheduling:

There are two possible solutions:

$$\begin{aligned} \text{Solution1} & \left\{ \begin{array}{l} S_{nR_1^+, nR_1^-}^{init} = [3, 0, 0, 0] \\ S_{nR_4^+, nR_1^-}^{init} = [0, 0, 1, 0] \end{array} \right. \\ \text{Solution2} & \left\{ \begin{array}{l} S_{nR_1^+, nR_1^-}^{init} = [1, 0, 0, 0] \\ S_{nR_4^+, nR_1^-}^{init} = [2, 0, 1, 0] \end{array} \right. \end{aligned}$$

Those solutions were selected since the sum of the buying power at each time t is equal to the desired power quantity given as an input (3 kw at t=1 and 1 kw at t=3)

Candidate nR_2^- prescheduling:

There is one possible solution:

$$\text{Solution} \left\{ S_{nR_4^+, nR_2^-}^{init} = [0, 0, 0, 2] \right.$$

Those solutions were selected since the sum of the buying power at each time t is equal to the desired power quantity given as an input (2 kw at t=4)

Candidate nR_4^- prescheduling:

There is one possible solution:

$$\text{Solution} \left\{ S_{nR_1^+, nR_4^-}^{init} = [0, 14, 0, 0] \right.$$

Those solutions were selected since the sum of the buying power at each time t is equal to the desired power quantity given as an input (14 kw at t=2)

- Final components' prescheduling:

In our case, the output of the final components' prescheduling is the same output generated in the candidate components' prescheduling. Those solutions ensure that the sum of the power exchanged between a linkedcouple is equal to the exchanged value of this couple.

Final nR_1^+ prescheduling:

There are two possible solutions:

$$\text{Solution1} \begin{cases} S_{nR_1^+, nR_3^-}^{init} = [3, 11, 0, 0] : (nR_1^+, nR_3^-).EV = 14 = 11 + 3 + 0 + 0 \\ S_{nR_1^+, nR_1^-}^{init} = [0, 3, 0, 0] : (nR_1^+, nR_1^-).EV = 3 = 0 + 3 + 0 + 0 \end{cases}$$

$$\text{Solution2} \begin{cases} S_{nR_1^+, nR_1^-}^{init} = [3, 0, 0, 0] : (nR_1^+, nR_1^-).EV = 3 = 3 + 0 + 0 + 0 \\ S_{nR_1^+, nR_3^-}^{init} = [0, 14, 0, 0] : (nR_1^+, nR_3^-).EV = 14 = 0 + 14 + 0 + 0 \end{cases}$$

Final nR_4^+ prescheduling:

There are two possible solutions:

$$\text{Solution1} \begin{cases} S_{nR_4^+, nR_1^-}^{init} = [0, 0, 1, 0] : (nR_4^+, nR_1^-).EV = 1 = 0 + 0 + 1 + 0 \\ S_{nR_4^+, nR_2^-}^{init} = [0, 0, 0, 2] : (nR_4^+, nR_2^-).EV = 2 = 0 + 0 + 0 + 2 \end{cases}$$

$$\text{Solution2} \begin{cases} S_{nR_4^+, nR_1^-}^{init} = [0, 0, 0, 1] : (nR_4^+, nR_1^-).EV = 1 = 0 + 0 + 0 + 1 \\ S_{nR_4^+, nR_2^-}^{init} = [0, 0, 1, 1] : (nR_4^+, nR_2^-).EV = 2 = 0 + 0 + 1 + 1 \end{cases}$$

Final nR_1^- prescheduling:

There are two possible solutions:

$$\text{Solution1} \begin{cases} S_{nR_1^+, nR_1^-}^{init} = [3, 0, 0, 0] : (nR_1^+, nR_1^-).EV = 3 = 3 + 0 + 0 + 0 \\ S_{nR_4^+, nR_1^-}^{init} = [0, 0, 1, 0] : (nR_4^+, nR_1^-).EV = 1 = 0 + 0 + 1 + 0 \end{cases}$$

$$\text{Solution2} \begin{cases} S_{nR_4^+, nR_1^-}^{init} = [1, 0, 0, 0] : (nR_4^+, nR_1^-).EV = 1 = 1 + 0 + 0 + 0 \\ S_{nR_1^+, nR_1^-}^{init} = [2, 0, 1, 0] : (nR_1^+, nR_1^-).EV = 3 = 2 + 0 + 1 + 0 \end{cases}$$

Final nR_2^- prescheduling:

There is one possible solution:

$$\text{Solution} \begin{cases} S_{nR_4^+, nR_2^-}^{init} = [0, 0, 0, 2] : (nR_4^+, nR_2^-).EV = 2 = 0 + 0 + 0 + 2 \end{cases}$$

Final nR_4^- prescheduling:

There is one possible solution:

$$\text{Solution} \begin{cases} S_{nR_1^+, nR_4^-}^{init} = [0, 14, 0, 0] : (nR_1^+, nR_4^-).EV = 14 = 0 + 14 + 0 + 0 \end{cases}$$

- Compromise prescheduling:

The output of the compromise prescheduling is as follows:

$$\left\{ \begin{array}{l} S_{nR_1^+, nR_3^-}^{init} = [3, 0, 0, 0] \\ S_{nR_1^+, nR_1^-}^{init} = [0, 14, 0, 0] \\ S_{nR_4^+, nR_1^-}^{init} = [0, 0, 1, 0] \\ S_{nR_4^+, nR_2^-}^{init} = [0, 0, 0, 2] \end{array} \right.$$

This solution is the combination of the final seller and buyer preschedules that reduces the gap with the initial desired schedules of the sellers and buyers. Here, the Gap = 0 (the ideal solution).

4.3.2 Multi-objective Scheduler

Once done with the preferences-based combination generator that aims at extracting the desired schedules of the seller-to-buyer associations based on the sellers and buyers desired schedules given as input, it is time to schedule the resulting associations in a way to minimize the operational, economical and ecological aspects. As defined in Equation 25, our objective function takes into account the operational aspect by considering the comfort of the sellers and buyers measured by the delay time between the desired schedule and the real operation, the peak load reduction of the *MG* and the components calculated using the variance of the power at a time *t*. Besides, the economical aspect is considered by measuring the electricity price at a time *t*. The ecological aspect is treated by calculating the toxic gas emissions produced at a time *t* in the *MG*.

In our work, we adopted Particle Swarm Optimization (PSO), to search for the near-optimal scheduling and operation for each seller-to-buyer association, because of its straightforward implementation and demonstrated ability of optimization.

4.3.2.1 Particle Swarm Optimization

Standard Particle Swarm Optimization (PSO) is a computational method that optimizes a problem by iteratively trying to improve a candidate solution with regard to a given measure of quality using an objective function. PSO becomes a powerful to solve complex non-linear and non-convex optimization problems. Moreover, it has several other advantages, such as fewer parameters to adjust, and easier to escape from local optimal solutions.

In PSO, the problem is solved by having a population of candidate solutions, here dubbed particles, and moving these particles around in the search-space according to

simple mathematical formula over the particle’s position and velocity. Each particle’s movement is influenced by its local best known position, but is also guided toward the best-known positions in the search-space, which are updated as better positions are found by other particles. This is expected to move the swarm toward the best solutions. The pseudo-code of this process is giving as follows:

Algorithm 10: Particle Swarm Optimization Algorithm

```

Input:  $x[], v[]$  // Set of particles' positions and velocities
Output:  $x[], v[]$  // Set of updated particles' positions and velocities
1 for each particle  $i = 0; i < S; i ++$  do
2   Initialize the particle's position with a uniformly distributed random vector:  $x_i \sim U(b_{lo}, b_{up})$ 
3   Initialize the particle's best known position to its initial position:  $p_i = x_i$ 
4   if  $Dis(p_i) < Dis(g)$  then
5     Update the swarm's best known position:  $g = p_i$ 
6   Initialize the particle's velocity:  $v_i = U(|b_{up} - b_{lo}|, |b_{up} - b_{lo}|)$ 
7   while a termination criterion is not met do
8     for each particle  $i = 0; i < S; i ++$  do
9       for each dimension  $d = 0; d < n; d ++$  do
10        Pick random numbers:  $r_p, r_g \sim U(0, 1)$ 
11        Update the particle's velocity:  $v_{i,d} = \omega \times v_{i,d} + p \times r_p(p_i, d - x_i, d) + g \times r_g(g_d - x_i, d)$ 
12        Update the particle's position:  $x_i = x_i + v_i$ 
13        if  $Dis(x_i) < Dis(p_i)$  then
14          Update the particle's best known position:  $p_i = x_i$ 
15          if  $Dis(p_i) < Dis(g)$  then
16            Update the swarm's best known position:  $g = p_i$ 

```

The goal is to find a solution a for which $Dis(a) \leq Dis(b)$ for all b , which would mean that a is the global minimum. Let S be the number of particles in the swarm, each having a position x_i and a velocity v_i . Let p_i be the best known position of particle i and let g be the best known position of the entire swarm. The values b_{lo} and b_{up} are respectively the lower and upper boundaries. The termination criterion can be number of iterations performed, or a solution with adequate objective function value is found. The parameters ω , p , and g are selected by the user and control the behaviour and efficacy of the PSO method. In our method, we set the parameters as in [93] to calibrate the PSO problem, used for mathematical models of Smart Homes.

4.4 Experiments

A set of experiments have been done to highlight the efficiency of our approach as explained below.

4.4.1 Experimental Context

As we already mentioned, our *MOCSF* takes as an input the *DECF* output (the seller-to-buyer associations). Hence, the prototype developed to validate our *MOCSF* is a complement of the *DECF* one. It includes the following functionalities: 1) the Preference-based compromise builder and the 2) Multi-objective scheduler.

4.4.2 Experimental Metrics and Results

The main criteria used to evaluate the effectiveness of our approach are: i) the preference-based compromise builder effectiveness, ii) the time needed to generate the compromises, as well as, iii) the multi-objective scheduler impact on the electricity cost reduction, the peak loads and the gas emissions.

4.4.2.1 Preferences-based compromise builder effectiveness

The efficiency of the generated desired compromise schedule is measured by its similarity with the desired schedules of the sellers and the buyers given as an input. As an input, we used the output of the Seller2Buyer matcher presented in the previous chapter, where we varied the number of components from 2 to 50 components. The similarity measure used in our module is the ‘Cosine Similarity Measure’, which results a similarity between 0 and 1 (from an absence of similarity ‘0’ to the biggest similarity ‘1’).

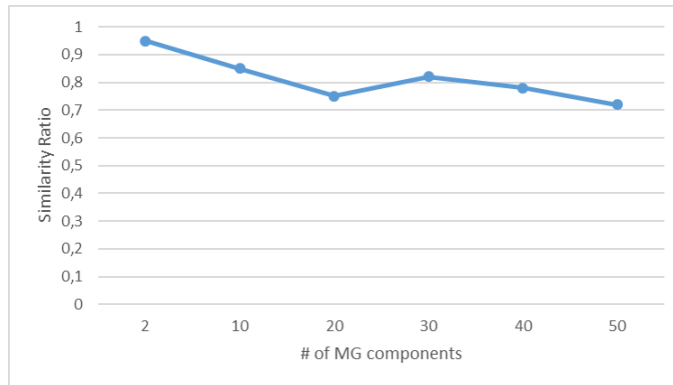

Figure 4.5: Compromise Similarity w.r.t the number of MG Components

Figure 4.5 shows that the worst similarity ratio obtained is 0.72 and the best one is 0.95. This result reflects that our module ensures nice results providing an adequate compromise between the sellers and the buyers preferences.

4.4.2.2 Preferences-based compromise builder performance

In addition to testing the effectiveness of our module in reducing the gap between the proposed compromise desired schedule and the desired sellers and buyers, we also evaluated its time performance. This test consisted of measuring the necessary time to build the compromise from the sellers and buyers associations resulting the tests done in the previous chapter.

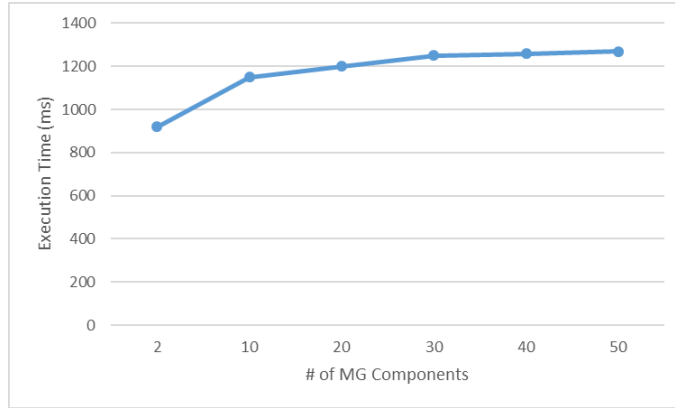

Figure 4.6: Time performance w.r.t the number of MG Components

Figure 4.6 shows that the time needed to create the compromises grows in an almost linear fashion w.r.t the number of components.

4.4.2.3 Multi-objective scheduler impact on the MG

The cooperation and the multi-objective aspects of the MG are the key features of our scheduling. Hence, we propose to measure the following resulting costs: the total electricity prices, the total toxic gas emissions, the components comfort, and the peak loads.

In this test, two different scenarios are considered: 1) a non-cooperative scheduling, where each association is selfish in that it only considered its desired schedule, and 3) a cooperative scheduling based on our proposed multi-objective scheduling. To remain coherent, we will consider the scheduling of the seller-to-buyer associations of our same previous illustration. Note that, the output of the preference-based compromise builder will be used here to calculate the comfort of the components by calculating the gap between the resulting schedule and the compromise desired schedule:

$$\left\{ \begin{array}{l} S_{nR_1^+, nR_3^-}^{init} = [3, 0, 0, 0] \\ S_{nR_1^+, nR_1^-}^{init} = [0, 7, 7, 0] \\ S_{nR_4^+, nR_1^-}^{init} = [0, 0, 1, 0] \\ S_{nR_4^+, nR_2^-}^{init} = [0, 0, 0, 2] \end{array} \right.$$

The time-varying electricity price is shown in Figure 4.7.

Figure 4.8 shows the electricity load resulting from the non-cooperative case. At $T=2$, a peak load (Electricity load = 14 Kw) appeared having several bad effects on the economical, ecological and the operational costs. From the economical perspective, this peak load leads to a total electricity cost of 163 c. From the ecological

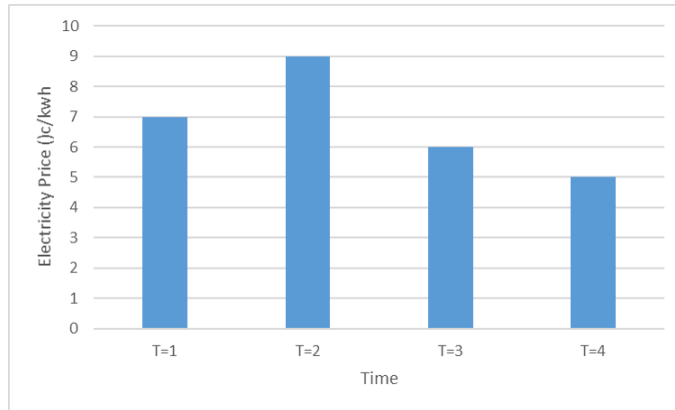

Figure 4.7: Time-varying electricity price

perspective, and having at T=2, a conventional power generator (emitting 0.26 Kg Co2/Kwh), the non-cooperation scheduling caused a simultaneous gas emissions of 3.64 KgCO2. The only advantage of this scheduling is that it answers exactly the desired preferences of the components, which gives a similarity of 1 (the highest), between the proposed schedule and the desired one.

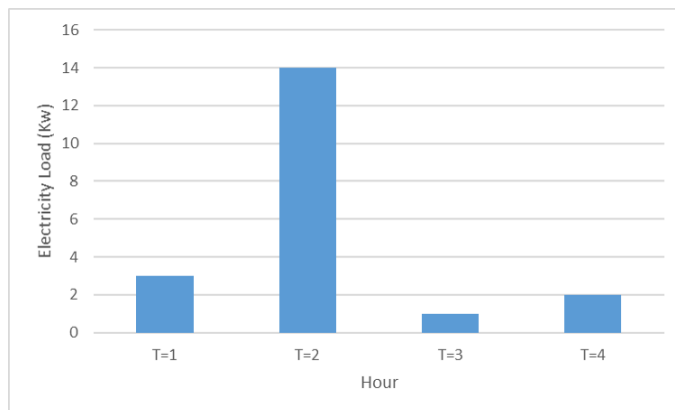

Figure 4.8: Non-cooperative electricity load result

Figure 4.9 shows the electricity load resulting from the our multi-objective scheduler. It shows how the peak loads are shaved (Highest electricity load = 6 Kw). The result is a trade-off between the economical, ecological and operational aspects. From the economical perspective, the total electricity cost is reduced to 136 c. From the ecological perspective, the highest simultaneous gas emissions is reduced to 1.57 KgCO2. The only feature affected negatively is the similarity between the desired and the proposed schedule, minimized to 0.75. Despite this reduction, the value remains a very good result.

The comparison between both cases confirmed our *MOCSF* capacity in finding the balance between the electricity prices, the peak loads, and the gas emissions while taking into account the desired schedules of the components.

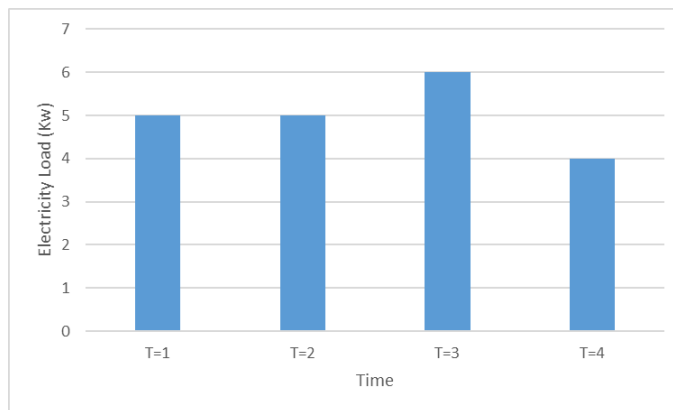

Figure 4.9: MOCSF electricity load result

4.5 Conclusion

In this chapter, we proposed our *MOCSF* aiming at providing an appropriate scheduling for the seller-to-buyer associations resulting from the *DECF* developed in our previous chapter. The idea of scheduling an association instead of scheduling the sellers and the buyers randomly, maintains the cooperation aspect of the *MG* by preserving the power exchange between the sellers and the buyers that achieve the highest benefits when working together. *MOCSF* consists of two main modules: the **Preference-based Compromise Builder**, providing the best balance between the desired schedulers of the sellers and the buyers given as an input, and the **Multi-objective Scheduler**, providing seller-to-buyer associations scheduling aiming at ensuring the economical, ecological and operational satisfactions. Experiments results showed the potential of our modules in providing efficient preference-based compromises able to reduce the gap with the initial components preferences and in minimizing the three-dimensional costs.

Chapter 5

Conclusion

“Every end is a new beginning”
- Marianne Williamson

5.1 Recap

The study presented in this thesis has mainly been concerned in the data modelling and the optimization of the power systems, and more specifically the *MG*.

In chapter 1, we focused on presenting the challenges encountering the current grid, summarized by its age, centralized control and the one-way communication infrastructure. Then we highlighted the importance of the *MG* as a new paradigm in the electricity domain. After that, we presented the challenges facing the *MG* in terms of interoperability, cooperation, multi-aspect benefits and power scheduling. Then the contributions of this report are summarized in the following.

In chapter 2, we presented our ontology-based *MG* model called *OntoMG*, capable of 1) being compliant with existing information models and standards, namely IEC 61970 and IEC 61850, 2) coping with the interoperability between the three layers, and 3) solving the multi-objective aspect of the *MG*. After presenting the state of the art of the of existing power systems information models, we described our proposed *MG* architecture and detailed its three layers: field, knowledge and management layers. Then, we introduced our *OntoMG* ontology through its main concepts. Finally, several evaluation results are conducted in order to validate our proposed framework and emphasize the importance of our *OntoMG* ontology.

In chapter 3, we introduced our ‘Digital Ecosystem Cooperative Framework’ called *DECF*, designed for optimizing the *MG* power exchange, presenting several advantages over existing approaches, namely: 1) it is generic in that it can process on all the heterogeneous *MG* components, 2) it is a cooperative model that reduces the technical, ecological and economic costs and encourages the local power exchange, and 3) it is user-oriented in that it gives the user the possibility to fine-tune the weight of each objective aspect. After presenting existing power exchange optimization techniques and their drawbacks, we detailed the ‘DECF’ modules: the Alliance Builder, designed to gather all the *MG* components having some interest in working together, and the Seller2Buyer Matcher, allowing to provide better power exchange matching between, on one hand, *MG* components, and, on the other, between *MG* and the main grid. An illustrative example is provided after each step to ease the understanding of each module. Finally, the experiments results showed the efficiency of our approach in resolving our challenges over existing approaches.

In chapter 4, we introduced *MOCSF*, a ‘Multi-objective Cooperative Scheduling Framework’ designed for scheduling the production, consumption and storage in the *MG*. *MOCSF* 1) provides a multi-type scheduling in that it allows the scheduling of all the power consumption, production and storage of the *MG*, 2) considers multiple energy sources and 3) considers the *MG* components’ preferences. After detailing the existing power scheduling techniques and their drawbacks regarding our challenges, we presented our ‘MOCSF’ modules: the Preference-based compromise builder, designed to generate the best balance between the sellers and buyers desired schedules and the Multi-objective Scheduler, aiming at scheduling the seller-to-buyer associations resulting from the *DECF*, while reducing the operational, economical and ecological costs of the *MG*. An illustrative example is provided after each step to ease the understanding of each module. Finally, a set of experiments showed the performance and efficiency of our approach.

5.2 Futur Works

There are several improvements we intend to make to our contributions and validations.

5.2.1 *OntoMG* ontology improvements

In chapter 2, we have introduced and detailed our *OntoMG* ontology. Several related improvements can be proposed as follows:

5.2.1.1 *OntoMG* non-experts manipulation

First, we hope to improve the visual retrieval interface coupled with some natural language processing (NLP) techniques to allow non-experts in computer science to write queries, insert, update and delete concepts in a simplified way.

5.2.1.2 *OntoMG* reasoning capabilities

Besides, we plan to enhance the reasoning capabilities of *OntoMG* by defining dedicated rules and constraints, to allow the power system components to react and take decisions autonomously and accordingly.

5.2.1.3 *OntoMG* deep learning

In addition, we are willing to work on applying deep learning techniques aiming at imitating the workings of the users brain in processing data and creating patterns for use in decision making, for a better implementation and reasoning of the ontology. This can reduce the human intervention and increase the *MG* autonomy in the management process.

5.2.2

In chapter 3, we have introduced and detailed our *DECF* and its modules. Several related improvements can be proposed as follows:

5.2.2.1 Real use cases applications

After the implementation of the *OntoMG* ontology in the Hit2Gap project and the ISare *MG* as a backbone to represent the power system components, it is primordial to validate our *DECF* using a real case scenario and mainly on those two projects. In addition, an ongoing project is on the way of development targeting th*DECF* improvementse power management of the Marina port in Henday (France's most southwesterly and a popular seaside tourist resort), and will be mainly relying on our *DECF*.

5.2.2.2 Auction games integration

Instead of using Vogels approximation method, it is also interesting to use an auction algorithm that enables to study the pricing that emerges in the *MG* energy exchange market. This also leads to a dynamic pricing which motivates the consumers to reduce or shift their consumptions to peak off periods.

5.2.3 *MOCSF* improvements

In chapter 4, we have introduced and detailed our *MOCSF* and its modules. Several related improvements can be proposed as follows:

5.2.3.1 Information privacy

The information privacy exchanged in the *MG* remains an essential issue in todays power systems. Hence, we are willing to achieve a privacy-by-design [51] grid control allowing to protect the components privacy whilst preserving the advanced control and monitoring functionalities of the power systems.

5.2.3.2 Strategy-proof techniques integration

In order to avoid cheating in the desired schedules, it is interesting to apply strategy-proof techniques that are robust to cheating.

Bibliography

- [1] Christopher O Adika and Lingfeng Wang. Smart charging and appliance scheduling approaches to demand side management. *International Journal of Electrical Power & Energy Systems*, 57:232–240, 2014.
- [2] Hunt Allcott. Social norms and energy conservation. *Journal of Public Economics*, 95(9):1082–1095, 2011.
- [3] Massoud Amin. Powering the 21st century. *IEEE Power & Energy*, pages 93–96, 2005.
- [4] Seyed Ali Arefifar, A-RI Mohamed Yasser, and Tarek HM El-Fouly. Optimum microgrid design for enhancing reliability and supply-security. *IEEE Transactions on Smart Grid*, 4(3):1567–1575, 2013.
- [5] H Nwe Aung, AM Khambadkone, Dipti Srinivasan, and T Logenthiran. Agent-based intelligent control for real-time operation of a microgrid. In *Power Electronics, Drives and Energy Systems (PEDES) & 2010 Power India, 2010 Joint International Conference on*, pages 1–6. IEEE, 2010.
- [6] Radhakisan Baheti and Helen Gill. Cyber-physical systems. *The impact of control technology*, 12:161–166, 2011.
- [7] Fabio Luigi Bellifemine, Giovanni Caire, and Dominic Greenwood. *Developing multi-agent systems with JADE*, volume 7. John Wiley & Sons, 2007.
- [8] B Douglas Bernheim, Bezalel Peleg, and Michael D Whinston. Coalition-proof nash equilibria i. concepts. *Journal of Economic Theory*, 42(1):1–12, 1987.
- [9] M. W. Berry and M. Castellanos, editors. *Survey of Text Mining II: Clustering, Classification, and Retrieval*. Springer, London, 2008.
- [10] Michael Berry. *Survey of Text Mining : Clustering, Classification, and Retrieval*. Springer, September 2003.

- [11] Dimitri P Bertsekas. *Nonlinear programming*. Athena scientific Belmont, 1999.
- [12] Marcel Boiteux. Peak-load pricing. *The Journal of Business*, 33(2):157–179, 1960.
- [13] Harold Boley and Elizabeth Chang. Digital ecosystems: Principles and semantics. In *Digital EcoSystems and Technologies Conference, 2007. DEST'07. Inaugural IEEE-IES*, pages 398–403. IEEE, 2007.
- [14] Janez Brank, Marko Grobelnik, and Dunja Mladenic. A survey of ontology evaluation techniques. In *Proceedings of the conference on data mining and data warehouses (SiKDD 2005)*, pages 166–170, 2005.
- [15] Steven T Bushby. Bacnet tm: a standard communication infrastructure for intelligent buildings. *Automation in Construction*, 6(5):529–540, 1997.
- [16] Victoria M Catterson, Euan M Davidson, and Stephen DJ McArthur. Issues in integrating existing multi-agent systems for power engineering applications. In *Proceedings of the 13th International Conference on, Intelligent Systems Application to Power Systems*, pages 6–pp. IEEE, 2005.
- [17] Elizabeth Chang and Martin West. Digital ecosystems a next generation of the collaborative environment. In *iiWAS*, pages 3–24, 2006.
- [18] William Cox and Toby Considine. Energy, micromarkets, and microgrids. In *Grid-Interop 2011*, pages 1–8, 2011.
- [19] William Cox, David Holmberg, and Don Sturek. Oasis collaborative energy standards, facilities, and zigbee smart energy. In *Grid-Interop Forum*, pages 1–8, 2011.
- [20] William T Cox, Toby Considine, and T Principal. Architecturally significant interfaces for the smart grid. *Grid-Interop-The road to an interoperable grid, Denver, Colorado, USA*, pages 17–19, 2009.
- [21] David Dallinger and Martin Wietschel. Grid integration of intermittent renewable energy sources using price-responsive plug-in electric vehicles. *Renewable and Sustainable Energy Reviews*, 16(5):3370–3382, 2012.

- [22] Sven De Breucker, Pieter Jacqmaer, Karel De Brabandere, Johan Driesen, and Ronnie Belmans. Grid power quality improvements using grid-coupled hybrid electric vehicles pemd 2006. In *Power Electronics, Machines and Drives, 2006. The 3rd IET International Conference on*, pages 505–509. IET, 2006.
- [23] Moritz Diehl, H Georg Bock, Johannes P Schlöder, Rolf Findeisen, Zoltan Nagy, and Frank Allgöwer. Real-time optimization and nonlinear model predictive control of processes governed by differential-algebraic equations. *Journal of Process Control*, 12(4):577–585, 2002.
- [24] Ibrahim Dincer. Renewable energy and sustainable development: a crucial review. *Renewable and Sustainable Energy Reviews*, 4(2):157–175, 2000.
- [25] H.A. Eiselt, K. Spielberg, E. Richards, C.L. Sandblom, B.T. Smith, G. Laporte, and B.T. Boffey. *Integer Programming and Network Models*. Springer Berlin Heidelberg, 2013.
- [26] J Eto and et. al. Overview of the certs microgrid laboratory test bed. In *Integration of Wide-Scale Renewable Resources Into the Power Delivery System, 2009 CIGRE/IEEE PES Joint Symposium*, pages 1–1. IEEE, 2009.
- [27] Peter Fairley. The unruly power grid. *IEEE Spectrum*, 41(8):22–27, 2004.
- [28] Amin Fakhrazari, Hamid Vakilzadian, and F Fred Choobineh. Optimal energy scheduling for a smart entity. *IEEE Transactions on Smart Grid*, 5(6):2919–2928, 2014.
- [29] Ily Hanisah Mohd Fauzey, Fatemeh Nateghi, Farahbod Mohammadi, and Faridah Ismail. Emergent occupational safety & health and environmental issues of demolition work: Towards public environment. *Procedia-Social and Behavioral Sciences*, 168:41–51, 2015.
- [30] Igor Nai Fovino, Andrea Carcano, Thibault De Lacheze Murel, Alberto Trombetta, and Marcelo Masera. Modbus/dnp3 state-based intrusion detection system. In *2010 24th IEEE International Conference on Advanced Information Networking and Applications*, pages 729–736. IEEE, 2010.
- [31] Clark W Gellings and JH Chamberlin. Demand-side management. *Energy Efficiency and Renewable Energy Handbook, Second Edition edited by D. Yogi Goswami, Frank Kreith (Chapter 15)*, pages 289–310, 1988.

- [32] Syed Gillani, Frederique Laforest, and Gauthier Picard. A generic ontology for prosumer-oriented smart grid. In *EDBT/ICDT Workshops*, pages 134–139, 2014.
- [33] Asunción Gómez-Pérez. Ontology evaluation. In *Handbook on ontologies*, pages 251–273. Springer, 2004.
- [34] Morten Goodwin and Anis Yazidi. A pattern recognition approach for peak prediction of electrical consumption. *Integrated Computer-Aided Engineering*, 23(2):101–113, 2016.
- [35] Santiago Grijalva and Muhammad Umer Tariq. Prosumer-based smart grid architecture enables a flat, sustainable electricity industry. In *Innovative Smart Grid Technologies (ISGT), 2011 IEEE PES*, pages 1–6. IEEE, 2011.
- [36] Nicola Guarino et al. Formal ontology and information systems. In *Proceedings of FOIS*, volume 98, pages 81–97, 1998.
- [37] DJ Hammerstrom, R Ambrosio, J Brous, TA Carlon, DP Chassin, JG DeSteese, RT Guttromson, GR Horst, OM Järvegren, R Kajfasz, et al. Pacific northwest gridwise testbed demonstration projects; part i. olympic peninsula project. Technical report, Pacific Northwest National Laboratory (PNNL), Richland, WA (US), 2007.
- [38] Donald J Hammerstrom, Jerry Brous, David P Chassin, Gale R Horst, Robert Kajfasz, Preston Michie, Terry V Oliver, Teresa A Carlon, Conrad Eustis, Olof M Jarvegren, et al. Pacific northwest gridwise testbed demonstration projects; part ii. grid friendly appliance project. Technical report, Pacific Northwest National Laboratory (PNNL), Richland, WA (US), 2007.
- [39] John A Hartigan. Clustering algorithms. 1975.
- [40] Nikos Hatziargyriou. *MicroGrids*. wiley-IEEE press, 2014.
- [41] Nikos Hatziargyriou, Hiroshi Asano, Reza Iravani, and Chris Marnay. Microgrids. *Power and Energy Magazine, IEEE*, 5(4):78–94, 2007.
- [42] Quang-Dung Ho and Tho Le-Ngoc. Smart grid communications networks: Wireless technologies, protocols, issues and standards. *Handbook of Green Information and Communication Systems, Obaidat, MS, A. Anpalagan and I. Woungang (Eds.)*. Academic Press, New York, pages 115–146, 2012.

- [43] Ijaz Hussain, Sajjad Mohsin, Abdul Basit, Zahoor Ali Khan, Umar Qasim, and Nadeem Javaid. A review on demand response: Pricing, optimization, and appliance scheduling. *Procedia Computer Science*, 52:843–850, 2015.
- [44] Anil K Jain, M Narasimha Murty, and Patrick J Flynn. Data clustering: a review. *ACM computing surveys (CSUR)*, 31(3):264–323, 1999.
- [45] M Jamil, B Hussain, M Abu-Sara, RJ Boltryk, and SM Sharkh. Microgrid power electronic converters: State of the art and future challenges. In *Universities Power Engineering Conference (UPEC), 2009 Proceedings of the 44th International*, pages 1–5. IEEE, 2009.
- [46] Xingbei Jia and e. al. Application of multi-agent technology in micro-grid system. In *Advanced Power System Automation and Protection (APAP), 2011 International Conference on*, volume 2, pages 962–967. IEEE, 2011.
- [47] Farid Katiraei, Reza Iravani, Nikos Hatziargyriou, and Aris Dimeas. Microgrids management. *IEEE power and energy magazine*, 6(3), 2008.
- [48] Leonard Kaufman and Peter J. Rousseeuw. *Finding groups in data : an introduction to cluster analysis*. Wiley series in probability and mathematical statistics. Wiley, New York, 1990. A Wiley-Interscience publication.
- [49] Willett Kempton and Steven E Letendre. Electric vehicles as a new power source for electric utilities. *Transportation Research Part D: Transport and Environment*, 2(3):157–175, 1997.
- [50] Gi Myung Kim, Se Hwan Kim, Seung Ho Hong, and Jin Lee. Design of a bacnet-zigbee gateway for smart grid in buildings. In *Conference Anthology, IEEE*, pages 1–5. IEEE, 2013.
- [51] Marc Langheinrich. Privacy by design principles of privacy-aware ubiquitous systems. In *International conference on Ubiquitous Computing*, pages 273–291. Springer, 2001.
- [52] Robert H Lasseter. Microgrids. In *Power Engineering Society Winter Meeting, 2002. IEEE*, volume 1, pages 305–308. IEEE, 2002.
- [53] Jay Lee, Behrad Bagheri, and Hung-An Kao. A cyber-physical systems architecture for industry 4.0-based manufacturing systems. *Manufacturing Letters*, 3:18–23, 2015.

- [54] Xu Li, Xiaohui Liang, Rongxing Lu, Xuemin Shen, Xiaodong Lin, and Haojin Zhu. Securing smart grid: cyber attacks, countermeasures, and challenges. *IEEE Communications Magazine*, 50(8), 2012.
- [55] Zhenjie Li, Yue Yuan, and Furong Li. Evaluating the reliability of islanded microgrid in an emergency mode. In *Universities Power Engineering Conference (UPEC), 2010 45th International*, pages 1–5. IEEE, 2010.
- [56] Thillainathan Logenthiran, Dipti Srinivasan, and Tan Zong Shun. Demand side management in smart grid using heuristic optimization. *IEEE transactions on smart grid*, 3(3):1244–1252, 2012.
- [57] Thillainathan Logenthiran, Dipti Srinivasan, and David Wong. Multi-agent coordination for der in microgrid. In *Sustainable Energy Technologies, 2008. ICSET 2008. IEEE International Conference on*, pages 77–82. IEEE, 2008.
- [58] Julio J Lucia and Eduardo S Schwartz. Electricity prices and power derivatives: Evidence from the nordic power exchange. *Review of derivatives research*, 5(1):5–50, 2002.
- [59] Indrani Maity and Shrisha Rao. Simulation and pricing mechanism analysis of a solar-powered electrical microgrid. *Systems Journal, IEEE*, 4(3):275–284, 2010.
- [60] Alan W McMorran. An introduction to iec 61970-301 & 61968-11: The common information model. *University of Strathclyde*, 93:124, 2007.
- [61] Yilin Mo, Tiffany Hyun-Jin Kim, Kenneth Brancik, Dona Dickinson, Heejo Lee, Adrian Perrig, and Bruno Sinopoli. Cyber-physical security of a smart grid infrastructure. *Proceedings of the IEEE*, 100(1):195–209, 2012.
- [62] Faisal A Mohamed and Heikki N Koivo. Online management of microgrid with battery storage using multiobjective optimization. In *Power Engineering, Energy and Electrical Drives, 2007. POWERENG 2007. International Conference on*, pages 231–236. IEEE, 2007.
- [63] Amir-Hamed Mohsenian-Rad and el. al. Autonomous demand-side management based on game-theoretic energy consumption scheduling for the future smart grid. *Smart Grid, IEEE Transactions on*, 1(3):320–331, 2010.

- [64] José Monteiro, Srinivas Devadas, Pranav Ashar, and Ashutosh Mauskar. Scheduling techniques to enable power management. In *Proceedings of the 33rd annual Design Automation Conference*, pages 349–352. ACM, 1996.
- [65] Yoosoo Oh, Sébastien Duval, Sehwan Kim, Hyoseok Yoon, Taejin Ha, and Woon-tack Woo. Foundation of a new digital ecosystem for u-content: Needs, definition, and design. *Virtual and Mixed Reality-Systems and Applications*, pages 377–386, 2011.
- [66] Giuliano Andrea Pagani and Marco Aiello. The power grid as a complex network: a survey. *Physica A: Statistical Mechanics and its Applications*, 392(11):2688–2700, 2013.
- [67] Dao-gang Peng, Hao Zhang, Li Yang, and YANG Li. Design and realization of modbus protocol based on embedded linux system. In *Embedded Software and Systems Symposia, 2008. ICSS Symposia'08. International Conference on*, pages 275–280. IEEE, 2008.
- [68] Paolo Piagi and Robert H Lasseter. Autonomous control of microgrids. In *Power Engineering Society General Meeting, 2006. IEEE*, pages 8–pp. IEEE, 2006.
- [69] NIST Smart Grid Priority Action Plan. 10: Standard energy usage information.
- [70] Yann G Rebours, Daniel S Kirschen, Marc Trotignon, and Sébastien Rossignol. A survey of frequency and voltage control ancillary services part i: Technical features. *Power Systems, IEEE Transactions on*, 22(1):350–357, 2007.
- [71] George Ritzer. Focusing on the prosumer. In *Prosumer revisited*, pages 61–79. Springer, 2010.
- [72] Walid Saad, Zhu Han, and H Vincent Poor. Coalitional game theory for cooperative micro-grid distribution networks. In *Communications Workshops (ICC), 2011 IEEE International Conference on*, pages 1–5. IEEE, 2011.
- [73] Walid Saad, Zhu Han, H Vincent Poor, and Tamer Başar. A noncooperative game for double auction-based energy trading between phev and distribution grids. In *Smart Grid Communications (SmartGridComm), 2011 IEEE International Conference on*, pages 267–272. IEEE, 2011.

- [74] Khoulood Salameh and et. al. A generic ontology-based information model for better management of microgrids. In *Artificial Intelligence Applications and Innovations*, pages 451–466. Springer, 2015.
- [75] Ditiro Setlhaolo, Xiaohua Xia, and Jiangfeng Zhang. Optimal scheduling of household appliances for demand response. *Electric Power Systems Research*, 116:24–28, 2014.
- [76] Mohammad Shahidehpour and Yaoyu Wang. *Communication and control in electric power systems: applications of parallel and distributed processing*. John Wiley & Sons, 2004.
- [77] HARVEY H Shore. The transportation problem and the vogel approximation method. *Decision Sciences*, 1(3-4):441–457, 1970.
- [78] Merrill Smith and Dan Ton. Key connections: The us department of energy? s microgrid initiative. *IEEE Power and Energy magazine*, 11(4):22–27, 2013.
- [79] Vijay K Sood, Daniel Fischer, JM Eklund, and Tim Brown. Developing a communication infrastructure for the smart grid. In *Electrical Power & Energy Conference (EPEC), 2009 IEEE*, pages 1–7. IEEE, 2009.
- [80] Goran Strbac. Demand side management: Benefits and challenges. *Energy policy*, 36(12):4419–4426, 2008.
- [81] Nikola M Tomašević, Marko Č Batić, Luis M Blanes, Marcus M Keane, and Sanja Vraneš. Ontology-based facility data model for energy management. *Advanced Engineering Informatics*, 29(4):971–984, 2015.
- [82] Antonis G Tsikalakis and Nikos D Hatziargyriou. Centralized control for optimizing microgrids operation. In *Power and Energy Society General Meeting, 2011 IEEE*, pages 1–8. IEEE, 2011.
- [83] Mike Uschold and Michael Gruninger. Ontologies: Principles, methods and applications. *The knowledge engineering review*, 11(02):93–136, 1996.
- [84] Naveen Venkatesan, Jignesh Solanki, and Sarika Khushalani Solanki. Market optimization for microgrid with demand response model. In *North American Power Symposium (NAPS), 2011*, pages 1–6. IEEE, 2011.

- [85] Jack Verhoosel, Frens-Jan Rumph, and Mente Konsman. Modeling of flexibility in electricity demand and supply for renewables integration. In *Workshop on eeBuildings Data Models, Sophia Antipolis, France*, pages 1–8, 2011.
- [86] Xavier Vives. Nash equilibrium with strategic complementarities. *Journal of Mathematical Economics*, 19(3):305–321, 1990.
- [87] Perukrishnen Vytelingum, Thomas D Voice, Sarvapali D Ramchurn, Alex Rogers, and Nicholas R Jennings. Agent-based micro-storage management for the smart grid. In *Proceedings of the 9th International Conference on Autonomous Agents and Multiagent Systems: Volume 1-Volume 1*, pages 39–46. International Foundation for Autonomous Agents and Multiagent Systems, 2010.
- [88] C. Wang, H. Liu, and F. Wu. The extend cim for microgrid. In *Electricity Distribution (CICED), 2012 China International Conference on*, pages 1–5, Sept 2012.
- [89] Laurence A Wolsey. Mixed integer programming. *Wiley Encyclopedia of Computer Science and Engineering*, 2008.
- [90] Chenye Wu, Hamed Mohsenian-Rad, Jianwei Huang, and Amy Yuexuan Wang. Demand side management for wind power integration in microgrid using dynamic potential game theory. In *GLOBECOM Workshops (GC Wkshps), 2011 IEEE*, pages 1199–1204. IEEE, 2011.
- [91] Xufeng Xu, Joydeep Mitra, Tingting Wang, and Longhua Mu. Evaluation of operational reliability of a microgrid using a short-term outage model. *IEEE Transactions on Power Systems*, 29(5):2238–2247, 2014.
- [92] Ramon Zamora and Anurag K Srivastava. Controls for microgrids with storage: Review, challenges, and research needs. *Renewable and Sustainable Energy Reviews*, 14(7):2009–2018, 2010.
- [93] Jiawei Zhu, Fabrice Lauri, Abderrafiaa Koukam, and Vincent Hilaire. Scheduling optimization of smart homes based on demand response. In *IFIP International Conference on Artificial Intelligence Applications and Innovations*, pages 223–236. Springer, 2015.

- [94] Didar Zowghi and Vincenzo Gervasi. The three cs of requirements: consistency, completeness, and correctness. In *International Workshop on Requirements Engineering: Foundations for Software Quality, Essen, Germany: Essener Informatik Beitiage*, pages 155–164, 2002.