



**HAL**  
open science

# Algebras of coloured Petri nets and their applications to modelling and verification

Franck Pommereau

► **To cite this version:**

Franck Pommereau. Algebras of coloured Petri nets and their applications to modelling and verification. Computer Science [cs]. Université de Paris-Est/Créteil, 2009. tel-02309973

**HAL Id: tel-02309973**

**<https://hal.science/tel-02309973>**

Submitted on 9 Oct 2019

**HAL** is a multi-disciplinary open access archive for the deposit and dissemination of scientific research documents, whether they are published or not. The documents may come from teaching and research institutions in France or abroad, or from public or private research centers.

L'archive ouverte pluridisciplinaire **HAL**, est destinée au dépôt et à la diffusion de documents scientifiques de niveau recherche, publiés ou non, émanant des établissements d'enseignement et de recherche français ou étrangers, des laboratoires publics ou privés.

# Algebras of coloured Petri nets and their applications to modelling and verification

Franck Pommereau

LACL, University Paris-East-Créteil

Habilitation thesis, defended the 24th of November 2009

|            |                            |                                       |
|------------|----------------------------|---------------------------------------|
| Reviewers: | Pr. Eike Best              | university of Oldenbug, Germany       |
|            | Pr. Serge Haddad           | ENS Cachan, France                    |
|            | Pr. François Vernadat      | INSA Toulouse, France                 |
| Examiners: | Pr. Didier Buchs           | university of Geneva, Switzerland     |
|            | Pr. Hanna Klaudel          | university of Évry, France            |
|            | Pr. Elisabeth Pelz (dir.)  | university Paris-East-Créteil, France |
|            | Pr. Laure Petrucci (pres.) | university Paris 13, France           |

**Abstract.** This document surveys my research work about a framework of composable coloured Petri nets. This framework is organised around a core model of coloured Petri nets that can be extended with various features: control flow, synchronous communication, exceptions, threads, functions and time. Extensions are made in such a way that the underlying model of coloured Petri net is preserved and the usual analysis tools and techniques can still be used. However, specific verifications issues arise from the proposed approaches; we discuss these issues and propose solutions to enable for efficient verification. An implementation of the framework is also presented, as well as applications to the modelling and verification of security protocols, and to the modelling and analysis of biological regulatory networks in the context of developmental processes.

**Résumé.** Ce document synthétise mes travaux de recherche concernant une famille de modèles de réseaux de Petri colorés composables. Ces modèles sont organisés autour d'une base de réseaux de Petri colorés qui peut être étendue par diverses fonctionnalités : contrôle de flot, communications synchrones, exceptions, multi-tâches, fonctions et temps. Ces extensions sont réalisées de telle sorte que le modèle sous-jacent de réseaux de Petri colorés est préservé, en conséquence de quoi les techniques d'analyse et les outils habituels pour ce formalisme restent utilisables. Cependant, avec les approches proposées, des questions spécifiques apparaissent concernant la vérification ; nous discutons de ces questions et proposons des solutions pour permettre la vérification efficace. Une implantation des modèles proposés est présentée, de même que des applications à la modélisation et la vérification de protocoles de sécurité, et à la modélisation et l'analyse de réseaux biologiques de signalisation dans le contexte de processus développementaux.

# Table of Contents

|     |   |    |
|-----|---|----|
| 1   | Introduction.....   | 3  |
| 1.1 | Outlines.....   | 4  |
| 2   | A framework of composable Petri nets.....                 | 6  |
| 2.1 | Preliminary definitions.....                              | 6  |
| 2.2 | Petri nets.....   | 6  |
| 2.3 | Control flow operations.....                              | 8  |
| 2.4 | Synchronous communication.....                            | 11 |
| 2.5 | Verification issues.....                                  | 15 |
| 2.6 | Related works.....  | 19 |
| 3   | SNAKES toolkit and syntactic layers.....                  | 22 |
| 3.1 | Architecture.....   | 22 |
| 3.2 | Main features and use cases.....                          | 23 |
| 3.3 | A syntactical layer for Petri nets with control flow..... | 23 |
| 3.4 | Related works.....  | 26 |
| 4   | Multi-threaded extension.....                             | 28 |
| 4.1 | Sequential fragment and exceptions.....                   | 28 |
| 4.2 | Threading mechanism.....                                  | 31 |
| 4.3 | Use cases.....  | 34 |
| 4.4 | Verification issues.....                                  | 37 |
| 4.5 | Related works.....  | 43 |
| 5   | Applications.....   | 45 |
| 5.1 | Modelling time by causality.....                          | 45 |
| 5.2 | Specification and verification of security protocols..... | 48 |
| 5.3 | Modelling biological regulatory networks.....             | 54 |
| 6   | Conclusion.....   | 61 |
| 6.1 | Ongoing and future works.....                             | 62 |
| 7   | References.....   | 64 |
| 7.1 | Habilitation references.....                              | 64 |
| 7.2 | General references.....                                   | 65 |

# 1 Introduction

Formal specifications are now widely used for modelling systems and reasoning about them. In particular, automated analysis through model-checking [24] is a successful approach that involves different activities:

- a *model* of the system to analyse is defined, expressed in an adequate *formalism*;
- the *properties* to be verified against the model are specified, usually as *logic* formulas;
- the *verification* phase, or *model-checking*, consists in automatically determining whether the properties hold or not for the defined model.

When the desired properties do not hold, the process often has to be started again: either the model is correct and a flaw in the real system has been found, in which case the modelling and verification process is likely to be restarted after the system is corrected; or the model contains errors or is not precise enough and has to be fixed before the analysis is started again. Even when the desired properties hold, some more details may often need to be added to the model, different scenarios may be modelled or variants of the properties may be checked to improve confidence in the obtained results. Modelling and verification are thus generally parts of an incremental and cyclic process, either during the design phases of a system (used for specification), or at a later point when the system exists (used for certification).

Among the numerous formalisms available for modelling, we concentrate here onto *Petri nets* which are widely known and used in a variety of domains. Petri nets themselves exist in many variants: from the basic model of *places/transitions* nets, or *P/T* nets [87], many extensions have been proposed. We consider here the *coloured Petri nets* [58] variant that allows to cope with high-level data types. In the field of formal modelling and verification, coloured Petri nets are probably the most used formalism, together with timed automata [4]; as shown by the incomplete and yet very long list of industrial case studies from the web pages of CPN tools [34]. One of the possible reasons for this success is that coloured Petri nets offer a set of modelling devices that makes them easily applicable to a wide range of domains. In particular:

- like other Petri net models, coloured Petri nets naturally support the modelling of resources consumption, production and sharing, access conflicts, concurrency and causal dependence, locality, etc.;
- the concrete form of colours is a language; the richer it is, the easier the modelling task. In particular, using a programming language for the colour domain makes it easy to model the features from real-life examples, like computation involving complex data structures.

This results in a formalism offering a very good expressivity on two complementary aspects that are linked to the essence of computing: *control flow* and *data flow*.

However, the weak point of Petri nets has been for a long time their lack of structuring features: a Petri net is usually defined as a whole, not as a hierarchical system obtained by assembling smaller blocks. This contrasts with the formalisms of the family of *process algebras* [9] that exactly address the question of formalising compositionality: processes are composed at a syntactical level and the behaviour of the compound is derived from the behaviour of the components, depending on the operator that is used.

This lack has inspired the development of the *Petri box calculus* [11, 12] with the goal to fill the gap between Petri nets and process algebras. The result is a family of Petri nets algebras with full support for compositionally and a common approach to this aspect: a class of Petri nets is considered and a special labelling is defined for it to provide all the information needed for compositions; operators are then defined as transformations on Petri nets. The benefit from this approach is that the result of a Petri net composition is still a regular Petri net (with labels) and as such can be analysed using existing tools. Moreover, because it has been obtained in a controlled way, some properties of a composed Petri net can be guaranteed by construction. Not only does this relax from the need to verify these properties, but also they can be assumed and exploited to improve further analyses.

The research presented in this document follows these principles. The purpose is to define coloured Petri net formalisms with support for various features needed in practical situations; in particular: explicit control flow, synchronous and asynchronous communication, exception and threading mechanisms, functions (allowing recursion), and time-related capabilities. All this is provided inside the domain of coloured Petri nets, with no extension of this base model that would forbid to use the existing tools.

Moreover, we are concerned with the question of usability more than with the question of expressivity: our formalisms should be easy to use and well suited for the modelling task they were chosen for. To achieve this goal, we do not try to work toward the definition of a thoroughly versatile formalism with all the possible features included. Instead, we prefer to offer a flexible and modular framework allowing to easily define a suitable formalism for each specific domain. Building a language with all included is not a difficulty in itself (see [POM6] for quite a complete example), but the complexity of such a formalism is likely to discourage modellers from learning it. Moreover, modelling power is almost always contradicting efficient verification: in the domain of Petri nets for example, the complexity of many analysis problems increases when more complex variants of Petri nets are considered, or the problems may even become undecidable [43]. So, on the one hand, we aim at proposing formalisms that are specific to a given usage or domain and, on the other hand, we shall exploit this specificity to accelerate verification.

When a compromise has to be found between ease of modelling and speed of verification, we try to consider the cyclic and incremental aspect of the modelling and verification process as described above. Indeed, the amount of time spent in each cycle is composed of modelling time spent by a human modeller, plus computation time spent by a program running on a computer. Both matter and it is not worth restricting the modelling expressivity to speedup verification if this is compensated for by a comparable modelling time penalty. Moreover, considering that computation time is comparatively cheaper than human time, especially that of a highly-qualified modeller, it may be worth considering the trade-off the other way round: to sacrifice some computation time for a simpler, faster and less error-prone modelling phase. Part of the work presented hereby is directed toward this question and dedicated to propose devices to improve modelling power while providing methods to preserve verification speed, or at least to allow for reasonable efficiency.

Finally, to improve the suitability of formalisms, we shall consider hiding the Petri nets from the modellers' eyes and provide them with a syntax adapted to their domain and modelling problems. Thus, Petri nets may be considered as the target domain for a compiler. This gives an opportunity to really match the users' needs, but also, this allows to limit the features introduced at the Petri net level to primitive ones on the top of which the expected high-level features can be implemented. Indeed, the modelling discipline and tedious steps to use these primitives correctly can be hidden in the compilation process, as it is usual with most compiled programming languages.

## 1.1 Outlines

In the next section, we present the core of a framework of composable Petri nets. It consists in coloured Petri nets that can be equipped with labellings and operations to support control flow and synchronous communication. These two aspects are presented separately but they are compatible and may be used together. Then, we discuss the specific verification issues related to the models presented in the section. Finally, a survey of related works is provided.

In section 3 we present the SNAKES toolkit that implements the presented models. Then, in subsection 3.3, we illustrate how easily a simple yet rich syntax can be translated into Petri nets thanks to the operations defined previously.

Section 4 defines an extension to the framework to support exceptions and threads. The former is provided in the context of a sequential variant of the formalism defined in subsection 2.3: considering sequential processes is crucial to define a lightweight interrupt mechanism on the top of which a fully-featured exception mechanism can be built. Then, this formalism is extended with multi-threading to restore the possibility to model concurrent systems (in a shape that is widely used in programming languages). A thread is here understood as a sequential process implemented as an identified flow of tokens in a Petri net. Threads can be started dynamically and their termination can be awaited for. We then show how threads can be used to model function calls. Introducing exception is harmless with respect to verification, but this is not the case with threads. Indeed,

adding thread identifiers increases the combinatorial explosion of the state space that may even become infinite. We show in subsection 4.4 how a suitable state equivalence relation can be defined and efficiently computed in order to tackle this issue. We end the section with a survey of related works.

Section 5 presents various applications of the formalisms presented in the previous sections. In subsection 5.1 we discuss how time-related features can be modelled by causality: the idea is to implement clocks by counters of occurrences of a tick transition; like for threads, this has an important impact on verification and we show how this can be addressed. Then, in subsection 5.2, we apply the syntax introduced in subsection 3.3 to the modelling and verification of security protocols. Finally, subsection 5.3 is a presentation of another application to the domain of bio-informatics and, more precisely, to the modelling of regulatory networks used to analyse patterning mechanisms in developmental processes. Each part of section 5 is provided with its own survey of related works.

This document provides a uniformed version of various published research works. As a consequence, some technical aspects have been simplified to streamline the presentation, but full details may be found in the corresponding publications:

- section 2: [KP1,POM2,PS,DKK<sup>+</sup>,POM3,DKKP1,DKKP2,POM4,BTKP3,POM6,KP5];
- section 3: [POM9,POM8,POM1];
- section 4: [KP2,KP3,KP4,POM6,KKPP1,KKPP3,KKPP2]
- subsection 5.1: [POM5,POM7,POM4,POM6,PDK,BDK<sup>+</sup>];
- subsection 5.2: [POM1,SPR];
- subsection 5.3: [CKP1,CKP2].

## 2 A framework of composable Petri nets

### 2.1 Preliminary definitions

We shall use the *lambda notation* to denote some functions. For instance  $\lambda x : x > 0$  denotes the function that takes an argument  $x$  and returns the Boolean value  $x > 0$ . Similarly, function  $\lambda x, y : x > y$  computes whether  $x$  is greater than  $y$ . If  $f$  and  $g$  are two functions on disjoint domains  $F$  and  $G$ , we define  $f \cup g$  as the function on domain  $F \cup G$  such that  $(f \cup g)|_F = f$  and  $(f \cup g)|_G = g$ .

A *multiset*  $m$  over a domain  $D$  is a function  $m : D \rightarrow \mathbb{N}$  (natural numbers), where, for  $d \in D$ ,  $m(d)$  denotes the number of occurrences of  $d$  in the multiset  $m$ . The empty multiset is denoted by  $\emptyset$  and is the constant function  $\emptyset \stackrel{\text{def}}{=} (\lambda x : 0)$ . We shall denote multisets like sets with repetitions, for instance  $m_1 \stackrel{\text{def}}{=} \{1, 1, 2, 3\}$  is a multiset and so is  $\{d + 1 \mid d \in m_1\}$ . The latter, given in extension, is denoted by  $\{2, 2, 3, 4\}$ . A multiset  $m$  over  $D$  may be naturally extended to any domain  $D' \supset D$  by defining  $m(d) \stackrel{\text{def}}{=} 0$  for all  $d \in D' \setminus D$ . If  $m_1$  and  $m_2$  are two multisets over the same domain  $D$ , we define:

- $m_1 \leq m_2$  iff  $m_1(d) \leq m_2(d)$  for all  $d \in D$ ;
- $m_1 + m_2$  is the multiset over  $D$  defined by  $(m_1 + m_2)(d) \stackrel{\text{def}}{=} m_1(d) + m_2(d)$  for all  $d \in D$ ;
- $m_1 - m_2$  is the multiset over  $D$  defined by  $(m_1 - m_2)(d) \stackrel{\text{def}}{=} \max(0, m_1(d) - m_2(d))$  for all  $d \in D$ ;
- for  $d \in D$ , we denote by  $d \in m_1$  the fact that  $m_1(d) > 0$ .

### 2.2 Petri nets

A (coloured) Petri net involves values, variables and expressions. These objects are defined by a *colour domain* that provides data values, variables, operators, a syntax for expressions, possibly typing rules, etc. For instance, one may use integer arithmetic or Boolean logic as colour domains. Usually, more elaborated colour domains are useful to ease modelling, in particular, one may consider a functional programming language or the functional fragment (expressions) of an imperative programming language. In most of this document, we consider an abstract colour domain with the following elements:

- $\mathbb{D}$  is the set of *data* values; it may include in particular the Petri net *black token*  $\bullet$ , integer values, Boolean values **True** and **False**, and a special “undefined” value  $\perp$ ;
- $\mathbb{V}$  is the set of *variables*, usually denoted as single letters  $x, y, \dots$ , or as subscripted letters like  $x_1, y_k, \dots$ ;
- $\mathbb{E}$  is the set of *expressions*, involving values, variables and appropriate operators. Let  $e \in \mathbb{E}$ , we denote by  $\text{vars}(e)$  the set of variables from  $\mathbb{V}$  involved in  $e$ . Moreover, variables or values may be considered as (simple) expressions, *i.e.*, we assume that  $\mathbb{D} \cup \mathbb{V} \subset \mathbb{E}$ .

We make no assumption about the typing or syntactical correctness of values or expressions; instead, we assume that any expression can be evaluated, possibly to  $\perp$  (undefined). More precisely, a *binding* is a partial function  $\beta : \mathbb{V} \rightarrow \mathbb{D}$ . Let  $e \in \mathbb{E}$  and  $\beta$  be a binding, we denote by  $\beta(e)$  the evaluation of  $e$  under  $\beta$ ; if the domain of  $\beta$  does not include  $\text{vars}(e)$  then  $\beta(e) \stackrel{\text{def}}{=} \perp$ . The application of a binding to evaluate an expression is naturally extended to sets and multisets of expressions.

For instance, if  $\beta \stackrel{\text{def}}{=} \{x \mapsto 1, y \mapsto 2\}$ , we have  $\beta(x + y) = 3$ . With  $\beta \stackrel{\text{def}}{=} \{x \mapsto 1, y \mapsto \text{"2"}\}$ , depending on the colour domain, we may have  $\beta(x + y) = \perp$  (no coercion), or  $\beta(x + y) = \text{"12"}$  (coercion of integer 1 to string "1"), or  $\beta(x + y) = 3$  (coercion of string "2" to integer 2), or even other values as defined by the concrete colour domain.

Two expressions  $e_1, e_2 \in \mathbb{E}$  are *equivalent*, which is denoted by  $e_1 \equiv e_2$ , iff for all possible binding  $\beta$  we have  $\beta(e_1) = \beta(e_2)$ . For instance,  $x + 1, 1 + x$  and  $2 + x - 1$  are pairwise equivalent expressions for the usual integer arithmetic.

**Definition 1 (Petri nets).** A Petri net is a tuple  $(S, T, \ell)$  where:

- $S$  is the finite set of places;
- $T$ , disjoint from  $S$ , is the finite set of transitions;

- $\ell$  is a labelling function such that:
  - for all  $s \in S$ ,  $\ell(s) \subseteq \mathbb{D}$  is the type of  $s$ , i.e., the set of values that  $s$  is allowed to carry,
  - for all  $t \in T$ ,  $\ell(t) \in \mathbb{E}$  is the guard of  $t$ , i.e., a condition for its execution,
  - for all  $(x, y) \in (S \times T) \cup (T \times S)$ ,  $\ell(x, y)$  is a multiset over  $\mathbb{E}$  and defines the arc from  $x$  toward  $y$ .  $\diamond$

As usual, Petri nets are depicted as graphs in which places are round nodes, transitions are square nodes, and arcs are directed edges. See figure 1 for a Petri net represented in both textual and graphical notations. Empty arcs, i.e., arcs such that  $\ell(x, y) = \emptyset$ , are not depicted. Moreover, to alleviate pictures, we shall omit some annotations (see figure 1):  $\{\bullet\}$  for place types or arc annotations, curly brackets  $\{\}$  around multisets of expressions on arcs, True guards, and node names that are not needed for explanations. Finally, two opposite arcs may be represented by a single double-headed arc, which occurs between  $s_1$  and  $t$  in the lower part of figure 1.

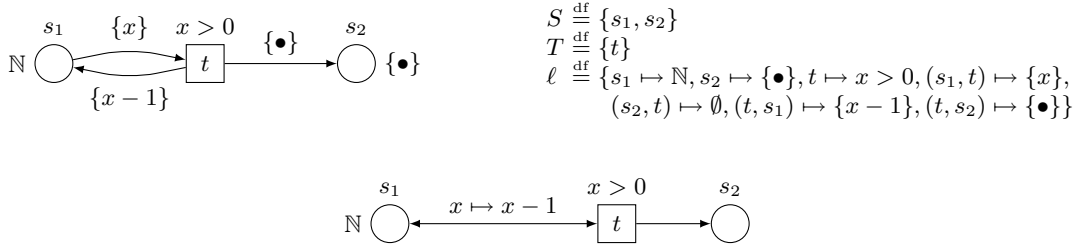

**Fig. 1.** A simple Petri net, with both full (top) and simplified annotations (below).

For any place or transition  $x \in S \cup T$ , we define  $\bullet x \stackrel{\text{df}}{=} \{y \in S \cup T \mid \ell(y, x) \neq \emptyset\}$  and, similarly,  $x^\bullet \stackrel{\text{df}}{=} \{y \in S \cup T \mid \ell(x, y) \neq \emptyset\}$ . For instance, considering the Petri net of figure 1, we have  $\bullet t = \{s_1\}$ ,  $t^\bullet = \{s_1, s_2\}$ ,  $\bullet s_2 = \{t\}$  and  $s_2^\bullet = \emptyset$ . Finally, two Petri nets  $(S_1, T_1, \ell_1)$  and  $(S_2, T_2, \ell_2)$  are *disjoint* iff  $S_1 \cap S_2 = T_1 \cap T_2 = \emptyset$ .

**Definition 2 (Markings and sequential semantics).** Let  $N \stackrel{\text{df}}{=} (S, T, \ell)$  be a Petri net.

A marking  $M$  of  $N$  is a function on  $S$  that maps each place  $s$  to a finite multiset over  $\ell(s)$  representing the tokens held by  $s$ .

A transition  $t \in T$  is enabled at a marking  $M$  and a binding  $\beta$ , which is denoted by  $M[t, \beta]$ , iff the following conditions hold:

- $M$  has enough tokens, i.e., for all  $s \in S$ ,  $\beta(\ell(s, t)) \leq M(s)$ ;
- the guard is satisfied, i.e.,  $\beta(\ell(t)) = \text{True}$ ;
- place types are respected, i.e., for all  $s \in S$ ,  $\beta(\ell(t, s))$  is a multiset over  $\ell(s)$ .

If  $t \in T$  is enabled at marking  $M$  and binding  $\beta$ , then  $t$  may fire and yield a marking  $M'$  defined for all  $s \in S$  as  $M'(s) \stackrel{\text{df}}{=} M(s) - \beta(\ell(s, t)) + \beta(\ell(t, s))$ . This is denoted by  $M[t, \beta]M'$ .

The marking graph  $G$  of a Petri net marked with  $M$  is the smallest labelled graph such that:

- $M$  is a node of  $G$ ;
- if  $M'$  is a node of  $G$  and  $M'[t, \beta]M''$  then  $M''$  is also a node of  $G$  and there is an arc in  $G$  from  $M'$  to  $M''$  labelled by  $(t, \beta)$ .  $\diamond$

It may be noted that this definition of marking graphs allows to add infinitely many arcs between two markings. Indeed, if  $M[t, \beta]$ , there might exist infinitely many other enabling bindings that differ from  $\beta$  only on variables not involved in  $t$ . So, we consider only firings  $M[t, \beta]$  such that the domain of  $\beta$  is  $\text{vars}(t) \stackrel{\text{df}}{=} \text{vars}(\ell(t)) \cup \bigcup_{s \in S} (\text{vars}(\ell(s, t)) \cup \text{vars}(\ell(t, s)))$ .

For example, let us consider again the Petri net of figure 1 and assume it is marked by  $M_0 \stackrel{\text{df}}{=} \{s_0 \mapsto \{2\}, s_2 \mapsto \emptyset\}$ , its marking graph has three nodes as depicted in figure 2. Notice that from marking  $M_2$ , no binding can enable  $t$  because, either  $x \not\mapsto 0$  and then  $M_2$  has not enough tokens, or  $x \mapsto 0$  and then both the guard  $x > 0$  is not satisfied and the type of  $s_1$  is not respected ( $x-1$  evaluates to  $-1$ ).



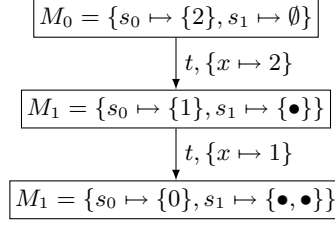

Fig. 2. The marking graph of the Petri net of figure 1.

### 2.3 Control flow operations

To define control flow compositions of Petri nets, we extend them with *node statuses*. Let  $\mathbb{S}$  be the set of statuses, comprising:

- $e$ , the status for *entry places*, *i.e.*, those marked in an initial state of a Petri net;
- $x$ , the status for *exit places*, *i.e.*, those marked in a final state of a Petri net;
- $i$ , the status for *internal places*, *i.e.*, those marked in intermediary states of a Petri net;
- $\varepsilon$ , the status of *anonymous places*, *i.e.*, those with no distinguished status;
- arbitrary names, like *count* or *var*, for *named places*.

Anonymous and named places together are called *data* or *buffer* places, whereas entry, internal and exit places together are called *control flow* places.

**Definition 3 (Petri nets with control flow).** A Petri net with control flow is a tuple  $(S, T, \ell, \sigma)$  where:

- $(S, T, \ell)$  is a Petri net;
- $\sigma$  is a function  $S \rightarrow \mathbb{S}$  that provides a status for each place;
- every place  $s \in S$  with  $\sigma(s) \in \{e, i, x\}$  is such that  $\ell(s) = \{\bullet\}$ . ◇

Statuses are depicted as labels, except for  $\varepsilon$  that is not depicted. Moreover, we denote by  $N^e$ , resp.  $N^x$ , the set of entry, resp. exit, places of  $N$ .

Let  $N_1$  and  $N_2$  be two Petri nets with control flow, we consider four control flow operations:

- sequential composition  $N_1 \circledast N_2$  allows to execute  $N_1$  followed by  $N_2$ ;
- choice  $N_1 \square N_2$  allows to execute either  $N_1$  or  $N_2$ ;
- iteration  $N_1 \otimes N_2$  allows to execute  $N_1$  repeatedly (including zero time), and then  $N_2$  once;
- parallel composition  $N_1 \parallel N_2$  allows to execute both  $N_1$  and  $N_2$  concurrently.

These operators are defined by two successive phases given below. The first one is a *gluing phase* that combines operand nets; in order to provide a unique definition of this phase for all the operators, we use the *operator nets* depicted in figure 3 to guide the gluing. These operator nets are themselves Petri nets with control flow. The second phase is a *named places merging* that fuses the places sharing the same named status.

**Gluing phase.** The intuition behind this phase is that each transition of the involved operator net represents one of the operands of the composition. The places in the operator net enforce the correct control flow between the transitions. In order to reproduce this control flow between the composed Petri nets, we have to combine their control flow places in a way that corresponds to what specified in the operator net. For instance, let us consider  $N_1 \circledast N_2$ . The corresponding operator net is  $N_{\circledast}$  and let us call  $s_i$  its internal place.  $s_i$  is marked when  $t_1^i$  has fired and this marking allows  $t_2^i$  to fire. At the level of composed nets, this should correspond to the fact that  $N_1$  has finished its execution and so is in a final marking where all its exit places are marked; at the same state, we should also have  $N_2$  in its initial marking where all its entry places are marked. This can be obtained by combining the exit places of  $N_1$  (the net that will replace  $\bullet s_i$ ) with the entry places of  $N_2$  (the net that will replace  $s_i \bullet$ ) through a Cartesian product. From this example we can infer

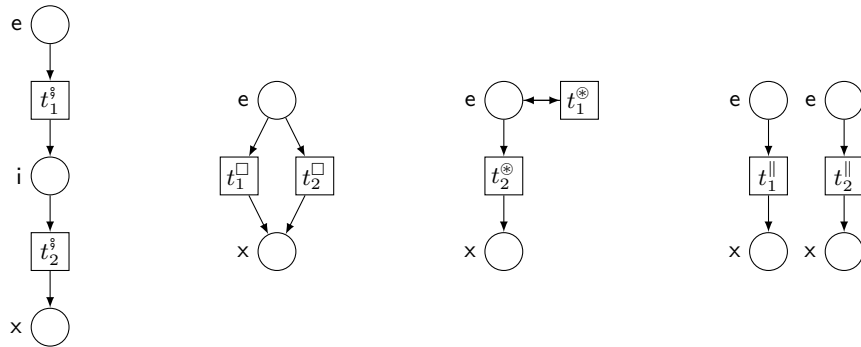

**Fig. 3.** Operators nets  $N_§$ ,  $N_□$ ,  $N_⊗$  and  $N_||$  (left to right). All the transition guards are **True** and all the depicted arcs are labelled by  $\{\bullet\}$ .

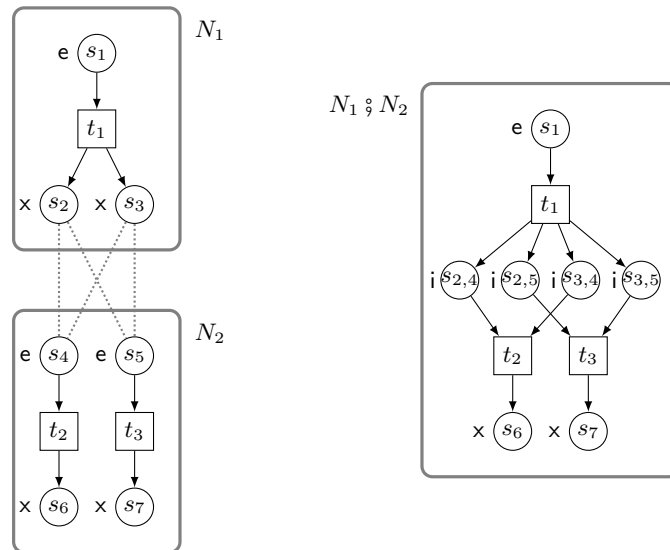

**Fig. 4.** On the left: two Petri nets with control flow  $N_1$ ,  $N_2$ . On the right: the result of the gluing phase of the sequential composition  $N_1 § N_2$ . Place names are indicated inside places. Dotted lines indicate how control flow places are paired by the Cartesian product during the gluing phase. Notice that, because no named place is present, the right net is exactly  $N_1 § N_2$ .

the gluing algorithm that consider in turn each place  $s$  of the operator net and combine the exit places from the operand nets corresponding to  $\bullet s$  with the entry places from the operand nets corresponding to  $s^\bullet$ . An example is provided in figure 4.

Let  $\diamond \in \{\circ, \square, \otimes, \parallel\}$  be a control flow operator and  $N_\diamond \stackrel{\text{df}}{=} (S_\diamond, T_\diamond, \ell_\diamond)$  the corresponding operator net. Let  $N_1 \stackrel{\text{df}}{=} (S_1, T_1, \ell_1, \sigma_1)$  marked by  $M_1$  and  $N_2 \stackrel{\text{df}}{=} (S_2, T_2, \ell_2, \sigma_2)$  marked by  $M_2$  be two Petri nets with control flow such that  $N_1$ ,  $N_2$  and  $N_\diamond$  are pairwise disjoint. In practice, nodes from  $N_1$  and  $N_2$  may be automatically renamed to enforce this condition. To simplify the definition, for  $1 \leq i \leq 2$ , we shall denote  $N_i$  by  $N_{i^\circ}$  and similarly for  $S_i$ ,  $T_i$ ,  $\ell_i$  and  $M_i$ .

We define the gluing of  $N_1$  and  $N_2$  according to  $\diamond$  as a Petri net with control flow  $(S, T, \ell, \sigma)$  such that:

- for  $1 \leq i \leq 2$ , for all  $t \in T_i$ , we also have  $t \in T$  with  $\ell(t) \stackrel{\text{df}}{=} \ell_i(t)$ ;
- for  $1 \leq i \leq 2$ , for all  $s \in S_i$  such that  $\sigma_i(s) \notin \{\mathbf{e}, \mathbf{x}\}$ , we also have  $s \in S$  with  $\ell(s) \stackrel{\text{df}}{=} \ell_i(s)$ ,  $\sigma(s) \stackrel{\text{df}}{=} \sigma_i(s)$  and  $M(s) \stackrel{\text{df}}{=} M_i(s)$ . Moreover, for all  $t \in T_i$ , we have  $\ell(s, t) \stackrel{\text{df}}{=} \ell_i(s, t)$  and  $\ell(t, s) \stackrel{\text{df}}{=} \ell_i(t, s)$ ;
- for every  $s_\diamond \in S_\diamond$  with  $s_\diamond^\bullet = \{u_1, \dots, u_n\}$  and  $\bullet s_\diamond \stackrel{\text{df}}{=} \{v_1, \dots, v_m\}$ , for every  $w \stackrel{\text{df}}{=} (e_1, \dots, e_n, x_1, \dots, x_m) \in N_{u_1}^e \times \dots \times N_{u_n}^e \times N_{v_1}^x \times \dots \times N_{v_m}^x$ , there is a place  $s_w$  in  $S$  such that:
  - $\ell(s_w) \stackrel{\text{df}}{=} \ell_\diamond(s_\diamond)$ ,
  - $\sigma(s_w) \stackrel{\text{df}}{=} \sigma_\diamond(s_\diamond)$ ,
  - $M(s_w) \stackrel{\text{df}}{=} \sum_{1 \leq i \leq n} M_{u_i}(e_i) + \sum_{1 \leq j \leq m} M_{v_j}(x_j)$ ,
  - for  $1 \leq i \leq n$ , for all  $t \in T_{u_i}$ ,  $\ell(t, s_w) \stackrel{\text{df}}{=} \ell_{u_i}(t, e_i)$ ,
  - for  $1 \leq j \leq m$ , for all  $t \in T_{v_j}$ ,  $\ell(s_w, t) \stackrel{\text{df}}{=} \ell_{v_j}(x_j, t)$ ;
- there is no other node nor arc.

**Merging phase.** Let  $N \stackrel{\text{df}}{=} (S, T, \ell, \sigma)$  be a Petri net with control flow marked by  $M$ . The merging phase simply consists in merging together the places that have all the same named status (*i.e.*, not a control flow or anonymous status). This is illustrated in figure 5. This merging resulting in the Petri net with control flow  $N' \stackrel{\text{df}}{=} (S', T', \ell', \sigma')$  marked by  $M'$  such that:

- $T' \stackrel{\text{df}}{=} T$  and, for all  $t \in T$ ,  $\ell'(t) \stackrel{\text{df}}{=} \ell(t)$ ;
- for all  $s \in S$  such that  $\sigma(s) \in \{\mathbf{e}, \mathbf{i}, \mathbf{x}, \varepsilon\}$ ,  $s$  is also a place in  $S'$  with  $\ell'(s) \stackrel{\text{df}}{=} \ell(s)$ ,  $\sigma'(s) \stackrel{\text{df}}{=} \sigma(s)$  and  $M'(s) \stackrel{\text{df}}{=} M(s)$ ;
- for all  $\varsigma \in \mathbb{S} \setminus \{\mathbf{e}, \mathbf{x}, \mathbf{i}, \varepsilon\}$ , let  $S_\varsigma \stackrel{\text{df}}{=} \{s \in S \mid \sigma(s) = \varsigma\}$ , if  $S_\varsigma \neq \emptyset$ , we add a place  $s_\varsigma$  to  $S'$  with  $\ell'(s_\varsigma) \stackrel{\text{df}}{=} \bigcup_{s \in S_\varsigma} \ell(s)$ ,  $\sigma'(s_\varsigma) = \varsigma$  and  $M'(s_\varsigma) \stackrel{\text{df}}{=} \sum_{s \in S_\varsigma} M(s)$ ; moreover, for all  $t \in T$ ,  $\ell'(s_\varsigma, t) \stackrel{\text{df}}{=} \sum_{s \in S_\varsigma} \ell(s, t)$  and  $\ell'(t, s_\varsigma) \stackrel{\text{df}}{=} \sum_{s \in S_\varsigma} \ell(t, s)$ ;
- there is no other node nor arc.

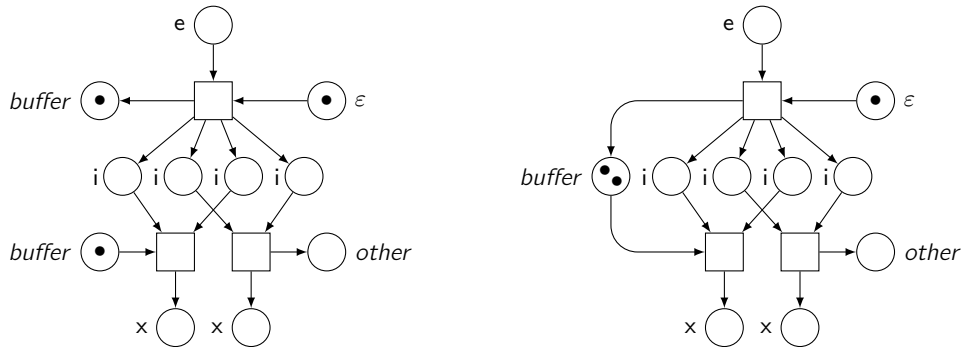

**Fig. 5.** On the left, a Petri net with control flow before the merging phase. On the right, named places have been merged.

**Definition 4 (Control flow compositions).** Let  $\diamond \in \{\circ, \square, \otimes, \parallel\}$  be a control flow operator and  $N_\diamond$  the corresponding operator net. Let  $N_1$  marked by  $M_1$  and  $N_2$  marked by  $M_2$  be two Petri nets with control flow such that  $N_1$ ,  $N_2$  and  $N_\diamond$  are pairwise disjoint. Then,  $N_1 \diamond N_2$  is defined as the Petri net with control flow resulting from the gluing phase followed by the merging phase.  $\diamond$

Named places are often used as buffers to support asynchronous communication, the sharing of buffers between sub-systems is achieved by the automatic merging of places that share the same name when the sub-systems are composed. In this context, we need a mechanism to specify that a buffer is local to some sub-system. This is provided by the *name hiding* operation that replaces a buffer name by  $\varepsilon$  thus forbidding further merges of the corresponding place. Name hiding itself is a special case of a more general *status renaming* operation.

**Definition 5 (Status renaming and name hiding).** Let  $N \stackrel{\text{df}}{=} (S, T, \ell, \sigma)$  be a Petri net with control flow marked by  $M$  and let  $\rho$  be a partial function  $\mathbb{S} \setminus \{\mathbf{e}, \mathbf{i}, \mathbf{x}, \varepsilon\} \rightarrow \mathbb{S} \setminus \{\mathbf{e}, \mathbf{i}, \mathbf{x}\}$  defining the renaming of some statuses. Then, the status renaming operation, denoted  $N[\rho]$ , results in the Petri net with control flow defined as  $(S, T, \ell, \sigma')$  and marked by  $M$  such that, for all  $s \in S$ :

$$\sigma'(s) \stackrel{\text{df}}{=} \begin{cases} \rho(\sigma(s)) & \text{if } \rho \text{ is defined on } \sigma(s), \\ \sigma(s) & \text{otherwise.} \end{cases}$$

Let  $\varsigma \in \mathbb{S} \setminus \{\mathbf{e}, \mathbf{i}, \mathbf{x}, \varepsilon\}$ , the name hiding operation is defined as  $N/\varsigma \stackrel{\text{df}}{=} N[\varsigma \mapsto \varepsilon]$ .  $\diamond$

**Properties.** Some interesting properties of Petri nets with control flow can be established, refer to [DKKP2, KP5] for details.

First, let us call *control-safe* a Petri net with control flow whose control flow places remain marked by at most one token under any evolution. Then, if two Petri nets are control-safe, their composition by any of the control flow operations is also control-safe. This property holds assuming a restriction about how operators may be nested. In particular, it should be avoided to nest a parallel composition into an iteration, which leads to 2-bounded control flow places instead of 1-bounded. We will see later on that such a restriction can be syntactically enforced without loss of expressivity (see section 4). Such a property is interesting for verification efficiency. In particular, it allows to efficiently compute unfoldings of Petri nets, or to introduce optimisations at various stages of the computation of markings successors (see section 2.5).

Moreover, algebraic properties of the control flow operations can be established. In particular, if  $N_1$ ,  $N_2$  and  $N_3$  are two Petri nets with control flow and  $\varsigma_1, \varsigma_2 \in \mathbb{S} \setminus \{\mathbf{e}, \mathbf{i}, \mathbf{x}, \varepsilon\}$ , then we have:

$$\begin{array}{ll} N_1 \square N_2 \simeq N_2 \square N_1 & \text{commutativity of } \square \\ (N_1 \square N_2) \square N_3 \simeq N_1 \square (N_2 \square N_3) & \text{associativity of } \square \\ N_1 \parallel N_2 \simeq N_2 \parallel N_1 & \text{commutativity of } \parallel \\ (N_1 \parallel N_2) \parallel N_3 \simeq N_1 \parallel (N_2 \parallel N_3) & \text{associativity of } \parallel \\ (N_1 \circlearrowleft N_2) \circlearrowleft N_3 \simeq N_1 \circlearrowleft (N_2 \circlearrowleft N_3) & \text{associativity of } \circlearrowleft \\ N_1/\varsigma_1/\varsigma_1 \simeq N_1/\varsigma_1 & \text{idempotence of } / \\ N_1/\varsigma_1/\varsigma_2 \simeq N_1/\varsigma_2/\varsigma_1 & \text{commutativity of } / \\ (N_1 \otimes N_2) \otimes N_3 \simeq (N_1 \square N_2) \otimes N_3 & \text{equivalence of } \otimes \text{ and } \square \text{ under } \otimes \end{array}$$

where  $\simeq$  is the equality of Petri nets up to nodes identities. The last property may be surprising and stands more like a warning for the modeller to avoid mistakes. If this property is really undesirable, the binary iteration may be replaced by a ternary iteration  $[N_1 * N_2 * N_3]$  that is equivalent to  $N_1 \circlearrowleft (N_2 \otimes N_3)$  and introduces a guard on the iteration  $N_2 \otimes N_3$  through  $N_1$  [KP5].

## 2.4 Synchronous communication

Thanks to node statuses and the automatic merging of named places from composed Petri nets, a form of asynchronous communication is possible. In this section, we consider an explicit synchronous

communication scheme based on *transitions synchronisation*, allowing to enforce a simultaneous firing of sets of transitions with information exchange.

To specify how transitions may be synchronised, they are decorated with *multi-actions*, *i.e.*, multisets of *actions*. Let  $\mathbb{A}$  be the set of *actions names*, an *action* is a term of the form  $a!(e_1, \dots, e_n)$  for a *send action* or  $a?(e_1, \dots, e_n)$  for a *receive action*, where  $a \in \mathbb{A}$  and  $e_1, \dots, e_n \in \mathbb{E}$ . Intuitively, a send and a receive action with the same name correspond to a binary synchronisation if their parameters can be unified. An action with no parameter is denoted without parentheses, as in  $a!$  or  $a?$ .

The operations described hereafter do not involve places and thus leave markings untouched; so, we consider unmarked nets only, but the definitions can be trivially extended to marked nets.

**Definition 6 (Petri nets with synchronisation).** A Petri net with synchronisation is a tuple  $(S, T, \ell, \alpha)$  where:

- $(S, T, \ell)$  is a Petri net;
- $\alpha$  is a function over  $T$  such that, for all  $t \in T$ ,  $\alpha(t)$  is a multi-action. ◇

Based on this labelling, we can define three operations:

- the *synchronisation with respect to*  $a \in \mathbb{A}$  creates new transitions that model the simultaneous firing a set of transitions with pairs of unifiable actions  $a!(\dots)$  and  $a?(\dots)$ ;
- the *restriction with respect to*  $a \in \mathbb{A}$  removes all the transitions involving actions  $a!(\dots)$  or  $a?(\dots)$ ;
- the *scoping with respect to*  $a \in \mathbb{A}$  is the synchronisation followed by the restriction: it creates all the possible synchronisations and removes all the unsatisfiable ones.

**Synchronisation.** We denote by  $\bar{x}$  a tuple of parameters for a send or receive action, for instance, action  $a!(1, y, z + 1)$  may be denoted as  $a!(\bar{x})$  with  $\bar{x} \stackrel{\text{df}}{=} (1, y, z + 1)$ . Let  $\bar{x}$  and  $\bar{y}$  be two such tuples of parameters, an *unifier*  $\gamma$  of  $\bar{x}$  and  $\bar{y}$  is a partial function  $\mathbb{V} \rightarrow \mathbb{V} \cup \mathbb{D} \cup \mathbb{E}$  such that  $\gamma(\bar{x}) \equiv \gamma(\bar{y})$ , where  $\gamma(e)$  denotes the substitution in  $e$  of the variables mapped by  $\gamma$ . A send action  $a!(\bar{x})$  and a receive action  $a?(\bar{y})$  on the same name  $a$  are called *conjugated* if  $\bar{x}$  and  $\bar{y}$  can be unified.

In general, if one unifier exists, there exist infinitely many others that can be obtained by augmenting the domain, mapping variables to values instead of to variables, or choosing different variables in the co-domain. In the following, we consider only one among the possible *most general unifiers*, *i.e.*, one that has a domain as small as possible and that do not map variables to values as much as possible. For instance,  $x + y$  and  $z + 1$  can be unified by  $\gamma_1 \stackrel{\text{df}}{=} \{x \mapsto z, y \mapsto 1\}$ , but also by  $\gamma_2 \stackrel{\text{df}}{=} \{x \mapsto z, y \mapsto 1, w \mapsto 3\}$ , or  $\gamma_3 \stackrel{\text{df}}{=} \{x \mapsto 1, y \mapsto 1, z \mapsto 1\}$ . Among  $\gamma_1$ ,  $\gamma_2$  and  $\gamma_3$ , only the former is a most general unifier. Notice that  $\gamma_4 \stackrel{\text{df}}{=} \{z \mapsto x, y \mapsto 1\}$  is another most general unifier that could be used instead of  $\gamma_1$ . As shown below, using any of the most general unifiers is equivalent.

Intuitively, the synchronisation is obtained by creating new transitions from pairs of transitions labelled with conjugated actions. The transition resulting from a binary synchronisation is obtained by merging the two synchronised transitions, while unifying their variables and removing the conjugated actions that allowed the binary synchronisation. This process of pairing transitions is repeated until saturation. An example of a synchronisation is provided in figure 6.

**Definition 7 (Synchronisation operation).** Let  $N \stackrel{\text{df}}{=} (S, T, \ell, \alpha)$  be a Petri net with synchronisation and  $a \in \mathbb{A}$  be an action name. The synchronisation of  $N$  with respect to  $a$ , denoted  $N$  sy  $a$ , is the Petri net with synchronisation  $N' \stackrel{\text{df}}{=} (S', T', \ell', \alpha')$  defined as follows:

- $S' \stackrel{\text{df}}{=} S$  and for all  $s \in S$ ,  $\ell'(s) \stackrel{\text{df}}{=} \ell(s)$ ;
- $\ell'$  is  $\ell$  extended on  $S' \cup T' \cup (S' \times T') \cup (T' \times S')$  and  $\alpha'$  is  $\alpha$  extended on  $T'$  as specified below;
- $T'$  is the smallest set of transitions such that  $T \subseteq T'$  and, for all  $t_1, t_2 \in T'$  such that there is one action  $a!(\bar{x}_1) \in \alpha(t_1)$  and one action  $a?(\bar{x}_2) \in \alpha(t_2)$ , and for every unifier  $\gamma$  of  $\bar{x}_1$  and  $\bar{x}_2$ , there is a transition  $t' \in T'$  with
  - $\ell'(t') \stackrel{\text{df}}{=} \gamma(\ell(t_1) \wedge \ell(t_2))$ ,
  - $\alpha'(t') \stackrel{\text{df}}{=} \gamma(\alpha(t_1) - \{a!(\bar{x}_1)\} + \alpha(t_2) - \{a?(\bar{x}_2)\})$
  - for all  $s \in S$ ,  $\ell'(s, t') \stackrel{\text{df}}{=} \gamma(\ell'(s, t_1) + \ell'(s, t_2))$  and  $\ell'(t', s) \stackrel{\text{df}}{=} \gamma(\ell'(t_1, s) + \ell'(t_2, s))$ . ◇

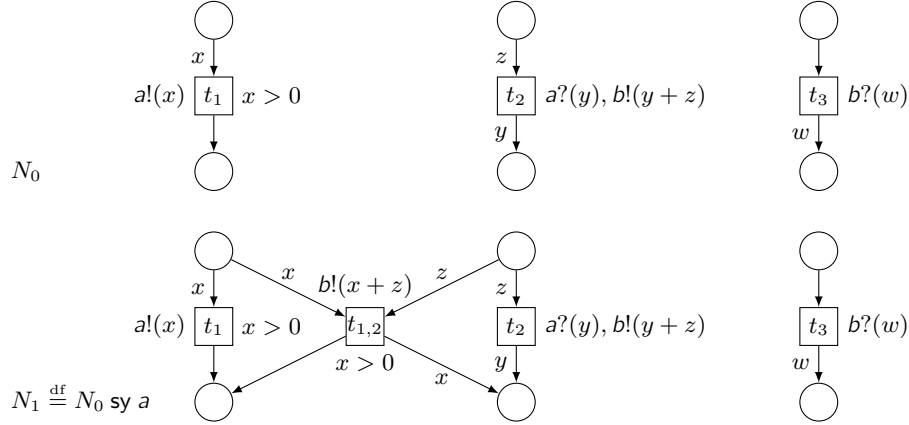

**Fig. 6.** Net  $N_1$  at the bottom is the result of the synchronisation with respect to  $a$  of net  $N_0$  at the top;  $t_1$  and  $t_2$  have been unified by  $\gamma \stackrel{\text{df}}{=} \{y \mapsto x\}$  and merged as  $t_{1,2}$ .

In this definition any most general unifier is acceptable because they all lead to transitions that differ only by a renaming of their variables. Since variables are scoped to each transition and its arcs, this makes no difference to rename them as far as it is made consistently in the guard and the arcs (which is the case in the definition where we use the same unifier for the new transition and its arcs). In general, to reduce the size of Petri nets, among a set of transitions that are identical up to the renaming of their variables, all but one may be removed without changing the behaviour in any essential way.

It may be noted that the definition above can lead to Petri nets with infinitely many transitions. This is the case for instance in the Petri net depicted in figure 7. In practice this situation can be avoided by forbidding a transition to be involved more than once in a synchronisation.

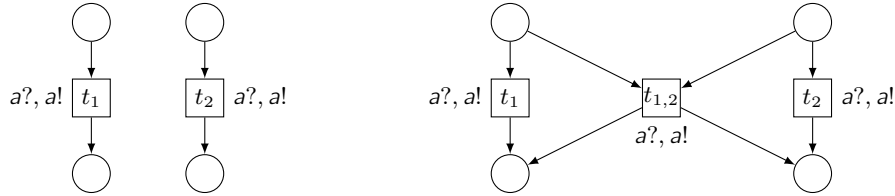

**Fig. 7.** A binary synchronisation of  $t_1$  and  $t_2$  from the left net results in  $t_{1,2}$  in the right net. Transition  $t_{1,2}$  may then be paired with either  $t_1$  or  $t_2$ , resulting in transitions still labelled with multi-action  $\{a?, a!\}$ . So, a similar binary synchronisation may be repeated at will.

**Restriction.** The restriction with respect to an action name simply consists in removing all the transitions that involve this action name. An example of a restriction is provided in figure 8.

**Definition 8 (Restriction operation).** Let  $N \stackrel{\text{df}}{=} (S, T, \ell, \alpha)$  be a Petri net with synchronisation and  $a \in \mathbb{A}$  be an action name. The restriction of  $N$  with respect to  $a$ , denoted  $N \text{ rs } a$ , is the Petri net with synchronisation  $N' \stackrel{\text{df}}{=} (S', T', \ell', \alpha')$  defined as follows:

- $S' \stackrel{\text{df}}{=} S$ ;
- $T' \stackrel{\text{df}}{=} \{t \in T \mid a!(\dots) \notin \alpha(t) \wedge a?(\dots) \notin \alpha(t)\}$ ;
- $\ell'$  is  $\ell$  restricted to  $S' \cup T' \cup (S' \times T') \cup (T' \cup S')$ ;
- $\alpha'$  is  $\alpha$  restricted to  $T'$ .

◇

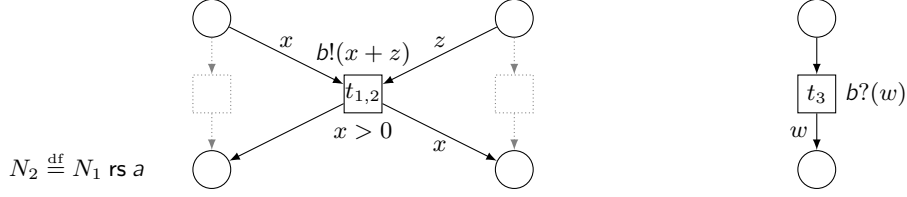

**Fig. 8.** The result of the restriction with respect to  $a$  of the net  $N_1$  from figure 6; transitions  $t_1$  and  $t_2$  (indicated in dotted gray lines) have been removed.

**Scoping.** The scoping operation is simply the successive application of the synchronisation and the restriction. An example of a scoping is provided in figure 9.

**Definition 9 (Scoping operation).** Let  $N$  be a Petri net with synchronisation and  $a \in \mathbb{A}$  be an action name. The scoping of  $N$  with respect to  $a$  is  $N \text{ sc } a \stackrel{\text{df}}{=} (N \text{ sy } a) \text{ rs } a$ .  $\diamond$

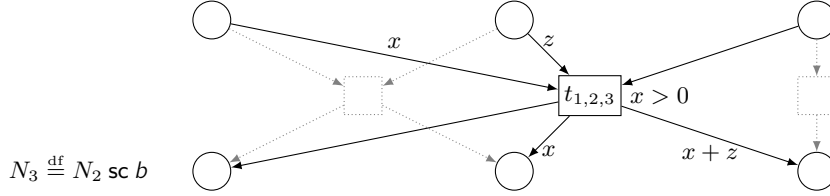

**Fig. 9.** The result of the scoping with respect to  $b$  of the net  $N_2$  from figure 8; transitions  $t_{1,2}$  and  $t_3$  (indicated in dotted gray lines) have been unified by  $\gamma \stackrel{\text{df}}{=} \{w \mapsto x + z\}$  and merged as  $t_{1,2,3}$ .

**Properties.** An important property of Petri nets with synchronisation is that they can be equipped for control flow (or, conversely, a Petri net with control flow can be equipped for synchronisation). Indeed, control flow involves places while synchronisation involves transitions. So, these extensions are orthogonal and perfectly compatible.

Like for control flow operations, algebraic properties of  $\text{sc}$ ,  $\text{sy}$  and  $\text{rs}$  can be established. If  $N$  is a Petri net with synchronisation and  $a_1, a_2 \in \mathbb{A}$ , then:

$$\begin{array}{ll}
 (N \text{ sy } a_1) \text{ sy } a_2 \simeq (N \text{ sy } a_2) \text{ sy } a_1 & \text{commutativity of sy} \\
 (N \text{ sy } a_1) \text{ sy } a_1 \simeq N \text{ sy } a_1 & \text{idempotence of sy} \\
 (N \text{ rs } a_1) \text{ rs } a_2 \simeq (N \text{ rs } a_2) \text{ rs } a_1 & \text{commutativity of rs} \\
 (N \text{ rs } a_1) \text{ rs } a_1 \simeq N \text{ rs } a_1 & \text{idempotence of rs}
 \end{array}$$

Moreover, considering Petri nets with both control flow and synchronisation, if  $\varrho : \mathbb{S} \setminus \{e, i, x, \varepsilon\} \rightarrow \mathbb{S} \setminus \{e, i, x\}$ , we also have:

$$\begin{array}{ll}
 (N \text{ sy } a_1)[\varrho] \simeq (N[\varrho]) \text{ sy } a_1 & \text{commutativity of sy and } [\cdot] \\
 (N \text{ rs } a_1)[\varrho] \simeq (N[\varrho]) \text{ rs } a_1 & \text{commutativity of rs and } [\cdot] \\
 (N \text{ sc } a_1)[\varrho] \simeq (N[\varrho]) \text{ sc } a_1 & \text{commutativity of sc and } [\cdot]
 \end{array}$$

As a consequence, we also have the commutativity of synchronisation, restrictions and scoping with buffer hiding.

## 2.5 Verification issues

In order to verify coloured Petri nets, the traditional approach has been *expansion*, *i.e.*, translation from coloured to place/transition nets. This translation is often called *unfolding* but, since this word is also used for MacMillan's approach [69, 44], we use expansion instead. In this approach, each possible token value in a place is converted into a P/T place and each possible enabling binding of a transition is converted into a P/T transition, the arcs being connected consistently. An example is provided in figure 10

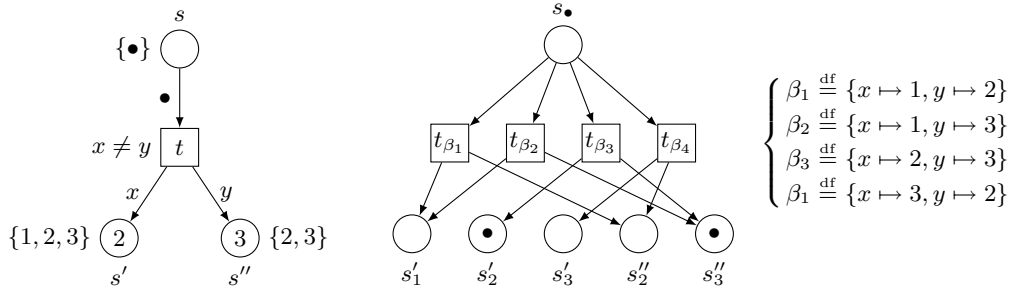

**Fig. 10.** A coloured Petri net (on the left) and its expanded equivalent (on the right). The  $\beta_i$ 's are the enabling bindings of  $t$  in the coloured net as defined on the right part of the picture, the indexes of the places in the right net correspond to the values in the place types from the left net.

The main benefit from the expansion approach is that there exist many analysis techniques and efficient tools dedicated to P/T nets. The problem in general is that the P/T net obtained through expansion is too big and thus intractable; this net can even be infinite if there exist coloured places with infinite types. A large or infinite type on a place does not mean that all these values will be actually present in a reachable marking; in fact only a small subset of these value is usually really reached. If this subset can be identified, expansion can be optimised by reducing the number of P/T places and possible transitions enabling bindings. But very often, this subset cannot be known in advance but only it can be discovered as the state space is explored.

Fortunately, many tools exist to directly analyse coloured Petri nets, in particular [34, 77, 83, 61, 3, 5]. The main efficiency concern with this kind of tool is related to the colour domain: the more general is the colour domain, the more difficult it is to perform fast analysis. In particular, when computing the successors of a marking, the discovery of enabling bindings is a time consuming process.

**Enabling bindings discovery.** Two difficult problems arise when trying to compute the enabling bindings of a transitions:

- matching token values against input arc annotations (an input arc is directed from a place toward a transition);
- finding suitable values for free variables, *i.e.*, those variables that cannot be bound to values by matching tokens with input arcs. For instance, in the left of figure 10,  $x$  and  $y$  are free variables.

The problem of binding free variables can be reduced to the problem of matching tokens by considering that output arcs (*i.e.*, from transitions toward places) can be matched against each of the value in the type of the output place, and guards can be matched against the Boolean domain  $\{\text{False}, \text{True}\}$ . However, this is usually not tractable because output places may have large or even infinite domains.

A simple solution to this problem is to forbid free variables. This is not an issue in practice since free variables usually result from either a mistake, or a need for generating a random value. Forbidding free variables prevents the corresponding mistakes and generating random values can be handled another way:



- add an input place containing all the values among which a random one has to be chosen;
- add a read arc or a self loop labelled by the variable that used to be free, from this place to the transition.

The new place introduce no additional information but increases the memory consumption of each state. However, because its marking never changes, the information about this place can be safely discarded from storage during the state space exploration.

The remaining problem is to match token values against arc annotations. There is in general two solutions to this problem:

- use a restricted colour domain that allows to match any expression against any value. This is for instance the approach in ALPINA [3] that uses *abstract data types* [40] as a colour domain;
- restrict the kind of annotations allowed on input arcs; for instance allowing only values or variables allows for very simple matching or binding.

Restricting the colour domain is generally good for analysis capabilities and performances, but usually bad for ease of modelling. For instance, abstract data types are expressive but not always easy to use by an untrained modeller. On the other hand, restricting the kind of annotations, when not done drastically, is rarely an issue in practice; in particular, we often can transform Petri nets to remove input arcs labelled by expressions. For instance, assume an arc from a place  $s$  toward a transition  $t$  labelled by an expression  $e$ . This arc label may be replaced by a variable  $x \notin \text{vars}(t)$  and the guard of  $t$  may be replaced by  $\ell(t) \wedge (x = e)$ , which usually produces the same result. This transformation is however not possible when the evaluation of  $e$  has side effects. Fortunately, side effects are generally avoided as an error prone programming practice; they are even impossible if the colour domain is a pure functional programming language.

In SNAKES (see section 3), we have chosen to restrict annotations in a way which allowed to have no restriction on the colour domain (full Python language). In CPN tools, annotations of the input arcs have been restricted to what can be expressed with ML pattern-matching [58, sec. 3.7]. Both SNAKES and CPN tools forbid free variables.

**Compiling Petri nets.** Tools like [83, 5, 56] improve efficiency by compiling a Petri net into machine code. The idea is to transform a Petri net into a library that provides all the primitives to explore the state space of the compiled Petri net. For example, each transition can be compiled into a function to discover enabling bindings at a given marking, plus a function to compute the successor of a marking under a given binding. By using this approach, arc annotations and guards are directly copied to the generated code, there is no need to interpret any of them during analysis. In general, compilation avoids the need to continuously query complex data structures (in particular the Petri net structure) throughout the computation. Notice that this is possible only if the annotation language is also the target language of the compiler or can be translated to it.

The code generated by the existing tools is rather generic in that it does not exploit any information from the compiled Petri net other than what is strictly necessary. We propose here to improve this approach by exploiting various information in order to optimise the code generated by the compilation of a Petri net. In particular, the marking data structure can be optimised for speed and memory consumption, which in turn allows to optimise algorithms accordingly:

- in general, the tokens held by a place are stored in a multiset structure; but if the place has singleton type  $\{x\} \subset \mathbb{D}$  (in particular  $\{\bullet\}$ ), a counter of tokens is enough; moreover, if such a place is known to be 1-bounded, then a Boolean is enough to record its marking; finally, the marking of other 1-bounded places can be encoded with a single value in the place type, or with  $\perp$ . By compiling the Petri net, these optimisations are inlined in exploration algorithms instead of being conditional branches of the code that handle the data structures;
- place invariants may be exploited to reduce the number of transitions examined during state space exploration. Consider for instance a Petri net  $(S, T, \ell)$  and let  $I \subseteq S$  be a set of places such that for all reachable marking  $M$ ,  $\sum_{s \in I} M(s) = \{\bullet\}$ . If a transition  $t$  fires and puts a token  $\bullet$  in a place  $s \in I$ , then, we know that all the transitions from  $(I \setminus \{s\})^\bullet$  are disabled because there cannot exist a token in another place in  $I$ . Moreover, transitions from  $\bullet s$  are also disabled since  $s$  cannot be marked by more than one token. In general, such a 1-invariant

$I$  allows to build a generalised exclusion relation: the firing of a transition  $t$  disables all the transitions in  $\bullet(t \cap I) \cup (I \setminus t \bullet)$ . If  $I$  can be computed statically, this conflict relation can also be computed statically and exploited during the state space exploration to avoid considering disabled transitions;

- token flows may be analysed to efficiently maintain a set of enabling bindings over the whole Petri net. For instance, if a transition consumes but does not produce tokens from a place  $s$ , then we know that this will remove enabling bindings for the transitions in  $s \bullet$ . Similarly, if tokens are added to  $s$  but none is removed, we know that this may add enabling binding for the transitions in  $s \bullet$ . Both these situations can be observed statically and the compiled code can be optimised to take this into account.

A prototype implementation of these techniques has been developed and various examples have been used as test cases, in particular some from the domain of security protocols (see section 5.2 for such an example). By compiling various Petri nets, we could achieve speedups ranging 6 to 10, depending on how many optimisations the models allowed us to introduce. These speedups have been measured by comparing compiled nets with all the optimisations disabled with respect to nets with all the optimisations allowed.

**Exploiting structural information.** Providing structural information about the Petri nets to analyse is usually either left to the user of a tool, or obtained by static analysis (*e.g.*, place invariants may be computed automatically). However, in our framework, Petri nets are usually constructed by composing smaller parts instead of being provided as a whole. This is the case in particular when the Petri net is obtained as the semantics of a syntax. In such a case, we can derive automatically many structural information about the Petri nets.

For instance, when considering the modelling and verification of security protocols (see section 5.2), systems mainly consist of a set of sequential processes composed in parallel and communicating through a shared buffer that models the network. In such a system, we know that, by construction, the set of control flow places of each parallel component forms a 1-invariant. This property comes from the fact that the process is sequential and that the Petri net is control-safe by construction. Moreover, we also know that control flow places are 1-bounded, so we can implement their marking with a Boolean instead of an integer to count the tokens as explained above. It is also possible to analyse buffer accesses at a syntactical level and discover buffers that are actually 1-bounded, for instance if any access is always composed either of a put and a get, or of a test, in the same atomic action.

**Parallel computation.** The particular application to security protocols verification is also the context of an ongoing PhD: the goal is to exploit the structure of these models to compute efficiently the reachable states of a Petri net on a parallel computer. In order to guarantee performances, the *bulk synchronous parallel* model of computation, *BSP* [102], is used. A BSP program execution is composed of a succession of *super-steps* separated by *synchronisation barriers*. This model of data parallelism enforces a strict separation of communication and computation: during a super-step, no communication between the processors is allowed, only at the synchronisation barrier they are able to exchange information. This execution policy has two main advantages: first, it removes non-determinism and guarantees the absence of deadlocks; second, it allows for an accurate model of performance prediction based on the throughput and latency of the interconnection network, and on the speed of processors. This performance prediction model can even be used online to dynamically make decisions, for instance choose whether to communicate in order to re-balance data, or to continue an unbalanced computation.

In this context, the current work investigate the use of a fine tuned placement function to distribute computed markings to the processors. Let  $h$  be a placement function to map any marking to a processor number: for a marking  $M$ ,  $h(M)$  is the number of the processor in charge to compute the successors of  $M$ . Let  $G$  be the marking graph of the analysed Petri net and  $B$  the spanning tree on  $G$  obtained from a breadth-first traversal. For two markings  $M_1$  and  $M_2$ , we define  $M_1 < M_2$  iff  $M_1$  is an ancestor of  $M_2$  in  $B$ , and  $\text{depth}(M_1) \stackrel{\text{df}}{=} |\{M' \text{ s.t. } M' < M_1\}|$  is the depth of  $M_1$  in  $B$ . We then define an equivalence relation over markings:  $M_1 \sim M_2$  iff there exist  $M'_1$  and  $M'_2$  such that the following hold:

- $h(M_1) = h(M_2)$ ;
- $\text{depth}(M'_1) = \text{depth}(M'_2)$ ;
- $M'_1 \leq M_1$  and  $M'_2 \leq M_2$ ;
- for  $1 \leq i \leq 2$ , for all  $M$  such that  $M'_i \leq M \leq M_i$  we have  $h(M) = h(M_i)$ .

Using this equivalence relation, we obtain  $G/\sim$  to coincide with the computation graph: each class in  $G/\sim$  is a set of markings in  $G$  that can be computed during a super-step on a given processor, without requiring a communication. For instance, we can use the following algorithm, executed on each processor in parallel:

```

1  todo ← {M0} if h(M0) = cpuid else {} # “cpuid” is the local CPU number
2  seen ← {}
3  wait ← {}
4  total ← 1
5  while total > 0 :
6    while todo ≠ ∅ :
7      choose M in todo
8      todo ← todo \ {M}
9      seen ← seen ∪ {M}
10     for M' in successors(M) :
11       if M' ∈ seen :
12         continue # start next iteration of the for loop
13       elif h(M') = cpuid :
14         todo ← todo ∪ {M'}
15       else :
16         wait ← wait ∪ {M'}
17     todo, total ← exchange(wait)

```

The algorithm starts by defining variables, locally to each processor. Line 1, each processor defines a set of markings it has to proceed in the current super-step; initially, only one processors has the initial marking  $M_0$ , all the other are idle. Line 2, each processor defines the set of states it knows, *i.e.*, all those it has encountered during the computation. Line 3, variable `wait` is defined to store all the states that have been computed by the processor but whose successors have to be computed by another processor; these are the states waiting to be exchanged during the next synchronisation barrier. Line 4, variable `total` is defined to store the total number of markings exchanged at the last barrier. It is initially 1 because there is only one known marking  $M_0$  (it was not exchanged however).

Then comes the main loop on line 5, that repeats until there is no more state to compute on any processor, which is captured by variable `total`. Line 6, an inner loop allows each processor to compute all it can without communicating with others. The computation is quite straightforward: each element in `todo` is proceeded in turn until exhaustion of `todo`; its successors are computed (line 9) and added to `todo` if they must be proceeded locally (line 14), or to `wait` if another processor should proceed them (line 16).

After this loop, line 17, all the awaiting data is exchanged during the synchronisation barrier (triggered by the presence of a communication). Each state in `wait` is sent to the corresponding processor according to  $h$ , and each processor receives a set of states to proceed and the number of states exchanged during the barrier. If this number is zero, then the main loop has to be stopped because all the processors are now idle.

So, a super-step corresponds to one execution of the main loop (except for the first super-step that also executes lines 1-4). The set of markings computed by one processor during a super-step corresponds exactly to one or several classes in  $G/\sim$  as illustrated in figure 11.

From this formalisation follow several observations, in particular:

1. The initial class of  $G/\sim$  should be as small as possible because the first super-step is highly unbalanced.
2. Each class should be large enough to allow for many local computation.
3. In a breadth-first traversal of  $G/\sim$ , each layer should have enough successors that should be well distributed to ensure that the processors have a comparable amount of computation to do.

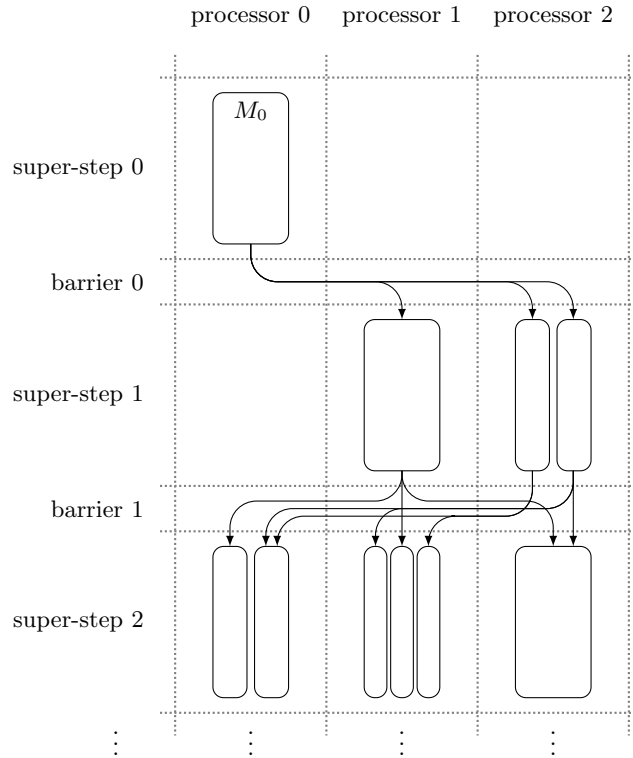

**Fig. 11.** A possible computation graph of the parallel algorithm, assuming three processors  $\{0, 1, 2\}$  and  $h(M_0) = 0$ . The depicted boxes denote classes in  $G/\sim$  ( $M_0$  is an element of the initial class). By definition of the algorithm, in super-step 1, processor 0 is idle (it does not send work to itself).

To satisfy these expectations as much as possible, we can exploit the structure of the analysed model to modify the placement function. In particular,  $h$  can be defined as a classical hash on a subset  $H$  of places instead of on the whole marking. Consider a model consisting of  $n$  sequential processes composed in parallel and communicating through shared places in a set  $S_0$ . Each sequential process  $i$  (for  $1 \leq i \leq n$ ) is defined by set of places  $S_i$  in such a way that the sets  $S_j$  ( $0 \leq j \leq n$ ) form a partition of the places of the Petri net.

The ongoing work is about finding more criteria like those above and trying to derive rules to ensure they can be fulfilled or at least not contradicted. For instance, from the items above, we can derive:

1.  $H$  should contain the entry places of the sequential processes. Doing so, each transition fired from  $M_0$  is likely to consume a token from one entry place and so to change class.
2. From the second item, it is clear that we should have  $H \cap S_0 = \emptyset$ : indeed, each time one of the sequential process sends or receives a message, it produces or consumes a token on a place from  $S_0$ ; if this place is in  $H$  then the new marking is in a new class. In communication protocol, almost each transition involves sending or receiving a message, so, choosing  $H \cap S_0 \neq \emptyset$  contradicts the second criteria.
3.  $H$  should be large enough or contain places with enough possible markings to allow for enough hash values and thus to distribute work on all the processors.

Moreover, we investigate different algorithms following the same methodology but using adapted definitions of  $\sim$ .

## 2.6 Related works

Coloured Petri nets are widely used in numerous variants: almost every tool that deals with coloured Petri nets defines its own colour domain and its own restrictions on annotations. Probably the most

well known tool is CPN tools [34] and its model of ML-coloured Petri nets [58]. Another example of using a functional language is the model of Haskell-coloured Petri nets [95]. In general however, the colour domain is not an existing programming language but is defined together with the analysis tool. For instance, Maria [77] and Helena [83] use a dedicated colour domain that corresponds to data structures that they handle efficiently.

Supporting compositions of Petri nets is generally made by allowing to split a Petri net into *pages* and hierarchies of *modules*, the union of which defining the whole system that is obtained by fusion of the nodes present in several pages. This is more related to decomposition than to composition of Petri nets, in an approach inspired from the splitting of programs into separate files, modules and sub-programs. This approach is a practical requirement for a modeller to be able to work directly at the Petri net level. Moreover it can be exploited for modular verification [29, 70].

On the other hand, defining algebras of Petri nets is the domain of the Petri box calculus family, PBC [11]. Unlike the previous one, this approach directly addresses compositions of Petri nets and so is also applicable to define compositional Petri nets semantics of various formalisms. The PBC is an algebra of P/T nets equipped with a process algebra syntax and two fully consistent semantics: one is a denotational semantics given in terms of Petri nets, the other is an operational semantics given in terms rewriting rules. The operators defined in the PBC are those presented above: control flow and synchronous communication. The PBC has been generalised later as the Petri net algebra, PNA [12]. In parallel, the Petri net compositions have been ported to coloured Petri nets, resulting in a model called M-nets [13], and a syntax have been proposed for the M-nets [64]. M-nets rely for the definition of control flow on a very general refinement operator that allows to substitute an arbitrary transition with an arbitrary net [37]. This operation is well defined and really flexible but in practice leads to nets with complex tree-shaped annotations and tokens, which cannot be handled efficiently during the verification phase. This led to a series of models introducing in PBC the various high-level features that exist in the M-nets. The asynchronous box calculus, ABC [DKKP1,DKK<sup>+</sup>,DKKP2], introduced named places to support explicit asynchronous communication. Then, a variant with coloured buffer places and parametrised synchronous communication have been introduced in [BTKP1,BTKP3]. The ABCD language presented in section 3.3 is a concrete implementation of the asynchronous fragment of this last model. Numerous other variants of the PBC exist, in particular to model timed systems, tasks and exceptions (see the related works surveyed in sections 4 and 5.1).

It is worth noting that not all the variants of the PBC are provided with an operational semantics. This is indeed a features that used to exist to fill a gap between process algebras and Petri nets but has never been really exploited: to the best of our knowledge, no analysis method from the process algebra domain [9] has ever been ported to exploit PBC-like algebras. This aspect has thus been left out of the present document that is focused toward providing models that can be used for systems analysis, which still relies on the Petri net part of those models.

There is a huge amount of literature about the questions around efficient verification of Petri nets, this is partly due to the fact that there exist many variants of Petri nets. But this is definitely a very active topic so we survey her only the works the most directly related to our presentation. As already explained, the traditional verification approach through full expansion is usually deprecated in favour of techniques that directly analyse coloured models. However, ALPINA [3] relies on partial expansion to perform structural analysis, and a tool like PUNF [61] offers a smart alternative to expansion: PUNF can compute finite prefixes of coloured Petri nets unfoldings, by producing just the P/T places that correspond to actually reached markings. So, the result is much smaller than a full expansion. Moreover, the obtained unfoldings are symbolic representations of the state space that can be directly analysed, usually achieving very good compression in the presence of concurrency [69, 44, 62]. Moreover, if the model being unfolded does not have auto-concurrency of transitions (this is the case with our models thanks to the restrictions on the control flow), the so-called *token swapping* phenomenon [10] is avoided, allowing a more efficient computation of the unfolding.

At the coloured level, the question of computing the reachable markings efficiently has been addressed through various works about Maria [77], Helena [83] and CPN tools [34], and more recently about ASAP [5]. Various techniques have been developed regarding various aspects of the problem:

- efficient data structures in the colour domain with dedicated implementation on the verification side allow to achieve both fast computation and low memory consumption [81, 80];

- the stubborn sets technique to reduce the state space by exploiting concurrency has been ported to coloured Petri nets [49];
- modular verification and incremental state space construction allow generally to reduce both memory usage and computation time by avoiding part of the combinatorial explosion that arises in the whole system [70, 68, 63];
- techniques exist to lower memory requirement for the state space, either by storing it explicitly [79, 48], by keeping only required fragments [28, 66], by loosing information about it [55], or by representing it symbolically using unfoldings [69, 44, 62] or decision diagrams [33, 52];
- the model itself may be reduced before to be analysed, while preserving its properties observable through verification [45, 46];
- compilation techniques have been used also in [78, 47], but without considering optimisations of the generated code with respect to the compiled model.

Distributed computation has been used as well either to reduce computation time or to increase storage capabilities. For instance, modular verification [84, 19] and unfolding [53] can be distributed, and the technique to select a subset of place for hashing has been first introduced in Spin model-checker [67]. However, these are *distributed* more than *parallel* algorithms. The difference resides in that parallel computation relies on a model of parallelism, *e.g.*, BSP as presented above. This generally allows to achieve better scalability of algorithms when using hundreds or thousands of processors, or to predict an optimal number of processors for a given computation. Indeed, increasing the number of processors for distributed algorithms usually dramatically increase the amount of communication, which can quickly lead to amortised speedup. Still, distributed algorithms are worth using on small clusters or local networks of workstations, which are widely available and cheap configurations compared to specialised parallel computers.

### 3 SNAKES toolkit and syntactic layers

SNAKES is a software library to define, manipulate and execute Petri nets [POM1]. A large part of the work presented in this document have been implemented within SNAKES or using it.

SNAKES is a Python library that implements Python-coloured Petri nets. Python is a mature, well established, interpreted language. According to its web site [91]:

*Python is a dynamic object-oriented programming language that can be used for many kinds of software development. It offers strong support for integration with other languages and tools, comes with extensive standard libraries, and can be learned in a few days. Many Python programmers report substantial productivity gains and feel the language encourages the development of higher quality, more maintainable code.*

It may be added that Python is free software and runs on a very wide range of platforms. Python has been chosen as the development language for SNAKES because its high-level features and library allows for quick development and easy maintenance, which is important considering that SNAKES is maintained by only one person.<sup>1</sup> The choice of Python as a colour domain then became natural since Python programs can evaluate Python code dynamically. Moreover, if Python is suitable to develop a Petri net library, it is likely that it is also suitable for Petri net annotations.

#### 3.1 Architecture

SNAKES is centred on a *core library* that defines classes related to Petri nets. Then, a set of *extension modules*, *i.e.*, *plugins*, allow to add features to the core library or to change its behaviour. SNAKES is organised as a hierarchy of modules:

- `snakes` is the top-level module and defines exceptions used throughout the library;
- `snakes.data` defines basic data types (*e.g.*, multisets and substitutions) and data manipulation functions (*e.g.*, Cartesian product);
- `snakes.typing` defines a typing system used to restrict the tokens allowed in a place;
- `snakes.nets` defines all the classes directly related to Petri nets: places, transitions, arcs, nets, markings, reachability graphs, etc. It also exposes all the API from the modules above;
- `snakes.plugins` is the root for all the extension modules of SNAKES.

The first four modules above (plus additional internal ones not listed here) form the core library. SNAKES is designed so that it can represent Petri nets in a very general fashion:

- each transition has a guard that can be any Python Boolean expression;
- each place has a type that can be an arbitrary Python Boolean function that is used to accept or refuse tokens;
- tokens may be arbitrary Python objects;
- input arcs (*i.e.*, from places to transitions) can be labelled by values that can be arbitrary Python object (to consume a known value), variables (to bind a token to a variable name), tuples of such objects (to match structured tokens, with nesting allowed), or multisets of all these objects (to consume several tokens). New kind of arcs may be added (*e.g.*, read and flush arcs are provided as simple extensions of existing arcs);
- output arcs (*i.e.*, from transitions to places) can be labelled the same way as input arcs, moreover, they can be labelled by arbitrary Python expressions to compute new values to be produced;
- a Petri net with these annotations is fully executable, the transition rule being that of coloured Petri nets: all the possible enabling bindings of a transition can be computed by SNAKES and used for firing.

<sup>1</sup> SNAKES is quite a large system, in its version 0.9.10 (July 2009), we could count in SNAKES around 100 classes and 14000 lines of code, API documentation and unit tests.

### 3.2 Main features and use cases

Apart from the possibility to handle Python-coloured Petri nets, the most noticeable other features of SNAKES are:

- flexible typing system for places: a type is understood as a set defined by comprehension; so, each place is equipped with a type checker to test whether a given value can be stored or not in the place. Using module `snakes.typing`, basic types may be defined and complex types may be obtained using various type operations (like union, intersection, difference, complement, etc.). User-defined Boolean functions can also be used as type checkers;
- variety of arc kinds can be used, in particular: regular arcs, read arcs and flush arcs;
- support for the Petri net markup language (PNML) [89]: Petri nets may be stored to or loaded from PNML files. In version 0.9.10 of SNAKES, only version 2.0 of PNML is supported: SNAKES can export any net as XML, but this is valid PNML only for P/T nets;
- fine control of the execution environment of the Python code embedded in a Petri net;
- flexible plugin system allowing to extend or replace any part of SNAKES;
- SNAKES is shipped with a compiler that reads ABCD specifications (see section 3.3) to produce PNML files or pictures;
- plugin `gv` allows to layout and draw Petri nets and marking graphs using GraphViz tool [42];
- plugin `ops` implements Petri nets with control flow as defined in section 2.3;
- plugin `synchro` implements Petri nets with synchronisation as defined in section 2.4;
- plugin `query` allows a program to invoke SNAKES remotely over a network connection by exchanging PNML, this makes it possible for a non-Python program to use SNAKES;
- having Python-coloured Petri nets in a Python-programmed library makes it possible to implement the various features of the *nets-within-nets* paradigm [107] as shown in [POM10].

Finally, SNAKES has been used to implement various Petri nets related problems:

- the causal time calculus [POM4] is a timed PBC-like process algebra with a Petri net semantics that has been implemented using SNAKES in less than 200 straightforward lines of code;
- BOON [23] is an object-oriented programming notation with a Petri net semantics that has been implemented using SNAKES from a Java program (over a network socket);
- a Petri net semantics of MINS interconnection networks has been implemented and used for simulation [86];
- a Petri net semantics of the security protocol language [35] has required also about 200 lines of code;
- the compressed state space construction for Petri nets with causal time (presented in section 5.1) have been implemented by combining SNAKES and Lash [17];
- security protocols have been specified and analysed using the ABCD compiler and SNAKES (see sections 5.2);
- the Petri net semantics of a formalism to model biological regulatory networks has been implemented and examples have been studied using SNAKES (see section 5.3).

### 3.3 A syntactical layer for Petri nets with control flow

Considering our Petri nets as a semantics domain, it is possible to define languages adapted to specific usages, with a well defined semantics given in terms of Petri nets. In order to show how our framework makes this easy, we present now a syntax for Petri nets with control flow that embeds Python programming language as colour domain. This language, called the *asynchronous box calculus with data*, or *ABCD*, is a syntax for Petri nets with control flow where:

- the elementary (*i.e.*, not composite) Petri nets are limited to simple ones like those depicted in figure 12;
- the colour domain is the Python language.

ABCD is a compromise between simplicity and expressiveness: not all the features available in the framework are implemented (*e.g.*, there is no synchronisation) but yet the language is useful for many practical situations. In particular, ABCD is well suited to specify modular systems with



basic control flow (including concurrency), and possibly complex data handling. This is the case for many examples from the domain of computing; for instance, security protocols will be addressed in section 5.2 while this section shows a simple railroad example.

An ABCD specification is composed of the following elements:

1. A possibly empty series of *declarations*, each can be:
  - a Python function declaration or module import: this corresponds to extensions of the colour domain;
  - a buffer declaration: a buffer corresponds to a named place in the semantics, thus buffers are typed, unordered and unbounded;
  - a sub-net declaration: this allows to declare a parametrised sub-system that can be instantiated inside an ABCD term.
2. A *process term* that plays the role of the “main” process: the semantics of the full specification is that of this term (built in the context of the provided declarations). Process terms are composed of atomic actions or sub-nets instantiations composed with the usual control flow operators (but replaced with symbols available on a keyboard: ; for sequence, \* for iteration, + for choice and | for parallel). An atomic term is composed of a list of buffer accesses and a guard. For instance:
  - [True] is the silent action that can always be executed and performs no buffer access;
  - [False] is the deadlocked action that can never be executed;
  - [count-(x), count+(x+1), shift?(j), buf+(j+x) if x<10] is an atomic action that consumes a token from a buffer count binding its value to variable x, produces a token computed as x+1 in the same buffer, binds one token in a buffer shift to variable y without consuming it, and produces the result of j+x in a buffer buf. All this is performed atomically and only if x<10 evaluates to True.

The Petri net semantics of these three actions is depicted in figure 12.

A sub-net instantiation is provided as the name of the declared net block followed by the list of effective parameters inside parentheses. The semantics of this instantiation is obtained by substituting the parameters inside the definition of the sub-net and building its semantics recursively. Then, the buffers declared locally to the sub-net are made anonymous using the buffer hiding operator.

The semantics of a term is obtained by composing the semantics of its sub-terms using the specified control flow operators. Finally, the semantics of a full specification also includes the initial marking of entry and buffer places.

Like in Python, blocks nesting is defined through source code indentation only, and comments start with character “#” and end with the line. Like in most compiled programming languages (and unlike in Python), ABCD has lexical scoping of the declared elements: an element is visible from the line that follows its declaration until the end of the block in which it is declared. As usual, declaring again an element results in masking the previous declaration.

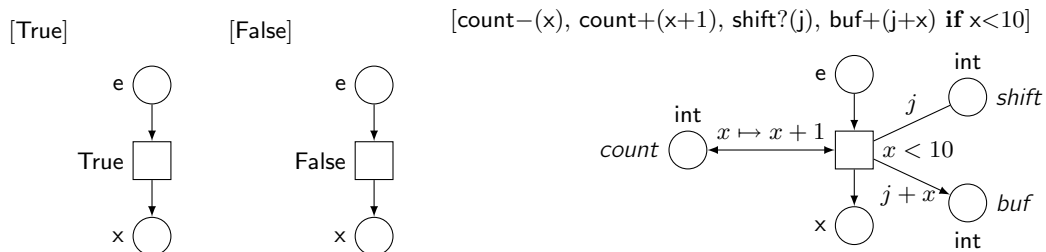

**Fig. 12.** The Petri net semantics of various ABCD atomic actions. The undirected arc attached to place *shift* is a read arc that binds *j* to a token but does not consume it upon firing.

**Example.** As an illustration, let us consider a simple railroad crossing involving:

- one track on which trains can arrive repeatedly;
- one road crossing the track;
- a pair of gates to prevent cars to go on the track when a train is approaching;
- a red light to prevent the train to cross the road before the gates completely close.

When a train is approaching, a sensor on the track turns light to red and commands the gates to go down. When they arrive down, the light is reset to green. When the train leaves the gates, they are commanded to go up.

This system can be specified in ABCD as follows. We first specify global buffers to model the red light and a communication channel between the track and the gates:

```

1 | # light is initially "green"
2 | buffer light : in("red", "green") = "green"
3 | # no command is available initially
4 | buffer command : in("up", "down") = ()

```

Keyword **in** used in the context of a buffer type definition specifies that this is an enumerated type whose values are those provided inside parentheses as Python values. So, for instance, buffer **light** can only hold the two strings "red" and "green" and initially contains "green".

Then we specify the behavior of the gates and provide for them an internal buffer allowing to easily observe their current state.

```

5 | net gates () :
6 |   # gates are initially "open"
7 |   buffer state : in("open", "move", "closed") = "open"
8 |   # a sequence of actions
9 |   (# receive command "down" and start moving
10 |    [command−("down"), state−("open"), state+("move")];
11 |    # finish to close and reset light to "green"
12 |    [state−("move"), state+("closed"), light−("red"), light+("green")];
13 |    # receive command "up" and start moving
14 |    [command−("up"), state−("closed"), state+("move")];
15 |    # finish to open
16 |    [state−("move"), state+("open")])
17 |   # this sequence is infinitely repeated because the loop exit cannot be executed
18 |   * [False]

```

Then we specify the track on which trains can repeatedly arrive:

```

19 | net track () :
20 |   # we also need to observe if a train is crossing the road
21 |   buffer crossing : bool = False
22 |   # here also a sequence is infinitely repeated
23 |   (# a train is approaching: light is turned red and gates are commanded to close
24 |    [command+("down"), light−("green"), light+("red")];
25 |    # the train must wait for green light before to go further and cross the road
26 |    [light?("green"), crossing−(False), crossing+(True)];
27 |    # when the train leaves, gates are commanded to open
28 |    [crossing−(True), crossing+(False), command+("up")])
29 |   * [False]

```

The full system is specified by running in parallel one instance of the gates and one of the track.

```

30 | gates() | track()

```

The semantics of this system is depicted in figure 13. We can notice that the buffers **state** and **crossing** declared in sub-nets result each in an anonymous place: indeed, each has been hidden during net instantiation, which takes place before the parallel composition, so the composition could not merge these buffers. On the contrary, buffers **command** and **light** are globally declared and thus result each in one merged named place.

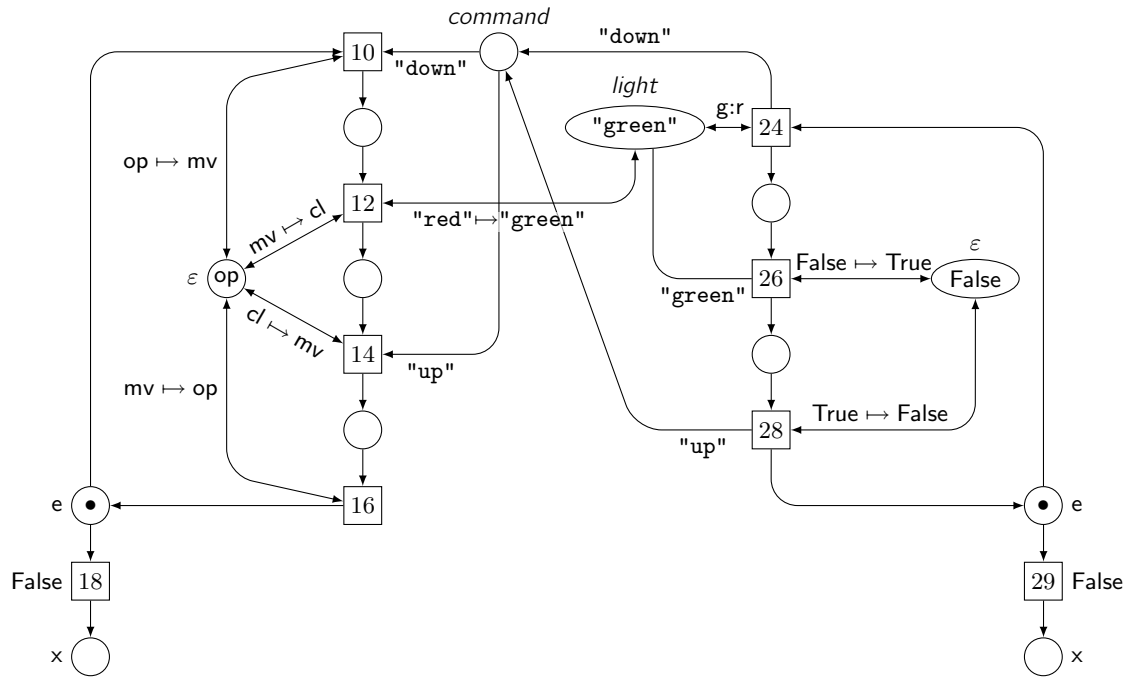

**Fig. 13.** The semantics of  $\text{gates}() \mid \text{track}()$ , where  $\text{op} \stackrel{\text{df}}{=} \text{"open"}$ ,  $\text{cl} \stackrel{\text{df}}{=} \text{"closed"}$ ,  $\text{mv} \stackrel{\text{df}}{=} \text{"move"}$  and  $\text{g:r} \stackrel{\text{df}}{=} (\text{"green"} \mapsto \text{"red"})$ . The unlabelled places are internal ones. The anonymous place marked by  $\text{op}$  implements buffer state of net  $\text{gates}$ . The anonymous place marked by  $\text{False}$  implements buffer crossing of net  $\text{track}$ . Transition names correspond to the line numbers of the atomic actions they implement.

This Petri net may be model-checked, for instance by searching a reachable state such that the right-most anonymous place (*i.e.*, buffer crossing from sub-net  $\text{track}$ ) is marked by  $\text{True}$  while the left-most anonymous place (*i.e.*, buffer state from sub-net  $\text{gates}$ ) is not marked by  $\text{"closed"}$ . Such a state would violate the basic safety condition: gates are closed whenever a train is crossing the road. It can be checked that no such state is reachable with the current model.

### 3.4 Related works

Several existing tools may be related in particular to  $\text{SNAKES}$ . The first one is the Petri net kernel,  $\text{PNK}$  [96], that shares with  $\text{SNAKES}$  the aim to provide a general framework for building Petri nets applications. The  $\text{PNK}$  provides a graphical user interface for editing and simulating Petri nets. With respect to  $\text{SNAKES}$ , the basic model of the  $\text{PNK}$  is a less general model of coloured Petri nets; however, this may be extended by writing Java code. Another difference is that the  $\text{PNK}$  does not provide any of the operations to manage models from the  $\text{PBC}$  family, which is of course not its aim. The development of the  $\text{PNK}$  does not appear to be active anymore, the last release being dated of March 2002. The  $\text{PNK}$  is free software distributed under the terms of the  $\text{GNU GPL}$ , which forces tools that use the  $\text{PNK}$  to be released under the same licence.  $\text{SNAKES}$  uses  $\text{GNU LGPL}$ , which is less restrictive and allows to produce non-free software that uses  $\text{SNAKES}$ , but forces to release under the  $\text{GNU LGPL}$  any change made to  $\text{SNAKES}$ .

Another tool with which  $\text{SNAKES}$  shares some goals is the Programming environment based on Petri nets,  $\text{PEP}$  [85]. The main similarity between the two tools is that both deal with  $\text{PBC}$  and  $\text{M-nets}$  models. The main difference is that  $\text{PEP}$  is oriented toward model-checking, proposing a graphical user interface to define Petri net models through various ways. The Petri nets variants in  $\text{PEP}$  are fixed, mainly variants of  $\text{PBC}$  and a restricted version of  $\text{M-nets}$ ; this cannot be changed by users.  $\text{PEP}$  also appears to be not maintained anymore, the last release being dated of September 2004.  $\text{PEP}$  was the tool we used before to decide to develop  $\text{SNAKES}$ . The main reason for this decision was the impossibility to update  $\text{PEP}$  quickly enough with respect to theoretical developments in

the PBC family, which is not surprising since PEP was never designed with this goal in mind. Like the PNK, PEP is released under the GNU GPL.

Compared with CPN tools [34], SNAKES shares the ability to use a programming language for nets inscriptions: a variant of ML for CPN tools, and Python for SNAKES. This makes it possible to extend a lot the features of CPN tools. However, it does not provide support to introduce another variant of Petri nets, for instance by changing the transition rule. So, there might be new models of Petri nets that cannot be represented using one of those provided by CPN tools, and thus for which the tools cannot be used. Another important difference is that CPN tools is a end-user tool with an advanced graphical user interface while SNAKES is a programming library. Finally, CPN tools is not open source.

More generally, since any Petri net modelled in SNAKES may be executed, it could be compared with any Petri net tool that can simulate nets or compute their reachability graph. However, executing nets is not the main purpose of SNAKES and it is not designed to do it efficiently (even if it turns out to be satisfactory in many practical situations).

There exist many works dedicated to the translation of various syntax to Petri nets among which essentially one can be directly related to ABCD: the basic Petri net programming notation,  $B(PN)^2$  [14, POM2, PS, KP4], aims at providing a syntax that is close to programming languages, unlike ABCD that is rather inspired by process algebra.  $B(PN)^2$  can be considered as more complete than ABCD with respect to its features, indeed, its latest extensions propose constructions for procedures, tasks, exceptions and preemption. However, only procedures are implemented in PEP. On the other hand, ABCD can be considered as a lightweight alternative whose semantics produces more compact Petri nets. Both languages use the notion of atomic actions as the most basic execution element. However, data in  $B(PN)^2$  is stored into variables instead of buffers; this makes necessary to distinguish the value of a variable before the execution of an atomic action from the value after its execution, denoted respectively by  $'x$  and  $x'$ .

## 4 Multi-threaded extension

In this section, we present an extension to Petri nets with control flow to introduce two modelling features: threads and exceptions. The former is modelled as the capability to execute concurrently several instances of a sub-net, each being a sequential process. By restricting parallelism to sequential threads running concurrently, it becomes possible to introduce in a simple way an exception mechanism. Notice that this extension is compatible with Petri nets with synchronisation. Notice also that exchanging parallel composition with threads does not limit expressivity. Indeed, instead of a parallel composition  $N_1 \parallel N_2$ , it is possible to specify a sequence like  $start(N_2) \ddagger N_1 \ddagger wait(N_2)$  where  $start(N_2)$  and  $wait(N_2)$  are appropriate nets to respectively start a new thread as an instance of  $N_2$  and wait for its termination. This results in essentially the same behaviour.

To start with, we introduce the sequential fragment of the extension, defining *Petri nets with exceptions*. On the top of this model, a new construct is added to support threading, leading to define *Petri nets with threads*. In most of this section, we deal with unmarked Petri nets; this will be justified when the elements to understand the reasons for this choice will be available. At the end, we will see how to introduced markings again.

### 4.1 Sequential fragment and exceptions

We consider a model of *Petri nets with exceptions*, similar to Petri nets with control flow. The main differences are that there is no parallel composition and that control flow places are now coloured by two kind of tokens:

- black tokens  $\bullet$  are used for regular control flow;
- white tokens  $\circ$  are used for exception control flow.

As a consequence of this change, we will need to redefine the control flow operations.

**Definition 10 (Petri nets with exceptions).** *A Petri net with exceptions is a tuple  $(S, T, \ell, \sigma)$  where:*

- $(S, T, \ell)$  is a Petri net;
- $\sigma$  is a function  $S \rightarrow \mathbb{S}$  that provides a status for each place;
- every place  $s \in S$  with  $\sigma(s) \in \{e, i, x\}$  is such that  $\ell(s) = \{\bullet, \circ\}$ ;
- there is exactly one entry place and one exit place in  $S$ .

Moreover, every marked Petri net with exception is assumed to be control-safe, i.e., its initial marking and any marking reachable from it are such that exactly one control flow place is marked and this marking is either  $\{\bullet\}$  or  $\{\circ\}$ .  $\diamond$

Notice that the control-safe requirement on Petri nets with exceptions does not really imply that they are sequential. However, this is enough since we ensure that exactly one control flow token resides in a net and so we can guarantee its correct transmission from one net to another through the control flow compositions.

**Operator nets.** By discarding the parallel composition, we consider only three of the previously defined control flow operations. Their behaviour is adapted to the possibility of an exception occurrence. Moreover, we define a new *trap* operator to capture exceptions. Let  $N_1$  and  $N_2$  be two Petri nets with exceptions:

- sequential composition  $N_1 \ddagger N_2$  is executed as usual, but if an exception occurs during the execution of  $N_1$ , then  $N_2$  is not executed and the exception is propagated outside of the composition (i.e., a token  $\circ$  is produced in the exit place of the sequence);
- choice  $N_1 \square N_2$  is as usual (but exceptions may occur during the execution of either  $N_1$  or  $N_2$ );
- iteration  $N_1 \otimes N_2$  is executed as usual, but if an exception occurs during an execution of  $N_1$ , then  $N_2$  is not executed and the exception is propagated outside of the composition;

- trap  $N_1 \triangleright N_2$  starts its execution as  $N_1$ , and if an exception occurs during the execution of  $N_1$ , then  $N_2$  is executed once; otherwise  $N_2$  is not executed at all. So,  $N_2$  can be considered as an exception handler.

These operators are defined as previously using operator nets and a two-phases algorithm (gluing and merging). The gluing phase has to be redefined but the merging phase is exactly the same as defined for Petri nets with control flow. The new operator nets are depicted in figure 14. As previously, they can be understood as if each transition  $t_i^\diamond$ , for  $\diamond \in \{\ddagger, \square, \otimes, \triangleright\}$ , is to be replaced by the  $i$ -th operand net, the labels on the arcs meaning:

- if  $\bullet$ , only black tokens are allowed to flow on this arc;
- if  $\circ$ , only white tokens are allowed;
- if  $\star$ , both black and white tokens are allowed.

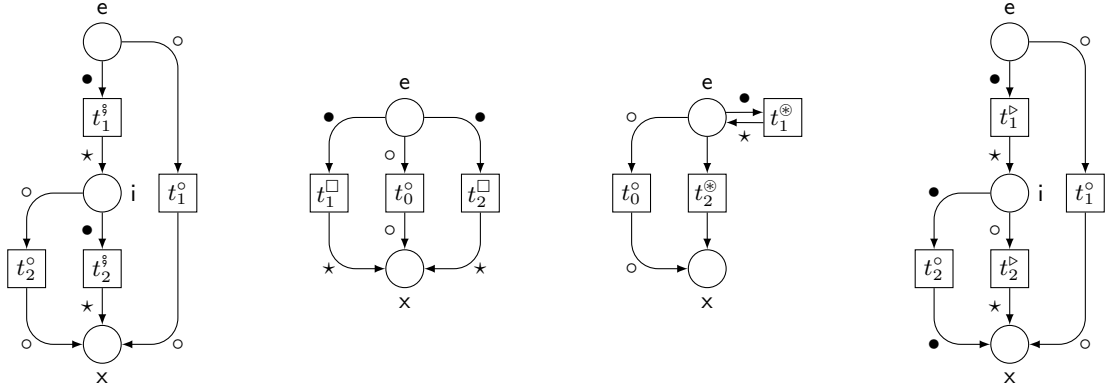

**Fig. 14.** Operators nets  $N_{\ddagger}$ ,  $N_{\square}$ ,  $N_{\otimes}$  and  $N_{\triangleright}$  (left to right). All transition guards are True.

Consider for instance the left most net, that specifies the sequence operator, and take  $N_1 \ddagger N_2$  the sequential composition of  $N_1$  and  $N_2$ .  $N_{\ddagger}$  is started by putting one token in its entry place, if this is  $\bullet$ , transition  $t_1^{\ddagger}$  and thus net  $N_1$  is executed. When it terminates, it produces a token in the internal place. Again, if this is  $\bullet$ ,  $t_2^{\ddagger}$  and thus  $N_2$  is executed until it puts a token in the exit place. But, if  $N_1$  terminates with a token  $\circ$ , indicating an exception during the execution of  $N_1$ , transition  $t_2^{\circ}$  is executed instead of  $t_2^{\ddagger}$ , which results in skipping  $N_2$  and propagating the error until a trap. Similarly, if the net is started with  $\circ$  in the entry place, this is directly propagated to the exit place through transition  $t_1^{\circ}$ . The situation is similar for the choice and iteration operators. Consider now the trap operator net  $N_{\triangleright}$ . It has the same structure as  $N_{\ddagger}$  but different tokens on the arcs after the internal place: here, if  $N_1$  terminates with  $\bullet$ , this token is directly propagated to the exit place; but if  $N_1$  produces  $\circ$ , this token allows to execute  $t_2^{\triangleright}$  and thus  $N_2$ , which is how the trap actually allows to capture exceptions. Notice that the arcs going out of the transitions  $t_i^\diamond$  allow any token to be produced as the result of the execution of  $N_i$ .

In order to know how the labelling of arcs in an operator net influences the labelling of arcs in the resulting nets, we define a function  $\theta$  that maps a pair of arcs labels (in operator and operand nets) to the label that has to be used in the resulting net. This function is defined by the array depicted in figure 15.

Consider for instance transition  $t_1^{\triangleright}$  in operator net  $N_{\triangleright}$  and assume an operand net  $N_1$  that has an entry places  $e$  with outgoing arcs to two transitions:

$$e \xrightarrow{\{\bullet\}} t_1 \quad \text{and} \quad e \xrightarrow{\{\circ\}} t_2 .$$

When  $N_1$  is substituted to  $t_1^{\triangleright}$ , its place  $e$  becomes the entry place of the resulting net that also includes  $t_1$  as well as  $t_2$ . But the operator net allows only  $\bullet$  to enter  $t_1^{\triangleright}$  and thus to enter  $N_1$ . To

|                |               |               |             |               |
|----------------|---------------|---------------|-------------|---------------|
| operator label | $\{\bullet\}$ | $\{\circ\}$   | $\{\star\}$ | $\emptyset$   |
| operand label  | $\{\bullet\}$ | $\{\bullet\}$ | $\{\circ\}$ | $\{\bullet\}$ |
|                | $\{\circ\}$   | $\{\perp\}$   | $\{\perp\}$ | $\{\circ\}$   |
|                | $\emptyset$   | $\emptyset$   | $\emptyset$ | $\emptyset$   |
|                | $m$           | $\{\perp\}$   | $\{\perp\}$ | $m$           |

**Fig. 15.** The definition of  $\theta$ , where  $m$  is a multiset over  $\mathbb{E}$  that is neither  $\{\bullet\}$ ,  $\{\circ\}$  nor  $\emptyset$ .

enforce this, the labels of the arcs outgoing from  $e$  in the resulting net are computed using  $\theta$  and we have:

$$\begin{aligned} e \xrightarrow{\theta(\{\bullet\},\{\bullet\})} t_1 &\implies e \xrightarrow{\{\bullet\}} t_1, \\ e \xrightarrow{\theta(\{\bullet\},\{\circ\})} t_2 &\implies e \xrightarrow{\{\perp\}} t_2. \end{aligned}$$

So the arc to  $t_1$  is preserved because it is allowed while the arc to  $t_2$  is relabelled with  $\{\perp\}$ . As a result,  $t_2$  becomes a dead transition because  $\perp$  is not in the type of control flow places. So, tokens  $\circ$  introduced in  $e$  flow through the transition  $t_1^\circ$  (from  $N_\triangleright$ ) in the resulting net, which is the expected behaviour. Because any token is allowed to flow out of  $t_1^\circ$ , the arcs to the exit place of  $N_1$  is not changed (see the  $\{\star\}$  column in figure 15). Consider now transition  $t_2^\triangleright$ , substituted with the same net  $N_1$ . The result of applying  $\theta$  is now:

$$\begin{aligned} e \xrightarrow{\theta(\{\circ\},\{\bullet\})} t_1 &\implies e \xrightarrow{\{\circ\}} t_1, \\ e \xrightarrow{\theta(\{\circ\},\{\circ\})} t_2 &\implies e \xrightarrow{\{\perp\}} t_2. \end{aligned}$$

So, the precise meaning of the arc to  $t_2^\triangleright$  is actually “take one token  $\circ$  in the internal place and start the net substituted to  $t_2^\triangleright$ ”. So, a token  $\circ$  is directly consumed by  $t_1$ , *i.e.*, by the transition that corresponds to the regular starting of  $N_1$ .

**Gluing phase.** We can now define the new gluing phase. Compared with the previous definition, the new one does not involve Cartesian products of entry or exit places because there is exactly one of each in every Petri net with exceptions. Instead, a simple merging of the combined places is enough to enforce the desired control flow. On the other hand, the definition takes into account the use of  $\theta$  and the presence of the additional transitions  $t_j^\circ$  from the operator nets.

Let  $N_1 \stackrel{\text{df}}{=} (S_1, T_1, \ell_1)$  and  $N_2 \stackrel{\text{df}}{=} (S_2, T_2, \ell_2)$  be two disjoint Petri nets with exceptions. Take  $\diamond \in \{\circ, \square, \otimes, \triangleright\}$  and the corresponding operator net  $N_\diamond \stackrel{\text{df}}{=} (S_\diamond, T_\diamond, \ell_\diamond)$  assumed disjoint from both  $N_1$  and  $N_2$ . Composition  $N_1 \diamond N_2$  is  $N \stackrel{\text{df}}{=} (S, T, \ell)$  defined as follows.

First, the nodes from  $N_1$  and  $N_2$  are copied to  $N$ , together with the arcs connecting them. So, for  $1 \leq i \leq 2$ , for all  $s_i \in S_i$  and all  $t_i \in T_i$

- $s_i$  is also a place in  $S$  with  $\ell(s_i) \stackrel{\text{df}}{=} \ell_i(s_i)$  and  $\sigma(s_i) \stackrel{\text{df}}{=} \sigma_i(s_i)$ ;
- $t_i$  is also a transition in  $T$  with  $\ell(t_i) \stackrel{\text{df}}{=} \ell_i(t_i)$ ;
- $\ell(s_i, t_i) \stackrel{\text{df}}{=} \ell_i(s_i, t_i)$  and  $\ell(t_i, s_i) \stackrel{\text{df}}{=} \ell_i(t_i, s_i)$ .

The transitions of the operator net that are not replaced by a  $N_i$  are also copied to the resulting net: for all  $t \in T_\diamond \setminus \{t_1^\circ, t_2^\circ\}$ , we also have  $t \in T$  with  $\ell(t) \stackrel{\text{df}}{=} \ell_\diamond(t)$ .

Finally, entry and exit places are combined to enforce the desired control flow. To do so, we rely on the operator net  $N_\diamond$ : we consider in turn all the places  $s_\diamond$  of  $N_\diamond$  and collect in a set  $P$  the places originated from each  $N_i$  that should be merged and become the realisation of  $s_\diamond$  in the resulting net. So, for  $1 \leq i \leq 2$ :

- if  $\ell_\diamond(s_\diamond, t_i^\circ) \neq \emptyset$  then the entry place  $e_i$  from  $N_i$  is added to  $P$ ;
- if  $\ell_\diamond(t_i^\circ, s_\diamond) \neq \emptyset$  then the exit place  $x_i$  from  $N_i$  is added to  $P$ .

The places in  $P$  are merged, yielding a new place  $s$  whose label and status are that of  $s_\diamond$ . The last operation related to  $s_\diamond$  is to adjust through  $\theta$  the labelling of the arcs between  $s$  and the transitions originated from each  $N_i$ ; moreover,  $s$  has to be connected to the transitions originated from  $N_\diamond$ :

- for  $1 \leq i \leq 2$ , for all  $t_i \in T_i$ , and for all  $c \in N_i^e \cup N_i^x$ :  $\ell(s, t_i) \stackrel{\text{df}}{=} \theta(\ell_\diamond(s_\diamond, t_i^\diamond), \ell_i(c, t_i))$  and  $\ell(t_i, s) \stackrel{\text{df}}{=} \theta(\ell_\diamond(t_i^\diamond, s_\diamond), \ell_i(t_i, c))$ ;
- for all  $t \in T_\diamond \setminus \{t_1^\diamond, t_2^\diamond\}$ ,  $\ell(s, t) \stackrel{\text{df}}{=} \ell_\diamond(s_\diamond, t)$  and  $\ell(t, s) \stackrel{\text{df}}{=} \ell_\diamond(t, s_\diamond)$ .

Optionally, the transitions in the resulting net having an incoming arc labelled by  $\{\perp\}$  can be removed because they are dead transitions.

**An exception mechanism.** What we have defined so far is a way to separate a regular control flow from an exception control flow. However, this is not really an exception mechanism since we cannot yet associate information to the occurrences of exceptions.

Usually, an exception is given a class (*i.e.*, the exception type) and a value (*e.g.*, a message); however we can consider that this is just one arbitrary value. To store this information, each Petri net with exception can be equipped with a data place named *except* whose type  $Err$  allows to store the desired values. Using a single place is possible since a Petri net with exception is sequential so there cannot occur more than one exception at the same time.

Then, to raise an exception associated with a value  $e \in Err$ , we can use the Petri net  $R_e$  depicted in figure 16. Its behaviour is very simple: when the transition fires, it changes the regular control flow to exception control flow (*i.e.*, consumes a black token in the entry place and produces a white token in the exit place), while storing the exception value in place *except*.

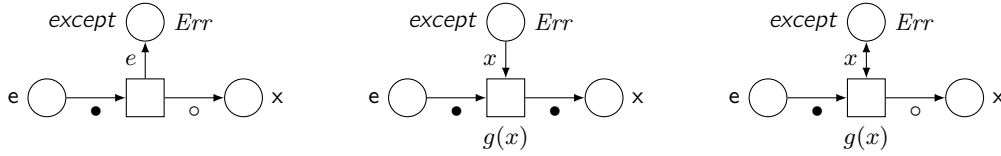

**Fig. 16.** Left: net  $R_e$  that raises an exception with value  $e \in Err$ . Middle: net  $C_g$  that catches an exception value according to a Boolean function  $g$ . Right: net  $P_g$  that catches and propagates an exception value according to a Boolean function  $g$ .

The exception value stored in *except* is intended to be retrieved by an exception handler. Most programming languages allow to select the exception to catch, usually according to its type. Let us consider a Petri net  $N$  from which we want to catch exceptions  $e_1$  or  $e_2$  to trigger handlers  $H_1$  and  $H_2$  respectively, while we want to let the other exceptions propagate to an outer handler. This is possible by combining a trap to capture the error and a choice to select the handler. Consider the Petri nets  $C_g$  and  $P_g$  depicted in figure 16, they are parametrised by a Boolean function  $g$  that is used in the guards to accept or refuse an exception value. Using these nets, our situation may then be modelled as:

$$N \triangleright ((C_{\lambda x: x=e_1} \ddagger H_1) \square (C_{\lambda x: x=e_2} \ddagger H_2) \square P_{\lambda x: x \notin \{e_1, e_2\}})$$

We can treat in a similar way the case where, instead of propagating an unknown exception, we want to handle it using a net  $H$ :

$$N \triangleright ((C_{\lambda x: x=e_1} \ddagger H_1) \square (C_{\lambda x: x=e_2} \ddagger H_2) \square (C_{\lambda x: x \notin \{e_1, e_2\}} \ddagger H))$$

## 4.2 Threading mechanism

We now define a model of *Petri nets with threads* that introduces various features allowing to:

- run concurrently multiple instances (*threads*) of a Petri net with exceptions;



- create (or *spawn*) threads dynamically;
- wait for threads termination;
- setup communication between threads through shared buffer places;
- check relationship between threads (parenthood, siblinghood, etc.);
- test whether a thread as terminated with an exception or not;
- implement function calls on the top of threads.

We call *task* a Petri that supports threads, *i.e.*, a task is a Petri net from which separate concurrent executions may be obtained. Each of this execution is a sequential process called a *thread*. A task is thus a static object that is implemented as a Petri net (or part of a Petri net), whereas a thread is a dynamic object that corresponds to tokens in the Petri net implementation of a task. To distinguish tasks, each is assigned a *task name* from a set  $\mathbb{T}$ . Similarly, to distinguish threads, each is assigned a *process identifier* (or *pid*) from a set  $\mathbb{P}$ .

A task is created from a Petri net with exceptions  $N$  and a task name  $task$  using a dedicated operation denoted by  $\langle task : N \rangle$ . This result in a Petri net with two distinguished places named  $task.start$  and  $task.stop$ . A thread is created by putting a token into the place named  $task.start$ ; when it terminates its execution, it creates a token in the place named  $task.stop$ , this token may be collected by another thread that is waiting for this termination. The two places named  $task.start$  and  $task.stop$  play the same role for the task that the entry and exit places for the corresponding Petri net with exceptions.

Finally, tasks may be combined using parallel composition, resulting in *Petri nets with threads*. The relations between these various classes of Petri nets is illustrated in figure 17.

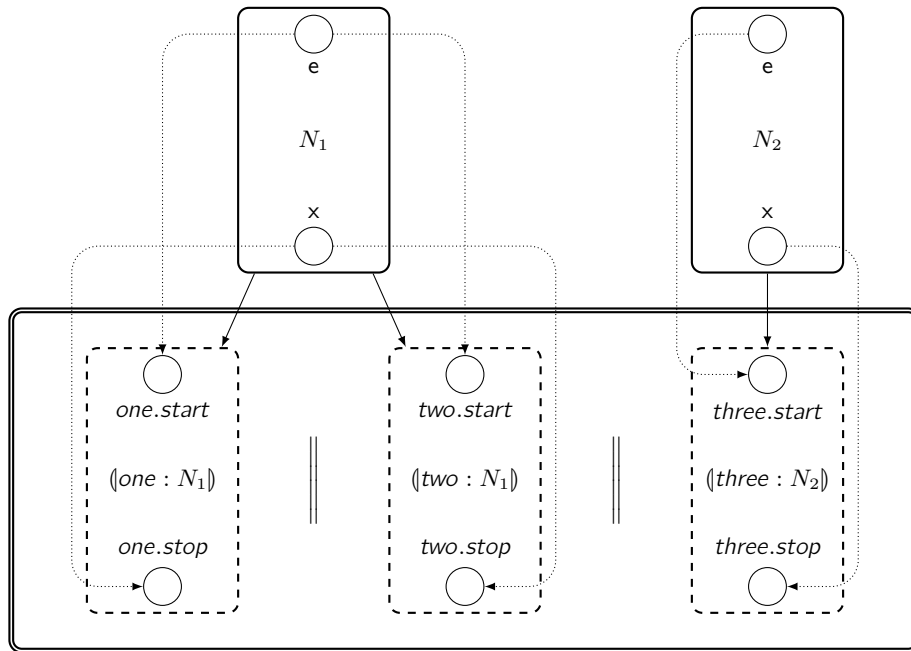

**Fig. 17.** The structure of the Petri net with threads framework. Boxes with plain line at the top represent Petri nets with exceptions  $N_1$  and  $N_2$ , each depicted with its entry and exit place. Boxes with dashed lines at the bottom represent tasks build from  $N_1$  and  $N_2$ . Plain arcs show which task derives from which Petri net with exception. Dotted arcs indicate how entry (resp. exit) places in the Petri nets with exceptions are transformed into start (resp. stop) places in the tasks. Finally, the large box with double line at the bottom represents the Petri net with threads obtained as  $\langle one : N_1 \rangle \parallel \langle two : N_1 \rangle \parallel \langle three : N_2 \rangle$ .

**Petri nets with threads.** Tasks are named from the elements of  $\mathbb{T}$ , these names are used to build place names in order to be able to start a thread or wait for its termination. So, we assume that, for all  $task \in \mathbb{T}$ , we have  $\{task.start, task.stop\} \subset \mathbb{S} \setminus \{e, i, x, \varepsilon\}$ .

Running several instances of a Petri net could not be obtained by just putting several tokens in its entry place because they would be all identical. Instead, we build the task so that every place  $s$  of the original Petri net is copied to the task with the type  $\mathbb{P} \times \ell(s)$  in order to associate each token to a pid. The arcs connected to these places are changed accordingly to pairs  $(\pi, x)$  where  $\pi \in \mathbb{V}$  is a reserved variable that can be interpreted as “my pid”. Some places should not be changed: these are the non-anonymous data places that may be merged later on with those from other tasks composed in parallel. These named places can be thought as external shared resources used from within the task and, as such, not modified by the operation.

More precisely, let  $N \stackrel{\text{df}}{=} (S, T, \ell, \sigma)$  be a Petri net with exceptions,  $(task : N) \stackrel{\text{df}}{=} (S', T', \ell', \sigma')$  is defined as follows:

- $T' \stackrel{\text{df}}{=} T$  and, for all  $t \in T'$ ,  $\ell'(t) \stackrel{\text{df}}{=} \ell(t)$ ;
- for every place  $s \in S$  such that  $\sigma(s) \in \mathbb{S} \setminus \{e, i, x, \varepsilon\}$ ,  $s$  is also a place in  $S'$  with  $\ell'(s) \stackrel{\text{df}}{=} \ell(s)$  and  $\sigma'(s) \stackrel{\text{df}}{=} \sigma(s)$ ; moreover, for all  $t \in T'$ ,  $\ell'(s, t) \stackrel{\text{df}}{=} \ell(s, t)$  and  $\ell'(t, s) \stackrel{\text{df}}{=} \ell(t, s)$ ;
- for every place  $s \in S$  such that  $\sigma(s) \in \{e, x, i, \varepsilon\}$ , there is a place  $s'$  in  $S'$  with  $\ell'(s') \stackrel{\text{df}}{=} \mathbb{P} \times \ell(s)$  and

$$\sigma'(s') \stackrel{\text{df}}{=} \begin{cases} task.start & \text{if } \sigma(s) = e, \\ task.stop & \text{if } \sigma(s) = x, \\ \sigma(s) & \text{otherwise;} \end{cases}$$

moreover, for all  $t \in T'$ ,  $\ell'(s', t) \stackrel{\text{df}}{=} \{(\pi, x) \mid x \in \ell(s, t)\}$  and  $\ell'(t, s') \stackrel{\text{df}}{=} \{(\pi, x) \mid x \in \ell(t, s)\}$ .

The parallel composition of two disjoint nets  $N_1 \stackrel{\text{df}}{=} (S_1, T_1, \ell_1, \sigma_1)$  and  $N_2 \stackrel{\text{df}}{=} (S_2, T_2, \ell_2, \sigma_2)$  is denoted as usual by  $N_1 \parallel N_2$  and defined by applying the merging phase to net  $(S_1 \cup S_2, T_1 \cup T_2, \ell_1 \cup \ell_2, \sigma_1 \cup \sigma_2)$ .

**Definition 11 (Petri nets with threads).** *The class of Petri nets with threads is the smallest class of Petri nets such that:*

- if  $N$  is a Petri net with exceptions and  $task \in \mathbb{T}$ , then  $(task : N)$  is a Petri net with threads;
- if  $N_1$  and  $N_2$  are Petri nets with threads then so is  $N_1 \parallel N_2$ .  $\diamond$

As noted above, we are working with unmarked nets. Indeed, applying the task construction to a marked net would raise the problem of choosing a thread to associate to the tokens. We generally cannot know this in advance. Another choice would be to multiply the tokens so that each possible thread can use its own copy. But this immediately produce large or infinite markings: for each token value  $v$ , we would create the set of tokens  $\mathbb{P} \times \{v\}$  in the task. Since none of these solution is satisfactory, we feel it is more reasonable to keep with unmarked net. However, when a system is completely constructed, it consists in tasks in parallel. We can choose one of the tasks as the main one and put a token in its start place: assuming that this task is called *main*, the initial marking just has one token  $(\pi_0, \bullet)$  in the place named *main.start*, where  $\pi_0$  is the pid of the initial thread.

**Process identifiers.** Each thread is identified by a *process identifier*, or *pid*, from set  $\mathbb{P}$ . We assume that it is possible to check whether two pids are equal or not, since different threads must be distinguished. Other operations may be applied to thread identifiers, in particular:

- $\pi \triangleleft_1 \pi'$  holds iff  $\pi$  is the parent of  $\pi'$  (i.e., thread  $\pi$  spawned thread  $\pi'$  at some point of its execution);
- $\pi \triangleleft \pi'$  holds iff  $\pi$  is an ancestor of  $\pi'$  (i.e.,  $\triangleleft$  is  $\triangleleft_1^+$ );
- $\pi \pitchfork_1 \pi'$  holds iff  $\pi$  is a sibling of  $\pi'$  and  $\pi$  was spawned immediately before  $\pi'$  (i.e., after spawning  $\pi$ , the parent of  $\pi$  and  $\pi'$  did not spawn any other thread before spawning  $\pi'$ );
- $\pi \pitchfork \pi'$  holds iff  $\pi$  is an elder sibling of  $\pi'$  (i.e.,  $\pitchfork$  is  $\pitchfork_1^+$ ).

Throughout this section, we denote by  $\Omega_{pid}$  the set of the four relations introduced, as yet informally, above together with the equality. (Note that other useful relations may be derived

from those in  $\Omega_{pid}$ .) In particular, only the operators in  $\Omega_{pid}$  can be used to compare pids in the annotations used in Petri nets. Crucially, it is not allowed to *decompose* a pid (to extract, for example, the parent pid of a given pid) which is considered as an opaque value (or a black box). This implies, in particular, that no literals nor concrete pid values are allowed in Petri net annotations (*i.e.*, in guards and arc labels) involving the pids.

This formalism is very expressive while still decidable. Indeed, it can be shown that the monadic second order theory of  $\mathbb{P}$  equipped with  $\triangleleft_1$  and  $\pitchfork_1$  can be reduced to a theory of binary trees equipped with the left-child and right-child relation, which has been shown exactly as expressive as tree automata [92]. However, many simple extensions of this formalism based on pids (de)composition are undecidable.

We assume that there exists a function  $\nu(\pi)$  that generates the next child of the thread identified by a pid  $\pi$ . There is no other way to create a thread's pid. A possible way of implementing dynamic pids creation—adopted here—is to consider them as finite sequences of positive integers: for all  $\pi$ , let  $i$  be the count of threads already spawned by  $\pi$ , set  $\nu(\pi) \stackrel{\text{df}}{=} \pi.(i+1)$  (*i.e.*, we write down the pids as dot-separated sequences). To be able to correctly implement  $\nu$ , each thread is assumed to maintain a count of the threads it has already spawned. Then the relations in  $\Omega_{pid}$  other than equality are given by:

$$\begin{aligned} \pi \triangleleft_1 \pi' &\iff \exists i \in \mathbb{N}^+ : \pi.i = \pi' \\ \pi \triangleleft \pi' &\iff \exists n \geq 1, \exists i_1, \dots, i_n \in \mathbb{N}^+ : \pi.i_1 \dots i_n = \pi' \\ \pi \pitchfork_1 \pi' &\iff \exists \pi'' \in \mathbb{P}, \exists i \in \mathbb{N}^+ : \pi = \pi''.i \wedge \pi' = \pi''.(i+1) \\ \pi \pitchfork \pi' &\iff \exists \pi'' \in \mathbb{P}, \exists i < j \in \mathbb{N}^+ : \pi = \pi''.i \wedge \pi' = \pi''.j \end{aligned}$$

Such a scheme has several advantages: (1) it is deterministic and allows for distributed generation of pids; (2) it is simple and easy to implement and there is no reuse of pids; and (3) it may be bounded by restricting, *e.g.*, the length of the pids, or the maximum number of children spawned by each thread. To implement  $\nu$ , each thread has to maintain a counter of its children. This can be made in a global place named *pidcount* and typed by  $\mathbb{P} \times \mathbb{N}^+$ : each token  $(\pi, i)$  in this place records that the thread identified by  $\pi$  has spawned  $i$  children so far. The next child spawned by  $\pi$  will thus receive pid  $\pi.(i+1)$ . Here again, we have a convention that implies a discipline: when a thread identified by  $\pi$  is created, a token  $(\pi, 0)$  has to be produced in place *pidcount*; when the thread is terminated and its control flow token removed from the stop place, it is important to remove also its token from place *pidcount*. Notice that it is possible to automatically enforce this discipline by providing high-level operations to encapsulate those defined here or by defining a syntactical layer. Notice also that having place *pidcount* requires to define an initial marking with token  $(1, 0)$  in it, additionally to the token  $(1, \bullet)$  in the start place of the main task.

### 4.3 Use cases

To illustrate how Petri nets with threads may be used in practice, we now show three simple examples:

- how a thread can spawn a child;
- how a thread can wait for another to terminate;
- how to emulate function calls with threads.

We assume that the implementation of pids presented above is used, as well as the place named *pidcount* to store for each thread the number of children it has spawned already.

**Starting threads.** Spawning a child as an instance of a task *task* is possible with a net having a single transition as depicted in the left of figure 18; it does the following:

- get the current count  $i$  of children from place *pidcount*;
- increment it and store it again;
- put a token  $(\nu(\pi), \bullet) = (\pi.(i+1), \bullet)$  in place *task.start*;
- store a token  $(\pi.(i+1), 0)$  in place *pidcount* to allow the new thread to spawn children.

It is worth noting that we use the special variable  $\pi$  to capture the identity of the thread that is executing the transition. We have to remember that this net will be embedded into a larger Petri net with exceptions that itself will be transformed into a task. During this transformation, the control flow part (and only it here) will be transformed: entry and exit places will receive type  $\mathbb{P} \times \{\bullet, \circ\}$  instead of  $\{\bullet, \circ\}$  and the attached arcs will receive labels  $\{(\pi, \bullet)\}$  instead of  $\{\bullet\}$ . So, the presence of  $\pi$  on the arc from the entry place to the transition will ensure the consistency of the execution with respect to the tokens consumed and produced in places *pidcount* and *task.start*.

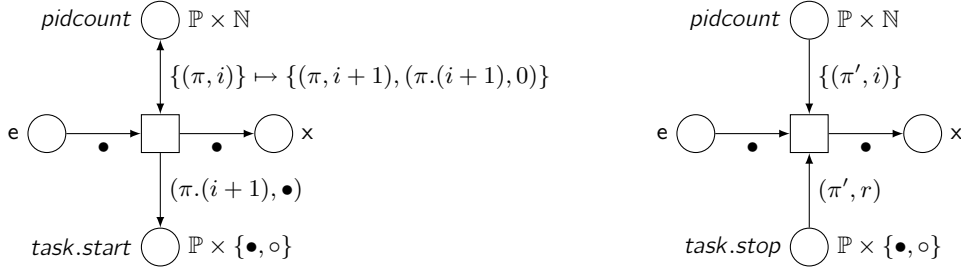

**Fig. 18.** Left: spawning a child thread. Right: waiting for another thread.

**Terminating threads.** Waiting for a thread to terminate can be achieved similarly using a net like the one depicted on the right of figure 18. When it fires, the transition does the following:

- get the token  $(\pi', r)$  from place *task.stop*, which is possible only when thread  $\pi'$  has terminated;
- remove the corresponding token from place *pidcount*.

Variable  $r$  is bound to either  $\bullet$  or  $\circ$ . This could be used to check in the guard the return status of the terminated thread:  $r = \bullet$  means that the thread terminated normally, but  $r = \circ$  means that it has been terminated by an exception. In the guard, we could also test the value of  $\pi'$ . For instance, by specifying  $\pi \triangleleft \pi'$ , we could restrict the behaviour so that only children of the thread that executes the transition are awaited for.

**Calling functions.** To emulate a function call, a thread can spawn a child as an instance of a task *fun* and immediately wait for its termination. The main difficulty is to pass parameters to the called function and get a result back. This can be solved by using two places named *fun.call* and *fun.return* to store respectively the tuple of call arguments and the returned value. The spawned thread has to be designed so that it uses these places to correctly get its arguments and to set a return value, *i.e.*, it has to be designed as a function. As previously, this discipline could be best enforced using a syntactic layer.

A possible termination of a function is also through an exception. We already know how to check the return status of a thread, and thus of a function. But in the case of function calls, we have to propagate an exception raised in the function. Assume that we use a named place *except* to store exception values as proposed before. We see now that the parent thread needs to access this place so it can retrieve the exception value from the called function and properly propagate the exception. This is possible by choosing to define *except* as a global buffer place (*i.e.*, never hidden) with type  $\mathbb{P} \times Err$ . To summarise, emulating a function call using threads requires:

- two transitions, one to spawn a thread and one to wait for it;
- two global places named *fun.call* and *fun.return* to pass the arguments and retrieve the return value;
- the global place named *except* with type  $\mathbb{P} \times Err$  to correctly propagate exceptions from the function;
- a specially crafted task *fun* that properly reads its argument and sets its return value.

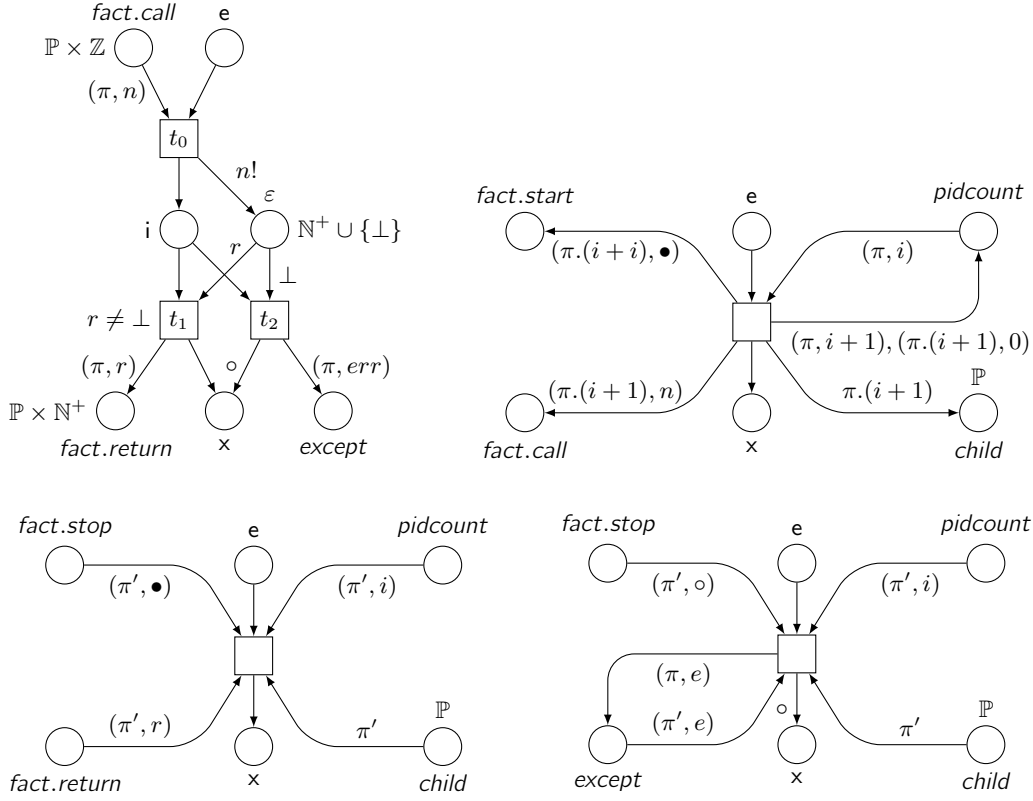

**Fig. 19.** Top left: the implementation of function `fact`, where `err` is a suitable error value. Top right: a sub-net  $N_c$  that calls `fact(n)` where  $n \in \mathbb{Z}$ . Bottom left: a sub-net  $N_r$  that waits for `fact` to return. Bottom right: a sub-net  $N_e$  that waits and propagate an exception from `fact`. As usual, labels  $\{\bullet\}$  on arcs have been omitted.

This is illustrated in the top left of figure 19 where a Petri net with exceptions is defined to implement function `fact` (i.e.,  $\lambda n : n!$ ).<sup>2</sup> The behaviour of this net is as follows:

- when the function is called,  $t_0$  can consume the value of the parameter  $n$  in place `fact.call` and produce the result of  $n!$  in the anonymous place on the right;
- if  $n!$  is not defined (i.e., if  $n < 0$ ), the undefined value  $\perp$  is produced in this place. In such a case,  $t_2$  can fire, and produce both a token  $\circ$  in the exit place and an exception value `err` in place `except`;
- if  $n!$  is well-defined (i.e., if  $n \geq 0$ ),  $t_1$  gets its value and puts it in place `fact.return`, as well as a token  $\bullet$  in the exit place.

Calling this function can be divided into three activities, implemented by three nets as depicted in figure 19:

- $N_c$  performs the call and passes the argument  $n \in \mathbb{Z}$ . It is very similar to the thread spawning depicted in figure 18 with only two differences: it produces a token in place `fact.call` to pass the argument; and it stores the identity of the new thread in place `child` so it will be possible to wait for exactly this thread;
- $N_r$  handles a regular return from the function. It is very similar to the thread waiting depicted in figure 18 with three differences: it only waits for a regular termination and so gets  $(\pi', \bullet)$  from `fact.stop`; it retrieves the return value from place `fact.return` (and discard it, but it could be used); and it gets the identity of the thread to wait for from place `child`;

<sup>2</sup> Notice that we have not implemented an algorithm to compute factorial: this is of course possible, even with a recursive algorithm since we now have functions; but our purpose is to illustrate complex control flow involving a function call, and exceptions propagation, not algorithmic aspects.

- $N_e$  catches any exception raised in *fact* and propagate it. Unlike  $N_r$ ,  $N_e$  consumes a token  $(\pi', \circ)$  from *fact.stop*, which ensures that an exception has been raised. In order to propagate it, two actions are necessary: change the exception value associated with  $\pi'$  in place *except* so that it is now associated with  $\pi$ ; and put a token  $\circ$  in the exit place to switch the caller thread to exception control flow.

The complete net that performs the call to *fact* can be obtained by composing these sub-nets as:

$$(N_c \circ (N_r \square N_e)) / child$$

#### 4.4 Verification issues

Using exception has no significant impact on verification and the techniques discussed in section 2.5 can be reused with a slight adaptation. In particular, we cannot rely anymore on the notion of place invariant for the control flow part since its now coloured. However, our technique of generalised exclusion remains usable: in the control flow of a Petri net with exceptions, only one place can be marked, which allows to exclude from the exploration of successor states all the transitions with an input from another control flow place than the marked one (or an output to the marked one).

On the other hand, using threads yields more problems. Indeed, the chosen scheme to generate pids can accelerate state explosion or lead to infinite state spaces. This is the case for instance in the system depicted in figure 20. It models a typical architecture for an Internet server (client part is not modelled):

- a main thread starts a bunch of server threads to wait for incoming connections. This is modelled by transition *init* in task *main*;
- each server thread executes a loop to either start a handler thread to process an incoming connection, or collect a terminated handlers. This is respectively modelled by transitions *spawn* and *wait* in task *server*;
- the server threads may terminate through transition *quit*, for instance if the program receives the signal to shutdown (which is not modelled here);
- a handler thread may perform computation (here modelled by transition *comp*) or call auxiliary functions (here modelled by transitions *call* and *ret*). For simplicity, this example assumes a sequence of these two behaviours with no possibility of exceptions;
- the auxiliary function is modelled by task *fun* with one single transition *body*;
- in order to control resources consumption,  $N$  server threads are initially started and each one may not spawn more than  $M$  handler;
- to simplify the picture, we have omitted the machinery involving place *pidcount* since it follows exactly the same principle as in the previous examples.

Assume  $N = M = 1$ , which constrains the system to be purely sequential, and let us execute some transitions. We show for each state the list of active threads, each provided as a term  $\pi:i@task$  where  $\pi$  is the pid,  $i$  is the number of children thread  $\pi$  has spawn so far as stored in place *pidcount*, and *task* is the name of the task that supports the thread:

$$\begin{array}{l}
1:0@main \xrightarrow{init} 1:1@main, 1.1:0@server \\
\quad \xrightarrow{spawn} 1:1@main, 1.1:1@server, 1.1.1:0@handler \\
\quad \xrightarrow{comp} 1:1@main, 1.1:1@server, 1.1.1:0@handler \\
\quad \xrightarrow{call} 1:1@main, 1.1:1@server, 1.1.1:1@handler, 1.1.1.1:0@fun \\
\quad \xrightarrow{ret} 1:1@main, 1.1:1@server, 1.1.1:1@handler \\
\quad \xrightarrow{wait} 1:1@main, 1.1:1@server
\end{array}$$

From the last state, the server thread is allowed to spawn a new handler that gets the new pid 1.1.2, which leads to a similar but completely new sequence of states. This may be repeated infinitely, leading to an infinite state space.

The reason for that is the use of counters of already spawned children: on the one hand, it guarantees that every generated pid is not in use, but on the other hand, these counters may be

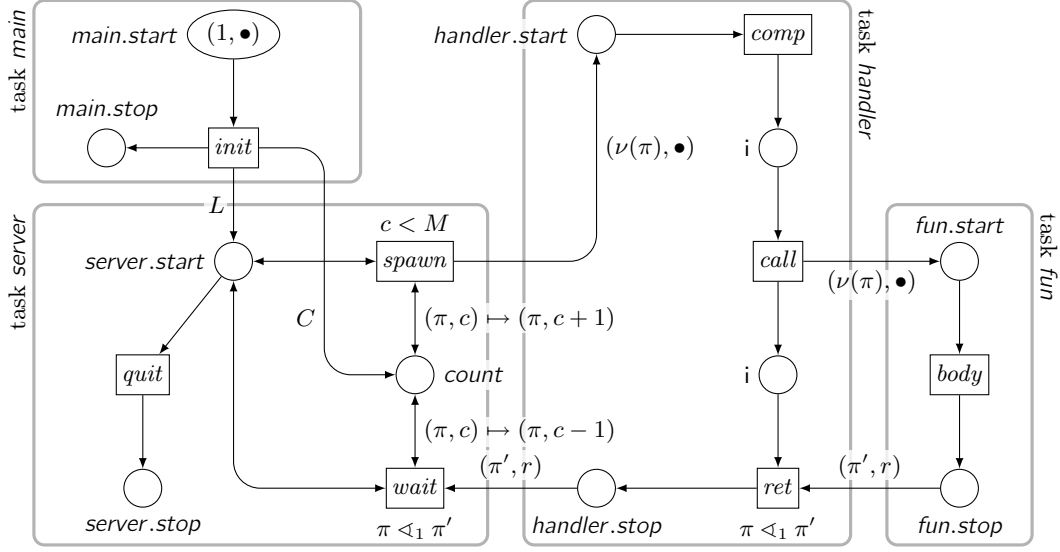

**Fig. 20.** A model of a multi-threaded server program composed of four tasks, where  $L \stackrel{\text{df}}{=} \{(\pi.i, \bullet) \mid 1 \leq i \leq N\}$  and  $C \stackrel{\text{df}}{=} \{(\pi.i, 0) \mid 1 \leq i \leq N\}$  for two chosen integers  $M, N \in \mathbb{N}^+$ . Omitted arc labels are here  $\{(\pi, \bullet)\}$ .

infinitely incremented. To solve this problem, we propose a method that allows to identify states that differ only by the value of pids, but have the same future (up to pids values). Notice that another solution would have been to change our implementation of pids, for instance by using a finite pool of pid values from which new pids are picked at spawning time and returned at termination time. However, our solution probably remains more interesting. Indeed:

- collecting pids of terminated threads is really complicated in a Petri net framework: each thread has a unique control flow token that is easy to collect from the stop place of a task; but it may also have data tokens stored in many places in the net and left here when the thread terminates. So, before to reuse any collected pid, we should ensure that no data token for it still exists in the net. This is a test to zero, which requires an extension of our base model with inhibitor arcs, possibly to the price of decidability [88, 94];
- our method is designed to recognise equivalent states when pid values are abstracted. As such, it handles the lack of pid reuse but also other kind of equivalences, in particular symmetric executions (this is explained below), but not only. To achieve similar results, another method should be complemented by an equivalence reduction technique [60][58, sec. 8.4];
- the proposed implementation of pids allows to easily define relations between them, like  $\triangleleft$  or  $\pitchfork$ . To achieve this, another method may need to maintain explicitly the relations between allocated pids;
- our method takes pids relationship into account to achieve more reduction. For instance, if  $\pi_1 \triangleleft \pi_2$  is observable by the system, then these two pids should not be considered as equivalent. However, if the system cannot observe this property, we may consider swapping those pids to obtain equivalent states. This aspect is automatically handled by our method.

**Marking equivalence.** Checking marking equivalence is achieved in two phases: first, markings are mapped to three-layered labelled directed graphs, and second the obtained graphs are checked for isomorphism.

The three-layered graphs are constructed as follows (see figure 21 for such a graph). The first layer is labelled by places, the second layer by (abstracted) tokens and the third one by (abstracted) pids. The arcs are of two sorts: those going from the container object toward the contained object (places contain tokens which contain pids), and those between the vertexes of the third layer reflecting the relationship between the corresponding pids through the comparisons in  $\Omega_{pid} \setminus \{=\}$ , denoted below as  $\triangleleft_j$ . To simplify figures, we do not consider  $\triangleleft$  and  $\pitchfork$  in  $\Omega_{pid}$  but only  $\triangleleft_1$  and

$\circlearrowleft_1$  (the former add no information since they are transitive closures of the latter). In this process, place *pidcount* is considered in a special way: it is not part of the first layer but allows to add nodes at the third layers (next child of each pid). This is required to ensure that equivalent markings lead to equivalent executions (see below).

To simplify the presentation and without loss of generality, we assume that the only data structures of the colour domain are non-nested tuples. The method presented below can be extended in a straightforward way to handle arbitrary data structure. The abstraction mapping  $[\cdot] : \mathbb{D} \cup \mathbb{P} \rightarrow \mathbb{D} \cup \{\dagger\}$  is defined as the identity on  $\mathbb{D}$  and as a constant mapping  $\dagger$  on  $\mathbb{P}$ , canonically extended to tuples:  $[(v_1, \dots, v_n)] \stackrel{\text{df}}{=} ([v_1], \dots, [v_n])$ .

**Definition 12 (Graph representation of a marking).** *Let  $M$  be a reachable marking of a Petri net with threads  $N$ , the corresponding graph representation  $R(M) \stackrel{\text{df}}{=} (V; A, A_{\triangleleft_1}, \dots, A_{\triangleleft_k}; \Lambda)$ , where  $V$  is the set of vertexes,  $A, A_{\triangleleft_1}, \dots, A_{\triangleleft_k}$  are sets of arcs and  $\Lambda$  is a labelling on vertexes and arcs, is defined as follows:*

1. *First layer: for each place  $s$  in  $N$  such that  $M(s) \neq \emptyset$  and  $\sigma(s) \neq \text{pidcount}$ ,  $s$  is a vertex in  $V$  labelled by  $s$ .*
2. *Second layer: for each place  $s$  added to the first layer, and for each token  $v \in M(s)$ ,  $v$  is a vertex in  $V$  labelled by  $[v]$  and there is a non labelled arc  $s \longrightarrow v$  in  $A$ .*
3. *Third layer:*
  - (a) *for each vertex  $v$  added at the second layer, for each pid  $\pi$  in  $v$  at the position  $n$  (in the tuple),  $\pi$  is a vertex labelled by  $\dagger$  in  $V$  and there is an arc  $v \xrightarrow{n} \pi$  in  $A$ ;*
  - (b) *for each token  $(\pi, i)$  in place *pidcount*,  $\pi.(i + 1)$ , the potential next child of  $\pi$ , is a vertex in  $V$  labelled by  $\dagger$ ;*
  - (c) *moreover, for all vertexes  $\pi, \pi'$  added at this layer, for all  $1 \leq j \leq k$ , there is an arc  $\pi \xrightarrow{\triangleleft_j} \pi'$  in  $A_{\triangleleft_j}$  iff  $\pi \triangleleft_j \pi'$ , i.e.,  $A_{\triangleleft_j}$  defines the graph of relation  $\triangleleft_j$  on  $V \cap \mathbb{P}$ .*
4. *There is no other vertex nor arc in  $R(M)$ .* ◇

It is important to understand why at point 3.(b) we need to add the next child of each pid in the third layer. Consider two states  $s$  and  $s'$  such that the pids in  $s$  are  $\{1, 1.1\}$  and the next child of 1 is 1.2, whereas the pids in  $s'$  are  $\{5, 5.1\}$  and the next child of 5 is 5.4. This is possible if 5 has spawned 5.2 and 5.3 and both are terminated and have been collected. Then consider a bijection  $h \stackrel{\text{df}}{=} \{1 \mapsto 5, 1.1 \mapsto 5.1\}$ . Everything is fine as far as preserving the parenthood/siblinghood of the corresponding pids is concerned. Let us now imagine that the two corresponding active threads, 1 and 5, created new pids, leading respectively to new states  $r$  and  $r'$  with pids  $\{1, 1.1, 1.2\}$  and  $\{5, 5.1, 5.4\}$ . Then the two new states are no longer equivalent, because  $1.1 \circlearrowleft_1 1.2$  yet  $5.1 \not\circlearrowleft_1 5.4$ .

**Definition 13 (Marking equivalence).** *Two markings  $M_1$  and  $M_2$  of a Petri net with threads are equivalent, which is denoted  $M_1 \sim M_2$ , iff their graph representation  $R(M_1)$  and  $R(M_2)$  are isomorphic.*

*If  $h$  is the bijection that relates the pids in the isomorphism between  $R(M_1)$  and  $R(M_2)$ , we may write  $M_1 \sim_h M_2$ .* ◇

**Properties.** Important properties can then be proved [KKPP2], in particular the two following ones. Let  $M_1$  and  $M_2$  be two markings of a Petri net with threads. Then:

1.  $\sim$  is an equivalent relation.
2. If  $M_1 \sim_h M_2$  and  $M_1[t, \beta]M'_1$ , then  $M_2[t, h \circ \beta]M'_2$  and  $M'_1 \sim_{h'} M'_2$  with  $h$  and  $h'$  coinciding on the intersection of their domains.

The second property is crucial because it states that two equivalent markings produce equivalent executions and that the pids are consistently swapped along the executions.

**Reducing infinite behaviours.** In the Internet server example presented above, our approach allows to produce a finite state space of the system by detecting loops in the behaviour, *i.e.*, parts



of the execution that are repeated with new pids. Consider again the run of the system with  $N = M = 1$  as given above:

$$\begin{array}{l}
 1:0@main \xrightarrow{\text{init}} 1:1@main, 1.1:0@server \\
 \xrightarrow{\text{spawn}} \dots \xrightarrow{\text{comp}} \dots \xrightarrow{\text{call}} \dots \xrightarrow{\text{ret}} \dots \\
 \xrightarrow{\text{wait}} 1:1@main, 1.1:1@server
 \end{array}$$

The two states on the right are equivalent as shown by their graph representations depicted in figure 21. So, applying the marking equivalence here allows to reduce an infinite state space to a finite cyclic one.

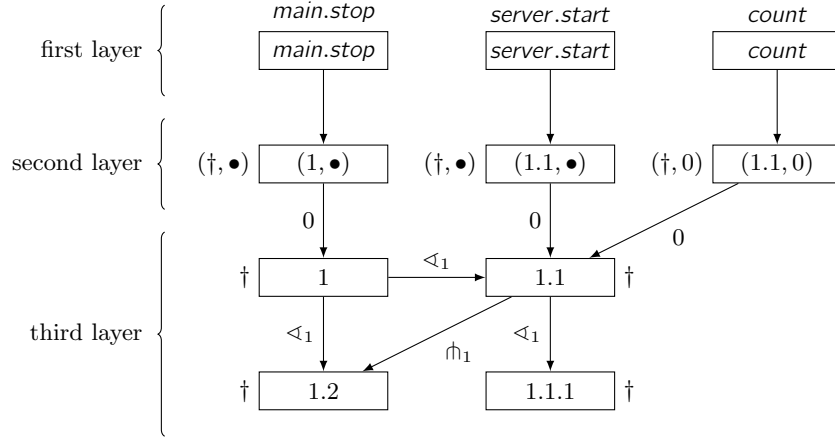

**Fig. 21.** The graph representations of state  $\{1:1@main, 1.1:0@server\}$ . For  $\{1:1@main, 1.1:1@server\}$ , the only difference is that node 1.1.1 has to be replaced by 1.1.2 (with the same label). For simplicity, we use place names instead of their identities.

**Handling symmetric executions.** Let us now consider the same example with  $N = 2$  and  $M = 1$ : two server threads are started and each can have at most one active handler child. This system exhibits symmetric executions since the behaviours of both threads are equivalent and completely independent. Both threads execute concurrently so their behaviours are interleaved in the marking graph. For instance, the state space has a diamond when the two threads spawn concurrently a child as shown in figure 22. The graph representations of the markings for states 2 and 3 are depicted in figure 23.

Because relation  $\hbar_1$  has been taken into account (see the dotted edges in the graph representations), the two markings are not equivalent. However, it should be considered that nowhere in the system  $\hbar_1$  is used. So, the fact that two states are siblings or not cannot have any influence on the behaviour of the system. As a consequence, we can remove  $\hbar_1$  from  $\Omega_{pid}$ . Doing so, the graph representation of both states 1 and 2 becomes that depicted at the bottom of figure 23 and the two graphs are now isomorphic. Indeed: let us first notice that the bottom graph perfectly overlaps the middle graph; then, let us imagine that we flip the bottom graph horizontally except its top row, then it would now perfectly overlap the top graph.

As a consequence, symmetric executions can now be identified, which results in a reduced graphs where, in particular, only one interleaving of concurrent executions is considered.

**Efficiency of graph isomorphism.** The complexity of checking graph isomorphism is, in general, not known. In order to evaluate how efficient in practice it turns out to be in our case, we generated random states and measured the time spent in checking isomorphism of the corresponding graphs. We only considered pairs of markings where the same places are non-empty. Indeed, pairs that do

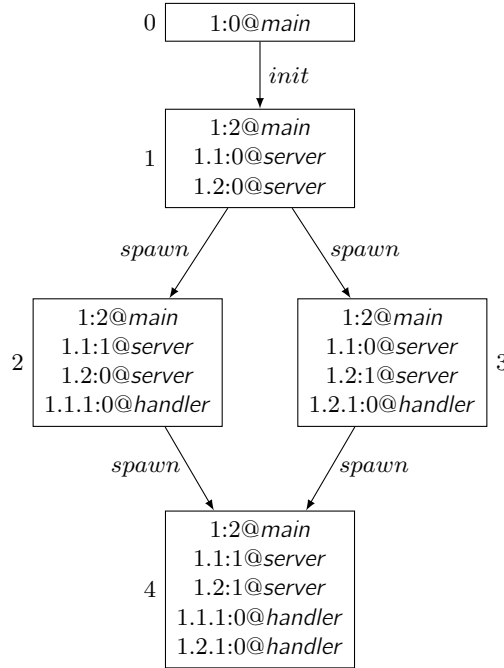

**Fig. 22.** An initial fragment of the state space for  $N = 2$  and  $M = 1$ . In the left branch of the diamond, thread 1.1 spawns first a handler, then thread 1.2 does; this is the reverse in the right branch.

not match this way can be checked for non-equivalence in linear time with respect to the number of places, without even converting them to graphs.

Our methodology has been to generate random states and compare each with similar ones obtained through all possible transformations based on:

- pids swapping preserving isomorphism;
- shuffling of tokens throughout places;
- shuffling of tokens components (remember that tokens are tuples here);
- exchange of components between tuples (pids, data or both);
- data replacement;
- pids replacement;
- shifting of integers that compose pids.

To check graph isomorphism, we used NetworkX [51] that implements the VF2 [31] algorithm that is considered as one of the fastest algorithms for graph isomorphism. We carried out more than two millions of comparisons, on the basis of which it may be observed that:

- computation time is growing with the size of the markings and with the percentage of pids in tokens (with respect to data);
- computation time improves when more distinct data values are involved in markings.

None of these observations should really be surprising. In particular, the presence of data leads to labelled nodes that can be quickly matched when comparing two graphs.

Moreover, we observed that the general evolution of computation time is linear with respect to  $p^{3/2}$  where  $p$  is the number of distinct pids in the compared states. With respect to  $p^2$ , the evolution of time is clearly sublinear. Hence it is justifiable to estimate that computation time is in mean polynomial (around  $p^{3/2}$ ) with respect to the number of threads in the observed system. Finally, we determined that the computation time looks slightly less than quadratic with respect to the number of tokens in compared markings.

It is worth noting that we observed similar results when, instead of considering random states, we used states from the Internet server example presented above.

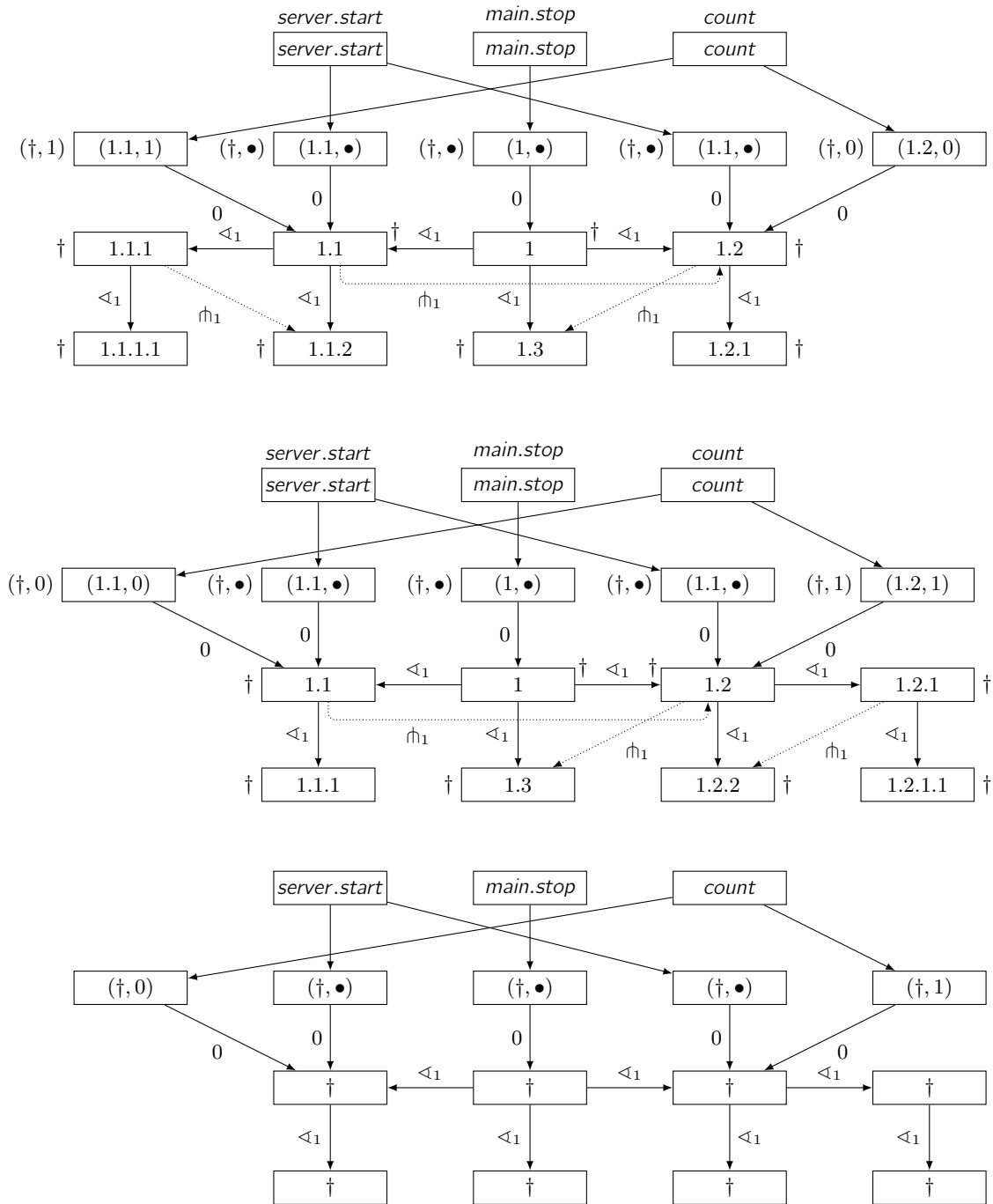

**Fig. 23.** Top: the graph representation of state 2 from figure 22. Middle: the graph representation of state 3. Bottom: the graph representation of both states when  $\dot{m}_1 \notin \Omega_{pid}$ , where nodes identities have been replaced by nodes labels.

As a result, we conclude that the cost of checking state equivalence is very low for states that are clearly different (most of the compared pairs) and stays good for states that are similar. Moreover, it should be noted that discovering equivalent states allows to limit the state space exploration. Thus the time spent in computing equivalences is likely to be often lower than the time required to compute the whole state space, which obviously holds for infinite state spaces reduced to finite ones. This reduction may also allow to analyze systems whose complete state space would simply not fit into the computer's memory, and thus would have been intractable regardless of the computation time.

## 4.5 Related works

Petri nets with threads have been initially defined with a syntax that extends the PBC syntax with task construction and trap operator [POM6], as well as with time-related operations inspired from [POM4] (see also section 5.1).

A modelling of multi-tasking systems in the context of M-nets has been proposed in [KP4], based on a Petri net model developed in [KP2,KP3]. However, it relied on general preemption operators allowing to suspend, resume or abort arbitrary M-nets, including with nested parallel compositions. To achieve this level of generality, the coloured Petri net model has been extended with priorities between transitions. The setting proposed above is much simpler and, at the same time, it is just as expressive. Indeed, every task can be constructed in a way that allows to suspend, resume or abort the corresponding threads, as depicted in figure 24. The idea is to add three places for a task named *task*:

- when a thread is started as an instance of *task*, its pid is added to place *task.run*;
- every transition in the task is added a side loop or a read arc labelled by  $\pi$  to this place so it can progress only if its pid is present here (a side loop does not reduce concurrency because a thread is already sequential);
- place *task.suspend* is the complementary place of *task.run*; so, to suspend a thread, its pid has to be moved from place *task.run* to *task.suspend*;
- to resume the execution of a suspended thread, its pid has to be moved back from place *task.suspend* to *task.run*;
- finally, to abort a thread, its pid is removed from *task.run* and added to *task.suspend* and *task.abort*. This enables transition  $t_a$  that directly terminates the thread by putting the appropriate token in the stop place of the task;
- to be correct, the input control flow places of  $t_a$  must be exactly the same as for  $t$ , but the arcs to  $t_a$  must be labelled with  $(\pi, x)$  so the thread may be aborted in both regular and exception control flow.

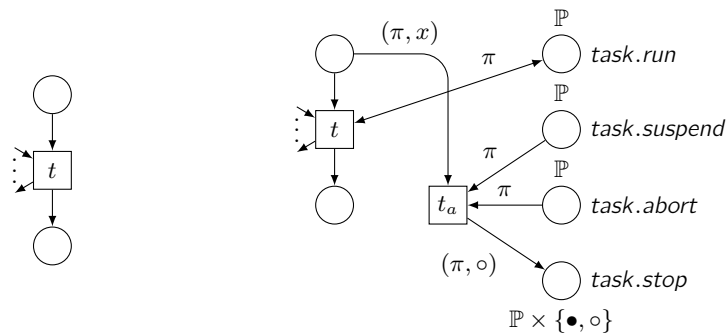

**Fig. 24.** Left: a transition in its context within a task; the depicted places are control flow places. Right: the same transition with additional context to support preemption.

The transformation proposed above to enable for external preemption leads to increase the size of Petri nets. In particular, the number of transitions is multiplied by two whereas three

places per task are added. However, it should be noted that this is comparable with the solution adopted for preemptible M-nets from [KP2,KP3,KP4]. Moreover, transitions priorities used in this model can be removed by transforming the nets, but to the price of a huge blow-up which is far more than doubling the number of transitions and leads to intractable nets. On the other hand, using priorities makes it possible to implement efficient garbage collection: tokens corresponding to terminated threads, in particular tokens in data places, can be removed from the Petri net using prioritised transitions, which can be achieved before any other transition in the net is allowed to fire. In the context of Petri nets with threads, collecting garbage tokens cannot be prioritised and thus we cannot guarantee that a token from a terminated thread is ever removed from the corresponding task. However, because pids are never reused, these tokens cannot be confused with tokens owned by another thread executed later on. They can be considered as garbage, which may be collected in the background if one wants to model a garbage collector; they could be ignored by the model-checker to reduce combinatorial explosion; or it may even be the purpose of such an analysis to decide whether garbage tokens exist or not.

The marking equivalence technique presented to reduce state spaces of Petri nets with threads is actually an instance of a more general *equivalence reduction* method defined for coloured Petri nets in [60]. This method requires an equivalence specification to be consistent [60, def. 1], *i.e.*, preserved along the executions of a system, which in our case is a corollary of the properties of  $\sim_h$ . As noted in [58, sec. 8.4], proving the consistency is often a complex prerequisite to use equivalence reduction. And indeed, establishing the properties of  $\sim_h$  required quite an involved proof [KKPP2]. But this has been done in a general setting and can then be reused in many contexts with a reasonable effort.

Verification of multi-threaded systems is a very active topic, possibly because threading is the major paradigm of concurrency in nowadays programming languages. A variety of methods such as those in [27, 57, 59] (see, *e.g.*, [75] for a survey) address the state explosion problem by exploiting, in particular, symmetries in the system in order to avoid searching parts of the state space which are equivalent to those that have already been explored. Some methods, such as [18, 54, 69], have been implemented in widely used verification tools and proved to be successful in the analysis of numerous communication protocols and distributed systems. The method proposed in this paper actually focuses on abstracting thread identifiers and symmetries are addressed only indirectly. So, not only it reduces symmetric executions but also it can cope with infinite repetitive behaviours. Moreover, it should be noted that symmetry reduction techniques rely on the computation of a canonical representation of each state. It has been shown in [30] that this is as hard as computing a graph isomorphism. So, our method, while being more general than symmetry reduction, is not computationally more complex.

Our approach appears to be closely related to that developed in [59] (which, incidentally, covers those in [57, 27]) where a general framework was proposed aiming at reduced state space exploration through the utilisation of symmetries in data types. More precisely, [59] defines three classes of primitive data types. Two of these, ordered (for which symmetries are not considered) and cyclic (which are finite) cannot lead to reductions based on pids. The remaining one, unordered, can in principle be used for reduction even for an infinite domain [59, section 7.5]. However, the approach proposed in [59] does not cover the case of dynamic process creation as considered here. Moreover, when comparing two states for equivalence, the approach of [59] considers only data actually present in the states. In our case, however, we have to look at additional data (potential children of the pids present in the states) to ensure the preservation of equivalence over possible behaviours. We believe that approaches like [59] are insufficient for dealing with dynamic process creation and checking relationships between pids such as the siblinghood.

## 5 Applications

### 5.1 Modelling time by causality

Starting from [POM3], we have introduced the modelling of time through explicit representation of clocks in a model. Basically, a clock is composed of a tick transition that increments or decrements counters stored in places typed by  $\mathbb{N}_\omega \stackrel{\text{df}}{=} \mathbb{N} \cup \{\omega\}$ , where  $\omega$  is an integer-like value such that  $\omega + i \stackrel{\text{df}}{=} \omega$  and  $\omega > i$  for all  $i \in \mathbb{Z}$ . Incrementing counters allows to measure the passing of time, decrementing counters allows to specify structural timing constraints that the system cannot overcome. This is illustrated in figure 25:

- at the initial state, ticks can occur without changing the marking;
- when  $t_1$  fires, it replaces the counters so that  $min = 0$  and  $max = 10$ ;
- because of its guard,  $t_2$  is now disabled until  $min$  reaches at least 3;
- each tick occurrence increments the value of  $min$  and decrements the value of  $max$ . The former can be incremented infinitely but the latter cannot decrease below zero;
- so  $t_2$  becomes enabled after three tick occurrences, but no more than ten ticks can occur because of the minimal value allowed for  $max$ ;
- when  $t_2$  fires, it replaces counter  $max$  with  $\omega$  so that ticks can occur again if  $max$  had already reached zero.

Assigning a non- $\omega$  value to a decreasing counter can be considered as setting a structural deadline; conversely, assigning  $\omega$  to such a counter can be seen as releasing the deadline constraint because this counter cannot block anymore the occurrence of ticks.

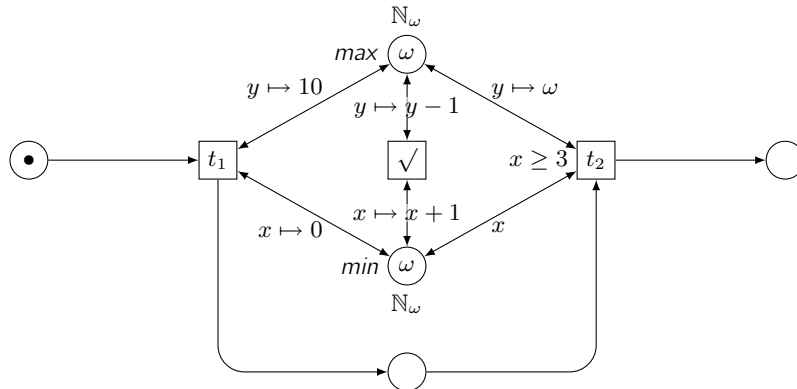

**Fig. 25.** A simple causally timed system with two counters  $min$  and  $max$  and a tick transition  $\sqrt{\phantom{x}}$ . Transition  $t_2$  must fire when at least 3 and at most 10 ticks have occurred since  $t_1$  has fired.

Such a system models time but actually only involves causality relations between transitions. That is why we say that time is modelled by causality. Several interesting characteristics of this approach have been shown, in particular:

- it is usable for practical system modelling and verification, it can even be more efficient than timed-automata based approaches [BTKP2];
- several ticks may be used, they can be kept independent or synchronised [POM3];
- timing features can be introduced in syntactic layers, avoiding to the user the task to deal with clock modelling [POM4,POM6];
- under reasonable assumption, a causally timed Petri net can be executed in a real time environment in such a way that ticks occur evenly with respect to environment's time (this is detailed below);
- the extra state explosion introduced by tick counters can be compensated for by using appropriate abstraction, even allowing in some cases to compute infinite state spaces (see below).

**Real-time execution.** When considering a causally timed system, the question arises whether this system is realistic or not: if we consider an external observer, equipped with a watch, who looks at tick occurrences, can we arrange any execution of the system so that ticks occur evenly from the observer’s point of view?

It turns out that this is not possible in general. For instance, consider the system depicted in figure 25. If we add a transition  $t_3$  connected to the bottom place with a side loop, then, the number of firings of  $t_3$  between  $t_1$  and  $t_2$  is unbounded. But we cannot in a finite amount of observer’s time execute arbitrarily many firings of  $t_3$ , except if firing transitions takes no computation time which is not realistic at all. The problem with  $t_3$  is that it can be repeated arbitrarily with no requirement that time progresses. This is sometimes called a Zeno execution.

In [POM5,POM7], we define a notion of *tractable* Petri nets with causal time. Such a Petri net is tractable if there exists a constant  $\delta$  such that any sequence of at least  $\delta$  transition firings contains at least two ticks. This is to say that only bounded execution can occur between two ticks. So, by choosing a large enough duration in observer’s time, any execution can be scheduled in such a way that ticks occurrences are even from the observer’s point of view.

Moreover, since we are considering an observer, we can address the question of communication between the Petri net and its observer. It is easy to produce output to the environment: the observer simply looks at more than just the tick transition. But it is more complicated to take into account at the Petri net side inputs from the environment. Indeed, the observer should not be allowed to modify the Petri net states nor to force events to occur (this would violate the semantics) but may just ask for some specific events to take place, if they are possible. This can be formalised as a notion of *input ports*, each consisting of a transition  $t$  and a subset of variables from  $\text{vars}(t)$ . An input from the environment to the Petri nets becomes a request that a specific transition is executed with a chosen binding of the selected variables. Then, we can define a notion *reactive* transitions to ensure that such a request is always handled within at most one tick. Reactive transitions are easy to implement using side loops while keeping the Petri net tractable; an example is shown in figure 26.

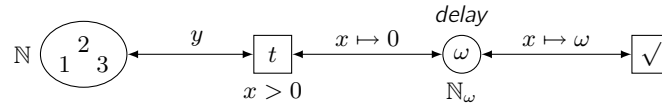

**Fig. 26.** A Petri net with causal time where transition  $t$  is reactive with respect to input port  $(t, \{y\})$ . The connection of  $t$  with the clock ensures that the net is tractable because  $t$  cannot fire more than once between two ticks.

**Verification issues.** Causal time approach is convenient because it allows to verify systems including timing aspects using any tool that supports coloured Petri nets. However, explicitly counting ticks increases the state explosion problem. Consider for example the Petri net given in figure 25, it has three “logical” states: (1) before  $t_1$ , (2) between  $t_1$  and  $t_2$ , and (3) after  $t_2$ . However, when considering its concrete states, we have to take into account all the possible values of the counters. For instance, in (2) we may have any valuation  $(\text{min}, \text{max}) \in \{(i, 10 - i) \mid 0 \leq i \leq 10\}$ ; *i.e.*, 11 different states. Worst, in (3) we have  $(\text{min}, \text{max}) \in \{(i, \omega) \mid i \geq 3\}$ ; *i.e.*, infinitely many equivalent states.

The second problem, *i.e.*, counting up to  $\omega$ , can be fixed by replacing  $\omega$  with the largest constant to which a counter is compared to, plus 1. For instance, in the system of figure 25, we can set  $\omega \stackrel{\text{def}}{=} 4$ . Then, expression like  $x + 1$  that label output arcs from the tick transition can be replaced with expressions like  $\min(\omega, x + 1)$ . This way, the behaviour of the system remains essentially the same but its state space is finite.

The first problem remains: tick counters introduce many equivalent markings in the state space. The problem is worst when several independent counters are used. In the previous example,  $\text{min}$  and  $\text{max}$  are not independent since we have  $\text{max} = 10 - \text{min}$  in (2). In this case, the possible values

of these counters do not combine in a way that increases the state space size. But consider two identical systems, just sharing the same tick transition, and distinguish them by putting primes in the second copy. There exists a kind of synchronisation through time between these two systems; but, since the firing of  $t_1$  and  $t'_1$  are not related, the whole Petri net may reach 9 logical states as shown in figure 27. Considering that we have set  $\omega \stackrel{\text{def}}{=} 4$  as explained before, (3) and (3') correspond to 2 concrete states ( $\min \in \{3, 4\}$ ). Then, the total number of concrete state is 196. In general, we can observe that independent timed subsystems contribute in a multiplicative way to the number of states, which leads to an exponential combinatorial explosion.

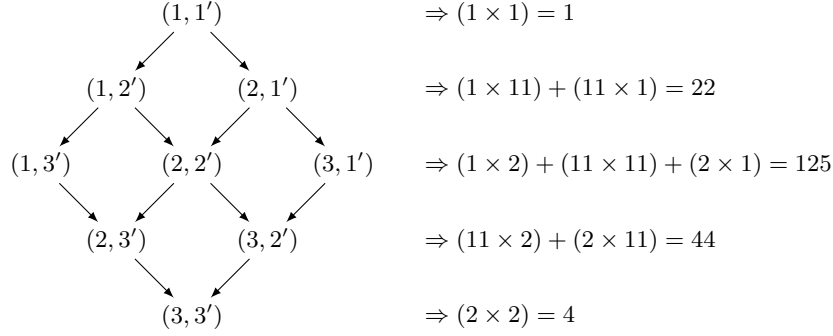

**Fig. 27.** The logical states corresponding to the interleaving of  $(1) \xrightarrow{t_1} (2) \xrightarrow{t_2} (3)$  and  $(1') \xrightarrow{t'_1} (2') \xrightarrow{t'_2} (3')$ . On the right is indicated the number of concrete states in each row of logical states.

This problem is addressed in [PDK] by proposing a model of Petri nets equipped with counters that are no more modelled has places. Instead, their values are stored in vectors of integers kept aside each marking: a state becomes a pair  $(M, v)$  where  $M$  is a marking and  $v$  is a vector that provides the valuation of counters. Each transition  $t$  is allowed to test a condition  $C_t$  on the counters and to update them using a transformation  $U_t$ . Then, we use a library [17] to represent efficiently large or infinite sets of such vectors, and to perform computation on these sets, like shifting by  $\pm 1$  all the components of all the vectors in a set. More interesting, it is possible to compute the accumulated effect of arbitrarily many repetitions of such a shifting. This allows to define an abstract state space construction in which an abstract state is a pair  $(M, V)$  where  $M$  is a marking and  $V$  is a set of vectors. When a transition fires, we have  $(M, V)[t](M', V')$  with  $M'$  computed from  $M$  as usual and  $V' \stackrel{\text{def}}{=} \{U_t(v) \mid C_t(v) \wedge (v \in V)\}$ . If  $V' = \emptyset$  then  $t$  is not enabled (no concrete state passes condition  $C_t$ ).

The idea to achieve compression is based on the detection of cycles in the state space with respect to the marking. Let  $(M', V')$  be a newly computed abstract state, several situations are possible:

- no abstract state of the form  $(M', V'')$  has been reached before, then we can add  $(M', V')$  to the abstract state space;
- there exists already an abstract state  $(M', V'')$  such that  $V'' \supseteq V'$ , then we have reached already known states;
- there exists already an abstract state  $(M', V'')$  such that  $V'' \subset V'$ , then we have found a cycle in the behaviour that loops through  $M'$  while reaching new valuation of counters. So, it is likely that from  $(M', V'')$  we can repeat again and again the same sequence  $t_1, \dots, t_k$  of transitions. This sequence corresponds to a transformation  $U_{t_1, \dots, t_k}$  that can be computed and we can also compute the repeated effect of  $U_{t_1, \dots, t_k}$  on  $V''$ , denoted by  $U_{t_1, \dots, t_k}^*(V'')$ . This corresponds to simulate in a finite computation the (possibly) infinite repetition of the same sequence of transitions. So,  $(M', V'')$  is replaced by  $(M', U_{t_1, \dots, t_k}^*(V''))$  in the state space (and its future is recomputed);
- finally if we observe a firing  $(M', V)[t](M', V')$ , we can expect  $t$  to be repeatable at  $M'$ . So we store  $(M', U_t^*(V))$  instead of  $(M', V)$  in the state space (and its future is recomputed).



This allows to compress sequences of transitions that update counters but do not change the marking, which is typically the behaviour of a tick transition (but not only).

In general, this method cannot be guaranteed to terminate when the concrete state space is infinite. But, on practical examples, it allows for efficient computation of large and even infinite state spaces. Typically, infinity that comes from the repeated incrementation of some counters is successfully tackled by the method. Moreover, we can show a behavioural equivalence between a Petri net equipped with external counters and its translation into a coloured Petri net in which counters are explicitly implemented as integer-valued places. More precisely, if  $N$  is a Petri net with counters and  $N'$  is its coloured implementation, we can show that:

- the set of reachable states of  $N$  and  $N'$  are essentially the same (we just have to translate between vector-based and place-based implementation of counters);
- any trace of  $N'$  is a path in the abstract state graph of  $N$ ;
- for any path in the abstract state graph of  $N$ , it can be checked whether it is a trace of  $N'$  or not by using only  $N$ .

The first point shows that the approach is exact with respect to reachability: no information is loosed not added. The second and third points show that the abstract state space is an over-approximation of the concrete state space in that it includes paths that are not realisable sequences of transitions. However, checking the realisability of such a path does not require to compute the concrete state spaces nor the coloured implementation of the Petri net with counters.

**Related works.** The causal time calculus as been proposed in [POM4] has an extension of the PBC to provide a syntax for causally timed systems, together with an operational semantics. Extended syntactical features have been later proposed in the context of multi-threaded systems [POM6]. Other timed extensions of the PBC have been proposed, however they are not based on the causal time approach but rather on various extensions of Petri nets with time; in particular, [65] and [2] introduce the features of time Petri nets [72] and timed Petri nets [93] respectively.

The question of efficiently verifying counter systems is addressed by numerous tools among which: FAST [7], MONA [41], Omega [90] and SATAF/PresTaf [32]. In [PDK], we used Lash library [17] to carry out experiments. These tools use various techniques and theories to efficiently deal with counter systems. However, it is likely that our approach may be adapted to use any of these tools since it treats in a separate way the aspects related to Petri nets on the one hand, and counters on the other hand, the latter being fully delegated to the library. A more drastic approach is proposed in [8] where Petri nets are completely translated to counter machines which are then verified with FAST. This is possible since P/T nets are considered so the marking of each place can be encoded as a counter; however, this would not apply to our model that is based on coloured Petri net.

## 5.2 Specification and verification of security protocols

In this section, we show how the ABCD language introduced in section 3.3 can be used to specify and verify security protocols. As an illustration, we model Needham&Schroeder's protocol for mutual authentication [82]. This is quite a small example, but ABCD is also used in the context of project SPREADS that aims at building a secure platform for distributed network storage with peer-to-peer architecture (see [SPR] for more information). These protocols are still under development and are anyway too big to be shown here. Fortunately, Needham&Schroeder's protocol allows to show the most important aspects about applying ABCD to security protocols.

**Needham&Schroeder's protocol for mutual authentication.** The protocol NS involves two agents Alice ( $A$ ) and Bob ( $B$ ) who want to mutually authenticate. This is performed through the exchange of three messages as illustrated in figure 28. In this specification, a message  $m$  is denoted by  $\langle m \rangle$  and a message encrypted by a key  $k$  is denoted by  $\langle m \rangle_k$  (we use the same notation for secret key and public key encryption). The three steps of the protocol can be understood as follows:

1. Alice sends her identity  $A$  to Bob, together with a nonce  $N_a$ . The message is encrypted with Bob's public key  $K_b$  so that only Bob can read it.  $N_a$  thus constitutes a challenge that allows Bob to prove his identity: he is the only one who can read the nonce and send it back to Alice.

2. Bob solves the challenge by sending  $N_a$  to Alice, together with another nonce  $N_b$  that is a new challenge to authenticate Alice.
3. Alice solves Bob's challenge, which results in mutual authentication.

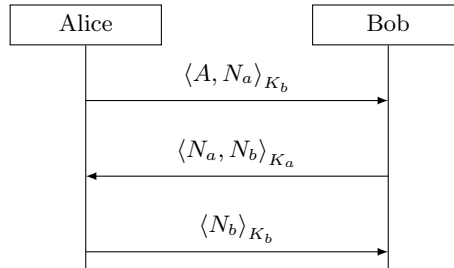

**Fig. 28.** An informal specification of NS protocol, where  $N_a$  and  $N_b$  are nonces and  $K_a$ ,  $K_b$  are the public keys of respectively Alice and Bob.

This protocol is well known for being flawed when initiated with a malicious third party Mallory ( $M$ ). Let us consider the run depicted in figure 29. It involves two parallel sessions, with Mallory participating in both of them.

- when Mallory receives Alice's first message, she decrypts it and forwards to Bob the same message (but encrypted with Bob's key) thus impersonating Alice;
- Bob has no way to know that this message is from Mallory instead of Alice, so he answers exactly as in the previous run;
- Mallory cannot decrypt this message because it is encrypted with Alice's key, but she might use Alice has an oracle and forward the message to her
- when Alice receives  $\langle N_a, N_b \rangle_{K_a}$ , she cannot know that this message has been generated by Bob instead of Mallory, and so she believes that this is Mallory's answer to her first message;
- so, Alice sends the last message of her session with Mallory who is now able to retrieve  $N_b$  and authenticate with Bob.

In this attack, both sessions (on the left and on the right) are perfectly valid according to the specification of the protocol. The flaw is thus really in the protocol itself, which is called a *logical attack*. This can be easily fixed by adding the identity of the sender to each message (like in the first one), in which case Alice can detect that the message forwarded by Mallory (now it is  $\langle B, N_a, N_b \rangle_{K_a}$ ) is originated from Bob.

**Modelling communication and cryptography.** Using ABCD, a simple model of a network is a globally shared buffer: to send a message we put its value on the buffer and to receive a message, we get it from the buffer.

Messages can be modelled by tuples and cryptography can be treated symbolically, *i.e.*, by writing terms instead of by performing the actual computation. For instance, the first message in NS protocol may be written as a nest of tuples ("crypt", ("pub", B), A, Na):

- string "crypt" denotes that the message is a cryptogram, the encryption key is thus expected as the second component of the tuple and the following components form the payload;
- tuple ("pub", B) indicates that this is a public key owned by B (we will see later on how to model agents' identities);
- the payload is the message (A, Na) (we will see later on how to model nonces).

Using this modelling, messages actually travel in plain text over the network. But if we adopt the Dolev&Yao model [39] and correctly implement it, this is a perfectly valid approach. In Dolev&Yao's model, the attacker is considered to reside *on* the network. So, Mallory can read, remove or even

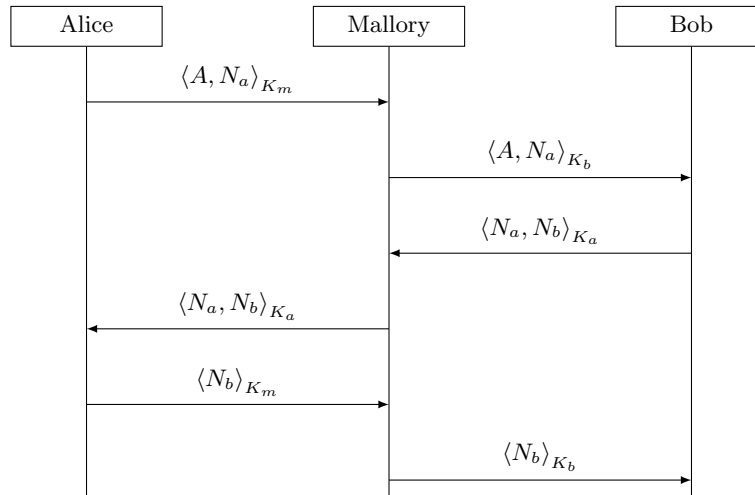

**Fig. 29.** An attack on NS protocol where Mallory authenticates as Alice with Bob.

replace any message on the network. Moreover, she can learn from the read messages by decomposing them and looking at their content. However, cryptography is considered to be perfect and so, Mallory cannot decrypt a message if she does not know the key to do so. For instance, if she reads ("crypt", ("pub", B), A, Na) on the network, she is allowed to learn A and Na only if she already knows Bob's private key ("priv", B). To correctly implement Dolev&Yao's model, we shall ensure that no agent can perform any action on an encrypted content knowing the key to do so.

Then we need to model agents' identities. In this protocol, we can just use positive integers because no such value is used somewhere else so there is no risk of confusion with another message fragment.

To model nonces, we cannot rely on a random generator unlike in implementations: this would lead to undesired non-determinism and possibly to a quick combinatorial explosion. To correctly model perfect cryptography while limiting state explosion, we must find an encoding such that:

- each nonce is unique;
- a nonce cannot be confused with another value;
- nonces can be generated in a deterministic way.

In our case, a simple solution is to program them a Python class `Nonce`. The constructor expects an agent's identity; for instance, `Nonce(1)` denotes the nonce for the agent whose identity is 1. Equality of two nonces is then implemented as the equality of the agents who own these nonces. To respect Dolev&Yao's model, we must forbid an agent to generate a nonce using another agent's identity.

So, let us call `nw` (for "network") the buffer that supports network communication and allow it to store any token (type object); moreover, let us import the content of a module `dolev_yao` that defines class `Nonce`:

```

1 | buffer nw : object = ()
2 | from dolev_yao import *
  
```

**Modelling Alice and Bob.** Each agent can be modelled as a sub-net. For instance, Alice can be modelled as follows:

```

4 | net Alice (this, agents) :
5 |     buffer peer : int = ()
6 |     buffer peer_nonce : Nonce = ()
7 |     [agents?(B), peer+(B), nw+("crypt", ("pub", B), this, Nonce(this))]
  
```

```

8 |      ; [nw-"crypt", ("pub", this), Na, Nb), peer_nonce+(Nb) if Na == Nonce(this)]
9 |      ; [peer?(B), peer_nonce?(Nb), nw+"crypt", ("pub", B), Nb)]

```

Parameter `this` provides the agent's identity, which is concretely provided when the sub-net is instantiated. This allows us to create several differentiated instances of Alice if needed. Parameter `agents` is expected to be a global buffer containing the identities of all the agents that Alice is allowed to contact. Line 5, a local buffer is declared to store the identity of the peer initially contacted by Alice. Line 6, another local buffer is declared to store peer's nonce received by Alice in the second message, in order to be able to forward it in the third message. Line 7, Alice gets one value from buffer `agents` (*i.e.*, chooses one peer to contact) and puts it into her buffer `peer`; she also sends the first message by producing the appropriate token in the global buffer `nw`. Line 8, Alice receives a message by consuming a token on `nw`, the received message is specified as a nest of tuples that forms a pattern to match the received message. Doing so, variables `Na` and `Nb` are bound to actual values from the message. In the same action, it is checked that `Na` has the correct value. Notice that this action respects Dolev&Yao's model: the content of the message is examined but the action is allowed to take place only if the received message is encrypted with Alice's key. Then, line 9, Alice sends the last message as expected by Bob whose nonce is fetched from the local buffer `peer_nonce` (without consuming it since the interrogation mark denotes a read arc). Lines 7–9 define one atomic action each and these three actions are composed sequentially.

The model for Bob is similar with two main differences: messages are specified from the receiver's point of view, and peer's identity is discovered from the first message instead of being chosen from a buffer. Apart from these changes, the specification is really similar:

```

11 | net Bob (this) :
12 |     buffer peer : int = ()
13 |     buffer peer_nonce : Nonce = ()
14 |     [nw-"crypt", ("pub", this), A, Na), peer+(A), peer_nonce+(Na)]
15 |     ; [peer?(A), peer_nonce?(Na), nw+"crypt", ("pub", A), Na, Nonce(this))]
16 |     ; [nw-"crypt", ("pub", this), Nb) if Nb == Nonce(this)]

```

**Modelling Mallory.** To model Mallory, we need to implement Dolev&Yao's attacker. She maintains a knowledge base  $k$  containing all the information learnt so far and repeatedly executes the following algorithm:

1. Get one message  $m$  from the network.
2. Learn from  $m$  by decomposition or decryption using a key already in  $k$ . Whenever a new piece of information is discovered, add it to  $k$  and recursively learn from it.
3. Optionally, compose a message from the information available in  $k$  and send it on the network.

The last action is optional, which means that a message may be removed from the network with nothing to replace it. This corresponds to a message destruction, which the attacker is allowed to do. Notice also that, when composing a new message, Mallory may rebuild the message she has just stolen. This corresponds to a message eavesdropping, which the attacker is also allowed to do.

The hard part in modelling this attacker is the message decomposition and composition machinery. This is feasible with just Petri nets (and has been done in [BDK<sup>+</sup>]) but is really complicated and leads to many intermediate states that quickly make the state space intractable. Fortunately, using ABCD, we can implement this part in Python. So, module `dolev_yao` also provides a class `Spy` that implements Dolev&Yao's attacker. Only the algorithmic part is implemented, taking into account our conventions about symbolic cryptography. For instance, tuples like (`"crypt"`, ...) or (`"pub"`, ...) are correctly recognised as special terms.

To reduce combinatorial explosion in the state spaces, an instance of `Spy` is given a signature of the protocol. This consists in a series of nested tuples in which the elements are either values or types. Each such tuple specifies a set of messages that the protocol can exhibit. For instance, NS protocol has three types of message:

- (`"crypt"`, (`"pub"`, int), int, Nonce) corresponding to the first message;
- (`"crypt"`, (`"pub"`, int), Nonce, Nonce) corresponding to the second message;

- ("crypt", ("pub", int), Nonce) corresponding to the third message.

This information is exploited by the attacker to avoid composing pieces of information in a way that does not match any possible message (or message part) in the attacked protocol. Without this mechanism, learning just one message  $m$  would lead the attacker to build an infinite knowledge containing, *e.g.*,  $(m, m)$ ,  $(m, m, m)$ ,  $(m, (m, m))$ , etc. However, this would be completely useless unless such values would be parts of the protocol and may be accepted as a message by an agent if these values were sent on the network. So, the attacker uses the protocol signature to restrict the knowledge to valid messages or message parts.

The knowledge part of the attacker is modelled by a Petri net place, *i.e.*, by an ABCD buffer. This allows to observe in the state space what the attacker has learnt, for instance to check for leaking secrets. This knowledge has to be initialised, in our case, we would like Mallory to be able to initiate a communication with another agent. So we shall provide her with an identity, and the corresponding nonce and private key. We shall also provide the list of other agents and their public keys. So, Mallory is specified as follows:

```

18 net Mallory (this, init) :
19   buffer knowledge : object = (this, Nonce(this), ("priv", this)) + init
20   buffer spy : object = Spy(("crypt", ("pub", int), int, Nonce),
21                           ("crypt", ("pub", int), Nonce, Nonce),
22                           ("crypt", ("pub", int), Nonce))
23   ([spy?(s), nw-(m), knowledge>>(k), knowledge<<(s.learn(m, k))]
24   ; ([True] + [spy?(s), knowledge?(x), nw+(x) if s.message(x)]))
25   * [False]
```

Parameter `this` is like for the other agents, parameter `init` is intended to be a tuple of initially known pieces of information. Line 19, Mallory's knowledge is declared and initialised: it contains her identity, nonce and private key, plus all the information from `init`. Line 20, an instance of `Spy` is created in a buffer `spy`, with the signature of the protocol. Then comes the infinite loop (because of the impossible exit line 25) to execute the attacker's algorithm:

- line 23, a message  $m$  is removed from the network with `nw-(m)`, the content of buffer `knowledge` is flushed to variable `k` with `knowledge>>(k)` and replaced with all that can be learnt from  $m$  and `k`, thanks to `knowledge<<(s.learn(m, k))`;
- line 24, either `[True]` is executed (do nothing), or a value  $x$  is fetched from `knowledge` and put on the network, but only if it is a valid message, which is checked in the guard.

Notice that this model of attacker is generic (except possibly for its initial knowledge) and one may safely copy/paste its code to another specification.

**Defining and verifying a scenario.** To create a complete ABCD specification, we need to provide a main term. This consists in a composition of instances of the defined agents. By providing this, we create a scenario, *i.e.*, a particular situation that can then be analysed. Let us consider a simple scenario with one instance of Alice, one of Bob and one of Mallory; a buffer `agents` will store the identities of Bob and Mallory so that Alice will contact one or the other at the beginning. This scenario includes the possibility for Mallory to try to authenticate with Bob since we gave to her enough knowledge to play the protocol. So, this simple scenario involves all kind of communications between honest and dishonest agents. Notice that including more than one attacker would result in a quick state explosion; fortunately, this is rarely needed and if so, may be simulated by providing more than one identity to the same and only attacker. Our scenario is thus specified as:

```

27 buffer agents : int = 2, 3
28 Alice(1, agents) | Bob(2) | Mallory(3, (1, ("pub", 1), 2, ("pub", 2)))
```

Using the ABCD compiler, we can create a PNML file from this system. This file can be loaded from a Python program using `SNAKES` to build the state space and search for a faulty one where Alice and Bob are in a final state (*i.e.*, their exit places are marked) and mutual authentication is violated (*i.e.*, data in buffers `peer` and `peer_nonce` of each agent are not consistent).

The state space has 2048 states among which one shows that Alice authenticated Bob but Bob authenticated Mallory, which corresponds to the known attack. There are also states showing

that both Alice and Bob may authenticate Mallory, but these are just regular runs of two parallel sessions (Alice with Mallory and Bob with Mallory). When looking closer to the states, we can see that Mallory is able to use someone else’s nonce for authentication: for instance she may use Alice’s nonce as a challenge for Alice. This is not an error in the protocol and is fully consistent with the fact that nonces freshness is never tested.

**Related works.** In order to specify security protocols, formal description languages have been proposed, like the spi-calculus [1] or the security protocol language, SPL [35]. The latter is an economical process language inspired from process algebras like the asynchronous  $\pi$ -calculus [76]: each process is defined by a term of a specialised algebra which allows to represent sequences and parallel compositions of input and output actions that may handle messages. Thus, in contrast to frequently used notations like the message sequence chart of figure 28 or textual variants (so called “Alice/Bob notations”), sending and receiving messages have to be specified separately.

Previous experiences with SPL [21, BDK<sup>+</sup>] showed that it only has a limited expressivity that restrict its possible usages: a protocol in SPL can only be specified using parallel and sequential compositions of send or receive actions, and no initial knowledge can be specified. Many useful features are not provided by SPL, in particular: looping or recursion, choice (with conditional execution), explicit data storage and manipulation, local computation (*i.e.*, actions with no communication), and of course initial knowledge. This last point has motivated extensions of SPL in [20, 21, BDK<sup>+</sup>]. As shown above, this feature is provided by ABCD as well as the other desired features. This is particularly important in the context of project SPREADS [SPR]: parts of the studied peer-to-peer protocols involve exchanging lists of peers identities, the length of which being not known in advance, and then communicate with a chosen subset of peers from the lists. Here, the capability of ABCD to express data structures (*e.g.*, lists) and complex control flow (*e.g.*, iterating over a list) is a crucial aspect.

One more aspect of SPL is arguably a drawback or an advantage: when a message is received, it can be matched against a pattern, doing so, the variables in the pattern are bound to the received values and this is recorded for the whole future of the process (as usual in process algebras). This feature is very convenient for the ease of specification, but on the other hand, it hides important aspects of information management in the agents. In comparison, using ABCD, one has to explicitly specify data storage. This might be considered as tedious but it has at least three advantages:

- the model is closer to an implementation in that not only it specifies how communication takes place, but also it shows which piece of information should be stored by each agent;
- parts of this information may be security critical, for instance cryptographic keys. Explicitly modelling their storage makes it possible to analyse these aspects, for instance information leak;
- using an explicit modelling of the spy allows to use any general purpose model checker to verify the modelled protocols, instead of being forced to use a model-checker that implements the spy.

Looking at the SPORE or AVISPA protocols collections [103, 6] we can observe that most of the analysed protocols listed on the page do not need loop or choice. This could be an argument against our claim that such features are needed. However, other protocols involve complex control flow and have been verified, but not using tools dedicated to protocols; see for instance the industrial case studies from the web pages of CPN tools [34]. It is worth noting that we advocate for tools with rich control flow and extensive data domain, not for ABCD in particular. Indeed, not every aspect of protocols verification can be addressed using a symbolic treatment of cryptography. For example, approaches like [15, 16] can represent aspects of protocols like algebraic properties of cryptographic primitives. For some protocols, like Diffie&Hellman’s key exchange [38], these are required features in order to correctly address the security concern. It is likely that this case can be handled in ABCD by implementing dedicated classes in Python, like we did for the treatment of nonces. This shows that an expressive data model is very much required and, thanks to a mixture of modelling and implementation, lacks in the analysis tool may be compensated for by user-defined extensions of the data model.

### 5.3 Modelling biological regulatory networks

Great advances in molecular biology, genomics and functional genomics open the way to the understanding of regulatory mechanisms controlling essential biological processes. These mechanisms interplay and operate at diverse levels (transcription and translation of the genetic material, protein modifications, etc.). They define large and complex networks, which in turn constitute a relevant functional integrative framework to study the regulation of cellular processes. To assess the behaviours induced by such networks, dedicated mathematical and computational tools are very much required. In general, mathematical models for concrete regulatory networks are defined as a unique whole, considering networks of a limited size (up to few dozens of components). This approach is not scalable and has to be modified as networks are increasing in size and complexity.

We rely on a qualitative discrete framework for the modelling of regulatory networks, namely the generalised logical formalism, initially proposed by R. Thomas [105, 106]. This formalism is now applied to the modelling of regulatory networks encompassing hundreds of nodes or interacting cells within a population. In particular, in the case of patterning in developmental processes, one has to consider patches of communicating cells. In such processes, modularity clearly arises, each intracellular network defining a module. To address this scalability problem, we propose a framework to extend the logical formalism with explicit modules. It is equipped with a Petri net semantics allowing to analyse the modelled systems. This section briefly presents the logical framework before to concentrate on its Petri net semantics and an application on patterning.

**Logical regulatory graphs.** Regulation refers to the molecular mechanisms responsible for the changes in the concentration or activity of a functional product. Such mechanisms range from DNA-RNA transcription to post-translational protein modifications. In regulatory networks, details on the precise molecular mechanisms that drive the regulation are often abstracted, the semantics associated to the interactions being reduced to activatory *versus* inhibitory effects.

A *logical regulatory graph* is a graph, where each node represents a regulatory component, associated with a range of discrete functional levels (of expression or of activity). In most of the cases, the Boolean abstraction (*e.g.*, a gene is expressed or not, a protein is active or not) is sufficient, but there are situations where more than two levels are necessary to convey the functional role of a regulator that varies when the concentration of the product crosses different thresholds. In particular, this is the case when a product regulates several targets, these regulations possibly occurring at distinct thresholds. This leads to the arcs of the graph that represent regulatory interactions. Finally, one needs to define the behaviours of the components submitted to regulatory interactions. This is done by setting up a logical function that defines the target level of the component (within the admissible range of levels) for each possible combination of incoming interactions.

**Definition 14 (Logical regulatory graph).** A logical regulatory graph, or LRG, is defined as a labelled directed multi-graph  $\mathcal{R} = (\mathcal{G}, \mathcal{E}, \mathcal{K})$  where,

- $\mathcal{G} = \{g_1, \dots, g_n\}$  is the set of nodes, representing regulatory components. Each  $g_i \in \mathcal{G}$  is associated to its maximum level  $Max_i \in \mathbb{N}^+$ , its current level being represented by the variable  $x_i \in \{0, \dots, Max_i\}$ . We define  $x \stackrel{\text{def}}{=} (x_1, \dots, x_n)$  the current state, and  $\mathcal{S} \stackrel{\text{def}}{=} \prod_{g_i \in \mathcal{G}} \{0, \dots, Max_i\}$  the set of all possible states.
- $\mathcal{K} = (\mathcal{K}_1, \dots, \mathcal{K}_n)$  defines the logical functions attached to the nodes and specifying their behaviours:  $\mathcal{K}_j$  is a multi-valued logical function that gives the target level of  $g_j$ , depending on the state of the system:  $\mathcal{K}_j : \mathcal{S} \rightarrow \{0, \dots, Max_j\}$ .
- $\mathcal{E}$  is the set of oriented edges (or arcs) representing regulatory interactions. An arc  $(g_i, g_j)$  specifies that  $g_i$  regulates  $g_j$  (when there is no possible confusion,  $i$  stands for  $g_i$ ), i.e.,  $\mathcal{K}_j$  varies with  $x_i$ .

For each  $g_j \in \mathcal{G}$ ,  $Reg(j)$  denotes the set of its regulators:  $i \in Reg(j)$  if and only if  $(i, j) \in \mathcal{E}$ .  $\diamond$

An example of a LRG is depicted in figure 32, notice that two kind of arcs are used to distinguish activatory effects ( $\rightarrow$ ) from inhibitory effects ( $\dashv$ ).

It is worth noting that a set of logical functions  $\mathcal{K}_i$  ( $1 \leq i \leq n$ ), fully defines an LRG encompassing  $n$  regulatory components. In particular, for each  $i \in \{1, \dots, n\}$ , its maximum level is given by the maximum value of  $\mathcal{K}_i$ .

The dynamics of an LRG is represented by a state transition graph as defined hereafter.

**Definition 15 (State transition graph of a LRG).** Given an LRG  $\mathcal{R} \stackrel{\text{def}}{=} (\mathcal{G}, \mathcal{E}, \mathcal{K})$ , its full state transition graph is an oriented graph  $(\mathcal{S}, \mathcal{T})$  such that:

- the set of nodes is the set of states  $\mathcal{S}$  as defined above;
- $\mathcal{T} \subseteq \mathcal{S} \times \mathcal{S}$  defines the set of transitions (arcs) as follows. For all  $(x, y) \in \mathcal{S} \times \mathcal{S}$ :

$$(x, y) \in \mathcal{T} \iff \exists g_i \in \mathcal{G} : \begin{cases} \mathcal{K}_i(x) \neq x_i, \\ y_i = \delta_i(x_i) \stackrel{\text{def}}{=} x_i + \text{sign}(\mathcal{K}_i(x) - x_i), \\ y_j = x_j \quad \forall j \neq i. \end{cases}$$

Given an initial state  $x^0$ , we further define the state transition graph  $(\mathcal{S}_{|x^0}, \mathcal{T}_{|x^0})$  as follows:

- $x^0 \in \mathcal{S}_{|x^0}$ ;
- $\forall x \in \mathcal{S}_{|x^0}, \forall y \in \mathcal{S}$ , if  $(x, y) \in \mathcal{T}$  then  $y \in \mathcal{S}_{|x^0}$  and  $(x, y) \in \mathcal{T}_{|x^0}$ ;
- there is no other node in  $\mathcal{S}_{|x^0}$  nor other arc in  $\mathcal{T}_{|x^0}$ . ◇

**Introducing modules.** In what follows, a *logical regulatory module* is defined as a uniquely identified logical regulatory network associated with a set of *input* components that regulate internal ones. Notice that no output components are defined because any internal component may generate an external signal towards other modules; moreover, input components are not effective regulatory components in that they do not introduce any intermediary step in the signalling. These inputs are meant to combine external signals from other modules. Functions  $\varphi$  in the definition below perform such combinations by calculating the levels of the integrated signals, depending on the levels of the corresponding individual incoming signals and on their attributed weights. These weights, defined as real numbers on the interval  $[0; 1]$ , encode neighbouring relations, which in turn are defined when connecting the modules (see below). Hence, at this stage, to define a logical regulatory module, one has to specify the components that are likely to signal the module, and how input signals are combined through the functions  $\varphi$ .

**Definition 16 (Logical regulatory modules).** Given  $\Gamma$  a domain of regulatory components, a Logical Regulatory Module, or LRM,  $\mathcal{M}$  is a tuple  $(\mathcal{G}, \mathcal{E}, \mathcal{V}, \varphi, \mathcal{K})$ , where

- $\mathcal{G} \subseteq \Gamma$  is the set of internal components;
- $\mathcal{E} \subseteq \mathcal{G} \times \mathcal{G}$  is the set of internal interactions between internal components;
- $\mathcal{V} \subseteq \Gamma$  is the set of input components;
- $\varphi = \{\varphi_{v,g} \mid (v, g) \in E \subseteq \mathcal{V} \times \mathcal{G}\}$  is a set of integration functions,

$$\varphi_{v,g} : (\{0, \dots, \text{Max}_v\} \times ]0; 1])^* \rightarrow \{0, \dots, \text{Max}_g\}$$

- computing the combined level for all inputs  $v$  regulating  $g$ . Their arguments are pairs  $(x_v, d_v)$  where each  $x_v$  is the level of  $v$  in one neighbour, weighted by  $d_v > 0$ ;
- $\mathcal{K}$  is a set of logical functions defined on  $\mathcal{G}$  giving, for each component  $g \in \mathcal{G}$ , its target level in  $\{0, \dots, \text{Max}_g\}$ , depending on the levels of its regulators. For an internal regulator  $r \in \mathcal{G}$  the level used to evaluate  $\mathcal{K}_g$  is  $x_r$  as usual, while for an input regulator  $v \in \mathcal{V}$ , the level used to evaluate  $\mathcal{K}_g$  is the current value of  $\varphi_{v,g}$ . We denote by  $\text{Args}(\mathcal{K}_g)$  the set of arguments of  $\mathcal{K}_g$ . ◇

Figure 30 provides a simple example of an LRM. If  $\varphi_{v,g} \in \text{Args}(\mathcal{K}_g)$  then,  $v$  is an input regulator of  $g$ ; in the pictures, this is denoted by an  $v$ -labelled arc toward the node  $g$ .

An LRM can be viewed as an *encapsulated* regulatory network with input components behaving as integrators of external signals of the components from other modules. For example, for the LRM depicted in figure 30, the level of external signal corresponding to  $B$  is calculated as a weighted maximum over all the levels of  $B$  in neighbouring modules (*i.e.*, having a non-zero weight). Hence, this level can be evaluated only when the module is connected to other modules (see below). Nevertheless, at this stage, it is possible to recover a fully defined LRG, by setting the integration functions and specifying the behaviours of the input components (for example as having constant levels).

We now proceed with collections of LRMs, which contain all the information needed to connect LRMs through their input components. It simply consists in defining a set of LRMs and a neighbouring relation between these LRMs that establishes the actual connexions between modules and allows the evaluation of the levels of input components.



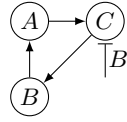

$$\begin{aligned}\mathcal{K}_A(x_B) &\stackrel{\text{df}}{=} 1 \text{ if } (x_B = 1), \text{ else } 0 \\ \mathcal{K}_B(x_C) &\stackrel{\text{df}}{=} 1 \text{ if } (x_C = 1), \text{ else } 0 \\ \mathcal{K}_C(x_A, \varphi_{B,C}) &\stackrel{\text{df}}{=} 1 \text{ if } (x_A = 1 \wedge \varphi_{B,C} = 0), \text{ else } 0\end{aligned}$$

**Fig. 30.** A “toy” LRM  $\mathcal{M}$  with:  $\mathcal{G} \stackrel{\text{df}}{=} \{A, B, C\}$ ,  $\mathcal{E} \stackrel{\text{df}}{=} \{(A, C), (C, B), (B, A)\}$ ,  $\mathcal{V} \stackrel{\text{df}}{=} \{B\}$ ,  $\mathcal{K} \stackrel{\text{df}}{=} \{\mathcal{K}_A, \mathcal{K}_B, \mathcal{K}_C\}$  as defined on the right part of the figure and  $\varphi \stackrel{\text{df}}{=} \{\varphi_{B,C} : (y_j, d_j)_{j \geq 0} \mapsto \text{round}(\max_j (y_j \cdot d_j))\}$ . We have  $\text{Args}(\mathcal{K}_C) = \{x_A, \varphi_{B,C}\}$ .

**Definition 17 (Collection of connected LRMs).** A collection of connected logical regulatory modules, or CLRMS, is defined as a triplet  $(\mathfrak{J}, \mathfrak{M}, \mathfrak{T})$ , where:

- $\mathfrak{J} \subset \mathbb{N}$  is a finite set of integers (module identifiers);
- $\mathfrak{M} = \{(m, \mathcal{M}) \mid m \in \mathfrak{J}\}$  is a set of LRMs, each being associated to an identifier in  $\mathfrak{J}$ ;
- $\mathfrak{T} : \mathfrak{J} \times \mathfrak{J} \setminus \{(m, m) \mid m \in \mathfrak{J}\} \rightarrow [0, 1]$ , is a neighbouring relation between modules in  $\mathfrak{M}$ ; the values of  $\mathfrak{T}$  can be interpreted as weights associated to external signals.  $\diamond$

In a CLRMS, one can define several copies of the same LRM (these copies are differentiated by their identifiers). This is the case in figure 31 that shows a CLRMS encompassing three times the LRM of figure 30. Notice the dashed arcs that represent how each LRM signals its neighbours according to the neighbouring relation.

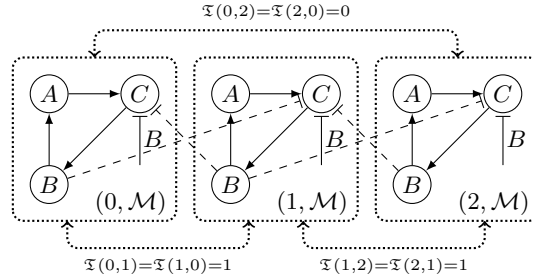
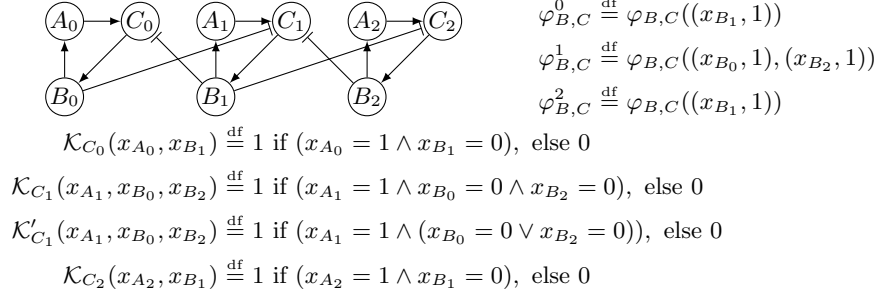

**Fig. 31.** A CLRMS  $(\mathfrak{J}, \mathfrak{M}, \mathfrak{T})$  encompassing three copies of the LRM  $\mathcal{M}$  from figure 30, where:  $\mathfrak{J} \stackrel{\text{df}}{=} \{0, 1, 2\}$ ,  $\mathfrak{M} \stackrel{\text{df}}{=} \{(0, \mathcal{M}), (1, \mathcal{M}), (2, \mathcal{M})\}$ , and  $\mathfrak{T} \stackrel{\text{df}}{=} \{(0, 1) \mapsto 1; (1, 2) \mapsto 1; (2, 0) \mapsto 0\}$  completed symmetrically. Functions  $\varphi_{B,C}$  in modules 0 and 1 depend on the level of  $B$  in module 1 (the sole connected module containing  $B$ ) whereas  $\varphi_{B,C}$  in module 1 depends on the levels of  $B$  in both modules 0 and 2.

Given a CLRMS, the integration functions are expressible as logical terms. Indeed, the neighbouring relations are fixed and the values of the  $\varphi$  functions depend on discrete bounded variables and take discrete bounded values. Hence, it is possible to recover an LRG (a logical model for the whole set of modules). For example, consider the CLRMS in figure 31, its associated LRG is shown in figure 32.

**Petri nets semantics.** Let  $\mathcal{K}_g$  be the logical function of  $g$ . As previously, we define the updating function  $\delta_g(x_{g_m}) \stackrel{\text{df}}{=} x_{g_m} + \text{sign}(\mathcal{K}_g(\dots) - x_{g_m})$  where  $\mathcal{K}_g$  is computed with the appropriate arguments (including integration functions calls) as defined above.

Each internal regulatory component  $g \in \mathcal{G}$  is modelled by a Petri net place  $s_g$  that stores the numeric value of the corresponding level for each module  $m$ . In order to model several modules (each having a unique identifier), each place holds tokens of the form  $(m, x_g)$ , where  $m \in \mathfrak{J}$  and  $x_g$  is the level of  $g$  in module  $m$ . The evolution of each regulatory component  $g \in \mathcal{G}$  is implemented by a unique transition  $t_g$  that consumes the value of  $g$  in  $m$  (token  $(m, x_g)$  from place  $s_g$ ), reads the values of the regulators of  $g$ , and produces the new level  $\delta_g(x_{g_m})$  of  $g$  in  $m$ . Thus, transition  $t_g$  has all the necessary arcs to the places modelling  $g$  and its regulators. In the definition below,



**Fig. 32.** The LRG obtained from the CLRM given in figure 31 with integration functions defined on the right and logical functions at the bottom. If we choose  $\varphi_{B,C}^m$  as the maximal value of its argument levels, *i.e.*,  $\varphi_{B,C}^m \stackrel{\text{df}}{=} \text{round}(\max_n(x_{B_n} \cdot \mathfrak{T}(n, m)))$  as proposed in the caption of figure 30, then, the logical function of  $C_0$  (resp.  $C_2$ ) is  $\mathcal{K}_{C_0}$  (resp.  $\mathcal{K}_{C_2}$ ), and the logical function of  $C_1$  is  $\mathcal{K}_{C_1}$ . Now, if  $\varphi_{B,C}^m \stackrel{\text{df}}{=} \text{round}(\min_n(x_{B_n} \cdot \mathfrak{T}(n, m)))$ , then,  $\mathcal{K}_{C_0}$  and  $\mathcal{K}_{C_2}$  remain the same, but  $\mathcal{K}_{C_1}$  is replaced by  $\mathcal{K}'_{C_1}$ .

each update transition  $t_g$  is constructed in a separate Petri net with control flow and all these nets are then composed to form the semantics of a CLRM. Surprisingly enough, we use Petri nets with control flow without control flow places: automatic merging of named places is here the only needed feature.

**Definition 18 (Petri net semantics of CLRMs).** *Let  $(\mathfrak{J}, \mathfrak{M}, \mathfrak{T})$  be a CLRM. We define  $\mathcal{G} \stackrel{\text{df}}{=} \bigcup_{m \in \mathfrak{J}} \mathcal{G}^m$  the set of components involved in the CLRM. We assume that  $\mathcal{G} \subseteq \mathbb{S} \setminus \{\mathbf{e}, \mathbf{i}, \mathbf{x}, \varepsilon\}$ , *i.e.*, that components are valid names for places. For every  $g \in \mathcal{G}$ , let  $m$  be the identifier of the LRM such that  $g \in \mathcal{G}^m$ , and define a Petri net with control flow  $N_g \stackrel{\text{df}}{=} (S_g, T_g, \ell_g, \sigma_g)$ :*

- $S_g \stackrel{\text{df}}{=} \{s_g\} \cup \{s_v \mid x_v \in \text{Args}(\mathcal{K}_g) \vee \varphi_{v,g} \in \text{Args}(\mathcal{K}_g)\}$  and, for every  $s_h \in S_g$ ,  $\ell_g(s_h) \stackrel{\text{df}}{=} \mathfrak{J} \times \{0, \dots, \text{Max}_h\}$  and  $\sigma_g(s_h) \stackrel{\text{df}}{=} h$ ;
- $T_g \stackrel{\text{df}}{=} \{t_g\}$  with  $\ell_g(t_g) \stackrel{\text{df}}{=} \text{True}$ ;
- a first pair of arcs allows to read and update the current level of  $g$  for module  $m$ , whose identifier is captured by a net variable  $\mu$ :
  - if  $\varphi_{g,g} \notin \text{Args}(\mathcal{K}_g)$ , there is one arc  $(s_g, t_g)$  labelled by  $\{(\mu, x_{g_\mu})\}$  and one arc  $(t_g, s_g)$  labelled by  $\{(\mu, \delta_g(x_{g_\mu}))\}$ ;
  - otherwise, there is one arc  $(s_g, t_g)$  labelled by  $\{(\mu, x_{g_\mu})\} \cup \{(\eta, x_{g_\eta}) \mid \mathfrak{T}(\mu, \eta) > 0\}$  and one arc  $(t_g, s_g)$  labelled by  $\{(\mu, \delta_g(x_{g_\mu}))\} \cup \{(\eta, x_{g_\eta}) \mid \mathfrak{T}(\mu, \eta) > 0\}$ ; it means that the levels of  $g$  in all modules  $\eta$  in the neighbourhood of  $m$  are read and only the level of  $g$  in  $m$  is updated;
- then, for each  $g' \in \mathcal{G}^m \setminus \{g\}$ , a test arc  $(s_{g'}, t_g)$  is added to bind the parameters of the logical and integration functions, with net variable  $\mu$  capturing as above the identity of module  $m$ :
  - if  $(g', g) \in \mathcal{E}^m$  and  $\varphi_{g',g} \notin \text{Args}(\mathcal{K}_g)$ ,  $\ell_g(s_{g'}, t_g) \stackrel{\text{df}}{=} \{(\mu, x_{g'_\mu})\}$ ,
  - if  $(g', g) \in \mathcal{E}^m$  and  $\varphi_{g',g} \in \text{Args}(\mathcal{K}_g)$ ,  $\ell_g(s_{g'}, t_g) \stackrel{\text{df}}{=} \{(\mu, x_{g'_\mu})\} \cup \{(\eta, x_{g'_\eta}) \mid \mathfrak{T}(\mu, \eta) > 0\}$ ,
  - if  $(g', g) \notin \mathcal{E}^m$  and  $\varphi_{g',g} \in \text{Args}(\mathcal{K}_g)$ ,  $\ell_g(s_{g'}, t_g) \stackrel{\text{df}}{=} \{(\eta, x_{g'_\eta}) \mid \mathfrak{T}(\mu, \eta) > 0\}$ .

The Petri net associated to  $(\mathfrak{J}, \mathfrak{M}, \mathfrak{T})$  is  $N$ , defined as the parallel composition of all the  $N_g$ 's for  $g \in \mathcal{G}$  as defined above. In  $N$  as well as in all the  $N_g$ 's,  $\mathfrak{T}$  is considered as a global function (*i.e.*, available from the annotations but not stored as a token).  $\diamond$

For the collection in figure 31, we obtain the Petri net depicted in figure 33. A possible initial marking may be  $M_0$ :

$$\begin{aligned}
M_0(s_A) &\stackrel{\text{df}}{=} \{(0, 1), (1, 0), (2, 1)\} \\
M_0(s_B) &\stackrel{\text{df}}{=} \{(0, 1), (1, 1), (2, 0)\} \\
M_0(s_C) &\stackrel{\text{df}}{=} \{(0, 0), (1, 1), (2, 0)\}
\end{aligned}$$

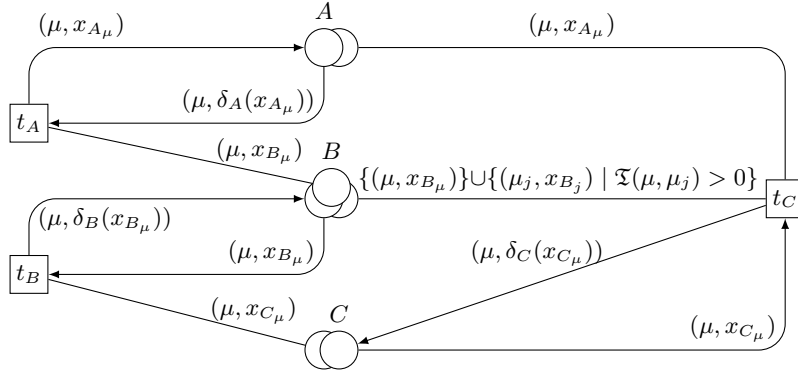

**Fig. 33.** The Petri net representation of the CLRM from figure 31. In order to show how places have been merged during the parallel composition of  $N_A$ ,  $N_B$  and  $N_C$ , they are depicted by several overlapping copies with arcs consistently connected to the copies from the corresponding sub-nets.

**Application.** The formalism of CLRM and its Petri nets semantics can be applied in particular to the study of patterning in tissues through cells differentiation. Consider the toy LRM  $\mathcal{M}$  defined in figure 30, we now analyse the behaviours of a series of collections encompassing a number of occurrences of  $\mathcal{M}$ . All the considered collections are based on tapes of modules, of width 2, and various lengths and neighbouring relations as depicted in figure 34. Each  $\mathfrak{T}_k$  is so called because a module may have neighbours in  $k$  directions. Moreover, we denote  $Toy(n, k)$  the CLRM containing  $2 \cdot n$  copies of  $\mathcal{M}$  arranged using  $\mathfrak{T}_k$  on a tape, as illustrated in figure 34.

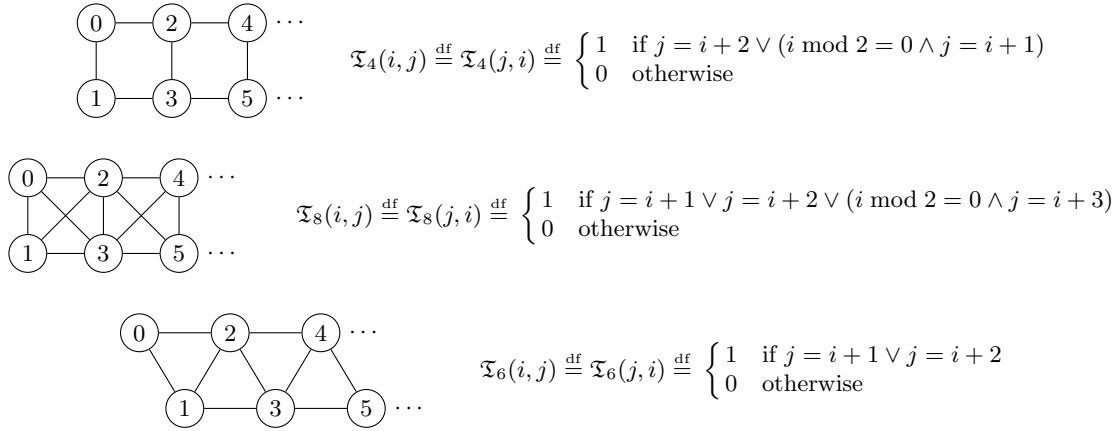



















**Fig. 34.** The various neighbouring relations considered for 2-width tapes. On the left, the graphical view showing the organisation of the connexions. Definitions of the corresponding neighbouring relations on the right side rely on the assumption that modules on the top line of the tape are numbered with consecutive even numbers, while modules on the bottom line are numbered (following the same direction) with consecutive odd numbers.

Stable states of systems  $Toy(n, k)$  turn out to be all such that the levels of all the components in each module are equal (all 0 or all 1). So, to depict such a module stable state, we shall print a black and white pattern, where black (resp. white) positions correspond to modules whose components are all 1 (resp. all 0), these positions respecting the neighbouring relations of the modules. To simplify the presentation, we have also considered initial states that can be represented this way.

Figure 35 shows the stable states that can be reached from chosen initial states. We can observe variations in the number of reachable states and reachable stable states; moreover, the stable states themselves are different depending on the neighbouring relation.

All these examples have been obtained using integration function  $\varphi_{B,C}$  defined as  $(v_i, d_i)_i \mapsto \text{round}(\max_i(v_i \cdot d_i))$ . We may consider instead a function that returns 1 if at least two levels in the environment equal 1, and return 0 otherwise. In this case, all the initial states considered in figure 35 for  $Toy(2,4)$ ,  $Toy(3,4)$  and  $Toy(4,4)$  become stable states. This shows that the choice of integration functions have an influence on the systems as well as the choice of neighbouring relations.

|  |  |
|--|--|
| <p><math>Toy(2,4)</math></p>    | <p>1 reachable state (1 stable)</p>         |
| <p><math>Toy(2,8)</math></p>    | <p>64 reachable states (3 stable)</p>       |
| <p><math>Toy(2,6)</math></p>    | <p>64 reachable states (3 stable)</p>       |
| <p><math>Toy(3,4)</math></p>    | <p>54 reachable states (3 stable)</p>       |
| <p><math>Toy(3,8)</math></p>  | <p>512 reachable states (5 stable)</p>   |
| <p><math>Toy(3,6)</math></p>  | <p>512 reachable states (5 stable)</p>   |
| <p><math>Toy(4,4)</math></p>  | <p>64 reachable states (3 stable)</p>     |
| <p><math>Toy(4,8)</math></p>  | <p>4096 reachable states (8 stable)</p>  |
| <p><math>Toy(4,6)</math></p>  | <p>512 reachable states (5 stable)</p>   |

**Fig. 35.** The reachable stable states for the considered  $Toy(n, k)$ . Each row indicates on the left the considered model and its initial state; on the right are indicated the total number of reachable states among which the stable ones are depicted. The top-left module of each state is decorated with links showing the directions of its potential neighbours.

**Related works.** Among the diversity of modelling frameworks used to model regulatory networks (see [36, 101] for surveys), the logical approach, initially developed by R. Thomas and co-workers [105, 106], is a successful qualitative formalism. It has been applied to model and analyse

regulatory networks controlling a variety of cellular processes from pattern formation and cell differentiation [99, 100, 71] to cell cycle [50], including regulatory networks comprising relatively large numbers of components [97, 98].

Various Petri net semantics of logical regulatory graphs have been defined, using either P/T nets or coloured Petri nets [25, 26]. The global idea of these semantics is to represent the value of a regulatory component by an integer-valued token in a place (or by several black tokens in one place and its complementary place in the case of P/T nets). Then, the possible evolutions of each component are encoded as transitions that update the encoded value of the component while testing the value of other components in order to ensure that evolutions are actually allowed at a given state. The approach proposed in [104] is quite similar but additional constructs are used to enforce a synchronous semantics of the modelled networks, *i.e.*, a simultaneous update of all the regulation components. In terms of Petri nets, this amounts to implement a maximal step semantics, which is done in [104] through a two-phases update process: the first phase identifies all the components that are called to change their value, the second phase performs this update synchronously.

With respect to these Petri nets semantics, our approach follows the same principles but produces more compact Petri nets by folding into a unique place and a unique transition all the information and logic for each regulatory component. Moreover, this Petri net is obtained in a structured way which is much easier to implement (and less error prone). In our SNAKES-based implementation, each LRM is defined as a Python class whose methods implement the logical functions from  $\mathcal{K}$ ; a CLRM is obtained by instantiating such classes and providing the neighbouring information. This way, the Petri net needed for the analysis is derived from a textual specification in a fully automated way, without any requirement to manipulate regulatory graphs.

## 6 Conclusion

We have presented a modular framework of coloured Petri nets with various modelling features (see also figure 36):

- the core of the framework is a general class of *coloured Petri nets* that is not tied to any specific colour domain;
- by adding statuses to the places, we have defined *Petri nets with control flow* that introduce explicit asynchronous communication through named places and four control flow compositions (sequence, parallel, iteration and choice);
- by adding multi-actions to the transitions, we have defined *Petri nets with synchronisation* that provide with an explicit mechanism of multi-way transitions synchronisation with argument passing;
- by removing parallel composition from Petri nets with control flow and adding an exception control flow as white tokens in addition to black tokens, we have defined *Petri nets with exceptions* allowing to model a full-featured exception mechanism;
- finally, by defining a task construction operator and a distributed scheme for process identifier generation, we have defined *Petri nets with threads* allowing to define dynamic thread creations and function calls.

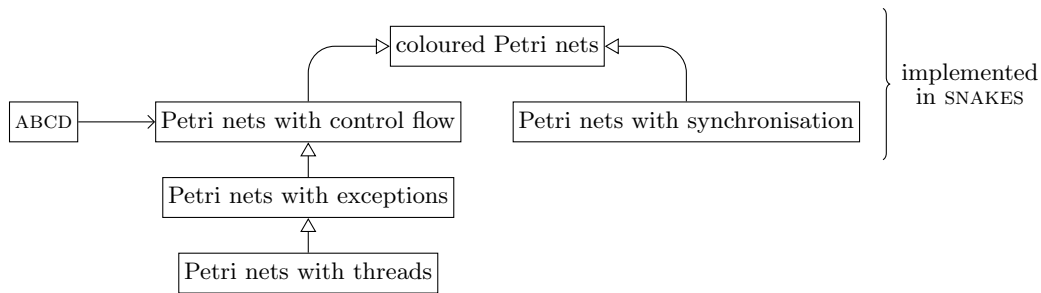

**Fig. 36.** The structure of our framework.

The SNAKES toolkit that implement part of this framework has been presented. SNAKES itself is designed to be flexible and modular thanks to a built-in plugin system.

Models based on this framework have been applied to various domains. We have presented an approach to the modelling of timed systems by implementing clocks as counters of a tick transition occurrences. Then we have illustrated how the ABCD syntax, defined on the top of Petri nets with control flow, can be used to specify and verify security protocols with a mixture of symbolic treatment and Python implementation of the cryptographic features. A third application has been to define a modular formalism for modelling regulation between biological entities (*e.g.*, cells), taking into account their neighbouring relations. This has been used to study patterning mechanisms in the context of developmental processes.

On the way, we have identified specific verification issues and proposed solutions to improve the efficiency of verification:

- using a compilation approach, a coloured Petri nets can be implemented as a software library that can be used for model-checking the Petri net of interest. Doing so, it is possible to introduce specific optimisations at many levels by taking advantage of the structure and properties of the compiled Petri net;
- moreover, when a Petri net is constructed by compositions, structural information can be derived automatically and used to improve the verification or to introduce more optimisation in the compilation. This kind of information can also be exploited to improve the parallel computation of the reachability graph of a Petri net;

- the generation scheme proposed for threads identifiers allows to define a method to deal with symmetric executions of a multi-threaded system, or infinite repetitions with varying thread identifiers. This method is based on a general behaviour-preserving marking equivalence that can be implemented has a graph isomorphism check, and we could show that this test is efficient in practice;
- the modelling of time by causality introduces counters of ticks that accelerate the state explosion problem and possibly lead to infinite state space. We have shown how counters can be implemented aside the Petri net using a dedicated library. By using a detection of cycles in the behaviour, large or infinite state spaces can be compressed to a storage-efficient over-approximation that is suitable for reachability analysis.

## 6.1 Ongoing and future works

The framework presented in this document is still under active development, several tasks have been already started and others are planned. In the following, we use one to three stars to denote: ongoing and short-term tasks ( $\star$ ), medium-term tasks ( $\star\star$ ), or long-term projects ( $\star\star\star$ ).

First, a Master thesis has just finished ( $\star$ ) about improving the modelling of topological aspects in the bio-informatics application, including the possibility of cells migration, replication and apoptosis (death). The idea is to maintain, aside the Petri net that encode the logic of regulatory components, a structure to encode the neighbourhood relationship; this is made in such a way that the topology can be queried from the Petri net, for instance to retrieve information or require a topological change. For this purpose, we use the tool MGS that can model in a flexible way very general topological collections [74, 73]. Finally, approach to model patterning mechanism described above for a toy example is being applied to study the segment-polarity module involved in the segmentation of the *Drosophila* embryo ( $\star$ ).

Next, work is planned to implement the full framework in SNAKES, in particular Petri nets with exceptions and Petri nets with threads ( $\star\star$ ). This should lead to extend the ABCD language to support these features ( $\star\star$ ). SNAKES will also be extended to support version 3 of the PNML standard [89] that defines the representation of coloured Petri nets ( $\star$ ). The compilation approach for faster verification presented in section 2.5 has been developed by a Master student who has implemented a prototype. It is planned to integrate this work into SNAKES to improve simulation performances ( $\star$ ). On the long term, SNAKES may be extended to support colour domains others than the Python language, in particular compiled languages ( $\star\star\star$ ). Indeed, by using the compilation approach, Petri nets can be compiled to native libraries that in turn may be loaded from Python and thus used by SNAKES.

This work will also help to support an industrial thesis that will start in December 2009 ( $\star\star\star$ ) in the context of project SPREADS [SPR] and, among other questions, will address the problem of interfacing a Petri net with an execution context. The issue here is to formalise the link between a specification and the corresponding implementation, which is envisaged in two ways: parts of an existing implementation can be embedded as annotations in a Petri net model to be verified; conversely, a Petri net model may be integrated to an existing application as a component. The goal of this approach is to improve the confidence about the implementation by tightening its relationship with a verified specification.

Several case studies are in progress and more are envisaged to apply our approaches. First, project SPREADS [SPR] will continue until the end of 2010. Currently, a first version of the protocol involving a central directory server has been modelled and verified using ABCD ( $\star$ ). The next version uses a directory service that is distributed over the network of peers ( $\star\star$ ). This is currently being designed, both through the implementation of prototypes and through ABCD modelling, verification and simulation. Another case study in progress is about a non-repudiation protocol that involves complex control-flow to model alternative and repetitive behaviours of a server, and the possibility of timeouts on the clients side. This protocol is being modelled using ABCD to verify its properties. This work is in its early stages but a paper is planned on the subject ( $\star$ ). It is also planned to run several case studies concerning causal time to consolidate our results and extend the approach if necessary ( $\star\star$ ).

Concerning verification, the PhD thesis about parallel computing is still in progress. We expect results by the end of the PhD that is planned in October 2010. On the short term, several algorithms

have been designed and benchmarked, the resulting raw measures are being analysed in order to draw conclusions about their comparative performances ( $\star$ ). Moreover, we envisage to study how the verification methods we proposed can be combined. In particular, combining the compact state space abstraction of Petri nets with counters with the marking equivalence for Petri nets with threads seems particularly challenging and in the same time interesting for many applications ( $\star\star$ ). On the other hand, combining the compilation approach with other techniques is expected to be quite straightforward ( $\star\star$ ).

Several other ways are envisaged to improve the verification of our models. First, a work has been started to adapt the sweep-line method [28, 66] in the context of security protocol models ( $\star$ ). Indeed, this method relies on a measure of progression in the analysed system: each computed state  $s$  is associated a measure  $\psi(s)$  from an ordered set in a way that is compatible with the reachability relation (*i.e.*, if state  $s'$  is reachable from state  $s$  then we should have  $\psi(s') \geq \psi(s)$ ). The principle of the sweep-line method is to process states in growing order and dispose from memory the states that cannot be reached again according to the measure. The difficulty with this method is usually to define a non-trivial measure that is fine enough to really lower memory consumption. In the context of security protocols where agents have sequential behaviours, we can observe their control-flow state to measure their progression. A very fine-grain measure can thus be automatically derived from the model and used to save memory, allowing to analyse complex scenarios with huge state spaces.

Other ways of exploiting the structure of the analysed models are envisaged as future works. In particular, modular verification [29, 70] relies on a decomposition of the model into a hierarchy of sub-models. Such a decomposition is usually not available and has to be defined by the user of the tool. But since our models are build by compositions, we have natural knowledge about their structure, which should be exploitable to derive automatically a sensible decomposition that is suitable for modular verification ( $\star\star$ ). A similar approach should be applicable to encode efficiently the state spaces of our models into hierarchical decision diagrams as defined in [52, 22] and implemented in ALPINA [3] ( $\star\star$ ). Indeed, a good ordering of variables is known to be a key issue to achieve good compression using decision diagrams, and this question is even more crucial and more complex at the same time when hierarchical diagrams are considered. Here also, our knowledge of the structure of the analysed model should be exploitable to derive automatically sensible ordering and hierarchy of the variables needed to encode states. We expect to achieved very good compression on systems with many regularities, in particular systems with duplicated components (like models of protocols with several instances of an agent), multi-threaded systems (with several instances of a task), or systems with many similar tokens like models of biological regulatory networks.



## 7 References

### 7.1 Habilitation references

- [BDK<sup>+</sup>] Roland Bouroulet, Raymond Devillers, Hanna Klaudel, Elisabeth Pelz, and Franck Pommereau. Modeling and analysis of security protocols using role based specifications and Petri nets. In *ICATPN'08*, volume 5062 of *LNCS*, pages 72–91. Springer, 2008.
- [BTKP1] Cécile Bui Thanh, Hanna Klaudel, and Franck Pommereau. Box calculus with coloured buffers. Technical Report 16, LACL, University Paris East, 2002.
- [BTKP2] Cécile Bui Thanh, Hanna Klaudel, and Franck Pommereau. Petri nets with causal time for system verification. In *MTCS'02*, volume 68(5) of *ENTCS*, pages 1–16. Elsevier, 2003.
- [BTKP3] Cécile Bui Thanh, Hanna Klaudel, and Franck Pommereau. Box calculus with high-level buffers. In *DADS'04*, pages 1–6. SCS, 2004.
- [CKP1] Claudine Chaouiya, Hanna Klaudel, and Franck Pommereau. A Petri net based framework for a qualitative modelling of regulatory networks encompassing inter-cellular signalling. In Arcadi Navarro and Arlindo Oliveira, editors, *JB'09*, pages 1–5, 2009.
- [CKP2] Claudine Chaouiya, Hanna Klaudel, and Franck Pommereau. *Qualitative modelling of regulatory networks using Petri nets: application to developmental processes*, chapter in preparation. Ina Koch, editor. Springer, to appear.
- [DKK<sup>+</sup>] Raymond Devillers, Hanna Klaudel, Maciej Koutny, Elisabeth Pelz, and Franck Pommereau. Operational semantics for PBC with asynchronous communication. In *HPC'02*, pages 1–6. SCS, 2002.
- [DKKP1] Raymond Devillers, Hanna Klaudel, Maciej Koutny, and Franck Pommereau. An algebra of non-safe Petri boxes. In *AMAST'02*, volume 2422 of *LNCS*, pages 185–214. Springer, 2002.
- [DKKP2] Raymond Devillers, Hanna Klaudel, Maciej Koutny, and Franck Pommereau. Asynchronous box calculus. *Fundamenta Informaticae*, 54(1):1–50, IOS Press, 2003.
- [KKPP1] Hanna Klaudel, Maciej Koutny, Elisabeth Pelz, and Franck Pommereau. Towards efficient verification of systems with dynamic process creation. In *ICTAC'08*, volume 5160 of *LNCS*, pages 186–200. Springer, 2008.
- [KKPP2] Hanna Klaudel, Maciej Koutny, Elisabeth Pelz, and Franck Pommereau. Towards efficient verification of systems with dynamic process creation. Technical Report 8, LACL, University Paris East, 2008.
- [KKPP3] Hanna Klaudel, Maciej Koutny, Elisabeth Pelz, and Franck Pommereau. An approach to state space reduction for systems with dynamic process creation. In *ISCIS'09*, pages 1–6. IEEE Computer Society, to appear.
- [KP1] Hanna Klaudel and Franck Pommereau. Asynchronous links in the PBC and M-nets. In *ASIAN'99*, volume 1742 of *LNCS*, pages 190–200. Springer, 1999.
- [KP2] Hanna Klaudel and Franck Pommereau. A concurrent and compositional Petri net semantics of preemption. In *IFM'00*, volume 1945 of *LNCS*, pages 318–337. Springer, 2000.
- [KP3] Hanna Klaudel and Franck Pommereau. A concurrent semantics of static exceptions in a parallel programming language. In *ICATPN'01*, volume 2075 of *LNCS*, pages 204–223. Springer, 2001.
- [KP4] Hanna Klaudel and Franck Pommereau. A class of composable and preemptible high-level Petri nets with an application to multi-tasking systems. *Fundamenta Informaticae*, 50(1):33–55, IOS Press, 2002.
- [KP5] Hanna Klaudel and Franck Pommereau. M-nets: a survey. *Acta Informatica*, 45(7–8):537–564, Springer, 2009.
- [POM1] Franck Pommereau. SNAKES is the net algebra kit for editors and simulators. (<http://lACL.univ-paris12.fr/pommereau/soft/snakes>).
- [POM2] Franck Pommereau. FIFO buffers in tie sauce. In *DAPSYS'00*, pages 95–104. Kluwer Academic Publishers, 2000.
- [POM3] Franck Pommereau. *Modèles composables et concurrents pour le temps-réel*. PhD thesis, LACL, University Paris East, 2002.
- [POM4] Franck Pommereau. Causal time calculus. In *FORMATS'03*, volume 2791 of *LNCS*, pages 1–12. Springer, 2003.
- [POM5] Franck Pommereau. Petri nets as executable specifications of high-level timed parallel systems. In *PAPP/ICCS'04*, volume 3038 of *LNCS*, pages 331–338. Springer, 2004.
- [POM6] Franck Pommereau. Versatile boxes: a multi-purpose algebra of high-level Petri nets. In *DADS'07*, pages 665–672. SCS/ACM, 2004.

- [POM7] Franck Pommereau. Petri nets as executable specifications of high-level timed parallel systems. *Scalable Computing: Practice and Experience*, 6(6):71–82, SWPS, 2005.
- [POM8] Franck Pommereau. Quickly prototyping Petri nets tools with SNAKES. *Petri net newsletter*, pages 1–18, Gesellschaft für Informatik, Bonn, Germany, 2008.
- [POM9] Franck Pommereau. Quickly prototyping Petri nets tools with SNAKES. In *PNTAP'08*, ACM Digital Library, pages 1–10. ACM, 2008.
- [POM10] Franck Pommereau. Nets-in-nets with SNAKES. In Michael Duvigneau and Daniel Moldt, editors, *MOCA'09*, pages 107–126. Universität Hamburg, Dept. Informatik, 2009.
- [PDK] Franck Pommereau, Raymond Devillers, and Hanna Klaudel. Efficient reachability graph representation of Petri nets with unbounded counters. In *INFINITY'07*, volume 239 of *ENTCS*, pages 1–10. Elsevier, 2009.
- [PS] Franck Pommereau and Christian Stehno. FIFO buffers is hot tie sauce. Technical Report 04, LACL, University Paris East, 2001.
- [SPR] ANR project SPREADS. (<http://www.spreads.fr>), 2007–2010.

## 7.2 General references

1. Martín Abadi and Andrew D. Gordon. A calculus for cryptographic protocols: the spi calculus. In *CCS'97*. ACM, 1997.
2. Olga Marroquín Alonso and David de Frutos Escrig. Extending the Petri box calculus with time. In *ICATPN'01*, volume 2075 of *LNCS*. Springer, 2001.
3. AlPiNA: an algebraic Petri net analyzer. (<http://alpina.unige.ch>).
4. Rajeev Alur and David L. Dill. A theory of timed automata. *Theoretical Computer Science*, 126(2), Elsevier, 1994.
5. The ASCoVeCo project. (<http://www.daimi.au.dk/~ascoveco>).
6. AVISPA: Automated validation of Internet security protocols and applications. (<http://avispa-project.org>).
7. Sébastien Bardin, Alain Finkel, Jérôme Leroux, and Laure Petrucci. FAST: Fast acceleration of symbolic transition systems. In *CAV'03*, volume 2725 of *LNCS*. Springer, 2003.
8. Sébastien Bardin and Laure Petrucci. From PNML to counter systems for accelerating Petri nets with FAST. In Ekkart Kindler, editor, *Workshop on Definition, Implementation and Application of a Standard Interchange Format for Petri Nets*, Universität Paderborn, Germany, 2004.
9. J. A. Bergstra, A. Ponse, and Scott A. Smolka, editors. *Handbook of Process Algebra*. Elsevier, 2001.
10. Eike Best and Raymond Devillers. Sequential and concurrent behaviour in Petri net theory. *Theoretical Computer Science*, 55(1), Elsevier, 1987.
11. Eike Best, Raymond Devillers, and Jon G. Hall. The box calculus: a new causal algebra with multi-label communication. In *Advances in Petri Nets 1992, The DEMON Project*. Springer, 1992.
12. Eike Best, Raymond Devillers, and Maciej Koutny. *Petri net algebra*. Springer, 2001.
13. Eike Best, Wojciech Fraczak, Richard P. Hopkins, Hanna Klaudel, and Elisabeth Pelz. M-nets: An algebra of high-level Petri nets, with an application to the semantics of concurrent programming languages. *Acta Informatica*, 35(10), IOS Press, 1998.
14. Eike Best and Richard P. Hopkins.  $B(PN)^2$  – a basic Petri net programming notation. In *PARLE'93*. Springer, 1993.
15. Bruno Blanchet. An efficient cryptographic protocol verifier based on Prolog rules. In *IEEE CSFW'01*. IEEE Computer Society, 2001.
16. Yohan Boichut, Pierre-Cyrille Héam, and Olga Kouchnarenko. Handling algebraic properties in automatic analysis of security protocols. In *ICTAC'06*, volume 4281 of *LNCS*. Springer, 2006.
17. Bernard Boigelot. The Liège automata-based symbolic handler. (<http://www.montefiore.ulg.ac.be/~boigelot/research/lash>).
18. Dragan Bosnacki, Dennis Dams, and Leszek Holenderski. Symmetric Spin. *International Journal Software Tools for Technology Transfer*, 4(1), Springer, 2002.
19. Cherif Boukala and Laure Petrucci. Towards distributed verification of Petri nets properties. In *VECOS'07*, eWiC. British Computer Society, 2007.
20. Roland Bouroulet, Hanna Klaudel, and Elisabeth Pelz. A semantics of security protocol language (SPL) using a class of composable high-level Petri nets. In *ACSD'04*. IEEE Computer Society, 2004.
21. Roland Bouroulet, Hanna Klaudel, and Elisabeth Pelz. Modelling and verification of authentication using enhanced net semantics of SPL (security protocol language). In *ACSD'06*. IEEE Computer Society, 2006.
22. Didier Buchs and Steve Hostettler. Managing complexity in model checking with decision diagrams for algebraic petri net. In Daniel Moldt, editor, *Pre-proceedings of PNSE'09*, 2009.

23. Cécile Bui Thanh. Generating coloured Petri nets of concurrent object-oriented programs. In *ESMc'04*. EUROSIS, 2004.
24. Béatrice Bérard, Michel Bidoit, Alain Finkel, François Laroussinie, Antoine Petit, Laure Petrucci, and Philippe Schnoebelen. *Systems and software verification: model-checking techniques and tools*. Springer, 2001.
25. Claudine Chaouiya, Élisabeth Remy, Paul Ruet, and Denis Thieffry. Qualitative modelling of genetic networks: From logical regulatory graphs to standard Petri nets. In *ICATPN'04*, volume 3099 of *LNCS*. Springer, 2004.
26. Claudine Chaouiya, Élisabeth Remy, and Denis Thieffry. Qualitative Petri net modelling of genetic networks. *TCSB*, VI(4220), Springer, 2006.
27. Giovanni Chiola, Claude Duthéillet, Giuliana Franceschinis, and Serge Haddad. On well-formed coloured nets and their symbolic reachability graph. In *High-Level Petri Nets – Theory and Application*. Springer, 1991.
28. Søren Christensen, Lars Michael Kristensen, and Thomas Mailund. A sweep-line method for state space exploration. In *TACAS'01*, volume 2031 of *LNCS*. Springer, 2001.
29. Søren Christensen and Laure Petrucci. Modular analysis of Petri nets. *The Computer Journal*, 43(3), The British Computer Society, 2000.
30. Edmund M. Clarke, E. Allen Emerson, Somesh Jha, and A. Prasad Sistla. Symmetry reductions in model checking. In *CAV'98*, volume 1427 of *LNCS*. Springer, 1998.
31. Luigi P. Cordella, Pasquale Foggia, Carlo Sansone, and Mario Vento. A (sub)graph isomorphism algorithm for matching large graphs. *IEEE Transactions on Pattern Analysis and Machine Intelligence*, 26(10), IEEE Computer Society, 2004.
32. Jean-Michel Couvreur. A BDD-like implementation of an automata package. In *CIAA'04*, volume 3317 of *LNCS*. Springer, 2004.
33. Jean-Michel Couvreur, Emmanuelle Encrenaz, Emmanuel Paviot-Adet, Denis Poitrenaud, and Pierre-André Wacrenier. Data decision diagrams for Petri net analysis. In *ICATPN'02*. Springer, 2002.
34. CPN Group, University of Aarhus. CPN Tools. (<http://wiki.daimi.au.dk/cpntools>).
35. Federico Crazzolaro and Glynn Winskel. Events in security protocols. In *CCS'01*. ACM, 2001.
36. Hidde de Jong. Modeling and simulation of genetic regulatory systems: a literature review. *Journal of Computational Biology*, 1(9), Mary Ann Liebert, Inc., 2002.
37. Raymond R. Devillers, Hanna Klaudel, and Robert-C. Riemann. General parameterised refinement and recursion for the M-net calculus. *Theoretical Computer Science*, 300(1–3), Elsevier, 2003.
38. Whitfield Diffie and Martin Hellman. New directions in cryptography. *IEEE Transactions on Information Theory*, 22(6), IEEE, 1976.
39. Danny Dolev and Andrew Yao. On the security of public key protocols. *IEEE Transactions on Information Theory*, 29(2), IEEE Computer Society, 1983.
40. Hartmut Ehrig and Bernd Mahr. *Fundamentals of Algebraic Specification I*. Springer, 1985.
41. Jacob Elgaard, Nils Klarlund, and Anders Møller. MONA 1.x: new techniques for WS1S and WS2S. In *CAV'98*, volume 1427 of *LNCS*. Springer, 1998.
42. John Ellson, Emden R. Gansner, Eleftherios Koutsofios, Stephen C. North, and Gordon Woodhull. Graphviz - open source graph drawing tools. In *Graph Drawing'01*, volume 2265 of *LNCS*. Springer, 2001.
43. Javier Esparza and Mogens Nielsen. Decidability issues for Petri nets—A survey. *Bulletin of the European Association for Theoretical Computer Science*, 52, EATCS, 1994.
44. Javier Esparza, Stefan Römer, and Walter Vogler. An improvement of McMillan's unfolding algorithm. In *FMSD'96*. Springer, 1996.
45. Sami Evangelista, Serge Haddad, and Jean-François Pradat-Peyre. New coloured reductions for software validation. In *WODES'04*, 2004.
46. Sami Evangelista, Serge Haddad, and Jean-François Pradat-Peyre. Syntactical colored Petri nets reductions. In *ATVA'05*, volume 3707 of *LNCS*. Springer, 2005.
47. Sami Evangelista and Jean-François Pradat-Peyre. An efficient algorithm for the enabling test of colored Petri nets. In *CPN'04*, number 570 in DAIMI report PB. University of Århus, Denmark, 2004.
48. Sami Evangelista and Jean-François Pradat-Peyre. Memory efficient state space storage in explicit software model checking. In *SPIN'05*, volume 3639 of *LNCS*. Springer, 2005.
49. Sami Evangelista and Jean-François Pradat-Peyre. On the computation of stubborn sets of colored Petri nets. In *ICATPN'06*, volume 4024 of *LNCS*. Springer, 2006.
50. Adrien Fauré, Aurélien Naldi, Claudine Chaouiya, and Denis Thieffry. Dynamical analysis of a generic Boolean model for the control of the mammalian cell cycle. *Bioinformatics*, 22(14), Oxford Journals, 2006.
51. Aric A. Hagberg, Daniel A. Schult, and Pieter J. Swart. Exploring network structure, dynamics, and function using NetworkX. In *SciPy'08*. (<http://conference.scipy.org>), 2008.

52. Alexandre Hamez, Yann Thierry-Mieg, and Fabrice Kordon. Hierarchical set decision diagrams and automatic saturation. In *ICATPN'08*. Springer, 2008.
53. Keijo Heljanko, Victor Khomenko, and Maciej Koutny. Parallelisation of the Petri net unfolding algorithm. In *TACAS'02*, volume 2280 of *LNCS*. Springer, 2002.
54. Martijn Hendriks, Gerd Behrmann, Kim Guldstrand Larsen, Peter Niebert, and Frits W. Vaandrager. Adding symmetry reduction to Uppaal. In *FORMATS'03*, volume 2791 of *LNCS*. Springer, 2003.
55. Gerard J. Holzmann. An analysis of bitstate hashing. *Formal Methods in System Design*, 13(3), Kluwer Academic Publishers, 1998.
56. Gerard J. Holzmann and al. Spin, formal verification. (<http://spinroot.com>).
57. C. Norris Ip and David L. Dill. Better verification through symmetry. *Formal Methods in System Design*, 9(1–2), Kluwer Academic Publishers, 1996.
58. Kurt Jensen and Lars M. Kristensen. *Coloured Petri Nets: Modelling and Validation of Concurrent Systems*. Springer, 2009.
59. Tommi Junttila. *On the Symmetry Reduction Method for Petri Nets and Similar Formalisms*. PhD thesis, Helsinki University of Technology, Laboratory for Theoretical Computer Science, Espoo, Finland, 2003.
60. Jens B. Jørgensen and Lars M. Kristensen. Verification of coloured Petri nets using state spaces with equivalence classes. *LINCOM Studies in Computer Science*, 1, Lincom Europa, 2003.
61. Victor Khomenko. Punf: Petri net unfolders. (<http://homepages.cs.ncl.ac.uk/victor.khomenko/tools/punf>).
62. Victor Khomenko. *Model Checking Based on Prefixes of Petri Net Unfoldings*. PhD thesis, School of Computing Science, Newcastle University, Newcastle upon Tyne, GB, 2003.
63. Kais Klai, Laure Petrucci, and Michel Reniers. An incremental and modular technique for checking LTL\X properties of Petri nets. In *FORTE'07*. Springer, 2007.
64. Hanna Klaudel. Parameterized M-expression semantics of parallel procedures. In *DAPSYS'00*. Kluwer Academic Publishers, 2000.
65. Maciej Koutny. A compositional model of time Petri nets. In *ICATPN'00*, volume 1825 of *LNCS*. Springer, 2000.
66. Lars Michael Kristensen and Thomas Mailund. A generalised sweep-line method for safety properties. In *FME/FM'02*, volume 2391 of *LNCS*. Springer, 2002.
67. Flavio Lerda and Riccardo Sisto. Distributed-memory model checking with Spin. In *SPIN'99*. Springer, 1999.
68. Glenn Lewis and Charles Lakos. Incremental state space construction for coloured Petri nets. In *ICATPN'01*. Springer, 2001.
69. Kenneth L. MacMillan. *Symbolic Model Checking*. Kluwer Academic Publishers, 1993.
70. Marko Mäkelä. Maria: Modular reachability analyser for algebraic system nets. In *ICATPN'02*, volume 2360 of *LNCS*. Springer, 2002.
71. Luis Mendoza. A network model for the control of the differentiation process in Th cells. *Biosystems*, 84(2), Elsevier, 2006.
72. Philip M. Merlin and David J. Farber. Recoverability of communication protocols: Implications of a theoretical study. *IEEE Transaction on Communications*, 24(9), IEEE Communications Society, 1976.
73. Olivier Michel. There is plenty of room for unconventional programming languages or declaratives simulations of dynamical systems (with a dynamical structure). Habilitation Thesis, IBISC, University of Evry, 2007.
74. Olivier Michel, Jean-Louis Giavitto, Julien Cohen, and Antoine Spicher. MGS. (<http://mgs.ibisc.univ-evry.fr>).
75. Alice Miller, Alastair Donaldson, and Muffy Calder. Symmetry in temporal logic model checking. *ACM Computing Surveys (CSUR)*, 38(3), ACM, 2006.
76. Robin Milner. *Communicating and Mobile Systems: the Pi-Calculus*. Cambridge University Press, 1999.
77. Marko Mäkelä. Maria: The modular reachability analyzer. (<http://www.tcs.hut.fi/Software/maria>).
78. Marko Mäkelä. Applying compiler techniques to reachability analysis of high-level models. In Hans-Dieter Burkhard, Ludwik Czaja, Andrzej Skowron, and Peter Starke, editors, *CS&P'00*, number 140 in Informatik-Bericht. Humboldt-Universität zu Berlin, Germany, 2000.
79. Marko Mäkelä. Condensed storage of multi-set sequences. In Kurt Jensen, editor, *CPN'00*, number 547 in DAIMI report PB. University of Århus, Denmark, 2000.
80. Marko Mäkelä. Optimising enabling tests and unfoldings of algebraic system nets. In *ICATPN'01*, volume 2075 of *LNCS*. Springer, 2001.
81. Marko Mäkelä. A reachability analyser for algebraic system nets. Research Report A69, Helsinki University of Technology, Laboratory for Theoretical Computer Science, 2001.

82. Roger M. Needham and Michael D. Schroeder. Using encryption for authentication in large networks of computers. *Communication of the ACM*, 21(12), ACM, 1978.
83. Christophe Pajault and Sami Evangelista. Helena: a high level net analyzer. (<http://helena.cnam.fr>).
84. Christophe Pajault and Jean-François Pradat-Peyre. Distributed colored Petri net model-checking with Cyclades. In *FMICS/PDMC'06*, volume 4346 of *LNCS*. Springer, 2006.
85. Parallel Systems Group, University of Oldenburg. The PEP tool. (<http://peptool.sourceforge.net>).
86. Elisabeth Pelz and Dietmar Tutsch. Formal models for multicast traffic in network on chip architectures with compositional high-level Petri nets. In *ICATPN'07*, volume 4546 of *LNCS*. Springer, 2007.
87. James L. Peterson. Petri nets. *ACM Computing Surveys*, 9(3), ACM, 1977.
88. James Lyle Peterson. *Petri Net Theory and the Modeling of Systems*. Prentice Hall PTR, 1981.
89. Petri net markup language. (<http://www.pnml.org>).
90. William Pugh. The Omega test: a fast and practical integer programming algorithm for dependence analysis. In *ACM/IEEE SC'91*. ACM, 1991.
91. Python Software Foundation. Python programming language. (<http://www.python.org>).
92. Michael O. Rabin. Decidability of second-order theories and automata on infinite trees. *Transactions of the AMS*, 141, AMS, 1969.
93. Chandler Ramchandani. *Analysis of Asynchronous Concurrent Systems by Timed Petri Nets*. PhD thesis, MIT, Department of Electrical Engineering, Cambridge, Massachusetts, USA, 1974.
94. Klaus Reinhardt. Reachability in Petri nets with inhibitor arcs. *ENTCS*, 223, Elsevier, 2008.
95. Claus Reinke. Haskell-coloured Petri nets. In *IFL'99*. Springer, 2000.
96. Research Group Petri Net Technology, Humboldt Universität of Berlin. The Petri net kernel. (<http://www.informatik.hu-berlin.de/top/pnkn>).
97. Julio Saez-Rodriguez, Luca Simeoni, Jonathan A Lindquist, Rebecca Hemenway, Ursula Bommhardt, Boerge Arndt, Utz-Uwe Haus, Robert Weismantel, Ernst D Gilles, Steffen Klamt, and Burkhard Schraven. A logical model provides insights into T cell receptor signaling. *PLoS Computational Biology*, 3, ISCB, 2007.
98. Lucas Sánchez, Claudine Chaouiya, and Denis Thieffry. Segmenting the fly embryo: a logical analysis of the segment polarity cross-regulatory module. *The International Journal of Developmental Biology*, 52(8), UBC Press, 2008.
99. Lucas Sánchez and Denis Thieffry. A logical analysis of the drosophila gap-gene system. *Journal of Theoretical Biology*, 211(2), Elsevier, 2001.
100. Lucas Sánchez and Denis Thieffry. Segmenting the fly embryo: a logical analysis of the pair-rule cross-regulatory module. *Journal of Theoretical Biology*, 224(4), Elsevier, 2003.
101. Thomas Schlitt and Alvis Brazma. Current approaches to gene regulatory network modelling. *BMC Bioinformatics*, 8(Suppl 6), BioMed Central, 2007.
102. David B. Skillicorn, Jonathan M. D. Hill, and William F. McColl. Questions and answers about BSP. *Scientific Programming*, 6(3), ISO Press, 1997.
103. Security protocols open repository. (<http://www.lsv.ens-cachan.fr/Software/spore>).
104. L. Jason Steggles, Richard Banks, Oliver Shaw, and Anil Wipat. Qualitatively modelling and analysing genetic regulatory networks: a Petri net approach. *Bioinformatics*, 23(3), Oxford Journals, 2007.
105. René Thomas. Boolean formalisation of genetic control circuits. *Journal of Theoretical Biology*, 42, Elsevier, 1973.
106. René Thomas, Denis Thieffry, and Marcelle Kaufman. Dynamical behaviour of biological regulatory networks—I. Biological role of feedback loops and practical use of the concept of the loop-characteristic state. *Bulletin of mathematical Biology*, 57(57), Springer, 1995.
107. Rüdiger Valk. Object Petri nets: Using the nets-within-nets paradigm. In *Advanced course on Petri nets*, volume 3098 of *LNCS*, pages 819–848. Springer, 2003.