



**HAL**  
open science

# Daily Human Activity Recognition in Smart Home based on Feature Selection, Neural Network and Load Signature of Appliances

Nadia Oukrich

► **To cite this version:**

Nadia Oukrich. Daily Human Activity Recognition in Smart Home based on Feature Selection, Neural Network and Load Signature of Appliances. Technology for Human Learning. Université Mohamed V; Ecole Mohammadia d'Ingénieurs - Université Mohammed V de Rabat - Maroc, 2019. English. NNT: . tel-02193228

**HAL Id: tel-02193228**

**<https://hal.science/tel-02193228>**

Submitted on 24 Jul 2019

**HAL** is a multi-disciplinary open access archive for the deposit and dissemination of scientific research documents, whether they are published or not. The documents may come from teaching and research institutions in France or abroad, or from public or private research centers.

L'archive ouverte pluridisciplinaire **HAL**, est destinée au dépôt et à la diffusion de documents scientifiques de niveau recherche, publiés ou non, émanant des établissements d'enseignement et de recherche français ou étrangers, des laboratoires publics ou privés.

**MOHAMMED V UNIVERSITY IN RABAT**  
**MOHAMMEDIA SCHOOL OF ENGINEERS**

CENTER FOR DOCTORAL STUDIES: SCIENCES AND TECHNIQUES FOR THE  
ENGINEER

Computer and Education Research Laboratory (LRIE)

DOCTORAL THESIS

Supported and presented publicly on 26/04/2019 by:

**Nadia OUKRICH**

In order to obtain

Doctor in sciences and techniques for the engineer

Specialty: Computer Engineering

---

**Daily Human Activity Recognition in Smart Home  
based on Feature Selection, Neural Network and  
Load Signature of Appliances**

---

**Jury members:**

Chairman	<b>:Prof.S.BENNANI</b>	<b>Mohammedia School of Engineers</b>
Supervisor	<b>:Prof.A.MAACH</b>	<b>Mohammedia School of Engineers</b>
Supervisor	<b>:Prof. D. EL GHANAMI</b>	<b>Mohammedia School of Engineers</b>
Rapporteur	<b>:Prof. B. EL ASRI</b>	<b>High National School for Computer Science and Systems Analysis</b>
	<b>:Prof. A. HASBI</b>	<b>Mohammedia School of Engineers</b>
	<b>:Prof. M. AMGHAR</b>	<b>Mohammedia School of Engineers</b>

## ABSTRACT

A smart home is a standard residence that was improved and equipped with all kinds of sensors and effectors in order to provide services to its residents. One of the most key subjects and input to several smart home applications (e.g. healthcare and home security) is the recognition of activities of a resident's daily living. Being able to automate the activity recognition from human motion patterns is challenging because of the complexity of the human life inside home either by one or multiple residents. To surmount all databases complexity, several algorithms of features selection and machine learning were tested in order to increase the human activity recognition accuracy. Another major challenge to cope with is to reduce the costs of maintenance and installation of sensors at home. These sensors, despite their modest costs, are generally out of reach of most people. To overcome this challenge, we used another approach based on household appliances recognition as sensors that detect human interaction with appliances and resident movements.

This study aims to solve the complexity of human activity recognition and increase accuracy by proposing two different approaches. The first approach is based on recognizing human activities using ambient sensors (motion and door sensors), neural and deep neural network combined with several feature selection methods in order to compare results and define the influence of each one in learning accuracy. The second approach is based on load signatures of appliances presented using an Intrusive Load Monitoring in order to identify the most accurate classifier suitable for appliances recognition. Once determined, the next phase is to know resident activities through appliances recognition. Each part of our methodologies is thoroughly tested, and the results are discussed.

## RESUMÉ

Une maison intelligente est une résidence dotée de capteurs et des outils technologiques, permettant la surveillance et la gestion à distance des systèmes tels que l'éclairage, le chauffage, etc.

Afin de mettre en service la plupart des applications de la maison intelligente, il faut reconnaître les activités quotidiennes de la personne résidente. L'automatisation la reconnaissance d'activité à partir des données délivrées par les capteurs présente, en elle-même, une difficulté en raison de la complexité et la diversité des mouvements des résidents.

De plus, les coûts de la maintenance et de l'installation de système de capteurs à l'intérieur de la maison, restent généralement hors de portée de la plupart des gens.

Partant de ces deux problématiques, nous avons mené notre thèse doctorale qui a pour objectif de résoudre la difficulté de la reconnaissance de l'activité humaine et augmenter sa précision.

Pour se faire, nous avons proposé deux approches différentes. La première est basée sur la sélection des caractéristiques et l'apprentissage à base de réseaux neuronaux. Les réseaux neuronaux sont combinés à plusieurs méthodes de sélection de caractéristiques pour comparer les résultats et définir l'influence de chaque approche sur la précision et l'apprentissage.

La seconde approche est basée sur les signatures de charge des appareils électriques. Ces signatures sont présentées à l'aide d'un prétraitement automatique basé sur la surveillance de charge intrusive. Cette charge permet d'identifier le classificateur le plus adéquat à la reconnaissance des appareils électriques et donc à la reconnaissance de l'activité humaine.

Chaque partie de nos méthodologies est minutieusement testé et les résultats sont discutés.

## ملخص الرسالة

المنزل الذكي هو محل إقامة يحتوي على العديد من مستشعرات ومستجيبات من أجل تقديم الخدمات إلى المقيمين به. معرفة أنشطة الحياة اليومية للمقيم هو واحد من أهم الموضوعات الرئيسية للبحوث في المنزل الذكي والأساسية للعديد من التطبيقات المنزلية الذكية (مثل الرعاية الصحية وأمن المنزل). تعتبر القدرة على التعرف على الأنشطة البشرية المنزلية سواء لشخص واحد أو عدة أشخاص باستخدام أجهزة الاستشعار الناشئة أمرًا صعبًا نظرًا لتعقيد الحياة البشرية داخل المنزل وكثرة حركة القاطنين بها. لتجاوز كل تعقيد في قاعدة البيانات وفي معرفة أنشطة القاطنين بالمنزل، اخترنا عدة خوارزميات لاختيار المميزات وأخرى للتعلم الآلي لزيادة دقة التعرف على النشاط البشري. التحدي الثالث الذي وجهناه هو تقليل تكاليف صيانة وتركيب أجهزة الاستشعار في المنزل، ورغم التكلفة المتواضعة لهذه المستشعرات تبقى بعيدة عن متناول معظم الناس. للتغلب على هذا التحدي، استخدمنا نشاط الأجهزة الكهربائية في المنزل ككاشفات للحركة البشرية.

يهدف البحث المقدم في هذه الرسالة إلى تسهيل التعرف على النشاط البشري وزيادة الدقة في معرفة الأنشطة البشرية. على وجه الخصوص، يقترح البحث أسلوبين مختلفين لذلك، أول أسلوب يستند إلى التعرف على الأنشطة البشرية باستخدام أجهزة الاستشعار المحيطية والشبكة العصبية والعصبية العميقة إلى جانب عدة طرق لاختيار الخاصية ثم مقارنة النتائج وتحديد تأثير كل منها في دقة التعلم. ويستند الثاني في تحميل توقعات الأجهزة المقدمة باستخدام المعالجة المسبقة التلقائية على أساس تحويل الموجات المنفصلة من أجل تحديد المصنف الأكثر دقة للتعرف على الأجهزة، والتعرف على الأجهزة هو مدخل للتعرف على النشاط البشري.

## ACKNOWLEDGEMENTS

*I start in the name of the Almighty God, the most Gracious, the most Merciful, for bestowing upon me good health and mental state to carry on this research.*

*I would like to express my deepest and sincerest gratitude and appreciation to my supervisors, Professor Abdelilah Maach and Professor Driss Elghanami for giving me the opportunity to work under their supervision. I insist on thanking them for their understanding and support throughout the research process. They have always been by my side whenever I needed them, providing me with their full support, ideas and suggestions to improve my work. Besides their guidance and support in the practical work, they have also rigorously analysed and read my research paper and manuscript to make them easily understandable and highly useful for others. Their review improved my documents, not only regarding the structure but also the sentences, phrases and grammar etc. They have always encouraged me to participate in the relevant international conferences, schools and courses that improved my knowledge, skills and expertise in my domain and over certain tools. Without their continuous support, guidance and help I would have never been able to achieve the reward of completing my PhD.*

*I am grateful to the members of the jury: Mr. Samir Bennani, Mr. Mustapha amghar, Mr. Abderrahim Hasbi and Mss. Bouchra El Asri who took time out of their busy schedules and attended my thesis defence. The jury members rigorously read the manuscript and offered their valuable comments and suggestions.*

*I am also thankful to my research lab LRJE in the IT department, where I worked in an encouraging, comfortable and productive environment and had all the necessary equipment and tools to carry on my research without any problems. I spent a very good time with my colleagues with whom I entertained healthy discussions.*

*I would also like to thank Dr. Kevin Bouchard for his valuable help and support in my first and second year in PHD. Thank you for sharing your ideas and suggestions, and for providing me with sources of data and correcting my articles.*

*My special thanks go to my parents for their unconditional love and moral support throughout the completion of this research work and their candid wishes and prayers for me. Many thanks to my husband and colleague Soufiane for always being there for me. I end with the pray to the Almighty God to enable me to use the knowledge, that I have gained during this research work, in the great interest and betterment of society and humanity.*

# TABLE OF CONTENTS

ABSTRACT .....	1
RESUMÉ.....	2
ملخص الرسالة .....	3
ACKNOWLEDGEMENTS .....	4
TABLE OF CONTENTS .....	6
LIST OF FIGURES.....	9
ILLUSTRATION TABLES .....	10
LIST OF ACRONYMES .....	11
INTRODUCTION.....	12
<b>CHAPTER I:OVERVIEW OF RESEARCH CONTEXT .....</b>	<b>16</b>
1.1- Definitions.....	17
1.1.1 Smart home .....	17
1.1.2 Notion of “activity”.....	17
1.1.3 Human Activity recognition.....	18
1.1.4 Notion of “Appliance” .....	18
1.1.5 Appliance load monitoring .....	19
1.1.6 Activities of Daily Living .....	20
1.1.7 Human activities type.....	21
1.1.8 Ambient assisted living.....	22
1.1.9 Smart home applications.....	22
1.2- Activity recognition algorithms .....	24
1.2.1 Sensors platform .....	25
1.2.2 Features extraction .....	27
1.2.3 Machine learning approaches to activity recognition .....	30
1.3 Conclusion .....	32
<b>CHAPTER II:RELATED WORK: APPROACHES USED TO FEATURES SELECTION AND ACTIVITY RECOGNITION.....</b>	<b>34</b>
2.1 Introduction .....	35
2.2 Feature selection based on neural network algorithms.....	35
2.3 Neural network algorithms for human activity recognition .....	37
2.4 Deep Neural Network Used in Human activity recognition.....	39
2.5 Activity recognition based on Load Signatures of Appliance .....	43
2.5.1 ILM methods.....	43



2.5.2 NIALM methods .....	44
2.6 Other related techniques in human activity recognition .....	45
2.6.1 Data mining used to recognise human activity .....	45
2.6.2 IoT technologies used in human activity recognition .....	46
2.7 Conclusion .....	48
<b>CHAPTER 3:RESEARCH DEVELOPMENT AND METHODOLOGY .....</b>	<b>49</b>
3.1 Introduction .....	50
3.2- Activity recognition using neural network and based on ambient sensors .....	50
3.2.1 Description of ADLs databases.....	50
Figure 3.2: the smart apartment testbed and sensors location in the Aruba apartment.....	53
3.2.2 Feature construction.....	54
3.2.3 mRMR for supervised features selection .....	56
3.2.4 Autoencoder for unsupervised feature selection .....	57
3.2.5 Human activity recognition using Neural Networks.....	58
3.2.6 Human activity recognition using Deep Neural Networks .....	59
3.2.7 Support Vector Machines for ADLs Classification .....	60
3.3- Activity recognition using appliance recognition .....	61
3.3.1 Description of the tracebase data set used in appliance recognition.....	62
3.3.2 Feature extraction using DWT.....	63
3.3.3 Classifiers used in appliance recognition.....	63
3.3.4 Activity recognition based in appliance recognition.....	65
3.3.5 Limitations and advantages of this method .....	69
3.4 Conclusion .....	70
<b>CHAPTER 4:ACTIVITY RECOGNITION USING NEURAL NETWORKS AND AMBIENT SENSORS.....</b>	<b>71</b>
4.1- Introduction .....	72
4.2- One user activity recognition using back-propagation algorithm and mRMR feature selection .....	72
4.2.1 Parameters.....	72
4.2.2 Results.....	73
4.3- Multi-user activity recognition using back-propagation algorithm and mRMR feature selection .....	75
4.4- Human activity recognition using autoencoder and back-propagation algorithm.....	78
4.4.1 Autoencoder and BP Algorithm Parameters for ActivityRecognition .....	78
4.4.2 Results discussion .....	79
4.4.3 Comparison Results .....	83

4.4.4 Conclusion .....	84
4.5- Multi-resident activity recognition using deep belief network .....	84
4.5.1 experiments and results .....	84
4.5.2 Results discussion .....	85
4.6 Conclusion .....	90
<b>CHAPTER 5:HUMAN ACTIVITY RECOGNITION USING APPLIANCES</b> .....	91
5.1 Introduction .....	92
5.2 Implementation and Results .....	92
5.2.1 Experimental results for appliance recognition .....	93
5.2.2 Experimental results for activity recognition .....	95
5.3 Discussion of results .....	96
5.4: Conclusion .....	98
<b>GENERAL CONCLUSION</b> .....	99
<b>Bibliography</b> .....	103
<b>Appendix 1:</b> Features extraction algorithm .....	114
<b>Appendix 2:</b> DBN implementation for ADLs recognition .....	120
<b>Appendix 3 :</b> Appliance recognition algorithm .....	124
<b>Appendix 4:</b> Scientific Publications .....	128

## LIST OF FIGURES

<i>Figure 1.1: smart home components</i> .....	17
<i>Figure 1.2: Distinction between ILM and NILM</i> .....	20
<i>Figure 1.3: An illustration of sensor-based activity recognition</i> .....	24
<i>Figure 1.4: type of well-known machine learning</i> .....	30
<i>Figure 2.1: typical Neural Network structure</i> .....	38
<i>Figure 2.2: Taxonomy of feedforward and feedback network architectures</i> .....	39
<i>Figure 2.3: different deep learning algorithms</i> .....	39
<i>Figure 2.4: The benefits of using smart home applications based on IoT</i> .....	46
<i>Figure 3.1: block diagram summarizing how the methodology of the research was carried out</i> .....	51
<i>Figure 3.2: the smart apartment testbed and sensors location in the Aruba apartment</i> .....	52
<i>Figure 3.3: Ontological representation of activity</i> .....	54
<i>Figure 3.4: Unsupervised Autoencoder Learning architecture</i> .....	55
<i>Figure 3.5: Structure of a DBN used in this work with 17 neurons in input layer and 3 hidden layers</i> .....	59
<i>Figure 3.6: Discrete wavelet transform with two levels</i> .....	62
<i>Figure 4.1: Number of Iterations Depends on the Gradient Error</i> .....	78
<i>Figure 4.2: Comparison of BPA, SVM and DBN of Twor dataset</i> .....	88
<i>Figure 4.3: Comparison of BPA, SVM and DBN of Tulum dataset</i> .....	88
<i>Figure 5.1: Variations of Log loss function for the nine classifiers used</i> .....	93

## ILLUSTRATION TABLES

<i>Table 2.1: description of different neural network algorithms .....</i>	<i>37</i>
<i>Table 2.2: Deep Learning methods comparison based in recent literature works in human activity recognition.....</i>	<i>40</i>
<i>Table 2.2: continued .....</i>	<i>41</i>
<i>Table 3.1: Databases description .....</i>	<i>50</i>
<i>Table 3.2: Description of ADLs Activities of Aruba and Cairo Databases .....</i>	<i>52</i>
<i>Table 3.3: ADLs Activities of Tulum and Twor datasets .....</i>	<i>53</i>
<i>Table 3.4 Number of instances prepared from Tracebase dataset for each appliance.....</i>	<i>62</i>
<i>Table 3.5 present a list of human activities monitored using appliance recognition.....</i>	<i>65</i>
<i>Table 4.1: features classification based in their mRMR score.....</i>	<i>71</i>
<i>Table 4.2: parameters of neural network using bp algorithm.....</i>	<i>72</i>
<i>Table 4.3: results of recognition accuracy performance with the four different feature Subsets.....</i>	<i>73</i>
<i>Table 4.4: features classification based in their mRMR score .....</i>	<i>75</i>
<i>Table 4.5: Comparison results of the two method of activity recognition accuracy of the different feature datasets .....</i>	<i>75</i>
<i>Table 4.6. Parameters of Neural Network Using BP Algorithm .....</i>	<i>77</i>
<i>Table 4.7: Activity Recognition Accuracy for the Two Initial Subsets: Aruba and Cairo ..</i>	<i>79</i>
<i>Table 4.8: Accuracy of Different Hidden Neurons of Subset 2 .....</i>	<i>79</i>
<i>Table 4.9 Accuracy of Different Hidden Neurons of Subset 3 .....</i>	<i>80</i>
<i>Table 4.10: Accuracy of Different Hidden Neurons of Subset 4 .....</i>	<i>80</i>
<i>Table 4.11: Accuracy of Different Hidden Neurons of Subset 5 .....</i>	<i>81</i>
<i>Table 4.12: Accuracy of Different Hidden Neurons of Subset 6 .....</i>	<i>81</i>
<i>Table 4.13: Ranking of the 13 Features Using Weighting Features Selection Method ....</i>	<i>82</i>
<i>Table 4.14: Activity Recognition Accuracy Using BP Algorithm and Weighting Features Selection .....</i>	<i>82</i>
<i>Table 4.15: HAR-experiment results using Back-propagation based approach .....</i>	<i>85</i>
<i>Table 4.16: HAR-experiment results using traditional SVM-based approach .....</i>	<i>86</i>
<i>Table 4.17: HAR-experiment results using DBN-based approach .....</i>	<i>87</i>
<i>Table 5.1: Classifiers accuracies and training times.....</i>	<i>93</i>
<i>Table 5.2: Accuracy of activity recognition based on appliance recognition .....</i>	<i>95</i>

## LIST OF ACRONYMES

<b>Symbol</b>	<b>Definition</b>
<b>AAL</b>	Ambient Assisting Living
<b>ADL</b>	Activities of Daily Living
<b>AI</b>	Artificiel Intelligence
<b>ALM</b>	Appliance Load Monitoring
<b>Anns</b>	Artificial Neural Networks
<b>BBP</b>	Batch Back Propagation
<b>BP</b>	Back-Propagation
<b>CASAS</b>	Comprehensive Adult Student Assessment Systems
<b>CNN</b>	Convolutional Neural Network
<b>Crfs</b>	Conditional Random Fields
<b>Dbns</b>	Deep Belief Networks
<b>FSA</b>	Finite State Appliances
<b>HAR</b>	Human Activity Recognition
<b>HMM</b>	Hidden Markov Model
<b>ICT</b>	Information and Communication Technologies
<b>ILM</b>	Intrusive Load Monitoring
<b>LM</b>	Levenberg Marquardt
<b>MIT</b>	Massachusetts Institute of Technology
<b>NB</b>	Naïve Bayes
<b>NILM</b>	Non-Intrusive Load Monitoring
<b>QP</b>	Quick Propagation
<b>RBM</b>	Restricted Boltzmann Machine
<b>RFID</b>	Radio-Frequency IDentification
<b>SM</b>	Smart Home
<b>Svms</b>	Support Vector Machines

# INTRODUCTION

---

A smart home is a normal house equipped with sensors and technology tools that anticipate and respond to the needs and requirements of the residents, working to promote their luxury, convenience, security, and entertainment [1]. A key point in the development of smart home is the recognition of normal and daily routine activities of its residents. This recognition can reduce costs of health and elderly care [2] that exceed \$7 trillion annually worldwide [3], ensure comfort, homecare [4], safety, and reduce energy consumption. For these reasons, human activity recognition has been researched for nearly a couple of decades. In fact, a large number of research focuses on the recognition of Activities of Daily Living [5] (ADLs), performed by a resident in daily routine, such as eating, cooking, sleeping, and toileting. There are various reasons for mostly covering ADLs in the literature. First, those activities are general, real, and common between young and old people. Second, ADLs are the most used in standard tests of resident autonomy; disability with ADLs is the most common reason why older people live in nursing homes [6]. Finally, ADLs are the best suited as inputs to perform different home applications. For those reasons, we focus on recognizing ADLs activities in this research.

The recognition of one and multi-residents ADLs activities are investigated in this thesis using inexpensive ambient sensors. Despite the progress in smart phones and wearable sensors [7]–[10] and the excessive use of visual sensing in research area, ambient sensors were adopted to collect information about residents instead of wearable sensors and cameras. The reasons behind this choice are the respect of residents' privacy and the reduction of smart home system maintenance and installation cost. In the second part of this research, a new technique in activity recognition based on appliances recognition was developed and adopted.

Human activity recognition is the key for several applications in smart home (e.g. home security, home energy management and healthcare); it is the first and the most important research field in smart home research area. Human activity recognition is a challenging area because of the complexity of human life inside home either for one or multiple residents. Generally, a resident moves a lot in the house sometimes without doing any activity, thus generates a non-exploitable database to pursue the recognition of the activities. To overcome

the complexity of the database, several algorithms of features selection and learning were tested in order to increase the recognition accuracy.

Smart homes provide continuous monitoring capability that conventional methodologies lack. Being able to automate the activity recognition from human motion patterns using unobtrusive sensors or other devices can be useful in monitoring humans (e.g. elders, children), and automatically responding to several situations at home. The main problem to resolve is to design an algorithm that labels the activity performed by inhabitants in a smart environment from sensor data collected during the activity.

Recently, human activity discovery and recognition have gained a lot of interest due to their enormous potential in context-aware computing systems, including smart home environments. Researchers have commonly tested the machine learning algorithms to resolve this problem. However, well known machine learning algorithm usually has some defects to some extent. For example, NB classifier is a simple probabilistic classifier based on the application of the Bayes' theorem, but the independence assumptions of variables are not always accurate. Another key problem is that these approaches require the knowledge about probabilities, therefore, they yield lower accuracy rate with fewer observed samples. Therefore, an approach which is not sensitive to the amount of available data is especially reasonable for activity recognition in smart homes. The choice of the features selection method as well as learning algorithm is a big challenge which depends on several parameters including the nature of the database and the desired activities to be recognized.

Recognition of multi-users activities using inexpensive and ambient sensors is challenging because of the complexity of real human life, noises in database and the complexity of multi-resident 'concurrent activities; recognition of these activities requires powerful learning algorithms and specific steps in the recognition process.

Another major challenge to be overcome is to reduce the costs of maintenance and installation of sensors in the house; these sensors, despite their modest costs, are generally out of reach of most people. To resolve this problem, researchers have been thinking of using smart electrical appliances at home as sensors that detect human movements, especially with the excessive use of these smart appliances. This research area is still in a development phase and needs a lot of research and experiments to reach the mature phase.

The objective of this thesis is to recognise activities of one resident and multi-residents daily activities inside home using inexpensive ambient sensors installed in several places at home. In order to increase the accuracy of activity recognition, various methods are proposed based on features selection methods and neural network in learning phase. In these recent years, neural network is used in various researches to recognize human activities, and they prove successful and more efficient compared to other usual machine learning algorithms. In order to overcome challenges related to the use of motion and door sensors, we have proceeded into using a new technique based on the recognition of activities via the electrical appliances used in the house.

This thesis report consists of five chapters organized as follows:

- Chapter 1 [OVERVIEW OF RESEARCH CONTEXT]: This first chapter presents a global overview of the thesis research area and the main definitions in this research, and highlights research domains in human activity recognition inside home. The objective of this chapter is to clearly our research questions and goals. This chapter is divided in two main parts: (i) clarify definitions of the area of research and present a general framework of the research (ii) present recent methods and algorithms used for activity recognition.
- Chapter 2 [RELATED WORK: APPROACHES USED TO FEATURES SELECTION AND ACTIVITY RECOGNITION]: Chapter two aims to explore the main related works relevant to our research and our applicative context. In the first part, we particularly present some recent proposed strategies in literature using neural networks, based on ambient sensors (door and motion sensors). In the second part, we focus on recognising activities via appliances recognition at home in order to reduce the number of sensors used and reduce costs of building a smart home. We conclude the chapter by exploring new areas of research in smart home and activity recognition with a description of the advantages and limitations of each method.
- Chapter 3 [RESEARCH DEVELOPMENT AND METHODOLOGY]: Chapter three details the methodologies used to recognise activities of one and multiple users inside home. Two methodologies are explained, the first is based on sensors and neural networks and the second on appliance recognition; The methodology is graphically presented as a block diagram, summarizing how the methodology of the research was carried out, within the two sections 1 and 2 described in detail in this chapter.



- Chapter 4 [ACTIVITY RECOGNITION USING NEURAL NETWORKS AND AMBIENT SENSORS]: In this chapter, we perform several simulations of databases using machine learning algorithms and feature selection techniques. The objective of this study is to raise accuracy of activity recognition of one and multiple residents at home. Several neural and deep neural networks algorithms combined with feature selection techniques are trained and lead to different results.

- Chapter 5 [ACTIVITY RECOGNITION USING APPLIANCE RECOGNITION] This chapter presents simulation results of activity recognition of one resident living in a smart habitat through load signatures of appliances. This simulation is divided into two algorithms; the first recognises the state of appliances while the second recognises activities through appliances recognition.

# **CHAPTER I:**

## **OVERVIEW OF RESEARCH CONTEXT**

This first chapter presents a global overview of the thesis research area and the main definitions in this research, and highlights research domains in human activity recognition inside home. The objective of this chapter is to clearly our research questions and goals. This chapter is divided in two main parts: (i) clarify definitions of the area of research and present a general framework of the research (ii) present recent methods and algorithms used for activity recognition.

---

# 1.1 Definitions

This part presents the main definitions of the researched area and the process of recognizing activities inside home based on ambient sensors or appliances state. Data is collected once it is obtained from sensors reading, then a list of features are extracted from row data and used as input to machine learning algorithms. Activity recognition can be used as input to different home applications such as healthcare and security.

## 1.1.1 Smart home

A smart home can be defined as a home equipped with sensors, middleware system, and communication interfaces, which anticipate and respond to the needs and requirements of the inhabitants, working to promote their luxury, convenience, security, and entertainment through the supervision of technology within home [11]. A smart home can provide a variety of services and automated tasks as room-temperature control and smart air conditioner to complex tasks as analysis or prediction of the location of a resident, to behaviour or health status recognition of an occupant living at home[12].

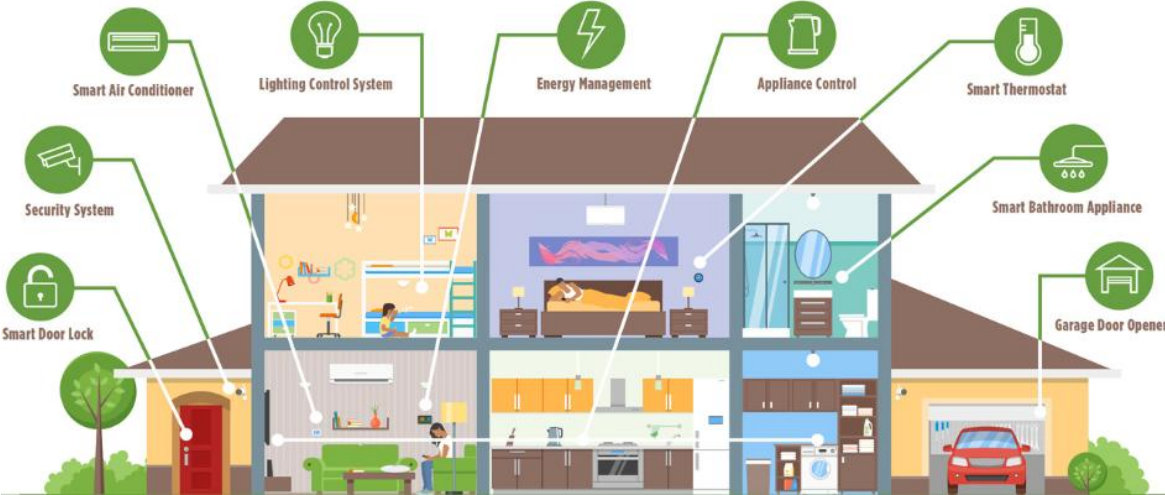

Figure 1.1 [13] illustrates some smart home applications and systems.

## 1.1.2 Notion of “activity”

In our research domain, an activity is a set of the physical behaviours of the human inside home which can be hierarchically structured into actions. For example, the activity ‘sleep’ can be divided into a series of actions (e.g. “enter the bedroom,” “lie down in

Figure 1.1 : smart home components

bed”) that are composed of operations that are atomic steps implementing the action (like “close the light” “push the door handle”...). Therefore, activities are a sum of actions which are made of a sum of atomic operations[14].

### 1.1.3 Human Activity recognition

Human activity recognition (HAR) is a highly dynamic and challenging research topic[14]. The target of HAR is to determine activities performed by one resident or multiple residents inside home based on a sequence of observed events by means of multiple sensors such as motion sensors[4], pressure detectors, RFID tags[16], electrical power analyser[17], etc. The HAR process involves several steps. The main four steps are as follows[14]:

1. *pre-processing*: extracting of the raw data from sensor streams to handle incompleteness, eliminate noise and redundancy, and perform data normalization and labelling;
2. *features extraction*: extracting features from raw data to use it as input to machine learning;
3. *features selection*: decreasing the number of features to increase their quality and reduce the computational effort needed for the classification;
4. *classification*: determining the given activity based on machine learning and reasoning.

The overall goal of HAR system is to replace the human operations inside home partially or totally either by predicting these operations and realizing them when necessary or by meeting the requirements and needs predefined by the humans. For example, with the help of sensory devices, a HAR system can keep track of the health condition of a resident and notify the health personnel in case of an urgent need[12], [14], [18], [19].

### 1.1.4 Notion of “Appliance”

An appliance is a household machine using by humans, using electricity as energy input and performs various functions according to its design. We describe four types of almost known appliances[20][21][22] :

- *Type 1*: Such as light bulbs or toasters, those type of appliances have a Boolean function that allows them two simple states of operation on and off at any given time.

- *Type 2: Finite State Appliances (FSA)* Such as dishwashers, washing machines, stove burner and the most of appliances used at home. The signature of these appliances is presented as multi-state. Despite FSA signatures are repeatable with fixed number of states at time; it is not easy to detect it. In [23], Baranski developed an algorithm that focuses only on recognition of finite state electric appliances.
- *Type 3: Appliances with continuous energy consumption.* In this category, we find appliances with battery charging such as Laptop and phone.
- *Type 4: Zeifman* introduced a fourth class which comprises smoke detector, TV receiver and phone [24]. This category of appliances remains active throughout weeks or days consuming approximately constant energy in a time.

### 1.1.5 Appliance load monitoring

The load monitoring in general is a process of identifying and acquiring the load measurement in a power system[25]. These load measurements will determine the energy consumption and status of appliances. Depending on the approach used in the appliance monitoring the load monitoring can be Intrusive Load Monitoring (ILM) or Non-Intrusive Load Monitoring (NILM)[26], [27]:

- 1- **Non-Intrusive Load Monitoring:** NILM consists of measuring the electricity consumption using a smart meter, typically placed at the meter panel. Relying on a single point of measure it is also called one-sensor metering. The qualification of non-intrusive means that no extra equipment is installed in the house. With NILM, the appliance signatures are superposed and, for comprehending the contribution of single appliances, they have to be separated. This operation is called disaggregation of the total electricity consumption.
- 2- **Intrusive Load Monitoring:** ILM consists in measuring the electricity consumption of one or few appliances using a low-end metering device. The term intrusive means that the meter is located in the habitation, typically close to the appliance that is monitored.

The recognition of the state of the devices at home does not only allow us to manage energy but also to recognize activities performed by residents. Therefore, it gives us a clear vision of their behaviour in their homes [28].

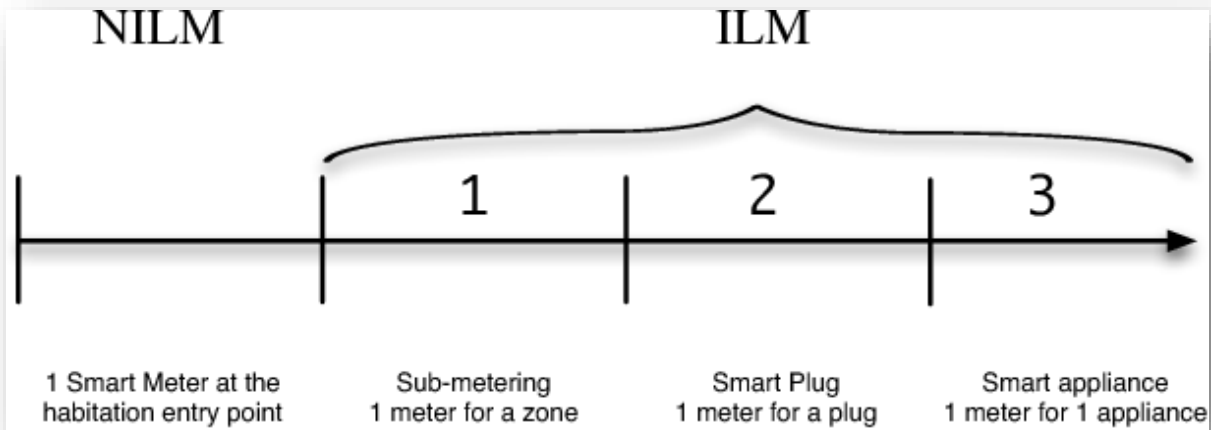

Figure 1.2: Distinction between ILM and NILM

In the literature, most of the research goes now in NILM and ILM in tree domains as described in figure 1.2 [27].

### 1.1.6 Activities of Daily Living

ADLs is a term mostly used in healthcare[12]to refer to the routine activities that people (one or more) perform the whole day at home without the need of others help. ADLs are done in specific locations, with certain objects, and at a particular time. We describe two types of ADLs, basic and instrumental ADLs.

- **Basic ADL** [29]: The basic activities of daily living (BADLs) are the set of activities that are fundamental and mandatory to answer primary needs of a person. This type includes simple tasks performed in few steps and consists especially of self-care tasks. Basic ADLs are generally, activities performed after getting up in the morning, such as: personal hygiene, toileting, grooming, bathing, showering, and dressing.
- **Instrumental ADL** [30]: This kind of activity needs basic planning to be performed and implies objects manipulations. These activities are needed to live alone and to live in society. For a person, being able to realize all instrumental ADLs can be translated into being relatively autonomous, such as using the phone, shopping, housekeeping, accounting, food preparation, and taking medicines.

Various activities and sub-activities are annotated as ADLs. Most of scientific works relates to a portion of ADLs but not to those activities as a whole. Mostly, researchers use ADLs without distinguishing the specific type. Although people are able to do basic ALDs alone without help, instrumental ADLs are hard for some. Consequently, distinction between

instrumental and basic ADLs is important to recognise the ability of a person to be autonomous.

New researches using smart phone and accelerometer[9], [31]focused on recognition ADLs related to human physical activities. Papers using visual sensing detect human activities located within visual field of imaging device. Czarnuch in[32]uses one camera installed in a washroom to recognize activities related to personal hygiene only. The work is based on the use of ambient sensors[33][34]to detect various activities depending on the installation place of the sensors inside the house. There are various reasons for mostly covering ADLs in the literature. First, those activities are general, real, and common between young and old people. Second, ADLs are the most used in standard tests of resident autonomy; disability with ADLs is the most common reason why older people live in nursing homes[6]. Finally, ADLs are the best suited as inputs to perform different home applications. For those reasons, we focus on recognizing ADLs in our research.

### 1.1.7 Human activities type

Earlier works mainly focused on identifying ADL for a single user [35], however in real-life, there are often multiple residents living in the same environment, sometimes performing daily tasks simultaneously or together. Based on Tao Gu research [36]activities nature can be divided into five different categories:

- **Single user activities:** One user performs activities independently, such as toileting or dress.
- **Multi-user simultaneous activities:** two or more users perform the same activity together in the same time, e.g. two or more users are eating meal together.
- **Multi-user collaborative activities:** one or more users perform different sub-activities in a cooperative manner to finish the same activity; e.g. two users do the housekeeping together.
- **Multi-user concurrent activities:** one or more users perform different activities independently and aim for different goals; e.g. one user is sleeping while the other is watching TV.
- **Multi-user conflict activities:** two or more users are involved in two activities in a conflicting manner, e.g. while a user is taking a shower, another user wants to use the toilet.

In addition to these five categories, many other cases of ADLs are possible, but we detailed above the most common in everyday life. Other less frequent possibilities are not cited; e.g. a user accomplished an activity already started by another user, a user started an activity alone and requests for help to finish it.

### **1.1.8 Ambient assisted living**

Ambient Assisted Living (AAL) can be defined as “the use of Information and Communication Technologies (ICT) in a person's daily living and working environment to enable them to stay active longer, remain socially connected and live independently into old age”[37]. AAL systems have a huge potential to meet the personal healthcare challenges and involve citizens in their healthcare through Information and Communication technologies (ICT). The AAL systems provide an ecosystem of medical sensors, computers, wireless networks and software applications for healthcare monitoring. The primary goal of AAL solutions is to extend the time which elderly people can live independently in their preferred environment using ICT for personal healthcare[38]. Currently, there is a huge demand for AAL systems, applications and devices for personal health monitoring and telehealth services[39]. AAL system is based in a high recognition of human activities inside living places.

### **1.1.9 Smart home applications**

The ADLs recognition is the first key used in many applications at home environment [14]. This section presents four types of smart home applications based on ADLs. Home energy management, home security, healthcare and home automation are all examples of ADLs applications for smart home.

#### *1.1.9.1 Home energy management*

More recently, activity recognition approaches have been investigated by researchers in the energy management domain to improve energy efficiency of buildings[33], because of the significant contribution of lighting systems and appliances to the total electricity consumption of buildings. Towards this end, several approaches have been developed that are based on encouraging occupants to change their wasteful behaviour by making them aware of



their personalized and detailed energy consumptions[37][41]. Although these approaches could potentially result in a remarkable increase in buildings' energy efficiency, the savings depend on the conscious actions of occupants or change of occupant behaviour which is not always aligned with occupants' convenience[42]. To overcome this obstacle, new approaches have been developed that are based on automating the operation of service systems in buildings to be more energy efficient without requiring any behaviour change in occupants considering basic daily information about users, such as the prediction of user activities in order to minimize energy consumption by guaranteeing that peak demands do not exceed a given threshold.

#### *1.1.9.2 Healthcare*

Healthcare applications[34], [43]–[46] are growing at a very fast phase in all parts of the world. One main requirement of such applications is the human detection and activity classification. The necessity for the development of human detection methods in the field of modern Home-care has become very popular and essential, for example, knowing ADLs of elderly people or patients helps doctors or family to care remotely of those persons; detected abnormal situation of elderly in a given period home system can automatically alert to their family or a medical team for emergency treatment.

In order to improve healthcare services and support clinical professionals, it is important to develop an automatic ADLs monitoring system for healthcare applications. Currently, various works have been developed for the monitoring of one or multiple daily activities. Tokunaga [47] designs and develops care robot which provides personalization for elderly people with an efficient and reasonable way based on elderly recognition behaviours. Liu [48] designs and develops a wearable sensor-based activity recognition system to recognize one complex activity (housekeeping) and classify the activity level.

#### *1.1.9.3 Home security*

Individuals spend the majority of their time in their home or workplace[49] and feel that these places are their sanctuaries. In order to preserve that feeling, smart homes can make use of technologies such as embedded sensors and machine learning techniques to detect,

identify, and respond to potential threats. The home security system is also an interesting field of smart home applications[50]–[52]. Home protection is the most required application in the worldwide market, this confirm the importance of this application. The home security application must use activity recognition to perform a good and solid protection. For example, when home system detects abnormal activity in the house it will send an alert message to the house owner or the police.

#### *1.1.9.4 Home automation*

The recent years have witnessed significant progress in the automation of human activity recognition[16], [53] in order to realize intelligent environments which are capable of detecting users actions and gestures. The exact needed services can be provided automatically and instantly for maximizing the user comfort and safety as well as minimizing energy. For example, home system detects when the user is awake and prepares hot water for them to take a shower.

Home automation would allow many potential applications in areas such as healthcare, and security. For example, in elderly care, ADLs are used to assess the cognitive and physical capabilities of an elderly person. An activity recognition system allows us to automatically monitor their decline overtime and detect anomalies [54].

## **1.2 Activity recognition algorithms**

In general, the HAR process includes three important steps, from collecting information on human behaviour and environment to the conclusion about the currently performed activity. These steps are as follows: first, reception of sensor data from different sensor technologies then, elimination of noise and redundancy, and performing data aggregation and normalization. Second, features extraction to retrieve the most important activities features (e.g., temporal and spatial information) from data. Finally, classification using machine learning and reasoning in order to determine the given activity [13]. Those steps are illustrated in figure 1.3.

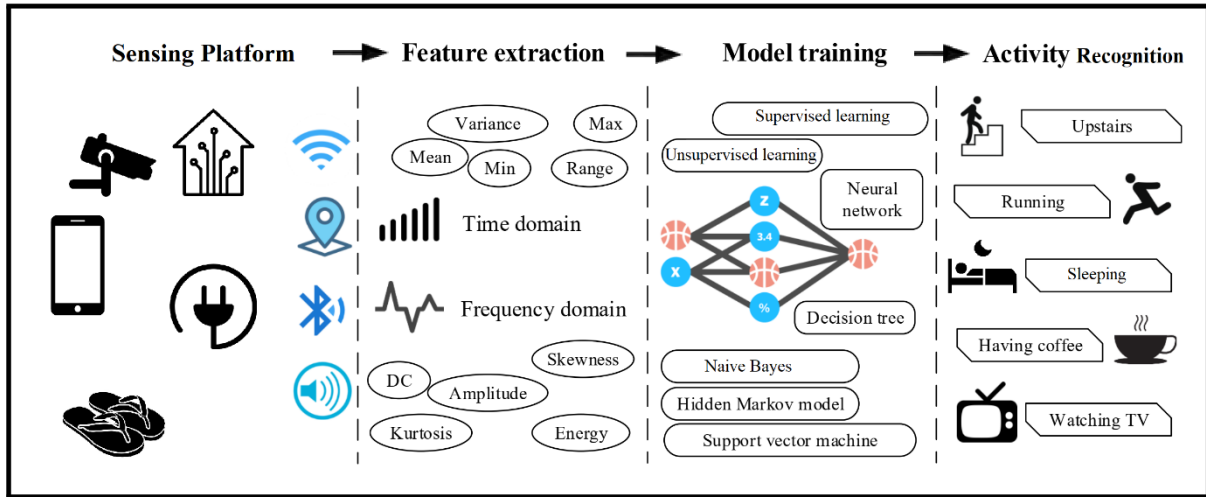

Figure 1.3: An illustration of sensor-based activity recognition

### 1.2.1 Sensors platform

Nowadays a wide variety of sensors are used to collect information about human activities. There are currently three main activity recognition approaches; vision-based activity recognition, ambient sensor-based activity recognition and wearable sensor-based activity recognition. While vision-based activity monitoring has been generally used in security application, dense sensor-based activity is the most used in smart home environments due to the respect of user privacy and other considerations. In addition to these three approaches, load signature of appliances is a new approach that is still very slightly exploited. Load signatures of appliances can be considered as ambient sensors.

#### 1.2.1.1 Visual sensors

Visual sensing facilities is based on the use of visual sensing products, especially cameras, to extract visual data and use it to observe behaviour of users and environmental fluctuations[55]. Computer vision analysis tools is used in this category to recognize daily activities of one or multi-users[56]. The use of video visual sensing for activity recognition is very dominant in home security. Brdiczka [57] proposes to videotape smart home residents and process the video to recognize activities. Recent works have improved the field of visual data in smart homes such as the analysis of various abnormal behaviours in real-time[52], assistance system[58], and human activities detection [43].However, there are still many challenges around visual sensing facilities related to the respect of home owner privacy, higher price of installation, illumination variations, and cameras inefficiency in front of

brightness and colour variations. Moreover, big size of camera data requires large storage capacity and powerful analysis system.

#### *1.2.1.2 Ambient sensors*

Recognizing human activities based on ambient sensor readings is motivating since sensors can capture many valuable low-level data of human users and their living environment, this data is analysed using data mining and machine learning techniques to form activity models. Ambient sensors can often provide powerful information about some activities and home status. For example, activation of Boolean sensor in bed can strongly mean sleeping activity. Motion sensors infer activities by monitoring human-object interactions[59], and[60] used sensors that can be quickly and ubiquitously installed at home in order to recognize activities such as toileting, bathing, and grooming. Cottone in [33] used sensors of diverse nature, proximity sensors, item sensors, and environmental sensors, whose state may be represented by a binary, discrete, or continuous variable in order to recognize user daily life activities. Some recent studies in activity recognition[33], [34], [61], [62]are more focused on low-cost and low power sensors of different natures to recognize human activities inside home. Recent research used new type of ambient sensors that is still very lightly exploited, i.e. the activity recognition through load signature using smart plug and energy meter [63].However, using ambient sensors is challenging because of noise sensor data and low efficiency in recognising complex form of human activities, e.g. cooking and housekeeping. Ambient sensors generate significant charges in installation, and maintenance. Moreover, they are unable to provide adequate information to perform fine-grained activity recognition.

#### *1.2.1.3 Wearable sensors*

Wearable sensors are electronic sensors that can be worn on the body, shoes[44], [64], [65]or clothes [66], implant or accessories. Wearable sensors often use inertial measurement units and RFID tags to collect users' behavioural information[16]. Wearable sensors have been widely used in the recognition of human physical movements[67]–[69]. Moreover, with the invasion of smart phones in our daily lives, research has focused on using data acquired from mobile phones to recognize human activities and by using the capacity of a smart phone

to act as a wearable sensor with accelerometer and gyroscope aptitudes[7]–[9], [31]. However, wearable sensors are challenging because of the need to bring sensors everywhere and every time inside home, wearable systems and devices must have efficient software and hardware, unobtrusive, and robust against water and temperature. Moreover, Sensor data from wearable sensors alone cannot differentiate between some instrumental activities, e.g., making tea and making coffee.

#### *1.2.1.4 Multimodal sensing*

Recently, to overcome the challenges associated with single sensor modalities and increase generalization, many studies have proposed information fusion strategies that combine multiple sensors modalities or classifiers to increase robustness, reliabilities, derive confidence measures among different classifiers and reduce the complexity of recognition system[70]. Wang in [59] developed a multimodal sensing platform and presented a theoretical framework to recognize both single-user and multi-user activities. In the same year, Brdiczka [71] used a multimodal sensor composed by 3D video tracking system and speech activity detector to analyse audio streams in order to identify basic individual activities such as walking. The SWEET-HOME[72]project that started in 2010 is based on multimodal sensors to detect distress situations of a person and provide assistance via voice and tactile commands in order to ensure security anytime and anywhere in the house. However, it is essential to note that no sensors technology is superior to the other. Instead, the nature of the application and user requirements will dictate the choice of technologies to use and whether or not to combine sensors, vision facilities with other sensors techniques.

### **1.2.2 Features extraction**

Feature extraction is a vital part of the human activity recognition process as it helps to identify lower sets of features from input sensor data to minimise classification errors and computational complexity. Effective performance of Human activity recognition system depends on appropriate and efficient feature representation. Therefore, extraction of efficient feature vectors from sensor data helps to reduce computation time and provide accurate recognition performance. Feature extraction can be performed manually or automatically based on expert knowledge. Manually engineered features follow bottom-up approaches that consist of data collection, signal pre-processing and segmentation, handcrafted features

extraction and selection, and classification. Manually engineered feature processes utilise appropriate domain knowledge and expert-driven approach to extract time domain, frequency domain and Hulbert-Huang features using Empirical mode decomposition to represent signal details [73]. Therefore, appropriate feature selection methods as explained below are employed to reduce computation time and memory usage. Automatic feature extraction enables extraction of feature vectors without reliance on domain expert knowledge. Automatic feature representation provides the ability to learn features from raw sensor data with little pre-processing.

However, There are no universal procedures for selecting appropriate features but many studies resort to extensive heuristic knowledge to develop and select appropriate tasks for a given human activity recognition system[73].

#### *1.2.2.1 Features construction*

Features construction starts from an initial set of measured data to build derived values (features) or from the original set of features from row data. It is the process of manually constructing new attributes from raw data[74]. It involves intelligently combining or splitting existing raw attributes into new ones which have a higher predictive power. For example, date may be used to generate four new attributes such as seasons of the year which may be useful in activity recognition. Feature construction is essentially a data transformation process.

#### *1.2.2.2 Features selection*

The global aim of features selection is to select the most relevant subset of features, from the original set of features. High quality features are essential to improve the classification accuracy of any pattern recognition system. In human activity recognition, features such as time, variance, location and triggered commonly used[15], [74]. To perform a classification, one naive idea is to use all available features (features construction) directly as input to the classifier. The disadvantage here is that some features may be irrelevant or redundant, and do not provide new information to improve the classification accuracy. Some features might even confuse the classifier rather than help discriminate various activities. What is worse, due to the “curse of dimensionality”, the performance may degrade sharply as more features are added when there is not enough training data to reliably learn all the parameters of the activity models[75]. Therefore, to achieve the best classification

performance, the dimensionality of the feature vector should be as small as possible, keeping only the most relevant and complementary features. In addition, keeping the dimensionality small could reduce the computational cost in such a way that recognition algorithms can be implemented and run on lightweight wearable devices such as mobile phones. The two main techniques that are used to identify important features and reduce dimensionality in human activity recognition are: feature transformation which is the creation of new features based on transformations or combinations of the original extracted feature set [76]; and features selection which is a method based on the selection of the best subset of original extracted features set [77]. One common strategy is to apply either features transformation or features selection to get a fixed set of features for the whole set of activities to be recognised.

In [7], Maurer used a correlation-based features selection method to select a subset of features. An 87% classification accuracy was achieved when using the top eight features selected to classify six basic human activities. In [78], researchers identified energy as the least significant feature among all the five available features by using a sequential backward elimination method. In [79], Atallah applied three features selection methods: Relief-F, Simba, and mRMR to assess the relevance of features for discriminating 15 different activities. All these three methods achieved similar performance. The other strategy assumes that different activities may be characterized by different sets of features. In [68] and through performing cluster analysis, Huynh showed that the classification performance could be improved by selecting features and window lengths for each activity separately. In [80] Lester demonstrated that a feature's usefulness depends on the specific activity to be inferred. They applied a modified version of AdaBoost [81] to select the top 50 features and then learn a package of discriminative static classifiers based on the selected features for each activity. They found that the selected features were different for different activities.

In the human activity recognition based on Appliance Load Monitoring (ALM), the extracted common temporal features are the real (active) power (P) and the reactive power (Q). Some appliances can be easily distinguished in the P-Q space depending on their resistive, capacitive and inductive characteristics [28], [82]. From these features, others can be computed, as the complex power and the apparent power. The voltage (V) and current (I) are as well very popular as features [83]. The root mean square and the peak values of the current are also used, for example as in [84]. A reduction of the feature space is also applied using Principal Component Analysis (PCA) [83]. Features based on the signal evolution, as the first and second derivative, have been proposed in [85]. Such features have shown to bring useful

information in the classification task. Other features can be added to the list, as the maximum, minimum or average of power in a certain interval of time [86], [87]. Frequency analysis is also used in the context of appliance recognition, especially when the acquisition frequency is medium to high (from 1 kHz up to 100 kHz). Discrete Fourier Transformation (DFT) or Fast Fourier Transformation (FFT) are typically applied. DFT is reported to be less efficient when the sampling frequency is low [88], [89].

**1.2.3 Machine learning approaches to activity recognition**

After extraction and selection of features from sensor signals, features are used as inputs to machine learning algorithms. In literature, various algorithms and computational techniques(not machine learning)are used to develop activities models and recognize human activity. However, we are interested in machine learning algorithms[90]. Extracting useful information from raw sensor data requires specific methods and algorithms and it depends on the nature of the input data: visual, mobile or ambient sensors[91].Below, we review some of the most frequently machine learning algorithms based on types of sensed data. Well known machine learning algorithms are illustrated in figure1.4 [92].

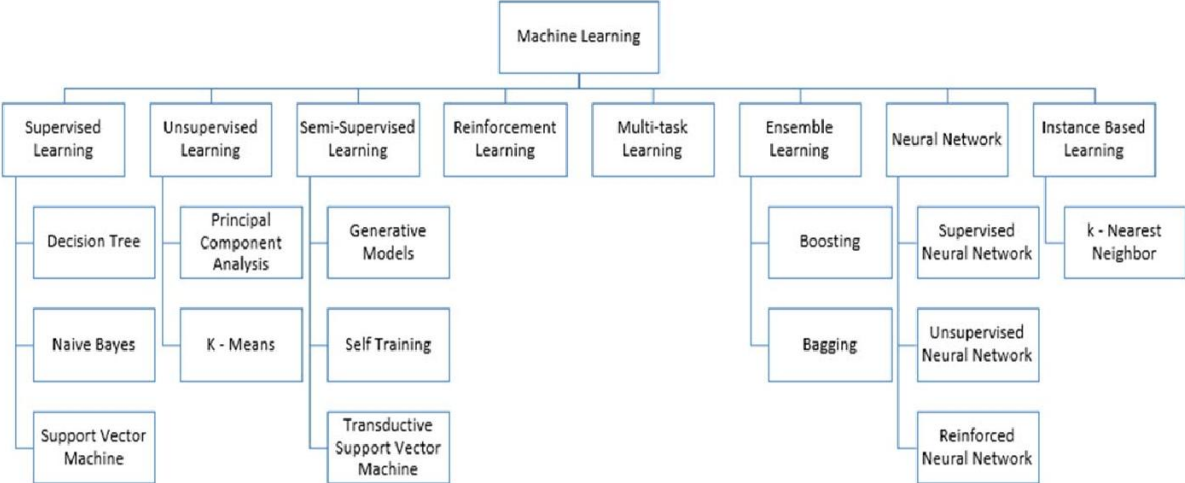

Figure 1.4: type of well-known machine learning



### *1.2.3.1 Ambient Activity Recognition*

To recognize a wide range of simple and instrumental activities, a network of ambient sensors is used to pursue resident activities at home, as a sequence of sensor events. The majority of machine learning algorithms used with sensor events are supervised and rely on labelled data for training. Supervised learning is the machine learning task that train and test labelled data. Labelled data means that all instances in the data are a pair consisting of an input object and a desired output value. Researchers have commonly tested several learning algorithms. Hidden Markov [31] and Naive Bayes Networks [93] are the most popular models for activity recognition. Other algorithms used are: Nearest Neighbour [94], decision trees [7], support vector machines (SVMs) [95], [96], and conditional random fields (CRFs) [97]. Je wan in [93] evaluated four machine learning algorithms (Naïve Bayes, Bayesian network, C4.5 decision tree, and Naïve Bayes tree) both individually and in combination (hybrid) in order to improve recognition performances. Nonetheless, a key limitation of this combination is that it is confined to certain activities and cannot be used for interleaved or concurrent activities. Nowadays researchers tried to train neural networks inspired by the architecture of the brain. Neural networks and deep neural network are used in various research in recent years to recognize human activities (e.g. [98]–[100]), and they prove to be successful and more efficient compared to other usual machine learning algorithms [89]. Since deep neural networks was introduced in 2006, it has become a centre of interest and presents a higher performance compared to traditional machine learning algorithm. It includes several algorithms including: Deep Belief Networks (DBNs) [101], Restricted Boltzmann Machine (RBM) [102] and autoencoders [103].

### *1.2.3.2 Mobile activity recognition*

With the real explosion in smart phones and their high use by users inside or outside home, researchers are more interested in recognizing human activities via these devices. Activities that are recognized from smart phones or wearable sensors as accelerometer and gyroscope, are the simplest actions related to physical human activities such as walking, jogging, and running. Recognizing such activities can be useful in many applications either supervised or unsupervised such as detecting physical activity level, promoting health and

fitness, and monitoring hazardous events like falling. Charissa in[31]proposes a two-stage continuous hidden Markov model approach using smart phones to recognise physical activities. In [9] Akram illustrated that performances of neural networks (Multilayer Perceptron) is better than other classifiers Random Forest and SVM. Moreover, accuracy reaches a rate of 91.15% by combining Multilayer Perceptron with **other** classifiers. Most wearable systems are still in their early stages. However, Information technology and electronics are mature fields and can provide viable, disposable, and affordable wearable systems. The most important challenges remain to be done are the development of smart signal processing, data analysis and interpretation, communication standards interoperability, electronic components efficiency and energy supply [104].

### *1.2.3.3 Vision-based activity recognition*

Vision-based activity recognition techniques are based on 2D or 3D data representation. In 2D (XY)[105], global variations in body size, as well as some scale and translation variations resulting from perspective changes are removed. In 3D(XYT) volume[106], an orientation cue is used to compute a reference frame. Several 3D based approaches are based on an estimation of body orientation like walking direction. Single-layered approaches recognise human activities directly from a sequence of images and are more appropriate for recognising gestures or simple actions. Hierarchical approaches represent high-level human activities in terms of simpler activities or actions; therefore, such techniques are appropriate for recognising more complex activities. Single-layer approaches are further categorized into space-time approaches and sequential approaches. Space-time approaches view an input video as a volume, while sequential approaches read it as a series of observations. Hierarchical approaches are also further categorized into statistical, syntactic, and description-based approaches. Statistical approaches construct statistical state-based models in a hierarchical fashion (e.g., hierarchical HMM). For more enlightenment on such techniques, refer to related reviews[107], [108].

## **1.3 Conclusion**

In this chapter, we presented the elements to be taken into account when recognising activities inside home. This chapter was dedicated to the most frequent to-use techniques and

implementations for activity recognition of one and multiple residents using different kinds of sensors and energy desegregation. It represented the existing methodologies based on machine learning for activity recognition inside the house, concepts and terminologies with explication of existing works in literature. To eliminate sensors used at home and reduce installation and maintain costs, we investigated this issue by using load signatures of appliances in an attempt to recognise appliances and then human activities recognition. Related approaches used in recent literature are discussed in more detail in the next chapter.

## **CHAPTER II:**

### **RELATED WORK: APPROACHES USED TO FEATURES SELECTION AND ACTIVITY RECOGNITION**

Chapter two aims to explore the main related works relevant to our research and our applicative context. In the first part, we particularly present some recent proposed strategies in literature using neural networks, based on ambient sensors (door and motion sensors). In the second part, we focus on recognising activities via appliances recognition at home in order to reduce the number of sensors used and reduce costs of building a smart home. We conclude the chapter by exploring new areas of research in smart home and activity recognition with a description of the advantages and limitations of each method.

---

## **2.1 Introduction**

Neural networks and deep learning are big topics in Computer Science and in the technology industry. They currently provide the best solutions to many problems in image recognition, speech recognition and natural language processing. Recently, many papers have been published featuring AI that can extract and select features, recognise human activities and appliances. Much more is being achieved every day using neural networks. To improve the accuracy of human activity recognition using ambient sensors, many studies opt for neural networks in the learning phase. We have summarized some recent proposed strategies in literature using neural networks and ambient sensors (door and motion sensors).

Approaches used to recognise the activities of a person in a smart home based on sensors and RFID have some drawbacks. The main issues with these approaches are the intrusiveness for the resident and the periodic maintenance required. Consequently, to provide a solution to these problems, a cheap load signature system of appliances that ensures the recognition of activities is proposed in literature. In the last few years, the research conducted on appliance recognition or appliance load monitoring has been more specifically observed to be in the interest of customers of utilities. In fact, as each appliance has a load signature specific to its operation that varies with the time and its mode of function, this helps to determine energy consumption, frequency, time and the exact moment of use of an appliance.

In addition to methodologies that we have worked on in this thesis and that we have improved with several new algorithms and tools, there are several other methods in the literature that aim to recognize human activities inside home. The two more researched approaches in literature have been discussed: human activity recognition based on IT technologies and Data Mining.

## **2.2 Feature selection based on neural network algorithms**

Deep learning as a machine learning method and artificial intelligence techniques for feature extraction has come a long way since its resurgence in 2006 with the work of Hinton[109]. The upsurge in deep learning research is fuelled by its ability to extract salient features from raw sensor data without relying on laboriously handcrafted features. Furthermore, in the area of human activity recognition, for instance, complex human activities

are translational invariant and hierarchical in nature, and the same activities can be performed in different ways by the same participants. In some cases, activities can be a starting point for other complex activities; running and jogging might not be distinguishable depending on the age and health condition of the person performing the activity. Deep learning[101] is a machine learning technique that uses representational learning to discover feature representation in raw sensor data automatically. Unlike classical machine learning (support vector machine, k-nearest neighbour, k-mean, mRMR, etc.) that requires a human engineered feature to perform optimally. Deep learning methods learn intricate features representation from raw sensor data and discover the best pattern to improve recognition performance. Recently, studies have indicated the incredible results of deep learning over conventional features for human activity recognition[76], [110]. Also, the use of automatic feature representation helps to capture local dependencies and scale invariants features. Thus, deep learning provides effective means to solve the problem of intraclass variability and inter-class similarities that are fundamental challenges for implementing human activity recognition inside home. The commonly-used deep learning methods in feature extraction include stacked autoencoders [99], deep belief networks [111], convolutional neural networks[110], and recurrent neural networks[112]. These methods are originally proposed for image classification, natural language processing and speech recognition, but they can also be applied to the human activity recognition. Indeed, deep learning methods have been used for activity recognition in a few recent works[113]–[115].

Moreover, recently various deep learning-based methods have been proposed for feature selection and demonstrate good results compared with other traditional techniques[109], [116]. In[111]artificial neural network on feed-forward back-propagation neural network (FF-BPNN)has been applied and evaluated on four types of pushes, i.e., small, medium, moderately high, high in order to classify features. Earlier, Hinton developed in[109]developed an effective method for initializing the network weights in autoencoder. The low-dimensional representations obtained outperform the PCA approach. Kai Han [117]proposed a novel autoencoder Feature Selector (AEFS) for unsupervised feature selection which combines autoencoder regression and group lasso tasks. Compared to traditional feature selection methods, AEFS can select the most important features by excavating both linear and nonlinear information among features, which is more flexible than the conventional self-representation method for unsupervised feature selection with only linear assumptions. In [118], Tomar proposed traversing back the autoencoder through more

probable links for feature selection. Experiments on five publicly available large datasets showed autoencoder giving significant gains in accuracy over most of the state-of-the-art feature selection methods.

However, the neural network is not the most efficient solution for extraction and selection of features. Neural Network requires many tests to choose the combination of the hidden neurons and the number of the hidden layers suitable for the tested database. According to some cases, the manual extraction of the features gives higher accuracy than neural network [74]. In order to have good learning results, the right combination of feature selection algorithm and activity recognition method is very important to get good results in the learning phase. We have tried to explore this issue in this thesis to explore and conclude results about the utility and usage of neural network in human activity recognition.

## **2.3 Neural network algorithms for human activity recognition**

In the field of human activity recognition, neural networks have proved recently proved a good efficiency and a good accuracy compared to other machine learning algorithms. Three types of learning algorithms are classified [119]: Supervised neural network, unsupervised neural network and Semi-supervised neural network. A quick comparison between the three algorithms is described in the table 2.1. A typical Neural Network structure is showed in figure 2.1.

ANNs can be grouped into two categories feed forward networks and feedback networks as described in figure 2.2. Each learning algorithm is designed for training a specific architecture. Therefore, when we discuss a learning algorithm, a particular network architecture association is implied [120].

In [15] Back-propagation (BP) has been used to train the feed forward neural network for human activity recognition; this algorithm was compared with other probabilistic algorithms: Naïve Bayes (NB) classifier and Hidden Markov Model (HMM). The results show that neural network using BP algorithm has relatively better human activity recognition performances than NB classifier and HMM.

In [98] Quick Propagation (QP), Levenberg Marquardt (LM) and Batch Back Propagation (BBP), have been used for human activity recognition and compared according to

performance on Massachusetts Institute of Technology (MIT) smart home dataset. The achieved results demonstrated that LM algorithm has better human activity recognition performance (by 92.81% accuracy) than QP and BBP algorithms. This analysis is done only for a single resident home. In case of multiple users, more complicated learning approaches with features selection and more sophisticated sensors are required.

Authors in[121]proposed a one-dimensional (1D) Convolutional Neural Network (CNN)-based method for recognising human activity using triaxial accelerometer data collected from users' smart phones. The three human activity data, walking, running, and staying still, are gathered using smart phone accelerometer sensor. The x, y, and z acceleration data are transformed into a vector magnitude data and used as the input for learning the 1D CNN. The ternary activity recognition performance of 1D CNN-based method showed 92.71% accuracy that outperformed the baseline random forest approach of 89.10%.

Endingly, there is no specific neural network algorithm that gives good results and a higher accuracy in human activity recognition. Accuracy of neural networks depends on features nature, targeted activities and other parameters.

Table 2.1: description of different neural network algorithms

<b>Supervised Neural Network</b>	<b>Unsupervised Neural Network</b>	<b>Semi-supervised Neural Network</b>
<ul style="list-style-type: none"> <li>✓ Trying to predict a specific quantity</li> <li>✓ Have training examples with labels</li> <li>✓ Can measure accuracy directly</li> </ul>	<ul style="list-style-type: none"> <li>✓ Trying to “understand” the data</li> <li>✓ Looking for structure or unusual patterns</li> <li>✓ Not looking for something specific</li> <li>✓ Does not require labelled data</li> <li>✓ Evaluation usually indirect or qualitative</li> </ul>	<ul style="list-style-type: none"> <li>✓ Using unsupervised methods to improve supervised algorithms</li> <li>✓ Usually few labelled examples and a lot of unlabelled data.</li> </ul>



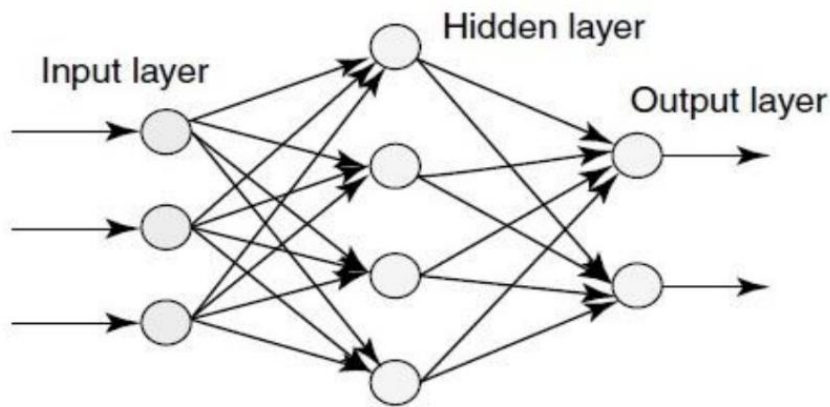

Figure 2.1: typical Neural Network structure

## 2.4 Deep Neural Network Used in Human activity recognition

In recent years, there has been a growing interest in deep learning techniques. It has become a critical research area in human activity recognition, natural language processing, machine translation and environmental monitoring [122]. Deep learning is a general term for neural network methods which are based on learning representations from raw data and contain more than one hidden layer. The network has many layers of non-linear information processing for feature extraction and transformation. Each successive layer uses the output from the previous layer as input. Deep machine learning algorithms include restricted Boltzmann machine, autoencoder, sparse coding, convolutional neural network and recurrent neural network as described in figure 2.3. These deep learning methods can be stacked into different layers to form deep learning models that provide enhanced system performance, flexibility, robustness and remove the need to depend on conventional handcrafted feature. These methods are reviewed in the subsection below, outlining the characteristics, advantages and drawbacks of each method in Table 2.2 [113].

Fang and Hu [123] proposed a deep learning algorithm to recognise human activities. They adopted the deep belief networks (DBNs) built by restricted Boltzmann machine in the research. They also compared their results with HMM and NBC. Oniga and Suto [124] analysed the signals acquired from acceleration sensors using several artificial neural network (ANN) algorithms. Zhang [125] combined HMM and DNN models to recognize activities. However, there is currently no preferred deep learning technique for human activity

recognition. This is probably due to the variability of human behaviours, activities performed, the kind of sensors used and features selection adopted.

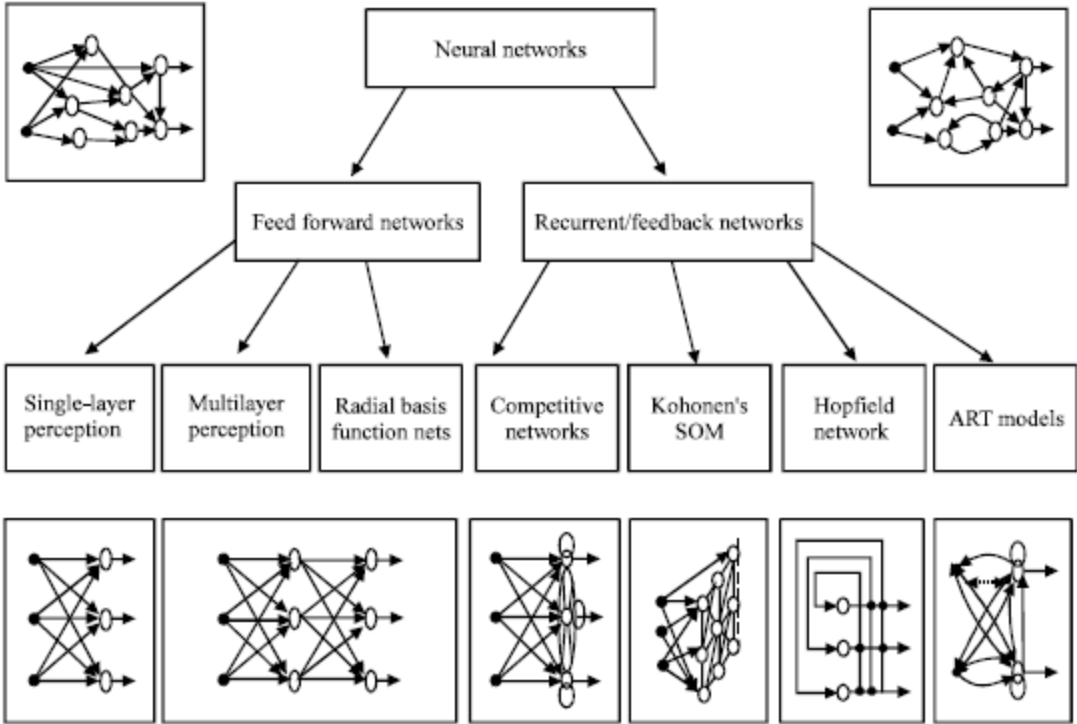

Figure 2.2: Taxonomy of feed forward and feedback network architectures [93]

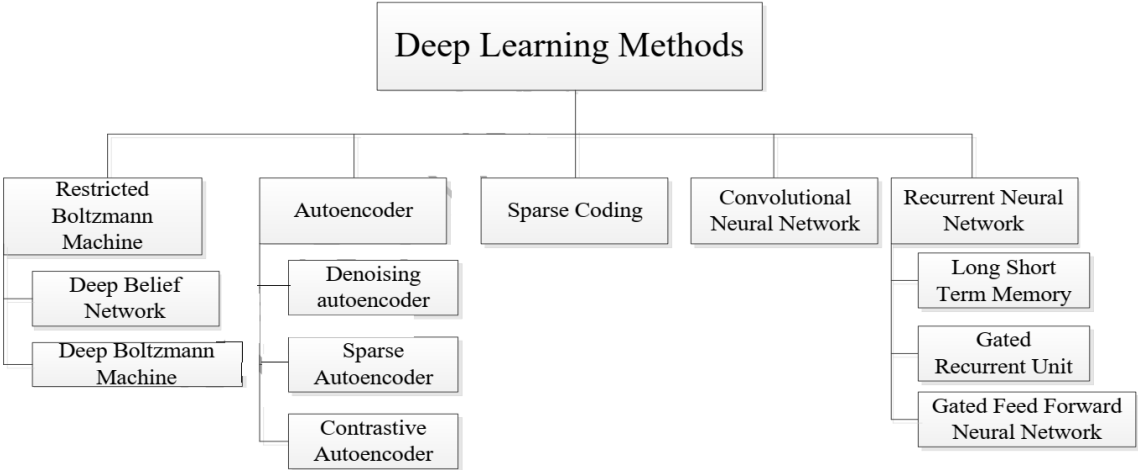

Figure 2.3: different deep learning algorithms

Table 2.2: Deep Learning methods comparison based in recent literature works in human activity recognition

Methods	Description	Strengths	Weaknesses	Recent application in HAR
<b>Deep Belief Network</b>	Has directed connection at the lower layer and undirected connection at two topmost layers.	Unsupervised training with unlabelled sensor streams which is naturally available through cyber-physical systems and Internet of Things and initialisation prevent convergence at local minima.	Mobile and wearable sensor onboard training of the network is computationally complex due to extensive parameters initialization process.	Activity of daily living (ADL)[123], [126]localisation, detection of posture [127] and hand gestures activities in Alzheimer[128].
<b>Deep Boltzmann Machine</b>	Has undirected connection at every layer of the network.	Allow feedback mechanism for more robust feature extraction through unsupervised training.	Due to resource constraint nature of mobile devices optimisations are required to reduce operation overhead execution cost. However, DBM joint optimisation is practically difficult to achieve.	Diagnosis of emotional state in elderly [114].
<b>Denoising autoencoder</b>	Enable correct reconstruction of corrupted input values.	Robust to corrupted sensor data streams.	High computational time, lack of scalability to high dimensional data, rely on iterative and numerical optimisation and high parameter tuning.	Automatic detection of activity of daily living (ADL)[99], [129].
<b>Sparse Auto encoder</b>	Impose sparsity term to the loss function to produce robust features that are invariant to learning applications	Produce more linearly separable features.	High computational time due to numerous forward passes for every example of the data sample.	Health rate analysis during intensive sports activities and health monitoring[130].

Table 2.2: continued

Methods	Description	Strengths	Weaknesses	Recent application in HAR
<b>Sparse Coding</b>	Over-complete basis for reducing the dimensionality of data as linear combination of basis vector.	The use of sparse coding method for dimensionality reduction of input data helps to minimise computational complexity.	Efficient handling and computation of feature vectors are non-trivial. It is also difficult to develop deep architecture with sparse coding.	Representation of energy related and health monitoring smart homes and Activity of daily living (ADL) [131].
<b>Convolutional Neural Network</b>	Deep neural network with interconnected structure inspired by biological visual cortex	Widely implemented in deep learning with a lot of training strategies proposed. Automatically learn features from raw sensor data. Moreover, CNN is invariant to sensor data orientation and change in activity details.	Require large dataset and high number of hyper-parameter tuning to achieve optimal features. Maybe difficult to support effective on-board recognition of complex activity details.	Predict relationship between exercises and sleep patterns, automatic pain recognition during strenuous sports activities, energy expenditure estimation and tracking of personal activities [110], [132].
<b>Recurrent Neural Network</b>	Neural network for modelling sequential time series data. Incorporate temporal layer to learn complex changes in data	Used to model time dependencies in data	Difficult to train and suffer from vanishing or exploding gradients. In case of LSTM, require too many parameter updates. Large parameter up date is challenging for real-time activity predictions.	Model temporal patterns in activity of daily living (ADL), progressive detection of activity levels, fall and heart failures in elderly [112].

## **2.5 Activity recognition based on Load Signatures of Appliance**

In the last few years, research done on appliance load monitoring has been more specifically observed in the interest of human activity recognition, due to several reasons: eliminate or reduce the number of ambient sensors used inside home, reduce installation costs and reduce maintenance interventions[28]. In fact, as each appliance has a load signature specific to its operation, which varies with time and its mode of function, it helps to determine energy consumption, frequency, time and the exact moment of use of an appliance[28]. In this context, Appliance Load Monitoring (ALM) has become a key application for appliances recognition and human behaviours recognition. Two approaches exist[27], Non-Intrusive Load Monitoring and Intrusive Load Monitoring explained in the section 1. In the last years several projects were done in this field and the use of ALM has given promising results in human activity recognition.

### **2.5.1 ILM methods**

In most cases, the ILM system uses smart plugs to measure the power consumption of individual loads with the majority of meters presenting the power consumption on LCD display and send the measurements to a computer via USB, wired internet or wireless connection.

Most of the research works about ILM are based on supervised techniques in the context of appliance identification. Paradiso [86] proposed the use of multilayer perceptron trained with back-propagation. Low sampling frequency data are used from extracted power-based features such as the number of samples and transitions between power intervals. Accuracy achieves 95.26% for 8 monitored devices. Zufferey [133] compared k-Nearest Neighbors (kNN) and Gaussian Mixture Models (GMMs) using six appliance categories. Electric measurements are sampled at 10–1 Hz using low-end Plug meters and the features are power-based. Their best reported performance is 85% accuracy using k-NN. Reinhardt reported on several works[89], [134], comparing various algorithms as Bagging, Bayesian Network, J48, JRip, LogitBoost, Naïve Bayes, Random Committee, Random Forest and Random Tree for the classification of appliance categories using a ILM scenario. In a first work, they used data from the Tracebase database recorded at low frequency. The best

reported performance is up to 95.5% accuracy using Random Committee. In another work, the same classification algorithms are used on higher frequency data (1.6 kHz) from which current-based and harmonics features are extracted. Better performances are reported up to 100% for Bayesian network. In the work of Adeel Abbas Zaidi and Palensky [88], Dynamic Time Warping (DTW) and Hidden Markov Models (HMMs) are proposed. Signatures are sampled at 10–1 Hz and several features are extracted and benchmarked. HMMs are reported to perform better than DTW using a six categories task. Fitta [135] proposed to recognize the switch-on and off events from appliance signatures acquired at 6.4 kHz. They used K-NN systems trained on extracted features such as real power and current harmonic. Performance on this 2-class task of 87.5% and 90.6% correct identification is reported for switch-on and switch-off events respectively.

### **2.5.2 NIALM methods**

The majority of NIALM methodologies [17], [22], [28], [136] are inspired from the one developed in the late 20th century by George W. Hart [20] from MIT. Hart used the NIALM that, contrary to ILM, is more convenient and very effective to collect loading data. NIALM did not require the presence of sensors on all appliances. Indeed, ILM has some drawbacks, including installation, which is fastidious in a house and whose presence may be an inconvenient and a disruptive element for its residents. Hart's work [20] aimed to determine the exact moment where appliances are switched on, the power consumption in residential area, time of the day and temperature. NIALM used only the ON/OFF model. For that reason, it has not been able to properly account for multistate appliances (methods developed and tested after) such as dishwashers and washing machines, as well as continuous-variable appliances, like air conditioner, heat pump, etc.

Belley [28] proposed an algorithmic method based on steady-state operations and signatures. The extraction process of load signatures of 16 appliances is carried out in a three-dimensional space through a single NIALM power analyser. This approach was tested and verified rigorously through daily scenarios reproduced in the smart home prototype in a laboratory. This approach is solely based on a single power analyser placed in the electric panel. In another work [17], Belley developed an algorithmic approach based on load signatures study of appliances represented by three features (active power (P), reactive power (Q) and line-to-neutral), which allows to determine the errors committed by the resident. This system is implemented in smart-home prototype equipped with household appliances used by

the resident during their morning routines. The system is tested with real-case scenarios modelled from former clinical trials, allowing demonstration of accuracy and effectiveness of the system in assisting a cognitively-impaired resident in the completion of daily activities.

## **2.6 Other related techniques in human activity recognition**

In this section, we provide a detailed review and a state-of-the-art of recent research advances in the field of human activity recognition and smart home based on other techniques than those used in this thesis. The advantages and limitations of those techniques are discussed, particularly human activity recognition based on data mining and IT methods.

### **2.6.1 Data mining used to recognise human activity**

Many recent research teams are trying to exploit data mining techniques in smart homes[137], [138]. However, most of them are supervised in the sense that they require human intervention to label the training datasets. For example, Kasteren [139] exploited a learned Markovian model and conditional random field to perform coarse-grained recognition of activities. Their model achieved a recognition rate of 79.4-95.6%. The labelling of the training dataset is performed by unfolding a voice recognition system to annotate the data during the realization of daily living activities. Models that exploit unsupervised algorithms are still very scarce in the literature and limited to low granularity recognition [140]. This can be explained by two factors. First, there are many challenges to implement such a method: data collection, generalization, etc. Second, most researchers use existing data mining algorithms used in other issues. Many researchers have recently begun to claim that one of the major reasons limiting the progression of activity recognition is that some fundamental information hidden in the data is ignored[141, p. 20]. Constraints of different natures (logical, probabilistic, temporal, etc.) can be exploited to improve recognition. For example, Jakkula &Cook[142] exploited the temporal relationships between events created by the trigger of sensors. Spatial knowledge would naturally fit in the process of data mining for activity recognition. In fact, it should also be understood that an activity can be performed in a valid sequence in time, but still be incorrect due to problems of spatial nature. For example, an activity may seem correct but because of the bad orientation of an object, the execution is wrong (e.g.pouring coffee in a cup upside down). The same thing can happen if each step is correctly detected, but at some point, an object is moving away rather than closer to the

activity's zone(the problem of distance). For instance, during the task *Preparing a Coffee*, the system could be waiting to detect a movement of the coffee jar to suppose the step *Putting coffee in the cup* has been fulfilled. If the distance between the coffee and the cup is increasing, it might be because the resident skipped the step and he is storing the coffee jar. Therefore, it is of crucial importance to consider spatial aspects. Nonetheless, we note that works focusing on the field of smart homes offer rigid recognition models that do not take into account the spatial aspect, or that incorporate it in a very limited way even when they recognize its important role[143]. Moreover, most of the existing works are largely theoretical and not tested or only experimented in anon-realistic context that does not allow determining their actual effectiveness [16].

Despite the success of data mining in recent research in smart home and activity recognition, this research area requires more years of research. The first drawback is that the aggregation of data carries the risk of losing important information, and thus many researchers prefer to work on the complete Big Data warehouse. The second drawback of data mining is that performance decrease in more realistic usage context (busier environment). Precision also decreases during activity realization if too many objects were grouped together[144]. The final limitation of data mining came from AR data sets that are sufficiently limited as to impact the reliability of existing research results[145]. More research should be done on that aspect in the future in order to design specific algorithms that palliate to data mining and HAR.

### **2.6.2 IoT technologies used in human activity recognition**

Since 2010, researchers have analysed IoT-based smart home applications using several approaches. Regardless of their category, existing research articles focus on the challenges that hinder the full utilization of smart home IoT applications and provide recommendations to mitigate these problems. The benefits of using smart home applications based on IoT are explained in figure 2.4.



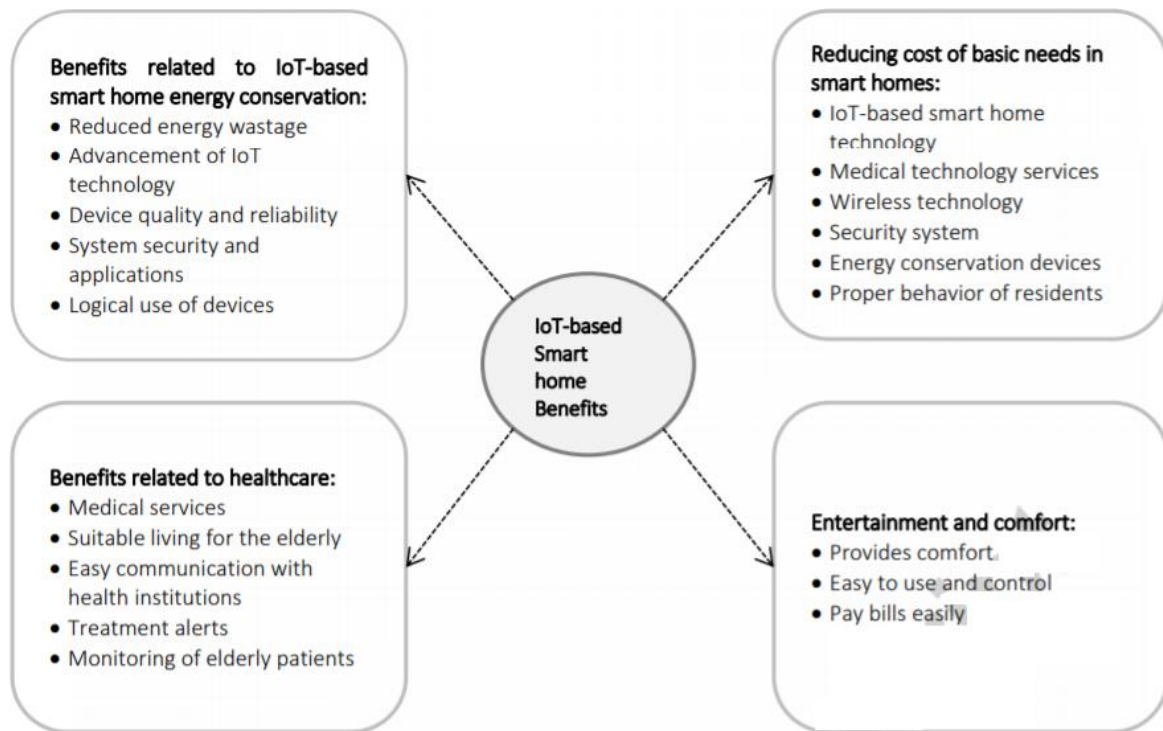

Figure 2.4: IoT based smart home benefits

It is expected that smart objects will be dominant on the market in the next few years and will become omnipresent in households, which will impose the need for new and improved services for smart homes. For these reasons, the need for IoT based solutions will be incontestable. Most recent publications focus on developing a general IoT framework that is suitable for broader range of application domains. Five IoT technologies as essential for building successful IoT solutions: radio frequency identification, wireless sensor networks, middleware, cloud computing and software for application development. In [146], the list of enabling technologies is enhanced with Near Field Communication, location based services and social networks. They suggest a four-layer architecture made up of: sensing, networking, service and interface. The role of the cloud is missing; therefore, it is not clear how smart home services would be enabled. Liu presented in [147] a middleware that supports naming and addressing. Storage insights into this emerging trend are important. The idea is to develop a middleware at the top of the existing systems (inside home), thus to achieve an easier integration of existing applications into IoT smart home. Once again, the cloud is omitted as an enabling technology that should support all these services. Research on this trend is ongoing, although related descriptions and limitations remain vague. Obtaining insights into this emerging trend is important.

## **2.7 Conclusion**

This chapter presented a state of art research in neural and deep neural network used in features selection and activity recognition inside home. We have, first, explored this area and discussed the strengths and limitations of approaches and algorithms. Then, we have explained techniques based on ILM and NILM used in literature to recognise appliances used by residents in their daily routine activities. This chapter concluded by discussing other methods in the literature that aim to recognize human activities inside home. We have concentrated on the two more researched methodologies in literature: human activity recognition based on IT technologies and Data Mining with a description of their strengths and limitations. In the next chapter, our methodologies of recognising human activities are presented in detail using motion sensors first, and then smart plugs based on several machine learning approaches.

# **CHAPTER 3:**

## **RESEARCH DEVELOPMENT AND METHODOLOGY**

Chapter three details the methodologies used to recognise activities of one and multiple users inside home. Two methodologies are explained, the first is based on sensors and neural networks and the second on appliance recognition; the methodology is graphically presented as a block diagram, summarizing how the methodology of the research was carried out, within the two sections 1 and 2 described in detail in this chapter

---

## **3.1 Introduction**

The development of this research is guided by a set of methods and techniques that instruct the scientific process. In our case, to achieve the main objective of improving the accuracy of human activity recognition inside home, we have resorted to two distinct techniques; the first is human activity recognition using ambient sensors and neural network, while the second is human activity recognition using appliance recognition. We have done several successful tests of neural network and features extraction and selection. Once we have improved accuracy of human activity recognition using ambient sensors, we have tried to overcome other big issues in smart home and activity recognition such as the cost of installation and maintenance of ambient sensors. In order to reach this objective, we have tried to recognise human activities inside home using load signature of appliances without additive sensors.

The methodology is graphically presented in Figure 3.1 as a block diagram, summarizing how the methodology of the research was carried out. The methodology is described in detail within this chapter in sections 1 and 2.

## **3.2-Activity recognition using neural network and based on ambient sensors**

The smart apartment is equipped with motion and door sensors distributed throughout the space of the house, shown in figure 3.2. Sensor data is captured using a sensor network that was designed in-house and is stored in a Structured-Query-Language (SQL) database. After collecting data from the smart apartment testbed, the sensor events are annotated for ADLs, which are used for training and testing the activity recognition algorithms using neural network algorithms.

### **3.2.1 Description of ADLs databases**

Databases used in the first section of research were all made by The Centre for Advanced Studies in Adaptive Systems(CASAS)[148], [149]. CASAS project is a multidisciplinary research project at Washington State University (WSU), which focused on the creation of an intelligent home environment. Databases are described in table 3.1. Sensor data is captured using a sensor network that was designed in-house and is stored in a database. The sensor events are annotated for ADLs, which are used for training and testing the activity

recognition algorithms. The four datasets are represented by the same following parameters: Date, time, and the value of sensor as well as activity target output.

The databases contain ADLs which we practice every day in our homes. Sleeping and toilet are examples of simple activities to detect that require few steps to achieve them. More complex activities like Meal Preparation and Housekeeping use a large number of sensors and are more difficult to detect and know. Multi-user activities are done by two people whether married or not doing together or concurrently.

An extract from the Aruba dataset is presented below:

```

Date      Time  Sensor ID Value  Target Output
2010-11-04 00:03:50 M003    ON   Sleeping begin
2010-11-04 00:03:57 M003    OFF
.....
2010-11-04 05:40:42 M007    ON
2010-11-04 05:40:43 M003    OFF   Sleeping end

```

This example shows the sensor events that correspond to the Sleeping activity in Aruba database. All activities start by begin and finish by end. The frequencies of activities vary from one to another. Activities are grouped in to basic or instrumental activities in Aruba and Cairo databases to provide physical training data for neural network using BP algorithm. Tables 3.2 and 3.3 hereafter describe tasks with the number of times the activity appears in the four databases used in the first section of this research thesis.

Table 3.1: Databases description

<b>Dataset</b>	<b>Country</b>	<b>Period</b>	<b>Users</b>	<b>Instances</b>	<b>N° of ADLs performed</b>
Aruba	Netherlands	2010-11-04 2011-06-11	1 adult	1 719 558	10
Cairo	Egypt	2009-06-10 2009-08-05	2 adults married	7 264	13
Tulum	Mexico	2009-04-02 2009-07-31	2 adults married	1513	10
Twor	United State	2009-08-24 2010-05-01	2 residents	3896	26

Figure 3.1: block diagram summarizing how the methodology of the research was carried out.

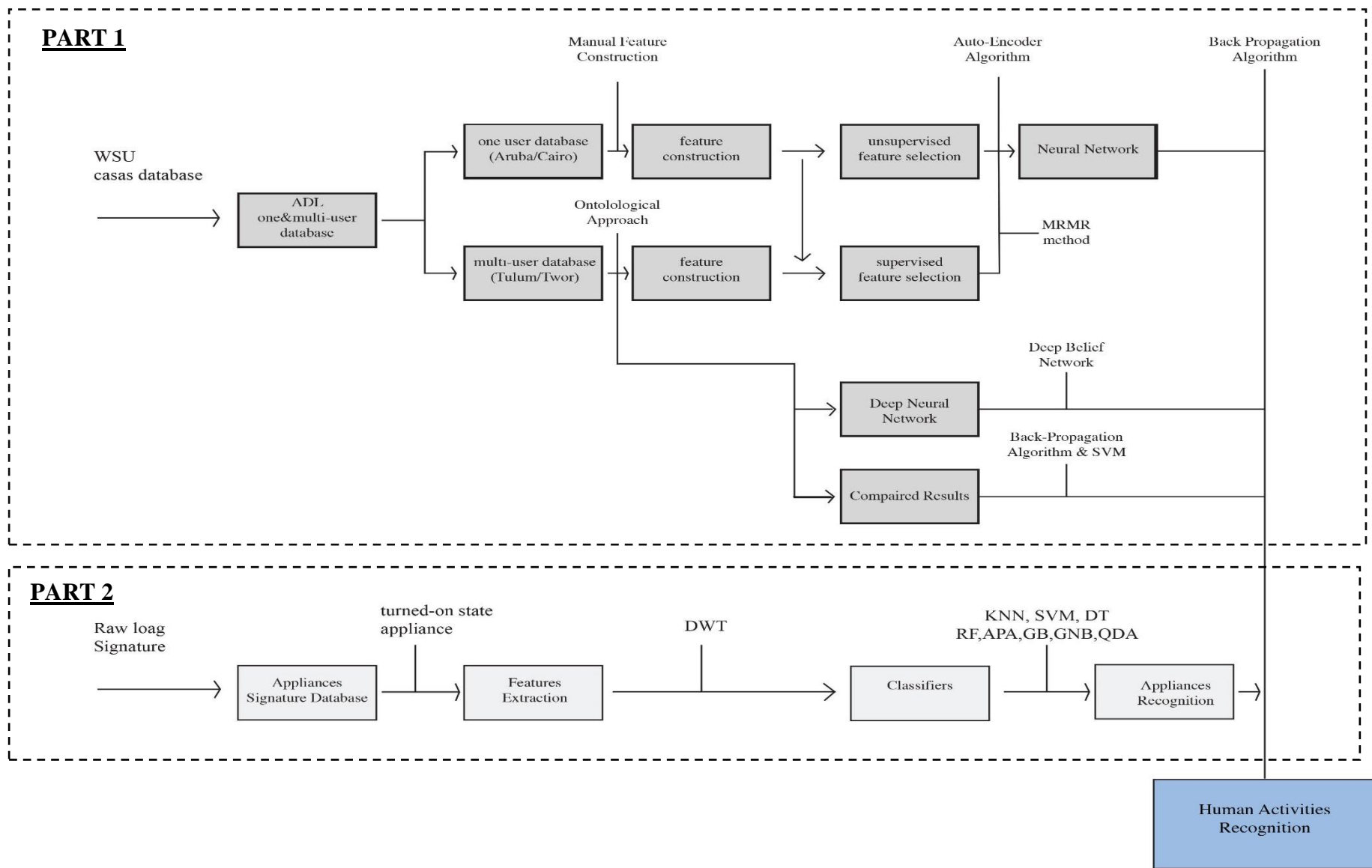

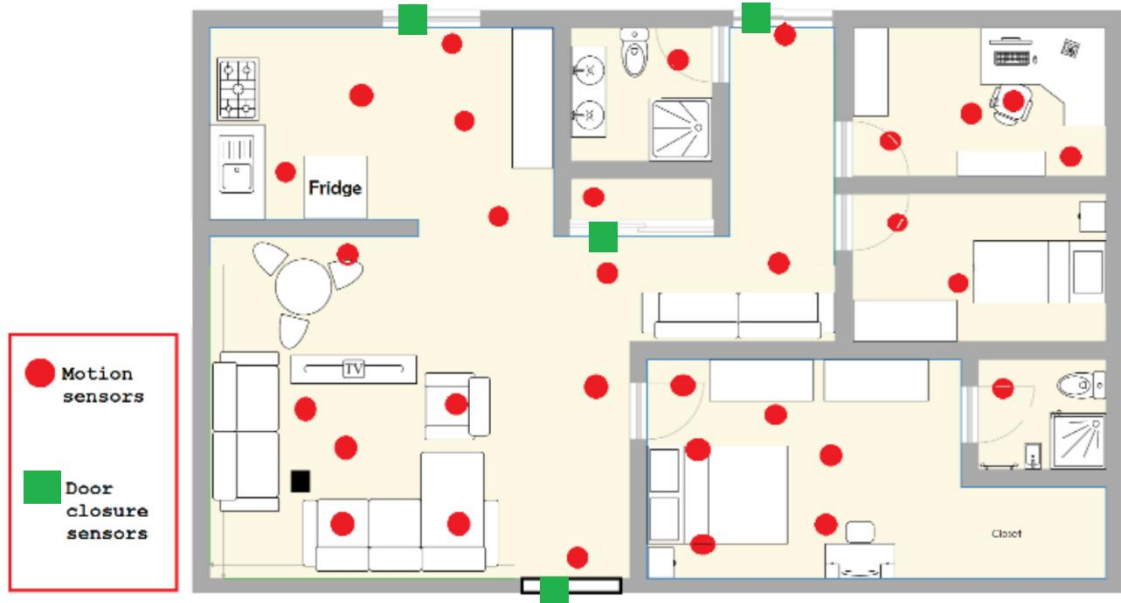

Figure 3.2: the smart apartment testbed and sensors location in the Aruba apartment

Table 3.2: Description of ADLs Activities of Aruba and Cairo Databases

Activity type	Activity Name	Activity Description	Instances
<b>Aruba: Basic ADL</b>	Activity_0	Sleeping	385
	Activity_3	Work	133
	Activity_4	Relax	1095
	Activity_6	Bed_to_Toilet	155
	Activity_7	Enter_Home	431
	Activity_8	Leave_Home	431
<b>Aruba : Instrumental ADL</b>	Activity_1	Meal_Preparation	1034
	Activity_2	Eating	238
	Activity_5	Wash_Dishes	66
	Activity_9	Housekeeping	34
<b>Cairo: Basic ADL</b>	Activity_0	Bed_to_toilet	25
	Activity_2	R1_sleep	55
	Activity_3	R1_wake	58
	Activity_4	R1_work_in_office	46
	Activity_6	Leave_home	59
	Activity_9	R2_sleep	58
	Activity_11	R2_wake	64
<b>Cairo: Instrumental ADL</b>	Activity_1	Breakfast	49
	Activity_5	Dinner	42
	Activity_7	Lunch	37
	Activity_8	Night_wandering	47
	Activity_10	R2_take_medicine	44

Table 3.3: ADLs Activities of Tulum and Twor datasets

Data set name	Activity name	Performed by	Instances
Twor	Bathing	R1 or R2	86
	Bed_Toilet_Transition	R1 or R2	40
	Eating	R1 or R2	97
	Enter_Home	R1 or R2	137
	Leave_Home	R1 or R2	215
	Housekeeping	R1 or R2	1
	Meal_Preparation	R1 or R2	315
	Personal_Hygiene	R1 or R2	1084
	Sleep	R1 or R2	585
	Sleeping_Not_in_Bed	R1 or R2	6
	Wandering_in_room	R1 or R2	20
	Watch_TV	R1 or R2	227
	Work	R1 or R2	937
Tulum	Cook_Breakfast	anonymous	80
	R1_Eat_Breakfast	R1	66
	Cook_Lunch	anonymous	71
	Leave_Home	anonymous	75
	Watch_TV	anonymous	528
	R1_Snack	R1	491
	Enter_Home	anonymous	73
	R2_Eat_Breakfast	R2	47
	Wash_Dishes	anonymous	71
	Group_Meeting	Both	11

### 3.2.2 Feature construction

To achieve a better representation of ADLs of one and multi-users databases, extracting manually a maximum of relevant features seems to be essential. In this trend, an ontology approach is used as the feature space to represent the training dataset and extract information from raw data. As explained in figure 3.3, a relationship was established between activity and other entities. Based on this ontological approach, 17 features are extracted and detailed below:

$$1- S_i = \frac{1}{n_i} \sum_{k=1}^{n_i} S_{ik} \quad (3.1)$$

$S_i$  (3.1) is the means of Sensors ID of activity  $i$ ,  $n_i$  is the number of motion and door sensors noted in the dataset between the beginning and the end of the activity, and  $S_{ik}$  is the  $k_{th}$  Sensor ID.



- 2- The logical value of the first Sensor ID triggered by the current activity;
- 3- The logical value of the second Sensor ID triggered by the current activity;
- 4- The logical value of the last Sensor ID triggered by the current activity;
- 5- The logical value of before the last Sensor ID triggered by the current activity;
- 6- The name of the first sensor triggered by the current activity;
- 7- The name of the last sensor triggered by the current activity;
- 8- The variance of all Sensor IDs triggered by the current activity;
- 9- The beginning time of the current activity;
- 10- The finishing time of the current activity;
- 11- The duration of the current activity;
- 12- The day of week, which is converted into a value in the range of 0 to 6;
- 13- Previous activity, which represents the activity that occurred before the current activity;
- 14- The activity length, which is the number of instances between the beginning and the end of current activity;
- 15- The name of the dominant sensor during the current activity;
- 16- The location of the dominant sensor;
- 17- The frequency of the dominant sensor.

According to the above-mentioned features, an algorithm was developed on the basis of C++ for better assessment of extracting features from row data. A small part of the code was given in appendix 1.

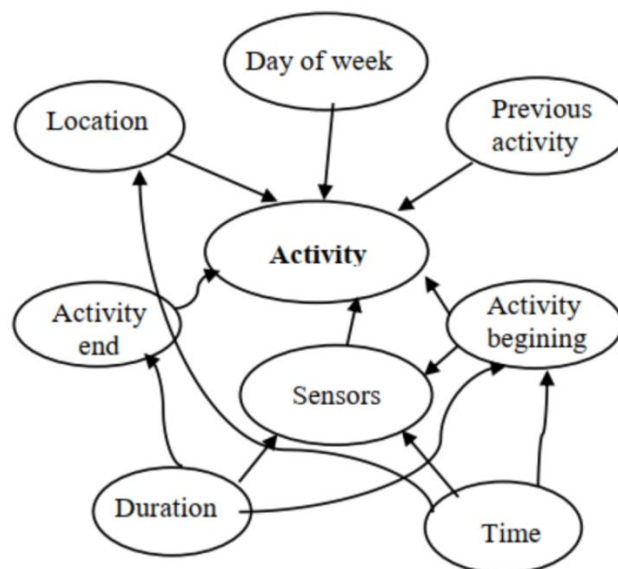

Figure 3.3: Ontological representation of activity

These 17 features are the largest list of manually well selected features in our research. In an earlier work, we extracted 13 features used as inputs to Back-propagation algorithm. Based in mRMR features selection method, the feature called ‘the season of the year’ had a less score [77]. We eliminated this feature in the other works and we had added new features based on an ontological approach in order to have more relevant and less redundant features[74].

### 3.2.3 mRMR for supervised features selection

After features construction, features selection is an important step especially after an automatic construction of the features. Supervised features selection is the earliest and most common practice. Supervised feature selection utilizes the labelled data in the feature selection process. A better understanding of the desired target and algorithm used in learning steps helps in choosing the features selection method to be used. Based on this criterion, we choose Minimal Redundancy and Maximum Relevancy (mRMR) method as supervised feature selection method[150]. This approach is based on the use of features relevance and redundancy in the selection process. The relevance is calculated by using mutual information. The redundancy of a feature is determined based on mutual dissimilarity to other features. Features values are uniformly distributed in different classes. If a feature is strongly differentially expressed for different classes, it should have large mutual information with classes. Thus, we use mutual information as a measure of relevance of features. For discrete variables, the mutual information (I) (in formula 3.2) of two variables x and y is defined based on their joint probabilistic distribution  $p(x,y)$  and the respective marginal probabilities  $p(x)$  and  $p(y)$ :

$$I(x, y) = \sum_{i,j} p(x_i, y_j) \log \frac{p(x_i, y_j)}{p(x_i)p(y_j)} \quad (3.2)$$

For categorical variables, we use mutual information to measure the level of “similarity” between features. The idea of minimum redundancy is to select the features that are mutually maximally dissimilar. Let  $S=\{S_1, S_2, \dots, S_s\}$  denote the subset of features we are seeking. The minimum redundancy condition is:

$$\min[W_1, W_s], \quad W_I = \frac{1}{s^2} \sum_{i,j \in S} I(f_i, f_j) \quad (3.3)$$

Where  $I(f_i, f_j)$  is the mutual information between feature  $f_i$  and  $f_j$ ,  $s$  is the number of features in  $S$  and  $W_I \in [W_1, W_s]$ . To measure the level of discriminant powers of features when they are differentially expressed for different target classes  $T = \{T_1, T_2, \dots, T_t\}$ , we again use mutual information between the targeted classes and the features. Thus, the maximum relevance condition is to maximize the total relevance of all features in  $S$ :

$$\max[V_1, V_s], \quad V_I = \frac{1}{s} \sum_{i \in S} I(f_i, T) \quad (3.4)$$

Where  $V_I \in [V_1, V_s]$ . The mRMR features set is obtained by optimizing conditions in the two equations described above. Optimization of both conditions requires combining them into a single criterion function. After several tests we choose a simple subtraction for this combination, that we found more suitable for the learning part, below is the equation used.

$$\max \{V_I - W_I\}_{I=1}^s \quad (3.5)$$

### 3.2.4 Autoencoder for unsupervised feature selection

After testing the best-known method in supervised feature selection, we proceeded to test another method in unsupervised features selection to compare them and select the most suitable for learning phase. In the unsupervised features selection, label information is directly unavailable, which makes the task of features selection more challenging. Nevertheless, it has several advantages, e.g., it is unbiased since there is no need to utilize experts or data analysts to categorize the samples and it still can perform well even when no prior knowledge is available.

Autoencoder as an unsupervised features selection, can select the most important features by excavating both linear and nonlinear information among features.

An autoencoder is an artificial deep neural network used in unsupervised learning for features selection. Architecturally, it is composed by an input layer, an output layer and one or more hidden layers connecting them. As showed in figure 3.4, unsupervised learning consists of two parts: encoder and decoder. The encoder takes an input vector  $x \in [0, 1]_d$ , and maps it to a hidden layer  $y \in [0, 1]_{d'}$  through a deterministic mapping  $y = f_{\theta}(x) = s(Wx + b)$ , parameterized by  $\theta = \{W, b\}$ .  $W$  is a  $d' \times d$  weight matrix and  $b$  is a bias vector. The resulting latent representation  $y$  is then mapped back to the decoder or a “reconstructed” vector  $z \in [0, 1]_d$  in input space  $z = g_{\theta'}(y) = s(W'y + b')$  with  $\theta' = \{W', b'\}$ . The weight matrix  $W'$  of the opposite

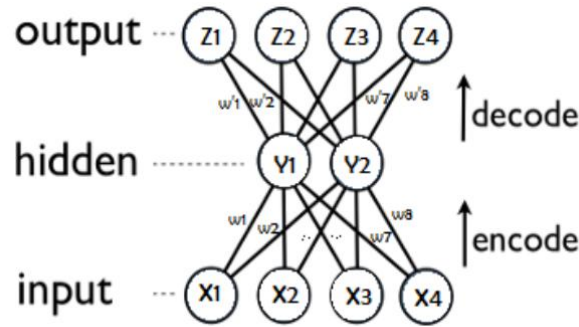

Figure 3.4: Unsupervised Autoencoder Learning architecture

mapping may optionally be constrained by  $W' = WT$ , in which case the autoencoder is said to have tied weights.  $y = f_{\theta}(x) = s(Wx + b)$ , parameterized by  $\theta = \{W, b\}$ .  $W$  is a  $d' \times d$  weight matrix and  $b$  is a bias vector. The resulting latent representation  $y$  is then mapped back to the decoder or a “reconstructed” vector  $z \in [0, 1]^d$  in input space  $z = g_{\theta'}(y) = s(W'y + b')$  with  $\theta' = \{W', b'\}$ . The weight matrix  $W'$  of the opposite mapping may optionally be constrained by  $W' = WT$ , in which case the autoencoder is said to have tied weights. Each training  $x(i)$  is thus mapped to a corresponding  $y(i)$  and a reconstruction  $z(i)$ . The parameters of this model are improved to reduce the average reconstruction error. Once we have a useful higher-level representation of the initial inputs, they are conducted to the second part: the supervised learning.

### 3.2.5 Human activity recognition using Neural Networks

Using these two techniques of features selection, supervised and unsepervised, we built different data sets as input to neural network algorithms. Back-Propagation algorithm is the first network algorithm tested to recognise human activities. Back-propagation algorithm attempts to associate a relationship between the input layer and the output layer, by computing the errors in the output layer and determining the measures of the hidden layer output errors, so as to adjust all weights connections (synaptic weights ) of the network in the iterative process until the errors decrease to a certain tolerance level.

Initially, before adjusting weights, they will be set randomly. Then, the neuron learns from the training subset and corrects weights value, finally loads to the testing mode. Our network contains only one hidden layer according to Kolmogorov's theorem which proves that the network might be capable to have better performance using one hidden layer. If the

number of input neuron is  $n$ , and the inputs are normalized between 0 and 1, a network with only one hidden layer exactly maps these inputs to the outputs.

In the output layer,  $O_j$  the value of the neuron,  $net_j$  is the  $j$ th value of the sum of the weighted values of hidden nodes.

$$Y_j = f(net_j) \quad j = \{1, 2, \dots, m\} \quad (3.6)$$

$$net_j = \sum_{k=1}^h w_{kj} H_k \quad k = \{1, 2, \dots, h\} \quad (3.7)$$

Where  $w_{kj}$  is the weight between the  $k$ th neuron in hidden layer and the  $j$ th neuron in output layer.

$$H_k = f(net_k) \quad k = \{1, 2, \dots, m\} \quad (3.8)$$

$$net_k = \sum_{i=1}^n w_{ik} X_i \quad i = \{1, 2, \dots, n\} \quad (3.9)$$

$X_i$  is the input value of the  $i$ th neuron in input layer,  $net_k$  is the  $k$ th value of the sum of the weighted values of input nodes. The active function  $f$  in (3.6) and (3.8) is Sigmoid function:

$$f(x) = \frac{1}{1+e^{-x}} \quad (3.10)$$

The objective of BP approach is to minimize not only local error (3.10) but also minimize the sum-squares-error function defined by:

$$E = \frac{1}{2} (D - O)^2 = \frac{1}{2} \sum_{j=1}^m (d_j - o_j)^2 \quad (3.11)$$

We can minimize this error by applying the gradient descent rule to each weight between the  $k$ th neuron in hidden layer and the  $i$ th neuron in input  $v_{ji}$  neuron  $k$  by the equation in the  $t$  iteration, the value of modification of the weight between the  $j$ th neuron in output layer and the  $k$ th neuron in hidden layer, is:

$$w_{ji}(t) = w_{ji}(t-1) + \eta \delta_j(t) y_i(t) \quad (3.12)$$

With:

$$\text{if } j \in \text{output layer} \quad \delta_j(t) = y_j(t) (1 - y_j(t)) \times e_j(t) \quad (3.13)$$

$$\text{else} \quad \delta_j(t) = y_j(t) (1 - y_j(t)) \quad (3.14)$$

$$0 < \eta < 1$$

Where  $\eta$  is the learning rate.  $i$  is hidden layer and  $j$  is the output layer or  $i$  is the input layer and  $j$  is the hidden layer. These operations will be repeated until the error  $E(t)$  is greater than a predefined threshold or since the limit of iterations is not yet reached.

### 3.2.6 Human activity recognition using Deep Neural Networks

Testing deep neural network is an important step in this research in order to have a complete vision of neural network algorithm. Deep Belief Networks had proved its strong learning power in the field of activity recognition especially with incomplete and small data.

DBN is stacked and trained in a greedy manner using Restricted Boltzmann Machines (RBM). In fact, DBN has two basic parts: pre-training and fine-tuning. Once the network is pre-trained based on RBM, fine-tuning is performed using supervised gradient descent. Specifically, a logistic regression classifier is used to classify the input based on the output of the last hidden layer of the DBN. That is, once the weights of the RBMs in the first hidden layer are trained, they are used as inputs to the second hidden layer. Figure 3.5 shows the three hidden layers that are being used in this work. According to Hinton et al. proposal, this work is based on the contrastive divergence (CD) algorithm to train RBM in supervised scenario.

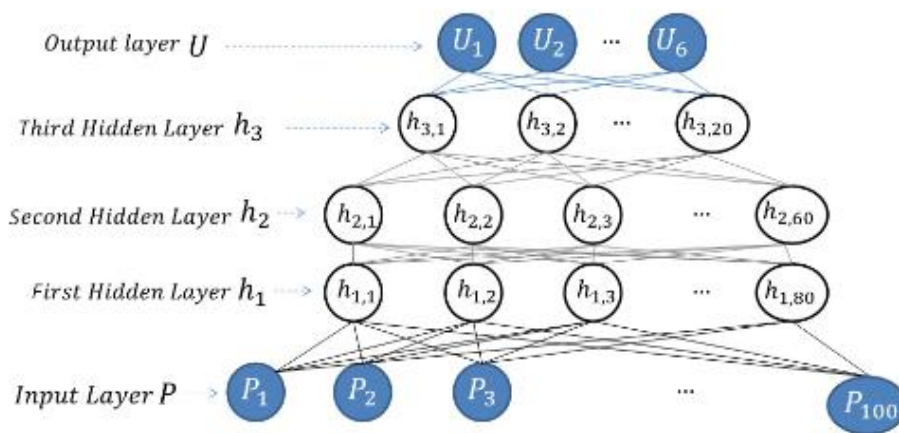

Figure 3.5: Structure of a DBN used in this work with 17 neurons in input layer and 3 hidden layers

### 3.2.7 Support Vector Machines for ADLs Classification

To compare neural network algorithm with other machine learning algorithm, SVM is chosen because it proves strong in several ADLs recognition problems. SVM have been widely used to solve classification problems since their invention[151]. Support Vector Machines (SVMs) were introduced by Vapnik [152]. SVM classifier deals with two-category classification problems. Given a training sample set  $\{(x_i, y_i), i = 1, \dots, n, x_i \in R^d, y_i \in \{+1, -1\}\}$ , where  $x_i$  is the feature vector,  $y_i$  is the label; SVM is developed for finding the optimal classification plane in the case of linear separability. The aim of SVM classifier is to

maximize the margin between two categories besides distinguishing them. Under the case of linear separability, the optimal hyper plane can be constructed by solving an optimization problem:

$$\min \quad \theta(w) = \frac{1}{2} (w \cdot w) \quad (3.15)$$

$$\text{s.t. } y_i((w \cdot x_i) + b) \geq 1, \quad i = 1, \dots, n$$

whose dual problem is:

$$\max W(\alpha) = \sum_{i=1}^n \alpha_i - \frac{1}{2} \sum_{i,j=1}^n \alpha_i \alpha_j y_i y_j (x_i, x_j) \quad (3.16)$$

$$\text{s.t. } \sum_{i=1}^n \alpha_i y_i = 0, \alpha_i \geq 0, i = 1, \dots, n$$

If  $a$  is a solution of equation (3.15), then  $w = \sum_{i=1}^n \alpha_i^* y_i x_i$ . Choose an  $\alpha_i \neq 0$ , and the corresponding solution  $b$  is computed from the equation  $\alpha_i (y_i (w \cdot x_i + b) - 1) = 0$ . Then the label of an unknown sample  $x$  can be decided through  $gn[w \cdot x + b]$ .

In practical applications, the linearly separable condition can not always be met in most of the case. Therefore, a relaxation variable  $\epsilon_i \geq 0$  and a mapping  $\phi(x)$  are introduced to get a nonlinear support vector machine [152]. The optimal hyper plane can also be constructed by calculating the following optimization problem:

$$\min \quad \theta(w) = \frac{1}{2} (w \cdot w) + C \sum_{i=1}^n \epsilon_i \quad (3.17)$$

$$\text{s.t. } y_i((w \cdot \phi(x)) + b) \geq 1, \quad i = 1, \dots, n$$

where  $C$  is a penalty factor. Its dual problem is:

$$\max L(\alpha) = \sum_{i=1}^n \alpha_i - \frac{1}{2} \sum_{i,j=1}^n \alpha_i \alpha_j y_i y_j K(x_i, x_j) \quad (3.18)$$

$$\text{s.t. } \sum_{i=1}^n \alpha_i y_i = 0, \quad 0 \leq \alpha_i \leq C, \quad i = 1, \dots, n$$

where  $K(x_i, y_i)$  is a kernel function satisfying the Mercer condition. There are several commonly used kernel functions, such as linear kernel, RBF kernel, and polynomial kernel.

### 3.3- Activity recognition using appliance recognition

We have stated another objective: is to reduce the costs of maintenance and installation of motion and door sensors in the house, and to recognise human activities in a normal house without additional sensors system. We have proposed a system for identifying load signatures of appliances with the aim to ensure the recognition of human activities. This approach consists in recognizing human activities inside the house through the extraction of the load signatures of the appliances used at home based on power analysis at the steady-state.

### 3.3.1 Description of the tracebase data set used in appliance recognition

The tracebase data set used in section 2 is a collection of power consumption traces of appliances which can be used in appliance recognition inside home. Tracebase has been collected from individual electrical appliances, at an average reporting rate of one sample per second[153].

Traces were recorded over a period of 24 hours. Each trace starts at midnight and ends at midnight the next day. The smart plug was not disconnected during this period even if the device had been switched off. Table 3.4 shows details about the appliances used and the number of load signatures instances for each appliance. We have chosen seven classes that are the most known in residential sector such as refrigerator, washing machine, laptop and so on. This database is used to extract load signatures of appliances.

Table 3.4 Number of instances prepared from Tracebase dataset for each appliance.

<b>Appliance</b>	<b>Number of load signatures instances</b>
Refrigerator	1026
Washing machine	56
Laptop-PC	482
Desktop-PC	1728
Monitor TFT	818
Router	455
Multimedia	111



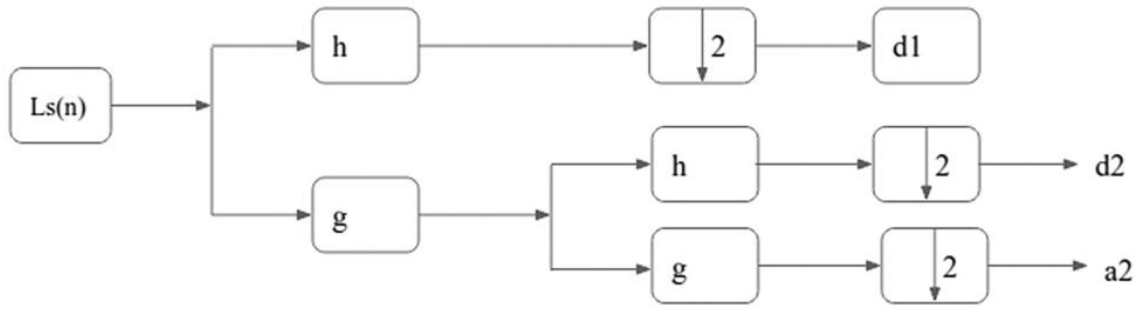

Figure 3.6: Discrete wavelet transform with two levels

### 3.3.2 Feature extraction using DWT

Load signature is a sequence of values that varies during time; in this case values are real power. formally a load signature can be represented by  $L_s = \{l_{s1}, l_{s2}, l_{s3}, \dots, l_{sn}\}$  where  $L_s$  is the whole load signature of appliance  $l_s$  is the recorded value of real power and  $n$  is total number of values. The number of observation, high dimensionality and multivariate property make the classification difficult. To reduce the size of data and denoised it Discrete Wavelet Transform is performed to extract approximate coefficients that represent the whole signal. Decomposition of signal is generated as a tree known as Mallat's decomposition tree that is shown in Figure 3.6.  $L_s(n)$  is the load signature and the high and low filters are represented respectively by  $h$  and  $g$ . The first and second wavelet details are  $d_1$  and  $d_2$ . The second level approximation is represented by  $a_2$  which represents the input of classifiers.

### 3.3.3 Classifiers used in appliance recognition

In the second section of this thesis, nine classifiers are implemented belonging to eight distinct families in order to recognise appliances inside home, namely, nearest-neighbours, support vector machines, decision trees, random forests, Boosting, Bayesian, discriminant analysis. Above, the implemented classification algorithms were briefly introduced. Algorithms described below are implemented using Sklearn library[154].

#### 3.3.3.1 K-Nearest Neighbours (KNN)

KNN[69] is one of the most simple and fundamental classifier, based on the minimal distance

between the training dataset and the testing dataset. This algorithm is widely used to solve the classification problems.

### **3.3.3.2 Support vector machine (SVM)**

Described in detail in this chapter (3.1.7).

### **3.3.3.3 Decision Trees Classifier (DT)**

DT is composed of nodes structured like a tree[155]. Nodes relate to direct edge from starting root node. Internal nodes are created with one incoming edge and producing two or more than two edges in this level. Values are compared to choose the right decision according to the feature; DT ending with terminal nodes, and Discrete Wavelet Transform and Classifiers for Appliances Recognition.

### **3.3.3.4 Random Forest Classifier (RF)**

Random forests use multiple trees. Each tree depends on random vector values that tested independently with the same distribution for all trees in the forest. Each tree makes its own decision and the final decision is completed based on voting. Where the decision of a significant part of trees is the decision of overall outcome.

### **3.3.3.5 Adaboost Classifier (ADA)**

An ADA classifier is a popular boosting technique. This classifier helps to combine multiple classifiers that perform poorly into a single strong classifier, beginning by fitting a classifier on the original dataset and then fitting additional copies of the classifier on the same dataset. However, when the weights of incorrectly classified instances are adjusted, the subsequent classifiers focus more on difficult cases.

### **3.3.3.6 Gradient Boosting classifier (GB)**

GB[156] is one of the most powerful machine-learning techniques for building predictive models. GB approach is based on construction of new base-learners to be excellently linked with the negative gradient of the loss function that connected with the whole ensemble. The choice of the loss function may be arbitrary, with both of rich variety of loss functions derived distant and the possibility of applying one's own task-specific loss.

### **3.3.3.7 Gaussian NB (GNB)**

GNB[157] subdivided inputs into continuous variables and outputs as discrete variables. GNB is characterized by the conditional probability between features that given the label.

Supervised classification with conditional Gaussian networks increasing the structure complexity from naive Bayes.

### **3.3.3.8 Linear Discriminant Analysis (LDA) and Quadratic Discriminant Analysis (QDA)**

LDA is widely used for dimensionality reduction and classification. This technique maximizes the ratio between classes. This approach is known as class dependent transformation. Also, it can be used to create independence between different classes, QDA has the same property as LDA but the observations in QDA are separated by quadratic hyper plane.

### **3.3.4 Activity recognition based in appliance recognition**

The second phase of this method, corresponding to the developing and the designing of an algorithm for recognizing activities through the use of appliances. For this algorithm, the algorithm of appliance recognition (detailed in appendix 3) was repeated and was improved following the experiments that have helped to create the database of load

signatures. Table 3.4 describe household appliances whose we monitored and determined the load signature previously.

Table 3.5 presents a list of human activities monitored using appliance recognition. For each appliance, we linked one or more activities. Those daily activities are done by one resident living alone in their house. Multimedia is installed in bedroom and is only used to listen to music, while the Desktop-PC is installed in office (work room). We have assumed that the resident does not have a TV and uses their laptop-PC to watch TV online. Those activities are based on appliances recognition. Those algorithms below were developed and used in activity recognition phase.

Table 3.5: a list of human activities monitored using appliance recognition

<b>Appliance</b>	<b>Human Activity recognized</b>
Refrigerator	<b>Kitchen activities:</b> Overly Open Refrigerator Close refrigerator: refrigerator in standby
Washing machine	<b>Laundry:</b> Turn on washing machine Turn off washing machine
Laptop-PC	<b>Watch TV:</b> Turn on Laptop-PC Turn off Laptop-PC
Desktop-PC	<b>Work:</b> Turn on Desktop-PC Turn off Desktop-PC
Monitor TFT	<b>Work:</b> Turn on Monitor TFT Turn off Monitor TFT
Router	<b>Enter home/ Leave home:</b> Detection of appliances using Wi-Fi
Multimedia	<b>Relax</b> Listen to music in bedroom

Algorithms for recognizing activities using devices are presented below. Activities to be recognised are based on household appliances which load signature were monitored and determined previously. The second phase consists of recognising 7 daily activities of one

resident in kitchen, bed room and work room. We have tried to link the use of appliances to detect various activities even if it appears that no relation exists between activities and appliances. In fact, when the modem detects an appliance connected to the network, generally a smart phone, it may indicate the presence of the resident is inside the house (general cases). These recognized activities are limited to a specific case with a very restrictive daily life routine of a model resident.

#### **Output: Kitchen activities**

---

**Do**

**If** refrigerator power > threshold and the last “Yes” event was detected for less than 10 min

Activity detected is: **Kitchen activities**

**Else if** refrigerator power < threshold for more than 10 min

No activity detected, refrigerator in standby

**End**

**End**

**Until** the monitoring is stopped

#### **Output: Laundry**

---

**Do**

**If** Washing machine power is ON

Activity detected is: **Laundry**

**Else if** Washing machine power is OFF

No activity detected

**End**

**End**

**Until** the monitoring is stopped

#### **Output: Watch TV**

---

**Do**

**If** Laptop-PC power is ON

Activity detected is: **watching TV**

**Else if** Laptop-PC power is OFF

No activity detected

**End**

**End**

**Until** the monitoring is stopped

---

**Output: Work**

**Do**

**If**Desktop-PC power > threshold and Monitor TFT> threshold

Activity detected is:**Work**

**Else if**Desktop-PC power < threshold or Monitor TFT< threshold

No activity detected

**End**

**End**

**Until** the monitoring is stopped

---

**Output: Enter home/ Leave home**

**Do**

**If**Router power> threshold and the last 'on' event was detected for more than 60 measures

Appliance detected, phone detected

Resident enter home

Activity detected is:**Laundry**

**Else if**router active power < threshold and the last 'on' event was detected for more than 60 measures

No activity detected

Resident leave home

**End**

**End**

**Until** the monitoring is stopped

## **Output: Relax**

---

**Do**

**If** Multimedia power > threshold

Activity detected is: **Relax**

**Else if** Multimedia power < threshold

No activity detected

**End**

**End**

**Until** the monitoring is stopped

The implementation of recognition algorithms is made using python code and running using Linux system. The recognition of these activities is relatively simple since it based on ILM where each appliance is linked to its smart plug which detects fluctuations of appliance linked in.

### **3.3.5 Limitations and advantages of this method**

Despite multiple advantages of this approach it has some limitations. For example, it is clear that the algorithm will not allow the recognition of daily activities that require no electrical power supply such as ingesting drugs, taking a shower, brushing teeth, preparing a sandwich, opening the door of refrigerator, etc. cannot be recognized. Although these daily activities are very important for building a smart home, they cannot be considered by this method, because it focuses specifically on power-consuming activities.

However, it would be possible to add a water flow analyser to detect the events requiring a water supply. Also, the installation of supplementary sensors and existing ones could help to strengthen measures for the recognition of activities, but it is beyond the scope of this approach. It is important to note that the combination of all these suggested measurement tools will be beneficial to the improvement and optimization of the recognition of activities in smart home.

Finally, the step of load signature extraction for each different appliance is a constraint that could eventually disappear. To do this, we should develop techniques that would recognize the new devices that have never been used before within the smart home and add them automatically to database with their features. Furthermore, through gathering data

during the on/off events of a same device, this algorithm could adjust and improve progressively the appropriate load signature recorded in the database after the event has been associated to the corresponding appliance. This modification would maximize the time allocated to the construction of the database.

### **3.4 Conclusion**

All databases used in simulation phase were presented as shown in tables 3.2 and 3.3. Our methodology was graphically presented in figure 3.1. We have used neural and deep neural network to recognise human activity using ambient sensors combined with several features selection method in order to compare results and define the influence of each method in learning accuracy. Moreover, load signatures of appliances were presented using an automatic pre-processing based on Discrete Wavelet Transform, in order to identify the most accurate classifier between nine classifiers for appliances recognition using a low frequency sampling rate dataset. Finally, the algorithm for recognizing pre-defined activities using devices was detailed.

In the next chapter, results of using ambient sensors and based on several neural and deep neural networks are presented and discussed in detail. Moreover, the next chapter presents our future work in this emerging field.



# **CHAPTER 4:**

## **ACTIVITY RECOGNITION USING NEURAL NETWORKS AND AMBIENT SENSORS**

In this chapter, we perform several simulations of databases using machine learning algorithms and feature selection techniques. The objective of this study is to raise accuracy of activity recognition of one and multiple residents at home. Several neural and deep neural networks algorithms combined with feature selection techniques are trained and lead to different results.

---

## 4.1- Introduction

Several simulations are made in order to validate our approaches and compare them. Those simulations are based on open sources databases delivered by The Centre for Advanced Studies in Adaptive Systems (CASAS)[148], [149]. The objective of this chapter is to prove by simulations the utility of our approaches to raise accuracy of activity recognition of one and multiple residents at home. Several neural and deep neural networks algorithms combined with feature selection techniques are trained and lead to different results.

To validate the relevance of our approaches, they are compared with other popular methods. A part of our developed algorithm is available in Appendix 1, while the implementation of the DBN algorithm is explained in detail in Appendix 2.

## 4.2- One user activity recognition using back-propagation algorithm and mRMR feature selection

In the smart home, 11 test bed activities are to be recognized from Aruba database. These activities include both basic and instrumental ADLs. These activities are described in chapter 3.

### 4.2.1 Parameters

In our first work [77], we have classified the features according to the mRMR score in order to obtain better recognition accuracy, as described in table 4.1. The dataset was tested with total features, then features were eliminated one by one and tested each time, results were compared as explained below:

Table 4.1: features classification based in their mRMR score

f	f8	f7	f9	f12	f11	f2	f4	f6	f1	f3	f5	f10	f13
S	3.065	3.063	2.712	1.998	1.570	0.835	0.821	0.793	0.770	0.437	0.109	0.041	0.028

Parameters of neural network using BP algorithm are listed in Table 4.2Thevalue of each feature is normalized as Multilayer perceptron model  $X_n = \frac{X}{x_{max}}$

Table 4.2: parameters of neural network using bp algorithm

Learning rate $\eta$	Number of iteration	Error threshold
0.1	2000	0.01

Where  $X$  is the value before normalization;  $X_{\max}$  is the largest value for each feature and  $X_n$  is the value of normalized feature. All 11 activities were performed in neural network using BP algorithm, output contains 11 neurons and only one node produces an output close to 1 when present with a given activity and all others close to 0. In the test, the activity recognition accuracy is performed in two methods, first referring to a threshold to choose the result. In this research we have chosen a threshold equal to 0.7. e.g. if the output vector is  $\{0.30.4 0.2 0.60.2 0.00.90.10.10.10.5\}$  the corresponding recognition result is activity 6. The second, called the winner, chooses the maximum output vector value that corresponds in the recognition result. Table 4.3 presents the comparison results of the two methods of activity recognition accuracy of the different feature datasets; the subsets are described as:

Subset 1: all features without selection;

Subset 2: all features are selected except  $\{f_{13}\}$ ;

Subset 3: all features are selected except  $\{f_{13}, f_{10}\}$ ;

Subset 4: all features are selected except  $\{f_{13}, f_{10}, f_5\}$ ;

Subset 5: all features are selected except  $\{f_{13}, f_{10}, f_5, f_3\}$ ;

Subset 6: all features are selected except  $\{f_{13}, f_{10}, f_5, f_3, f_1\}$ .

## 4.2.2 Results

Table 4.3 shows the comparison results of activity recognition accuracy performance of the six different feature subsets. It can be seen that the activity recognition accuracy is lower for subset 1 than subset 2, Subset 6 has relatively higher proportion of recognition accuracy. Selecting Subset 6 generates the best result and represents the relatively better recognition than others with fewer instances.

Exactly, the winner method yields 96% and 82% for the threshold

method for a number of neurons in the hidden layer equal to 13 with only 8 features. The variance of

Sensor IDs with low mutual information score value means that redundant information degrades the recognition performance of neural network using BP algorithm. Therefore, the results indicate that the improper selection of the number of neurons increases the computational complexity and degrades the activity recognition accuracy. In sum, considering the factors including total accuracy and training error convergence rate, the feature subset is set to Subset6.

Table 4.3: results of recognition accuracy performance with the four different feature subsets

	Hidden neurons	Accuracy threshold (%)	Accuracy winner (%)
Subset 1	13	66	88
	14	54	90
	15	58	92
	16	54	90
	17	56	88
	18	62	88
	19	60	88
	20	66	88
Subset 2	12	72	92
	13	74	90
	14	66	86
	15	72	88
	16	70	88
	17	68	88
	18	70	92
	19	70	94
Subset 3	11	66	88
	12	68	92
	13	68	90
	14	70	90
	15	66	92
	16	72	92
	17	62	88
	18	66	84
Subset 4	10	70	90
	11	72	92
	12	72	90
	13	70	92
	14	68	90
	15	70	90
	16	66	90
	17	70	90

Table 4.3: continued

Subset 5	9	78	90
	10	78	94
	11	78	94
	12	68	94
	13	78	92
	14	74	94
	15	76	96
	16	76	92
Subset 6	8	76	92
	9	72	92
	10	78	94
	11	76	94
	12	78	92
	13	82	96
	14	74	92
	15	74	94

We have use dback-propagation algorithm for training the network and mRMR technique to choose features. We conclude that different feature sets and different numbers of neurons in hidden layer generate different human activity recognition accuracy, the selection of unsuitable feature sets increases influence of noise and degrade the human activity recognition accuracy. To improve human activity recognition accuracy, an effective approach is to properly select the feature subsets. The main benefit of mRMR feature set is that by reducing mutual redundancy within the feature set, these features capture the class characteristics in a broader scope.

#### **4.3- Multi-user activity recognition using back-propagation algorithm and mRMR feature selection**

For multi-user activity recognition, back-propagation algorithm and mRMR feature selection were applied with the same parameters to Cairo Database (described in chapter 3 and table 3.2). This database describes activities done by two married adults. Table 4.5 presents the comparison results of the two methods of activity recognition accuracy of the different feature datasets and the performance measures of multilayer perceptron neural network using BP algorithm. The subsets are described based on mRMR classification presented in table 4.4.

- Subset 1: all features without selection;
- Subset 2: all features are selected except {f8};
- Subset 3: all features are selected except {f8, f12};
- Subset 4: all features are selected except {f8, f12, f2};
- Subset 5: all features are selected except {f8, f12, f2, f5};
- Subset 6: all features are selected except {f8, f12, f2, f5, f1};
- Subset 7: all features are selected except {f8, f12, f2, f5, f1, f3}.

Table 4.4: features classification based in their mRMR score

f	f9	f10	f11	f14	f13	f17	f6	f7	f15	f16	f4	f3	f1	f5	f2	f12	f8
s	3.59	3.57	3.32	2.89	2.18	2.15	1.93	1.90	1.60	1.30	0.19	0.10	0.06	0.05	0.03	0.02	0.01

Table 4.5: Comparison results of the two method of activity recognition accuracy of the different feature datasets

	Hidden neurons	Accuracy-threshold (%)	Accuracy-winner (%)
Subset1	17	88	92
	18	80	90
	19	82	90
	20	80	90
	21	82	92
	22	88	92
	23	90	90
	24	94	96
Subset 2	16	88	90
	17	96	98
	18	84	92
	19	84	92
	20	86	94
	21	80	88
	22	82	92
	23	84	90
Subset 3	15	80	96
	16	82	90
	17	90	96
	18	80	88
	19	86	94
	20	80	90
	21	74	86
	22	80	88
Subset 4	14	78	92
	15	82	92
	16	80	92
	17	94	96
	18	78	90
	19	82	92
	20	70	90
	21	76	90

Table 4.5: continued

Subset 5	13	74	82
	14	96	99
	15	74	86
	16	70	90
	17	94	99
	18	78	88
	19	74	94
	20	70	86
Subset 6	12	84	94
	13	72	94
	14	72	90
	15	76	90
	16	74	88
	17	88	94
	18	74	86
	19	70	90
Subset 7	11	68	88
	12	70	86
	13	68	86
	14	78	96
	15	74	88
	16	66	86
	17	80	92

Table 4.5 shows the comparison results of activity recognition accuracy performance of the seven different feature subsets. It can be seen that the activity recognition accuracy is lower for subset 1 a bit more in subset 2 ... etc. Subset 5 has relatively higher proportion of recognition accuracy. However, in the subset 6 and 7, the accuracy rate decreases. Obviously, if the number of features is quite low the recognition performance of neural network using BP algorithm degrades. Selecting Subset 5 generates the best result and represents the relatively better recognition than others with fewer instances. Exactly, the recognition accuracy has been improved to 99% in the winner method and 96% in the threshold method for a number of neurons in the hidden layer equal to 14 with only 13 features. The variance of Sensor IDs with low mutual information score value means that redundant information degrades the recognition performance of neural network using BP algorithm. Therefore, the results indicate that the improper selection of number of neurons increases the computational complexity and degrades the activity recognition accuracy. In sum, considering the factors including total accuracy and training error convergence rate, the best features subset is set to Subset 5.

Back-propagation algorithm is used for training the network and mRMR technique is used for choosing adequate features between proposed ones. We conclude that different features set and different number of neurons in hidden layer generate different multi-users activity recognition accuracy, the selection of unsuitable feature sets increases influence of noise and degrades the human activity recognition accuracy. To improve human activity recognition accuracy, an effective approach is to properly select the feature subsets.

#### 4.4- Human activity recognition using autoencoder and back-propagation algorithm

##### 4.4.1 Autoencoder and BP Algorithm Parameters for Activity Recognition

The values of each feature of both data sets are normalized as  $X = \frac{x}{X_{max}}$  where  $X$  is the actual value and  $X_{max}$  is the largest value for each feature. The weight of each neuron of autoencoder is initialized randomly between -1 and 1. In back propagation, only one hidden layer is adopted. In supervised learning, the number of neurons in the input layer is equal to the number of features of the selected features subset. The number of neurons in the output layer is equal to the number of activities to be recognized in the data set. In addition, the number of the hidden neurons are between the size of the input layer and the size of the output layer. It can be seen in Figure 4.1 that neural network using BP algorithm tends to converge in 40,000 iterations using initial data sets of Cairo and Aruba. We adopted 40,000 iterations for all data sets, but the optimal number of iterations change a lot depending on the number of features in the data set. The 3-fold cross validation is applied on three algorithms data under the same conditions to ensure that the experimental comparison is fair.

Table 4.6. Parameters of Neural Network Using BP Algorithm

Learning rate $\eta$	Number of iteration	Error threshold
0.01	40 000	0.01



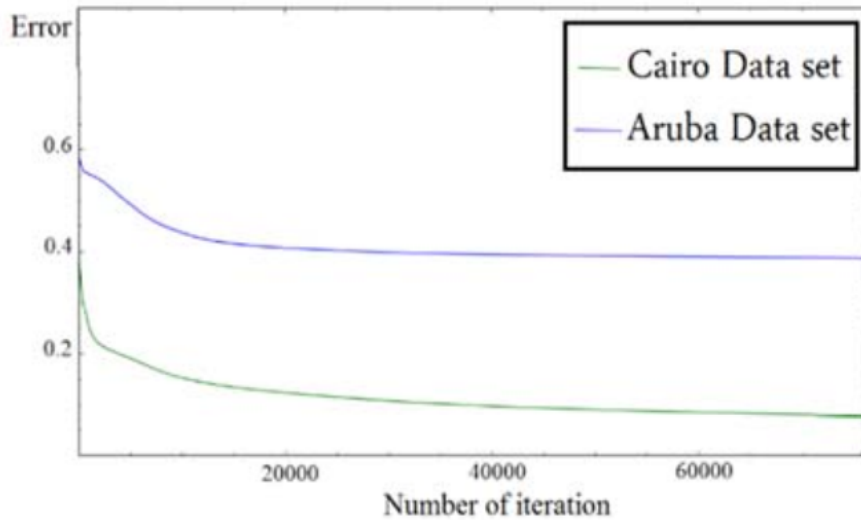

Figure4.1: Number of Iterations Depends on the Gradient Error

#### 4.4.2 Results discussion

First, we report on the first results of total activity recognition accuracy for the two initial subsets Cairo and Aruba (described in chapter 3 and table 3.2). Thirteen features generate those two data sets. Table 4.7 show accuracy results of the two initial subsets Cairo and Aruba. Those results are presented before any data manipulation. It can be seen that the highest average of recognition accuracy performance of neural network using BP algorithm for the initial Cairo and Aruba subsets, are 85.74% and 87.38% respectively. In the majority of cases, the accuracy of basic activities is higher than instrumental ones, since basic activities are simple and require one or two sensors to be detected. Otherwise, the instrumental activity is more complex and requires a series of sensors to detect it. After creating subsets with reconstructed features using autoencoder. We present only the results of subset 1 that consists of 12 features, subset 2 consists of 14 features, subset 3 consists of 16 features, subset 4 consists of 18 features, and subset 5 that consists of 20 features. The results, in tables 4.7–4.12, reveal that the highest average accuracy of BP algorithm using autoencoder is 91.46% for Aruba dataset and 90.62% for Cairo dataset. Tables 4.8–4.12 show the comparison results of recognition accuracy performance of neural network using BP algorithm for the five feature reconstructed subsets with different numbers of neurons of hidden layer. Activity recognition accuracy is lower for Subset 2 and Subset 3. It can also be found that for Subset 5, activity recognition accuracy is better than those previous subsets. Subset 6 presents the relatively higher proportion of recognition accuracy with 20 features; Subset 6 presents the best constructed representation of input. We clearly see a strict ordering: autoencoder pre-

training being better than no pre-training. From the results, we can note that autoencoder not only change dimensionality, but can also detect repetitive features and reconstruct new powerful ones, which can lead to good results. To avoid that the autoencoder copies the individual elements from the input vector, number of neurons in hidden layer should be different than number of neurons in input layer. In our case, most of features are significant, the compression is not useful. It is proved by the simulations carried out in this research that the reconstructed input layer using autoencoder with a higher number of features extracts a meaningful structure.

Table 4.7: Activity Recognition Accuracy for the Two Initial Subsets: Aruba and Cairo

	Aruba				Cairo			
	Hidden neurons	Basic ADL	Instrumental ADL	Total	Hidden neurons	Basic ADL	Instrumental ADL	Total
<b>Subset 1</b> <b>13</b> <b>features</b>	10	88,58	82,78	85,68	12	82,56	84,33	83,445
	<b>11</b>	<b>89,2</b>	<b>85,57</b>	<b>87,38</b>	13	83,48	83,13	83,305
	12	88,58	84,05	86,315	14	81,65	80,72	81,185
	13	87,34	83,29	85,315	15	82,56	83,13	82,845
	14	86,84	83,8	85,32	16	81,65	81,92	81,785
	15	86,6	83,79	85,195	<b>17</b>	<b>87,15</b>	<b>84,33</b>	<b>85,74</b>
	16	87,09	83,79	85,44	18	85,32	84,32	84,82
	17	87,22	83,04	85,13	19	80,73	83,13	81,93
	18	87,22	82,53	84,875	20	81,65	81,93	81,79

Table 4.8: Accuracy of Different Hidden Neurons of Subset 2

	Aruba				Cairo			
	Hidden neurons	Basic ADL	Instrumental ADL	Total	Hidden neurons	Basic ADL	Instrumental ADL	Total
Subset 2 12 features	<b>10</b>	<b>93,42</b>	<b>76,27</b>	<b>84,845</b>	12	88,2	79,52	83,86
	11	90,75	76,35	83,55	13	88,2	77,81	83,005
	12	90,42	76,77	83,595	<b>14</b>	<b>91,04</b>	<b>78,38</b>	<b>84,71</b>
	13	90,5	76,19	83,345	15	89,34	79,52	84,43
	14	90,5	75,94	83,22	16	89,34	79,52	84,43

Table 4.9 Accuracy of Different Hidden Neurons of Subset 3

	Aruba				Cairo			
	Hidden neurons	Basic ADL	Instrumental ADL	Total	Hidden neurons	Basic ADL	Instrumental ADL	Total
Subset 3 14 features	10	92,09	76,27	84,18	12	89,77	84,09	86,93
	11	91,67	76,02	83,845	<b>13</b>	<b>90,34</b>	<b>84,09</b>	<b>87,215</b>
	12	91,75	76,02	83,885	14	90,34	82,95	86,645
	<b>13</b>	<b>92,5</b>	<b>75,94</b>	<b>84,22</b>	15	89,77	84,65	87,21
	14	91,94	75,94	83,94	16	88,06	84,09	86,075
	15	92,09	76,27	84,18	17	89,20	84,09	86,645

Table 4.10: Accuracy of Different Hidden Neurons of Subset 4

	Aruba				Cairo			
	Hidden neurons	Basic ADL	Instrumental ADL	Total	Hidden neurons	Basic ADL	Instrumental ADL	Total
Subset 4 16 features	10	92,84	81,02	86,93	<b>12</b>	<b>90,90</b>	<b>83,52</b>	<b>87,21</b>
	11	92,34	83,1	87,72	13	92,61	81,81	87,21
	<b>12</b>	<b>93,01</b>	<b>87,94</b>	<b>90,475</b>	14	90,34	81,81	86,075
	13	94,42	83,19	88,805	15	92,04	81,81	86,925
	14	93,09	82,19	87,64	16	90,34	81,25	85,795
	15	93,09	82,19	87,64	17	91,47	81,81	86,64
	16	92,42	81,52	86,97	18	92,04	82,38	87,21

Table 4.11: Accuracy of Different Hidden Neurons of Subset 5

	Aruba				Cairo			
	Hidden neurons	Basic ADL	Instrumental ADL	Total	Hidden neurons	Basic ADL	Instrumental ADL	Total
Subset 5 18 features	10	92,25	76,52	84,385	12	90,34	88,06	89,2
	11	92,34	75,94	84,14	13	92,04	83,52	87,78
	12	92,59	78,94	85,765	14	91,47	84,09	87,78
	13	97,17	83,69	90,43	15	92,61	82,38	87,495
	14	95,25	79,85	87,55	16	90,90	82,95	86,925
	15	92,59	76,35	84,47	17	92,04	83,52	87,78
	16	93,42	76,19	84,805	18	92,04	82,95	87,495
	17	93,25	76,19	84,72	19	90,90	82,38	86,64

Table 4.12: Accuracy of Different Hidden Neurons of Subset 6

	Aruba				Cairo			
	Hidden neurons	Basic ADL	Instrumental ADL	Total	Hidden neurons	Basic ADL	Instrumental ADL	Total
Subset 6 20 features	10	91,09	78,1	84,595	12	89,20	86,36	87,78
	11	91,75	77,1	84,425	13	91,47	84,65	88,06
	12	92,51	79,61	86,06	14	92,61	88,06	90,335
	13	93,09	79,09	86,09	15	90,90	86,93	88,915
	14	93,75	81,44	87,595	<b>16</b>	92,04	85,79	88,915
	15	92,42	88,1	90,26	17	90,90	89,77	90,335
	<b>16</b>	<b>94,33</b>	<b>88,59</b>	<b>91,46</b>	18	90,90	84,09	87,495
	17	90,76	80,27	85,515	<b>19</b>	<b>92,04</b>	<b>89,20</b>	<b>90,62</b>
	18	90,84	78,77	84,805	20	92,61	87,5	90,05
	19	90,92	77,69	84,305	21	92,61	84,65	88,63
	20	89,84	75,77	82,805	22	90,90	84,09	87,495

### 4.4.3 Comparison Results

In this subsection, the influence of unsupervised pre-training on the recognition accuracy is evaluated by comparison with BP algorithm using traditional weighting features selection method. Table 4.13 presents ranking of the 13 features using weighting features selection method of Cairo and Aruba datasets. Table 4.14 shows, that the using of features selection reaches the higher accuracy of 90.05% for Aruba dataset and 88.49% for Cairo data set using Weighting Features Selection. It can be concluded that the human activity recognition performances of neural network using autoencoder pre-training and BP algorithm are better than neural network using BP algorithm and weighting features selection. The main reasons are first, that neural network using BP algorithm repeats a two-phase cycle, propagation and weight update since it uses gradient descent to tune network weights to best fit a training set of input–output pairs. Second, autoencoder can select features that are more interesting and reconstruct

Table 4.13: Ranking of the 13 Features Using Weighting Features Selection Method

<i>Rank</i>	<b>1</b>	<b>2</b>	<b>3</b>	<b>4</b>	<b>5</b>	<b>6</b>	<b>7</b>	<b>8</b>	<b>9</b>	<b>10</b>	<b>11</b>	<b>12</b>	<b>13</b>
<i>Aruba</i>	f4	f7	f9	f10	f5	f6	f1	f12	f3	f2	f8	f13	f11
<i>Cairo</i>	f5	f6	f9	f10	f7	f1	f4	f3	f13	f8	f12	f2	f11

Subset	Aruba			Cairo		
	N° of features	Hidden	Accuracy	features	Hidden	Accuracy
subset 2	12	12	89,12	12	13	84,02
subset 3	11	13	89,45	11	12	85,19
subset 4	10	12	90,05	10	11	85,88
subset 5	9	10	89,70	9	9	88,49
subset 6	8	9	88,91	8	12	80,75
subset 7	7	8	88,14	7	10	78,19
subset 8	6	7	87,24	6	9	74,45
subset 9	5	7	86,88	5	10	70,98

Table 4.14: Activity Recognition Accuracy Using BP Algorithm and Weighting Features Selection

new powerful and useful representations of features. Finally, different feature sets generate different human activity recognition accuracy, and the selection of suitable feature sets increases the human activity recognition accuracy.

#### **4.4.4 Conclusion**

Back-propagation algorithm with autoencoder pre-training was applied to represent and recognize human activities based on observed sensor events. From the results, it can be concluded that the human activity recognition performances of neural network using autoencoder is better than neural network using classical method of features selection (Weighting Features Selection). The main reasons are that neural network using BP algorithm is immune to errors in training data since it uses gradient descent to tune network weights to best fit a training set of input/output pairs and has strong ability in learning to interpret complex sensor events in smart home environments. Furthermore, different feature sets generate different human activity recognition accuracy, therefore, the suitable feature set must be selected in advance, and the selection of unsuitable feature sets increases the computational complexity and degrades the human activity recognition accuracy. To improve human activity recognition accuracy, an effective approach is to properly select the feature subsets.

### **4.5-Multi-resident activity recognition using deep belief network**

#### **4.5.1 Experiments and results**

For experiments, as described above, two databases are used to validate proposed approach. Twor database had 3896 events and Tulum database had 1367 events; where 70% used in training and 30% used in testing activities. It is to be noted that in the database used in this work, the number of samples for training and testing different activity is not evenly distributed (described in chapter 3, table 3.3). Some activities contained huge number of samples whereas some of them had a very small number of samples. The number of inputs for the three algorithms has been fixed to ensure a good comparison. Several numbers of hidden layer have been tested for both BPA and DBN algorithms, and the ideal results were kept.

The experiments were started with Back-Propagation Algorithm (BPA). For that, this algorithm was running several times using different numbers of hidden layers and fixed

numbers of inputs and outputs layers according to dataset. At last, mean recognition rate yielded 88.75% at best in the Twor datasets and 76.79% in Tulum datasets. The Back-propagation-based experimental results are shown in Table 4.15. Next, Support Vector Machines (SVMs) were applied contributing in 87.42% of mean recognition rate at best in the Twor datasets and 73.52% in Tulum datasets. The SVM-based experimental results were reported in Table 4.16. Finally, the proposed approach was tested and yielded the highest recognition rate of 90.23% in Twor datasets and 78.49% in Tulum datasets. Thus, the proposed approach has shown the superiority over others. Table 4.17 exhibited the experimental results using the proposed approach. Figures 4.2 and 4.3 demonstrated the three models BPA, SVM and DBN the accuracies comparison of different activities of Twor and Tulum datasets. Recognition of activities when multiple residents performed different activities independently is quite easy. In general, there are activities that are specific to the woman and others that are generally exerted by the man. The method followed by the woman was different to the man, and by this difference the algorithm proposed learns to detect the activity and the person who carried it out.

The results from experiments confirm that DBN have proved supremacy in terms of accuracy compared to other algorithms. Those results were confirmed by other recent research done in the field of human activity recognition[123], [158], [159]. However, this result did not mean that DBN is superior to other deep learning algorithms in activity recognition field. Technically there is no model which outperforms all the others in all situations[115], so it is recommended to choose models based on several features explained in detail in Wang survey's[115].

Although there was a different number of samples in different tested activities, as demonstrated in[158], [160]-[15] weak mean recognition rate does not indicate poor accuracy. For instance, the activity Group\_Meeting where the two married residents performed the same activity together was difficult to recognize because it happened within very few instances. Moreover, the meeting place were not fixed and based on ambient sensors, the system cannot detect the presence of two residents in the same place.

#### **4.5.2 Results discussion**

Three machine learning algorithms were trained to represent and recognize human activities. From the results, it can be concluded that DBN algorithm is better than SVM and BPA. The main reasons are that DBN is the most suitable for ADLs activities and it has a

strong ability in learning to interpret complex sensor events in smart home environments. Furthermore, the robust feature sets that were manually and one by one extracted generate a higher human activity recognition accuracy since they consider the specificity of the database.

Table 4.15: HAR-experiment results using Back-propagation based approach

<b>Data set name</b>	<b>Activity number</b>	<b>Activity name</b>	<b>Recognition rate (%)</b>	<b>Mean</b>
<b>Twor</b>	1	Bathing	90.32	88.75
	2	Bed_Toilet_Transition	88.65	
	3	Eating	91.44	
	4	Enter_Home	95.89	
	5	Leave_Home	96.56	
	6	Housekeeping	92.94	
	7	Meal_Preparation	99.12	
	8	Personal_Hygiene	94.87	
	9	Sleep	46.64	
	10	Sleeping_Not_in_Bed	78.21	
	11	Wandering_in_room	94.84	
	12	Watch_TV	95.57	
	13	Work	90.32	
<b>Tulum</b>	1	Cook_Breakfast	83.23	76.79
	2	R1_Eat_Breakfast	75.97	
	3	Cook_Lunch	77.45	
	4	Leave_Home	85.31	
	5	Watch_TV	89.64	
	6	R1_Snack	88.72	
	7	Enter_Home	69.54	
	8	R2_Eat_Breakfast	66.54	
	9	Wash_Dishes	54.71	
	10	Group_Meeting	83.23	



Table 4.16: HAR-experiment results using traditional SVM-based approach

<b>Data set name</b>	<b>Activity number</b>	<b>Activity name</b>	<b>Recognition rate</b>	<b>Mean</b>
<b>Twor</b>	1	Bathing	88.43	87.42
	2	Bed_Toilet_Transition	86.69	
	3	Eating	89.61	
	4	Enter_Home	95.92	
	5	Leave_Home	94.92	
	6	Housekeeping	91.35	
	7	Meal_Preparation	97.64	
	8	Personal_Hygiene	93.05	
	9	Sleep	44.33	
	10	Sleeping_Not_in_Bed	79.81	
	11	Wandering_in_room	94.21	
	12	Watch_TV	93.09	
	13	Work	88.43	
<b>Tulum</b>	1	Cook_Breakfast	77.44	73.52
	2	R1_Eat_Breakfast	69.32	
	3	Cook_Lunch	75.45	
	4	Leave_Home	77.05	
	5	Watch_TV	85.42	
	6	R1_Snack	83.90	
	7	Enter_Home	68.36	
	8	R2_Eat_Breakfast	66.84	
	9	Wash_Dishes	57.91	
	10	Group_Meeting	77.44	

Table 4.17: HAR-experiment results using DBN-based approach

<b>Data set name</b>	<b>Activity number</b>	<b>Activity name</b>	<b>Recognition rate</b>	<b>Mean</b>
<b>Twor</b>	1	Bathing	91.43	90.23
	2	Bed_Toilet_Transition	92.58	
	3	Eating	95.66	
	4	Enter_Home	97.82	
	5	Leave_Home	97.32	
	6	Housekeeping	92.77	
	7	Meal_Preparation	98.45	
	8	Personal_Hygiene	94.08	
	9	Sleep	47.99	
	10	Sleeping_Not_in_Bed	82.20	
	11	Wandering_in_room	95.92	
	12	Watch_TV	96.51	
	13	Work	91.43	
<b>Tulum</b>	1	Cook_Breakfast	81.84	78.49
	2	R1_Eat_Breakfast	76.81	
	3	Cook_Lunch	79.73	
	4	Leave_Home	79.43	
	5	Watch_TV	89.67	
	6	R1_Snack	84.93	
	7	Enter_Home	77.58	
	8	R2_Eat_Breakfast	70.05	
	9	Wash_Dishes	66.43	
	10	Group_Meeting	81.84	

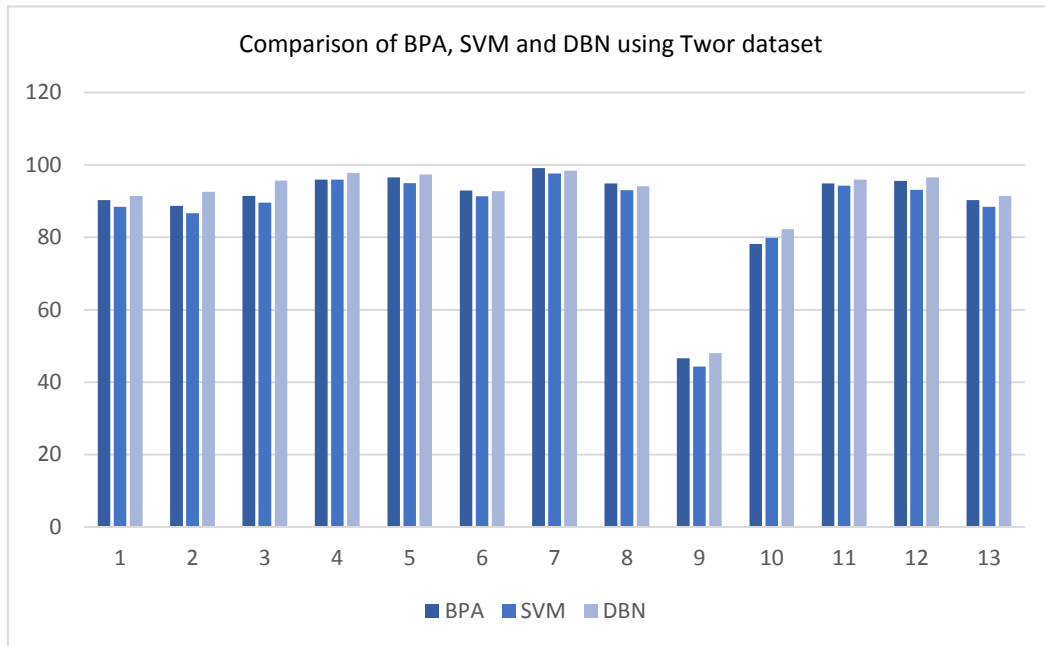

Figure 4.2: Comparison of BPA, SVM and DBN using Twor dataset

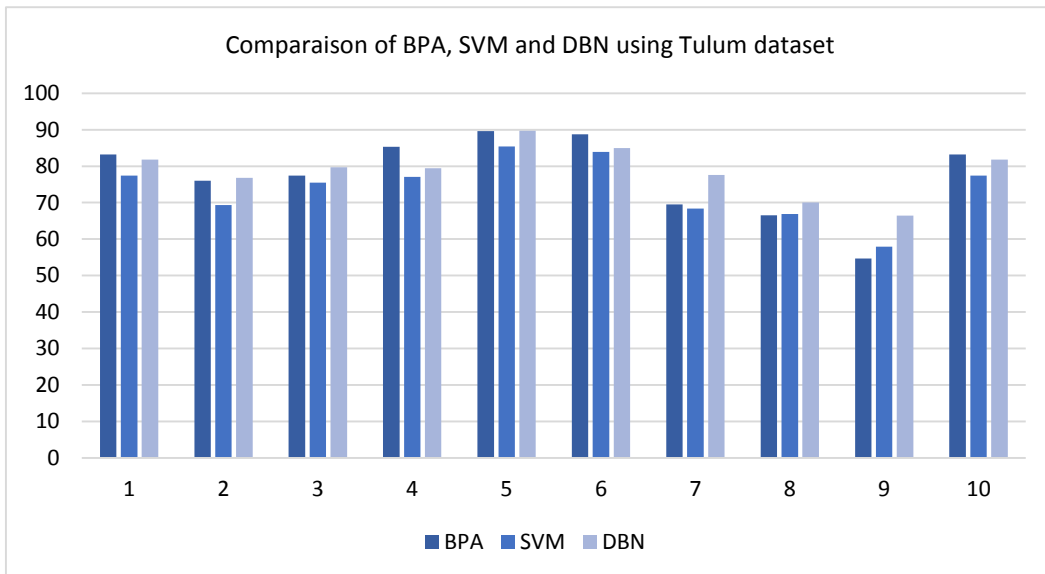

Figure 4.3: Comparison of BPA, SVM and DBN using Tulum dataset

## 4.6 Conclusion

To recognise human activity of one and multiple residents inside home, we have trained and tested several machine learning and neural network algorithms. Comparing accuracy results of Deep Belief Network to Back-propagation algorithm and SVM, it can be noticed that deep neural network has the higher accuracy in learning phase of human activity recognition. As for appliances recognition, several machine learning algorithms are tested and compared including neural network. Training time and accuracy indicated that Decision Tree classifier was faster and more accurate than neural network and other machine learning algorithms for such prepared database. Consequently, no preferred machine learning technique for human activity recognition currently exists. This is due to the variability of human behaviours, the performed activities, the type of sensors used and the adopted features selection.

The following chapter presents simulations results of activity recognition of one resident through load signatures of appliances with a brief presentation of ongoing works.

# **CHAPTER 5:**

## **HUMAN ACTIVITY RECOGNITION USING APPLIANCES**

This chapter presents simulation results of activity recognition of one resident living in a smart habitat through load signatures of appliances. This simulation is divided into two algorithms; the first recognises the state of appliances while the second recognises activities through appliances recognition. The extraction process of load signatures of appliances is carried out using active power of appliances.

---

## 5.1 Introduction

We have developed a relatively simple ILM algorithm at a very low cost based on active power of appliances and where the load signatures are studied in a one-dimensional space. Hence, our method is divided into two phases: the first focuses on the recognition of devices through their load signatures and the second identifies activities of resident based on the first phase.

The second phase consists of recognising 7 daily activities of one resident at their own home, especially in Kitchen, bed room and work room. The recognition of these activities is relatively simple since it is based on ILM where each appliance is linked to its smart plug which detects fluctuations of appliance linked in.

## 5.2 Implementation and Results

In order to implement our methodology based on ILM of appliances, a system is set up composed by two phases: appliance detection and activity recognition. Data was collected using inexpensive smart plugs linked to every appliance. Those plugs monitor the electrical consumption of seven appliances: Refrigerator, washing machine, Laptop-PC, Desktop-PC, Monitor TFT, Router and Multimedia, and can send to a computer server the active power of every appliance. A sequence of code in the algorithm can then store this data in database on the server because all these devices work on the same network. Moreover, it solely treats the RMS values; sending is approximately 60 data/s in the database. An important point to mention is that the appliance load monitoring depends only on this analyser. It means that there are no additive sensors or equipment for this process. Regarding our methodology, it was divided into two phases. The first was designed to use database for our algorithm to recognize the appliances (Algorithm 2). The second phase was used to evaluate the accuracy of the algorithm for the activity recognition when an appliance is operating.

### 5.2.1 Experimental results for appliance recognition

In the experimental phase of appliances recognition we have tested classifiers using python based on Sklearn modules [154]. This library contains a wide range of machine learning algorithms. Our implementation consists on bringing all classifiers in the same script and run them in the same python successively. The machine used here is a personal notebook with 2.4 GHz in processor and 4 GB of RAM, all this work has been set up under GNU/Linux environment. More detail about algorithm implementation is explained in appendix 3.

This study is based on pre-processing of Tracebase database to enhance classification. As it is described in the previous sections the main step in classification is feature extraction in order to simplify learning for classifiers. In our work features are extracted and dimensionality reduced using the DWT. It should be noted that the threshold for the detection of events was set once so as to be as small as possible to detect the on/off event which have small power variation, but large enough to avoid any confusion between an on/off event and a random fluctuation in an electrical signal. Consequently, the threshold of power variation for each appliance is unique, but they are approximately of the same values.

The performance of classifiers is evaluated based on the reached accuracy by each classifier and the duration of providing results. DT with accuracy of 100% of and takes 1.07 s to map all database and create the model used for the test, GB reaches 100% of precision but it takes a long time exactly 115.70 s compared with KNN which reaches 98.93% in only 2.27s. Random Forest Classifier is the third best classifier, RF classifier is the faster classifier with 0.86 s in this application, but the accuracy is less than KNN, Gradient Boosting and DT. QDA reaches less than 20% that showing the lowest accuracy among the nine classifiers performed in this work. Table 5.1 gives more details.

**Table 5.1:** Classifiers accuracies and training times

Classifier	Accuracy (%)	Time (s)
KNN	98.93	2.27
SVM	64.93	370.98
<b>DT</b>	<b>100</b>	<b>1.07</b>
RF	95.33	0.61
Adaboost	61.20	23.16
GBoosting	100	117.99
GaussianNB	66.53	0.91
LDA	69.06	50.62
QDA	19.06	27.33

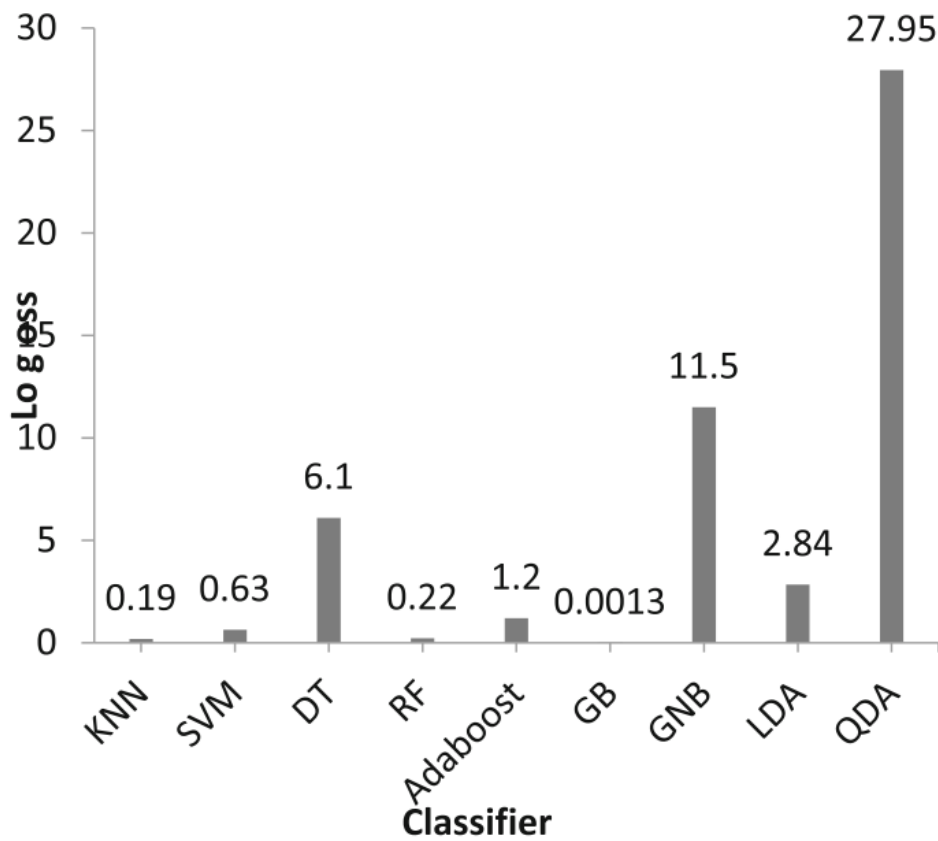

**Figure 5.1:** Variations of Log loss function for the nine classifiers used



To quantify accuracy of each classifier, penalization of false classification is performed by log loss function. Classifier with the maximum accuracy minimizes log loss function. Mathematically this metric can be defined as negative log-likelihood of the desired labels given observed probabilistic classifier's predictions. Figure 5.1 shows the variation of log loss function for all used classifiers. According to the negative log likelihood GB is more accurate the only weakness of this algorithm is the running time compared to DT. The poor classification detected by Log loss function is obtained by the algorithm QDA.

### **5.2.2 Experimental results for activity recognition**

First, we have adopted Decision Trees classifier in the first phase of our methodology because it presents the highest results in appliances recognition. Then, to validate the algorithm of activity recognition phase based on appliance load monitoring, 10 tests were firstly carried out to evaluate the accuracy of the detection of the on/off events for individual appliances. Consequently, each appliance was turned on and off 10 consecutive times without involving any other devices except refrigerator and router which have never been turned off (They are Finite State Appliances). We have adopted a predefined threshold for router and refrigerator. Next, activities of daily living were simulated. These activities were taken from usual daily activities performed by one resident at home. Each activity was repeated 10 times total to determine the accuracy of detection and identification of events for each of them obtained through our algorithmic method. The database resulting from the analysis of the characteristics recorded for each appliance during phase 1, has been integrated into the final algorithm for the recognition of activities through the identification of devices in operation. Thus, for the second part of the experiment, the percentages of success for the identification of individual devices and the recognition of the activities of each scenario are shown

respectively in Table 5.2. We noted that, in the case of individual appliances, most have rate identification events of 100%.

Table 5.2: Accuracy of activity recognition based on appliance recognition

<b>Human Activity recognized</b>	<b>Linked Appliance</b>	<b>Accuracy of activity recognition (%)</b>
<b>Kitchen activities:</b> Overly Open Refrigerator Close refrigerator: refrigerator in standby	Refrigerator	100
<b>Laundry:</b> Turn on washing machine Turn off washing machine	Washing machine	94
<b>Watch TV:</b> Turn on Laptop-PC Turn off Laptop-PC	Laptop-PC	100
<b>Work:</b> Turn on Desktop-PC Turn off Desktop-PC	Desktop-PC	100
<b>Work:</b> Turn on Monitor TFT Turn off Monitor TFT	Monitor TFT	100
<b>Enter home/ Leave home:</b> Detection of appliances using Wi-Fi	Router	100
<b>Relax</b> Listen to music in bedroom	Multimedia	100

According to data referred in table 5.2, activities recognition accuracies are 100% except a little difference for the washing machine. Those higher results are expected because we have used a smart plug (sensor) linked to every appliance that makes the recognition phase easier. The activity of turn on and off Washing machine is quite hard because the signature of washing machine is presented as multi-state that it is not easy to detect.

### 5.3 Discussion of results

Although our results are promising, we consider that there are some limitations to which we will have to remedy. For example, a suitable solution has to be found to resolve the

restriction to plug the appliances, because for the moment being, the residents have to respect a particular schema of connections. We will also attempt to enlarge our database gradually to increase the capacity of recognizing different household appliances. Moreover, we would like to investigate if certain machine learning techniques could be applied in order to help selecting the most discriminative features from the raw load signatures extracted to see whether or not they improve the performance of activity recognition. Eventually, our algorithm will slightly be modified so that it records each event as it occurs, and not only when the use is completed. Moreover, we ought to eventually verify this method on a real patient in a smart home, with new scenarios, to ensure that the monitoring report operates well and that important details are not overlooked pertaining to the activity recognition. Consequently, we will be able to draw a portrait of daily living of each resident of a smart home.

Moreover, the big challenge faced by our research in ILM is that it requires a sensor or set of sensors in every load of interest while the installation is complex but systematic. Improved energy management using ILM can still be obtained when more research is carried out, especially with sensor technology becoming more affordable. Therefore, less expensive and reliable monitoring system can be obtained using the ILM to recognise appliances and ongoing activities. Furthermore, recent research works in NILM have been carried out using smart meter[161], [162], but still there is a need to go deeper and research for a better disaggregation. The smart meter is communication enabled; hence it can serve as a useful instrument for many home applications including activity recognition. A research work that can combine smart meter with some sensor technologies (e.g. motion and door sensors) will be our future focus area. In most load monitoring research, the electrical signatures are used to carry out the disaggregation analysis. However, the use of the non-traditional signatures can improve the accuracy of the load disaggregation as proved by some researches [90,91].

Therefore, researchers should focus on how to improve the disaggregation procedure by incorporating the non-traditional signatures like time of the day, temperature, frequency of appliance usage and light sensing apart from the usual transient and steady state signatures.

In conclusion, the NILM process is more economical and effective than the ILM because it has only one set of sensors for the load monitoring of the whole building. Therefore, more research in NILM with the view of getting more accurate recognition/disaggregation is needed.

## **5.4: Conclusion**

In this chapter, we tested an economical and efficient method based on ILM for activity recognition within a smart home via appliance recognition. First, load signatures recognition was presented using an automatic pre-processing based on Discrete Wavelet Transform. The aim of this simulation is to identify the most accurate classifier for appliances recognition using a low frequency sampling rate dataset. The applied methodology showed promising results proved by the well-known classifiers such as DT, KNN, LDA and so on. Training time and accuracy indicated that Decision Tree classifier was faster and more accurate for such prepared database.

## GENERAL CONCLUSION

The five previous chapters have suggested original solutions to problems of human activity recognition inside home. The research on smart home is one of the disciplines that would greatly benefit from a better improvement in human activity recognition. As discussed, one of the major challenges of research on smart homes is the recognition of activities of daily living. To address this problem, this thesis proposed several machine learning and neural network algorithm combined with features selection methods using ambient sensors (motion and door sensors and smart plugs).

The first phase of this project aimed at investigating in depth the context of research. In a first time, the smart home technologies and the context of research were explored. This has allowed us to better understand the issues in this domain in order to explore the classical machine learning approaches and feature selection methods of activity recognition. We have also reviewed recent related works using neural and deep neural network in human activity recognition, ILM and NILM monitoring techniques and other new areas of research. The results of this investigation have allowed us to have a glimpse of the strengths and limitations of machine learning models of activity recognition in order to understand the interest of our works.

The second phase of this project has, in the light of previous investigations, to set forward our research methodology. We decided to focus on one and multiple resident daily activity recognition. We designed several human activity recognition solutions that consisted of three steps: 1-Feature extraction from raw data, 2-selection of relevant features 3- Proceeding to learning phase. We tried to test different solutions in order to understand the strength and weakness of every solution. At the feature extraction step, we designed an algorithm able to extract features from row data already defined one by one (a part of this algorithm is written in appendix 1). At the feature selection step, we have tested two techniques mainly feature transformation and feature selection by using Autoencoder and

mRMR respectively. At the step of learning, we have tested several machine learning algorithm and neural network in order to increase recognition accuracy and compare each approach.

The third phase of the research project allowed us to identify the strengths and limitations of each proposed method. In addition, we were able to pinpoint interesting improvement for our future research.

The contribution of this thesis follows in the footsteps of data mining and activity recognition approaches that have been developed during the last decades. This thesis tries to make a step forward in the context of Smart Home by providing answers to the questions raised that are related to human activity recognition. In particular, this thesis explores the fundamental knowledge related to algorithms of extraction features and machine learning for recognising ADLs. As the reader may have noticed through this thesis, the contributions go beyond machine learning algorithms and activity recognition in the context of smart homes. Most of the algorithms developed could be used for other purposes and are general enough to be applied in different applicative contexts.

Three important contributions are proposed. The first one consists in defining a robust set of features based on an ontological approach and features engineering; those features directly influence the accuracy of neural and deep neural networks. In fact, the achieved results are a factor of the choosing model, the available data and the prepared features. The results of our simulations confirm that choosing features lead to higher accuracy. The second contribution is the comparison of several supervised and unsupervised features selection technique: autoencoder as unsupervised technique has more power than other traditional techniques as mRMR and Weighting. We have also concluded that the type of choosing features selection method depends on the data nature and on the used machine learning algorithm. Finally, we also propose in this thesis a new algorithm for activity recognition based on appliances recognition. Despite the promising results of this approach, it is still in the development phase and needs deeper work.

Despite the success of the models proposed in this thesis, we believe that research on appliance and human activity recognition, especially for smart homes will require many more years of research. The combination of several data collection techniques as appliances load signatures with ambient sensors can be benefiting to increase human activity recognition accuracy and solve complex human situations. Another drawback of our model is that performance decreased in more realistic usage context (real environment). Recognition algorithm performed less than when they were tested as standalone algorithms.

Despite the limitations of our methodologies, we are very optimistic about the future. This thesis project has broadened the foundation on an emerging field of research that should provide a lot of challenges to the community for many years to come. In our future work we aim to deal with those three areas of research:

- A. Real time activity recognition.** This is an important issue related to the implementation of smart home applications. Recognizing activities is often the initial step in many applications. For instance, some professional skill assessment is required in fitness exercises while smart home assistant plays an important role in healthcare services. We aim to work on this issue in future in order to deal with real situations and have real remedies to those situations.
- B. Flexible models to recognize high-level activities.** More complex high-level activities need to be recognized other than only simple daily activities. It is difficult to determine the hierarchical structure of high-level activities because they contain more semantic and context information. We aim to deeply explore neural network in future work because of its benefits in learning high level activities.
- C. Multi-modal activity sensing.** Traditional activity collection strategies based on one type of sensing need to be updated with the use of several kind of sensors. Mainly, in future works, we aim to use smart meter to recognise appliances used at home combined with ambient and visual sensors.

In conclusion, I would like to do a brief personal assessment of my initiation to the world of research. The journey I made throughout this project was quite hard and of constant work. However, it was very rewarding, worthy of all these long nights for which I traded hours of sleep for the acquisition of precious knowledge in the context of smart home for activity recognition. I was able to successfully conduct this project because of its stimulating

nature. As a member of a formidable multidisciplinary team, I have been lucky enough to participate in multiple projects and activities with peers from different fields. This experience allowed me to develop important new skills such as a rigorous research methodology and communication skills. This rewarding experience also allowed me to make few contributions to the scientific community in my field of research that I presented at the occasion of renowned international conferences [74], [77], [87] and journals [76]. After such a positive introduction to research, I only look toward beginning a career as a researcher and pushing the limit of science. My last words go to all the people who supported me, one way or another, intentionally or not, in my quest to obtain an expertise, new skills set and a priceless knowledge.



## Bibliography

- [1] F. K. Aldrich, 'Smart Homes: Past, Present and Future', in *Inside the Smart Home*, Springer, London, 2003, pp. 17–39.
- [2] E. Rodriguez and K. Chan, 'Smart interactions for home healthcare: a semantic shift', *Int. J. Arts Technol.*, vol. 9, no. 4, pp. 299–319, Jan. 2016.
- [3] 'Healthcare, pharmaceuticals, and medical devices industry analysis and data from the EIU'. [Online]. Available: <http://www.eiu.com/industry/Healthcare>. [Accessed: 13-Aug-2018].
- [4] L. Vadillo Moreno, M. L. Martín Ruiz, J. Malagón Hernández, M. Á. Valero Duboy, and M. Lindén, 'Chapter 14 - The Role of Smart Homes in Intelligent Homecare and Healthcare Environments', in *Ambient Assisted Living and Enhanced Living Environments*. 2017, pp. 345–394.
- [5] J. Merrilees, 'Activities of Daily Living', in *Encyclopedia of the Neurological Sciences (Second Edition)*, Oxford: Academic Press, 2014, pp. 47–48.
- [6] L. P. Fried and J. M. Guralnik, 'Disability in Older Adults: Evidence Regarding Significance, Etiology, and Risk', *J. Am. Geriatr. Soc.*, vol. 45, no. 1, pp. 92–100, Jan. 1997.
- [7] U. Maurer, A. Smailagic, D. P. Siewiorek, and M. Deisher, 'Activity recognition and monitoring using multiple sensors on different body positions', in *International Workshop on Wearable and Implantable Body Sensor Networks (BSN'06)*, 2006, pp. 4 pp. – 116.
- [8] J. R. Kwapisz, G. M. Weiss, and S. A. Moore, 'Activity Recognition Using Cell Phone Accelerometers', *SIGKDD Explor Newsl*, vol. 12, no. 2, pp. 74–82, Mar. 2011.
- [9] A. Bayat, M. Pomplun, and D. A. Tran, 'A Study on Human Activity Recognition Using Accelerometer Data from Smartphones', *Procedia Comput. Sci.*, vol. 34, pp. 450–457, 2014.
- [10] J. J. Marron, M. A. Labrador, A. Menendez-Valle, D. Fernandez-Lanvin, and M. Gonzalez-Rodriguez, 'Multi sensor system for pedestrian tracking and activity recognition in indoor environments', *Int. J. Ad Hoc Ubiquitous Comput.*, vol. 23, no. 1–2, pp. 3–23, Jan. 2016.
- [11] F. Aldrich, 'Smart homes: past, present and future', *Smart Home*, pp. 17–39, 2003.
- [12] L. Liu, E. Stroulia, I. Nikolaidis, A. Miguel-Cruz, and A. Rios Rincon, 'Smart homes and home health monitoring technologies for older adults: A systematic review', *Int. J. Med. Inf.*, vol. 91, pp. 44–59, Jul. 2016.
- [13] K. Heddinger, 'Top 5 Single -Family Home Trends to Watch Out For', *Golden Realty*. [Online]. Available: <https://www.goldensold.com/2018/05/04/top-5-single-family-home-trends-to-watch-out-for/>. [Accessed: 11-Oct-2018].
- [14] Suneth Ranasinghe, F. A. Machot, and Heinrich C Mayr, 'A review on applications of activity recognition systems with regard to performance and evaluation', *Int. J. Distrib. Sens. Netw.*, vol. 12(8), no. 8, 2016.
- [15] H. Fang, L. He, H. Si, P. Liu, and X. Xie, 'Human activity recognition based on feature selection in smart home using back-propagation algorithm', *ICCA 2013*, vol. 53, no. 5, pp. 1629–1638, Sep. 2014.

- [16] D. Fortin-Simard, J.-S. Bilodeau, K. Bouchard, S. Gaboury, B. Bouchard, and A. Bouzouane, 'Exploiting Passive RFID Technology for Activity Recognition in Smart Homes', *IEEE Intell. Syst.*, vol. 30, no. 4, pp. 7–15, Jul. 2015.
- [17] C. Belley, S. Gaboury, B. Bouchard, and A. Bouzouane, 'Nonintrusive system for assistance and guidance in smart homes based on electrical devices identification', *Expert Syst. Appl.*, vol. 42, no. 19, pp. 6552–6577, Nov. 2015.
- [18] P. Rashidi and A. Mihailidis, 'A Survey on Ambient-Assisted Living Tools for Older Adults', *IEEE J. Biomed. Health Inform.*, vol. 17, no. 3, pp. 579–590, May 2013.
- [19] R. Zhao, R. Yan, Z. Chen, K. Mao, P. Wang, and R. X. Gao, 'Deep learning and its applications to machine health monitoring', *Mech. Syst. Signal Process.*, vol. 115, pp. 213–237, Jan. 2019.
- [20] G. W. Hart, 'Nonintrusive appliance load monitoring', *Proc. IEEE*, vol. 80, no. 12, pp. 1870–1891, Dec. 1992.
- [21] H. Najmeddine *et al.*, 'State of art on load monitoring methods', in *Power and Energy Conference, 2008. PECon 2008. IEEE 2nd International*, 2008, pp. 1256–1258.
- [22] Baranski, Michael, and Jürgen Voss. "Nonintrusive appliance load monitoring based on an optical sensor." *2003 IEEE Bologna Power Tech Conference Proceedings*. Vol. 4. IEEE, 2003.
- [23] M. Baranski and J. Voss, 'Detecting patterns of appliances from total load data using a dynamic programming approach', in *Data Mining, 2004. ICDM'04. Fourth IEEE International Conference on*, 2004, pp. 327–330.
- [24] M. Zeifman and K. Roth, 'Nonintrusive appliance load monitoring: Review and outlook', *IEEE Trans. Consum. Electron.*, vol. 57, no. 1, 2011.
- [25] I. Abubakar, S. N. Khalid, M. W. Mustafa, H. Shareef, and M. Mustapha, 'Application of load monitoring in appliances' energy management – A review', *Renew. Sustain. Energy Rev.*, vol. 67, pp. 235–245, Jan. 2017.
- [26] S. S. Hosseini, K. Agbossou, S. Kelouwani, and A. Cardenas, 'Non-intrusive load monitoring through home energy management systems: A comprehensive review', *Renew. Sustain. Energy Rev.*, vol. 79, pp. 1266–1274, Nov. 2017.
- [27] A. Ridi, C. Gisler, and J. Hennebert, 'A Survey on Intrusive Load Monitoring for Appliance Recognition', in *2014 22nd International Conference on Pattern Recognition*, 2014, pp. 3702–3707.
- [28] C. Belley, S. Gaboury, B. Bouchard, and A. Bouzouane, 'An efficient and inexpensive method for activity recognition within a smart home based on load signatures of appliances', *Pervasive Mob. Comput.*, vol. 12, pp. 58–78, Jun. 2014.
- [29] S. E. Hardy, 'Consideration of Function & Functional Decline', in *Current Diagnosis & Treatment: Geriatrics*, 2nd ed., B. A. Williams, A. Chang, C. Ahalt, H. Chen, R. Conant, C. S. Landefeld, C. Ritchie, and M. Yukawa, Eds. New York, NY: McGraw-Hill Education, 2014.
- [30] K. L. MacLaughlin, 'Current Diagnosis and Treatment in Family Medicine', *Mayo Clin. Proc.*, vol. 80, no. 6, p. 830, Jun. 2005.
- [31] C. A. Ronao and S.-B. Cho, 'Human activity recognition using smartphone sensors with two-stage continuous hidden Markov models', in *Natural Computation (ICNC), 2014 10th International Conference on*, 2014, pp. 681–686.

- [32] S. Czarnuch, S. Cohen, V. Parameswaran, and A. Mihailidis, ‘A real-world deployment of the COACH prompting system’, *J. Ambient Intell. Smart Environ.*, vol. 5, no. 5, pp. 463–478, 2013.
- [33] P. Cottone, S. Gaglio, G. Lo Re, and M. Ortolani, ‘User activity recognition for energy saving in smart homes’, *Pervasive Mob. Comput.*, vol. 16, pp. 156–170, Jan. 2015.
- [34] J. Ye, G. Stevenson, and S. Dobson, ‘Detecting abnormal events on binary sensors in smart home environments’, *Pervasive Mob. Comput.*, vol. 33, pp. 32–49, Dec. 2016.
- [35] J. Ye, S. Dobson, and S. McKeever, ‘Situation identification techniques in pervasive computing: A review’, *Pervasive Mob. Comput.*, vol. 8, no. 1, pp. 36–66, Feb. 2012.
- [36] T. Gu, Z. Wu, L. Wang, X. Tao, and J. Lu, ‘Mining emerging patterns for recognizing activities of multiple users in pervasive computing’, in *Mobile and Ubiquitous Systems: Networking & Services, MobiQuitous, 2009. MobiQuitous’ 09. 6th Annual International*, 2009, pp. 1–10.
- [37] ‘AAL Programme - Active Assisted Living Programme - Ageing Well’, *AAL Programme*. [Online]. Available: <http://www.aal-europe.eu/>. [Accessed: 01-Nov-2018].
- [38] ‘Archives | CORDIS | European Commission’. [Online]. Available: [https://cordis.europa.eu/guidance/archive\\_en.html](https://cordis.europa.eu/guidance/archive_en.html). [Accessed: 01-Nov-2018].
- [39] K. Spitalewsky, J. Rochon, M. Ganzinger, and P. Knaup, ‘Potential and Requirements of IT for Ambient Assisted Living Technologies’, *Methods Inf. Med.*, vol. 52, no. 3, pp. 231–238, 2013.
- [40] S. Faye, R. Frank, and T. Engel, ‘Adaptive Activity and Context Recognition Using Multimodal Sensors in Smart Devices’, in *Mobile Computing, Applications, and Services*, vol. 162, S. Sigg, P. Nurmi, and F. Salim, Eds. Cham: Springer International Publishing, 2015, pp. 33–50.
- [41] I. Vassileva, E. Dahlquist, F. Wallin, and J. Campillo, ‘Energy consumption feedback devices’ impact evaluation on domestic energy use’, *Appl. Energy*, vol. 106, pp. 314–320, Jun. 2013.
- [42] T. A. Nguyen and M. Aiello, ‘Energy intelligent buildings based on user activity: A survey’, *Energy Build.*, vol. 56, pp. 244–257, Jan. 2013.
- [43] S. J. Ismail, M. A. A. Rahman, S. A. Mazlan, and H. Zamzuri, ‘Human gesture recognition using a low cost stereo vision in rehab activities’, in *Robotics and Intelligent Sensors (IRIS), 2015 IEEE International Symposium on*, 2015, pp. 220–225.
- [44] M. Vacher *et al.*, ‘Evaluation of a Context-Aware Voice Interface for Ambient Assisted Living: Qualitative User Study vs. Quantitative System Evaluation’, *ACM Trans Access Comput*, vol. 7, no. 2, pp. 1-36, May 2015.
- [45] C. Wang *et al.*, ‘Near-Threshold Energy- and Area-Efficient Reconfigurable DWPT/DWT Processor for Healthcare-Monitoring Applications’, *IEEE Trans. Circuits Syst. II Express Briefs*, vol. 62, no. 1, pp. 70–74, Jan. 2015.
- [46] J. Michael and H. C. Mayr, ‘Creating a Domain Specific Modelling Method for Ambient Assistance’, in *2015 Fifteenth International Conference on Advances in ICT for Emerging Regions (ICTer)*, 2015, pp. 119–124.
- [47] S. Tokunaga, K. Tamamizu, S. Saiki, M. Nakamura, and K. Yasuda, ‘VirtualCareGiver: Personalized Smart Elderly Care’, *Int. J. Softw. Innov. IJSI*, vol. 5, no. 1, pp. 30–43, Jan. 2017.

- [48] K. Liu, C. Yen, L. Chang, C. Hsieh, and C. Chan, ‘Wearable sensor-based activity recognition for housekeeping task’, in *2017 IEEE 14th International Conference on Wearable and Implantable Body Sensor Networks (BSN)*, 2017, pp. 67–70.
- [49] ‘American Time Use Survey Home Page’. [Online]. Available: <https://www.bls.gov/tus/>. [Accessed: 01-Nov-2018].
- [50] S. C. Huang, ‘An Advanced Motion Detection Algorithm with Video Quality Analysis for Video Surveillance Systems’, *IEEE Trans. Circuits Syst. Video Technol.*, vol. 21, no. 1, pp. 1–14, Jan. 2011.
- [51] Z. Xu, C. Hu, and L. Mei, ‘Video structured description technology based intelligence analysis of surveillance videos for public security applications’, *Multimed. Tools Appl.*, vol. 75, no. 19, pp. 12155–12172, Oct. 2016.
- [52] J. Zhang, Y. Shan, and K. Huang, ‘ISEE Smart Home (ISH): Smart video analysis for home security’, *Neurocomputing*, vol. 149, pp. 752–766, Feb. 2015.
- [53] M. Vacher, B. Lecouteux, P. Chahuara, F. Portet, B. Meillon, and N. Bonnefond, ‘The Sweet-Home speech and multimodal corpus for home automation interaction’, in *The 9th edition of the Language Resources and Evaluation Conference (LREC)*, Reykjavik, Iceland, 2014, pp. 4499–4506.
- [54] Wilson, Daniel H. "Assistive intelligent environments for automatic health monitoring." *Robotics Institute. Carnegie Mellon University*, 2005.
- [55] Moeslund, Thomas B., Adrian Hilton, and Volker Krüger. "A survey of advances in vision-based human motion capture and analysis." *Computer vision and image understanding*. 2006, pp. 90-126.
- [56] P. Turaga, R. Chellappa, V. S. Subrahmanian, and O. Udrea, ‘Machine recognition of human activities: A survey’, *IEEE Trans. Circuits Syst. Video Technol.*, vol. 18, no. 11, pp. 1473–1488, 2008.
- [57] O. Brdiczka, J. L. Crowley, and P. Reignier, ‘Learning Situation Models in a Smart Home’, *IEEE Trans. Syst. Man Cybern. Part B Cybern.*, vol. 39, no. 1, pp. 56–63, Feb. 2009.
- [58] C. Peters, T. Hermann, S. Wachsmuth, and J. Hoey, ‘Automatic Task Assistance for People with Cognitive Disabilities in Brushing Teeth - A User Study with the TEBRA System’, *ACM Trans Access Comput*, vol. 5, no. 4, pp.1–34, Mar. 2014.
- [59] M. Philipose *et al.*, ‘Inferring activities from interactions with objects’, *IEEE Pervasive Comput.*, vol. 3, no. 4, pp. 50–57, Oct. 2004.
- [60] E. M. Tapia, S. S. Intille, and K. Larson, ‘Activity Recognition in the Home Using Simple and Ubiquitous Sensors’, in *Pervasive Computing*, 2004, pp. 158–175.
- [61] K. D. Feuz, D. J. Cook, C. Rosasco, K. Robertson, and M. Schmitter-Edgecombe, ‘Automated Detection of Activity Transitions for Prompting’, *IEEE Trans. Hum.-Mach. Syst.*, vol. 45, no. 5, pp. 575–585, Oct. 2015.
- [62] L. Gillani Fahad, A. Khan, and M. Rajarajan, ‘Activity recognition in smart homes with self verification of assignments’, *Neurocomputing*, vol. 149, pp. 1286–1298, Feb. 2015.
- [63] D. George and L. G. Swan, ‘A method for distinguishing appliance, lighting and plug load profiles from electricity “smart meter” datasets’, *Energy Build.*, vol. 134, pp. 212–222, Jan. 2017.

- [64] S. J. M. Bamberg, A. Y. Benbasat, D. M. Scarborough, D. E. Krebs, and J. A. Paradiso, 'Gait Analysis Using a Shoe-Integrated Wireless Sensor System', *IEEE Trans. Inf. Technol. Biomed.*, vol. 12, no. 4, pp. 413–423, Jul. 2008.
- [65] Moeslund, Thomas B., Adrian Hilton, and Volker Krüger. "A survey of advances in vision-based human motion capture and analysis." *Computer vision and image understanding*. 2006, pp. 90-126.
- [66] Jourand, Philippe, Hans De Clercq, and Robert Puers. "Robust monitoring of vital signs integrated in textile." *Sensors and Actuators A: Physical*, 2010, pp.288-296.
- [67] J. Parkka, M. Ermes, P. Korpipaa, J. Mantyjarvi, J. Peltola, and I. Korhonen, 'Activity classification using realistic data from wearable sensors', *IEEE Trans. Inf. Technol. Biomed.*, vol. 10, no. 1, pp. 119–128, Jan. 2006.
- [68] D. T. G. Huynh, 'Human Activity Recognition with Wearable Sensors', phd, Technische Universität, Darmstadt, 2008.
- [69] F. Attal, S. Mohammed, M. Dedabrishvili, F. Chamroukhi, L. Oukhellou, and Y. Amirat, 'Physical Human Activity Recognition Using Wearable Sensors', *Sensors*, vol. 15, no. 12, pp. 31314–31338, Dec. 2015.
- [70] S. Chen and Y. Huang, 'Recognizing human activities from multi-modal sensors', in *Intelligence and Security Informatics, 2009. ISI'09. IEEE International Conference on*, 2009, pp. 220–222.
- [71] O. Brdiczka, M. Langet, J. Maisonnasse, and J. L. Crowley, 'Detecting Human Behavior Models from Multimodal Observation in a Smart Home', *IEEE Trans. Autom. Sci. Eng.*, vol. 6, no. 4, pp. 588–597, Oct. 2009.
- [72] 'Projet SWEET-HOME - ANR'. [Online]. Available: <http://sweet-home.imag.fr/>. [Accessed: 25-Jan-2018].
- [73] E. Zdravevski *et al.*, 'Improving Activity Recognition Accuracy in Ambient-Assisted Living Systems by Automated Feature Engineering', *IEEE Access*, vol. 5, pp. 5262–5280, 2017.
- [74] N. Oukrich, E. B. Cherraji, and A. Maach, 'Human Daily Activity Recognition Using Neural Networks and Ontology-Based Activity Representation', in *Innovations in Smart Cities and Applications*, 2017, pp. 622–633.
- [75] C. M. Bishop, *Pattern recognition and machine learning*. New York: Springer, 2006.
- [76] N. Oukrich, C. E. Bouazzaoui, A. Maach, And E. Driss, 'Human Activities Recognition Based on Auto- Encoder Pre-Training and Back-Propagation Algorithm', . *Vol.*, no. 19, 2017.
- [77] N. Oukrich, A. Maach, E. Sabri, E. Mabrouk, and K. Bouchard, 'Activity recognition using back-propagation algorithm and minimum redundancy feature selection method', in *2016 4th IEEE International Colloquium on Information Science and Technology (CiSt)*, Tangier, Morocco, 2016, pp. 818–823.
- [78] Ravi, Nishkam, Nikhil Dandekar, Preetham Mysore, and Michael L. Littman. "Activity recognition from accelerometer data." In *Aaai*, vol. 5, no. 2005, pp. 1541-1546. 2005.
- [79] L. Atallah, B. Lo, R. King, and G. Yang, 'Sensor Placement for Activity Detection Using Wearable Accelerometers', in *2010 International Conference on Body Sensor Networks*, 2010, pp. 24–29.

- [80] J. Lester, T. Choudhury, N. Kern, G. Borriello, and B. Hannaford, 'A Hybrid Discriminative/Generative Approach for Modeling Human Activities', presented at the Proceedings of the Nineteenth International Joint Conference on Artificial Intelligence, Edinburgh, Scotland, 2005, pp. 766–722.
- [81] Viola, Paul, and Michael Jones. "Rapid object detection using a boosted cascade of simple features." In *null*, p. 511. IEEE, 2001.
- [82] J. Liang, S. K. K. Ng, G. Kendall, and J. W. M. Cheng, 'Load Signature Study—Part I: Basic Concept, Structure, and Methodology', *IEEE Trans. Power Deliv.*, vol. 25, no. 2, pp. 551–560, Apr. 2010.
- [83] T. Kato, H. S. Cho, D. Lee, T. Toyomura, and T. Yamazaki, 'Appliance Recognition from Electric Current Signals for Information-Energy Integrated Network in Home Environments', in *Ambient Assistive Health and Wellness Management in the Heart of the City*, 2009, pp. 150–157.
- [84] M. Ito, R. Uda, S. Ichimura, K. Tago, T. Hoshi, and Y. Matsushita, 'A method of appliance detection based on features of power waveform', in *2004 International Symposium on Applications and the Internet. Proceedings.*, 2004, pp. 291–294.
- [85] A. Ridi, C. Gisler, and J. Hennebert, 'Unseen Appliances Identification', in *Progress in Pattern Recognition, Image Analysis, Computer Vision, and Applications*, 2013, pp. 75–82.
- [86] F. Paradiso, F. Paganelli, A. Luchetta, D. Giuli, and P. Castrogiovanni, 'ANN-based appliance recognition from low-frequency energy monitoring data', in *2013 IEEE 14th International Symposium on 'A World of Wireless, Mobile and Multimedia Networks' (WoWMoM)*, 2013, pp. 1–6.
- [87] E. B. Cherraqi and A. Maach, 'Load Signatures Identification Based on Real Power Fluctuations', in *International Conference on Information Technology and Communication Systems*, 2017, pp. 143–152.
- [88] A. A. Zaidi, F. Kupzog, T. Zia, and P. Palensky, 'Load recognition for automated demand response in microgrids', in *IECON 2010 - 36th Annual Conference on IEEE Industrial Electronics Society*, 2010, pp. 2442–2447.
- [89] Reinhardt, Andreas, Paul Baumann, Daniel Burgstahler, Matthias Hollick, Hristo Chonov, Marc Werner, and Ralf Steinmetz. "On the accuracy of appliance identification based on distributed load metering data." In *2012 Sustainable Internet and ICT for Sustainability (SustainIT)*, pp. 1-9. IEEE, 2012.
- [90] R. S. Michalski, J. G. Carbonell, and T. M. Mitchell, *Machine Learning: An Artificial Intelligence Approach*. Springer Science & Business Media, 2013.
- [91] A. Moraru, M. Pesko, M. Porcius, C. Fortuna, and D. Mladenic, 'Using Machine Learning on Sensor Data', *J. Comput. Inf. Technol.*, vol. 18, no. 4, pp. 341–347, Dec. 2010.
- [92] Dey, Ayon. "Machine learning algorithms: a review." *International Journal of Computer Science and Information Technologies* 7, no. 3. 2016, pp.1174-1179.
- [93] J. Wan, M. J. O'Grady, and G. M. P. O'Hare, 'Dynamic sensor event segmentation for real-time activity recognition in a smart home context', *Pers. Ubiquitous Comput.*, vol. 19, no. 2, pp. 287–301, Feb. 2015.

- [94] Long, Yang, Fan Zhu, and Ling Shao. "Recognising occluded multi-view actions using local nearest neighbour embedding." *Computer Vision and Image Understanding* 144, 2016. pp.36-45.
- [95] N.C.Krishnan, 'Real Time Human Activity Recognition Using Tri-Axial Accelerometers', 2008.
- [96] A. Fleury, M. Vacher, and N. Noury, 'SVM-based multimodal classification of activities of daily living in health smart homes: sensors, algorithms, and first experimental results', *IEEE Trans. Inf. Technol. Biomed.*, vol. 14, no. 2, pp. 274–283, 2010.
- [97] L. Zhao, X. Wang, G. Sukthankar, and R. Sukthankar, 'Motif Discovery and Feature Selection for CRF-based Activity Recognition', in *2010 20th International Conference on Pattern Recognition*, 2010, pp. 3826–3829.
- [98] H. D. Mehr, H. Polat, and A. Cetin, 'Resident activity recognition in smart homes by using artificial neural networks', in *2016 4th International Istanbul Smart Grid Congress and Fair (ICSG)*, 2016, pp. 1–5.
- [99] A. Wang, G. Chen, C. Shang, M. Zhang, and L. Liu, 'Human Activity Recognition in a Smart Home Environment with Stacked Denoising Autoencoders', in *Web-Age Information Management*, 2016, pp. 29–40.
- [100] S. T. M. Bourobou and Y. Yoo, 'User Activity Recognition in Smart Homes Using Pattern Clustering Applied to Temporal ANN Algorithm', *Sensors*, vol. 15, no. 5, pp. 11953–11971, May 2015.
- [101] G. E. Hinton, 'Learning multiple layers of representation', *Trends Cogn. Sci.*, vol. 11, no. 10, pp. 428–434, Oct. 2007.
- [102] T. B. Tang and A. F. Murray, 'Adaptive sensor modelling and classification using a continuous restricted Boltzmann machine (CRBM)', *Adv. Comput. Intell. Learn.*, vol. 70, no. 7, pp. 1198–1206, Mar. 2007.
- [103] L. Xia and P. Shum, 'Design of novel DS-OCDMA encoders/decoders using phase sampled long period grating', *Opt. Commun.*, vol. 281, no. 17, pp. 4317–4320, Sep. 2008.
- [104] M. Chan, D. Estève, J.-Y. Fourniols, C. Escriba, and E. Campo, 'Smart wearable systems: Current status and future challenges', *Artif. Intell. Med.*, vol. 56, no. 3, pp. 137–156, Nov. 2012.
- [105] I. Haritaoglu, D. Harwood, and L. S. Davis, 'W4: real-time surveillance of people and their activities', *IEEE Trans. Pattern Anal. Mach. Intell.*, vol. 22, no. 8, pp. 809–830, Aug. 2000.
- [106] M.-C. Roh, H.-K. Shin, S.-W. Lee, and S.-W. Lee, 'Volume Motion Template for View-Invariant Gesture Recognition', in *18th International Conference on Pattern Recognition (ICPR'06)*, 2006, vol. 2, pp. 1229–1232.
- [107] P. Afsar, P. Cortez, and H. Santos, 'Automatic visual detection of human behavior: A review from 2000 to 2014', *Expert Syst. Appl.*, vol. 42, no. 20, pp. 6935–6956, Nov. 2015.
- [108] T. Ko, 'A survey on behavior analysis in video surveillance for homeland security applications', in *2008 37th IEEE Applied Imagery Pattern Recognition Workshop*, 2008, pp. 1–8.

- [109] G. E. Hinton, ‘Reducing the Dimensionality of Data with Neural Networks’, *Science*, vol. 313, no. 5786, pp. 504–507, Jul. 2006.
- [110] Yang, Jianbo, Minh Nhut Nguyen, Phyo Phyo San, Xiao Li Li, and Shonali Krishnaswamy. "Deep convolutional neural networks on multichannel time series for human activity recognition." In *Twenty-Fourth International Joint Conference on Artificial Intelligence*. 2015.
- [111] Y. Rizk, N. Hajj, N. Mitri, and M. Awad, ‘Deep belief networks and cortical algorithms: A comparative study for supervised classification’, *Appl. Comput. Inform.*, Mar. 2018.
- [112] F. Ordóñez, D. Roggen, F. J. Ordóñez, and D. Roggen, ‘Deep Convolutional and LSTM Recurrent Neural Networks for Multimodal Wearable Activity Recognition’, *Sensors*, vol. 16, no. 1, p. 115, Jan. 2016.
- [113] H. F. Nweke, Y. W. Teh, M. A. Al-garadi, and U. R. Alo, ‘Deep learning algorithms for human activity recognition using mobile and wearable sensor networks: State of the art and research challenges’, *Expert Syst. Appl.*, vol. 105, pp. 233–261, Sep. 2018.
- [114] Ravì, D., Wong, C., Deligianni, F., Berthelot, M., Andreu-Perez, J., Lo, B., & Yang, G. Z. ‘Deep Learning for Health Informatics’, *IEEE J. Biomed. Health Inform.*, vol. 21, no. 1, pp. 4–21, Jan. 2017.
- [115] J. Wang, Y. Chen, S. Hao, X. Peng, and L. Hu, ‘Deep learning for sensor-based activity recognition: A Survey’, *Pattern Recognit. Lett.*, Feb. 2018.
- [116] V. B. Semwal, K. Mondal, and G. C. Nandi, ‘Robust and accurate feature selection for humanoid push recovery and classification: deep learning approach’, *Neural Comput. Appl.*, vol. 28, no. 3, pp. 565–574, Mar. 2017.
- [117] K. Han, Y. Wang, C. Zhang, C. Li, and C. Xu, ‘Autoencoder Inspired Unsupervised Feature Selection’, in *2018 IEEE International Conference on Acoustics, Speech and Signal Processing (ICASSP)*, 2018, pp. 2941–2945.
- [118] D. Tomar, Y. Prasad, M. K. Thakur, and K. K. Biswas, ‘Feature Selection Using Autoencoders’, in *2017 International Conference on Machine Learning and Data Science (MLDS)*, 2017, pp. 56–60.
- [119] Hiregoudar, S. B., K. Manjunath, and K. S. Patil. "A survey: research summary on neural networks." *International Journal of Research in Engineering and Technology* 3.15 , 2014. pp. 385-389.
- [120] A. K. Jain, J. Mao, and K. M. Mohiuddin, ‘Artificial neural networks: a tutorial’, *Computer*, vol. 29, no. 3, pp. 31–44, Mar. 1996.
- [121] S.-M. Lee, S. M. Yoon, and H. Cho, ‘Human activity recognition from accelerometer data using Convolutional Neural Network’, in *2017 IEEE International Conference on Big Data and Smart Computing (BigComp)*, 2017, pp. 131–134.
- [122] J. Guo, X. Xie, R. Bie, and L. Sun, ‘Structural Health Monitoring by Using a Sparse Coding-based Deep Learning Algorithm with Wireless Sensor Networks’, *Pers. Ubiquitous Comput.*, vol. 18, no. 8, pp. 1977–1987, Dec. 2014.
- [123] H. Fang and C. Hu, ‘Recognizing human activity in smart home using deep learning algorithm’, 2014, pp. 4716–4720.



- [124] S. Oniga and J. Sütő, ‘Human activity recognition using neural networks’, in *Proceedings of the 2014 15th International Carpathian Control Conference (ICCC)*, 2014, pp. 403–406.
- [125] L. Zhang, X. Wu, and D. Luo, ‘Human activity recognition with HMM-DNN model’, in *2015 IEEE 14th International Conference on Cognitive Informatics Cognitive Computing (ICCI\*CC)*, 2015, pp. 192–197.
- [126] Y. Chen and Y. Xue, ‘A Deep Learning Approach to Human Activity Recognition Based on Single Accelerometer’, in *2015 IEEE International Conference on Systems, Man, and Cybernetics*, 2015, pp. 1488–1492.
- [127] Hassan, Mohammed Mehedi, Md Zia Uddin, Amr Mohamed, and Ahmad Almogren. "A robust human activity recognition system using smartphone sensors and deep learning." *Future Generation Computer Systems* 81, 2018. pp. 307-313.
- [128] Mohamed, Abdel-rahman, George Dahl, and Geoffrey Hinton. "Deep belief networks for phone recognition." *Nips workshop on deep learning for speech recognition and related applications*. Vol. 1. No. 9. 2009.
- [129] F. Gu, K. Khoshelham, S. Valaee, J. Shang, and R. Zhang, ‘Locomotion Activity Recognition Using Stacked Denoising Autoencoders’, *IEEE Internet Things J.*, vol. 5, no. 3, pp. 2085–2093, Jun. 2018.
- [130] H. F. Nweke, Y. W. Teh, G. Mujtaba, and M. A. Al-garadi, ‘Data fusion and multiple classifier systems for human activity detection and health monitoring: Review and open research directions’, *Inf. Fusion*, vol. 46, pp. 147–170, Mar. 2019.
- [131] A. Jalal, Y.-H. Kim, Y.-J. Kim, S. Kamal, and D. Kim, ‘Robust human activity recognition from depth video using spatiotemporal multi-fused features’, *Pattern Recognit.*, vol. 61, pp. 295–308, Jan. 2017.
- [132] N. Y. Hammerla, S. Halloran, and T. Ploetz, ‘Deep, Convolutional, and Recurrent Models for Human Activity Recognition using Wearables’, *ArXiv160408880 Cs Stat*, Apr. 2016.
- [133] D. Zufferey, C. Gisler, O. A. Khaled, and J. Hennebert, ‘Machine learning approaches for electric appliance classification’, in *2012 11th International Conference on Information Science, Signal Processing and their Applications (ISSPA)*, 2012, pp. 740–745.
- [134] A. Reinhardt, D. Burkhardt, M. Zaheer, and R. Steinmetz, ‘Electric appliance classification based on distributed high resolution current sensing’, in *37th Annual IEEE Conference on Local Computer Networks - Workshops*, 2012, pp. 999–1005.
- [135] M. Fitta, S. Biza, M. Lehtonen, T. Nieminen, and G. Jacucci, ‘Exploring Techniques for Monitoring Electric Power Consumption in Households’, pp. 471-477, 2010.
- [136] M. Figueiredo, A. de Almeida, and B. Ribeiro, ‘Home electrical signal disaggregation for non-intrusive load monitoring (NILM) systems’, *Neurocomputing*, vol. 96, pp. 66–73, Nov. 2012.
- [137] A. Yassine, S. Singh, and A. Alamri, ‘Mining Human Activity Patterns from Smart Home Big Data for Health Care Applications’, *IEEE Access*, vol. 5, pp. 13131–13141, 2017.
- [138] D. Riboni and M. Murtas, ‘Web Mining amp; Computer Vision: New Partners for Object-Based Activity Recognition’, in *2017 IEEE 26th International Conference on*

- Enabling Technologies: Infrastructure for Collaborative Enterprises (WETICE)*, 2017, pp. 158–163.
- [139] T. van Kasteren, A. Noulas, G. Englebienne, and B. Kröse, ‘Accurate Activity Recognition in a Home Setting’, in *Proceedings of the 10th International Conference on Ubiquitous Computing*, New York, NY, USA, 2008, pp. 1–9.
- [140] P. Palmes, H. K. Pung, T. Gu, W. Xue, and S. Chen, ‘Object relevance weight pattern mining for activity recognition and segmentation’, *Pervasive Mob. Comput.*, vol. 6, no. 1, pp. 43–57, Feb. 2010.
- [141] A. Mihailidis, *Technology and Aging: Selected Papers from the 2007 International Conference on Technology and Aging*. IOS Press, 2008.
- [142] V. R. Jakkula, A. S. Crandall, and D. J. Cook, ‘Knowledge Discovery in Entity Based Smart Environment Resident Data Using Temporal Relation Based Data Mining’, in *Seventh IEEE International Conference on Data Mining Workshops (ICDMW 2007)*, 2007, pp. 625–630.
- [143] J. C. Augusto, J. Liu, P. McCullagh, H. Wang, and J.-B. Yang, ‘Management of Uncertainty and Spatio-Temporal Aspects for Monitoring and Diagnosis in a Smart Home’, *Int. J. Comput. Intell. Syst.*, vol. 1, no. 4, pp. 361–378, Dec. 2008.
- [144] K. Bouchard, ‘Unsupervised spatial data mining for human activity recognition based on objects movement and emergent behaviours’, Thesis report, 2014.
- [145] J. W. Lockhart and G. M. Weiss, ‘Limitations with Activity Recognition Methodology & Data Sets’, in *Proceedings of the 2014 ACM International Joint Conference on Pervasive and Ubiquitous Computing: Adjunct Publication*, New York, NY, USA, 2014, pp. 747–756.
- [146] L. D. Xu, W. He, and S. Li, ‘Internet of Things in Industries: A Survey’, *IEEE Trans. Ind. Inform.*, vol. 10, no. 4, pp. 2233–2243, Nov. 2014.
- [147] C. Liu, C. Yang, X. Zhang, and J. Chen, ‘External integrity verification for outsourced big data in cloud and IoT: A big picture’, *Future Gener. Comput. Syst.*, vol. 49, pp. 58–67, Aug. 2015.
- [148] D. Cook, ‘Learning Setting-Generalized Activity Models for Smart Spaces’, *IEEE Intell. Syst.*, vol. 27, no. 1, pp. 32–38, Jan. 2012.
- [149] D. J. Cook and M. Schmitter-Edgecombe, ‘Assessing the Quality of Activities in a Smart Environment’, *Methods Inf. Med.*, vol. 48, no. 5, pp. 480–485, 2009.
- [150] C. Ding and H. Peng, ‘Minimum redundancy feature selection from microarray gene expression data’, *J. Bioinform. Comput. Biol.*, vol. 03, no. 02, pp. 185–205, Apr. 2005.
- [151] Z. Chen, Q. Zhu, Y. C. Soh, and L. Zhang, ‘Robust Human Activity Recognition Using Smartphone Sensors via CT-PCA and Online SVM’, *IEEE Trans. Ind. Inform.*, vol. 13, no. 6, pp. 3070–3080, Dec. 2017.
- [152] V. Vapnik, ‘The Support Vector Method of Function Estimation’, in *Nonlinear Modeling: Advanced Black-Box Techniques*, J. A. K. Suykens and J. Vandewalle, Eds. Boston, MA: Springer US, 1998, pp. 55–85.
- [153] A. Reinhardt, *The tracebase appliance-level power consumption data set*. Computer program[Online]. Available: <https://github.com/areinhardt/tracebase>. [Accessed: 06-March-2018].

- [154] N. Batra, M. Gulati, A. Singh, and M. B. Srivastava, ‘It’s Different: Insights into Home Energy Consumption in India’, in *Proceedings of the 5th ACM Workshop on Embedded Systems for Energy-Efficient Buildings*, New York, NY, USA, 2013, pp. 3:1–3:8.
- [155] Bilski, Piotr, et al. "Application of Decision trees to the Fall Detection of elderly People using Depth-based sensors." *Proc. IEEE International Conference on Intelligent Data Acqut and Advanced Computing Systems (IDAACS 2015)*. 2015.
- [156] A. Natekin and A. Knoll, ‘Gradient boosting machines, a tutorial’, *Front. Neurorobotics*, vol. 7, Dec. 2013.
- [157] L.-L. Lu-Lulu, S.-W. Park, and B.-H. Wang, ‘Electric Load Signature Analysis for Home Energy Monitoring System’, *Int. J. Fuzzy Log. Intell. Syst.*, vol. 12, no. 3, pp. 193–197, 2012.
- [158] M. M. Hassan, M. Z. Uddin, A. Mohamed, and A. Almogren, ‘A robust human activity recognition system using smartphone sensors and deep learning’, *Future Gener. Comput. Syst.*, vol. 81, pp. 307–313, Apr. 2018.
- [159] L. Zhang, X. Wu, and D. Luo, ‘Recognizing Human Activities from Raw Accelerometer Data Using Deep Neural Networks’, in *2015 IEEE 14th International Conference on Machine Learning and Applications (ICMLA)*, 2015, pp. 865–870.
- [160] E. M. Tapia, S. S. Intille, and K. Larson, ‘Activity Recognition in the Home Using Simple and Ubiquitous Sensors’, in *Pervasive Computing*, 2004, pp. 158–175.
- [161] Agata Paulina Baran ‘Smart meters - the analysis of deployments in Europe and the recognition of household appliances based on load profiles’. [Online]. Available:<http://repo.bg.pw.edu.pl/index.php/en/r#/info/master/WUT1162d94dc22f42c7b935fef3fd2bf228/>. [Accessed: 14-Nov-2018].
- [162] M. Ma, W. Lin, J. Zhang, P. Wang, Y. Zhou, and X. Liang, ‘Toward Energy-Awareness Smart Building: Discover the Fingerprint of Your Electrical Appliances’, *IEEE Trans. Ind. Inform.*, vol. 14, no. 4, pp. 1458–1468, Apr. 2018.

## Appendix 1: Features extraction algorithm

---

First, the typing errors was corrected in databases, then features were extracted one by one using this algorithm developed using C++ language and Linux, below a part of the code using in features extraction and data normalisation.

```
#include <iostream>
#include <fstream>
#include <string>
#include <array>
#include <iomanip>
#include <stdio.h>
#include <sstream>
#include <vector>

using namespace std;

int dayOfWeek(int d, int m, int y){
    int t[] = { 0, 3, 2, 5, 0, 3, 5, 1, 4, 6, 2, 4 };
    y -= m <3;
    return ( y + y/4 - y/100 + y/400 + t[m-1] + d) % 7;
}

void divideDate(string date, string dateStream[]){
    size_t k = 0;
    size_t col = 0;
    while(k < 10){
        bool testLine = false;
        string tmp = "";
        while(date[k] != '-' && k < 10){
            tmp += date[k];
            k++;
            testLine = true;
        }

        if(testLine){
            dateStream[col] = tmp;
            col++;
        }
        k++;
    }
}

bool dateValidee(string date){
    int cpt(0);

    for(size_t i=0; i<date.size(); i++){
        if(date[i]=='-') cpt++;
    }

    return (cpt==2 &&date.size()==10);
}

int saison(int mois){
```

```

    if(mois==12 || mois<=2){
        return 0;
    }
    else if(mois>=3 && mois<=5){
        return 1;
    }
    else if(mois>=6 && mois<=8){
        return 2;
    }
    else{
        return 3;
    }
}

int charToAscii(char caractere){
    return ((int)caractere);
}

void deteleTemp(vector<vector<string>>&array){
    vector<size_t> indice;
    vector<vector<string>> tmp;

    for(size_t i=0; i<array.size(); i++){
        if(array[i][3][0]!='T'){
            indice.push_back(i);
        }
    }

    for(size_t i=0; i<indice.size(); i++){
        tmp.push_back(array[indice[i]]);
    }

    array = tmp;
}

int main() {

    int dateInt[3];
    bool sizeDep = false;
    string line, dateStream[3], x, mem;

    vector<vector<string>> arrayA;
    vector<string> arrayB;

    ofstream dataS("dataS1.txt", ios::trunc);
    ifstream dataE("data1", ios::in);

    if(!dataE){
        cout<<"le fichier n'a pas été ouvert"<<endl;
        return 1;
    }
    else{
        dataE.is_open();
        if(dataE.fail()){
            cout<< "fichier introuvable"<<endl;

```

```

        return 1;
    }
}

cout<<"The file is found successfully"<<endl;

cout<<endl;

cout<<"Copying data from File -> Begin"<<endl;
while(dataE.good()){

getline(dataE, line);

size_t k=0;
while(k < line.size()){
    bool testLine = false;
    string tmp = "";
    while(line[k] != ' ' && line[k] != '\n' && k <
line.size()){
        tmp += line[k];
        k++;
        testLine = true;
    }

    if(testLine){
        arrayB.push_back(tmp);
    }
    k++;
}

if(arrayB.size()>1) arrayA.push_back(arrayB);
arrayB.clear();
}
cout<<"Copying data from File -> End"<<endl;

cout<<endl;

cout<<"Coding dates and seasons -> Begin"<<endl;
for(size_t i=0; i<arrayA.size(); i++){

    if(dateValidee(arrayB[0])) divideDate(arrayA[i][0],
dateStream);

    for(size_t i=0; i<3; i++){
        dateInt[i] = stoi(dateStream[i]);
    }

    int dow = dayOfWeek(dateInt[2], dateInt[1], dateInt[0]);
    dow--;
    if(dow<0) dow = 6;

    arrayA[i][0] = to_string(dow);

    arrayA[i].insert(arrayA[i].begin()+1,
to_string(saison(dateInt[1])));
}

```

```

cout<<"Coding dates and seasons -> End"<<endl;

cout<<endl;

cout<<"Deleting temperature sensors -> Begin"<<endl;
deteleTemp(arrayA);
cout<<"Deleting temperature sensors -> End"<<endl;

cout<<endl;

cout<<"Changing Time presentation -> Begin"<<endl;
for(size_t i=0; i<arrayA.size();i++){
    while(arrayA[i][2].size()<15){
        arrayA[i][2]+='0';
    }
    for(size_t j=0; j<arrayA[i][2].size(); j++){
        if(arrayA[i][2][j]==':') arrayA[i][2][j]=' ';
    }
}
cout<<"Changing Time presentation -> End"<<endl;

cout<<endl;

cout<<"Coding sensors name -> Begin"<<endl;
for(size_t i=0;i<arrayA.size();i++){
    if(arrayA[i][3] == "c") arrayA[i][3]="M015";
    string arrayString =
to_string(charToAscii(arrayA[i][3][0]));

    for(size_t j=1; j<arrayA[i][3].size(); j++){
        arrayString += arrayA[i][3][j];
    }
    arrayA[i][3] = arrayString;
}
cout<<"Coding sensors name -> End"<<endl;

cout<<endl;

cout<<"Coding the logical values of sensors -> Begin"<<endl;
for(size_t i=0;i<arrayA.size();i++){
if (arrayA[i][4]=="ON" || arrayA[i][4]=="ONc"
    || arrayA[i][4]=="ON5" || arrayA[i][4]=="ON55"
    || arrayA[i][4]=="ON5c" || arrayA[i][4]=="ONcc"
    || arrayA[i][4]=="ONc5c" || arrayA[i][4]=="ONc5"
    || arrayA[i][4]=="ONM026" || arrayA[i][4]=="ONM009"
    || arrayA[i][4]=="ONM024" || arrayA[i][4]=="O")
{arrayA[i][4]= "1";}
    else if (arrayA[i][4]=="OFF" || arrayA[i][4]=="OFFc"
        || arrayA[i][4]=="OFF5" || arrayA[i][4]=="OFFcF"
        || arrayA[i][4]=="OFFcc" || arrayA[i][4]=="OFF5cc"
        || arrayA[i][4]=="OFF5c" || arrayA[i][4]=="OFFc5"
        || arrayA[i][4]=="OcFF" || arrayA[i][4]=="OFFccc5"
        || arrayA[i][4]=="OF") {arrayA[i][4]= "0";}
    else if (arrayA[i][4]=="CLOSE" || arrayA[i][4]=="CLOSED")
{arrayA[i][4]= "3";}
}
}

```

```

        else if (arrayA[i][4]=="OPEN" || arrayA[i][4]=="OPENC")
{arrayA[i][4]= "4";}
}
cout<<"Coding the logical values of sensors -> End"<<endl;

cout<<endl;

cout<<"Coding Activities -> Begin"<<endl;
for(size_t i=0;i<arrayA.size();i++){
    if(arrayA[i].size()>5){
        if (arrayA[i][5]=="Sleeping") {arrayA[i][5]= "0";}
        else if (arrayA[i][5]=="Meal_Preparation") {arrayA[i][5]=
"1";}
        else if (arrayA[i][5]=="Eating") {arrayA[i][5]= "2";}
        else if (arrayA[i][5]=="Work") {arrayA[i][5]= "3";}
        else if (arrayA[i][5]=="Relax") {arrayA[i][5]= "4";}
        else if (arrayA[i][5]=="Wash_Dishes") {arrayA[i][5]=
"5";}
        else if (arrayA[i][5]=="Bed_to_Toilet") {arrayA[i][5]=
"6";}
        else if (arrayA[i][5]=="Enter_Home") {arrayA[i][5]= "7";}
        else if (arrayA[i][5]=="Leave_Home") {arrayA[i][5]= "8";}
        else if (arrayA[i][5]=="Housekeeping") {arrayA[i][5]=
"9";}
        else if (arrayA[i][5]=="Resperate") {arrayA[i][5]= "10";}
    }
    if(arrayA[i].size()>6) arrayA[i].pop_back();
}

for(size_t i=0; i<arrayA.size(); i++){
    if(arrayA[i].size()>5){
        if(sizeDep){
            sizeDep = false;
        }
        else{
            mem = arrayA[i][5];
            sizeDep = true;
        }
    }
    else if(sizeDep){
        arrayA[i].push_back(mem);
    }
}

for(size_t i=0; i<arrayA.size(); i++){
    if(arrayA[i].size()<6) arrayA[i].push_back("11");
}

cout<<"Coding Activities -> End"<<endl;

cout<<endl;

for(size_t i=0;i<arrayA.size();i++){
    if(arrayA[i][3].size() == 5){
        for(size_t j=0;j<arrayA[i].size();j++){
            cout<<arrayA[i][j]<<" ";

```



```

        dataS<<arrayA[i][j]<<" ";
        /*if(j < arrayA[i].size()-2){
        cout<<"\t";
            dataS<<"\t";
        }*/
    }
    dataS<<endl;
    cout<<endl;
}

//cout<< "Nbre of Rows ----> "<< Row-1 <<endl;
//cout<< "Nbre of colomns ----> "<< Col-1 <<endl;
//cout<<arrayA[62][3]<<endl;

dataE.close();
dataS.close();
return 0;
}

```

## Appendix 2: DBN implementation for ADLs recognition

---

This appendix presents an extraction of DBN used to train Tulum database with 17 features and 10 outputs. The code was running using Python code and launched in Linux.

Code start by defining the DBN class which will store the layers of the MLP, along with their associated RBMs. The viewpoint was taking of using the RBMs to initialize an MLP, the code will reflect this by separating as much as possible the RBMs used to initialize the network and the MLP used for classification.

```
class DBN(object):

def __init__(self, numpy_rng, theano_rng=None, n_ins=17,
hidden_layers_sizes=[30,30], n_outs=10):

    self.sigmoid_layers=[]
    self.rbm_layers=[]
    self.params=[]
    self.n_layers=len(hidden_layers_sizes)

    assert self.n_layers>0

    if not theano_rng:
        theano_rng=MRG_RandomStreams(numpy_rng.randint(2**30))

    self.x=T.matrix('x')

    self.y=T.ivector('y')

    for i in range(self.n_layers):

        if i==0:
            input_size=n_ins
        else:
            input_size=hidden_layers_sizes[i-1]

        if i==0:
            layer_input=self.x
        else:
            layer_input=self.sigmoid_layers[-1].output

        sigmoid_layer=HiddenLayer(rng=numpy_rng,
input=layer_input,
n_in=input_size,
n_out=hidden_layers_sizes[i],
activation=T.nnet.sigmoid)

        self.sigmoid_layers.append(sigmoid_layer)
```

```

self.params.extend(sigmoid_layer.params)

rbm_layer=RBM(numpy_rng=numpy_rng,
theano_rng=theano_rng,
input=layer_input,
n_visible=input_size,
n_hidden=hidden_layers_sizes[i],
W=sigmoid_layer.W,
hbias=sigmoid_layer.b)
self.rbm_layers.append(rbm_layer)

```

All that is left is to stack one last logistic regression layer in order to form an MLP. *LogisticRegression* class is introduced in Classifying MNIST digits using Logistic Regression.

```

self.logLayer=LogisticRegression(
input=self.sigmoid_layers[-1].output,
n_in=hidden_layers_sizes[-1],
n_out=n_outs)
self.params.extend(self.logLayer.params)

self.finetune_cost=self.logLayer.negative_log_likelihood(self.y)

self.errors=self.logLayer.errors(self.y)

```

The class also provides a method which generates training functions for each of the RBMs. They are returned as a list, where element  $i$  is a function which implements one step of training for the RBM at layer  $i$ . In order to be able to change the learning rate during training, a Theano variable is associated to it that has a default value.

```

def pretraining_functions(self, train_set_x, batch_size, k):
    index=T.lscalar('index')
    learning_rate=T.scalar('lr')# learning rate to use

    # begining of a batch, given `index`
    batch_begin=index*batch_size
    # ending of a batch given `index`
    batch_end=batch_begin+batch_size

    pretrain_fns=[]
    for rbm in self.rbm_layers:
        cost,updates=rbm.get_cost_updates(learning_rate,
        persistent=None,k=k)

    # compile the theano function
    fn=theano.function(
    inputs=[index,theano.In(learning_rate,value=0.1)],

```

```

outputs=cost,
updates=updates,
givens={
self.x:train_set_x[batch_begin:batch_end]
}
)
# append `fn` to the list of functions
pretrain_fns.append(fn)

return pretrain_fns

```

In the same fashion, the DBN class includes a method for building the functions required for fine tuning ( a train\_model, a validate\_model and a test\_model function).

```

def build_finetune_functions(self, datasets, batch_size, learning_rate):

```

```

(train_set_x, train_set_y) = datasets[0]
(valid_set_x, valid_set_y) = datasets[1]
(test_set_x, test_set_y) = datasets[2]

```

```

n_valid_batches = valid_set_x.get_value(borrow=True).shape[0]
n_valid_batches //= batch_size
n_test_batches = test_set_x.get_value(borrow=True).shape[0]
n_test_batches //= batch_size

```

```

index = T.lscalar('index') # index to a [mini]batch

```

```

# compute the gradients with respect to the model parameters
gparams = T.grad(self.finetune_cost, self.params)

```

```

# compute list of fine-tuning updates

```

```

updates = []
for param, gparam in zip(self.params, gparams):
updates.append((param, param - gparam * learning_rate))

```

```

train_fn = theano.function(
inputs=[index],
outputs=self.finetune_cost,
updates=updates,
givens={
self.x: train_set_x[
index*batch_size:(index+1)*batch_size
],
self.y: train_set_y[
index*batch_size:(index+1)*batch_size
]
}
)

```

```

test_score_i = theano.function(
[index],

```

```

self.errors,
givens={
self.x:test_set_x[
index*batch_size:(index+1)*batch_size
],
self.y:test_set_y[
index*batch_size:(index+1)*batch_size
]
}
)

valid_score_i=theano.function(
[index],
self.errors,
givens={
self.x:valid_set_x[
index*batch_size:(index+1)*batch_size
],
self.y:valid_set_y[
index*batch_size:(index+1)*batch_size
]
}
)

def valid_score():
return [valid_score_i(i) for i in range(n_valid_batches)]

def test_score():
return [test_score_i(i) for i in range(n_test_batches)]

return train_fn, valid_score, test_score

```

There are two stages in training this network: (1) a layer-wise pre-training and (2) a fine-tuning stage. For the pre-training stage, all the layers of the network are looped over. For each layer, a compiled theano function is used which determines the input to the  $i$ -th level RBM and performs one step of CD- $k$  within this RBM. This function is applied to the training set for a fixed number of epochs given by `pretraining_epochs`. The fine-tuning loop is very similar to the one in the Multilayer Perceptron tutorial, the only difference being that it uses the functions given by `build_finetune_functions`.

```

#####
# PRETRAINING THE MODEL #
#####
print(... getting the pretraining functions')
pretraining_fns=dbn.pretraining_functions(train_set_x=train_set_x,
batch_size=batch_size,
k=k)
print(... pre-training the model')
start_time=timeit.default_timer()

```

```

# Pre-train layer-wise
for i in range(dbn.n_layers):
# go through pretraining epochs
for epoch in range(pretraining_epochs):
# go through the training set
c=[]
for batch_index in range(n_train_batches):
c.append(pretraining_fns[i](index=batch_index,
lr=pretrain_lr))
print('Pre-training layer %i, epoch %d, cost %f'%(i,epoch),end=' ')
print(numpy.mean(c,dtype='float64'))

end_time=timeit.default_timer()

```

### Appendix 3 : Appliance recognition algorithm

Classifiers are implemented in python based on Sklearn modules. This library contains a wide range of machine learning algorithms. Our implementation consists on bringing all classifiers in the same script and run them in the same python successively.

The machine used here is a personal notebook with 2.4 GHz in processor and 4 GB of RAM, all this work has been set up under GNU/Linux environment.

## 1- Models importation

```
import numpy as np
import pandas as pd
import seaborn as sns
import matplotlib.pyplot as plt
from sklearn.metrics import accuracy_score, log_loss
from sklearn.neighbors import KNeighborsClassifier
from sklearn.svm import SVC, LinearSVC, NuSVC
from sklearn.tree import DecisionTreeClassifier
from sklearn.ensemble import RandomForestClassifier, AdaBoostClassifier, GradientBoostingClassifier
from sklearn.naive_bayes import GaussianNB
from sklearn.discriminant_analysis import LinearDiscriminantAnalysis
from sklearn.discriminant_analysis import QuadraticDiscriminantAnalysis
from sklearn.gaussian_process.kernels import RBF
from sklearn.gaussian_process import GaussianProcessClassifier
from sklearn.neural_network import MLPClassifier
from sklearn.preprocessing import LabelEncoder
from sklearn.cross_validation import StratifiedShuffleSplit
import time
```

## 2- Data normalisation

```
def encode(train):
    le=LabelEncoder().fit(train.appliances)
```

```

labels=le.transform(train.appliances)# encode appliances strings
classes=list(le.classes_)# save column names
# save test ids

train=train.drop(['appliances','id'],axis=1)

return train,labels,classes

```

### 3- Split Dataset into training and test database

```

sss=StratifiedShuffleSplit(labels,1,test_size=0.4,random_state=23)
for train_index,test_index in sss:
X_train,X_test=train.values[train_index],train.values[test_index]
y_train,y_test=labels[train_index],labels[test_index]

```

### 4- Classifiers parameters

```

classifiers=[
KNeighborsClassifier(3),
MLPClassifier(verbose=True,random_state=0,max_iter=1000,solver='adam',alpha=1e-
5,learning_rate_init=0.000001,
hidden_layer_sizes=(1000,)),
DecisionTreeClassifier(max_depth=5),
RandomForestClassifier(max_depth=5,n_estimators=10,max_features=1400),
AdaBoostClassifier(),
GradientBoostingClassifier(),
GaussianNB(),
LinearDiscriminantAnalysis(solver='lsqr',shrinkage='auto'),
QuadraticDiscriminantAnalysis(),
GaussianProcessClassifier(1.0*RBF(1.0)),

```



```

SVC(kernel="linear",C=0.025,probability=True,verbose=True)
SVC(gamma=2,C=1,probability=True)
]

```

## 5- Classifiers training

```

for clf in classifiers:
    d=time.clock()
    clf.fit(X_train,y_train)
    name=clf.__class__.__name__
    print("="*30)
    print(name)
    print(' Results ')
    train_predictions=clf.predict(X_test)
    acc=accuracy_score(y_test,train_predictions)
    print("Accuracy: {:.4%}".format(acc))
    f=time.clock()
    print(f-d,'s')
    train_predictions=clf.predict_proba(X_test)
    ll=log_loss(y_test,train_predictions)
    print("Log Loss: {}".format(ll))
    log_entry=pd.DataFrame([[name,acc*100,ll]],columns=log_cols)
    log=log.append(log_entry)
    print("="*30)

```

## 6- Classification results

```

sns.set_color_codes("muted")
sns.barplot(y='Accuracy',x='Classifier',data=log,color="g")

```

## **Appendix 4: Scientific Publications**

### **Journals:**

- **Nadia Oukrich**, Abdelilah Maach, Cherraqi EL Bouazzaoui (2017). « Human Activities Recognition Based on Autoencoder Pre-Training and Back-Propagation Algorithm ». **Journal Of Theoretical & Applied Information Technology**, 2017, Vol. 95, No 19.
- **Nadia Oukrich.**, Cherraqi E.B., Maach A. El Ghanami D. (2018). "An Indoor Multiple Human Activity Recognition Method Based on Emerging Sensors and Deep Learning", **Journal of Artificial Intelligence**, Volume 11, Issue 2, **Page 65-70**, Year 2018.

### Conferences:

- **Nadia Oukrich**, Abdelilah Maach, El mehdi Sabri, ElMahdi Mabrouk, Kevin Bouchard (2016). «**Activity recognition using Back-propagation algorithm and minimum redundancy feature selection method**» in the **4<sup>th</sup> international colloquium on information science and technology** (Cist'16) le 24-26 Octobre 2016 Tanger.
- **Nadia Oukrich**, Abdelilah Maach, Cherraqi EL Bouazzaoui «**Multi-Users Activity Recognition using Back-Propagation Algorithm Based on Feature Selection**» The Mediterranean Symposium on Smart City Applications SCAMS 2017, October 25-27, 2017, Tangier.
- El Bouazzaoui Cheraqi, **Oukrich, Nadia**, Soufiane El Moumni, and Abdelilah Maach (2017). "**Discrete Wavelet Transform and Classifiers for Appliances Recognition.**" Proceedings of the Mediterranean Symposium on Smart City Applications. Springer, Cham.
- **Nadia Oukrich.**, Cherraqi E.B., Maach A. (2018). « **Human Daily Activity Recognition Using Neural Networks and Ontology-Based Activity Representation**». In: Ben Ahmed M., Boudhir A. (eds) Innovations in Smart Cities and Applications. SCAMS 2017. Lecture Notes in Networks and Systems, vol 37. **Springer**, Cham.