



HAL
open science

Modélisation intégrée produit-process à l'aide d'une approche de méta-modélisation reposant sur une représentation sous forme de graphes: Application à la fabrication additive

Hossein Mokhtarian

► To cite this version:

Hossein Mokhtarian. Modélisation intégrée produit-process à l'aide d'une approche de méta-modélisation reposant sur une représentation sous forme de graphes: Application à la fabrication additive. Mécanique [physics.med-ph]. Tampere University; Université Grenoble Alpes, 2019. Français. NNT: . tel-02163504

HAL Id: tel-02163504

<https://hal.science/tel-02163504>

Submitted on 24 Jun 2019

HAL is a multi-disciplinary open access archive for the deposit and dissemination of scientific research documents, whether they are published or not. The documents may come from teaching and research institutions in France or abroad, or from public or private research centers.

L'archive ouverte pluridisciplinaire **HAL**, est destinée au dépôt et à la diffusion de documents scientifiques de niveau recherche, publiés ou non, émanant des établissements d'enseignement et de recherche français ou étrangers, des laboratoires publics ou privés.

THÈSE

Pour obtenir le grade de

**DOCTEUR DE LA COMMUNAUTE UNIVERSITE
GRENOBLE ALPES**

**préparée dans le cadre d'une cotutelle entre la
Communauté Université Grenoble Alpes et Tampere
University**

Spécialité : **GI : Génie Industriel : conception et production**

Arrêté ministériel : le 6 janvier 2005 – 25 mai 2016

Présentée par

Hossein MOKHTARIAN

Thèse codirigée par **Henri PARIS** et **Eric COATANÉA**

préparée au sein du **Laboratoire des Science pour la
Conception, l'Optimisation et la Production de Grenoble et la
Faculty of Engineering and Natural Sciences of Tampere
University**

dans l'**École Doctorale I-MEP2 – Ingénierie – Matériaux,
Mécanique, Environnement, Énergétique, Procédés,
Production et Faculty Council of the Faculty of Engineering
and Natural Sciences of Tampere University**

**Modélisation intégrée produit-process à l'aide
d'une approche de méta-modélisation reposant
sur une représentation sous forme de graphes:
Application à la fabrication additive**

Thèse soutenue publiquement le **27 Mars 2019**,

devant le jury composé de :

Monsieur Henri PARIS

Professeur, Communauté Université Grenoble Alpes, Directeur de thèse

Monsieur Eric COATANÉA

Professeur, Tampere University, Directeur de thèse

Monsieur, Paul WITHERELL

National Institute of Standards and Technology, Maryland, Rapporteur

Monsieur, Lionel ROUCOULES

Professeur, Arts et Métiers ParisTech, Aix en Provence, Rapporteur

Monsieur, Kai CHENG

Professeur, Brunel University London, Président



“I would rather discover a causal
law than be King of Persia.”

Democritus (460-370 BC)

PREFACE

This Joint-PhD thesis was carried out in the period from October 2015 to September 2018 in the laboratory of ‘Mechanical Engineering and Industrial systems (MEI)’ at Tampere University of Finland and laboratory of ‘Sciences pour la conception, l’Optimisation et la Production (GSCOP)’ at Université Grenoble Alpes. Three universities in Tampere merged and currently known as Tampere University.

First and foremost, I would express my sincere gratitude to my supervisors, Professor Eric Coatanéa and Professor Henri Paris for their support, instruction, supervision, and patience throughout my doctoral studies. Their supervision and encouragement have kept me focused and motivated during the entire period of research. In addition to their scientific supervision, I highly appreciate their great personal characteristics.

I should say that I am thankful to all my colleagues at GSCOP Laboratory in France and MEI laboratory in Finland. Special thanks to Jorma Vihinen for the technical advice. Special thanks to Professor Frank Pourroy for his encouragement during the research. I would also like to forward my deepest gratitude to the head of laboratories: Professor François Villeneuve and Professor Kari Koskinen. I would like to thank the administrative officers as well for their supports on establishing this joint-PhD, especially Anna Nykänen and Fadila Messaoud.

I would like to acknowledge the preliminary examiners Dr. Paul Witherell from National Institute of Standards and Technology (NIST) and Professor Lionel Roucoules from Ecole Nationale Supérieure d’Arts et Métiers for their time and effort they put to provide feedback to improve the manuscript quality. I would like to thank Professor Kai Cheng from Brunel University London for his acceptance to act as opponent and join Professor Roucoules in the jury.

Finally, yet importantly, my deepest gratitude goes to my parents (Masoumeh and Masoud) and my brothers (Sephehr and Sahab) for their unconditional, limitless love and care from miles and miles away. I appreciate Farideh Farmani and Cyrus Mahdjoubi for their emotional supports. My warmest thanks go to my close friends for their emotional supports: Suvi-Sisko, Parisa, Marzieh, Laleh, Sara, Azarakhsh, Shahriar, Soheil, Alireza, Sina, Romaric, Suraj and Hari.

Tampere 31.3. 2018

Hossein Mokhtarian

ABSTRACT

Additive manufacturing (AM) has created a paradigm shift in product design and manufacturing sector due to its unique capabilities. However, the integration of AM technologies in mainstream production faces the challenge of ensuring reliable production and repeatable quality of parts. Toward this end, modeling and simulation play a significant role to enhance the understanding of the complex multi-physics nature of AM processes. In addition, a central issue in modeling AM technologies is the integration of different models and concurrent consideration of the AM process and the part to be manufactured. Hence, the ultimate goal of this research is to present and apply a modeling approach to develop integrated modeling in AM. Accordingly, the thesis oversees the product development process and presents the Dimensional Analysis Conceptual Modeling (DACM) framework to model the product and manufacturing processes at the design stages of the product development process. The framework aims at providing simulation capabilities and systematic search for weaknesses and contradictions to the models for the early evaluation of solution variants. The developed methodology is applied in multiple case studies to present models integrating AM processes and the parts to be manufactured. This thesis results show that the proposed modeling framework is not only able to model the product and manufacturing process but also provide the capability to concurrently model product and manufacturing process, and also integrate existing theoretical and experimental models. The DACM framework contributes to the design for additive manufacturing and helps the designer to anticipate limitations of the AM process and part design earlier in the design stage. In particular, it enables the designer to make informed decisions on potential design alterations and AM machine redesign, and optimized part design or process parameter settings. DACM framework shows potentials to be used as a metamodeling approach for additive manufacturing.

Keyword:

Additive Manufacturing, Design for Additive Manufacturing, Integrated Modeling, Product Development, Dimensional Analysis Conceptual Modeling Framework

CONTENTS

1	Introduction.....	29
1.1	Objectives and Scope.....	30
1.2	Dissertation Structure	31
2	Background.....	33
2.1	Product Development Process	33
2.1.1	Introduction.....	33
2.1.2	Early Design Stages in Product Development Process.....	36
2.1.3	Conceptual Design for Manufacturing.....	37
2.1.3.1	Function Modeling	41
2.1.3.2	Abstraction, Fidelity, and Resolution.....	46
2.1.3.3	Variability in Function Modeling.....	47
2.1.4	Embodiment Design.....	47
2.1.5	Evaluation of Solution Variants	48
2.2	Discussion.....	49
2.3	Additive Manufacturing.....	51
2.3.1	Additive Manufacturing Classification.....	51
2.3.2	Powder Bed Fusion	53
2.3.3	Direct Energy Deposition.....	53
2.3.4	Material Extrusion.....	55
2.3.5	Design for Additive Manufacturing.....	56
2.3.6	Variability in Additive Manufacturing	57
2.3.7	Metamodeling in Additive Manufacturing	58
2.4	Discussion.....	60
3	Methodology.....	63
3.1	DACM Framework Modeling Steps and Associated Theories	63
3.1.1	Function Modeling and Variable Assignment.....	64
3.1.2	Causal Graph	69
3.1.3	Dimensional Analysis.....	72
3.1.4	Qualitative Simulation (Backward Propagation).....	78
3.2	Illustrative Modeling Examples and Energy Domain Analogy.....	80
3.2.1	RLC Circuit.....	80
3.2.2	Pipe Insulation.....	82
3.3	Inventive Principles.....	85
3.4	Discussion.....	86
3.4.1	Characteristics and Misconception of DACM Framework	89

4	Results and Contributions of the Thesis.....	91
4.1	Integrated Modeling in Product Development	94
4.1.1	Product Modeling (Reverse Engineering vs. New Product Design)	94
4.1.2	Manufacturing Process Modeling	101
4.1.3	Concurrent Part-Process Modeling.....	105
4.2	Modeling and Design in Additive Manufacturing.....	105
4.2.1	Systematic Modeling and Continuous Improvement in Additive Manufacturing	105
4.2.2	Design for Additive Manufacturing.....	108
4.2.2.1	Design for Fused Deposition Modeling.....	109
4.2.2.2	Curling Defect in Powder Bed Fusion.....	111
4.2.3	Dimensionless Indicator for Comparing Additive and Subtractive Manufacturing on Environmental Impact	115
4.2.4	Metamodeling in Additive Manufacturing	118
4.2.4.1	Validation and Comparison of Classical ANN with KB-ANN Architecture.....	126
4.2.5	Probabilistic Modeling of Defects in Additive Manufacturing.....	127
4.2.5.1	Forward Simulation	132
4.2.5.2	Backward Simulation.....	135
5	Conclusion and Perspective	137
5.1	Perspective.....	139
6	References.....	141

List of Figures

Figure 1. Structure of the dissertation.....	31
Figure 2. Product design process, re-arranged from (Pahl et al., 2007).....	34
Figure 3. Top: Manufacturing costs during product design stages (Ullmann, 2015), Bottom: Cost of design change at different stages of PDP (Namouz, Summers, Mocko, & Obieglo, 2010).....	36
Figure 4. Conceptual modeling in simulation process (Robinson, 2004).....	38
Figure 5. Steps required in setting up requirement lists, conceptual design, embodiment design, rearranged from (Pahl et al., 2007)	39
Figure 6. Modeling and simulation role for solution variant evaluation in the design process	40
Figure 7. Different functional model representations.....	43
Figure 8. Inputs-outputs in function basis elements (Pahl et al., 2007) (Marca & McGowan, 1987).....	44
Figure 9. Function hierarchical decomposition (Faisandier, 2013)	44
Figure 10. Product model based on FBS and design process steps (Helms & Shea, 2012).....	45
Figure 11. A classification for additive manufacturing processes.....	52
Figure 12. Additive manufacturing processes mapped according to their functions (Williams & Rosen, 2016).....	52
Figure 13. Variable classification for Direct Energy Deposition (Publication I)	54
Figure 14. A simple representation of the classical meta-model concept (Yu & Popplewell, 1994).....	59
Figure 15. Modeling steps in DACM framework (Publication III)	64
Figure 16. An example of function modeling in DACM framework (Publication I).....	65
Figure 17. Representation of the generic variables and their interconnections (Publication III)	69
Figure 18. Causality in the main Bond graph elements (Publication III)	70
Figure 19. Description of the causal ordering algorithm (Publication III).....	71
Figure 20. Description of the behavioral law computation algorithm (Publication III).	73
Figure 21. Left: An example of the functional model. Right: and its associated causal graph	74
Figure 22. Description of the algorithm for non-singularity of $[A]$	76
Figure 23. Description of the algorithm for equation integration.....	77
Figure 24. Contradiction detection algorithm (Publication III).....	79

Figure 25. Model of RLC circuit using DACM approach. Left: concept space, functional model. Right: knowledge space, extracted colored causal graph for the circuit (**Publication IV**).....81

Figure 26. Functional model and generated the causal graph by the analogy between three energy domains (electrical, hydraulic, thermal) (**Publication IV**).....82

Figure 27. Function modeling for pipe insulation case study.....83

Figure 28. Extracted causal graph for pipe insulation and the contradiction detection.....84

Figure 29. TRIZ Problem solving process.....87

Figure 30. DSM as a key approach in DACM implementation88

Figure 31. Contributions of author’s publications.....92

Figure 32. Schematic view of associated functions in a glue gun (**Publication III**).....95

Figure 33. Glue gun functional model based on function schematic interaction (**Publication III**)97

Figure 34. Functional model of glue gun using a reverse engineering approach (**Publication III**)97

Figure 35. Generic functional representation filled with variables (**Publication III**).....98

Figure 36. Contradiction analysis in glue gun’s causal graph (**Publication III**)..... 100

Figure 37. A) Typical machine liquefier, B) thermal interfaces between block materials in RepRap liquefier, C) geometry of the part to be manufactured (**Publication IV**) 102

Figure 38. A) Systematic transformation between interface analysis, B) functional model, C) generic functional representation, and extracting causal graph for thermal heat exchange in FFF liquefier (**Publication IV**) 102

Figure 39. Partial causal graph of the FDM process model 104

Figure 40. Partial causal graph of FDM liquefier and the part to be manufactured. (Qualitative objectives are underlined. Backward propagations on the graph are shown with the same colors) (**Publication IV**) 106

Figure 41. Design for Additive Manufacturing flow, envisioned and pursued in the thesis 109

Figure 42. Printing result before and after process parameter modification (**Publication IV**)..... 110

Figure 43. Functional model for curling defect (**Publication IV**)..... 112

Figure 44. Causal graph for curling defect modeling (DACM for DFAM support) (**Publication IV**)..... 114

Figure 45. Environmental impacts of EBM (black) and milling (gray) for K=7.08 (**Publication V**)..... 116

Figure 46. Correlation between R and K for environmental impacts “CML 2 Baseline 2000” (**Publication V**) 117

Figure 47. Correlation between R and K for environmental impacts “CExD” (Publication V)	117
Figure 48. A modular KB-ANN topology for the FDM process using causal graph developed by DACM framework (Nagarajan et al., 2019)	120
Figure 49. A simplified modular KB-ANN topology for the FDM process using causal graph developed by DACM framework (Nagarajan et al., 2019)	120
Figure 50. Pursued concurrent modeling and experimental approach (Nagarajan et al., 2019).....	122
Figure 51. Performance curves for classical ANNs to model part’s a) wall thickness, b) height, c) mass and d) performance curve for the best-fit scenario (standard function $z=\sin(x).\cos(y)$) (Nagarajan et al., 2019).....	124
Figure 52. Performance curves in the KB-ANN for: a) modular ANN 1 (viscosity), b) modular ANN 2 (thickness), c) modular ANN 3 (height), d) modular ANN4 (mass) (Nagarajan et al., 2019)	125
Figure 53. Comparison of validation error for the classical ANN architecture and the KB-ANN architecture in the case study (Nagarajan et al., 2019)	126
Figure 54. Proposed methodology workflow of the case study	128
Figure 55. Causal graph for curling defect (represented in BayesiaLab)	129
Figure 56. Predicted effect of part geometric dimensional features on the probability of curling defects for medium-sized parts ($45 < L < 75$)	133
Figure 57. Predicted effect of part width and part height on the probability of curling defects for medium-sized parts ($45 < L < 75$) compared to Figure 56	134
Figure 58. Effect of part height and part width on the curling defect.....	134
Figure 59. Backward simulation to minimize curling defect and supports’ mass for small-sized parts ($15 < L < 45$).....	136

List of Tables

Table 1. Fundamental categories of variables	66
Table 2. Functional mapping for models transformation (to generic functions blocks) (Publication III)	67
Table 3. Domain-specific state variables (adapted from Publication III)	68
Table 4. Matrices [A] and [B] for the variable (m) derived from the causal graph in Figure 21	74
Table 5. Initial matrix for variable (Q) derived from (12).....	75
Table 6. Split matrices [A] and [B] for the variable (Q) derived from the initial matrix in Table 5	77
Table 7. Variables assigned to the generic functional model of the RLC circuit (Publication IV)	81
Table 8. Variables assigned to the generic functional model of the pipe insulation.....	84
Table 9. Two selected inventive principles for the causal graph (Publication IV)	85
Table 10. Function definition for the schematic view of the glue gun and its associated functions (Publication III)	96
Table 11. Variables and associated dimensions for the glue gun case study (Publication III)	99
Table 12. Influencing variables and their associated dimensions for the curling defect case study (Publication IV)	113
Table 13. List of case study variables with the range of values and equations.....	131
Table 14. Initial and defined acceptable value ranges for geometric constraint ratios	132

ABBREVIATIONS

AHP	Analytic Hierarchy Process
AM	Additive Manufacturing
ANN	Artificial Neural Network
ASME	American Society of Mechanical Engineers
ASTM	American Society for Testing Materials
BG	Bond Graph
BN	Bayesian Networks
CDTC	Conceptual Design to Cost
CED	Cumulative Energy Demand
CExD	Cumulative Exergy Demand
CFD	Computational Fluid Dynamics
CM	Conceptual Model
DA	Dimensional Analysis
DACM	Dimensional Analysis Conceptual Modeling
DAG	Directed Acyclic Graph
DED	Direct Energy Deposition
DFAM	Design for Additive Manufacturing
DFMA	Design for Manufacturing and Assembly
DFM	Design for Manufacturing
DFX	Design for X
DMD	Direct Material Deposition
DOE	Design of Experiment
DSM	Design Structure Matrix
DTC	Design to Cost
DTM	Design Theory and Methodology
EBM	Electron Beam Melting
FAST	Function Analysis System Technique
FBS	Function-Behavior-Structure
FDM	Fused Deposition Modeling
FEM	Finite Element Method

FFF	Fused Filament Fabrication
FFR	Filament Feed Rate
FM	Functional Model
HoQ	House of Quality
KB-ANN	Knowledge-Based Artificial Neural Network
M&S	Modeling and Simulation
MFR	Mass Flow Rate
MSE	Mean Squared Error
NIST	National Institute of Standards and Technology
PBF	Powder Bed Fusion
PDP	Product Development Process
QFD	Quality Function Deployment
RMP	Reusable Modeling Primitives
SADT	Structured Analysis and Design Technique
SE	System Engineering
SLM	Selective Laser Melting
SLS	Selective Laser Sintering
SOI	System of Interest
TS	Travel Speed
V&V	Validation and Verification
VFR	Volumetric Flow Rate

Latin Symbols

A	Filament Cross Section
C	Capacitance
C	Capacitor Element
C	Connecting Variable type
C_p	Specific Heat Capacity
D	Displacement Variable type
e	Effort
f	Flow
F	Force
FC	Fluid Capacitance
GY	Gyrator Element
h	Coefficient of Convection

h_f	Heat of Fusion
H	Inductance
I	Current
I	Inertia Element
I_f	Fluid Inertia
JE	Junction of Effort
JF	Junction of Flow
k	Coefficient of Conduction
M	Mass
M	Momentum Variable Type
\dot{M}	Mass Flow Rate
P	Power
PM	Pressure Momentum
Pr	Pressure
q	Electric Charge
q	Heat Energy
Q	Volume
\dot{Q}	Volumetric Flow Rate
\dot{q}	Heat Flow Rate
R	Resistance
R	Resistor Element
S	Heat Exchange Surface
SE	Source of Effort
SF	Source of Flow
T	Temperature
TF	Transformer
u	feed rate
U	Voltage
Y_{melt}	Location of Melt Front

Greek Symbols

α	Thermal Diffusivity
α	Thermal Expansion
β	Nozzle Angle
δ	Curling Defect

θ	Dimensionless Temperature
λ	Flux Linkage
μ	Viscosity
π	Dimensionless Product
ρ	Density
σ	Thermal Constraint
τ	Torque
ω	Angular Velocity

TERMINOLOGY

Term	Definition
3D Printing	The fabrication of objects through the deposition of a material using a print head, nozzle, or another printer technology. The term often used synonymously with additive manufacturing. (Standard ASTM., 2012) (ISO/ASTM-52900, 2015)
Abstraction	The process of selecting the essential aspect of a system to be represented in a model or simulation while ignoring those aspects that are not relevant to the purpose of the model and simulation (Roza, 2005) Abstraction is what the modeler decides to include or exclude in the model (Abbass, 2015)
Additive Manufacturing	A process of joining materials to make objects from 3D model data, usually layer upon layer, as opposed to subtractive manufacturing methodologies. (Standard ASTM., 2012) Synonyms: additive fabrication, additive processes, additive techniques, additive layer manufacturing, layer manufacturing, and freeform fabrication. (Standard ASTM., 2012) (ISO/ASTM-52900, 2015)
Additive Systems	Machines used for additive manufacturing. (Standard ASTM., 2012). The thesis uses the term Additive Manufacturing machine synonymously.
Assumption	A thing that is accepted as true or as certain to happen, without proof. (ISO/IEC/IEEE, 2015) It is made when there are uncertainty or beliefs about the real world being modeled (Robinson, 2008)
Binder Jetting	An additive manufacturing process in which a liquid bonding agent is selectively deposited to join powder materials. (ISO/ASTM-52900, 2015)
Black Box Model	A model whose input, output, and functional performance are known, but whose internal implementation is unknown or irrelevant. (Roza, 2005)

Black Box System	A device, system or object which can be viewed solely in terms of its input, output and transfer characteristics without any knowledge of its internal workings, that is, its implementation is "opaque" (black). (Ashby, 1961)
Bond Graph Theory	A form of object-oriented tool for modeling engineering systems using uniform notations for all types of the physical system based on energy flow. (Shim, 2002)
Causal Ordering	A partial ordering based on 'causally happens before' relationship. (Roza, 2005)
C-K Theory	A design process proposed by Hatchuel and Weil, in which concepts generate other concepts or are transformed into knowledge. (Hatchuel & Weil, 2003)
Concept	An abstraction; a general idea inferred or derived from specific instances. (Oxford Dictionaries Online) A set of core technical activities of systems engineering in which the problem space and the needs of the stakeholders are closely examined. This consists of an analysis of the problem space and definition of stakeholder needs for required services within it. (SeBoK, 2017)
Concept Space	A concept space represents propositions whose logical status are unknown and cannot be determined with respect to a given knowledge space. (Kazakçı, 2009)
Conceptual Model	A non-software specific description of the computer simulation model, describing the objectives, inputs, outputs, content, assumption, and simplifications of the model. (Robinson, 2008)
Conceptual Modeling	The process of abstracting a model from a real or proposed system. (Process of creating/developing the conceptual model) (Robinson, 2008)
Design Theory and Methodology	Design theory is about how to model and understand the design and design methodology is about how to design, more precisely a design process model with logical consequential phases in which a design task is completed to develop product specifications. (Tomiyama et al., 2009)
Dimensional Analysis	A method for reducing the number and complexity of experimental variables that affect a given physical phenomenon. (White, 2003)
Direct Energy Deposition	An additive manufacturing process in which focused thermal energy is used to fuse materials by melting as they are being deposited. (Standard ASTM., 2012)

Entropy	A thermodynamic quantity that expresses the degree of disorder or randomness in a system at the molecular level.
Environment	All elements external to the system that interact with it. (Object Management Group, 2003)
Fidelity	Fidelity is a measure of model coverage of the space defined by the level of resolution (Abbass, 2015)
Function	A function is defined by the transformation of input flows to output flows, with defined performance (SeBoK, 2017) An action, a task, or an activity performed to achieve the desired outcome. (Hitchins, 2008)
Function Modeling	The activity of developing models of devices, products, objects, and processes based on their functionalities and the functionalities of their subcomponents. (Erden et al., 2008)
Functional Architecture	A functional architecture is a set of functions and their sub-functions that defines the transformations of input flows into output flows performed by the system to achieve its mission. (SeBoK, 2017)
Fused Deposition Modeling	A material extrusion process used to make thermoplastic parts through heated extrusion and deposition of materials layer by layer; term denotes machines built by Stratasys, Inc. (Standard ASTM., 2012)
Incremental Design	Iterative development of improvement of design.
Knowledge	The sum or result of what has been perceived, discovered or learned. (Roza, 2005)
Knowledge Space	A knowledge space represents all the knowledge available to a designer at a given time. (Kazakçi, 2009)
Laser Sintering	A powder bed fusion process used to produce objects from powdered materials using one or more lasers to selectively fuse or melt the particles at the surface, layer upon layer, in an enclosed chamber. (ISO/ASTM-52900, 2015)
Material Extrusion	An additive manufacturing process in which material is selectively dispensed through a nozzle or orifice. (Standard ASTM., 2012)
Material Jetting	An additive manufacturing process in which droplets of build material are selectively deposited. (ISO/ASTM-52900, 2015)
Meta-model	A model developed to enable integrating multiple models and representing relationships among different models. (Standard ASTM., 2012)

Model	A simplified representation of a system at some particular point in time or space intended to promote understanding of the real system. (Bellinger, 2004)
Model Validation	The process of ensuring the model correctly represents the domain or system-of-interest. (Standard ASTM., 2012)
Powder Bed Fusion	An additive manufacturing process in which thermal energy selectively fuses regions of a powder bed. (Standard ASTM., 2012)
Problem Space	Problem space exhibits major invariants across design problem-solving situations and major variants across design and non-design problem-solving situations. (Goel & Pirolli, 1992)
Procedure	Specified way to carry out an activity or a process (ISO/IEC/IEEE, 2015)
Process	A process is a set of interrelated or interacting activities, which transforms inputs into outputs. (ISO/IEC, 2000)
Process Parameter	Set of operating parameters and system settings used during a build cycle. (ISO/ASTM-52900, 2015)
Product	An artifact that is produced is quantifiable and can be either an end item in itself or a component item. (PMI, 2008)
Rapid Prototyping	Additive manufacturing of a design, often iterative, for form, fit, or functional testing, or combination thereof. (Standard ASTM., 2012)
Repeatability	Degree of alignment of two or more measurements of the same property using the same equipment and in the same environment. (ISO/ASTM-52900, 2015)
Resolution	Resolution is what the modeler intends to model about the problem (Abbass, 2015)
Reverse Engineering	Reverse engineering is the process of analyzing a subject system to identify the system's components and their interrelationships and to create representations of the system in another form or at a higher level of abstraction. (Chikofsky & Cross, 1990)
Sheet Lamination	An additive manufacturing process in which sheets of material are bonded to form a part. (ISO/ASTM-52900, 2015)
SI System	International System of units (Standard ASTM., 2012)

Simplification	It is incorporated in the model to enable more rapid model development and use, and to improve transparency. (Robinson, 2008)
Simulation	A simulation is the manipulation of a model in such a way that it operates on time or space to compress it, thus enabling one to perceive the interactions that would not otherwise be apparent because of their separation in time or space. (Bellinger, 2004)
Solution Space	Solution spaces exhibit the solution alternatives responding to the identified problem or gap.
Subtractive Manufacturing	Making objects by removing material (for example, milling, drilling, grinding, carving, etc.) from a bulk solid to leave the desired shape, as opposed to additive manufacturing. (Standard ASTM., 2012)
System	Combination of interacting elements organized to achieve one or more stated purposes. (ISO/IEC/IEEE, 2015)
System behavior	Systems behavior is a change, which leads to events in itself or other systems. Thus, action, reaction or response may constitute behavior in some cases. (Ackoff, 2018)
System Boundary	A distinction made by an observer which marks the difference between an entity taken be a system and its environment. (Checkland, 1999)
System Property	Any named measurable or observable attribute, quality or characteristic of a system or system element. (Object Management Group, 2003)
System Structure	The static existence of the system; namely its elements and their relationships. (SeBoK, 2017)
System-of-Interest	The system whose life-cycle is under consideration. (ISO/IEC/IEEE, 2015) The part of a broader System Context, which also includes an environment. (SeBoK, 2017)
Systems Analysis	The system analysis refers to the activities used to provide the link between problems and solutions. (SeBoK, 2017)
TRIZ	An Inventive problem-solving theory. (G. S. Altshuller, 1984)
Vat photo-polymerization	An additive manufacturing process in which liquid photopolymer in a vat is selectively cured by light-activated polymerization (ISO/ASTM-52900, 2015)

Validation	The set of activities ensuring and gaining confidence that a system is able to accomplish its intended use, goals and objectives (i.e., meet stakeholder requirements) in the intended operational environment. (ISO/IEC/IEEE, 2015) Confirmation if the model or system is built right.
Verification	The set of activities that compares a system or system element against the required characteristics. This includes, but is not limited to, specified requirements, design description and the system itself. (ISO/IEC/IEEE, 2015) Confirmation if the right model or right system is built.
White box model	A model whose internal implementation is known and fully visible. Also called glass box model.

LIST OF ORIGINAL PUBLICATIONS

- Publication I **Mokhtarian, H.**, Coatanéa, E., Paris, H., Ritola, T., Ellman, A., Vihinen, J., Koskinen, K., Ikkala, K. (2016, August). A network-based modelling approach using the Dimensional Analysis Conceptual Modeling (DACM) framework for additive manufacturing technologies. In ASME International Design Engineering Technical Conferences and Computers and Information in Engineering Conference, Volume 1A, Charlotte, United States of America.
(DOI: [10.1115/DETC2016-60473](https://doi.org/10.1115/DETC2016-60473))
- Publication II Coatanéa, E., Roca, R., **Mokhtarian, H.**, Mokammel, F., & Ikkala, K. (2016). A conceptual modeling and simulation framework for system design. *Journal of Computing in Science & Engineering*, 18(4), 42-52.
(DOI: [10.1109/MCSE.2016.75](https://doi.org/10.1109/MCSE.2016.75))
- Publication III **Mokhtarian, H.**, Coatanéa, E., & Paris, H. (2017). Function modeling combined with physics-based reasoning for assessing design options and supporting innovative ideation. *Journal of Artificial Intelligence for Engineering Design, Analysis, and Manufacturing (AI-EDAM)*, 31(4), 476-500.
(DOI: [10.1017/S0890060417000403](https://doi.org/10.1017/S0890060417000403))
- Publication IV **Mokhtarian, H.**, Coatanéa, E., Paris, H., Mbow, M., Pourroy, F., Marrin, P., Vihinen, J., Ellman, A. (2018). A conceptual design and modeling framework for integrated additive manufacturing. *ASME Journal of Mechanical Design (JMD)*, 140(8).
(DOI: [10.1115/1.4040163](https://doi.org/10.1115/1.4040163))
- Publication V Paris, H., **Mokhtarian, H.**, Coatanéa, E., Museau, M., Ituarte, I. (2016). Comparative environmental impacts of additive and subtractive manufacturing technologies. *CIRP Annals-Manufacturing Technology*, 65(1), 29-32.
(DOI: [10.1016/j.cirp.2016.04.036](https://doi.org/10.1016/j.cirp.2016.04.036))

AUTHOR'S CONTRIBUTIONS

This thesis includes the scientific outputs followed by five publications. The contributions of the author are presented as follows:

Publication I: The author was the main contributor to this conference article. This paper demonstrates an initial attempt at applying DACM framework in additive manufacturing. The manuscript was written and revised by the author. Co-authors provided their feedback on the manuscript. (**Mokhtarian** et al., 2016)

Publication II: This journal article presents a conceptual modeling and simulation framework for system design. The author's contribution consists of applying the modeling framework in the additive manufacturing case study. The thesis author contributed to the manuscript by collaborating in writing and revision of the article with article's first author. The other co-authors provided their feedback. (Coatanéa, Roca, **Mokhtarian**, Mokammel, & Ikkala, 2016)

Publication III: The author was the main contributor to this journal paper. The author's contributions consist of developing algorithms for the DACM framework and applying the method to a product design case study. The manuscript was written and revised by the author. The co-authors contributed by giving their feedback and review of the paper. (**Mokhtarian**, Coatanéa, & Paris, 2017)

Publication IV: The author was the main contributor to this journal paper. The author presented the modified DACM framework and developed an integrated model in additive manufacturing. The manuscript was written and revised by the author. The co-authors contributed to the manuscript by sharing feedback. (**Mokhtarian** et al., 2018)

Publication V: The contribution of the author in this journal article was limited to analyzing the results and finalizing the research paper including structuring, writing and editing the paper. The other co-authors had a bigger contribution in designing the case study and analyzing life-cycle assessment, data and results. (Paris, **Mokhtarian**, Coatanéa, Museau, & Ituarte, 2016)

Apart from the publications, this thesis considers the results of the recently published article. This article is a result of collaboration between authors. The thesis author is the second main contributor to this journal article. The idea is derived from the thesis point of view in **Publication IV**. The author contributed to the article by collaborating in writing and revising the manuscript, as well as providing a causal graph and measurement data and conducting experiments. However, the role of other co-authors in developing Artificial Neural Networks (ANN) and analyzing the results were also significant, without whom the realization of this article would not be possible. (Nagarajan, **Mokhtarian**, et al., 2019)

1 INTRODUCTION

The manufacturing and production of parts with repeatable desired quality is a crucial step toward the integration of Additive Manufacturing (AM) technologies in mainstream production. AM processes involve complex multi-physics phenomena that require a complete understanding of the process to be able to produce products with repeatable and reliable quality. Modeling and simulation play a significant role to enhance the understanding of the complex multi-physics nature of AM processes. Various models that are continuously being developed provide a better understanding of those processes. However, each model is developed with a specific purpose, constraints and different level of detail. Integrating those models with each other remains a hurdle also due to the variety of AM technologies, materials, and influencing variables.

From the product development point of view, AM expands the product design space allowing the fabrication of complex designs with new functionalities. This characteristic of AM has changed the design and reduced the constraints for the designer in terms of providing more complex product design. However, designers are not entirely free to consider any random geometry, since the existing AM technologies have their own limitations and constraints. This becomes crucial when it comes to ensuring manufacturing of the part with repeatable desired quality. This expansion of design space requires designers to move beyond the traditional design rules for manufacturing and adopt new design guidelines that can leverage the advantages of AM. Toward this direction, it is necessary that designers and manufacturers have the essential information and tools to make informed decisions about the product and processes. It is required to anticipate the consideration of AM constraints and limitations earlier in design stages and enable integrated design. This issue is initially addressed in Design for Manufacturing (DFM) approaches that are derived from concurrent engineering. Applying DFM principles to AM is called Design for Additive Manufacturing (DFAM). In another term, DFAM deals with revisiting and adopting DFM principles for AM processes.

Concurrently consider processes and products, or in another term manufacturing processes and parts to be manufactured is a key to alleviate the issue. This thesis

focuses on the development of a framework for concurrent consideration product and process and assess the design options at the design stages in product development process and consequently apply this framework to develop integrated modeling in AM.

1.1 Objectives and Scope

The scope of the thesis lays into the design stages in the Product Development Process (PDP). The ultimate aim of the thesis is to provide a modeling approach capable of integrating models at the design stages in the PDP. The proposed approach is generic at this stage and can be applied to various domains, such as product development, artificial intelligence, multi-criteria optimization, and manufacturing sector. The modeling approach is applied to AM in this thesis. From PDP aspect, the thesis seeks to attain the following objectives in the design stages of PDP:

- 1- Presenting a systematic modeling approach, capable of modeling product and manufacturing processes.
- 2- Enabling the early evaluation of solution variants or early assessment of the design options.
- 3- Providing simulation capabilities and systematic search for weaknesses and contradictions to the models.

By applying the modeling approach developed for PDP to AM, the thesis seeks to achieve the following objectives in AM context:

- 4- Integrating models at design stages and presenting models that integrate the AM process and the part to be manufactured.
- 5- Contributing to DFAM at earlier design stages by concurrently considering the manufacturing process and the part to be manufactured.
- 6- Presenting a metamodeling approach, capable of integrating models.

To achieve those objectives, the thesis attempts to answer the following detailed questions for the proposed modeling approach:

- a) How to create models by focusing on the functionality of the products and/or processes rather than their design configuration?
- b) What is the approach for the concretization of the abstract functional model?
- c) How to integrate the design and process variables into the functional model?
- d) How to provide simulation capabilities to evaluate the solution variants?

- e) How to represent an integrated model by concurrently considering AM process and the part to be manufactured?
- f) How to extract DFAM rules earlier in design stages from the integrated model?
- g) How to highlight the weaknesses of part design or AM process/machine from the integrated model?
- h) How to use the proposed approach as a metamodeling tool for AM, capable of integrating the AM process model, part design model, and the other existing models?

1.2 Dissertation Structure

The current thesis outlines the research published in five publications. Figure 1 shows the visual structure of the thesis. The thesis is structured into five chapters and is organized as follows.

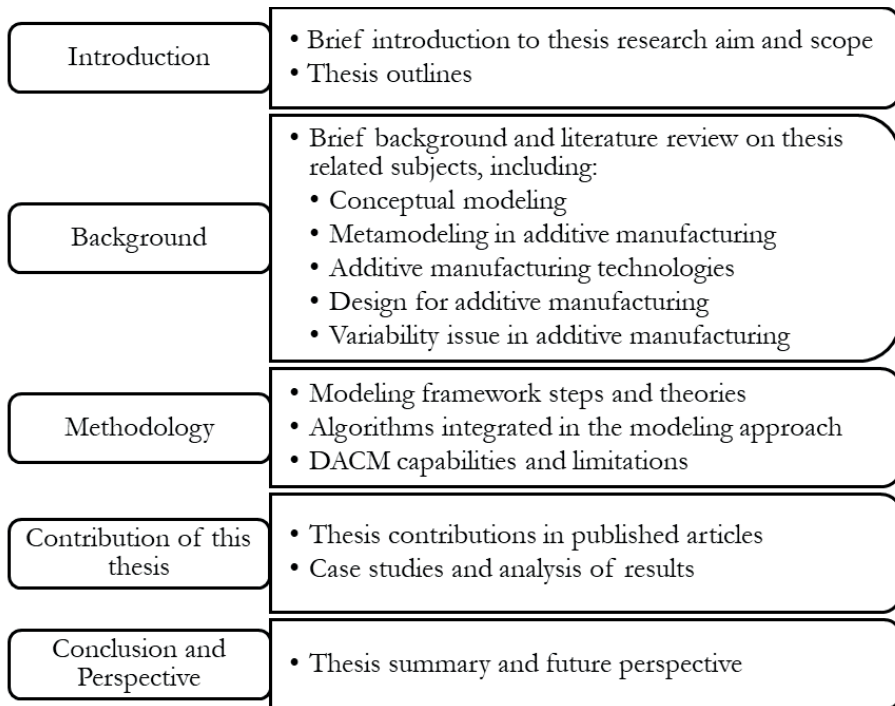

Figure 1. Structure of the dissertation

Chapter 1 is a brief introduction to the research problem, aim and scope. Chapter 2 covers the theoretical background and state-of-the-art of thesis-related subjects. Chapter 3 represents thoroughly the proposed modeling methodology named Dimensional Analysis Conceptual Modeling (DACM) framework followed by analyzing its capabilities and limitations. Chapter 4 is dedicated to the discussion on the results and contribution of the thesis. Finally, Chapter 5 summarizes the research and presents remarks and perspective to the extension of this work.

2 BACKGROUND

This chapter briefly introduces the existing literature related to thesis scope and shows how this research goes beyond the current knowledge in the literature. This chapter articulates around the importance of early design stages in the PDP. This chapter also briefly discusses the background related to AM to position the thesis in the AM context. It highlights the need for the modeling framework that can enable concurrent product-process modeling earlier in the design stages of PDP.

2.1 Product Development Process

2.1.1 Introduction

Product development refers to the process of taking a product (service) from requirements, ideas, and conception to the market for satisfying specific needs. There are different approaches to be followed as PDP, and all the existing approaches share similar principles (Pugh, 1991)(Rowe, 1991) (Pahl, Beitz, Feldhusen, & Grote, 2007)(Suh, 1990). For the purpose of this discussion, the PDP proposed by Pahl & Beitz is adapted for this research (Pahl et al., 2007). The systematic design process, proposed by Pahl & Beitz, consists of four main sub-processes: planning and task clarification, conceptual design, embodiment design, and detail design. Figure 2 represents the steps and phases of this systematic design process. The design process starts with the problem clarification by collecting requirements that the final part should meet. The outcome of this initial phase is problem definition in a precise, solution-neutral manner and generating a list of requirements. In the subsequent phase, conceptual design, designers identify the essential problems and determine the principle solution variants (concepts) through abstraction. The solution variants are then evaluated to eliminate the options that do not satisfy the requirements. After solution variants' evaluation in the conceptual design phase, the design refinement continues into the embodiment and detail design phases in a PDP.

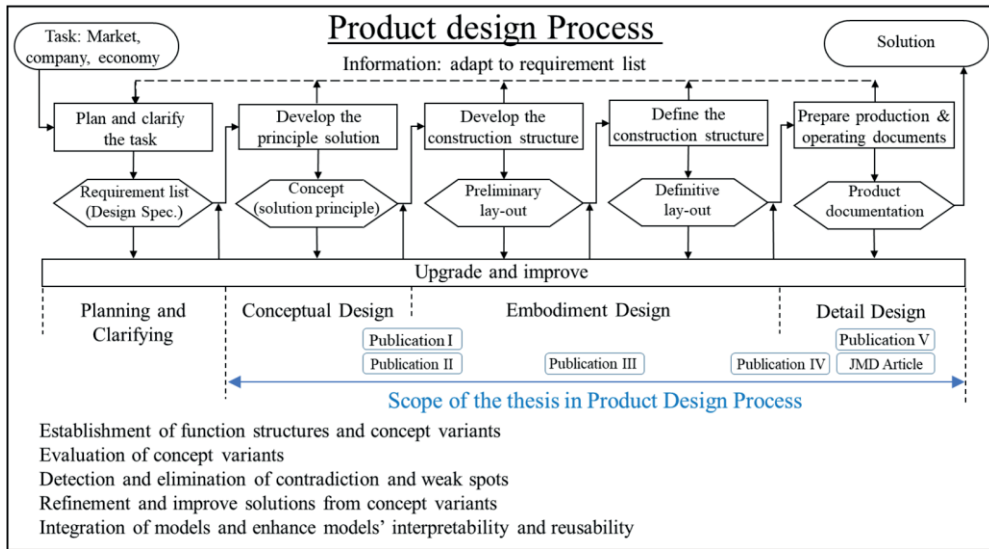

Figure 2. Product design process, re-arranged from (Pahl et al., 2007)

Before going further, it is worth mentioning that not all design problems try to invent products with new functionalities but often follow an improvement purpose of already existing products. Even in the new product design, the starting point of design often involves with concretization of a concept to an existing solution variant. The starting point of product design is discussed as the degree of novelty in product design studies (Pahl et al., 2007). There are three different types of design development: original design (Invention and innovation), adaptive design, and variation design (Orawski, Krollmann, Mörtl, & Lindemann, 2011). Original designs solve the problem by applying the latest scientific knowledge (invention) or by combining known solution principles (innovation). Adaptive designs adapt new embodiment to new requirements while keeping the solution principle unchanged. Variation design considers that the sizes of parts are varied with respect to the limitations sets in the previous design. New product design deals with designing products for new functionalities, new embodiment, while the incremental design is the re-arrangement and improvement of an existing product. The majority of the design tasks fall into the incremental design of which the purpose is to improve and optimize an existing system or product. The success of a product does not only rely on the novelty provided in the design stages of the product. Indeed, novelty should be ideally considered in all steps of the product life-cycle from ideation and design to the commercialization of the product and dismantling phase.

At the early design stages, as soon as the list of requirements is established, designers might come up quickly with a solution, based on their experiences and intuition. We all have this tendency to relate the problems to the solutions we know. The emergence of such initial ideas as the solutions based on designer's experience or the existing solution seems rewarding but can lead to design fixation that prevent searching for an optimum answer to the design problem. The ideal goal in the early design stages is to provide a condition that designers present abundant solution variants and avoid design fixation. Product design studies propose numerous methods, such as analogy and brainstorming to enhance overcoming this fixation (Ullmann, 2015). An efficient approach to prevent sticking to design fixation in systematic product development is abstraction. Abstraction is the process of ignoring the details and particularities and instead emphasizing on the generalities and essential aspects of the problem. For instance, paying attention to the functionality of the components rather than their shape and configurations is an abstraction in reverse engineering of an existing product. Establishing the overall functional model and further sub-functions is a means for the abstraction of an existing design solution.

Both conceptual design and embodiment design phases consist of the evaluation of solution variants against technical and economic criteria. Designers should evaluate and decide to keep or eliminate the solution variants for the subsequent phases. This entails being able to qualitatively and/or quantitatively analyze the performance of solution variants and find their weaknesses (limitations) at the early design stages. This early evaluation of solution variants is possible by analyzing their performance versus the design objectives. Fulfilling design objectives might lead to incompatibility of desired features within a system. This incompatibility is referred to as the concept of contradiction (Ilevbare, Probert, & Phaal, 2013). The contradictions in a solution variant or a system indicate a possible improvement track by overcoming the contradictions (G. Altshuller, 1999). For instance, TRIZ is an approach that enables systematic innovation on contradiction zones, without needing to wait for inspiration or using trial and error (G. Altshuller, 1999). The remainder of this section focuses on discussing the importance of the early design stages in the PDP and existing methods for establishing functional models.

2.1.2 Early Design Stages in Product Development Process

Earlier in this chapter, different design phases in the systematic PDP were briefly discussed. For a successful PDP, all of the phases and their associated steps should be carried out carefully. Failure in any phase of the PDP will often result in the failure of the whole design project. In particular, from the cost point of view, the early design phases are most critical in the PDP. As shown in Figure 3, between 70% to 80% of the manufacturing cost of a product is committed by the end of the conceptual design phase, but only 10% of the projected product cost is incurred until this stage (Blanchard, 1978)(Ullmann, 2015).

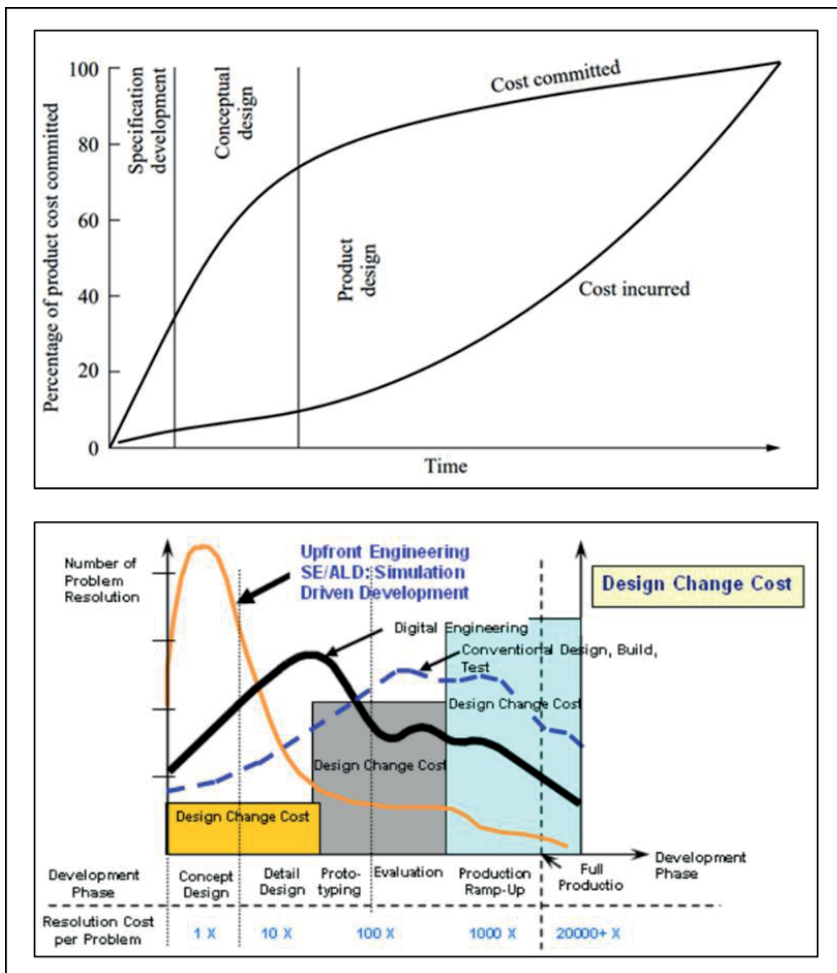

Figure 3. Top: Manufacturing costs during product design stages (Ullmann, 2015), Bottom: Cost of design change at different stages of PDP (Namouz, Summers, Mocko, & Obieglo, 2010)

Furthermore, the cost of design changes in later phases is drastically increasing (Saravi, Newnes, Mileham, & Goh, 2008). Therefore, we are in the phase where activities are not costly but have a significant impact on the overall cost and product's success.

The ideal early design stages of a PDP involve divergent-convergent design thinking to provide maximum possible variants of a product and to consequently choose the best variant (UK Design Council, 2005). Brainstorming, abstraction, and function-based thinking enhance the divergent thinking mode. The designers then narrow down the available solution variants into the most promising one(s) with regard to requirements and analyzing these variants, using convergent thinking mode. Note that the term 'early design stage(s)' incorporates the temporal notion of 'early' which means that the associated design phase depends on the objective of design and does not necessarily indicate any specific phase within the PDP. For instance, embodiment design is considered as an early design stage when integrating manufacturing constraint consideration into the product design. While for other studies this phase might not be considered as an early design stage.

2.1.3 Conceptual Design for Manufacturing

The notions of conceptual design and conceptual modeling are often used interchangeably. Conceptual design is an early phase of a design process, while conceptual modeling refers to a broader concept that is used in other design stages of the PDP as well. The impression of conceptual modeling varies among different research fields. According to Tolk, conceptual modeling in software engineering aims to model a real-world problem independent from solution domain (Tolk, Diallo, King, Turnista, & Padilla, 2010)(Robinson, Arbez, Birta, Tolk, & Wagner, 2015). In Modeling and Simulation (M&S), a Conceptual Model (CM) is the result of making solution design independent of a specific simulation platform. In Systems Engineering (SE), a CM is an information model that captures the essential concepts of a system (requirement, functions, etc.) and the relationships among those concepts. It can include the system's requirements, behavior, structure and its properties (SeBoK, 2017). SE often refers to CMs as meta-models (SeBoK, 2017). The conceptual modeling in this thesis is similar to the impression of M&S and SE community. It is used to conceptualize a system in term of solution-neutral functionality. Note that conceptual modeling is not associated with only early design stages activities, but it is an iterative process that needs to be revisited and referred

during further design or simulation steps (Willemain, 1995). The term ‘appropriate conceptual model’ does not mean that the CM of a system is unique; rather it implies the iterative nature of conceptual modeling to reach a well-defined CM with the appropriate level of detail in respect to modeling objectives (Pace, 1999). Robinson schematizes the conceptual modeling in mainstream iterative simulation studies in Figure 4. The simulation follows the four main processes: conceptual modeling, model coding, experimentation, and implementation. As shown in Figure 4, the CM consists of four components. Those components represent the model’s objective, inputs, outputs, and model content (scope and level of detail) as well as considered assumptions and simplification (Robinson, 2004; Robinson et al., 2015).

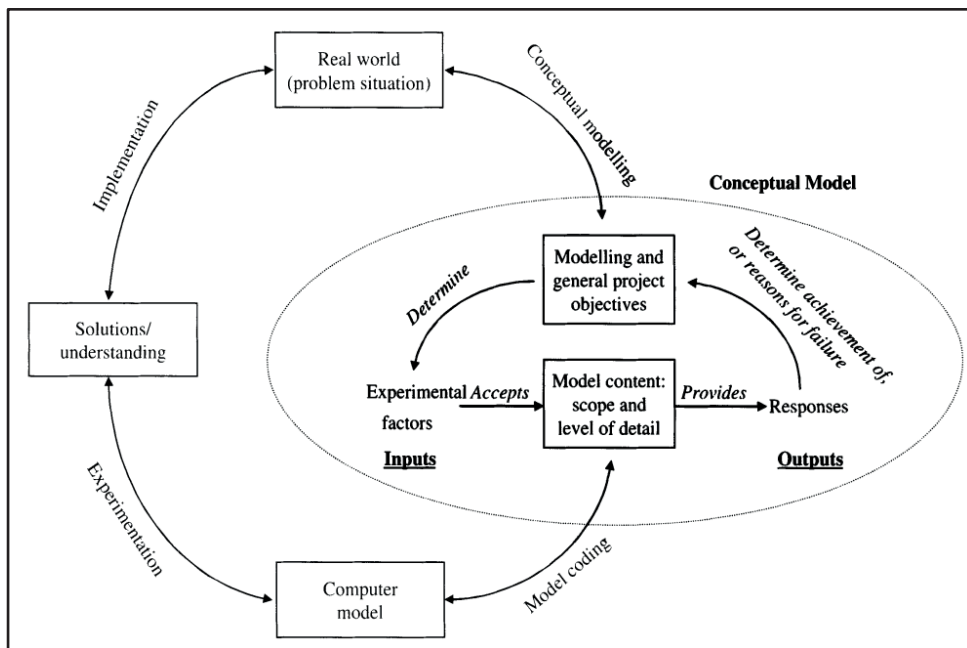

Figure 4. Conceptual modeling in simulation process (Robinson, 2004)

From the systematic design perspective, conceptual design is an initial design phase that follows the task clarification phase, wherein the final goal is to determine the principle promising solution variants that meet product requirements. Figure 5 shows the sequence of steps in conceptual design and embodiment design. Conceptual design phase starts with identifying the design’s essential problem through abstraction, generating possible concepts, establishing and refining functional models, and proposing solution concepts (solution variants).

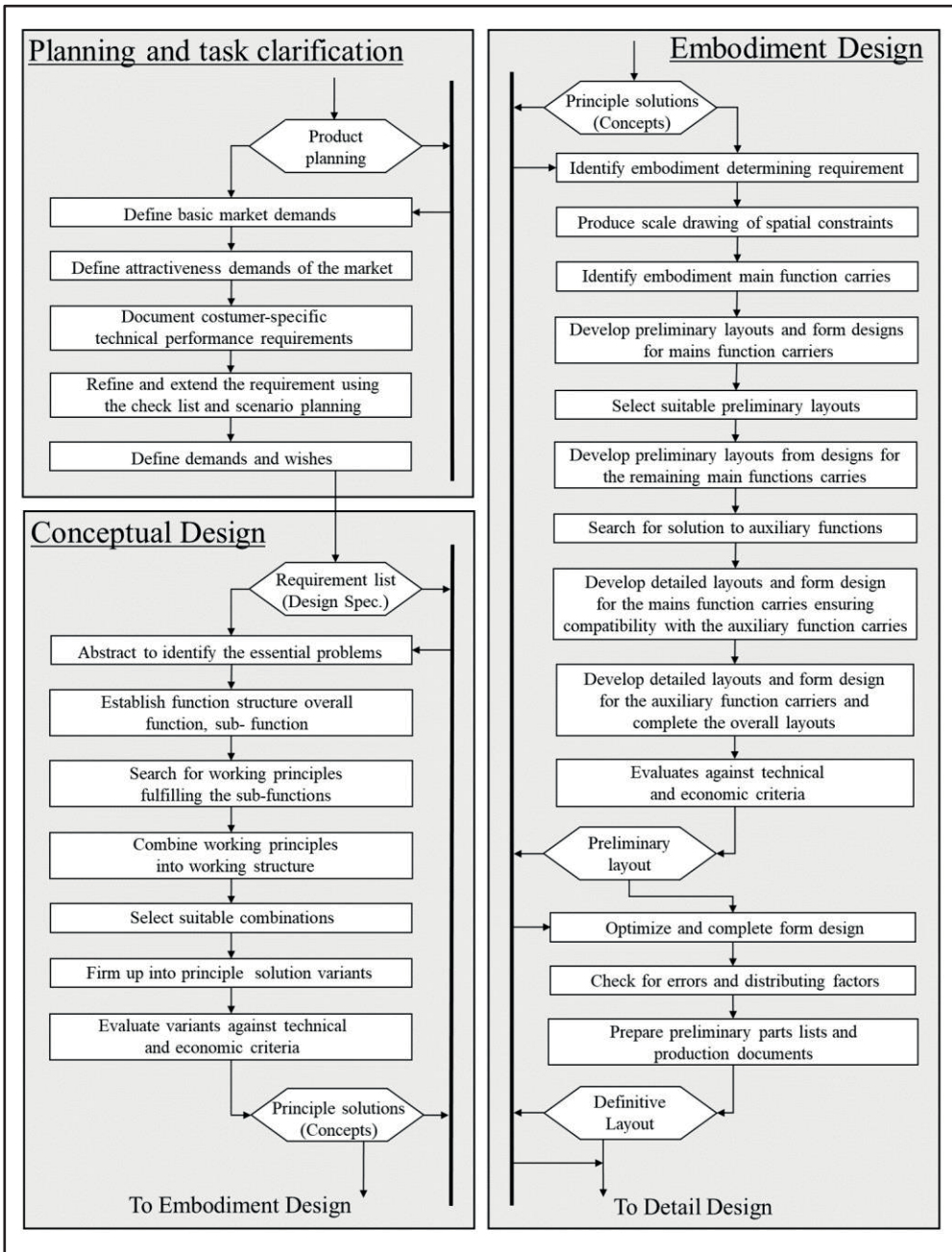

Figure 5. Steps required in setting up requirement lists, conceptual design, embodiment design, rearranged from (Pahl et al., 2007)

The solution variants should be evaluated against technical and economic criteria before going to the next stage of design. The identified best potential solution variants are then used as input to the next stage of design, namely, embodiment design. Establishing functional models and evaluating solution variants are crucial steps in the conceptual design.

As shown in Figure 5, the evaluation of solution variants is required at the end of both conceptual and embodiment design phases. The objectives of evaluating solution variants are to identify the weaknesses of solution variant and consequently filtering the variants that are not promising to satisfy the design requirements. Providing simulation capabilities at these stages is a key toward evaluation objective. Figure 6 illustrates the role of modeling and simulation for solution variant evaluation in the design process. In this context, a solution variant needs an appropriate conceptual model. The conceptual model is defined with respect to the concepts of model hierarchy in terms of abstraction, fidelity, and resolution. This model is then served to simulation process that enables the solution variant evaluation. The concepts of function, abstraction, fidelity are explained in the next section.

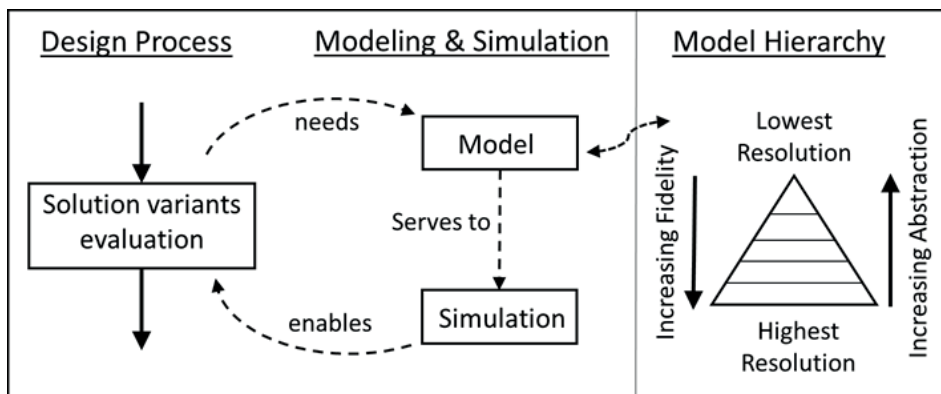

Figure 6. Modeling and simulation role for solution variant evaluation in the design process

The American Society of Mechanical Engineers (ASME) (Schwer, 2009) states that conceptual modeling should enable:

- Assumptions and determination of the components in a computable model.
- Approach to model the system or phenomenon behavior.
- Elimination of unimportant features.
- Selection of interface and boundary types.

Robinson discussed the need for conceptual frameworks to support both the design and development of a system and the simulation of large-scale complex modeling and simulation problems (Robinson, 2008). A conceptual framework should include the following activities (Robinson, 2008):

- Understanding the problem situation.
- Identifying model inputs (experimental factors) and outputs (responses).
- Determining modeling objectives and the model content (scope and level of detail).
- Clarifying assumptions and simplifications.

2.1.3.1 Function Modeling

The term ‘Function’ is a common concept in various disciplines (Dusenbery, 1992; Luhmann, 2013; Stahel, 1997). In mathematics, a function describes the relation between a set of input and output. In engineering, a function is an action or an activity performed to achieve the desired outcome (Hitchins, 2008). From a system-oriented point of view, the functions are the abstract concepts describing the system’s activities. Functions share commonalities among disciplines: relating inputs and outputs with an intended purpose. The concept of function is extremely useful in analyzing complex systems by decomposing the system into its components performing the functions. Function Modeling refers to the activity of developing models describing the functionality of devices, products, processes and their associated subcomponents (Erden et al., 2008). It facilitates the communication and understanding of complex systems across different disciplines.

Affordance is another related concept to function: Both affordance and function represent ways to convey the behavior of a product, process, or systems. Functions refer to the intended behavior of an artifact, while affordance refers to what the environment offers or provides either for good or ill (Gibson, 2015). Function modeling entails analyzing intention, whereas affordance modeling considers possible actions and possible behavior of an artifact (Ciavola, 2014).

In most design methodologies or theories, the arguments about functions do not aim to give a clear definition of the function itself. Their aim is to show how desired overall functions are decomposed into identifiable sub-functions until they correspond to certain entities or design objects. The concrete usage of a function depends on the viewpoint being adapted by the user. In the work of Pahl & Beitz, a functional structure is “a meaningful and compatible combination of sub-functions into an overall function” (Pahl et al., 2007). The functions are classified as main and

auxiliary functions. Main functions are those sub-functions that directly serve the overall desired functionality, and auxiliary functions are the functions that indirectly contribute to the product's overall functionality. In the NF X50-151 standard, a function is "an action of a product or one of its components expressed in terms of finality" (NFX50, 1991). The standard distinguishes two types of functions: service function and constraint function. The service function is "the actions expected of the product to answer the user's needs." The constraint function is the "limitation of the designer's freedom considered to be necessary for the applicant." In Axiomatic Design (Suh, 1990), the concept of function is used to understand the product's functional requirements. Functional requirements are defined as "the minimum set of independent requirements that completely characterize the design objective for a specific need." New product design focuses on the desired functionality of the products, while extra attention should be paid to non-desired functions in reverse engineering or incremental design of the existing products (systems).

Functions are usually used in two ways, for analyzing an existing object by discovering 'How does this object function?' and for designing a new service or artifact by answering the question 'What are the artifact's functions?' In other terms, function modeling can be used to perform reverse engineering analysis (Otto & Wood, 2001) or to create new artifacts. One of the aims of developing functional models is to help designers for abstraction by thinking in functions rather than components. Figure 7 summarizes a few of the most common forms used for the decomposition of a function or functional architecture, such as functional trees, functional structures, octopus representation, coupling matrices, and functional analysis system technique diagram.

Function tree is a visual representation of a system in the form of a tree diagram. It is used to highlight the dependencies among functions of a system by breaking down the overall functionality into simpler functions. Whereas, functional structure (the most commonly used approach) shows the sequence and functional dependencies within a system with different levels of detail. The octopus diagram represents the different elements of the environment and the system to be designed (De la Bretesche, 2000). It allows the listing of the service functions, as well as constraint function of systems. It can be replaced in the SysML language using a use case diagram (Friedenthal, Moore, & Steiner, 2008). Design Structures Matrix (DSM) can be used both to represent a graph and to model the functional architecture of systems or processes (Eppinger & Browning, 2012). A DSM lists all the constituent parts of a system or the activities of a process and the corresponding information

exchange, interactions, or dependency patterns. DSM is a square matrix that maps elements of the same domain and compares the interactions between elements of a similar nature. Following the DSM, the Domain Mapping Matrix (DMM) can map the interactions between functions and components in the same. DMMs associates elements of diverse natures in a matrix format. Function Analysis System Technique (FAST) diagrams can be used to study the functions of a system in the form of ‘how’ and ‘why’ questions. The usage of the FAST diagram is originated from the value analysis discipline (AFNOR, 2011). The functions are described as a verb of action and a measurable noun.

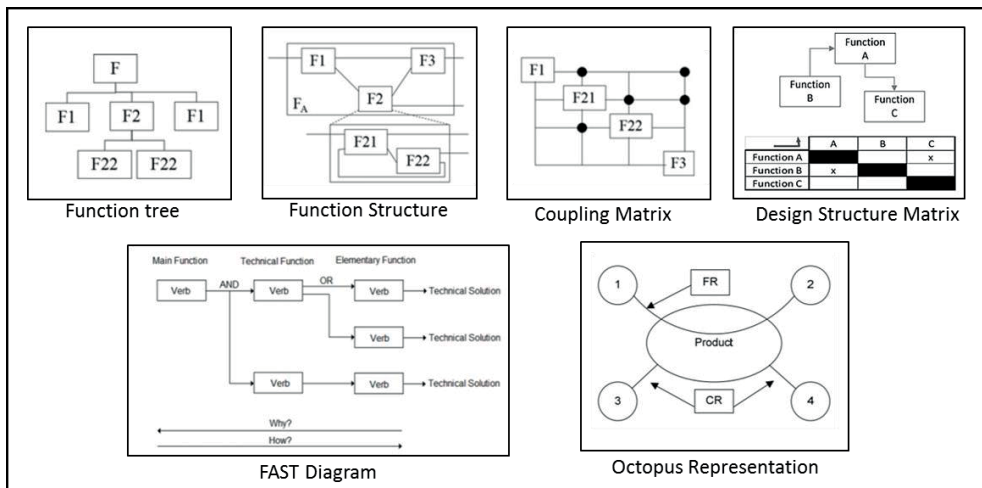

Figure 7. Different functional model representations

The functional boxes themselves can be depicted using three colors to characterize the level of knowledge associated with those boxes (IEEE, 2005). The black box is used when the internal structure and behavior of the function is not known. The white box model represents a function for which the internal structure and behavior of the function is visible and accessible. Consequently, when those characteristics are partly known and accessible, the gray box model is used. Pahl & Beitz considered different types of input and output for the functional boxes. They categorized the inputs/outputs to three types of Energy, Material, and Signal, shown in Figure 8.

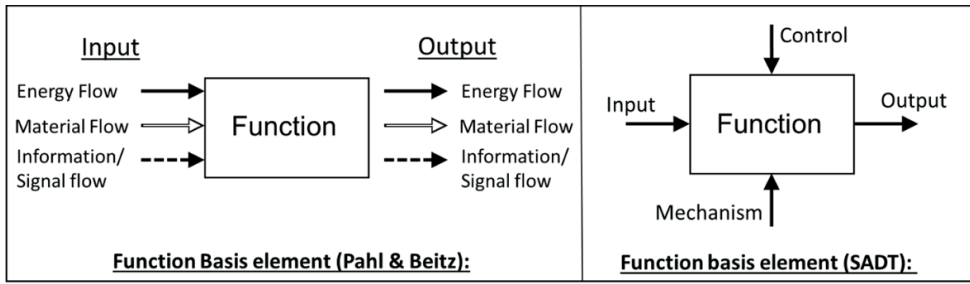

Figure 8. Inputs-outputs in function basis elements (Pahl et al., 2007) (Marca & McGowan, 1987)

In addition to the above mentioned functional architectures, Structured Analysis and Design Technique (SADT) can be used to describe systems as a hierarchy of functions (Marca & McGowan, 1987). This method is used in conceptual design in systems engineering and structured design. As shown in Figure 9, at the highest level of the hierarchy, SADT represents a system with a unique function (F_0).

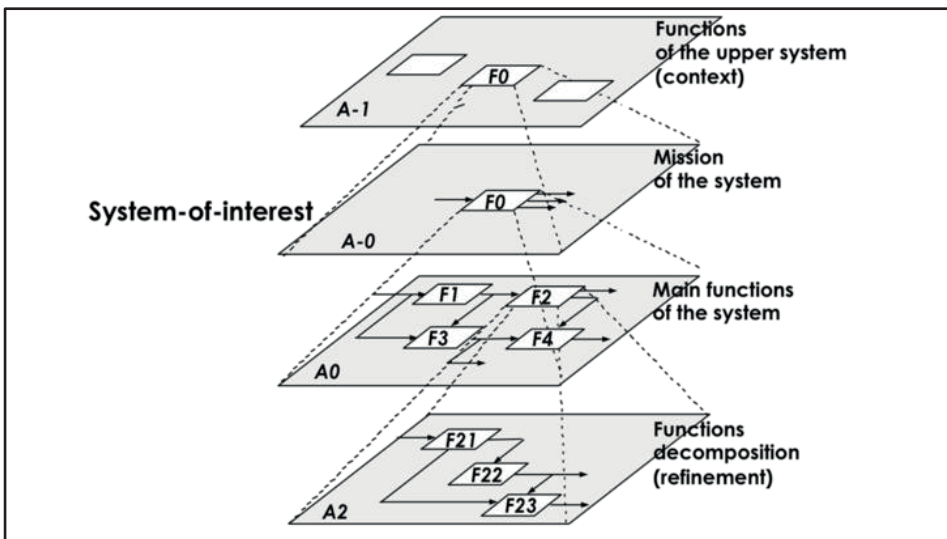

Figure 9. Function hierarchical decomposition (Faisandier, 2013)

This black-box function is often called the mission of the system. One-step lower in the hierarchy, the function (F_0) is decomposed into the sub-functions that are the main functionalities of the system. The function decomposition (refinement) continues until the desired level of detail for the designer, normally until the level that the designer can consider physical solutions for different functions.

Figure 8 depicts the incoming and outgoing arrows in the SADT function basis. Similar to function basis of Pahl & Beitz, the left and right arrows are for inputs and outputs of the function. The upper incoming arrow shows the data required for the function and the incoming arrow in the bottom shows the mechanism applied for the action of function. Refinement in the functional architecture of the systems from the highest level of the hierarchy to the lower levels is discussed as abstraction and fidelity in the following section.

Gero et al. considered the design process as interactions between the triplet of Function, Behavior, and Structure (FBS) (Gero & Kannengiesser, 2004). Figure 10 depicts the interaction of the triplet in product design at three levels. Function level shows the functional hierarchical decomposition explained above, where the high-level functions break down into their sub-functions. The behavior level allocates physical effect to the sub-functions to embody required functions. This level provides the idealized physical effects of the desired product. It acts as an intermediate between the desired functions of the product and the concrete component architecture of the product. The structure level associates the concrete components to fulfill the physical behavior of the intended sub-functions.

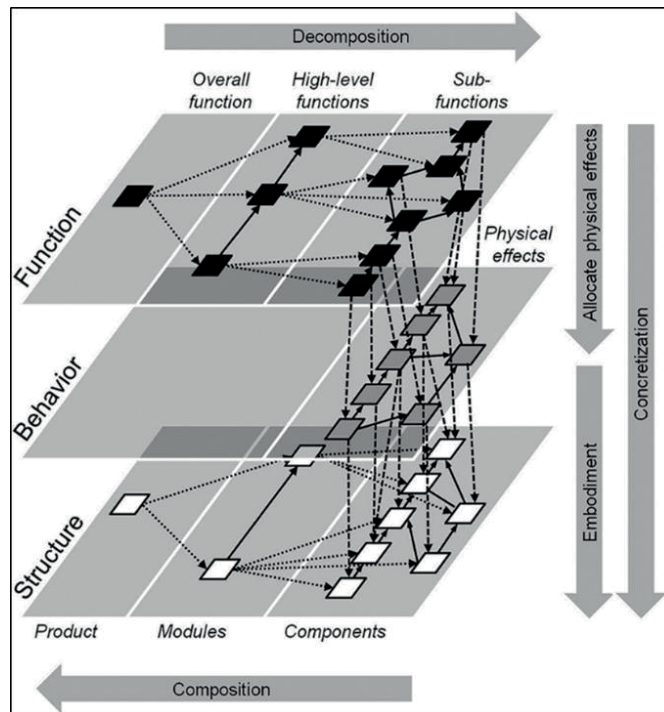

Figure 10. Product model based on FBS and design process steps (Helms & Shea, 2012)

The concretization of the abstract functions in FBS model is done by the Allocation of the physical effect to the functional model and further embodiments to the concrete components.

2.1.3.2 Abstraction, Fidelity, and Resolution

Abstraction and fidelity present two important qualities of a functional model. The fidelity of a model refers to the degree of exactness of the model compared to the real world (Roza, 2005). Moving from a high-level model of an existing system to a more detailed model containing more detailed functions will increase the fidelity of the model (Abbass, 2015). Models with higher fidelity are informative during simulation of an existing system. It is difficult and often impossible to replicate the exact real attributes and behavior of systems (Moon & Hounng, 2013). That is where concepts of resolution and abstractions come to the picture. According to the definition provided by Abbass, resolution is ‘what the modeler intends to model about the problem’ and abstraction is ‘what a modeler decides to include or exclude in the model’(Abbass, 2015). Abbas underlines that resolution is a function of the system while abstraction is related to the model (Abbass, 2015). Abstraction is the selection of essential functions while neglecting the unnecessary functions during the modeling of a system (Roza, 2005). Amin defines abstraction as a process of reducing the behavioral complexity of model while maintaining the validity of the simulation (Amin & Technology, 2015). Models with higher abstraction are suitable for early design stages since they encourage exploration of novel concepts and ideas as possible design solutions. Another related concept in line with fidelity is the concept of concretization. Concretization refers to attributing concrete physical effects on the functions. Eventually, this physical effect can be either an exact physical effect of the system’s component or an analogy of the desired behavior. Thus, increasing the model’s fidelity will increase the concretization of the model, but increasing the model’s concretization does not necessarily increase the model’s fidelity. Helms et al. investigated an approach to concretize the functional model by assigning the physical effect to the functions (Helms, Schultheiss, & Shea, 2013). Abstraction is considered the most fundamental concept in SE because models should focus on a few characteristics of a system in order to be computationally and intellectually manageable (SeBoK, 2017). A widely known abstraction approach is to consider a system as a black-box model, where only inputs and outputs are the point of interest and the internal implementation is unknown or irrelevant.

2.1.3.3 Variability in Function Modeling

Function modeling is a source of high variability, which depends on the modeler's preferences, expertise, and experience in deciding a model's objectives, the level of detail and its abstraction. Variability can exist both in the functional architecture and at the semantic level. Variability as such is not a source of problems if the goal is to generate a large number of solutions. These sources of variability can be a source of creativity during the divergent thinking process in the early design stages. Nevertheless, when repeatability in the models is required in order to communicate function modeling without ambiguity, the variability of function modeling is the source of problems for the modelers during physics-based reasoning analysis. To reduce the variability in functional models, an initial approach followed is to limit the functional vocabulary used during modeling. Hirtz et al. made a significant effort in this direction in their development of a reconciled functional basis (Hirtz, Stone, Mcadams, Szykman, & Wood, 2002). They provided a reconciled list of functional vocabulary along with a list of fundamental energies represented by functions and their names in the form of generalized effort and flow. Several authors in the research community indicate the benefits of the usage of the vocabulary in Hirtz's functional basis vocabulary (Kurfman, Stone, Rajan, & Wood, 2003) (Ahmed & Wallace, 2003) (Sen, Caldwell, Summers, & Mocko, 2010) (Helms et al., 2013).

2.1.4 Embodiment Design

The conceptual design phase is followed by the embodiment design, where the overall possible solutions and preliminary design layouts from the conceptual design phase are available. The solution variants (concepts) are then transferred to a more concrete design. In comparison to the conceptual design phase, more information is available to analyze the solution variants iteratively. Embodiment design is also the starting point of the incremental design (reverse engineering) of existing products. In the former case, it is beneficial to analyze the weaknesses (limitations) and the failure of an existing design layout. Pahl et al. suggest following a number of design guidelines at this stage. They referred those guidelines to Design for X in their book (Pahl et al., 2007). To cite a few, they have proposed design for assembly, design for maintenance, design for recycling, etc. Design for X is the term given to basic rules that help designers to anticipate constraints earlier in the design process. However, Design of X approaches are not limited to this stage and can be applied to all design stages as well. For instance, Design for Manufacturability (DFM) focus on the

anticipation and integration of the manufacturing constraints in the design process. Since there are various manufacturing processes, there are different guidelines for DFM for each manufacturing process to enable designers to design products (parts) that are easy and less costly to manufacture using specific technologies (Boothroyd, 1994). The emphasis of DFM is often on the components (parts to be manufactured) and not on tailoring the manufacturing process itself because it is less costly to adapt to a specific manufacturing process. In addition, it is assumed that the optimization of a manufacturing process is separate from the specifications of the part to be manufactured. However, the former should be questioned in an AM process, where the processes are not yet fully optimized for mainstream manufacturing and consequently finding possible improvements in AM processes is essential and beneficial to the industry.

2.1.5 Evaluation of Solution Variants

The evaluation of the solution variants is a common step at the end of both conceptual and embodiment design phases. This evaluation is a comparative determination of strengths and weaknesses of solution variants with respect to the given objectives or the initial requirements. The clarification of the objective(s) or the evaluation criteria is an essential point. It refers to a fundamental decision-making process, where the designer should evaluate and rationally decide to keep or eliminate the solution variants for the next phases of design. Pahl & Beitz highlighted the need for evaluation methods allowing more comprehensive evaluation (Pahl et al., 2007). The evaluation methods should enable qualitative and quantitative reasoning, contradiction and weakness analysis when limited knowledge is available at the early design stages. Apart from the evaluation process proposed by Pahl et Beitz, Analytic Hierarchy Process (AHP) is a structured method for comparative decision-making among options to select best-fit solution variants (Saaty, 2008). AHP enables a pair-wise comparison between the solution variants with respect to the importance of objective(s) or requirements (Roza, 2005)(Robinson, 2004). Pugh proposed an iterative comparative graphical approach in which the performances of concepts against different criteria are compared with each other (Pugh, 1981). The concept selection proposed by Pugh and Saaty is based on a qualitative comparison between concepts, while systematic evaluation of Pahl suggests to assign parameters to criteria and evaluate the solution variants based on the parameters describing solution variants. DSM is another approach to evaluate solution variants and identify

consistent concepts (Browning, 2015). Hellenbrand and Lindemann presented a DSM-based approach to support the selection of concepts eliminating inconsistent solutions and identifying promising combinations of concepts (Hellenbrand & Lindemann, 2008). Okudan and Touhid highlighted that House of Quality (HOQ) is another method that enables concepts compatibility evaluations (Okudan & Tauhid, 2008). HOQ as a part of Quality Function Deployment (QFD) methodology forms a matrix to map customer needs into engineering requirements to be met by a new product (Terharr, Calusing, & Eppinger, 1993). AHP, DSM, and HOQ utilize the pairwise comparison approach to enable comparing and assessing design options. Since decisions in the early stages of design have a huge impact on the commitment cost and project's cost overruns (Blanchard, 1978), the solution variants should be evaluated from design to cost (DTC) perspective (Michaels & Wood, 1989). Toward this direction, Hari et al. proposed a Conceptual Design to Cost (CDTC) that they claimed to be more efficient than existing DTC methods (Hari, Shoal, & Kasser, 2008). An overview of the concept selection methods concluded that the concept selection suffers from the lack of multi-criteria decision and inability to integrate uncertainty (Okudan & Tauhid, 2008).

2.2 Discussion

Early stages in product development include proposing a variety of possible solutions to satisfy the design requirements. A common concern of the design community is the design fixation, which prevents designers to propose various solution variants. Abstraction is said to be an approach to deal with this issue. Once the solution variants are generated, designers should analyze the feasibility of the initial solutions, consider trade-offs and evaluate the initial solution variants. Concretization of the solution concepts via prototyping or simulation is an essential step toward the evaluation of solution variants. The concretization and this early evaluation of the solution variants are dependent on the designers' experience of providing rationales. Therefore, there is a need for both abstraction and concretization in the early design stages. The concretization does not necessarily require concrete components; it can be some elementary bricks to allocate physical effect to the function (Helms et al., 2013). Those bricks can express energy sources, transformation and storage processes. In this direction, the Bond Graph (BG) theory provides a compact universal list of those elementary bricks that are analogically applicable to different energy domains (D. Karnopp, 1979) (Paynter, 1961). Mapping

functions to BG elements support the iterative interplay between abstraction and concretization at the early design stages. The proposed approach helps to close the gap between abstraction and concretization for evaluation of solutions variant in the early design stages. Nevertheless, it not sufficient without integrating the variables and equations to the functions. The central issue to tackle is how to anticipate modeling and simulation capabilities in early design stages to assess solution variants (design options) and systematic ideation. In order to enhance such early analysis, one possible direction is to enable physics-based reasoning on functional models (Sen, 2011). Sen and Summers identified requirements to enable physics-based reasoning from a functional model (Sen & Summers, 2013). They extracted the following requirements:

- 1- **Coverage:** Covering the knowledge and principles of various domains and their interactions, such as electrical, mechanical, thermal, and chemical engineering.
- 2- **Consistency:** Fulfilling internal property in the representation to prevent internal conflict.
- 3- **Validity with respect to physics laws:** The functional model representation should remain valid against the existing laws of physics in each domain.
- 4- **Physics-based concreteness:** Defining functions in terms of physical actions.
- 5- **Normative and descriptive modeling:** Supporting both developing a functional model for new product design (so-called normative modeling) and the function modeling of an existing artifact, concepts, or physical principles (so-called descriptive modeling).
- 6- **Qualitative modeling and reasoning:** Supporting both qualitative and quantitative reasoning.

This brief analysis of the background illustrates that although existing theories and methods are able to solve the above-mentioned issues to some extent, there is still the need for a framework that meets the above-mentioned requirements provide by Sen and Summers. This framework should be able to systematically:

- Provide an approach to enable analysis of the functionality of the system under investigation, the concretization of the functional models for early evaluation of the solution variants (design options).
- Integrate the variables describing the functions to the model establish a mathematical relationship between them.

- Enable qualitative and quantitative simulation capabilities for evaluating the performance of the solution variants and for detecting the weaknesses and contradictions of the models.

The methodology section describes the modeling framework developed and pursued in this thesis to answer these identified needs in PDP. The modeling framework enables generating conceptual models similar to Figure 4, where the functional model, variables and their associated dimensions are the inputs, and the resultant output is the combination of a set of governing equations and causal graph among variables.

2.3 Additive Manufacturing

This section is an introduction to AM. It introduces the AM technologies addressed in the thesis and well as discussion on other AM related topics such as design for AM, variability, and metamodeling in AM.

2.3.1 Additive Manufacturing Classification

Numerous classifications are available for AM technologies based on various criteria. More often, AM processes are classified according to the type of raw material input and baseline technology (Kruth, Leu, & Nakagawa, 1998; Levy, Schindel, & Kruth, 2003). These classifications enhance the selection of an appropriate process by comparing the processes' capabilities and limitations. The American Society for Testing and Materials (ASTM) classified the AM processes into seven categories (Standard ASTM., 2012). Among seven AM categories, Powder Bed Fusion (PBF), Material Extrusion and Direct Energy Deposition (DED), the following three categories are addressed in this thesis. Figure 11 depicts a classification for the essential AM processes, adapted to (Standard ASTM., 2012) and (Kruth et al., 1998).

Despite providing useful information, these classifications do not elucidate all shared similarities among the AM process. Therefore, it is not suitable to use a single classification approach (D.W. Rosen, 2010). An ontology approach is an alternative approach. Dinar and Rosen suggest developing an ontology to formalize knowledge for DFAM. Use of ontology facilitates expressing knowledge and capturing information from benchmark and comparative studies (Dinar & Rosen, 2016).

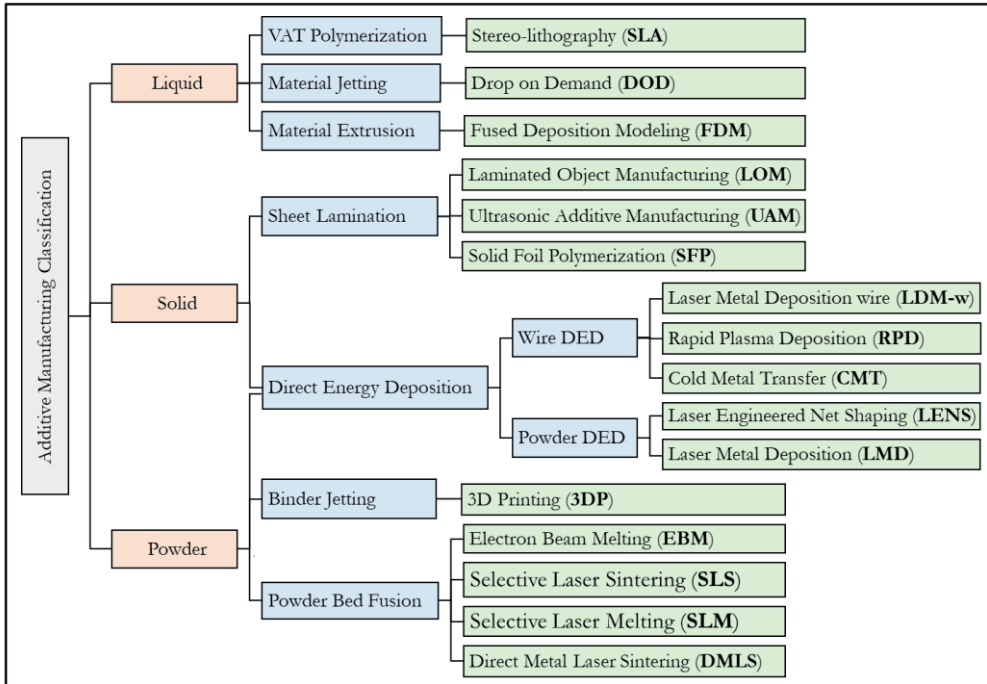

Figure 11. A classification for additive manufacturing processes

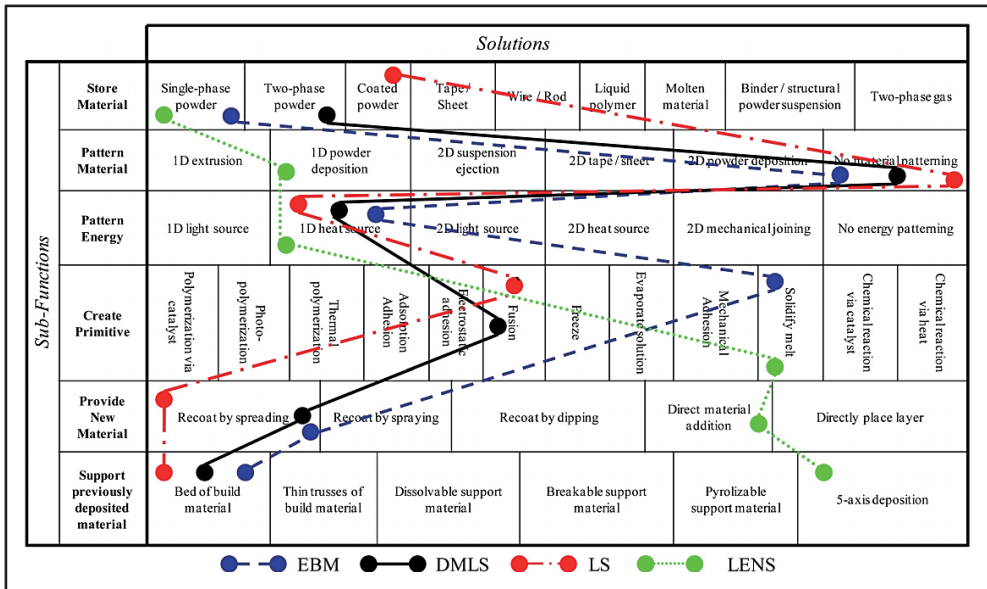

Figure 12. Additive manufacturing processes mapped according to their functions (Williams & Rosen, 2016)

A function-based classification framework proposed by Williams and Rosen targeting functional commonality among AM technologies (Williams & Rosen, 2016). They decomposed the primary function of converting raw material into connected solid primitives in an additive manner into several limited sub-functions and considered different possible solutions for fulfilling the sub-function using Zwicky morphological matrix (Zwicky, 1967). Figure 12 maps the provided solutions to the principle sub-functions for few AM processes. This classification offers an opportunity for the conceptual design of new AM technologies (Williams & Rosen, 2016).

2.3.2 Powder Bed Fusion

Electron Beam Melting (EBM), Selective Laser Melting (SLM), and Selective Laser Sintering (SLS) are the prominent processes of this category (Gu, Meiners, Wissenbach, & Poprawe, 2012). PBF processes deposit layers of powder and consequently use a laser beam (or an electron beam) as the source of energy to melt or sinter powder at specified locations to achieve the desired geometry. When a layer is completed, the machine provides a new layer of powder. The same process iterates until the covering the full geometry. PBF technologies offer a unique ability to provide parts with high-resolution features. The multi-physics nature of the process together with a significant number process parameters limit the reliability and repeatability of the PBF processes and consequently slow down their integration in the manufacturing mainstream. Residual stress, porosity, cracking are some of the most critical issues in PBF processes (Mindt, Desmaison, Megahed, Peralta, & Neumann, 2018). Despite recent progress, according to the report of Lawrence Livermore National Laboratory, the qualification of additively manufactured parts remains a hurdle, which might be tackled by multiscale and multi-physics modeling approaches (King et al., 2014).

2.3.3 Direct Energy Deposition

Direct Energy Deposition (DED) is also known as Direct Metal Deposition (DMD). DED processes are suitable for building the near-net-shape geometry of complex large parts, adding feature(s) to the existing components or for repairing damaged components (Wilson, Piya, Shin, Zhao, & Ramani, 2014) (S. M. Thompson, Bian, Shamsaei, & Yadollahi, 2015)(W. Wang, Pinkerton, Wee, & Li, 2007). In powder

DED processes, the powder is conveyed to the build surface through the nozzle. The laser beam forms a melt pool on the substrate into which the powder is fed. The nozzle moves on a predefined path and deposits the material layer by layer until the part is complete. The wire DED processes share similarities in principles except that the feedstock is wire, and the energy source is either electron beam, laser beam or plasma arc. The performance and dimensional accuracy of the parts are highly dependent on the uniformity and repeatability of deposited bead geometry (thickness, height, and profile) and the predefined path planning. Machine parameters settings, as well as laser and powder parameters, Influence the bead geometry. Figure 13 illustrates the classification of influencing variables in DED. Multiple publications on bead geometry prediction and path planning are available for DED processes. Kumar et al. applied dimensional analysis to model the material deposition and predicted the thickness of a single bead (Kumar, Sharma, Choudhary, Chattopadhyaya, & Hloch, 2013). Other researchers developed the empirical models based on experimental data to predict the height and thickness of overlapping bead (Ruan, Tang, Sparks, Landers, & Liou, 2008)(Xiong, Zhang, Gao, & Wu, 2013). In the research work of (Ding et al., 2016), a neural network model is established to efficiently determine the optimal parameter settings for desired bead geometry prior to path planning (Ding & Cuiuri, 2015) (Ding et al., 2016).

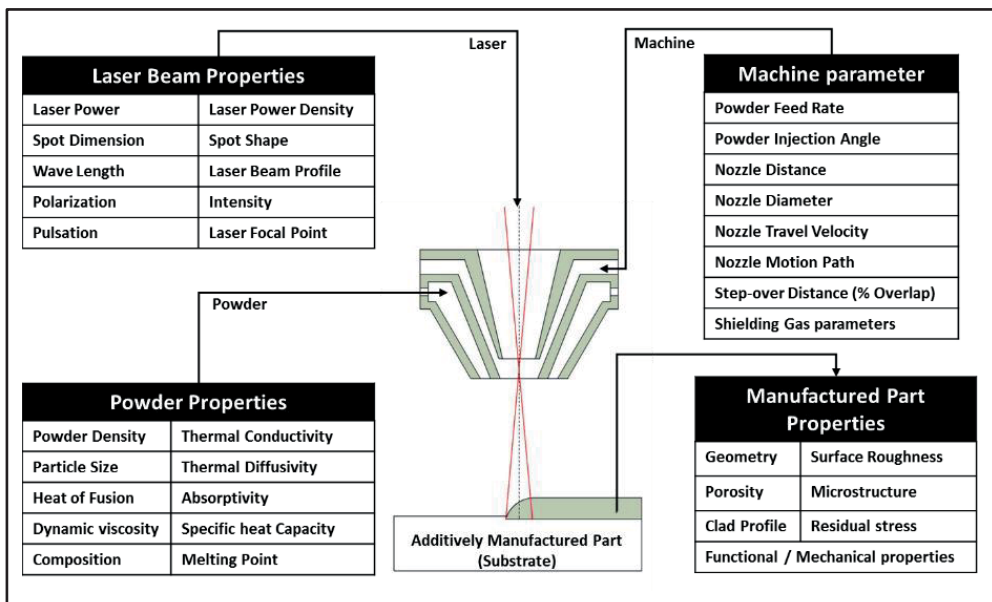

Figure 13. Variable classification for Direct Energy Deposition (Publication I)

2.3.4 Material Extrusion

Fused Filament Fabrication (FFF) also known as Fused Deposition Modeling (FDM) uses a movable nozzle to deposit the molten thermoplastics (i.e., ABS or PLA) onto a substrate. The filament is fed into a liquefier and is melted by an electrical heater. The molten polymer is extruded from a nozzle located on the head of the liquefier. At the same time, the extruder moves to deposit the melted material at the appropriate coordinates, according to a predefined pattern. Once the deposition of the material on a layer is completed, either the extruder is incremented up, or the platform is lowered down to a controlled height so that the next layer can be deposited. The process continues layer by layer until the desired complete geometry is reached. The dimensional accuracy, bonding quality, and final mechanical properties of the part are dependent on the melted polymer flow rate and its temperature (Bellehumeur, Li, Sun, & Gu, 2004; Sun, Rizvi, Bellehumeur, & Gu, 2013). They are directly affected by the filament feed rate and the temperature of the heat source. Studies show that the liquefier has complex behavior because of (but not limited to) (Bellini, Guceri, & Bertoldi, 2004; Yardmci, 1999):

- Uneven distribution of the input heat flow.
- Gradual change in the physical state of the filament inside the liquefier.
- Modeling complexity of heat transfer in the liquefier.

Most studies focus on the effect of the process parameters on parts' quality but few on the behavior of the liquefier itself. Bellini et al. investigate the behavior of the liquefier by developing a mathematical model of the physical phenomenon taking place in the liquefier and comparing the results with experimental data (Bellini et al., 2004). Other authors applied the Finite Element Method (FEM) to predict the melt front in the liquefier (Yardmci, Hattori, Guceri, & Danforth, 1997), the pressure drop of the melt flow and the temperature gradient of the melt (Nikzad, Masood, Sbarski, & Groth, 2009). Literature indicates that models have been produced but with a limited scope. **Publication IV** aims at developing a model with a broader scope for the usage at the conceptual design stage. A recent article of the author attempts to enhance model interpretability and reusability of models for the FDM process (Nagarajan et al., 2019).

2.3.5 Design for Additive Manufacturing

Design for Manufacturability (DFM) also known as design for manufacturing is the process of tailoring product design by anticipating manufacturing issues during the design stages of PDP. DFM approaches aim at improving the quality, performance, reliability, and profitability of a product by reducing the development time and cost (Anderson, 2004). Design For Manufacturing and Assembly (DFMA) methods systematically involve identifying available manufacturing and assembly techniques and understanding their associated capabilities and limitations (M. K. Thompson et al., 2016). These Design for X (DFX) methods belong to a more global context called Design Theory and Methodology (DTM). The ultimate aim of DTM is to provide methodologies enhancing systematic design that meets the required specification in respect of manufacturing constraints.

The advent of AM as an alternative manufacturing method have significantly reduced the manufacturing constraints and increased the design freedom while providing unique capabilities for shape, material, and functional complexity (D.W. Rosen, 2010). Nevertheless, the current AM technologies are relatively weak for criteria such as geometrical tolerances, dimensional accuracy, surface roughness, thermal dissipation and repeatability in the quality of the manufactured part. However, the unique capabilities offered by AM technologies motivate the researchers to revisit DFM methods to take benefits of these emerging technologies.

An analysis of AM impact on the DTM indicates that conventional DTMs are not capable to fully benefit from the unique capabilities of AM (S. Yang & Zhao, 2015). Yang et al. categorize the design methods related to AM into three categories (S. Yang & Zhao, 2015). The research outputs of the first category aim at providing guidelines and a general set of design rules to improve designs by taking advantage of AM capabilities (ASTM-International, 2017) (Adam & Zimmer, 2014) (Klahn, Singer, & Meboldt, 2016). Those studies are often case-specific using experimental approaches (Adam & Zimmer, 2014). In a broader scope, ASTM released design guidelines to cover design opportunities and limitations of AM processes (ASTM-International, 2017). The second category modifies conventional DTM for AM to improve the design process in an AM context (Boyard, Rivette, Christmann, & Richir, 2013). The third category contains specific approaches for Design for DFAM (S. Yang & Zhao, 2015). This category identifies the commonality in manufacturing capabilities, the constraint and limitations of the available AM, and proposes design methodologies suitable for different AM technologies (R. Ponche, Hascoet, Kerbrat, & Mognol, 2012) (Remi Ponche, Kerbrat, Mognol, & Hascoet, 2014) (Vayre, Vignat,

& Villeneuve, 2012). The majority of research efforts in this category focus on AM structure optimization such as topology optimization (Rezaie, Badrossamay, Ghaie, & Moosavi, 2013) and lattice structures (C. Yan, Hao, Hussein, & Raymont, 2012). This category also seeks for systematic design methodologies for AM (Kumke, Watschke, & Vietor, 2016). Dinar et al. proposed an ontology-based DFAM to guide designers in understanding the limitations and capabilities of various AM technologies (Dinar & Rosen, 2016). In the same direction, Ponche et al. proposed a global approach to obtain part design by taking into account both design requirements and manufacturing constraints (R. Ponche et al., 2012) (Remi Ponche et al., 2014). The critical review of Yang et al. outlines that most of DFAM methodologies are in the phase of semantic representation and provide limited support to use the full potential of AM and underlines the need for more specific AM design methodologies (S. Yang & Zhao, 2015).

The above-mentioned methods are technology-driven methods that attempt to find a compromise between the design rules and existing AM technologies (AM machines). This limits to achieve the full potential of AM technologies. William et al. stated that future development in AM is becoming application-driven and it either involves new AM processes that specialize in the specific type of parts or tailors AM processes to adapt the manufacturing of the desired parts (Williams, Mistree, & Rosen, 2011). In other words, the exiting technology-driven methods focus on tailoring the part design and process parameter settings, while the application-driven approach focuses on tailoring AM machine design. Currently, there is a lack of a systematic method to detect machines' weakness for machine design tailoring. Concurrent consideration of part and process is the key to effective weakness contradiction. **Publication IV** addresses this research gap by presenting the DACM framework as a method to develop simulatable integrated models.

2.3.6 Variability in Additive Manufacturing

The round-robin studies conducted by National Institute of Standards and Technology (NIST) demonstrate the variability in the parts' characteristics produced with same AM processes and same parameter settings (Brown et al., 2016) (Moylan, Brown, & Slotwinski, 2016). The study categorized the variability into two categories. The between-participants variability that considers the produced parts by different participants, and within-participants variability that deals with the variability among the parts produced by the same laboratory. According to their report, between-

participant variability was considerably greater than the within-participant variability. Being aware of the variability in AM is an eye-opening point toward developing an effective certification for the additively manufactured part. It probably entails the integration of machine learning techniques and uncertainty analysis in addition to multi-physics modeling expertise in order to predict the parts' characteristics, more accurately.

2.3.7 Metamodeling in Additive Manufacturing

The multidisciplinary nature of the simulations and multi-objective optimization of large models, make the simulations time-consuming and expensive. The ever-increasing advancement of computer science increases the computational capabilities of the tools such as Finite Element Method (FEM) and Computational Fluid Dynamics (CFD), which enables to run the complex simulation. However, simulating these multidisciplinary complex models are highly time-consuming that makes the iteration of simulations practically impossible (G. Wang & Shan, 2007). Simulating computationally intensive models entails faster, yet accurate methods. To alleviate the issue, Blanning was among the pioneer researchers that proposed the concept of metamodeling (Blanning, 1975). Metamodeling in simulation discipline refers to the methods and techniques for developing a simpler approximation model, so-called meta-model, in order to approximate a computationally intensive simulation (Shan & Wang, 2010). While the model is an abstraction of the real-world system, a meta-model is then another level of abstraction. Figure 14 represents the concept of meta-model in one of the early-published surveys on metamodeling in manufacturing (Yu & Popplewell, 1994). Shan and Wang reviewed the metamodeling techniques in engineering design optimization and indicated the techniques are increasingly used in the discipline (Shan & Wang, 2010).

In AM context, despite the advancement in M&S (Bikas, Stavropoulos, & Chrysosouris, 2016), the impact of M&S efforts on a reliable comprehensive understanding of AM still remained limited due to:

- Variety in AM process: equipment specification and limitations.
- Variety in available materials: material choice and material properties.
- Numerous variables associated with AM technologies.
- Multi-physics nature of AM processes which entails coupled (integrated) models.

- Lack of reusability of models: diversity in purpose, constraints, scale and level of detail.
- Experimental variability and measurement challenges of various features.

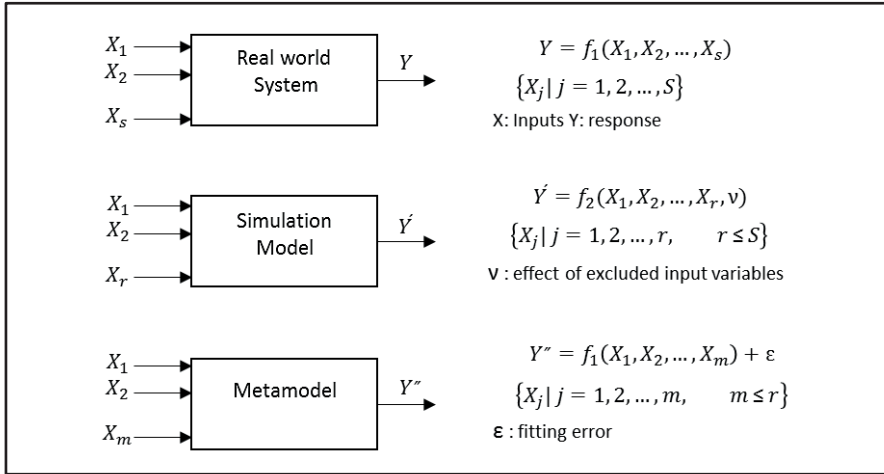

Figure 14. A simple representation of the classical meta-model concept (Yu & Popplewell, 1994)

Yang et al. addressed the challenges in the complex interaction of numerous physical phenomena occurring in the process. They have sought for an approach to construct a predictive meta-model from limited empirical datasets (Z. Yang, Eddy, Krishnamurthy, & Grosse, 2016). Their approach proposes using a statistical random sampling method (such as Latin Hypercube Design). The meta-model is then built based on selected initial data from larger available data. An iterative error updating technique enhances the convergence of the meta-model to the non-selected data. Their approach, even though promising, does not provide any physics-based insight into the existing theoretical knowledge in the field. The second limitation is that the method does not favor the model reusability, which means that the approach should be applied to different AM processes, separately.

ASTM's definition of meta-model is more relevant to this thesis. ASTM defines meta-model as a model developed to enable integrating multiple models and representing relationships among different models (Standard ASTM., 2012). Metamodeling in simulation discipline is linked with the abstraction of the model. It is an attempt to reduce the simulation complexity and interactions while still maintaining the validity of the simulation. Nevertheless, the ASTM definition of metamodeling is more about architectural perspective which aims at integrating models and representing relationships among models. Witherell et al. demonstrate

that creating a meta-model supporting the models' reusability requires model classification to simplify the complexity of AM processes (Witherell et al., 2014). The simplification is done in term of reducing the variability in how AM models are defined, constrained and developed. Therefore, their metamodeling approach involves with a classification capturing parameters and relationships among them which ensures the choosing the right sub-processes, specifying input, output, and boundary condition and constraints for each model correctly (Witherell et al., 2014). In a related research article, Roh et al. investigate the inter-relationship between different laser models and thermal models existing in the literature (Roh et al., 2016). They have proposed an ontology-based metamodeling approach to identify the causal connections among the AM parameters in different thermal models and different types of laser models. They have highlighted the need for data reconciliation and creating meta-model. The ability to integrate the existing theoretical models is the advantage of their ontology-based approach (Roh et al., 2016). Considering ANN as an example of the metamodeling approach, the application of ANNs face the central issues of reusability and interpretability. The results of ANNs are case-specific and often challenging to interpret. ANNs oversees the systems and processes as a black box. This means that the pre-existing knowledge of engineers on the processes or systems has not been used. The results of the ANNs are not reusable to model another type of machines or processes and even the machine with the same type processes. A recently published paper indicates a proof of concept for breaking down an ANN describing the whole system into several small ANNs provide higher interpretability and model reusability (Nagarajan et al., 2019).

2.4 Discussion

The brief review of the current situation of AM reveals the great potential to boost the manufacturing and industrial competences due to the unique capabilities offered by these technologies. However, the integration of these technologies slowed down due to issues such as variability and lack of repeatability of the additively manufactured parts which requires a complete and deep understanding of the AM processes. The multi-physics nature of the phenomenon associated with each technology makes the understanding of those processes challenging. Recent advancement in modeling and simulation enhances the understanding of the complex multi-physics nature of AM processes. Nevertheless, the integration of

models that are (being) developed with specific purpose, constraints and different level of detail, remains a hurdle. Toward this direction, there is a need for a metamodeling approach to enable the integration of the models and machine learning techniques.

The philosophy of concurrent engineering recommends considering the capabilities and constraint of manufacturing processes, earlier in the design phase of a part (product). The work of Witherell et al. also implicitly highlights the importance of concurrent consideration of the AM process and the part to be manufactured (Witherell et al., 2014). It justifies the need for a modeling framework enabling the integration of different model and developing a concurrent model of the process and the part to be manufactured. This can enhance a greater reliance on models and simulations for part and process qualification (Witherell et al., 2014). Keeping in mind that future development in AM is becoming application-driven, it is necessary to have a systematic approach to detect the weaknesses of AM machines for machine design tailoring.

This thesis aims at contributing to the modeling and simulation in AM by developing and applying a generic systematic approach to present models that integrate manufacturing processes and the part to be manufactured. The goal of the thesis at this stage is to develop a systematic general modeling approach that is applicable to all manufacturing processes through analyzing the functions taking place in the process. The thesis contributes to DFAM using integrated models and highlight the weaknesses of part design and AM machines.

The modeling framework developed in the thesis is a metamodeling approach. It aims at addressing the central issue of interpretability and reusability of models in additive manufacturing. It is also necessary that the metamodeling approach enable machine-learning techniques, due to the variability of AM.

Chapter 3 describes the developed methodology in detail. The second section of chapter 4 discusses the contribution of the thesis to the AM-related subjects, such as DFAM, metamodeling, and concurrent part-process modeling.

3 METHODOLOGY

This chapter introduces the Dimensional Analysis Conceptual Modeling (DACM) framework as the modeling approach in the thesis. The theoretical backgrounds of the framework have been extensively described in the previous publications **Publication II**, **Publication III** and **Publication IV**). This chapter includes the extensions and algorithms developed for DACM framework in the context of the thesis.

3.1 DACM Framework Modeling Steps and Associated Theories

DACM framework was initially developed as a specification and verification approach for complex systems (Coatanéa, 2015). It provides an approach to integrate theories and methodologies related to engineering design, modeling, and simulation. The framework offers a systematic modeling procedure to establish the causality among the variables describing the system's behavior. It enables model integration and providing capabilities to the qualitative and quantitative simulation of the integrated models. Hence, the framework is a suitable approach for metamodeling purposes. Figure 15 visualizes the sequence of steps in DACM and the theories integrated into the framework (**Publication III**).

The modeling starts with a precise definition of the system's border and the model's objectives. Function modeling represents the sequence of functions taking place in the Systems-of-Interest (SOI). This step is followed by variable assignment to the functional model. Applying DACM's causal rules and color patterns lead to extract the colored causal graph among the system's variables. In the next step, dimensional analysis is applied to the causal graph to establish the system's behavioral equations. The primary result of this modeling is a colored hypergraph and a list of governing equations. This model is used further for qualitative or quantitative simulations and contradictions detection.

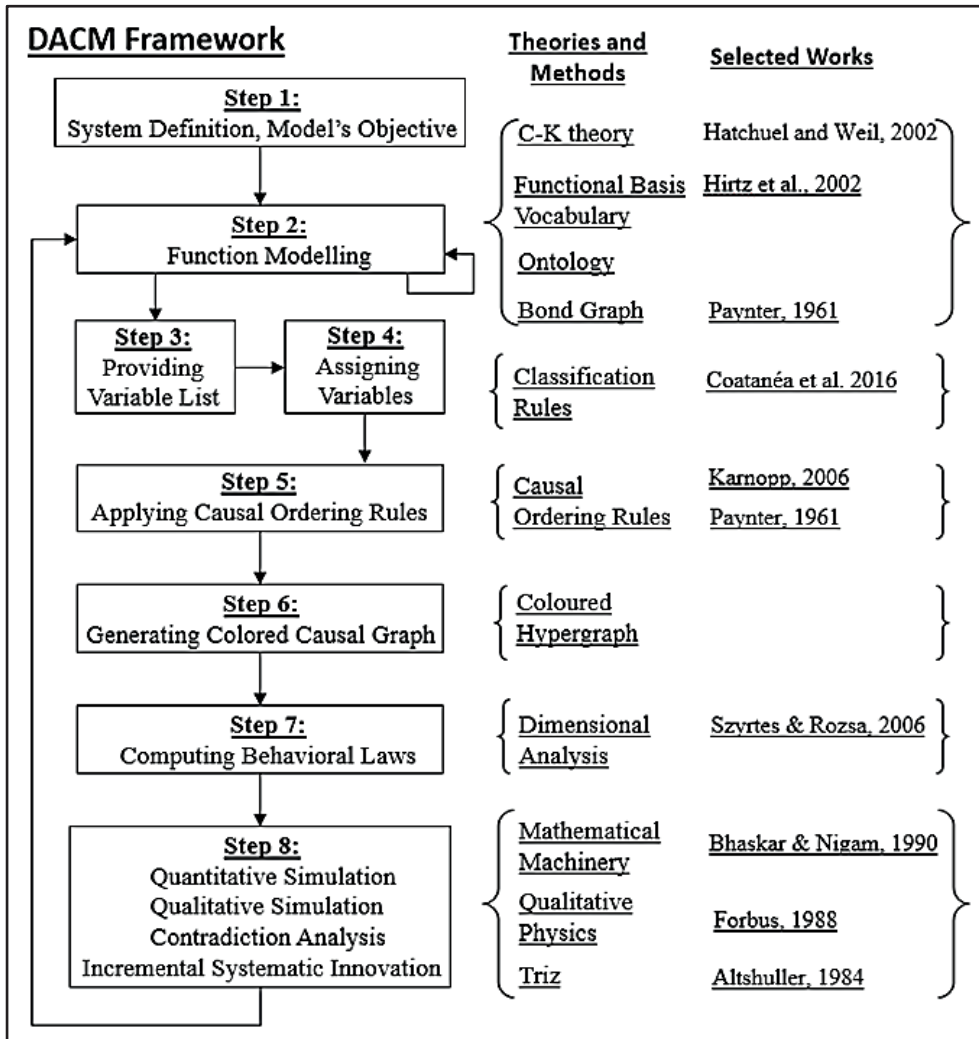

Figure 15. Modeling steps in DACM framework (Publication III)

3.1.1 Function Modeling and Variable Assignment

Function modeling is a crucial step in the DACM framework, since the ultimate system's causal graph and consequently, the final analysis is heavily dependent on the produced functional model. The function modeling in the framework is followed by variable assignment to functional model. This step requires iterative attempts to reach adequate functional architecture with the desired level of detail. The starting point can be either an existing system (existing design solution) or a new conceptual

system. Developing functional model in DACM depends on the purpose of the model, required detail and availability of the knowledge and equations prior to the modeling process.

Developed functional model in **Publication I** is suitable for the new conceptual system design or modeling an existing system with higher abstraction when limited knowledge is available, and the overall functionality of the system is important. The overall functionality of the system is decomposed into the sequence of functions interacting with each other. Functions are represented with verbs of actions in boxes and are connected to each other with arrows in respect of the sequence of occurrence. Figure 16 exemplifies function modeling for the DED process, where the overall functionality of ‘deposit melted material’ is decomposed into the sequence of functions.

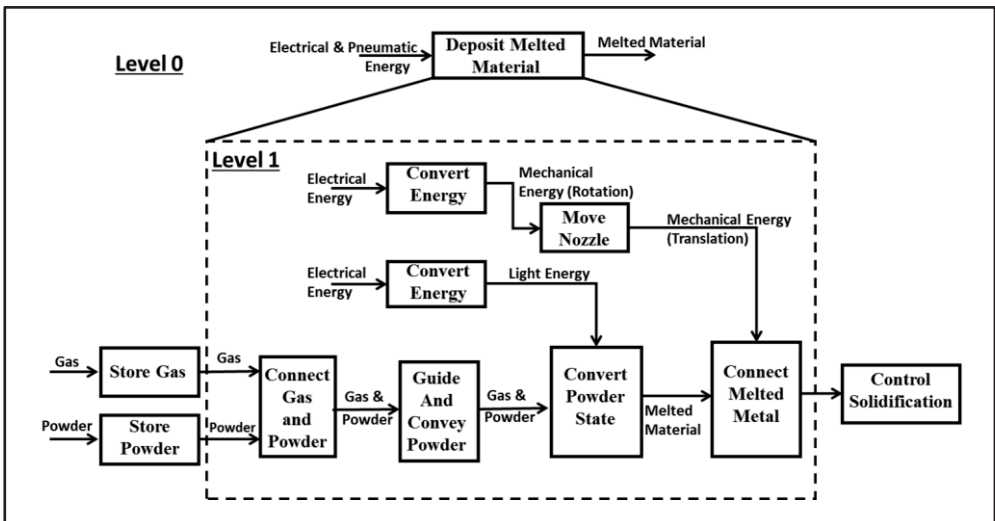

Figure 16. An example of function modeling in DACM framework (**Publication I**)

The fundamental categories of variables, listed in Table 1, guide the variable assignment to the functional model. The power variables (including flow and effort) are attributed to the arrows that connect functions and the state variables are assigned inside function boxes. Afterward, DACM established the system’s causal graph and behavioral laws. This approach is followed to model the DED process (**Publication I**) and Torpedo (**Publication II**) case studies. The extraction of the causal graph depends on the sequence of functions and the category of variables. The produced functional models at this stage are not unique: the model’s level of detail and the variable assignment depend on the modeler’s reasoning. This

motivates to develop a more systematic manner for the concretization of functional model and variable assignment, in case of reverse engineering and incremental designs where already a detailed functionality of the SOI is available.

Table 1. Fundamental categories of variables

Primary Category of Variables	Secondary Category of Variables
Overall system variables	Energy (En)
	Efficiency rate (η)
Power variables (P)	Generalized effort (E)
	Generalized flow (F)
State variables	Generalized displacement (D)
	Generalized momentum (M)
	Connecting variables (C)

The functional model developed in **Publication III** is established by transforming the initial functional model into a ‘generic functional model’ derived from Bond Graph (BG) theory in a systematic manner (Paynter 1961) (D. C. Karnopp, Margolis Donald L, & Rosenberg Roland C, 2012). To reduce the modeling variability and facilitate the systematic transformation of the initial functional model to the generic functional model, DACM proposes to use a limited set of functional vocabulary introduced by Hirtz (Hirtz et al., 2002). The reason for allocating BG elements to the functions is to take advantage of the validated causal rules in BG theory and analogy among different energy domains. Table 2 represents the mapping between function vocabularies to the nine generic functional blocks.

The variables are then assigned to the generic functional model based on the second category of Table 1. Regardless of the energy domain, the variables are classified into five generalized categories: Flow, Effort, Momentum, Displacement, and Connecting (Paynter 1961) (Coatanéa, 2005). The mathematical relationship between generic variables describes how those variables relate to each other. In each energy domain, power variable is the multiplication of effort and flow. For instance, in the electrical domain, voltage and current are equivalents of generalized effort and flow, respectively. Table 3 lists the mapping of generalized categories of variables for several energy domains.

Table 2. Functional mapping for models transformation (to generic functions blocks) (**Publication III**)

Possible Name of Functions to Describe the Organs	Functional Basis Vocabulary	Generic Blocks	Functional
To transform effort into flow or flow into effort. To resist effort or flow.	To Magnitude		To Magnitude (Resistor: R)
To transform flow into displacement. To store displacement. To transform displacement into effort. To provide effort.	To Magnitude To Provision		To Provision (Capacitor: C)
To transform effort into momentum. To store momentum. To transform momentum into flow. To provide flow.	To Magnitude To Provision		To Provision (Inertia: I)
To transform input effort into output effort of another magnitude. To transform input flow into the output flow of another magnitude.	To Signal To Magnitude To Convert		To Convert (Transformer: TF)
To transform input effort into the output flow of another magnitude. To transform input flow into output effort into output effort of another magnitude.	To Convert		To Convert (Gyrator: GY)
To connect the efforts of different magnitudes when flows are similar. To connect the flow of different magnitudes when efforts are similar.	To Branch To Channel To Connect To Support		To Connect (Flow Junction: JF) (Effort Junction: JE)
To provide a constant effort. To provide a constant flow.	To Provision		To Provision (Source of Effort: SE) (Source of flow: SF)

Table 3. Domain-specific state variables (adapted from **Publication III**)

Energy Domain	Generalized Effort	Generalized Flow	Generalized Momentum	Generalized Displacement
Electrical	Voltage (Volt)	Current (Ampere)	Flux Linkage (Volt second)	Charge (Coulomb)
Hydraulic Pneumatic	Pressure (Pascal)	Volumetric flow rate (m ³ /s)	Pressure Momentum (kg/m.s ²)	Volume (m ³)
Mechanical (Rotational)	Torque (Newton-meter)	Angular Velocity (rad/s)	Angular Momentum (kg.m ² /s)	Angle (Radian)
Mechanical (Translational)	Force (Newton)	Linear Velocity (m/s)	Momentum (kg.m/s)	Displacement (m)
Thermal	Temperature (Kelvin)	Entropy flow rate (J/k/s)	---	Entropy (J/k)
Thermal (Pseudo-BG)	Temperature (Kelvin)	Heat flow rate (J/s)	---	Heat energy (Joule)

‘Displacement’ is the result of the integration of the ‘Flow’ over time. Equation (1) indicates that the integration of the electrical current (I) over time is equal to the charge (q). The charge is equivalent to the ‘Displacement’ in the electrical domain. The generalized ‘Momentum’ is the result of the integration of ‘Effort’ over time. Flux linkage (known as ‘Momentum’) is defined in equation (2), where U (known as ‘Effort’) is the potential difference between two terminals of an electrical element.

The ‘Connecting’ variables proposed by Coatanéa (Coatanéa, 2005) cover the other variables that are not in the four above-mentioned categories and are used to describe the material properties, geometry dimensions, etc. For instance, consider Ohm’s law in Equation (3), which indicates the relation between the voltage and current in a conductor. The connecting variable (R), known as the resistance, creates the relation between ‘Effort’ and ‘Flow’.

$$\int I. dt = q \quad (1)$$

$$\int U. dt = \lambda \quad (2)$$

$$U = IR \quad (3)$$

Figure 17 summarizes these relations, where the state variables (Momentum, Connecting, and Displacement) are located inside the elements, and the power variables are located outside the elements. This ‘generic function modeling’ in this thesis, is pursued in **Publication III** to analyze the reverse engineering of product design.

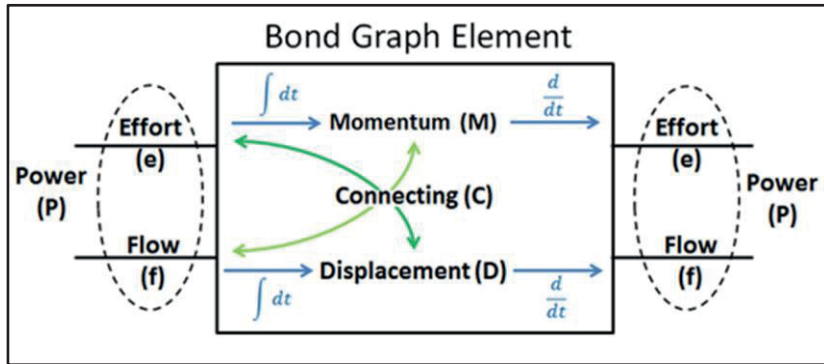

Figure 17. Representation of the generic variables and their interconnections (**Publication III**)

DACM framework enables the integration of the existing theoretical and experimental equations when some knowledge and equations are available at the beginning of the design or modeling process. The existing models and equations are integrated into the function modeling phase or later directly to the causal graph and list of equations. **Publication IV** and the work published in recent paper (Nagarajan et al., 2019) present an integrated model of the FDM process and the part to be manufactured.

3.1.2 Causal Graph

In this step, DACM defines the cause-effect relationship among the variables in the form of a colored causal graph. DACM considers the following color pattern (four main classes), depending on the border of the SOI and the design nature of variables:

- Exogenous variables (Black/Gray) are outside the system border and part of the system’s environment. They are imposed on the system, and the designer cannot (would not) modify their values.
- Independent variables (Green) are the variables that are not influenced by other variables in the system. The designer can freely modify the values.

- Dependent design variables (Blue) are influenced by other variables such as exogenous and independent variables. It is more difficult to modify and control the dependent variables.
- Performance variables (Red) are the objective variables. They usually belong to the category of dependent variables as well. They are selected by the designers to evaluate the performance of a system.

The causal relationship among variables for generic functional models is built upon the existing validated causal rules in BG theory. Figure 18 illustrates the causality rules in different BG elements (Paynter, 1961). The source, inertial and capacitive elements have fixed causalities, while the other the causality in other elements varies according to the neighbor elements.

Bond Graph Element	Schematic view	Bond Graph Element	Schematic view
Source of effort (Se) Fixed effort-out causality		Source of flow (Sf) Fixed flow-out causality	
Capacitor (C) Fixed effort-out causality		Inertia (I) Fixed flow-out causality	
Resistor (R) Preferable effort-out causality (Resistive)		Resistor (R) Preferable flow-out causality (Conductive)	
Transformer (TF) Maintain incoming causality (two-port element)		Transformer (TF) Switch incoming causality (two-port element)	
Effort Junction (JE) or (0) (multi-port element) Only one incoming effort $e_1 = e_2 = e_3 = e_4$ $f_1 + f_2 + f_3 + f_4 = 0$		Flow Junction (JF) or (1) (multi-port element) Only one incoming flow $f_1 = f_2 = f_3 = f_4$ $e_1 + e_2 + e_3 + e_4 = 0$	

Figure 18. Causality in the main Bond graph elements (Publication III)

The cause-effect relationship is not only dependent on the sequence of functions but also the nature of the BG element and the type of the assigned variables. An algorithm shown in Figure 19 is developed to automatize the causal graph extraction. The algorithm first verifies the one-to-one mapping between functional blocks and BG elements. Afterward, it travels into the structure and applies the fixed causality and other associated deduced causality. The loop continues until completely covering the generic functional model (BG elements). The existence of any contradiction in this level demonstrates that the functional model is not valid or the

assigned BG element is incorrect. The functional architecture and assigned variables give an initial insight into the final causal graph. The causal rules considered for the functional models are the following:

- 1- The variables that appear earlier in the functional model are the cause of the variable(s) appearing afterward.
- 2- The exogenous and independent variables are always the cause of other variables.
- 3- The incoming Flow is the cause of Displacement (by integration over time).
- 4- The incoming Effort is the cause of Momentum (by integration over time).
- 5- The Displacement is the cause of outgoing Flow (by derivation over time).
- 6- The Momentum is the cause of outgoing Effort (by derivation over time).
- 7- The Connecting variables are the cause of outgoing Effort or outgoing Flow.

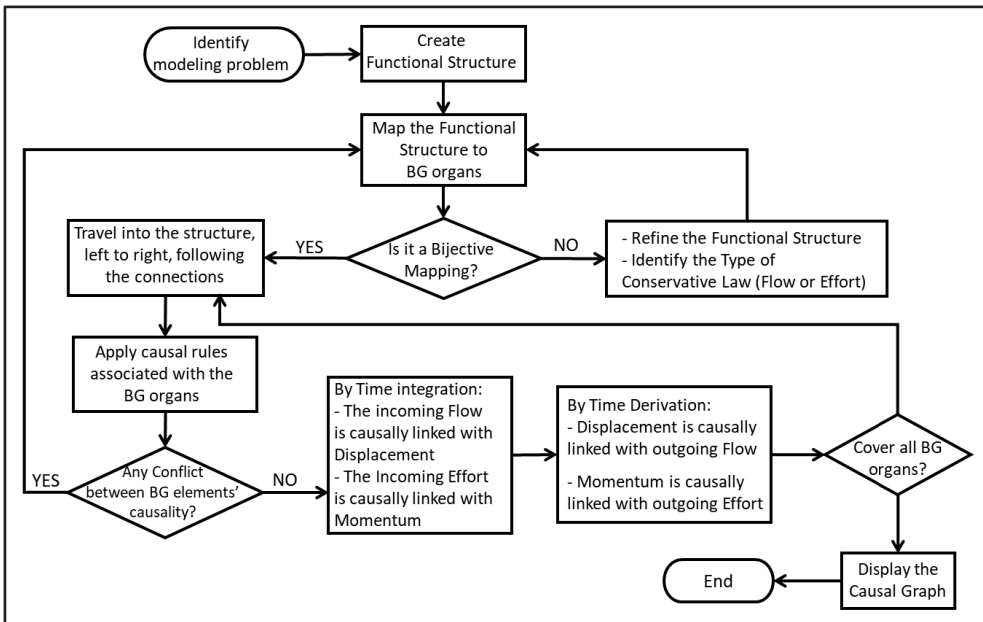

Figure 19. Description of the causal ordering algorithm (Publication III)

3.1.3 Dimensional Analysis

Dimensional Analysis (DA) in the DACM framework seeks to deduce the mathematical relationships among variables. Initially, this step follows the causal graph and establishes the mathematical relationships among variables by applying homogeneity principals and Buckingham's π -theorem (Barenblatt, 1996). The opposite direction is pursued, in the case of enriching (building) the causal graph with existing theoretical or experimental equations. The inputs for dimensional analysis are the cause-effect relationships in the form of (4) and the associated dimensions of variables.

$$y_i = f(x_{i1}, x_{i2}, \dots, x_{ij}), \quad 1 \leq j \leq n \quad (4)$$

Based on the input information, DA finally provides the mathematical relationship among variables in the form of equation (5) Where $\{x_{i1}, x_{i2}, \dots, x_{in}\}$ are the influencing (cause) variables and y_i is the performance (effect) variable and $\{\alpha_{ij} \mid 1 \leq j \leq n\}$ are the exponent of variables. In another term, DA seeks for finding suitable exponent for the variables to respect the dimensional homogeneity principle. Equation (5) is called π -number or dimensionless number for variable y_i .

$$\pi_{y_i} = y_i \cdot x_{i1}^{\alpha_{i1}} \cdot x_{i2}^{\alpha_{i2}} \dots x_{ij}^{\alpha_{ij}} \quad (5)$$

The physical quantities are expressed in terms of the combination of seven basic dimensions. The basic dimensions are mass (M), length (L), time (T), temperature (t), electrical current (A), amount of substance (N), and luminous intensity (J). For instance, the dimensional term 'MLT⁻²' shows the dimension of the 'Force.' Let the term x_{ij} defines the dimension of an arbitrary variable of x_{ij} , where the bases (M, L, T, etc.) are basic physical dimensions, and the exponent (a, b, c, etc.) are the dimensional exponents. Equation (6) symbolically represents the dimensions of variable x_{ij} using seven basic dimensions. Homogeneity principal is respected when the following system of equations shown in (7) is satisfied. Note that the variable exponents (α_{ij}) are calculated by DA, while the dimensional exponents (a, b, c, etc.) are intrinsic to the unit definition of the variables.

$$x_{ij} = Dim(x_{ij}) = M^a \cdot L^b \cdot T^c \cdot t^d \cdot A^e \cdot N^f \cdot J^g \quad (6)$$

$$\begin{cases} a_{y_i} = \sum_{j=1}^n \alpha_{ij} \cdot a_{ij} \\ b_{y_i} = \sum_{j=1}^n \alpha_{ij} \cdot b_{ij} \\ \vdots \end{cases} \quad (7)$$

The algorithm depicted in Figure 20 describes the procedure of presenting dimensionless equations in this thesis. The algorithm forms a matrix for each dependent (blue) and performance (red) variables. The matrix contains all influencing variables and their associated dimensions. The initial matrix is then separated into two sub-matrices [A] and [B] in a way that [B] only contains the variable for which we are seeking a dimensionless equation. The algorithm proceeds to calculate and represent the π -number equation, if [A] is a non-singular matrix.

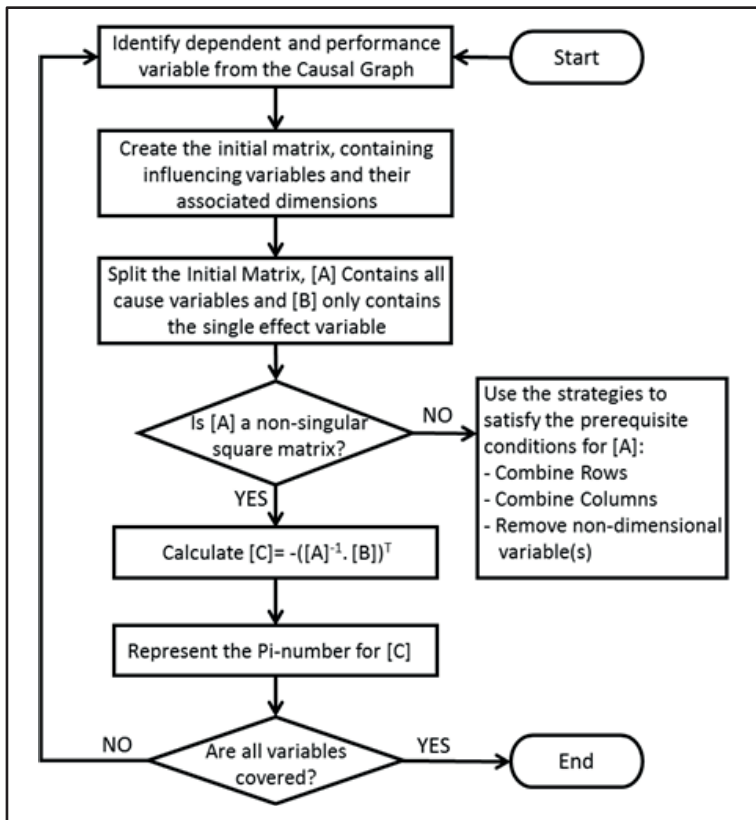

Figure 20. Description of the behavioral law computation algorithm (Publication III)

The algorithm computes the exponent of the dimensionless number, using the following simple formula shown in equation (8), where [C] is a vector matrix representing the exponents of variables in [B].

$$[C] = -([A]^{-1} \cdot [B])^T \tag{8}$$

The example below illustrates the construction of behavioral law from the causal graph, using DA. Figure 21 shows the extracted causal graph from a given partial functional model. The functional architecture models the material input in DED process, where the associated variables are: material providing pressure (Pr), material density (ρ), Nozzle diameter (N_d), and material mass flow rate (m). The causal graph depicts the causes and effect variables that are reformulated in (9).

$$m = f(Pr, \rho, N_d) \tag{9}$$

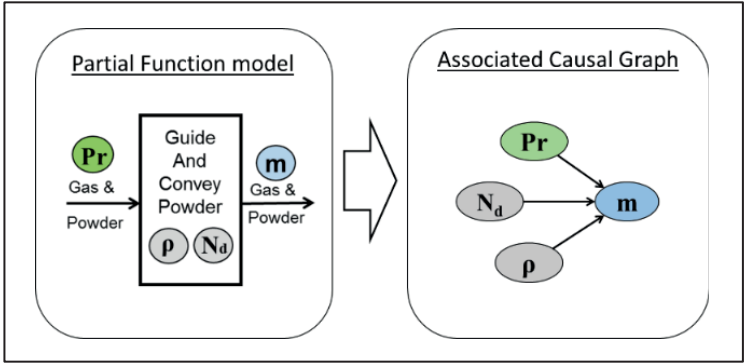

Figure 21. Left: An example of the functional model. Right: and its associated causal graph

Table 4 shows the matrices [A] and [B] that contain all influencing variables and their associated dimensions for the variable (m). The target variable fills [B] and all other cause variables from [A].

Table 4. Matrices [A] and [B] for the variable (m) derived from the causal graph in Figure 21

	[B]	[A]		
	m	Pr	N_d	ρ
Mass	1	1	0	1
Length	0	-1	1	-3
Time	-1	-2	0	0

In this case, [A] is a non-singular square matrix, so the calculation of [C] reveals the exponents of influencing variables for creating a dimensionless product. Equation (11) is the dimensionless number for the variable (m) in which the exponents are calculated in (10).

$$[C] = -([A]^{-1} \cdot [B])^T = -\left(\begin{bmatrix} 1 & 0 & 1 \\ -1 & 1 & -3 \\ -2 & 0 & 0 \end{bmatrix}^{-1} \cdot \begin{bmatrix} 1 \\ 0 \\ -1 \end{bmatrix}\right)^T = [-0.5 \quad -2 \quad -0.5] \quad (10)$$

$$\pi_m = m \cdot Pr^{-0.5} \cdot \rho^{-2} \cdot N_d^{-0.5} \quad (11)$$

Let us consider another simple example formulated in (12), for which the [A] is not a square matrix. Here Q is the required energy to heat up material with from the initial temperature (T₁) to the higher temperature (T₂). Variables (m) and (C_p) are the mass and specific heat capacity of the material. The initial matrix for the variable (Q) in Table 5 demonstrates that [A] is not always a square matrix, and not necessarily meet the non-singularity prerequisites. It justifies having an algorithm to build up [A] which meet the prerequisites mentioned above, systematically.

$$Q = f(m, c, T_1, T_2) = f(m, c, \Delta T) \quad (12)$$

Table 5. Initial matrix for variable (Q) derived from (12)

	Q	m	C _p	ΔT
Mass	1	1	0	0
Length	2	0	2	0
Time	-2	0	-2	0
Temperature	0	0	-1	1

Figure 22 illustrates the algorithm developed for satisfying the prerequisite of non-singularity of [A]. A non-singular matrix is a square matrix that has matrix inverse, or in another word, a square matrix with nonzero determinant. After creating [A] and [B], the algorithm first eliminates the non-dimensional variables to avoid having columns of zeros in [A]. In the next step, the algorithm compares the rank of [A] with its size. Let's consider Rank [A]=r and Size [A]=(n*m). If the rank of [A] is smaller than the size of the matrix (r < (min (n, m))), it means that at least two rows or columns are linearly dependent, which lead the determinant of the following matrix to be zero. At this stage, [A] is not necessarily a square matrix. Therefore, the

algorithm considers three main scenarios. In the scenario I, where the number of columns (variables) in $[A]$ is more than the number of rows (dimensions), we need to combine two variables in the initial matrix. This combination is in the form of algebraic summation among the matrix entities with the same dimensions. In the same way, two rows (dimensions) should be combined in scenario II to make the matrix $[A]$ a square matrix. Scenario III is related to the situation where the $[A]$ is already a square matrix. If the determinant is zero, the algorithm combines two rows and two columns, simultaneously. To assure that $[A]$ is of non-singular, the algorithm applies the same procedure on the new obtained matrix. Finally, if the determinant of $[A]$ is non-zero, $[A]$ and $[B]$ matrices are sent to the π -number computation. Table 6 illustrates the split matrices for the variable (Q). This example follows scenario II where we need to combine two rows. The dimension (t) and (T) are combined. Different grouping and positions of the variables in columns are leading to different dimensionless products. Table 6 shows one possible arrangement.

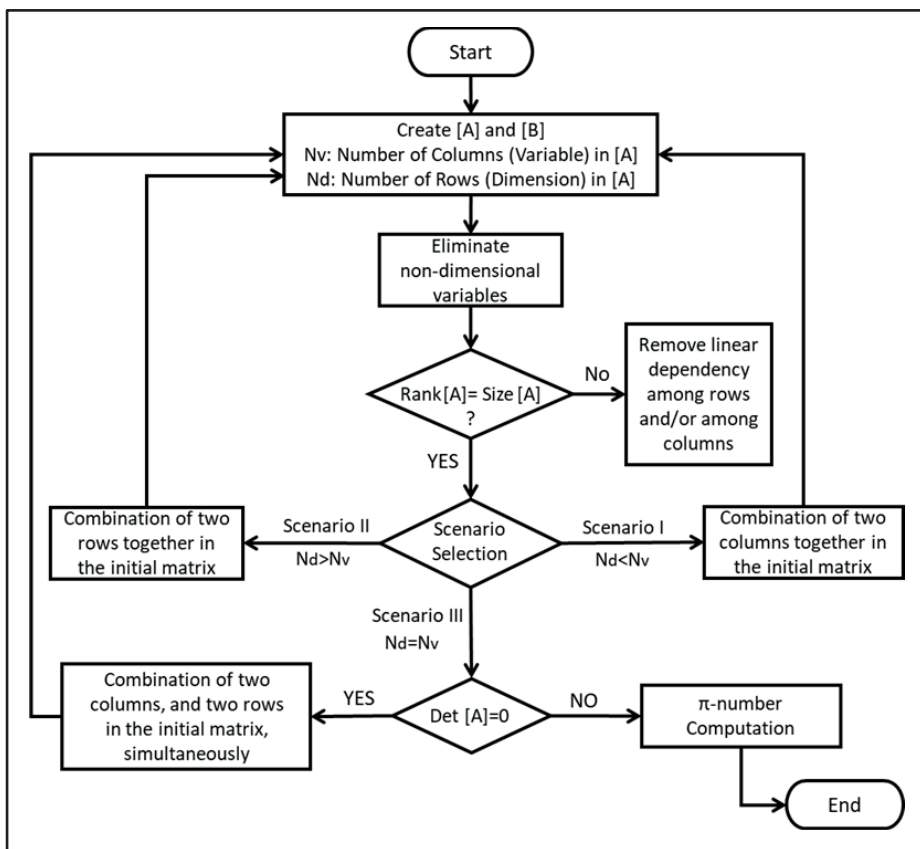

Figure 22. Description of the algorithm for non-singularity of $[A]$

Table 6. Split matrices [A] and [B] for the variable (Q) derived from the initial matrix in Table 5

	[B]	[A]		
	Q	m	C_p	ΔT
Mass	1	1	0	0
Length	2	0	2	0
Temperature*Time	-2	0	-3	1

As mentioned above, DACM is capable of enriching the model with the existing theoretical and experimental equations (**Publication IV**). Nevertheless, the empirical equations for fitting the experimental results often seem to be non-homogenous. Figure 23 illustrates the algorithm for re-writing these equations to be dimensionally homogeneous.

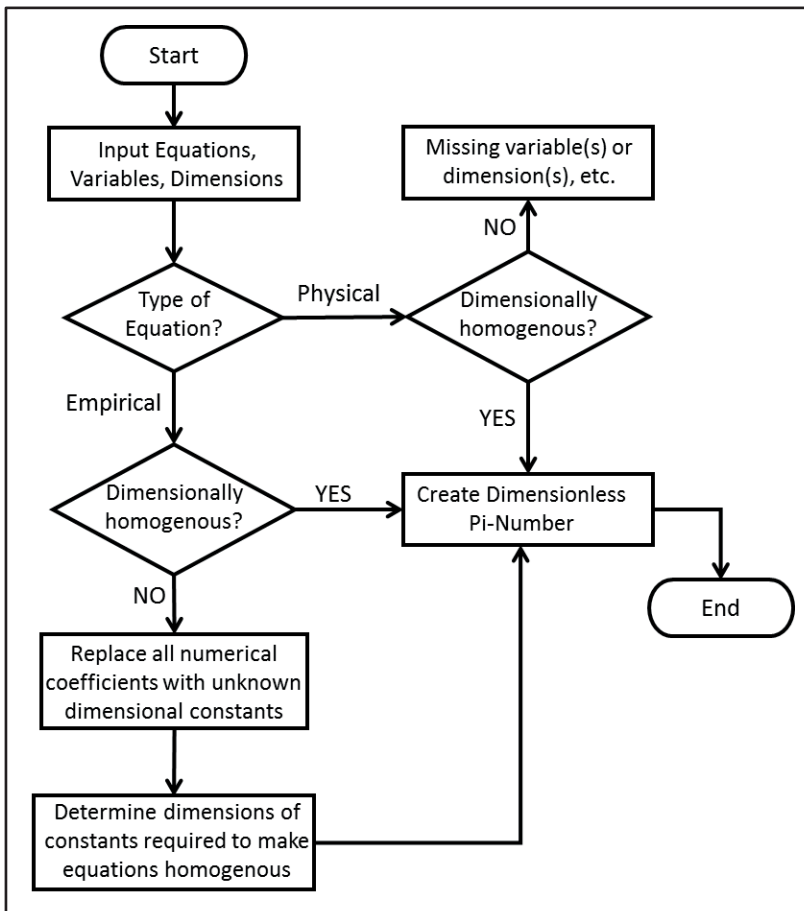

Figure 23. Description of the algorithm for equation integration

3.1.4 Qualitative Simulation (Backward Propagation)

Once the causal graph is established and associated behavioral laws are extracted, DACM enables the qualitative simulation using mathematical machinery developed by (Bhaskar & Nigam, 1990). This qualitative simulation is called backward propagation in this thesis. The machinery obtains the sign of the partial derivative of y_i concerning x_{ij} , from equation (5), as follows:

$$\frac{\partial y_i}{\partial x_{ij}} = -\alpha_{ij} \frac{y_i}{x_{ij}} \quad (13)$$

The objective of qualitative simulation can be either maximizing or minimizing the performance variable(s). A positive sign in the partial derivative indicates that the variable considered in the partial derivative varies in the same direction as the variable considered in the objective. Otherwise, in the case of a negative sign, the variable varies in the opposite direction. It is possible to apply the backward propagation principle to more than one performance variables simultaneously (multi-objective qualitative simulation).

The contradictions and weaknesses of the system appear, after conducting the backward propagation of the system's objective(s) in the causal graph. The contradictions are detected when one or more variables need to be maximized and minimized at the same time to fulfill the system objective(s). Figure 24 shows the contradiction detection algorithm from qualitative simulation. The qualitative simulation is applied to the **Publication II**, **Publication III**, and **Publication IV**.

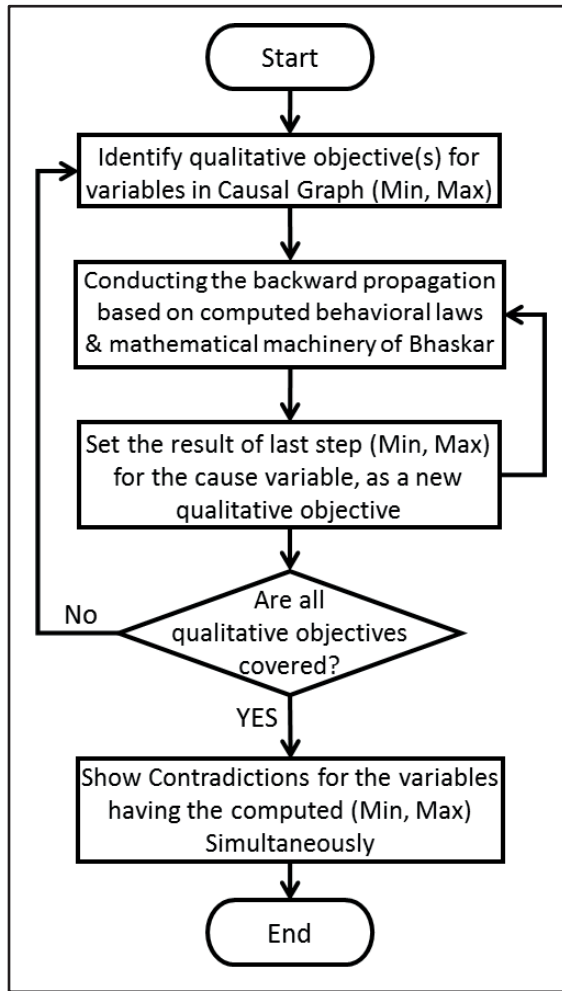

Figure 24. Contradiction detection algorithm (Publication III)

3.2 Illustrative Modeling Examples and Energy Domain Analogy

Two examples with simple governing physics are considered to exemplify the methodology explained above. The first example demonstrates the iterative modeling of RLC circuit by navigation between concept space and knowledge space (Hatchuel & Weil, 2003). This example also shows the use of analogy in establishing causal rules among different energy domains. The second case study is dedicated to the contradiction detection in the pipe insulation.

3.2.1 RLC Circuit

The modeling starts with thinking and identifying a need in the concept space. The identified need or requirement here is to filter the radio frequency. To answer this need, there are existing solutions in the knowledge space. Let us consider that one would consider the RLC circuit and would need to integrate the architecture of RLC circuit in the system in order to filter the radio frequency. Figure 25 illustrates the modeling procedure of the RLC circuit.

The modeling continues in the concept space by function modeling. The functional model in the concept space connects the functionality of electrical components such as resistor, inductor, and capacitor. The functional model at this stage does not consider the way that components are connected to each other (parallel or series). Two design variants are then available in the concept space for RLC circuit: parallel circuit and series circuit. The generic functional model in the knowledge space aims at providing more concretization to the yet abstract functional model in the concept space. Here the series RLC circuit is chosen where the current is constant for all RLC components. Functional boxes are then mapped to the BG element, where 'e' and 'f' stand for effort (voltage) and flow (current) respectively.

Variables are then assigned to the associated functions. Table 7 summarizes the variables assigned to the generic functional representation of the RLC circuit. It is assumed to model an existing RLC circuit with a variable resistor that enables the tuning functionality. Thus, variables 'L' and 'C' are shown as exogenous variables because they have been fixed and cannot be modified and 'R' is considered as a dependent design variable. Once the generic functional model is established and variables are assigned, the DACM algorithms are used to build the causal graph and consequently the calculating the governing equations of the model.

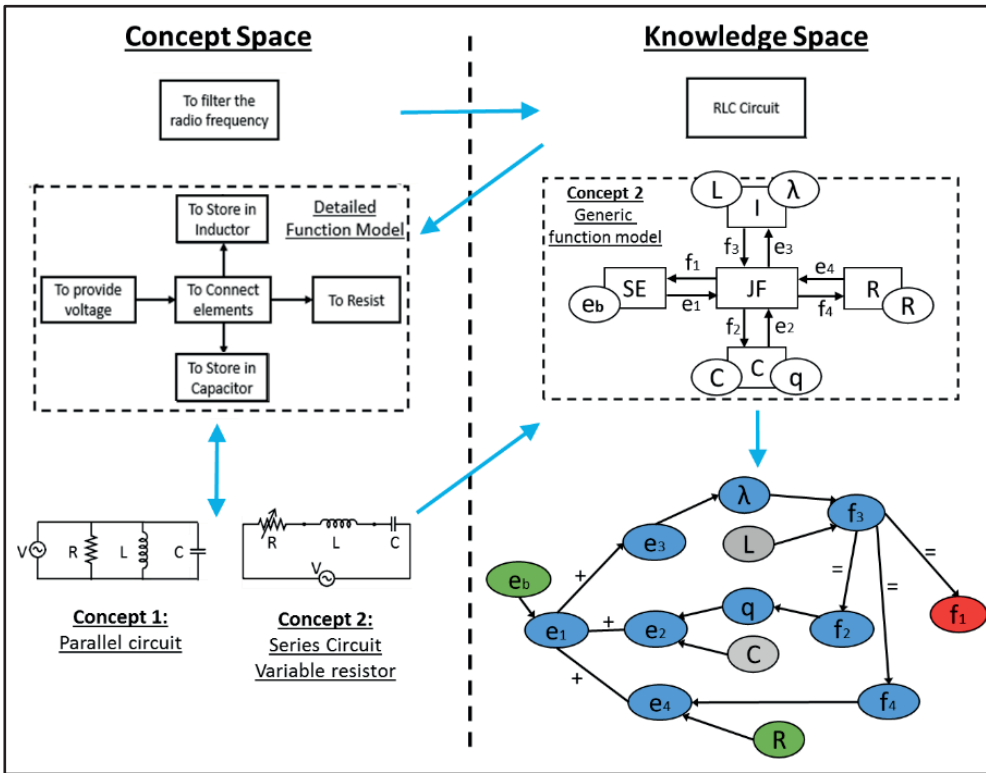

Figure 25. Model of RLC circuit using DACM approach. Left: concept space, functional model. Right: knowledge space, extracted colored causal graph for the circuit (**Publication IV**)

Table 7. Variables assigned to the generic functional model of the RLC circuit (**Publication IV**)

Variable (symbol)	Generic Functional Elements	Dimension	Category
Capacitance (C)	Capacitor	$[M^{-1}L^{-2}T^4A^2]$	Connecting
Electrical charge (q)	Capacitor	$[TA]$	Displacement
Inductance (H)	Inertia	$[ML^2T^{-2}A^{-2}]$	Connecting
Flux linkage (λ)	Inertia	$[ML^2T^{-2}A^{-1}]$	Momentum
Resistance (R)	Resistor	$[ML^2T^{-3}A^{-2}]$	Connecting

Figure 26 represents the analogy between three different fields, such as the electrical, hydraulic and thermal domains. The ultimate causal graphs share similarities because of the functional model's similarities.

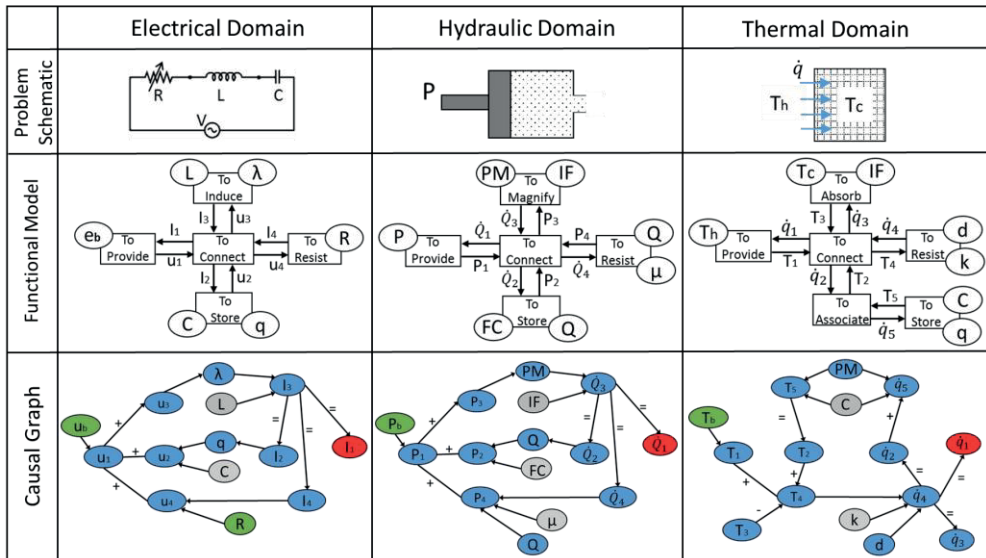

Figure 26. Functional model and generated the causal graph by the analogy between three energy domains (electrical, hydraulic, thermal) (**Publication IV**)

3.2.2 Pipe Insulation

A classical heat transfer problem is addressed to show the contradiction detection using DACM framework. Let's consider a cylindrical pipe of outer radius (R_o), whose temperature on the outer surface (T_o) is maintained constant by the floating fluid inside the pipe. The insulation material with thermal conductivity of (k) and the outer radius of (R_i) is applied to the pipe. Figure 27 illustrates the development of the generic functional model from the problem space. The objective of the model is to minimize the heat loss from the pipe to the surrounding at a temperature of (T_a).

Once the generic functional model (here BG representation) is completed, the variables in Table 8 is attributed to the functional model. Based on the developed generic functional model, DACM establishes the causal graph. Figure 28 illustrates the causal graph and the governing equations of the pipe insulation example. The objective is to minimize the heat energy loss ($Min \dot{q}_7$). The backward propagation of the objective in the causal graph leads to find a contradiction on the outer radius (R_o) that needs to be minimized and maximized simultaneously.

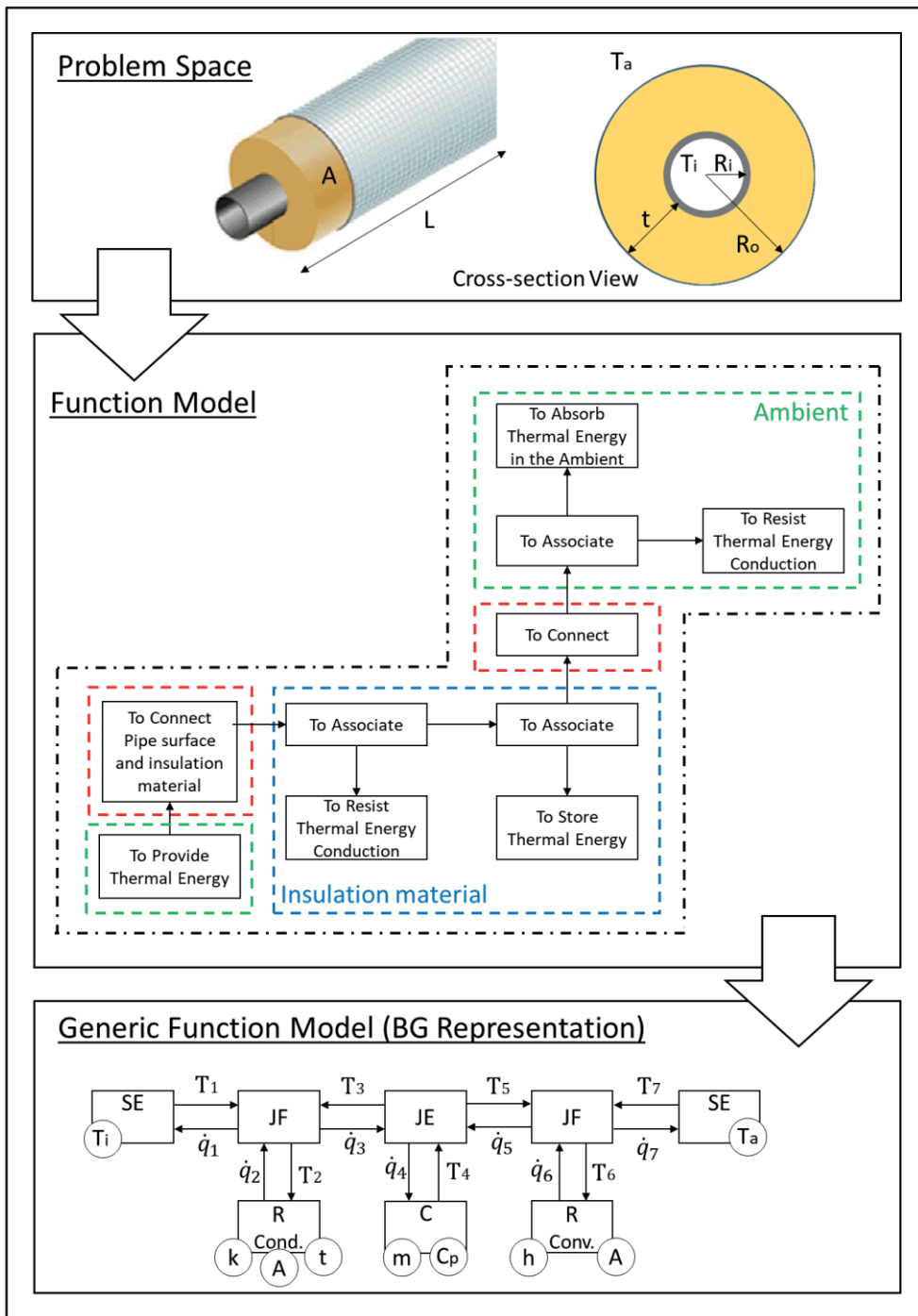

Figure 27. Function modeling for pipe insulation case study

Table 8. Variables assigned to the generic functional model of the pipe insulation

Variable (symbol)	Generic functional elements	Dimension
Insulator thickness (t)	Resistor	[L]
Heat exchange Area (A)	Resistor	[L ²]
Coefficient of conduction (k)	Resistor	[MLT ⁻³ t ⁻¹]
Coefficient of convection (h)	Resistor	[MT ⁻³ t ⁻¹]
Insulator mass (m)	Capacitor	[M]
Heat specific (C _p)	Capacitor	[L ² T ⁻² t ⁻¹]
Heat energy (q)	Capacitor	[ML ² T ⁻²]

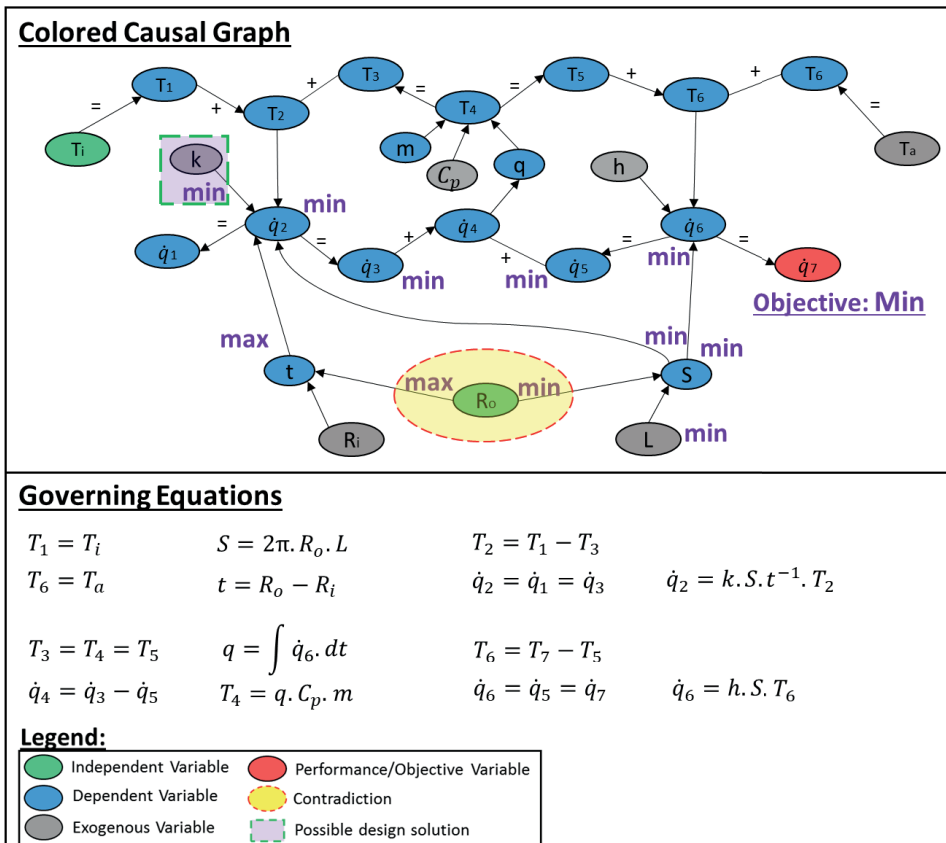

Figure 28. Extracted causal graph for pipe insulation and the contradiction detection

The contradiction reveals that in a cylindrical pipe, the additional insulation increases the conduction resistance, but decrease the convection resistance due to the increase in the outer surface area. The contradiction zone gives an insight where optimization is required. The heat transfer from the pipe may increase or decrease, depending on which of these opposite effects dominates. Heat transfer principles define a critical radius that provides maximum heat transfer resistance. In DACM, the inventive principles enable the reasoning on the causal graph to alleviate the contradictions in the system.

3.3 Inventive Principles

Once the contradictions and weaknesses of the system have been detected, one possible direction is to apply the innovative principles to remove design contradictions. The inventive principles proposed by DACM, systematically suggest possible solution(s) to reduce/remove contradictions on the causal graph topology. Some of these principles map the TRIZ inventive principles (G. Altshuller, 1999). An extensive list of nine inventive principles published in **Publication III**. For the sake of brevity, Table 9 represents two principles used in the case studies discussed in the next chapter.

Table 9. Two selected inventive principles for the causal graph (**Publication IV**)

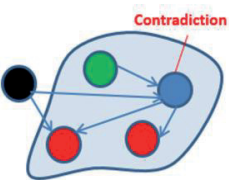
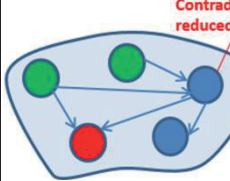
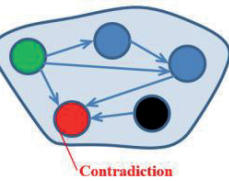
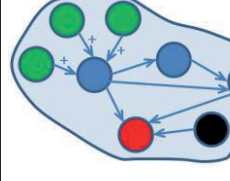
	Before Applying the Principle	After Applying the Principle	Principle Description
Principle 1: Border expansion	 A causal graph with five nodes: one black, two green, and two red. A red arrow points from a green node to a red node, labeled 'Contradiction'. The nodes are contained within a blue irregular boundary.	 The same causal graph as before, but the blue boundary has expanded to include an additional blue node. The red arrow labeled 'Contradiction' is now outside the boundary, labeled 'Contradiction reduced'.	The borders of the system are expanded by transforming exogenous variables into design variables.
Principle 2: Segmentation	 A causal graph with five nodes: two green, two blue, and one red. A red arrow points from a red node to a black node, labeled 'Contradiction'. The nodes are contained within a blue irregular boundary.	 The same causal graph as before, but the blue boundary has been segmented into two separate regions. The red arrow labeled 'Contradiction' is now outside both regions.	The variables in the causal graph are segmented to remove the contradiction.

The principle of ‘border expansion’ suggests designers re-think about the exogenous variable and investigate the possibility of transforming exogenous variables into design variables by expanding the system’s border. This is often an effective approach to reduce the existing contradictory effect in the system. The other principle, shown in Table 9, is extracted from the segmentation principle of TRIZ. The segmentation principle in TRIZ is about to divide an object into independent parts. It suggests designer pondering the possibility of this division and considering further influencing variables for those that have been considered as independent variables.

Back to the pipe insulation case study, the inventive principles can be applied to the causal graph. The principle of border expansion brings the coefficient of conduction (k) into the systems border, by changing the exogenous nature of the variable into a design independent variable. The second principle investigates the integration of the variables affecting the coefficient of conduction (h) in the free or forced convection condition.

3.4 Discussion

This chapter described the modeling steps of DACM framework and the theories integrated into each step. The framework offers the simulation capabilities, physics-based reasoning and systematic search for contradiction(s) to the functional models developed in the design stages of PDP. It enables concretization of the functional model by linking the functional model to BG elements and attributing variables describing the behavior of the functions.

Let us consider the problem-solving process, shown in Figure 29. In TRIZ problem-solving process, a specific problem is mapped to a general problem for which a general solution exists. The general solutions are used by analogy to enhance finding a specific innovative solution. The problem-solving process in TRIZ follows two central concepts: generalizing problem and solutions and eliminating contradictions. Toward this direction, DACM is an attempt for detecting the contradictions and automatizing this problem-solving process with the use of graph representation. The theory of Design Structure Matrix (DSM) and Domain Mapping Matrix (DMM) (Eppinger & Browning, 2012) are the key approaches to automatize these transformations in DACM approach and provide inputs to the algorithms. As it is shown in Figure 30, the user-defined inputs are transferred to DSMs and DMMs and fed the different algorithms.

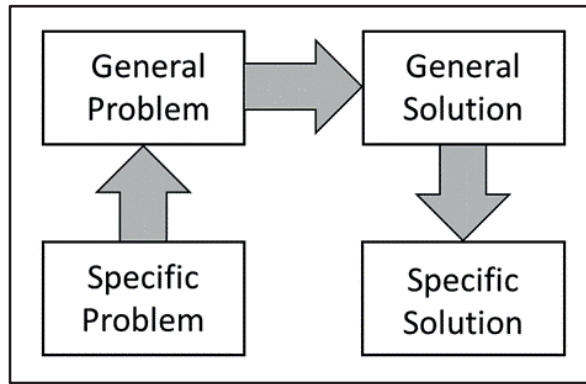

Figure 29. TRIZ Problem solving process

In the relevant research works, researchers focus on using functional models in supporting computational design activities and innovation. For instance, Helms et al. aimed at developing a computational approach to support designers in the innovation process by introducing an approach to map the physical effects with the BG theory (Helms et al., 2013). The research of Lucero et al. is focused on developing a framework to support producing analogies and different design solutions based on performance metrics related to functionality (Lucero, Linsey, & Turner, 2017). They investigated how analogies can be implemented using performance metrics instead of linguistics. The framework proposed by Lucero et al. shares some similarities with the current DACM framework. Those similarities are limited to the use of Functional Basis vocabulary (Hirtz et al., 2002) in developing a functional model and mapping the functional model to the BG elements. However, the two frameworks are different regarding the usage and capabilities. Here are some of those differences. Lucero et al. use the BG theory to group the performance metrics in functions in the Functional Basis, while the fundamental reason of using BG theory in DACM is being able to extract the causality of variables defining the functions. The framework of Lucero et al. seeks the innovative design solution by analogy generation across different domains, while DACM also enables the incremental improvement by providing simulation capabilities and systematic contradiction analysis. The simulation capability is not addressed in their research (Lucero et al., 2017). The generation of the cause-effect network among the variables describing the functions, qualitative and quantitative simulations, and contradiction analysis are of the most important capabilities provided in the DACM framework.

Development of the DACM framework answers to the research questions highlighted in the introduction chapter. DACM focuses on the functionality of the product designs and processes by insisting on function modeling as a fundamental modeling step. It allows designers to provide functional models with different level of detail and abstraction depending on availability of design information associated with different design stages. Functional models with more details and a higher level of fidelity are developed while moving forward in the design stages. DACM suggests mapping the functional model with BG elements in order to provide concretization to the abstract functional model. The algorithms in DACM offer a systematic approach to assign variables for describing functions, extract causality among variables and establish governing equations among variables in the model. Therefore, it brings the simulation capabilities to the functional model in order to evaluate the solution variants and detecting contradictions at any design stages.

DACM is a generic modeling approach which is still under development. The maturity of the approach is increasing by applying it to different disciplines and by further developing the algorithms and functionality of the framework. So far, DACM is applied in various domains such as systems engineering, product development process, multidisciplinary optimization, artificial intelligence, additive manufacturing and most recently to cyber security.

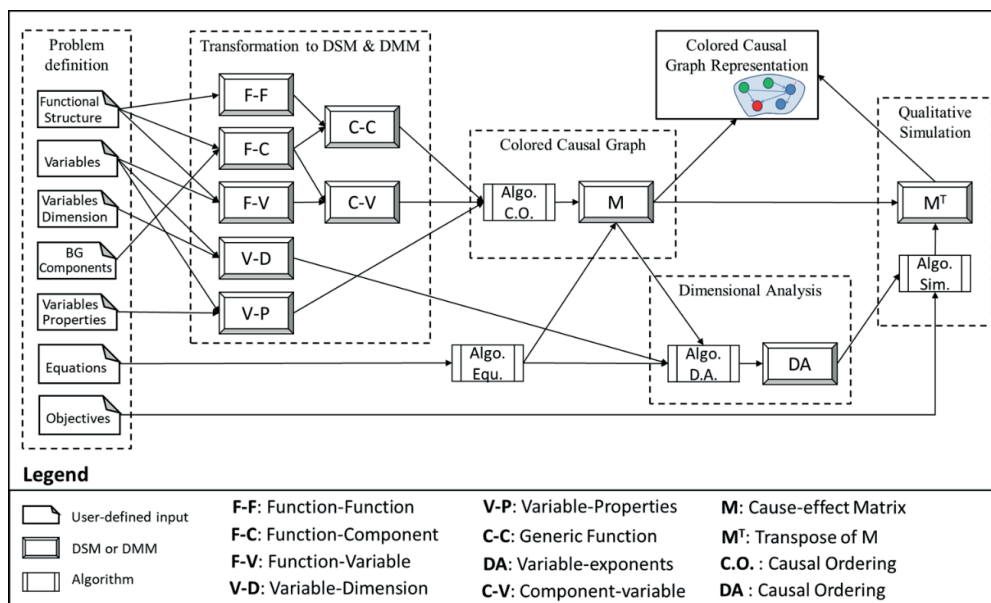

Figure 30. DSM as a key approach in DACM implementation

3.4.1 Characteristics and Misconception of DACM Framework

The current development of the methodology explained in this chapter has its own limitations and considerations. Consequently, future developments can remove some of these limitations. Here are some of the common misconception and characteristics of the framework.

1- DACM is sensitive to the correctness of inputs:

The dimensional analysis in DACM approach creates the dimensionless number from the user-defined variables, as long as dimensional homogeneity is respected between variables. Therefore, the designer should pay attention to the definition of the right influencing variables. This weakness is common with dimension analysis principles. However, more detailed function modeling can solve the problem.

2- DACM does not investigate the effect of contradictions:

The framework detects contradictions. Nevertheless, the current version of the DACM, presented in the thesis, does not reveal that removing which one of those contradictions is the most influence on the performance of the system. With the current state of methodology, it is the user's responsibility to analyze the effect and the importance of contradictions in the system's performance.

It is worth mentioning that the current development and research attempt to link the DACM models with systems dynamics in order to simulate the effect of contradictions, dynamically.

3- DACM creates causal graph not directly ANN topology:

The models in DACM are the combination of the causal graph and the list of governing equations. The causal graph is a starting point for creating a modular topology of sequence ANNs, and it is not directly an ANN topology itself. A work published in a recently published paper is an attempt to extract a knowledge-based modular ANN topology from the causal graph (Nagarajan et al., 2019).

4- DACM as a metamodeling tool:

The framework is a metamodeling tool because it enables the capability of integrating models with different purposes with different level of detail into a single integrated model. However, it should be differentiated with the capabilities that pure metamodeling techniques (e.g., ANN) offer. DACM provides a modular KB-ANN topology that is in the form of a sequence of ANNs.

5- DACM enables sensitivity analysis using a virtual design of experiments:

Behavioral equations in DACM enables calculating the response of the model with respect to the input values for variables. Moreover, by having the order of magnitude of variables, it is possible to conduct virtual design of experiments (for instance Taguchi DOE) and analyze the sensitivity of changing values of the variables on the performance of the system in the early design stages.

6- DACM is not an extension of Bond graph theory

DACM suggests mapping the functional models to the BG elements to provide concretization (physical effect) to the abstract functional models. The causality extraction algorithm of DACM is also adapted from exiting validated causal rules in BG. However, establishing the causal graph can be done without mapping the functional model to the BG elements, since DACM uses variables categories.

4 RESULTS AND CONTRIBUTIONS OF THE THESIS

The following chapter articulates around the results and contributions of the publications. Figure 31 highlights the contribution of each published articles. The contribution of the work done in the thesis lays into two sections. In the first section, the methodology is applied to model product, manufacturing process and then to concurrent product-process modeling. The second section discusses the contributions of publications in terms of AM-related topics.

The article presented in ASME IDETC 2016 conference (**Publication I**), represents the simplification of the causal relationships among the variables describing the DED process, using dimensional analysis. It uses the methodology to demonstrate how to find influencing variables, create dimensionless numbers among them and connect those dimensionless numbers together to simplify the complexity of the initial causal graph. The weak point of this initial attempt is that a lot of variables are attributed to a function when the model is very abstract. Therefore, a modeler might mistakenly consider less relevant variables to the functions and builds the behavioral laws. Note that in the worst case, attributing the irrelevant variables can lead to the wrong model. The latter issue is a common issue in dimensional analysis. However, the use of function modeling enhances the selection of relevant variables. This article concluded that a more systematic variable assignment approach is required for models with less abstraction and higher fidelity.

Publication II introduced the DACM framework in a journal publication and applied the methodology for modeling product and manufacturing process separately. The torpedo is modeled with a low level of detail using a few influencing variables. It demonstrates that DACM can detect contradictions for fulfilling performance objectives in the torpedo case study. This paper shows how to analyze and estimate the effect of variables on the final performance of the product by having the order of magnitude of variables in the conceptual design phase. The case study justifies the potential of using TRIZ inventive principles systematically to suppress or reduce the contradictions in the systems. The DED process was modeled in more details in comparison with the torpedo case study.

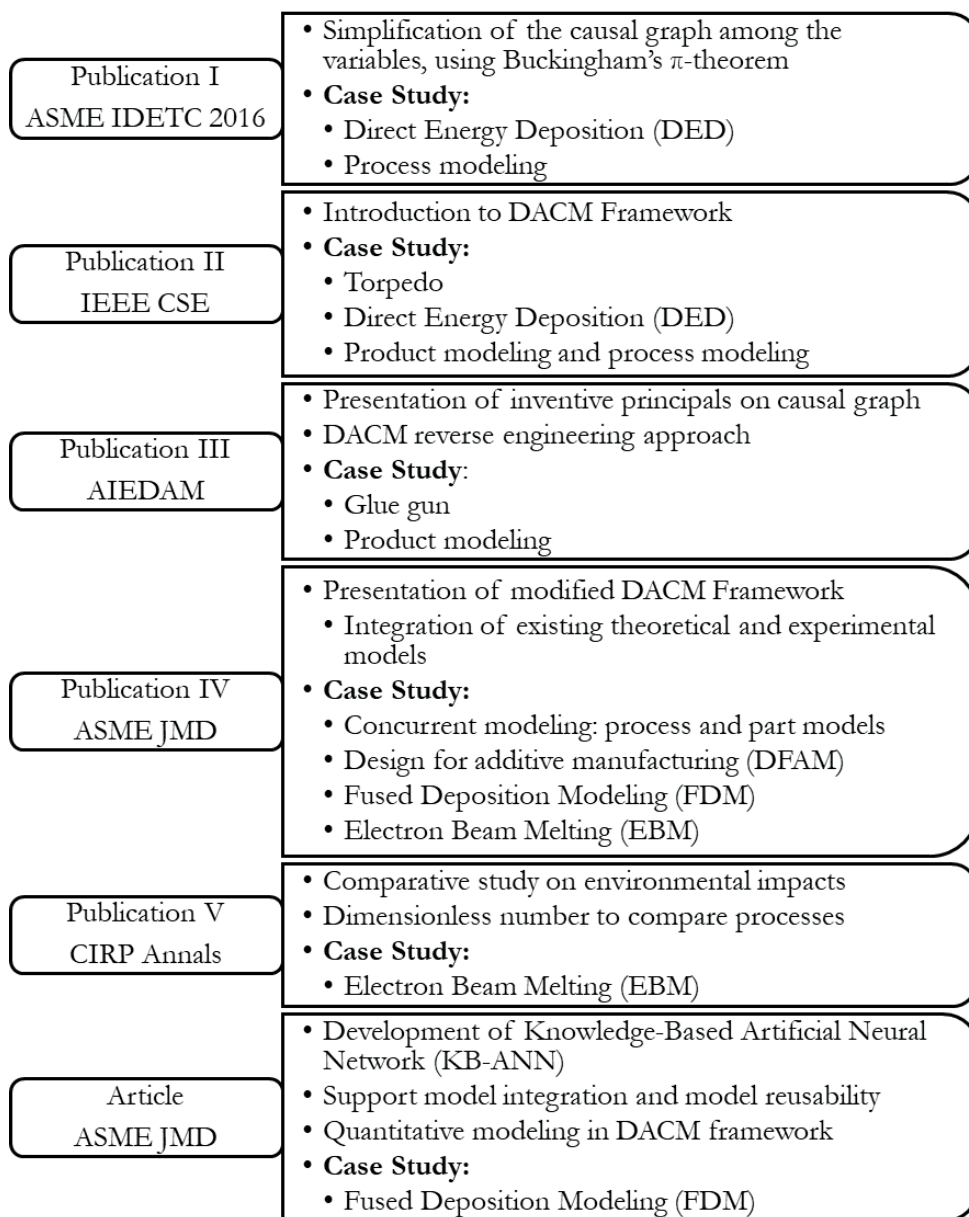

Figure 31. Contributions of author's publications

However, due to the abstractive characteristics of the functional model, assigning variables to the functions is often subjective and not systematic. In other words, a more systematic approach was needed to model the existing systems (product or process) with higher level of fidelity.

Publication III answered to the needs revealed in **Publication I** and **Publication II**. This paper contributes to the physics-based reasoning in function modeling for assessing design options and supporting innovation ideation. The functional model in the paper transformed into a more generic functional model using BG theory. This transformation leads to a preliminary concretization of the functional models. Consequently, it increases fidelity in the modeling of the existing systems, while not completely losing the abstract characteristics of the functional model. The variables are then assigned with a more systematic manner, and the methodology also benefits from the existing validated causal rules in the BG theory. The approach was applied for reverse engineering of the glue gun, which was imposed by the journal's special issue. Modeling of the glue gun is considered as a product modeling for which the paper seeks to improve the performance systematically. Apart from the modeling progress, the paper developed a systematic approach to applying inventive principles in the causal graph. The glue gun shares similarities with the FDM process in AM, which is the subject of the next publication.

By analyzing the models initially developed for the AM technologies, it became apparent that concurrent consideration of the part model and AM process model is necessary. Moreover, the integration of the existing theoretical or experimental equations to the models is extremely beneficial. Consequently, **Publication IV** pushed the modeling approach one-step forward by enabling the integration of the existing equations and mathematical models into the models developed by the framework. This journal paper presents the framework in additive manufacturing as conceptual modeling and DFAM tool by enabling the concurrent modeling of the part and AM process. The modeling approach is applied to FDM and EBM processes for highlighting the weaknesses of the systems, extracting design rules, and exploring possible solutions in the design phases. **Publication IV** utilized the DACM framework as a DFAM tool. The framework not only reveals the limitations of the AM process in creating parts' features and extracts design rules but also attempts to highlight the root causes for those limitations.

Publication V is a comparative study on the environmental impact of additive and subtractive manufacturing processes. This paper proposes an approach to facilitate the selection process between alternative manufacturing processes from an environmental impact point of view. The proposed approach compares manufacturing alternatives by concurrently considering dimensionless indicators for environmental impact ratio and volume of material removal ratio. The approach is applied to define trade-offs between milling and EBM process from an environmental point of view for manufacturing an aeronautic turbine. From another

perspective, this paper contributes to the selection of AM processes at the design stages of PDP considering the environmental impact.

A recently published work aims at providing quantitative analysis capabilities to models developed by DACM framework using ANN (Nagarajan et al., 2019). The publication proposes to use the DACM causal graph as a basis to develop a modular Knowledge-Based Artificial Neural Network (KB-ANN). The proposed approach breaks down an ANN describing the whole system into multiple small ANNs, where each small ANN characterizes a functionality or a physical phenomenon in the systems. The paper attempts to alleviate the issues of interpretability and reusability of models in AM. The proposed approach encodes the existing knowledge of theoretical and experimental models in the KB-ANN. Encoding the knowledge enables superior interpretation capability to model and enhances the reusability of developed models and gathered data for further studies. The proposed method is applied to a case study with the same part geometry considered in **Publication IV**.

Following in this chapter, the contributions of the thesis are organized into two major sub-sections: ‘integrated modeling in product development’ and ‘modeling and design in additive manufacturing.’ The first section focuses on product modeling, manufacturing process modeling, and concurrent product-process modeling. The second section focuses on AM-related topics. Note that the following subsections illustrate the publication contributions in the related topics and consequently contain overlapping material.

4.1 Integrated Modeling in Product Development

4.1.1 Product Modeling (Reverse Engineering vs. New Product Design)

In this section, two basic approaches are compared to present the functional model of the glue gun. The first approach attempts to build a functional model for new product design and avoid having any initial design solution. This approach can eventually result in a different function modeling when compared with the purely reverse engineering approach. The reverse engineering approach is then applied for the function modeling of the glue gun, since this approach is preferred in an incremental innovation process.

In the first approach, the modeling begins with defining the boundaries of the system (product) to be designed, recognizing different elements of the systems’

environment in order to satisfy the system’s objectives(s). Here, the ultimate objective of the gun is to deliver a controlled amount of molten glue. The input material is a solid glue, and the output material is the molten glue. The system requires thermal energy to melt the glue. To keep the initial conditions constant for both modeling approaches, let us assume at first glance that the primary energy used to provide heat is electrical energy, and the mechanical energy to feed the glue stick is provided by human. The octopus diagram in Figure 32 shows the elements of the system’s environment and interacting functions among them. The associated energy domains and materials in the glue gun are shown in different colors in Figure 32 (i.e., orange for energies and blue for materials).

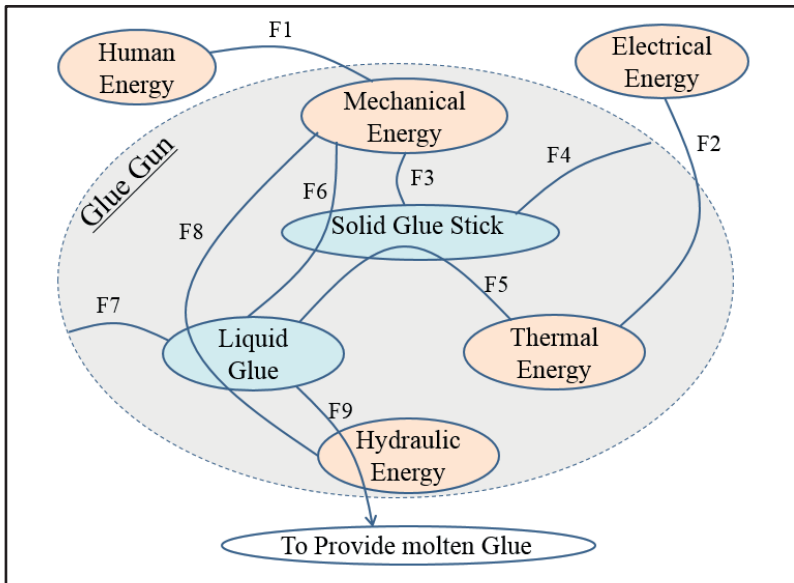

Figure 32. Schematic view of associated functions in a glue gun (Publication III)

The necessary functions are defined between different energies and materials. While some functions can only be defined between energies or between materials, some other functions need to use an energy domain to act between two materials. Table 10 lists the functions shown in Figure 32, systematically. Each function is also given an approximate sequence of occurrence, indicating the order by which the function should be activated. The active functions in the same time interval in Table 10 are represented in parallel in Figure 33. The function schematic in Table 10 shows each function in the form of input and output. Having the input, output, and time sequence interval for each function helps us to capture how the functions are

connected. To relate two functions together, we need to match the output of the function to the input of the function in the next time sequence interval.

Figure 33 represents the functional model based on this initial analysis. Using this approach, the modeler has a significant impact on the nature of the model. For example, one might think that the pressure on the liquid glue stick can be provided by directly pushing the glue stick by hand or by an indirect action performed on the glue stick, or even by a specific device or mechanism generating pressure on the liquid glue.

The second approach for functional modeling is a purely reverse engineering approach. In this approach, an existing design architecture is available, and the modeler’s role is to represent the functional model using the existing system as a reference. ‘Level 0’ in Figure 34 considers the glue gun as a black-box system: the solid glue stick is the input material, the electrical and human energy the energy inputs, which transform to the melted glue as the output of the system.

Table 10. Function definition for the schematic view of the glue gun and its associated functions (Publication III)

Function	Subject	Object	By	Function Schematic	Sequence Interval
F1 (to transform)	Human Energy (HE)	Mechanical Energy (ME)	----	$HE \xrightarrow{F1} ME$	T1
F2 (to transform)	Electrical Energy (EE)	Thermal Energy (TE)	----	$EE \xrightarrow{F2} TE$	T1
F3 (to grip and move)	Mechanical Energy (ME)	Solid Glue Stick (SG)	----	$SG, ME \xrightarrow{F3} SG, ME$	T2
F4 (to guide)	Solid Glue Stick (SG)		Body Component (BC)	$SG \xrightarrow{F4} BC$	T2
F5 (to transform)	Solid Glue Stick (SG)	Liquid Glue (LG)	Thermal Energy (TE)	$TE, SG \xrightarrow{F5} TE, LG$	T3
F6 (to create pressure)	Solid Glue Stick (SG)	Liquid Glue (LG)	Mechanical Energy (ME)	$ME, SG \xrightarrow{F6} ME, LG$	T3
F7 (to guide and to contain)	Liquid Glue (LG)		Container (C)	$LG \xrightarrow{F7} C$	T3
F8 (to transform)	Mechanical Energy (ME)	Hydraulic Energy (HyE)	----	$ME \xrightarrow{F8} HyE$	T4
F9 (to provide)	Liquid Glue (LG)	Liquid Glue (LG)	Hydraulic Energy (HyE)	$LG, HyE \xrightarrow{F9} LG$	T5

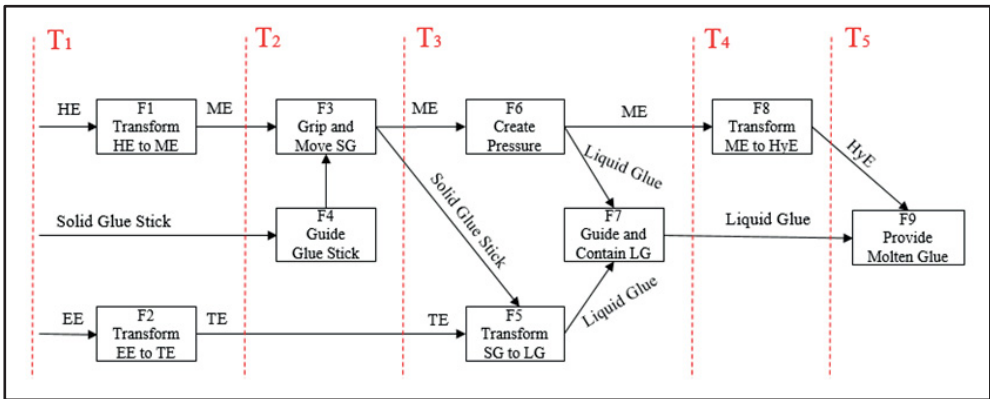

Figure 33. Glue gun functional model based on function schematic interaction (Publication III)

The overall functionality is then decomposed into the sequence of functions to satisfy the overall functionality of the system. Figure 34 depicts a functional model resulting from numerous iterations. Note that the functional models of Figure 33 and Figure 34 are different, because the initial functional model in Figure 33 was not trying to abstract from any specific solutions.

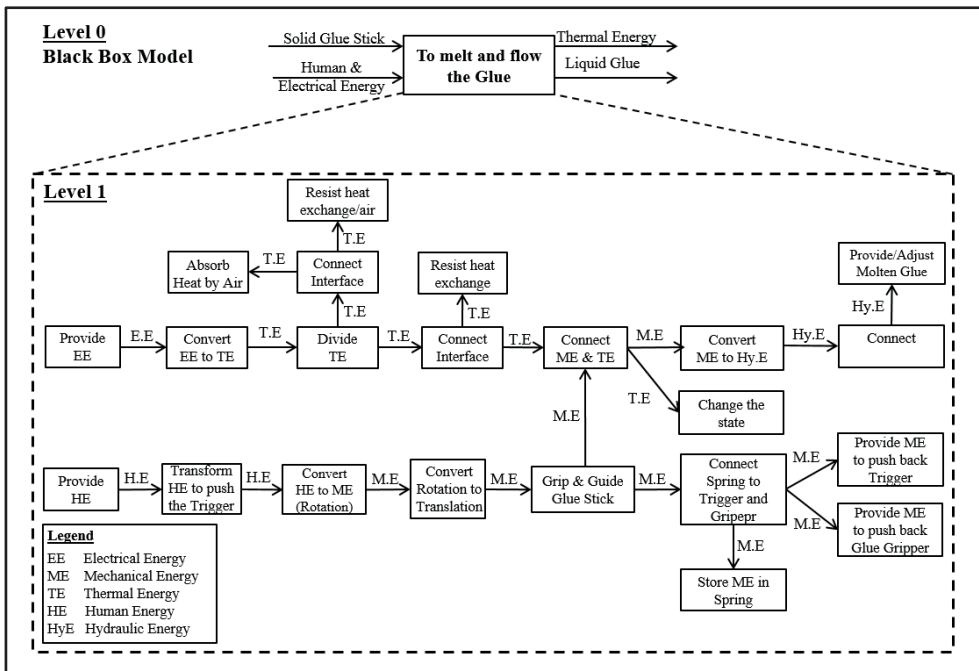

Figure 34. Functional model of glue gun using a reverse engineering approach (Publication III)

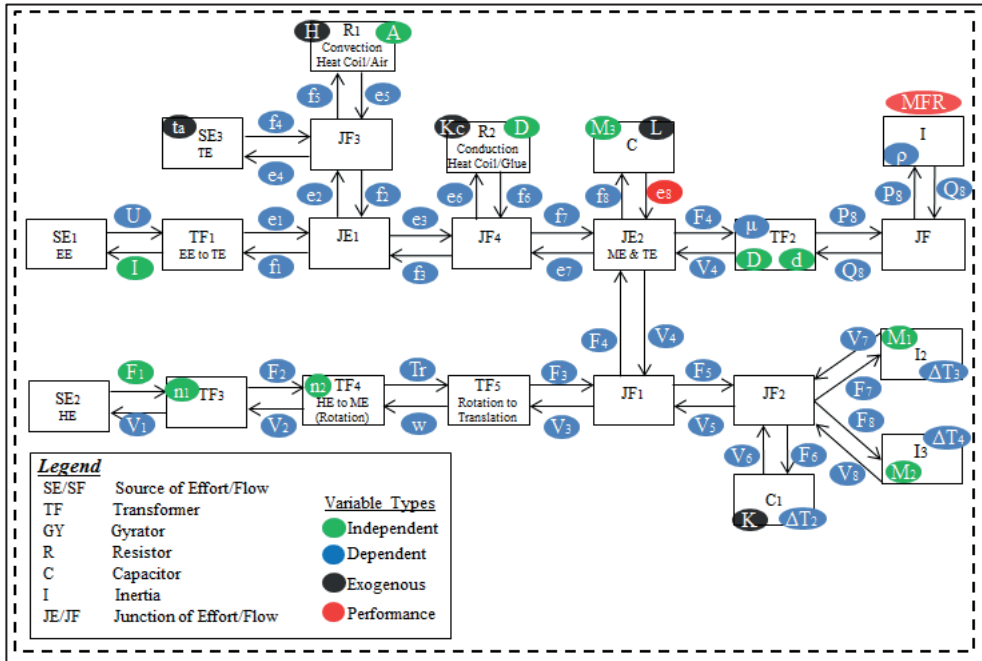

Figure 35. Generic functional representation filled with variables (**Publication III**)

The functions in the functional model are then mapped to the BG elements. Figure 35 shows generic functional representation with the assigned variables to each BG elements. Table 11 contains the variables assigned to the functional model with their associated dimension. Figure 35 shows a generated causal graph using the predefined causality rules in BG theory. The causal graph shows the cause-effect relationship among variables in a visual manner, and governing equations relate the variables in a mathematical manner (**Publication III**). Let us consider that finding a design solution that lets the user provide molten glue with less effort and less energy consumption is desirable. Less energy consumption is partly related to the insulation condition of the system. However, it is also related to the final temperature of the output molten glue. So minimizing the output temperature of the molten glue (i.e., minimizing (e_8)) to a few degrees above its melting point is the first qualitative performance. Higher material flow rate while pressing the trigger satisfies the desired need to have molten glue with less human effort. Increasing the output material flow rate (i.e., maximizing (MFR)) is the second qualitative performance. Note that different qualitative performances can be considered based on different aims. The backward propagation as the result of considering the two above-mentioned performances is also shown in the causal graph of Figure 36.

Table 11. Variables and associated dimensions for the glue gun case study (**Publication III**)

Variables	Symbol	Dimension	Category
Electric Potential	U	$ML^2T^{-3}A^{-1}$	Effort
Electric Current	I	A	Flow
Velocity (Feed Rate)	V	LT^{-1}	Flow
Force	F	MLT^{-2}	Effort
Volumetric Flow Rate	Q	L^3T^{-1}	Flow
Pressure	P	$ML^{-1}T^{-2}$	Effort
Torque	Tr	ML^2T^{-2}	Effort
Angular Velocity	w	T^{-1}	Flow
Melted Glue Viscosity	μ	$ML^{-1}T^{-1}$	Momentum
Temperature Difference	t	t	Effort
Entropy Flow Rate	S	$ML^2T^{-3}t^{-1}$	Flow
Heat Flow Rate	f	$ML^{-2}T^{-3}$	Flow
Temperature	e	t	Effort
Stiffness Coefficient	K	MT^{-2}	Connecting
Glue Gun Nozzle Diameter	d	L	Displacement
Coefficient of Conduction	K_c	$MLT^{-3}t^{-1}$	Connecting
Glue Stick Diameter	D	L	Displacement
Coefficient of Convection	H	$MT^{-3}t^{-1}$	Connecting
Coil Heat Exchange Surface	A	L^2	Displacement
Glue Gripper Mass	M_1	M	Connecting
Trigger Mass	M_2	M	Connecting
Mass of Glue Stick in Coil	M_3	M	Connecting
Glue Stick and Glue Density	ρ	ML^{-3}	Connecting
Mass Flow Rate	MFR	MT^{-1}	Flow
Transformation Modulus	n	---	---
Specific Heat Capacity	C_p	$L^2T^{-2}t^{-1}$	Connecting
Duration of Function	ΔT	T	Connecting
Ambient Temperature	t_a	t	Effort

Maximizing the flow rate of molten glue (MFR) requires the volumetric flow rate (Q) to be maximized. Volumetric flow rate depends on multiple variables such as pressure (P), viscosity (μ) and the volume of molten glue (cross-section (S) and

length (L)). Maximizing the flow rate requires maximizing or minimizing one or several of these variables. To increase the volume of molten glue, we need to increase the pressure on the glue stick (P), and/or the cross-section of the glue stick (S). Increasing the pressure has a direct relation with applied force and a reverse direction with the glue stick cross-section. Therefore, the first contradiction is detected, since we need to minimize and maximize the cross section (S) simultaneously (see Figure 36). On the other hand, based on the causal graph, to minimize the viscosity (μ), the temperature of molten glue (e_8) should be increased. The latter is in contradiction with the second objective of the study, which is to decrease the temperature (e_8). The backward propagation of the second objective (Min e_8) also indicates that the glue stick diameter (D) should be minimized to melt the glue stick faster and reduce energy consumption. Figure 36 highlights the contradictions on the causal graph. The result of the contradiction analysis and the visual causal relationships among variables guide where the designer(s) should search for an idea to innovate or to improve the performance of the system. The TRIZ segmentation principle is used to suppress the contradiction and to present an innovative solution in the current case study. The principle suggests dividing the object into other objects. Therefore, using several glue sticks with a small diameter can solve the contradictions in this case study. The pressure is applied to an area, which is equal to the sum of the cross-sections of the glue sticks. The smaller diameter of glue sticks enables the faster melting, and the sum of the cross-sections can be increased without interfering with the fast melting condition.

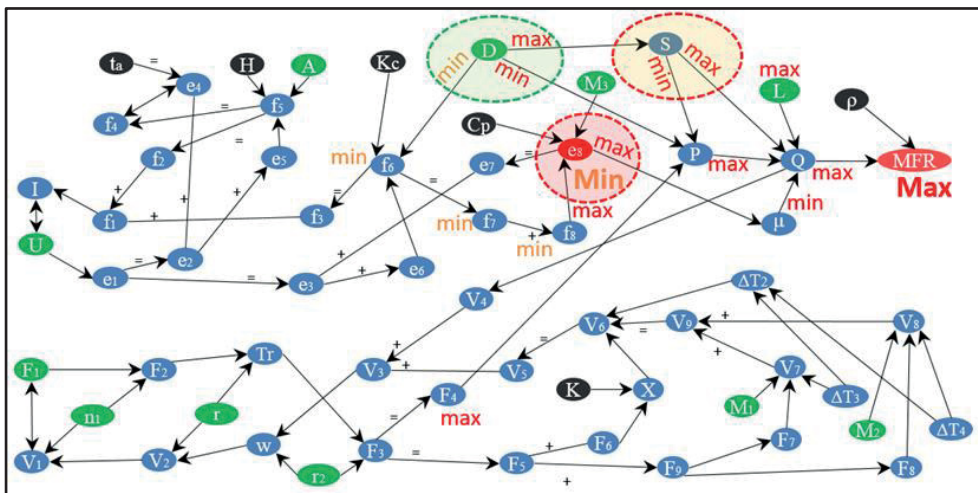

Figure 36. Contradiction analysis in glue gun's causal graph (Publication III)

4.1.2 Manufacturing Process Modeling

Publication I and **Publication IV** utilize the DACM modeling approach to model the DED and FDM processes, respectively. The systematic modeling of the FDM process is described here, due to the more maturity level of the modeling procedure in **Publication IV**.

Modeling of the FDM process starts with establishing a functional model. From the functional point of view, the filament is fed into a liquefier, which is heated by an electrical heater. The molten polymer is extruded from a nozzle located on the head of the liquefier. At the same time, the extruder is moved to deposit the melted material at the appropriate coordinates, according to a predefined pattern. Therefore, the functional model consists of various energy domains: mechanical energy to feed the filament, electrical energy to provide the thermal energy for melting the polymer, and the hydraulic energy domain for characterizing the molten material. The systematic procedure, pursued by DACM is described below.

The thermal energy provided from the source flows to the neighboring materials and finally melts the filament. A portion of the initial thermal energy is used to melt the polymer (i.e., PLA, with a melting temperature of 200°C to 220°C), and the other portion is dissipated by flowing to the aluminum part on the top of the extruder or by convection to the ambient air. A portion of the thermal energy is stored in the material, and the other portion is transferred (via conduction or convection) to the next interface material. The functions, ‘To store thermal energy’ and ‘To resist the heat transfer’ appear in each material. In order to analyze the sequence of the heat transfer in the liquefier, the detection of the different materials and interfaces is needed. Figure 37 depicts the thermal interfaces between the different blocks of materials in the liquefier. The direction of the arrows in Figure 37 indicates the direction of the heat flow in the liquefier.

Once the model of the interfaces and material block is established, the following modeling phase is attributing functions to each interface and material and consequently transforming Figure 37 into a functional representation. The function ‘To connect’ is attributed to each interface. The function ‘To store thermal energy’ is used to characterize the thermal energy capacity and the function ‘To resist the heat transfer’ is used to give resistance to the heat transfer of each material. Figure 38 illustrates this transformation (T1) for materials, interfaces, and sources. The functional mapping transforms the functional model into the generic functional representation (T2) in Figure 38.

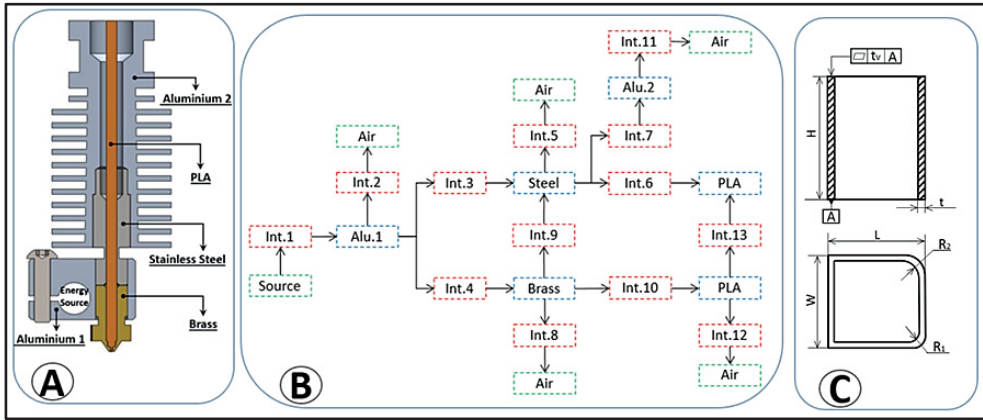

Figure 37. A) Typical machine liquefier, B) thermal interfaces between block materials in RepRap liquefier, C) geometry of the part to be manufactured (Publication IV)

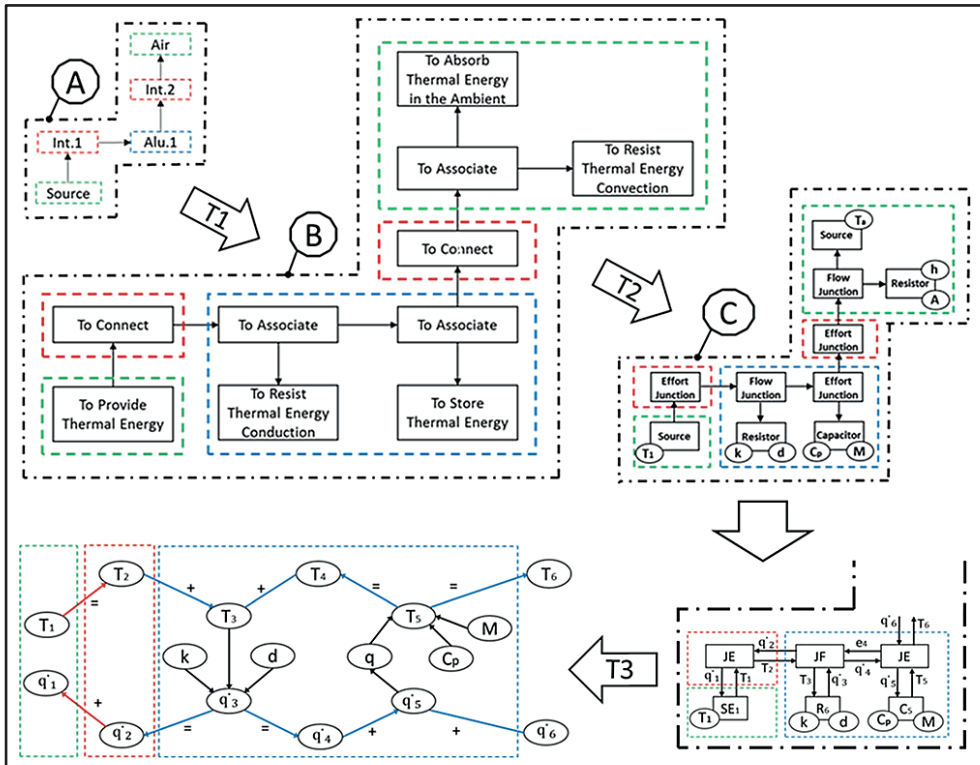

Figure 38. A) Systematic transformation between interface analysis, B) functional model, C) generic functional representation, and extracting causal graph for thermal heat exchange in FFF liquefier (Publication IV)

The transformation T2 is followed by a transformation T3 associating generic functions with BG elements. In thermal energy problems, the effort junction (0) is attributed to each function 'To connect' to describe the temperature at each interface between materials. At the same time, variables are associated with the generic functions and the BG elements. The resistive elements characterize the conduction and the convection heat transfer. The coefficient of conduction (k) and the average distance (d) between two interfaces define the conduction. The coefficient of convection (h) and exchange surface (S) define the convection in the resistive elements. The capacitive elements are defined by the mass and specific heat capacity (C_p).

The machine feeds the filament inside the liquefier. The solid part of the filament acts as a plunger to push the melted polymer to the nozzle tip. This part is modeled with an analogy to hydraulic energy domain, using the following procedure. First, an effort junction (0) is attributed to each pressure change, and a flow junction (1) is used to connect the effort junctions. Inertial and resistive organs are attached to the flow junctions (1), which cause the pressure drop in the liquefier. The key variables associated with those organs are the viscosity and the volume of the melted polymer to characterize the resistive element. Fluid inertia is the main variable defining the inertial element. The fluid inertia is related to the density and length of the hydraulic tube, and to the cross-section of the tube.

The temperature of the cylinder wall melts the polymer filament inside the liquefier. The melting of the moving filament happens gradually, and there is no real point at which the state of the polymer changes from solid to liquid. Nevertheless, an approximation of the location of the melt front is helpful in connecting the model of 'flow of thermal energy' and the model of 'flow of material' together. According to Yardimci et al., the location of the melting point is influenced by the filament feed rate (u), thermal diffusivity (α), and a dimensionless temperature (θ) (Yardimci, Hattori, Guçeri, & Danforth, 1997). Dimensionless temperature, shown in (15), is the ratio between melt temperature (T_m), wall temperature (T_w), and the initial temperature (T_i) of the filament. Thermal conductivity (k), specific heat capacity (C_p), and density (ρ) characterize the thermal diffusivity (α). Equations (14) to (17) summarize the relations between the influencing variables for calculating the melt front location.

After extracting the influencing variables from the literature, the equations of the problem are constructed using DA if an equation is not existing. Equation (18) represents the dimensionless product for the melt front location.

$$Y_{melt} = f(\dot{Q}, \alpha, \theta) \quad (14)$$

$$\theta = \frac{T_m - T_w}{T_i - T_w} \quad (15)$$

$$\alpha = f(k, C_p, \rho) \quad (16)$$

$$\dot{Q} = u \cdot d^2 \quad (17)$$

$$\pi_{Y_{melt}} = Y_{melt} \cdot \dot{Q}^{-1} \cdot k \cdot C_p^{-1} \cdot \rho^{-1} \cdot \theta \quad (18)$$

Figure 39 illustrates the causal graph of the FDM process. The volumetric flow rate (\dot{Q}_6) and the temperature (T_{output}) of extruded material are considered as performance variables. Those variables have a significant impact on dimensional accuracy, bonding quality, and the final mechanical properties of the part produced by the process.

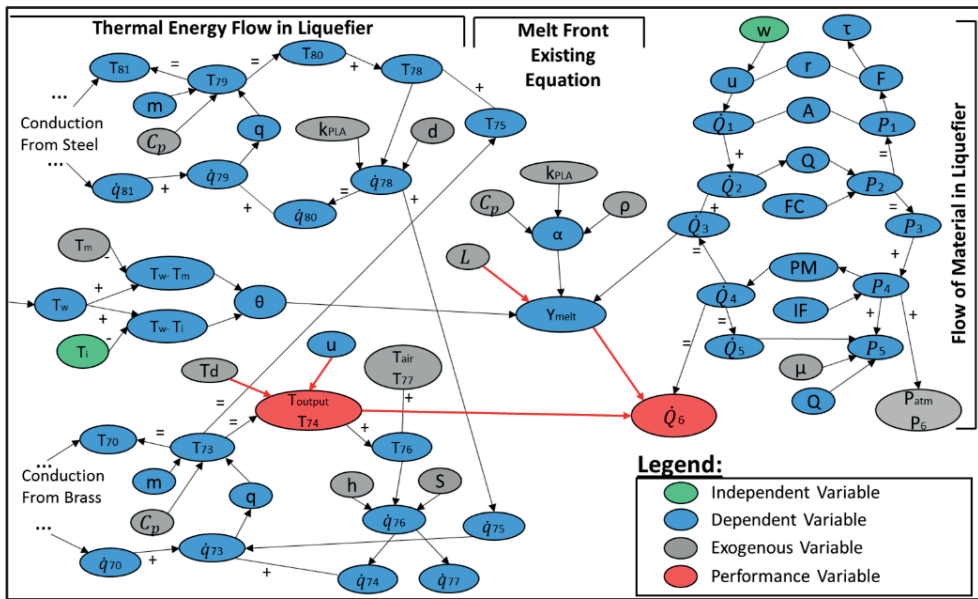

Figure 39. Partial causal graph of the FDM process model

4.1.3 Concurrent Part-Process Modeling

Once the model of the process is established, it is necessary to integrate the model of the part in order to analyze the relationship between the geometrical features of the part and the variables of the process. The same simple test part geometry of Figure 37 was considered. The key characteristics of the desired part are the specified flatness tolerance (t_v), relatively small radius in the corners (R) and uniform bonding quality between layers. Assume that any curve-like path is created by incrementally changing the coordinate or changing the direction of movement of the nozzle. The movement of the nozzle in the X and Y directions and the time of the movement in each direction forms the causality for nozzle travel speed. The geometrical flatness tolerance is affected by the variation in material deposited per length ($\Delta(M/L)$). The travel velocity of the nozzle and melted material flow rate are the causes of the amount of material deposited per length. The bonding quality, also known as coalescence, plays an essential role in the part's final mechanical properties. One of the key variables in determining the bonding quality is the temperature of the fused filament (Sun et al., 2013); minimizing the variation in the temperature of the fused filament supports uniform bonding quality on the part. Figure 40 illustrates the generated partial causal graph integrating the liquefier model (shown in Figure 39) and the part model. The causal graph of Figure 40 is composed of four zones: Thermal energy flow, flow of material, melt front location and the part. The part zone represents the characteristics of the part in the form of measurable variables. The following subsection shows how DACM qualitatively simulates the model and contributes to the continuous improvement in AM by finding systems weaknesses and contradiction.

4.2 Modeling and Design in Additive Manufacturing

4.2.1 Systematic Modeling and Continuous Improvement in Additive Manufacturing

Once the model is developed and the causal graph is established, DACM enables systematic identification of the weaknesses and contradictions by means of a qualitative simulation. Detection of the contradictions at the design stages of PDP guides the designer toward the most valuable and required part design and process

improvements. In the model of the FDM process, integrated with the part model, the selected performance criteria (qualitative objectives) are:

- Minimizing the flatness defects by minimizing the variation in material deposited per length: (Min $\Delta(M/L)$).
- Reducing the fillet radius: (Min R).
- Minimizing the variation in the temperature of the melted material to enhance the uniformity of the bonding quality: (Min ΔT).
- Increasing the printing speed by maximizing the nozzle velocity: (Max V).

Figure 40 represents the partial causal graph of the integrated model (FDM process and the part to be manufactured). The performance variables are shown in red and the qualitative objectives are underlined with different colors. The results of the backward propagations of the qualitative objectives and the two contradictions discovered are shown in Figure 40.

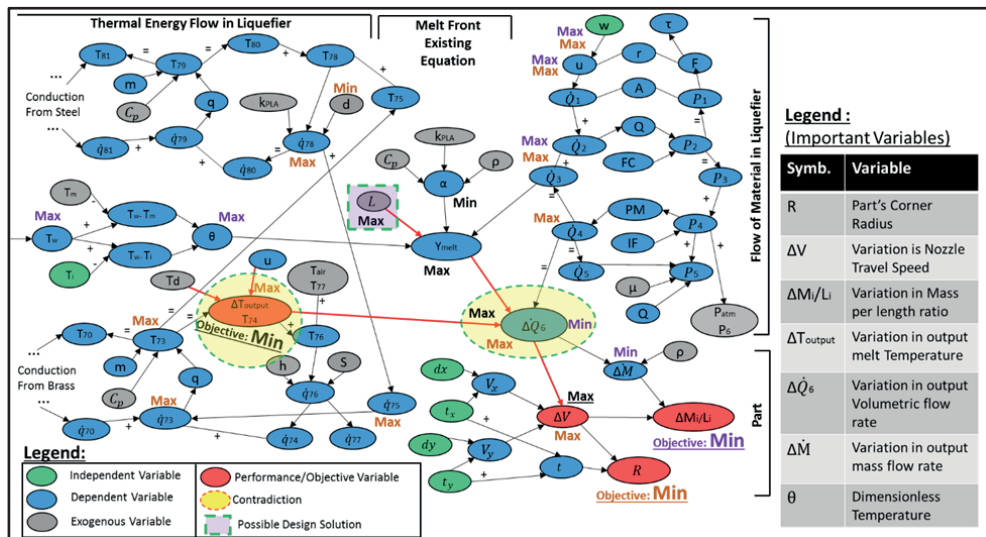

Figure 40. Partial causal graph of FDM liquefier and the part to be manufactured. (Qualitative objectives are underlined. Backward propagations on the graph are shown with the same colors) **(Publication IV)**

The detected contradictions and the possible ways to overcome them by modifying the part design, dimension, and tolerances (tailoring part design), optimizing process parameter settings (tailoring process), or by adjusting the process technology (tailoring AM machine) are summarized below:

1- Objective/Performance:

- Maximizing the uniformity of bonding quality
- Minimizing fillet radius (Min R)

Achieved through:

- Minimizing the variation in the filament temperature (Min ΔT)
- Maximizing the variation in the filament temperature (Max ΔT)

Possible Solution(s):

- Increase the fillet radius to get desired bonding quality (Tailoring part design)
- Find the optimal set temperature by experiments (Tailoring process settings)
- Redesign the liquefier to reduce thermal inertia (Tailoring process/AM machine)
- Re-location of temperature sensors (Tailoring process/AM machine)

2- Objective/Performance:

- Minimizing the variation in the deposited material per length (Min $\Delta(M/L)$)
- Minimizing fillet radius (Min R)

Achieved through:

- Minimizing the variation in the output flowrate of melted material (Min \dot{Q}_6)
- Maximizing the variation in the output flowrate of melted material (Max \dot{Q}_6)

Possible Solution(s):

- Increase the range of acceptable flatness tolerance (Tailoring part design)
- Modify the filament feed rate at the beginning and the end of the radius (Tailoring process)
- Increase the minimum fillet radius required to fulfill the flatness tolerances (Tailoring part design)
- Re-design the material supply of the machine to reduce the slippery contact condition of the filament and feeder (Tailoring AM Machine)

3- Objective/Performance:

- Maximizing printing speed or nozzle travel speed (Max V)

Achieved through:

- Maximizing filament feed rate (Max u)
- Maximizing the distance of the melt location from the nozzle tip (Max Y_{melt})
- Increasing the capacity of providing heat and the variation in temperature (max ΔT)
- Increasing the total heat conductivity (Max) or reducing thermal diffusivity (Min α)

Possible Solution(s):

- Re-design the machine or modify the material input (Tailoring process/AM machine)

4.2.2 Design for Additive Manufacturing

Publication IV contributes to DFAM by presenting an approach to concurrently consider the AM machine and part to be manufactured in an integrated model, in the design stage. Traditionally, the design process starts with an initial set of requirements for the part geometry and characteristics to be manufactured. Designers anticipate the AM process selection by mapping the capabilities and limitations of the AM processes with the requirements. Designers are supposed to provide the design of the part and specifications (often suitable for specific AM process), using DFAM (or in larger context DFM) principles. At this stage, designers may benefit from the existing DFAM rules, topological optimization or other principles such as part consolidation. Eventually, the more designers anticipate manufacturing challenges and refine the design to address them, the better the design is. The provided design options at this stage is not necessarily the best to fulfill all the requirements and designers need the feedback of the final manufactured part. The manufacturing of the designed part evolves with a different type of activities such as process parameter settings, support structure consideration, and path planning for DED processes. The phase of process parameter settings is often an iterative process based on the part initial inspection. The additively manufactured part follows the rest of the manufacturing chain to post-processing and heat treatment if needed.

Once the manufacturing process is completed, various tests and measurements evaluate the manufactured part against the requirements. It is at this stage that designers get feedback on the initial provided design, which is quite late in the design and manufacturing phase. As a result of the part validation process, designers can extract the DFAM rules and consequently tailor the part design and manufactures tailor the process settings. The thesis contributes to the DFAM by providing an approach to concurrently consider AM process and the part for the anticipation of these feedbacks earlier in design stages. Figure 41 represents the iterative process of DFAM. The figure illustrates how DACM framework contributes to DFAM.

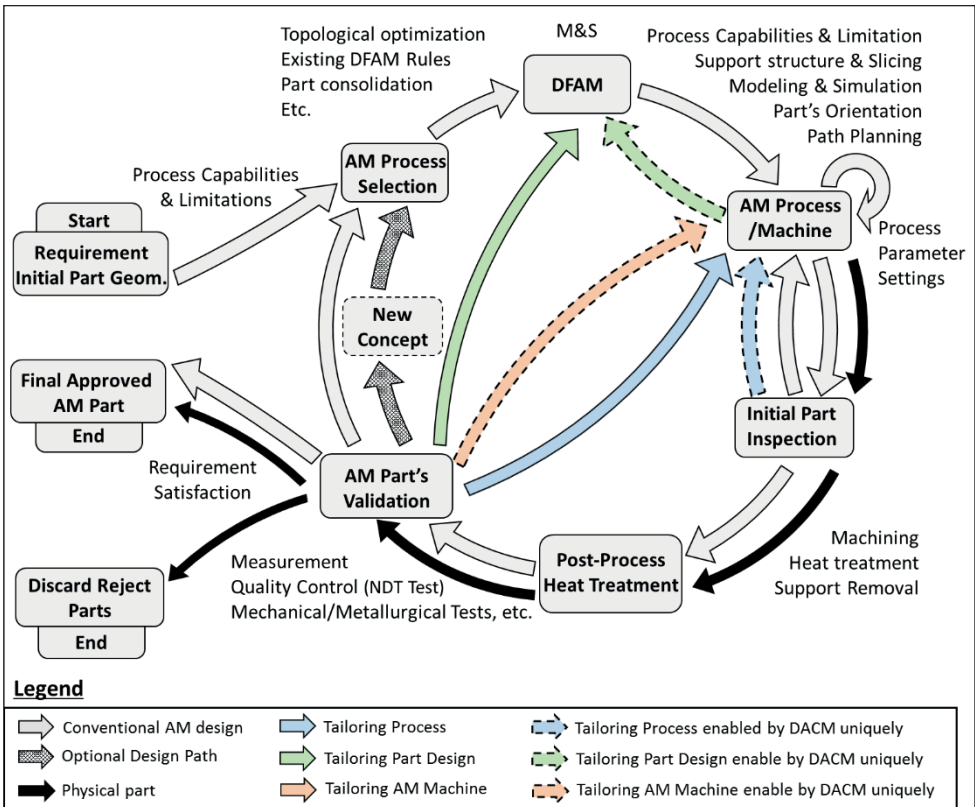

Figure 41. Design for Additive Manufacturing flow, envisioned and pursued in the thesis

4.2.2.1 Design for Fused Deposition Modeling

To evaluate the qualitative analysis shown in Figure 40, **Publication IV** considers printing test parts. Excluding the starting point, the test part has two round corners ($R_1=1\text{mm}$ and $R_2=2\text{mm}$) and a sharp corner. The geometry of the test part is shown in Figure 42. The initial printed parts demonstrate the predicted defects around corners and poor bonding quality near the starting point (see Figure 42).

The defects appeared around all the corners except the corner with the two-millimeter radius. The contradictions found in the causal graph (see Figure 40) demonstrate that acting on the variation of polymer volumetric flow rate in the nozzle outlet ($\Delta\dot{Q}_6$) can remove or reduce the defect. Variable ($\Delta\dot{Q}_6$) is the difference of volumetric flow rate before and after the radius.

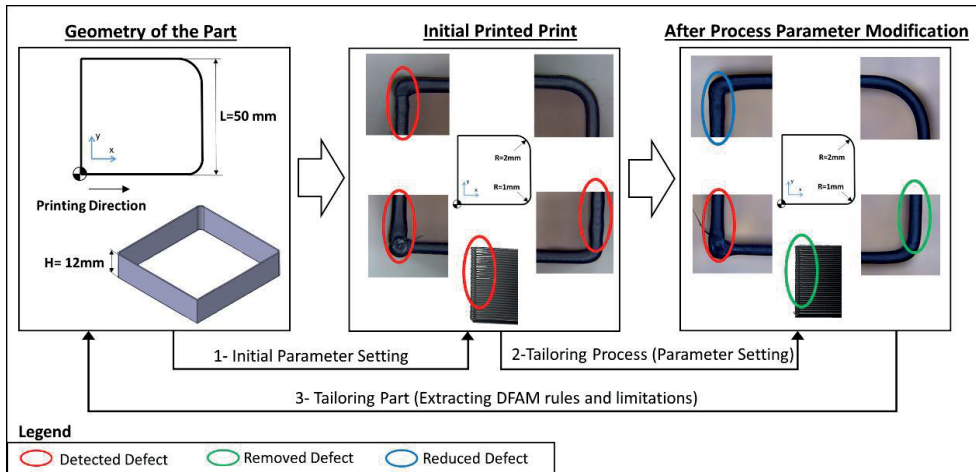

Figure 42. Printing result before and after process parameter modification (**Publication IV**)

Nevertheless, the volumetric flow rate (\dot{Q}) is a dependent variable. The slicer software (here Repetier) calculates the filament feed rate (u) and consequently volumetric flow rate (\dot{Q}) according to the input value of nozzle travel speed (V). On the other hand, the inspection of the initial printed part illustrates that the excess of deposited material after the radius causes the defect (Figure 42). Therefore, we have reduced the filament flow rate in the G-code generated by the slicer. Furthermore, by adjusting temperature, the defect around the corner with $R=1\text{mm}$ is removed and improve the bonding quality near the starting point (tailoring process settings). In the sharp corner's zone, the defect was reduced but never removed. Moreover, the minimum achievable radius was 0.6 mm . This limitation led to a DFAM rule for existing machine setup. Therefore, the part design should be modified and consider a corner radius superior to 0.6 mm (tailoring part design). This is the limitation induced by the available FDM machine design and can be improved by the redesign of the machine (tailoring AM machine). The concurrent consideration of the part and process models in DACM anticipates the system's weaknesses for fulfilling design requirements in design stages and proposed several feasible solutions. The experimental tests verify those weaknesses and propose redesigning the part (considering $R>0.6\text{ mm}$).

4.2.2.2 Curling Defect in Powder Bed Fusion

Curling defect is one of the recurring defects in metal PBF technologies. It predominantly occurs on overhang surfaces that are not supported by enough material from previous layers. The excessive heat energy input (overheating) leads to a cumulative thermal constraint on the part being processed. The cumulative thermal constraint finally results in the deflection of the overhang surfaces upward. According to Béraud et al., reducing the curling defect is an important issue, since it is the result of internal stresses and possibly results in residual stress on the final part (Béraud, Vignat, Villeneuve, & Dendievel, 2014). Several studies investigate different ways to reduce curling defect. Béraud et al. investigated the effect of trajectories in EBM and proposed new trajectories to reduce the curling effect (Béraud et al., 2014). Considering an efficient support structure is another way to reduce this defect. Tounsi and Vignat experimentally investigated the effect of different support structure shapes in reducing the defect (Tounsi & Vignat, 2017). The support structure is used for two main reasons: 1) to dissipate excessive heat and 2) to resist distortion by increasing the inertia of the part. Design and manufacturing strategies generate contradictory effects; for instance, applying a more dense support structure to minimize the curling defect increases the manufacturing time, material cost and difficulties involved in removing the supports. The design space in the functional model shown in Figure 43 is divided into three domains: cyclic functions of the AM process, useful functions of the support structure and non-desired functions. The behavioral laws and the key factors of the model are collected from the literature. They are not created in this case study by using the DACM algorithm generator of behavior laws. By having the functional model and the variables of the problem, it is possible to generate the causal graph.

The cyclic functional model of the AM process simply describes the sequence of functions required to build one layer of the part upon the previous layers. The induced heat energy melts the powder, and the excess energy is transferred to the supports to be dissipated. The functional model of the support structure includes two main functionalities of the supports, the function ‘to dissipate’ heat energy, which is defined by the convection variables, and the function ‘to increase inertia’ which contains the variables characterizing the geometry of the supports and material density. The non-desired functional model characterizes the generation of a thermal constraint that results in the creation of the bending moment and the function ‘to resist’ against the deflection. Figure 43 illustrates the connection between these three functional models with their assigned variables.

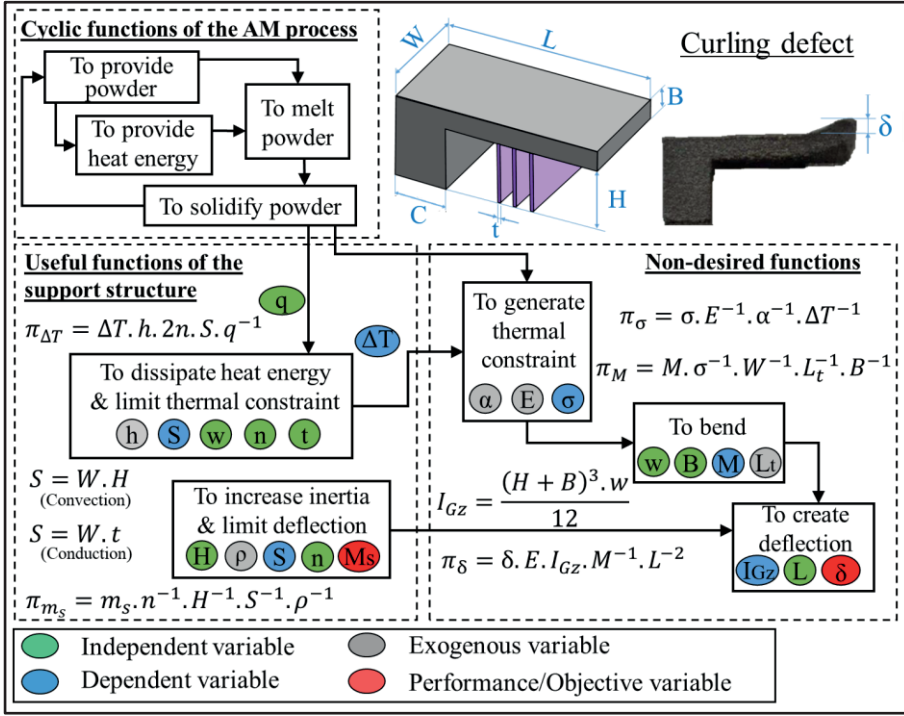

Figure 43. Functional model for curling defect (Publication IV)

Table 12 represents the variables with their associated dimensions. The associated causal graph and governing equations are extracted with the same procedures explained in the methodology section. The design variables, material properties variables and performance variables are shown in green, black/gray and red, respectively. The governing equations are the following:

$$\pi_{\Delta T} = \Delta T \cdot h \cdot 2n \cdot W \cdot H \cdot q^{-1} \quad (19)$$

$$\pi_{m_s} = M_s \cdot n^{-1} \cdot t^{-1} \cdot W^{-1} \cdot t^{-1} \cdot \rho^{-1} \quad (20)$$

$$\pi_{\sigma} = \sigma \cdot E^{-1} \cdot \alpha^{-1} \cdot \Delta T^{-1} \quad (21)$$

$$\pi_M = M \cdot \sigma^{-1} \cdot W^{-1} \cdot L_t^{-1} \cdot B^{-1} \quad (22)$$

$$\pi_{\delta} = \delta \cdot E \cdot I_{Gz} \cdot M^{-1} \cdot L^{-2} \quad (23)$$

$$I_{Gz} = \frac{(H + B)^3 \cdot W}{12} \quad (24)$$

Table 12. Influencing variables and their associated dimensions for the curling defect case study (Publication IV)

Variables	Symbol	Dimension
Heat energy input	q	$ML^{-2}T^{-2}$
Coefficient of convection	h	$MT^{-3}t^{-1}$
Temperature difference between layers	ΔT	t
Surface of heat exchange	S	L^2
Number of supports	n	--
Thickness of supports	t	L
Material density	ρ	ML^{-3}
Total mass of the supports	m_s	M
Width of the supports	W	L
Height of the supports	H	L
Length of the part	L	L
Part thickness	B	L
Moment of inertia	I_{GZ}	L^4
Thermal constraint	σ	$ML^{-1}T^{-2}$
Thermal expansion	α	t^{-1}
Elasticity modulus	E	$ML^{-1}T^{-2}$
Moment of inertia	I_{GZ}	L^4
Moment induced by thermal constraint	M	ML^2T^{-2}
Layer thickness	L_t	L
Curling defect	δ	L

The objectives in this example are minimizing the curling defect (δ), minimizing the total mass of the support structure (m_s) and possibly modifying the design of the part to support those objectives. The backward propagations of both objectives are shown in different colors in Figure 44. The two backward propagations generated several design contradictions related to the dimensions of the beam and supports (i.e., W, H, t), the total surface of the support structure (W and H) and the number of elements (n) in the support structure.

The DACM framework applied to DFAM consists of removing or reducing the contradictions by providing innovative design solutions. The ‘segmentation’ of the support structure suggests increasing the number of elements (Maximizing n) while keeping the thickness of elements (t) as small as possible. This reduces the contradictions for the surface of the support structure (S) and thickness of supports (t) and maintains the capability of the support structure to reduce the temperature difference between layers (ΔT). In the same way, the desire to minimize the mass of

the supports (m_s), surface of the support structure (S) or Height of the supports (H) needs to be minimized. This minimization can be achieved by varying the value of the thickness of supports (t) in the support structure. There is no need to keep a constant value for thickness; (t) can be smaller at the bottom and bigger in the zone of the attachment to the cantilever. Ideally, minimizing the need for the support structure means removing it totally. In the context of the cantilever beam, this can possibly be achieved by rotating the cantilever structure to print it on the side or to print the long beam part with the dimension (L) first, followed by the prismatic part of height (H) and width (W). The root cause of the problem is the temperature difference between layers (ΔT). An option is to reduce the energy input (q). The study of Béraud et al. confirms the effect of heat energy input on curling defects (Béraud et al., 2014). They investigated the beam trajectory as an important parameter influencing the energy input (Béraud et al., 2014). The ‘porous material’ principle suggests using a porous structure, lattice structure, or topology-optimized structure for the part. Another possibility will be to modify the beam shape to integrate the deflection and the distortions of the shape (‘Preliminary anti-action’).

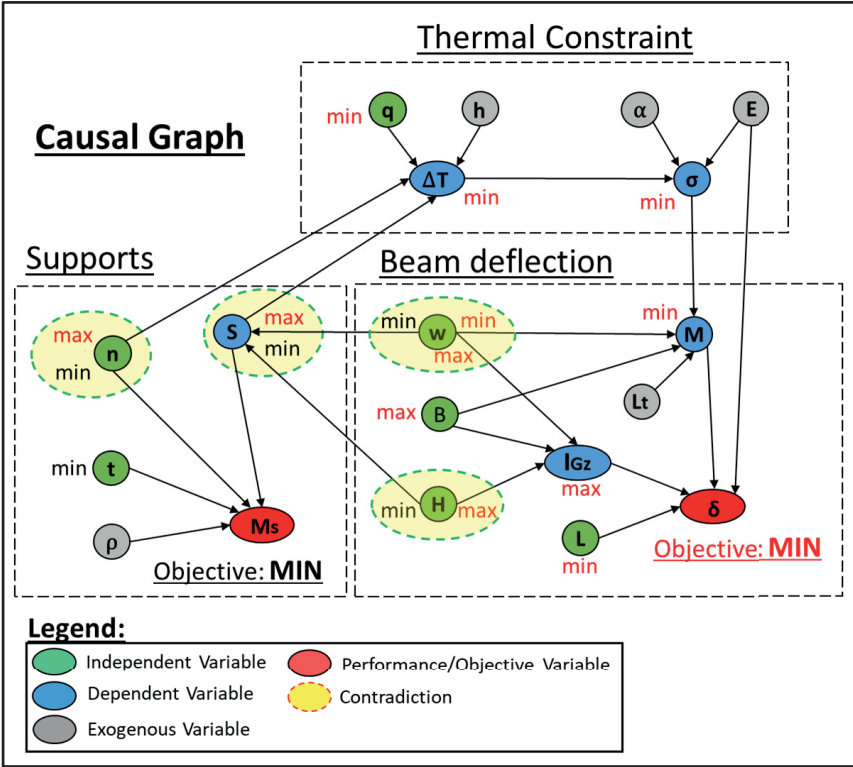

Figure 44. Causal graph for curling defect modeling (DACM for DFAM support) (Publication IV)

In line with the concept of ideality in TRIZ, Cooper et al. proposed the novel concept of contract-free support structures for the overhanging features. (Cooper, Steele, Cheng, & Chou, 2017). They proved that create the heat sink underneath the overhanging features, can minimize the overhang distortions without increasing the post-processing time and expense. However, the concept does not support minimizing material usage in the support structure. The other limitation of the concept is that the heat supports concept is not able to eliminate the distortion entirely for the longer overhang.

4.2.3 Dimensionless Indicator for Comparing Additive and Subtractive Manufacturing on Environmental Impact

Publication V aims at proposing an approach to facilitate process selection between alternative manufacturing processes (here EBM vs. Milling process), from an environmental point of view. The first part of the study is related to the life-cycle assessment and comparative environmental impact analysis of process alternatives, using Simapro Software. To assess the environmental impacts, the indicators such as Eco-Indicator 99 (EI 99), Cumulative Energy Demand (CED), CML 2 Baseline 2000 or Cumulative Exergy Demand (CExD) are be used **Publication V**. The Cumulative Exergy Demand (CExD), for instance, is defined as the sum of exergy of all resources required to provide a process or product (Bösch, Hellweg, Huijbregts, & Frischknecht, 2007).

The thesis contributes to the second part of the study by defining dimensionless indicators that enable comparing the environmental impact of the processes and the shape of the part to be manufactured. To compare the EBM and milling process from the environmental impact point of view, a dimensionless number of (R) is considered to provide a ratio on indicator between EBM and milling processes. For the value below one (1), it is more beneficial to select EBM; for the value above one (1) it is more valuable to select milling process. Eventually, if the ratio is equal to one (1) then both options are similar in term of environmental impact.

$$R = \frac{\textit{Environmental Impact of EBM Process}}{\textit{Environmental Impact of Milling Process}} \quad (25)$$

In addition, a factor such as raw part shape plays an important role in the evaluation of the process selection. Combining the ratio R with a criterion considering the raw part shape is valuable. The ratio K provides a dimensionless shape factor comparing

a reference process. This shape factor is a ratio constructed to evaluate the amount of material removed by subtractive techniques in order to obtain the final part. The ratio provides an aggregative evaluation of the shape and complexity of parts. The shape factor K is used to compare EBm and milling processes in **Publication V**. The volume removed during the finishing process common to both processes is neglected from the volume of material required in both cases.

$$K = \frac{\text{Volume of Material Required in Milling Process}}{\text{Volume of the Part}} \quad (26)$$

The approach is applied to an aeronautical turbine with a nominal diameter of 130 mm and a height of 30 mm. The raw block material is considered to have a diameter of 130.4 mm and the height of 30.4 mm (volume of 406 cm³) with the shape factor $K=7.08$ for the milling process. Figure 45 represents the comparative results of the environmental impact of EBm and the milling process with respect to ten environmental impacts factors for $K=7.08$.

Those ten factors are extracted from two main methods of ‘CML 2 Baseline 2000’ and ‘CExD.’ The factors of abiotic depletion (1), acidification (2), global warming (3), fresh water aquatic ecotox (4), marine aquatic ecotoxicity (5), terrestrial ecotoxicity (6) form ‘CML 2 Baseline 2000’ Method and non-renewable fossil (7), non-renewable nuclear (8), renewable potential (9), renewable water (10) from the ‘CExD’ method. Figure 45 indicates that for $K=7.08$, EBm process always generates less environmental impacts than the milling.

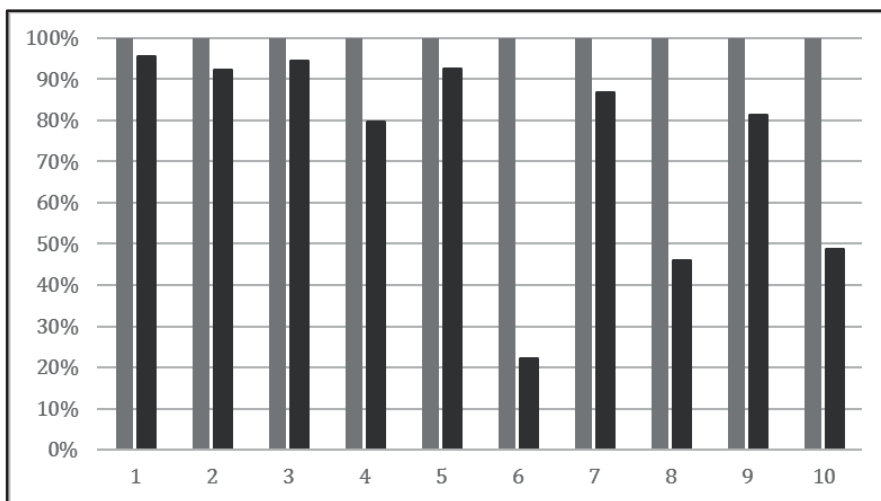

Figure 45. Environmental impacts of EBm (black) and milling (gray) for $K=7.08$ (**Publication V**)

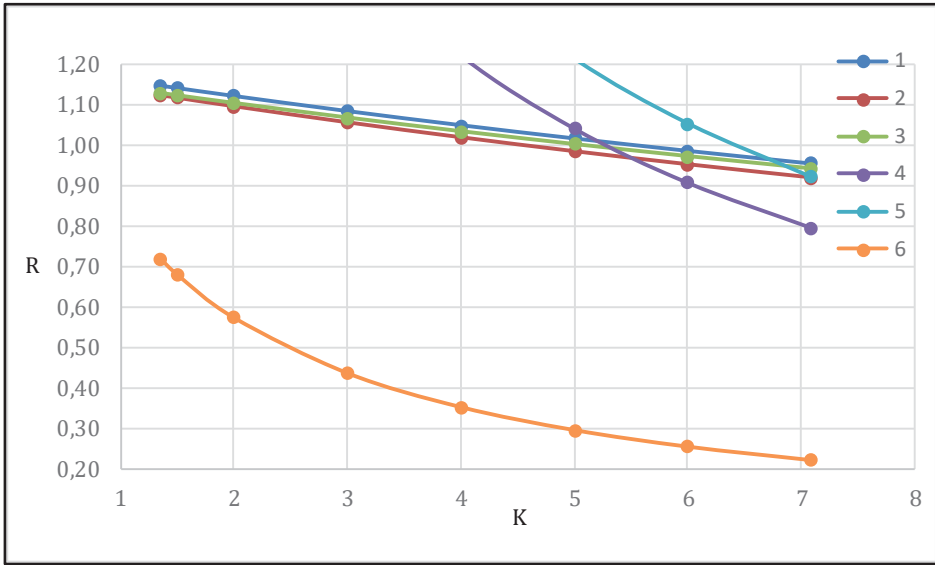

Figure 46. Correlation between R and K for environmental impacts "CML 2 Baseline 2000" (Publication V)

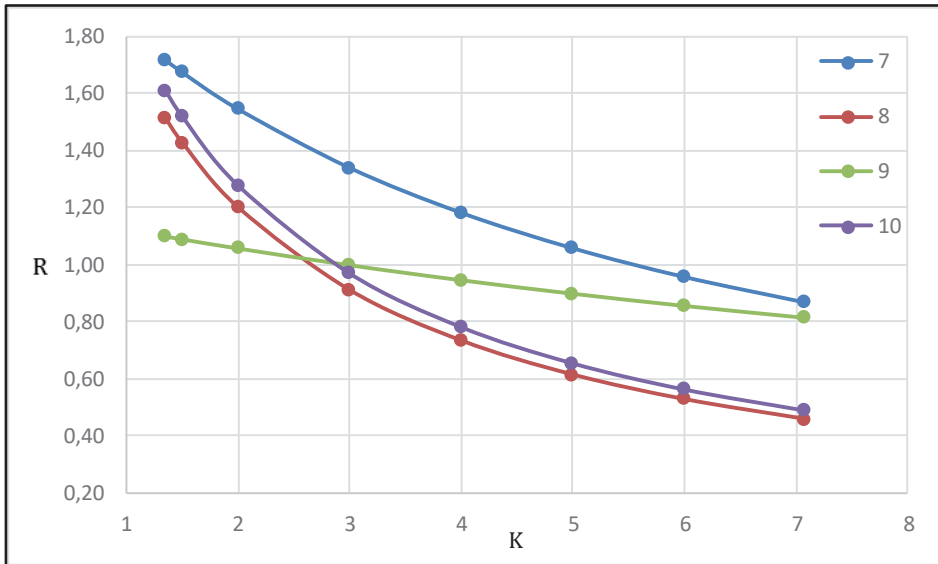

Figure 47. Correlation between R and K for environmental impacts "CExD" (Publication V)

Figure 46 shows the correlation between R and K for ‘CML 2 Baseline 2000’. According to equation (25), the use of EBM is more environmentally friendly when the value of R ratio is below one (1). Therefore, EBM is more environmentally friendly for a K value between 4.5 and 5.5 based on the indicators one to four, 6.4 for the indicator five and all value of K for the indicator six, respectively. In a similar way, Figure 47 illustrates the correlation between R and K for indicators ‘CExD’. According to Figure 47, EBM is more environmentally friendly for K superior to 5.7 based on indicator seven and for K superior to 2.6 and three based on the indicators eight to ten.

As a result of this study, parts implying a low amount of material removal (below $K=2.6$), it is environmentally beneficial to use milling process, while for parts with high material removal (above $K=7$) using EBM is the environmentally friendlier option. Milling process remains interesting for the parts with an acceptable level of shape complexity and EBM for the parts with higher shape complexity.

4.2.4 Metamodeling in Additive Manufacturing

Artificial Neural Networks (ANNs) as a machine learning approach is used to approximately model the systems with complex behavior as a black box. In this context, ANNs are considered as one type of metamodeling approach. Applying ANNs usually requires little theoretical knowledge about the problem domain. The main advantages of ANNs in modeling are, 1) ability to handle noisy and ambiguous data, 2) lower cost of implementation, 3) and their suitability for accurate representation of dynamic problems (Tu, 1996) (Moré, 1977). Apart from the advantages of ANNs, the main challenge of developing and implementing ANNs is the demand for a large number of training data. Moreover, the application of ANNs is limited due to the central issues of interpretability and reusability of models. The results of ANNs are case-specific and often challenging to interpret.

To alleviate these issues, the thesis point of view suggests developing a modular knowledge-based ANN topology based on the established causal graph among the system’s variables. It suggests breaking down an ANN describing the whole system into multiple small ANNs. Each small ANNs can characterize a functionality in the system or a physical phenomenon that takes place in the system. This Knowledge-Based Artificial Neural Network (KB-ANN) topology is the combination of topological zones derived from existing knowledge of the system (process) and other zones where the missing knowledge is modeled using classical ANNs. The first

major difference of this approach comparing to classical ANN is the integration the pre-existing knowledge on the system (process) and eventually changing a black box model to a gray box model for better interpretability. Encoding Knowledge in KB-ANN can enable superior interpretation capability to the model. The second difference is that the small ANNs which describe the physical phenomenon and laboratory experiments results can be used to model different machines and processes in case of having common physical phenomenon taking place in those processes. This enhances eventually the reusability of developed models and captured data. The third major difference is that the proposed approach relies partially on experiments. The experimental datasets are not used to train the entire model but to train only the zones of the model where the knowledge does not exist in the form of deterministic or empirical equations. Therefore, KB-ANN is a hybrid-learning network that uses both theoretical knowledge and empirical data to construct a model of a system.

The modeling framework developed and pursued in the thesis provides the approach mentioned above to integrate different models, including experimental and theoretical models. The DACM framework presents models in the form of the combination of the causal graph and their associated governing equations. The pre-existing knowledge integrated into the models can be either deterministic equations, empirical equations or tentative causal relationships among variables that we seek to establish the equation. The available deterministic and empirical equations encode the pre-existing knowledge zone. The input and output variables are extracted from the causal graph to model the zones where the missing knowledge is required using classical ANNs. Note that developing such modular ANN topology is not unique. The level of detail of the KB-ANN depends on the level of detail in the causal graph, availability of datasets, and availability of the sensors to measure parameters on the machine. The proposed approach also offers an indication of the variables that need to be monitored in the system or process under investigation. Figure 48 and Figure 49 illustrate two possible KB-ANN modular topologies for the FDM process based on the causal graph developed in **Publication IV**. The modular KB-ANN topology shown in Figure 48 depicts some selective sequence of functions and phenomena taking place in the FDM process.

The filament is fed to the extruder based on the settings in the slicer, where the filament feed rate model approximates the slicer behavior by linking nozzle travel speed (V) and layer height (h_i) as the input variables to the filament feed rate (FFR). The filament gets melted gradually while traversing the extruder channel. The melting of the filament does not happen at a specific location; however, the melt

location model estimates this location as a function of material input volumetric flow rate (VFR_i), temperature and filament thermal diffusivity (α).

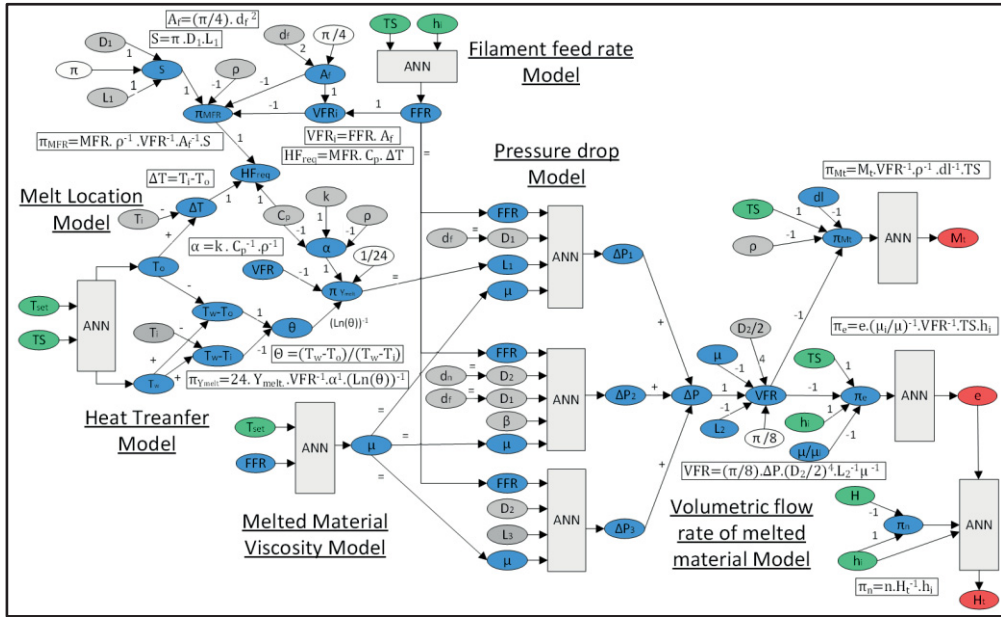

Figure 48. A modular KB-ANN topology for the FDM process using causal graph developed by DACM framework (Nagarajan et al., 2019)

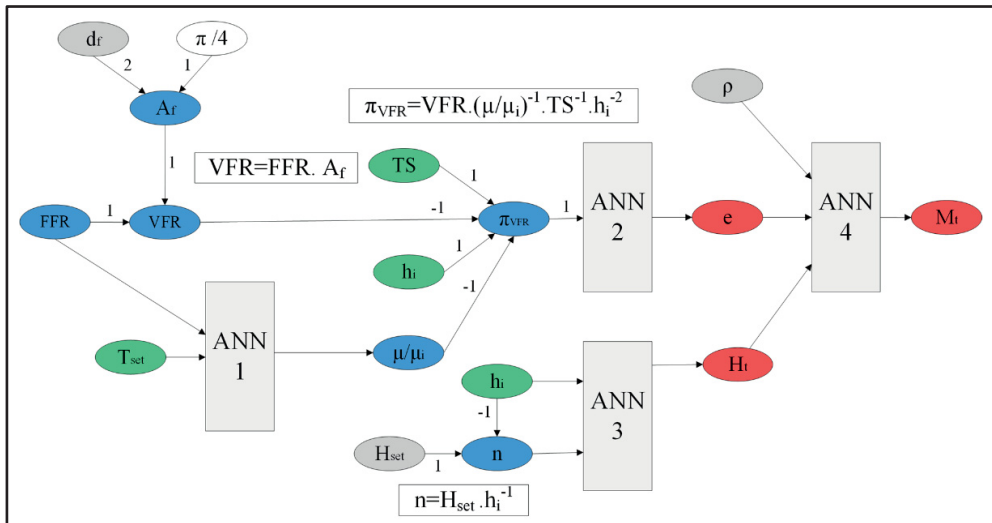

Figure 49. A simplified modular KB-ANN topology for the FDM process using causal graph developed by DACM framework (Nagarajan et al., 2019)

According to melt location model, the temperature itself depends on an initial temperature of the filament (T_i), the temperature of the channel wall (T_w) that is in contact with the filament, and ultimate temperature of melted material (T_o) in the outlet of the extruder. The temperature of the channel wall (T_w), and ultimate temperature (T_o) of the melted material depend on the values of nozzle travel speed (T_S) and set temperature (T_{set}) in the slicer. Later in this model, the output variables such as total deposited mass (M_t), wall thickness (e), and the total height (H_t) are modeled regarding the central variables of volumetric flow rate (VFR) of material near to the outlet of the extruder. Volumetric flow rate (VFR) at the outlet of the extruder is different from the input volumetric flow rate (VFR_i) of material due to the pressure drop takes place inside the extruder. The pressure drop model is a function of filament flow rate (FFR), viscosity (μ) and geometrical characteristics of the extruder, such as diameter and conical angle of the extruder. The viscosity itself can be modeled according to the influencing variables such as filament feed rate (FFR) and set temperature (T_{set}). In order to be able to train the small ANNs in the current topology of KB-ANN shown in Figure 48, training datasets are required for the red and blue variables. The training values can be gathered using measurements, sensors, and validated simulation results. Therefore, the causal graph indicates the zones (variables) that need to be monitored or measured in the system. One can simplify the causal graph or slightly change the logic of the causal graph according to the availability of monitor and measurement devices. For instance, Figure 49 shows a simplified modular KB-ANN topology for the FDM process with four small modular ANNs.

ANN 1 is dedicated to approximate the behavior of polymer viscosity according to the temperature (T_{set}) and filament feed rate (FFR). ANN 1 can be trained using both data gathered from laboratory tests or simulations. The ANN 2, ANN 3 and ANN 4 are considered to model the thickness, height and the mass of the test part, respectively. Note that, ANN 2 utilizes a dimensionless number (π_{VFR}), instead of all four influencing variables. It is proved that reducing the number of input variables, often referred to dimensionality reduction, is beneficial to train the ANN faster (Wu, Coatanéa, & Wang, 2017).

The following case study considers the same geometry shown in Figure 42 for the test part (Nagarajan et al., 2019). The test part is considered to have a wall thickness $e = 0.5 \pm 0.05$ mm and height $H_t = 12 \pm 0.05$ mm. The case study follows the concurrent modeling and experimental steps shown in Figure 50. Four test parts are initially printed using pre-selected printing process parameters proposed by the Repetier slicing software. The most influencing parameters that

could potentially affect the part quality were detected and taken into consideration. The study considers wall thickness (e), part height (H_t), and part mass (M_t) as the target parameters and the layer height (h_i) in mm, the extruder temperature (T_{set}) in °C, the nozzle travel speed (TS) in mm/s, and the fan speed (Fan) in rpm as the influencing parameters. An L27 standard orthogonal array was adopted to consider three levels for the four input parameters. The experiments were replicated to ensure repeatability of the FDM machine. In Step 4, fan speed variations were removed from the model because of the latency of its effects on the three performance variables. The fan speed parameter was fixed to a value of ON at 50% for all experiments. In step 5, the prediction models for thickness, height, and mass are built for the remaining control factors: nozzle travel speed (TS), layer height (h_i), and extruder temperature (T_{set}) using both Classical ANN and KB-ANN architecture.

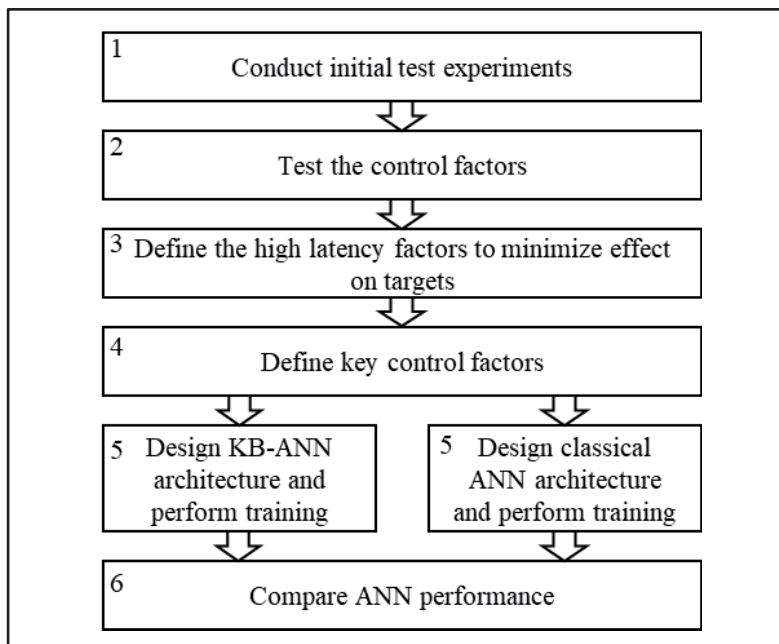

Figure 50. Pursued concurrent modeling and experimental approach (Nagarajan et al., 2019)

Three classical ANNs are designed to model the three outputs, namely, wall thickness, part height, and mass using three inputs: layer height, travel speed, and extruder temperature. The ANNs are designed with two hidden layers consisting of three nodes each and one output layer with one node. The performance of the network is measured in terms of Mean Squared Error (MSE). The Levenberg-Marquardt algorithm was chosen as the training function and the tangent sigmoid

function was chosen for the transfer function (Moré, 1977). The input data for the ANN was divided, using 70% for training, 15% for validation, and 15% for testing. Typical performance graphs contain three curves, namely, a training curve, a validation curve, and a test curve, which together indicate the mean square error of a training process. The performance curves indicate the quality of the training in terms of error reduction, under-fitting (bad training), and overfitting. For a good fit performance, the three curves must follow a downward trend indicating low MSE. In addition, the curves must be smooth and must follow the pattern of training and testing curves at the very bottom, followed by a validation curve. The performance curves for the three classical ANNs are shown in Figure 51.

The MSE value for best performance was found to be $5.43\text{e-}04$ after nine iterations for wall thickness, $1.15\text{e-}04$ after 10 iterations for height, and $2.01\text{e-}03$ after 23 iterations part mass. the training curves for wall thickness and mass follow a downward trend, while the testing and validation curves follow a downward slope until the lowest MSE value achievable; it then trends slightly upwards, indicating a low generalization to inputs with values lying outside the range of the training data. In addition, the upward trend of the validation and testing curves against the continuous downward trend of the training curve indicate the possibility of overfitting. The curves for height are steady at a fixed MSE value with the validation curve trending below the testing curve, indicating a poor fit to the provided data samples and a low level of generalization for inputs that lie outside the training state.

On the other side, the KB-ANN was designed as three modular ANNs following the simplified causal graph shown in Figure 49. The first modular ANN is designed for one output: the ratio of viscosity (μ) of molten polymer at extrusion temperature to the viscosity (μ_i) of molten polymer at a reference temperature ($175\text{ }^\circ\text{C}$). The filament feed rate (FFR) and extruder temperature (T_{set}) are used as inputs. Here, the output of the modular ANN 1 is an intermediate (blue) variable, which cannot be directly measured and, hence, has to be estimated using numerical simulations. The second modular ANN is designed for the output, wall thickness. To reduce the dimensionality of the ANN, the inputs to predict wall thickness were represented in the form of a dimensionless number. The third modular ANN was designed for part height (Ht) as the output, with layer height (h_i) and the number of layers (n) as the inputs. The fourth modular ANN was designed for mass (Mt) as output, with wall thickness (e), height (Ht), and density of the material (ρ) used as the inputs. ANN performance was measured using Mean Squared Error (MSE). The input data for the ANN was divided, using 70% for training, 15% for validation, and 15% for testing. Figure 52 shows the performance curves for the four modular ANNs.

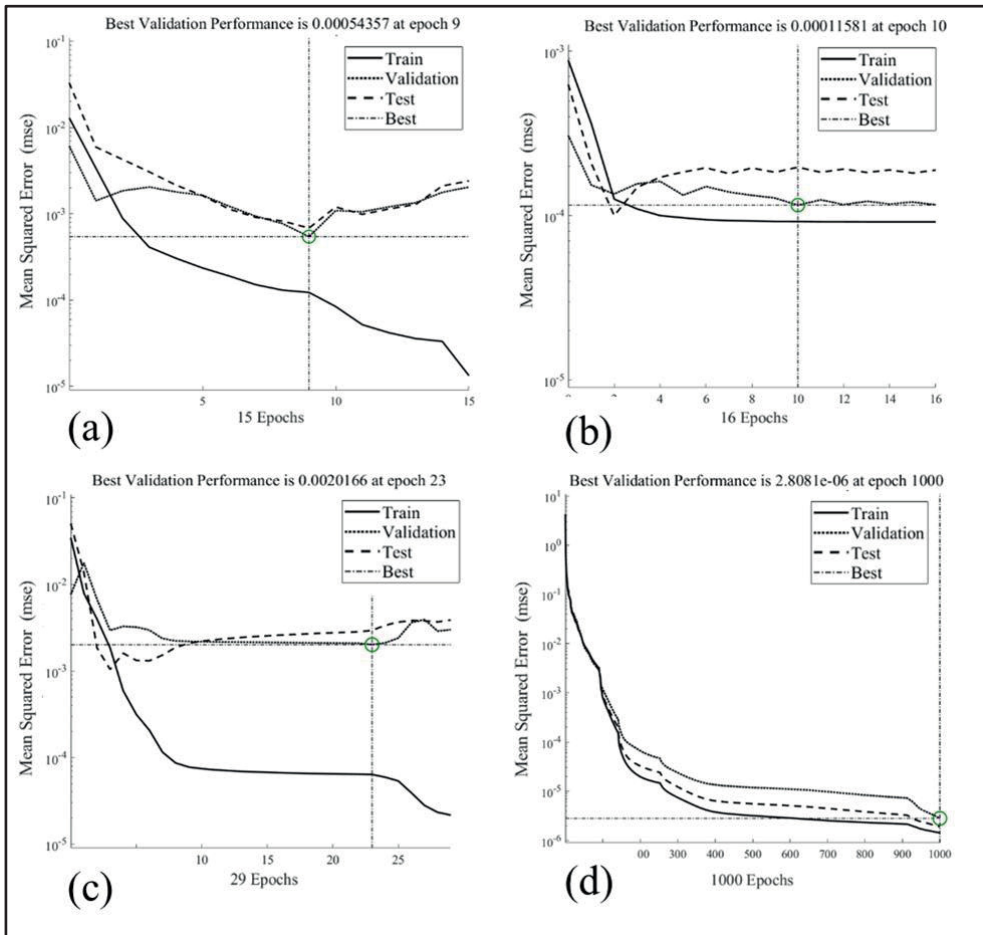

Figure 51. Performance curves for classical ANNs to model part's a) wall thickness, b) height, c) mass and d) performance curve for the best-fit scenario (standard function $z=\sin(x).\cos(y)$) (Nagarajan et al., 2019)

Figure 52(a) shows that the modular ANN 1 was able to obtain the best validation performance at the 53rd iteration with an MSE of $7.7186e-05$. The performance curves show training, testing, and validation following each other in a downward trend, indicating a good fit and good generalization capability. The downward trend also implies that a better model could be obtained by increasing the number of training samples. The results for modular ANN 2 for wall thickness (c) is shown in Figure 52(b). The observed MSE was found to be $9.30e-05$ after 93 iterations. The curves show overlap during the first 10 iterations but soon smoothen and follow a uniform trend. This shows that the ANN was able to train for 93 iterations without failure, indicating a good fit to the training data.

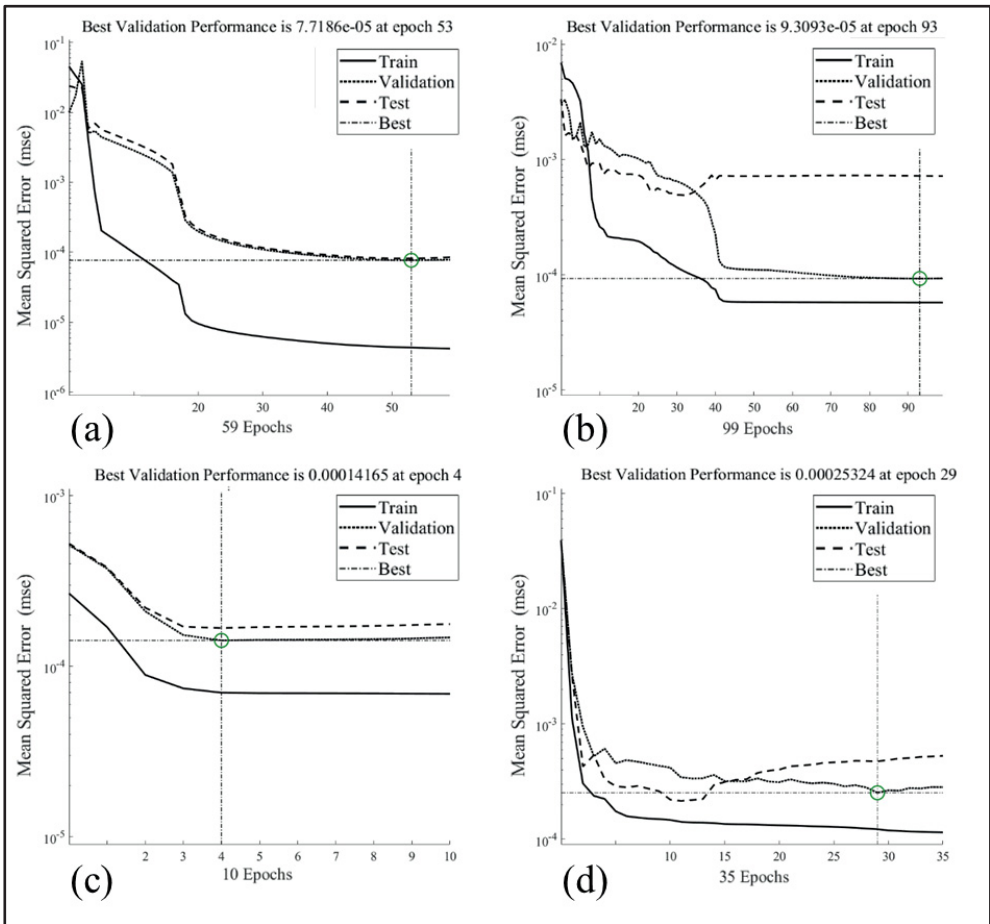

Figure 52. Performance curves in the KB-ANN for: a) modular ANN 1 (viscosity), b) modular ANN 2 (thickness), c) modular ANN 3 (height), d) modular ANN4 (mass) (Nagarajan et al., 2019)

The modular ANN 3 results for part height shown in Figure 52(c) have a best-fit performance with an MSE of 1.41×10^{-4} after only four iterations. The curves are smooth and follow each other in the graph; however, the ANN achieved the best performance at four iterations, indicating a mediocre fit to the training data. Finally, the results of modular ANN 4 for part mass (Mt) are shown in Figure 52(d). The observed MSE is 2.54×10^{-4} after 23 iterations. It was seen that the performance curves follow a downward trend with the validation curve below or at par with the testing curve. This indicates an average fit to the provided data samples, but with the possibility of overfitting.

4.2.4.1 Validation and Comparison of Classical ANN with KB-ANN Architecture

The validation of the developed models was carried out with nine experimental tests. The values for the independent input variables (layer thickness, extruder temperature, and travel speed) were chosen at random. The range of values for the independent variables are as follows, layer thickness (0.1 mm to 0.4 mm), extruder temperature (175°C to 215°C), and travel speed (5 mm/s to 19 mm/s). From validation, the standard prediction errors for thickness, height, and mass using the KB-ANN were found to be 0.1627, 0.3647, and 0.4621, respectively. Similarly, the prediction errors for the fully connected classical ANN were found as 0.1376 (thickness), 0.5898 (height), and 0.4667 (mass). The propagated global error of the KB-ANN model was found to be 0.5220. It can be noted that the KB-ANN global model error is propagated due to the output of modular ANN 1 acting as input for modular ANN 2, and similarly, the output of modular ANN 2 acting as input for modular ANN 3. The MSE and standard error calculated after validation for the two types of networks are compared in Figure 53. It is seen that the errors for the KB-ANN are in the same range as the prediction error of the classical ANN.

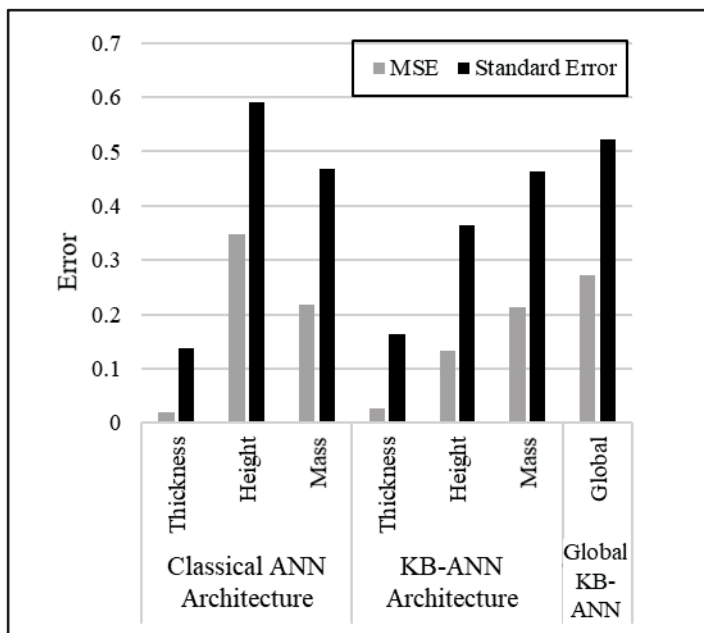

Figure 53. Comparison of validation error for the classical ANN architecture and the KB-ANN architecture in the case study (Nagarajan et al., 2019)

In the case study presented in this paper, the KB-ANN method performed better than the classical ANN architecture in terms of fit to the provided experimental data (Nagarajan et al., 2019). Specifically, the prediction error for the KB-ANN method was found to be nearly the same as the classical approach for wall thickness and part mass, while lower for part height. This prediction error was largely the result of lost information when streamlining the complete causal graph in Figure 48 to the simpler version. In particular, the regression fit for the height using the KB-ANN method was poor largely due to the absence of adequate knowledge or models to represent the phenomena that influence part height. For instance, the cooling effect of the fan may affect the solidification rate of the molten polymer, resulting in tight bonding or sparse bonding of layers, which would have a direct impact on part height.

This case study was limited to the prediction of three target variables in comparison to a large number of target variables that essentially need to be modeled for a complex AM system. Nevertheless, the case study demonstrates an initial proof of concept to use DACM for combining knowledge and providing better interpretability and reusability of models.

4.2.5 Probabilistic Modeling of Defects in Additive Manufacturing

This section aims at providing quantitative simulation capabilities to the models developed by DACM framework, via translating DACM models to Bayesian Network (BN). This section is thus an extension of the curling defect case study of **Publication IV**. The case study develops a probabilistic model to explore the design space for additive manufacturing the same L-shape geometry of **Publication IV** and to characterize the effect of design parameters on the curling defect during the early design stages.

The case study presented here follows the workflow proposed in Figure 54. This generic workflow includes three main stages:

- Generate a causal graph of the phenomenon take place in the process and associated governing equations using the DACM framework.
- Translate the resultant causal graph into Directed Acyclic Graph (DAG) for Bayesian network model development.
- Develop probabilistic modeling and provide simulation capability to the model. BayesiaLab software is used to implement probabilistic modeling.

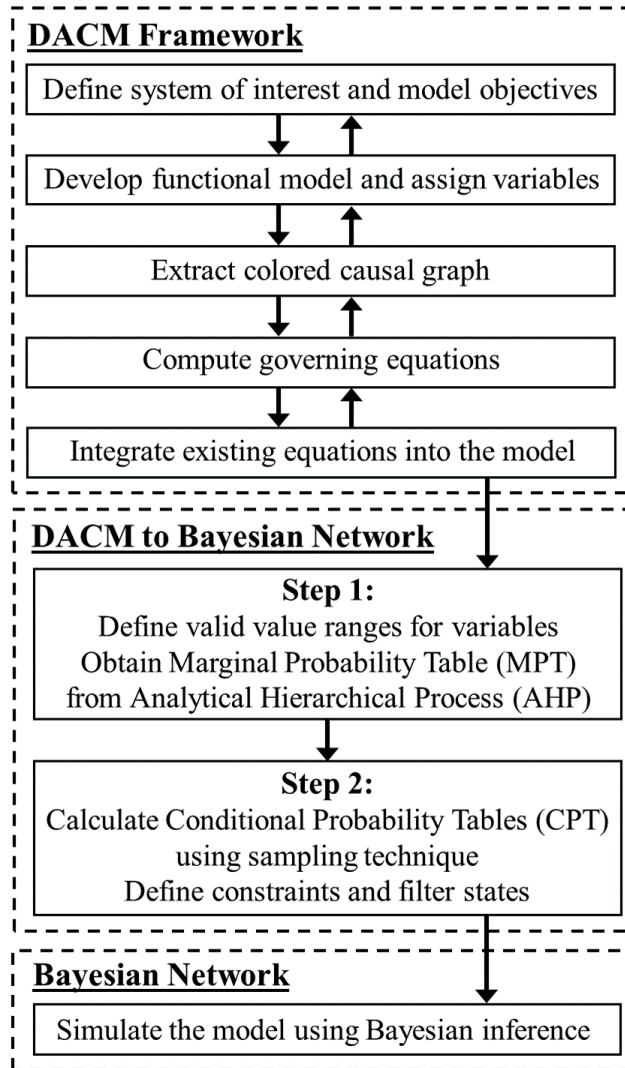

Figure 54. Proposed methodology workflow of the case study

In the first stage, the causal graph and governing equations are established using the same modeling approach presented in **Publication IV**. The governing equations are listed below where only the equation for the temperature difference between layer is replaced with equation (27). Equation (27) approximates the temperature difference between layers as a function of heating rate (HR), cooling rate (CR), part geometry variables (W , L , and B), and process parameters (d_l , L_t , v , and t_w). Heat energy dissipation is defined here by cooling rate (CR), which depends on the geometry of the support and heat transfer variables.

Figure 55 illustrates the causal graph considered in this case study, where some additional variables are considered in comparison to **Publication IV**.

$$\pi_{m_s} = M_s \cdot n^{-1} \cdot t^{-1} \cdot W^{-1} \cdot t^{-1} \cdot \rho^{-1} \quad (20)$$

$$\pi_{\sigma} = \sigma \cdot E^{-1} \cdot \alpha^{-1} \cdot \Delta T^{-1} \quad (21)$$

$$\pi_M = 2 \cdot M \cdot \sigma^{-1} \cdot W^{-1} \cdot L_t^{-1} \cdot B^{-1} \quad (22)$$

$$\pi_{\delta} = \delta \cdot E \cdot I_{Gz} \cdot M^{-1} \cdot L^{-2} \quad (23)$$

$$I_{Gz} = \frac{(H + B)^3 \cdot W}{12} \quad (24)$$

$$\Delta T = \left(\frac{L \cdot W \cdot B}{d_l \cdot L_t \cdot v} \right) (HR - CR) - \left(\frac{b \cdot t_w}{L_t} \right) (CR) \quad (27)$$

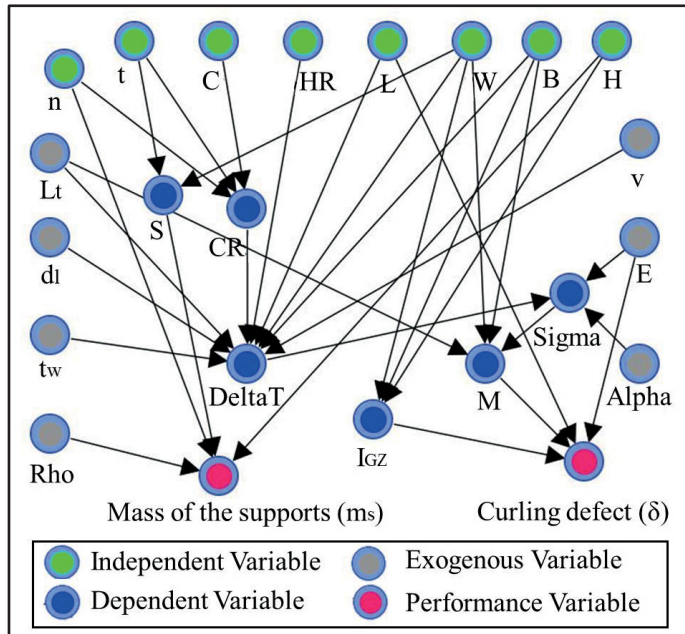

Figure 55. Causal graph for curling defect (represented in BayesiaLab)

The second stage of the work flow which is translating the DACM model into a BN model proceeds through following two main steps, as discussed below.

Step 1: In the first step, we define the valid value ranges for the independent variables of the functional model. These ranges are then divided into several intervals or states. It is necessary to provide Marginal Probability Tables (MPT) to each interval of the independent variables. For providing MPTs to each interval of the independent variables, it is possible either to assign a probability distribution of occurrence (e.g., normal distribution, uniform distribution) to the intervals or to integrate expert knowledge and preferences (Shadbolt & Smart, 2015). In this case study, we used the analytical hierarchy process (AHP) to capture experts' knowledge and preferences in the BN model (Saaty, 2013). Three experts were asked to answer a series of questions by filling AHP tables associated with the required comparisons. The aim was to capture the experts' preferences over different intervals for each independent variable. To enhance this process, AHP tables were transformed into a series of questions. For instance, supposing four intervals ($i=4$) for the number of supports (n), the questions are formulated to capture expert preferences over the intervals two-by-two (e.g., interval 1 vs. interval 2), as follows: 'considering all conditions for printing a desired part, what is your preference of interval 1 compared to interval 2?' The questions were asked $((i^2-i)/2)$ times to obtain two-by-two comparisons of all intervals for all independent variables.

Once all preferences were captured from pairwise comparisons, AHP was used to generate a weight for each interval, in a way that the sum of all individual interval weights is equal to one. Hence, the weights generated by AHP are equivalent to the probability of selection of that interval by experts. The process of capturing experts' preferences continues to cover all independent variables. Table 13 provides the list of variables of the case study with their associated units, ranges of values, marginal probabilities, and equations.

Step 2: The causal graph established by DACM in this case study shown in Figure 55 is a directed acyclic graph (DAG). This is an initial BN prerequisite. However, a few systematic modifications need to be carried out to adapt the DACM causal graph to the BN model. First, exogenous variables which have a fixed value and do not vary in the system should be removed from the causal graph. Not that the effect of exogenous variables is not eliminated from the model since they are considered in the equations as constants. The second modification is to define constraints and filter state among variables, which is necessary to avoid impossible combinations of values for independent variables and also to limit the design space. Constraints are defined between parent nodes, and filter states are used as an interval/state within child nodes.

Table 13. List of case study variables with the range of values and equations

Variable (Symbol)	Unit	(Range of values)/Equations Marginal Probability (%)			
Part length (L)	mm	(15, 45) 11.11	(45, 75) 66.67	(75, 120) 22.22	
Part height (H)	mm	(3, 9) 9.53	(9, 18) 24.99	(18, 36) 65.48	
Part width (W)	mm	(3, 9) 23.85	(9, 18) 62.50	(18, 36) 13.65	
Part base (C)	mm	(4, 12) 10.95	(12, 21) 30.90	(21, 33) 58.16	
Part thickness (B)	mm	(2, 6) 19.63	(6, 12) 65.71	(12, 18) 14.66	
Support thickness (t)	mm	(0.3, 1) 65.86	(1, 1.8) 26.28	(1.8, 3) 7.86	
Number of supports (n)	---	(1, 5)	(6, 10)	(11, 15)	(16, 20)
Elasticity modulus (E)	MPa	113.8 * 10 ³ (M. Yan & Yu, 2015)			
Thermal expansion (α)	1/K	8.6 * 10 ⁻⁶			
Density (ρ)	g/mm ³	4.43 * 10 ⁻³			
Powder layer thickness (L_r)	mm	0.1			
Laser diameter (d_l)	mm	0.115			
Laser scan velocity (v)	mm/s	1000 (Cheng & Chou, 2015)			
Temperature difference (ΔT)	K	Calculated by equation (27)			
Total support mass (m_s)	g	Calculated by equation (20)			
Thermal constraint (σ)	MPa	Calculated by equation (21)			
Thermal constraint moment (M)	N.mm	Calculated by equation (22)			
Curling defect (δ)	mm	Calculated by equation (23)			

The geometric parameters in the case study have been limited using constraints in terms of ratio to avoid the simulation of undesirable geometries. Table 14 represents the acceptable ranges for the design parameters for this case study.

Once the MPTs are established for the independent variables, Conditional Probability Tables (CPTs) are then populated based on the causal graph and governing equations using a sampling technique. The sampling technique starts with calculating the range for the child nodes based on the maximum and minimum value of the parents and the governing equations. The range of values for CPT is then divided into several intervals. The sampling technique continues by taking a number of samples from the parent nodes. The process uses the governing equations for

each interval in the parent node(s) to calculate the corresponding value in the child node(s). The current case study uses the available algorithms in commercial software of BayesiaLab to calculate CPT for the dependent and performance variables (nodes). Therefore, mathematical algorithms of CPT calculation is currently out of the scope of this thesis. Finally, filtering the impossible values for each child node is essential to avoid propagation of error in the network.

Bayesian inference for the case study is implemented in BayesiaLab software. The software uses a sampling technique from available values in the model to calculate all possibilities for the variables in the network. The Bayesian inference mechanism enables simulations to observe the effect of user preferences or evidence across a developed network. Bayesian inference mechanism of BayesiaLab enable the designers to simulate the network in two directions:

- 1- To predict the effect of specific design and manufacturing parameters on defects (prognosis) (forward simulation).
- 2- To predict the independent variables' most probable value for particular results in performance (diagnosis) (backward simulation).

Few simulations are considered below to demonstrate the type of results that we are able to get for the forward and backward simulations.

Table 14. Initial and defined acceptable value ranges for geometric constraint ratios

Constraint Ratio	Initial Range	Acceptable Range
C1=B/L	(0.016, 1.2)	(0.1, 0.2)
C2=W/L	(0.025, 2.4)	(0.16, 0.5)
C3=C/L	(0.033, 2.2)	(0.25, 0.5)
C4=H/L	(0.025, 2.4)	(0.2, 1)
C5=n.t/L	(0.0025, 4.0)	(0.0025, 0.5)

4.2.5.1 Forward Simulation

Figure 56 shows the effect of the design variables on the resulting curling defect for AM of the L-shaped part. During simulation, the values for part height (H, 9-18 mm), width (W, 9-18 mm), length (L, 45-75 mm), and thickness (b, 12-18 mm) are set as evidence for the BN model. For these part dimensions, it is seen that the probability of curling increases in the high value state of the variable (curling ≤ 1.0) to 44.78%. This value warn designer that with the considered geometry, the probability of having unaccepted curling defect is high.

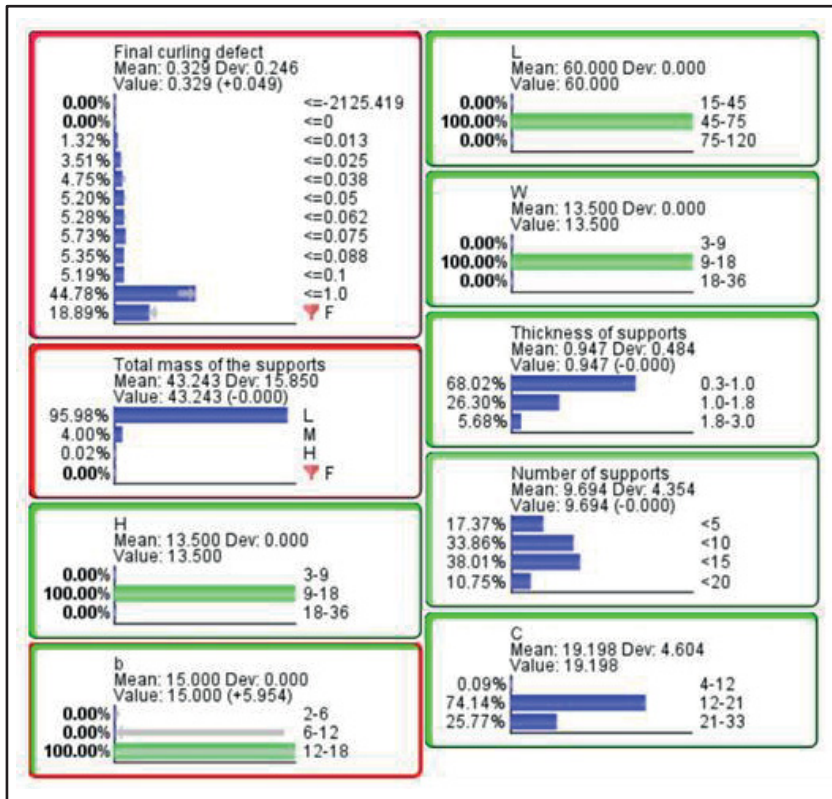

Figure 56. Predicted effect of part geometric dimensional features on the probability of curling defects for medium-sized parts ($45 < L < 75$)

Note that this value is based on the governing equations of the model and provided MPT's and values to the software and not based on real experimental data. However, the simulations, especially comparative simulations are informative in the early design stages. In Figure 57, new evidence for part width (W, 18-36 mm) and part height (H, 18-36 mm) are presented to characterize the effect of these changes on the curling defect. It is seen that the changes reduced value for curling defect. The probability that the curling defect lies in low value states of the variable (≤ 0.025 , ≤ 0.038 , and ≤ 0.05) increased to 22.97%, 21.68%, and 14%, respectively, representing significant decrease in the value of curling defect from the range (0.1 mm-1 mm) to range (0.013 mm to 0.038 mm). Thus, these comparative simulations provide insights to the designer about the effect of simultaneously change in part width (W) and height (H) in reducing the probability of unacceptable curling defect.



Figure 57. Predicted effect of part width and part height on the probability of curling defects for medium-sized parts (45 < L < 75) compared to Figure 56

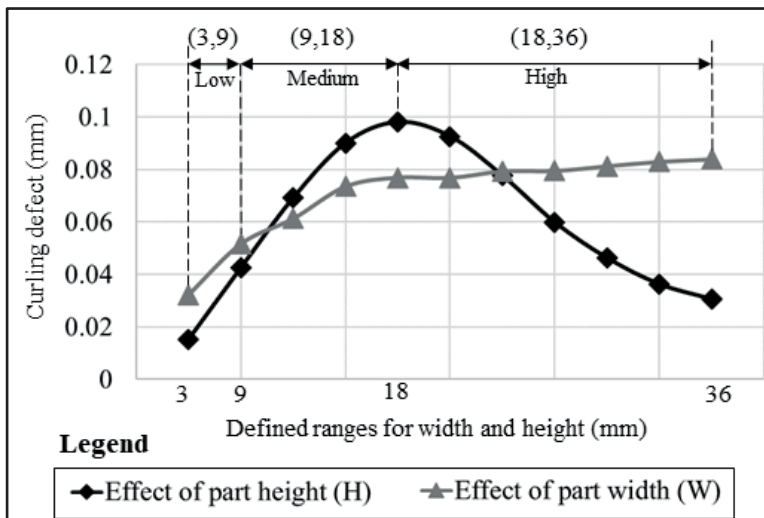

Figure 58. Effect of part height and part width on the curling defect

The individual effects of width and height on the curling defect is shown in Figure 58. It is seen that increasing part width is predicted to result in an increased curling defect. Lower range values for part height (3-18 mm) are predicted to increase the magnitude of curling, while high range values (18-36 mm) would reduce the curling defect.

4.2.5.2 Backward Simulation

During backward simulation, the curling defect was set to be in a low state (≤ 0.013) and the total mass of supports was set in the low range (≤ 80 g) for small parts ($15 < L < 45$). The effect of this evidence is shown in Figure 59, where the most probable states for the part and support dimensions are found for the set evidence for the length of the part, curling defect, and the total mass of supports.

For low curling defect and low total mass of supports, the model predicts the following. The part height must be in the high-value state (0.3-1.0 mm, with a probability of 72.47%), part thickness in the low-value state (2-6 mm, with a probability of 71.31%), part width in medium value state (9-18 mm, with a probability of 74.21%), and the number of supports must be less than or equal to five (with a probability of 57.78%).

Note that the aim of this case study at this stage was to demonstrate the proof of concept that BN is able provide quantitative simulation capabilities to the models developed by DACM. This BN model enables designers to visualize in real time the cascading impacts of choices regarding design variables and dynamically explore the design space in the early design stages of PDP.

The results of this study are used to give insight to designers in the early design stage. One limitation of this case study is that the results of this model should be used as prior knowledge and requires to be calibrated experimental data for further usages. Another limitation of the case study refers to the fact that the curling defect is a recursive phenomenon, thus the equations used to model the curling defect uses recursive computation. However, the model in this research uses an approximation to avoid loops in the BN. Hence, to improve the accuracy of the model, future work will focus on training the BN using data generated through constraint programming for the same governing equations and experimental data.



Figure 59. Backward simulation to minimize curling defect and supports' mass for small-sized parts (15 < L < 45)

5 CONCLUSION AND PERSPECTIVE

This research was conducted to advance design stages in PDP for AM in response to the increasing need for product and manufacturing process performance improvement. Toward this end, the thesis first focuses on PDP by presenting a systematic modeling framework capable of modeling product and manufacturing processes at the design stages of PDP. Secondly, it contributes to AM by applying the proposed modeling approach to develop integrated models for AM process and parts to be manufactured. The thesis is an attempt to provide an answer to the lack of modeling methodologies that can concurrently evaluate the performance of product design, manufacturing processes at the earlier stages of the design process. The conclusions of this thesis are best presented by returning to the thesis objectives and their associated detailed questions addresses in the introduction:

The first three objectives were related to the need for systematic modeling approach to evaluate solution variants, providing simulation capabilities, and systematic search for weaknesses and contradictions to models at the design stages of PDP. These objectives were achieved by further developing the DACM framework and providing algorithm associated with the different steps in the framework in order to automatize the modeling procedure. The framework focuses on the functionality of a system and establishes the causality between variables describing the functions according to the concepts available in BG theory. The modeling pursues with assigning variables to functions in a systematic manner. Once the causal graph is established, the framework builds the governing equations from related variables using dimensional analysis. The ultimate models presented by the framework are the combination of the causal graph and their associated governing equations. Current development of the framework enables qualitative simulations of the model and search for contradiction inside the causal network. Thesis pushes the DACM framework one step further, by providing quantitative simulation capabilities to the DACM models through translating the models to ANN and Bayesian networks.

From the product development point of view, the modeling approach is applied to model glue gun as a product. This provided a proof of concept for product modeling using the developed methodology. It enabled physics-based reasoning on

functional models to identify the limitations of current product design and propose novel solutions to enhance product performance.

Other objectives of the thesis related to AM were achieved by applying the modeling approach to present integrated models. The thesis seeks to contribute to DFAM at earlier design stages by concurrently considering the manufacturing process and the part to be manufactured. The framework is applied to model AM processes, namely, DED, FDM, EBM processes. This provided a proof of concept for process modeling using the developed methodology. The developed model for DED process illustrated that DACM framework is able to simplify the AM process model using dimensional analysis. The developed models for FDM and EBM processes enable designers to extract contradiction and weaknesses on both part design's features and AM manufacturing machines. Concurrent modeling of a test part and FDM process also enabled the extraction of design rules for FDM in the design process. It allowed designers to have an insight on the evaluation of design variables, process parameters, and their interactions to make informed decisions on product design improvement, process parameter tuning and possible AM machine design improvement to increase the product-process performance. The integrated model developed for the PBF process illustrates the capability of models to reduce or suppress the AM defects on the parts. This model was developed further by translating the model to a probabilistic study using Bayesian network. Bayesian networks and probability theories enrich the analysis of the DACM models. Enriching the DACM model with the probabilities theory help designers in the decision-making process at different design stages of PDP. This model will be calibrated with experimental data in the author's future publication.

As shown in the thesis, DACM framework establishes the causal graph among the influencing variables of the model. This causal graph of the model can be used as a basis to develop a modular meta-model for AM. This modular causal graph consists of various models that are integrated into the single model. This approach enables integrating existing models in the literature including experimental models, theoretical models, or the result of computer simulation models. This provided a proof of concept metamodeling in AM. The developed KB-ANN topology illustrated a promising result toward alleviating the issues of interpretability and reusability of models AM.

5.1 Perspective

The future research development envisioned for the methodology is to enable more quantitative simulation techniques. There are multiple approaches to bring quantitative simulation to DACM framework. The models developed by the framework can be transferred to the existing valid methods such as systems dynamics, Bayesian networks, and artificial neural network principles. Coupling the DACM's models and systems dynamics will enable to simulate the model dynamically. It enables representation of the effect of changing the values of variables in the performance of the whole system under investigation. Constraint programming is another approach that can enable quantitative simulation capabilities to the DACM models. From the metamodeling perspective, the author's future work will be dedicated to applying the proposed metamodeling approach derived from DACM to the wire arc additive manufacturing process. Another research direction is to use machine-learning approaches to form a causal graph among variables or as a means to modify the causal graph extracted from DACM.

6 REFERENCES

- Abbass, H. A. (2015). *Computational Red Teaming: Big Analytics of Big-Data-to- Decisions Intelligent Systems*. Canberra, Australia: Springer.
- Ackoff, R. L. (2018). Towards a system of systems concepts. *Management Science*, 17(11), 661–671. <https://doi.org/10.1287/mnsc.17.11.661>
- Adam, G. A. O., & Zimmer, D. (2014). Design for Additive Manufacturing— Element transitions and aggregated structures. *CIRP Journal of Manufacturing Science and Technology*, 7, 20–28. <https://doi.org/10.1016/j.cirpj.2013.10.001>
- AFNOR. (2011). NF EN X 50-100 Management par la valeur - Analyse fonctionnelle, caractéristiques fondamentales - Analyse fonctionnelle: analyse fonctionnelle du besoin et analyse fonctionnelle technique.
- Ahmed, S., & Wallace, K. (2003). Evaluating a functional basis. In *ASME 2003 International design engineering technical conferences and computers and information in engineering conference*. Chicago: American Society of Mechanical Engineers. <https://doi.org/10.1115/DETC2003/DTM-48685>
- Altshuller, G. (1999). *The innovation algorithm: TRIZ, systematic innovation and technical creativity*. echnical Innovation Center, Inc.
- Altshuller, G. S. (1984). *Creativity as an exact science- altshuller*. Gordon and Breach.
- Amin, R., & Technology, I. (2015). *Simulation Fidelity , Abstraction and Resolution in Real-Time Multi-objective Optimisation of Air Traffic Complexity*. University of New South Wales.
- Anderson, D. M. (2004). *Design for manufacturability & concurrent engineering: How to design for low cost, design in high quality, design for lean manufacture, and design quickly for fast production* . California: CIM press.
- Ashby, R. W. (1961). *An Introduction to Cybernetics*. London: Chapman & Hall Ltd.
- ASTM-International. (2017). New Guide for Desing for Additive Manufacturing, Technical Design Guideline for Powder Bed Fusion,.
- Barenblatt, G. I. (1996). *Scaling, self-similarity, and intermediate asymptotics: dimensional analysis and intermediate asymptotics*. New York, USA: Cambridge University Press. <https://doi.org/0521435226>
- Bellehumeur, C., Li, L., Sun, Q., & Gu, P. (2004). Modeling of Bond Formation Between Polymer Filaments in the Fused Deposition Modeling Process. *Journal of Manufacturing Processes*, 6(2), 170–178. [https://doi.org/10.1016/S1526-6125\(04\)70071-7](https://doi.org/10.1016/S1526-6125(04)70071-7)
- Bellinger, G. (2004). Modeling & simulation: An introduction. Retrieved from <http://www.systems-thinking.org/modsim/modsim.htm>

- Bellini, A., Guceri, S., & Bertoldi, M. (2004). Liquefier Dynamics in Fused. *Journal of Manufacturing Science and Engineering*, 126(2), 237–246. <https://doi.org/10.1115/1.1688377>
- Béraud, N., Vignat, F., Villeneuve, F., & Dendievel, R. (2014). New trajectories in Electron Beam Melting manufacturing to reduce curling effect. In *Procedia CIRP* (Vol. 17, pp. 738–743). Elsevier. <https://doi.org/10.1016/j.procir.2014.02.038>
- Bhaskar, R., & Nigam, A. (1990). Qualitative Physics Using Dimensional Analysis. *Artificial Intelligence*, 45(1–2), 73–111.
- Bikas, H., Stavropoulos, P., & Chryssolouris, G. (2016). Additive manufacturing methods and modelling approaches: a critical review. *The International Journal of Advanced Manufacturing Technology*, 83(1–4), 389–405. <https://doi.org/10.1007/s00170-015-7576-2>
- Blanchard, B. S. (1978). Design and manage to life cycle cost. Portland.
- Blanning, R. W. (1975). The construction and implementation of metamodels. *Simulation*, 24(6), 177–184. <https://doi.org/10.1177/003754977502400606>
- Bösch, M. E., Hellweg, S., Huijbregts, M. A. J., & Frischknecht, R. (2007). Applying Cumulative Exergy Demand (CExD) indicators to the ecoinvent database. *International Journal of Life Cycle Assessment*, 12(3), 181–190. <https://doi.org/10.1065/lca2006.11.282>
- Boyard, N., Rivette, M., Christmann, O., & Richir, S. (2013). A design methodology for parts using additive manufacturing. In *High Value Manufacturing: Advanced Research in Virtual and Rapid Prototyping: Proceedings of the 6th International Conference on Advanced Research in Virtual and Rapid Prototyping*. Leiria, Portugal. <https://doi.org/978-1-138-00137-4>
- Brown, C. U., Jacob, G., Stoudt, M., Moylan, S., Slotwinski, J., & Donmez, A. (2016). Interlaboratory Study for Nickel Alloy 625 Made by Laser Powder Bed Fusion to Quantify Mechanical Property Variability. *Journal of Materials Engineering and Performance*, 25(8), 3390–3397. <https://doi.org/10.1007/s11665-016-2169-2>
- Browning, T. R. (2015). Design Structure Matrix Extensions and Innovations : A Survey and New Opportunities. *IEEE Transactions on Engineering Management*, 63(1), 1–24. <https://doi.org/10.1109/TEM.2015.2491283>
- Checkland, P. (1999). *Systems Thinking, Systems Practice*. New York, USA: John Wiley & Sons.
- Cheng, B., & Chou, K. (2015). Computer-Aided Design fabrications by electron beam additive manufacturing ☆. *Computer-Aided Design*, 69, 102–111. <https://doi.org/10.1016/j.cad.2015.06.007>
- Chikofsky, E., & Cross, J. (1990). Reverse engineering and design recovery: A Taxonomy. *IEEE Software*, 7(1), 13–17. <https://doi.org/10.1109/52.43044>
- Ciavola, B. T. (2014). *Reconciling Function- and Affordance-Based Design*. Michigan

Technological University.

- Coatanéa, E. (2005). *Conceptual modelling of life cycle design: a modelling and evaluation method based on analogies and dimensionless numbers*. Helsinki University of Technology.
- Coatanéa, E. (2015). *Dimensional Analysis Conceptual Modelling (DACM): A Comprehensive Framework for Specifying, Validating, and Analyzing System Models From a Model-Based System Engineering Perspective*. (Contract SOW 4.5, 4). Washington, DC.
- Coatanéa, E., Roca, R., Mokhtarian, H., Mokammel, F., & Ikkala, K. (2016). A Conceptual Modeling and Simulation Framework for System Design. *Computing in Science & Engineering*, 18(4), 42–52. <https://doi.org/10.1109/MCSE.2016.75>
- Cooper, K., Steele, P., Cheng, B., & Chou, K. (2017). Contact-Free Support Structures for Part Overhangs in Powder-Bed Metal Additive Manufacturing. *Inventions*, 3(1), 1–11. <https://doi.org/10.3390/inventions3010002>
- D.W. Rosen, B. S. I. G. (2010). *Additive Manufacturing Technologies*. Boston, MA: Springer.
- De la Bretesche, B. (2000). *La méthode APTE: Analyse de la valeur, analyse fonctionnelle*.
- Dinar, M., & Rosen, D. W. (2016). A Design for Additive Manufacturing Ontology. In *Proceedings of the ASME 2016 International Design Engineering Technical Conferences and Computers and Information in Engineering Conference*. Charlotte, North Carolina. <https://doi.org/10.1115/1.4035787>
- Ding, D., & Cuiuri, D. (2015). A practical path planning methodology for wire and arc additive manufacturing of thin-walled structures. *A Practical Path Planning Methodology for Wire and Arc Additive Manufacturing of Thin-Walled Structures*, 34, 8–19. <https://doi.org/10.1016/j.rcim.2015.01.003>
- Ding, D., Pan, Z., Cuiuri, D., Li, H., Van Duin, S., & Larkin, N. (2016). Bead modelling and implementation of adaptive MAT path in wire and arc additive manufacturing. *Robotics and Computer-Integrated Manufacturing*, 39, 32–42. <https://doi.org/10.1016/j.rcim.2015.12.004>
- Dusenbery, D. (1992). *Sensory ecology: How Organisms Acquire and Respond to Information*. New York: W. H. Freeman.
- Eppinger, S. D., & Browning, T. R. (2012). *Design structure matrix methods and applications*. London, England: MIT press. <https://doi.org/978-0-262-01752-7>
- Erden, M. S., Komoto, H., Beek, T. J. V. A. N., Amelio, V. D., Echavarría, E., & Tomiyama, T. (2008). A review of function modeling: Approaches and applications. *Artificial Intelligence for Engineering Design, Analysis and Manufacturing*, 22(2), 147–169.

- <https://doi.org/10.1017/S0890060408000103>
- Faisandier, A. (2013). *Systems architecture and design*. BELBERAUD – France: Sinergy'Com.
- Friedenthal, S., Moore, A., & Steiner, R. (2008). OMG systems modeling language (OMG SysML™) tutorial. *INCOSE International Symposium*, 18(1), 1731–1862. <https://doi.org/10.1002/j.2334-5837.2008.tb00914.x>
- Gero, J. S., & Kannengiesser, U. (2004). The situated function-behaviour-structure framework. *Design Studies*, 25(4), 373–391. <https://doi.org/10.1016/j.destud.2003.10.010>
- Gibson, J. J. (2015). The Theory of Affordances. In *The Ecological Approach to Visual Perception* (pp. 119–136). New York, USA: Psychology Press.
- Goel, V., & Pirolli, P. (1992). The structure of design problem spaces. *Cognitive Science*, 16(3), 395–429. https://doi.org/10.1207/s15516709cog1603_3
- Gu, D. D., Meiners, W., Wissenbach, K., & Poprawe, R. (2012). Laser additive manufacturing of metallic components: materials, processes and mechanisms. *International Materials Reviews*, 57(3), 133–164. <https://doi.org/10.1179/1743280411Y.00000000014>
- Hari, A., Shoval, S., & Kasser, J. (2008). Conceptual design to cost: anew systems engineering tool. *International Council on Systems Engineering*.
- Hatchuel, A., & Weil, B. (2003). A new approach of innovative Design: an introduction to CK theory. In *ICED 03, the 14th International Conference on Engineering Design*. Stockholm.
- Hellenbrand, D., & Lindemann, U. (2008). Using the DSM to support the selection of product concepts. In *10th International design structure matrix conference* (pp. 363–374). Stockholm, Sweden.
- Helms, B., Schultheiss, H., & Shea, K. (2013). Automated Mapping of Physical Effects to Functions Using Abstraction Ports Based on Bond Graphs. *Journal of Mechanical Design*, 135(5). <https://doi.org/10.1115/1.4023923>
- Helms, B., & Shea, K. (2012). Computational Synthesis of Product Architectures Based on Object-Oriented Graph Grammars. *Journal of Mechanical Design*, 134(2), 021008. <https://doi.org/10.1115/1.4005592>
- Hirtz, J., Stone, R. B., Mcadams, D. A., Szykman, S., & Wood, K. L. (2002). A functional basis for engineering design : Reconciling and evolving previous efforts. *Research in Engineering Design*, 13(2), 65–82. <https://doi.org/10.1007/s00163-001-0008-3>
- Hitchins, D. K. (2008). *systems engineering: a 21st century systems methodology*. John Wiley & Sons. <https://doi.org/978-0470-05856-5>
- IEEE. (2005). IEEE Standard 1220 for Application and Management of Systems Engineering Process. Piscataway: IEEE Standards Association.
- Ilevbare, I. M., Probert, D., & Phaal, R. (2013). A review of TRIZ, and its benefits and challenges in practice. *Technovation*, 33(2–3), 30–37.

- <https://doi.org/10.1016/j.technovation.2012.11.003>
- ISO/ASTM-52900. (2015). ISO/ASTM 52900:2015: Additive manufacturing — General principles — Terminology.
- ISO/IEC/IEEE. (2015). Systems and software engineering—System life cycle processes. International Organization for Standardization (ISO)/International Electrotechnical Commission (IEC), Institute of Electrical and Electronics Engineers.
- ISO/IEC. (2000). International standards for quality management. Geneva, Switzerland: International Organization for Standardization (ISO)/International Electrotechnical Commission (IEC), Institute of Electrical and Electronics Engineers.
- Karnopp, D. (1979). State variables and pseudo bond graphs for compressible thermofluid systems. *Journal of Dynamic Systems, Measurement, and Control*, 101(3), 201–204. <https://doi.org/10.1115/1.3426425>
- Karnopp, D. C., Margolis Donald L., & Rosenberg Roland C. (2012). *System dynamics: modeling, simulation, and control of mechatronic systems* (5th Editio). New Jeresy: John Wiley & Sons.
- Kazakçi, O. (2009). A formalization of CK design theory based on Intuitionist Logic. In *Proceedings of the 2nd International Conference on Research into Design* (pp. 499–507). Bangalore, India.
- King, W., Anderson, a. T., Ferencz, R. M., Hodge, N. E., Kamath, C., & Khairallah, S. a. (2014). Overview of modelling and simulation of metal powder–bed fusion process at Lawrence Livermore National Laboratory. *Materials Science and Technology*, 31(8), 1743284714Y.000. <https://doi.org/10.1179/1743284714Y.0000000728>
- Klahn, C., Singer, D., & Meboldt, M. (2016). Design Guidelines for Additive Manufactured Snap-Fit Joints. In *Procedia CIRP* (Vol. 50, pp. 264–269). Elsevier B.V. <https://doi.org/10.1016/j.procir.2016.04.130>
- Kruth, J.-P., Leu, M. C., & Nakagawa, T. (1998). Progress in Additive Manufacturing and Rapid Prototyping. *CIRP Annals - Manufacturing Technology*, 47(2), 525–540. [https://doi.org/10.1016/S0007-8506\(07\)63240-5](https://doi.org/10.1016/S0007-8506(07)63240-5)
- Kumar, S., Sharma, V., Choudhary, A. K. S., Chattopadhyaya, S., & Hloch, S. (2013). Determination of layer thickness in direct metal deposition using dimensional analysis. *The International Journal of Advanced Manufacturing Technology*, 67(9–12), 2681–2687. <https://doi.org/10.1007/s00170-012-4683-1>
- Kumke, M., Watschke, H., & Vietor, T. (2016). A new methodological framework for design for additive manufacturing. *Virtual and Physical Prototyping*, 11(1), 3–19. <https://doi.org/10.1080/17452759.2016.1139377>
- Kurfman, M. A., Stone, R. B., Rajan, J., & Wood, K. L. (2003). Experimental Studies Assessing the Repeatability of a Functional Modeling Derivation

- Method. *Journal of Mechanical Design*, 125, 682.
<https://doi.org/10.1115/1.1625400>
- Levy, G. N., Schindel, R., & Kruth, J. P. (2003). Rapid manufacturing and rapid tooling with layer manufacturing(LM) technologies, state of the art and future perspectives. *CIRP Annals-Manufacturing Technology*, 52(2), 589–609.
[https://doi.org/10.1016/S0007-8506\(07\)60206-6](https://doi.org/10.1016/S0007-8506(07)60206-6)
- Lucero, B., Linsey, J., & Turner, C. J. (2017). Frameworks for organising design performance metrics. *Journal of Engineering Design*, 175–204(27), 175–204.
<https://doi.org/10.1080/09544828.2015.1135235>
- Luhmann, N. (2013). *Introduction to systems theory*. Wiley.
- Marca, D. A., & McGowan, C. L. (1987). *SADT: structured analysis and design technique*. New York, NY, USA: McGraw-Hill, Inc.
- Michaels, J. V., & Wood, W. P. (1989). *Design to cost*. Orlando, Florida: John Wiley & Sons.
- Mindt, H. W., Desmaison, O., Megahed, M., Peralta, A., & Neumann, J. (2018). Modeling of Powder Bed Manufacturing Defects. *Journal of Materials Engineering and Performance*, 27(1), 32–43. <https://doi.org/10.1007/s11665-017-2874-5>
- Mokhtarian, H., Coatanéa, E., & Paris, H. (2017). Function modeling combined with physics-based reasoning for assessing design options and supporting innovative ideation. *Artificial Intelligence for Engineering Design, Analysis and Manufacturing: AIEDAM*, 31(4), 476–500.
<https://doi.org/10.1017/S0890060417000403>
- Mokhtarian, H., Coatanéa, E., Paris, H., Mbow, M. M., Pourroy, F., Marin, P. R., ... Ellman, A. (2018). A Conceptual Design and Modeling Framework for Integrated Additive Manufacturing. *Journal of Mechanical Design*, 140(8), 081101–081113. <https://doi.org/10.1115/1.4040163>
- Mokhtarian, H., Coatanéa, E., Paris, H., Ritola, T., Ellman, A., Vihinen, J., ... Ikkala, K. (2016). A network based modeling approach using the dimensional analysis conceptual modeling (DACM) framework for additive manufacturing technologies. In *ASME 2016 International Design Engineering Technical Conferences and Computers and Information in Engineering Conference* (Vol. Volume 1A, p. V01AT02A046). Charlotte, North Carolina, USA: American Society of Mechanical Engineers. <https://doi.org/10.1115/DETC2016-60473>
- Moon, I., & Houg, J. H. (2013). THEORETIC INTERPLAY BETWEEN ABSTRACTION, RESOLUTION, AND FIDELITY IN MODEL INFORMATION. In *2013 Winter Simulation Conference: Simulation: Making Decisions in a Complex World*. (pp. 1283–1291). IEEE Press.
- Moré, J. J. (1977). The Levenberg-Marquardt algorithm: implementation and theory. In *Conference on Numerical Analysis*. University of Dundee, Scotland.
- Moylan, S., Brown, C., & Slotwinski, J. (2016). Recommended Protocol for

- Round-Robin Studies in Additive Manufacturing. *Journal of Testing and Evaluation*, 44(2), 1009–1018. <https://doi.org/10.1520/JTE20150317>
- Nagarajan, H., Mokhtarian, H., Jafarian, H., Dimassi, S., Bakrani, S., Hamed, A., ... Haapala, K. (2019). Knowledge-Based Design of Artificial Neural Network Topology for Additive Manufacturing Process Modeling: A New Approach and Case Study for Fused Deposition Modeling. *Journal of Mechanical Design*, 141(February), 02170501-12. <https://doi.org/10.1115/1.4042084>
- Namouz, E. Z., Summers, J. D., Mocko, G. M., & Obieglo, A. (2010). Workshop for identifying assembly time savings: An OEM empirical study. In *Proceedings - 2010 International Conference on Manufacturing Automation, ICMA 2010* (pp. 178–185). <https://doi.org/10.1109/ICMA.2010.55>
- NFX50. (1991). Analyse de la Valeur, Analyse Fonctionnelle, Expression fonctionnelle du besoin et cahier des charges fonctionnel.
- Object Management Group. (2003). SE Conceptual Model Semantic Dictionary. Retrieved from http://syseng.omg.org/SE_Conceptual_Model/Draft_12/Concept_Model_Semantic_Dictionary_12th_Draft_Partitioned_3_27_03.xls
- Okudan, G. E., & Tauhid, S. (2008). Concept selection methods—a literature review from 1980 to 2008. *International Journal of Design Engineering*, 1(3), 243. <https://doi.org/10.1504/IJDE.2008.023764>
- Orawski, R., Krollmann, J., Mörtl, M., & Lindemann, U. (2011). Generic model of the early phase of an innovation process regarding different degrees of product novelty. In *International conference on engineering design (ICED11)* (pp. 1–13). Copenhagen, Denmark.
- Otto, K. N., & Wood, K. L. (2001). *Product design: techniques in reverse engineering and new product development*. Upper Saddle River: Prentice Hall.
- Pace, D. k. (1999). Development and documentation of a simulation conceptual model. In *1999 Fall Simulation Interoperability Workshop* (p. 42).
- Pahl, G., Beitz, W., Feldhusen, J., & Grote, K. . (2007). *Engineering design: a systematic approach* (3rd editio). London: Springer-Verlag.
- Paris, H., Mokhtarian, H., Coatanéa, E., Museau, M., & Ituarte, I. F. (2016). Comparative environmental impacts of additive and subtractive manufacturing technologies. *CIRP Annals - Manufacturing Technology*, 65(1), 29–32. <https://doi.org/10.1016/j.cirp.2016.04.036>
- Paynter, H. (1961). *Analysis and Design of Engineering Systems*. Cambridge: MIT press.
- PMI. (2008). *A Guide to the Project Management Body of Knowledge (PMBOK® Guide)* (4th editio). PA, USA: Project Management Institute (PMI).
- Ponche, R., Hascoet, J. Y., Kerbrat, O., & Mognol, P. (2012). A new global approach to design for additive manufacturing. *Virtual and Physical Prototyping*, 7(2), 93–105. <https://doi.org/10.1080/17452759.2012.679499>

- Ponche, R., Kerbrat, O., Mognol, P., & Hascoet, J. Y. (2014). A novel methodology of design for Additive Manufacturing applied to Additive Laser Manufacturing process. *Robotics and Computer-Integrated Manufacturing*, 30(4), 389–398. <https://doi.org/10.1016/j.rcim.2013.12.001>
- Pugh, S. (1981). Concept Selection: A method that works. In *ICED 81* (pp. 497–506). Rome.
- Pugh, S. (1991). *Total design: integrated methods for successful product engineering*. Addison-Wesley Publishing Company.
- Rezaie, R., Badrossamay, M., Ghaie, A., & Moosavi, H. (2013). Topology optimization for fused deposition modeling process. *Procedia - Social and Behavioral Sciences*, 6, 521–526. <https://doi.org/10.1016/j.procir.2013.03.098>
- Robinson, S. (2004). *Simulation: the practice of model development and use*. John Wiley & Sons.
- Robinson, S. (2008). Conceptual modelling for simulation Part I: Definition and requirements. *Journal of the Operational Research Society*, 59(3), 278–290. <https://doi.org/10.1057/palgrave.jors.2602368>
- Robinson, S., Arbez, G., Birta, L., Tolk, A., & Wagner, G. (2015). CONCEPTUAL MODELING: DEFINITION, PURPOSE AND BENEFITS. In *the 2015 Winter Simulation Conference* (pp. 2812–2826). IEEE Press.
- Roh, B., Kumara, S. R. T., Simpson, T. W., Michaleris, P., Witherell, P., & Assourocko, I. (2016). Ontology-based laser and thermal metamodels for metal-based additive manufacturing. In *ASME 2016 International Design Engineering Technical Conferences and Computers and Information in Engineering Conference. American Society of Mechanical Engineers*. Charlotte, North Carolina. <https://doi.org/10.1115/DETC2016-60233>
- Rowe, P. G. (1991). *Design Thinking*. Cambridge, MA: MIT Press.
- Roza, Z. . (2005). *Simulation fidelity theory and practice*. Delft University of Technology.
- Ruan, J., Tang, L., Sparks, T. E., Landers, R. G., & Liou, F. (2008). Direct 3D Layer Metal Deposition and Toolpath Generation. In *International Design Engineering Technical Conferences and Computers and Information in Engineering Conference* (pp. 597–603). Brooklyn, New York, USA: American Society of Mechanical Engineers. <https://doi.org/10.1115/DETC2008-50062>
- Saaty, T. L. (2008). Decision making with the analytic hierarchy process. *International Journal of Services Sciences*, 1(1), 83–98. <https://doi.org/10.1504/IJSSCI.2008.017590>
- Saaty, T. L. (2013). The Modern Science of Multicriteria Decision Making and Its Practical Applications : The AHP / ANP Approach The Modern Science of Multicriteria Decision Making and Its Practical Applications : The AHP / ANP Approach. *Operations Research*, 61(5), 1101–1118.

- <https://doi.org/10.1287/opre.2013.1197>
- Saravi, M., Newnes, L., Mileham, A. R., & Goh, Y. M. (2008). Estimating cost at the conceptual design stage to optimize design in terms of performance and cost. In *Collaborative product and service life cycle management for a sustainable world* (pp. 123–130). London. https://doi.org/10.1007/978-1-84800-972-1_11
- Schwer, L. E. (2009). An Overview of the ASME V&V-10 Guide for Verification and Validation in Computational Solid Mechanics. In *20th International Conference on Structural Mechanics in Reactor Technology* (pp. 1–10). Espoo, Finland.
- SeBoK. (2017). The Guide to the Systems Engineering Body of Knowledge (SEBoK), v. 1.9. R.D. . Adcock (EIC). Hoboken, NJ: The Trustees of the Stevens Institute of Technology. BKCASE Editorial Board. Retrieved from <http://g2sebok.incose.org/app/mss/menu/index.cfm>
- Sen, C. (2011). *A formal representation of mechanical functions to support physics-based computational reasoning in early mechanical design*. Clemson University.
- Sen, C., Caldwell, B. W., Summers, J. D., & Mocko, G. (2010). Evaluation of the Functional Basis using an Information Theoretic Approach. *Artificial Intelligence for Engineering Design, Analysis & Manufacturing*, 24(1), 85–103. <https://doi.org/10.1017/S0890060409990187>
- Sen, C., & Summers, J. D. (2013). Analysis and Identifying requirements for physics-based reasoning on function structure graphs. *Artificial Intelligence for Engineering Design*, 27(3), 291–299. <https://doi.org/10.1017/S0890060413000292>
- Shadbolt, N., & Smart, P. (2015). Knowledge Elicitation: Methods, Tools and Techniques. In S. (eds. . Wilson, John R and Sharples (Ed.), *Evaluation of Human Work* (pp. 163–200). Boca Raton, Florida, USA: CRC Press.
- Shan, S., & Wang, G. G. (2010). Metamodeling for High Dimensional Simulation-Based Design Problems. *Journal of Mechanical Design*, 132(5), 051009. <https://doi.org/10.1115/1.4001597>
- Shim, T. (2002). *Introduction to physical system modelling using bond graphs*. University of Michigan-Dearborn.
- Stahel, W. R. (1997). The functional economy: cultural and organizational change. In *The industrial green game: implications for environmental design and management* (pp. 91–100). National Academies Press.
- Standard ASTM. (2012). F2792.2012 standard terminology for additive manufacturing technologies.
- Suh, N. P. (1990). *The principles of design*. New York, USA: Oxford University Press.
- Sun, Q., Rizvi, G., Bellehumeur, C. ., & Gu, P. (2013). Effect of processing conditions on the bonding quality of FDM polymer filaments. *Rapid Prototyping Journal*, 14(2), 72–80. <https://doi.org/10.1108/13552540810862028>

- Terharr, S., Calusing, D., & Eppinger, S. D. (1993). *Integration of quality function deployment and the design structure matrix*. Massachusetts: Cambridge.
- Thompson, M. K., Moroni, G., Vaneker, T., Fadel, G., Campbell, R. I., Gibson, I., ... Martina, F. (2016). CIRP Annals - Manufacturing Technology Design for Additive Manufacturing: Trends, opportunities, considerations, and constraints. *CIRP Annals - Manufacturing Technology*, 65(2), 737–760. <https://doi.org/10.1016/j.cirp.2016.05.004>
- Thompson, S. M., Bian, L., Shamsaei, N., & Yadollahi, A. (2015). An Overview of Direct Laser Deposition for Additive Manufacturing Part I: Transport Phenomena, Modeling and Diagnostics. *Additive Manufacturing*, 8, 36–62. <https://doi.org/10.1016/j.addma.2015.07.001>
- Tolk, A., Diallo, S. Y., King, R. D., Turnista, C. D., & Padilla, J. J. (2010). Conceptual Modeling for Composition of Model-Based Complex Systems. In *Conceptual Modeling for Discrete-Event Simulation* (pp. 355–381). Boca Raton, Florida: CRC Press Taylor & Francis Group.
- Tomiyama, T., Gu, P., Jin, Y., Lutters, D., Kind, C., & Kimura, F. (2009). Design methodologies: Industrial and educational applications. *CIRP Annals - Manufacturing Technology*, 58(2), 543–565. <https://doi.org/10.1016/j.cirp.2009.09.003>
- Tounsi, R., & Vignat, F. (2017). New concept of support structures in Electron Beam Melting manufacturing to reduce geometric defects. In *15e Colloque National AIP-Priméca* (pp. 1–6).
- Tu, J. V. (1996). Advantages and Disadvantages of Using Artificial Neural Networks versus Logistic Regression for Predicting Medical Outcomes. *Journal of Clinical Epidemiology*, 49(11), 1225–1231.
- UK Design Council. (2005). *Eleven lessons: managing design in eleven global brands. A study of the design process*. Design Council. Retrieved from www.designcouncil.org.uk
- Ullmann, D. G. (2015). *The mechanical design process*. New York, USA: McGraw-Hill Science.
- Vayre, B., Vignat, F., & Villeneuve, F. (2012). Designing for Additive Manufacturing. In *Procedia CIRP* (Vol. 3, pp. 632–637). <https://doi.org/10.1016/j.procir.2012.07.108>
- Wang, G., & Shan, S. (2007). Review of Metamodeling Techniques in Support of Engineering Design Optimization. *Journal of Mechanical Design*, 129(4), 370. <https://doi.org/10.1115/1.2429697>
- Wang, W., Pinkerton, A., Wee, L., & Li, L. (2007). Component repair using laser direct metal deposition. In *Proceedings of the 35th International MATADOR Conference* (pp. 345–350). London: Springer., <https://doi.org/10.1243/09544054JEM1008>
- White, F. M. (2003). *Fluid mechanics* (5th Edition). Boston: McGraw-Hill Book

Company.

- Willemain, T. R. (1995). Model Formulation : What Experts Think About and When. *Operations Research*, 43(6), 916–932. <https://doi.org/https://doi.org/10.1287/opre.43.6.916>
- Williams, C. B., Mistree, F., & Rosen, D. W. (2011). A Functional Classification Framework for the Conceptual Design of Additive Manufacturing Technologies. *Journal of Mechanical Design*, 133(12), 121002. <https://doi.org/10.1115/1.4005231>
- Williams, C. B., & Rosen, D. W. (2016). Framework for the Conceptual Design of Additive Manufacturing Technologies. *Journal of Mechanical Design*, 133(12), 1–11. <https://doi.org/10.1115/1.4005231>
- Wilson, J. M., Piya, C., Shin, Y. C., Zhao, F., & Ramani, K. (2014). Remanufacturing of turbine blades by laser direct deposition with its energy and environmental impact analysis. *Journal of Cleaner Production*, 80, 170–178. <https://doi.org/10.1016/j.jclepro.2014.05.084>
- Witherell, P., Feng, S., Simpson, T. W., Saint John, D. B., Michaleris, P., Liu, Z.-K., ... Martukanitz, R. (2014). Toward Metamodels for Composable and Reusable Additive Manufacturing Process Models. *Journal of Manufacturing Science and Engineering*, 136(6), 061025. <https://doi.org/10.1115/1.4028533>
- Wu, D., Coatanéa, E., & Wang, G. G. (2017). Dimension Reduction and Decomposition Using Causal Graph and Qualitative Analysis for Aircraft Concept Design Optimization. In *ASME 2017 International Design Engineering Technical Conferences and Computers and Information in Engineering Conference* (Vol. 2B, pp. 1–12). Ohio, USA: American Society of Mechanical Engineers. <https://doi.org/10.1115/DETC2017-67601>
- Xiong, J., Zhang, G., Gao, H., & Wu, L. (2013). Robotics and Computer-Integrated Manufacturing Modeling of bead section profile and overlapping beads with experimental validation for robotic GMAW-based rapid manufacturing. *Robotics and Computer Integrated Manufacturing*, 29(2), 417–423. <https://doi.org/10.1016/j.rcim.2012.09.011>
- Yan, C., Hao, L., Hussein, A., & Raymont, D. (2012). Evaluations of cellular lattice structures manufactured using selective laser melting. *International Journal of Machine Tools and Manufacture*, 62, 32–38. <https://doi.org/10.1016/j.ijmactools.2012.06.002>
- Yan, M., & Yu, P. (2015). An Overview of Densification, Microstructure and Mechanical Property of Additively Manufactured Ti-6Al-4V — Comparison among Selective Laser Melting, Electron Beam Melting, Laser Metal Deposition and Selective Laser Sintering, and with Conventional Powder. In *Sintering techniques of materials* (pp. 77–106). InTech. <https://doi.org/10.5772/59275>
- Yang, S., & Zhao, Y. F. (2015). Additive manufacturing-enabled design theory

- and methodology: a critical review. *The International Journal of Advanced Manufacturing Technology*, 80(1–4), 327–342.
<https://doi.org/10.1007/s00170-015-6994-5>
- Yang, Z., Eddy, D., Krishnamurty, S., & Grosse, I. (2016). Investigating predictive metamodeling for additive manufacturing. In *ASME 2016 International Design Engineering Technical Conferences and Computers and Information in Engineering Conference*. American Society of Mechanical Engineers. Charlotte, North Carolina. <https://doi.org/10.1115/DETC2016-60506>
- Yardmci, A. (1999). *Process Analysis and Development for Fused Deposition*. University of Illinois at Chicago.
- Yardmci, A., Hattori, T., Gucer, I., & Danforth, S. (1997). Thermal analysis of fused deposition. In *solid freeform fabrication conference* (pp. 689–698). Austin, Texas, USA.
- Yu, B., & Popplewell, K. (1994). Metamodels in manufacturing: a review. *The International Journal of Production Research*, 32(4), 787–796.
<https://doi.org/10.1080/00207549408956970>
- Zwicky, F. (1967). The Morphological Approach to Discovery, Invention, Research and Construction. In *New methods of thought and procedure* (pp. 273–297). Berlin: Springer.

PUBLICATIONS

- Publication I **Mokhtarian, H.**, Coatanéa, E., Paris, H., Ritola, T., Ellman, A., Vihinen, J., Koskinen, K., Ikkala, K. (2016, August). A network-based modelling approach using the Dimensional Analysis Conceptual Modeling (DACM) framework for additive manufacturing technologies. In ASME International Design Engineering Technical Conferences and Computers and Information in Engineering Conference, Volume 1A, Charlotte, United States of America.
(DOI: [10.1115/DETC2016-60473](https://doi.org/10.1115/DETC2016-60473))
- Publication II Coatanéa, E., Roca, R., **Mokhtarian, H.**, Mokammel, F., & Ikkala, K. (2016). A conceptual modeling and simulation framework for system design. *Journal of Computing in Science & Engineering*, 18(4), 42-52.
(DOI: [10.1109/MCSE.2016.75](https://doi.org/10.1109/MCSE.2016.75))
- Publication III **Mokhtarian, H.**, Coatanéa, E., & Paris, H. (2017). Function modeling combined with physics-based reasoning for assessing design options and supporting innovative ideation. *Journal of Artificial Intelligence for Engineering Design, Analysis, and Manufacturing (AI-EDAM)*, 31(4), 476-500.
(DOI: [10.1017/S0890060417000403](https://doi.org/10.1017/S0890060417000403))
- Publication IV **Mokhtarian, H.**, Coatanéa, E., Paris, H., Mbow, M., Pourroy, F., Marrin, P., Vihinen, J., Ellman, A. (2018). A conceptual design and modeling framework for integrated additive manufacturing. *ASME Journal of Mechanical Design (JMD)*, 140(8).
(DOI: [10.1115/1.4040163](https://doi.org/10.1115/1.4040163))
- Publication V Paris, H., **Mokhtarian, H.**, Coatanéa, E., Museau, M., Ituarte, I. (2016). Comparative environmental impacts of additive and subtractive manufacturing technologies. *CIRP Annals-Manufacturing Technology*, 65(1), 29-32.
(DOI: [10.1016/j.cirp.2016.04.036](https://doi.org/10.1016/j.cirp.2016.04.036))

PUBLICATION

|

**A network based modelling approach using the Dimensional Analysis
Conceptual Modeling (DACM) framework for additive manufacturing
technologies**

Mokhtarian, H., Coatanéa, E., Paris, H., Ritola, T., Ellman, A., Vihinen, J.,
Koskinen, K., Ikkala, K.

ASME 2016 International Design Engineering Technical Conferences and Computers and
Information in Engineering Conference, Charlotte, USA, Volume 1A
(<https://doi.org/10.1115/DETC2016-60473>)

Publication reprinted with the permission of the copyright holders.

PUBLICATION II

A conceptual modeling and simulation framework for system design

Coatanéa, E., Roca, R., **Mokhtarian, H.**, Mokammel, F., Ikkala, K.

Journal of Computing in science & engineering, Vol. 4, Issue 4. (2016)
(<https://doi.org/10.1109/MCSE.2016.75>)

Publication reprinted with the permission of the copyright holders.

PUBLICATION III

**Function modeling combined with physics-based reasoning for assessing
design options and supporting innovative ideation**

Mokhtarian, H., Coatanéa, E., Paris, H.

Journal of Artificial Intelligence for Engineering Design and Manufacturing (AI EDAM), Vol.
31, Issue 4. (2017)

(<https://doi.org/10.1017/S0890060417000403>)

Publication reprinted with the permission of the copyright holders.

PUBLICATION IV

**A conceptual design and modeling framework for integrated additive
manufacturing**

Mokhtarian H., Coatanéa E., Paris H., Mbow M., Pourroy F., Marin P., Vihinen
J., Ellman A.

Journal of Mechanical Design (JMD) ASME, Vol. 140, Issue 8. (2018)
(<https://doi.org/10.1115/1.4040163>)

Publication reprinted with the permission of the copyright holders.

PUBLICATION V

Comparative environmental impacts of additive and subtractive manufacturing technologies

Paris H., **Mokhtarian H.**, Coatanéa E., Museau M., and Ituarte I.

Journal of CIRP Annals-Manufacturing Technology, Vol. 65, Issue 1. (2016)
(<https://doi.org/10.1016/j.cirp.2016.04.036>)

Publication reprinted with the permission of the copyright holders.

OTHER PUBLICATION (VI)

Knowledge-Based Design of Artificial Neural Network Topology for Additive Manufacturing Process Modeling: A New Approach and Case Study for Fused Deposition Modeling

Nagarajan H., **Mokhtarian H.**, Jafarian H., Dimassi S., Bakrani S., Hamed A., Coatanéa E., Wang G., and Haapala K.

Journal of Mechanical Design (JMD) ASME, Vol. 141, Issue 2. (2018)
(<https://doi.org/10.1115/1.4042084>)

Publication reprinted with the permission of the copyright holders.

**OTHER PUBLICATION,
(VII)**

**Probabilistic Modelling of Defects in Additive Manufacturing:
A Case Study in Powder Bed Fusion Technology**

Mokhtarian H., Hamed A., Nagarajan H., Panicker S., Coatanéa E., Haapala K.

CIRP Conference on Manufacturing Systems (CMS-2019)
Ljubljana, Slovenia

Publication reprinted with the permission of the copyright holders.

