



HAL
open science

Microbiogeochemistry of cold ecosystems

Catherine Larose

► **To cite this version:**

Catherine Larose. Microbiogeochemistry of cold ecosystems. Environmental Sciences. ECL, 2016. tel-01974576

HAL Id: tel-01974576

<https://hal.science/tel-01974576v1>

Submitted on 17 Dec 2020

HAL is a multi-disciplinary open access archive for the deposit and dissemination of scientific research documents, whether they are published or not. The documents may come from teaching and research institutions in France or abroad, or from public or private research centers.

L'archive ouverte pluridisciplinaire **HAL**, est destinée au dépôt et à la diffusion de documents scientifiques de niveau recherche, publiés ou non, émanant des établissements d'enseignement et de recherche français ou étrangers, des laboratoires publics ou privés.

Ecole Centrale de Lyon

Mémoire présenté en vue de l'obtention du Diplôme d'Habilitation à Diriger des Recherches

Microbiogeochemistry of cold ecosystems

Catherine Larose

Chercheur CNRS Section 30

Date de la soutenance : 17.10.2016

Composition du jury de soutenance :

Corinne Leyval, HDR
Alexandre Anesio, Professeur
Carsten Suhr Jacobsen, Professeur
Aurélien Dommergue, HDR, MCF
Graeme Nicol, Professeur
Timothy M. Vogel, Professeur

Résumé

Les milieux polaires constituent des environnements en pleine évolution, le pôle arctique subissant, non seulement, fortement le dérèglement climatique, mais y participant activement par effet levier. Ces dérèglements amènent des changements à l'échelle de la planète altérant profondément la structure et le fonctionnement de nombreux écosystèmes. En raison des conditions extrêmes de température et de la présence restreinte d'eau liquide, la neige et la glace ont longtemps été considérées simplement comme des pièges à microorganismes, au mieux conservés dans un état végétatif après avoir été transportés dans l'atmosphère par des particules minérales. La diversité des microorganismes de la cryosphère, leur structuration en communautés microbiennes et les fonctions qu'ils pouvaient être amenés à exprimer au sein même de ces écosystèmes ont été longtemps sous-estimés et donc inexplorés. Ce manuscrit présente notre approche d'étude du rôle des microorganismes dans le fonctionnement des glaces environnementales, mettant en avant les liens entre les mondes biotique et abiotique. Nos travaux portent sur des observations de la neige et de la glace en Arctique, la biodiversité, la dynamique des populations microbiennes, l'influence des microorganismes sur les cycles biogéochimiques ainsi que leurs interactions avec les composantes physico-chimiques des environnements glacés. Nous montrons à travers ces études, qu'il est désormais nécessaire d'aborder le manteau neigeux et les glaces comme des écosystèmes à part entière.

Mots clés : Arctique, manteaux neigeux, glace, microorganismes, cycles biogéochimiques

Abstract

Polar Regions are transforming, they constitute integrators of climate variability, providing visible signals of change, and yet, are also actors, intrinsically involved in global cooling through a number of feedback mechanisms. The observed changes alter the structure and functioning of many cryosphere ecosystems, and by extension that of the planet. Due to the extreme temperatures and the limited presence of liquid water, snow and ice have long been regarded simply as freezers that entrap and store microorganisms in a vegetative state and therefore, the microbial ecology of the cryosphere has been largely overlooked. This manuscript presents our research on the role of microorganisms in the functioning of environmental ices, highlighting the links between their biotic and abiotic components. Our work focuses on observations of snow and ice in the Arctic and explores the biodiversity, the microbial population dynamics and influence of microorganisms on biogeochemical cycling, in addition to their interactions with their physical and chemical environment. Through these studies, we have challenged the view of snow and ice as freezers and have shown that they should be considered as ecosystems.

Key words: Arctic, snowpack, ice, microorganisms, biogeochemical cycling

Table of Contents

Introduction	1
Chapter 1: The icy biosphere, a review on cryosphere habitats and inhabitants	5
Microbiology of the Cryosphere	5
Snow and ice inhabitants	5
Life in the cryosphere	7
Temperature adaptations	7
Low water activity / salinity	9
Solar irradiation	9
Nutrients	11
Snow and ice inhabitants in complex communities	13
Conclusion	14
Chapter 2: Microbial interactions with their chemical environment: lessons learned from snowpack studies ...	15
Physico-chemical properties of snow	15
A brief overview of snow structure and its formation	15
Deposition and incorporation of impurities within snowpacks	16
Snow metamorphism and impurity cycling	17
Seasonal chemical dynamics in snowpacks	17
Seasonal microbial dynamics	19
Microbial interactions with chemistry	20
Functional dynamics of snowpack microbial community	21
Conclusion	22
Chapter 3: Are microorganisms active in the cryosphere? Challenges and limits	23
Microbial activity in frozen environments	23
Technical issues linked with the use of meta-omics in snow environments	23
The use of meta-omics to explore the active members of snow microbial communities	25
Differences between RNA and DNA datasets	25
Metatranscriptomics as a proxy for microbial activity in snow	27
Getting beyond the descriptive	28
Snow microcosms: laboratory tools for determining activity and testing hypotheses	28
Conclusion	31
Chapter 4: Mercury in the environment, a case study on the role of bacteria	32
Snowpack Hg dynamics	34
Impact of mercury on microbial communities in the snow	36
Gene transfer as an adaptive mechanism to mercury exposure	38
Viral Role on Microbial Evolution	39
Chapter 5: Future research perspectives	41
How do trophic interactions impact community function and biogeochemical cycling?	41
What is the impact of photochemistry on substrate availability and microbial ecology?	42
Concluding remarks	46
References	47
Annex Curriculum Vitae	58

List of Figures

FIGURE 1 : COVERAGE AND MICROBIAL PRODUCTIVITY OF SNOW AND ICE.....	2
FIGURE 2. SNOW AND ICE PROKARYOTIC INHABITANTS.	6
FIGURE 3. MICROBIAL INTERACTIONS WITH ABIOTIC CONDITIONS IN THE DIFFERENT HABITATS WITHIN SNOW AND ICE ENVIRONMENTS.	8
FIGURE 4: PROCESSES INVOLVED IN THE DELIVERY AND LOSS OF CONTAMINANTS IN A SEASONAL SNOW COVER.....	16
FIGURE 5: CHEMICAL SNOWPACK MODEL REPRESENTING VOLATILIZATION LOSS AND MELTWATER CONCENTRATION	17
FIGURE 6 : CHEMICAL VARIABILITY OF SNOWPACK.....	18
FIGURE 7 : COMPARISON OF THE MAJOR PHYLA/CLASSES (NCBI-TAXONOMY IN MEGAN) IN ALL SNOW SAMPLES.....	19
FIGURE 8: HEATMAP FROM PEARSON CORRELATIONS BETWEEN CHEMICAL DATA AND THE FIRST 50 SEED SUBSYSTEMS.....	22
FIGURE 9 : DISCREPANCY BETWEEN METAGENOMES AND METATRANSCRIPTOMES.....	26
FIGURE 10: ACTIVITY LEVELS FOR SNOW MICROBIAL COMMUNITIES AT DIFFERENT TEMPERATURES WITH OR WITHOUT CARBON ADDITION.....	30
FIGURE 11: BCA FOR FOUR GROUPS OF SAMPLES AFTER TWO AND FOUR WEEKS, CONTAINING NO CARBON.	30
FIGURE 12 : CONCENTRATIONS OF MERCURY SPECIES IN DAILY SURFACE SNOW SAMPLES OF AN ARCTIC SNOWPACK.....	34
FIGURE 13 : EXAMPLES OF CHANGES IN RELATIVE ABUNDANCE OF PROBES TARGETING DIFFERENT GENERA TO BIOHG CONCENTRATIONS IN ARCTIC SNOWPACKS.	36
FIGURE 14 : RELATIVE ABUNDANCE OF MERCURY CYCLING RELATED SEQUENCES IN SNOW METATRANSCRIPTOMES.	37
FIGURE 15: RELATIVE ABUNDANCE OF HGT MARKER GENE SUB-SYSTEMS, SEED LEVEL 2, PHAGES PROPHAGES AS A FUNCTION OF SEASON.	38
FIGURE 16 : CROSS-ENVIRONMENT COMPARAISONS OF THE RELATIVE ABUNDANCE IN HGT MARKER GENES.	39
FIGURE 17: SCHEMATIC SUMMARY OF TRANSDUCTION.	39
FIGURE 18 : PERCENT OF TRANSCRIBED SEQUENCES (MRNA) RELATED TO DIFFERENT OM METABOLIC PATHWAYS	44

Introduction

Polar fascination

The cryosphere has captured our collective imagination for centuries, both as an imaginary realm and a geographic place to be discovered, explored and exploited ¹. Defined as the portion of the Earth where the water is in solid form, the cryosphere includes sea ice, freshwater ice, glaciers, ice sheets, permafrost and snow cover ². It is an integrator of climate variability, providing visible signals of change, and yet, it is also an actor, intrinsically involved in global cooling through a number of feedback mechanisms. The most compelling evidence of climate change is derived from observations of the cryosphere, which controls the physical, biological and chemical environment over a large part of the Earth's surface ³.

Since the 16th century, merchant companies, sovereigns and adventurers set out on dozens of expeditions to find new trade routes, and to define what the world looked like from its extremities¹. By the end of the 18th century, the cryosphere was interpreted as a place of romance and spiritualism requiring exploration by scientists, writers and mystics alike ⁴ and their accounts contributed to fueling the fantasy, myth and adventure of exploring the North and South Poles. As of the 19th century, Polar Regions became politically alluring and it became difficult to separate national political goals from scientific research ⁵. Polar science became a useful tool for delineating empire: "the pursuit of power through the pursuit of knowledge." Learning about the regions enables better survival and enhances the imperial stature of the nations involved. In the first quarter of the 20th century, the goal became to reach the poles first and the achievement involved fame, fortune and bragging rights ⁵. Although these expeditions may have been politically motivated, scientists accompanied famed explorers, such as Nansen, Amudsen and Scott, on their quests to conquer the poles. Polar Regions have also fascinated scientists for hundreds of years: how is it possible to understand an environment that tolerates virtually no life?



Northern lights woodcut. Adapted from an illustration by Fridjof Nansen based on a sketch from 1883.

To date, no place on Earth has been shown to be sterile, even the most inhospitable environments, such as deep sea hydrothermal vent, acid mine drainage and hot springs, contain many viable microorganisms⁶. Many studies have focused on the ecology of these environments both for fundamental and application purposes: as a model for the development of life under putative primitive Earth conditions and for enzymes with industrial interest due to their activity at high temperatures. At the opposite end of the temperature spectrum, the cryosphere has received much less attention. Snow, glacial ice and sea ice, main components of the cryosphere, cover up to $1.06 \times 10^8 \text{ km}^2$ of the Earth's surface. Snow in the winter can cover up to 12% of the Earth's surface, which is about 61 million km^2 ⁷. Approximately 10% of the planet's land, about 15 million square kilometers, is covered by glacial ice in the form of ice caps, ice sheets or glaciers and stores 75% of the world's fresh water⁸. Given their massive coverage at a global scale, snow and ice could have a major and underestimated role in global biogeochemical cycling (Figure 1). Therefore, the relevant knowledge and knowledge gaps concerning the microbial ecology of snow and ice ecosystems need to be evaluated for future research. So how come we know so little?

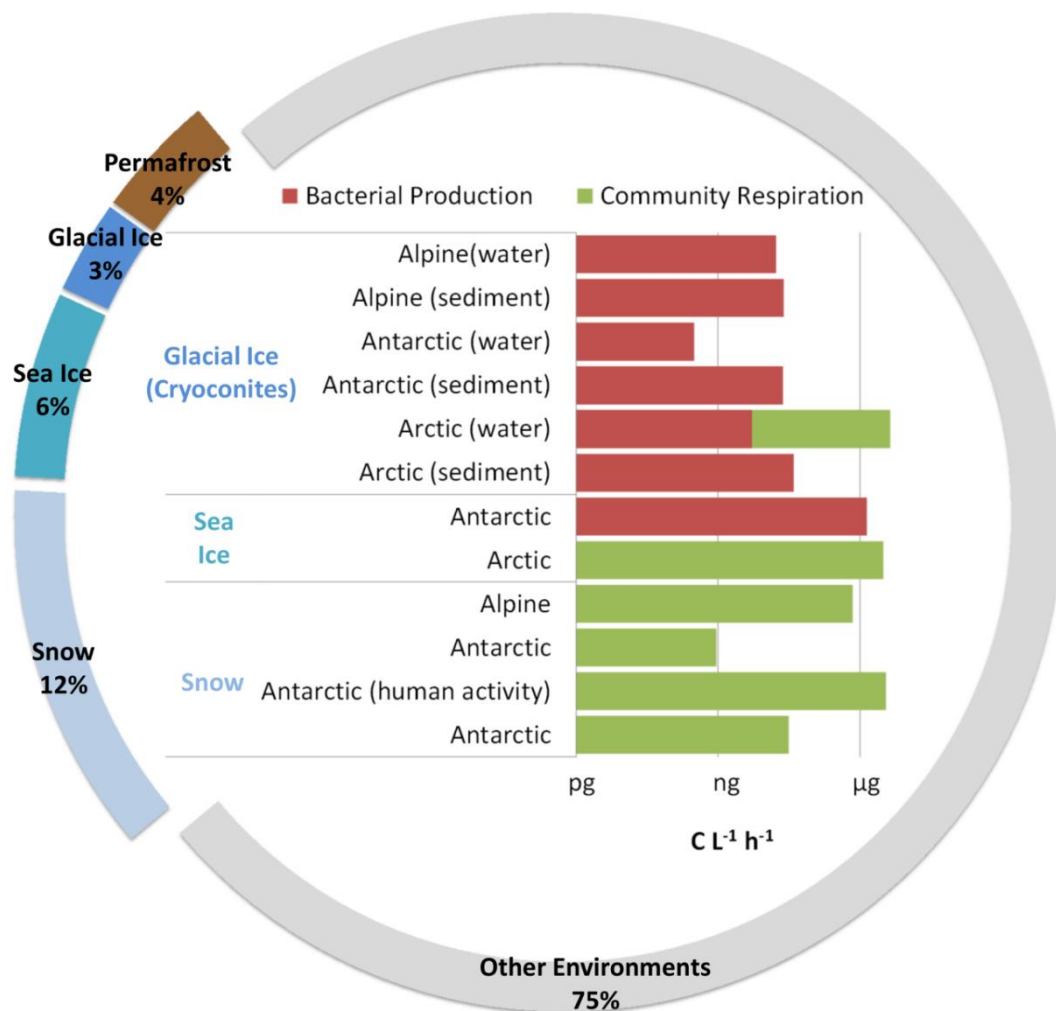

Figure 1 : Coverage and microbial productivity of snow and ice.

The graph on the outer ring depicts the percentage of the surface of the Earth covered by the different environments of the cryosphere. The bar chart shows bacterial production and community respiration rates (in carbon (C) per liter per hour) for these environments. Sediment or water represents the different parts of cryoconites. Human activity refers to snow samples taken near a scientific station and potentially impacted by human activity.

History of microbiology at the North and South Poles: science at the intersection of geopolitics

One of the first documented studies on polar microbiology was carried out by Nyström (1868) in Spitzbergen where the presence of bacteria in the Arctic air was demonstrated using the method developed by Pasteur in 1860⁵. This initiated bacteriological experiments on Arctic and Antarctic expeditions, although these studies were minor in comparison to other scientific research⁹. Ekelöf (1908) was the first to identify bacteria, fungi and yeast in air and soil samples from Antarctica. These results were confirmed by other researchers, such as Pirie (1912), Gazert (1912), Tsikinsky (1908), McLean (1918) and Darling and Siple (1941), who conducted studies on the microbiology of air, snow, surface sea water and animals¹⁰. Gazert (1912) suggested that marine microorganisms were involved in nutrient cycling in Antarctic sea water and McLean (1918) was among the first to demonstrate that bacteria not only survived, but were able to multiply at temperatures close to 0°C¹¹. These early explorations of the cryosphere showed that microorganisms were widespread in ice, snow, soil and water. The proposed sources of these microorganisms included humans during the various expeditions, migrating birds, fish, mammals and atmospheric transport¹⁰. It is striking how little these have evolved over the past 60 or 70 years. Following this “heroic age” of polar exploration, there was a drop in interest in the cryosphere, although this was short-lived¹².

As stated by Francis Bacon over 300 years ago: “long distance travel, and the growth of geographic knowledge, were key to state power and the control of nature.” In polar research, science, technology, politics, economics and culture all interact. Some form of national motivation is vital to the success of promoting research and this was the case during the Cold War⁵. Military funding played a pivotal role in the development of earth sciences in the mid-20th century¹³. During the cold war era, the U.S. saw the Arctic as a potential battle space, consequentially there was a massive investment by the armed services in understanding and mapping the region, whether underseas, on the ice and land or in the air and space above the poles⁵. Detailed knowledge of the physical characteristics of the cryosphere was required for military purposes. For example, the study of ice thickness and polar warming in the Arctic was of interest to the U.S. Pentagon in case there was a conflict with the Soviet Union¹³. These interests led to the development of physical environmental sciences (oceanography, atmospheric science, terrestrial magnetism, solid earth physics, etc.), but almost completely ignored the biological components of environmental sciences¹⁴. As stated in Kelly (1954), the microbial description of the cryosphere, though interesting, was not complete: “further investigations will be carried out, but because they seemingly have no utilitarian value, these remaining parts of the picture, through lack of support, may be slow in coming.”⁹. This vision might have contributed to our overall lack of knowledge.

As rapid warming resumed in the far north late in the twentieth century, a wide range of non-military state funders and private groups began funding research about the cryosphere¹⁴. Recent research suggests that large-scale effects on our planet can be pinned down to biological and chemical activity at the microscopic level. However, the perturbation of biological processes is rarely included in cryospheric climate change models. Given the technological advances and fascination with the cryosphere, it is surprising how little we truly understand about the functioning of frozen environments.

Scientific challenges

If we are to accurately predict how ecosystems respond to climate and anthropogenic forces, we need to understand the interactions that govern their functioning. This means that all the components that make up these ecosystems, both biotic and abiotic, must be studied. The microbial ecology of the cryosphere has been largely overlooked. Based on earlier studies and in the present context of polar research centered on the study of global change, we must evaluate our current understanding. How has our vision of the functioning of the cryosphere evolved? Have new ideas emerged? Or are we recycling old concepts or applying those from non-cryospheric ecosystems? Do we need more data to support pre-existing hypotheses?

This “Habilitation à Diriger des Recherches” (HDR) will provide a review on our current state of knowledge of the cryobiosphere. More specifically, this work will also cover recent advances in our understanding of arctic snowpack and ice, and will be based on studies published during my thesis, post-doctoral studies and my current CNRS research position including the PhD students I have mentor. The manuscript is organized in several chapters:

Chapter 1: The icy biosphere, a review on cryosphere habitats and inhabitants

Chapter 2: Microbial interactions with their chemical environment: lessons learned from snowpack studies

Chapter 3: Are microorganisms active in the cryosphere? Challenges and limits

Chapter 4: Mercury in the environment, a case study on the role of bacteria

Chapter 5: Future research perspectives

Chapter 1: The icy biosphere, a review on cryosphere habitats and inhabitants

In this chapter, the current state of knowledge on the biology of the cryosphere will be reviewed. An overview of adaptive mechanisms to the specific habitat conditions of frozen environments will also be described.

Microbiology of the Cryosphere

Microorganisms exist in several extreme cold environments such as glacial ice¹⁵⁻¹⁷, sea ice¹⁸, Arctic biofilms¹⁹, supercooled clouds²⁰ and Antarctic permafrost²¹. Extreme environments are defined as areas where one or more of the abiotic parameters, i.e. pH, temperature, water content, nutrient levels, solar irradiation, pressure, etc., reach extreme values². Due to the cold conditions and the limited supply of liquid water, snow and ice have long been only considered as entrapment and storage systems for microorganisms that were thought to enter as vegetative and resting cells, transported by wind-blown particles, aerosols and ice crystals. These cells would then be buried by subsequent snowfall events before being transferred to other systems upon snowmelt²². However, this view started to change with a number of studies that examined microbial diversity, ecology and function in the cryosphere. Whether the microorganisms found in cold environments are metabolically active and reproducing remains unclear, but it is assumed that certain species are at least able to survive²³. Moreover, microorganisms might be metabolically active at low temperatures down to -20°C ^{24,25} and very low rates of metabolic activity might be sustained for up to 10^4 to 10^6 years and at temperatures as low as -40°C ²⁶. Carpenter et al. (2000) reported low rates of DNA synthesis and the presence of *Thermus-Deinococcus*-like organisms in Antarctic snow²⁷.

Snow and ice inhabitants

Bacteria seem to be ubiquitous in snow and ice, as they have been observed systematically in all snow and ice environments studied, regardless of the methodological approaches used (culture dependent or not) (Figure 2). The bacteria identified from these studies belong to numerous taxa, although mostly from Proteobacteria (Alpha-, Beta- and Gamma-), the Cytophaga-Flexibacter-Bacteriodes group, Actinobacteria, and Cyanobacteria. The estimated bacterial diversity varied among the different ecosystems studied. For example, the Shannon diversity index ranges from $H' = 0.18$ in Canadian high Arctic ice sheet snow to near $H' = 4.0$ in Tibetan plateau snow^{28,29}. The average bacterial diversity measured in snow and ice is similar to that of temperate soils ($2.4 < H' < 3.6$)³⁰.

Unlike Bacteria, Archaea are only rarely observed. Sequences associated with the Archaeal domain were detected with a relative abundance below 1% in Arctic spring snow samples over soil, sea-ice and ice-sheet. These sequences were annotated to *Thaumarchaeota* and *Euryarchaeota*³¹⁻³³. *Thaumarchaeota* were also detected at low levels in cryonite holes from Arctic and Antarctic glaciers^{34,35}. Archaea were estimated at up to 6.6% of the microbial community in Antarctic Sea ice³⁶. Snow and ice also provide habitats for a wide range of eukaryotic microorganisms such as fungi, microalgae or heterotrophic protists (see review by Arrigo, 2014³⁷). High concentrations of snow algae (*Chlamydomonas nivalis* and related species) can be found in snowpacks from various locations (from Arctic pack ice snow³⁸ to Alpine systems like the Rocky Mountains³⁹ or the Austrian Alps⁴⁰) producing the red snow or watermelon snow phenomenon. In sea ice/ice sheet snow cover, the eukaryotic community is largely dominated by Fungi (Ascomycota and Basidiomycota) followed by

Alveolata (Dinoflagellata)^{34,41,42}. However, Fungi are rarely detected in sea ice, which is dominated by microalgae, the most abundant taxa being diatoms (*Bacillariophyceae*) in both in Arctic and Antarctic samples. Heterotrophic protists including ciliates and flagellates are also common in sea ice. Algae can be found within cryoconite holes or on the surface of glaciers, creating what has been named “grey ice”⁴³. Little is known about the biodiversity in supraglacial lakes and streams and how their ephemeral nature might affect their habitability. Nevertheless, the presence of *Proteobacteria*, *Bacteroidetes* and Algal phototrophs was described in a stream system of Antarctica with low dissolved organic matter content⁴⁴. Another study reported the presence of green algae in two superglacial lakes of Antarctica, although biomass was considered to be low⁴⁵.

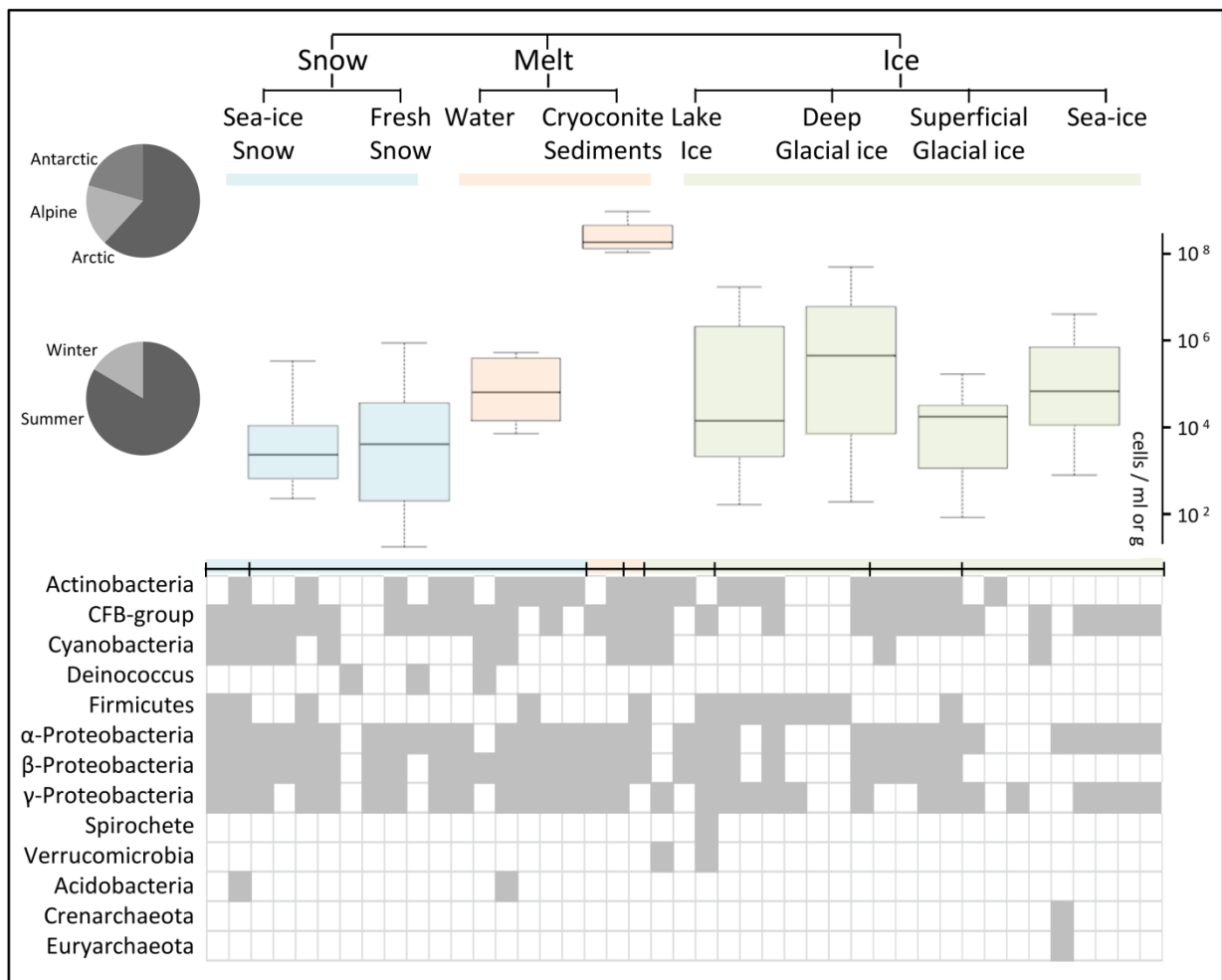

Figure 2. Snow and ice prokaryotic inhabitants.

Abundance and community composition data were extracted from available literature. Pie charts depict geographical distribution (Arctic, Antarctic or Alpine) and sampling season (summer/spring or winter/fall) of the data used. Data were grouped into 8 snow and ice ecotypes: snow over sea-ice, fresh snow over soil or glacier, melt water (ponds, streams, cryoconite hole water), lake ice, deep glacial ice, superficial glacial ice and sea-ice. Prokaryotic abundance is illustrated by boxplots of cell counts per ml of melted snow or ice (or g for cryoconite sediments) for each ecotype. Community composition is assessed by a heatmap of presence (in grey) of most detected taxa at phylum level in the following studies⁴⁶.

Snow and ice have unexpectedly high microbial abundance and diversity. In general, microbial cell counts registered in the snowpack range from 10^3 to 10^4 cells per ml of melted snow collected over

soil and ice in Arctic, Antarctic and Alpine environments⁴⁷⁻⁴⁹. A few reports described counts up to 10^5 cells per ml in some Alpine sites⁴⁰. In debris-rich sea and glacier ice, the microbial abundance varies between 10^4 to 10^7 cells per ml of melted bulk ice. Among the cryosphere ecosystems, the lowest microbial abundance was observed in Antarctic snowpack samples from Concordia, which had only hundreds of cells per ml of melted snow. At the bottom of the sea-ice, the concentration of microorganisms, especially algae, appears to increase. Subglacial lakes, which are formed by accumulation of glacial melt water at topographic depressions, can have two types of ice; the top layer is glacial ice formed through the deposition of snow, while the lower layer is accretion ice (refrozen lake water)⁵⁰. In Lake Vostok, observed microbial abundances in accretion ice were two to seven times higher than in overlying glacial ice⁵¹. Also, while microbial abundance is expressed by total volume of melted samples and therefore averaged over the sample size, cells are probably concentrated into the liquid phase of snow and ice. Models of particle exclusion in glacial ice veins predict that the concentration of cells could be a thousand times higher in the veins than the bulk melt water⁵². Due to the potential small cell sizes of cryosphere microorganisms, recent studies have suggested that the microbial abundance of frozen water ecosystems like snow and ice might be underestimated, given that the methods used for cell count measurements generally involve filtration and the entire community may not be retained by the filters^{53,54}.

Life in the cryosphere

Snow and ice are the only habitats on Earth whose matrices are partly composed of frozen water, and thus, impose specific conditions on microbial life. The driving forces for microbial community structure and function are likely the result of these physical-chemical conditions: low temperatures, scarcity of nutrients and water as well as high UV radiation^{31,55}. These environmental conditions vary temporally as well as spatially and necessitate physiological acclimation. In the Arctic, because of the high latitudes, a pronounced seasonality causes gradual, yet extreme, changes in the photoperiod, irradiance, and temperature. During the springtime melt period, snow undergoes temperature shifts across the freezing point of water, leading to a more dynamic environment, but also to an increase in freeze/thaw cycles⁵⁶. In this section, we compare the different abiotic attributes of snow and ice ecotypes and the related microbial adaptations (figure 3) in order to understand how the microbial community actively interacts with its physical-chemical environment.

Temperature adaptations

In laboratory experiments, the coldest temperature where bacterial growth has been observed is -15°C ⁵⁷ and activity was detected at temperatures as low as -40°C ²⁶. Many studies on microbial life in the cryosphere have focused on understanding how microorganisms can face the cold. The term psychrophiles refers to cold adapted microorganisms with optimal growth temperatures below 15°C and psychrotolerants are organisms able to survive below 0°C but with optimal growth temperatures between 20 and 25°C ⁵⁸. Different survival strategies at low temperatures have been observed in bacteria: reduction of cell size and capsular polysaccharide coat thickness, changes in fatty acid and phospholipid membrane composition, decrease of the fractional volume of cellular water, increase of the fraction of ordered cellular water, energy synthesis by catalyzes of redox reactions of ions in aqueous veins in ice or in thin aqueous films in permafrost²⁶. Moreover, many species that have been isolated form spores that provide high resistance levels, while others have thick cell walls or polysaccharide capsules that resist freeze/thaw cycles⁵⁹. Cold tolerance has been shown to involve

down-regulation of enzymes involved in major metabolic processes such as glycolysis, anaerobic respiration, ATP synthesis, fermentation, electron transport, sugar metabolism as well as the metabolism of lipids, amino acids, nucleotides and nucleic acids. However, up-regulation and overexpression of several enzymes and proteins (cold shock proteins, etc.) may enhance survivability during freeze-thaw cycles⁶⁰. Other adaptive strategies include the production of pigments such as oligosaccharide mycosporine-like amino acids, scytonemins, carotenoids, phycobiliproteins and chlorophylls that offer a broad strategy to cope with high irradiance⁵⁶.

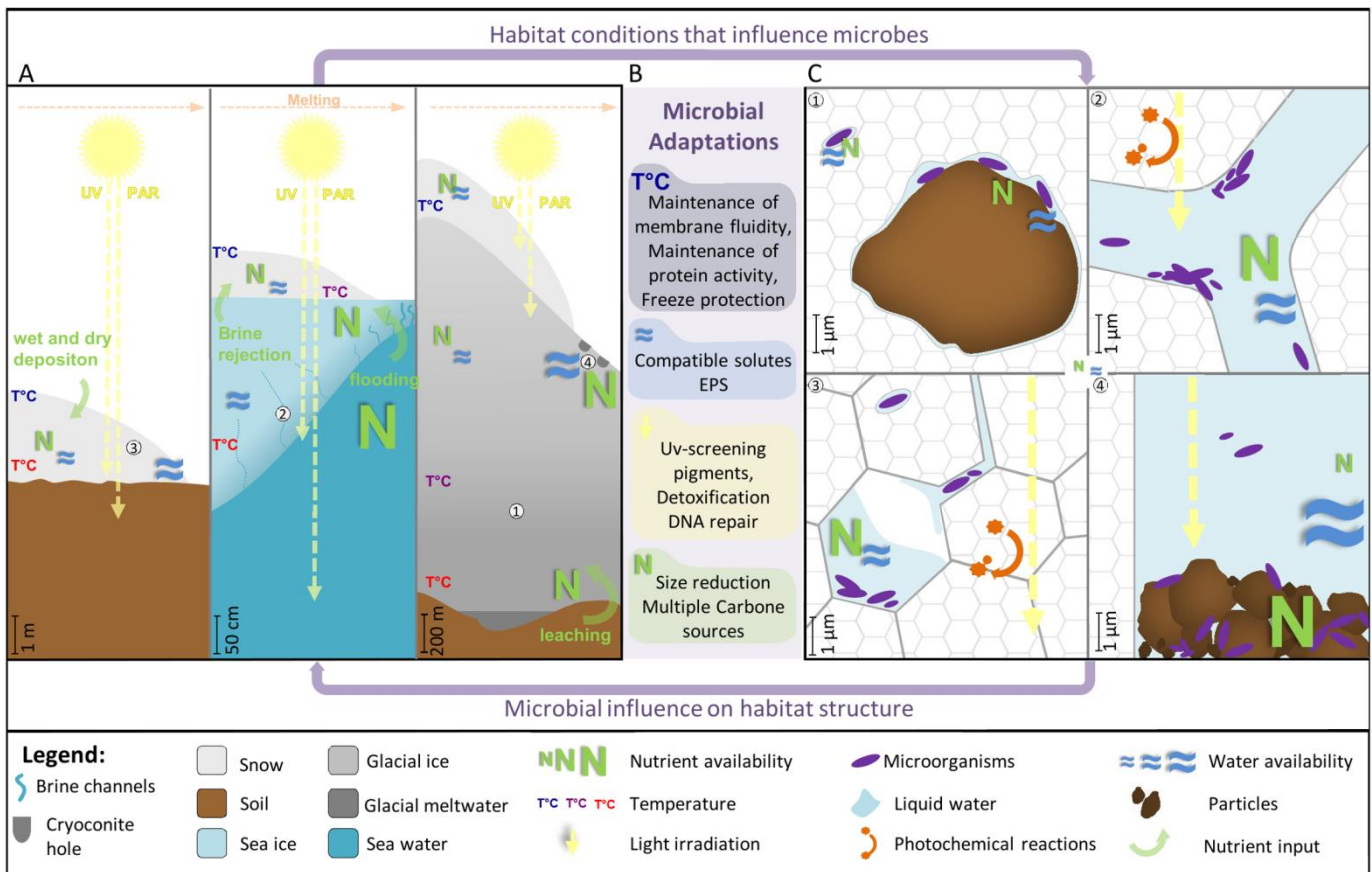

Figure 3. Microbial interactions with abiotic conditions in the different habitats within snow and ice environments.

A: habitat structure and abiotic conditions at macroscopic level. B: Microbial adaption in response to potential stress caused by low temperature, water and nutrient availability and high UV-radiation. C: Examples of niches at micro-scale (1: particle or microbial cell trapped within glacial ice, 2: Sea-ice brine channel, 3: Snow, 4: cryoconite hole)

Many of the organisms with specific cold adaptations are found in snow and ice environments. Sequences associated with cold adapted organisms have been systematically detected in snow and ice sequencing datasets^{30,31,61}. Psychrophilic lifestyle of some snow and ice microorganisms has been confirmed via isolates cultivated at low temperature^{62,63}. While cold adapted microorganisms or cold adaptations seem to be ubiquitous in snow and ice habitats, close relatives to psychrophilic or psychrotolerant microorganisms have also been detected in non-cold environments, which suggests that cold adaptation or adapted microorganisms are not been restricted to cold environments³¹. In addition, many of the microorganisms identified in snow and ice have not been described as psychrophiles and the bacteria found in the Arctic seem not to be different from those in temperate

regions. These bacteria may have come into the Arctic from more temperate zones and have adapted themselves to the rigorous conditions of temperature, light and soil. This is not necessarily the case, however, as it has never been shown that bacteria which are found in countries that are definitely not even subarctic and yet have extremely cold winters require any special adaptation to exist under these conditions⁹. This might suggest that these microorganisms are trapped in ice and snow in a vegetative non-adapted state until release upon snow and ice melting²², but this could also be explained by a bias towards mesophilic representatives in genome databases. Microbial genome plasticity that enables temperature adaptation could be another hypothesis. Experiments have shown that after exposing mesophiles, including *E. coli*, to temperatures of -1.8°C for forty-eight-days, their optimal growth temperature decreased and they even lost their ability to form colonies at 37°C⁶⁴. The psychrophilic life style might not be a unique criteria defining microbial ecology within snow and ice.

Low water activity / salinity

One physical consequence of cold temperature is the low liquid water activity, as frozen water is not available for chemical reactions. As the water freezes, liquid water containing all elements excluded from ice crystals is concentrated in brine channels, pockets, glacial ice veins and at the interface of snow crystals. As snow is transformed and frozen into ice crystals, impurities are excluded from the ice creating hyper-saline and hyper-acidic vein networks^{65,66}. Microorganisms within glacial and sea-ice veins are confronted with desiccation and osmotic pressure, resulting in cytoplasmic water loss and intracellular ionic imbalance. Potential microbial adaptations to low water availability include synthesis and uptake of compatible solutes acting as osmolytes. Genes encoding the synthesis of some osmoprotectants, such as glycine, betaine, choline, sarcosine, and glutamate, have been detected in alpine glacier ice core metagenomes^{67,68}. Extracellular polymeric substances are implicated in various aspects of life in the cold and can also help with tolerating osmotic stress⁶⁹.

Snow and ice water availability as well as the potential osmotic stress exerted on microorganisms might be variable within the different snow and ice ecotypes. Some niches, due to melting processes, can benefit of increased water availability, such as water ponds and streams and cryoconite holes. However these structures are mostly ephemeral and freeze again during cold season⁷⁰. Mechanisms from osmoadaptation that allow life at low water activity have largely been described, mostly involving the production or accumulation of compatible solutes that are used by a majority of halophiles and all xerophiles⁷¹. As seen above, this mechanism has been reported in both sea ice and glacial ice, but not in snow. Given the large variety of compatible solutes (free amino acids, sugars and polyol) used by a wide range of microorganisms (Archaea, Bacteria and Eukaryotes)^{72,73}, further research could help determine how important osmoprotection is in snow and ice ecosystems.

Solar irradiation

Snow and ice located in the polar zones are subjected to continuous light during the summer, while alpine ecosystems are exposed to high light levels due to altitude. Solar radiation reaching the surface is composed of ultraviolet (UV-B and A), photosynthetically active (PAR) and infrared (IR) radiation. The optical properties of snow and ice are related to their physical structure (air, water and dust content), but generally snow and ice are highly scattering media with a highly reflective surface (high albedo)⁷⁴. Due to recent ozone depletion, polar regions have been subjected to

increased UV exposure. Snowpacks are especially reactive to UV light and have been described as natural photochemical bioreactors due to a multitude of ice grains resulting in an ice-air interface increasing the scattering effect^{75,76}. The sequestered chemical compounds are photolyzed and reactive trace gases are released in the snow boundary layer. The processes are increased by higher gas diffusion due to low temperatures. These photochemically-induced reactions may result in the accumulation of reactive species within the snowpack, and thus, a hyper oxidative stressed habitat. However, UV-B transmittance is efficiently attenuated by the snow, levels have been measured one order of magnitude lower at a depth of 8 cm and photochemical reactions were estimated to occur for 85% within the ten first centimeters in arctic snowpacks⁷⁷.

UV radiation is known to be deleterious for cell physiology and the subsequent damage and microbial resistance are wavelength dependent and variable at the species level⁷⁸. Generally, UV-B is involved in direct damage to absorbing biomolecules, such as DNA, by forming pyrimidine dimers that impede replication and transcription, whereas UV-A has indirect effects by producing reactive oxidative species (ROS) that cause oxidative damage to lipids, DNA and proteins. The production of UV-screening compounds, mycosporine-like amino acids, was observed in several ice samples exposed to high levels of UV radiation in Arctic first year sea-ice⁷⁹, the surface layers of Baltic sea-ice⁸⁰ and in Antarctic sea-ice⁷⁹. Astaxanthin, a secondary carotenoid with multifunctional stress response characteristics, also acts as a detoxifier of ROS produced by photochemical reactions and UV-screen in various algae⁸¹. This pigment, cytoplasmic or in polymer structure in cell wall, has been identified in snow algae like *Chlamydomonas nivalis*^{81,82} and *Chloromonas polyptera*⁸³ and its production is increased after exposure to high light^{82,84}. Other algae, such as members of the Zygnematophyceae class inhabiting glacial surface bare ice do not harbor any mycosporine-like compounds or secondary carotenoids, but accumulates a brownish UV-absorbing pigment identified as purpurogallin-derived⁸⁵. Laboratory studies showed that when exposed to lower irradiance levels, *M. berggrenii* reduced or even lost the pigment-containing vacuoles⁸⁵. These examples illustrate that specific and unique strategies to face UV-radiation might exist in snow and ice communities, but the total community response to UV is probably not restricted to pigment in photosynthetic algae. Metabolic stress, with cell activity reduction has been observed in Antarctic sea ice bacteria after initial UV-B exposure, but the possible resistance mechanism was not elucidated⁷⁹. Although, arctic glacier ice core and microbial mats from arctic and antarctic ice-sheets ponds, highlighted the occurrence of some genetic traits for response to photo-oxidative stress, UV-radiation and photo-oxidative stress response mechanisms specific to snow and ice communities as a whole remain largely undescribed. A variety of defense mechanisms against oxidative and photooxidative stress are known for microorganisms, including heterotrophic representatives, from various habitats. For instance, melanin and mannitol are involved in antioxidant and UV protection in fungi also from Antarctic endophytic or rock communities⁸⁶. Detoxification systems (OxyR and SoxRS regulons) involving enzymatic oxidant elimination and DNA repair were described in a wide range of bacteria⁸⁷. DNA repair mechanisms are also widespread in all microbial kingdoms based on base or nucleotide excision⁸⁸. Searching for these mechanisms in snow and ice should be addressed in the future as microbial communities could have developed a wide diversity of adaptations given the levels of UV-light in these environments.

PAR radiation, used by phototrophic organisms during the process of photosynthesis, could also have deleterious effects. Snow and ice microbial communities are able to optimize their metabolism to

maximize light-harvesting and protect against damaging light levels. Adaptation and acclimation of photosynthetic microorganisms to permanently cold environments including snow and ice has been reviewed in detail ⁸⁹. In sea-ice, diatom algae adjust the pigmentation by increasing the ratio of xanthophyll diaxanthin with increasing levels of irradiance ⁹⁰. Antarctic sea ice microalgae dissipate extra light energy via non photochemical quenching to avoid short term photo-inhibition ⁹¹. Light intensities could influence the vertical distribution of photosynthetic microorganisms in snow or in the ice matrix ⁹². Other mechanisms such as the circadian clock, that permit Cyanobacteria to regulate metabolism depending on light, may also be crucial for light dependent metabolisms under constant light conditions ³¹. Light is a major factor driving microorganism ecology in a wide range of processes and thus determining various life styles; photosynthesis, photoacclimatation, phototacticism but also attachment and biofilm formation ⁹³.

Nutrients

Snow and ice environments are generally oligotrophic, therefore, sources of nutrients could be critical to their inhabiting communities. One carbon source might be inorganic carbon fixation and autotrophic energy production by primary producers ^{55,94}. Photosynthetic activity might be important in several cryosphere ecosystems such as colored snow colonized by snow algae ⁸⁵, ice sheet surfaces ⁹⁵, ice lake covers ⁴⁰, sea-ice ⁹⁶ and cryoconite holes ⁹⁷. However, algal blooms are periodic, probably restrained to specific conditions. Moreover, polar snow and ice microorganisms are subjected to total absence of light during winter. How the phototrophic members of the community survive through winter and are impacted by this low light regime is still largely unknown. The occurrence of mixotrophic algae, which are able to sustain their metabolism through bacterivory, has been described in arctic sea ice samples at the end of the polar night as an alternative pathway ⁴². Photosynthetic organisms and activity in deeper layers of glacier ice cores are rarely detected, likely due to lower levels of irradiation. Yet, non-photochemical autotrophic processes could also be involved in nutrient dynamics within these habitats. The importance of this lifestyle was supported by the presence in glacial ice metagenomes of a significant number of genes involved in carbon fixation ⁹⁸. In subglacial areas, water, organic carbon and minerals sustain the development of microbial communities where chemolithotrophic primary production could be an important process ^{16,99}.

Another source of organic compounds for microorganisms in glaciers and ice sheets could be carbon released from dead cells and allochthonous carbon from local or remote origins ¹⁰⁰. Numerous genes detected in glacier ice core metagenomes related to xenobiotics, biopolymers and other carbon sources suggest that glacial ice microorganisms have the potential to degrade a wide range of substrates ⁹⁸. Microbial degradation of xenobiotic compounds from distant allochthonous sources has been observed on the Greenland Ice sheet ¹⁰¹. Microbial preferences for different carbon classes were also studied in Antarctic snow and results showed a higher rate of carbon uptake when snow microcosms were amended with a combination of simple and complex carbon sources ¹⁰². In the same study, snow isolates were capable of oxidizing a broad spectrum of low and high molecular weight carbon sources including amino acids, amines, amides, carboxylic acids, carbohydrates, and complex polymers. Altogether these results highlight the potential for high metabolic versatility of microorganisms in snow and ice habitats with low concentrations of many different carbon sources.

One strategy to cope with low nutrients is to reduce cell size, since small size increases the surface to volume ratio, thereby improving the ability to efficiently scavenging for nutrients ¹⁰³. Miteva and Brenchley (2005) observed a dominance of cells with a size inferior to 0.1µm in addition to numerous isolates that were closely related to the oligotrophic ultramicrobacterium *Sphingopyxis alaskensis* in a Greenland glacial ice core ¹⁰⁴.

However, certain niches in snow and ice ecosystems could actually be nutrient-rich environments. For example, given that nutrients and particles are excluded from the ice crystal structure and are concentrated in pore spaces, concentrations of nitrate and sulfate in ice veins from Greenland and Antarctica were 10^3 to 10^5 times more concentrated than in bulk ice ¹⁰⁵. These levels of nutrients are similar to what can be found in rich growth media ⁵² and are likely sufficient to support microbial activity in deep glacial ice ⁶⁶. Even in the bulk ice, microorganisms might be associated with mineral particles and may extract energy from redox reactions with putative methane production based on observations from ice cores ¹⁰⁶. Cryoconite holes might also be nutrient-rich areas, as these semi-stagnant aquatic habitats have been considered to be eutrophic ^{107,108}. In sea-ice, organisms could be benefiting from tidal or wave induced transport of dissolved organic carbon (DOC) within the ice-brine channel network. The high culturability of sea ice microorganisms observed using both organic-rich and-poor media is consistent with the microorganisms coming from nutrient-rich conditions ⁸. As for the snow, crystal formation can be induced by particles named ice nuclei, which can be suspended in the atmosphere. As snowflakes fall, they scavenge atmospheric particles including microorganisms and pollutants ¹⁰⁹. Thus, snow has been defined as a nutrient and microbial reservoir ¹¹⁰. Due to dry and wet atmospheric deposition events, snowpack inhabitants can be exposed to occasional inputs of particles and nutrients, such as nitrogen compounds, derived from natural or anthropogenic sources. Several reports suggested that snow microorganisms are able to metabolize these nitrogen compounds. For example, nitrogen cycling pathway genes were apparently increased in microbial communities during spring and were correlated to different nitrogen compounds ¹¹¹. Fluxes of nitrogen species in snow during polar night (*i.e.* in the absence of photochemical reactions) were observed and attributed to microbial activity ¹¹². Other sources of nutrients for snow over sea-ice could be sea-ice brines and seawater. When snow accumulates on the sea-ice, the added weight can cause seawater to flood over the ice. Also, during sea-ice freeze-up, liquid brine is rejected to the surface, wetting the overlaying snow layer ⁶⁹.

In this section we have seen that snow and ice could be suitable to sustain microbial life and might not be so extreme from a microbial point of view. Although snow and ice share multiple characteristics due to their ice crystal backbone structure and their homogeneous appearance at a macroscopic level, they are composed of a multitude of niches under different conditions. At a microscopic level for each micro-habitat, stresses, such as low nutrients or water availability, might not be as extreme as expected. Moreover, a wide range of strategies could be used by individual cells to resist the potential stress in snow and ice. Snow and ice microorganisms are not only able to adapt to the physicochemical conditions of their habitats, but they are also shaping their biotic environment. Pigment producers developing at surfaces, and forming watermelon snow or brown, red and grey ice, drastically decrease surface albedo and increase local temperature and water content ^{43,113}. In glacier and lake ice, the production of ice binding proteins by bacteria can modify ice vein structure by inhibiting recrystallization, which seems to reduce diffusion in veins ^{73,114}. Likewise, EPS production by sea-ice algae and bacteria modify the structure of the ice by reducing

permeability, considered essential for the creation of connected and complex brine channels within sea-ice¹¹⁵. All of these physical and chemical modifications can facilitate the development of complex microbial communities.

Snow and ice inhabitants in complex communities

In the previous section, we discussed individual cells mechanisms involved in resistance to the potentially harsh conditions of snow and ice habitat. Here we would like to examine the complex communities of snow and ice inhabitants in order to investigate how their interactions can impact snow and habitability.

The majority of microorganisms that inhabit any given ecosystem are rarely alone as they often live in communities and share their niche with other organisms. Biological interactions between the members of a community can shape and partly define an ecosystem¹¹⁶. In the cryosphere, these relationships could be an important asset in the colonization of the different habitats. Horizontal gene transfer (HGT) between the members of the community might promote adaptation to environmental conditions¹¹⁷. Some studies suggest that conjugation events could be taking place in the cryosphere, for example with the occurrence of UV-tolerance operons and mercury resistance genes carried by plasmids in bacteria in glacier, sea-ice and snow^{118,119}. In addition, ice-binding protein genes might be transferred from bacteria to algae through horizontal gene transfer in sea ice and snow. This putative HGT within the snow and ice microbial community still needs confirmatory experiments in order to firmly establish the causation and HGT could help bacteria adapt to environmental perturbations. Viral-host interactions and transduction events might also take place in snow and ice. In the last twenty years, a variety of reports have pointed to an unforeseen high abundance and high diversity of viruses in cold environments^{28,120-124}. Abundance and diversity values seem to be highly variable with cryoconite hole sediments having the highest viral like particle (VLP) numbers (2.5×10^9 VLP g⁻¹)¹²⁵. Several studies have found newly undescribed viral groups for sea ice and supra-glacial systems^{80,123}. In sea ice, siphovirus and myoviruses were identified as phages of *Flavobacterium sp.* and *Shewanella sp.*, respectively¹²⁶. In glacial and sea ice, with most bacteria and viruses in the veins of liquid water, contact rates between viruses and bacteria might be higher than estimated in bulk ice¹²⁷. Indeed, a recent study suggested that viral interactions with their host in arctic glacial ice were more dynamic than in nearby soil¹²⁸, while high concentrations of extracellular DNA and viruses have been described in sea-ice¹²⁹. Thus, based on high viral abundance, diversity, infection rates¹³⁰, and broad host ranges¹³¹, viruses have been promoted as drivers of evolution in glaciers and, in general, in cold environments¹³². Viruses also influence nutrient and organic carbon recycling through the lysis of microbial cells in what has been named the “viral shunt”¹³³. This process might have an increased relevance in oligotrophic environments such as snow and ice. Although no study has attempted to determine the viral diversity in snow, prophages were induced from bacteria (*Paenibacillus spp.*) recovered from the snow and all bacteria tested had up to 3 morphologically different inducible phages¹³⁴. Viral sequences accounting for less than 0.1 % of the total sequences have also been detected in public snow metagenomes³¹. In snow, algal-bacterial interactions have been described where bacteria benefit from the organic carbon excreted by the algae³⁹. This commensalistic relationship has also been reported in sea ice¹³⁵. For example, bacteria were seen to consume the toxic hydrogen peroxide produced by diatoms during photosynthesis⁹⁶. A large diversity of non-microbial organisms has also been observed in snow and ice. Meiofauna

identified in glacial and lake ice as well as in sea ice includes nematodes, copepods, rotifers and tardigrades among others^{51,136,137}. Even macrofauna, such as annelids including several species of the genus *Mesenchytraeus*, (snow or ice worms) that has recurrently been found inhabiting glacial ice and snow, actually live their entire lifespans in these systems¹³⁸. They graze on microbial algae¹³⁹ and maybe also bacteria, and thus, control microbial populations. *M. solifugus* exhibit bacteria associated with their gut walls in what seems to be a symbiotic relationship¹⁴⁰. Thus, the macrofauna also provide yet another niche for microorganisms in snow and ice. Hypothetic network of trophic interactions in snow and ice ecosystems is presented in figure 4. As depicted above, interactions between organisms can promote the settlement of communities and can assist in the adaptation of its members. So community interactions can reinforce the capacity of microbial inhabitants to face the stresses of snow and ice ecosystems.

Conclusion

Here, we focused on the characterization of snow and ice ecosystems and especially how microorganisms interact with their complex abiotic habitat under specific conditions in terms of irradiation, water activity, salinity and nutrient content. Although many adaptive mechanisms remain to be described, snow and ice inhabitants possess a large set of tools to deal with these variable and intense conditions, which might not be so extreme from an adapted microbial point of view. Snow and ice microbial communities do not seem limited by their specific conditions, at least in superficial environments, and have numerous and diverse members involved in a complex network of interactions. Although their production rates might be low compared to other major biosphere compartments, such as ocean and soil, snow and ice ecosystems might sustain an underestimated part of global biogeochemical activity. Future research focusing on snow and ice ecology should expand past resistance studies to function studies of these ecosystems.

Chapter 2: Microbial interactions with their chemical environment: lessons learned from snowpack studies

A major component of the Arctic is seasonal snow. Snowpacks store nutrients, particles, contaminants, and microorganisms and are involved in the chemical cycling of trace gases and pollutants such as mercury. Seasonal snow has been shown to be a dynamic system that interacts with different environmental compartments such as the atmosphere, soil and aquatic systems. The exploration of the cryobiosphere has led to the discovery of diverse microbial communities that appear to be adapted to cold environments and are able to modify chemical processes. However, detailed knowledge about the interactions between the chemical composition of snow and microbial populations, is lacking. This section, based on a series of field experiments in Svalbard and Greenland, explores the relationships between snow/meltwater chemistry, microbial community structure and functional genes.

Physico-chemical properties of snow

An important feature of the Arctic is seasonal snow-cover, which extends over a third of the Earth's land surface, covering up to 47 million km² ¹⁴¹. It can be considered as a dynamic habitat of limited duration ¹¹⁰. Snow cover influences global energy and moisture budgets, thereby impacting climate ¹⁴¹. It is also be considered as a medium and a mediator that transmits and modifies interactions among microorganisms, plants, animals, nutrients, the atmosphere and soil ¹⁴². The influence of seasonal snow cover on soil temperature, soil freeze-thaw processes, and permafrost has considerable impact on carbon exchange between the atmosphere and the ground and on the hydrological cycle in cold regions ¹⁴³. Snow cover acts as both an energy bank by storing and releasing energy and a radiation shield due to its high radiative properties that reflect as much as 80-90% of the incoming radiation for fresh snow ¹⁴¹. This high surface albedo reduces absorbed solar energy and lowers snow surface temperature ¹⁴³. Physical metamorphism, phase changes and chemical transformations, which are modulated by interactions with the atmosphere and soil systems, control both the dynamics and the duration of the snow cover ¹⁴⁴. Thus snow cover is an important factor in the functioning of the Arctic, and by extension, the global ecosystem.

A brief overview of snow structure and its formation

Snow is formed in the atmosphere and consists of particles of ice that form in clouds. These crystals grow by vapor deposition and require atmospheric temperatures below 0°C and the presence of supercooled water ¹⁴⁵. Because ice formation is not spontaneous at temperatures > -40°C, ice nucleation occurs mainly in the presence of substrates that act as catalysts. These substrates include dust, seasalt particles, sulfate, combustion products from industrial plants, volcanoes, forests and bacteria ^{142,146}. A recent report by Christner *et al.* (2008) found that biological particles such as proteins or proteinaceous compounds play a significant role in the initiation of ice formation, especially when cloud temperatures are warm ¹⁴⁷. Once deposited, the snow cover forms as a result of snow crystal binding ¹⁴⁸. Snow crystals are subject to temperature gradients that generate water vapor fluxes between crystals. This results in the sublimation of parts of crystals and condensation on other parts, thus changing crystal size and shape, and altering the physical properties of the snowpack. With each snowfall, the cover changes and the new layer may possess different properties than the preceding layer ¹⁴⁹. As snow ages, its physical properties, such as density, porosity, heat

conductivity, hardness, specific surface area and albedo, evolve in response to thermodynamic stress and weather conditions¹⁴⁸. Therefore, the composition of layered snow cover and ongoing changes in each of the layers' properties are not only due to the circumstances of formation, but also to changing conditions over time.

Deposition and incorporation of impurities within snowpacks

The snowpack is a receptor surface and storage compartment for nutrients, soluble inorganic or organic matter and contaminants that may or may not be attached to insoluble particles that are delivered by wet and dry deposition (reviewed by Kuhn 2001; Daly and Wania 2004^{146,150}). Their distribution within the snow is heterogeneous⁴³ and depends upon different physical processes such as atmospheric loading, wind speed, and snow metamorphism. Nutrients exist in the atmosphere as trace gases such as SO₂, CO₂, NO_x, N₂O or HNO₃ and as aerosols such as pollen, sea salt particles, mineral dust and sulfates (reviewed by Kuhn 2001¹⁴⁶). Nutrients and contaminants can be delivered to the snowpack through wet and dry deposition (Figure 4). Wet deposition occurs when atmospheric components are scavenged and incorporated into growing or falling snow/rain as condensation or freezing nuclei, by either the impaction of particles, the solution of gases or by the collision of supercooled droplets with snow crystals¹⁵¹. Condensation or evaporation can alter the concentrations, resulting in the highly variable composition of individual snow crystals.

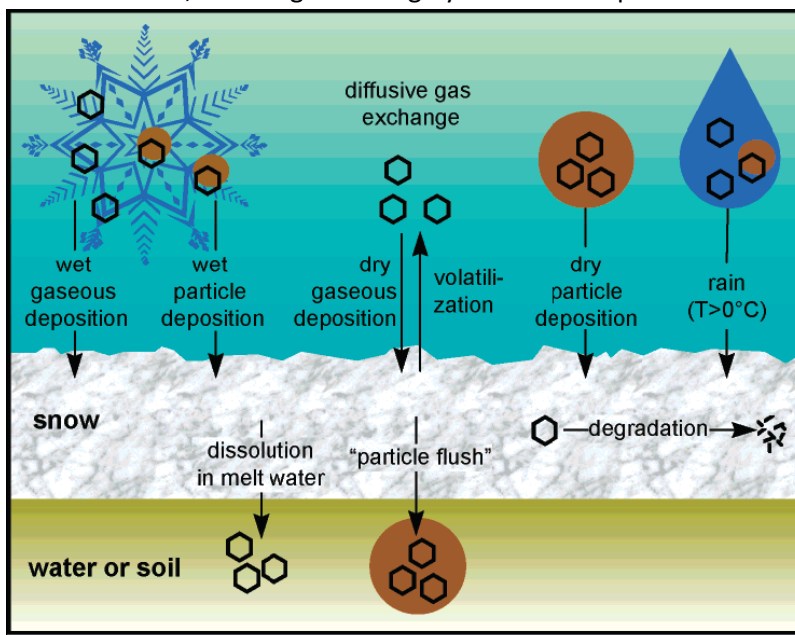

Figure 4: Processes involved in the delivery and loss of contaminants in a seasonal snow cover (reproduced from Daly and Wania 2004).

Atmospheric scavenging and condensation largely condition the presence of major ions in the snowpack, such as SO₄²⁻, NH₄⁺, NO₃⁻, Ca²⁺, Cl⁻ and Na⁺¹⁴⁶. Dry deposition occurs when gases and particulates are transferred directly to the snow surface without the intermediate scavenging by precipitation. This pathway is dependent upon the atmospheric concentration of the species, the stability or turbulence of the atmospheric boundary layer, as well as the capacity of the surface to retain the species¹⁵². Once deposited, these species can be redistributed to the snowpack. Due to the permeability of the snowpack, gaseous diffusion occurs along a concentration gradient. Gases can also diffuse from the soil to the atmosphere¹¹⁰. Snow-air exchanges occur when the vapor diffuses through the air-filled pore space to the top of the snowpack and from there through a

boundary layer to the atmosphere¹⁵⁰. The penetration of gases and particles within the snowpack is dependent upon physical-chemical properties, the geometry of the pore space, vapor pressure gradients and wind pressure¹⁵³. Wind advection can accelerate solute transport within the snow pores, even after the resistance to molecular diffusive transport is too large to allow gas exchange¹⁵⁰.

Snow metamorphism and impurity cycling

Physical processes of snow metamorphism also lead to the redistribution of chemical species (Figure 5). On a crystal, molecules diffuse from convex to concave sites, thus transforming crystals to small round snow grains that evaporate and distill onto larger grains once in close proximity. The grains grow rapidly by diffusion, which is initiated by temperature gradients within the snowpack and facilitated by the quasi-liquid surface layer of snow crystals that gives molecules high mobility. During this process, impurities are excluded from the crystals and concentrate at the grain boundaries and pore spaces of the snow¹⁵⁴. The layered nature of the snowpack, which is composed of a heterogeneous mixture of grains of various sizes, water saturation levels, densities, and ice layers that reduce the permeability to air and water¹⁴⁹, is also important in the redistribution of solutes. Chemicals can be lost from the snow through degradation, volatilization and runoff with meltwater¹⁵⁰. Impurities can be transformed within the snowpack and also returned to the atmosphere. Snow also transmits atmospherically derived impurities such as nutrients, microorganisms, particles and contaminants to meltwater-fed systems. Snow is thus a mediator favoring exchanges among different environmental compartments.

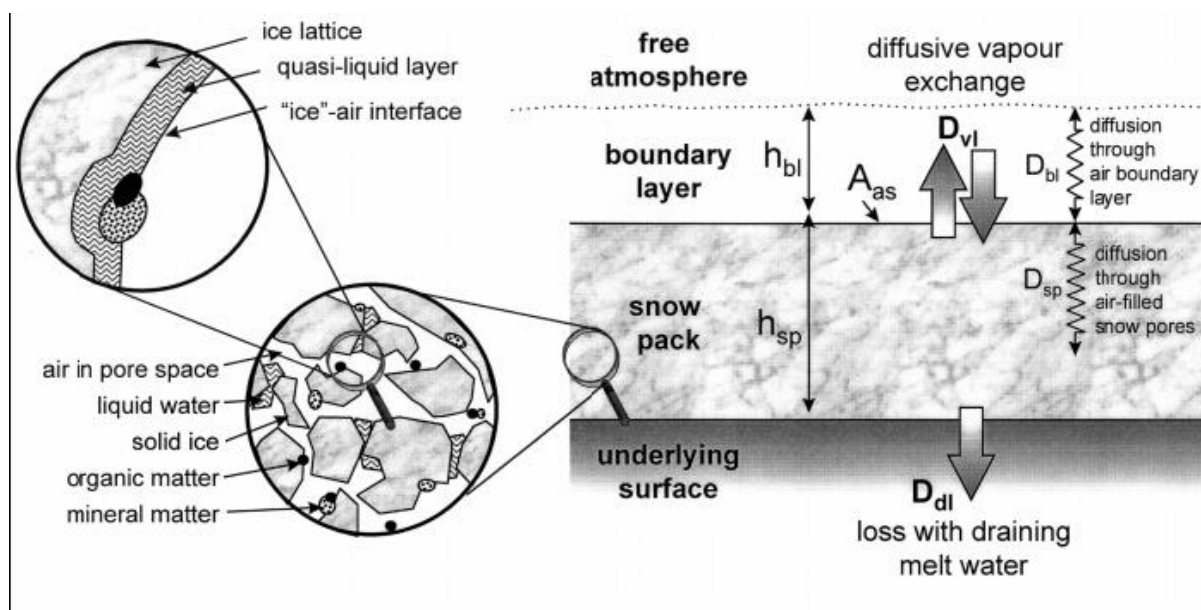

Figure 5: Chemical snowpack model representing volatilization loss and meltwater concentration (reproduced from Wania et al. 1999).

Seasonal chemical dynamics in snowpacks

In Svalbard snowpack field experiments carried out over several months where different snow layers were followed (Figure 6 for an example of data from 2011), we demonstrated that the snowpack evolves chemically over time¹⁵⁵.

Mid-season surface snow samples (generally collected in the month of May, where the snowpack is warm, but hasn't begun to melt) are generally characterized by high levels of glutaric acid, MSA, NO_3^- and high SO_4^{2-} to Cl^- ratios. Glutaric acid, a C_5 dicarboxylic acid commonly found in aerosols and as cloud-condensation nuclei, is derived from a variety of sources including anthropogenic emissions such as motor exhaust, as well as biogenic emissions from the ocean^{157,158}. Glutaric acid is also significantly positively correlated to MSA in snow, which further supports a close marine source for organic acids. MSA is indeed a photo-oxidation product of DMS, which itself is a derivative of dimethylsulphoniopropionate (DMSP) produced by phytoplankton¹⁵⁹. DMSP is known as both an osmoprotectant and cryoprotectant for microorganisms, as well as a carbon and sulfur source. It is released from senescent or stressed cells¹⁶⁰. MSA has been shown to exhibit a distinct seasonality that is linked to biological activity in Arctic waters and the importance of the phytoplankton bloom to DMS concentrations has also been reported¹⁶¹. These patterns in snowpack evolution recur year after year, and it is our hypothesis that they can be generalized to most arctic coastal snowpacks.

Seasonal microbial dynamics

Using a variety of metagenomic techniques (16S rRNA gene (*rrs*) clone libraries, phylochips, ITN, next generation sequencing, q-PCR), we followed seasonal changes in bacterial and fungal communities in different snow layers. Communities were shown to undergo dynamic shifts over time and an example of the types of results obtained is given in Figure 7.

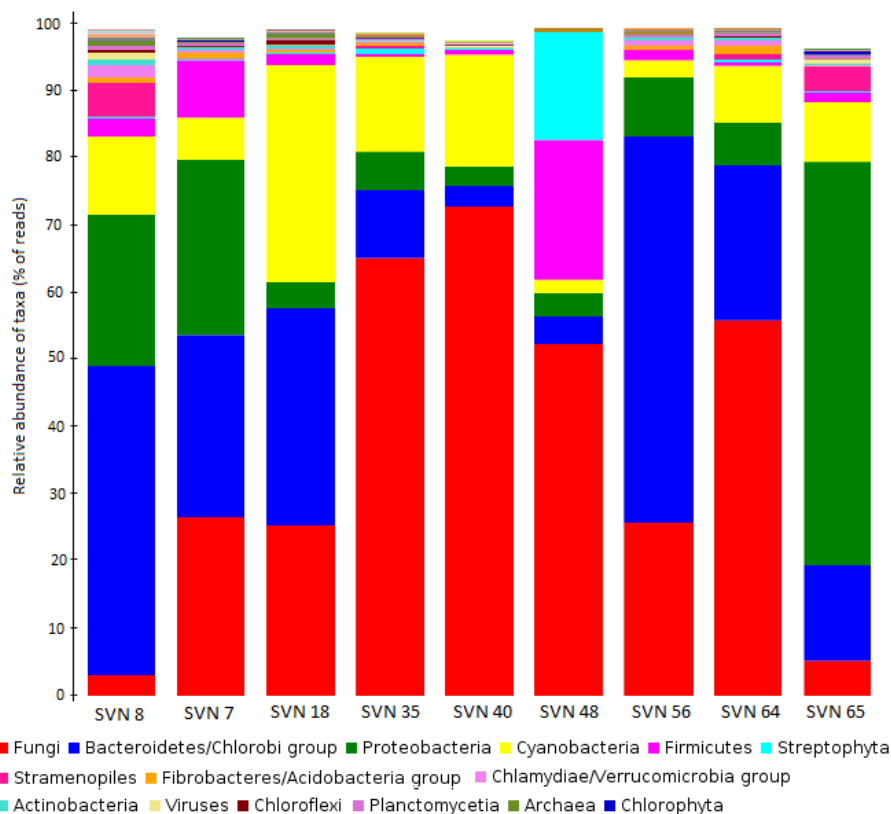

Figure 7 : Comparison of the major phyla/classes (NCBI-Taxonomy in MEGAN) in all snow samples. Data is plotted as the percentage of sequence reads annotated to genomes within each phyla/class. The legend is classified in decreasing order of read numbers.

In order to gain a better understanding of the drivers of these changes, we looked for interactions within the chemical environment of the snow³¹.

Microbial interactions with chemistry

Using multivariate analysis, we found a significant co-structure between microbial communities and snowpack/meltwater chemistry. Therefore, chemistry and microbial community structure are linked and likely interacting. The dynamic nature of the snowpack in terms of both community structure and chemistry was revealed by the clusters that evolve along a seasonal gradient. However, do microbial communities impact chemistry, or does chemistry drive population changes? Are these interactions unidirectional or bidirectional? In terms of identifying the nature of these interactions, co-inertia analysis determined the major chemical and microbial vectors that impacted the co-structure. An example of the types of snow groupings and main chemical and microbial drivers obtained from a field study conducted in 2008 in Ny-Alesund, Norway, are presented in table I.

Table I: Groups of samples and their characteristics as determined by co-inertia analysis.

Group	Sample type	Chemical drivers*	influential probes
1	Basal snow	High nitrate, high ion, salinity 0.7‰	<i>Actinobaculum</i> , <i>Micrococcus</i> , <i>Cyanothece</i> , <i>Halothece</i> , <i>Halobacillus</i> , <i>Neisseria</i> , <i>Glucunobacter</i>
2	Warm, wet surface snow	High MeHg, Glut, MSA, low ions salinity 0.05‰	<i>Oscillatoria</i> , <i>Planktothrix</i> , <i>Pelodictyon</i> , <i>Phormidium</i> , <i>Microcoleus</i> , <i>Microcystis</i> , <i>Synechococcus</i> , <i>Synechocystis</i> , <i>Scytonema</i>
3	Fresh surface snow, some basal samples	High Hg and BioHg, low pH, salinity 0.3‰	<i>Agrobacterium</i> , <i>Sorangium</i> , <i>Sulfobacillus</i> , <i>Thiobaca</i> , <i>Thiococcus</i>
4	Mainly surface snow	Low ion (salinity 0.06‰)	<i>Desulfosporosinus</i> , <i>Hydrogenimonas</i> , <i>Muricauda</i>
5	Basal sample, isothermal snowpack	High ion (salinity 23‰)	<i>Achromatium</i> , <i>Acidimicrobium</i> , <i>Aeromonas</i> , <i>Agarivorans</i> , <i>Roseovarius</i>
6	Fresh surface snow (deposition event), basal snow samples	High ion (salinity 8‰)	<i>Psychromonas</i> , <i>Alteromonas</i> , <i>Azoarcus</i> , <i>Exiguobacterium</i> , <i>Leptotrichia</i> , <i>Marinobacter</i> , <i>Pelobacter</i> , <i>Roseiflexus</i> , <i>Ruminococcus</i>
7	Late season, dry surface snow	Low ion (salinity 0.02‰)	<i>Flexibacter</i> , <i>Arenibacter</i> , <i>Lentisphaera</i> , <i>Hydrocoleum</i> , <i>Lyngbya</i> , <i>Virgibacillus</i> , <i>Oscillochloris</i> , <i>Rhodovibrio</i> , <i>Desulfobacca</i>
8	Meltwater samples	High organics, elevated pH, low Hg	<i>Flavobacter</i> , <i>Filifactor</i> , <i>Cycloclasticus</i> , <i>Opitutus</i> , <i>Xanthobacillum</i> , <i>Alkalibacterium</i>

*MeHg, Glut, MSA, Hg, BioHg represent methylmercury, glutarate, methylsulfonic acid, mercury and bioavailable mercury, respectively.

Marine salts drove the ordination of samples in the co-inertia analysis and the relative abundance of certain probes targeting specific phylotypes increased as a function of ion concentration. The genera

that had the most influence on the ordination were *Flavobacterium*, *Vibrio* and *Photobacterium*. Members of these genera are commonly retrieved from polar marine environments and are known to be halotolerant^{162,163}. Some strains of *Flavobacterium* isolated from Antarctic sea water even exhibited an absolute sea water requirement for growth¹⁶⁴. Organic acids and pH represented another important vector. The organic acids measured were short-chained acids with 1 or 2 carbons, and their concentrations increased as the season progresses and the snowpack begins to melt. pH, another important vector in the snow, has also been reported as one of the main factors in determining community structure in soils¹⁶⁵. For example, the relative abundance of *Bizionia* (*Flavobacteria* class) and *Aurantimonas* increased with pH, while that of *Acidobacteria* decreased. Members of both *Bizionia* and *Aurantimonas* have growth optima between pH 6 and 8^{166,167}. A major chemical vector was mercury, but this will be examined in more detail in Chapter 4.

Functional dynamics of snowpack microbial community

Environmental chemistry, such as pH, organic acids, nitrogen, sulfur cycling, and mercury, has been correlated with bacterial community dynamics measured by 16S rRNA gene phylogenetic microarray in the Svalbard snowpack⁵⁵. Unfortunately, taxonomical data associated with ribosomal gene analyses cannot provide the details of the ecological role of these organisms, since functional potential can differ between species and within the same taxonomic species¹⁶⁸. Functional metagenomic analysis has been proposed as a technique for assessing ecosystem ecology, *e.g* how microorganisms are adapted to a given environment and what role they play in this environment^{98,169,170}. We sequenced nine snow samples taken from the same study presented in Table I. The resulting metagenomic datasets were analyzed for both their taxonomic and their functional profiles based on comparing the sequences to known microorganisms and proteins.

Sequence reads from the snow metagenomes were classified into metabolic functions using the SEED database of the annotated reads, most were classified as carbohydrate metabolism genes (10-19%), followed by virulence, amino acid, protein, DNA, cell wall, cofactors and respiration. The functional profile varied among snow samples. For example, the proportions of reads associated with virulence varied between 8.72% for the surface snow sample to up to 18.10 % for the surface snow sampled three weeks later. Among virulence associated reads, the majority corresponded to antibiotic and toxic compound resistance, and pollutant biodegradation and reach up to 91 % of the annotated reads. Based on the heatmap from the Pearson correlation matrix (Figure 8), many of these physico-chemical factors correlated with the functional annotation from the high throughput sequencing. For example, total mercury (Hg), bio-available mercury (BioHg) concentrations were correlated to oxidative stress, tetrapyrroles (Cobalamin and coenzyme B12 biosynthesis and Heme/siroheme biosynthesis) and NAD/NADP metabolism. MSA was also positively correlated to iron acquisition and quinine cofactors. This demonstrates not only a link between the chemical environment and the structure of the community, but also a link between community function and the physico-chemical environment.

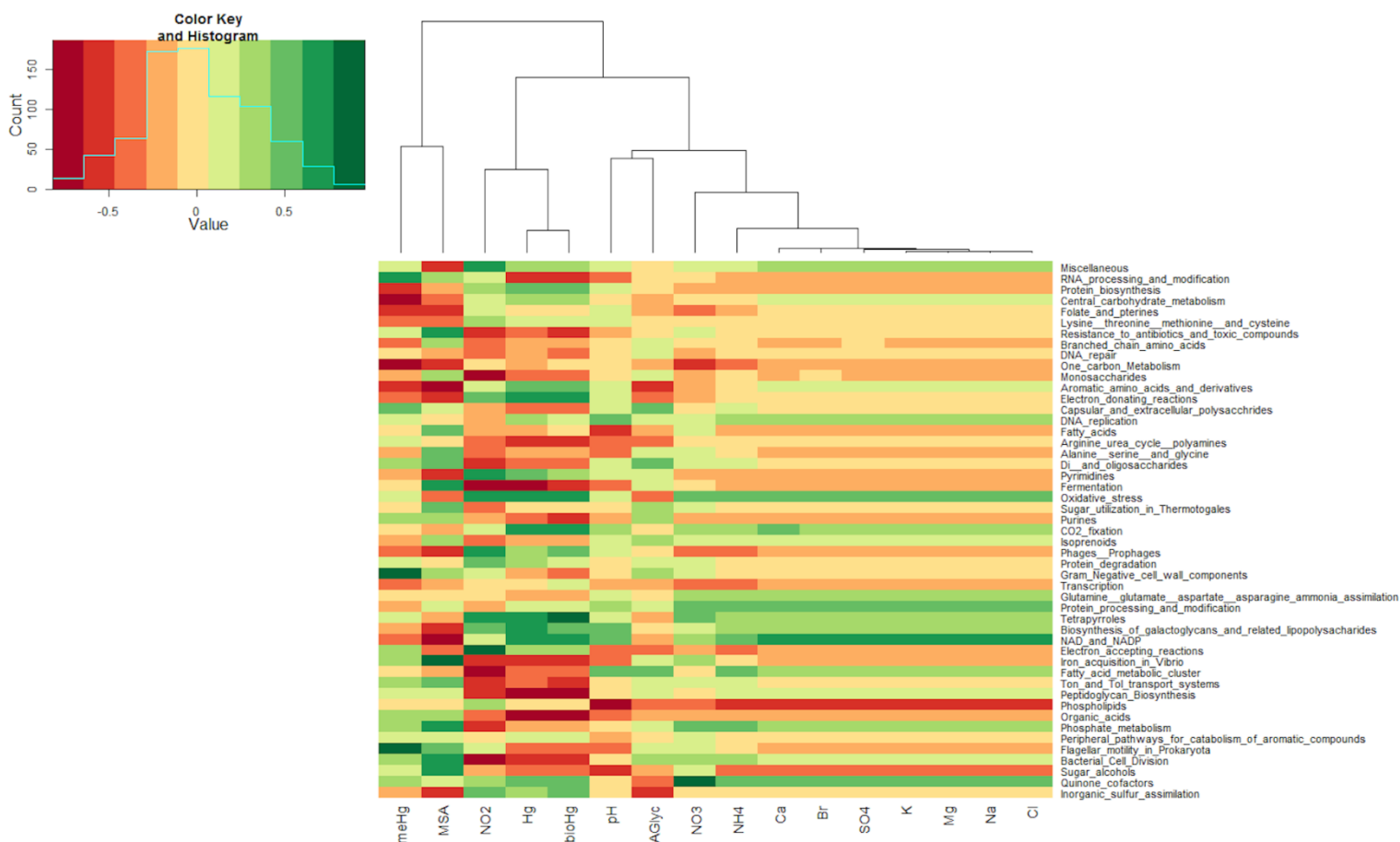

Figure 8: Heatmap from Pearson correlations between chemical data and the first 50 seed subsystems (in abundance) at the second level of seed classification. Functional subsystems are ordered from the most to the least abundant

This supports the hypothesis that snowpack is a dynamic ecosystem that responds to changes in environmental conditions.

Conclusion

This chapter explored the interactions between microbial communities and their chemical environment in a range of arctic snowpacks. Functional data that correlated with chemical parameters supported the hypothesis that this variation in microbial community structure and function could be explained by fluctuations in environmental conditions. Further sampling during the dark period as well as metatranscriptomic and atmosphere comparison studies year round would help establish how microorganisms are selected in snowpack and the role of light as a major driver of snowpack microbial community structure and function.

Chapter 3: Are microorganisms active in the cryosphere? Challenges and limits

One of the key questions related to the microbial ecology of the cryosphere is activity. How active are the microorganisms? To what extent do they contribute to biogeochemical cycling? What tools do we have to assess their activity? These questions will be explored in this chapter and examples of different studies will be used to illustrate some of the methodological challenges involved.

Microbial activity in frozen environments

The dynamic variation of microbial community structure and function with regard to season, location in the snowpack and geographical location as determined by DNA extraction supports the active nature of these microbial communities in the snowpack, but does not remove all doubt that that these changes are the results of other phenomena. Activity is therefore a question central to studying microorganisms that live in environmental ices. Different techniques have been used to assess activity. Microbial activity in snowpack, as measured by labelled thymidine and leucine incorporation, varies as a function of temperature, location and the proximity of anthropogenic activities⁴⁰, and ranges from 4.2 fmol.L⁻¹.h⁻¹ in fresh fallen snow to more than 160 pmol L⁻¹.h⁻¹ in antarctic sites that have clear anthropogenic effects^{47,171,172}. Due to variations in temperature and water content measurements in the laboratory, these measurements might not provide evidence of in situ metabolism for extremely low temperature habitat such as Antarctic plateau snow fields^{171,173}. Actively respiring cells, labelled using fluorescent electron transport system-specific reagent CTC, were observed within brine in winter sea-ice section at -20°C²⁵. In the same study, the proportion of active cells that were attached increased with decreasing temperature compared to free cells, thereby suggesting an important role of attachment in survival at cold temperature in ice. Within deep glacial ice, microbial activity is supposed to be very low but sufficient to maintain cells and methanogen metabolism¹⁷⁴. Comparison of temperature dependence of metabolic rates for microbial communities from diverse environments suggests that liquid water inside ice at temperatures far below the freezing point is available for microbial metabolism²⁶. In order to provide further demonstration of the activity of these snowpack microorganisms in the snow, experiments were initiated to examine messenger RNA variations in the snowpack and snow microcosms studies were carried out. Here, we will provide an overview of the application of novel techniques to connect microbial communities to environmental functions.

Technical issues linked with the use of meta-omics in snow environments

Low abundance of organisms and the icy structure of snow lead to unique challenges when attempting to apply meta-omics approaches to describe communities. Snow is far from sterile, but microbial abundance is generally low with around 10² to 10⁴ cells/ml and occasionally reaching 10⁵ cells/ml. In terms of logistics, it seems unrealistic to exponentially increase samples size. In addition, the melting process might influence DNA recovery; for example, plasmolysis during melt could increase extracellular DNA loss during filtration step. In addition, extracellular DNA can persist long term in the environment, as adsorbed to clay particles in soils, for example¹⁷⁵. In the Canadian Arctic shelf ice, extracellular DNA measurements indicated concentrations up to 135 µg/L¹²⁹. The persistence of DNA and factors influencing DNA breakdown, such as temperature and radiation, were

reviewed for different environments including soil, fresh and marine water ¹⁷⁶. In snowpacks, low temperature could lead to DNA preservation, as nuclease activity has been shown to be much lower at 4°C than at 37°C in marine sediments ¹⁷⁷. However the sensitivity of DNA to UV radiation ¹⁷⁸ could greatly limit its persistence in snow. Although extracellular DNA might persist in snow and some molecules might be maintained in the particle film on the filter, the majority should be excluded during the filtration step. In these conditions, it can be difficult to reach the DNA yield needed for sequencing technologies (3 µg for 454 pyrosequencing technologies). DNA recovery, preservation during shipping and storage and efficiency of whole genome amplification are reinforcing the difficulties in management of already rare samples. With the recent improvements in sequencing technologies, it is possible to obtain sequencing datasets with as low as 1ng of DNA starting material, which should improve data quality, results and interpretation.

The metatranscriptomic approach for exploring snow communities has similar and also unique challenges as compared to metagenomics, in terms of sample preparation and sequence analysis. The mRNA content of a bacterial cell, depending on growth state, is difficult to estimate. The number of mRNA molecules in *Escherichia coli* during exponential growth in culture has been estimated to ≈1380, a small number compared to more than 43000 genes and 42 000 000 proteins ¹⁷⁹. Using the addition of artificial mRNA standards to environmental samples for mRNA content estimation, cells in marine microbial communities from southeastern US coastal waters and the Amazon River plume may contain as low as 200 mRNA molecules ¹⁸⁰. RNA extraction yield from environmental samples is thus expected to be very low. The quantification technics available are not suitable for these low concentrations. For instance, qBit assay based on fluophore quantification (life technologies) detection limit for sample concentration is 1ng/µl, which is not sensitive enough for most environmental samples. mRNA molecules are also extremely labile, which implies that in contrast to DNA, the persistence of extracellular molecules is unlikely. The intracellular half-life of mRNA has been shown to be as low as a few minutes and independent of growth rate ¹⁸⁰, implying that even in ecosystems where organisms have a slow growth rate, as is likely the case with snow, the transcriptional response could be a very short signal and rapidly fluctuating in changes in environmental conditions. In the case of snowpack, as well for icy habitats, melting might greatly influence transcript pools in samples, with release and bioavailability of nutrients and hypo-osmotic stress. The preservation of samples representative to *in situ* community in the specific conditions observed is thus a major concern. In terms of bioinformatics analyses, metatranscriptomics present the same issues as metagenomics. In addition the high dominance of rRNA in sequencing datasets can be challenging to obtain sufficient coverage for mRNA functional response exploration, depending on the research questions.

The use of meta-omics to explore the active members of snow microbial communities

Microbial community composition modification and correlation of function abundance with chemical input support the hypothesis that the microbial community is dynamic and responds to changes in environmental conditions. However, the active members of this community and the time scale of microbial response remain unknown. In this section, preliminary results obtained from Arctic spring snow will be presented. Samples were collected during a 2011 springtime field campaign in Ny-Ålesund (Svalbard, Norway, 78°56'N, 11°52'E). Surface snow layers were collected on a daily basis from mid-April to beginning of June 2011. Two sets of samples were chosen for microbial community analyses based on chemical results, *i.e.* organic acids and particles concentration. Late spring samples (svn40 to 66, n=12) had higher concentrations of organic and particles compared to early spring (svn1 to 10, n=8). DNA and cDNA samples were amplified using multiple displacement amplification with the illustra™ GenomiPhi™ HS DNA Amplification Kit (GE Healthcare) and sequenced using a Roche 454 Titanium pyrosequencer. Metagenomic and metatranscriptomic datasets were analyzed for taxonomy and functional attributes using the Metagenome Rapid Annotation with Subsystem Technology (Mg-RAST)¹⁸¹.

Differences between RNA and DNA datasets

The occurrence of taxa (presence/absence of a taxon at family level) did not completely overlap between metagenomic and metatranscriptomic datasets (figure 9A). Some taxa were observed in both DNA and RNA, for example, the family of *beta-Proteobacteria*, *Comamonadaceae* including *Variovorax*. A high number of families were only detected in metatranscriptomic datasets. In contrast, some taxa were detected only in the DNA pool, such as families belonging to *Ascomyceta*. Functional distribution in metatranscriptomic versus metagenomic datasets was also compared for early and late spring (figure 9B). The pattern of functional distribution in terms of relative abundance is different between early and late spring. In late spring, a majority of functions is detected in the RNA pool as well in the DNA pool, with only a few functions highly abundant in RNA and not in DNA and vice versa. Conversely, in early spring samples, most of the functions do not overlap in the RNA and DNA pools, *i.e.* functions are detected only in metatranscriptomic or metagenomic datasets. In figure 9C, we compared the discrepancy between RNA and DNA from snow sequencing datasets with publically available sequencing datasets from eutrophic marine mesocosms at two different stages during algal bloom. The phase during mid-bloom might support high modifications of community activity, with algal growth and concomitant influence on heterotrophic microbes, compared to a more stable phase during the post-bloom. The proportion of genera potentially expressing genes (only in RNA, in DNA and RNA) is higher in the mid-bloom than in post-bloom phase. The fraction of present but potentially not transcribing genes (only DNA) in our snow metagenomes is comparable to mid-bloom phase marine mesocosms, whereas the fraction of genera detected only in RNA is much more important. This suggests that snow microbial community could be highly dynamic in terms of transcriptional response and that that low abundant and diverse taxa might contribute to RNA molecule production and thus be active in the present conditions. However this pattern of response might be also largely biased by microbial response triggered by melting procedure as described previously in technical limitations. As for annotation efficiency, this meta-omes comparison is not exhaustive but further analyses with more meta-omes from various conventional and non-conventional environments annotated in similar way would help to investigate the divergence between present and active members of snow microbial communities.

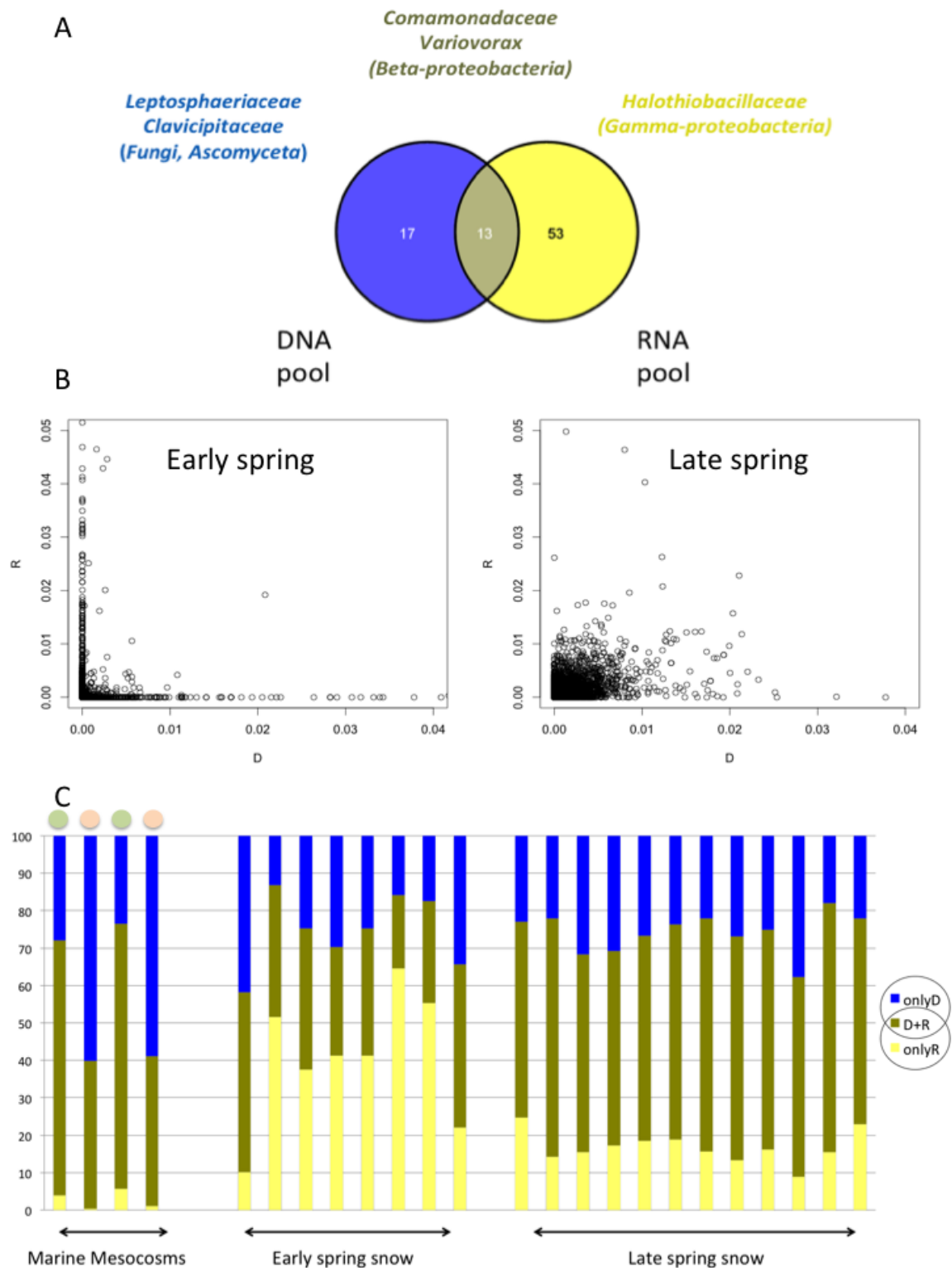

Figure 9 : Discrepancy between metagenomes and metatranscriptomes.

Taxonomical and functional annotations are based on assignment of shotgun sequences to M5nr database in Mgrast with an e-value cut-off of 10^{-5} . **A:** Venn diagram of number of taxa detected in both types datasets, only in metagenome (blue) and only in metatranscriptomes (yellow). **B:** Relative abundance in metagenomic (D = X axis) and metatranscriptomic (R = Y axis) datasets of each function at deepest level of hierarchical classification of SEED database in early spring (left) compared to late spring (right). **C:** Percentage of genera detected only in metagenome (blue), only in metatranscriptome (yellow) or in both (brown) compared to total of genera detected per sample in our meta-omes compared to marine mesocosms (green dots indicate mid-bloom samples whereas orange dots indicated post-bloom samples).

Further characterization of the presented metagenomes and metatranscriptomes indicated the possibility of low quality dataset analyses, such as low assignment, high relative abundance of plasmid related functions and low abundance of reads associated to rRNA. This pattern can potentially be due to biased amplification towards small amplicons and creation of chimeric sequences, known for low material whole genome amplification via the multi-displacement technique used. Further bioinformatic analyses including additional quality filters are needed to evaluate dataset accuracy and thus no other analyses of these data will be described in this chapter. However, it helps to illustrate issues, both technical and conceptual, related to the characterization of snow microbial communities.

Metatranscriptomics as a proxy for microbial activity in snow

The production or presence of RNA as a proxy of microbial activity might be a step further in providing data that microbes are active in the snowpack and not just stored in a frozen or dormant state. The analysis of genes transcripts and in particular 16S rRNA has been proposed to identify the bacteria that are most likely to be present in a metabolically active state in the snow⁴⁷. Genera that have previously been considered as endogenous Antarctic snow inhabitants, such as *Janthinobacterium*, *Pseudomonas*, *Sphingomonas* and *Variovorax* were detected in our datasets both DNA and RNA. A high number of families, such as *Halithiobacillaceae*, a purple sulfur bacteria belonging to *gamma-Proteobacteria* and already reported in Arctic and Antarctic lakes^{182,183} and within ice bubbles in a subarctic lake ice¹⁸⁴ were only detected in metatranscriptomic datasets. This suggests that low abundant and diverse taxa, present but under the detection limit in the DNA pool, might contribute to RNA molecule production and thus be active in the present conditions. In contrast, some taxa were detected only in the DNA pool, such as families belonging to *Ascomyceta*, and might not be active members of the snow community, at least at this time of sampling. The occurrence of reads annotated as fungi and especially *Ascomyceta* in snow was observed in early spring snow with an increase at the end of the spring (mid-May). However the same trend was not observed in these late spring samples largely dominated by *Pseudomonodaceae*. Among microbes brought by wind and deposited in snow with dust or snowfall, some might not be able to grow in the snow, whose characteristics are too different as compared to the environments from which they originated. For instance, plant pathogens such as *Agrobacterium* were detected in freshly fallen snow, but were no longer detected after deposition⁵⁵. However, the real proportion of these dormant cells and their persistence within snowpack remain unknown. This difference between metagenomic and metatranscriptomic annotation was also observed in our data at a functional level, with higher discrepancy between present and potentially expressed functions during early spring.

However, as previously mentioned in the section about technical limitations, the intracellular half-life of mRNA has been shown to be as low as a few minutes and independent of growth rate¹⁸⁰, implying that even in ecosystems where organisms have a slow growth rate, as is likely the case with snow, the transcriptional response could be a very short signal. The lack of environmental information about RNA and protein turnover, the occurrence of constitutive or induced transcription and the extent of post-transcriptional modifications¹⁸⁰ are common for all types of environments and constitute a major concern encountered by microbial ecologists concerning the proxy of RNA presence or production for microbial activity with metatranscriptomic approaches. Snowpack is highly dynamic, with regular input of minerals and organic compounds, whose distribution and concentrations are

modified by physical processes in the snowpack (photochemistry, wind pumping, freeze thaw cycles, and snow metamorphism). These chemical conditions are highly variable on a daily basis, *e.g.* ion concentrations can be increased by a factor 30 in one day. Metatranscriptomics might be a tool that can help to evaluate short-term responses of snow microbial communities.

Getting beyond the descriptive

The advent of molecular microbial ecology enabled culture-independent phylogenetic analyses of communities and functional genes, however, linking biogeochemical transformations to phylogenetic identity and specific genes/enzymes of metabolically active microbes remains a major challenge¹⁸⁵. The development of stable isotope probing (SIP) was instrumental in circumventing the limitations of culture based investigations of microorganisms. SIP allows researchers to directly link microbial metabolic capability to phylogenetic and metagenomic information within a community context by tracking isotopically labeled substances into phylogenetically and functionally informative biomarkers, thereby enabling a mechanistic understanding of biogeochemical processes¹⁸⁶. A commercially prepared, labeled substrate (typically >99.5% stable isotope) is added to an environmental sample, and biomarkers are purified and analyzed following the consumption of the substrate. Variations of SIP focus on different biomarker molecules that become labeled by growth on ¹³C-substrate. These SIP variations include labeling of membrane lipids, such as phospholipid-derived fatty acid (PLFA-SIP), deoxyribonucleic acid (DNA-SIP), and ribonucleic acid (RNA-SIP)¹⁸⁵. Identifying the appropriate substrate concentration and incubation time is critical for a successful SIP, as well as monitoring the appropriate biomarker for a particular experiment. In general, PLFA-SIP provides the highest sensitivity. DNA-SIP is the least sensitive SIP approach, because unlike RNA and PLFA regeneration, DNA replication normally requires cell division. Therefore, successful DNA-SIP experiments require cell division in the presence of labeled substrate to achieve sufficient incorporation for separation of labeled DNA¹⁸⁵. Applying SIP in controlled laboratory microcosm studies on the snow, might allow us to identify active community members and link their metabolic activity to biogeochemical cycling. In addition, these experiments can be carried out without transforming the physical matrix of the snow to a great extent and information can be obtained without melting samples, which, as mentioned above, might impact results.

Snow microcosms: laboratory tools for determining activity and testing hypotheses

Microcosm studies at sub-zero temperatures have never been described in the literature. The only snow microcosm study published to date was carried out at 5°C, using melted snow samples¹⁰². Although this work provided interesting results that help shed light on microbial functioning, it is not representative of in situ field conditions and is therefore difficult to generalize. In a preliminary study to test the feasibility and reproducibility of this approach, we carried out a two-month microcosm study which addressed the impact of temperature and carbon addition on snow microbial communities using snow collected from Svalbard. The main objective was to determine the effects of an increased temperature (but always below zero) on the activity of microorganisms: an aspect which forms the basis of many of the larger questions surrounding research related to climate change studies. A secondary aspect addressed questions regarding the input of carbon and other nutrients to arctic ecosystems through wet (falling snow) or dry deposition.

Two principal questions were addressed:

1. How does a change in temperature affect the level of activity among the microorganisms present?
2. How does the increase in carbon available to the microorganisms affect their activity?

Briefly, snow samples were collected during a 2012 March field campaign in Ny-Ålesund (Svalbard, Norway, 78°56'N, 11°52'E) and stored at -20°C. Freshly fallen snow samples were collected in 3L sterile sampling bags using a Teflon shovel sterilized for microbial analysis. It is reasonably likely that the microorganisms that were tested during this project are not entirely representative of the life present in situ: there will inevitably have been some changes in the structure of the snow/ice as the samples were extracted and transported, which may have caused stresses on the microbes, and consequently slight chemical/population changes. However, the samples remain a good proxy. Snow samples were homogenized in sterilized containers and 96 microcosms were prepared (2L glass bottles, 500 g of snow/microcosm) for molecular studies, while 12 OxiTop bottles were prepared (150g/bottle) for activity measurements. OxiTop bottles measure changes of pressure occurring inside the bottle: the unit-less value provided (the bottle automatically gives readings every 24 hours, and additional intermediate manual values can also be obtained as desired) can subsequently be used to calculate the quantity of oxygen consumed by the microorganisms in the sample. The bottles are therefore often used to carry out Biological Oxygen Demand (BOD) tests of water (usually waste water). In this experiment, it was not necessary to know the exact quantity of oxygen consumed: instead a simple comparison between the raw values measured was adequate for making conclusions regarding the activity occurring at different temperatures and conditions. NaOH pellets are used to absorb carbon dioxide (WTW, n.d.,a): in this test two (Sigma- Aldrich product S8045-1kg, Sigma-Aldrich (2015a)) were added to each bottle. Replicate samples of snow were incubated at -5°C and -15°C in the dark, with and without the addition of carbon (see Table II for a summary of the conditions).

Table II: Microcosm conditions prepared for the carbon cycling experiment

<u>Carbon Condition</u>	<u>Preparation date</u>	<u>Temperature = -15C</u>				<u>Temperature = -5C</u>			
		<i>Time period:</i>	T1	T2	T3	T4	T1	T2	T3
	<i>Planned incubation time (weeks):</i>	1	2	4	8*	1	2	4	8*
No Carbon	26/06/2015	1-4	5-8	9-12	13-16	49-52	53-56	57-60	61-64
C12	24/06/2015	17-20	21-24	25-28	29-32	65-68	69-72	73-76	77-80
C13	22/06/2015	33-36	37-40	41-44	45-48	81-84	85-88	89-92	93-96

Activity levels were measured and changes in community structure were monitored throughout using RISA profiling. Samples were prepared for DNA was extraction at the different time points. The most commonly- used method of DNA extraction involves filtering the sample (as a liquid). However, in order to avoid melting the samples, which might significantly alter the level of activity, we freeze-dried them and then extracted the DNA.

Within a few days, changes in community structure were apparent, highlighting a temperature effect, and the addition of carbon was shown to have a significant impact on microbial community activity at -15°C (Figure 10)¹⁸⁷.

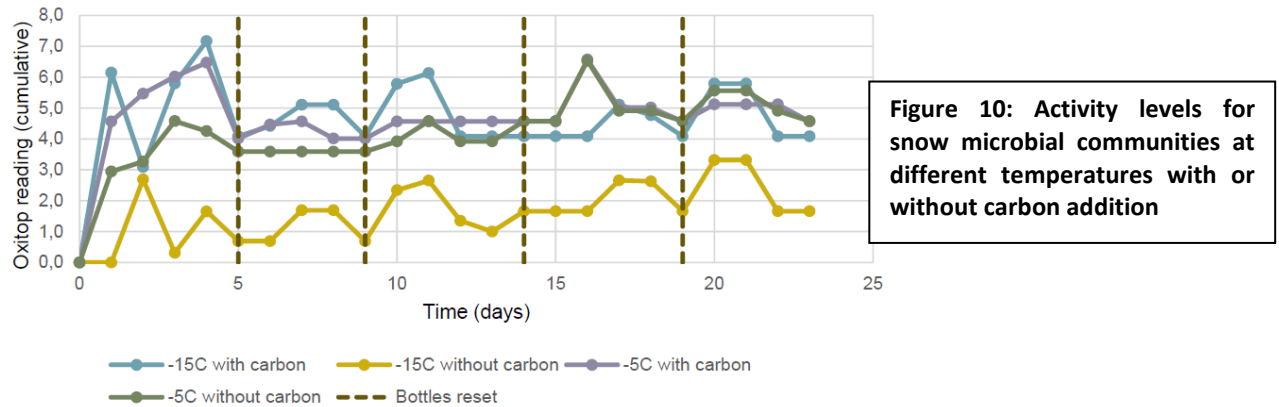

The level of activity at the start of the testing, in the first few days, was far higher than during the rest of the test for the two sets of bottles stored at -5°C and the bottles stored at -15°C with carbon. There is a difference between these three sets and the bottles stored at -15°C without carbon, whose values rarely exceeded those believed to be within the range of natural variation.

Between Class Analyses (BCAs) were carried out on the RISA community profiling data for a variety of groups, in order to analyze the effects of changes in temperature, carbon and time. For samples without carbon, there is a clear separation between the two temperatures, suggesting it had a significantly greater effect on the samples than the length of the incubation time (simulated p-value = 0.034) (Figure 11). The BCA shows four groups, based on their temperature and incubation time (week 2 and week 4).

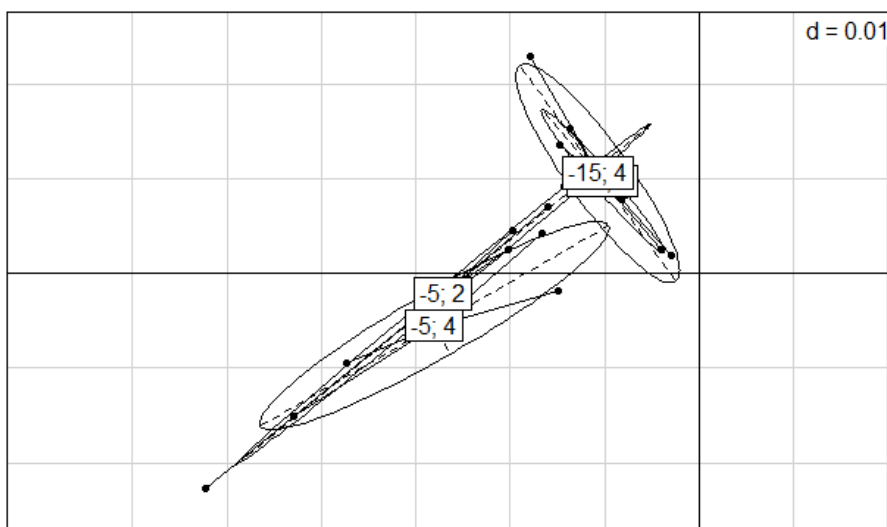

There is a significant difference (3.36%) between the pairs of groups at the two different temperatures, while there is very little change in groups over time, when compared to other samples incubated at the same temperature.

The results from this study show that snow microcosms are reproducible, that the communities respond dynamically to changing conditions and can be used to explore biogeochemical cycling in a laboratory setting, without having to melt the samples. This approach, coupled to omics approaches, will be useful tools for quantifying the impact of microorganisms on their environment in frozen ecosystems.

Conclusion

Microorganisms employ a multitude of adaptive strategies allowing them to acclimate and adapt to even the most extreme habitats, such as the deep sea, hot springs, deep-sea vents, ultra-dry soil, and icy environments. The field of research in cryospheric microbial ecology is directly influenced by extreme conditions on humans doing the sampling and analyses due to technical and logistical issues more than on the microorganisms themselves. Metatranscriptomics could help investigate the microbial response to highly fluctuating conditions characteristic of their habitat, despite conceptual and technical issues, and should be further integrated in new experimental plans. The use of metagenomic tools allowed us to draw hypotheses on potential drivers involved in structuring the community and selection processes occurring within snowpack. However in order to further investigate these hypotheses, these holistic and observation analyses should be complemented by mechanistic and controlled experiments, such as microcosm studies that apply SIP technologies for example.

Chapter 4: Mercury in the environment, a case study on the role of bacteria

In this chapter, we will explore how microorganisms respond to chemical inputs and are able to transform their environment by focusing on the biogeochemical cycle of mercury in the Arctic.

Biogeochemical mercury transformations

Mercury exists in several forms in the environment: elemental (Hg^0), divalent form (Hg^{2+}) and an organo-metallic form of which methylmercury (MeHg) is the most important. The MeHg organic form is the most toxic of the three forms, even at very low exposure doses¹⁸⁸. MeHg is highly neurotoxic¹⁸⁹ and can cause damage to the visual cortex and the sensory system in humans. Symptoms of intoxication include constriction of the visual field, sensory impairment of extremities, hearing loss, muscle weakness, tremors, cardiovascular problems and mental deterioration^{190–192}. The main source of MeHg in humans occurs by consumption of contaminated fish^{191,193}. In light of all these adverse effects, many countries developed consumer advisories which encourage people to limit their consumption of fish. The concentrations of MeHg tend to increase with the trophic level in a foodweb, with top predators being the most contaminated¹⁹⁴. This phenomenon, known as MeHg biomagnification, is observed in most ecosystems regardless of the Hg source. Hg, a toxic element for all life forms, is found both naturally and as a human-introduced compound in the environment^{195–197}.

Different simultaneous biotic and abiotic processes alter the chemical state of mercury and thereby its toxicity in the environment. Four different reactions control mercury speciation: methylation, demethylation, reduction and oxidation¹⁹⁸. These reactions are summarized in Table III.

Table III: Summary of processes involved in Hg transformations

Process	Type	Mechanism
Methylation	Biotic	Enzymatic methyl transfer in sulfate reducers
	Abiotic	Methylation by organic compounds involving photochemical reactions. Determined in laboratory studies only
Demethylation	Biotic	Reductive demethylation via MerAB Oxidative demethylation via unknown processes
	Abiotic	Photodegradation
Reduction	Biotic	Bacterial reduction via the <i>mer</i> operon
	Abiotic	Photochemical and chemical reactions
Oxidation	Biotic	Oxidation by hydroperoxidases
	Abiotic	Oxidation involving reactive halogens, and/or other oxidants (OH , O_3) Photo-oxidation and dark reactions involving Br

In terms of mercury toxicity, bioavailability is an important factor since several of the environmental biochemical transformations described above, such as methylation and reduction, are enzymatically catalyzed within the cytoplasm of the bacterial cell and are therefore dependent on Hg uptake¹⁹⁹.

The most well documented mechanism of specific microbial mercury resistance involves the *mer* operon, a genetic system encoding transporters, regulators and the mercuric reductase (MerA) enzyme that catalyzes the reduction of Hg^{2+} to Hg^0 , which then diffuses outside the cell²⁰⁰. This

system is described in detail in Barkay et al. (2003)¹⁹⁸. Genes encoding MerA have been isolated from diverse environments, including soil²⁰¹, Siberian permafrost²⁰² and Arctic biofilms¹⁹, and have been described in bacteria¹⁹⁸ and archaea²⁰³. The MerA sequences are highly diverse, with differences in protein length, depending on the presence of zero, one or two Hg-binding domains at the N-terminus. The MerA protein has been found in *Firmicutes*, *Actinobacteria*, α - β / γ -, and δ -*Proteobacteria*, *Bacteroidetes*, *Deinococcus-Thermus* and Archaea²⁰¹.

Mercury transport and deposition in arctic snowpacks

Mercury is mainly emitted to the atmosphere in its gaseous form (Hg°), but also in the oxidized form (reactive gaseous mercury, RGM) or in the particle-bound form (particulate mercury, PM). Hg° has a relatively long atmospheric residence time (between 0.5 and 1.5 years) and average atmospheric concentrations have been estimated at 1.7 g/m^3 for the Northern Hemisphere. RGM and PM have shorter lifetimes and tend to be deposited near their sources²⁰⁴. Mercury reaches polar ecosystems mainly as Hg° ; however due to the cyclical nature of Hg transformations (transport-deposition-re-emission), even mercury originally emitted as RGM and PM can be transported to the Arctic²⁰⁵. As for other contaminants, Hg can be deposited after atmospheric scavenging by precipitation and dry deposition. Once RGM is formed in the atmosphere, snow can act as an efficient surface for its sorption. In addition, active growth of snow and ice crystals from the vapor phase readily scavenges available RGM²⁰⁶.

In 1995 at Alert, Canada, Schroeder et al. (1998) measured the episodic near-total depletion of Hg° from the atmosphere during the spring²⁰⁷. These events, termed Atmospheric Mercury Depletion Events (AMDEs), were observed in parallel to the depletion of ozone²⁰⁸ and led to intense field, laboratory and theoretical studies to determine which reactions were involved. In particular, mercury was shown to undergo rapid oxidation and deposition via photochemically-initiated reactions believed to involve reactive marine halogens, mainly Br and BrO²⁰⁹⁻²¹¹. These reactions transform Hg° to PM and RGM species that can then be deposited onto the snow. It has been estimated that AMDEs enhance polar mercury deposition by 100 tonnes a year²⁰⁵, yet the post-depositional fate of this Hg remains uncertain. Field campaigns carried out in Ny-Ålesund that monitor THg concentrations in surface snow daily have shown that AMDEs deposit an important quantity of mercury (Figure 12).

Despite the high inputs of THg, it seems that most of the deposited Hg on snow is reduced back to Hg° and returns to the atmosphere, as evidenced by the high Hg° fluxes and the drop in surface snow THg concentrations (**Erreur ! Source du renvoi introuvable.**). Based on these observations, most of the Hg deposited by AMDEs on surface snow is photochemically active. The photoreduction of oxidized Hg has been demonstrated in other laboratory or incubation experiments²¹²⁻²¹⁴. Even though most of deposited Hg is reemitted, there is still a fraction which is not active as evidenced by the presence of a THg background level of a few $\text{ng}\cdot\text{L}^{-1}$ and values above detection limit in the snowmelt water.

When comparing these data to concentrations of bioavailable mercury (BioHg), we found a highly significant positive correlation ($p < 0.0001$) between THg and BioHg levels measured in the surface snow samples. BioHg concentrations varied throughout the season and only rarely represented 100%

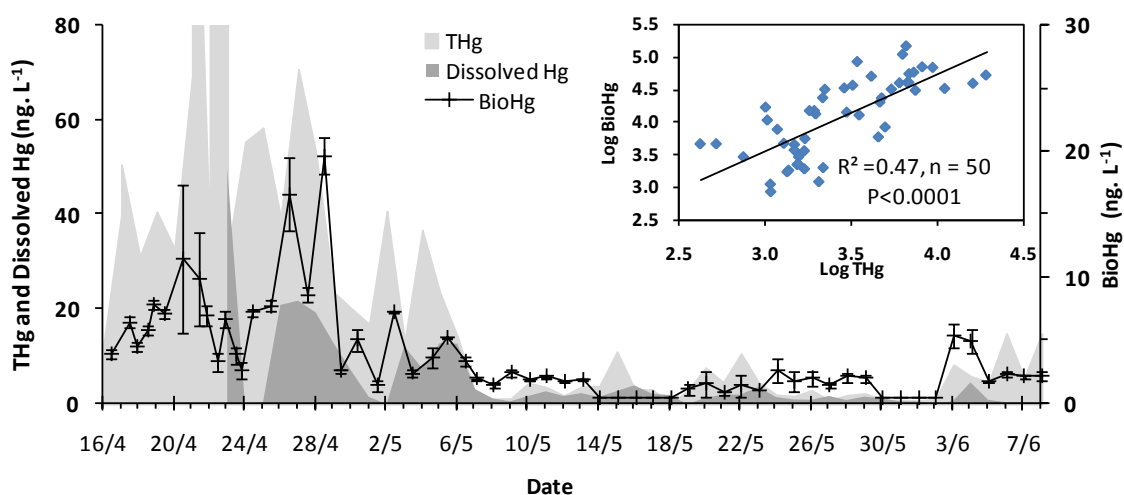

of the THg fraction, which suggests post-depositional changes in Hg speciation and bioavailability. A portion is certainly photoreducible, which would account for the concomitant drop in both THg and

Figure 12 : Concentrations of mercury species in daily surface snow samples of an arctic snowpack.

Total Hg (THg, light grey) and Dissolved Hg (after filtration on 0.45 μm filters, dark grey) are shown on the left axis. The error bars of THg and Dissolved Hg are typically less than 0.2 ng.L^{-1} and therefore cannot be represented here. Two THg concentration peaks (148.9 ng.L^{-1} and 110.6 ng.L^{-1} on April 21th and 22th respectively) are omitted on this graph for scaling clarity. Dissolved Hg measurements are not available from April 16th to April 23th. Bioavailable Hg (BioHg) is represented with a different scale on the right axis. BioHg is not available and set arbitrarily to 0 ng.L^{-1} from both May 14th to May 18th and May 30th to June 2nd. In the upper right corner, we represent the linear relationship between THg and BioHg with log-transformed data. Significance levels were determined using the F-test.

BioHg concentrations following the AMDEs, consistent with high fluxes measured during the same period²². Another fraction of Hg in the snow is bound to particles and probably not bioavailable due to large particle size ($> 0.45 \mu\text{m}$) relative to microbial cells. It is also likely that the high chloride concentrations in our samples limited bacterial uptake^{19,23,24}. Finally, the drop in BioHg concentrations may be due to its rapid assimilation by microorganisms, although the reaction kinetics are unknown.

Snowpack Hg dynamics

While AMDEs have been shown to lead to high deposition of Hg onto snow surfaces, the post-depositional fate of Hg has yet to be completely clarified. The consensus among researchers now is that a large portion is reemitted back to the atmosphere following an event²¹⁵; and others. These results suggest that although a large portion of Hg deposited by AMDEs returns to the atmosphere, a non-negligible quantity is trapped within the snowpack, from which it can then be transferred to other systems upon melting.

In a review on Hg microbiogeochemistry in polar environments, Barkay and Poulain (2007) outline possible methylmercury sources and methylation pathways in arctic ecosystems. These include atmospheric and aquatic sources with either abiotic or biotic methylation pathways²¹⁶. In terms of snowpack MeHg concentrations, the most plausible sources are: 1) an atmospheric source of MeHg due to the photodegradation and deposition of plankton-derived dimethylmercury, 2) *in situ*

methylation of BioHg in the snowpack (microbial), 3) biotic or abiotic methylation in the atmosphere, and 4) phytoplankton MeHg production.

MeHg is significantly anti-correlated to BioHg in our snow samples, which suggests that a fraction of the BioHg is being transformed into MeHg. This supports the second hypothesis outlined by Barkay and Poulain (2007). Bacteria have been isolated from Arctic snowpacks⁴⁹ and microbial activity has been measured at temperatures down to -20°C²⁴. Poulain et al. (2007) reported the presence of Hg resistance (*merA*) gene transcripts in Arctic biofilm samples; therefore it is likely that the microbial populations in Arctic environments are able to metabolize mercury¹⁹. Whether Hg methylation can occur in the snow remains uncertain. Constant et al. 2007, reported increases in the MeHg:THg ratio and positive correlations with bacterial colony counts and particles²¹⁷. These results led to the hypothesis that MeHg was being formed within the snowpack, despite the absence of correlation with sulfate-reducing bacteria (SRB), the principal methylators in anoxic environments²¹⁷. Since the snowpack is most likely oxygenated, this would suggest that other species able to methylate Hg aerobically may exist. We recently proposed a mechanism for oxic methylation in the snow involving DMSP metabolism¹⁵⁵. DMSP, an important molecule in the marine microbial sulfur cycle¹⁶⁰ can be metabolized via several different pathways, one involving enzymatic cleavage to produce DMS, but also by demethylation and demethiolation to produce methylsulfate in bacterial cells. Methylsulfate can then undergo thiol transmethylation to produce DMS¹⁵⁹. The initial demethylation (and a possible second demethylation) has recently been shown to be THF-dependent and catalyzed by an amino-methyltransferase enzyme in aerobic bacteria²¹⁸. The similarities to anaerobic Hg methylation are striking, and it is not unlikely that BioHg, upon entering the cell, may undergo methylation by aerobic bacteria able to demethylate or metabolize DMSP. A total of four methyl transfer reactions occur at various stages of DMSP metabolism, and BioHg may serve as a methyl group acceptor at some point throughout.

Hg methylation has been linked to sulfur and iron metabolism in bacteria^{219,220}. Early research into the mechanisms involved in Hg methylation is based on anoxic sediments^{221,222} and quickly focused on anaerobic, sulfate reducing bacteria. Choi et al. (1994) used radio-labeled ¹⁴C incorporation and enzyme activity measurements to propose that methylation involves the tetrahydrofolate (THF) pathway in *Desulfovibrio desulfuricans*²²³. In their model, the methyl group is transferred from CH₃-tetrahydrofolate via methylcobalamin with either serine or formate as the original methyl donors during the acetyl-CoA synthase pathway²²³. Recently, Parks et al. (2013), using comparative genomics, identified two genes that encode a corrinoid and iron-sulfur proteins in six known Hg-methylating bacteria but were absent in non-methylating bacteria. The presence of this two-gene cluster in several other bacterial and lineages for which genome sequences are available suggests the ability to produce methylmercury may be more broadly distributed in the microbial world than previously recognized²²⁴.

Whether the methylation is occurring within the snowpack, in the water column or both simultaneously remains under debate, however, methylation appears to require a substrate involved in DMSP cycling. Therefore coastal sites may be especially at risk for MeHg contamination, since they are reported to contain higher Hg concentrations relative to inland sites^{225,226} and are close to a DMSP source. In addition, the run-off during springtime melt may return concentrated water back to the aquatic ecosystem.

Impact of mercury on microbial communities in the snow

Microbial adaptation to environmental stress can occur via three different mechanisms: enrichment of populations that carry the required resistance/tolerance traits, induction of expression of genes involved in the detoxification or resistance mechanisms, and genetic adaptation by horizontal gene transfer²²⁷. In order to gain insight on how microbial communities respond to mercury contamination in the environment, especially in arctic snowpacks that are subject to transient, yet non-negligible deposition of Hg, we carried out several field campaigns and collected taxonomic and function data for microorganisms⁵⁵. We used multivariate analysis to determine major drivers of community structure in arctic snowpacks and MeHg and BioHg constituted important. Probe abundance along these axes was low, suggesting a negative effect on diversity even at $\mu\text{g.L}^{-1}$ (MeHg) and ng.L^{-1} (BioHg) levels. Only very few probes were significantly and positively correlated to BioHg (less than 5% of the 140 most-influential probes) and among these were *Rhizobiales* and *Pseudomonas* (see Figure 13 for examples of responses). This implies that although a large fraction of Hg is returned to the atmosphere following its deposition, AMDEs still impact community structure through the rapid loss of non-resistant phylotypes. In a laboratory study with soil microcosms, Rasmussen and Sørensen (2001) also reported an immediate decrease in microbial diversity following the addition of $25 \mu\text{g Hg}^{2+}.\text{g}^{-1}$ to the soil²²⁷. Although diversity was recovered over time, this was due to a shift in community structure by enrichment of Hg-resistant members. Using protein-fingerprinting and automated ribosomal intergenic spacer analysis (ARISA), Maron et al. (2007) also demonstrated that Hg was able to induce changes in community functional and genetic structures. However, these results were obtained by adding $8 \text{ mg of Hg.L}^{-1}$, far above the values found in natural environments that are typically in the ng.L^{-1} range²²⁸. This is to our knowledge the first time that environmentally-relevant concentrations of MeHg and BioHg have been shown to induce a shift in community structure.

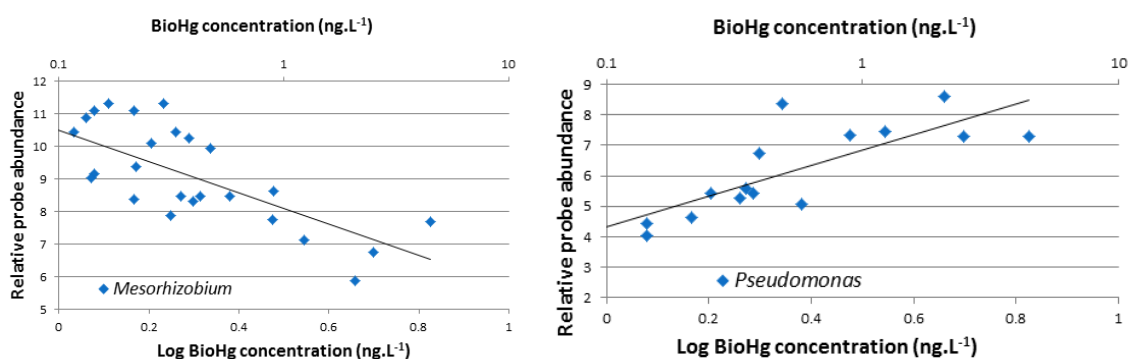

Figure 13 : Examples of changes in relative abundance of probes targeting different genera to BioHg concentrations in arctic snowpacks.

While Hg appears to impact community structure, this relationship is likely bidirectional. Microorganisms can alter their chemical environment through the metabolism and transformation of elements or contaminants. In order to cope with the toxicity of Hg and MeHg, bacteria have developed specialized resistance mechanisms. In order to cope with the toxicity of Hg^{2+} and MeHg, bacteria have developed specific resistance mechanisms. For example, bacteria possessing the *mer* operon are able to detoxify Hg^{2+} via a MerA reductase that transforms mercuric ions into elemental

volatile Hg (Hg(0))²²⁹. Other bacteria are able to transform organic mercury compounds such as MeHg using a second enzyme, MerB that cleaves the mercury- carbon bound. In addition, *merA* genes have been detected in diverse environments including soil²⁰¹, Siberian permafrost²⁰² and Arctic biofilms¹⁹ as well as in specific bacteria¹⁹⁸ and archaea²⁰³. Based on our q-PCR results, *merA* gene copy number was positively correlated to BioHg concentrations. Competing processes leading to modifications in the Hg levels could potentially be performed by different members of the same community in the snowpack: some microorganisms might be methylating Hg to MeHg, while others might be reducing BioHg via *merA*. Therefore, potential MeHg accumulation by organisms is dependent on the methylation/demethylation reaction rates²³⁰. These results were obtained from field observations based on DNA, and although the correlation analysis appears convincing, it does not show that these processes are actively occurring in the snowpack.

The production or presence of RNA as a proxy of microbial activity might be a step further in providing data that microbes are active in the snowpack and not just stored in a frozen or dormant state. To test whether microbial communities were active, we collected snow samples during a 2011 springtime field campaign in Ny-Ålesund (Svalbard, Norway, 78°56'N, 11°52'E). Total nucleic acids were extracted and cDNA libraries were prepared and sequenced. Metatranscriptomic datasets were analyzed for taxonomy and functional attributes using the Metagenome Rapid Annotation with Subsystem Technology (MG-Rast)¹⁸¹. Based on the results of these analyses, microbial communities appear to be actively responding to atmospheric inputs of Hg (Figure 14). The orange circles represent the concentration of BioHg (ng/L) measured in the snow samples. The sample collected for N07_R represents a freshly fallen snow sample. Within a day of the snowfall event, we can observe a drop in BioHg in addition to increases in the relative abundance of genes transcripts related to mercury resistance, such as organomercurial lyase and the mer resistance operon. While these results are promising, more work is required to quantitatively determine the impact of microbial metabolism and activity on the biogeochemical cycling of mercury.

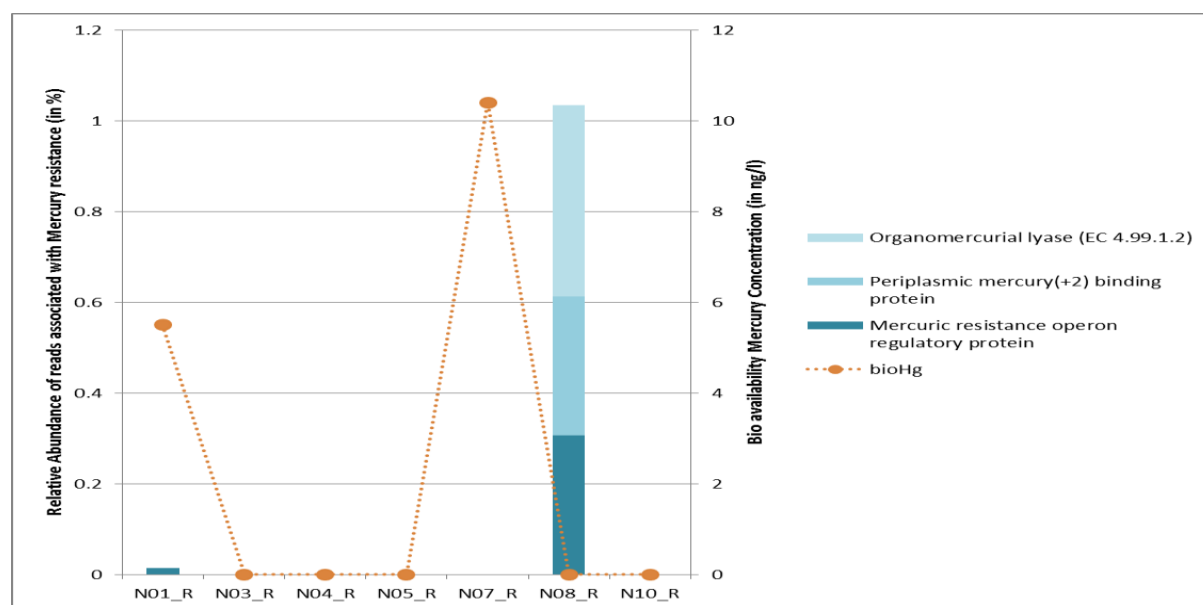

Figure 14 : Relative abundance of mercury cycling related sequences in snow metatranscriptomes. BioHg concentrations are presented as orange circles.

Gene transfer as an adaptive mechanism to mercury exposure

Microbial adaptation to environmental stress can occur via three different mechanisms: enrichment of populations that carry the required resistance/tolerance traits, induction of expression of genes involved in the detoxification or resistance mechanisms, and genetic adaptation by horizontal gene transfer (HGT) ²²⁷. So far, based on the examples above, changes in community structure and the induction of genes seem to be occurring in snowpacks. We can also probe the snow metagenomes in search of evidence of HGT, which is believed to be a very important phenomenon in prokaryotic evolution. It enables the acquisition of new genes or sets of genes that can accelerate evolution and adaptation to new environments or changing conditions. Two types of methods have generally been used to detect HGT events in genomic sequences: Phylogenetic methods, based on the examination of the phylogenies of individual genes or proteins; and compositional methods, based on the analysis of DNA composition, which is assumed to contain some evolutionary information in the form of species-specific signatures ²³¹. There have been many methods focused on the prediction of genomic islands (large regions of HGT) and the accuracy of such genomic island predictors has been increased through the coupling of sequence composition analysis with the identification of additional gene features such as the presence of mobility genes (e.g. integrases and transposases) or tRNAs and direct repeats (known integration sites). We screened our snow metagenomes (n= 24) to search for gene features that would suggest HGT. At SEED level 1, these markers are identified in the Phages, prophages, transposable elements and plamid-related functions and can be compared individually at SEED level 2. Markers for HGT are apparent in metagenomes from all snow samples, regardless of sampling season. Samples collected in early spring (April) have the highest variability. Sequences related to phages/prophages subsystem are roughly 10 times more abundant than those of transposable elements, which suggests a critical role for phages in shaping microbial communities (Figure 15). When carrying out cross environment comparisons, snow metagenomes were shown to have similar relative abundance in these functions as compared to oceans, and it is likely that similar mechanisms for gene exchange exist (Figure 16).

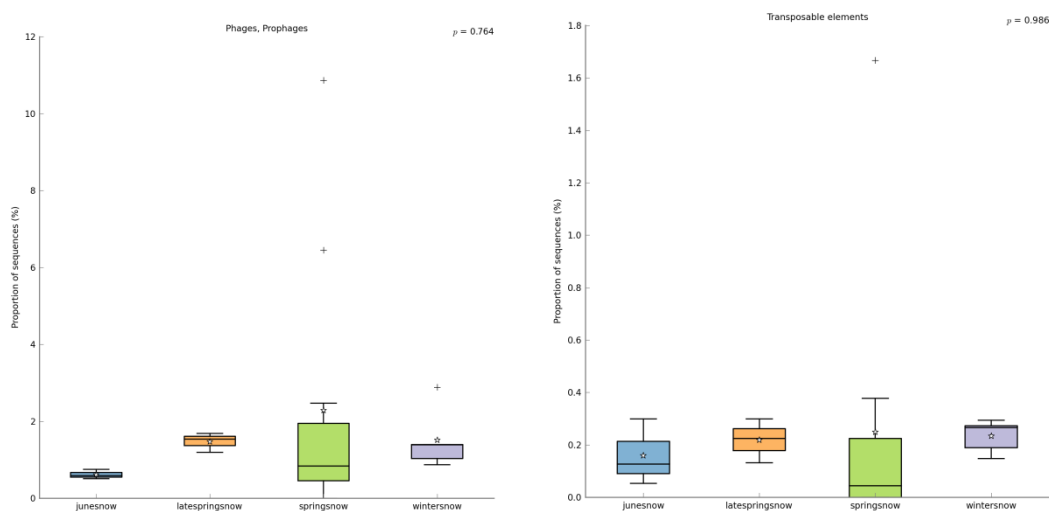

Figure 15: Relative abundance of HGT marker gene sub-systems, SEED level 2, phages prophages as a function of season.

Snow metagenomes were collected at different periods of the year (n=24).

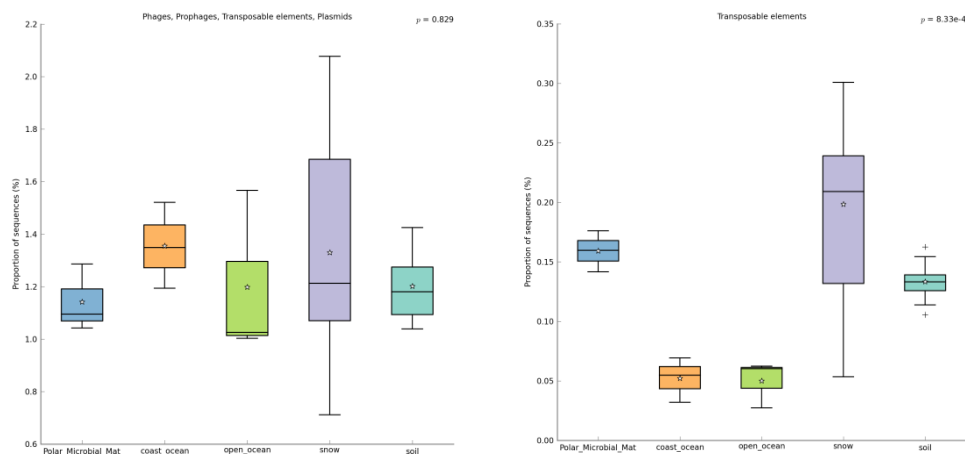

Figure 16 : Cross-environment comparisons of the relative abundance in HGT marker genes.

Viral Role on Microbial Evolution

The effect of phages on microbial evolution does not only rely on the development of mechanisms to escape infection, a much more direct path of microbial genetic alteration exists and is called transduction. Transduction involves the packaging of microbial genetic material into the viral capsid during the lytic cycle and its transfer into another host²³². There are two types of transduction, specialized and generalized transduction (Figure 17). Generalized transduction is when a virus, generally a lytic one, encapsidates pieces of microbial DNA instead of its own genome. On the other hand, when a lysogenic virus integrates into the host's genome and takes an adjacent piece of microbial DNA along with its viral genome, it is called specialized transduction²³³. Other mechanisms of HGT exist, such as gene transfer agents (GTA) and nanotubes^{234,235}. GTAs are phage-like particles which carry DNA from the producing cell and are not able to replicate²³⁶. Advantages of transduction are that no direct contact between cells is needed^{117,237}. While transduction is believed to be the least inhibited by physical distance, this process is limited by the virus host range²³⁸.

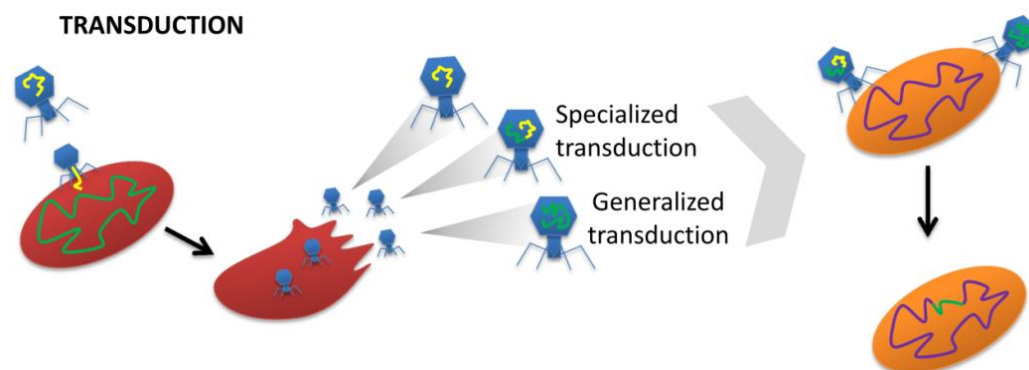

Figure 17: Schematic summary of transduction.

Even though transduction has been found to take place in a series of environments²³⁹⁻²⁴¹, we do not know its real implications in bacterial adaptation and evolution. Examples of specific viral transduction events with potential profit for the bacteria host have been reported. For example, marine viruses can carry a range of carbon metabolism genes²⁴²⁻²⁴⁴. Taking into account that the rate

of gene transfer by transduction in oceans has been calculated to be as high as 10^{24} genes per year^{239,245}, this process could be shaping microbial metabolism in the oceans. However, in order to determine the impact of transduction, we first need to have a better knowledge on the interaction dynamics between viruses and their hosts in the environment. Data on environmental viruses is scarce and ways of tracking their interactions with prokaryotes are being sought. CRISPRs (Clustered Regularly Interspaced Short Palindromic Repeats) can document the history of viral-host interactions in the environment. CRISPRs (Clustered Regularly Interspaced Short Palindromic Repeats), which play a role in the defense of prokaryotes against viruses, have been suggested as potential tools to identify microbial hosts in complex environmental communities²⁴⁶. The system is heritable and widespread²⁴⁷, and nearly all Archaea and about half of the Bacteria have been found to have CRISPR-Cas systems²⁴⁸. CRISPRs are made of a series of direct repeats (DR) of microbial origin interspaced by short sequences called spacers of viral origin (among others). After an infection, short sequences from the virus (proto-spacers) are inserted in the CRISPR. This will enable the host to recognize the virus during future infections²⁴⁹ and protect itself. Spacers and direct repeats could help us identify viral-host interactions and their dynamics in different ecosystems. Recently, we developed a network linking viruses and their hosts from Arctic glacial ice and soil using CRISPR sequences obtained from metagenomic data¹²⁸.

This workflow identified putative viral-host interactions and provided the basis for understanding bacteria/virus interaction dynamics. Gene transfer events were also addressed in an effort to further define the nature of these interactions in ice. We looked for mercury resistance genes as traits that might be an asset for microorganisms living in the Arctic environment. We browsed our assembled viral metagenomes for hybrid contigs and subsequently identified the transduction agent through the viral part of the contig. Based on this result, *Ralstonia* phages in ice appear to be carrying pieces of various microbial genes that could be (or have been) transferred to their host(s). In addition, individual *Ralstonia* phages appear to be capable of infecting several different strains of *Ralstonia solanacearum*²⁵⁰ and possibly spreading important environmental genes throughout the population. Moreover, *Cupriavidus metallidurans*, formerly *Ralstonia metallidurans*²⁵¹, is a bacteria known to resist a range of different metals including mercury, by carrying the genes responsible for this resistance in a *mer* operon²⁵². Given that we could find *Cupriavidus metallidurans* in our Mg-Rast functional assignment data²⁵³, it is possible that the *Ralstonia* phages found in this study as transduction agents of mercury resistance genes in the ice could have *Cupriavidus metallidurans* as a host.

Studies on viruses in polar environments support high viral infection rates^{121,125} and broad host ranges that would enable them to infect different bacteria within the same environment^{130,131} and possibly bacteria from different environments^{123,131,254}. Thus, we developed a method to construct infection networks using CRISPRs sequences from arctic ice and soil microbial metagenomes and comparing them to the viral metagenomes. Although this approach was developed and tested on ice samples, it seems to be a relevant tool to apply to the snowpack as well, given that mercury concentrations are higher in the snow and that genetic markers for the presence of phages are abundant in snow metagenomes. Delving into the viral composition of snow and its influence on structuring snow communities constitutes one of the future directions in my research.

Chapter 5: Future research perspectives

Two major research avenues are planned, one related to trophic interactions and how they relate to microbial ecology and nutrient cycling in cold environments, and one investigating the impact of photochemistry on biogeochemical cycling in snowpacks.

How do trophic interactions impact community function and biogeochemical cycling?

While we are beginning to understand the nature and complexity of prokaryotic communities in the environment, we are currently ignorant on the role of viruses (both bacteriophage and archaeal viruses) in influencing the ecology of these populations²⁵⁵. Viruses are the most abundant life forms on Earth with an estimated 10^{31} total viruses globally. The majority of these viruses infect microorganisms, whether bacteria, archaea or microeukaryotes. The mechanisms by which viruses can influence microbial communities and energy flow include controlling numbers through viral infection and lysis or horizontal gene transfer and acquisition of new phenotypic traits²⁵⁶. In the marine environment, viruses are thought to have the predominant role in horizontal gene exchange, and viral lysis is a major control of prokaryotic population size and microbial biomass. Up to 40% of all prokaryotic cells are subject to viral lysis each day in the oceans. This lysis could result in a 'viral shunt' where 150 Gt of carbon/year (and other nutrients) are recirculated within the prokaryotic community rather than flowing through food chains towards higher organisms²⁴⁵. The few available studies in polar regions suggest that viral control of microbial mortality is important in these habitats and that the strong relationships between viruses and their hosts in a range of polar habitats could explain why polar regions are hot spots of microbial diversity and evolution¹³². Recently, we have developed a pipeline that allows us to link environmental viruses with their hosts in glacial ice. This pipeline detects gene transfer events and describes networks of interaction between viruses and their hosts¹²⁸. We hypothesize that this information is critical for evaluating the importance of viruses in controlling microbial populations and ecosystem functions, such as the regeneration, storage and export of carbon and other nutrients.

Even though transduction has been found to take place in a range of environments²³⁹⁻²⁴¹, we do not know its implications in bacterial adaptation and evolution *in situ*. Examples of specific viral transduction events with potential profit for the bacteria host have been reported. For example, marine viruses can carry a range of carbon metabolism genes²⁴²⁻²⁴⁴. Taking into account that the rate of gene transfer by transduction in oceans has been calculated to be as high as 10^{24} genes per year^{239,245}, this process could be shaping microbial metabolism in the oceans. However, there are some factors that could limit the relevance of transduction as a mechanism for bacterial adaptation. One of these factors is host survival after viral infection. Available data shows that up to 20% of cells having acquired genes through transduction are able to survive the infection of the transduction agent²⁵⁷. Another limitation of genetic exchange through transduction is related to viral host ranges. Traditionally, phages were believed to be highly host specific, which would limit gene exchange to closely related cells. However, with the increase in environmental virus studies, the relative importance (or lack) of phage specificity in natural environments is unknown²⁵⁸. Several studies have identified environmental viruses capable of infecting a broad range of bacteria^{250,259,260}. However, these could be exceptions rather than the general rule.

Consequently, transduction rates and their impact on microbial adaptation in a given ecosystem will be determined by the nature of virus-host interactions; which viruses infect which bacteria, if there are more lytic or lysogenic phages, viral host ranges, what proportion of viruses can act as transduction agents, etc. Due to the lack of information about environmental viruses and their interactions with their hosts, assessing the impact of transduction on microbial evolution and adaptation is, as of today, unfeasible. The development of new techniques and approaches to try and elucidate the different variables involved in virus-hosts interactions are required.

Fungi and bacteria play central roles in terrestrial ecosystems, where they participate in numerous biochemical cycles. Despite evidence that fungi can colonize most terrestrial and aquatic habitats, the presence and distribution of fungi in frozen environments are poorly documented, while the co-occurrence of fungi and bacteria is even less studied. For example, in our metagenomes, reads related to Fungi were dominant in surface snow and reached up to 70 percent of annotated reads in some samples. Gunde-Cimermann and colleagues hypothesized that fungi might be able to grow and develop in such habitats due to effective adaptation mechanisms and are not just windblown contaminant spores²⁶¹. If this is the case, then Fungi might be carrying out several different metabolic activities in the snow. Unfortunately, the large majority of Fungi affiliated reads in our metagenomic datasets (up to 86%) were not functionally annotated due to a lack of fungal genomic and protein data, and therefore, we were unable to clearly characterize the functional potential of the fungal microbial community. This gap in our understanding of the trophic interactions among organisms needs to be addressed. Microorganisms engage in a rich diversity of relationships that can influence ecosystem functioning. Interactions can be antagonistic, such as competition for a limiting resource or direct interference. Trophic competition between fungi and bacteria for nutrients such as carbon is well documented in many environments and can impact biogeochemical cycling²⁶². For example, studies have shown that competitive interactions between fungi and bacteria can be important during the fungal degradation of recalcitrant organic matter such as lignin, which is an organic compound that plays a central role in the terrestrial carbon cycle²⁶³. Interactions can also be cooperative, such as the transfer of complementary metabolites or quorum sensing²⁶⁴. Recent evidence suggests a role of fungal-bacterial consortia in the degradation and transformation of environmental PAHs²⁶⁵. However, the role and importance of bacterial-fungal consortia in environmental nutrient cycling have been largely overlooked and needs to be clarified if we are to fully comprehend and predict how communities will respond to changing environments. Signatures of microbial interactions are probably imprinted in microbial survey datasets because these interactions affect population dynamics. In order to investigate potential interactions between microbial taxa, network analysis of significant taxon co-occurrence patterns may help to decipher the structure of complex microbial communities across spatial or temporal gradients²⁶⁶.

What is the impact of photochemistry on substrate availability and microbial ecology?

In the cryosphere, the movement of organic matter (OM) from land to aquatic environments is mediated by its transit through snowpacks. Snow is an efficient scavenger of atmospheric OM. Due to the high specific surface areas of snowflakes and the enhanced partitioning of gas-phase chemicals to the snow surface at cold temperatures, snow is an excellent scavenger of semi-volatile organic chemicals from the atmospheric gas phase^{267,268}. Once OM is in snowpacks, post-depositional processes can then play a role in determining its fate, via processes such as revolatilization, snowmelt, snowpack photochemical processing or microbial activity, although the quantitative

contribution of microorganisms to OM cycling has yet to be quantified⁷⁶. The subsequent release of the products may significantly impact the composition and chemistry of the overlying atmosphere or the aquatic environment¹⁵³.

One of the factors that makes snowpacks different from other environments is its high photoreactivity. Compounds that absorb solar radiation may undergo direct photochemical reactions. If the compounds do not absorb solar radiation they may still react with other species present in snow and ice via secondary (indirect) photochemical processes⁷⁴. Compounds such as H₂O₂, nitrate, and organic materials are efficient photosensitizers in sunlit snow and ice^{269–271}. Dark reactions of organic compounds may also occur, but typically only with the most chemically reactive substances such as radicals (e.g. OH) or reactive oxygen species (e.g. O₃). The likelihood of a photochemical reaction depends on many factors, including the optical, photophysical, and chemical properties of the chromophores (lightabsorbing species), the optical and phase properties of the host matrix (ice/snow), the presence of potential photosensitizers, and temperature⁷⁴. Given the high albedo (reflectivity) related to the physical structure of snow, snowpacks have been described as complex multiphase photocatalytic reactors under the influence of the solar radiation¹⁵³ where reactive species can be located in the interstitial air, in aerosol particles trapped in the snow, within ice crystals, at the ice-air interface, or in the disordered surface layer of ice crystals²⁶⁸. Photons from the ultraviolet (UV) spectral region is the most critical for photochemistry in the snowpack because they possess high enough energy to break chemical bonds, but low enough energy to penetrate the ozone layer and reach the troposphere. In addition to the albedo effect at very high latitudes, there is also an influence from having 24 h of continuous photolysis, and thus, continuous photochemistry in summer⁷⁴. Additionally, the loss of stratospheric ozone in both the Antarctic and Arctic has increased the penetration of shorter wavelength (and more photochemically reactive) UV radiation to the Earth's surface²⁷². In the UV and visible regions, the absorption coefficient of snow is dependent on impurity content and chemical nature. Compared to the few OM measurements available, biogenic organic matter represents a significant fraction of the total organic carbon measured in high latitude snow and ice, and could be a relatively abundant substrate available for photochemical processing⁷⁴.

The reaction mechanisms in snow/ice could be significantly different than what would occur in an aqueous sample. Chemical reaction products that have been shown to be produced due in snow/ice are different to those observed in aqueous chemistry. The unusual photobehavior of halobenzenes (such as chlorobenzene, 2- or 4-dichlorobenzene, bromobenzene, and 1,4-dibromobenzene) in ice has been demonstrated both in the laboratory and in field studies^{273,274}. Photolysis of frozen solutions of chlorobenzene produced chlorinated biphenyls (PCBs) or terphenyls as the major products instead of the photosolvolysis products (i.e. those resulting from reactions between OM and water molecules) generally obtained in aqueous solutions. The compounds produced in the frozen matrices were shown to be more toxic than those formed in liquids. These more toxic compounds could have an impact on toxicity and bioaccumulation potentials in the cryosphere²⁷⁵. Photochemistry of dissolved organic matter (DOM) has been shown to produce several biologically available compounds such as low molecular weight organic acids²⁷⁶. In aquatic ecosystems, these compounds have a positive effect on bacterial growth²⁷⁷, but UV-exposure of DOM also causes production of peroxides and free radicals that may inhibit bacteria²⁷⁸. DOM can also be

photooxidized to dissolved inorganic carbon (DIC)²⁷⁹, making part of the DOM unavailable to heterotrophic bacteria.

Microbial degradation is thought to preferentially target freshly produced, low-molecular weight molecules with low aromaticity²⁸⁰, whereas photochemical degradation mainly acts on colored, photoreactive molecules generally associated with high molecular weight and aromaticity²⁷⁶. The extent to which microorganisms are involved in degrading OM in snowpacks has yet to be determined, however, numerous genes detected in environmental ice metagenomes related to xenobiotics, biopolymers and other carbon sources suggest that glacial ice microorganisms have the potential to degrade a wide range of substrates³¹. Microbial preferences for different carbon classes were also studied in Antarctic snow and the results showed a higher rate of carbon uptake when snow microcosms were amended with a combination of simple and complex carbon sources¹⁰².

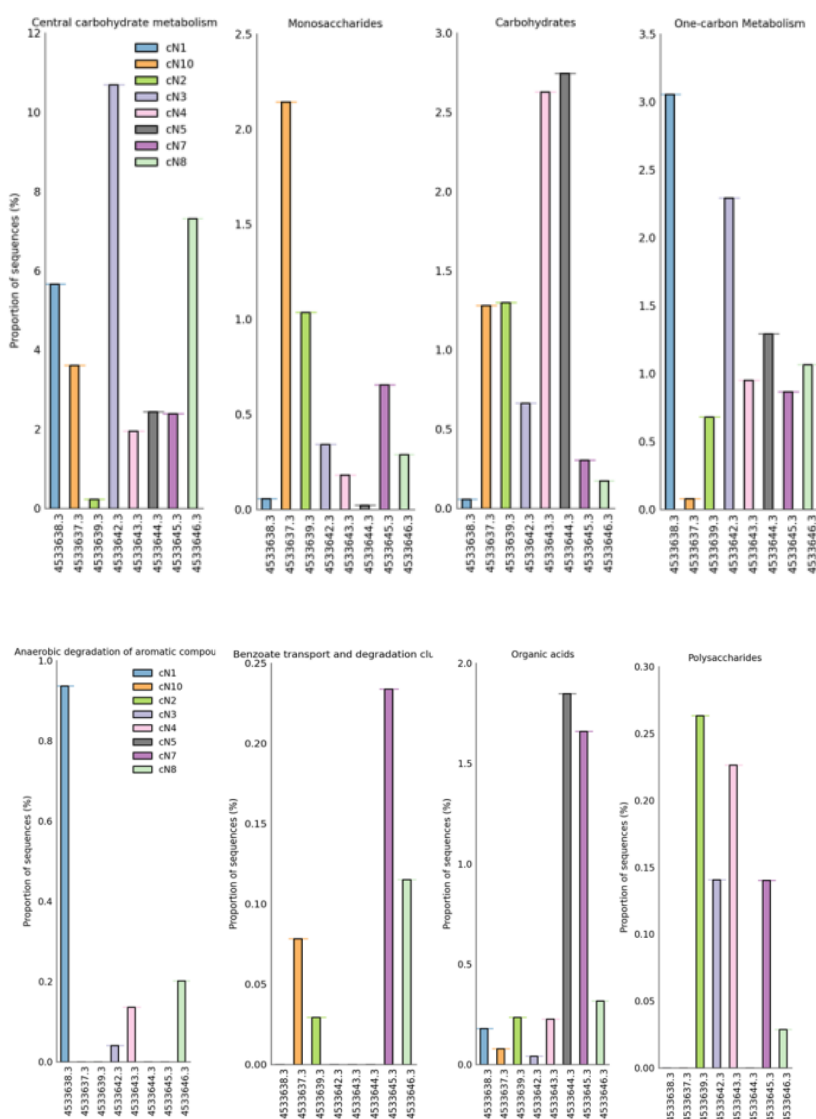

Figure 18 : Percent of transcribed sequences (mRNA) related to different OM metabolic pathways extracted from snow microbial communities in Arctic snow collected at -15°C.

In the same study, snow isolates were capable of oxidizing a broad spectrum of low and high molecular weight carbon sources including amino acids, amines, amides, carboxylic acids, carbohydrates, and complex polymers. Bacteria and fungi were also shown to oxidize methane, benzene, and toluene in soil and snowpack as a result of metabolic activity⁷⁵. We were also able to demonstrate that microorganisms are actively transcribing genes related to several types of carbon (C) cycling in snow at sub-zero temperatures (Figure 18). Altogether these results highlight the potential for high metabolic versatility of microorganisms in snow and ice habitats with low concentrations of many different carbon sources. An outstanding research question is related to the impact of photochemical transformations on the metabolic capacity of microorganisms in the snowpack. Is there a photochemical priming effect that renders recalcitrant OM more easily metabolized by microorganisms? What is the impact on biogeochemical cycling of contaminants? In aquatic environments, the photochemical breakdown of humic substances provides a source of substrates for bacteria by at least four pathways: (i) by increasing the bioavailability of molecules that are bound to humic substances (*e.g.*, amino acids, carbohydrates, and aromatic compounds), (ii) through photolytic formation of low-molecular-weight (LMW) substrates such as organic acids, carbonyl compounds, and hydrocarbons, (iii) by modifying the high-molecular-weight (HMW) fraction of humic substances rendering it more labile to microbial attack, and (iv) by increasing the pool of limiting inorganic nutrients¹⁷⁶. These same pathways are likely to occur in snowpacks as well.

Unraveling the impacts of both trophic interactions and photochemistry will be addressed in field and laboratory studies in future studies, through funding provided in part by the MicroArctic project and other submitted research proposals.

Concluding remarks

Due to the cold conditions and the limited supply of liquid water, cold environments have long been considered as an entrapment and storage system for microorganisms, nutrients, soluble inorganic and organic matter and contaminants delivered by wet and dry deposition. However, this view has begun to change with the publication of a number of studies that examined microbial diversity, ecology, and function in the cryosphere. Microorganisms harbor a remarkable capacity to adapt to a wide range of habitats and to date, no place on Earth has been shown to be sterile. The research carried out by my group and that of others has shown that the different compartments of the cryosphere have unexpectedly high microbial abundance and diversity and that the communities they harbor are able to interact and adapt to their physical-chemical environment. Although much progress has been made in understanding the role of these communities in biogeochemical cycling, many questions remain. The cryosphere is changing and modelling trends show that it is disappearing – with reduced snow and ice cover, depth and duration. Without knowing more about the molecular mechanisms and rates of the underlying processes involved in biotic dynamics in frozen ecosystems, we will be ill-equipped to face, predict and respond adequately to the environmental problems related to climate change.

References

1. Truitt, E. R. Fantasy North. *Aeon* (2016).
2. Laybourn-Parry, J. Microbiology. No place too cold. *Science* (80-.). **324**, 1521–2 (2009).
3. Physical & Basis, S. *Climate Change 2013*. (2013). doi:10.1017/CBO9781107415324.Summary
4. Wilson, E. G. *The Spiritual History of Ice*. (Palgrave Macmillan, 2003). doi:10.1057/9781403981806
5. Launius, R. D. Toward the Poles: A Historiography of Scientific Exploration during the International Polar Years and the International Geophysical Year. 47–81 (2010). doi:10.1007/978-0-230-11465-4_5
6. Brock, T. D. Life at high temperatures. *Science* **230**, 132–8 (1985).
7. Margesin, R. & Miteva, V. Diversity and ecology of psychrophilic microorganisms. *Res. Microbiol.* **162**, 346–61 (2011).
8. Deming, J. W. in *Sea Ice: An Introduction to Its Physics, Chemistry, Biology, and Geology* (eds. Thomas, D. N. & Dieckmann, G. S.) 247–282 (Wiley-Blackwell, 2009). doi:10.1002/9781444317145
9. Kelly, C. D. IV. Bacteria. *Bot. Rev.* **20**, 417–424 (1954).
10. Darling, Chester A. Siple, P. A. Bacteria of Antarctica. *J. Bacteriol.* **42**, 83–98 (1941).
11. McLean, A. L. Bacteria of ice and snow in Antarctica. *Nature* **102**, 35–39 (1918).
12. Wynn-Williams, D. D. Ecological Aspects of Antarctic Microbiology. *Adv. Microb. Ecol.* **11**, 71–146 (1990).
13. Dennis, M. A. Postscript: Earthly Matters: On the Cold War and the Earth Sciences. *Soc. Stud. Sci.* **33**, (2003).
14. Doel, R. E., Friedman, R. M., Lajus, J., Sorlin, S. & Wrakberg, U. Strategic Arctic science: National interests in building natural knowledge - interwar era through the Cold War. *J. Hist. Geogr.* **44**, 60–80 (2014).
15. Christner, B. C. *et al.* Recovery and Identification of Viable Bacteria Immured in Glacial Ice. *Icarus* **144**, 479–485 (2000).
16. Skidmore, M. L., Foght, J. M. & Sharp, M. J. Microbial life beneath a high arctic glacier. *Appl. Environ. Microbiol.* **66**, 3214–3220 (2000).
17. Christner, B. C., Mosley-Thompson, E., Thompson, L. G. & Reeve, J. N. Isolation of bacteria and 16S rDNAs from Lake Vostok accretion ice. *Env. Microbiol* **3**, 570–577 (2001).
18. Brinkmeyer, R. *et al.* Diversity and structure of bacterial communities in Arctic versus Antarctic pack ice. *Appl. Environ. Microbiol.* **69**, 6610–6619 (2003).
19. Poulain, A. J. *et al.* Potential for mercury reduction by microbes in the high arctic. *Appl. Environ. Microbiol.* **73**, 2230–2238 (2007).
20. Sattler, B., Puxbaum, H. & Psenner, R. Bacterial growth in super cooled cloud droplets. *Geophys. Res. Lett.* **28**, 239–242 (2001).
21. Yergeau, E., Newsham, K. K., Pearce, D. A. & Kowalchuk, G. A. Patterns of bacterial diversity across a range of Antarctic terrestrial habitats. *Environ. Microbiol.* **9**, 2670–2682 (2007).
22. Cowan, D. A. & Tow, L. A. Endangered Antarctic Environments. *Annu. Rev. Microbiol.* **58**, 649–690 (2004).
23. Miteva, V. in *Psychrophiles: from Biodiversity to Biotechnology* (ed. Margesin, R. *et al.*) 31–47 (Springer-Verlag, 2008).
24. Christner, B. C. Incorporation of DNA and protein precursors into macromolecules by bacteria at -15 degrees C. *Appl Env. Microbiol* **68**, 6435–6438 (2002).
25. Junge, K., Eicken, H. & Deming, J. W. Wintertime Sea Ice Bacterial Activity at ± 2 to ± 20 ° C in Arctic Wintertime Sea Ice. **70**, (2004).
26. Price, P. B. & Sowers, T. Temperature dependence of metabolic rates for microbial growth, survival and maintenance. *Proc Natl Acad Sci USA* **101**, 4631–4636 (2004).
27. Carpenter, E. J., Lin, S. & Capone, D. G. Bacterial activity in South Pole snow. *Appl Env. Microbiol* **66**, 4514–4517 (2000).
28. Maranger, R., Bird, D. F. & Juniper, S. K. Viral and bacterial dynamics in Arctic sea ice during the spring algal bloom near Resolute, NWT, Canada. *Mar. Ecol. Prog. Ser.* **111**, 121–128 (1994).
29. Zhang, S., Yang, G., Wang, Y. & Hou, S. Abundance and community of snow bacteria from three glaciers in the Tibetan Plateau. *J. Environ. Sci.* **22**, 1418–1424 (2010).
30. Larose, C. *et al.* Microbial sequences retrieved from environmental samples from seasonal Arctic snow and meltwater from Svalbard, Norway. *Extremophiles* **14**, 205–212 (2010).
31. Maccario, L., Vogel, T. M. & Larose, C. Potential drivers of microbial community structure and function

- in Arctic spring snow. *Front. Microbiol.* **5**, 413 (2014).
32. Moller, A. K. *et al.* Diversity and characterization of mercury-resistant bacteria in snow, freshwater and sea-ice brine from the High Arctic. *FEMS Microbiol Ecol* **75**, 390–401 (2011).
 33. Cameron, K. a *et al.* Diversity and potential sources of microbiota associated with snow on western portions of the Greenland Ice Sheet. *Environ. Microbiol.* (2014). doi:10.1111/1462-2920.12446
 34. Cameron, K. a, Hodson, A. J. & Osborn, a M. Structure and diversity of bacterial, eukaryotic and archaeal communities in glacial cryoconite holes from the Arctic and the Antarctic. *FEMS Microbiol. Ecol.* **82**, 254–67 (2012).
 35. Zarsky, J. D. *et al.* Large cryoconite aggregates on a Svalbard glacier support a diverse microbial community including ammonia-oxidizing archaea. *Environ. Res. Lett.* **8**, 035044 (2013).
 36. Cowie, R. O. M., Maas, E. W. & Ryan, K. G. Archaeal diversity revealed in Antarctic sea ice. *Antarct. Sci.* **23**, 531–536 (2011).
 37. Arrigo, K. R. Sea ice ecosystems. *Ann. Rev. Mar. Sci.* **6**, 439–67 (2014).
 38. Gradinger, R. & Nurnberg, D. Snow algal communities on Arctic pack ice floes dominated by *Chlamydomonas nivalis* (Bauer) Wille. 35–43 (1996).
 39. Thomas, W. H. & Duval, B. Sierra Nevada, California, USA, snow algae: snow albedo changes, algal-bacterial interrelationships, and ultraviolet radiation effects. *Arctic, Antarct. Alp. Res.* **27**, 389–399 (1995).
 40. Felip, M., Sattler, B., Psenner, R. & Catalan, J. Highly active microbial communities in the ice and snow cover of high mountain lakes. *Appl. Environ. Microbiol.* **61**, 2394–401 (1995).
 41. Harding, T., Jungblut, A. D., Lovejoy, C. & Vincent, W. F. Microbes in high arctic snow and implications for the cold biosphere. *Appl Env. Microbiol* **77**, 3234–3243 (2011).
 42. Bachy, C., López-García, P., Vereshchaka, A. & Moreira, D. Diversity and vertical distribution of microbial eukaryotes in the snow, sea ice and seawater near the North Pole at the end of the polar night. *Front. Microbiol.* **2**, 1–12 (2011).
 43. Hodson, A. *et al.* Glacial Ecosystems. *Ecol. Monogr.* **78**, 41–67 (2008).
 44. Foreman, C. M. *et al.* Microbial growth under humic-free conditions in a supraglacial stream system on the Cotton Glacier , Antarctica. *Environ. Res. Lett.* **8**, 1–11 (2013).
 45. Morgan-Kiss, R. M. *et al.* Identity and physiology of a new psychrophilic eukaryotic green alga, *Chlorella* sp., strain BI, isolated from a transitory pond near Bratina Island, Antarctica. *Extremophiles* **12**, 701–711 (2008).
 46. Maccario, L., Sanguino, L., Vogel, T. M. & Larose, C. Snow and ice ecosystems: Not so extreme. *Res. Microbiol.* **166**, 782–795 (2015).
 47. Lopatina, A., Krylenkov, V. & Severinov, K. Activity and bacterial diversity of snow around russian antarctic stations. *Res. Microbiol.* **164**, 949–958 (2013).
 48. Chuvochina, M. S. *et al.* Community Variability of Bacteria in Alpine Snow (Mont Blanc) Containing Saharan Dust Deposition and Their Snow Colonisation Potential. *Microbes Environ.* **26**, 237–247 (2011).
 49. Amato, P. *et al.* Bacterial characterization of the snow cover at Spitzberg, Svalbard. *FEMS Microbiol Ecol* **59**, 255–264 (2007).
 50. Skidmore, M., Anderson, S. P., Sharp, M., Foght, J. & Lanoil, B. D. Comparison of microbial community compositions of two subglacial environments reveals a possible role for microbes in chemical weathering processes. *Appl. Environ. Microbiol.* **71**, 6986–6997 (2005).
 51. Shtarkman, Y. M. *et al.* Subglacial Lake Vostok (Antarctica) accretion ice contains a diverse set of sequences from aquatic, marine and sediment-inhabiting bacteria and eukarya. *PLoS One* **8**, e67221 (2013).
 52. Mader, H. M., Pettitt, M. E., Wadham, J. L., Wolff, E. W. & Parkes, R. J. Subsurface ice as a microbial habitat. *Geology* **34**, 169 (2006).
 53. Miteva, V. I. & Brenchley, J. E. Detection and isolation of ultrasmall microorganisms from a 120,000-year-old Greenland glacier ice core. *Appl. Environ. Microbiol.* **71**, 7806–18 (2005).
 54. Karl, D. . *et al.* Microorganisms in the Accreted Ice of Lake Vostok , Antarctica. *Science (80-)*. **286**, 2144–2147 (1999).
 55. Larose, C. *et al.* Interactions between Snow Chemistry, Mercury Inputs and Microbial Population Dynamics in an Arctic Snowpack. *PLoS One* **8**, e79972 (2013).
 56. Mueller, D. R., Vincent, W. F., Bonilla, S. & Laurion, I. Extremotrophs, extremophiles and broadband pigmentation strategies in a high arctic ice shelf ecosystem. *FEMS Microbiol Ecol* **53**, 73–87 (2005).
 57. Mykytczuk, N. C. S. *et al.* Bacterial growth at -15 °C; molecular insights from the permafrost bacterium *Planococcus halocryophilus* Or1. *ISME J.* **7**, 1211–26 (2013).

58. Morita, R. Y. Psychrophilic bacteria. *Bacteriol. Rev.* **39**, 144–67 (1975).
59. Priscu, J. C. & Christner, B. C. in *Microbial Diversity and Bioprospecting* (ed. Bull, A. T.) 130–145 (American Society for Microbiology, 2004).
60. Qiu, Y., Vishnivetskaya, T. A. & Lubman, D. M. in *Permafrost Soils* 169–181 (2009).
61. Prabakaran, S. R., Manorama, R., Delille, D. & Shivaji, S. Predominance of Roseobacter, Sulfitobacter, Glaciecola and Psychrobacter in seawater collected off Ushuaia, Argentina, Sub-Antarctica. *FEMS Microbiol Ecol* **59**, 342–355 (2007).
62. Cheng, S. M. & Foght, J. M. Cultivation-independent and -dependent characterization of Bacteria resident beneath John Evans Glacier. *FEMS Microbiol Ecol* **59**, 318–330 (2007).
63. Møller, A. K., Søbørg, D. A., Al-soud, W. A., Sørensen, S. J. & Kroer, N. Bacterial community structure in High-Arctic snow and freshwater as revealed by pyrosequencing of 16S rRNA genes and cultivation. *Polar Res.* **1**, 1–11 (2013).
64. Smith, J. J., Howington, J. P. & McFeters, G. A. Survival, physiological response and recovery of enteric bacteria exposed to a polar marine environment. *Appl. Environ. Microbiol.* **60**, 2977–84 (1994).
65. Price, P. B. A habitat for psychrophiles in deep Antarctic ice. *Proc. Natl. Acad. Sci. U. S. A.* **97**, 1247–51 (2000).
66. Price, P. B. Life in solid ice. 21 (2005).
67. Varin, T., Lovejoy, C., Jungblut, A. D., Vincent, W. F. & Corbeil, J. Metagenomic analysis of stress genes in microbial mat communities from Antarctica and the High Arctic. *Appl. Environ. Microbiol.* **78**, 549–59 (2012).
68. Edwards, A. *et al.* A metagenomic snapshot of taxonomic and functional diversity in an alpine glacier cryoconite ecosystem. *Environ. Res. Lett.* **8**, 035003 (2013).
69. Ewert, M., Carpenter, S. D., Colangelo-Lillis, J. & Deming, J. W. Bacterial and extracellular polysaccharide content of brine-wetted snow over Arctic winter first-year sea ice. *J. Geophys. Res. Ocean.* **118**, 726–735 (2013).
70. MacDonell, S. & Fitzsimons, S. The formation and hydrological significance of cryoconite holes. *Prog. Phys. Geogr.* **32**, 595–610 (2008).
71. Csonka, L. N. Physiological and Genetic Responses of Bacteria to Osmotic Stress. *Am. Soc. Microbiol.* **53**, 121–147 (1989).
72. Roberts, M. F. Organic compatible solutes of halotolerant and halophilic microorganisms. *Saline Systems* **1**, 5 (2005).
73. Brown, J. R. *et al.* Recrystallization inhibition in ice due to ice binding protein activity detected by nuclear magnetic resonance. *Biotechnol. Reports* **3**, 60–64 (2014).
74. Grannas, A. M. *et al.* An overview of snow photochemistry: evidence, mechanisms and impacts. *Atmos. Chem. Phys.* **7**, 4329–4373 (2007).
75. McNeill, V. F. *et al.* Organics in environmental ices: Sources, chemistry, and impacts. *Atmos. Chem. Phys.* **12**, 9653–9678 (2012).
76. Ariya, P. A. *et al.* Snow a photobiochemical exchange platform for volatile and semi-volatile organic compounds with the atmosphere. *Environ. Chem.* **8**, 63–73 (2011).
77. King, M. D., France, J. L., Fisher, F. N. & Beine, H. J. Measurement and modelling of UV radiation penetration and photolysis rates of nitrate and hydrogen peroxide in Antarctic sea ice: An estimate of the production rate of hydroxyl radicals in first-year sea ice. *J. Photochem. Photobiol. A Chem.* **176**, 39–49 (2005).
78. Santos, A. L. *et al.* Wavelength dependence of biological damage induced by UV radiation on bacteria. *Arch. Microbiol.* **195**, 63–74 (2013).
79. Martin, A., Hall, J. & Ryan, K. Low salinity and high-level UV-B radiation reduce single-cell activity in antarctic sea ice bacteria. *Appl. Environ. Microbiol.* **75**, 7570–3 (2009).
80. Senčilo, A., Luhtanen, A.-M., Saarijärvi, M., Bamford, D. H. & Roine, E. Cold-active bacteriophages from the Baltic Sea ice have diverse genomes and virus-host interactions. *Environ. Microbiol.* (2014). doi:10.1111/1462-2920.12611
81. Remias, D., Lütz-meindl, U., Lütz, C. & Lu, U. Photosynthesis, pigments and ultrastructure of the alpine snow alga *Chlamydomonas nivalis*. *Eur. J. Phycol.* **40**, 259–268 (2005).
82. Gorton, H. L. & Vogelmann, T. C. Ultraviolet radiation and the snow alga *Chlamydomonas nivalis* (Bauer) Wille. *Photochem. Photobiol.* **77**, 608–15 (2003).
83. Remias, D., Wastian, H., Lütz, C. & Leya, T. Insights into the biology and phylogeny of *Chloromonas polyptera* (Chlorophyta), an alga causing orange snow in Maritime Antarctica. *Antarct. Sci.* **25**, 648–656 (2013).

84. Lemoine, Y. & Schoefs, B. Secondary ketocarotenoid astaxanthin biosynthesis in algae: a multifunctional response to stress. *Photosynth. Res.* **106**, 155–77 (2010).
85. Remias, D. *et al.* Characterization of an UV- and VIS-absorbing, purpurogallin-derived secondary pigment new to algae and highly abundant in *Mesotaenium berggrenii* (Zygnematophyceae, Chlorophyta), an extremophyte living on glaciers. *FEMS Microbiol. Ecol.* **79**, 638–648 (2011).
86. Omelon, C., Pollard, W. & Ferris, F. Environmental controls on microbial colonization of high Arctic cryptoendolithic habitats. *Polar Biol.* **30**, 19–29 (2006).
87. Ziegelhoffer, E. C. & Donohue, T. J. Bacterial responses to photo-oxidative stress. **7**, 856–863 (2009).
88. Sinha, R. P. & Häder, D. P. UV-induced DNA damage and repair: a review. *Photochem. Photobiol. Sci.* **1**, 225–36 (2002).
89. Morgan-Kiss, R. M., Priscu, J. C., Pockock, T., Gudynaite-Savitch, L. & Huner, N. P. Adaptation and acclimation of photosynthetic microorganisms to permanently cold environments. *Microbiol. Mol. Biol. Rev.* **70**, 222–252 (2006).
90. Falkowski, P. G. & LaRoche, J. ACCLIMATION TO SPECTRAL IRRADIANCE IN ALGAE. *J. Phycol.* **27**, 8–14 (1991).
91. Ralph, P. J., McMinn, A., Ryan, K. G. & Ashworth, C. SHORT-TERM EFFECT OF TEMPERATURE ON THE PHOTOKINETICS OF MICROALGAE FROM THE SURFACE LAYERS OF ANTARCTIC PACK ICE1. *J. Phycol.* **41**, 763–769 (2005).
92. Stibal, M., Elster, J., Sabacka, M. & Kastovska, K. Seasonal and diel changes in photosynthetic activity of the snow alga *Chlamydomonas nivalis* (Chlorophyceae) from Svalbard determined by pulse amplitude modulation fluorometry. *FEMS Microbiol Ecol* **59**, 265–273 (2007).
93. Gomelsky, M. & Hoff, W. D. Light helps bacteria make important lifestyle decisions. *Trends Microbiol.* **19**, 441–8 (2011).
94. Thomas, D. N. & Papadimitriou, S. in *Sea Ice: An Introduction to its Physics, Chemistry, Biology and Geology* (eds. Thomas, D. N. & Dieckmann, G. S.) 267–302 (Blackwell publishing, 2008).
95. Stibal, M. *et al.* Environmental controls on microbial abundance and activity on the greenland ice sheet: a multivariate analysis approach. *Microb. Ecol.* **63**, 74–84 (2012).
96. Hünken, M., Harder, J. & Kirst, G. O. Epiphytic bacteria on the Antarctic ice diatom *Amphiprora kufferathii* Manguin cleave hydrogen peroxide produced during algal photosynthesis. *Plant Biol.* **10**, 519–526 (2008).
97. Telling, J. *et al.* Controls on the autochthonous production and respiration of organic matter in cryoconite holes on high Arctic glaciers. *J. Geophys. Res. Biogeosciences* **117**, (2012).
98. Simon, C., Wiezer, A., Strittmatter, A. W. & Daniel, R. Phylogenetic diversity and metabolic potential revealed in a glacier ice metagenome. *Appl. Environ. Microbiol.* **75**, 7519–26 (2009).
99. Boyd, E. S., Hamilton, T. L., Havig, J. R., Skidmore, M. L. & Shock, E. L. Chemolithotrophic primary production in a subglacial ecosystem. *Appl. Environ. Microbiol.* **80**, 6146–53 (2014).
100. Stibal, M., Šabacká, M. & Žárský, J. Biological processes on glacier and ice sheet surfaces. *Nat. Geosci.* **5**, 771–774 (2012).
101. Stibal, M. *et al.* Microbial degradation of 2,4-dichlorophenoxyacetic acid on the Greenland ice sheet. *Appl. Environ. Microbiol.* **78**, 5070–6 (2012).
102. Antony, R., Mahalinganathan, K., Krishnan, K. P. & Thamban, M. Microbial preference for different size classes of organic carbon: A study from Antarctic snow. *Environ. Monit. Assess.* **184**, 5929–5943 (2012).
103. Christner, B. C., Mosley-Thompson, E., Thompson, L. G. & Reeve, J. N. Bacterial recovery from ancient glacial ice. *Env. Microbiol* **5**, 433–436 (2003).
104. Miteva, V. I., Sheridan, P. P. & Brenchley, J. E. Phylogenetic and Physiological Diversity of Microorganisms Isolated from a Deep Greenland Glacier Ice Core. *Appl. Environ. Microbiol.* **70**, 202–213 (2004).
105. Barletta, R. E., Priscu, J. C., Mader, H. M., Jones, W. L. & Roe, C. H. Chemical analysis of ice vein microenvironments: II. Analysis of glacial samples from Greenland and Antarctica. *J. Glaciol.* **58**, 1109–1118 (2012).
106. Tung, H. C., Bramall, N. E. & Price, P. B. Microbial origin of excess methane in glacial ice and implications for life on Mars. *Proc. Natl. Acad. Sci. U. S. A.* **102**, 18292–6 (2005).
107. Takeuchi, N. Structure, formation, and darkening process of albedo-reducing material cryoconite on a Himalayan glacier: a granular algal mat growing on the glacier. *Arctic, Antarct. Alp. Res.* **33**, 115–122 (2001).
108. Margesin, R., Zacke, G. & Schinner, F. Characterization of Heterotrophic Microorganisms in Alpine Glacier Cryoconite. *Arctic, Antarct. Alp. Res.* **34**, 88–93 (2002).

109. Barrie, L. A. in *Seasonal Snowpacks SE - 1* (eds. Davies, T. D., Tranter, M. & Jones, H. G.) **28**, 1–20 (Springer Berlin Heidelberg, 1991).
110. Jones, H. G. The ecology of snow-covered systems: a brief overview of nutrient cycling and life in the cold. *Hydrol. Process.* **13**, 2135–2147 (1999).
111. Larose, C., Dommergue, A. & Vogel, T. M. Microbial nitrogen cycling in Arctic snowpacks. *Environ. Res. Lett.* **8**, 035004 (2013).
112. Amoroso, A. *et al.* Microorganisms in Dry Polar Snow Are Involved in the Exchanges of Reactive Nitrogen Species with the Atmosphere. *Environ. Sci. Technol.* **44**, 714–719 (2009).
113. Vincent, W. F., Mueller, D. R. & Bonilla, S. Ecosystems on ice: The microbial ecology of Markham Ice Shelf in the high Arctic. *Cryobiology* **48**, 103–112 (2004).
114. Achberger, A. M., Brox, T. I., Skidmore, M. L. & Christner, B. C. Expression and partial characterization of an ice-binding protein from a bacterium isolated at a depth of 3,519 m in the Vostok ice core, Antarctica. *Front. Microbiol.* **2**, 1–8 (2011).
115. Ewert, M. & Deming, J. Sea Ice Microorganisms: Environmental Constraints and Extracellular Responses. *Biology (Basel)*. **2**, 603–628 (2013).
116. Konopka, A. What is microbial community ecology? *ISME J.* **3**, 1223–30 (2009).
117. Frost, L. S., Leplae, R., Summers, A. O. & Toussaint, A. Mobile genetic elements: the agents of open source evolution. *Nat. Rev. Microbiol.* **3**, 722–32 (2005).
118. Dziewit, L. *et al.* Sequence determination and analysis of three plasmids of *Pseudomonas* sp. GLE121, a psychrophile isolated from surface ice of Ecology Glacier (Antarctica). *Plasmid* **70**, 254–262 (2013).
119. Moller, A. K. *et al.* Mercuric reductase genes (*merA*) and mercury resistance plasmids in High Arctic snow, freshwater and sea-ice brine. *FEMS Microbiol. Ecol.* **87**, 52–63 (2014).
120. Kepner, R. L., Wharton, R. a & Suttle, C. a. Viruses in Antarctic lakes. *Limnol. Oceanogr.* **43**, 1754–1761 (1998).
121. López-Bueno, A. *et al.* High diversity of the viral community from an Antarctic lake. *Science* **326**, 858–61 (2009).
122. Laybourn-Parry, J., Marshall, W. a. & Madan, N. J. Viral dynamics and patterns of lysogeny in saline Antarctic lakes. *Polar Biol.* **30**, 351–358 (2007).
123. Bellas, C. M. & Anesio, A. M. High diversity and potential origins of T4-type bacteriophages on the surface of Arctic glaciers. *Extremophiles* **17**, 861–70 (2013).
124. Zawar-Reza, P. *et al.* Diverse small circular single-stranded DNA viruses identified in a freshwater pond on the McMurdo Ice Shelf (Antarctica). *Infect. Genet. Evol.* **26**, 132–8 (2014).
125. Bellas, C. M. *et al.* Viral impacts on bacterial communities in Arctic cryoconite. *Environ. Res. Lett.* **8**, 045021 (2013).
126. Luhtanen, A.-M. *et al.* Isolation and characterization of phage-host systems from the Baltic Sea ice. *Extremophiles* **18**, 121–30 (2014).
127. Wells, L. E. & Deming, J. W. Brief report Modelled and measured dynamics of viruses in Arctic winter sea-ice brines. *Environ. Microbiol.* **8**, 1115–1121 (2006).
128. Sanguino, L., Franqueville, L., Vogel, T. M. & Larose, C. Linking environmental prokaryotic viruses and their host through CRISPRs. *FEMS Microbiol. Ecol.* **91**, fiv046 (2015).
129. Collins, R. E. & Deming, J. W. Abundant dissolved genetic material in Arctic sea ice Part I: Extracellular DNA. *Polar Biol.* **34**, 1819–1830 (2011).
130. Sävström, C., Granéli, W., Laybourn-Parry, J. & Anesio, A. M. High viral infection rates in Antarctic and Arctic bacterioplankton. *Environ. Microbiol.* **9**, 250–5 (2007).
131. Anesio, A. M., Mindl, B., Laybourn-Parry, J., Hodson, A. J. & Sattler, B. Viral dynamics in cryoconite holes on a high Arctic glacier (Svalbard). *J. Geophys. Res. Biogeosciences* **112**, (2007).
132. Anesio, A. M. & Bellas, C. M. Are low temperature habitats hot spots of microbial evolution driven by viruses? *Trends Microbiol.* **19**, 52–57 (2011).
133. Wilhelm, S. W. & Suttle, C. A. Viruses and Nutrient Cycles in the Sea aquatic food webs. *Bioscience* **49**, 781–788 (1999).
134. Van Houdt, R. *et al.* Characterization of culturable *Paenibacillus* spp. from the snow surface on the high Antarctic Plateau (DOME C) and their dissemination in the Concordia research station. *Extremophiles* **17**, 565–73 (2013).
135. Stewart, F. J. & Fritsen, C. H. Bacteria-algae relationships in Antarctic sea ice. *Antarct. Sci.* **16**, 143–156 (2004).
136. Marquardt, M., Kramer, M., Carnat, G. & Werner, I. Vertical distribution of sympagic meiofauna in sea ice in the Canadian Beaufort Sea. *Polar Biol.* **34**, 1887–1900 (2011).

137. Zawierucha, K., Kolicka, M., Takeuchi, N. & Kaczmarek, Ł. What animals can live in cryoconite holes ? A faunal review. *J. Zool.* 1–11 (2014). doi:10.1111/jzo.12195
138. Hartzell, P. L., Nghiem, J. V., Richio, K. J. & Shain, D. H. Distribution and phylogeny of glacier ice worms (*Mesenchytraeus solifugus* and *Mesenchytraeus solifugus rainierensis*). *Can. J. Zool.* **83**, 1206–1213 (2005).
139. Goodman, D. *Ecological Investigations of Ice Worms on Casement Glacier, Southeastern Alaska. Institute of Polar Studies. Ohio State University Research Foundation, Columbus. Report No.*, (1971).
140. Murakami, T., Segawa, T., Bodington, D. & Dial, R. Census of bacterial microbiota associated with the glacier ice worm *Mesenchytraeus solifugus*. *FEMS Microbiol. Ecol.* 1–28 (2015).
141. Hinkler, J., Hansen, B. U., Tamstorf, M. P., Sigsgaard, C. & Petersen, D. Snow and Snow-Cover in Central Northeast Greenland. *Adv. Ecol. Res.* **40**, 175–195 (2008).
142. Pomeroy Brun, E., J. W. in *Snow Ecology. An Interdisciplinary Examination of Snow-Covered Ecosystems* (ed. H.G. Jones D.A. Walker and R.W. Hoham, J. W. P.) 45–126 (Cambridge University Press, 2001).
143. Zhang, T. Influence of the seasonal snow cover on the ground thermal regime: An overview . *Rev. Geophys.* **43**, RG4002, doi:10.1029/2004RG000157 (2005).
144. Jones Pomeroy, J. W., Walker, D. A., Hoham, R. W., H. G. Snow Ecology. 398 (2001).
145. Libbrecht, K. G. The physics of snow crystals. *Reports Prog. Phys.* **68**, 855–895 (2005).
146. Kuhn, M. The nutrient cycle through snow and ice, a review. *Aquat. Sci.* **63**, 150–167 (2001).
147. Christner, B. C., Morris, C. E., Foreman, C. M., Cai, R. & Sands, D. C. Ubiquity of biological ice nucleators in snowfall. *Science (80-)*. **319**, 1214 (2008).
148. Jordan Albert, M.R., Brun, E., R. E. in *Snow and Climate* (ed. Armstrong Brun, E., R. L.) 12–69 (Cambridge University Press, 2008).
149. Colbeck, S. C. The layered character of snow covers. *Rev. Geophys.* **29**, 81–96 (1991).
150. Daly, G. L. & Wania, F. Simulating the Influence of Snow on the Fate of Organic Compounds. *Environ. Sci. Technol.* **38**, 4176–4186 (2004).
151. Cabanes, A., Legagneux, L. & Dominé, F. Evolution of the specific surface area and of crystal morphology of Arctic fresh snow during the ALERT 2000 campaign. *Atmos. Environ.* **36**, 2767–2777 (2002).
152. Albert, M. R., Grannas, A. M., Bottenheim, J., Shepson, P. B. & Perron Jr, F. E. Processes and Properties of Snow–Air Transfer in the High Arctic with Application to Interstitial Ozone at Alert, Canada. *Atmos. Environ.* **36**, 2779–2787 (2002).
153. Dominé, F. & Shepson, P. B. Air–Snow Interactions and Atmospheric Chemistry. *Science (80-)*. **297**, 1506–1510 (2002).
154. Domine, F. *et al.* Snow physics as relevant to snow photochemistry. **10**, 171–208 (2008).
155. Larose, C. *et al.* Springtime changes in snow chemistry lead to new insights into mercury methylation in the Arctic. *Geochim. Cosmochim. Acta* **74**, 6263–6275
156. Kuhn, M. Micro-meteorological conditions for snow melt . *J. Glaciol.* **33**, 24–26 (1987).
157. Kawamura, K. & Ikushima, K. Seasonal changes in the distribution of dicarboxylic acids in the urban atmosphere. *Envir. Sci. Technol.* **27**, 2227–2235 (1993).
158. Kawamura, K. & Kasukabe, H. Sources and reaction pathways of dicarboxylic acids, ketoacids and dicarbonyls in Arctic aerosols: one year of observations. *Atmos. Environ.* **30**, 1709–1722 (1996).
159. Bentley, R. & Chasteen, T. G. Environmental VOSCs--formation and degradation of dimethyl sulfide, methanethiol and related materials. *Chemosphere* **55**, 291–317 (2004).
160. Kiene, R. P. & Linn, L. J. The fate of dissolved dimethylsulfoniopropionate (DMSP) in seawater: tracer studies using 35S-DMSP. *Geochim. Cosmochim. Acta* **64**, 2797–2810 (2000).
161. Leck, C. & Persson, C. The central Arctic Ocean as a source of dimethyl sulfide - Seasonal variability in relation to biological activity . *Tellus* **48B**, 156–177
162. Farmer, J. & Hickman-Brenner, F. in *The Prokaryotes* 508–563 (2006).
163. Murray, A. E. & Grzymiski, J. J. Diversity and genomics of Antarctic marine micro-organisms. *Philos. Trans. R. Soc. B Biol. Sci.* **362**, 2259–2271 (2007).
164. Bowman, J. P. *Algoriphagus ratkowskyi* gen. nov., sp. nov., *Brumimicrobium glaciale* gen. nov., sp. nov., *Cryomorpha ignava* gen. nov., sp. nov. and *Crocinitomix catalasitica* gen. nov., sp. nov., novel flavobacteria isolated from various polar habitats. *Int. J. Syst. Evol. Microbiol.* **53**, 1343–1355 (2003).
165. Lauber, C. L., Hamady, M., Knight, R. & Fierer, N. Soil pH as a predictor of soil bacterial community structure at the continental scale: a pyrosequencing-based assessment. *Appl. Environ. Microbiol.* AEM.00335–09 (2009). doi:10.1128/aem.00335-09
166. Einen, J. & Ovreås, L. *Flaviramulus basaltis* gen. nov., sp. nov., a novel member of the family

- Flavobacteriaceae isolated from seafloor basalt. *Int. J. Syst. Evol. Microbiol.* **56**, 2455–61 (2006).
167. Anderson, C. R. *et al.* Aurantimonas manganoxydans, sp. nov. and Aurantimonas litoralis, sp. nov.: Mn(II) oxidizing representatives of a globally distributed clade of alpha-Proteobacteria from the order Rhizobiales. *Geomicrobiol. J.* **26**, 189–198 (2009).
 168. Polz, M. F., Alm, E. J. & Hanage, W. P. Horizontal gene transfer and the evolution of bacterial and archaeal population structure. *Trends Genet.* **29**, 170–5 (2013).
 169. Dinsdale, E. A. *et al.* Functional Metagenomic Profiling of Nine Biomes. *Nature* (2008).
 170. Delmont, T. O. *et al.* Metagenomic mining for microbiologists. *ISME J.* **5**, 1837–1843 (2011).
 171. Carpenter, E. J., Lin, S. & Capone, D. G. Bacterial Activity in South Pole Snow Bacterial Activity in South Pole Snow. **66**, (2000).
 172. Sattler, B., Puxbaum, H. & Psenner, R. Bacterial growth in supercooled cloud droplets. *Geophys. Res. Lett.* **28**, 239–242 (2001).
 173. Warren, S. G. & Hudson, S. R. Bacterial Activity in South Pole Snow Is Questionable Letters to the Editor Bacterial Activity in South Pole Snow Is Questionable. **69**, 6340–6342 (2003).
 174. Anesio, A. M., Hodson, A. J., Fritz, A., Psenner, R. & Sattler, B. High microbial activity on glaciers: importance to the global carbon cycle. *Glob. Chang. Biol.* **15**, 955–960 (2009).
 175. Paget, E., Monrozier, L. J. & Simonet, P. Adsorption of DNA on clay minerals: protection against DNaseI and influence on gene transfer. *FEMS Microbiol. Lett.* **97**, 31–39 (1992).
 176. Anesio, a M., Theil-Nielsen, J. & Granéli, W. Bacterial growth on photochemically transformed leachates from aquatic and terrestrial primary producers. *Microb. Ecol.* **40**, 200–208 (2000).
 177. Nielsen, K. M., Johnsen, P. J., Bensasson, D. & Daffonchio, D. Release and persistence of extracellular DNA in the environment. *Environ. Biosafety Res.* **6**, 37–53
 178. Lorenz, M. G., Aardema, B. W. & Krumbein, W. E. Interaction of marine sediment with DNA and DNA availability to nucleases. *Mar. Biol.* **64**, 225–230 (1981).
 179. Neidhardt FC, Ingraham JL, Low KB, Magasanik B, Schaechter M, U. H. in *American Society for Microbiology* (1987).
 180. Moran, M. A. *et al.* Sizing up metatranscriptomics. *ISME J.* **7**, 237–43 (2013).
 181. Meyer, F., Paarmann, D., D’Souza, M. & Etal. The metagenomics RAST server—a public resource for the automatic phylo- genetic and functional analysis of metagenomes. *BMC Bioinformatics* **9**, 386 (2008).
 182. Liu, Y. *et al.* Microbial community structure in moraine lakes and glacial meltwaters, Mount Everest. *FEMS Microbiol. Lett.* **265**, 98–105 (2006).
 183. Priscu, J. C. *et al.* Perennial Antarctic lake ice: an oasis for life in a polar desert. *Science (80-.)*. **280**, 2095–2098 (1998).
 184. Männistö, M. K. & Häggblom, M. M. Characterization of psychrotolerant heterotrophic bacteria from Finnish Lapland. *Syst. Appl. Microbiol.* **29**, 229–243 (2006).
 185. Neufeld, J. D., Dumont, M. G., Vohra, J. & Murrell, J. C. Methodological considerations for the use of stable isotope probing in microbial ecology. *Microb. Ecol.* **53**, 435–442 (2007).
 186. Martineau, C., Whyte, L. G. & Greer, C. W. Stable Isotope Probing Analysis of the Diversity and Activity of Methanotrophic Bacteria in Soils from the Canadian High Arctic. *Appl. Environ. Microbiol.* **76**, 5773–5784 (2010).
 187. Morris, A., Vogel, T. M. & Larose, C. *Arctic Microbial Engineering: Climate Change Implications.* (2015).
 188. Ullrich Tanton, T.W., Abdrashitova, S.A., S. M. Mercury in the aquatic environment: a review of factors affecting methylation. *Crit. Rev. Environ. Sci. Technol.* **31**, 241–293 (2001).
 189. Yee Choi, B. H., S. Methylmercury Poisoning Induces Oxidative Stress in the Mouse Brain. *Exp. Mol. Pathol.* **60**, 188–196 (1994).
 190. Harada, M. Minamata disease: methylmercury poisoning in Japan caused by environmental pollution. *Crit. Rev. Toxicol.* **25**, 1–24 (1995).
 191. Castoldi Coccini, Teresa, Ceccatelli, Sandra, Manzo, Luigi, A. F. Neurotoxicity and molecular effects of methylmercury . *Brain Res. Bull.* **55**, 197–203 (2001).
 192. Yokoo Valente, J. G., Grattan, L., Schmidt, S. L., Platt, I., Silbergeld, E. K., E. M. Low level methylmercury exposure affects neurophysiological function in adults. *Environ. Heal. A Glob. Access Sci. Source* **2**, 8 (2003).
 193. Daré Li, W., Zhivotovsky, B., Yuan, X., Ceccatelli, S., E. Methylmercury and H2O2 provoke lysosomal damage in human astrocytoma D384 cells followed by apoptosis . *Free Radic. Biol. Med.* **30**, 1347–1356 (2001).
 194. Schultz Newman, M. C., I. R. Methyl mercury toxicokinetics in channel catfish (*Ictalurus punctatus*) and largemouth bass (*Micropterus salmoides*) after intravascular administration. *Environ. Toxicol. Chem.* **16**,

- 990–996 (1997).
195. Nriagu Pacyna, J.M., J. O. Quantitative assessment of worldwide contamination of air, water and soils with trace metals. *Nature* **333**, 134–139 (1988).
 196. Nriagu, J. O. A global assessment of natural sources of atmospheric trace metals. *Nature* **338**, 47–49 (1989).
 197. Fitzgerald Engstrom, D. R., Mason, R. P., Nater, E. A., W. F., Fitzgerald, W. F., Engstrom, D. R., Mason, R. P. & Nater, E. A. No Title. **32**, (1998).
 198. Barkay, T., Miller, S. M. & Summers, A. O. Bacterial mercury resistance from atoms to ecosystems. *FEMS Microbiol. Rev.* **27**, 355–384 (2003).
 199. Golding, G. R., Kelly, C. A., Sparling, R., Loewen, P. C. & Barkay, T. Evaluation of mercury toxicity as a predictor of mercury bioavailability. *Env. Sci Technol* **41**, 5685–5692 (2007).
 200. Wiatrowski, H. A., Ward, P. M. & Barkay, T. Novel reduction of mercury (II) by mercury-sensitive dissimilatory metal reducing bacteria. *Environ. Sci. Technol.* **40**, 6690–6696 (2006).
 201. Oregaard, G. & Sorensen, S. J. High diversity of bacterial mercuric reductase genes from surface and sub-surface floodplain soil (Oak Ridge, USA). *ISME J* **1**, 453–467 (2007).
 202. Mindlin, S. *et al.* Present-day mercury resistance transposons are common in bacteria preserved in permafrost grounds since the Upper Pleistocene. *Res. Microbiol.* **156**, 994–1004 (2005).
 203. Schelert, J. *et al.* Occurrence and Characterization of Mercury Resistance in the Hyperthermophilic Archaeon *Sulfolobus solfataricus* by Use of Gene Disruption. *J. Bacteriol.* **186**, 427–437 (2004).
 204. Lindberg, S. *et al.* A synthesis of progress and uncertainties in attributing the sources of mercury in deposition. *Ambio* **36**, 19–32 (2007).
 205. Ariya, P. A. *et al.* The Arctic: a sink for mercury. *Tellus Ser. B-Chemical Phys. Meteorol.* **56**, 397–403 (2004).
 206. Douglas, T. A. *et al.* Elevated mercury measured in snow and frost flowers near Arctic sea ice leads. *Geophys. Res. Lett.* **32**, - (2005).
 207. Lu, J. Y. *et al.* A device for sampling and determination of Total Particulate Mercury in ambient air. *Anal. Chem.* **70**, 2403–2408 (1998).
 208. Barrie, L. A., Bottenheim, J. W., Schnell, R. C., Crutzen, P. J. & Rasmussen, R. A. Ozone destruction and photochemical reactions at polar sunrise in the lower Arctic atmosphere. *Nature* **334**, 138–141 (1988).
 209. Lu, J. Y. *et al.* Magnification of atmospheric mercury deposition to polar regions in springtime: the link to tropospheric ozone depletion chemistry. *Geophys. Res. Lett.* **28**, 3219–3222 (2001).
 210. Lindberg, S. E. *et al.* Dynamic Oxidation of Gaseous Mercury in the Arctic Troposphere at Polar Sunrise. *Environ. Sci. Technol.* **36**, 1245–256 (2002).
 211. Skov, H. *et al.* Fate of elemental mercury in the arctic during atmospheric mercury depletion episodes and the load of atmospheric mercury to the arctic. *Environ. Sci. Technol.* **38**, 2373–2382 (2004).
 212. Nriagu, J. O. Mechanistic steps in the photoreduction of mercury in natural waters. *Sci. Total Environ.* **154**, 1–8 (1994).
 213. Ababneh, F. A., Scott, S. L., Al-Reasi, H. A. & Lean, D. R. S. Photochemical reduction and reoxidation of aqueous mercuric chloride in the presence of ferrioxalate and air. *Sci. Total Environ.* **367**, 831–839 (2006).
 214. Dommergue, A., Ferrari, C. P., Poissant, L., Gauchard, P. A. & Boutron, C. F. Diurnal cycles of gaseous mercury within the snowpack at Kuujuarapik/Whapmagoostui, Quebec, Canada. *Env. Sci Technol* **37**, 3289–3297 (2003).
 215. Poulain, A. J. *et al.* Redox transformations of mercury in an Arctic snowpack at springtime. *Atmos. Environ.* **38**, 6763–6774 (2004).
 216. Barkay, T. & Poulain, A. J. Mercury (micro)biogeochemistry in polar environments. *FEMS Microbiol Ecol* **59**, 232–241 (2007).
 217. Constant, P., Poissant, L., Villemur, R., Yumvihoze, E. & Lean, D. Fate of inorganic mercury and methyl mercury within the snow cover in the low arctic tundra on the shore of Hudson Bay (Québec, Canada). *J. Geophys. Res.* **112**, (2007).
 218. Reisch, C. R., Moran, M. A. & Whitman, W. B. Dimethylsulfoniopropionate-dependent demethylase (DmdA) from *Pelagibacter ubique* and *Silicibacter pomeroyi*. *J. Bacteriol.* **190**, 8018–8024 (2008).
 219. Fleming, E. J., Mack, E. E., Green, P. G. & Nelson, D. C. Mercury Methylation from Unexpected Sources: Molybdate-Inhibited Freshwater Sediments and an Iron-Reducing Bacterium. *Appl. Environ. Microbiol.* **72**, 457–464 (2006).
 220. Kerin, E. J. *et al.* Mercury Methylation by Dissimilatory Iron-Reducing Bacteria. *Appl. Environ. Microbiol.* **72**, 7919–7921 (2006).

221. Compeau, G. C. & Bartha, R. Sulfate reducing bacteria: principal methylators of mercury in anoxic estuarine sediment. *Appl. Environ. Microbiol.* **50**, 498–502 (1985).
222. Berman, M., Chase Jr., T. & Bartha, R. Carbon Flow in Mercury Biomethylation by *Desulfovibrio desulfuricans*. *Appl. Environ. Microbiol.* **56**, 298–300 (1990).
223. Choi, S. C., Chase Jr., T., Bartha, R. & Chase Jr., T. Enzymatic catalysis of mercury methylation by *Desulfovibrio desulfuricans* LS. *Appl. Environ. Microbiol.* **60**, 1342–1346 (1994).
224. Parks, J. M. *et al.* The Genetic Basis for Bacterial Mercury Methylation. *Science (80-.)*. **339**, 1049–1052 (2013).
225. Douglas, T. A. & Sturm, M. Arctic haze, mercury and the chemical composition of snow across northwestern Alaska. *Atmos. Environ.* **38**, 805–820 (2004).
226. Brooks, S., Arimoto, R., Lindberg, S. & Southworth, G. Antarctic polar plateau snow surface conversion of deposited oxidized mercury to gaseous elemental mercury with fractional long-term burial. *Atmos. Environ.* **42**, 2877–2884 (2008).
227. Rasmussen, L. D. & Sørensen, S. J. Effects of mercury contamination on the culturable heterotrophic, functional and genetic diversity of the bacterial community in soil. *FEMS Microbiol Ecol* **36**, 1–9 (2001).
228. Maron, P.-A. *et al.* Protein Extraction and Fingerprinting Optimization of Bacterial Communities in Natural Environment. *Microb. Ecol.* **53**, 426–434 (2007).
229. Barkay, T., Gillman, M. & Liebert, C. Genes encoding mercuric reductases from selected gram-negative aquatic bacteria have a low degree of homology with merA of transposon Tn501. *Appl. Environ. Microbiol.* **56**, 1695–1701 (1990).
230. Schaefer, J. K. *et al.* Role of the Bacterial Organomercury Lyase (MerB) in Controlling Methylmercury Accumulation in Mercury-Contaminated Natural Waters. *Environ. Sci. Technol.* **38**, 4304–4311 (2004).
231. Tamames, J. & Moya, A. Estimating the extent of horizontal gene transfer in metagenomic sequences. *BMC Genomics* **9**, 136 (2008).
232. Canchaya, C., Fournous, G., Chibani-Chennoufi, S., Dillmann, M.-L. & Brüssow, H. Phage as agents of lateral gene transfer. *Curr. Opin. Microbiol.* **6**, 417–424 (2003).
233. Weinbauer, M. G. Ecology of prokaryotic viruses. *FEMS Microbiol. Rev.* **28**, 127–81 (2004).
234. Dubey, G. P. & Ben-Yehuda, S. Intercellular nanotubes mediate bacterial communication. *Cell* **144**, 590–600 (2011).
235. Popa, O. & Dagan, T. Trends and barriers to lateral gene transfer in prokaryotes. *Curr. Opin. Microbiol.* **14**, 615–623 (2011).
236. Lang, A. S., Zhaxybayeva, O. & Beatty, J. T. Gene transfer agents: phage-like elements of genetic exchange. *Nat. Rev. Microbiol.* **10**, 472–82 (2012).
237. Barkay, T. & Smets, B. F. Horizontal Gene Flow in Microbial Communities. **71**, 412–419 (2005).
238. Majewski, J. Sexual isolation in bacteria. *FEMS Microbiol. Lett.* **199**, 161–169 (2001).
239. Jiang, S. C. & Paul, J. H. Gene transfer by transduction in the marine environment. *Appl. Environ. Microbiol.* **64**, 2780–7 (1998).
240. Del Casale, A., Flanagan, P. V., Larkin, M. J., Allen, C. C. R. & Kulakov, L. a. Analysis of transduction in wastewater bacterial populations by targeting the phage-derived 16S rRNA gene sequences. *FEMS Microbiol. Ecol.* **76**, 100–108 (2011).
241. Solheim, H. T., Sekse, C., Urdahl, A. M., Wasteson, Y. & Nesse, L. L. Biofilm as an environment for dissemination of stx genes by transduction. *Appl. Environ. Microbiol.* **79**, 896–900 (2013).
242. Lindell, D., Jaffe, J. D., Johnson, Z. I., Church, G. M. & Chisholm, S. W. Photosynthesis genes in marine viruses yield proteins during host infection. *Nature* **438**, 86–9 (2005).
243. Hurwitz, B. L., Hallam, S. J. & Sullivan, M. B. Metabolic reprogramming by viruses in the sunlit and dark ocean. *Genome Biol.* **14**, R123 (2013).
244. Lindell, D. *et al.* Transfer of photosynthesis genes to and from *Prochlorococcus* viruses. *Proc. Natl. Acad. Sci. U. S. A.* **101**, 11013–8 (2004).
245. Rohwer, F. & Thurber, R. V. Viruses manipulate the marine environment. *Nature* **459**, 207–212 (2009).
246. Anderson, R. E., Brazelton, W. J. & Baross, J. a. Using CRISPRs as a metagenomic tool to identify microbial hosts of a diffuse flow hydrothermal vent viral assemblage. *FEMS Microbiol. Ecol.* **77**, 120–33 (2011).
247. Fineran, P. C. & Charpentier, E. Memory of viral infections by CRISPR-Cas adaptive immune systems: acquisition of new information. *Virology* **434**, 202–9 (2012).
248. Terns, M. P. & Terns, R. M. CRISPR-based adaptive immune systems. *Curr. Opin. Microbiol.* **14**, 321–7 (2011).
249. Barrangou, R. *et al.* CRISPR provides acquired resistance against viruses in prokaryotes. *Science* **315**,

- 1709–12 (2007).
250. Kawasaki, T. *et al.* Genomic characterization of *Ralstonia solanacearum* phage phiRSB1, a T7-like wide-host-range phage. *J. Bacteriol.* **191**, 422–7 (2009).
 251. Vandamme, P. & Coenye, T. Taxonomy of the genus *Cupriavidus*: a tale of lost and found. *Int. J. Syst. Evol. Microbiol.* **54**, 2285–9 (2004).
 252. von Rozycki, T. & Nies, D. H. *Cupriavidus metallidurans*: evolution of a metal-resistant bacterium. *Antonie Van Leeuwenhoek* **96**, 115–39 (2009).
 253. Meyer, F. *et al.* The metagenomics RAST server - a public resource for the automatic phylogenetic and functional analysis of metagenomes. *BMC Bioinformatics* **9**, 386 (2008).
 254. Sano, E., Carlson, S., Wegley, L. & Rohwer, F. Movement of Viruses between Biomes. *Appl. Environ. Microbiol.* **70**, 5842–5846 (2004).
 255. Greene, S. E. & Reid, A. Viruses Throughout Life & Time: Friends, Foes, Change Agents. 1–28 (2013).
 256. Rohwer, F., Prangishvili, D. & Lindell, D. Roles of viruses in the environment. *Environmental Microbiology* **11**, 2771–2774 (2009).
 257. Kenzaka, T., Tani, K. & Nasu, M. High-frequency phage-mediated gene transfer in freshwater environments determined at single-cell level. *ISME J.* **4**, 648–659 (2010).
 258. Koskella, B. & Meaden, S. Understanding bacteriophage specificity in natural microbial communities. *Viruses* **5**, 806–23 (2013).
 259. Filée, J., Tétart, F., Suttle, C. a & Krisch, H. M. Marine T4-type bacteriophages, a ubiquitous component of the dark matter of the biosphere. *Proc. Natl. Acad. Sci. U. S. A.* **102**, 12471–6 (2005).
 260. Matilla, M. A. & Salmond, G. P. C. Bacteriophage ϕ MAM1, a viunlikevirus, is a broad-host-range, high-efficiency generalized transducer that infects environmental and clinical isolates of the enterobacterial genera *Serratia* and *Kluyvera*. *Appl. Environ. Microbiol.* **80**, 6446–57 (2014).
 261. Gunde-Cimerman, N. *et al.* Extremophilic fungi in arctic ice: a relationship between adaptation to low temperature and water activity. *Phys. Chem. Earth, Parts A/B/C* **28**, 1273–1278 (2003).
 262. Schmidt, S. K., Naff, C. S. & Lynch, R. C. Fungal communities at the edge: Ecological lessons from high alpine fungi. *Fungal Ecol.* **5**, 443–452 (2012).
 263. Bugg, T. D. H., Ahmad, M., Hardiman, E. M. & Rahmanpour, R. Pathways for degradation of lignin in bacteria and fungi. *Nat. Prod. Rep.* **28**, 1883–96 (2011).
 264. Berry, D. & Widder, S. Deciphering microbial interactions and detecting keystone species with co-occurrence networks. *Front. Microbiol.* **5**, 219 (2014).
 265. Folwell, B. D., McGenity, T. J. & Whitby, C. Biofilm and Planktonic Bacterial and Fungal Communities Transforming High-Molecular-Weight Polycyclic Aromatic Hydrocarbons. *Appl. Environ. Microbiol.* **82**, 2288–2299 (2016).
 266. Faust, K. *et al.* Cross-biome comparison of microbial association networks. *Front. Microbiol.* **6**, 1200 (2015).
 267. Lei, Y. D. Y. D. & Wania, F. Is rain or snow a more efficient scavenger of organic chemicals? *Atmos. Environ.* **38**, 3557–3571 (2004).
 268. Domine, F., Cincinelli, A., Bonnaud, E., Martellini, T. & Picaud, S. Adsorption of Phenanthrene on Natural Snow. *Environ. Sci. Technol.* **41**, 6033–6038 (2007).
 269. Bock, J. & Jacobi, H. W. Development of a mechanism for nitrate photochemistry in snow. *J Phys Chem A* **114**, 1790–1796 (2011).
 270. Yang, J. *et al.* Impacts of snowpack emissions on deduced levels of OH and peroxy radicals at Summit, Greenland. *Atmos. Environ.* **36**, 2523–2534 (2002).
 271. Voisin, D. *et al.* Carbonaceous species and humic like substances (HULIS) in Arctic snowpack during OASIS field campaign in Barrow. *J. Geophys. Res. Atmos.* **117**, (2012).
 272. Bianchi, T. S. The role of terrestrially derived organic carbon in the coastal ocean: A changing paradigm and the priming effect. *Proc. Natl. Acad. Sci.* **108**, 19473–19481 (2011).
 273. Klán, P. & Holoubek, I. Ice (photo)chemistry. Ice as a medium for long-term (photo)chemical transformations - Environmental implications. *Chemosphere* **46**, 1201–1210 (2002).
 274. Bartels-Rausch, T. *et al.* Relationship between snow microstructure and physical and chemical processes. *Atmos. Chem. Phys. Discuss.* **12**, 30409–30541 (2012).
 275. Grannas, A. M. *et al.* The role of the global cryosphere in the fate of organic contaminants. *Atmos. Chem. Phys.* **13**, 3271–3305 (2013).
 276. Bertilsson, S. & Tranvik, L. J. Photochemically produced carboxylic acids as substrates for freshwater bacterioplankton. *Limnol. Oceanogr.* **43**, 885–895 (1998).
 277. Anesio, A. M. *et al.* Effect of Humic Substance Photodegradation on Bacterial Growth and Respiration in

- Lake Water Effect of Humic Substance Photodegradation on Bacterial Growth and Respiration in Lake Water. *Appl. Environ. Microbiol.* **71**, 6267–6275 (2005).
278. Bertilsson, S. & Tranvik, L. J. Photochemical transformation of dissolved organic matter in lakes. *Limnol. Oceanogr.* **45**, 753–762 (2000).
279. Tranvik, L. J. & Bertilsson, S. Contrasting effects of solar UV radiation on dissolved organic sources for bacterial growth. *Ecol. Lett.* **4**, 458–463 (2001).
280. AMON, R. M. W. & BENNER, R. Bacterial utilization of different size classes of dissolved organic matter. *Limnol. Oceanogr.* **41**, 41–51 (1996).

Annex Curriculum Vitae

CATHERINE LAROSE

Ecole Centrale de Lyon, Université de Lyon, 36 avenue Guy de Collongue, Ecully Cedex, 69134
e-mail: catherine.larose@ec-lyon.fr, tel: +33669719019

PERSONAL PROFILE

Catherine Larose is a newly recruited CNRS CR2 (2013) who completed her PhD in Earth Sciences in 2010. She has published over 15 articles related to biogeochemistry, contaminant cycling and extreme environments (h = 13) and is developing one of the only French Arctic snow microbiology research themes at the EMG laboratory. Catherine Larose has participated and led over 10 field campaigns in the Arctic and is regularly an invited lecturer at international conferences (ex: Jacques Monod, Polar and Alpine Microbiology, Bageco). CL is co-supervising three PhD projects (financed by NORA and Trainbiodiverse ITN training networks, 2 have defended in 2015) and is an associate editor of *Frontiers in Terrestrial Microbiology* (Nature Publishing Group). She is also a work package leader for the recently financed ITN grant MicroArctic, related to microorganisms in arctic terrestrial ecosystems. The EMG group has been a pioneer (since the 1990's) in the development of new methodologies for extraction and purification of DNA from various environments.

EDUCATION

2007-2010 Doctorat Sciences de la Terre, Univers, Environnement, Université de Grenoble, France, Laboratoire de Glaciologie et Géophysique de l'Environnement et le Laboratoire d'Adaptation et Pathogénie Microbienne

Titre: Interactions entre composition chimique et populations microbiennes de la neige: quelles sont les conséquences sur le cycle du mercure en Arctique ?

2004-2006 M.Sc. Sciences de l'environnement, Université du Québec à Montréal (UQÀM), Canada, Centre de Recherche en Géochimie et en Géodynamique (GEOTOP) et le Réseau collaboratif de recherche sur le mercure (COMERN). Directeur de recherche : M. Lucotte, Professeur, UQÀM

Titre: Toxicocinétique du mercure chez le doré et la perchaude dans les lacs de la forêt boréale.

2001-2004 B.Sc. Sciences biologiques, Université du Québec à Montréal, Canada

Projet de recherche: Validation d'un protocole de préparation des échantillons en vue de la détermination des taux de production photochimique et métabolique de CO₂

EMPLOYMENT

2013-present CNRS research scientist, Section 30, Environmental microbial genomics group, University of Lyon

2010-2013 Post doctoral fellow, Environmental microbial genomics group, University of Lyon

PROFESSIONAL MEMBERSHIPS

I am a founding member of the European Polar and Alpine Microbiology society.

I am also on the editorial board of *Frontiers in Microbiology*, part of the Nature Group publications.

SKILLS

- Molecular Ecology : DNA, RNA protein extraction from complex environments, molecular fingerprinting (RISA), cloning-sequencing, quantitative PCR, omics techniques (preparing libraries, sequencing), DNA microarrays.
- Microbiology : isolation, aerobic and anaerobic cultures, micro and meso cosm work
- Biology : enzyme activity measurements, protein extraction and dosing, animal physiology, health bioindicators
- Analytical chemistry : GC (CO₂ and methane), GC/MS (PCBs in soils and sediments), CVAFS (mercury analysis in snow, soil and animal tissue samples), ion chromatography, atomic absorbance (Fe-Mn in water), spectrometry, radiometry
- Statistics : Biostatistics (population analysis, multivariate analysis) in R, JMP and bioinformatics (sequence analyses)
- Extensive experience in Arctic and cold environment (Canada, Greenland, Svalbard) field work: more than 10 years of expeditions as a member and over 10 field campaigns as the expedition leader

RESEARCH

My research focuses on understanding the the relationships between chemical parameters including a central contaminant such as mercury in arctic snowpacks and the microbial communities inhabiting them. Through a number of field studies, we have examined microbial community structure in the snow during the spring in different types of snow and identified potential changes in diversity, activity, function and sources (atmospheric deposition, sea aerosols, etc.) of microbial populations. Snow chemistry (inorganic ions, organic acids, pH, carbon and contaminants) was also studied in detail and related to microbial data (Larose et al, 2013b). We focused mainly on the environmental sources of mercury (Hg) species (bioavailable Hg and methylmercury) and their fate and transfer in the Arctic environment. These results were published in a series of papers (over 10 papers since 2007) and allowed us to improve our understanding of community dynamics in the snow, allowing us to gain insights on potential drivers of the snow ecosystem, and the drivers of mercury cycling in Arctic snow. We were able to experiment with new techniques to analyze microbial community function, such as bioreporters for measuring mercury and omics approaches. Through these studies, we have been able to identify key aspects that impact snow and ice ecosystem functioning in Svalbard (e.g. Maccario et al., 2014, Sanguino et al., 2015).

MENTORING

2016: 4 PhDs will be recruited to work on cryosphere and atmosphere microbiology

Carolina Hoyos (post-doctoral researcher) 2015-present: Microbial adaptations to extreme environments

Christoph Keuschnig (ITN Marie-Curie PhD), 2014-present: Biogeochemical cycling of nitrogen, role of microbial communities (2 publications under review)

Laura Sanguino (ITN Marie-Curie PhD) 2012-2015: Exploring environmental virus-host interactions and their relevance to microbial adaptation using CRISPRs (2 publications, 1 under review)

Lorrie Maccario (PhD) 2012-2015: Snow Ecosystem: Microbial community structure and function in Arctic snowpacks (2 publications, 1 under review)

Adrien Boniface (M2, ENS) 2015: Adaptation et écologie des communautés microbiennes de la neige

Anthony Morris (TFE ECL) 2015: Arctic snow microbial community responses to increases in temperature and carbon inputs

Sebastien David (M2) 2014-2015: Impact des radionucléides sur la structuration microbienne des sols de Fukushima

Eric Capo (M2) 2012-2013: Potentiel de dégradation des hydrocarbures des microorganismes de la neige

2003-present: Training of undergraduate and master's students in field (north of Québec, Arctic) and laboratory techniques. I helped define research projects, supervised lab and field work and help revise and prepare reports and oral presentations.

ADMINISTRATION

Member of the International Organizing Committee of the 5th International Polar and Alpine Microbiology Conference in Montana (2013). Organization of a session at the Goldschmidt Conference, 2015.

ACADEMIC AWARDS

2007-2009 PhD scholarship, excellence award, FQRNT (Fonds de recherche sur la nature et les technologies, Canadian funding agency)

2005-2006 Master's scholarship, excellence award, FQRNT (Fonds de recherche sur la nature et les technologies, Canadian funding agency)

2003 Undergraduate research scholarship, excellence award, NSERC, Natural Science and Engineering Council of Canada

FUNDING

2016 **Several different projects were funded in 2016:**

PARCS (Chantier Arctique, PI : Kathy Law), improving understanding about the sources and fate of Arctic pollution and its impacts on climate, ecosystems and human society. (650k€)

INHALE: Investigations of tHe Atmosphere as a real Ecosystem, (PI A. Dommergue): Composition, functioning and dynamics of microbial communities in the atmosphere, impact on biogeochemical cycling (350k€)

MicroArctic Call: H2020-MSCA-ITN-2015, (PI, A Anesio, Bristol University, C.Larose is workpackage leader, funded): understanding of the Arctic environment and the factors that impact ecosystem and organism response to the warming Arctic

Community Coordinated Snow Study in Svalbard (C2S3): 24 scientists from 15 institutes in 8 different countries: relationships and interactions that link carbon aerosols in the Arctic snowpack with other physical and chemical properties of snow, and to establish if and/or how these properties affect, or are affected by, microbial communities in the snowpack (100k€).

Montre-moi ta langue: (PIs M. Suchet, PL Patoine, University of Sorbonne, C Larose, ECL) a collaborative project linking literature and microbiology in cold environments

- 2015** French polar institute IPEV (Institut Polaire Emile Victor) project : ALCHEMI, 2015-2018): Microbial functioning in the Arctic (100k€)
- 2011** French polar institute IPEV (Institut Polaire Emile Victor) project : CHIMERPOL III, 2011-2014): Dynamics of the snow ecosystem in the Arctic (100k€)
- 2010** Environmental engineering grant National French research Institute CNRS – CEMAGREF : Metaproteomic approaches for understanding PCB bioremediation (40k€)
- 2009** ARCFAC (European Centre for Arctic Environmental Research): WAMAS, Winter assessment of mercury processes in the arctic snowpack (12k€)

Publications

1. Maccario L, Sanguino L, Vogel TM, **Larose C.**, 2015. Snow and ice ecosystems: not so extreme. *Res Microbiol.* 166(10):782-95. doi: 10.1016/j.resmic.2015.09.002.
2. Sanguino, L., Franqueville L., Vogel, T. M. and **Larose, C.**, 2015. Linking environmental prokaryotic viruses and their host through CRISPRs. *FEMS Microbiology Ecology.* Doi:10.1093/femsec/fiv046
3. Maccario L, Vogel TM, **Larose C.**, 2014. Potential drivers of microbial community structure and function in Arctic spring snow. *Front Microbiol.* 5: 413.
4. **Larose, C.**, Cecillon, S., Prestat, E., Malandain, C., Berger, S., Lyon, D., Dommergue, A., Ferrari, C., Schneider, D., Vogel, T. Interactions between snow chemistry, mercury contamination and microbial population dynamics in an Arctic snowpack. 2013. *PLoS ONE.* 8(11).
5. **Larose, C.**, Dommergue, A., Vogel, T. M. 2013. Microbial nitrogen cycling in Arctic snowpacks. 2013. *Environmental Research Letters.* 8(3).
6. Bowman J. S., **Larose C.**, Vogel T. M., Deming J. W. 2013. Dominance of the surface of young sea ice by Rhizobium spp., widely distributed bacterial members of the polar marine rare biosphere. *Environmental Microbiology Reports.* doi: 10.1111/1758-2229.12047
7. **Larose, C.**, Dommergue, A., Vogel, T. M. 2014. The dynamic Arctic Snow Pack: An Unexplored Environment for Microbial Diversity and Activity. *Biology.* 2(1): 317-330.
8. Douglas, T. A., Loseto, L., Macdonald, R. W., Outridge, P., Dommergue, A., Poulain, A. Amyot, M., Barkay, T., Berg, T., Chételat, J., Constant, P., Evans, M., Ferrari, C., Gantner, N., Johnson, M. S., Kirk, J., Kroer, N., **Larose, C.**, Lean, D., Muir, D., Nielsen, T. G., Poissant, L., Rognerud, S., Skov, H., Sørensen, S., Wang, F., Zdanowicz, C. M. 2013. The ultimate fate of mercury deposited to arctic terrestrial and aquatic ecosystems, a review. *Environmental Chemistry.* 9 (4): 321-355.
9. **Larose, C.**, Dommergue, A., Maruszczak, N., Ferrari, C. P., Schneider, D. 2011. Bioavailable Mercury Cycling in Polar Snowpacks. *Environmental Science & Technology* 45(6): 2150-2156.
10. Castro, L., Dommergue, A., **Larose, C.**, Ferrari, C., Maron, L. 2011. A theoretical study of abiotic methylation reactions of gaseous elemental mercury by halogen containing molecules. *Journal of Physical Chemistry A* 115(22): 5602-5608.
11. Delmont, T., Malandain, C., Prestat, E., **Larose, C.**, Monier, J. M., Simonet, P., Vogel, T. M. 2011. Metagenomic Mining for Microbiologists. *The ISME Journal* <http://dx.doi.org/10.1038/ismej.2011.61>

12. Maruszczak, N., **Larose, C.**, Dommergue, A., Nedjai, R., and Ferrari, C.P. 2011. Post-winter deposition of total mercury and methylmercury in high altitude surface snow from the French Alps. *Science of the Total Environment* 409(19): 3949-3954.
13. Maruszczak, N., **Larose, C.**, Dommergue, A., Paquet, S., Beaulne, J.S., Maury-Brachet, R., Lucotte, M., Nedjai, R., and Ferrari, C.P. 2011. Mercury and methylmercury concentration in high altitude lakes and fish populations from the French Alps related to watershed characteristics. *Science of the Total Environment* 409(10): 1909-1915.
14. **Larose, C.**, Dommergue, A., De Angelis, M., Cossa, D., Averty, B., Maruszczak, N., Soumis, N., Schneider, D., Ferrari, C., 2010. Seasonal changes in snow chemistry lead to new insights into mercury methylation in the Arctic. *Geochimica et Cosmochimica Acta* 74(22): 6263-6275.
15. **Larose, C.**, Berger, S., Ferrari, C. P., Navarro, E., Dommergue, A., Schneider, D., Vogel, T. M., 2010. Microbial sequences retrieved from environmental samples from seasonal Arctic snow and meltwater from Svalbard, Norway. *Extremophiles* 14(2):205-212.
16. Dommergue, A., **Larose, C.**, Faïn, X., Clarisse, O., Foucher, D., Hintelmann, H., Schneider, D., Ferrari, C. P., 2010. Deposition of mercury species in the Ny-Ålesund Area (79°N) and their transfer during snowmelt. *Environmental Science & Technology* 44(3):901-907.
17. **Larose, C.**, **Canuel, R.**, **Lucotte, M.** and **Di Giulio, R.T.**, 2008. Toxicological effects of methylmercury on walleye (*Sander vitreus*) and perch (*Perca flavescens*) from lakes of the boreal forest. *Comparative Biochemistry and Physiology Part C: Toxicology & Pharmacology*, 147(2):139-49.
18. Soumis, N., Lucotte, M., **Larose, C.**, Veillette, F. and Canuel, R., 2007. Photomineralization in a boreal hydroelectric reservoir: a comparison with natural aquatic ecosystems *Biogeochemistry* 86(2):123-135.
19. Canuel, R., de Grosbois, S. B., Lucotte, M., Atikessse, L., **Larose, C.**, Rheault, I., 2006. New evidence on the effects of tea on mercury metabolism in humans. *Archives of Environmental & Occupational Health* 61(5):232-238.
20. Garceau, S., Lucotte, M., Simoneau, M., Laliberté, D. and **Larose, C.**, 2004. Fish growth rates control mercury concentrations in certain sport fishes species from Eastern Canadian lakes. *RMZ-Materials and Geoenvironment* 51(2): 985-989.

Book chapters:

Soumis, N., Lucotte, M., Duchemin, É., Weissenberger, S., Canuel, R., Houel, S. and **Larose, C.**, 2006. Hydroelectric reservoirs as anthropogenic sources of greenhouse gases. In *Water Encyclopedia. Volume 3: Surface and agricultural water*, ed. J. H. Lehr et J. Keeley. p. 203-210. Hoboken, NJ: John Wiley & Sons.

Reports:

Douglas, T., Amyot, M., Barkay, T., Berg, T., Chételat, J., Constant, P., Dommergue, A., Evans, M., Ferrari, C., Gantner, L., Johnson, M., Kirk, J., Kroer, N., **Larose, C.**, Lean, D., Loseto, L., Macdonald, R., Muir, D., Nielsen, G., Outridge, P., Poulain, A., Poissant, L., Rognerud, S., Skov, H., Sørensen, S., Wang, F., 2011. Chapter 3: What is the fate of mercury entering the Arctic environment? In **AMAP Assessment: Mercury in the Arctic. Arctic Monitoring and Assessment Programme (AMAP)**. Oslo, Norway.