



HAL
open science

Energy-Aware Routing in Carrier Grade Ethernet Networks

Rihab Abid Maaloul

► **To cite this version:**

Rihab Abid Maaloul. Energy-Aware Routing in Carrier Grade Ethernet Networks. Networking and Internet Architecture [cs.NI]. Ecole Nationale d'Ingénieurs de Sfax, 2018. English. NNT: . tel-01965278

HAL Id: tel-01965278

<https://hal.science/tel-01965278v1>

Submitted on 25 Dec 2018

HAL is a multi-disciplinary open access archive for the deposit and dissemination of scientific research documents, whether they are published or not. The documents may come from teaching and research institutions in France or abroad, or from public or private research centers.

L'archive ouverte pluridisciplinaire **HAL**, est destinée au dépôt et à la diffusion de documents scientifiques de niveau recherche, publiés ou non, émanant des établissements d'enseignement et de recherche français ou étrangers, des laboratoires publics ou privés.



DISSERTATION

Presented to
The National Engineering School of Sfax

In partial fulfillment of the requirements for the degree of

DOCTOR OF PHILOSOPHY

In Computer System Engineering
by

Rihab MAALOUL

(Master of Research in Computer Science and Multimedia)

Energy-Aware Routing in Carrier Grade Ethernet Networks

Defended on April 21, 2018 in front of the committee formed of:

Mr. Abdennaceur KACHOURI (Professor-ENIS)	Chair
Mr. Zied CHOUKAIR (Professor-SupCom)	Reviewer
Mr. Slim REKHIS (Professor -SupCom)	Reviewer
Mr. Chokri BEN AMAR (Professor – ENIS)	Examiner
Mrs. Lamia CHAARI (Professor - ISIMS)	Supervisor
Mrs. Raouia TAKTAK (Assistant-professor - ISIMS)	Co-supervisor

Dedication

To my family,
and to all the friends
who supported me along these years. . .

Acknowledgements

A special thanks goes to my supervisor, Prof. Lamia CHAARI, who gave me the opportunity to start the Ph.D. I want to thank her for her suggestions and for her motivation that she puts in me.

My deepest gratitude goes to Prof. Bernard COUSIN, my internship supervisor, who taught me so many valuable things and whose contribution has been fundamental along these years. I want to thank him for his help, and for his cooperation.

I am also grateful to Dr. Raouia TAKTAK, who helped me to accomplish this work. I want to thank her for her valuable contribution.

A special thanks goes also to Prof. Abdennaceur KACHOURI my committee chairman for his expertise and precious time for agreeing to serve on my committee.

Last but not least, I should thank my committee members who were more than generous with their expertise and precious time. Thank you Prof. Zied CHOUKAIR, Prof. Slim REKHIS and Prof. Chokri BEN AMAR for agreeing to serve on my committee.

Abstract

Doctor of Philosophy

Energy Aware Routing in Carrier Grade Ethernet Networks

by Rihab MAALOUL

The reduction of energy consumption is a major concern for Telecom operators and Internet Service Providers (ISPs). This thesis addresses the problem of energy efficiency in the wired communication networks using Ethernet-based technology. We study the most relevant models of energy-aware routing which are Carrier-grade Ethernet compliant. For every routing model, we present mathematical formulation as an exact method based on linear programming. In addition, we propose a set of heuristic algorithms suitable for large-sized networks. In order to better understand the possible ways to limit energy consumption in Metro Ethernet systems, the first part of this thesis is to survey and classify the main approaches related to energy saving on IP networks that could be adapted to Metro Ethernet systems. The second part is devoted to the implementation of new energy-efficient routing models and algorithms for Carrier Ethernet networks. We present two models which are compliant with SPB (Shortest Path Bridging protocol, IEEE 802.1aq). The first model can be categorized as a topology oriented model that ignores the network traffic in sleeping decision. Whereas the second, can be categorized as traffic oriented model, that takes into account the network traffic matrices in sleeping decision. Afterwards, we deal with energy aware routing with SDN (Software Defined Network) approach. Finally, we evaluate the impact of our algorithms on the most relevant network performance metrics such as the network connectivity, the average paths length, the average traffic load, network reliability and the fairness of traffic distribution. The experiments on several realistic network topologies showed that our models could achieve a significant amount of energy saving while maintaining an acceptable network performance.

Contents

Acknowledgements	v
Abstract	vii
1 Energy Saving Carrier-Grade Networks	5
1.1 Background and motivation	5
1.2 Principal Contributors to Network Energy Consumption . . .	7
1.2.1 Network devices	8
1.2.2 Network architecture	10
1.2.3 Services	12
1.3 Building a green network	13
1.4 Energy profiles	17
1.5 Cost and power consumption in optical network	20
1.5.1 Network Node Architectures	21
1.5.2 Analytical model for the energy consumption of a WDM optical network	23
1.5.3 Cost and power consumption	24
1.6 Conclusion	28
2 Green networking approaches	29
2.1 Introduction	29
2.2 Taxonomy of green networking approaches	31
2.2.1 Node level	31
2.2.2 Network level	36
2.3 Issues in Carrier-grade networks	47
2.4 Conclusion	50
3 Energy-aware Forwarding Strategy for Metro Ethernet Networks	53
3.1 Introduction	53
3.2 Carrier grade Ethernet	54
3.3 Related work	56
3.4 Problem formulation	57

3.4.1	Network model and notations	58
3.4.2	EAR description	59
3.4.3	MEEAFS algorithm	61
3.5	Performance analysis	66
3.6	Conclusion and future work	70
4	Equal Cost Multiple Path Energy-Aware Routing in Carrier-Ethernet Networks with Bundled Links	73
4.1	Introduction	73
4.2	Related Works	75
4.3	Green ECMP routing problem	76
4.3.1	Network model and notations	76
4.3.2	Problem Formulation	77
4.4	Heuristic Algorithms	81
4.4.1	Green SPB (G-SPB)	81
4.4.2	Fast Greedy SPB (FG-SPB)	82
4.5	Performance analysis	83
4.6	Conclusion	91
5	Energy-aware Routing in Carrier-Grade Ethernet using SDN Approach	93
5.1	Introduction	93
5.2	Related Works	95
5.2.1	Energy-Aware Routing in traditional architectures	95
5.2.2	Energy-Aware Routing for SDN	97
5.2.3	Optimizing rule space in Openflow forwarding node	98
5.3	Problem statement and formulation	99
5.3.1	Problem statement	99
5.3.2	Binary integer linear programming model	101
5.4	Heuristic Algorithms	103
5.5	Performance analysis	108
5.5.1	Performance metrics	108
5.5.2	Experimental context	109
5.5.3	Computational results	111
	Optimal vs. heuristic solutions for Abilene network	111
	Optimal vs. heuristic solutions for various network topologies	112
	Heuristics performances analysis	115
5.6	Conclusion	122

6 Two Node Disjoint Path Routing for Energy Efficiency and Network Reliability	123
6.1 Introduction	123
6.2 Networks survivability	123
6.3 Disjoint path computation	127
6.4 Problem statement and related works	129
6.5 ILP formulations	134
6.5.1 Flow-based formulation	134
Undirected graphs	134
Directed graphs	136
6.5.2 Cut-based formulation	136
Undirected graph	136
Directed graphs	138
6.6 Heuristic-based algorithms	138
6.7 Experimental results	139
6.7.1 Performance metrics	139
TNDP-EAR vs. GreenTNDP _{basic} solutions	141
Route reliability	145
6.8 Conclusion	148
Bibliography	153

List of Figures

1.1	Estimated OPEX for the European telcos' network infrastructures in the "Business-As-Usual" (BAU) and in the Eco sustainable (ECO) scenarios, and cumulative savings between the two scenarios [4]	6
1.2	Overall network energy consumption	8
1.3	Energy use of network equipment	10
1.4	Key issues for greening networks	13
1.5	Proposed Energy Profile [56]	17
1.6	Load-dependent energy consumption [62]	19
1.7	Energy profiles in various AR states in the presence of LPI primitives and the resulting optimal device energy profile [5]	20
1.8	Opaque network architecture [73]	21
1.9	Transparent network architecture [73]	22
1.10	OXC architecture [79]	25
1.11	Fiber link model [79]	25
1.12	Normalised cost and power consumption for Ethernet Carrier-grade nodes	26
1.13	Normalised cost and power consumption for an OADM	26
1.14	Normalized cost and power consumption of WDM network components	27
2.1	Taxonomy of green networking approach	31
2.2	Relative power consumption for different periods of EEE	35
2.3	Network connectivity proxy	37
2.4	Example of the link weight optimization adopted in [158]	43
2.5	General overview of ETE [161]	44
2.6	Limited rule space in OpenFlow switches [174]	46
3.1	Traditional and carrier Ethernet technologies [199]	55
3.2	Evolution of Ethernet Data-link Layer	56
3.3	Topology planning of MEEAFS	62
3.4	Illustrative example for MEEAFS phases (1) and (2)	63

3.5	Flowchart describing the operation of MEEAFS	64
3.6	Energy saving versus link load threshold	67
3.7	Energy saving versus link load threshold (medium and high load)	67
3.8	Average traffic load in active links at medium load	68
3.9	Average traffic load in active links at high load	69
3.10	Fairness index versus link load threshold at medium load	70
3.11	Fairness index versus link load threshold at high load	70
4.1	Load sharing with ECMP	74
4.2	Bundled links	75
4.3	Example of network topology for EAR	79
4.4	G-SPB diagram	82
4.5	FG-SPB diagram	83
4.6	Daily traffic for different networks	84
4.7	Over-cost induced by G-SPB heuristic	87
4.8	Over-cost induced by FG-SPB heuristic	87
4.9	Atlanta network	87
4.10	Germany50 network	88
4.11	NobelGermany network	88
4.12	Polska network	88
4.13	Atlanta network	89
4.14	Germany50 network	89
4.15	NobelGermany network	89
4.16	Polska network	90
5.1	Traditional networking versus SDN networking	94
5.2	Example of EAR	100
5.3	Stored rules in node 4	101
5.4	Heuristic diagram.	104
5.5	Software architecture running inside SDN-based network	105
5.6	Daily traffic for different networks	110
5.7	The Abilene Network using the ILP model	112
5.8	The Abilene Network using MP-MP heuristic	113
5.9	Paths hops increase for Abilene Network	113
5.10	Paths hops increase by MP-MP heuristic using $TM1$	118
5.11	Turned off links versus μ using different combinations of sorting criteria for $TM1$	119

5.12 Percentage of turned off links $\eta_{L_{off}}$ using <i>TM1</i> scaled by γ with the MP-MP heuristic	120
5.13 Percentage of turned off links $\eta_{L_{off}}$ using <i>TM2</i> scaled by γ with the MP-MP heuristic	120
5.14 Percentage of turned off nodes $\eta_{N_{off}}$ using <i>TM2</i> scaled by γ with the MP-MP heuristic	120
5.15 Trade-off between power saving and network congestion . . .	121
5.16 Fairness index versus ρ using <i>TM1</i> with the MP-MP heuristic	121
6.1 Resilient schemes	124
6.2 Resilience at different layers [189]	125
6.3 A cut $\delta_G(W)$	126
6.4 A cut $\delta_G^+(W)$	127
6.5 Node splitting [244]	128
6.6 Directivity transformation [244]	128
6.7 Example of k node-disjoint source destination paths	132
6.8 Example of routing solution for TNDP-EAR	134
6.9 Atlanta network	142
6.10 Dfn-bwin network	143
6.11 Di-yuan network	143
6.12 Nobel-germany network	144
6.13 Pdh network	144
6.14 Polska network	144
6.15 CDF of routing reliability on Atlanta	146
6.16 CDF of routing reliability on Dfn-bwin	146
6.17 CDF of routing reliability on Di-yuan	146
6.18 CDF of routing reliability on Nobel-germany	147
6.19 CDF of routing reliability on Pdh	147
6.20 CDF of routing reliability on Polska	147

List of Tables

1	Publications	3
1.1	Power consumption summary for network devices [20]	9
1.2	Power consumption for major components of typical server [27]	9
1.3	Power consumption for WAN interfaces [28]	10
1.4	2015–2020 Network forecast/device density and energy requirements in the Business-As-Usual (BAU). Example based on the Italian network [31]	11
1.5	Renewable electricity and carbon reduction goals for leading ICT organization [60]	16
2.1	Focus concepts of this study vis-a-vis related surveys	32
2.2	Indicative energy saving and transition times for COTS (Commercial Off-The-Shelf) [120]	37
2.3	Comparison of virtualised routing techniques [131]	39
2.4	Taxonomy of undertaken green networking approaches	48
3.1	Summary of notation	60
4.1	Summary of notations and parameters	78
4.2	SPB-EAR formulation	85
4.3	G-SPB heuristic algorithm	86
4.4	FG-SPB heuristic algorithm	86
5.1	Similarities and differences between our work and the closest ones	99
5.2	Routing rules for Figure 5.2c (where each node can store at most three rules)	100
5.3	Summary of notations	103
5.4	Combination of sorting criteria for the first-fit heuristics	106
5.5	Properties of network topologies	109
5.6	Percentage of pass-through nodes for $TM2$	110
5.7	ILP formulation using $TM1$	115
5.8	Heuristic algorithms using $TM1$	116

5.9	ILP formulation using $TM2$	116
5.10	Heuristic algorithms using $TM2$	117
6.1	Main properties of this study with respect to the closest proposals	131
6.2	Summary of notations and parameters	133
6.3	ILP formulation (TNDP-EAR)	141
6.4	Heuristic algorithm (GreenTNDP _{basic})	142
6.5	Energy saving and average route reliability	148

List of Abbreviations

CAPEX	Capital Expenditure
CMCF	Capacitated Multi Commodity Flow
EAR	Energy-Aware Routing
ECMP	Equal-Cost Multi-Path
FG-SPB	FastGreedy SPB
G-SPB	GreenSPB
ICT	Information and Communication Technology
ILP	Integear Linear Program
IP	Internet Protocol
IS-IS	Intermediate System to Intermediate System
ISP	Internet Service Provider
MAN	Metro Area Network
MEEAFS	Metro Ethernet Energy-Aware Forwarding Strategy
MILP	Mixed Integear Linear Program
MSPT	Modified Shortest Path Tree
OPEX	Operational Expenditure
TCAM	Ternary Content Addressable Memory
SDN	Soft-Defined Network
SPB	Shortest Path Bridging
SPT	Shortest Path Tree
QoS	Quality of Service
TE	Traffic Engineering
TNDP	Two Node Disjoint Path
WAN	Wide Area Network

General Introduction

Context

In recent years, significant innovations have been elaborated to Ethernet standards to meet the requirements of next-generation high-speed networks that can support innovative applications. This makes Ethernet a widely used technology deployed at all levels of network architectures (access, metropolitan and extended). For instance, carrier Ethernet is massively used to deliver data center applications that involve high performance and high availability computing. The wired green network is an energy efficient network that has enough energy to operate with the desire to reduce its consumption as recommended by many global guidelines. The increase in traffic is accompanied by an increasing amount of equipment needed to carry this traffic and, consequently, the total energy consumption of the network equipment will increase. The research challenges facing academic and industrial communities is to reduce energy consumption in the different categories of elements. The ambitious goal set out by the GreenTouch consortium in 2015 is to achieve 98% energy reduction by 2020 compared to the reference scenario developed previously in 2010. In this regard, the effective use of energy in communication becomes a key issue for industry, society, and government. In order to reduce energy consumption, it is imperative to design and develop energy-efficient network protocols and architectures. In this context, the thesis topic is built around. Indeed, the basic objective is to study and propose solutions to the problem of energy consumption optimization in Metro-Ethernet networks. Some innovations in protocol and architecture design are necessary for energy efficiency. The typical research idea is usually called energy-aware routing (EAR), that aims at putting unused network elements into sleep mode to reduce the energy consumption. However, several communication requirements should be respected by EAR.

Problem

The challenge of saving energy needs to be addressed at many different levels, such as network architecture, equipment; network protocols, and network management algorithms. Implementation of energy savings for interconnection equipment (routers or switches) is complex because they often exchange routing information through routing protocols and therefore cannot simply enter a sleep mode even if there is no data traffic. On the other hand, there are very often many possible paths between two points of the network and a certain number of these paths can be deactivated if certain nodes do not have packets to be transmitted. Therefore, coordination is necessary to rearrange certain paths so that traffic can be aggregated along these paths while allowing network devices on "idle" routes to go into sleep mode. Indeed, often there is enough redundancy in the network so that some of the nodes can be disabled when not used as a source or as a destination for traffic, and they are not essential as transit nodes. In the same way, node interfaces can be asleep when there is no traffic on the associated links, or when traffic is below a given threshold and it is possible to re-route traffic via another path. However, the ability to disable nodes or links must be carefully evaluated regarding different aspects: (i) how to guarantee the network connectivity and to maintain QoS requirements, (ii) where to place the intelligence of the system (centralized or distributed architecture), and, (iii) how to ensure network resilience in case of failure.

Contributions

In this thesis, we address the problem of optimizing the routing protocols used in carrier Ethernet networks. We have first studied the possibility to integrate and extend already existing and successful IP-based techniques. Therefore, we implement and extend an IP based EAR algorithm to propose a MEEAFS (Metro-Ethernet Energy-aware Forwarding Strategy). This algorithm is a traffic-unaware algorithm in which nodes are categorized in importer and exporter nodes. This strategy can be applied with Shortest Path Bridging (SPB IEEE 802.1aq) protocol that uses the shortest path of only exporter nodes to allow switching off the links on the shortest path of non-exporters. In order to guarantee a certain level of QoS, the candidate links to be switched off can be actually turned off only if their utilization is below a

given link utilization threshold. We considered single path unsplittable routing and a connection between two nodes is considered by simple link. We have then considered multi-path splittable routing and the connection between two nodes is represented by bundled links consisting of multiple cables. We have formulated a mixed integer linear program, called SPB-EAR, to model the problem. Then we have proposed two heuristics, Green-SPB (G-SPB) and Fast greedy (FG-SPB) to rapidly obtain near-optimal solutions.

After that, we consider further problems when deploying EAR in Soft-defined network (SDN). In particular, we consider the limited rule space in OpenFlow switches. Finally, we consider ensuring route reliability for each traffic request. Each request is routed along two node-disjoint paths considering dedicated protection scheme.

Table 1 summarizes our publications associated with each chapter.

TABLE 1: Publications

Publications	Chapters	Rank/IF
R. Maaloul, L. C. Fourati, and B. Cousin, "Energy Saving Carrier-Grade Networks: A Survey", <i>Computer Standards & Interfaces</i> (2017)	1,2	1.268
R. Maaloul, L. C. Fourati, and B. Cousin, "Study of energy saving in carrier-Ethernet network", <i>Artificial Intelligence, Modelling and Simulation (AIMS), 2014 2nd international conference on. IEEE, 2014.</i>	2	-
R. Maaloul, L. C. Fourati, and B. Cousin, "Energy-aware forwarding strategy for metro ethernet networks", <i>ACS/IEEE International Conference on Computer Systems and Applications AICCSA 2015.</i>	3	C
R. Maaloul, R. Taktak, L. C. Fourati, and B. Cousin, "Equal cost multiple path energy-aware routing in carrier-ethernet networks with bundled links", <i>ACS/IEEE International Conference on Computer Systems and Applications AICCSA 2017</i>	4	C
R. Maaloul, R. Taktak, L. C. Fourati, and B. Cousin, "Energy-Aware Routing in Carrier-Grade Ethernet using SDN Approach", <i>required revision by IEEE transactions on green communications and networking</i>	5	-
R. Maaloul, R. Taktak, L. C. Fourati, and B. Cousin, "Two Node Disjoint Path Routing for Energy Efficiency and Network Reliability", <i>submitted in ICT 25th international conference on telecommunication</i>	6	C

Manuscript organization

Chapter 1, presents the practical context of the energy consumption problem in wired networks. We identify how energy is consumed within the global network architecture. Also, we present some relevant measurements

in optical networks. In Chapter 2, we present a literature review of green networking and related optimization problem. We propose a new taxonomy of the energy saving approaches based on their deployment and operation. In Chapter 3, we present our MEEAFS (Metro Ethernet Energy-Aware Forwarding Strategy) approach which is SPB compliant and based on Dijkstra's algorithm. We discuss how to adopt the inspired approach which is OSPF-based in the Metro Ethernet context especially with SPB protocol. Chapter 4, presents an exact formulation of the energy aware routing problem considering the ECMP (Equal Cost Multi-Path) routing policy of SPB with bundled links. We use optimization techniques Mixed Integer Linear Programming (MILP) and greedy heuristics to tackle the problem. In Chapter 5, we propose an energy-aware routing with Software-Defined Networks architecture. We consider the limitation of flow table size. We also use optimization techniques Integer Linear Programming (ILP) and first-fit heuristics to solve the problem. Finally, Chapter 6, presents a new energy-aware routing with node-disjoint backup path to minimize consumption when dedicated protection is considered.

Chapter 1

Energy Saving Carrier-Grade Networks

1.1 Background and motivation

Reducing electricity bills and energy consumption has become a crucial goal for all sectors, including the Information and Communication Technology (ICT) sector, as it is rapidly becoming an important play-actor in daily life [1, 2]. The alarming figures reported by worldwide energy consumption have pushed telecom operators to rethink their network policy [3]. Nowadays, the function of the ICT is progressed by addressing energy awareness in all phases of production and service delivery. Energy-aware studies in communication networks, especially with respect to the environmental conditions, are commonly referred to as green networking.

As the traffic demand continues to grow, it requires additional network resources with higher capacity and faster processing speeds. Moreover, the improvements in network infrastructure drive the quest for green networking. In particular, for transport and carrier grade networks, represent permanent and extensive resources of power consumers. For instance, data center operators require a considerable amount of power to operate server stacks, storage equipment, cooling equipment, operation room and so on. Green networking has two main reasons [4]:

1) *The environmental reason*: most energy consumption is accompanied by non-negligible GHG (Green House Gas) emission that has harmful consequences on climate. In addition, a decrease in GHG emission volume between 15-30% is required before 2020 to keep the global temperature increase below 2°C [5]. A large set of telecom operators and Internet Service Providers (ISPs) consider GHG reduction and its ecological impacts. In fact, the volume of carbon dioxide emissions produced by the ICT sector alone is estimated to be over 2% of the total world carbon footprint in 2020 [6]. In 2007, this 2% was

equivalent to 830 million metric tonnes of carbon dioxide [7] and it would be about 1100 million tonnes by 2020 [8, 9].

Statistical reports provided by certain telecom operators state the overall amount of their power requirements and the related carbon footprint [10–12]. All of these studies show that ICT energy consumption represents an important carbon dioxide emission and will increase rapidly if no green technique is adopted. It might account for more than 35.8 TWh by 2020 [8, 13, 14].

2) *The economic reason:* the rapid increasing of CAPEX (Capital Expenditure) and OPEX (Operational Expenditure) represents a major economic concern. CAPEX is related to network infrastructure establishment cost, whereas OPEX is related to network operation and administration. Energy costs have been investigated by the operators and their financial damage has been put in perspective. Figure 1.1 shows the constantly rising energy costs. Moreover, [15] anticipates that a one-third reduction of carbon footprint emissions could create an economical benefit greater than the investments required to attain this goal.



FIGURE 1.1: Estimated OPEX for the European telcos' network infrastructures in the "Business-As-Usual" (BAU) and in the Eco sustainable (ECO) scenarios, and cumulative savings between the two scenarios [4]

The estimation of energy consumption is based on the primary seminal study done by [16], which states the annual electricity consumed by networking devices in the U.S. was 6.06 TWh, which costs USD\$ 1 billion per year and it is equivalent to one nuclear reactor.

As a result of these two reasons, international projects and research bodies have focused on developing green network infrastructures. We show

here the key enablers to understand the source of energy waste and by what means energy could be saved. Also we present the most relevant achievements that allow a better ratio of performance to energy consumption in wired networks. The emergence of a multitude of approaches and mechanisms on power saving necessitates a study and an analysis of these different approaches in order to identify and classify the potential mechanisms for different scenarios and network domains.

We place specific emphasis on energy-saving studies dedicated to carrier-grade transport networks [17, 18]. These networks are energy-hungry infrastructures; they run large-scale systems to deliver internet services. We choose correspondingly to overview approaches that could be helpful and adapted to carrier-grade transport networks. Carrier grade means extremely high reliability and refers to the capability to support thousands if not millions of subscribers [19]. To the best of our knowledge, it doesn't exist any review focused on carrier-grade networks. A carrier-grade network is not a single technology, but rather a collection of different technologies. A set of functionalities and requirements must be defined in carrier-grade communication: (1) Scalability; (2) Resilience; (3) Quality of service; and (4) Service management. In networks that involve carrier-grade requirements, power saving often induces the reduction of network redundancy or network performance. For instance, in order to meet the resiliency and quality of service requirements, the network should provide fast fault recovery (under 50 ms) through a number of duplicated resources that are not used frequently. Considering the performance trade-off versus power saving, designing efficient power-saving strategies is a real challenge. Nevertheless, the green communications and networking fields are still in their early stages; yet they have already spurred a considerable number of interesting works, which are surveyed and analyzed in this chapter.

1.2 Principal Contributors to Network Energy Consumption

In order to gain a complete view of the principal contributors to energy consumption, it is crucial to consider the communication networks globally from the user level to the transport level, as shown in Figure 1.2. We identify three key contributors that consume energy within the overall network infrastructure: network devices, network architecture, and delivered services.

1.2.1 Network devices

The most important contributor to the power expenditure of network systems are the physical networking devices. This includes elements in different network domains: core, metro, and access networks. Several strategies have been proposed for the energy management of networking devices, ([20] among others).

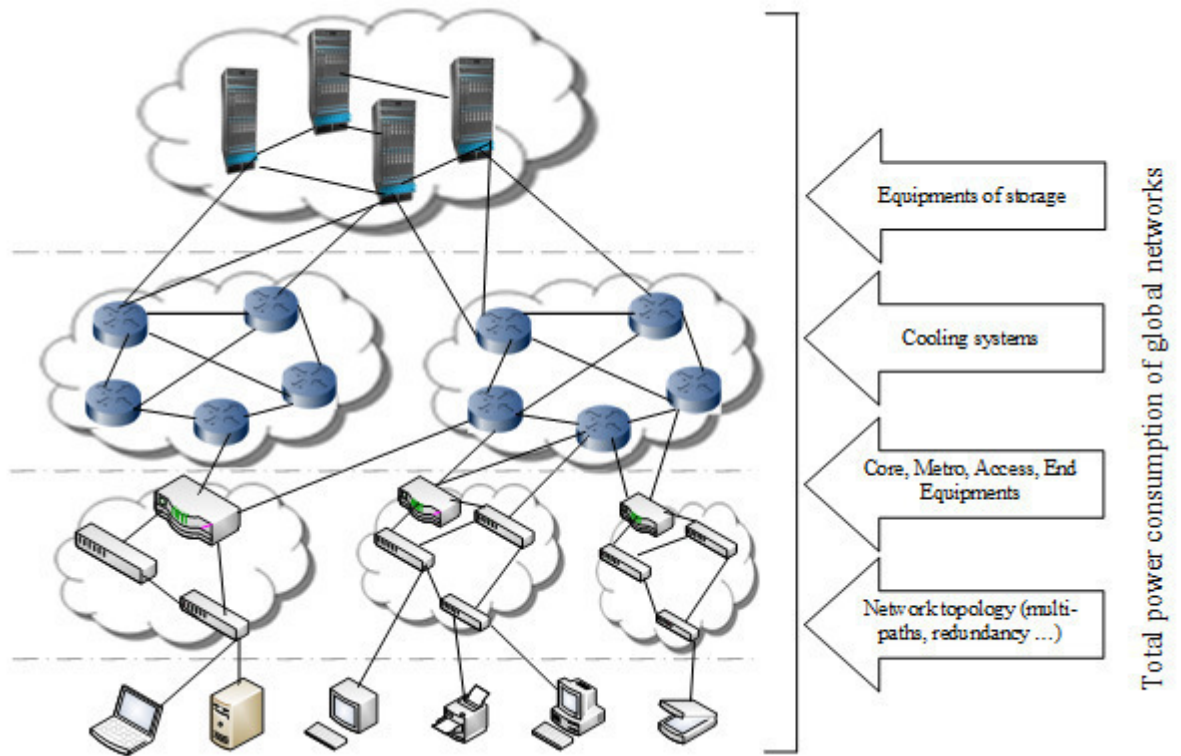

FIGURE 1.2: Overall network energy consumption

Each type of network device (hubs, routers, switches ...) has its own architecture and functionalities. Hence, each network device presents a power consumption that is influenced by many factors such as manufacturer type, number of active ports, number of line cards, traffic characteristics, and used protocols. Since there is no standard used in power-line measurement of network devices, some benchmarks are used as reference to characterize the power consumption. Indeed, various workers have proposed models to describe the energy consumed by network devices such as hubs, switches, routers, and other network devices, starting from the pioneering work of [16] and following works such as [20–23]. Table 1.1 lists the power consumption of the main network devices, as shown in [20]. We observe that almost every specified device demonstrates non-proportional energy consumption behavior,

TABLE 1.1: Power consumption summary for network devices [20]

Device category	10/100 Hub	Edge switch 12-port	Edge switch 24-port	Edge switch 48-port	Core switch	Edge router
Rated Max Power (in %)	35	759 ^d	857 ^e	300	3000	300
Measured Max Power (M) ^a	12.8	198	175	102	656	210
Measured Idle Power	11.7	150	133.5	76.4	555	168.5
EPI ^b (in %)	8.59	24.2	23.7	25.1	15.4	19.8
Aggregate bandwidth in Mbps	1200	48000	48000	48000	48000	24000
mW /Mbps ^c	10.7	4.1	3.7	2.1	13.7	8.75

^a M is the amount of the power consumed in W,

^b Energy Proportionality Index

^c Measured max power in mW / Aggregate bandwidth in Mbps. This term is equivalent to Joules per bit.

^d including 400 W for PoE (P over Ethernet)

^e including 400 W for PoE .

TABLE 1.2: Power consumption for major components of typical server [27]

Component	Peak power (W)	Count	Total (W)
CPU	100	2	200
Memory	20	4	80
Disk	10	1	10
Motherboard	40	1	40
Fan	30	1	30
System total			360

as shown by the EPI values. Thus we observe significant independency between the energy consumed and the traffic throughput. However, relying only on the power consumed at the maximum rate reported by data sheets can overestimate the current power consumption.

Other studies [24–26] focus on minimizing the power dissipation of specific components such as Network Interface Card (NIC), hard disks, and CPUs. Thus, [27] measure the power consumed by the main components of a typical rack server (Table 1.2). European Union (EU) has published power consumption guidelines in different updated version of conduct code on energy consumption of broadband equipment. In this respect, we reproduce in Table 1.3 the power values for WAN components interfaces [28].

Figure 1.3 shows the contribution of different types of network device to the worldwide energy consumption according to the analysis of Lawrence Berkeley National Laboratory (LBNL) campus [29] in 2009. These figures

TABLE 1.3: Power consumption for WAN interfaces [28]

Component	2013-2014	
	Idle State (W)	On State (W)
Fast Ethernet WAN	2.0	3.0
Gigabit Ethernet WAN	2.5	5.0
FibrePtPFast Ethernet WAN	2.9	5.0
Fibre PtPGigabit Ethernet WAN	3.2	5.6
10/1G-EPON	4.8	6.2
10/10G-EPON	5.3	7.7
XG-PON1	4.8	6.5
Gigabit Passive Optical Network (GPON)	3.5	5.0
Ethernet Passive Optical Network (EPON)	3.5	4.7

demonstrate that network switching and premises equipment are the largest categories, for about 70%, of the overall energy use.

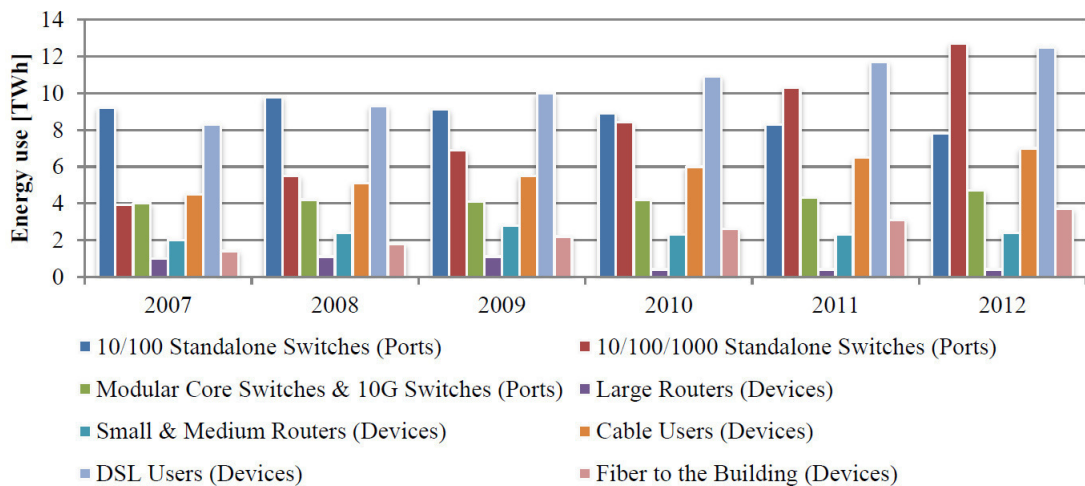

FIGURE 1.3: Energy use of network equipment

Due to the technological advances in the ICT field, there is an important necessity for a permanent evaluation of the energy consumed by network devices. Such an evaluation is achieved by the cooperation of network manufacturers, ISPs, standard organizations, and national regulators [30].

1.2.2 Network architecture

The network architecture is the design of the telecom network that specifies the network's physical elements and their operational configuration. The network architecture is typically split into three network domains: core,

TABLE 1.4: 2015–2020 Network forecast/device density and energy requirements in the Business-As-Usual (BAU). Example based on the Italian network [31]

	Power consumption [W]	Number of devices [#]	Overall consumption [GWh/year]
Home	10	17,500,000	1,533
Access	1,28	27,344	307
Metro	6	1,75	92
Core	10	175	15
Overall network consumption 1,947			

metro, and access networks. In these different domains, the equipment involved, their objectives, their expected performance, and their power consumption levels differ. According to [31], Telecom Italia was the second largest consumer of energy in Italy, consuming more than 2TWh per year. Table 1.4 shows overall consumption foreseen for each network domain of Telecom Italia for the years 2015–2020.

- Core network: often referred to as the backbone network or as the long-haul infrastructure, which interconnects large cities over continental and even intercontinental distances [32]. The core network is based on a mesh interconnection pattern and carries a large volume of traffic. In the backbone network, pairs of routers are typically connected by multiple physical cables that form one logical bundled link [33] that participates in intra-domain routing protocol. Link bundles are accustomed because when capacity is upgraded, new links are joined beside the existing ones, rather than replacing the existing equipment with a higher capacity link. For example, a 40 Gbit/s bundled link can involve four OC-192 cables with 10 Gbit/s of capacity for each cable. In 2009, [34] suggested an increase of core network consumption: by 2017, the power consumption of the core network will be equal to that of network access. Furthermore, this study predicts a staggering increase of 300% in power consumption of the core domain in the coming decade.
- Metro network: this is the domain of the telecom network that typically covers metropolitan regions. It aggregates the highly fluctuating traffic of residential subscribers from the end user to the core network serving as an interface between the access and the core. Different networking technologies have been deployed in diverse metro regions across the world. Today's dominant metropolitan area networks (MAN) are: SONET (Synchronous optical Networking), Optical WDM ring, and

Metro Ethernet Hierarchy. Nowadays, ISPs tend to offer Ethernet in MAN networks, which are arguably more flexible, scalable, and cost-effective compared to legacy SONET architecture [35]. Its basic components are edge routers, broadband network gateways, and Ethernet switches.

- Access network: this part represents the end users connected to POPs (Point of Presence) via a multitude of physical media (e.g. optical, DSL, wireless). It is a major consumer of energy because it comprises a huge number of active elements [36]. There are several different access technologies that can be roughly classified into two main categories: wired and wireless. A detailed analysis of the energy consumption for the main used access technologies was given in [37–39].

1.2.3 Services

Power consumption is influenced by the nature of the services being provided. In other words, the system activity and the usage of network resources deployed to deliver network services. Indeed, the greatest amount of Internet traffic arises from a wide range of web-based services and applications available to end users via the Internet [40], such as cloud services, content delivery and storage as a service. For instance, content services involve servers that store up the data/content and control access to it. The ability to run any of these services assumes that the network system has sufficient power to perform the task. The network system offers the following types of services:

- Shared services: such as Network File System (NFS), web browsing and email. These services can be oversubscribed in that many users may share the offered bandwidth without observing any degradation in the quality of their service.
- Dedicated hosting services imposing different levels of quality of service: a dedicated network resource for each service has to be supplied through the access and backhaul network to the hosting servers.

Cloud services: cloud computing is expected to be the future internet service model by offering network-based rather than desktop-based applications [41]. Clouds exploit a significant amount of equipment and management techniques to allow customers to share a large pool of software, storage, platforms, and computational resources [42]. The most popular cloud based services are content delivery, Storage as a Service (StaaS) and virtual

machines-based applications. Also, these services consume various levels of energy according to their proprieties, i.e. complexity, heterogeneity and large scale.

The key points for greening carrier-grade networks are the green operations of network infrastructure, the delivery of services through energy-efficient equipment and implemented power management, as outlined in the next section.

1.3 Building a green network

Making a network operate in green way compels the identification of several issues using energy efficiency as the primary goal. In order to obtain a green network, at least four key issues should be adopted, as presented in Figure 1.4. *The green devices issue* seeks to build a new generation of energy-

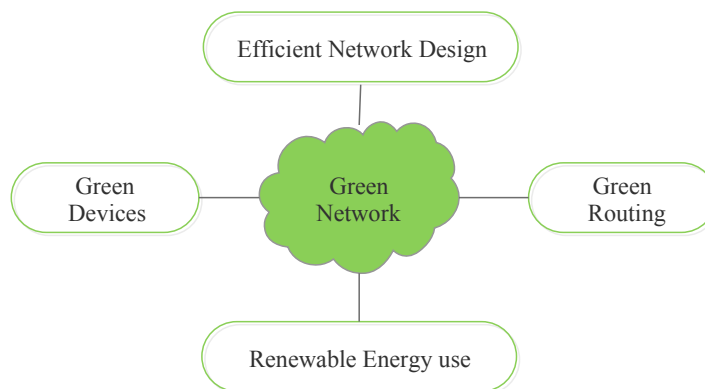

FIGURE 1.4: Key issues for greening networks

efficient devices. In this respect, over the next few years, industry has developed energy-efficient and low-carbon technologies. In order to accomplish this objective, 10 key actions should be realised that are outlined in [43]. [44] proposes to replace the electronic circuits within routers by photonic circuits. They could reach over 10 Tbit/s of attainable speed versus 100 Gbit/s attained by electronics. However, the power consumption of photonic signal processing technologies is not feasible to be adopted. The same workers, in one of their next works [45], presented a perspective on device power consumption. They claim that network devices working in the different parts of the network play a crucial role because the main power consumption in networks comes from their operational power exigencies and density. The GreenTouch [46] and ECONET [47, 48] initiatives are the most relevant green

networking projects appeared by the year 2010. GreenTouch focused on all-optical networking systems, while the ECONET project has contributed to speed-up the reduction of energy consumption in silicon elements of network devices, as well as in copper-based access technologies (namely, VDSL), which both are expected to be used and deployed in telco networks up to the next 15 years. *The efficient network design issue* aims at dimensioning the network architecture and organizing the devices in such a way that they consume a lower amount of energy. The European Commission realized the significance of this issue, which appeared in its 7th Framework Program FP7 [49]. This later activated the TREND project (Toward Really Energy-Efficient Network Design), which has certain pertinent achievements [50]:

- Collection of comparable data to assess the power consumption of terminals, devices and infrastructures, and the identification of power consumption trends in networking.
- Identification of energy-friendly devices, technologies, algorithms, protocols and architectures, and the investigation of how they can be introduced into operational networks.
- Definition of new energy-aware network design criteria.
- Experiments that prove the effectiveness of the proposed approaches.
- Identification of a road map for energy-efficient networking.

Green routing issues aim at introducing energy-aware mechanisms inside routing protocols, which would be able to manage the power state of network resources dynamically. In this regard, numerous studies have proposed several energy-efficient algorithms to route the traffic [51–55]. These works focus on routing path selection subject to minimizing the energy consumption, whether by powering off devices (or part of them) or by routing the traffic through energy-efficient paths that are weighted according to their energy impact [56]. On the other hand, [57] validated that geographical delocalization is a promising approach to reduce the cost of electricity related to the routing. In fact, large companies like Amazon have systems that are geographically distributed where electricity has a lower cost. However, this technique is helpful from an economical point of view, but does not reduce the power consumption.

Renewable energy use aims at exploiting renewable resources such as the Sun,

wind, and water, hence reducing expenditure as well as the emission of a carbon footprint. In this respect, renewable energy utilization makes use of several concepts such as the option to choose a greener resource, electricity price-based, energy resource availability and the localization of renewable energy generators for smart grid communications and renewable electricity use [58, 59]. Moreover, a number of popular ICT companies are becoming dynamic supervisors in their electricity use. Table 1.3 indicates information on renewable electricity and carbon footprint reduction goals identified by ICT organizations [60].

TABLE 1.5: Renewable electricity and carbon reduction goals for leading ICT organization [60]

Company	Renewable Energy Goals	Renewable Energy Goal year	Carbon Reduction Goal Year Goal	Carbon Reduction Goal year
Amazon	100%	Long-Term	None Specified	None Specified
Apple	100%	Long-Term	None Specified	None Specified
Cisco	25%	Annual Goal: 2013 ~ 2017 ^a	40%	2017
Dell	50%	2020	50%	2020
eBay	8%	2015	10 % reduction in carbon per transaction in 2013	2013
Facebook	100%	Long-Term	None Specified	None Specified
Google	100%	Long-Term	Carbon Neutral	Ongoing
IBM ^b	None Specified	None Specified	Third-Generation GHG Goal Upcoming	Upcoming
Intel	None Specified	None Specified	10 % reduction per chip in GHG direct emissions	2020
Microsoft	100%	2014	Carbon Neutral	2014
Rackspace	5% increase annually (35% in 2013)	2026 (based on 5% annual increase from 35% in 2013)	None Specified	None Specified
Sprint	10%	2017	20%	2017
Twitter	None Specified	None Specified	None Specified	None Specified
Vmware	Not Applicable	Not Applicable	40%	2050
Yahoo!	None Specified	None Specified	None Specified	None Specified

^a Cisco is seeking to source 25% of its electricity use annually from renewable energy from 2013–2017.

^b Information is specific to IBM's Austin, TX; Costa Mesa, CA; and Foster City, CA facility.

1.4 Energy profiles

Profiling the energy consumption for network devices motivates manufacturers to implement green technologies and to achieve meaningful power savings. The energy profile is defined as the dependence of the energy consumption (in Watt-hours, Wh) as a function of four main factors: the traffic load through the device, the number of active ports, the line speeds, and firmware version [33]. Figure 1.5 shows various energy profiles depending on the traffic through the network devices [56]. Moreover, the case-study calculation results show that by applying energy profile aware routing, a significant amount of energy and operational cost can be saved. *-On-Off*: this

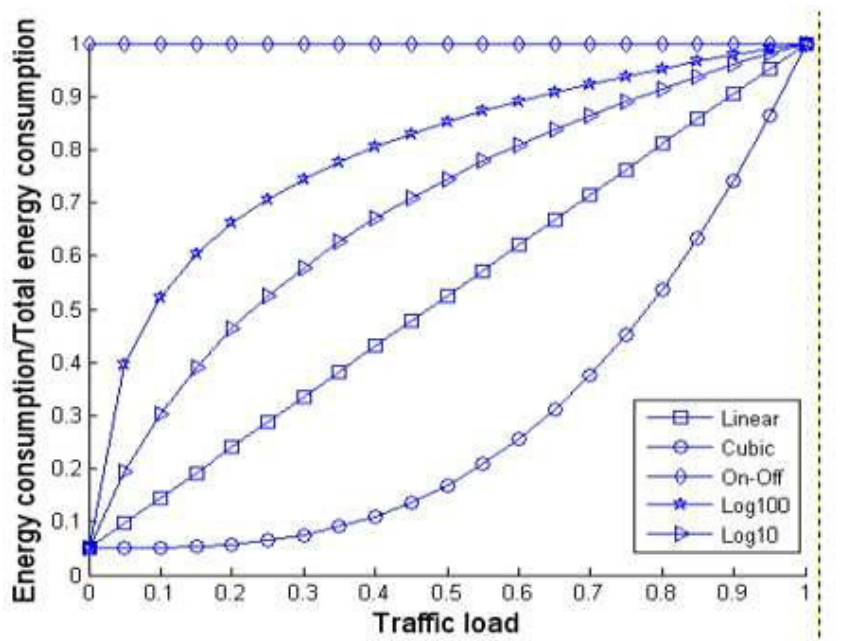

FIGURE 1.5: Proposed Energy Profile [56]

energy profile corresponds to the characteristics of many existing devices. It is the most simple energy profile that fully empowers the network equipment when this is later turned on (e.g. the operation of traditional Ethernet switches). The energy consumption of this profile does not depend on the usage (i.e. actual traffic load).

-Linear: devices belonging to this energy profile exhibit a power consumption that is proportional to their usage. Switch manufacturers such as Batcher, Fully connected and Crossbar follow this energy profile [61]. Ideally, devices should have a linear energy profile. In addition, Barroso [62] introduced the proportional computing concept that may be applied to individual devices and components such as PCI slots and CPU cores to be into a sleep state

when they are idle.

–*Log 10*: this energy profile is an approximation of the profile produced by devices using the hibernation technique, so-called low-power idle proposal adopted in IEEE 802.3az Task Force [63]. Moreover, in [64], it was shown that the energy consumption can be as low as 10% compared to that of the *On-Off* energy profile.

–*Log 100*: this energy profile corresponds to an intermediate function between *Log10* and *On-Off* representation. It might be a realistic end result when the proposed techniques by IEEE 802.3az are implemented.

–*Cubic*: this profile corresponds to equipment that adopts power reduction techniques like dynamic frequency scaling DVS (Dynamic Voltage Scaling) and DFS (Dynamic Frequency Scaling). In [65], Ethernet interface cards implementing DVS and DFS were demonstrated to reduce power consumption cubically.

Another study of energy consumption profiles was introduced in [66]. Figure 1.6 depicts the different load-dependent energy profiles as well the optimized footprint that a device could present as a function of its utilization.

Another important energy profile model was introduced in [5]. This model is achieved through analytical framework. It allows estimating the energy profile of network devices, within diverse states, adopting two mechanisms, i.e. Adaptive Rate (AR) and Low Power Idle, described in Chapter 2. Figure 1.7 shows an energy profile corresponds to a generic device that has four available AR states (S). The power consumption of a device is assumed to have S power states, which are thought to be ordered from the lowest energy consumption state ($s=0$) to the most energy-hungry state ($s = S - 1$). Where λ is the dependency parameter of idle optimization from power states (if $\lambda = 0$, idle logic is completely unaware of power states, if $\lambda = 1$ there is no idle logic). λ is the normalized value of traffic load incoming to the device. ϕ indicates the energy consumption of the device. σ is a shape parameter of idle optimization efficiency (ideal case, real case). ξ represents how much is conservative the optimization in terms of choosing the most suitable power state maintaining the desired QoS level for the incoming traffic. Finally, ν is a shape parameter of power states' energy consumption. The optimal profile simply consists of a piece-wise curve, composed by the most power saving parts of AR curves guaranteeing that the sum between the average incoming traffic load and a guaranteed threshold (ξ) is lower than the maximum value of the service rate in AR states.

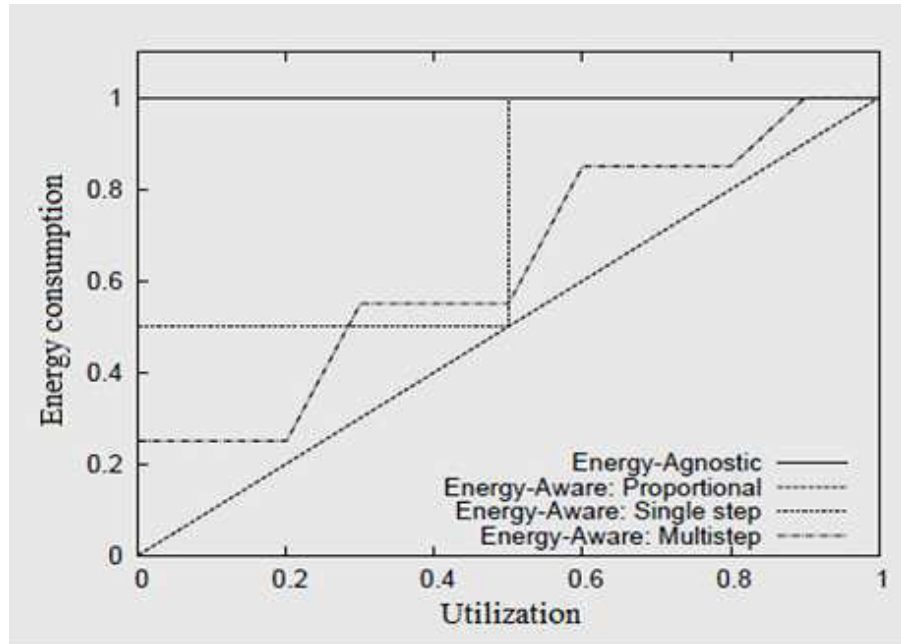

(A) Energy consumption as a function of utilization

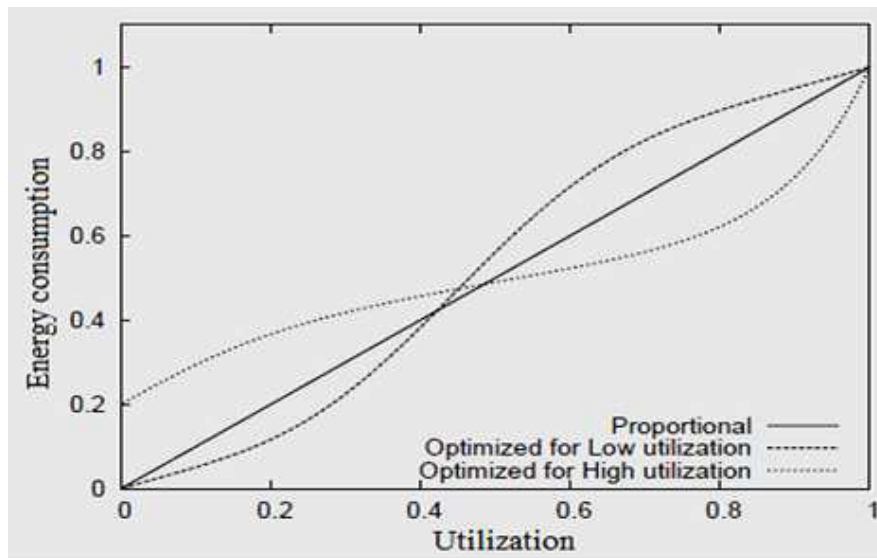

(B) Optimized footprint as a function of utilization

FIGURE 1.6: Load-dependent energy consumption [62]

Network design and traffic-engineering decisions can exploit the full energy-saving potential of network devices using information of load-dependent energy consumption and energy profiles. In this respect, a recent standardized interface referred as Green Abstraction Layer (GAL), has been approved by ETSI (the European Telecommunication Standards Institute) [67]. GAL interface enables energy management protocols to consistently determine which

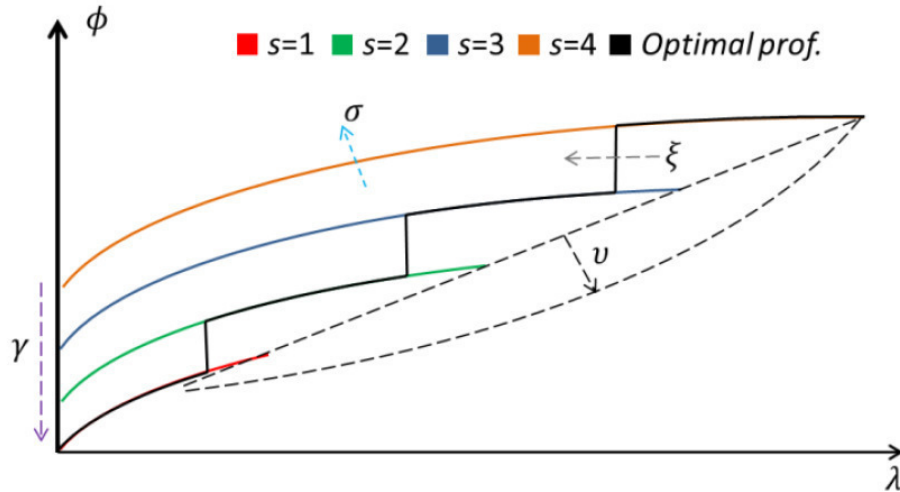

FIGURE 1.7: Energy profiles in various AR states in the presence of LPI primitives and the resulting optimal device energy profile [5]

power management capabilities are available at the data plane, their potential effects on both energy consumption and network performance, and how to interact with them. [68] illustrates how GAL represents a multilayered (four-layers) abstract model of the energy-saving capabilities for devices deploying local and network-wide control policies in a heterogeneous setting. Besides GAL, an energy-management working group (EMAN) has been established by the IETF [69]. EMAN reuses existing works and investigates existing standards such as those from IEC (International Electrotechnical Commission), DMTF (the Distributed Management Task Force), ANSI and others. The EMAN framework allows monitoring heterogeneous devices connected to a network to report their energy use over the time. For instance, the EMAN framework [70] describes how energy information (measurement, characteristics, identification) can be retrieved from IP-enabled devices using Simple Network Management Protocol (SNMP) with the help of MIB (Management Information Base) modules.

1.5 Cost and power consumption in optical network

Carrier-grade networks are provisioned in order to meet a set of requirements, as mentioned before, resiliency, scalability, quality of service and service management of the network. All these critical aspects are commonly supported through optical networks. Besides, deploying optical switching

technologies is considered as a promising solution to enable energy efficiency in the core/transport segment of the internet. These reasons highlight the necessity to identify the cost and the power consumption of optical networks. Hence, this section defines different architectures suitable for carrier-grade networks, especially those employing optical WDM (Wavelength Division Multiplexing) technologies. Then, we present their corresponding cost (CAPEX) and energy consumption (OPEX) models. WDM is a technology that is most probably deployed in broadband area networks. It multiplexes multiple optical carrier signals on a single optical fiber by using different wavelengths of light. WDM technology utilizes Optical Cross-Connect (OXC) devices to perform switching and accelerates routing at the optical layer.

1.5.1 Network Node Architectures

The core/metro optical network architecture can be opaque and transparent [71, 72]. In the opaque architecture (Figure 1.8), all optical signals carrying traffic undergo an optical to electronic to optical (OEO) conversion (and vice-versa) at every node in the network. On the other hand, in transparent and translucent architecture (Figure 1.9), OEO conversion can be avoided by simply allowing in-transit traffic to bypass optically intermediate nodes. The OEO conversion represents the largest operational cost for optical fiber networks.

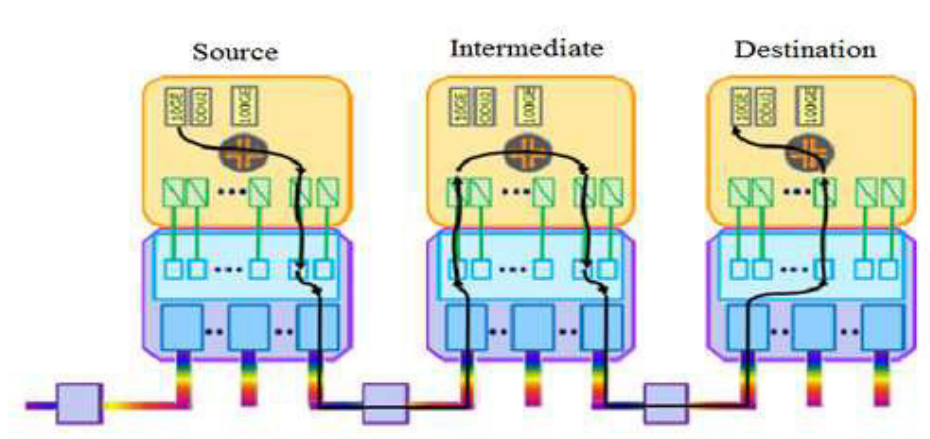

FIGURE 1.8: Opaque network architecture [73]

- Different opaque architectures are used in practice among others: SONET/SDH, basic IP over WDM (B-IPoWDM), and carrier-grade Ethernet technologies. SONET/SDH is the legacy architecture in MAN. It is a circuit-based technology that can aggregate low-bit rate traffic streams from

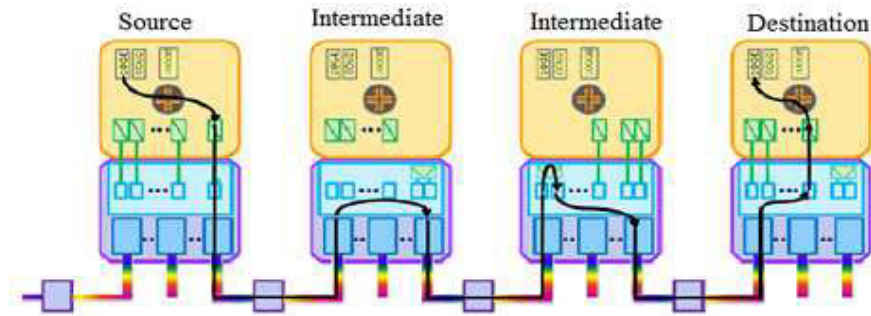

FIGURE 1.9: Transparent network architecture [73]

metro networks into high bandwidth pipes of core networks [74]. In SONET/SDH nodes, all switching in the data plane takes place in the electronic domain. In the next generation of optical transport networks, SONET/SDH will progressively disappear because it is no longer efficient to sustain today's data traffic progress. In B-IPoWDM) architecture, inside each node an OXC is interconnected to the IP router. This architecture is also known as lightpath non-bypass design. The routers are interconnected by point-to-point optical fiber links; traffic flows undergo O/E/O conversion at every intermediate node. Moreover, in order to provide carrier-grade service, extensions to regular Ethernet switching have led the definition of what is known as carrier grade Ethernet, taking advantages of its simplicity, scalability and effective cost. Ethernet-over-fiber supports a link rate of up to 100 Gbit/s. Carrier Ethernet switch performs OEO conversion of every wavelength as in a SONE/SDH node. It can use DWDM (Dense WDM) technology. DWDM is used to transmit many optical channels on the same fiber component.

- Transparent architectures are expected to enable significant power conservation, due to the minimum needed number of OEO conversions. Among the transparent architectures one can consider: transparent Tp-IPoWDM (Tp-IPoWDM) and hub-based. This architecture is also known as lightpath bypass design. In Tp-IPoWDM, each node is equipped with micro-electrical mechanical systems (MEMS) and as for the opaque case the IP router is interconnected to an OXC device. If signal regeneration is required, the lightpath has to be dropped and the matching traffic sent to the IP router to be processed. When no regeneration is required, a significant amount of energy can be saved because the traffic can be switched directly in the optical domain by OXCs (bypassed),

conserving the capacity of the wavelength [72].

In the hub-based architecture, the traffic sent/received by an access node is either local (i.e. transmitted from/to one of the access nodes in the same metro optical network) or intermediate (i.e. directed to/from the Internet). As most of the traffic is transit traffic, the transparency is carried out by permitting every access node to have a direct light-path (i.e. specific wavelength channel) to the hub node. Evidently, the hub-based architecture is suitable for today's network traffic states, i.e., the traffic is either terminated or originating from the Internet. Although the hub-based architecture avoids OEO conversion costs at intermediate nodes, it is insufficiently powerful especially in the case of dynamic traffic scenarios, since the qualities of optical signals degrade as they travel through numerous optical components. To overcome these impairments, sharing bandwidth of each channel between multiple source-destination nodes should be implanted.

Interested approaches are suggested in order to optimize the energy consumption in transparent networks [75–77].

1.5.2 Analytical model for the energy consumption of a WDM optical network

The estimation of the energy consumption of the physical infrastructure resources is highly dependent on the network architecture employed and the technology made. In this section, we present an analytical model that considers the WDM optical network architecture employing wavelength selective switches using MEMS [78]. The overall energy consumption model is based on the active elements of the network that can be classified as OXC nodes and transmission link-related elements. Each OXC node comprises a set of active and passive elements. Figure 10 illustrates the assumed OXC architecture. The passive elements incorporated in these nodes are: the multiplexers (MUX) and demultiplexers (DEMUX), while the active elements are: the photonic switching matrix, one Erbium-Doped Fiber Amplifier (EDFA) per output fiber port, one Optical-Electrical-Optical (OEO) transponder per output wavelength port and one transmitter (Tx) – receiver (Rx) per lightpath located at the add and drop ports of the OXC. As the assumed OXCs are symmetrical, the number of bypass ports of the OXC is calculated as the product of the number of input fibres and the maximum number of wavelengths that a fiber can support. The overall network power consumption is determined

by the power consumption of the individual OXCs and fiber links (which includes the installed optical amplifiers). The power consumption of node n (P_{OXC_n}), depends on the four active elements in the OXC: the power of the switching fabric P_{sf} , power of OEO transponders for transmission P_{Tran} , the power of the wavelength converters P_{Con} , and the power of the optical amplifier P_{Amp} . Equations (1.1)-(1.4) describe the dependence of the power consumption of the node on the individual elements power consumption.

$$P_{SF} = ports_{total} \times P_{portpair} = (ports_{th} + ports_{a/d}) \times P_{portpair} \quad (1.1)$$

$$P_{Tran} = ports_{a/d} \times P_{Tx/Rx} \quad (1.2)$$

$$P_{Con} = ports_{th} \times P_{transpoder} \quad (1.3)$$

$$P_{Amp} = (f_{in} + f_{out}) \times P_{Edfa} \quad (1.4)$$

The power of a switch fabric is computed as the number of ports (i.e. the sum of bypass ports $ports_{th}$ and add/drop $ports_{a/d}$) multiplied by the power consumed by each switch port. The power related to the OEO transponders for transmission is the product of the add/drop ports and the power related to the transmission device $P_{Tx/Rx}$. The power consumption of the installed amplifiers is computed as the product of the number of incoming and outgoing fibers (f_{in} and f_{out}) and the power related to the optical amplifiers.

Figure 1.11 illustrates the fiber link model [79], where the only power-consuming elements are the optical amplifiers installed per span. The maximum span length (span) is expected to be 80 km. Thus the power consumption P_l of a fibre link l is length-dependent and is calculated as follows:

$$P_l = \lfloor \frac{length(l)}{span} \rfloor P_{Edfa} \quad (1.5)$$

Finally, the total energy consumption of the physical infrastructure of N OXC nodes is calculated as follows:

$$P_{Net} = \sum_{n \in N} P_{OXC_n} + \sum_{l \in L} P_l \quad (1.6)$$

1.5.3 Cost and power consumption

The CAPEX and OPEX of optical WDM architectures has been the subject of several case studies [71, 73, 78, 80]. These analysis are often based on linear programming models and heuristic approaches. [71] provides models for

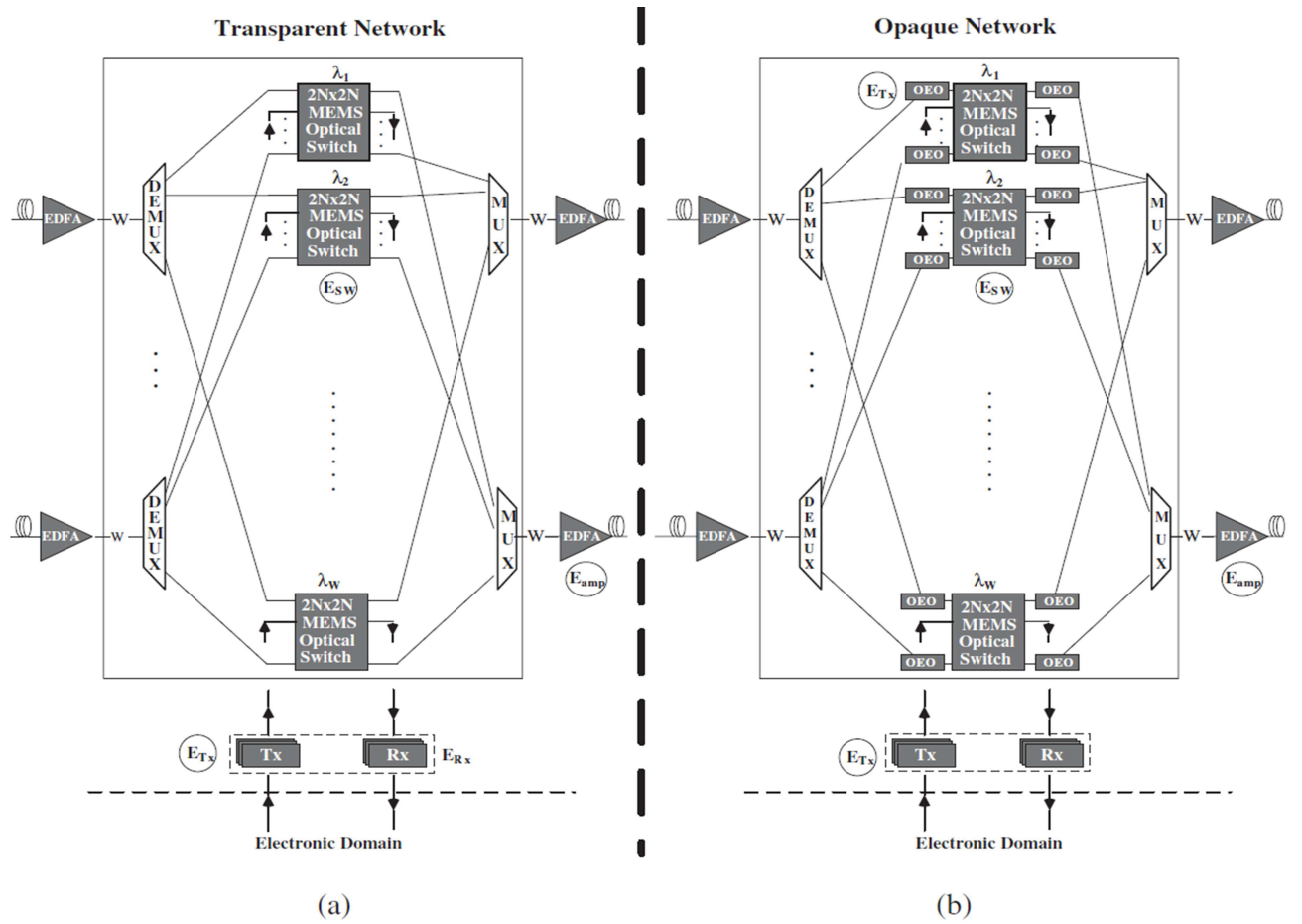

FIGURE 1.10: OXC architecture [79]

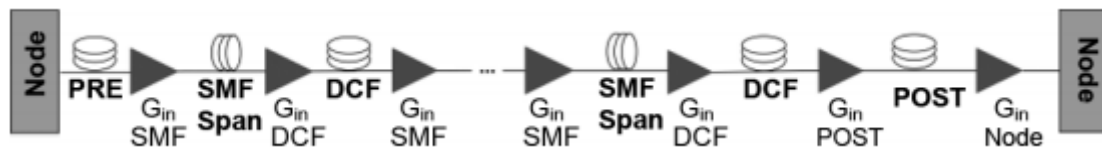

FIGURE 1.11: Fiber link model [79]

evaluating the cost, power and traffic capacity for opaque and transparent architectures. The total power consumption and the cost of an opaque and a transparent network node are determined by subdividing the node into its main functional blocks: the base node and the equipment related to the physical layer interfaces. The base node consists of the chassis, the mechanical assembly, the switching matrix, the cooling functionalities, the power supply, the control and the management functions. Every base node has a limited number of slots for physical layer interfaces. Figures 1.12 and 1.13 recapitulate the normalized cost and power consumption for the components of Ethernet carrier-grade switches and OADM (Optical add-drop Multiplexer),

respectively.

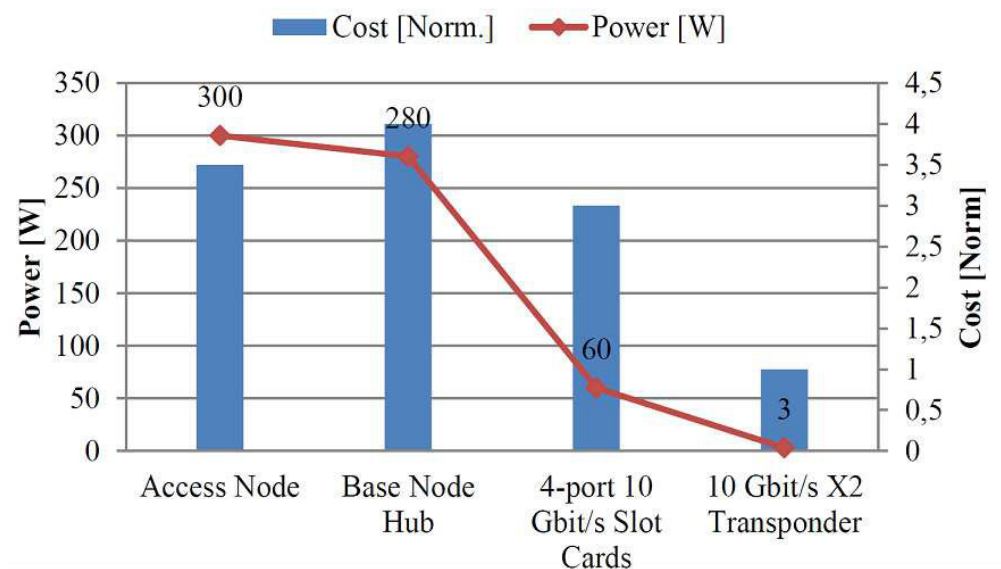

FIGURE 1.12: Normalised cost and power consumption for Ethernet Carrier-grade nodes

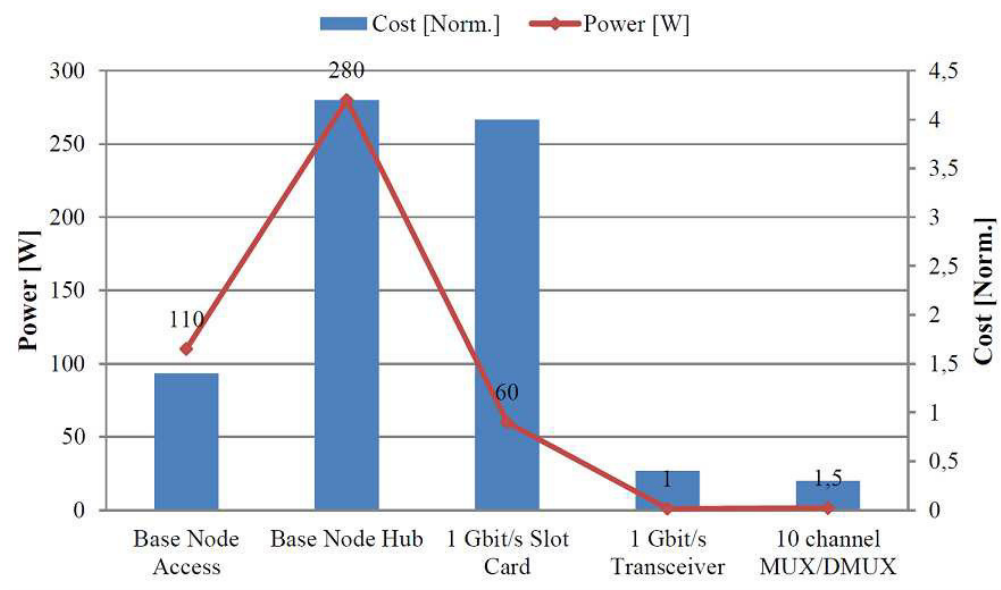

FIGURE 1.13: Normalised cost and power consumption for an OADM

[78] models the cost of the power consumption of WDM network components in terms of cost and operational power by signal transmission, as reported in Figure 1.14. The estimation of the power consumption of the network components is highly dependent on the network node architecture and the network topology. However, packet transmission time or the link load can be crucial parameters to compute the energy consumption in networks

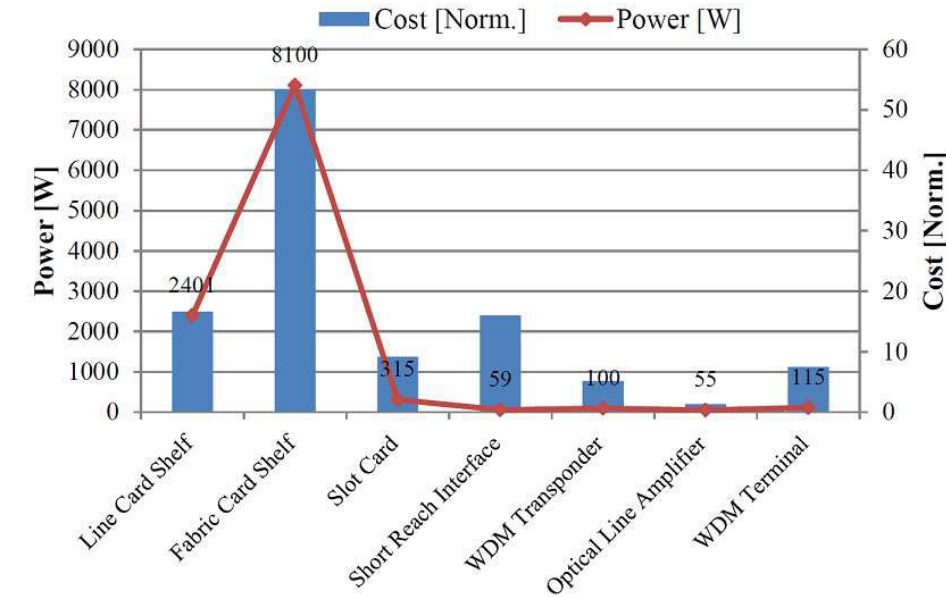

FIGURE 1.14: Normalized cost and power consumption of WDM network components

that implement power-saving mode, as demonstrated in [81]. These authors provide an analytical model to estimate the power consumption of optical Ethernet links that implement a power-saving mode. The model splits the time into discrete time intervals and assumes that the transition times between modes are a multiple of the frame transmission time. Measuring the overall power consumption of carrier-grade networks before and after applying green approaches is an efficient metric to evaluate the performance of the applied techniques. For instance, in data centres, the most frequently used metric is power usage effectiveness (PUE). PUE is the ratio of the total energy used by a data centre, including IT equipment, to the energy consumed by the IT equipment only. Along with PUE, three metrics allow the measurement of the energy efficiency of carrier grade networks: IT Equipment Utilization (ITEU), IT Equipment Energy Efficiency (ITEE) and Green Energy Coefficient (GEC) [82].

$$ITEU = \frac{\sum \text{Measured energy consumption of IT equipment}}{\sum \text{Rated energy consumption of IT equipment}} \quad (1.7)$$

$$ITEE = \frac{\sum \text{IT equipment rated work capacity}}{\sum \text{Rated energy consumption of IT equipment}} \quad (1.8)$$

$$GEC = \frac{\sum \text{Energy input from renewable resources}}{\sum \text{Energy consumption of operating network}} \quad (1.9)$$

In this section, we have described the main node architectures in carrier-grade networks and provided illustrative examples of how to measure overall network power consumption, as well as the energy efficiency. Going further, more emphasis is given regarding saving energy in optical networks; among others: [75–77, 83–95].

1.6 Conclusion

This chapter has surveyed the state-of-the-art on energy consumption in the ICT sector and especially in carrier-grade networks. Identifying the energy distribution within the global network is essential when designing a green network. We have shown the key contributors to the power consumption of wired networks: network devices, network architecture and service scenarios. Since the device elements represent an important source of power consumption, we revised the energy consumption profiles for network devices. Indeed, the energy profiles of devices under various loads can influence the choice of energy-saving technique. Then, we discussed the key issues for building an energy-efficient network: green operation of devices, efficient network design, energy-aware routing, and renewable energy supplies. Also, we have presented some relevant measurements in optical network.

Chapter 2

Green networking approaches

2.1 Introduction

This chapter depicts the relevant classifications provided in the literature. We give a comparison and insights of the presented classifications. Then, we provide our taxonomy for current green networking approaches.

Before presenting our taxonomy and discussing the different approaches for saving energy in networking, we introduce the most related pertinent surveys in the literature.

In the research literature, there are extensive surveys from slightly different points of view that cover approaches related to green networking [4, 30, 42, 96, 97].

A detailed survey on emerging technologies, standards efforts, and projects is given in [4]. These authors identified three categories of green networking research: (i) re-engineering, (ii) dynamic adaptation, and (iii) sleeping/standby. The first category intends for network devices and architecture to be optimized or to design new network equipment. The second category, dynamic adaptation, suggests approaches that work on modulating the capacities of network device resources in order to meet the actual services and traffic requirements. Finally, sleeping/standby is founded on power management basics that allow network equipment (or parts of them) to be switched off, to enter very low power states.

Another survey gives a review and taxonomy of relevant techniques applied in wired networking [30]. Their taxonomy identified four branches of green networking research: (i) adaptive link rate, (ii) interface proxying, (iii) energy-aware infrastructure, and (iv) energy-aware applications. Adaptive link rate refers to scaling down the link rate proportional to the traffic load, even to zero i.e. to the sleep state. Interface proxying refers to reducing power consumption at the application layer while the network connectivity is maintained due to the proxy structure. The energy-aware infrastructure

category includes methods that adopt energy consciousness throughout the network design stage. The final category, energy-aware applications, focuses on studies that call for energy consciousness in software design.

The survey in [42] provides a comprehensive review of the techniques and solutions that aim to improve the energy efficiency of large-scale distributed systems. The authors classify existing research into four categories: (i) hardware, (ii) shutdown, (iii) slowdown, and (iv) coordination and network-wide solutions. Hardware studies approach energy efficiency by exploiting optimal equipment architecture or by designing novel energy-efficient technologies. Shutdown approaches are devoted to putting idle components to sleep. Slowdown approaches are devoted to scaling the transmission speed of interfaces dynamically according to the needs. Coordination refers to the management of network power through the improvement in protocols and architecture design.

A recent survey [96] mainly focuses on energy efficient solutions for cloud-based networking components, making use of the system literature review (SLR) research method [98]. Four groups of methodologies have been identified based on the networking component granularity: (i) Data Center (DC) layer, (ii) Application (App) layer, (iii) Network layer, and (iv) Device layer. Additionally, the green traffic engineering approaches have been studied from the perspective of optimization modelling issues in the survey article [97]. The approaches have been split into two main groups: (i) flow-based routing and (ii) shortest path routing. We draw Table 2.1 to compare this study with other related works.

2.2 Taxonomy of green networking approaches

Merging the main points of the three reviews above, we propose a new taxonomy of energy-aware strategies for green networks, as illustrated by Figure 2.1. Our classification is focused on two main categories: node level and network level. In the former category, two kinds of optimization-based strategies are proposed: either energy optimization strategies, which are applied on hardware design; or energy optimization strategies, which are applied on software functions. In the latter category, the energy-saving problem is treated at network level; this category can be divided into three main sub-categories: proxying, virtualization, and traffic engineering. The final sub-category can be further classified into two kinds of traffic engineering: soft-defined networks and traditional protocols.

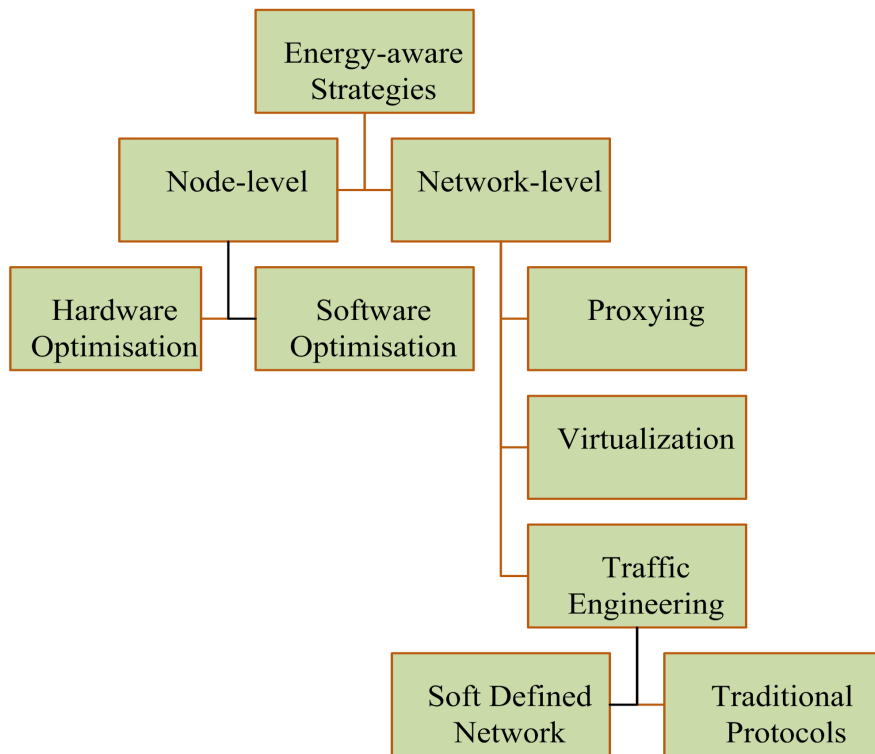

FIGURE 2.1: Taxonomy of green networking approach

2.2.1 Node level

Hardware optimization

A large number of studies and projects have introduced energy-aware technologies to exploit them efficiently inside network equipment design [66, 99–

TABLE 2.1: Focus concepts of this study vis-a-vis related surveys

Survey paper	Key aspect	Node level		Network level				
		Hardware optimization	Software optimization	Proxying	Virtualization	Traffic engineering with traditional protocols	Traffic engineering with SDN	
[4]	Engineering of wired and wireless network devices	✓	✓	✓	✓	-	-	
[42]	Techniques that improve the energy efficiency of computing and wired network resources	✓	✓	✓	✓	-	-	
[30]	Green emergent technologies in wired and wireless networks	✓	✓	✓	✓	-	-	
[96]	Energy efficient solution in cloud-based networking	✓	-	-	✓	✓	✓	
[97]	Optimization modelling for energy-aware traffic engineering in wired and wireless networks	-	-	-	-	✓	✓	
This study	Energy consumption measurement and techniques that enhance energy efficiency for wired (main focus) and carrier grade networks	✓	✓	✓	✓	✓	✓	

[102]. The main focus of these projects is to reduce the power consumption of specific components per node such as CPUs [26], disks [25] and NICs [24]. The basic technique of these approaches is to scale the voltage and frequency (i.e. power consumption) proportional to the service demand. For example, link transmission rates between components can be modulated to limit the energy consumption and to meet the actual traffic requirements. This hardware management capability is usually referred to as power scaling, AR (Adaptive Rate) or as ALR (Adaptive Link Rate). The ALR technique was first described by Gunaratne et al in 2005 [24] target to adjust NICs speed to the effective workload. Two main methods keys are needed to develop the ALR technique. The first is to determine exactly how the link data rate is switched, namely ALR mechanism. The second defines an ALR policy to decide when to switch the link data rate, in such a way as to minimise the increase of the packet delay and to maximize the power saving. Thus, the performance tradeoff in ALR techniques is packet delay versus power saving.

In order to avoid the time of sending a long frame preamble, Gunaratne et al in 2008 [103] proposed a faster handshake and resynchronization mechanism, which is implemented using Ethernet MAC frames, able to execute them effectively in less than 100 μ s at 1 Gbit/s. Initially, the link that determines the need to increase or decrease its data rate requests a data rate change using ALR Request MAC frame. Then, the receiving link replies to the data rate change request with either an *ALR ACK reply* if it agrees to change the data rate, or an *ALR NACK* reply if it does not agree. After the ALR ACK response, the link data rate can be switched and the link resynchronized. The total time of the handshake and resynchronization process can be less than 100 μ s for 1 Gbit/s Ethernet.

In [104], a Markov model is developed where the Ethernet link data rate is a function of link use. This proposal identifies high-buffer and low-buffer thresholds. The use of two thresholds avoids frequent oscillations between two rates. When the buffer occupancy reaches the high-buffer threshold, the link rate is increased to a higher value, and when it goes under the low-buffer threshold, the link rate is decreased. The difficulty lies in finding good values for these thresholds in order to avoid packet losses and oscillations, since switching between rates takes time. A similar mechanism, called the Dynamic Adjustment of Link Width (DAWL), suggested in [105], also uses dual-threshold based on link utilization. These authors advocate that the distribution of operating rates and their corresponding power consumption

significantly influences the efficiency of the adaptation techniques. In addition, components can be exchanged by more energy-efficient mechanisms such as the replacement of electrical components with their corresponding item in the optical domain [18, 106, 107].

In addition to ALR technique, LPI is also an energy saving technique delivered by the hardware level. Indeed, the IEEE 802.3az task force [108] defines the LPI technique to offer the standardization solution, Energy Efficient Ethernet (EEE), to improve Ethernet NICs and switches. EEE defines two operational modes for transmitters and receivers: active mode and LPI mode (i.e. idle link period). Compared to the active mode, LPI mode brings the energy consumption down to 10%. The basic concept is to transmit data as fast as possible; to let then the device spends a significant fraction of time in low power or (sleep) mode. However, the transition between the different modes creates an overhead to every burst of one or more packets sent consecutively. As a result the energy saving achieved is strongly dependent on the traffic pattern and packet size distribution. In other words, the average power consumption of Ethernet interface is heavily dependent on the fraction of time the interface spends in LPI, active, and transitioning between states. The EEE performance is improved in particularly using a technique called burst transmission [109] or packet coalescing [64], which allow overcoming the effect of EEE overhead. The idea of packet coalescing technique is to aggregate packets in a buffer until either the buffer is full or the timeout expires. However, the buffer size and the coalescing timeout setting strongly affect the trade-off in EEE performance. Since then, several works addressed modeling and performance analysis of EEE based on various traffic parameters and with and without consideration to packet coalescing [110–116]. In [110] authors provide an evaluation of static and dynamic coalescing for EEE in which buffer size and timeout are fixed (static) and adapted to traffic pattern (dynamic). The results show that static coalescing and dynamic coalescing algorithms achieve similar power saving and delay tradeoffs. Therefore, static coalescers are preferable for real implementation due to their low complexity.

The work in [112] provides an accurate traffic model with GI/G/1 queues for both frame and burst transmissions. The model allows predicting the average energy saving as well as the impact of sleeping algorithms on packets delay. However, this model is valid only for unidirectional traffic and specifically designed for the case of 10 Gbit/s links. Also, the work in [116] provides a model that can be used for three available EEE links: 100BASE-TX, 1000BASE-T and 10GBASE-T. By analyzing energy consumption and various

network performance indexes in closed form, i.e., without upper bound and lower bound approximations, makes the model suitable to be adopted in optimization frameworks. This model can be used and useful for dimensioning interfaces during the design phase of a datacenter.

Figure 2.2 shows the transitions between modes as defined in EEE, as well as, it indicates a qualitative indication of the energy consumption $E(t)$ for the different periods. However, the sleep and wake-up periods are intensely greater for small frames and higher speed [116]. T_s is the sleep time required

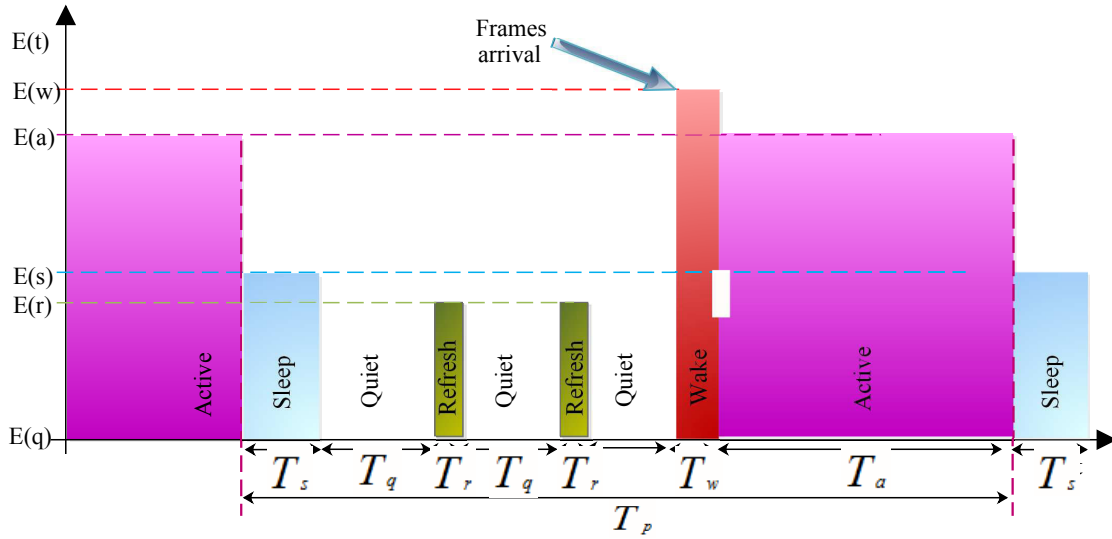

FIGURE 2.2: Relative power consumption for different periods of EEE

to enter LPI mode. Once the device enters LPI mode, it stays quiet during large period T_q , and only sends signals during short period T_r (refresh time). T_r permits faster wake-up time and maintains alignment between Transmitter (TX) and Receiver (RX). Once frames arrive, the link should exit the LPI mode taking T_w seconds to be in active mode during T_a seconds. Finally, refers to the average duration idle/busy cycle.

In [38], the energy consumption of representative optical and wireless devices that are provided from manufacturers data sheets for optical access networks is analyzed. The energy consumption model is defined as a function of the access rate to users, and is strongly based on traffic estimation. This analysis takes into account various network technologies (DSL, HFC, PON, FTTN, point-to-point optical system, UMTS (WCDMA), and WiMAX). They demonstrate that passive optical access networks (PONs) and point-to-point optical networks are the most energy-efficient of the available access technologies.

Software optimization

Current technologies, including software, consider energy efficiency in their operating systems and software applications. The running software hides various processor techniques that might waste electricity. Research demonstrates that operating systems having a heterogeneous power consumption could be improved to consume less power [117, 118]. In other words, device consumption within a different version of the same operating system can have considerable variation. Software power management is promoted by the Advanced Configuration & Power Interface (ACPI) standard [119]. The main idea consists of the operating system managing power supply for each component, in order to avoid unnecessary power consumption. This standard provides an interface between the hardware and software layers, by modelling the different set of working and idle states (*C-states*). *C-states* are described as follows: the *C0* power state is an active power state where the CPU performs tasks, while the *C1* to *Cn* power states are processor sleeping or idle states, where the processor consumes less power and dissipates less heat. Furthermore, as the sleeping power state (*C1*, ..., *Cn*) becomes deeper, the transition between the active and the sleeping state (and vice versa) needs longer time. Table 2.2 shows that the transition between the *C0* and *C1* states requires only a few ns, while 50 μ s are required for the *C3* state. Practically, the higher the index of *C* states is, the lower will be the power consumed, and the heat spent.

Similar research has attempted to hide the details of energy-saving techniques that are implemented in data-plane, by creating middleware running in computing resources [121]. In fact, middleware can influence the power consumed by the platforms as it maps physical resources and the users tasks [122]. For that matter, Blanquicet et al. [123] provided the means for the management of applications to measure the power consumption of IT equipment and to indicate the state at which their components operate.

2.2.2 Network level

Proxying

The sleep proxy concept was introduced in 1998 with the pioneering work of Christensen [124]. A sleep proxy scheme enables idle end devices such as PCs to pass into sleep state dealing with their potential loss of network

TABLE 2.2: Indicative energy saving and transition times for COTS (Commercial Off-The-Shelf [120])

C-state	Energy-saving with respect to the C0 state	Transition times
C0	0%	-
C1	70%	10 ns
C2	75%	100 ns
C3	80%	50 μ s
C4	98%	160 μ s
C5	99%	200 μ s
C6	99.9%	Unknown

connectivity. Before going to sleep, the idle PC transfers its network presence to the proxy, and after that the proxy responds to non-urgent messages on behalf of the sleeping node/PC and wakes-up the node/PC only if required. It handles network requests such as ARP, ICMP and DHCP. The structure of the NPC (Network Proxy Connectivity) scheme is shown in Figure 2.3. Since the proxy consumes much less than the CPU of the PC and one proxy can be shared by many PCs, the energy consumption of the system is reduced.

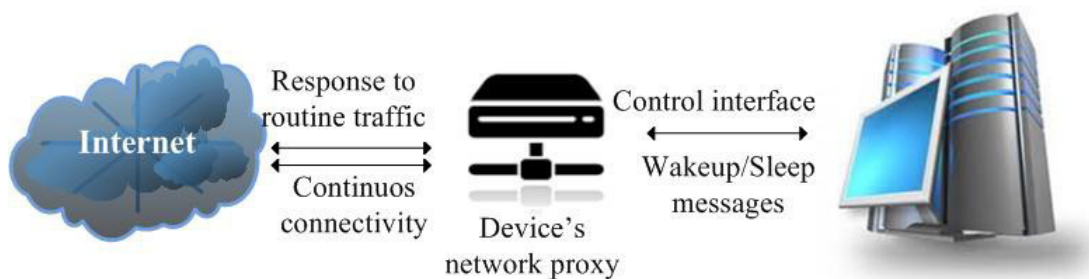

FIGURE 2.3: Network connectivity proxy

Another proxy structure can be implemented in NICs. This solution is referred as interface proxying, and does not need external proxy devices. NIC proxying implements a small handling to the incoming traffic: each NIC handles non-urgent traffic, while a whole node will wake up when urgent traffic

requiring further computation is received. In [125], a framework is proposed to implant NIC proxying over existing hardware. It supports a line speed of up to 1 Gbit/s in its software implementation (on the Smart-NIC), and up to 10 Gbit/s in its hardware implementation. The hardware implementation consumes only 25% of the power consumed by the software implementation. For higher energy savings, it should reduce the number of device wake-ups and define longer sleeping intervals.

[126] analyzed the possibility of easily deploying SleepServer architecture, i.e. dedicated on-demand proxy servers. The proposed architecture allows end hosts to utilize power saving modes more frequently. SleepServers use a very simple application agent on the end hosts. They are easily deployable because they do not necessitate any changes to current hardware, software or networking structure. [127] implements four different types of proxies with increasing complexity. They demonstrate that simple approaches are not sufficient to achieve the potential energy saving. A significant implementation is vital to handle broadcast traffic accurately and take into account the residential setting. The ECMA-393 standard [128], namely ProxyZzzy, have been recently introduced to provide an overall architecture and describe a common way to implement proxy functionality. This standard specifies essentially: capabilities that a proxy may expose to a host, information that must be exchanged between a host and a proxy, and proxy behavior for IEEE 802.3 and IEEE 802.11. However, it is neutral about communication mechanisms between host and proxies as well as with an external proxy. Also, it does not specify a common interface for monitoring the proxying operations. Finally, to estimate the potential savings, authors in [129] analyzed real patterns for home and office environment of proxying network connections. They provide full spectrum of deployment solutions, as well as consider both on-board (like NICs) and external proxy (like switches and routers) implementations.

Virtualization

The virtualization of physical resources combines a set of mechanisms that enable the operation of more than one service within the same machine. Applying virtualization to computing resources brings many benefits such as efficient hardware utilization and resource provisioning on demand, besides the reduction of both CAPEX and OPEX costs. The virtualization technique is considered as a mature research field [130]. In fact, it occurred

very frequently in data centers. Because rack space and power are expensive, deploying additional servers and routing entities without an increase in rack space is very much needed. Multiple resources and applications within the same organization (like servers, firewall, storage, and network entities) are on the same physical device and hence employ virtualization to assure the proper functioning of each resource and application. The routers are defined to be isolated logical router processes and act like a physical router. Actually, these routers do not carry full internet routes, and the flows have a tendency to inferior speed due to bandwidth sharing on the servers. In [131], the authors focus on two main techniques for creating virtualised routing entities as defined by their physical and operational characteristics. A Hardware-Isolated Virtual Router (HVR) has hardware-based resource isolation between routing entities, whereas a Software-Isolated Virtual Router (SVR) comprises software-based resource isolation between routing entities. Table 2.3 presents a comparison of the two virtualised routing techniques.

TABLE 2.3: Comparison of virtualised routing techniques [131]

Category	Hardware-Isolated Virtual Router	Software-Isolated Virtual Router
Control plane resources (CPU, memory)	Dedicated	Shared
Data plane resources (forwarding engines, queues)	Dedicated	Shared
Chassis resources (power supplies, blowers, fabric)	Shared	Shared
Management configuration	Dedicated	Typically shared, but varies depending on degree of virtualization
Connection between virtualised routing entities	Typically external	Typically internal, but possibly external
Per-chassis scalability (routing adjacencies, prefixes)	Increased with additional logical routers	Unaffected by additional virtual routers

In [132] VirtualPower is presented, a power management capability for

virtualised systems that combined software and hardware scaling methods to control the power consumption of a given platform. The proposed infrastructure of the VirtualPower advocates two basic ideas. The first is to present VM guests with what appears to be a rich set of software states available to their application-specific policies, termed VPM states. The second is to use the state changes requested by VMs as inputs to virtualisation-level management policies. They also evaluate the dynamic power consumption by a dual-core chip at different levels of frequency and voltage, and suggest that such a solution be coupled with a software scheme. On the other hand, [133] reported that the sole use of virtualization does not guarantee diminution in energy consumption. To achieve energy efficiency, other power management with the aid of virtualization should be jointly utilized, such as CPU throttling and dynamic reconfigurations that enable unused resources to be switched off.

However, initial implementations of virtualization require all virtual nodes to use the same hardware platform. [134–136] present the idea of virtual machine migration that allows logical nodes to move among different hardware platforms without losing packets. In fact, the virtual machine migration that recovers the capacity and the features of Cloud systems can reduce the operational cost of the network system [137, 138]. However, if this technique does not consider the limited memory capacity, limited processing power and limited communication bandwidth of hardware platforms, it would suffer from scalability problems for carrier-grade networks. Furthermore, migrating VMs from one node to another leads to energy overhead, because this process may require an important number of nodes to be powered on until the migration is completed. In [139], an interesting approach is proposed which could reroute traffic at layer 2, mainly by MPLS and Ethernet protocols instead of IP layer. The authors exploit the virtualization capabilities of layer 2 protocols in core networks, in which the router can transparently transfer all the virtual links from one (less used) to another putting the first one enter into standby mode. However, this solution adds a new part in the control plane, and needs further reconfigurations in order to maintain connectivity of physical topology.

The virtualization technique, especially in MAN/WAN (or in any large infrastructures) needs more flexible management mechanisms to help from migrating and resuming virtual machines. It can also be coupled with traffic engineering capabilities to provide opportunities for foundations for energy-efficient and acceptable operation required by carrier-grade networks.

Traffic engineering: with traditional protocols

In networking terms, traffic engineering is a method that puts the traffic where the bandwidth is, by dynamic analysis of data traffic aimed at optimizing the performance of telecommunication networks. The Energy-aware Traffic Engineering (ETE) strategy refers to routing traffic smartly based on energy-saving objectives. This aim is reached by bringing the network power consumption closely proportional to the actual traffic. A typical example of energy-aware traffic engineering consists of modifying the network protocols in order to route traffic over energy efficient paths, and switching off unused links. Typically in the ETE problem, the network is modelled as a graph, comprising a set of nodes interconnected by a set of unidirectional links. It is typically formulated as Mixed Integer Linear Programming (MILP), and the problem is known to be NP-hard. As a consequence, various heuristics are proposed. Several ETE approaches have been proposed by carefully handling the energy profile of network devices and the network routing [140–143]. The ETE may have the same taxonomy as the traffic engineering systems. It is well known that the traffic engineering systems can be done either with centralized or distributed decision, while their computation can be performed either offline or online.

In [144], an ETE scheme is proposed for carrier-Ethernet networks using Multiple Spanning Tree Protocol (MSTP). This approach computes the best subset of spanning trees and the best mapping of the traffic demands to the spanning trees, in such a way that a part of network is forced to be switched off. The traffic flows are then routed over the network over paths defined by the spanning trees (each spanning tree is assigned to a VLAN virtual local area network). This is achieved by defining an optimization model aimed at both considering the minimization of power consumption and the load-balancing, subject to a set of constraints of traffic engineering; and ensuring minimal network performance. Load-balancing aims to reduce the link over-utilization when the traffic load is high. However, the solution of such models is expensive to compute for large networks. Moreover, heuristics are rare; when they exist their performances are incompletely evaluated.

In reference [145], an interesting approach is proposed, called GRiDA, which builds upon link-state based protocols a distributed ETE. The turn-off decision is based on the feedback of past decisions history and the current link load, as well as the penalty of infeasible node configuration. Accordingly, GRiDA time complexity scales linearly with the network size N (number of nodes) and exponentially with nodal degree d , i.e., $O(d2^d + dN)$. To

avoid the complexity of frequent configuration, in their next proposal [146], the authors devise a distributed solution based only on current topology configuration and the knowledge of traffic load on links. In [147], the power consumption is reduced making use optimization modelling for simultaneous routing and bandwidth allocation. The major benefit of this proposal is that it does not rely on the assumption that traffic matrix is known, because its cost prediction. Hence, the authors resolve the problem introducing the notion of valuation of transmission service by employing a user utility function.

An important concept of mathematical optimization, is called Γ -robustness [148, 149], which has been successfully applied for backbone networks [150–152]. The EAR Γ -robustness-based allows to handle uncertain data, such as traffic demand volume and redundant traffic to be eliminated.

An energy-aware management approach is proposed in [153], exploiting the possibility to turn off nodes and interfaces. In addition, this work provides efficient greedy heuristic with different sorting policies. Note that a crucial step of the greedy heuristic is the way elements are sorted. The algorithm sorts elements, i.e., nodes and links, candidate to turn off using one of the following criteria: (i) most-power (MP), where MP iteratively selects the element which has the highest power consumption; (ii) least-flow (LF), where LF iteratively selects the element with the smallest amount of traffic already routed through it; (iii) least-link (LL) where LL iteratively selects the nodes with small number of its incident links; (iv) random (R), the element is selected randomly. If line cards are connected by multiple physical cables that form one logical bundled link (or bundle of lightpaths). This technique of composite link, called link aggregation, is standardized by the IEEE 802.1AX [154]. In this respect, we found relevant works have sketched the problem of ETE and network design with bundled links by turning off single physical cables [143, 155–157].

[158] proposes a heuristic algorithm, Green Load-balancing Algorithm (GLA), which is able to optimize load balancing and energy efficiency jointly based on existing ETE algorithms for backbone networks. The GLA optimizes the Interior Gateway Protocol (IGP) link weights of a network, using a genetic algorithm to find the link weights that influence the traffic distribution within the network. Figure 2.4 illustrates the operation of the GLA algorithm for a simple traffic matrix composed of only two traffic demands: 30 units from C to D and 75 units from A to D. The link utilization of C→D is 60%, A→D is

75%. Thus the maximum link utilization in this scenario is 75%. The least-flow policy is adopted to iterate through the link set. If the link $C \rightarrow D$ is turned off, its load is rerouted through the alternative path $C \rightarrow A \rightarrow D$. Then the maximum link utilization on $A \rightarrow D$ increases to 105%. Therefore, this link cannot be turned off because of network overload. On the other hand, the link $A \rightarrow D$ can be turned off because the alternative path $A \rightarrow B \rightarrow D$ will produce a maximum link utilization of 60%. In this example, only one link (link $A \rightarrow D$) can be turned off.

If the link weights are optimized as shown on the right side of Figure 2.4 ,

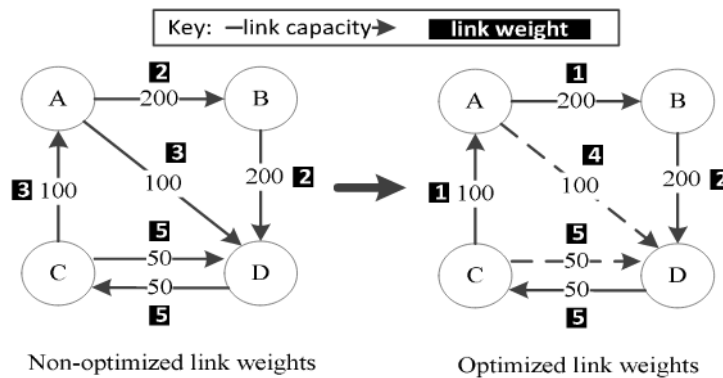

FIGURE 2.4: Example of the link weight optimization adopted in [158]

both links $C \rightarrow D$ and $A \rightarrow D$ can be turned off without affecting the network load. The traffic demands are then routed along the new paths $C \rightarrow A \rightarrow B \rightarrow D$ and $A \rightarrow B \rightarrow D$ respectively. The resulting network ends up with maximum link utilization of 52.5%. Therefore, this algorithm can achieve simultaneous improvement of both energy saving and load balancing.

Regarding traffic engineering and load balancing performances, works [159] and [160] provide analytical models to capture the performance of energy-aware network devices, especially those compliant with ACPI standard, that include LPI and AR techniques. As well as, they trade off energy consumption devices for packet forwarding. Moreover, the optimization policies presented in [160] focus on the packet processing with respect to the overall device consumption, and able to find the best way to distribute traffic among the packet processing engines pipelines. As the traffic matrices are considered independent, this algorithm can find different sets of link weights in the optimization technique for each traffic matrix. A generic overview of ETE approach is presented in [161] and is shown in Figure 2.5. This approach uses the network

topology, a power model of the network devices, and traffic matrix estimation (if offered) to pre-compute the sets of paths; three sets of paths are defined: always-on, on-demand, and failover. This approach defines a model that minimizes the network energy consumption and puts the complementary set of links in power-saving mode. The decisions taken by the computation of the model are reassigned to the network routers to be installed in their routing tables. Traffic information is collected online and transferred to the processing functional blocks residing in the offline level. This approach allows traffic to be aggregated on the always-on paths achieving low energy consumption at the low traffic levels, while an online component can progressively use the on-demand paths to satisfy the offered load. Inter-

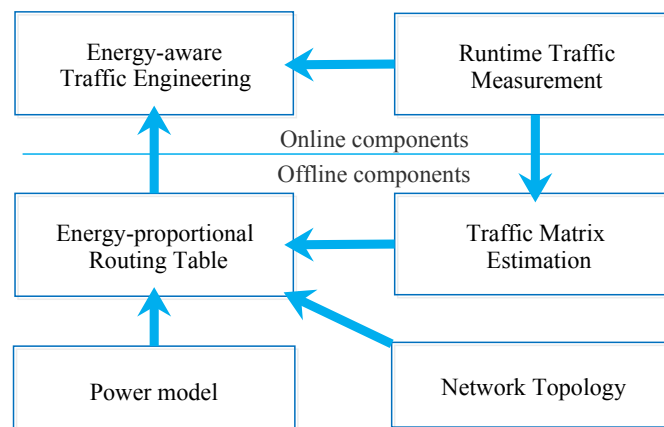

FIGURE 2.5: General overview of ETE [161]

esting works have dealt with the multi-period traffic optimisation; among others: [95, 162–164]. Two MILP-based algorithms are presented in [162], the first adopts a fixed configuration for routing along multi periods of daily time, while the second MILP allowing flexibility of routing path to the network administrator.

Traffic engineering: Software defined network

The Software Defined Network (SDN) is a novel networking paradigm showing significant promise through network programmability, and by splitting network functions between the forwarding elements and the controller element. Actually, SDN was introduced 20 years ago [165]. There are two main SDN technologies: OpenFlow [166] and ForCES; the second is called ProGFE (Programmable Generic Forwarding-Element) [167]. Recently, OpenFlow has succeeded in launching itself as an SDN industry engineering standard because it has less complex functionality compared to ProGFE. OpenFlow is

the most widely used to support energy-aware functionalities [168]. It offers new prospects to deploy several energy-aware routing algorithms. Indeed, the Openflow architecture takes out the control software from the switches ("forwarding elements") and moves it to a chief part ("controller element) that is logically centralized; this enables non-negligible power saving in the switches at the cost of the power consumed by the controller.

Following green networking improvement, recent works have targeted both shortest path routing and ETE [169–171]. As the shortest path routing is supported in all OpenFlow controller platforms, it is powerful to use this protocol in order to enable energy efficiency in the network and to offer the shortest path routing.

ElasticTree [170] is one of the most popular approaches to ETE that utilizes SDN in data center networks. It allows to a network admin running an energy-aware configuration which dynamically turn off not needed devices. The work in [172] proposes an ETE solution inside OpenFlow protocol, with the aid of the GAL (Green Abstraction Layer) [67]. This integration permits internal communication between network devices to interchange their power states. In this way, the OpenFlow controller becomes aware of the energy consumption of each network components. In) [173], an extension of the work [172], is presented to include more power states based on link capacity instead of simple On-Off states. The technique takes as input, the topology, the logical resources and the traffic demands and finds a satisfying mapping, that minimize entire power consumption, between traffic demands and action and flow configuration.

Giroire et al. [174] propose an optimization method to minimize the energy consumption in backbone networks subject to the rule space constraints of OpenFlow switch and general constraints reflecting the minimum of performance guarantees. To carry out an important variety of network applications, the flow table of an OpenFlow switch should hold a very large number of rules. However, this assumption is not fulfilled because, actually, the number of flow rules in the hardware switch is bounded by the TCAM (Ternary Content Addressable Memory) memory size. This kind of memory is very expensive and very power-hungry. This causes a major roadblock in large-scale OpenFlow deployments, particularly in energy-aware routing solutions whose main objective is to reduce the number of used links. Note that this problem is not limited to SDN, any ETE technique could face it. However, TCAM-based energy-aware SDN issues received significant attention as shown in [175]. Figure 2.6 illustrates the limited rule space problem in

energy-aware routing within the OpenFlow switch. Figure 12b presents an optimal solution, since it uses a minimum number of active links and satisfies the capacity constraints. With limited rule space, the routing solution moves away from the optimal solution, as shown in Figure 2.6(c). We notice that without rule space constraints, node 2 holds nine flows, whereas it cannot hold more than five in the case of the limited space rule. Only the second solution will be compatible with hardware whose capacity is limited to a number of flows less than nine. By means of an exact formulation using the ILP model and greedy heuristic algorithm, the authors in [174] succeeded in computing the minimum number of links that must remain active, fulfilling the rule placement constraints.

Table 2.4 summarizes this section and reports the undertaken approaches

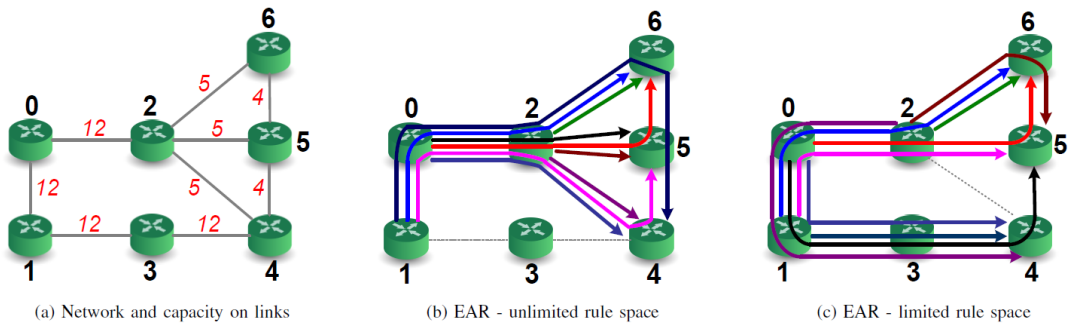

FIGURE 2.6: Limited rule space in OpenFlow switches [174]

of green networking with respect to the layer applicable and the basic mechanisms. This section discussed practical approaches whose objective is to reduce the power consumed in wired networks in general. We described the main ideas belonging to these approaches and proposed to adopt those that fit especially carrier-grade networks. For instance, energy-aware traffic engineering fits traffic variation observed within carrier-grade networks. Indeed, network traffic is usually higher during the day and lower during the night, thus it is powerful to implement such a mechanism in order to put unused devices and/or redundant resources into the low power state. Virtualization approaches are also another promising solution to enable energy saving in carrier-grade networks. In fact, with virtualization, different services can share the same resources. Therefore, network operators do not need anymore to dedicate hardware to each application or workload. In this section, we introduced and classified the fundamental techniques that could be used to green a carrier-grade network. The classification criterion comes

from network technology deployment and its operation (i.e. at node level and network level).

2.3 Issues in Carrier-grade networks

This section summarizes the major issues related to power saving in carrier-grade networks. Their requirements are resiliency, scalability, quality of service and service management.

At the moment, network operators try to improve the energy efficiency of their network and to provide the high service level required by their users. However, these two objectives are contentious: a trade-off becomes inevitable. From the state-of-the-art, performance metrics are energy efficiency metrics and QoS performance metrics. However, new metrics need to be defined for energy-efficient, resilient, and scalable networks; they are required to have a good evaluation of the satisfactory factor for carrier-grade networks.

- *Resiliency* The resilience of optical transport networks is a very important aspect (more so than general access networks). Indeed, a link of a core network supports, at each instance, thousands and sometime hundreds of thousands of user connections. Thus, a failure of one link may disrupt the communication service offer to a very large number of users. It is generally required for carrier-grade networks to resume service delivery within 50 ms. To enable this reliability, core networks rely on redundant hardware components. Hence, the design of energy-efficient resilient networks has a significant impact on the resources required, and therefore on their power consumption. Network resilience can be categorized as protection or restoration [181]. Protection is a proactive mechanism, while restoration is a reactive mechanism. In protection mechanism, alternative paths are kept and reserved before a failure occurs. When a failure occurs, no further signalling is required to establish the protection paths. In the case of the restoration mechanism, the recovery paths are dynamically assigned, and resources are not reserved until failure occurs. When a failure occurs, extra signalling is required to establish the restoration path. Computing the number of deployed resources as well their capacities is a difficult tradeoff against power consumption. This tradeoff was considered in [83].

In order to trade-off the energy saving versus the resilience performance, the work of [169] proposes a flow restoration technique showing that is hard to achieve energy saving performing 50 ms maximum

TABLE 2.4: Taxonomy of undertaken green networking approaches

		Proposal	Mechanisms	Targeted devices	Layers
Node level	Hardware Optimization	[18, 24–26, 66, 110, 111] [99–103, 105–107] [112–116, 120, 176–180]	Dynamic frequency and voltage of processors	Node chassis LCs	Data link Multi-layer
	Software Optimization	[117–119]	Power management applications	Routers	Multi-layer
Network level	Proxying	[124, 126, 127, 129]	Traffic analysis and sleeping	Web servers Routers Switches	Application Multi-layer
	Virtualisation	[130–132, 135–137, 139]	Virtual machines Virtual machine migration	Routers Switches LCs	Application
	Traffic Engineering	[84–95, 140–153] [155–167, 169–173]	MILP and heuristics Math models and simulations	Routers Switches LCs	Network Data link

delay for failure recovery as required by carrier-grade network. Also a very recent study, [182], focuses on energy versus resiliency trade-off in optical inter-datacenter networks along with solutions on an elastic optical backbone. They consider two resilient designs MOPIC (Minimum Outage Probability in Cloud) [183] and RPMPC (Resilient Provisioning with Minimum Power Consumption) [184]. RPMPC shows a good compromising scheme to offer resilient provisioning with minimum energy consumption.

- *Scalability* Network scalability is vital to meet the constant demand growth. Providers require that the network scales to support hundreds of thousands of customers to address adequately metropolitan and regional supplied areas. The scalability requires a very large physical infrastructure that is interconnected through many switches and routers; it should allow users to reach a wide variety of applications. However, such an infrastructure brings high costs in terms of CAPEX and OPEX. Hence, reducing these costs presents a major challenge for the operators. In this regard, virtualization is considered as a promising solution [83, 170, 185]. Also essential aspects have been investigated on how to minimize energy consumption for scalable networks, by optimizing the internal architectures of optical and optoelectronic devices. For instance, [186] provide a detailed analysis of the scalability and energy efficiency requirements for board and chip level interconnects and the corresponding targets for the potential of optical technologies. Only few works address energy saving versus scalability trade-off issues [187, 188]. For instance, [187] introduces an OpenScale inter-data center architecture, which can be upgraded gradually from traditional electrical switching DCNs in a plug-and-play technology achieving lower operational cost.
- *Quality of Service* Nowadays, carrier-grade networks promise to offer a good quality of service to their end users. Moreover, energy saving is becoming a crucial concern. Good trade-off between these two potential opposing concerns is required. An analytical model in [159, 160] allows the impact of power-saving techniques (such as adaptive link and low power idle techniques) on the quality of service metrics to be characterized, as well as how they affect the overall system behavior. This model can initiate a large set of network switching architectures,

technologies and components and is becoming an interesting estimation tool that can be effectively adopted inside optimization techniques for the dynamic control of green networking equipment.

- *Service management* All services provided by network operators must be managed and supervised in order to ensure that they are operating as expected. The service provider must have the performance measurements to back up any service level claims. If a fault does occur, then the service provider has to identify which services have been impacted to react appropriately. When this functionality is combined with energy efficiency, specialized systems and equipment are required to be added into the network. For instance, to meet the service level agreements (SLAs) in optical networks, some strategies can be taken [189]: (1) *physical impairment*, energy efficiency techniques may augment the effect of physical impairments like the fiber loss or dispersion. [190] addresses this problem and shows that it can be solved by hosting design strategies that are both power- and impairment-aware; (2) *differentiated quality of protection*; [191] proposes an efficient policy to apply differentiated QoP by assigning different levels to demand with different SLA requirements. This application allows for a reduction of protection resources with significant energy efficiency; (3) *lightpath preemption*, based on the intuition that low-priority services can be provisioned with the possibility of being rejected when connected to a level of criticality must use network resources. In this regard, lightpath preemption levels are used to decide to which routes the optical signal must be assigned first, releasing the resources used by lightpaths with lower preemption levels.

2.4 Conclusion

In this chapter, we have described the most suitable techniques that could improve the energy efficiency of carrier grade-networks from two different aspects: the network and node level.

After examining different approaches described in existing surveys, we proposed a new taxonomy of the energy-saving approaches based on two main categories. The classification criterion comes from network technology deployment and its operation (node level and network level).

Carrier-grade networks are energy-hungry infrastructures that run large-scale

systems to deliver services. In this respect, we give useful references for workers who are interested in energy-efficient and wide networks. Future research should deal with the joint impact of the different approaches.

Aspects of carrier-grade networks, being resilience, scalability, and quality of service, make it more difficult to determine the best performance trade-off between energy efficiency and required functionalities. Although valuable solutions have been studied to save energy, to the best of our knowledge, there is no work that considers all the carrier-grade requirements at the same time. Two key issues remain open: what is the best way to assess the trade-off between energy saving and network performance? And how to achieve a power consumption that is proportional to network load? These issues concern not only carrier-grade networks but also a large set of wired networks.

In this thesis, the approaches we proposed are designed to be treated at the network level. Our contributions come under traffic engineering mechanisms, which relate to different routing protocols of carrier Ethernet networks. We propose several resolution methods that can be performed in a coordinated fashion by a centralized entity. In the next chapter, we introduce our first approach which is called MEEAFS (Metro Ethernet Energy Aware Forwarding Strategy).

Chapter 3

Energy-aware Forwarding Strategy for Metro Ethernet Networks

3.1 Introduction

Much research related to ICT has sought for more efficient solutions that can improve energy efficiency. Currently, minimal research has addressed energy saving in Carrier Ethernet networks compared with those in IP networks. Metro Ethernet is the use of Carrier-Ethernet technology in Metropolitan Area Networks (MANs). It can be used to connect business local area networks (LANs) and individual end users to wide area networks (WAN) or to the Internet. Recently, significant innovations have been developed around Ethernet standards to meet the requirements of next generation broadband networks. These developments have made Ethernet a widely used technology, deployed at all levels of the network architecture (Access, Metro and Core networks). Current Ethernet technologies rely on the Spanning Tree Protocol (STP), which was standardized in IEEE 802.1D [192], and its variants: Rapid Spanning Tree Protocol (RSTP) [192] and Multiple Spanning Tree Protocol (MSTP) [193]. These protocols manage the topology autonomously and provide a loop-free connectivity across a variety of network nodes. Although these protocols have been used for most Ethernet networks, they are not sufficiently powerful to satisfy Metro Ethernet network features as a Carrier-grade technology. These protocols have the following main shortcomings:

1. *Inefficient use of resources*: STP and its variants restrict the number of bridge ports being used, which reduces the available bandwidth, especially in cases of high traffic load.

2. *Suboptimal path*: The path selection is based on a single spanning tree for the entire network (the shortest path tree roots at an arbitrary node) instead of the shortest path between source and destination node pairs.
3. *Re-convergence*: STP implements a transactional distance-vector class of routing algorithm instead of a routing algorithm based on a network link topology database. This adversely impacts the convergence time of an Ethernet network after a topology change [194].

Recently, a new class of shortest path routing solutions has been introduced for Ethernet networks, the Shortest Path Bridging (SPB), standardized in IEEE 802.1aq [195]. SPB aims to ensure frame forwarding on the shortest path within a Shortest Path Tree (SPT) region of a network by using an extension of the Intermediate System to Intermediate System (IS-IS) link state routing protocol [196]. In this way, SPB uses IS-IS procedures to construct and update the link state database in each SPT bridge. The aim of this chapter is to develop an energy-saving strategy within a Metro Ethernet network. This idea is inspired from the EAR (Energy Aware Routing for Green OSPF) approach [53], which is designed for IP networks and is OSPF compliant. The EAR approach is an energy-saving strategy that is based on powering off parts of network devices (links and interfaces). Because we focus on Metro Ethernet networks, we propose a Metro Ethernet Energy Aware Forwarding Strategy (MEEAFS) that is IS-IS compliant. OSPF [197] and IS-IS [198] are link state protocols that use Dijkstra's algorithm for computing the shortest path between node pairs. OSPF is an IP routing protocol only, while IS-IS supports the handling of MAC addresses; it is able to run directly over Ethernet as it is not tight to IP. Since we focus on Metro Ethernet networks, we propose an energy-aware forwarding strategy for green carrier-Ethernet networks that is SPB-based and is IS-IS compliant.

3.2 Carrier grade Ethernet

Figure 3.1 illustrates the difference between traditional Wide Area Network (WAN) and Ethernet Wide Area Network (E-WAN). It shows also technology options available for deploying them. As the figure point out, Ethernet technology is developed in WAN for carrying Ethernet WAN services.

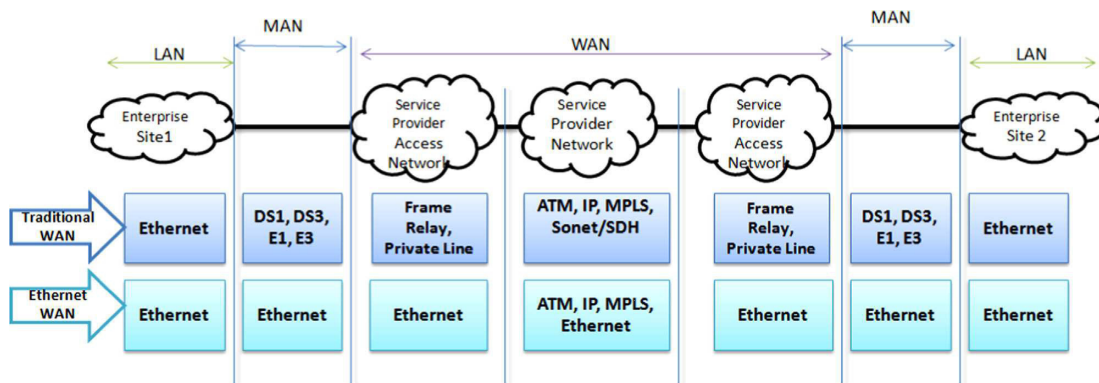

FIGURE 3.1: Traditional and carrier Ethernet technologies [199]

Figure 3.2 shows the evolution of Ethernet data-link layer. We first found the legacy IEEE 802.1D which was defined in 1985 defining STP as routing algorithm. Then two amendments appeared with IEEE 802.1w (RSTP) and IEEE 802.1s (MSTP) have introduced new mechanisms to offer faster convergence time and better network utilization than IEEE 802.1D. After that, the Virtual LANs is appeared in 1998. which provides tags to Ethernet frames with VLAN IDs. (it is the basic technology for carrier grade Ethernet). IEEE 802.1Q only supports up to 4094 VLANs, which is a scaling constraint for service providers. Then two standards were defined that resolve this issue: IEEE 802.1ad (allows a provider up to 4094 service instances) and IEEE 802.1ah which supports up to 16 million services (removing the scalability problems). 802.1aq allows for true shortest path routing, multiple equal cost paths, much larger layer 2 topologies, faster convergence, abstraction of attached device MAC addresses from the transit devices, head end and/or transit multicast replication, all while supporting the full suit of 802.1 OAM (operations, administration and maintenance) [200]. SPB enables frame forwarding on the shortest path between any two bridges of an Ethernet network. In order to achieve shortest path forwarding, each bridge maintains its own Shortest Path Tree (SPT). SPB form an SPT region and edge bridges of the region forward the frames that are incoming to the region on their own tree. In other words, it provides frame forwarding on the shortest path within an SPT region of a network by using ISIS-SPB (link state routing protocol) on all SPT bridges to control the forwarding paths. ISIS-SPB uses the standard IS-IS procedures to construct and update the link state database in each SPT bridge [196]. Bridges exchange link state information using IS-IS routing protocol to achieve a global consistent view of all bridges, topology and location of end nodes. The bridges forward layer 2 frames to their destination using the shortest path available. This combination of using a routing protocol to

forward frames on a layer 2 network, helps keep the ease of configuration of a layer 2 segment while adding the advantages of layer 3. These advantages can be summarized as load balancing, fast failure reroute, and shortest path routing.

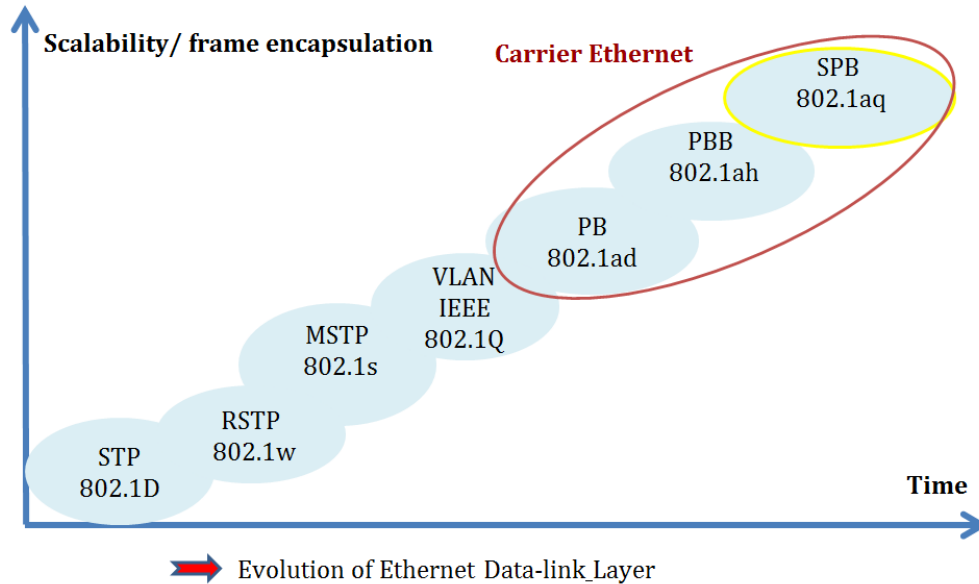

FIGURE 3.2: Evolution of Ethernet Data-link Layer

3.3 Related work

Minimal research has focused on energy saving in Metro Ethernet networks. Besides, there are several industrial efforts are devoted for to Metro Ethernet, but none of them cares about energy economy at routing level. In order to better understand the possible ways to limit energy consumption in Metro Ethernet systems, we overview IP approaches which propose energy-aware routing protocols compatible with SPB-based Metro-Ethernet.

The authors in [144] have proposed an optimization model based on the traditional Multiple Spanning Tree Protocols (MSTP) green routing protocol. This model is intended for minimizing the energy consumption of Carrier-Ethernet networks. This optimization is performed in such a way that a portion of the network is forced by the objective function of the model to remain unused, thus making it possible to turn off the elements of that portion of the network. These network components are put into sleep mode to conserve energy. The main shortcoming of this approach is the use of MSTP, which is inefficient in the Metro Ethernet context.

In [201], the authors proposed an IP-related approach that switches the router to sleep mode during low-traffic periods and returns them to the working state during peak hours. This approach could be adapted to an Ethernet Bridge; however, this approach puts the whole router to sleep instead of powering off some of its interfaces (links), which leads to poor network performance.

In [53], the authors propose an Energy Aware Routing algorithm to power off a maximum of active links by dividing the network routers into three subsets (exporter, importer, neutral). The main idea of this algorithm is that only a subset of routers are elected to serve as exporters. Elected exporter nodes must have a high number of neighbors, so node election is based on the node degree. In that case, each exporter computes its SPT to export it toward its direct neighbors' routers. The latter, called importer routers, utilize the SPT of the associated exporter routers, but use the importer router as the root node. Doing this allows the powering off of the links that are no longer in the SPT of the importer routers. However, this algorithm considers neither the QoS constraints nor the traffic demand. Motivated by this EAR idea, we propose an energy-saving strategy applied within a Metro Ethernet network, considering a new criterion to select adequate exporter bridges and supporting acceptable network performance. To achieve this goal, we formulate an optimization model for the choice of exporter bridges that takes into account energy consumption impact. In our model, an energy consumption function needs to be minimized that is subject to a set of constraints involving the minimal performance guarantees, which are explained in the next section.

3.4 Problem formulation

To achieve energy conservation, the network management system must solve an optimization problem that takes the network topology and traffic demands as input, and identifies the maximum number of elements (e.g. links) that can be turned off. Our work takes as first input the network topology and as second input the traffic demands. The energy saving solutions are typically formulated as traffic engineering problem, Integer Linear Programming (ILP) or Mixed Integer Linear Programming (MILP) formulation, able to compute the minimum number of network elements that must remain active to fulfill the traffic requirements. In this section, we present the theoretical formulation of the problem. The following ILP presents the trade off between energy saving and network performance.

3.4.1 Network model and notations

Consider a Carrier-Ethernet core network presented as a weighted graph $G = (N, E)$. The nodes in N represent bridges, and the links in E represent connections between those bridges. Let $|N|$ and $|E|$ be the number of network nodes and links, respectively. Each link $(i, j) \in E$ between two nodes $i, j \in N$ has an energy consumption \mathcal{E}_{ij} and a capacity c_{ij} . The traffic demand between a pair of nodes could be presented as d^{st} , where $s \in N$ is the originated node and $t \in N$ is the destination node. f_{ij} denotes the total flow on each link from i to j .

The optimization of power consumption can be expressed formally with the following objective and constraints:

$$\min \sum_{(i,j) \in E} x_{ij} \mathcal{E}_{ij} \quad (3.1)$$

$$\text{Subject to } \sum_{n \in N_G(u)} (f_{ij}^{st} - f_{ij}^{st}) = \begin{cases} -1 & \text{if } i = s_d, \\ 1 & \text{if } i = t_d, \\ 0 & \text{if } i \neq s_d, t_d, \end{cases} \quad \begin{matrix} \forall i \in N; \\ (s, t) \in D, \end{matrix} \quad (3.2)$$

$$f_{ij} = \sum_{(s,t) \in D} d^{st} f_{ij}^{st} \quad \forall (i, j) \in E, \quad (3.3)$$

$$f_{ij} \leq \mu_{ij} C_{ij} \quad \forall (i, j) \in E, \quad (3.4)$$

$$\mu_{ij} \in]0, 1] \quad (3.5)$$

The objective function (3.1) minimizes the total power consumption induced by links. Equations (3.2) represent the classical flow conservation constraints ensuring that flows entering and leaving a node are equal. Equations (3.3) compute the total flow on each link. Inequalities (3.4) force the link load to be smaller than the maximum target utilization μ_{ij} .

Let SPT_k be the subgraph of G obtained by the k^{th} bridge using Dijkstra's shortest path first algorithm toward all network nodes. Let $SPG(N, E_s)$ be the subgraph of G obtained by the superposition of all SPT_k ($k = 1, \dots, |N|$), i.e. $SPG = \cup_{i=1..|N|} SPT_i$.

E_s includes all of the links that belong to at least one SPT_k , and identifies all of the paths used to route traffic. We consider this type of link as an active link.

$$E_s = \|\| SPT_i \cup_{i=1..|N|} SPT_i \|\| \quad (3.6)$$

It can be demonstrated that

$$|E_s| \subseteq |E| \quad (3.7)$$

Proof: The equality between $|E_s|$ and $|E|$ holds when all link costs are equal. In this case, the routing paths correspond to the shortest paths, and SPG coincides with G because when all links have equal cost, the shortest path between two neighbor switches is always the direct link between these two neighbors.

In more general cases, when the link weights are different, the number of active links is smaller than $|E|$, i.e. $|E_s| \subseteq |E|$. A first step to obtain a reduction of energy consumption is to switch off the links belonging to the set $E \setminus E_s$. The minimum value of $|E_s|$, i.e. the minimum number of unidirectional links needed to route traffic between any pair of bridges, is

$$L_{min} = 2(N - 1) \quad (3.8)$$

L_{min} is the minimum number of links that guarantees total connectivity for the network. The condition (3.8) is verified when all of the nodes compute the same *SPT*. According to this condition, by switching off the $|E| - 2(N-1)$ links of G , we would obtain the maximum energy savings, but this leads to traffic congestion and subsequently poor network performance.

According to the NMS (Network Management System), given the traffic demand and the network topology as inputs, the outputs of the optimization problem will be the set of links to switch off and the paths that the traffic should use over the residual links. Table 3.1 lists a summary of the parameter definitions.

3.4.2 EAR description

The EAR algorithm defined in [53] is a traffic unaware algorithm in which routers/nodes are categorized in exporter (ER) routers, importer (IR) and neutral (NR) routers. This algorithm involves forcing a subset of routers to use some routes that are different from those computed in their *SPTs*. Only ERs and NRs compute their *SPTs* performing the classical Dijkstra algorithm. While IR will use the links of the *SPTs* evaluated by the exporter ones to construct their own path trees and to fix the links that have to be turned off. The EAR proceeds by the execution of three consecutive phases: // The EAR algorithm defined in [53] is a distributed, energy-aware routing protocol that is able to save energy by performing the election of exporter nodes. The scheme involves forcing a subset of routers to use some routes that are different from those elected in their *SPTs*. The set of network routers is divided into three subsets: exporters, importers, and neutral routers. This scheme is

TABLE 3.1: Summary of notation

Notation	Description
$G(N, E, W)$	Directed graph where N is the set of nodes, E is the set of links between two nodes, and W is the set of weights associated with each link.
$ N , E $	Cardinality of set N and E , respectively.
\mathcal{E}_{ij}	The energy consumption of the link $(i, j) \in E$.
x_{ij}	Binary variable to indicate whether the link (i, j) is asleep or not.
c_{ij}	The capacity of the link $(i, j) \in E$.
D	A set of all traffic demands.
d^{st}	Demand of traffic flow from s to t .
f_{ij}^{st}	Traffic demand from s to t that traverses the arc from i to j .
E_s	The set of links utilized to route traffic.
Th	Threshold of link load.
μ_{ij}	The maximum link utilization.

achieved by the three following phases: *i) During the first phase* (election of exporter routers), each node calculates its shortest path tree (performing Dijkstra algorithm). During this phase, each router selects from its LSA (Link State Advertisement) database a list containing the exporter routers; *ii) In the second phase*, called Modified Path Tree (MPT) evaluation, every importer router fulfills its new path tree by using the associated exporter's tree and extracts the links to be switched off; *iii) During the third phase*, called routing path optimization, after removing the links that have been switched off, each router computes its paths, using the Dijkstra algorithm, on the residual network topology. The aim of this step is to update the routing paths and to ensure that all of the routers are on the same reference topology.

Briefly, the EAR algorithm [53] is an energy-efficient algorithm in which some SPTs between neighbor routers can be shared to reduce the overall set of active links. The main advantage of this algorithm is that it can be applied without knowledge of the actual traffic in the network and with no complexity increase. However, the EAR algorithm ignores the current network traffic which may overload the remained topology.

Our work aims to apply the EAR strategy to Metro Ethernet. Exploiting the

fact that OSPF and SPB (or ISIS-SPB) are both link state routing protocols using the Dijkstra algorithm. Our MEEAFS considers SPB protocol to fit Metro Ethernet network. We propose a new criterion for exporter bridge selection and energy conservation. Unlike the EAR algorithm, which is based on the node degree for the exporter router selection, MEEAFS takes into account the impact of line cards of nodes on the overall energy consumption (nodes having the lowest impact on energy consumption). The impact on the overall energy consumption can be set by network administrator. Moreover, we consider in a later step the current traffic load in order to reroute traffic minimizing the energy consumption induced by links and maintaining the maximum links load under a prefixed threshold value.

3.4.3 MEEAFS algorithm

Our MEEAFS algorithm uses the topological information exchanged among nodes (due to the SPTs computed by nodes). Given the tradeoff between the graph connectivity, energy saving and network performance, MEEAFS offers two enhancement criteria. The first one is related to the impact of energy consumption and the second one is related to the link congestion minimization. As in the MEEAFS algorithm, the set of network bridges is divided into three subsets: exporter (EB), importer (IB), and neutral bridges (NB). the topology planning can be illustrated as described in Figure 3.3. The MEEAFS algorithm can be summarized as follows: 1) *Selection of the EBs*: During this phase, each bridge computes its energy impact. This information is obtained by computing the energy impact of the line cards (EILCs) of each bridge. In [56], an energy profile is defined as the energy consumption (in Watt-hours) in the function of the traffic load and throughput of a particular network component. EILC can be estimated due to the knowledge of the topology and the traffic conditions by means of the SPB and IS-IS protocols. We assume that EILC is given by the network administrator. W_i denotes the power consumption weight of bridge i and is defined as follows.

$$W_i = \sum_{k=1}^{nc_i} EILC_{i,k} \forall i \in N \quad (3.9)$$

where nc_i is the number of cards of the bridge i . According to (3.9), the bridge power consumption expresses the energy impact as a function of link traffic load. Bridges having the lowest power consumption are inserted in the

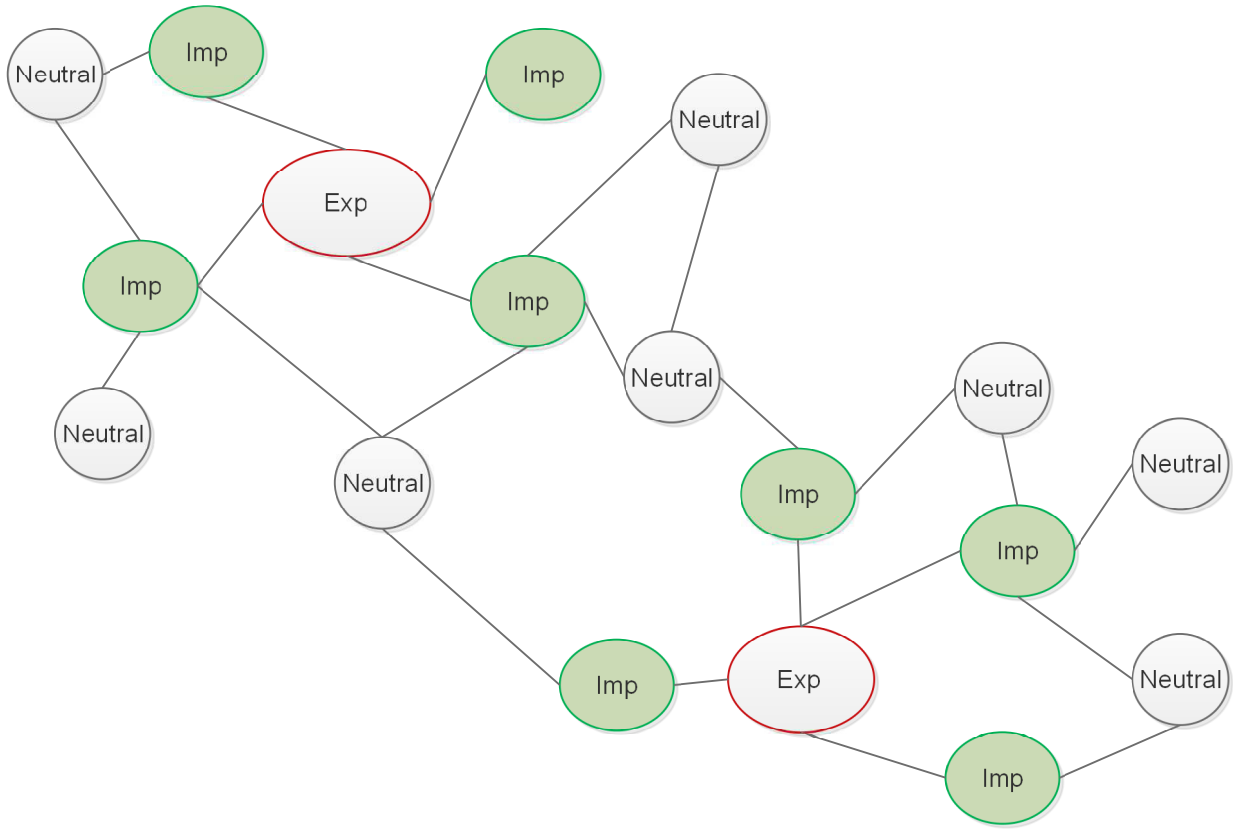

FIGURE 3.3: Topology planning of MEEAFS

exporter bridge list, called *EB_list*. The direct neighbors cannot be considered as candidate EBs. This process is applied recursively on the remaining bridges. Consequently, the bridges inserted into *EB_list* have the minimum energy consumption impact. The links associated to EBs are less likely to be switched off when an IB uses the SPT's EB as its own. In Figure 3.4, initially we assume that the *A* and *B* bridges are candidates to be exporters. In Figure 3.4(a) shows an example of a network graph with EILC weights. According to (5), $W_A = 0.3 + 0.4 + 0.3 + 0.4 = 1.4$ and $W_B = 0.3 + 0.3 + 0.4 + 0.5 = 1.5$. The bridge *A* is elected as EB, and hence *B* is an IB that will use *A* as its packet forwarder.

2) *Modification of the SPT of IB*: In this phase, each IB has to execute a slight translation of Dijkstra's algorithm based on its associated EB, in order to identify the set of links that can be switched off. Each IB transforms its SPT into a Modified Shortest Path Tree (MSPT). As explained in the first section, SPB uses the IS-IS standard to construct and update a link state database in each bridge. Thus, the complexity of the classical SPB remains the same, when the IB computes an SPT in which the root node is the associated EB. Figure 3.4(d) shows an example of a network graph in which *A* is elected as

an EB and B is an IB that uses the SPT of A as its own modified SPT. We denote $MSPT(B, A)$ the imported SPT of A for B . The bridge B has to force itself as the tree root node by changing the direction of the link between A and B .

Once all of the IBs have computed their MSPT, any network link that no longer appears in any MSPT will be declared as a link to turn off. Thus, each IB checks iteratively if a given link (that belongs to the links to turn off, denoted by L_{off}) can legitimately be turned off or must be kept in its modified shortest path tree (MSPT). For each iteration, the considered link is removed from the forwarding table if the link load f_{ij} is smaller than a fixed threshold Th .

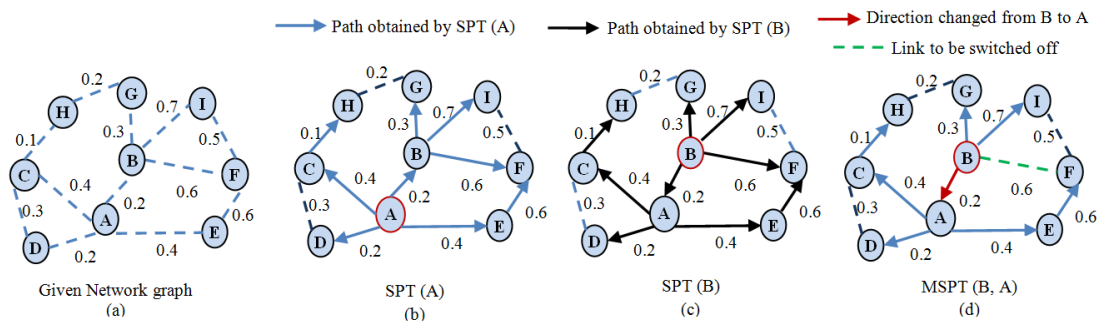

FIGURE 3.4: Illustrative example for MEEAFS phases (1) and (2)

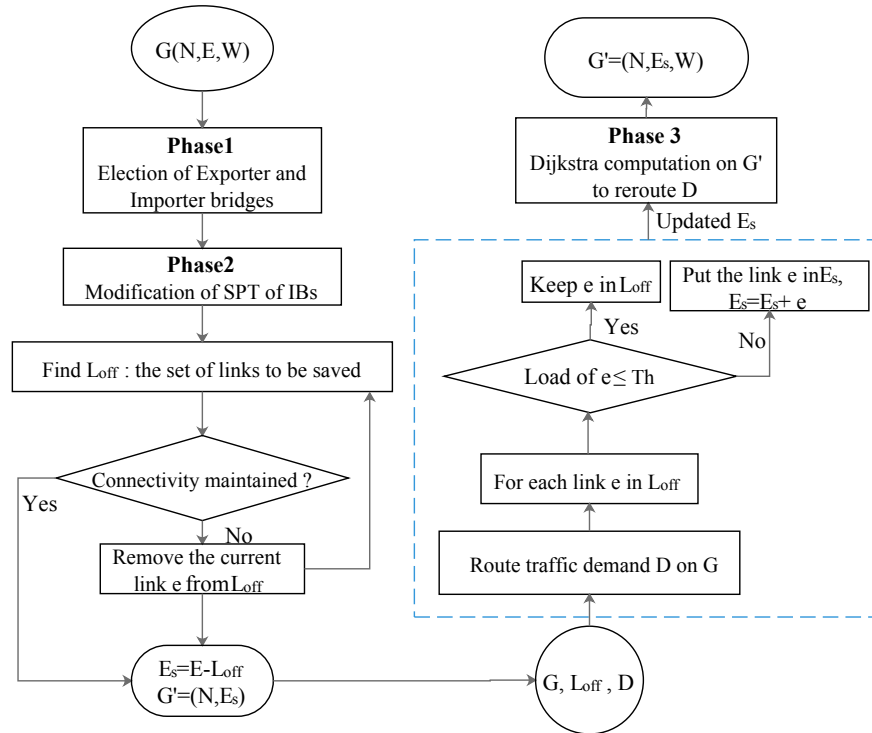

FIGURE 3.5: Flowchart describing the operation of MEEAFS

3) *Forwarding path optimization*: At the end of the previous phase, each IB has to assess the modified forwarding path tree MSPT. Thereafter, each IB indicates the set of links that has to be removed. In order to optimize the forwarding path trees, each IB having at least one switched off link processes IS-IS Hello until the topology database has been updated. Once the update process is terminated, SPB performs the shortest path calculation on

the residual network topology.

```

Input:  $G=(N,E)$ , a network graph.
Output:  $G'=(N,E_s)$ : network graph with the set of links to be used
1 /*Begin*/
2  $B\_list=N, EB\_list=\emptyset, IB\_list=\emptyset, NB\_list=\emptyset$ ;
3 for (  $i = 1; i \leq N; i++$  ) do
4   | calculate the weight of each bridge using (3.9);
5 end
6 /*Phase 1*/
7 while (  $B\_list \neq \text{empty}$  ) do
8   |  $exp = \text{finding\_exporter}(B\_list)$ ;
9   |  $EB\_list = EB\_list \cup \{exp\}$  ;
10  |  $B\_list = B\_list - \{exp\}$  ;
11  |  $imps = \text{finding\_importer}(B\_list, exp)$  ;
12  |  $IB\_list = IB\_list \cup \{imps\}$  ;
13  |  $B\_list = B\_list - \{imps\}$  ;
14  |  $neutrals = \text{finding\_neutral}(B\_list, imps)$ ;
15  |  $NB\_list = NB\_list \cup \{neutrals\}$  ;
16  |  $B\_list = B\_list - \{neutrals\}$  ;
17 end
18 /*Phase 2*/
19  $L_{off} = \emptyset$ ; /*links to be turned off */
20  $i=0$  ;
21 while (  $IB\_list \neq \text{empty}$  ) do
22   |  $\text{modify\_the\_shortest\_path\_tree\_of}(IB\_list[i])$ ;
23   |  $L_{off} = L_{off} \cup \text{fixing\_links}(IB\_list[i])$  ;
24   | if (  $L - L_{off} = 2(B - 1)$  ) according to (3.8) then
25     | Break ;
26   | end
27   |  $i++$  ;
28 end
29 for ( each  $e \in L_{off}$  ) do
30   | if  $f_e > Th$  then
31     |  $L_{off} = L_{off} - e$ ;
32   | end
33 end
34 /*Phase 3*/
35  $E_s = E - L_{off}$  ;
36 compute_all_shortest_path using SPB for the residual topology
    $G'(N, E_s)$  ;

```

Algorithm 1: MEEAFS

3.5 Performance analysis

This section presents the MEEAFS performance obtained in different scenarios using the ns-3 simulator. Initially, the simulator reads a weighted adjacency matrix of an input topology of 50, 100, 200 and 300 nodes, respectively. These weights represent the energy impact of links (two adjacent nodes), assuming that they are set by the network administrator. We have considered four core network topologies: the first one is composed of 50 nodes and 348 links; the second one composed of 100 nodes and 964 links; the third one is composed of 200 nodes and 1,926 links; and the fourth one is composed of 300 nodes and 2,276 links. Each bridge is assumed to generate traffic toward any other bridge. Traffic demands arrive at the network nodes following a Poisson process with arrival demands rate λ and required k_d traffic units that is randomly generated between $0.001*c$ and $0.1*c$ (c being the link capacity in traffic unit). We consider the following two evaluations:

1. A comparison of the MEEAFS algorithm versus the EAR algorithm with different topologies.
2. A general performance analysis of the MEEAFS algorithm.

The obtained results are the average of ten independent runs. To evaluate the energy savings that could be achieved by EAR and MEEAFS, we consider the σ index:

$$\sigma\% = 100 \times \frac{|E| - |E_s|}{|E| - L_{min}} \quad (3.10)$$

Figure 3.6 depicts the energy savings obtained by EAR and MEEAFS algorithms for the four topologies. The EAR energy savings are constant, because the EAR algorithm has not defined a threshold either to turn off or to keep links in the active state. The EAR algorithm also does not consider the traffic load.

Therefore, when EAR is used, 55% of possible links are turned off. However, we notice that the performance of MEEAFS is dependent on the Th value. The power saving obtained by MEEAFS increases with the increase of the threshold Th. This algorithm was able to achieve more than 65% energy savings when the value of the threshold was greater than 75%.

Figure 3.7 depicts the energy savings obtained by MEEAFS in both medium and high loads of traffic. We have already observed that in medium loads more energy saving can be achieved compared with high loads. Indeed, as the traffic load increases, fewer links can be turned off. In order to analyze the impact of the MEEAFS algorithm on network performance, we evaluate

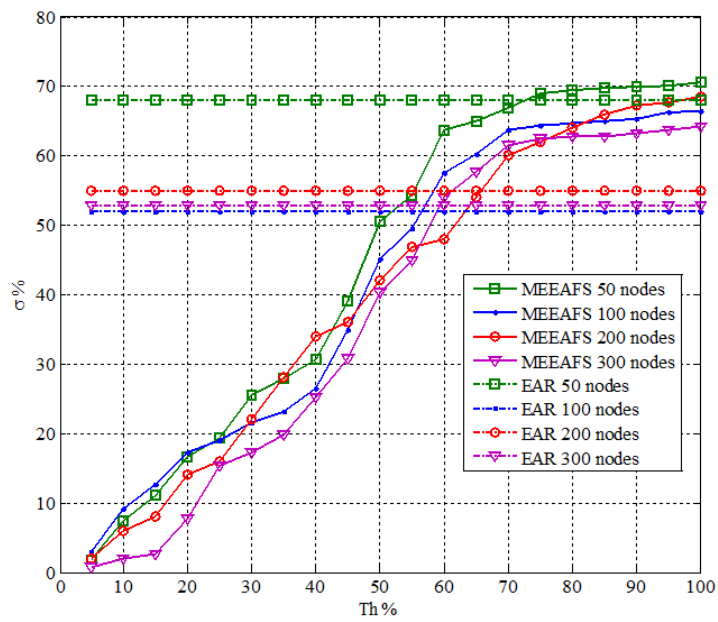

FIGURE 3.6: Energy saving versus link load threshold

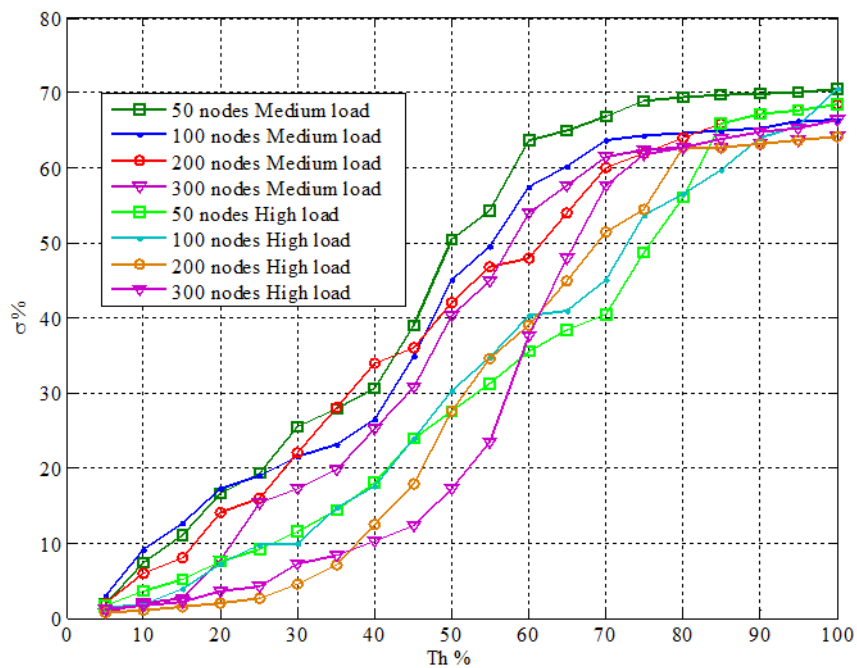

FIGURE 3.7: Energy saving versus link load threshold (medium and high load)

the average traffic load on active links by varying the number of turned off links (thus varying Th). We introduce the $\rho\%$ parameter (average link load

of active links), which is computed as follows [202]:

$$\rho\% = 100 \times \frac{\sum_{e=1}^{|E_s|} \rho_e}{|E_s|} rhoALU \quad (3.11)$$

where ρ_i is the traffic utilization of link i .

In Figure 3.8, the average traffic load on active links as a function of Th is reported when MEEAFS is performed. In this scenario, we generate medium loads with traffic demand rate λ equal to 0.2. We observe that our strategy achieves satisfactory results in terms of average link load. Figure 3.9 reports

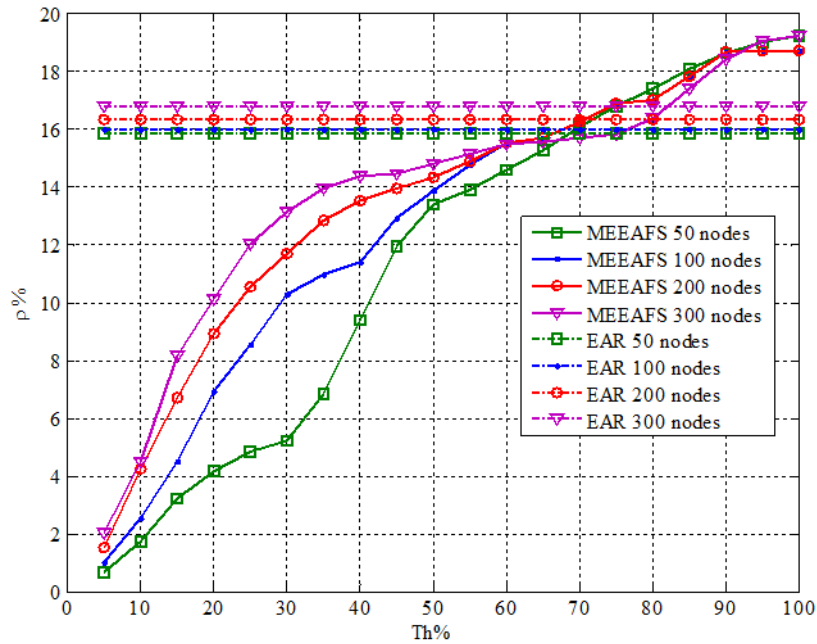

FIGURE 3.8: Average traffic load in active links at medium load

the average traffic load on active links. In this scenario, we generate high loads with traffic demand rate λ equal to 0.7. In this case, we observe that our strategy can achieve an acceptable link load if the threshold does not exceed 55%.

The increase of threshold value corresponds to the increase in energy savings. As shown in Figure 3.9, the MEEAFS algorithm reports significant performance at medium traffic loads, with energy saving that can exceed 60%. Moreover, the MEEAFS algorithm can achieve approximately 40% energy savings at high traffic loads without affecting the network performance. Therefore, the choice of the threshold value in each scenario is critical to modulate the energy savings. Hence, MEEAFS could potentially guarantee a reduced impact on traffic performance.

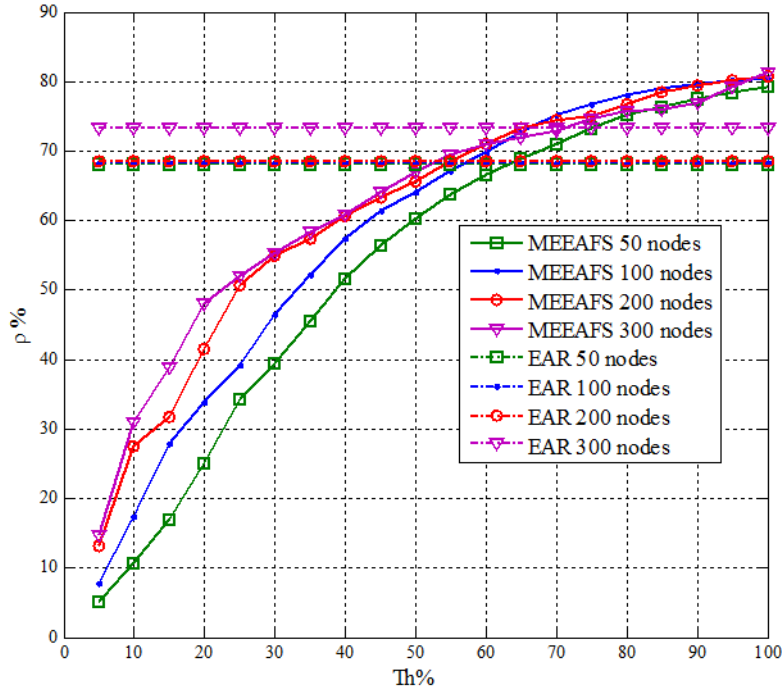

FIGURE 3.9: Average traffic load in active links at high load

Load balancing is considered to be a requirement that should be fulfilled in Carrier Ethernet. Hence, the third performance analysis is devoted to measuring the fairness of the traffic distribution on the active links E_s . The fairness index FI is used to measure whether the traffic load is fairly distributed among all of the links. We utilize Jain's Fairness Index [203]:

$$FI = \frac{(\sum_{e \in E_s} \rho_e)^2}{|E_s| \times \sum_{e \in E_s} \rho_e^2} \quad (3.12)$$

When $FI = 1$, this indicates that the traffic is distributed in a fair way.

Figures 3.10 and 3.11 summarize the value of FI obtained by MEEAFS and EAR in medium and high loads of traffic, respectively.

We observe that the fairness index in both load conditions (high and medium) is nearly similar. Similarly, the fairness index decreases when the number of turned-off links increases, i.e., when the threshold Th values increase. Thus, as we discussed earlier, the choice of threshold value is critical to obtain the desired performance versus the energy saving gain.

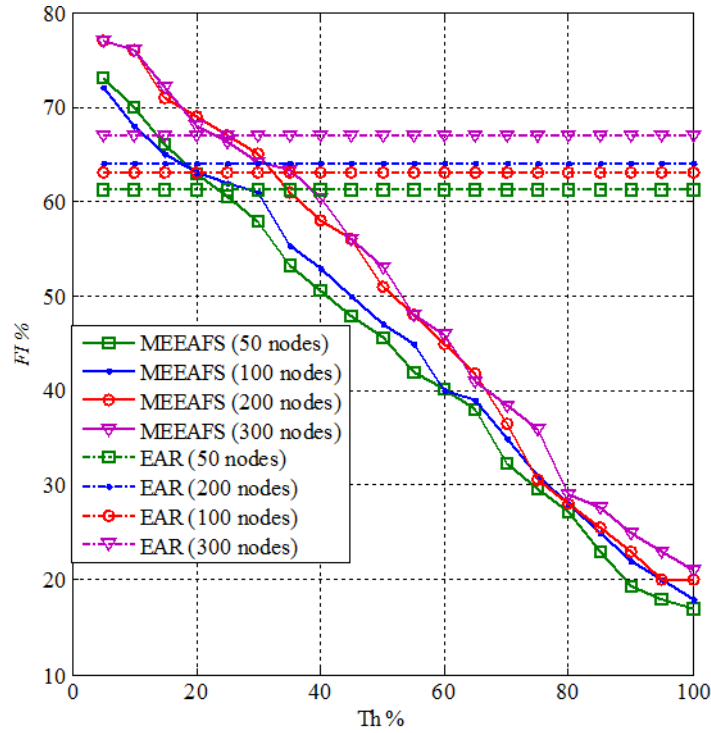

FIGURE 3.10: Fairness index versus link load threshold at medium load

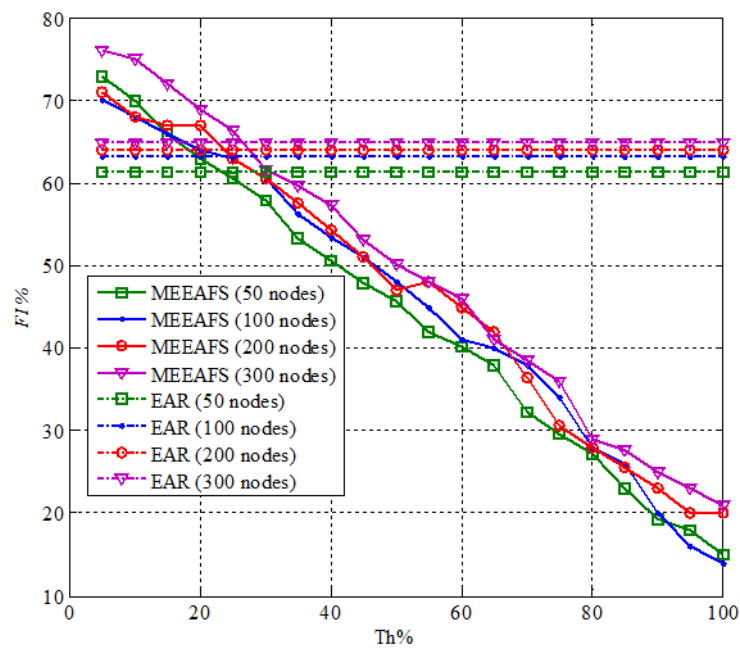

FIGURE 3.11: Fairness index versus link load threshold at high load

3.6 Conclusion and future work

This work proposes a new routing algorithm, called MEEAFS, to save energy in Carrier Ethernet networks. It allows a subset of bridge interfaces to

be turned off. Our algorithm is based on a modification of the Internet Energy Aware Routing Algorithm [53]. Among the limitations of their EAR algorithm, the traffic loads on links are ignored and the energy consumption impacts of link cards are not taken into account. Our algorithm resolves those constraints. It is based on a heuristic that identifies the exporter bridges and fixes a value of link load threshold to ensure acceptable network performance. Nevertheless, MEEAFS could affect the average route length. It is not evaluated in this work and it will be considered in the next work. The presented results show that important energy savings may be achieved with MEEAFS for our scenarios. This was typically true at medium traffic loads and for threshold values higher than 50%. However and obviously, at high traffic loads, MEEAFS cannot achieve significant energy reduction without degrading network performance. We tested the behavior of MEEAFS by considering only the core network segment. Based on these encouraging results, our future work will consider an actual network topology, including all of the network segments: core, metro, and access. For example, realistic network topologies from available datasets might be used, such as the Rocket-Fuel [204] and Topology Zoo datasets [205], SNDlib [206] and dynamic (cyclostationary) traffic matrices could be generated [207].

Chapter 4

Equal Cost Multiple Path Energy-Aware Routing in Carrier-Ethernet Networks with Bundled Links

4.1 Introduction

In modern communication infrastructures, power consumption along with congestion are the most critical aspects of designing the network topologies. In the case of multiple shortest paths available for a given demands, it is better to use the Equal Cost Multiple Path (ECMP) routing policy, that allows minimizing the network congestion and increasing load balancing. Figure 4.1 illustrates the load sharing when ECMP rule is enabled. The ECMP feature seems relevant to reduce delays but it can however increase energy consumption, as the traffic passes through a larger number of links. Nevertheless the lines are then less loaded and can therefore be put to sleep especially in case of bundled links.

Recall that the energy consumption of Carrier Ethernet devices is largely dependent on their installed capacity [22] [56]. By its characteristic, the energy consumed by a switch increases linearly with the number of line cards plugged into the switch as well as the number of active ports on each card [20]. For this kind of devices, two basic techniques can be adopted to reduce the power consumption. The first one is the so-called power scaling or Adaptive Link Rate (ALR), which allows dynamic modulation of the device capacity to be proportional to the traffic load. The second one, named

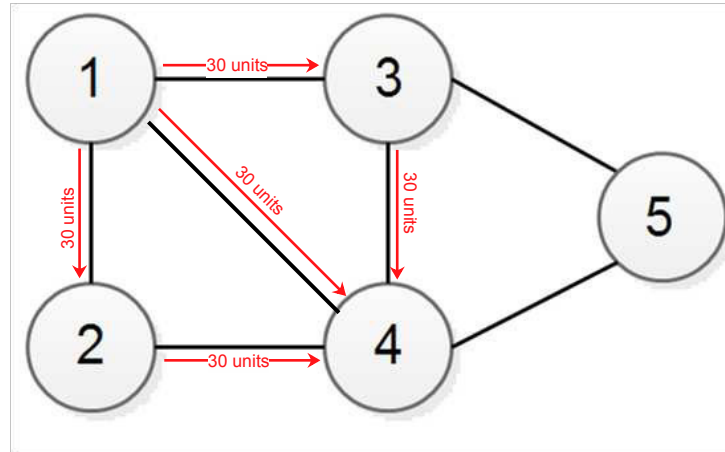

FIGURE 4.1: Load sharing with ECMP

EAR: energy-aware routing, forces some selected devices (e.g. the least used devices) to be turned off and consolidating the traffic on a small set of network devices. Current network devices cannot support ALR technique, thus architectural designs of network elements should be undertaken. However, an efficient traffic engineering can achieve an EAR by smartly aggregating traffic demands into a small number of network elements and turning off unnecessary elements. In this chapter, we still consider the SPB (IEEE 802.1aq [195]). Recall that SPB computes the shortest path between any pair of nodes. Indeed, it aims to ensure frame forwarding on the shortest path within a Shortest Path Tree (SPT) spanning the network by using an extension of IS-IS link state routing protocol [196]. IS-IS protocol supports the handling of MAC addresses; it is able to run directly over Ethernet as it is not tight to IP. In order to guarantee the load balancing requirement, SPB allows the use of ECMP-based routing strategy [208]. ECMP improves network bandwidth utilization, allows an enhanced use of mesh topologies, and provides additional resiliency by enabling fast access to backup paths. Moreover, the concept of bundled link could help to favor the network connectivity along with improved resilience in case of a link failure. This technique of bundled link, called also link aggregation, is standardized by the IEEE 802.1AX [154] and revised in [209]. This standard defines the bundled link capability (which is MAC independent), and general information relevant to specific MAC types that support bundled link. Figure 4.2 shows an example of link aggregation group (or bundled link). The Link Aggregation Control Protocol (LACP) is a control protocol running over Ethernet Link Aggregation Group (LAG) members. LACP can be used in MPLS over Ethernet, IP over Ethernet and anything over Ethernet. The two main reasons behind using bundled links

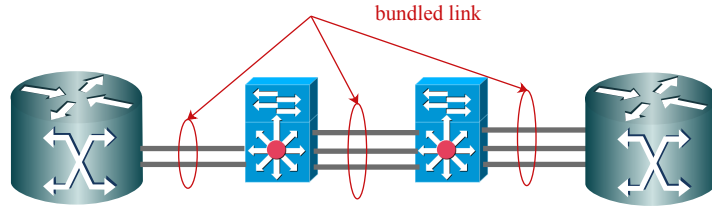

FIGURE 4.2: Bundled links

are (i) allowing network operators to easily upgrade their network capacity, (ii) resilience and network stability in case of cable failure and congestion. In this chapter, the term ‘link’ refers to one bundled link that is composed by multiple cables.

In order to model an EAR compliant with SPB protocol, we make use of optimization techniques. Our main contributions are:

- First, we formulate a MILP, called SPB-EAR, based on the MILP given in [164], whose objective is to solve the problem of reducing power consumption in SPB-based Carrier Ethernet networks. To the best of our knowledge this is the first work that jointly minimizes the number of active cables in bundled links whilst satisfying ECMP routing rule.
- Second, we propose two heuristics, called G-SPB (Green SPB) and FG-SPB (Fast Greedy SPB), to solve SPB-EAR. The main difference between the two heuristics is the selection order of candidate bundled links to power-off.

4.2 Related Works

Related to literature addressing EAR, we found few researches focus on energy saving in Carrier Ethernet networks [64] [144]. Moreover, none of them cares about saving energy considering SPB protocol. In order to better analyze EAR approach, we choose to study IP approaches which propose EAR protocols compatible with SPB-based Carrier Ethernet context. In this respect, [164] and [94] propose EAR operated with the very popular shortest path protocol, i.e. OSPF, which uses ECMP policy to prevent network congestion. The authors in [164] [158] assume to turn off only the links since turning on/off an entire device may reduce device life cycle. Moreover, the authors in [164] have proposed to use heuristic approach to find a stable OSPF weight setting, along with robust optimization design, for multi-period traffic matrices. As for [158], authors have used genetic algorithms to

find the link weights that influence the traffic distribution optimizing both energy-efficiency and load-balancing. Efficient greedy heuristics with different sorting criteria are proposed in [153] and [94], exploiting the possibility to turn off both nodes and links but, in [94], the links weight is optimized so as to reduce both power consumption and network congestion. Fortz et al in [210] have resorted to a local search heuristic by iteratively modifying the OSPF weights setting for load balancing purpose only. Some relevant works have sketched the problem of energy-aware traffic engineering with bundled links by turning off single cables. In [211], which was the first work dealing with energy-aware traffic engineering considering bundled links, the authors formulate the problem as an Integer Linear Program (ILP), and propose to power-off single cables. Moreover, the total load is balanced over all links maximizing the residual capacity of links, which can therefore be powered off. Moreover, this solution does not consider any specific routing rule for traffic demands except the classical flow-conservation constraints. In [156], the authors have proposed an energy-aware traffic engineering that aims at maximizing the number of cables to be powered off while respecting the given traffic demands and maintaining a required level of network reliability.

4.3 Green ECMP routing problem

4.3.1 Network model and notations

In this work, we aim at reducing energy consumption in Carrier Networks so we propose to implement EAR on Carrier Ethernet network operated with SPB protocol (SPB-EAR). We show through an example in Figure 4.3 how SPB-EAR can be applied in this context. We consider the undirected graph $G(V, E)$ with $V = \{0, 1, 2, 3, 4, 5\}$ and $E = \{(0, 1), (0, 2), (0, 3), (1, 4), (2, 4), (3, 4), (4, 5)\}$, each node represent bridge/switch and each link (u, v) represents a bundled link with finite capacity $C_{uv} > 0$. We assume that each link is comprised of 3 cables, i.e., with bundle size equals to three, and capacities on links are as depicted in Figure 6.8a. The capacity of a link is the total capacity of its operational cables. We denote f_{uv} the total flow on link $(u, v) \in E$. Let D be the set of all traffic demands in G and the triple (s_d, t_d, h^d) refers to the demand indexed by $d = 1, 2, \dots, |D|$ between node $s_d \in V$ and node $t_d \in V$, where h^d is the amount of traffic exchanged between s_d and t_d . Let $SPB_d = \{spb_{d^q} | \text{all}(s, t) \text{ shortest paths for traffic demand } d, \text{ indexed by}$

$q > 0$ }. Let D_{TM_p} denote the traffic matrix that collects all the demands at period p . In the example of Figure 4.3, we assume that there are 2 traffic matrices D_{TM1} and D_{TM2} at two different periods. Each traffic matrix has two traffic demands: $D_{TM1} = \{(0, 4, 6), (0, 5, 7)\}$, and $D_{TM2} = \{(0, 4, 3), (0, 5, 4)\}$. For D_{TM1} , the traffic demands are equally split over 3 different paths from node 0 to node 4. i.e., $SPB_1 = \{spb_{1^1} = (0, 2, 4), spb_{1^2} = (0, 1, 4), spb_{1^3} = (0, 3, 4)\}$, $SPB_2 = \{spb_{2^1} = (0, 2, 4, 5), spb_{2^2} = (0, 1, 4, 5), spb_{2^3} = (0, 3, 4, 5)\}$. We obtain $f_{01} = f_{02} = f_{03} = f_{14} = f_{24} = f_{34} = (6 + 7)/3 = 4.33 < 5$. This routing is feasible but there is no possible way to turn off any link, we can only remove one cable from the link $(4, 5)$ since $f_{45} = 7 < 13(2/3) = 8.6$. However, in the case of D_{TM2} (where the demand ends are identical to D_{TM1} but the demand capacities are lower) more links can be powered off. Indeed the decreasing traffic demands may be equally split among 2 different paths between node 0 to node 4. i.e., $f_{01} = f_{03} = f_{14} = f_{34} = (3 + 4)/2 = 3.5 < 5$. So, we can totally turn off the two links $(0, 2), (2, 4)$, besides, turning off 2 cables from the link $(4, 5)$, i.e, $f_{45} = 4 < 13 * (1/3) = 4.33$. For the first traffic matrix, only 4.76%, i.e., $(1 - (20/21)) \times 100$ power consumption can be saved, while for the second traffic matrix 33.33%, i.e., $(1 - (13/21)) \times 100$ of power saving can be reached. The power saving computation is described in Section 4.5.

Energy-aware traffic engineering allows to assign an appropriate links weight setting for each traffic matrix independently. The links weight is used to compute the shortest path (the sequence of links used by a demand) and a link can be powered off by assigning a very large value to its weight and therefore it could be excluded from the shortest paths. The problem of ECMP weight setting is known to be NP-hard [94, 158, 210]. In this work we assume that we use any solution provided by any of the existing solutions (for instance one provided by [164]). For the sake of simplicity and without loss of generality, in heuristic algorithms we consider that the initial weight setting uses the inverse of link capacity. If the bundled link e is still used in the new routing solution its weight remains stable. Otherwise, its weight is changed to w_{max} .

4.3.2 Problem Formulation

In this section, we propose a MILP programming formulation for the SPB-EAR problem. Table 4.1 summarizes notations and parameters of the model.

$$\min \sum_{e \in E} n_e \mathcal{E}_e + \beta \left\{ \sum_{(e) \in E} (B_e - n_e) \mathcal{E}_e \right\} \quad (4.1)$$

TABLE 4.1: Summary of notations and parameters

Parameters	Description
$G=(V, E)$	Undirected graph where V is the set of vertices (nodes) and E is the set of edges (links)
E'	Set of links used to route traffic
\mathcal{E}_{uv}	Power consumption of a powered cable in link $(u, v) \in E$
β	Parameter set to 0.1, assuming that the powered-off cables consume 10% of the power spent in the active mode
C_{uv}	Capacity of link $(u, v) \in E$
μ	Maximum tolerated link utilization; $\mu \in]0, 1]$
$N_G(u)$	Set of neighbors of $u \in V$
D	Set of all traffic demands $D = \{(s_d, t_d, h^d), s_d \in V, t_d \in V\}$
D^t	Set of all destination nodes $t \in V$
h^d	Demand of the traffic flow from node s_d to t_d
B_e	Bundle size of link $e \in E$
n_{uv}	Integer variable giving the number of powered-on cables in link (u, v)
x_{uv}	Binary variable indicating if the link (u, v) has at least one powered-on cable or not
f_{uv}^d	Real variable to present the amount of flow of the demand d that is routed traversing the link (u, v) ; $f_{uv}^d \in [0, 1]$
f_{uv}	Real variable representing the total flow traversing the link (u, v) ; $f_{uv} \geq 0$
r_{uv}^t	Binary variable determining whether link (u, v) belongs to one of shortest paths from u to t (i.e., using ECMP)
z_u^d	Real variable representing fraction of the demand d routed on the outgoing node u belonging to one of shortest paths from s to t (i.e., using ECMP); $z_u^{st} \in [0, 1]$
k_u^t	Real variable representing the cost of shortest path from u to t
M	Non-negative and a big enough constant
w_{max}	Maximum value of link weight assigned to the powered-off link (i.e., all its cables are powered-off)
w_{uv}	Weight of the link $(u, v) \in E$; $1 \leq w_{uv} \leq w_{max}$

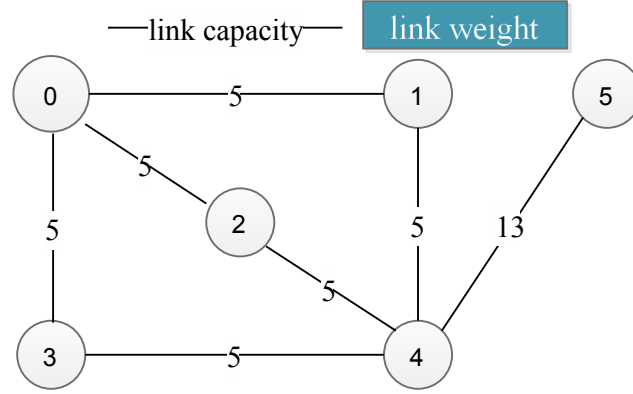

(A) Network topology before using EAR

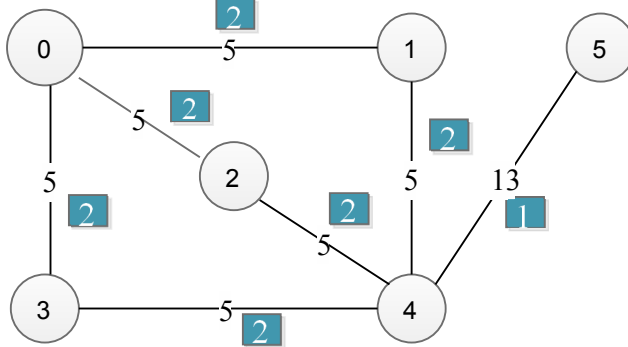

(B) Network topology after using EAR

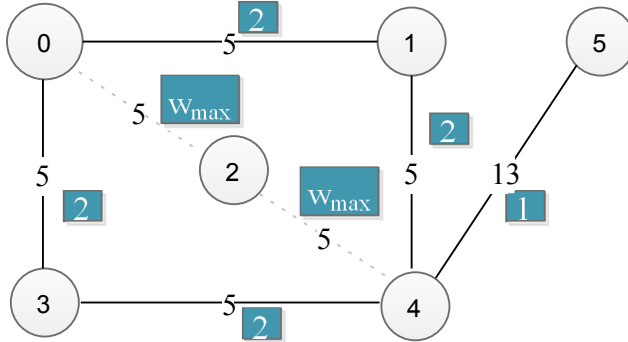

(C) Network topology after using EAR

FIGURE 4.3: Example of network topology for EAR

$$\sum_{v \in N_G(u)} (f_{vu}^d - f_{uv}^d) = \begin{cases} -1 & \text{if } u = s_d, \\ 1 & \text{if } u = t_d, \\ 0 & \text{if } u \neq s_d, t_d, \end{cases} \quad \forall u \in V; \quad d \in D, \quad (4.2)$$

$$f_{uv} = \sum_{d \in D} h^d (f_{uv}^d + f_{vu}^d) \leq \mu(n_e/B_e) C_e \quad (4.3)$$

$$\forall e = (u, v) \in E,$$

$$x_e \leq n_e \quad \forall e \in E, \quad (4.4)$$

$$B_e x_e \geq n_e \quad \forall e \in E, \quad (4.5)$$

$$0 \leq z_u^d - f_{uv}^d \leq 1 - r_{uv}^t \quad \forall d \in D; (u, v) \in E, \quad (4.6)$$

$$f_{uv}^d - r_{uv}^t \leq 0 \quad \forall (u, v) \in E; d \in D, \quad (4.7)$$

$$r_{uv}^t \leq x_{uv} \quad \forall (u, v) \in E; t \in V, \quad (4.8)$$

$$1 - r_{uv}^t \leq k_v^t + w_{uv} - k_u^t \leq M(1 - r_{uv}^t) \quad (4.9)$$

$$\forall u, t \in V; (u, v) \in E,$$

$$w_{max}(1 - x_{uv}) \leq w_{uv} \quad \forall (u, v) \in E, \quad (4.10)$$

$$w_{uv} + x_{uv} \leq w_{max} \quad \forall (u, v) \in E, \quad (4.11)$$

$$0 \leq n_e \leq B_e \quad \forall e \in E. \quad (4.12)$$

The objective function (4.1) minimizes the total power consumption induced by cables. It is composed of two parts. The first part computes the power consumption of powered-on cables. The second part computes the consumption of powered-off cables. It is weighted by the parameter β that is set to 0.1, assuming that the powered-off cables consume 10% of the power spent in the active mode. Constraints (4.2) express the classical flow conservation. They ensure that incoming and outgoing flows are equal for each node except the demand end nodes. Constraints (4.3) say that the sum of traffic of all demands routed on the link $e = (u, v)$ must not exceed the tolerated link capacity μC_e . We consider that the capacity of a link is shared between the traffic in both directions [212]. Indeed, this model allows to reduce the number of variables without loss of generality. Inequalities (4.4) make sure that if the link e has no powered-on any cables, then $x_e=0$. Inequalities (4.5) make sure if the link e has at least one cable powered-on (i.e., $n_e \geq 1$) then $x_e = 1$. Inequalities (4.6) are for ECMP routing configuration. They guarantee that if the link (u, v) belongs to one of the shortest path from u to t (i.e., $r_{uv}^t = 1$), then the flow f_{uv}^{st} is equal to z_u^{st} . This latter represents the common value of the flow assigned to all links outgoing from u belonging to the shortest paths from u to t . Inequalities (4.7) force $f_{uv}^{st} = 0$ for all links (u, v) that do not belong to the shortest path from u to t . Inequalities (4.8) forbid powered-off links to belong to one of the shortest paths. Inequalities (4.9) compute the weight of the link (u, v) congruent with the length of the shortest path from u to t . The variable k_v^t corresponds to the cost/length of the shortest from node u to v node t . Inequalities (4.10) and (4.11) put the weights of powered-off links to w_{max} . Finally, inequalities (4.12) bound the number of powered-on cables per link to be less or equal to the B_e .

4.4 Heuristic Algorithms

It is very challenging and sometimes impossible to get an optimal solution in a reasonable time for the previous MILP formulation, mainly for large topologies and dense instances. This is due to the fact that our problem is NP-hard. It is indeed a particular case of the problems studied in [211] [164] and proved to be strongly NP-hard. Therefore, to find feasible solutions in reasonable time, we use two greedy heuristics, called Green SPB (G-SPB) and Fast Greedy SPB (FG-SPB). The greedy heuristic has been chosen in our case because it can provide good approximations to the optimum. For the sake of simplicity and without loss of generality, we consider that the initial weight setting uses the inverse of link capacity. Further, the links weight will not be modified only if whole the link is removed, in this case the new link weight will be equal to w_{max} .

4.4.1 Green SPB (G-SPB)

Figure 4.4 reports a diagram description of the process of G-SPB. It takes into account the network topology $G = (V, E, W)$ and traffic matrix D , the output is a routing solution on $G' = (V, E', W')$, containing only the powered-on cables used to route the demands. G-SPB consists of two main phases. In the first phase, we try to turn off the whole of the bundled link. The intuition considers that the power saving achieved by powering off, initially, the whole link is better than powering off a part of the bundle. We choose to sort links by the amount of traffic already routed through it, the smallest first. In other words, we sort the links in decreasing order of their residual capacities. The heuristic iteratively selects a candidate link to be turned off. At each iteration, a feasible route (SPB performed) is computed. If no feasible route exists, then we put back the selected link in G' . If no violation of the operational constraints occurs, the selected link is turned off. This process is repeated until no more links can be turned off. The second phase is devoted to turning off as many cables as possible so that all the flow demands are still satisfied. For each used link (i.e., $e \in G'$) we keep the minimum number of cables by rounding up the following ratio:

$$n_e = \lceil \frac{f_e B_e}{\mu C_e} \rceil \quad (4.13)$$

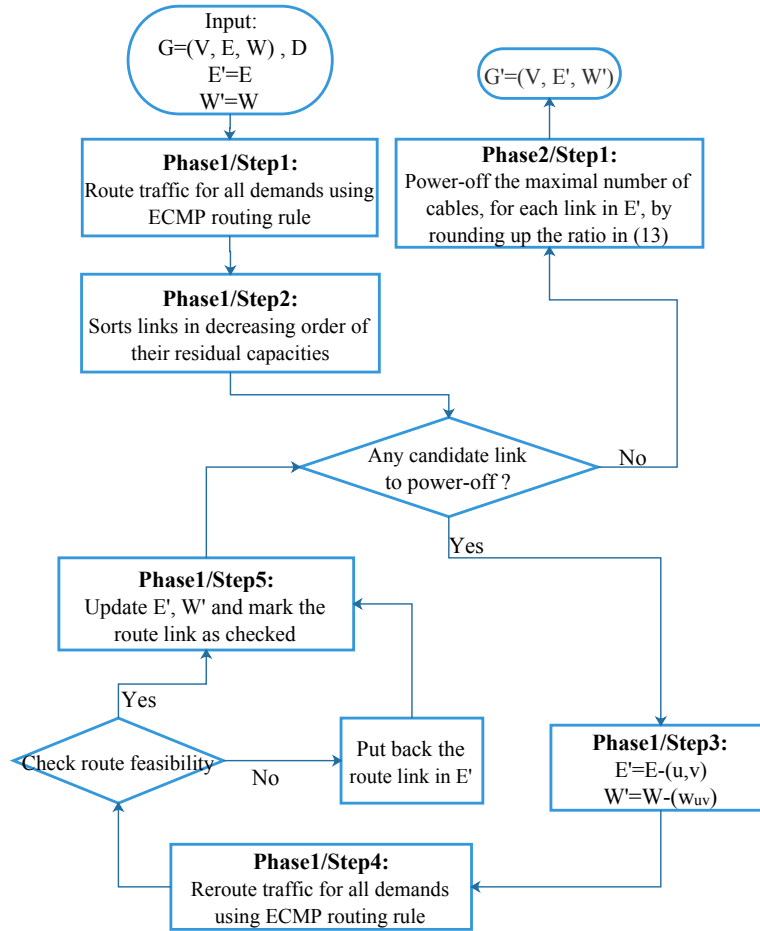

FIGURE 4.4: G-SPB diagram

4.4.2 Fast Greedy SPB (FG-SPB)

Figure 4.5 reports a diagram description of the process of FG-SPB. The flows in each link take initially the values of the dual variables obtained by solving the MILP (4.14)-(4.17), that minimizes the total flow summed on each link, subject to the classical constraints of flow conservation and link allowable capacity utilization. This MILP can achieve an upper bound on energy saving for any feasible solution in the case of using at most the sufficient number of cables that satisfies all traffic demands. The work [211] has shown that this solution performs poorly comparing to the optimal one. Therefore, we propose to continue the FG-SPB proceeding as follows. Each unused link will be powered-off, i.e., each link with $f_e = 0$. The next step sorts the remaining links E' in priority with the largest residual capacity. For each candidate link, we try to power-off the maximal number of cables using (4.13). Then we check the feasibility of SPB route. If it exists, the current link is marked as checked. If the route is not feasible, the cables are powered on and the corresponding link marked as checked. This process is repeated until every

link is checked.

$$\min \sum_{e \in E} f_e \quad (4.14)$$

$$\sum_{v \in N_G(u)} (f_{vu}^d - f_{uv}^d) = \begin{cases} -1 & \text{if } \mathbf{u} = s_d, \\ 1 & \text{if } \mathbf{u} = t_d, \\ 0 & \text{if } \mathbf{u} \neq s_d, t_d, \end{cases} \quad \begin{matrix} \forall u \in V; \\ d \in D, \end{matrix} \quad (4.15)$$

$$f_e = \sum_{d \in D} h^d (f_{uv}^d + f_{vu}^d) \quad \forall e = (u, v) \in E, \quad (4.16)$$

$$f_e \leq \mu C_e \quad \forall (u, v) \in E. \quad (4.17)$$

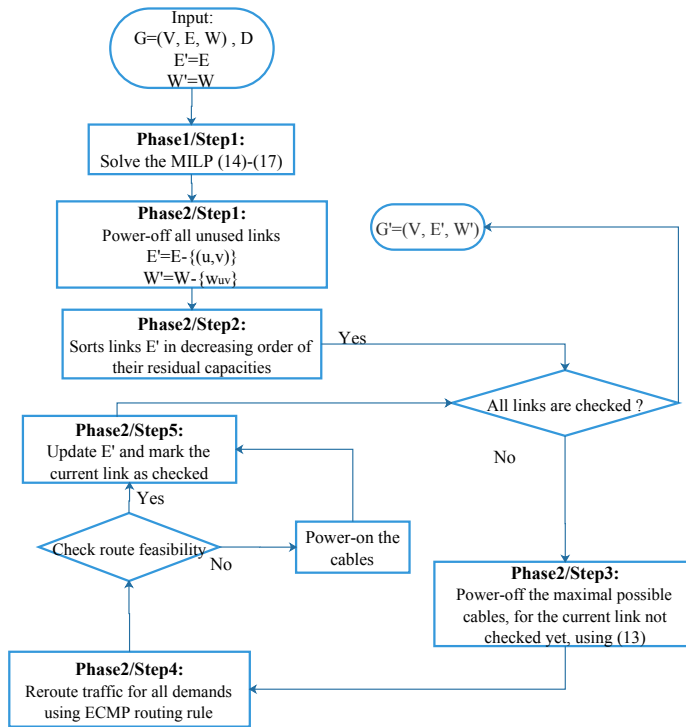

FIGURE 4.5: FG-SPB diagram

4.5 Performance analysis

In this section, we evaluate the SPB-EAR, and the heuristic-based algorithms (G-SPB and FG-SPB). We start by comparing solutions obtained by the exact formulation (SPB-EAR) with the heuristic ones on the same network instances. Then, we provide a performance analysis of the heuristic solutions for large network instances. We consider realistic network instances collected from SNDlib [206], considering three traffic level (low, medium, high). We assume that the daily traffic patterns have the shape of Figure 5.6, taken from [213]. Note that the traffic matrices found in SNDlib are collected at

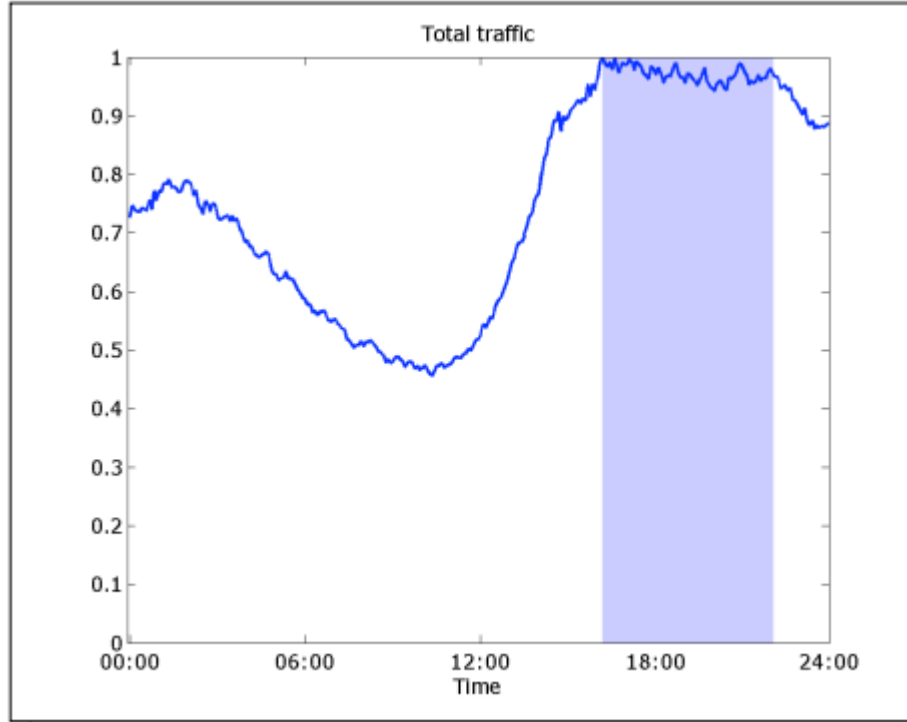

FIGURE 4.6: Daily traffic for different networks

6:00 a.m. In order to fit the best to reality and represent three daily traffic levels, the traffic matrix is scaled with the load parameter γ that is set to three different values 0.5, 1, and 2.5. The performance of the proposed approaches (SPB-EAR, G-SPB and FG-SPB) is evaluated using the following metric:

- η indicates a network's power saving that can be obtained. It is computed as follow:

$$\eta = \left(1 - \frac{\sum_{e \in E} n_e}{\sum_{e \in E} B_e}\right) \times 100\% \quad (4.18)$$

- ϕ measures the increase of path cost. In order to report the distribution of this parameter, we calculate for all the demands the difference of costs between an EAR algorithm route and the corresponding ECMP path (before applying any EAR algorithm).
- Jain's Fairness Index 3.12 is used to evaluate the load balancing.

We solve the ILP model using the solver CPLEX with Concert Technology (C++) [214]. Note that Cplex is a solver that uses exact methods of resolution to solve integer, mixed integer and quadratic programs [215]. The time limit is set to 3 hours (10800 seconds). All the experiments are performed on a PC

with 2.6 GHz Intel Core i7 and 8GB RAM.

As known, in practice, network operators do not run their networks at full load in order to avoid transient congestion. The maximum allowed utilization of links is set to 70% ($\mu = 0.7$). Both MILP algorithm and heuristics have been tested on four realistic topologies taking into account three different traffic loads. Obtained results are reported in Table 4.2, Table 4.3, and Table 4.4. Entries of tables are the following. The first column indicates the network instance name. The second column gives the load parameter γ by which the traffic matrix is scaled. Energy saving column reports the percentage of powered off cables η . The gap to the optimum column reports the energy performance of the optimized network, i.e., the ratio $(UB-LB)/LB$, where UB is the upper bound on power consumption, the power consumption of the sub-graph solution, and LB is the lower bound on power consumption (the power consumption of the linear relaxation). Note that, the relaxation technique replaces the integer variables of the original MILP by appropriate continuous constraints, Interested readers are referred to [216] for more details. Power (W) is the upper bound on power consumption of the sub-graph solution, i.e., UB. We assume that the power consumption of a single powered-on cable estimated to be 30 W and the powered-off consumes 10%, i.e., $\beta = 0.1$, of the power spent in the active mode. FI reports fairness of traffic distribution. Finally, time column reports the computation time in seconds.

TABLE 4.2: SPB-EAR formulation

Network	V	E	D	load (γ)	Saving ($\eta\%$)	Gap (%)	Power (W)	Fairness (FI)	Time (s)
Atlanta	15	22	210	0.5	78.78	0	960	0.68	1183.48
				1	78.78	0	960	0.68	1637.89
				2.5	75.75	7.3	762	0.61	10800
Germany50	50	88	662	0.5	72.72	32	4560	0.52	10800
				1	71.21	35	4740	0.64	10800
				2.5	66.66	40	5280	0.47	10800
Nobel-germany	17	26	121	0.5	79.48	0	1110	0.40	1902.95
				1	79.48	0	1110	0.45	1460.56
				2.5	76.92	0	1200	0.45	6203.29
Polska	12	18	66	0.5	74.07	0	900	0.76	141.7
				1	55.55	0	1350	0.73	320.96
				2.5	37.03	0	1800	0.69	1736.75

Figures 4.13 to 4.16 present the topologies before and after G-SPB and FG-SPB for the four network instances.

TABLE 4.3: G-SPB heuristic algorithm

Network	V	E	D	load (γ)	Saving ($\eta\%$)	Power (W)	Fairness FI	Time (s)
Atlanta	15	22	210	0.5	71.21	1055	0.46	< 84
				1	68.18	1275	0.51	
				2.5	51.51	1770	0.43	
Germany50	50	88	662	0.5	81.44	3525	0.75	< 7000
				1	81.06	3570	0.72	
				2.5	66.29	5325	0.67	
Nobel-germany	17	26	121	0.5	74.35	1290	0.51	< 40
				1	74.35	1290	0.51	
				2.5	69.23	1470	0.46	
Polska	12	18	66	0.5	70.03	990	0.79	< 20
				1	46.29	1575	0.77	
				2.5	31.48	1990	0.69	

TABLE 4.4: FG-SPB heuristic algorithm

Network	V	E	D	load (γ)	Saving ($\eta\%$)	Power (W)	Fairness FI	Time (s)
Atlanta	15	22	210	0.5	68.18	1275	0.51	< 30
				1	68.18	1275	0.51	
				2.5	51.51	1770	0.43	
Germany50	50	88	662	0.5	67.04	5235	0.62	< 5245
				1	65.90	5370	0.62	
				2.5	64.77	5505	0.59	
Nobel-germany	17	26	121	0.5	74.35	1290	0.51	< 26
				1	74.35	1290	0.51	
				2.5	71.79	1380	0.46	
Polska	12	18	66	0.5	70.03	990	0.79	< 8
				1	55.55	1350	0.73	
				2.5	37.03	1800	0.69	

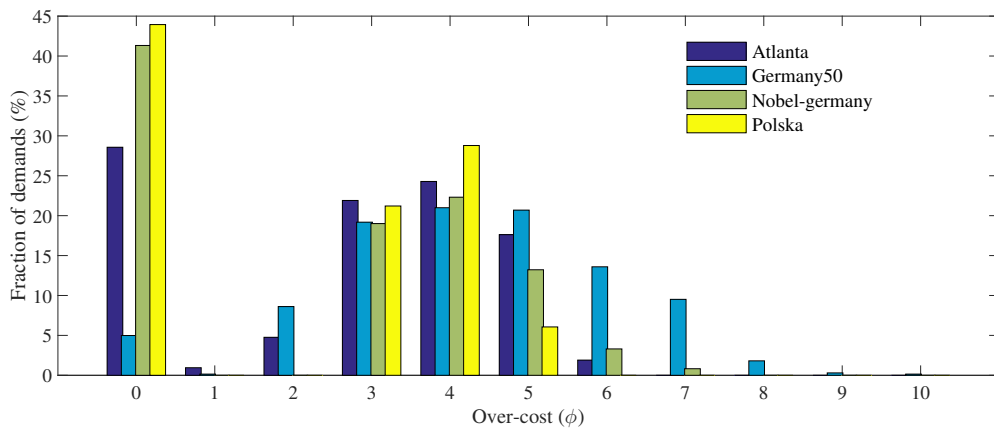

FIGURE 4.7: Over-cost induced by G-SPB heuristic

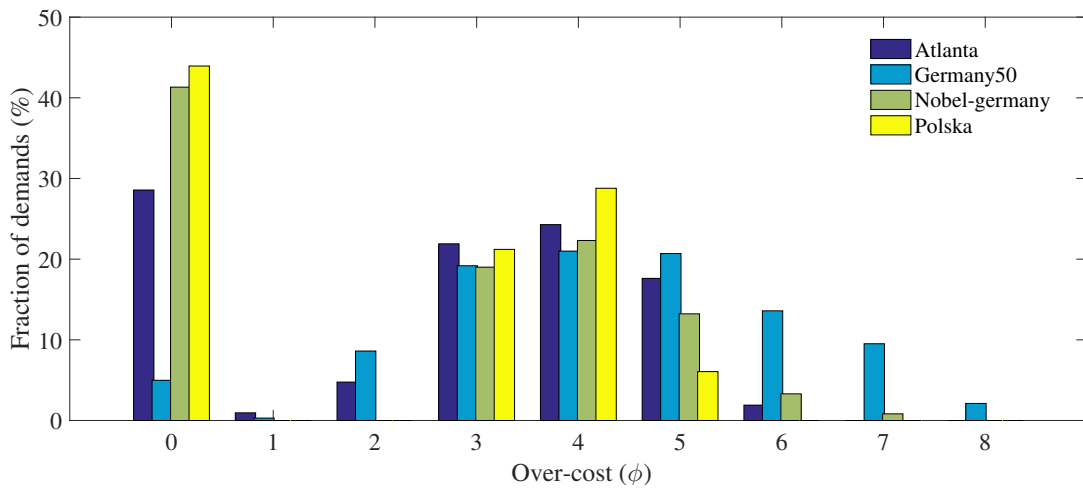
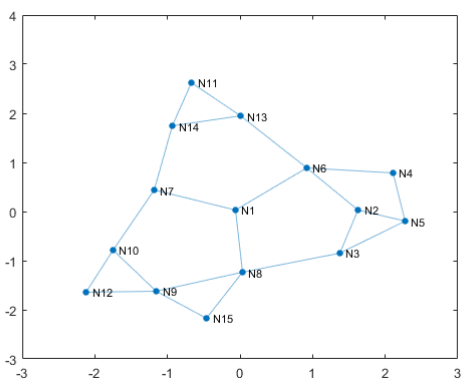
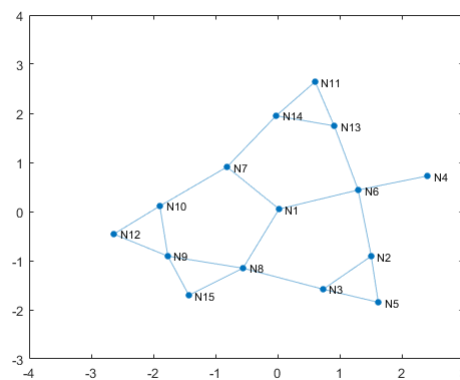

FIGURE 4.8: Over-cost induced by FG-SPB heuristic



(A) Before G-SPB execution



(B) After G-SPB execution

FIGURE 4.9: Atlanta network

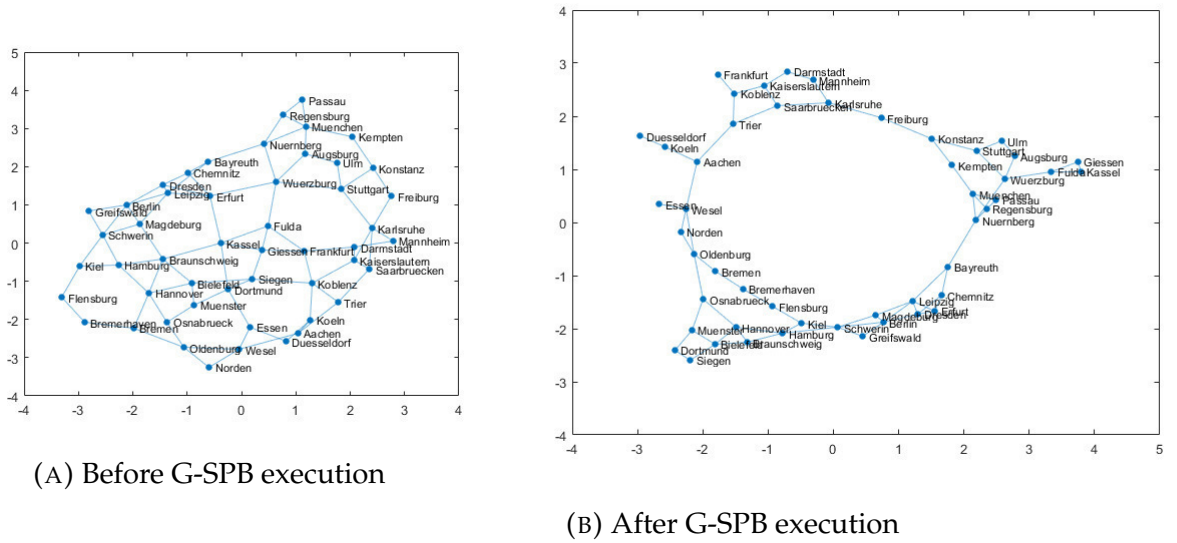

FIGURE 4.10: Germany50 network

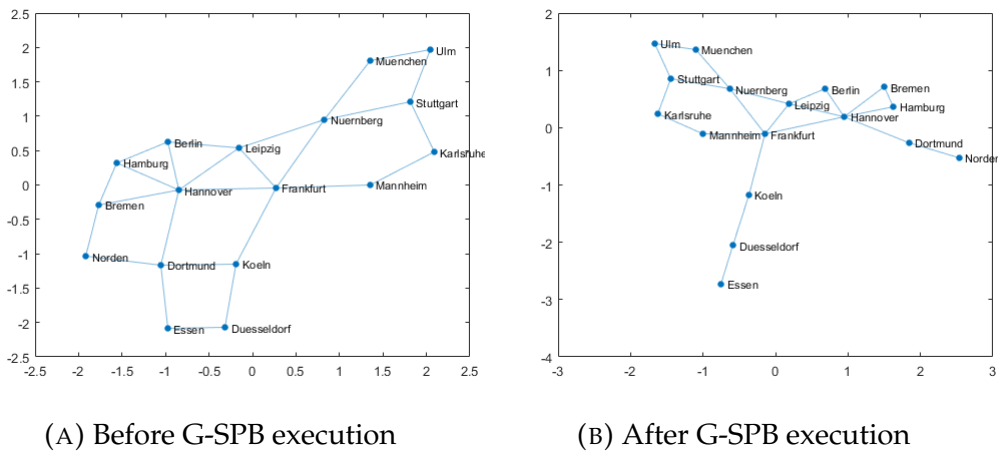

FIGURE 4.11: NobelGermany network

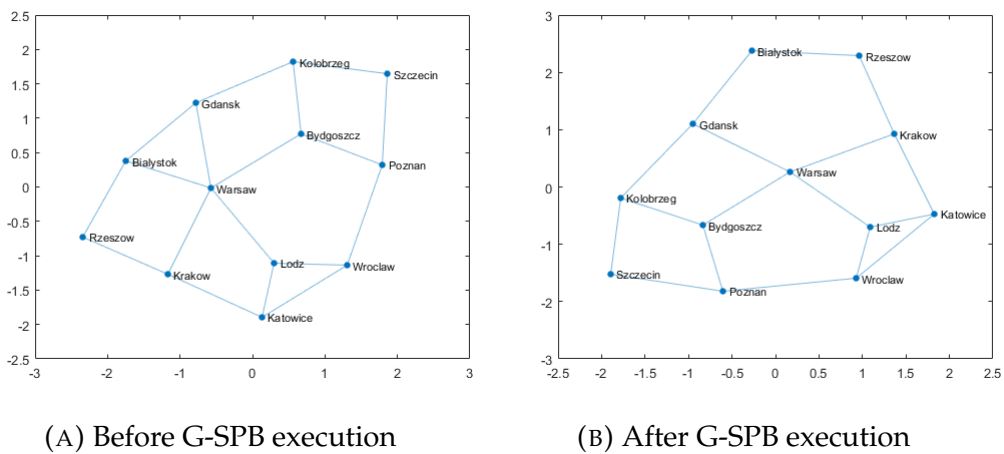
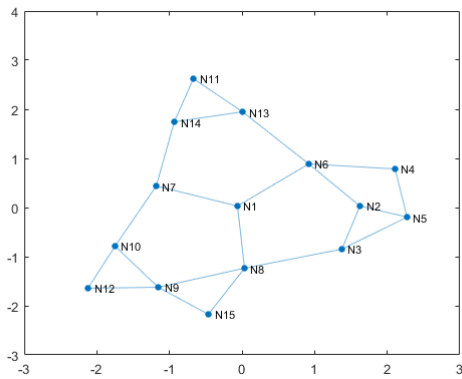
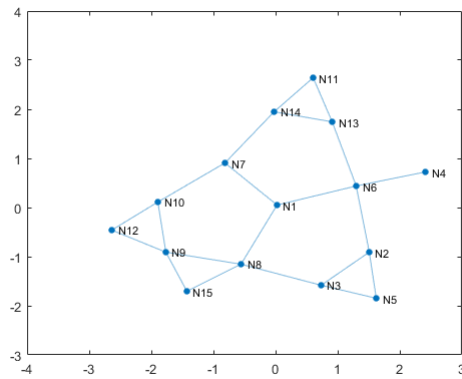

FIGURE 4.12: Polska network



(A) Before FG-SPB execution



(B) After FG-SPB execution

FIGURE 4.13: Atlanta network

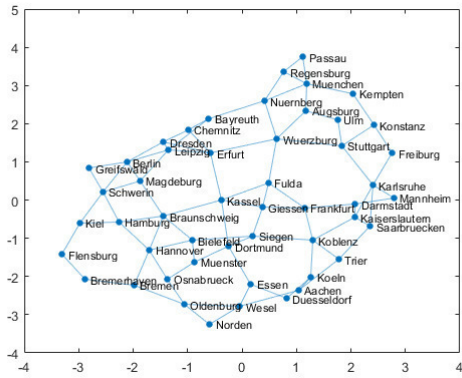

(A) Before FG-SPB execution

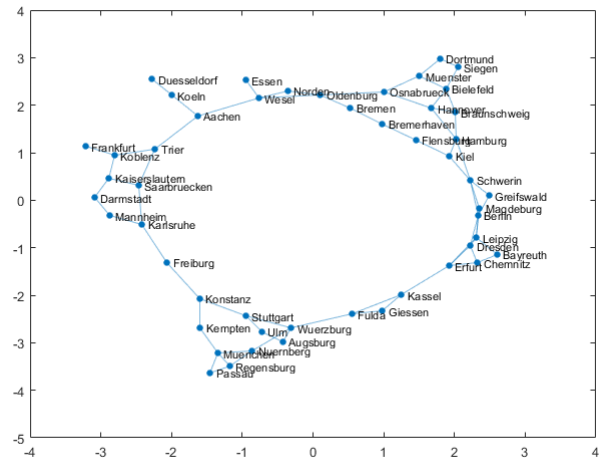

(B) After FG-SPB execution

FIGURE 4.14: Germany50 network

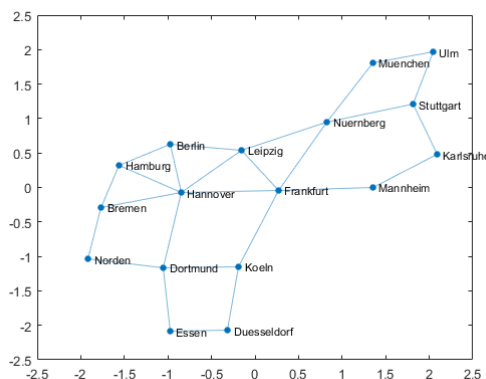

(A) Before FG-SPB execution

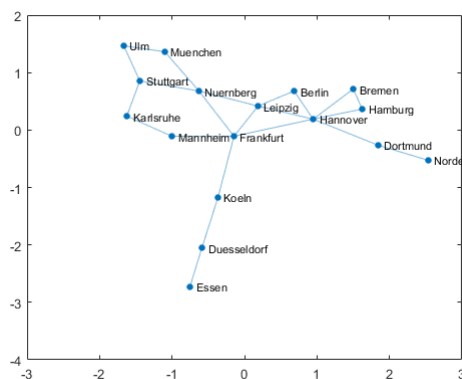

(B) After FG-SPB execution

FIGURE 4.15: NobelGermany network

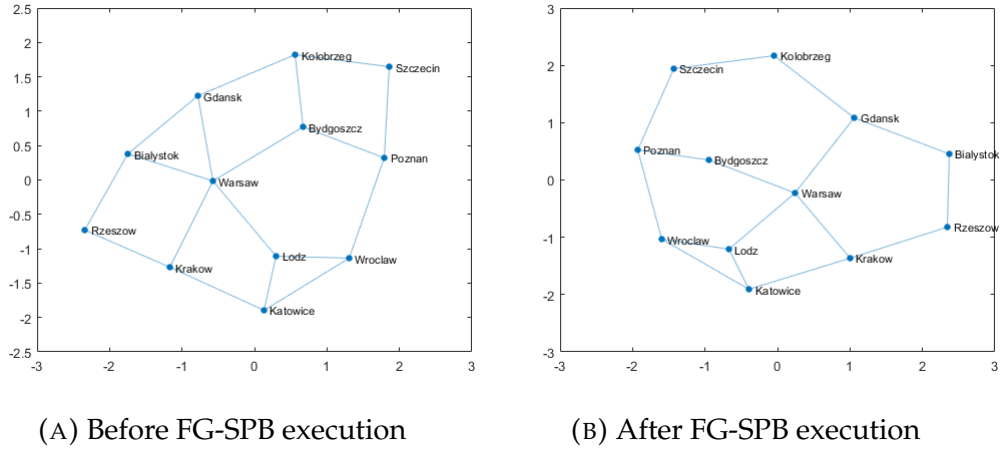

FIGURE 4.16: Polska network

As a first observation, both heuristic algorithms produce encouraging results in terms of execution times. When analyzing the results reported in Table 4.3 and Table 4.4, we can state that G-SPB algorithm performs better than FG-SPB. In addition, for Germany50 network G-SPB achieves higher percentage of energy saving compared to the FG-SPB heuristic and SPB-EAR algorithm (the MILP model has been stopped before reaching optimality due to large topology and dense instance). It can be noted that, on average, a good load balancing (FI), is obtained by all algorithms for nearly all instances, ranging from 0.43 to 0.79.

Results clearly show that, as expected, the energy saving decreases when γ parameter increases. However, for some instances as the case of Nobel-germany and Polska networks with both heuristics, the percentage of powered off cables remains the same for different values of γ , i.e., $\gamma = 0.5$ and $\gamma = 1$. This is obviously due the fact that cables capacities for the latter instances are sufficient to satisfy high traffic demands. Experiments show also that for the execution time for FG-SPB is relatively better than G-SPB. This is obvious because FG-SPB has an initial distribution of traffic provided by the MILP (4.14)-(4.17). In summary, compared with MILP solutions, both heuristics perform similarly. Moreover, the solutions provided by G-SPB and FG-SPB especially for large instance (e.g., Germany50) prove the efficiency of our heuristics.

Figure 4.7 and Figure 4.8 depict the increase of path cost in terms of over cost caused by both heuristics with respect to SPB routing (the load parameter γ is set to 1). When the over-cost parameter ϕ is equal to 0, it means that the routing solution is exactly the same the SPB one performed in the original graph. We remark that a significant fraction of demands (from 27% to 43%) is

not affected, apart from Germany50 (only about 5%). However, the path cost can be affected by adding extra cost units to a demand. That is for instance the case of Germany50 network for which 2% of demands add 9 extra units of cost to their routes. Indeed, the initial link weight setting can impact not only the energy saving but also over-cost paths of the optimized topology.

4.6 Conclusion

In this chapter, we proposed two heuristics performing energy-aware routing, Green SPB (G-SPB) and Fast Greedy SPB (FG-SPB), which are compliant to Carrier Ethernet network operating with Shortest Path Bridging (SPB) protocol. We formulated the problem as a mixed integer linear program (MILP) that aims at maximizing the number of cables to be powered off while fulfilling the given traffic demand and the ECMP routing rules. Both MILP algorithm and heuristics have been tested on four realistic topologies taking into account three different traffic loads. Experiments prove also that the heuristics are appropriated as energy efficient routing in Carrier Ethernet networks. Based on the obtained encouraging results, our future work will focus on optimizing the initial weight setting based on the projected demands aiming at efficient routing cost.

Chapter 5

Energy-aware Routing in Carrier-Grade Ethernet using SDN Approach

5.1 Introduction

Soft-Defined Networking (SDN) is a new approach that enables operators to easily manage all the network elements. In this chapter, we address the problem of energy-aware routing in SDN-based carrier-grade Ethernet networks. Our approach is based on turning off network nodes and links to reduce energy consumption, while respecting the rule space capacity for each Open-flow switch, and maintaining an allowable maximum link utilization. We first present an exact model based on an Integer Linear Programming formulation for the problem. Then, we describe a set of *first-fit* heuristic algorithms suitable for large-sized networks. The exact and heuristic approaches are tested on nine SNDlib-based instances. Experimentations show the efficiency of both exact and heuristic methods for different network topologies. In particular, our heuristic algorithms are able to achieve a good balance among energy consumption, resource utilization, and service performance.

Recall that in case of an ON-OFF power profile, it would be more energy efficient to aggregate traffic on a small set of network devices (line cards and a router chassis) to allow the maximal set to be turned off. Accordingly, Energy Aware Routing (EAR) mechanisms constitute a potential solution to energy consumption minimization. EAR can be implemented and integrated over two architectures (centralized and distributed). Distributed architectures exploit limited amounts of data, relying on multiple agents which are able to

locally adjust the sleeping decision. Compared to the distributed architectures, centralized ones dispose of a central controller. Sleeping decisions are carried out in a coordinated way by a central entity who has a global network knowledge. The implementation of an energy-aware routing within an SDN (Software Defined Network) logically centralized architecture can be easily achieved. Carrier-grade network operators specify the need for creating an SDN architecture to facilitate the management and increase the flexibility of their networks [217, 218]. In fact, for the optical transport networks, the Optical Transport working group of the Open Networking Foundation (ONF) [219] emphasizes the improvements in the flexibility of control and management by leveraging virtualization and SDNs.

SDN implementations, in particular using Openflow , focus on carrier Ethernet to optimize its operational expenditures. A detailed description of how Openflow promotes carrier Ethernet advances is provided in [220, 221].

Openflow switches can either be pure or hybrid. Pure switches do not support legacy control protocols and only rely on the Openflow controller for routing decisions, while hybrid switches integrate both. In [222], the authors demonstrate an effective use of SDN for traffic engineering especially when SDN is incrementally introduced into an existing networks. As hybrid switches are the most deployed in carrier-grade Ethernet [217, 223], they will be considered in our work.

Openflow architecture makes energy-aware routing algorithms less complex due to its logically centralized controller. The Openflow controller can learn network topology and network devices' states, and then can compute the best paths in terms of energy savings.

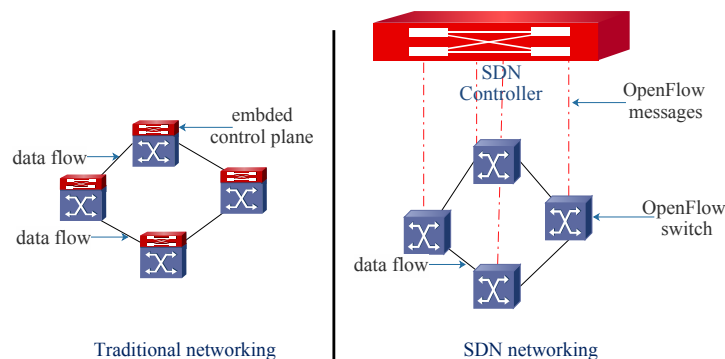

FIGURE 5.1: Traditional networking versus SDN networking

In traditional networks, as illustrated in Figure 5.1, the strong coupling between the data and control planes makes the deployment of energy-aware routing algorithms very difficult. It may also become very costly when the

numerous devices come from different manufacturers, or when they use different programming interfaces or different protocols. In fact, this would imply a modification of the control plane for all the network devices which act as a closed-system. In contrast, an SDN-based architecture decouples the control plane from the data plane to produce an external entity which is called the SDN controller or the Network Operating System. The logically centralized architecture has the advantage of being consistent with energy-aware traffic engineering. However, to enable energy savings in the Openflow controller, specific features must be controllable by adding extra messages such as the port power status on/off and the adaptive line rate [224]. These messages and their processing add overhead to the control plane and increase the communication delay between the controller and the forwarding devices. Furthermore, the performance of the control plane depends on the size of the flow table embedded in the openflow switches.

In this work, we neglect the message exchange issues and consider only the flow-table size. We also assume that network operators use hybrid Openflow switches in their carrier Ethernet networks. These run a network management system that allows energy-aware routing based on an estimation of the traffic matrix. The network management system sets an optimization problem that takes into account the limitation of the flow-table size (rule space capacity constraint), as well as flow conservation and resource utilization constraints.

The chapter is organized as follows. We present related works in the next section. In Section 5.3, we formally describe the problem and model it as an ILP formulation. In Section 5.4, we describe heuristic algorithms. A performance analysis of the proposed resolution methods is presented in Section 5.5. Finally, Section 5.6 is devoted to concluding remarks and to new directions for future work.

5.2 Related Works

5.2.1 Energy-Aware Routing in traditional architectures

Energy-Aware Routing strategy refers to smartly routed traffic based on energy-saving objectives. A typical example of EAR consists in modifying the network protocol and turning off unused elements, in order to route traffic over energy efficient paths. Dabaghi et al. [225] categorize EAR approaches that use sleeping techniques into two main types: (i) traffic-unaware algorithms

that ignore the network traffic; and (ii) traffic-aware approaches that consider a network traffic matrix in a sleeping decision. Only the works of [53, 202, 226–228] and [229] have considered type (i) of the problem. Although these approaches are able to achieve high energy conservation, they may impact the reachability of network destinations and may result in important congestion on transiting elements especially during high traffic periods.

Type-(ii) EAR approaches, which are the most common, offer a satisfactory level of QoS while achieving a considerable energy efficiency. Typically, a type-(ii) EAR problem in the network is modeled as a graph composed of a set of nodes that are interconnected by a set of directed or undirected links. In this context, using integer linear programming or mixed integer linear programming, the energy saving is formulated as an objective function, while the network's technical requirements are modeled through mathematical constraints. As the EAR problem is NP-hard [230], various heuristics are typically proposed. Chiaraviglio et al. [153] provide a basic formulation of the EAR problem as a capacitated multi-commodity flow (CMCF) problem with continuous flow variables (splittable flows). They propose different heuristics, where a single routing path is considered, based on several sorting policies for turning off both links and nodes. Another variant of sleeping routing algorithms involves turning off both links and nodes, which is considered in [95]. The authors consider the case of flow-based, fully-splittable routing. They propose a MILP-based heuristic that efficiently configures the link weights of an Interior Gateway Protocol to reduce both power consumption and network congestion. As in [95], Moulhierac et al. [164] consider an EAR that takes into account link weights optimization. The authors use in addition robust optimization techniques to deal with multi-period traffic variations. In [144], Capone et al. propose an optimization model based on the traditional Multiple Spanning Tree Protocol (MSTP) used by carrier Ethernet networks. They optimize both network congestion and energy consumption (on both links and nodes). The main shortcoming of this approach is the use of MSTP, which can no longer meet the needs of modern carrier Ethernet networks. The aforementioned EAR approaches are assumed to be performed in a coordinated way by a centralized entity. However, none of them have discussed an actual deployment on SND-based architecture networks.

5.2.2 Energy-Aware Routing for SDN

In [170], Heller et al. develop the so-called ElasticTree which is one of the most popular approaches that achieve energy efficiency in data center networks. It is implemented on a testbed consisting of OpenFlow switches. The idea is to turn off links and switches based on the amount of traffic load. The authors show that the traffic flows can be consolidated through a small set of links and switches which are sufficient to serve the bandwidth requests for most of the time. The work in [172] proposes an EAR solution inside OpenFlow protocol with Green Abstraction Layer (GAL) [67], a recently approved standard of the European Telecommunications Standards Institute (ETSI). This integration permits internal communication between network devices to interchange their power states. In this way, the OpenFlow controller becomes aware of the energy consumption of each network component. In [173], an extension of the work presented in [172] is proposed including more power states instead of simple ON-OFF states. The authors consider an Openflow protocol that integrates further energy-aware capabilities and power management primitives of the hardware components, line cards, nodes and logical resources. Authors in [231] take the advantage of SDN to create their power management model by collecting real time information about network traffic and users' demands. They propose an ILP formulation that guarantees energy savings for both links and nodes while considering QoS requirements in terms of delay and link utilization constraints. In order to solve the problem in polynomial time, the authors propose global and alternative greedy heuristics. However, they do not consider the limitation of the flow table size, which is one of the main constraints in our model. Typically, EAR approaches assume that the node routing/forwarding table (router/switch) can hold an infinite number of routing rules. However, this assumption does not fit with reality since the actual number of rules in the hardware node is bounded by the Ternary Content Addressable Memory (TCAM) size. A new EAR approach [174] for SDN-based networks allows only links to be turned off when the rule space constraint is considered. The authors first model the problem in terms of ILP. They also propose a greedy heuristic based on one sorting criterion that iteratively selects the minimally loaded link as a candidate for being turned off.

Recall that in [174], using an SDN-based network for EAR offers the major advantage of logically centralized operation. SDN approaches also allow low operating expenses and the flexibility to manage the network and to improve the QoS. In this work, we focus on using Openflow to deploy energy-aware

routing in a carrier-grade Ethernet networks. Our work can be seen as an extension of [231] considering the rule space capacity, and an extension of [174] offering the possibility to save energy on both links and nodes.

5.2.3 Optimizing rule space in Openflow forwarding node

In an Openflow network, the forwarding node contains one or more separated flow tables for handling packets. Starting from version 1.1 and thereafter, Openflow supports a pipeline process consisting of multiple flow tables [217, 223]. Each flow table consists of a set of flow entries that are created by the controller, and that determine how flows will be processed. Each entry in the table corresponds to a routing rule associated with an appropriate action. A flow entry can be divided into three parts: (1) a matching rule that may contain packet header information (e.g., source and destination MAC/IP addresses, and the ingress port); (2) an action to be executed on matching packets (e.g., to output the frame to a specific interface or flood it to all interfaces, to discard the frame, etc.); (3) a counter used to keep statistics on the matching packets. Large tables which are powerful for storing an important number of rules, provide fine-grained flow control and efficient energy-aware traffic engineering. However, it is worth noting that these rules are installed in an a TCAM on-chip that is expensive and has limited space to hold a great number of rules. Hence, it would be interesting to optimize the number of rules installed in forwarding devices. TCAM-based energy-aware SDN issues received significant attention as shown in [175]. Some of the works address the problem of rule placement without considering energy savings, see [232, 233] and [234]. In other works, such as [174] and [235], both rule space capacity and energy consumption are optimized. Giroire et al. [174] come with idea of using a default rule to deal with the rule capacity limitation. They have proposed an energy-aware routing algorithm that optimizes the rule placement of an Openflow router in backbone networks. In [235], the authors propose to reduce the size of flow entries and manage large-sized SDN flows, while optimizing only the power consumption induced by the TCAM (without turning off network elements). The authors introduce the Flow-ID concept to enable a new TCAM look-up process that reduced the TCAM power cost.

Our main contribution in this work is to model SDN-based, energy-aware routing in carrier Ethernet networks while respecting the memory limitations

in an Openflow switch, which is also known as rule of space capacity. Consequently, it is important to route flows on a single path when the maximum number of rules that can be installed at each node is limited. We use the default rule for optimizing flow tables after [174]. To the best of our knowledge, the previous works that are the closest to ours are [153], [174] and [231]. Our work is an extension of [174], [231] and [153]. Table 5.1 gives in details the main common points and differences between our work and those proposed in [153], [174] and [231].

TABLE 5.1: Similarities and differences between our work and the closest ones

		Our contribution	[153]	[231]	[174]
Assumptions	Rule space capacity	✓	-	-	✓
	Asleep elements	Nodes/Links	Nodes/Links	Links only	Nodes/Links
	Traffic routing	Unsplittable flow (ILP and heuristic)	Splittable flow (MILP) Unsplittable flow (heuristic)	Unsplittable flow (ILP and heuristic)	Unsplittable flow (ILP and heuristic)
Resolution methods	Exact methods	ILP (binary variables)	MILP (continuous/binary variables)	ILP (binary variables)	ILP (binary variables)
	Heuristic methods	Sorting policies for network elements (random; least-flow; most-power)	Sorting policies for network elements (random; least-flow; most-power; least-links)	Sorting policies for demands (priority order of delay)	Sorting policies for network elements (least-flow)

5.3 Problem statement and formulation

5.3.1 Problem statement

As an example of EAR, we consider the network topology shown in Figure 5.2a. The capacity of each link is $7Gbps$. There are six traffic demands. Each demand is given by a pair of nodes (the source and destination nodes): $D = \{(1, 6), (1, 5), (1, 4), (2, 6), (2, 5), (2, 7)\}$. All demands have a volume of $1 Gbps$. When rule space constraints on the flow table are not considered, an optimal EAR routing is obtained as shown in Figure 5.2b. In this solution, each demand is routed through its shortest path as follows:
 $(1,6) : 1-2-4-6$; $(1,5) : 1-2-4-5$; $(1,4) : 1-2-4$; $(2,6) : 2-4-6$; $(2,5) : 2-4-5$; $(2,7) : 2-4-5-7$

Figure 5.2b illustrates how EAR allows energy savings by turning off node 3 and four links (i.e, $(3,1)$, $(3,2)$, $(3,5)$ and $(5,6)$). In the obtained solution, the flow table of node 2 stores three routing rules, the flow table of

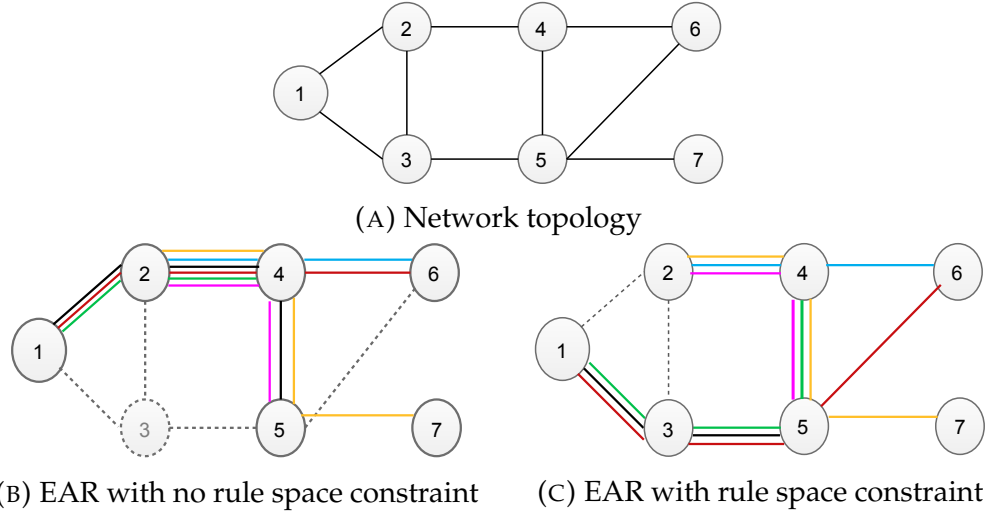

FIGURE 5.2: Example of EAR

node 4 stores four rules, and the flow table of node 5 stores only one rule. Now, if we assume that the flow table for each node can store, at most, three routing rules, then node 4 cannot route demands (2, 5) and (2, 7). Similarly, demands (2, 6) and (2, 5) cannot be routed via node 2. Note that demand (1, 4) does not need to be stored in node 4’s flow table as node 4 is a destination. As a consequence, the best EAR solution with the rule space constraint is shown in Figure 5.2c and is as follows.

(1,6) : 1-3-5-6 ; (1,5) : 1-3-5 ; (1,4) : 1-3-5-4 ; (2,6) : 2-4-6 ; (2,5) : 2-4-5 ; (2,7) : 2-4-5-7

As shown in Figure 5.2c, EAR can turn off only two links. Note that, links (1, 3) and (3, 5), can never be turned off. Table 5.2 shows the routing rules used by the nodes, *i.e.*, each node’s flow table contains at most three rules. The flow table of node 6 and node 7 are not reported because they have no demands (rules) to handle.

TABLE 5.2: Routing rules for Figure 5.2c (where each node can store at most three rules)

Node 1		Node 2		Node 3		Node 4		Node 5	
Rule	Action	Rule	Action	Rule	Action	Rule	Action	Rule	Action
(1,6)	port 3	(2,6)	port 4	(1,6)	port 5	(2,6)	port 6	(1,6)	port 6
(1,5)	port 3	(2,5)	port 4	(1,5)	port 5	(2,5)	port 5	(1,4)	port 4
(1,4)	port 3	(2,7)	port 4	(1,4)	port 5	(2,7)	port 5	(2,7)	port 7

To address the space limitation issue, one can use, as in [174] default rule to optimize the flow-table size and to enhance the EAR solution. For instance, if we come back to the example in Figure 5.2a and apply the default rule to the node flow tables (see Figure 5.3, contains the flow table for node 4), then

the routing solution produces exactly the same topology as the one described in Figure 5.2b.

In the given example of Figure 5.3, before reducing the number of entries in the flow table, we cannot route more than 5 demands according to the available space. To address a large number of flow demands, port 5 is defined as a default port because it initially carried the largest number of rules. Assume that, after shrinking the rule space, we have ten flow demands to route. A feasible solution will match 4 demands with 4 distinct rules, and the 6 remaining demands will match the default one.

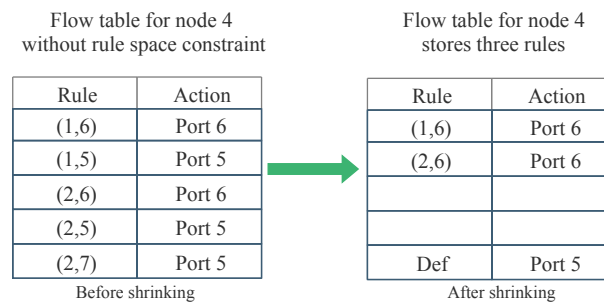

FIGURE 5.3: Stored rules in node 4

5.3.2 Binary integer linear programming model

The EAR problem, with the rule space constraint, is formulated as a binary integer linear program. The notations used are shown in Table 5.3.

$$\min \sum_{e \in E} \mathcal{E}_e x_e + \sum_{u \in V} \mathcal{E}_u y_u \quad (5.1)$$

$$\sum_{v \in N_G(u)} [(f_{uv}^{st} - f_{vu}^{st}) + (g_{uv}^{st} - g_{vu}^{st})] = \begin{cases} -1 & \text{if } u=s, \\ 1 & \text{if } u=t, \\ 0 & \text{if } u \neq s,t, \end{cases} \quad \begin{matrix} \forall u \in V, \\ \forall (s,t) \in D, \end{matrix} \quad (5.2)$$

$$\sum_{(s,t) \in D} d^{st} (f_{uv}^{st} + f_{vu}^{st} + g_{uv}^{st} + g_{vu}^{st}) \leq \mu C_e x_e \quad \forall e = (u,v) \in E, \quad (5.3)$$

$$f_{uv}^{st} + f_{vu}^{st} + g_{uv}^{st} + g_{vu}^{st} \leq 1 \quad \begin{matrix} \forall (u,v) \in E, \\ \forall (s,t) \in D, \end{matrix} \quad (5.4)$$

$$\sum_{d^{st} \in D} \sum_{v \in N_G(u)} f_{vu}^{st} \leq (R_u - 1) y_u \quad \forall u \in V, \quad (5.5)$$

$$\sum_{v \in N_G(u)} k_{uv} \leq 1 \quad \forall u \in V, \quad (5.6)$$

$$g_{uv}^{st} \leq k_{uv} \quad \begin{matrix} \forall (u,v) \in E, \\ \forall (s,t) \in D, \end{matrix} \quad (5.7)$$

$$\sum_{e \in \delta_G(u)} x_e \leq M y_u \quad \forall u \in V. \quad (5.8)$$

Objective function (5.1) minimizes the total energy consumed by links and nodes. Constraint (5.2) expresses the classical flow conservation. It ensures that incoming and outgoing flows are equal for each node except for the source and destination. Inequality (5.3) says that the sum of traffic for all demands routed through link $e = (u, v)$ must not exceed the tolerated link capacity μC_e . Inequality (5.4) ensures that the flow passing through link (u,v) is routed using only one rule, which can be either a distinct or a default rule. It also guarantees that the flow for a demand (s,t) is routed in one direction on link (u,v) , which can either be from u to v or from v to u . Inequality (5.5) limits the rule space to a maximum allowed rule space capacity at each node, while keeping only one rule as the default rule. Inequalities (5.6) and (5.7) are used to restrict the default port for each node to one. Finally, inequality (5.8) ensures that when a node u is turned off, none of its incident links can be turned on.

Note that the choice of parameter M is crucial for the experiments. M should be greater than or equal to $\max_{u \in V} |\delta_G(u)|$, or largely $M \geq |V| - 1$.

It is very challenging, and sometimes impossible, to achieve an optimal solution using the previous ILP formulation for large topologies and dense instances. In fact, formulation (5.1) - (5.3) falls into the class of multi-commodity

TABLE 5.3: Summary of notations

Notation	Description
$G=(V,E)$	Undirected graph where V is the set of vertices (nodes) and E is the set of edges (links)
$ V , E $	$ V $ is the size of V , $ E $ is the size of E
\mathcal{E}_e	Power consumption of link $e \in E$
\mathcal{E}_u	Power consumption of node $u \in V$
C_e	Capacity of link $e \in E$
R_u	Maximum number of rules that can be installed in node $u \in V$
D	Set of all traffic demands $D = \{(s,t), s \in V, t \in V\}$
d^{st}	Traffic demand from node s to t
x_e	1 if link e is in use, 0 otherwise
y_u	1 if node u is in use, 0 otherwise
f_{uv}^{st}	1 if flow (s,t) goes through link (u,v) by a distinct rule, 0 otherwise
g_{uv}^{st}	1 if flow (s,t) goes through link (u,v) by the default rule, 0 otherwise
k_{uv}	1 if the default port of node u goes to v , 0 otherwise
F_u	Set of distinct flows
G_u	Set of default flows
V'	Set of nodes used to route the traffic
E'	Set of links used to route traffic
μ	$\mu \in]0, 1]$; maximum tolerated link utilization
$N_G(u)$	Set of neighboring nodes of $u \in V$
$\delta_G(u)$	Incident links to $u \in V$
M	A non-negative, big enough constant

integral flow problems (see [236]). According to [97], the multicommodity flow problem, with *continuous* flow variables, can be solved in a polynomial time. However, when flow variables are integers, the corresponding decision problem is NP-complete even when considering only two demands and unitary capacities (see [237]). Moreover, if we omit all the coefficients, variables and constraints related to rule space and energy optimization, then we obtain the problem studied in [230], which is proven to be NP-hard. Thus, solving the previous ILP using only exact methods for the resolution is expected to be inefficient. As a consequence, for large topologies, we choose to tackle the problem using heuristic methods.

5.4 Heuristic Algorithms

We present a set of *first-fit* heuristic-based algorithms that are practical for large-sized networks. The *first-fit* heuristic is an efficient heuristic that is widely used to solve bin-packing-like problems. It was chosen for this case

because it is a straightforward greedy approximation algorithm that can provide a feasible solution in polynomial-time. For more details about the bin-packing optimization problem and the *first-fit* heuristic, the reader may refer to [238, 239].

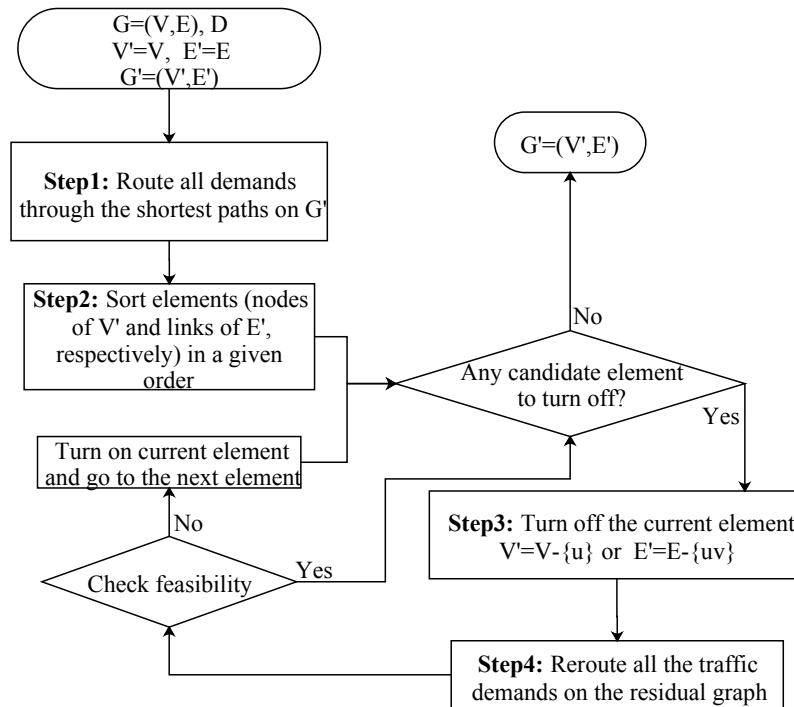

FIGURE 5.4: Heuristic diagram.

We propose a centralized implementation of the heuristic algorithms into an Openflow controller. First, the controller collects information on the network topology and the user traffic demands. Then, the controller runs the heuristic to find a subset of selected nodes and links to route traffic demands. In Figure 5.5, we present the software architecture running inside SDN-based network. There are three layers in an SDN architecture; (i) Application layer transfers requirements to the controller using an open application programming interface (north-bound API) that allows a better orchestration of network resources, (ii) Control layer maps the application requirements to the network resources, (iii) Infrastructure layer (data plane), consists of heterogeneous network devices that support an open Southbound API, i.e. OpenFlow protocol. Note that implementing energy saving heuristic algorithms will mainly involve the application modules (Topology, EAR, users' requests, statistics Information).

Figure 5.4 contains a diagram description of our proposed heuristics. Step1 uses Dijkstra's algorithm [240] to route traffic demands through the shortest

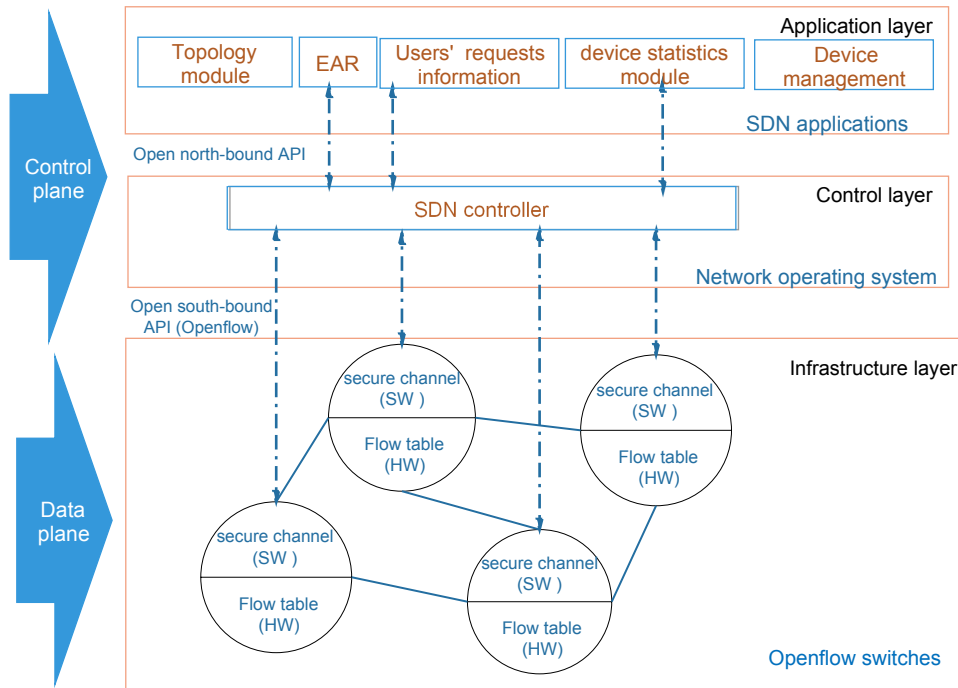

FIGURE 5.5: Software architecture running inside SDN-based network

paths; it requires $O(|D||E|.log|V|)$. Step2 sorts the elements according to a given criterion and has a complexity of $O(|E| + |V|)$. Step3 requires $O(1)$ because the candidate element for being turned off can be found using the list head from Step2. Step4 uses Dijkstra's algorithm at most $|D|$ times.

Note that a crucial step for this *first-fit* heuristic is the way the elements are sorted. In our algorithms, we choose three criteria to sort nodes and links:

1. First-Fit Most-Power (MP): iteratively selects the element with the highest power consumption.
2. First-Fit Least-Flow (LF): iteratively selects the element with the smallest amount of traffic already routed through it. This selection criterion is used by [174] to sort candidate links.
3. First-Fit Random (R): randomly selects an element. Here, Step2 is neglected because it does not need to sort the network elements.

Table 5.4 summarizes the combined node/link sorting policies. The columns correspond to the nodes' criteria and the rows to the links' criteria.

TABLE 5.4: Combination of sorting criteria for the first-fit heuristics

	nodes	MP	LF	R
links				
	LF	MP-LF	LF-LF	R-LF
	MP	MP-MP	LF-MP	R-MP

Input: $G=(V,E)$, initial flow tables and rule capacity R_u for all $u \in V$, link capacity C_e for all $e \in E$, and a set D of demands with traffic requirements d^{st} for all $(s,t) \in D$.

Output: $G'=(V',E')$: the output graph containing only elements used to route the demands.

```

1 initially, the remaining link capacity  $Cr_e = C_e$  for all  $e \in E$ ;
2 /*Node optimization*/
3 sort nodes according to a predefined order in node-list;
4 for ( $i=1; i \leq |V|; i++$ ) do
5     turn off (node-list[i]);
6     for each  $(s,t) \in D$  do
7         path( $s,t$ )=compute the best possible path from  $s$  to  $t$ ;
8         if !path ( $s,t$ ) then
9             turn on (node-list);
10        else
11            update the graph and flow tables using Algorithm 2;
12        end
13    end
14 end
15 /*Link optimization*/
16 sort links according to a predefined order in node-list;
17 for ( $j=1; j \leq |E|; j++$ ) do
18     turn off (link-list[j]);
19     for each  $(s,t) \in D$  do
20         path( $s,t$ )=compute the best possible path from  $s$  to  $t$ ;
21         if !path ( $s,t$ ) then
22             turn on (link-list[j]);
23         else
24             update the graph and flow tables using Algorithm 2;
25         end
26     end
27 end

```

Algorithm 2: First-fit heuristic-based algorithms.

For example, the MP-MP heuristic selects respectively the node and the link that consumes the highest amount of power as a candidate to be powered off. Hence, V and E are sorted according to decreasing values of $\mathcal{E}_u, \mathcal{E}_e$ respectively. The LF-LF heuristic turns off elements (nodes and links) with

increasing values of traffic that was already routed through each element. Algorithm 1 describes, in detail, the different steps of our heuristics.

<p>Input: A subgraph G'' computed during the turning off step, the path $p(s,t)$, rule capacity R_u, the default port $\text{def}(u)$ for all $u \in V$, remaining link capacity Cr_e, and link capacity C_e for all $e \in E$.</p> <p>Output: Updated flow tables and updated sets of distinct F_u and default G_u flows.</p> <pre> 1 assign the route $p(s,t)$ to the demand (s, t) ; 2 update $Cr_e = Cr_e - d^{st}$ for all $e \in p(s,t)$; 3 for each $u \in p(s,t)$ do 4 if $F_u == R_u$ then 5 adjust the flow table of the node u as illustrated in Figure 5.3; 6 end 7 for each $v \in N_{G''}(u)$ do 8 if $((u,v) \in p(s,t) \text{ AND } \text{def}(u) == v)$ then 9 $G_u = G_u \cup (s, t)$; 10 else 11 if $((u,v) \in p(s,t) \text{ AND } \text{def}(u) \neq v)$ then 12 $F_u = F_u \cup (s, t)$; 13 end 14 end 15 end 16 end </pre>

Algorithm 3: Updating flow tables, F_u , and G_u

We start from the whole network by considering the initial flow tables and assuming that all elements are turned on. After sorting the elements based on a given criteria, we next apply the following procedure for nodes and then for links. At each iteration, we remove (*i.e.*, turn off) the first element in the ordered set. Then, we compute, for each demand (s, t) , the best possible path along the residual network topology as described in Algorithm 1. The best path is the shortest path that satisfies inequalities (5.2)- (5.4). If no path exists, then the removed element is put back into the network topology. For the sake of simplicity and without loss of generality, when routing we consider that the weights of all links are equal to one. When a shortest path is found, the remaining capacity of the links is updated as described in Algorithm 2. Recall that, for each node u , the two sets F_u and G_u denote distinct and default flows respectively ((see Table 5.3). Initially, flow entries are created without hindrance until the flow table becomes full, and then there is no available space to assign a new rule. Then, the flow table is adjusted (line 4, Algorithm 2) by selecting the port that carries the largest number of flows, as the default port. This step has been previously described in Figure 5.3.

5.5 Performance analysis

In this section, we evaluate the ILP formulation and the heuristic-based algorithms. First, we describe the considered performance metrics and the experimental scenarios. Our goal is to accomplish the following evaluations:

1. a general performance analysis of the ILP model on different network instances that consider different rule space capacities;
2. a comparison of the solutions obtained using the ILP formulation with those obtained using the heuristic ones on the same network instances;
3. a general performance analysis of the heuristic solutions for large networks.

5.5.1 Performance metrics

The performance of the proposed approaches for resolution is evaluated using six performance metrics. The first two metrics indicate the percentage of energy savings that can be obtained.

- $\eta_{L_{off}}$ is the percentage of energy savings related to the links turned off by our EAR algorithms. It is computed as follows:

$$\eta_{L_{off}} = \frac{\sum_{e \in E} \mathcal{E}_e - \sum_{e \in E'} \mathcal{E}_e}{\sum_{e \in E} \mathcal{E}_e}. \quad (5.9)$$

- $\eta_{N_{off}}$ is the percentage of energy savings related to the nodes turned off by our EAR algorithms. It is computed as follows:

$$\eta_{N_{off}} = \frac{\sum_{u \in V} \mathcal{E}_u - \sum_{u \in V'} \mathcal{E}_u}{\sum_{u \in V} \mathcal{E}_u}. \quad (5.10)$$

The third metric, denoted by $\lambda_2(G)$, represents an important characteristic of graphs, which is the connectivity. This parameter can be computed using the Laplacian matrix of the undirected graph G and is denoted by L_G [241]. In graph theory, L_G is equal to the difference between the degree matrix D_G and the adjacency matrix A_G , i.e., $L_G = D_G - A_G$. A_G is a square binary matrix $|V| \times |V|$, where the generic matrix element $a(ij)$ indicates if vertices i and j are adjacent in the graph. The degree matrix D_G of G is the diagonal matrix

such that $d(i, i) = \sum_{j \in E} a(ij)$. The Laplacian matrix of an undirected graph is symmetric with real eigenvalues. The eigenspectrum $\lambda(G)$ of L_G is defined as the set of its $|V|$ eigenvalues, which can be ordered sequentially in ascending order ($\lambda_1(G) \leq \lambda_2(G) \leq \dots \leq \lambda_V(G)$). For a connected graph G , $\lambda_2(G) > 0$. The second smallest eigenvalue λ_2 is called the *algebraic connectivity* of the graph [242].

In our case, the computation of λ_2 enables to control the connectivity of the active part of the network.

The fourth metric, Γ , is used to measure the mean traffic utilization of the used links in G' (this metric is defined in Chapter 3 and denoted as ρ).

The fifth metric is the fairness index FI to measure the fairness of the traffic distribution.

The last metric to be introduced is related to the increase of route length. Consider a demand $(s, t) \in D$, then we define $\phi^{st} = L_2^{st} - L_1^{st}$, where L_1^{st} is the path length of routing demand (s, t) using the shortest path without considering EAR. L_2^{st} is the length of the path routing (s, t) using our EAR algorithms. L_1^{st} and L_2^{st} are given in terms of hops. Note that for $(s, t) \in D$, $L_2^{st} \geq L_1^{st}$. This is obvious as EAR algorithms may turn off some elements of the graph, which may increase the length of paths.

5.5.2 Experimental context

We solve the ILP model using the CPLEX solver. The time limit is set to 3 hours (10800 seconds), and M parameter is set to $|V| - 1$. The heuristic algorithms are implemented using MATLAB. Data for the real network topology used by ISPs are considered confidential, so they are not easily revealed. Consequently, we consider realistic network instances collected from SNDlib [206]. Table 5.5 presents the main properties of the used network topologies.

TABLE 5.5: Properties of network topologies

Network instance	$ V $	$ E $	$ D $	Origin of the traffic matrix	Link capacity (units)
Abilene	12	15	132	6:00 am of September 04 th 2004	[2480-9920]
Atlanta	15	22	210	Automatically produced by SNDlib	[575000-3200000]
Di-yuan	11	42	22	Automatically produced by SNDlib	[8200-159300]
France	25	45	300	Automatically produced by SNDlib	2500
Germany50	50	88	662	6:00 am of February 15 th 2005	[4150-3290]
Nobel-germany	17	26	121	6:00 am of February 02 nd 2005	600
Nobel-us	14	21	91	Automatically produced by SNDlib	[3580-20350]
Pdh	11	34	24	Automatically produced by SNDlib	1920
Polska	12	18	66	Automatically produced by SNDlib	[4260-6804]

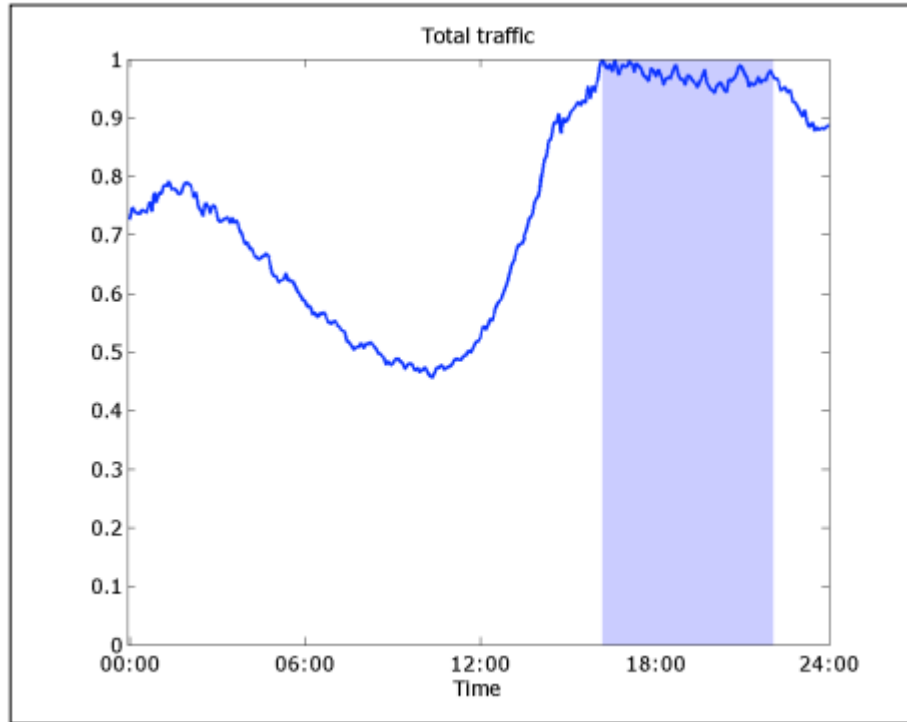

FIGURE 5.6: Daily traffic for different networks

We consider two main types of traffic matrices:

- *TM1*: is a meshed traffic matrix, *i.e.*, every node of the network appears at least in one demand as a source or destination. *TM1* is nothing but the traffic matrix provided by SNDlib for the chosen networks.
- *TM2*: is generated so that some randomly chosen nodes (from 10% to 15% of $|V|$) are assumed to be pass-through nodes (transit nodes, *i.e.*, neither source nor destination of any demand).

Table 5.6 present the percentage of through-pass nodes.

TABLE 5.6: Percentage of pass-through nodes for *TM2*

Abilene	Atlanta	Di-yuan	France	Germany50	Nobel-germany	Nobel-us	Pdh	Polska
10%	10%	12%	10%	10%	12%	15%	10%	15%

We assume that the daily traffic patterns have the shape of Figure 5.6, taken from [213]. Note that the traffic matrices found in SNDlib are collected at 6:00 a.m. In order to fit the best to reality and represent the daily traffic levels, we scale *TM1* and *TM2* with parameter γ ranging from $[0.25, 2.5]$.

We also assume, as in [174], that the rule capacity of each flow table is $R_u = (\rho \times |D|)$ where $\rho \in]0, 1]$.

In all the experiments, we use the same estimation of the power consumption as in [144]. The power consumption of a single line card is 150 Watts,

therefore, the power consumption of a link e is $\mathcal{E}_e = 300$ Watts. While the consumption of node v is assumed to be $\mathcal{E}_v = (1200 + |\delta(v)|)$ Watts.

5.5.3 Computational results

In this section, we present the performance results to confirm the effectiveness of our algorithms. We start with a demonstration on the smallest test instance (i.e., Abilene network). Then, we compare the performance of the ILP model with the heuristic algorithms on nine different network topologies. Finally, we evaluate the impact of the heuristics on network performances with respect to the route length, different link utilization levels with different combinations of sorting criteria, the scale factor of the traffic matrix (γ), and to the fairness of traffic distribution.

Optimal vs. heuristic solutions for Abilene network

As a first experimental evaluation, we consider the ILP model and the heuristics solutions for Abilene Network ($|V| = 12$, $|E| = 15$, $|D| = 132$), using *TM1* and varying the rule space capacity. Figure 5.7 and Figure 5.8 present the produced topologies after applying the ILP and MP-MP heuristic algorithms to the Abilene Network instances with rule capacities $\rho = 9\%$, $\rho = 20\%$, and $\rho = 100\%$ respectively. In Figure 5.7 and Figure 5.8, the continuous lines represent the links used in the final solution to route all demands. The dashed lines are links that appeared in the original graph and that have been turned off during the optimization process. For the different values of ρ , both algorithms (ILP and MP-MP heuristic) give solutions with always 26.5% of links turned off. However, we notice through Figure 5.7 and Figure 5.8, that the obtained solutions for the different rule spaces are not the same. The produced sub-graphs in fact are different for the various rule spaces. This is obvious because when the rule capacity value ρ changes, the flow table size changes as well, therefore producing different routing solutions for the same instance.

We also notice that, for all the cases, the obtained sub-graphs are always full-covering trees. Recall that, for this first set of experiments, we use a fully-meshed traffic matrix (i.e., *TM1*), which implies that all the nodes must be turned on for all the solutions. All the obtained solutions are full-covering trees, which means that we succeed in routing all the demands using the minimum number of links that guarantee network connectivity (i.e., $|E'| = |V| - 1$).

Figure 5.9a and Figure 5.9b illustrate the distribution of metric ϕ computed for Abilene instances ($\rho = 9\%$, $\rho = 20\%$ and $\rho = 100\%$) using ILP and MP-MP algorithms respectively. Obviously, using EAR algorithms increases the routing path lengths, which can, for some few demands, reach 9 extra hops compared to the shortest path routes. However, more than 70% of the demands have a reasonable number of extra hops that ranged from 0 to 4.

In summary, for the first experiment, the ILP and heuristic algorithms performed similarly. Both achieve the maximum possible energy savings without violating any operational constraints.

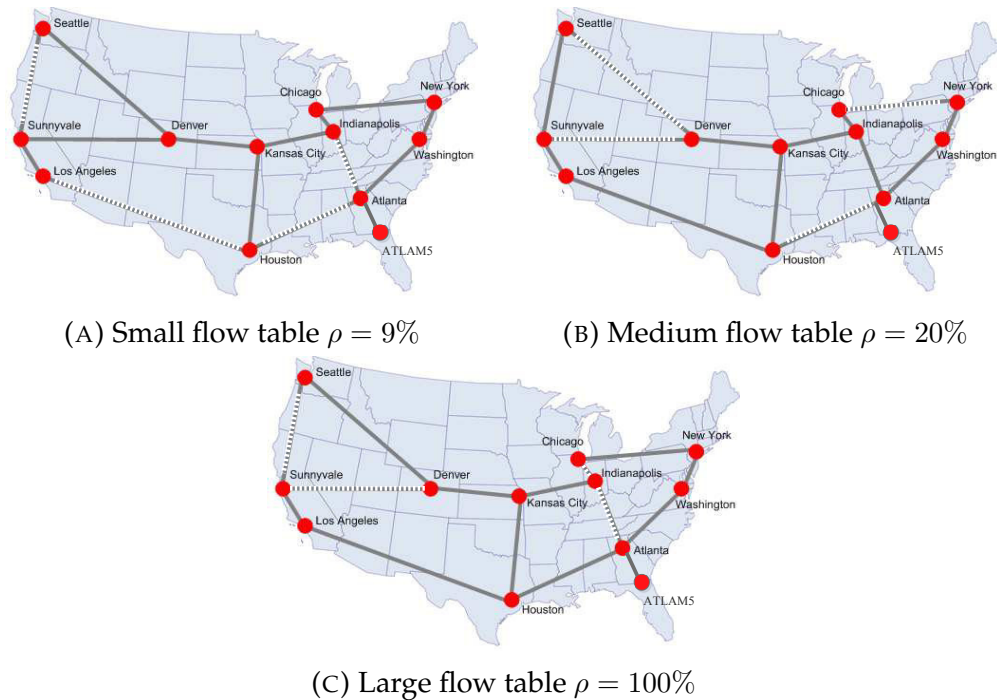

FIGURE 5.7: The Abilene Network using the ILP model

Optimal vs. heuristic solutions for various network topologies

To thoroughly compare the ILP and heuristic-based algorithms, we evaluate their performances on nine different network instances that present the two traffic matrices $TM1$ and $TM2$. To guarantee a normal operation of the network, the maximum allowed utilization of links is set to 70% ($\mu = 0.7$). Results are reported in Table 5.7, Table 5.8, Table 5.9, and Table 5.10. Entries for the tables are the following.

The first column indicates the network instance characteristics. The second column gives the rule capacity ρ which is set to the three values 9%, 20%, and 100%. The optimum column indicates if the optimal solution is found (only in Table 5.7 and Table 5.9). The sorting criteria column indicates the

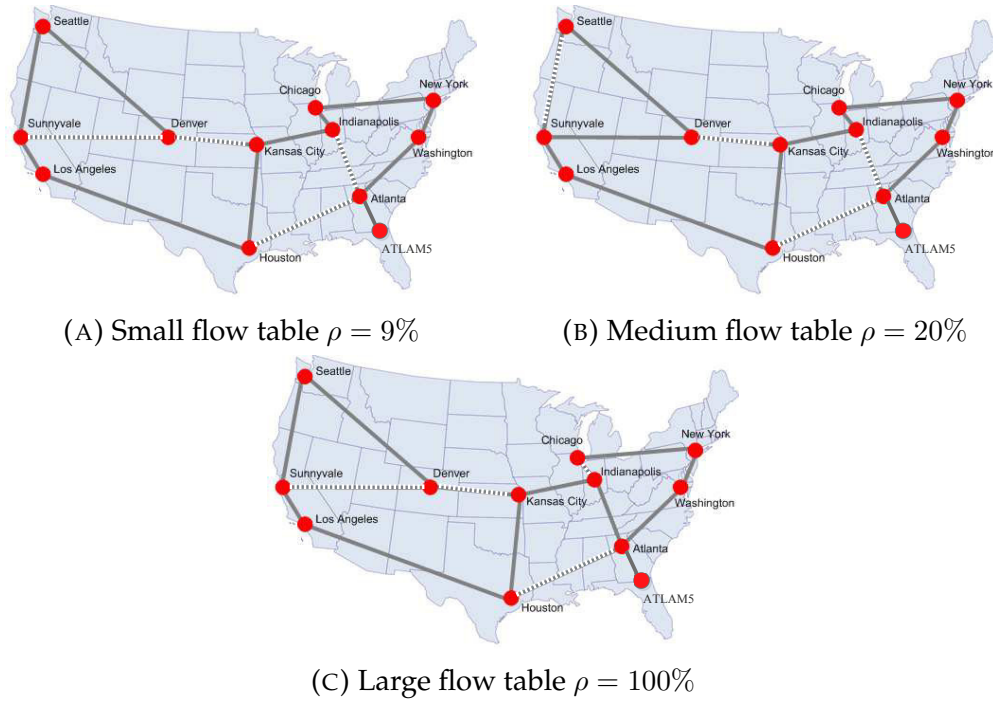

FIGURE 5.8: The Abilene Network using MP-MP heuristic

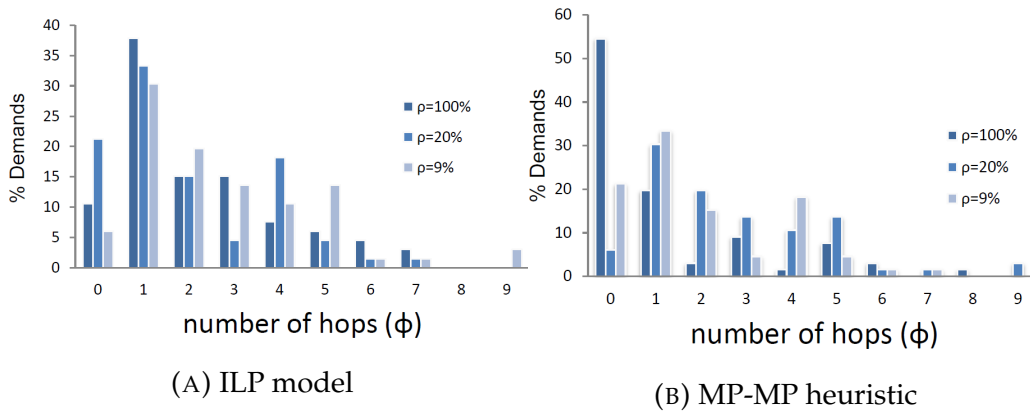

FIGURE 5.9: Paths hops increase for Abilene Network

sorting policies used to run the heuristic (only in Table 5.8 and Table 5.10). The energy savings column reports the percentage of turned off nodes $\eta_{N_{off}}$ and edges $\eta_{L_{off}}$. $\lambda_2(G)$ and $\lambda_2(G')$ columns report the network connectivity before and after running the EAR algorithms. In other words, $\lambda_2(G)$ is the initial graph connectivity, and $\lambda_2(G')$ is the computed graph connectivity. $\lambda_2(G)$ and $\lambda_2(G')$ are computed only for the fully meshed matrix, which is the case of *TM1* (Table 5.7 and Table 5.8). The gap column is computed as the ratio $(UB-LB)/LB$, where *UB* is the upper bound on power consumption, (the power consumption of the sub-graph solution), and *LB* is the lower bound on power consumption (the power consumption of the linear relaxation). Finally, the time column gives the computation time in seconds.

Table 5.7 and Table 5.8 report the computational results obtained by running the ILP and heuristic algorithms respectively for $TM1$. First, note that for all the instances, the percentage of nodes turned off using both algorithms is $\eta_{N_{off}} = 0\%$. This is obvious since the traffic matrix $TM1$ is fully meshed; therefore, no node can be turned off.

During the experiments for all network topologies except for France and Germany50, we remark that the number of links used to route the traffic is $|V| - 1$. As discussed earlier, this is the minimum number of links needed to route a fully meshed traffic matrix (such as $TM1$). We also observe that, when the original graph is dense (i.e., $\lambda_2(G)$ is high), the percentage of turned off links is important (see, for instance, Di-yuan and Pdh networks).

The impact of rule space can be noticed particularly for the France and Germany50 instances. Clearly, we notice that $\eta_{L_{off}}$ increases as ρ increases as well. We can explain this by the fact that, when providing more rule space, routing the demands would be more flexible and would use fewer links. Having more rule space also makes it easier to test instances. For example, with Atlanta or Nobel-us networks, when the rule space is scarce ($\rho = 9\%$), the ILP cannot reach optimality within the time limit. However, the same networks, when $\rho = 20\%$ and $\rho = 100\%$ are solved for optimality before reaching the time limit.

In Table 5.8, we report the results obtained using the heuristic-based algorithms and all the possible combinations of the sorting criteria given in Table 5.4. In particular, we report the best obtained solutions, in terms of energy savings and computation times, among all the combinations of sorting criteria. Note, however, that we obtain the same energy savings for the majority of combinations, but sometimes with different sub-graph solutions, (i.e., different values of $\lambda_2(G')$).

As a first observation, the heuristic algorithms represent encouraging results in terms of execution times. In addition, for France and Germany50 networks, our heuristics achieve a higher percentage of energy savings compared to those achieved with the ILP model (the ILP model is stopped before reaching optimality due to the large network size).

Table 5.9 and Table 5.10 report computational results obtained by running the ILP and heuristic algorithms respectively using $TM2$. Note that for these tables, we do not report the values of graph connectivity, i.e., $\lambda_2(G)$ and $\lambda_2(G')$ because the latter are not significant in this case. In fact, since $TM2$ is a sparse

traffic matrix, some nodes acted as pass-through nodes in the routing process, and hence, turning off these nodes improves the energy conservation. We notice that a significant gain of energy saving is achieved with both algorithms. For *TM1* like *TM2*, the impact of rule space is also noticed for France and Germany50 networks. As expected, the resulting energy savings increases when the rule space also increases.

When analyzing the results reported in Table 5.7 to Table 5.10, we can state that the heuristic algorithms provided energy saving values better than or equal to those obtained with the ILP model within reasonable computation times. Moreover, the heuristic results, especially those obtained for France and Germany50, demonstrate the efficiency of our heuristics on large-sized instances. Through the obtained results we also observe that the performance of our heuristics is influenced by the number of demands, such as Atlanta ($|D|=210$), France ($|D|=300$) or Germany50 ($|D|=662$). This is obvious since the heuristic algorithms are based on a demand re-routing process after turning off selected nodes/links at each iteration.

TABLE 5.7: ILP formulation using *TM1*

Network	Rule capacity (ρ %)	Optimum	Energy Saving		Graph connectivity		Optimality gap (%)	Power consumption Upper bound UB (W)	Execution Time (s)
			$\eta_{N_{off}}$ %	$\eta_{L_{off}}$ %	$\lambda_2(G)$	$\lambda_2(G')$			
Abilene	9	yes				0.13	0	2.22	
	20	yes	0	26.65	0.309	0.176	0	1.93	
	100	yes				0.086	0	1.83	
Atlanta	9	no				0.0467	2.6	10800	
	20	yes	0	36.35	0.422	0.0706	0	1961.49	
	100	yes				0.0642	0	1893.13	
Di-yuan	9	no				0.1023	7.4	10800	
	20	no	0	76.15	5.793	0.0741	7.1	10800	
	100	no				0.0938	7.5	10800	
France	9	no	0	33.33		0.1267	7.9	39090	
	20	no	0	35.55	0.350	0.0416	7.7	38790	
	100	no	0	37.75		0.0423	7.1	38490	
Germany50	9	no	0	31.8		0.029	15.7	78476	
	20	no	0	32.95	0.182	0.055	12.9	77876	
	100	no	0	34.05		0.046	10.07	77576	
Nobel-germany	9	yes				0.037	0	942.541	
	20	yes	0	38.45	0.301	0.063	0	1076.54	
	100	yes				0.049	0	10248.3	
Nobel-us	9	no				0.113	2.1	10800	
	20	yes	0	38.05	0.7326	0.064	0	5013.33	
	100	yes				0.018	0	942.541	
Pdh	9	no				0.127	5.5	10800	
	20	no	0	70.55	2.524	0.1857	4.6	10800	
	100	no				0.145	5.4	10800	
Polska	9	yes				0.0805	0	78.6207	
	20	yes	0	38.85	0.7125	0.1318	0	34.6595	
	100	yes				0.126	0	42.713	

Heuristics performances analysis

In what follows, we evaluate our heuristics with France, Germany50, and Nobel-germany networks using *TM1* and based on the performance metric ϕ . The increase in the path lengths for these networks using the MP-MP heuristic algorithm is reported in Figure 5.10.

TABLE 5.8: Heuristic algorithms using *TM1*

Network	Rule capacity ($\rho\%$)	Sorting criteria	Energy Saving		Graph connectivity		Power consumption Upper bound UB (W)	Execution Time (s)
			$\eta_{N_{off}}\%$	$\eta_{L_{off}}\%$	$\lambda_2(G)$	$\lambda_2(G')$		
Abilene	9	R-MP	0	26.65	0.309	0.269	17730	<0.60
	20	R-MP				0.258		
	100	R-MP				0.070		
Atlanta	9	R-MP	0	36.35	0.422	0.046	22244	< 135
	20	R-LF				0.070		
	100	R-LF				0.064		
Di-yuan	9	R-LF	0	76.15	5.793	0.162	16284	< 82
	20	R-LF				0.128		
	100	R-LF				0.137		
France	9	R-LF	0	46.65	0.350	0.095	37290	< 1161
	20	R-MP				0.087		
	100	R-LF				0.095		
Germany50	9	R-LF	0	44.3	0.182	0.090	74876	< 9310
	20	R-LF				0.011		
	100	R-LF				0.034		
Nobel-germany	9	R-LF	0	38.45	0.301	0.087	25252	< 112
	20	R-MP				0.082		
	100	R-MP				0.056		
Nobel-us	9	R-LF	0	38.05	0.7326	0.186	20742	< 53
	20	R-LF				0.123		
	100	R-LF				0.171		
Pdh	9	R-MP	0	70.55	2.524	0.154	16268	< 45
	20	R-MP				0.185		
	100	R-LF				0.026		
Polska	9	R-MP	0	38.85	0.7125	0.117	17736	< 7
	20	R-LF				0.092		
	100	R-LF				0.092		

TABLE 5.9: ILP formulation using *TM2*

Network	Rule capacity ($\rho\%$)	Optimum	Energy Saving		Optimality gap (%)	Power consumption Upper bound UB (W)	Execution Time (s)
			$\eta_{N_{off}}\%$	$\eta_{L_{off}}\%$			
Abilene	9	yes	8.33	33.33	0	16528	1.25
	20						0.54
	100						0.13
Atlanta	9	yes	6.66	40.90	0	20740	171.56
	20						635.06
	100						3514.68
Di-yuan	9	yes	09.09	78.57	0	14776	3791
	20						10800
	100						10800
France	9	no	8	46.66	4.4	35183	10800
	20		8	44.44	3.8	34883	10800
	100		8	44.44	3.8	34883	10800
Germany50	9	no	10	42.04	27.1	70668	10800
	20		6	39.77	27.5	70668	10800
	100		6	39.77	12.9	69454	10800
Nobel-germany	9	yes	11.76	46.15	0	22244	14.63
	20						18.22
	100						14.51
Nobel-us	9	yes	14.28	47.61	0	17736	370.08
	20						210.08
	100						1387.4
Pdh	9	yes	9.09	73.52	0	14762	6222.73
	20						6474.38
	100						4384.39
Polska	9	yes	16.66	50	0	14728	19.92
	20						14.55
	100						3.42

We first remark that a significant fraction of demands (30% to 50%) is not affected by path length increase ($\phi = 0$). However, the increase in path length

TABLE 5.10: Heuristic algorithms using *TM2*

Network	Rule capacity ($\rho\%$)	Sorting criteria	Energy Saving		Power consumption Upper bound UB (W)	Execution Time (s)
			$\eta_{N_{off}}\%$	$\eta_{L_{off}}\%$		
Abilene	9	MP-LF	8.33	33.33	16528	< 1
	20	MP-LF				
	100	LF-LF				
Atlanta	9	MP-LF	6.66	40.90	20740	< 25
	20	LF-LF				
	100	MP-LF				
Di-yuan	9	R-MP	09.09	78.57	14776	< 40
	20	R-MP				
	100	LF-MP				
France	9	MP-LF	8	51.11	34577	< 743
	20	MP-LF				
	100	MP-MP				
Germany50	9	MP-LF	10	50	67359	< 11282
	20	MP-LF				
	100	MP-LF				
Nobel-germany	9	LF-LF	11.76	46.15	22244	< 10
	20	MP-MP				
	100	R-MP				
Nobel-us	9	MP-LF	14.28	47.61	17736	< 27
	20	MP-LF				
	100	MP-LF				
Pdh	9	R-MP	9.09	73.52	14762	< 49
	20	MP-MP				
	100	MP-LF				
Polska	9	MP-MP	16.66	50	14728	< 15
	20	LF-LF				
	100	MP-LF				

reaches for a small fraction of demands an important number of hops. An example is Germany50 Network, where the path length increases by 20 hops. Consequently, restrictions on the maximum number of hops should be considered in the future using additional constraint to limit the number of visited nodes especially for large-sized networks.

We can limit the path length (in terms of hop) by adding the following constraint:

$$\sum_{(u,v) \in E} (f_{uv} + f_{vu} + g_{uv} + g_{vu}) \leq L^{st} \quad \forall (s,t) \in D \quad (5.11)$$

To satisfy the actual path delay the following constraints can be added:

$$\sum_{(u,v) \in E} (f_{uv} + f_{vu} + g_{uv} + g_{vu}) \cdot lat_{uv} \leq latency_{st} \quad \forall (s,t) \in D \quad (5.12)$$

where lat_{uv} is the edge delay and $latency_{st}$ is the delay of the demand (s,t) .

Further analysis is needed to evaluate the different sorting criteria used for the heuristic algorithms that are always applied to France, Germany50 and Nobel-germany networks. To this end, we evaluate the different heuristics performances when the maximum link utilization μ on the network varies.

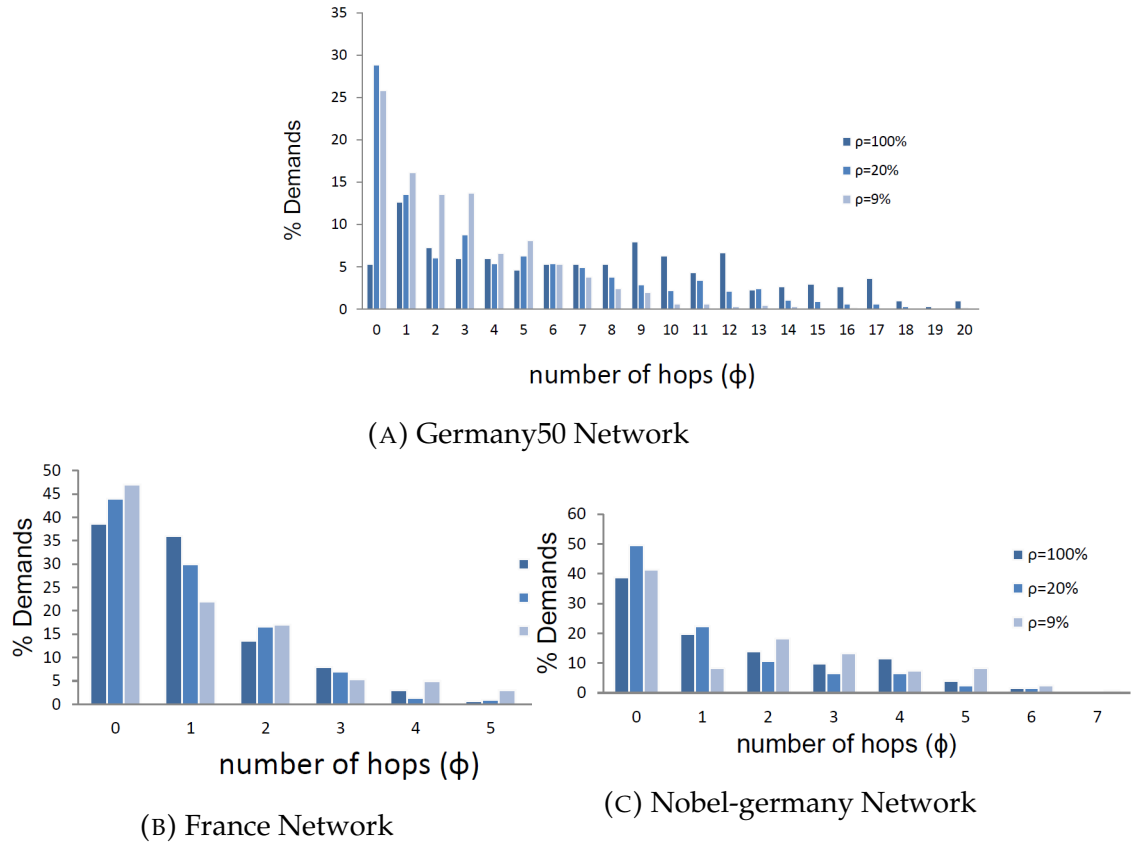

FIGURE 5.10: Paths hops increase by MP-MP heuristic using $TM1$

In Figure 5.11, we present the percentage of turned off links using the heuristic algorithms when considering different combinations of sorting criteria. We observe that all combinations show identical results for $\mu \geq 0.6$. Otherwise, MP-MP and MP-LF prove to be the most efficient heuristics. For $\mu > 0.65$ no improvements in terms of the energy savings is noticed because the traffic demand requirement implies a limitation of the number of links that can be turned off.

To evaluate the heuristics performance for the daily variations in traffic between day and night, we scale the traffic matrices ($TM1$ and $TM2$) by γ while setting $\mu = 0.7$ for all network instances. We use the MP-MP heuristic, which gives, in most cases, the best results among all combinations of the sorting criteria. Figure 5.12 reports the percentage of turned off links using $TM1$. While Figure 5.13 and Figure 5.14 report the percentage of turned off links and nodes, respectively, using $TM2$.

In Figure 5.12 and Figure 5.13, the obtained results are as expected. When the

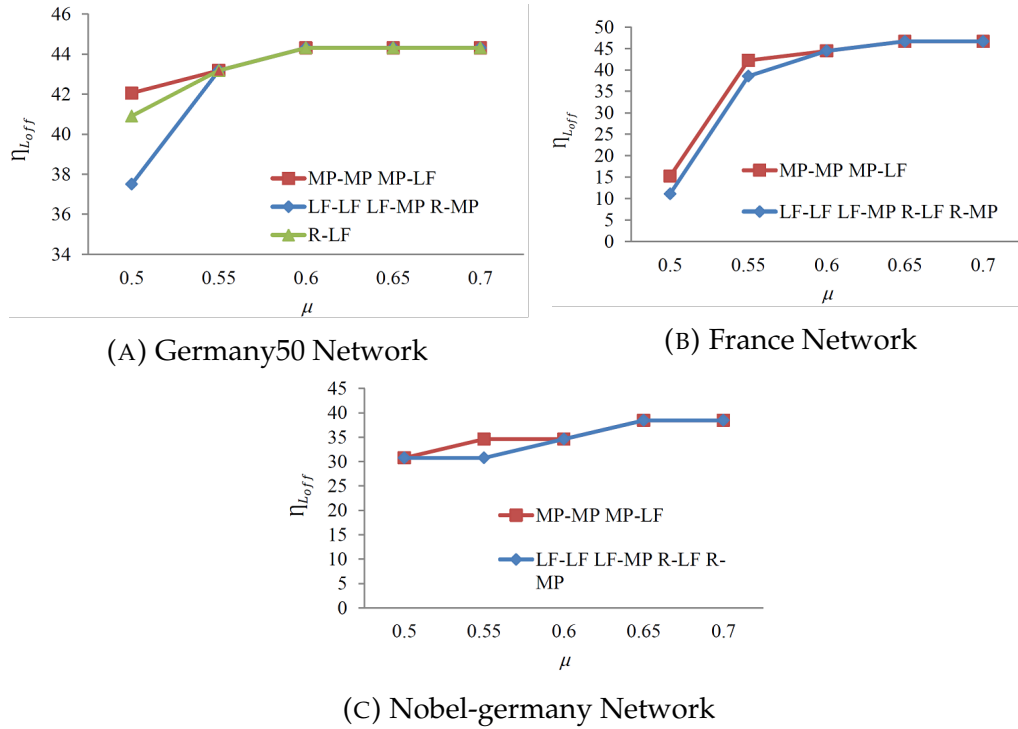

FIGURE 5.11: Turned off links versus μ using different combinations of sorting criteria for $TM1$

matrix factor increases for France, Nobel-germany, Nobel-us, and Polska networks, the energy savings are reduced. However, for the other networks except Abilene, the percentage of turned off links remains almost the same for the different values of γ . This is obviously due the fact that link capacities for the these networks are sufficient to satisfy the high-valued traffic demands. Only for Abilene Network, no feasible energy savings can be achieved for high-valued traffic demands. In Figure 5.14, we notice that, for France, Germany50, Nobel-germany, Nobel-us, and Polska networks, some nodes have to be turned on to route a large number of traffic demands. For the other networks except Abilene Network, it is possible to route a large number of traffic demands with the same number of nodes. Concerning Abilene instances, no feasible solution can be found when $\gamma \geq 2$ because of the link capacity constraint.

To better highlight the existing tradeoff between the possible power consumption minimization and the resulting network congestion, we report in Figure 5.15 the upper bound of power consumption obtained by varying the rate of allowable link utilization μ . The network operator can freely adjust the value of μ in order to reach the desired balance between energy saving and QoS.

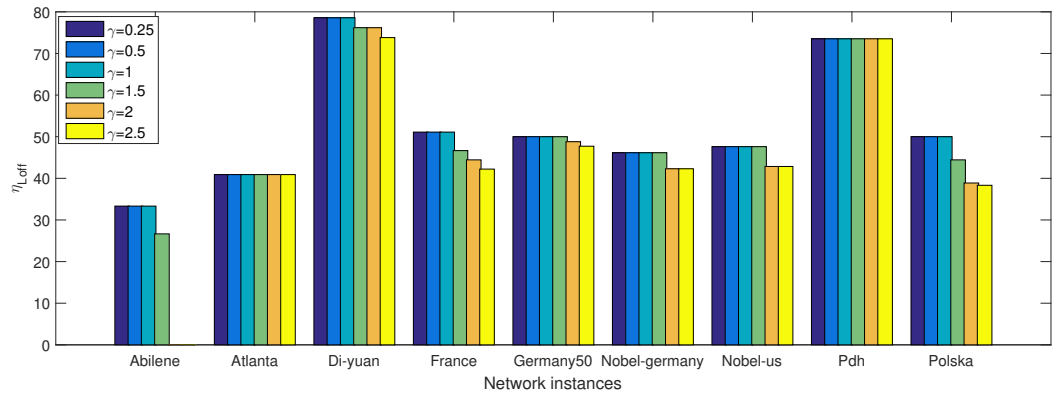

FIGURE 5.12: Percentage of turned off links $\eta_{L_{off}}$ using *TM1* scaled by γ with the MP-MP heuristic

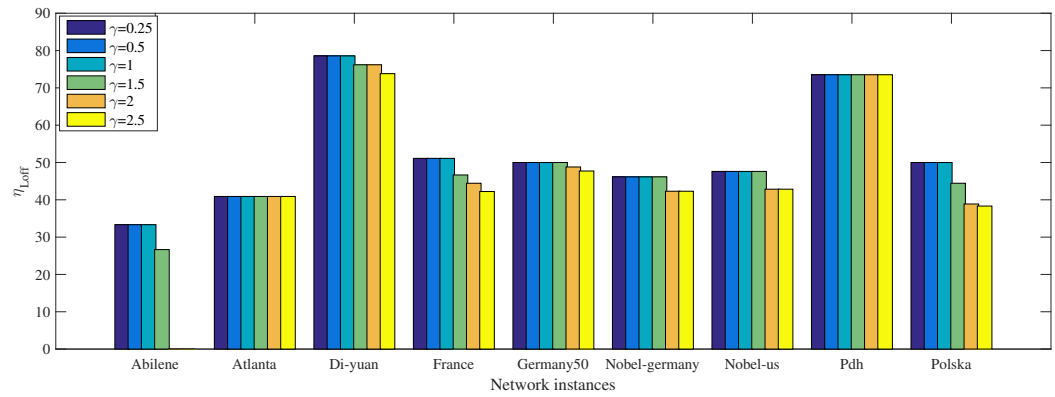

FIGURE 5.13: Percentage of turned off links $\eta_{L_{off}}$ using *TM2* scaled by γ with the MP-MP heuristic

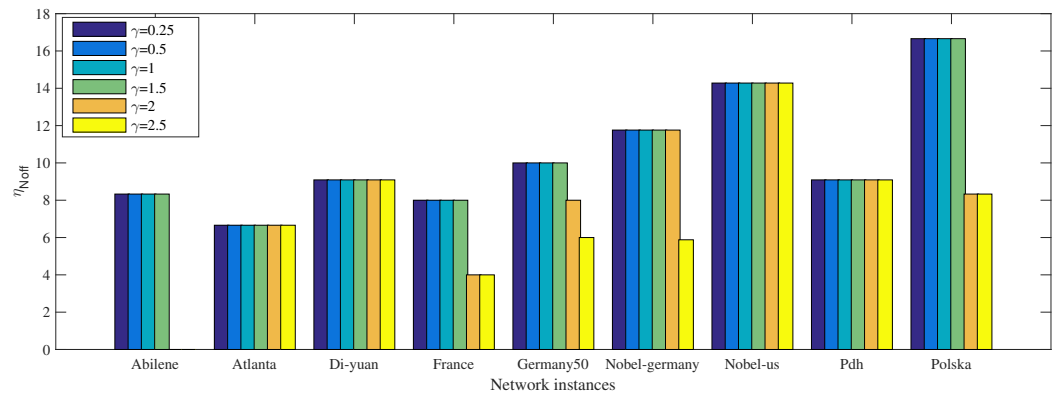

FIGURE 5.14: Percentage of turned off nodes $\eta_{N_{off}}$ using *TM2* scaled by γ with the MP-MP heuristic

Finally, we evaluate the impact of rule space capacity in terms of load balancing. Figure 5.16 describes the fairness index FI behavior as a function of ρ for the nine networks running the MP-MP heuristic. When the rule capacity decreases, the traffic demand is routed through the allowed ports, and

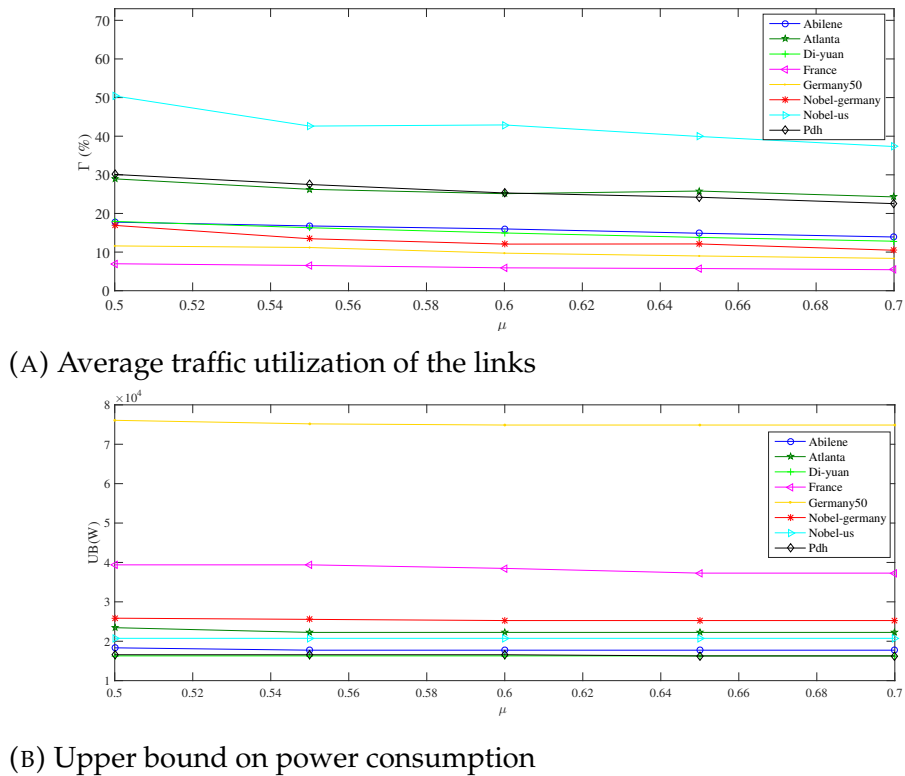

FIGURE 5.15: Trade-off between power saving and network congestion

according to the matching rule in the flow table, an unfair traffic distribution is resulted for all the links. However, based on the results from Figure 5.16, we observe that the heuristic solution maintains a good fairness index that ranged from 0.45 to 0.8 for Di-yuan and Pdh networks respectively.

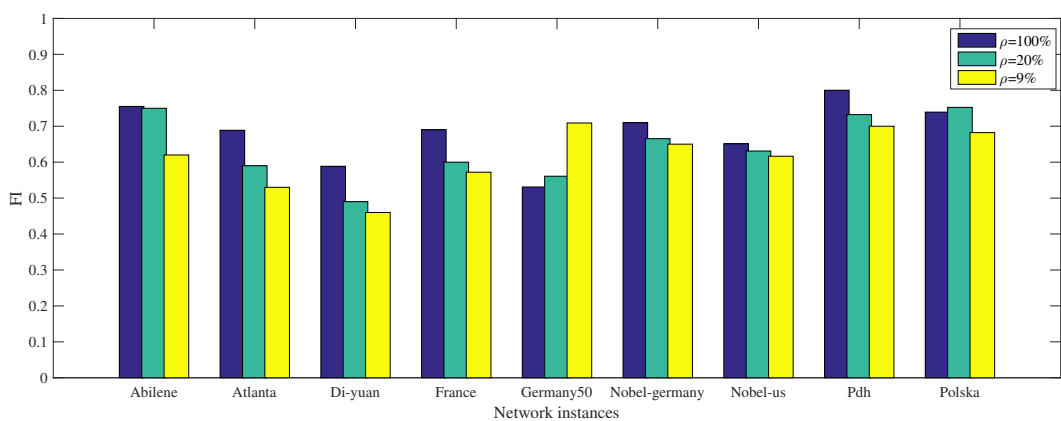

FIGURE 5.16: Fairness index versus ρ using *TM1* with the MP-MP heuristic

5.6 Conclusion

In this chapter, we present an energy-aware routing solution that is compliant with SDN-based carrier Ethernet networks. We first propose a binary linear programming formulation for the EAR problem that maximizes the number of network elements to be turned off, while respecting traffic demand and rule space constraints. Since identifying the optimal set of nodes and links to be turned off is an NP-hard problem, along with the ILP model, we propose a set of *first-fit* heuristic algorithms to reduce the computation time. We also discuss some EAR implementations in an SDN controller. Both the ILP algorithm and the heuristics are tested on nine realistic network topologies from SNDlib taking into account the rule space constraint. Our algorithms balance between saving energy and link utilization constraints while respecting the size limitation of flow tables. Experiments also prove that the heuristics that are appropriate for achieving energy efficient routing in carrier-grade networks. Based on the obtained results, which are encouraging, we aim, as a next step, to implement the proposed heuristics via a network emulator (using a POX controller). As a future work, it would be interesting to include restrictions on the maximum length of paths, which can be ensured by the delay or the hop constraints. Moreover, one could improve the deployment of EAR by considering the so-called reliability constraint, which is one of the crucial requirements for carrier Ethernet networks.

Chapter 6

Two Node Disjoint Path Routing for Energy Efficiency and Network Reliability

6.1 Introduction

Ensuring a sufficient level of reliability while taking into account energy savings is a very challenging task. In this chapter, we study the multi-commodity reliable network design problem for carrier Ethernet networks. Each traffic demand is routed along two disjoint paths considering dedicated protection scheme. The primary and backup path must be node-disjoint. We also assume, as in chapter 4, that the links of the carrier-grade networks are made of multiple physical cables called bundles. In order to solve it efficiently, we make use of powerful optimization techniques. We first model the problem as an integer linear program called the (TNDP-EAR). We also propose a heuristic based method called GreenTNDP, suitable for large-sized networks.

6.2 Networks survivability

At the moment, network operators tend to optimize the energy expenditure of their network and to provide the high service level required by their users. However, these two objectives are contentious, a trade-off between these two objectives becomes hence inevitable. More resources and power are also needed when it comes to ensuring network reliability. Critical applications need to be protected against unexpected failure events. In this context, network resilience versus energy-efficiency is a key concern in carrier-grade networks [189, 243]. The different terms "resiliency", "survivability", "reliability",

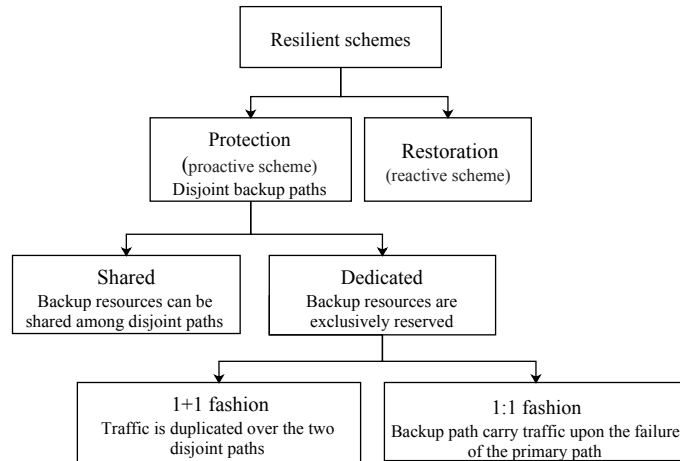

FIGURE 6.1: Resilient schemes

and "robustness" can be interchangeably used in the literature of telecommunications networks to refer to networks that are able to survive in the face of faults.

Network resilience implementation applies a mechanism for fault detection and localization together with a set of recovery techniques to reroute traffic around the failed component. The path used by default for routing is called *working path* or *primary path*. However, the path used to replace the working path in case of failure is called *backup path*. Depending on whether backup paths are computed before or after a fault of the working path, recovery techniques can be implemented based on two general schemes *restoration* or *protection* as illustrated in Figure 6.1.

- Restoration is a reactive scheme which handles dynamically a failure after it occurs (i.e., backup paths are computed on the fly). Further, using restoration scheme is more efficient in terms of resources utilization and energy conservation, but it has longer recovery time and does not provide a 100% recovery guarantee against failures.
- Protection is a proactive scheme that computes and reserves in advance backup route in order to protect against failures that may occur in the network and to ensure the continuity of traffic. Protection schemes can be divided into two modes *dedicated* and *shared* based on the way backup resources are used [189]. Shared scheme allows backup paths to share the same resources among them. In the dedicated scheme, the sharing of resources is not allowed among backup paths and resources should be exclusively reserved for each path demand. Dedicated protection can be implemented in a *1+1* or *1:1* fashion.

In $1+1$ protection, the traffic is duplicated and sent concurrently over two disjoint paths, while in $1:1$, the backup path may carry traffic only after failure of the primary path. Therefore, $1+1$ protection is the most reliable scheme. In particular, in this chapter, we will be interested to $1+1$ protection scheme.

Routing with node-disjoint paths is more resilient to failures than routing with link-disjoint paths, because it can protect against both node and link failures. Further, routing with node-disjoint paths is also link-disjoint paths, but not vice versa. Figure 6.2 taken from [189] illustrates the resilience of multilayer networks where each layer can be considered as single network. Figure 6.2(a) illustrates $1+1$ protection in the IP layer, whereas Figure 6.2(b) shows the same traffic demand protected at the optical layer. Figure 6.2(c) shows the difference when employing optical bypass with $1+1$ protection at the IP layer. Figure 6.2(c) shows $1+1$ protection at OTN (Optical Transport Network) layer, which results in four times capacity utilization at the optical layer.

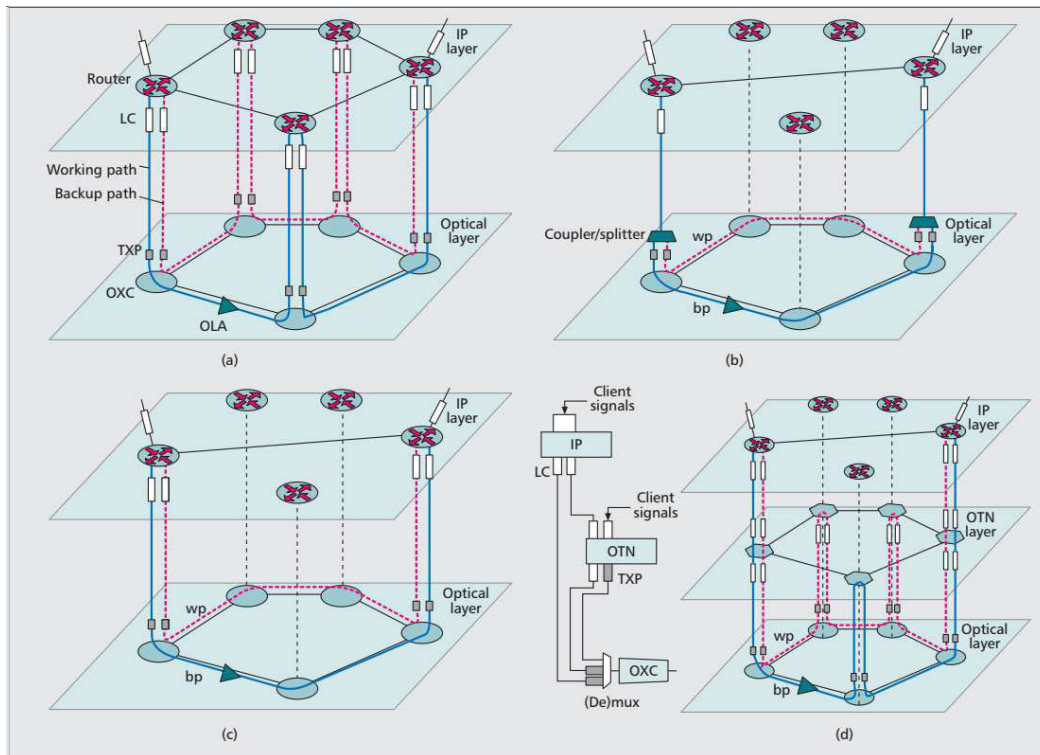

FIGURE 6.2: Resilience at different layers [189]

Disjoint paths problem can be stated as follows:

Given a graph $G = (V, A)$ of V nodes and A weighted links, a source-destination pair $s, t \in V$, and an integer $K > 0$. Find a set of K paths $P = \{p_1, p_2, \dots, p_K\}$ from s to t , such that the paths have no common links (or nodes). There can

be several constraints associated with finding link (or node) disjoint paths [244], such as :

- *Min-sum Disjoint paths problem.* The total weight of the K paths is minimized.
- *Min-max disjoint paths problem.* The sum of the weights of the path with the largest path weight is minimized
- *Min-min disjoint paths problem.* The sum of the weights of the path with the smallest path weight is minimized.
- *Bounded disjoint paths problem.* The sum of weights of each path should be less than Δ_K .

In the context of graph theory, the notion of survivability may be further specified as K connectivity [245, 246], where at least K disjoint paths exist between each pair of nodes. G is called K -node (resp. K -link) connected ($K \geq 0$) if for every pair of nodes $u, v \in V$, there are at least K node-disjoint (resp. K link-disjoint) paths between u and v .

We assume that G is undirected without multiple edges. Given W and W' , two disjoint subsets of V , $[W, W']$ denotes the set of edges of G having one end node in W and the other in W' . If $W' = \overline{W}$, then $[W, \overline{W}]$ is called a *cut* of G denoted by $\delta_G(W)$ (see Figure 6.3). \overline{W} denotes the node set $V \setminus W$. A cut $\delta_G(W)$ such that $s \in W$ and $t \in \overline{W}$ is called an *st-cut*.

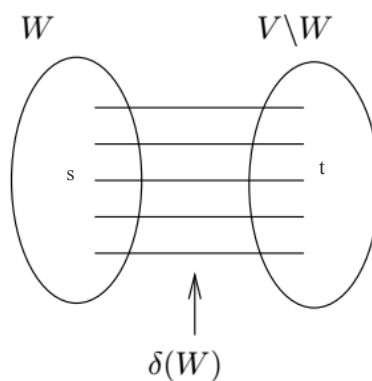

FIGURE 6.3: A cut $\delta_G(W)$

For a directed G without multiple arcs. Given W and W' , two disjoint subsets of V , $[W, W']$ denotes the set of arcs whose origin are in W and destinations in W' . As before, if $W' = \overline{W}$, then $[W, \overline{W}]$ is called a *directed cut* or *dicut* of G denoted either by $\delta_G^+(W)$ or $\delta_G^-(\overline{W})$ (see Figure 6.4). \overline{W} denotes the

node set $V \setminus W$. If s and t are two nodes of V such that $s \in W$ and $t \in \overline{W}$, then $\delta_G^+(W)$ and $\delta_G^-(\overline{W})$ are called st -cuts of G .

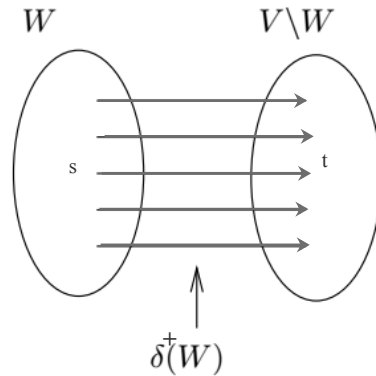

FIGURE 6.4: A cut $\delta_G^+(W)$

The minimum number of links/nodes separating two nodes or sets of nodes is referred to as a minimum cut. In [247], Menger states a fundamental relation between the number of link-disjoint paths and the cardinality of cuts in the graph G . This relation is given in the following theorem.

[Menger's theorem]. The maximum number of link-disjoint paths between s and t is equal to the minimum number of links that would separate s and t .

In order to assess the link/node connectivity of a network, one therefore needs to find its minimum cut.

Definition node (vertex) cut. A node cut refers to a set of nodes whose removal separates the graph into two disjoint subgraphs, and where all nodes in the removed cut-set have at least one adjacent link to both subgraphs. Let u and v be two non adjacent nodes in a graph. A set S of nodes is a $u - v$ separating set if u and v lie in different components of $G - S$; that is, if every uv path contains a vertex in S . The minimum order of a uv separating set is called the uv connectivity and is denoted by $K(u, v)$.

Since our goal is to enhance network resilience by providing disjoint paths to network traffic, the next section presents some representative disjoint paths algorithms.

6.3 Disjoint path computation

Suurballe's algorithm [248] is the most used to compute k node/link disjoint paths between a single source-terminal pair in a directed graph. This algorithm can be solved in $O(|V|^k \log |V|)$. Later, Suurballe and Tarjan [249] have used Suurballe algorithm [248] to find a pair of disjoint paths, by using two

shortest path computations, that runs in $O(|A|\log_{(1+|A|/|V|)}|V|)$.

The node-disjoint paths problem can be considered as a link-disjoint paths problem but not vice versa. Therefore, additional constraints should be put in place.

In directed graphs, two link-disjoint paths algorithm can be used to compute two node-disjoint paths by node splitting on graph, which is illustrated in Figure 6.5, each node u is split into two nodes u_1 and u_2 , with the incoming links of u connected to u_1 , while the outgoing links will depart from u_2 . In

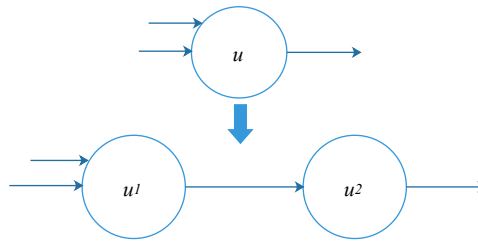

FIGURE 6.5: Node splitting [244]

undirected networks, a link-disjoint paths algorithm can be used to compute node-disjoint paths by the transformation illustrated in Figure 6.6. Each node u is split into two nodes u_1 and u_2 that are connected by a directed link with zero weight, and each undirected edge (u, v) is replaced with directed links (u_2, v_1) and (v_2, u_1) of weight ℓ_{uv} .

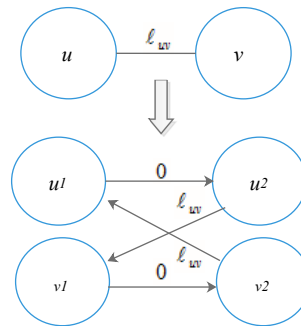

FIGURE 6.6: Directivity transformation [244]

Algorithm 4 presents Suurballe-Tarjan algorithm [249] for computing two link-disjoint paths between s and t .

A simple algorithm for solving the node disjoint paths problem is presented in [244] shown in Algorithm 5. It is based on the use of k consecutive shortest path computations. We refer to this algorithm as the basic disjoint path algorithm.

Input: A weighted-directed graph $G = (V, A)$, a pair of source and destination nodes (s, t) .

Output: A pair of link-disjoint paths P_1 and P_2 .

- 1 Compute the shortest path tree T rooted at s ;
- 2 Store the shortest path from s to t in P_1 ;
- 3 Transform the weights of each link $(u, v) \in A$ to
 $w'(u, v) = w(u, v) - d(v) + d(u)$;
- 4 /* $d(u)$ denotes the length of the shortest path from s to u */
- 5 Compute the modified graph G_f by reversing the direction of all the links in P_1 ;
- 6 Find the shortest path P_2 from s to t in G_f ;

Algorithm 4: Suurballe-Tarjan-2-link-disjoint-paths in directed graphs

Input: A weighted-directed graph $G = (V, A)$, a pair of source and destination nodes (s, t) , and k , the number required of disjoint paths.

Output: k node-disjoint paths P_1, \dots, P_k .

- 1 **for** $i=1, \dots, k$ **do**
- 2 Find the shortest path P_i from node s to node t ;
- 3 Delete intermediate node of P_i from G ;
- 4 **end**

Algorithm 5: Basic k -node-disjoint-paths in directed graphs

Also, Yen's algorithm [250] can be used to generate K disjoint paths pair as proposed in [251]. Algorithm 6 illustrates its pseudo code.

The next section is devoted to summarize related works (especially energy-aware routing with reliability), and to give the basic background and assumptions.

6.4 Problem statement and related works

We consider the EAR problem with two node disjoint paths to minimize router power consumption during off-peak hours in carrier Ethernet network. Of particular interest are approaches such as [251] and [252] which propose an energy-aware routing with two link disjoint paths maintaining the network reliability. Moreover, we consider the use of bundled links. Recall that, this technique could help to favor the network capacity along with improved resilience in case of link failure. As well as, in this chapter, a single network link is referred to one bundled link that is composed of multiple cables (or ports). All the cables have the same capacity and the same power consumption, and each port can be turned off independently. To the best of

```

Input: A weighted-directed graph  $G = (V, A)$ , a given demand  $d$ .
Output: A set of pair of link-disjoint paths  $P$ .
1 Generate  $k$  paths for  $d$  in  $G(V, A)$ , and store in  $KSP_d$ ;
2  $P = \emptyset$ ;
3  $pair=1$ ;
4 for each  $sp_1 \in KSP_d$  do
5   Generate  $G_1(V, A_1)$  from  $G(V, A)$  by deleting all nodes and links in
    $sp_1$ ;
6   Generate  $k$  paths for  $d$  in  $G_1(V, A_1)$ , and store in  $KSP'_d$ ;
7   for each  $sp_2 \in KSP'_d$  do
8      $DP_{pair} = \{sp_1, sp_2\}$ ;
9     if  $DP_{pair} \notin P$  then
10       $P = P \cup DP_{pair}$ ;
11       $pair++$ ;
12    end
13  end
14 end
15 Reorder  $DP_{pair}$  in  $P$  in ascending order of path length ;

```

Algorithm 6: KSP-based disjoint-paths

our knowledge this is the first work that jointly minimizes the number of active cables in bundled links whilst considering routing with node disjoint backup paths. In addition to energy efficiency, many studies have been interested to reliability issues in the network design problems. In [253] and [162], the authors provide a set of algorithm and optimization models suitable with IP networks, considering unsplittable routing. In both works, the network resilience requirements are taken into account while reducing the link and node consumption. In addition to network survivability, robust optimization model is proposed in [162] to handle uncertain traffic demands. In [251], Lin et al. have proposed an energy-aware routing with two disjoint paths, according to which each request can be routed via multiple paths (may have common links) besides two link disjoint paths, to provide higher protection against eventual failures. The same authors have proposed an interesting strategy in [156] which considers reliability and protection constraints in the formulation. Terminal Reliability (TR) and Route Reliability (RR) are defined to determine the reliability of each single link (consisting of multiple cables) crossed by the routing path for each source-to-terminal request. When a failure occurs, based on K-shortest paths computation, alternative paths have to be found either shared or dedicated.

Finding primary and backup link-disjoint paths for each source-to-terminal

request is proposed in [252]. Two heuristic algorithms based on the computation of Suurballe algorithm [249] for each request (finding the active and backup paths) to turn off both nodes and links are presented and tested. The optimization model aims at minimizing the fixed energy cost paid to keep a router or a link in the active state. To obtain only a single active path routing, binary flow variables are introduced. However, the solution proposed in [252] can protect against only link failures, i.e., it does not consider the node failures event. To the best of our knowledge, the closest works to ours are [156, 251, 252]. Like ours, they all are intended to be run in a centralized manner, which is perfectly compliant with the logically centralized controller in Software-Defined Networking. For the sake of clarification, we draw Table 6.1 that presents the common points and differences of our work compared to [156, 251, 252].

TABLE 6.1: Main properties of this study with respect to the closest proposals

Proposal	[252]	[156]	[251]	This work
Routing	Unsplittable	Splittable	Splittable	Unsplittable
Path computation	Suurballe's algorithm [249]	Yen's algorithm [250]	Yen's algorithm [250]	Basic disjoint path algorithm[244]
Exact formulation	0-1ILP	MILP	MILP	ILP
Backup paths	Dedicated	Dedicated and shared	Dedicated and shared	Dedicated
Failure assumption	Link	Link	Node and link	Node and link
Nodes off	✓	-	✓	-
Bundled links	-	✓	-	✓

In this work, we advocate the implementation of an EAR for carrier-grade Ethernet in the metropolitan area networks. For instance, the implementation of EAR within a logically-centralized power management is compliant by deploying Software Defined Network (SDN) architecture [175]. Moreover, carrier-grade network operators specify the need for creating an SDN architecture for controlling and increasing the flexibility of their networks [218, 224]. The principal objective of our optimization model is to reduce the energy consumption induced by cables in a bundled link. This model can be extended to turn off also nodes. However, it is very difficult from a practical point of view to alternate turning on/off nodes, and this also would affect the life cycle of devices. We consider the case of dedicated protection scheme against any single failure (node or link), where a backup path is computed for each request, independently from the fault. In case of failure, the backup path should serve as the current primary path, and the repaired (primary) path is acting as the backup path. Each demand may use multiple, i.e., *k-node disjoint* paths to route its traffic (as illustrated in Figure 6.7). All nodes in each

path except s and t have exactly one outgoing link and s has exactly k outgoing links. In our work, we compute two node disjoint paths for each demand (i.e., $k=2$).

Our network model is based on the following assumptions: (i) each link consists of B cables that can be turned off independently. (ii) we consider that the network is at least biconnected (2-node connected) graph thus every request has always two node disjoint paths. (iii) single link/node failure (the probability of simultaneous failures is very rare because failures are very quickly solved when compared with failure rate).

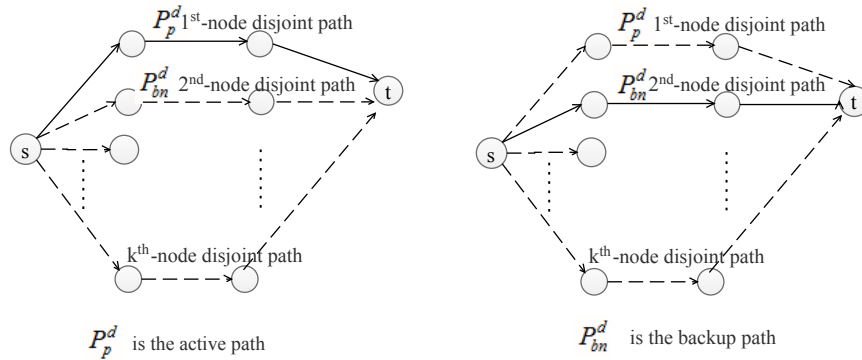

FIGURE 6.7: Example of k node-disjoint source destination paths

Let the 2-node connected directed graph $G = (V, A)$ models the network topology, where V is the set of nodes (Ethernet switches), and A is the set of links. Each link (u, v) represents a bundled link with $B_{uv} \geq 1$ cables. The capacity of each link, i.e., $C_{uv} \geq 1$, is the total capacity of its cables which are assumed to have the same capacity. The power consumption of each link is the total consumption induced by its operational cables. The number of turned-on cables in any given link (u, v) is denoted $n_{uv} \leq B_{uv}$. When $n_{uv} = 0$, it means that the whole link (u, v) is turned off. Let D be the set of all traffic demands (traffic matrix) in G , and the triple (s_d, t_d, h_d) denotes the traffic demand indexed by $d = 1, 2, \dots, |D|$ from the source node $s_d \in V$ to the destination node $t \in V$, where h_d is the amount of traffic going from $s_d \in V$ to $t_d \in V$.

Given G and D as input, the TNDP-EAR (Two Node Disjoint Paths energy-aware routing) consists in routing each traffic demand along a single routing solution that minimizes the number of powered-on cables while reserving for each demand d a primary path P_p^d , and a backup P_b^d . The routing solution must also fulfill the maximum link utilization rate threshold that is denoted

by U_T . We denote f_{uv} the total flow assigned to link $(u, v) \in A$, y_{uv}^d the flow of d that is routed on link (u, v) through the primary path P_p^d , and z_{uv}^d the flow of d that is routed on link (u, v) through the backup path P_b^d . The link utilization of link (u, v) is calculated as $\mu_{uv} = 100 \times (f_{uv}/c_{uv})$. The remaining/residual capacity on link (u, v) is computed as $r_{uv} = U_T c_{uv} (n_{uv}/B_{uv}) - f_{uv}$. For ease of reading, Table 6.2 lists parameters and notations used along the chapter.

To illustrate TNDP-EAR, we consider an example of 6-nodes networks as shown in Figure 6.8. We assume that each link is composed of four cables ($B=4$). The capacity of each bundled link is assumed to be 24 units. Assume that there are two demands on the network, i.e., $D = \{(0, 2, 2), (0, 5, 3)\}$. Figure 6.8b presents the produced topology when using TNDP-EAR. For demand $d = 1$, the primary path $P_p^1 = 0 \rightarrow 2$, and the backup path $P_b^1 = 0 \rightarrow 1 \rightarrow 3 \rightarrow 2$. For demand $d = 2$, $P_p^2 = 0 \rightarrow 2 \rightarrow 4 \rightarrow 5$, and the backup path $P_b^2 = 0 \rightarrow 1 \rightarrow 3 \rightarrow 5$. As TNDP-EAR considers 1 + 1 protection, the traffic is duplicated over the two disjoint paths. In this case, we obtain $f_{01} = f_{02} = f_{13} = 5$; $f_{32} = 2$; $f_{35} = f_{24} = f_{45} = 3$. Dashed lines correspond to links that are totally turned off, whereas turned off cables are not illustrated. After routing by TNDP-EAR, the spare capacity on each arc can be turned off by rounding up the number of cables, we obtain $n_{01} = n_{02} = n_{13} = 2$; $n_{32} = n_{35} = n_{24} = n_{45} = 1$; $n_{14} = n_{34} = 0$.

Figure 6.8c illustrates the TNDP-EAR solution in case of node 4 failure. Demand $d = 1$ keeps its both paths while demand $d = 2$ is served along P_b^2 .

TABLE 6.2: Summary of notations and parameters

Parameters	Description
$G=(V, A)$	Directed graph where V is the set of vertices (nodes) and A is the set of arcs (links)
$G=(V, E)$	Undirected graph where V is the set of vertices (nodes) and E is the set of edges (links)
A'	Set of links used to route the traffic demands
\mathcal{E}_{uv}	Power consumption of a powered cable in link $(u, v) \in A$
β	Parameter set to 0.1, assuming that a powered-off cables consumes 10% of the power spent in the active mode
C_{uv}	Capacity of link $(u, v) \in A$
U_T	Maximum tolerated link utilization, $U_T \in]0, 1]$
r_{uv}	Remaining capacity of link (u, v)
D	Set of all traffic demands $D = \{(s_d, t_d, h_d), s_d \in V, t_d \in V\}$
D^t	Set of all demands having t as destination node $t \in V$
h_d	Demand of the traffic flow from node s_d to t_d
B_{uv}	Number of cables in link $(u, v) \in A$
n_{uv}	Integer variable to indicate the number of powered-on cables in link (u, v)
x_{uv}	Binary variable to indicate if the link (u, v) has at least one powered-on cable or not
y_{uv}^d	Binary variable to indicate whether link (u, v) is used to route d by primary path P_p^d
z_{uv}^d	Binary variable to indicate whether link (u, v) is used to route d by backup path P_b^d
f_{uv}	Total flow of link (u, v) ; $f_{uv} \geq 0$
g_u^d	Binary variable to indicate whether node u is used to route d by primary path P_p^d , $u \in V \setminus \{s_d, t_d\}$
k_u^d	Binary variable to indicate whether node u is used to route d by backup path P_b^d , $u \in V \setminus \{s_d, t_d\}$

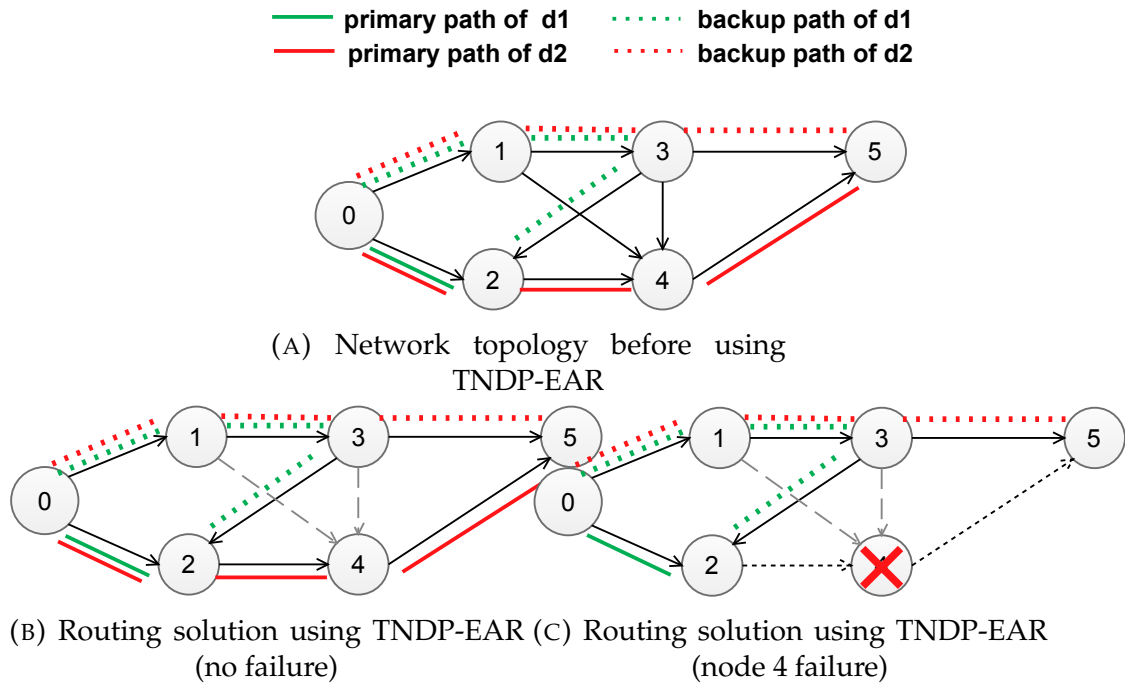

FIGURE 6.8: Example of routing solution for TNDP-EAR

6.5 ILP formulations

6.5.1 Flow-based formulation

Undirected graphs

Consider an undirected link capacity model in which the capacity of a link is shared between the traffic in both directions. Given an undirected graph $G = (V, E)$, where V represents the node set, and E the set of edges, each of which represents an undirected link between two nodes. We formulate the model of TNDP-EAR as integer linear programming model for undirected

graphs as follows.

$$\min \sum_{(u,v) \in E} \mathcal{E}_{uv} n_{uv} + \beta \left\{ \sum_{(u,v) \in E} \mathcal{E}_{uv} (B_{uv} - n_{uv}) \right\} \quad (6.1)$$

$$x_{uv} \leq n_{uv} \quad \forall (u,v) \in E, \quad (6.2)$$

$$B_{uv} x_{uv} \geq n_{uv} \quad \forall (u,v) \in E, \quad (6.3)$$

$$\sum_{(u,v) \in E} y_{uv}^d - \sum_{(v,u) \in E} y_{vu}^d = \begin{cases} 1 & \text{if } u = s_d, \\ -1 & \text{if } u = t_d, \\ 0 & \text{if } u \neq s_d, t_d, \end{cases} \quad \forall d \in D, \quad (6.4)$$

$$\sum_{(u,v) \in E} z_{uv}^d - \sum_{(v,u) \in E} z_{vu}^d = \begin{cases} 1 & \text{if } u = s_d, \\ -1 & \text{if } u = t_d, \\ 0 & \text{if } u \neq s_d, t_d, \end{cases} \quad \forall d \in D, \quad (6.5)$$

$$\sum_{d \in D} h_d (y_{uv}^d + y_{vu}^d + z_{uv}^d + z_{vu}^d) \leq U_T (n_{uv} / B_{uv}) C_{uv} \quad \forall (u,v) \in E, \quad (6.6)$$

$$y_{uv}^d + z_{uv}^d + y_{vu}^d + z_{vu}^d \leq x_{uv} \quad \forall (u,v) \in E; d \in D, \quad (6.7)$$

$$g_u^d + k_u^d \leq 1 \quad \forall u \in V \setminus \{s_d, t_d\}; d \in D, \quad (6.8)$$

$$y_{uv}^d + y_{vu}^d \leq g_u^d \quad \forall u \in V; (u,v) \in E; d \in D, \quad (6.9)$$

$$z_{uv}^d + z_{vu}^d \leq k_u^d \quad \forall u \in V; (u,v) \in E; d \in D, \quad (6.10)$$

The objective function (6.1) minimizes the total power consumption induced by cables. It is composed of two parts. The first part computes the power consumption of powered-on cables. The second part computes the consumption of powered-off cables. Inequalities (6.2) make sure all cables of link (u, v) are powered-off when $x_{uv} = 0$. Inequalities (6.3) ensures that if link (u, v) has at least one cable powered-on (i.e., $n_{uv} \geq 1$) then $x_{uv} = 1$. Equations (6.4) and (6.5) express the classical flow conservation constraints for a primary and backup paths for each demand, respectively. Constraints (6.6) ensure that the total flow traversing each link (u, v) of the primary and backup path cannot exceed the tolerated link capacity, i.e., $U_T (n_{uv} / B_{uv}) C_{uv}$. (6.6) also implies the dedicated protection of the backup path as it should have sufficient resources/bandwidth (h_d), to support its demand in case of link or node failure. Finally, inequalities (6.8)-(6.10) ensure that, for each demand, the primary and the backup paths are node-disjoint. They guarantee that if node u is used by primary path ($g_u^d = 1$), then node u should be excluded from the backup path ($k_u^d = 0$), and vice versa.

Directed graphs

Given a directed graph $G = (V, A)$, where V represents the node set, and A represents the set of arcs, that are directed links between nodes. By considering path direction, the previous ILP can be straightforwardly formulated for directed graphs. Constraints (6.6)-(6.7) should be replaced as follows.

$$\sum_{d \in D} h_d(y_{uv}^d + z_{uv}^d) \leq U_T(n_{uv}/B_{uv})C_{uv} \forall (u, v) \in A, \quad (6.11)$$

$$y_{uv}^d + z_{uv}^d \leq x_{uv} \quad \forall (u, v) \in A; d \in D, \quad (6.12)$$

Constraints (6.9)-(6.10) should be as follows.

$$y_{uv}^d + y_{vu}^d \leq g_u^d \quad \forall u \in V; (u, v), (v, u) \in A; d \in D, \quad (6.13)$$

$$z_{uv}^d + z_{vu}^d \leq k_u^d \quad \forall u \in V; (u, v), (v, u) \in A; d \in D, \quad (6.14)$$

6.5.2 Cut-based formulation

This section presents a second integer linear programming formulation for the problem based on Menger's theorem [247]. Recall, the theorem says that the maximum number of node-disjoint st -paths is equal to the minimum size of a node cut set disconnecting s and t . We reformulate the ILP model studied in [245] to fit with our objective.

Undirected graph

Given an undirected graph $G = (V, E)$, where V represents the node set, and E the set of edges, each of which represents an undirected link between two nodes. The TNDP-EAR can be formulated as cut-based integer linear programming as follows.

$$\min \sum_{e \in E} \mathcal{E}_e n_e + \beta \left\{ \sum_{e \in E} \mathcal{E}_e (B_e - n_e) \right\} \quad (6.15)$$

$$x_e \leq n_e \quad \forall e \in E, \quad (6.16)$$

$$B_e x_e \geq n_e \quad \forall e \in E, \quad (6.17)$$

$$y^d(\delta_G(W)) = \sum_{e \in \delta_G(W)} y_e^d \geq 2 \quad \forall d \in D, \forall W \subset V : s_d \in W, t_d \in \overline{W} = V \setminus W, \quad (6.18)$$

$$y^d(\delta_{G \setminus \{u\}}(W)) = \sum_{e \in \delta_{G \setminus \{u\}}(W)} y_e^d \geq 1 \quad \forall d \in D, u \in V \setminus \{s_d, t_d\}, \quad (6.19)$$

$$\forall W \subset V : s_d \in W, t_d \in \overline{W},$$

$$\sum_{d \in D} h_d y_e^d \leq U_T(n_e/B_e) C_e \quad \forall e \in E, \quad (6.20)$$

$$y_e^d \leq x_e \quad \forall e \in E; d \in D, \quad (6.21)$$

$$x_e, y_e^d \in \{0, 1\} \quad \forall e \in E; d \in D, \quad (6.22)$$

$$n_e \in \mathbb{N} \quad (6.23)$$

Directed graphs

By replacing the path direction, the previous ILP can straightforwardly be extended to the directed graph $G = (V, A)$. The linear program can be formulated as follows.

$$\min \sum_{(u,v) \in A} \mathcal{E}_{uv} n_{uv} + \beta \left\{ \sum_{(u,v) \in A} \mathcal{E}_{uv} (B_{uv} - n_{uv}) \right\} \quad (6.24)$$

$$x_{uv} \leq n_{uv} \quad \forall (u, v) \in A, \quad (6.25)$$

$$B_{uv} x_{uv} \geq n_{uv} \quad \forall (u, v) \in A, \quad (6.26)$$

$$y^d(\delta_G^+(W)) = \sum_{(u,v) \in \delta_G^+(W)} y_{uv}^d \geq 2 \quad \forall d \in D, \forall W \subset V : s_d \in W, t_d \in \overline{W} = V \setminus W, \quad (6.27)$$

$$y^d(\delta_{G \setminus \{u\}}^+(W)) = \sum_{(u,v) \in \delta_{G \setminus \{u\}}^+(W)} y_{uv}^d \geq 1 \quad \begin{aligned} &\forall d \in D, u \in V \setminus \{s_d, t_d\}, \\ &\forall W \subset V : s_d \in W, t_d \in \overline{W}, \end{aligned} \quad (6.28)$$

$$\sum_{d \in D} h_d y_{uv}^d \leq U_T (n_{uv} / B_{uv}) C_{uv} \quad \forall (u, v) \in A, \quad (6.29)$$

$$y_{uv}^d \leq x_{uv} \quad \forall (u, v) \in A; d \in D, \quad (6.30)$$

$$x_{uv}, y_{uv}^d \in \{0, 1\} \quad \forall (u, v) \in A; d \in D, \quad (6.31)$$

$$n_{uv} \in \mathbb{N} \quad (6.32)$$

6.6 Heuristic-based algorithms

As EAR link disjoint path is proven in [252] to be NP-hard even for only two different requests. Thus, we can state that TNDP-EAR is also an NP-hard problem as well. Hence, heuristic methods are preferred to quickly find efficient solutions for large networks. We propose a heuristic algorithm that includes node disjoint path computation phase and EAR phase. Three heuristics can be proposed $GreenTNDP_{ksp}$, $GreenTNDP_{basic}$, and $GreenTNDP_{Suur}$, that differ in the algorithm used to compute the node disjoint paths.

- $GreenTNDP_{ksp}$ Algorithm 6 is applied in Phase 1 to find two disjoint paths for each demand.
- $GreenTNDP_{basic}$ Algorithm 5 is applied in Phase 1 to find two disjoint paths for each demand.

- *GreenTNDP_{Suar}* Algorithm 4 is applied in Phase 1 to find two disjoint paths for each demand.

The idea of our heuristic is as follows. Sort all demands in a descending order of h_d ; create the residual graph for each demand by removing all links with residual capacity lower than h_d ; find the primary path and backup paths (using any algorithm that computes node disjoint paths) for each demand; then, (the energy aware routing phase is initialized), select iteratively a link with maximum residual capacity to turn off. Find all demands that contain the deleted link, then release the bandwidth of the affected demands and reroute traffic for these affected demands through the remaining links. If any of the affected demands fails to be rerouted, the candidate link must be turned on (i.e. put it back to A_r). Repeat the process until all links are considered. Finally, turn-off the unused cables using (4.13). Heuristic algorithms are described in Algorithm 7.

6.7 Experimental results

In this section, we evaluate the flow based ILP formulation for directed graphs and the heuristic-based algorithm *GreenTNDP_{basic}*.

We use the following experiments setup (i) bundle size $B_{uv} = 4$; (ii) the maximum tolerated link utilization $U_T = 100\%$; and (iii) each cable has the same power consumption $\mathcal{E}_{uv} = 100$ watts.

6.7.1 Performance metrics

To evaluate the performance of our algorithms, we use the following metrics.

$\eta\%$ is the percentage of power savings related to the cables turned off by the EAR algorithms. It is computed as follows:

$$\eta\% = \left(1 - \frac{\sum_{(u,v) \in A} n_{uv}}{\sum_{(u,v) \in A} B_{uv}}\right) \times 100\% \quad (6.33)$$

ρ is used to measure the mean traffic utilization of the used links in G' . It is previously defined in Chapter 2.

Finally, we evaluate the effect of our EAR algorithms on the reliability of each demand. We measure route reliability as in [156]. Let $p_{uv} = 0.9$ be the

```

Input: A weighted-directed graph  $G = (V, A)$ , a set  $D$  of demands with
traffic requirements  $h_d$  for all  $d \in D$ ,
Output:  $G' = (V, A')$ : the output graph containing only links used to
route the demands.
1 Initially,  $A' = A$ ;
2 /*Phase 1*/
3 Paths= $\emptyset$ ;
4 Sort demands in a descending order of demands  $h_d$ ;
5 for each  $d \in D$  do
6   Compute the residual graph  $G_r$  for  $d$  by removing the links with
    $r_{uv} \leq h_d, \forall (u, v) \in A'$ ;
7    $P_d = \text{call find-TNDP}(G_r, d)$ ;
8   if  $P_d$  exist then
9     Update residual capacity of links of  $P_d$  on  $G'$ ;
10    Paths=Paths  $\cup P_d$ ;  $P_d = \{P_p^d, P_b^d\}$ ;
11    return true;
12  else
13    return false;
14    break;
15  end
16 end
17 /*Phase 2*/
18 //Step 1
19 for each link  $(u, v) \in A'$  in a descending order of its residual capacity do
20    $A' = A' - \{(u, v)\}$ ; // turn off candidate link  $(u, v)$ 
21   //Find affected demands by turning off  $(u, v)$ 
22    $D^a = \{d | P_d \cap (u, v) \neq \emptyset, d \in D\}$ ;
23   Release the bandwidth of  $D^a$ ;
24   feasible=Reroute traffic of  $D^a$  on  $G'$  by repeating Phase 1;
25   if feasible==false then
26     put  $(u, v)$  back to  $A'$ ;
27     assign bandwidth of  $D^a$  on  $G'$ ;
28   end
29 end
30 //Step 2
31 for each each link  $(u, v) \in A'$  do
32   turn off unused cables using (4.13);
33 end

```

Algorithm 7: Pseudo-code description for the proposed heuristic (green TNDP)

probability of a cable in link (u, v) being functional. The reliability of a link (u, v) is denoted by l_{uv} can be computed as follow:

$$l_{uv} = 1 - (1 - p_{uv})^{n_{uv}}. \quad (6.34)$$

Let RR_d denote the global route reliability for a demand d routed through two node-disjoint paths (*i.e.*, represented by variables y and z). RR_d is computed as follows:

$$RR_d = 1 - (1 - R_{dy})(1 - R_{dz}), \quad (6.35)$$

where R_{dy} and R_{dz} are the route reliability of the primary and back-up paths respectively. R_{dy} and R_{dz} are calculated by the following formula :

$$R_{d\{y/z\}} = \log^{-1} \left(\sum_{(uv) \in R_{d\{y/z\}}} \log l_{uv} \right), \forall d \in D. \quad (6.36)$$

We can also compute the average route reliability (ARR) for a given traffic matrix D as follows.

$$ARR = \frac{\sum_{d \in D} RR_d}{|D|} \quad (6.37)$$

TNDP-EAR vs. GreenTNDP_{basic} solutions

We test our algorithms TNDP-EAR and GreenTNDP_{basic} on six realistic network topologies collected from the Survivable Network Design Library (SNDlib) [206].

We choose network instances where two node-disjoint paths always exist. We solved the ILP model using the CPLEX solver with Concert Technology (C++) [concertplex], with a time limit set to 3 hours (10800 seconds).

Table 6.3 and Table 6.4 report the computational results obtained by running the ILP and GreenTNDP_{basic} heuristic on six realistic topologies. The gap column reports the energy performance of the resulting network topology, *i.e.*, the ratio (UB-LB)/LB, where UB is the upper bound on power consumption, and LB is the power consumption of the linear relaxation. If the gap equals to zero, it means that the optimal solution is found.

TABLE 6.3: ILP formulation (TNDP-EAR)

Network	$ V $	$ E $	$ D $	Power Saving ($\eta\%$)	Optimality gap (%)	Power consumption Upper bound UB (W)	Mean links Utilization (ρ)	Execution Time (s)
Atlanta	15	44	132	67.61	5	5147.6	23.29	10800
Dfn-bwin	10	90	90	90.83	21	3006	22.46	10800
Di-yuan	11	84	22	88.39	6	3543.6	22.09	10800
Nobel-germany	17	52	121	55.28	2	8390.8	43.89	10800
Pdh	11	68	24	88.06	0	1917.2	11.05	30.25
Polska	12	36	66	71.52	0	3704.4	27.66	1529.89

The obtained results confirm the effectiveness of our heuristic GreenTNDP_{basic}. For instance, the ILP model cannot find an optimal solution for Atlanta, Dfn-bwin, Di-yuan, and Nobel-germany networks within 3 hours, meanwhile

TABLE 6.4: Heuristic algorithm ($GreenTNDP_{basic}$)

Network	$ V $	$ E $	$ D $	Power Saving ($\eta\%$)	Power consumption Upper bound UB (W)	Mean links Utilization (ρ)	Execution Time (s)
Atlanta	15	44	132	73.29	4247.6	52.72	19.31
Dfn-bwin	10	90	90	87.22	4176.0	25.32	31.92
Di-yuan	11	84	22	91.66	2553.6	11.94	8.96
Nobel-germany	17	52	121	75	5061.8	13.90	30.54
Pdh	11	68	24	88.06	1917.2	11.05	8.20
Polska	12	36	66	65.97	4424.4	18.84	6.86

$GreenTNDP_{basic}$ can find better solutions in reasonable time (within at most 11 seconds). Moreover, we notice that the heuristic algorithm outperforms the ILP model for these four instances, not only in terms of computational time but also in terms of energy savings. Concerning Pdh network instance, $TNDP-EAR$ and $GreenTNDP_{basic}$ find the same solution (optimal). This result shows that $GreenTNDP_{basic}$ may reduce the computation time. Finally, $TNDP-EAR$ can find the optimal solution for Polska instance within 1529 seconds, meanwhile $GreenTNDP_{basic}$ find less efficient solution (with 19.43% of gap) in 6.86 seconds.

However once some of the links are turned-off, the same traffic is rerouted on fewer set of links, which impact the traffic capabilities (i.e., network congestion). This trade-off between energy-saving and network congestion is clearly demonstrated by ρ parameter. For instance, when comparing $\rho\%$ values (for the same network instance and by the two algorithms), we notice that $\rho\%$ increases when $\eta\%$ increases as well.

Figures 6.9 to 6.14 present the topologies before and after $GreenTNDP_{basic}$ for the six network instances.

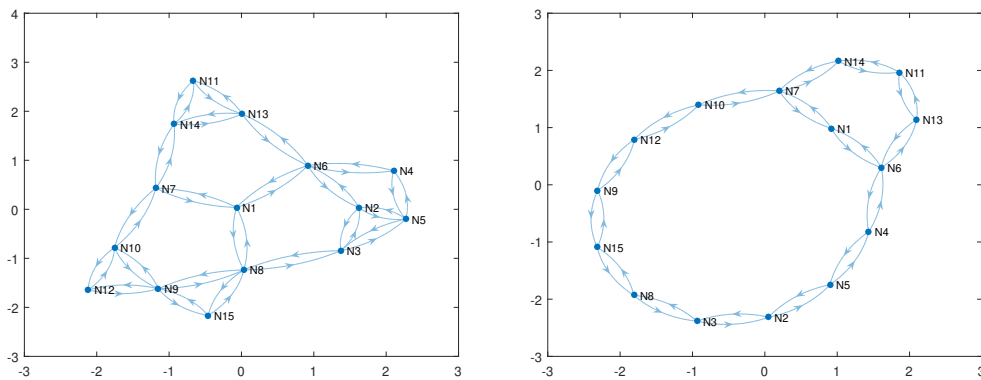

(A) Before $GreenTNDP_{basic}$ execution (B) After $GreenTNDP_{basic}$ execution

FIGURE 6.9: Atlanta network

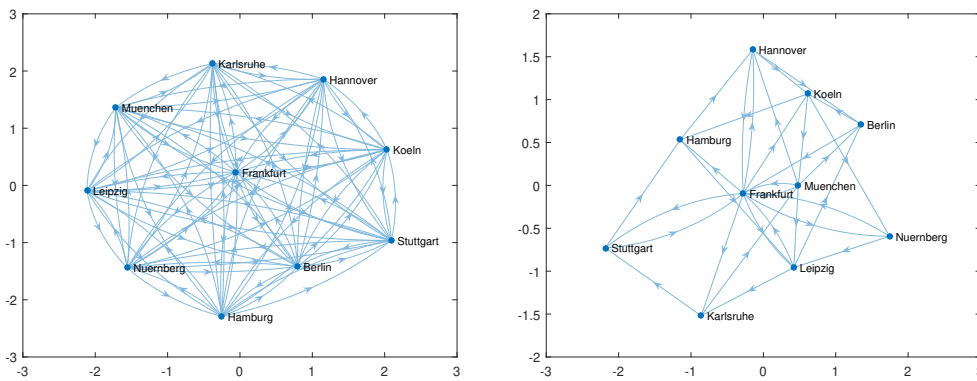

(A) Before $GreenTNDP_{basic}$ execution (B) After $GreenTNDP_{basic}$ execution

FIGURE 6.10: Dfn-bwin network

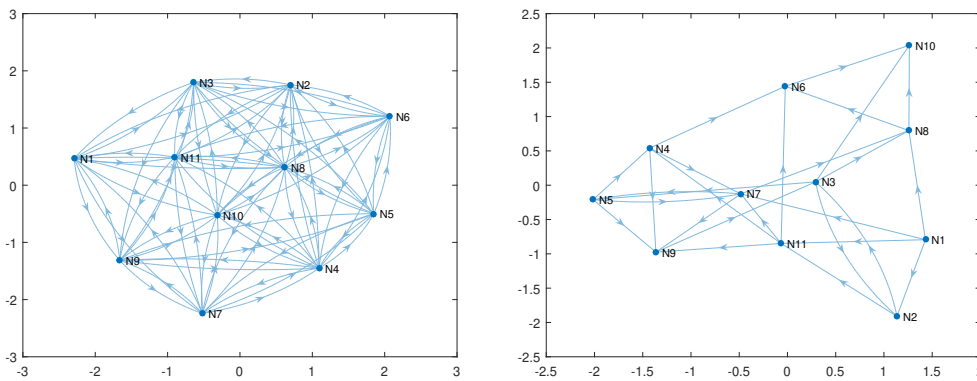

(A) Before $GreenTNDP_{basic}$ execution (B) After $GreenTNDP_{basic}$ execution

FIGURE 6.11: Di-yuan network

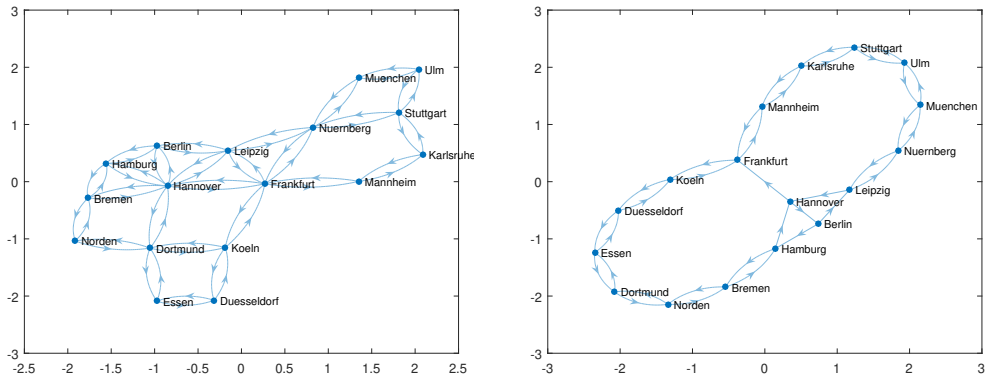

(A) Before $GreenTNDP_{basic}$ execution (B) After $GreenTNDP_{basic}$ execution

FIGURE 6.12: Nobel-germany network

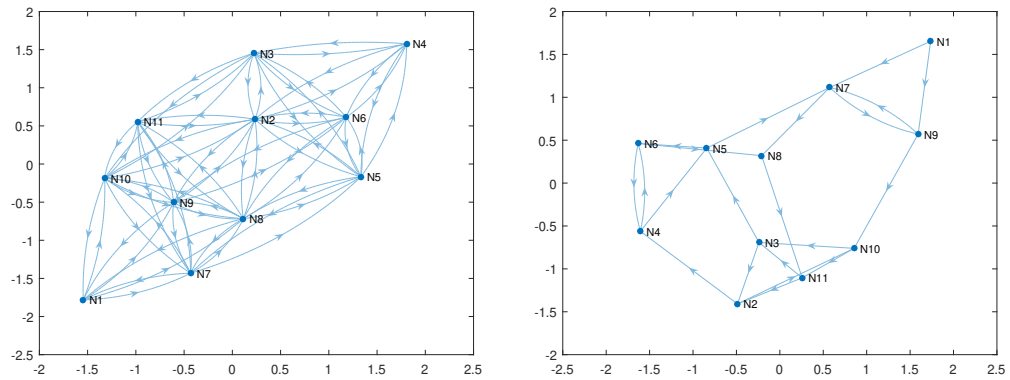

(A) Before $GreenTNDP_{basic}$ execution (B) After $GreenTNDP_{basic}$ execution

FIGURE 6.13: Pdh network

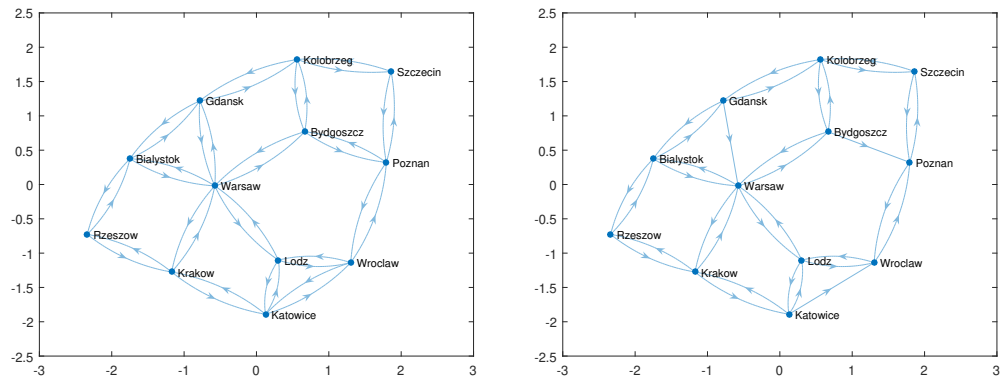

(A) Before $GreenTNDP_{basic}$ execution (B) After $GreenTNDP_{basic}$ execution

FIGURE 6.14: Polska network

Route reliability

Figure 6.15 to Figure 6.20 show the cumulative distribution function (CDF) of routing reliability. We show the route reliability for GreenTNDP_{basic}, TNDP-EAR and SP (Shortest Path routing without disjoint backup path) for the six networks. Note that SP is an energy aware routing that minimizes the total number of cables that route each demand along only one path (the primary one). The figures show that both TNDP-EAR and GreenTNDP_{basic} enhance the route reliability. Meanwhile, SP consistently has the worst CDF on the six networks because it saves the most energy and uses less cables than TNDP-EAR and GreenTNDP_{basic}. Specifically on Atlanta 60% of its routes generated by SP have reliability no higher than 0.7. On Dfn-bwin and Di-yuan, SP maintains a good route reliability more than 50% of demands have route reliability higher than 0.8. TNDP-EAR and GreenTNDP_{basic} show better route reliability, for instance 50% of route have reliability higher than 0.97), while on Di-yuan all the demands have reliability more than 0.97. On Nobel-germany, 70% of routes generated by SP have reliability between 0.58 and 0.9. Whereas 80% of demands generated by TNDP-EAR and GreenTNDP_{basic} have reliability between 0.857 and 1, and 20% of demands have reliability between 0.77 and 0.857. For the four previous networks, i.e., Atlanta, Dfn-bwin, Di-yuan, Nobel-germany, we observe that TNDP-EAR has slightly better CDF, i.e., it has more reliable routes compared to GreenTNDP_{basic}. This is due the fact that TNDP-EAR saves less energy and therefore uses more cables than GreenTNDP_{basic}.

Concerning Pdh network, SP generates 40% of routes with route reliability between 0.43 and 0.81. Since TNDP-EAR and GreenTNDP_{basic} find the same routing solution, they also have the same route reliability (i.e., all routes have reliability higher than 0.9).

Finally, on Polska network, 50% of routes generated by SP have route reliability less than 0.8. On this network instance, GreenTNDP_{basic} has CDF better than TNDP-EAR, because here the heuristic turns off less number of cables.

As expected, when the number of links and cables is reduced, there are more traffic with lower reliability. We draw Table 6.5 to highlight the trade-off between minimizing energy usage and enhancing network reliability.

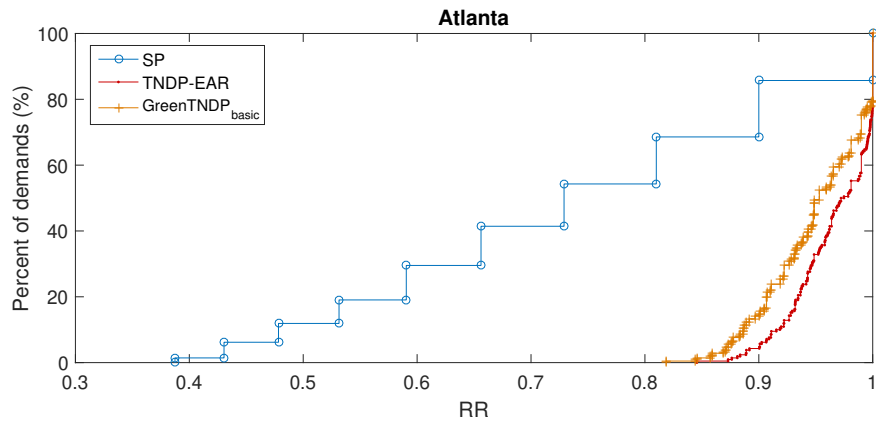

FIGURE 6.15: CDF of routing reliability on Atlanta

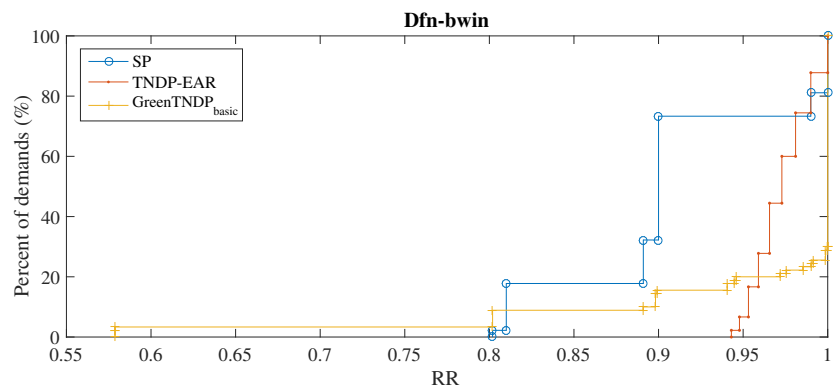

FIGURE 6.16: CDF of routing reliability on Dfn-bwin

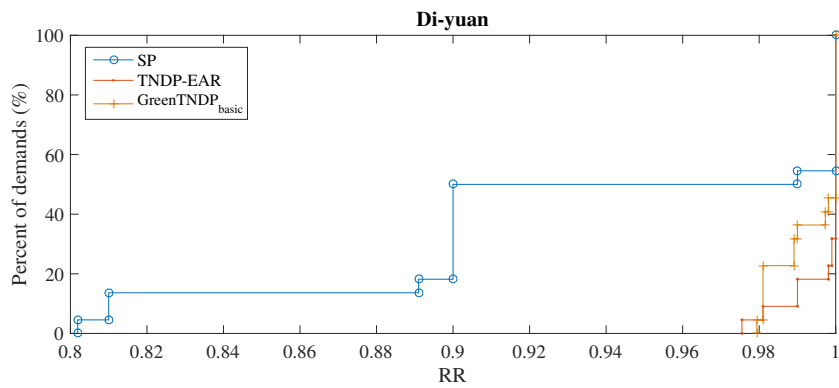

FIGURE 6.17: CDF of routing reliability on Di-yuan

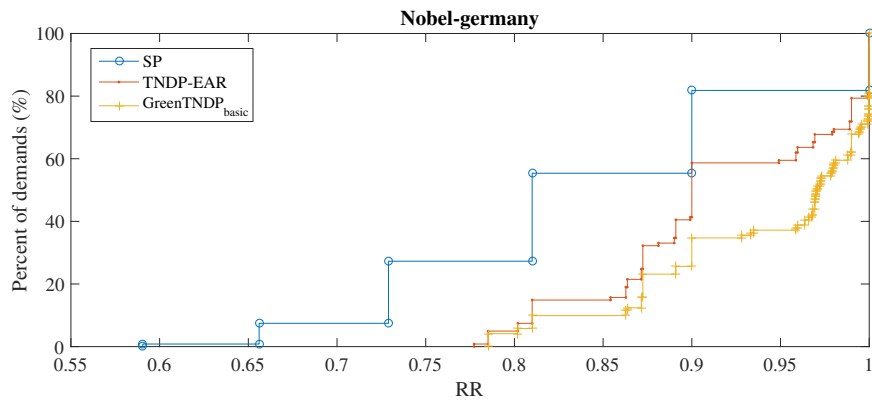

FIGURE 6.18: CDF of routing reliability on Nobel-germany

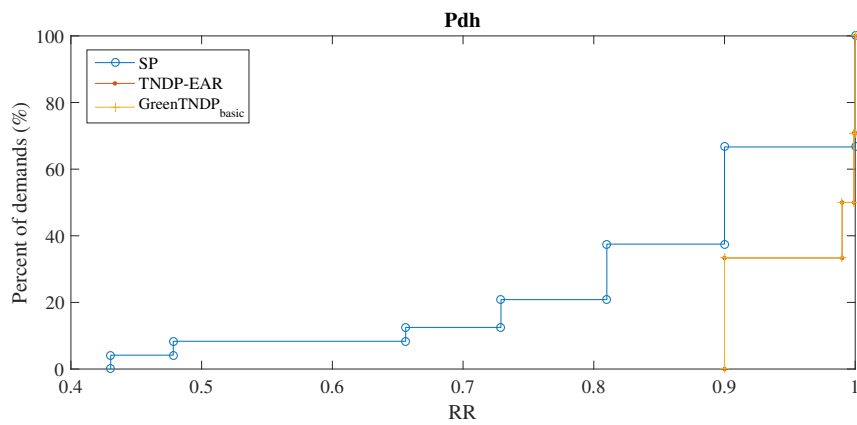

FIGURE 6.19: CDF of routing reliability on Pdh

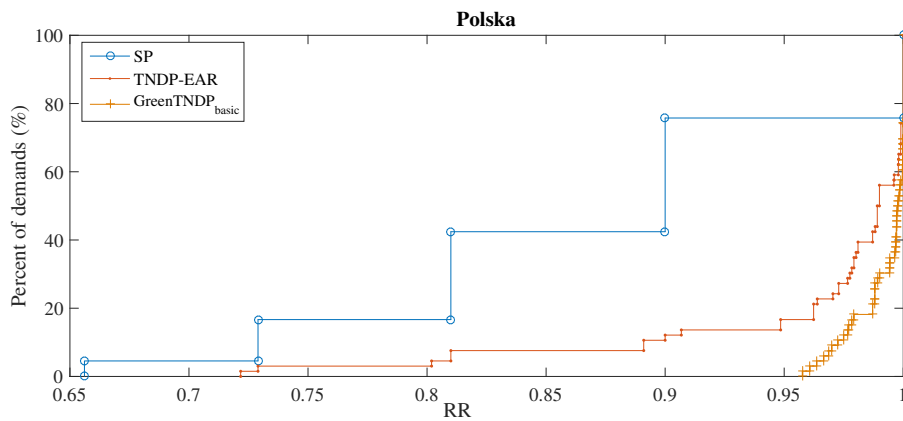

FIGURE 6.20: CDF of routing reliability on Polska

TABLE 6.5: Energy saving and average route reliability

		SP	TNDP-EAR	GreenTNDP _{basic}
Atlanta	$\eta\%$	80.68	67.61	73.29
	ARR	0.7379	0.9661	0.9503
Dfn-bwin	$\eta\%$	94.72	90.83	87.22
	ARR	0.9084	0.9646	0.9732
Di-yuan	$\eta\%$	94.64	88.39	91.66
	ARR	0.9365	0.9969	0.994
Nobel-germany	$\eta\%$	76.44	55.28	75
	ARR	0.8403	0.9418	0.8926
Pdh	$\eta\%$	92.27	88.06	88.06
	ARR	0.8568	0.9486	0.9486
Polska	$\eta\%$	81.94	71.52	65.97
	ARR	0.8692	0.8813	0.9923

6.8 Conclusion

To the best of our knowledge, this is the first study that presents two novel ILP formulations to solve the energy aware routing with two node disjoint path problem. In this chapter, we formally defined and modeled the reliable energy-aware routing problem. We then proposed three heuristic algorithms $GreenTNDP_{ksp}$, $GreenTNDP_{basic}$, and $GreenTNDP_{Suurr}$, that differ in the way the node disjoint paths are computed. The implementation of our proposed algorithms can be run on a logically-centralized power monitor such as in Software Defined Network (SDN) architecture. Our evaluation for the ILP model TNDP-EAR and the heuristic $GreenTNDP_{basic}$ on six realistic networks, showed that the heuristic is efficient to produce a network with a low energy usage under a high reliability level in reasonable time. The algorithms presented in this chapter work for traffic instances where disjoint path computation is always feasible. As a future work, it would be interesting to consider shared scheme along with EAR.

Conclusion

Summary of work

In this thesis, focusing on green networking, we have addressed the issue of energy consumption in wired networks and especially in carrier Ethernet networks. A potential solution to reduce the power consumption of Carrier-Ethernet is to manage the whole network configuration in a coordinated way such that to power off redundant network elements. Accordingly, we have developed centralized approaches for carrier Ethernet operated with different configurations and routing policies. We have considered saving energy with splittable and unsplittable flows, i.e., with Equal Cost Multi-Path (ECMP) rules and with simple shortest path routing. Consequently, the energy consumption is the minimum required to satisfy the traffic request, but it comes with an important impact on resilience since there are no redundant elements in the network topology. Therefore, we have enhanced our centralized approaches to ensure, along with the energy saving, both link and node protection in case of unexpected failure, considering dedicated protection scheme. We have used optimization methods (greedy heuristics and ILP/MILP formulation) to solve the problem. After describing the key contributors to the power consumption of wired networks, we have surveyed, in Chapter 1 and 2, the state-of-the-art on energy consumption in the ICT sector and especially in carrier-grade networks. We have described the most suitable techniques that could improve the energy efficiency of carrier-grade networks from two different aspects: the network and node level. Chapter 3 presents a new energy-aware routing algorithm, called MEEAFS, to save energy in Carrier Ethernet networks. It allows a subset of bridge interfaces to be turned off. The candidate links to be turned off are initially depending on the topology (traffic-unaware). In order to maintain a satisfactory of QoS, the sleeping decision depends on a threshold based on link utilization. MEEAFS is compliant with Shortest Path Bridging (SPB) protocol (IEEE 802.1aq). The same problem is tackled in Chapter 4, taking into

account the network topology and the traffic matrices before sleeping decision. Moreover, ECMP routing policy is considered to minimize the network congestion. We have formally defined the problem and modeled it as mixed integer linear program. Then, we have proposed two heuristics performing energy-aware routing, Green SPB (G-SPB) and Fast Greedy SPB (FG-SPB), which are compliant to Carrier Ethernet network operating with SPB protocol. Chapter 5 deals with energy aware routing with SDN (Software Defined Network) approach. We have presented an energy-aware routing solution which is compliant for SDN-based carrier Ethernet networks. We have taken into account the limitation of the flow-table size (rule space capacity constraint). We have formulated the problem as a binary integer program formulation, since identifying the optimal set of nodes and links to be turned off is an NP-hard problem, we have proposed a set of first fit heuristic algorithms to reduce the computation time. We have also discussed some EAR implementations in an SDN controller. Finally, in Chapter 6, we have presented a new reliable energy-aware routing that guarantees, along with energy saving, both protection to nodes and links. To survive the network in case of node or link failures, we deal with dedicated protection scheme. Accordingly, a node-backup path is computed for each traffic demand, which have sufficient capacity to cope with probable failures. The algorithms presented in this chapter work only for network instances where disjoint path computation is always feasible.

Further research

We suggest that the future work should take into account the following improvement:

- Include *robust* optimization methods whose objective is to reduce the network configuration in daily traffic variations. As well as, traffic uncertainty should be integrated into the EAR procedures.
- Focus on optimizing the initial weight setting with the aim to get efficient routing cost with low network congestion.
- Include additional QoS constraints such as on the maximum length of paths, which can be ensured by the delay or the hop constraints.

-
- Taking into account the discreteness of link rates constraint, i.e., the availability of different link rates.
 - Extend our reliable EAR (TNDP-EAR) to protect against both multiple link-failure and multiple node-failure.
 - Implementation of all our proposed approaches via network emulators.

Bibliography

- [1] Minghong Lin et al. “Dynamic right-sizing for power-proportional data centers”. In: *IEEE/ACM Transactions on Networking (TON)* 21.5 (2013), pp. 1378–1391.
- [2] Jan M Rabaey and Massoud Pedram. *Low power design methodologies*. Vol. 336. Springer Science & Business Media, 2012.
- [3] *Global Energy Statistical Yearbook 2014. Addressing the Challenge of Energy Efficiency through Information and Communication Technologies. Technical Report*. [Online] <https://yearbook.enerdata.net/>.
- [4] Raffaele Bolla et al. “Energy efficiency in the future internet: A survey of existing approaches and trends in energy-aware fixed network infrastructures”. In: *IEEE Communications Surveys & Tutorials* 13.2 (2011), pp. 223–244.
- [5] Raffaele Bolla et al. “Cutting the energy bills of Internet Service Providers and telecoms through power management: An impact analysis”. In: *Computer Networks* 56.10 (2012), pp. 2320–2342.
- [6] Jayant Baliga et al. “Green cloud computing: Balancing energy in processing, storage, and transport”. In: *Proceedings of the IEEE* 99.1 (2011), pp. 149–167.
- [7] Jennifer Mankoff, Robin Kravets, and Eli Blevis. “Some computer science issues in creating a sustainable world”. In: *Computer* 41.8 (2008).
- [8] Jens Malmodin, Pernilla Bergmark, and Dag Lundén. “The future carbon footprint of the ICT and E&M sectors”. In: *on Information and Communication Technologies* (2013), p. 12.
- [9] Jens Malmodin, Pernilla Bergmark, and Dag Lundén. *Energy and carbon footprint performance metrics for the ICT sector based on LCA*. 2014.
- [10] British Telecom Group. *Sustainability Report 2010*. [Online] <http://www.btplc.com/>.

- [11] IT Wales. "Green evangelist to call for big changes in computer use to aid environment". In: *ITWales Conf.*, November. 2007.
- [12] Deutsche Telekom Group. *Ecological Indicators*. [Online] <http://www.cr-report.telekom.com/site08/>.
- [13] Global e Sustainability Initiative (GeSI). *SMARTer2020: The Role of ICT in Driving a Sustainable Future*. [Online] <http://gesi.org/SMARTer2020>.
- [14] even Global e Sustainability Initiative (GeSI). *SMARTer2030 : ICT Solutions for 21st Century Challenges*. [Online] <http://smarter2030.gesi.org/>. 2015.
- [15] William D Nordhaus. "To slow or not to slow: the economics of the greenhouse effect". In: *The economic journal* 101.407 (1991), pp. 920–937.
- [16] Maruti Gupta and Suresh Singh. "Greening of the Internet". In: *Proceedings of the 2003 conference on Applications, technologies, architectures, and protocols for computer communications*. ACM. 2003, pp. 19–26.
- [17] Oliver Tamm, Christian Hermsmeyer, and Allen M Rush. "Eco-sustainable system and network architectures for future transport networks". In: *Bell Labs Technical Journal* 14.4 (2010), pp. 311–327.
- [18] Rodney S Tucker. "Green optical communications Part II: Energy limitations in networks". In: *IEEE Journal of Selected Topics in Quantum Electronics* 17.2 (2011), pp. 261–274.
- [19] Daniel Collins et al. *Carrier grade voice over IP*. Vol. 2. McGraw-Hill, 2001.
- [20] Priya Mahadevan et al. "A power benchmarking framework for network devices". In: *NETWORKING 2009* (2009), pp. 795–808.
- [21] Li Shang, Li-Shiuan Peh, and Niraj K Jha. "PowerHerd: a distributed scheme for dynamically satisfying peak-power constraints in interconnection networks". In: *IEEE Transactions on Computer-Aided Design of Integrated Circuits and Systems* 25.1 (2006), pp. 92–110.
- [22] Joseph Chabarek et al. "Power awareness in network design and routing". In: *INFOCOM 2008. The 27th Conference on Computer Communications*. IEEE. IEEE. 2008, pp. 457–465.

- [23] Bogdan Florin Cornea, Anne-Cécile Orgerie, and Laurent Lefèvre. “Studying the energy consumption of data transfers in Clouds: the Ecofen approach”. In: *Cloud Networking (CloudNet), 2014 IEEE 3rd International Conference on*. IEEE. 2014, pp. 143–148.
- [24] Chamara Gunaratne, Ken Christensen, and Bruce Nordman. “Managing energy consumption costs in desktop PCs and LAN switches with proxying, split TCP connections, and scaling of link speed”. In: *International Journal of Network Management* 15.5 (2005), pp. 297–310.
- [25] Miriam Allalouf et al. “Storage modeling for power estimation”. In: *Proceedings of SYSTOR 2009: The Israeli Experimental Systems Conference*. ACM. 2009, p. 3.
- [26] Henry G Dietz and William R Dieter. “Compiler and runtime support for predictive control of power and cooling”. In: *Parallel and Distributed Processing Symposium, 2006. IPDPS 2006. 20th International*. IEEE. 2006, 8–pp.
- [27] Marilyn Wolf. *The Physics of computing*. Elsevier, 2017.
- [28] [Online] <https://ec.europa.eu/jrc/en/energy-efficiency>.
- [29] Steven Lanzisera, Bruce Nordman, and Richard E Brown. “Data network equipment energy use and savings potential in buildings”. In: *Energy Efficiency* 5.2 (2012), pp. 149–162.
- [30] Aruna Prem Bianzino et al. “A survey of green networking research”. In: *IEEE Communications Surveys & Tutorials* 14.1 (2012), pp. 3–20.
- [31] Raffaele Bolla et al. “The potential impact of green technologies in next-generation wireline networks: Is there room for energy saving optimization?” In: *IEEE Communications Magazine* 49.8 (2011).
- [32] Yi Zhang et al. “Energy efficiency in telecom optical networks”. In: *IEEE Communications Surveys & Tutorials* 12.4 (2010), pp. 441–458.
- [33] Robert D Doverspike, KK Ramakrishnan, and Chris Chase. “Structural overview of ISP networks”. In: *Guide to Reliable Internet Services and Applications*. Springer, 2010, pp. 19–93.

- [34] Christoph Lange. "Energy-related aspects in backbone networks". In: *Proceedings of 35th European Conference on Optical Communication (ECOC 2009)*, (Wien, AU). 2009.
- [35] Ralph Santitoro. "Metro Ethernet Services—A Technical Overview". In: *Metro Ethernet Forum*. Vol. 2006. 2003.
- [36] Christoph Lange et al. "Energy consumption of telecommunication networks". In: *Optical Communication, 2009. ECOC'09. 35th European Conference on*. IEEE. 2009, pp. 1–2.
- [37] Jayant Baliga et al. "Energy consumption in access networks". In: *Optical Fiber communication/National Fiber Optic Engineers Conference, 2008. OFC/NFOEC 2008. Conference on*. IEEE. 2008, pp. 1–3.
- [38] Jayant Baliga et al. "Energy consumption in wired and wireless access networks". In: *IEEE Communications Magazine* 49.6 (2011).
- [39] Yuhwa Suh et al. "A study on impact of wired access networks for green Internet". In: *Journal of Network and Computer Applications* 57 (2015), pp. 156–168.
- [40] Kerry Hinton et al. "Power consumption and energy efficiency in the internet". In: *IEEE Network* 25.2 (2011).
- [41] Ahmed Q Lawey, Taisir EH El-Gorashi, and Jaafar MH Elmirghani. "Distributed energy efficient clouds over core networks". In: *Journal of Lightwave Technology* 32.7 (2014), pp. 1261–1281.
- [42] Anne-Cecile Orgerie, Marcos Dias de Assuncao, and Laurent Lefevre. "A survey on techniques for improving the energy efficiency of large-scale distributed systems". In: *ACM Computing Surveys (CSUR)* 46.4 (2014), p. 47.
- [43] Technology Roadmap. *Energy-efficient Buildings: Heating and Cooling Equipment*. International Energy Agency. 2011.
- [44] J Baliga et al. "Photonic switching and the energy bottleneck". In: *Photonics in Switching, 2007*. IEEE. 2007, pp. 125–126.
- [45] Jayant Baliga et al. "Energy consumption in optical IP networks". In: *Journal of Lightwave Technology* 27.13 (2009), pp. 2391–2403.
- [46] *Green Touch TM Initiative: A Five Year Quest to Achieve Sustainable Networking*. [Online] <https://www.computerworld.com.pt/media/2010/01/ALGreenTouch-20100111.pdf>.

- [47] *ECONET (low Energy Consumption NETWORKS)*. [Online] <http://www.econet-project.eu/>.
- [48] Raffaele Bolla et al. "Setting the course for a green internet". In: *Science* 342.6164 (2013), pp. 1316–1316.
- [49] Marco Ajmone Marsan et al. "TREND: Toward real energy-efficient network design". In: *Sustainable Internet and ICT for Sustainability (SustainIT)*, 2012. IEEE. 2012, pp. 1–6.
- [50] Michela Meo et al. "Research challenges on energy-efficient networking design". In: *Computer Communications* 50 (2014), pp. 187–195.
- [51] Bokyung Wang and Suresh Singh. "Computational energy cost of TCP". In: *INFOCOM 2004. Twenty-third Annual Joint Conference of the IEEE Computer and Communications Societies*. Vol. 2. IEEE. 2004, pp. 785–795.
- [52] Liam Irish and Kenneth J Christensen. "A "Green TCP/IP" to reduce electricity consumed by computers". In: *Southeastcon'98. Proceedings*. IEEE. IEEE. 1998, pp. 302–305.
- [53] Antonio Cianfrani et al. "An energy saving routing algorithm for a green OSPF protocol". In: *INFOCOM IEEE Conference on Computer Communications Workshops, 2010*. IEEE. 2010, pp. 1–5.
- [54] Ward Van Heddeghem et al. "Energy-efficiency in telecommunications networks: Link-by-link versus end-to-end grooming". In: *Optical Network Design and Modeling (ONDM), 2010 14th Conference on*. IEEE. 2010, pp. 1–6.
- [55] Isaac Seoane et al. "Energy-aware flow allocation algorithm for Energy Efficient Ethernet networks". In: *Software, Telecommunications and Computer Networks (SoftCOM), 2011 19th International Conference on*. IEEE. 2011, pp. 1–5.
- [56] JC Cardona Restrepo, Claus G Gruber, and C Mas Machuca. "Energy profile aware routing". In: *Communications Workshops, 2009. ICC Workshops 2009. IEEE International Conference on*. IEEE. 2009, pp. 1–5.
- [57] Asfandyar Qureshi et al. "Cutting the electric bill for internet-scale systems". In: *ACM SIGCOMM computer communication review*. Vol. 39. 4. ACM. 2009, pp. 123–134.

- [58] Europäische Union. "Directive 2009/28/EC of the European Parliament and of the Council of 23 April 2009 on the promotion of the use of energy from renewable sources and amending and subsequently repealing Directives 2001/77/EC and 2003/30/EC". In: *Official Journal of the European Union* 5 (2009), p. 2009.
- [59] ETP SmartGrids. "European technology platform for the electricity networks of the future". In: (2010).
- [60] John Miller et al. "Renewable Electricity Use by the US Information and Communication Technology (ICT) Industry". In: *National Renewable Energy Laboratory, Tech. Rep. NREL/TP-6A20-64011* (2015).
- [61] Terry Tao Ye, Giovanni De Micheli, and Luca Benini. "Analysis of power consumption on switch fabrics in network routers". In: *Proceedings of the 39th annual Design Automation Conference*. ACM. 2002, pp. 524–529.
- [62] Luiz André Barroso and Urs Hölzle. "The case for energy-proportional computing". In: *Computer* 40.12 (2007).
- [63] "IEEE Standard for Information technology– Local and metropolitan area networks– Specific requirements– Part 3: CSMA/CD Access Method and Physical Layer Specifications Amendment 5: Media Access Control Parameters, Physical Layers, and Management Parameters for Energy-Efficient Ethernet". In: *IEEE Std 802.3az-2010 (Amendment to IEEE Std 802.3-2008)* (2010), pp. 1–302. DOI: [10.1109/IEEESTD.2010.5621025](https://doi.org/10.1109/IEEESTD.2010.5621025).
- [64] Ken Christensen et al. "IEEE 802.3 az: the road to energy efficient ethernet". In: *IEEE Communications Magazine* 48.11 (2010).
- [65] Bo Zhai et al. "Theoretical and practical limits of dynamic voltage scaling". In: *Proceedings of the 41st annual Design Automation Conference*. ACM. 2004, pp. 868–873.
- [66] Alan Meier, Bruce Nordman, and Mark Ellis. "Buildings as Networks: Danger, Opportunity, and Guiding Principles for Energy Efficiency". In: *IEA conference on Digital Networks*, <http://www.iea.org/textbase/work/2007/set-top/background/Background.pdf>. Paris, France: International Energy Agency. 2007.

- [67] Raffaele Bolla et al. "The green abstraction layer: A standard power-management interface for next-generation network devices". In: *IEEE Internet Computing* 17.2 (2013), pp. 82–86.
- [68] Raffaele Bolla et al. "A northbound interface for power management in next generation network devices". In: *IEEE Communications Magazine* 52.1 (2014), pp. 149–157.
- [69] Brad Schoening, Mouli Chandramouli, and Bruce Nordman. *Energy Management (EMAN) Applicability Statement*. Tech. rep. 2015.
- [70] J Parello et al. *Energy management framework*. Tech. rep. 2014.
- [71] Andrea Bianco et al. "Cost, power consumption and performance evaluation of metro networks". In: *Journal of Optical Communications and Networking* 5.1 (2013), pp. 81–91.
- [72] F. Musumeci et al. "On the energy consumption of IP-over-WDM architectures". In: *2012 IEEE International Conference on Communications (ICC)*. 2012, pp. 3004–3008. DOI: [10.1109/ICC.2012.6363778](https://doi.org/10.1109/ICC.2012.6363778).
- [73] Achim Autenrieth et al. "Power consumption analysis of opaque and transparent optical core networks". In: *Transparent Optical Networks (ICTON), 2011 13th International Conference on*. IEEE. 2011, pp. 1–5.
- [74] Biswanath Mukherjee. *Optical WDM networks*. Springer Science & Business Media, 2006.
- [75] Filip Idzikowski et al. "Dynamic routing at different layers in IP-over-WDM networks-Maximizing energy savings". In: *Optical Switching and Networking* 8.3 (2011), pp. 181–200.
- [76] Gangxiang Shen and Rodney S Tucker. "Energy-minimized design for IP over WDM networks". In: *Journal of Optical Communications and Networking* 1.1 (2009), pp. 176–186.
- [77] Francesco Musumeci, Massimo Tornatore, and Achille Pattavina. "A power consumption analysis for IP-over-WDM core network architectures". In: *Journal of Optical Communications and Networking* 4.2 (2012), pp. 108–117.
- [78] Anna Tzanakaki et al. "Dimensioning the future Pan-European optical network with energy efficiency considerations". In: *Journal of Optical Communications and Networking* 3.4 (2011), pp. 272–280.

- [79] Kostas M Katrinis and Anna Tzanakaki. "On the dimensioning of WDM optical networks with impairment-aware regeneration". In: *IEEE/ACM Transactions on Networking (TON)* 19.3 (2011), pp. 735–746.
- [80] Sofie Verbrugge et al. "Methodology and input availability parameters for calculating OpEx and CapEx costs for realistic network scenarios". In: *Journal of Optical Networking* 5.6 (2006), pp. 509–520.
- [81] David Larrabeiti et al. "Towards an energy efficient 10 Gb/s optical ethernet: Performance analysis and viability". In: *Optical Switching and Networking* 8.3 (2011), pp. 131–138.
- [82] *The Organisation for Economic Co-operation and Development 23 (OECD), Nomura Research Institute (NRI) Presentation*. [Online] Available: <http://www.oecd.org/sti/ind/45009540.pdf>.
- [83] Xiaowen Dong, Taisir EH El-Gorashi, and Jaafar MH Elmirghani. "On the energy efficiency of physical topology design for IP over WDM networks". In: *Journal of Lightwave Technology* 30.11 (2012), pp. 1694–1705.
- [84] Bin Wu et al. "Joint scheduling and routing for QoS guaranteed packet transmission in energy efficient reconfigurable WDM mesh networks". In: *IEEE Journal on Selected Areas in Communications* 32.8 (2014), pp. 1533–1541.
- [85] Berk Birand et al. "Real-time power control for dynamic optical networks-Algorithms and experimentation". In: *IEEE Journal on Selected Areas in Communications* 32.8 (2014), pp. 1615–1628.
- [86] Yi Zhang et al. "Energy optimization in IP-over-WDM networks". In: *Optical Switching and Networking* 8.3 (2011), pp. 171–180.
- [87] Jingjing Zhang, Mina Taheri Hosseinabadi, and Nirwan Ansari. "Standards-compliant EPON sleep control for energy efficiency: Design and analysis". In: *Journal of Optical Communications and Networking* 5.7 (2013), pp. 677–685.
- [88] Isabella Cerutti, Nicola Sambo, and Piero Castoldi. "Sleeping link selection for energy-efficient GMPLS networks". In: *Journal of Lightwave Technology* 29.15 (2011), pp. 2292–2298.

- [89] Angelo Coiro et al. "Reducing power consumption in wavelength routed networks by selective switch off of optical links". In: *IEEE Journal of Selected Topics in Quantum Electronics* 17.2 (2011), pp. 428–436.
- [90] Ning-Hai Bao et al. "Power-aware provisioning strategy with shared path protection in optical WDM networks". In: *Optical Fiber Technology* 18.2 (2012), pp. 81–87.
- [91] Francesco Musumeci et al. "Energy-efficiency of protected IP-over-WDM networks with sleep-mode devices". In: *Journal of High Speed Networks* 19.1 (2013), pp. 19–32.
- [92] Jun-ichi Kani et al. "Energy-efficient optical access networks: issues and technologies". In: *IEEE Communications Magazine* 51.2 (2013), S22–S26.
- [93] Jun-ichi Kani. "Power saving techniques and mechanisms for optical access networks systems". In: *Journal of Lightwave Technology* 31.4 (2013), pp. 563–570.
- [94] Luca Valcarenghi et al. "Energy efficiency in passive optical networks: where, when, and how?" In: *IEEE Network* 26.6 (2012).
- [95] Edoardo Amaldi, Antonio Capone, and Luca G Gianoli. "Energy-aware IP traffic engineering with shortest path routing". In: *Computer Networks* 57.6 (2013), pp. 1503–1517.
- [96] Fahimeh Alizadeh Moghaddam, Patricia Lago, and Paola Grosso. "Energy-efficient networking solutions in cloud-based environments: A systematic literature review". In: *ACM Computing Surveys (CSUR)* 47.4 (2015), p. 64.
- [97] Bernardetta Addis et al. "Energy management in communication networks: a journey through modelling and optimization glasses". In: *arXiv preprint arXiv:1507.02636* (2015).
- [98] Barbara Kitchenham et al. "Systematic literature reviews in software engineering—a systematic literature review". In: *Information and software technology* 51.1 (2009), pp. 7–15.
- [99] *University of Florida, The Energy Efficient Internet Project*. [Online] <http://www.csee.usf.edu/kchriste/energy/main.html>.
- [100] Greg Goth. "The Net 's Going Green: Multipronged Approach Might Save Costs, Energy-and the Climate". In: *IEEE Internet Computing* 12.1 (2008).

- [101] Ken Christensen, Bruce Nordman, and Rich Brown. "Power management in networked devices". In: *Computer* 37.8 (2004), pp. 91–93.
- [102] Chamara Gunaratne and Ken Christensen. "Ethernet adaptive link rate: System design and performance evaluation". In: *Local Computer Networks, Proceedings 2006 31st IEEE Conference on*. IEEE. 2006, pp. 28–35.
- [103] Chamara Gunaratne et al. "Reducing the energy consumption of Ethernet with adaptive link rate (ALR)". In: *IEEE Transactions on Computers* 57.4 (2008), pp. 448–461.
- [104] Himanshu Anand et al. "Ethernet adaptive link rate (ALR): Analysis of a MAC handshake protocol". In: *Local Computer Networks, Proceedings 2006 31st IEEE Conference on*. IEEE. 2006, pp. 533–534.
- [105] Marina Alonso et al. "Reducing power consumption in interconnection networks by dynamically adjusting link width". In: *Euro-Par 2004 Parallel Processing*. Springer. 2004, pp. 882–890.
- [106] Ken-ichi Sato. "Optical technologies that enable Green networks". In: *Transparent Optical Networks (ICTON), 2010 12th International Conference on*. IEEE. 2010, pp. 1–4.
- [107] Ming Xia et al. "Greening the optical backbone network: A traffic engineering approach". In: *Communications (ICC), 2010 IEEE International Conference on*. IEEE. 2010, pp. 1–5.
- [108] "IEEE Draft Standard for Information technology-Telecommunications and information exchange between systems-Local and metropolitan area networks-Specific requirements Part 3: Carrier Sense Multiple Access with Collision Detection (CSMA/CD) Access Method and Physical Layer Specifications Amendment: Media Access Control parameters, Physical Layers and management parameters for Energy-Efficient Ethernet". In: *IEEE Unapproved Draft Std P802.3az/D2.3, Mar 2010* (2010).
- [109] Pedro Reviriego et al. "Burst transmission for energy-efficient ethernet". In: *IEEE Internet Computing* 14.4 (2010), pp. 50–57.
- [110] Angelos Chatzipapas and Vincenzo Mancuso. "Modelling and real-trace-based evaluation of static and dynamic coalescing for

- energy efficient ethernet". In: *Proceedings of the fourth international conference on Future energy systems*. ACM. 2013, pp. 161–172.
- [111] Sergio Herreria-Alonso et al. "A power saving model for burst transmission in Energy-Efficient Ethernet". In: *IEEE Communications Letters* 15.5 (2011), pp. 584–586.
- [112] Sergio Herreria-Alonso et al. "A GI/G/1 model for 10 Gb/s energy efficient Ethernet links". In: *IEEE Transactions on Communications* 60.11 (2012), pp. 3386–3395.
- [113] Marco Ajmone Marsan et al. "A simple analytical model for energy efficient Ethernet". In: *IEEE Communications Letters* 15.7 (2011), pp. 773–775.
- [114] Pedro Reviriego et al. "Performance evaluation of energy efficient ethernet". In: *IEEE Communications Letters* 13.9 (2009).
- [115] Pedro Reviriego et al. "An initial evaluation of energy efficient ethernet". In: *IEEE Communications Letters* 15.5 (2011), pp. 578–580.
- [116] Raffaele Bolla et al. "A closed-form model for the IEEE 802.3 az network and power performance". In: *IEEE Journal on Selected Areas in Communications* 32.1 (2014), pp. 16–27.
- [117] *EcoInfo 2011. From Windows 95 to Windows 7*.
- [118] *LessWatts 2010. Server power measurements*. [Online]=<https://software.intel.com/sites/default/files/LessWatts.org-whitepaper.pdf>.
- [119] *Advanced Configuration and Power Interface Specification*. [Online]<http://www.acpi.info>
- [120] Raffaele Bolla et al. "An analytical model for designing and controlling new-generation green devices". In: *GLOBECOM Workshops (GC Wkshps), 2010 IEEE*. IEEE. 2010, pp. 1388–1393.
- [121] Rajkumar Buyya et al. "Cloud computing and emerging IT platforms: Vision, hype, and reality for delivering computing as the 5th utility". In: *Future Generation computer systems* 25.6 (2009), pp. 599–616.
- [122] Vincent W Freeh et al. "Exploring the energy-time tradeoff in mpi programs on a power-scalable cluster". In: *Parallel and Distributed Processing Symposium, 2005. Proceedings. 19th IEEE International*. IEEE. 2005, 10–pp.

- [123] Francisco Blanquicet and Ken Christensen. "Managing energy use in a network with a new SNMP power state MIB". In: *Local Computer Networks, 2008. LCN 2008. 33rd IEEE Conference on*. IEEE. 2008, pp. 509–511.
- [124] Kenneth J Christensen and Franklin Bo Gulledge. "Enabling power management for network-attached computers". In: *International Journal of Network Management* 8.2 (1998), pp. 120–130.
- [125] Karthikeyan Sabhanatarajan and Ann Gordon-Ross. "A resource efficient content inspection system for next generation Smart NICs". In: *Computer Design, 2008. ICCD 2008. IEEE International Conference on*. IEEE. 2008, pp. 156–163.
- [126] Yuvraj Agarwal Stefan Savage and Rajesh Gupta. "Sleepserver: A software-only approach for reducing the energy consumption of pcs within enterprise environments". In: *Power (KW)* 100.150 (2010), p. 200.
- [127] Sergiu Nedeveschi et al. "Skilled in the Art of Being Idle: Reducing Energy Waste in Networked Systems." In: *NSDI*. Vol. 9. 2009, pp. 381–394.
- [128] *ProxZzzy TM for sleeping hosts - Ecma International*. [Online] <https://www.ecma-international.org/publications/files/ECMAST/ECMA393.pdf>.
- [129] Raffaele Bolla, Rafiullah Khan, and Matteo Repetto. "Assessing the Potential for Saving Energy by Impersonating Idle Networked Devices". In: *IEEE Journal on Selected Areas in Communications* 34.5 (2016), pp. 1676–1689.
- [130] Susanta Nanda Tzi-cker Chiueh and Stony Brook. "A survey on virtualization technologies". In: *RPE Report* (2005), pp. 1–42.
- [131] *Router Virtualization in Service Providers - Cisco*. Cisco White Paper, 2008.
- [132] Ripal Nathuji and Karsten Schwan. "Virtualpower: coordinated power management in virtualized enterprise systems". In: *ACM SIGOPS Operating Systems Review*. Vol. 41. 6. ACM. 2007, pp. 265–278.
- [133] Anne-Cecile Orgerie, Laurent Lefevre, and Jean-Patrick Gelas. "Demystifying energy consumption in grids and clouds". In: *Green Computing Conference, 2010 International*. IEEE. 2010, pp. 335–342.

- [134] Franco Travostino et al. "Seamless live migration of virtual machines over the MAN/WAN". In: *Future Generation Computer Systems* 22.8 (2006), pp. 901–907.
- [135] Yi Wang et al. "Virtual routers on the move: live router migration as a network-management primitive". In: *ACM SIGCOMM Computer Communication Review*. Vol. 38. 4. ACM. 2008, pp. 231–242.
- [136] Laura Grit et al. "Virtual machine hosting for networked clusters: Building the foundations for" autonomic" orchestration". In: *Virtualization Technology in Distributed Computing, 2006. VTDC 2006. First International Workshop on*. IEEE. 2006, pp. 7–7.
- [137] Christopher Clark et al. "Live migration of virtual machines". In: *Proceedings of the 2nd Conference on Symposium on Networked Systems Design & Implementation-Volume 2*. USENIX Association. 2005, pp. 273–286.
- [138] *End-user requirements, technology specifications and benchmarking methodologies*. [Online] <http://cordis.europa.eu/docs/projects/cnect/4/258454/080D21v10delivered.pdf>.
- [139] Raffaele Bolla et al. "Enabling backbone networks to sleep". In: *IEEE Network* 25.2 (2011).
- [140] Michele Aicardi et al. "A Decentralized Team Routing Strategy among Telecom Operators in an Energy-Aware Network". In: *2015 Proceedings of the Conference on Control and its Applications*. SIAM. 2015, pp. 340–347.
- [141] Raffaele Bolla, Roberto Bruschi, and Paolo Lago. "Energy adaptation in multi-core software routers". In: *Computer Networks* 65 (2014), pp. 111–128.
- [142] Arun Vishwanath et al. "Modeling energy consumption in high-capacity routers and switches". In: *IEEE Journal on Selected Areas in Communications* 32.8 (2014), pp. 1524–1532.
- [143] Rosario G Garroppo et al. "Power-aware routing and network design with bundled links: Solutions and analysis". In: *Journal of Computer Networks and Communications* 2013 (2013).

- [144] Antonio Capone et al. "An optimization framework for the energy management of carrier ethernet networks with multiple spanning trees". In: *Computer Networks* 56.17 (2012), pp. 3666–3681.
- [145] Aruna Prem Bianzino et al. "Grida: Green distributed algorithm for energy-efficient ip backbone networks". In: *Computer Networks* 56.14 (2012), pp. 3219–3232.
- [146] Aruna Prem Bianzino, Luca Chiaraviglio, and Marco Mellia. "Distributed algorithms for green IP networks". In: *Computer Communications Workshops (INFOCOM WKSHPS), 2012 IEEE Conference on*. IEEE. 2012, pp. 121–126.
- [147] Przemysław Jaskóła, Piotr Arabas, and Andrzej Karbowski. "Simultaneous routing and flow rate optimization in energy-aware computer networks". In: *International Journal of Applied Mathematics and Computer Science* 26.1 (2016), pp. 231–243.
- [148] Dimitris Bertsimas and Melvyn Sim. "Robust discrete optimization and network flows". In: *Mathematical programming* 98.1 (2003), pp. 49–71.
- [149] Dimitris Bertsimas and Melvyn Sim. "The price of robustness". In: *Operations research* 52.1 (2004), pp. 35–53.
- [150] David Coudert, Alvinice Kodjo, and Truong Khoa Phan. "Robust energy-aware routing with redundancy elimination". In: *Computers & Operations Research* 64 (2015), pp. 71–85.
- [151] Svetoslav Duhovnikov et al. "Γ-robust network design for mixed-line-rate-planning of optical networks". In: *National Fiber Optic Engineers Conference*. Optical Society of America. 2013, JTh2A–02.
- [152] Bernardetta Addis et al. "A robust optimization approach for energy-aware routing in MPLS networks". In: *Computing, Networking and Communications (ICNC), 2013 International Conference on*. IEEE. 2013, pp. 567–572.
- [153] Luca Chiaraviglio, Marco Mellia, and Fabio Neri. "Minimizing ISP network energy cost: Formulation and solutions". In: *IEEE/ACM Transactions on Networking (TON)* 20.2 (2012), pp. 463–476.

- [154] "IEEE Standard for Local and metropolitan area networks–Link Aggregation". In: *IEEE Std 802.1AX-2008* (2008), pp. 1–163. DOI: [10.1109/IEEESTD.2008.4668665](https://doi.org/10.1109/IEEESTD.2008.4668665).
- [155] Rosario G Garroppo et al. "Mixed integer non-linear programming models for green network design". In: *Computers & operations research* 40.1 (2013), pp. 273–281.
- [156] Gongqi Lin, Sieteng Soh, and Kwan-Wu Chin. "Energy-aware traffic engineering with reliability constraint". In: *Computer Communications* 57 (2015), pp. 115–128.
- [157] Rosario G Garroppo et al. "Energy saving heuristics in backbone networks". In: *Sustainable Internet and ICT for Sustainability (SustainIT), 2012*. IEEE. 2012, pp. 1–9.
- [158] Frederic Francois et al. "Green IGP link weights for energy-efficiency and load-balancing in IP backbone networks". In: *IFIP Networking Conference, 2013*. IEEE. 2013, pp. 1–9.
- [159] Raffaele Bolla et al. "Green network technologies and the art of trading-off". In: *Computer Communications Workshops (INFOCOM WKSHPS), 2011 IEEE Conference on*. IEEE. 2011, pp. 301–306.
- [160] Raffaele Bolla et al. "Green networking with packet processing engines: modeling and optimization". In: *IEEE/ACM Transactions on Networking (TON)* 22.1 (2014), pp. 110–123.
- [161] Nedeljko Vasic et al. "Responsive, Energy-Proportional Networks". In: *Traffic* 90 (2010), p. 100.
- [162] Bernardetta Addis et al. "Energy management through optimized routing and device powering for greener communication networks". In: *IEEE/ACM Transactions on Networking (TON)* 22.1 (2014), pp. 313–325.
- [163] Frederic Francois et al. "Optimizing link sleeping reconfigurations in ISP networks with off-peak time failure protection". In: *IEEE Transactions on Network and service Management* 10.2 (2013), pp. 176–188.
- [164] Joanna Moulrierac and Truong Khoa Phan. "Optimizing IGP link weights for energy-efficiency in multi-period traffic matrices". In: *Computer Communications* 61 (2015), pp. 79–89.

- [165] David L Tennenhouse and David J Wetherall. "Towards an active network architecture". In: *DARPA Active Networks Conference and Exposition, 2002. Proceedings*. IEEE. 2002, pp. 2–15.
- [166] Nick McKeown et al. "OpenFlow: enabling innovation in campus networks". In: *ACM SIGCOMM Computer Communication Review* 38.2 (2008), pp. 69–74.
- [167] Ran Giladi and Niv Yemini. "A programmable, generic forwarding element approach for dynamic network functionality". In: *Proceedings of the 2nd ACM SIGCOMM workshop on Programmable routers for extensible services of tomorrow*. ACM. 2009, pp. 19–24.
- [168] Diego Kreutz et al. "Software-defined networking: A comprehensive survey". In: *Proceedings of the IEEE* 103.1 (2015), pp. 14–76.
- [169] Dimitri Staessens et al. "Software defined networking: Meeting carrier grade requirements". In: *Local & Metropolitan Area Networks (LANMAN), 2011 18th IEEE Workshop on*. IEEE. 2011, pp. 1–6.
- [170] Heller Brandon et al. "ElasticTree: Saving Energy in Data Center Networks". In: *Proceedings of the 7th USENIX Conference on Networked Systems Design and Implementation*. 2010, pp. 249–264.
- [171] Nguyen Huu Thanh et al. "Enabling experiments for energy-efficient data center networks on openflow-based platform". In: *Communications and Electronics (ICCE), 2012 Fourth International Conference on*. IEEE. 2012, pp. 239–244.
- [172] Roberto Bruschi et al. "Green extension of OpenFlow". In: *Teletraffic Congress (ITC), 2014 26th International*. IEEE. 2014, pp. 1–6.
- [173] Raffaele Bolla et al. "Fine-grained energy-efficient consolidation in SDN networks and devices". In: *IEEE Transactions on Network and Service Management* 12.2 (2015), pp. 132–145.
- [174] Frédéric Giroire, Joanna Moulrierac, and Truong Khoa Phan. "Optimizing rule placement in software-defined networks for energy-aware routing". In: *Global Communications Conference (GLOBECOM), 2014 IEEE*. IEEE. 2014, pp. 2523–2529.

- [175] Mehmet Fatih Tuysuz, Zekiye Kubra Ankarali, and Didem Gözüpek. "A Survey on Energy Efficiency in Software Defined Networks". In: *Computer Networks* (2016).
- [176] Roberto Bruschi, Franco Davoli, and Maurizio Mongelli. "Adaptive frequency control of packet processing engines in telecommunication networks". In: *IEEE Communications Letters* 18.7 (2014), pp. 1135–1138.
- [177] Raffaele Bolla et al. "Large-scale validation and benchmarking of a network of power-conservative systems using ETSI's Green Abstraction Layer". In: *Transactions on Emerging Telecommunications Technologies* (2015).
- [178] Ewa Niewiadomska-Szynkiewicz et al. "Dynamic power management in energy-aware computer networks and data intensive computing systems". In: *Future Generation Computer Systems* 37 (2014), pp. 284–296.
- [179] Ewa Niewiadomska-Szynkiewicz et al. "Control system for reducing energy consumption in backbone computer network". In: *Concurrency and Computation: Practice and Experience* 25.12 (2013), pp. 1738–1754.
- [180] Luca Chiaraviglio et al. "Sleep modes effectiveness in backbone networks with limited configurations". In: *Computer Networks* 57.15 (2013), pp. 2931–2948.
- [181] Jean-Philippe Vasseur, Mario Pickavet, and Piet Demeester. *Network recovery: Protection and Restoration of Optical, SONET-SDH, IP, and MPLS*. Elsevier, 2004.
- [182] Zachary I Rauen, Burak Kantarci, and Hussein T Mouftah. "Resiliency versus energy sustainability in optical inter-datacenter networks". In: *Optical Switching and Networking* 23 (2017), pp. 144–155.
- [183] Burak Kantarci and Hussein T Mouftah. "Resilient optical inter-data-center network design". In: *Transparent Optical Networks (ICTON), 2014 16th International Conference on*. IEEE. 2014, pp. 1–4.
- [184] Burak Kantarci and Hussein T Mouftah. "Minimum outage probability provisioning in an energy-efficient cloud backbone". In: *Global Communications Conference (GLOBECOM), 2013 IEEE*. IEEE. 2013, pp. 2879–2884.

- [185] Aniruddha N Udipi, Naveen Muralimanohar, and Rajeev Balasubramonian. "Towards scalable, energy-efficient, bus-based on-chip networks". In: *High Performance Computer Architecture (HPCA), 2010 IEEE 16th International Symposium on*. IEEE. 2010, pp. 1–12.
- [186] David AB Miller. "Device requirements for optical interconnects to silicon chips". In: *Proceedings of the IEEE 97.7 (2009)*, pp. 1166–1185.
- [187] Dongxu Zhang et al. "Optical Switching based Small-world Data Center Network". In: *Computer Communications (2017)*.
- [188] William Maxwell Mellette et al. "A scalable, partially configurable optical switch for data center networks". In: *Journal of Lightwave Technology* 35.2 (2017), pp. 136–144.
- [189] Yabin Ye et al. "Energy-efficient resilient optical networks: Challenges and trade-offs". In: *IEEE Communications Magazine* 53.2 (2015), pp. 144–150.
- [190] Cicek Cavdar et al. "Design of green optical networks with signal quality guarantee". In: *Communications (ICC), 2012 IEEE International Conference on*. IEEE. 2012, pp. 3025–3030.
- [191] Jorge López et al. "Energy-and cost-efficient protection in core networks by a differentiated quality of protection scheme". In: *Optical Communication (ECOC 2013), 39th European Conference and Exhibition on*. IET. 2013, pp. 1–3.
- [192] "ISO/IEC/IEEE International Standard - Information Technology – Telecommunications and information exchange between systems – Local and metropolitan area networks – Common specifications – Part 5: Remote Media Access Control (MAC) bridging". In: *IEEE Std 802.1G, 1998 Edition (ISO/IEC15802-5:1998) (1998)*, pp. 1–237. DOI: [10.1109/IEEESTD.1998.339583](https://doi.org/10.1109/IEEESTD.1998.339583).
- [193] "IEEE Standards for Local and Metropolitan Area Networks—Virtual Bridged Local Area Networks—Amendment 3: Multiple Spanning Trees". In: *IEEE Std 802.1s-2002 (Amendment to IEEE Std 802.1Q, 1998 Edition) (2002)*, pp. 1–211.
- [194] Joris Soeurt and Iwan Hoogendoorn. "Shortest path forwarding using OpenFlow". In: (2012).

- [195] “IEEE Standard for Local and metropolitan area networks—Media Access Control (MAC) Bridges and Virtual Bridged Local Area Networks—Amendment 20: Shortest Path Bridging”. In: *IEEE Std 802.1aq-2012* (2012), pp. 1–340. DOI: [10.1109/IEEESTD.2012.6231597](https://doi.org/10.1109/IEEESTD.2012.6231597).
- [196] David Allan et al. “Shortest path bridging: Efficient control of larger ethernet networks”. In: *IEEE Communications Magazine* 48.10 (2010), pp. 128–135. ISSN: 0163-6804. DOI: [10.1109/MCOM.2010.5594687](https://doi.org/10.1109/MCOM.2010.5594687).
- [197] Rob Coltun. “The OSPF opaque LSA option”. In: (1998).
- [198] Ross W Callon. “Use of OSI IS-IS for routing in TCPIP and dual environments”. In: (1990).
- [199] Hela Mliki, Lamia Chaari, and Lotfi Kamoun. “A comprehensive survey on carrier ethernet congestion management mechanism”. In: *Journal of Network and Computer Applications* 47 (2015), pp. 107–130.
- [200] Peter Ashwood-Smith. “Shortest Path Bridging IEEE 802.1 aq Overview”. In: *Huawei*. Retrieved 11 (2012).
- [201] Kin-Hon Ho and Chi-Chung Cheung. “Green distributed routing protocol for sleep coordination in wired core networks”. In: *Networked Computing (INC), 2010 6th International Conference on*. IEEE. 2010, pp. 1–6.
- [202] Francesca Cuomo et al. “Network pruning for energy saving in the Internet”. In: *Computer Networks* 56.10 (2012), pp. 2355–2367.
- [203] Per Nikolaj D Bukh and Raj Jain. *The art of computer systems performance analysis, techniques for experimental design, measurement, simulation and modeling*. 1992.
- [204] Neil Spring et al. “Measuring ISP topologies with Rocketfuel”. In: *IEEE/ACM Transactions on networking* 12.1 (2004), pp. 2–16.
- [205] Simon Knight et al. “The internet topology zoo”. In: *IEEE Journal on Selected Areas in Communications* 29.9 (2011), pp. 1765–1775.
- [206] Sebastian Orłowski et al. “SNDlib 1.0 survivable network design library”. In: *Networks* 55.3 (2010), pp. 276–286.

- [207] Lorenzo Saino, Cosmin Cocora, and George Pavlou. "A toolchain for simplifying network simulation setup". In: *Proceedings of the 6th International ICST Conference on Simulation Tools and Techniques*. ICST (Institute for Computer Sciences, Social-Informatics and Telecommunications Engineering). 2013, pp. 82–91.
- [208] David Allan, Janos Farkas, and Scott Mansfield. "Intelligent load balancing for shortest path bridging". In: *IEEE Communications Magazine* 50.7 (2012), pp. 163–167.
- [209] "IEEE Standard for Local and metropolitan area networks – Link Aggregation". In: *IEEE Std 802.1AX-2014 (Revision of IEEE Std 802.1AX-2008)* (2014), pp. 1–344. DOI: [10 . 1109 / IEEESTD . 2014 . 7055197](https://doi.org/10.1109/IEEESTD.2014.7055197).
- [210] Bernard Fortz and Mikkel Thorup. "Internet traffic engineering by optimizing OSPF weights". In: *INFOCOM 2000. Nineteenth annual joint conference of the IEEE computer and communications societies. Proceedings. IEEE*. Vol. 2. IEEE. 2000, pp. 519–528.
- [211] Will Fisher, Martin Suchara, and Jennifer Rexford. "Greening backbone networks: reducing energy consumption by shutting off cables in bundled links". In: *Proceedings of the first ACM SIGCOMM workshop on Green networking*. ACM. 2010, pp. 29–34.
- [212] Christian Raack et al. "On cut-based inequalities for capacitated network design polyhedra". In: *Networks* 57.2 (2011), pp. 141–156.
- [213] Thomas Telkamp. "Best Practices for Determining the Traffic Matrix in IP Networks V 2.0". In: NANOG. 2005.
- [214] IBM ILOG. *IBM ILOG CPLEX 12.4 user's Manual*. 2012.
- [215] <https://http://www-01.ibm.com/software/commerce/optimization/cplex-optimizer/index.html>.
- [216] Marshall L Fisher. "The Lagrangian relaxation method for solving integer programming problems". In: *Management science* 27.1 (1981), pp. 1–18.
- [217] Bruno Astuto A Nunes et al. "A survey of software-defined networking: Past, present, and future of programmable networks". In: *IEEE Communications Surveys & Tutorials* 16.3 (2014), pp. 1617–1634.

- [218] Catello Di Martino, Veena Mendiratta, and Marina Thottan. "Resiliency Challenges in Accelerating Carrier-Grade Networks with SDN". In: *Dependable Systems and Networks Workshop, 2016 46th Annual IEEE/IFIP International Conference on*. IEEE. 2016, pp. 242–245.
- [219] O. N. Foundation. *Software-defined networking: the new norm for networks (white paper)*. <https://www.opennetworking.org>. 2012.
- [220] Chinmay Vaishampayan et al. "Demonstrating OpenFlow over a Carrier Ethernet Switch Router (CESR)-a services perspective". In: *Networks and Optical Communications (NOC), 2012 17th European Conference on*. IEEE. 2012, pp. 1–5.
- [221] Sarvesh Bidkar et al. "Field trial of a software defined network (SDN) using carrier ethernet and segment routing in a tier-1 provider". In: *Global Communications Conference (GLOBECOM), 2014 IEEE*. IEEE. 2014, pp. 2166–2172.
- [222] Sugam Agarwal, Murali Kodialam, and TV Lakshman. "Traffic engineering in software defined networks". In: *INFOCOM, 2013 Proceedings IEEE*. IEEE. 2013, pp. 2211–2219.
- [223] Diego Kreutz et al. "Software-defined networking: A comprehensive survey". In: *Proceedings of the IEEE 103.1 (2015)*, pp. 14–76.
- [224] Dimitri Staessens et al. "Software defined networking: Meeting carrier grade requirements". In: *Local & Metropolitan Area Networks (LANMAN), 2011 18th IEEE Workshop on*. IEEE. 2011, pp. 1–6.
- [225] Fahimeh Dabaghi, Zeinab Movahedi, and Rami Langar. "A survey on green routing protocols using sleep-scheduling in wired networks". In: *Journal of Network and Computer Applications 77 (2017)*, pp. 106–122.
- [226] Antonio Cianfrani et al. "An OSPF enhancement for energy saving in IP networks". In: *Computer Communications Workshops (INFOCOM WKSHPS), 2011 IEEE Conference on*. IEEE. 2011, pp. 325–330.

- [227] Francesca Cuomo, Anna Abbagnale, and Sabino Papagna. "ESOL: Energy saving in the Internet based on Occurrence of Links in routing paths". In: *World of Wireless, Mobile and Multimedia Networks (WoWMoM), 2011 IEEE International Symposium on a*. IEEE. 2011, pp. 1–6.
- [228] Hiroshi Matsuura. "Energy-saving routing algorithm using Steiner tree". In: *Integrated Network Management (IM 2013), 2013 IFIP/IEEE International Symposium on*. IEEE. 2013, pp. 378–386.
- [229] Rihab Maaloul, Lamia Chaari, and Bernard Cousin. "Energy-aware forwarding strategy for Metro Ethernet networks". In: *2015 IEEE/ACS 12th International Conference of Computer Systems and Applications (AICCSA)*. 2015, pp. 1–7. DOI: [10.1109/AICCSA.2015.7507246](https://doi.org/10.1109/AICCSA.2015.7507246).
- [230] Frédéric Giroire et al. "Minimizing routing energy consumption: from theoretical to practical results". In: *Green Computing and Communications (GreenCom), 2010 IEEE/ACM Int'l Conference on & Int'l Conference on Cyber, Physical and Social Computing (CPSCom)*. IEEE. 2010, pp. 252–259.
- [231] Rui Wang et al. "Energy-aware routing algorithms in software-defined networks". In: *World of Wireless, Mobile and Multimedia Networks (WoWMoM), 2014 IEEE 15th International Symposium on a*. IEEE. 2014, pp. 1–6.
- [232] Nanxi Kang et al. "Optimizing the one big switch abstraction in software-defined networks". In: *Proceedings of the ninth ACM conference on Emerging networking experiments and technologies*. ACM. 2013, pp. 13–24.
- [233] Yossi Kanizo, David Hay, and Isaac Keslassy. "Palette: Distributing tables in software-defined networks". In: *INFOCOM, 2013 Proceedings IEEE*. IEEE. 2013, pp. 545–549.
- [234] Myriana Rifai et al. "Too many SDN rules? Compress them with MINNIE". In: *2015 IEEE Global Communications Conference (GLOBECOM)*. IEEE. 2015, pp. 1–7.
- [235] Kalapriya Kannan and Subhasis Banerjee. "Compact TCAM: Flow entry compaction in TCAM for power aware SDN". In: *International Conference on Distributed Computing and Networking*. Springer. 2013, pp. 439–444.

- [236] Ravindra K Ahuja, Thomas L Magnanti, and James B Orlin. "Network flows: theory, algorithms, and applications". In: (1993).
- [237] Michael R Gary and David S Johnson. *Computers and Intractability: A Guide to the Theory of NP-completeness*. 1979.
- [238] David S Johnson. "Fast algorithms for bin packing". In: *Journal of Computer and System Sciences* 8.3 (1974), pp. 272–314.
- [239] Binzhou Xia and Zhiyi Tan. "Tighter bounds of the First Fit algorithm for the bin-packing problem". In: *Discrete Applied Mathematics* 158.15 (2010), pp. 1668–1675.
- [240] Edsger W Dijkstra. "A note on two problems in connexion with graphs". In: *Numerische mathematik* 1.1 (1959), pp. 269–271.
- [241] Bojan Mohar et al. "The Laplacian spectrum of graphs". In: *Graph theory, combinatorics, and applications* 2.871-898 (1991), p. 12.
- [242] Miroslav Fiedler. "Algebraic connectivity of graphs". In: *Czechoslovak mathematical journal* 23.2 (1973), pp. 298–305.
- [243] Alfonso Gazo Cervero et al. "Green Wired Networks". In: *Large-Scale Distributed Systems and Energy Efficiency*. John Wiley & Sons, Inc, 2015, pp. 41–80. ISBN: 9781118981122. DOI: [10.1002/9781118981122.ch3](https://doi.org/10.1002/9781118981122.ch3). URL: <http://dx.doi.org/10.1002/9781118981122.ch3>.
- [244] Farabi Iqbal and Fernando A Kuipers. "Disjoint paths in networks". In: *Wiley Encyclopedia of Electrical and Electronics Engineering* (2015).
- [245] Hervé Kerivin and A Ridha Mahjoub. "Design of survivable networks: A survey". In: *Networks* 46.1 (2005), pp. 1–21.
- [246] Meriem Mahjoub et al. "The survivable k-node-connected network design problem: Valid inequalities and Branch-and-Cut". In: *Computers & Industrial Engineering* (2017).
- [247] Karl Menger. "Zur allgemeinen kurventheorie". In: *Fundamenta Mathematicae* 10.1 (1927), pp. 96–115.
- [248] JW Suurballe. "Disjoint paths in a network". In: *Networks* 4.2 (1974), pp. 125–145.
- [249] John W Suurballe and Robert Endre Tarjan. "A quick method for finding shortest pairs of disjoint paths". In: *Networks* 14.2 (1984), pp. 325–336.

-
- [250] Jin Y Yen. "Finding the k shortest loopless paths in a network". In: *management Science* 17.11 (1971), pp. 712–716.
 - [251] Gongqi Lin et al. "Energy aware two disjoint paths routing". In: *Journal of Network and Computer Applications* 43 (2014), pp. 27–41.
 - [252] Rui Wang et al. "Energy aware routing with link disjoint backup paths". In: *Computer Networks* 115 (2017), pp. 42–53.
 - [253] Abdelnour Aldraho and Alexander A Kist. "Enabling energy efficient and resilient networks using dynamic topologies". In: *Sustainable Internet and ICT for Sustainability (SustainIT)*, 2012. IEEE. 2012, pp. 1–8.