



**HAL**  
open science

# Decoding perceptual vowel epenthesis: Experiments & Modelling

Adriana Guevara-Rukoz

► **To cite this version:**

Adriana Guevara-Rukoz. Decoding perceptual vowel epenthesis: Experiments & Modelling. Linguistics. Ecole Normale Supérieure (ENS), 2018. English. NNT : . tel-01948548

**HAL Id: tel-01948548**

**<https://hal.science/tel-01948548>**

Submitted on 7 Dec 2018

**HAL** is a multi-disciplinary open access archive for the deposit and dissemination of scientific research documents, whether they are published or not. The documents may come from teaching and research institutions in France or abroad, or from public or private research centers.

L'archive ouverte pluridisciplinaire **HAL**, est destinée au dépôt et à la diffusion de documents scientifiques de niveau recherche, publiés ou non, émanant des établissements d'enseignement et de recherche français ou étrangers, des laboratoires publics ou privés.

# THÈSE DE DOCTORAT

de l'Université de recherche Paris Sciences et Lettres  
PSL Research University

Préparée à l'École Normale Supérieure

Décodage de l'épenthèse vocalique perceptive: Expériences & Modélisation  
**Decoding perceptual vowel epenthesis: Experiments & Modelling**

**École doctorale n°158**

ÉCOLE DOCTORALE CERVEAU-COGNITION-COMPORTEMENT (ED3C)

**Spécialité** SCIENCES COGNITIVES

Soutenue par  
**Adriana GUEVARA RUKOZ**  
le 19 Octobre 2018

Dirigée par **Emmanuel DUPOUX**  
& **Sharon PEPPERKAMP**



## COMPOSITION DU JURY :

M Christophe PALLIER  
INSERM-CEA  
Cognitive Neuroimaging Unit,  
Président du jury

M Laurent BESACIER  
Université Grenoble Alpes,  
Rapporteur

Mme Sophie DUFOUR  
Aix-Marseille Université,  
Rapporteur

M Paul IVERSON  
University College London,  
Examineur

M Emmanuel DUPOUX  
École Normale Supérieure,  
Directeur

Mme Sharon PEPPERKAMP  
École Normale Supérieure,  
Co-Directrice



# Abstract

Why do people of different linguistic background sometimes perceive the same acoustic signal differently? For instance, when hearing nonnative speech that does not conform to sound structures allowed in their native language, listeners may report hearing vowels that are not acoustically present. This phenomenon, known as perceptual vowel epenthesis, has been attested in various languages such as Japanese, Brazilian Portuguese, Korean, and English. The quality of the epenthesized vowel varies between languages, but also within languages, given certain phonemic environments. How much of this process is guided by information directly accessible in the acoustic signal? What is the contribution of the native phonology? How are these two elements combined when computing the native percept? Two main families of theories have been proposed as explanations: two-step and one-step theories. The former advocate an initial parsing of the phonetic categories, followed by repairs by an abstract grammar (e.g., epenthesis), while one-step proposals posit that all acoustic, phonetic, and phonological factors are integrated simultaneously in a probabilistic manner, in order to find the optimal percept.

In this dissertation, we use a combination of experimental and modelling approaches in order to evaluate whether perceptual vowel epenthesis is a two-step or one-step process. In particular, we investigate this by assessing the role of acoustic details in modulations of epenthetic vowel quality.

In a first part, results from two behavioural experiments show that these modulations are influenced by acoustic cues as well as phonology; however, the former explain most of the variation in epenthetic vowel responses. Additionally, we present a one-step exemplar-based model of perception that is able to reproduce coarticulation effects observed in human data. These results constitute evidence for one-step models of nonnative speech perception.

In a second part, we present an implementation of the one-step proposal in [Wilson and Davidson, 2013], using HMM-GMM (hidden Markov models with Gaussian mixture models) from the field of automatic speech recognition. These models present two separate components determining the acoustic and phonotactic matches between speech and possible transcriptions. We can thus tweak them independently in order to evaluate the relative influence of acoustic/phonetic and phonological factors in perceptual vowel epenthesis. We propose a novel way to simulate with these models the forced choice paradigm used to probe vowel epenthesis in human participants, using constrained language models during the speech decoding process. In a first set of studies, we use this method to test whether various ASR systems with  $n$ -gram phonotactics as their language model better approximate human results than an ASR system with a null (i.e., no phonotactics) language model. Surprisingly, we find that this null model was the best predictor of human performance. In a sec-

---

ond set of studies, we evaluate whether effects traditionally attributed to phonology may be predictable solely from acoustic match. We find that, while promising, our models are only able to partially reproduce some effects observed in results from human experiments. Before attributing the source of these effects to phonology, it is necessary to test ASR systems with more performant acoustic models. We discuss future avenues for using enhanced models, and highlight the advantages of using a hybrid approach with behavioural experiments and computational modelling in order to elucidate the mechanisms underlying nonnative speech perception.

# Résumé

Pourquoi des personnes ayant grandi dans des milieux linguistiques différents ne perçoivent-elles pas toujours un même signal acoustique de la même manière? Par exemple, il arrive que des auditeurs rapportent avoir entendu des voyelles qui n'étaient pas présentes dans l'acoustique de mots non-natifs, lorsque ceux-ci ne se conforment pas aux structures sonores permises dans leur langue. Ce phénomène, connu sous le nom d'épenthèse vocalique perceptive, a été observée dans plusieurs langues telles que le japonais, le portugais brésilien, le coréen, et l'anglais. L'identité de la voyelle épenthétique varie en fonction des langues, mais aussi parmi les langues elles-mêmes, en fonction des environnements phonémiques. A quel point ce processus est-il dirigé par des informations directement accessibles dans le signal acoustique? Quelle est la part de contribution de la phonologie native? Comment sont combinés ces deux éléments lors du calcul de ce qui est perçu par l'auditeur? Deux familles principales de théories ont été proposées en tant qu'explications: les théories à deux étapes, et les théories à une étape. Les premières proposent une analyse initiale des catégories phonétiques, suivie de réparations faites par une grammaire abstraite (e.g., cas d'épenthèse). De leur côté, les théories à une étape proposent que tous les facteurs acoustiques, phonétiques, et phonologiques sont intégrés simultanément de manière probabiliste lors du calcul du percept optimal.

Dans cette thèse, nous combinons des approches expérimentales et de modélisation, afin d'évaluer si l'épenthèse vocalique perceptive est un processus à une ou deux étapes. En particulier, nous examinons ceci en mesurant le rôle des détails acoustiques dans les modulations de l'identité de la voyelle épenthétique.

Dans un premier temps, des résultats d'expériences comportementales nous montrent que ces modulations sont influencées aussi bien par les détails acoustiques que par des processus phonologiques. Cependant, la plupart de la variation de l'identité de la voyelle épenthétique est expliquée par l'acoustique. De plus, nous présentons un modèle de perception à une étape qui utilise des exemplaires; celui-ci est capable de reproduire les effets de la coarticulation qui ont été relevés dans les données expérimentales. Ces résultats constituent de l'évidence en faveur des modèles de perception étrangère à une étape.

Dans un deuxième temps, nous présentons une implémentation du modèle à une étape proposé par [Wilson and Davidson, 2013], en utilisant des modèles HMM-GMM (automates de Markov à états cachés en mélanges gaussiens), issus du milieu de la reconnaissance automatique de la parole (RAP). Ces modèles se composent d'un modèle acoustique et d'un modèle de langage, qui déterminent la correspondance acoustique et phonotactique entre la parole et des transcriptions possibles, respectivement. Il nous est alors possible de les ajuster indépendamment afin d'évaluer leur influence relative dans l'épenthèse vocalique perceptive. Nous proposons une

---

nouvelle manière d'utiliser ces modèles pour simuler des paradigmes de choix forcés utilisés pour étudier l'épenthèse vocalique chez des participants humains, en utilisant des modèles de langage contraints lors du processus de décodage de la parole.

Dans un premier ensemble d'études, nous utilisons cette nouvelle méthode afin de tester si des systèmes de RAP avec des modèles de langage à phonotactique à  $n$ -grammes donnent des résultats plus proches des résultats humains qu'un système de RAP avec un modèle de langage nul (i.e., sans phonotactique). De manière étonnante, les résultats montrent que le système à modèle de langage nul prédit le mieux la performance des participants. Dans un deuxième ensemble d'études, nous évaluons si certains effets traditionnellement attribués à des processus phonologiques peuvent être expliqués qu'à partir de la correspondance acoustique. Bien que les résultats soient prometteurs, nos modèles ne sont capables de reproduire qu'une sous-partie des effets observés chez l'humain. Avant de pouvoir attribuer l'origine de ces effets à des processus phonologiques, il est nécessaire de tester des systèmes de RAP avec des modèles acoustiques plus performants. Nous énumérons des futures pistes de recherche d'utilisation de modèles améliorés, et nous soulignons les avantages de l'utilisation conjointe d'expériences comportementales et modélisations computationnelles afin d'élucider les mécanismes sous-jacents la perception de la parole étrangère.

In general, we look for a new law by the following process:

First we guess it. Then we – now don't laugh, that's really true. Then we compute the consequences of the guess to see what, if this is right, if this law that we guessed is right, to see what it would imply. And then we compare the computation results to nature, or we say compare to experiment or experience, compare it directly with observations to see if it works. If it disagrees with experiment, it's wrong. In that simple statement is the key to science. It doesn't make any difference how beautiful your guess is, it doesn't make any difference how smart you are, who made the guess, or what his name is. If it disagrees with experiment, it's wrong. That's all there is to it.

---

RICHARD FEYNMAN

Los niños han ido con Platero al arroyo de los chopos, y ahora lo traen trotando, entre juegos sin razón y risas desproporcionadas, todo cargado de flores amarillas. Allá abajo les ha llovido —aquella nube fugaz que veló el prado verde con sus hilos de oro y plata, en los que tembló, como en una lira de llanto, el arco iris—. Y sobre la empapada lana del asnucho, las campanillas mojadas gotean todavía. ¡Idilio fresco, alegre, sentimental! ¡Hasta el rebuzno de Platero se hace tierno bajo la dulce carga llovida! De cuando en cuando, vuelve la cabeza y arranca las flores a que su bocota alcanza. Las campanillas, níveas y gualdas, le cuelgan, un momento, entre el blanco babear verdoso y luego se le van a la barrigota cinchada. ¡Quién, como tú, Platero, pudiera comer flores..., y que no le hicieran daño! ¡Tarde equívoca de abril!... Los ojos brillantes y vivos de Platero copian toda la hora de sol y lluvia, en cuyo ocaso, sobre el campo de San Juan, se ve llover, deshilachada, otra nube rosa.

---

Idilio de Abril. Platero y yo.  
JUAN RAMÓN JIMÉNEZ



# Acknowledgements

I've often been told to present my work using first person singular pronoun, but it has always made me feel uncomfortable. Do not interpret this as an attempt to belittle my personal investment in this work, however. The discomfort is due to all of my accomplishments resulting from what seems to be an unconsciously orchestrated team effort from everyone around me. As such, many thanks are in order.

First of all, I would like to thank the members of my thesis committee –Christophe Pallier, Laurent Besacier, Sophie Dufour, Paul Iverson– for reading these many many pages, and for providing thoughtful feedback and discussion before, during, and even after my thesis defence. In particular, thanks to Christophe who, along with David Janiszek, provided external guidance when some experiments were no more than mere ideas brewing.

If doing a PhD is like going through some sort of (exhausting) childhood, then I guess that supervisors are akin to eager parents. As if to reinforce the metaphore, I met Sharon and Emmanuel for the first time on my birthday five years ago. Without hesitation, both immediately decided to adopt a neurobiologist that barely knew anything about cognitive science and, after all these years, it feels weird to think that I am now leaving the nest with a doctoral degree under my wing. Sharon, you were the correct balance between being strict with timing and deadlines (which I very much need!), and being there precisely when morale was low. Cider and homemade pasta have never been so kind. Emmanuel, meetings with you always lasted double the scheduled time, either because ideas just kept coming out of nowhere, or because we'd diverge onto light-hearted conversation (full of puns that you were nice enough not to put down). Some say Elevator A is still going to the ground floor in 6PS. Your co-supervision worked wonders, as you complement each other extremely well. Both of you believed in me since day one, and for that I am very grateful.

If there was such a thing as additional thesis supervisors, I'd readily grant the title to Alex Cristià, who not only excelled as my LSCP tutor, but also patiently dealt with me being a slowpoke when writing papers. Thomas Schatz, you were an amazing inspiration, as well as a quintessential contributor for this thesis. You always found time to explain to me, again and again, what were probably trivial maths to you. There's a frood who really knows where his towel is! Ewan Dunbar, you are so knowledgeable that your last name cleverly articulates (pun intended) how I feel every time we have a discussion. Page Piccinini, the Nicolas Cage of teaching mixed models, your tutorials and comments are the closest thing I have to a Statistical Analysis Bible. Alex Martin, [insert awkward muah joke here]. Sanjeev Khudapur, the few conversations we had critically improved my project.

---

I thank the LSCP for being a welcoming environment, full of impressively wise people. I thank members of the language and modelling teams, of which I was part of. Anne Christophe and Emmanuel Chemla always provided relevant feedback, as did Mathilde Fort, Rory Turnbull, Sho Tsuji, Naomi Havron, Yue Sun, Alexandre Cremers, and Isabelle Dautriche. Bogdan Ludu-chan, Roberta Pinna e Luca Gasparri, grazie per tutti i cioccolati, gli scherzi, e il cibo tra amici (veramente volete che io sia cicciona...). Merci à Michel Dutat, Viréack Ul, Radhia Achheb, Anne-Ca Fiévet, Isabelle Brunet, Xuan-Nga Cao, et Catherine Urban pour leur aide lors des pépins administratifs, logistiques, ou informatiques. En parlant de ça, merci à Roland Thiollière (le gone aux rollers cher rapides dans les traboules), Juan Benjumea (mi vecino come-chigüire), Julien Karadayi (l'artiste fan de Virginia Woolf), et Mathieu Bernard (la source d'insultes en breton) pour leur patience lors de mes mésaventures avec ABXpy et Abkhazia. Good luck to fellow students Milica ドラゴンちゃん Denić, Rahma Chaabouni, Charlotte Hauser, Monica "Kimmy Schmidt" Barbir, Benjamin 合気道家 Rebouillat, Gerda Ana Melnik, Elin Larsen, Camila Scaff, and Matthieu Koroma, as well as my former interns Shi Yu and Paul Andrey.

There was an academic life outside of the lab. 馬塚れい子先生とRIKENの皆様はお世話になりました。 Cheers to my friends from the Johns Hopkins CLSP Jel... WAIT ...inek Summer School. Merci à mes collègues et amis du Palais de la Découverte, surtout Clémence Simonnet et Stéphane Fay. Last but not least, many thanks to NEMO Googlers for welcoming me to their team.

PhD life is all about working hard and playing hard. Merci aux filles du foot (on est vice-championnes !), aux petites hirondelles de l'atelier de théâtre de Lionel Parlier, and to my peers from the (one and only) Thursday Musical Theatre beginners class. I would have gone insane if it hadn't been for my friends supporting me throughout these past three years: In the lab, Julia "Júli" Carbajal (mi hermana mayor académica), Mora "Morita" Maldonado (como dices, mi compañera en aventuras burocráticas), et Neil Zeghidour (a supreme ape). Thanks to my muggle friends for being patient with my thesis-induced lack of energy: Hayate "Yaya" Misery (ton nom est le contraire de ce qu'est le temps à tes côtés !), Elodie Garcia (Rosendaaaa, subeee), José Daniel "Yodo" Contreras (ashuashua), Coline "Frau Hügel" Turon et Rémi Molina (the kindest gluten frees to you two), Noémie Ekstein et Félix Yan (et la petite Octavie !), Charlotte "Chachi" Bardet (Charmander, really), Louise Tolton (dancing queeeen), and Michael Kook Hyun Lim (what what). Gracias infinitas, Paula Izquierdo. Gracias a los Rukoz parisinos (tía Marta y tío Fran, Astrid y Johnny, Yumi y Camilo), y al padrino 2.0 Héctor Puyosa.

Last but not least, I'd like to thank my family for their unconditional support. Isabelle Aliart, Rémi Dubois, et Nicolas Dubois, merci pour votre soutien et votre gentillesse. Gracias a mi papá Carlos Guevara, por soportar que me metiera en estudios que casi le parecieron eternos, apoyándome fuera cual fuera mi camino. Gracias a mi mamá Yanira Rukoz, que aunque ya no esté a mi lado fue uno de mis motores principales durante el lío masoquista que fueron los estudios. Gracias a los dos por inculcarme el valor y la importancia del conocimiento. Gracias a mi abuela Rosa la Rosa, por los besitos (los de verdad y los de coco). Thanks to my sister Marta Guevara de Rechsteiner and my brodercito Roman Rechsteiner for their willingness to bear with my PhD shenanigans, and for taking care of our Honney. Pour finir, un million de mercis à Vincent Dubois, sans qui cette tour se serait écroulée depuis longtemps.

# Publications

## Journal articles

- **Guevara-Rukoz, A.**, Cristia, A., Ludusan, B., Thiollière, R., Martin, A., Mazuka, R., & Dupoux, E. (2018).  
Are words easier to learn from infant- than adult-directed speech? A quantitative corpus-based investigation.  
Cognitive Science. <https://doi.org/10.1111/cogs.12616>
- Fort, M., Lammertink, I., Peperkamp, S., **Guevara-Rukoz, A.**, Fikkert, P., & Tsuji, S. (2018).  
SymBouki: a meta-analysis on the emergence of sound symbolism in early language acquisition.  
Developmental Science. <https://doi.org/10.1111/desc.12659>
- **Guevara-Rukoz, A.**, Lin, I., Morii, M., Minagawa, Y., Dupoux, E., & Peperkamp, S. (2017).  
Which epenthetic vowel? Phonetic categories versus acoustic detail in perceptual vowel epenthesis.  
The Journal of the Acoustical Society of America, 142(2), EL211-EL217.

## Conference proceedings

- **Guevara-Rukoz, A.**, Parlato-Oliveira, E., Yu, S., Hirose, Y., Peperkamp, S., and Dupoux, E. (2017).  
Predicting epenthetic vowel quality from acoustics.  
Proceedings of Interspeech, 596-600.

# Contents

<b>1</b>	<b>Introduction</b>	<b>1</b>
1.1	Nonnative speech misperceptions . . . . .	2
1.2	Perceptual vowel epenthesis . . . . .	3
1.3	Processing steps in perceptual vowel epenthesis . . . . .	4
1.4	Modelling approach: An example . . . . .	6
1.5	Outline . . . . .	7
<b>2</b>	<b>Role of acoustic details in the choice of epenthetic vowel quality</b>	<b>10</b>
2.1	Introduction . . . . .	11
2.1.1	One-step vs two-step theories . . . . .	11
2.1.2	Role of acoustics . . . . .	12
2.1.3	Chapter preview . . . . .	12
2.2	Which epenthetic vowel? Phonetic categories versus acoustic detail in perceptual vowel epenthesis . . . . .	14
2.2.1	Introduction . . . . .	14
2.2.2	Methods . . . . .	15
2.2.3	Results . . . . .	16
2.2.4	Discussion and conclusion . . . . .	19
2.2.5	Annexes . . . . .	21
2.3	Predicting epenthetic vowel quality from acoustics . . . . .	27
2.3.1	Introduction . . . . .	28
2.3.2	Perception experiment . . . . .	28
2.3.3	Acoustic analyses . . . . .	30
2.3.4	Production-based exemplar model . . . . .	33
2.3.5	Discussion . . . . .	36
2.4	Predicting epenthetic vowel quality from acoustics II: It's about time!	37
2.4.1	Introduction . . . . .	37
2.4.2	Methods . . . . .	38
2.4.3	Results . . . . .	41
2.4.4	Discussion . . . . .	45
2.5	General Discussion . . . . .	47
<b>3</b>	<b>Modelling speech perception with ASR systems</b>	<b>49</b>
3.1	Introduction . . . . .	51
3.1.1	Implementation of a one-step model . . . . .	51
3.1.2	Is the acoustic match sufficient? . . . . .	52
3.1.3	Chapter preview . . . . .	53
3.2	Anatomy of a HMM-based speech recogniser . . . . .	54

3.2.1	Corpora . . . . .	54
3.2.2	Features . . . . .	56
3.2.3	Acoustic models . . . . .	58
3.2.4	Lexicon & language models . . . . .	60
3.2.5	Lattices . . . . .	61
3.2.6	Scoring: Assessing native performance . . . . .	61
3.3	Investigating the role of surface phonotactics . . . . .	64
3.3.1	Introduction . . . . .	64
3.3.2	Experiment 1 . . . . .	65
3.3.3	Experiment 2 . . . . .	74
3.3.4	Discussion . . . . .	79
3.3.5	Appendix . . . . .	81
3.3.6	Bigram (phone-level) language model . . . . .	84
3.3.7	Online and Retro language models . . . . .	85
3.4	Medley of epenthetic variations: Due to phonological processes or embedded in the phonetics? . . . . .	87
3.4.1	Introduction . . . . .	87
3.4.2	Experiment 3: Variations due to native phonology . . . . .	89
3.4.3	Experiment 4: Variations due to syllabic structure . . . . .	94
3.4.4	Discussion . . . . .	102
3.5	General Discussion . . . . .	105
3.5.1	Language model contributions . . . . .	105
3.5.2	Model adequacy . . . . .	105
3.5.3	Predictive power of the acoustic model . . . . .	106
3.5.4	Model enhancements . . . . .	107
3.5.5	Data enhancements . . . . .	108
3.5.6	Conclusion . . . . .	109
<b>4</b>	<b>Conclusion</b>	<b>110</b>
<b>A</b>	<b>Example of research based on computational modelling</b>	<b>120</b>
A.1	Are words easier to learn from infant- than adult-directed speech? A quantitative corpus-based investigation . . . . .	121
A.1.1	Introduction . . . . .	121
A.1.2	Experiment 1: Acoustic distribution of word tokens . . . . .	130
A.1.3	Experiment 2: Phonological density . . . . .	134
A.1.4	Experiment 3: Net discriminability . . . . .	138
A.1.5	General discussion . . . . .	141

# Chapter 1

## Introduction

Luke: Every time you say ‘Luke’, I think you’re saying ‘look’.  
Gloria: I don’t hear the difference.  
Luke: It’s not that hard; one is my name.  
Gloria: Juan is not your name!

---

MODERN FAMILY

Even after spending years learning a foreign language and becoming proficient at speaking it, very often, a dead giveaway that we are indeed not communicating in our own native language is the presence of a foreign accent (e.g., [Flege et al., 1995a, Munro et al., 1996]). For instance, Japanese speakers have difficulties producing the American English consonants /ɹ/ and /l/, since their native language does not have such a contrast of liquid consonant [Flege et al., 1995b]. This results in their productions of the words “right” and “light” being phonetically similar. This merger can also be attested in Japanese loanwords of English origin: the source word “lion” has been borrowed as /raion/, while “sale” became /seru/. In this second loanword there is also evidence of an extra /u/ vowel that was not present in the source word. This phenomenon of inserting a vowel to a borrowed loanword is known as vowel epenthesis. It often occurs when the borrowed word does not respect the phonotactics (i.e., legal sound combinations) of the borrowing language (e.g., illegal consonant clusters, illegal syllabification), as in the following examples:

- English “strike” /stɹaɪk/ → Japanese /sutoraiku/
- French “baguette” /bagnet/ → Japanese /bagnetɔ/
- English “snob” /snɒb/ → Spanish /esnob/

Nonnative words are imported to the borrowing language in a diachronic process involving word transmission amongst multiple individuals and possibly using various methods of transmission (e.g., through written materials, orally, etc). Additionally, adaptations can be influenced by orthography, when this is available [Daland et al., 2015, Vendelin and Peperkamp, 2006]. However, it is hypothesized that the modifications that we observe in loanwords are not exclusively due to incorrect productions of the nonnative words; both the modifications observed in loanwords and those observed in production are hypothesized to be at least in part due to incorrect *perception* of the nonnative speech [Peperkamp and Dupoux, 2003, Peperkamp,

2005, Peperkamp et al., 2008, Wilson and Davidson, 2013, Wilson et al., 2014]. How could individuals with different language experiences interpret the same acoustic signal differently?

## 1.1 Nonnative speech misperceptions

We can study nonnative misperceptions by using several types of experimental paradigms: transcription tasks, classification tasks, discrimination tasks.

In transcription tasks, participants are presented with an auditory stimulus and they are asked to provide a written transcription of what they perceived, either using their native language orthography, or by using a task-specific learned phonetic alphabet (e.g., transcription of items with /ɪ/ and /l/ by Japanese participants in [Best and Strange, 1992]). The output of these tasks is difficult to analyse due to the high variability in the responses.

A way to limit these is by turning to classification tasks, where participants are presented with an auditory stimulus and they are asked to assign it to one of multiple given category, therefore limiting the number of possible transcriptions. A particularly popular variation of this subset of paradigms is the identification task, where participants are asked to identify a specific segment within the stimulus. This task is also known as the  $n$ -forced choice task (where  $n$  is the number of possible choices available to the participant. An example of use is [Dupoux et al., 1999], where Japanese listeners were asked to say whether they heard a /u/ vowel between two consonants in items such as /ebzo/.

Finally, in discrimination tasks participants hear two or more stimuli. They are asked to judge which items belong to the same category. An example is the ABX discrimination task, where two items of different categories (A and B) are presented, followed by a third item that belongs to either A or B. Contrasts that are difficult to perceive result in high error rates. An example is how [Durvasula and Kahng, 2015] tested epenthesis by Korean listeners in an ABX task where A was an item with no medial vowel (e.g., /et<sup>h</sup>ma/, B an item with a medial vowel /et<sup>h</sup>ima/, and X an item of either category.

Nonnative misperceptions can be classified in three main categories:

- Segmental misperceptions: Difficulties perceiving the difference between two nonnative contrasting phonemes. E.g., Japanese listeners' difficulty perceiving the difference between American English /ɪ/ and /l/ [Goto, 1971, Miyawaki et al., 1975].
- Suprasegmental misperceptions: Difficulties perceiving the difference between two nonnative contrasting suprasegments such as lexical stress, lexical tone, pitch accent. E.g., French listeners' difficulty perceiving the difference between Spanish words such as "líquido" /'likido/ (*liquid*), "liquido" /li'kido/ (*I liquidate*), "liquidó" /liki'do/ (*s/he liquidated*) [Dupoux et al., 1997, Dupoux et al., 2008].
- Phonotactic repairs: Addition (i.e., epenthesis), modification (i.e., adaptation), or deletion (i.e., elipsis) of segments as a strategy to "fix" nonnative

input which does not conform to native phonotactics. E.g., Word-initial /e/-epenthesis by Spanish speakers in words beginning with an /s/ as part of a complex cluster as in “special” [Hallé et al., 2014]. Also: Perception of illegal /tl/ clusters as /kl/ by French listeners [Hallé and Best, 2007].

Interestingly, while they can be minimised with training [Logan et al., 1991, Lively et al., 1993, Wang and Munro, 2004, Iverson et al., 2005, Ylinen et al., 2010, Wong, 2012], the effects of native phonology on nonnative speech perception are long-lasting [Takagi and Mann, 1995, Dupoux et al., 2008] and may even be apparent in highly proficient bilinguals [Dupoux et al., 2010].

## 1.2 Perceptual vowel epenthesis

In this thesis we will focus on a subset of misperceptions resulting from phonotactic repair: perceptual vowel epenthesis. As previously mentioned, we say that listeners experience this phenomenon when they report hearing vowels that are not initially present in the nonnative speech. In cases that will be studied in this work, this seemingly happens as a way to break phonotactically illegal clusters. For instance, in Japanese most consonant clusters, such as /bz/, are phonotactically illegal. When hearing nonwords containing these clusters, such as /ebzo/, Japanese listeners may report hearing an epenthetic /u/<sup>1</sup> within the cluster, yielding /ebuzo/ as the percept [Dupoux et al., 1999]. Epenthesis of /u/ by Japanese listeners is not only evident in their behaviour but also in their brain responses; they have difficulties differentiating the clusters produced by a French speaker from their epenthesized counterparts (e.g., /ebzo/ vs. /ebuzo/) while also showing different event-related potentials compared to native French speakers. The fact that Japanese listeners fail to show sign of MMN (mismatch negativity) in the EEG signal attests that the process of epenthesis occurs early in the process of perception [Dehaene-Lambertz et al., 2000]. Importantly, experimental data also suggests that epenthesis is a pre-lexical process happening early in speech perception [Dupoux et al., 2001].

Perceptual vowel epenthesis has also been attested in languages other than Japanese [Dupoux et al., 1999, Dehaene-Lambertz et al., 2000, Dupoux et al., 2001, Monahan et al., 2009, Dupoux et al., 2011, Mattingley et al., 2015]; indeed, it has also been studied in Korean [Kabak and Idsardi, 2007, Shin and Iverson, 2011, de Jong and Park, 2012, Durvasula and Kahng, 2015, Durvasula and Kahng, 2016], Brazilian Portuguese [Dupoux et al., 2011], Spanish [Hallé et al., 2014], English [Berent et al., 2007, Zhao and Berent, 2018], and Mandarin Chinese [Durvasula et al., 2018]. The quality of the epenthetic vowel depends not only in the language (e.g., [u] in Japanese, [i] in Brazilian Portuguese [Dupoux et al., 2011]), but also in the phonemic environment (e.g., /i/ may be more readily epenthesized in clusters with palatalised consonants).

In order to estimate phonemic environments in which a listener might experience epenthesis, as well as eventual variations of epenthetic vowel quality, we may turn to loanwords. Since patterns of epenthesis observed in loanword adaptations are, at least in part, due to how the native perceptual system processes the nonnative source

<sup>1</sup>A more accurate phonetic transcription of the unrounded high back vowel used in Japanese is [ɯ] but, following previous work, the phonological notation /u/ will be used in the remainder of the thesis.



word, loanwords can be thought of as fossils from which we can extract hypotheses about online misperceptions. Of course, as we mentioned above loanwords are processed through more than one individual perceptual filter, and can be influenced by orthography, for instance. So, continuing with the fossil metaphore, the online percept is akin to the mosquito trapped in amber after accidentally landing on tree sap; preserved in time but possibly not in mint condition. Large corpora of loanwords exist, which allows us to examine epenthetic vowel patterns: Which phonemic combination trigger vowel epenthesis? Is there a vowel that is predominantly inserted? If so, are other vowels epenthesized in other phonemic environments? Similar to how the paleontologist posits theories about the fauna in ancient times by analysing fossils, the psycholinguist is able to posit theories about perceptual vowel epenthesis from epenthesis in loanwords, and test them empirically.

### 1.3 Processing steps in perceptual vowel epenthesis

Concerning the process of vowel epenthesis in perception, we can identify two types of proposed pipelines that differ in the amount of processing steps that the nonnative input is subjected to during perception: these are two-step and one-step theories of nonnative speech perception, illustrated in Figure 1.1. While their names are somewhat transparent, we will now explain in more detail the differences between the two types of proposals.

Two-step theories of nonnative speech perception divide the perception process in two stages. According to these proposals, the quality of the epenthetic vowel is determined by a language-specific grammar after an initial parsing of the nonnative input. For [Berent et al., 2007], the identity of the segments present in the nonnative input is retrieved in an initial step, yielding a *phonetic form*. The native grammar then assesses the phonotactic legality of this phonetic form in a second step. If a phonotactic violation is found, the grammar, which combines both language-specific and universal components, repairs the phonetic form by inserting a vowel. The output of this final step is the *phonological representation*. Another proposal, that of [Monahan et al., 2009], also consists in two steps, but with some differences. During the first step the identity of the segments in the input is retrieved and segments are grouped into syllables, following native phonotactics. Some syllables will contain indeterminate segments (e.g., /ebzo/ will have been parsed as /e.bV.zo/). In a second step, the quality of the indeterminate segments, in this case the epenthetic vowel, is chosen amongst vowels that are of low sonority<sup>2</sup> and can undergo devoicing<sup>3</sup>. The quality of the vowel might not be determined if an optimal match is not found. The two proposals that we have summarised share the fact that the categorisation of the segments that are not the epenthetic vowel occurs in a first step and it is not modified during the second step, where the identity of the epenthetic vowel is determined.

---

<sup>2</sup>Phonemes that are lower in the sonority scale are less audible than higher ranked phonemes. Due to how the tongue is positioned close to the mouth roof during their articulation, high vowels (and glides) are the least sonorous vowels in a vowel inventory.

<sup>3</sup>In Japanese, high vowels /i/ and /u/ can be devoiced in certain contexts, such as between two voiceless segments [Han, 1962, Vance, 1987, Tsuchida, 2001].

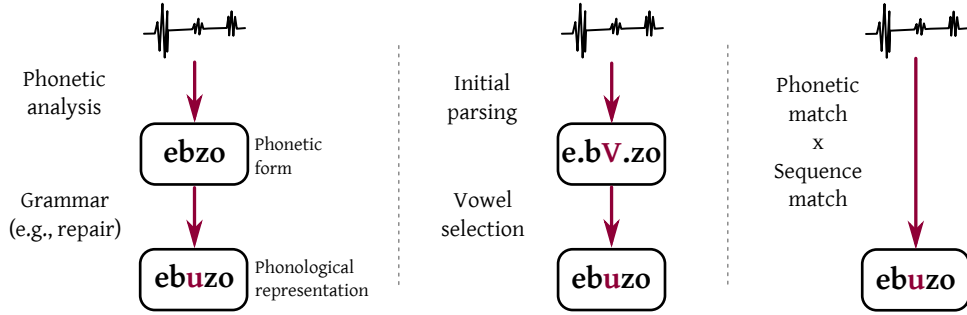

Figure 1.1: *Processing of the nonnative stimulus /ebzo/ by Japanese listeners, according to two-step and one-step proposals for perceptual vowel epenthesis. From left to right: two-step proposal from [Berent et al., 2007], two-step proposal from [Monahan et al., 2009], one-step proposal from [Dupoux et al., 2011, de Jong and Park, 2012, Wilson and Davidson, 2013]*

In contrast, by advancing one-step proposals, authors such as [Dupoux et al., 2011, de Jong and Park, 2012] and [Wilson and Davidson, 2013] argue that the identity of the epenthetic vowel is determined in the process of parsing the input, simultaneously to the categorisation of all other segments. The phonotactic legality of the input is therefore assessed at the same time as the categorisation happens. Notably, the input is not processed as a linear sequence of sounds; syllabic structure is taken into account during the parsing process [Kabak and Idsardi, 2007].

[Wilson and Davidson, 2013] qualify the process as a process of “reverse inference” within a Bayesian framework, where the perceptual system computes  $P(w|X)$  the posterior probability of candidate percepts  $w$  given the auditory input  $X$ . These are estimated, for each candidate percept, from the product of  $P(X|w)$  the likelihood of the acoustics given the percept and  $P(w)$  the prior probability of the percept, defined as its phonotactic acceptability. Mathematically, this can be formulated as in equation 3.1. Then, in a maximum *a posteriori* (MAP) estimation scenario, the final percept  $\hat{w}$  corresponds to the percept with the highest posterior probability, as shown in equation 3.2. Alternatively, the final percept may be estimated by weighted sampling, where weights are defined by the posterior probabilities.

$$P(w|X) \propto P(X|w) \cdot P(w) \quad (1.1)$$

$$\hat{w} = \underset{w}{\operatorname{arg\,max}} \{P(X|w) \cdot P(w)\} \quad (1.2)$$

In other words, for one-step models, parsing becomes an optimisation problem where the optimal output is the one maximising the acoustic match to the input and the likelihood of the phonemic sequence in the native language. [Durvasula and Kahng, 2015] add to the aforementioned proposals by suggesting that listeners are decoding nonnative speech through a process of reverse inference that not only optimises the output according to phonetic representations and surface phonotactics, but also according to native phonological alternations (i.e., mappings between underlying and surface representations). What this means is that listeners will also try to infer an underlying phoneme based on the possible surface realisations attached to this phoneme in their native language. For instance, in Korean, /s/ surfaces as

[ʃ] when in front of the vowel /i/. When hearing a cluster such as [ʃm], listeners may epenthesize [i] after interpreting [ʃ] as the allophone of /s/ in front of that vowel. Thus, the extended proposal by [Durvasula and Kahng, 2015] integrates the involvement of deeper phonological rules/constraints during the perception process.

## 1.4 Modelling approach: An example

... But why make models?

---

*Derek Zoolander, probably.*

In this thesis we will evaluate computational implementations of one-step theories of nonnative speech perception. Notably, we will investigate models from the field of automatic speech recognition (ASR) which are a direct implementation of the Bayesian model shown in equation 3.1<sup>4</sup>. While only the one-step family of theories will be evaluated in this work, we encourage further research to be done with similar methodologies in order to investigate all of the various co-existing proposals.

Indeed, using computational models in order to investigate competing theories is beneficial in several ways. Firstly, the need to translate the theories into model implementations forces model ideators to provide a mathematically and/or algorithmically well-defined model. This is in contrast with more vague and ambiguous verbally defined theories that leave more space to reader interpretations. Having more rigorous model definitions also allows us to better understand competing theories (what is the exact nature of the input? which grammar constraints are applied and how? ...), meaning that it is easier to compare proposals and see where they differ significantly or not.

Secondly, obtaining a computational implementation of a theory means that it is then possible to derive predictions from the models in question. It is then possible to qualitatively and quantitatively examine these predictions, and compare them to what is observed in behavioural data.

For the skeptical reader, possibly left frowning after reading the above statements, we will briefly develop an example of how modelling can allow us to test theories in ways that may be unfeasible otherwise. The specific example, the details of which can be found in Appendix A, is from the literature of developmental psycholinguistics, concerning how acoustic differences in Infant-Directed Speech might or might not promote language learning for infants, compared to Adult-Directed Speech (ADS). Indeed, IDS presents very salient prosodic, lexical, syntactic, and temporal properties (see [Soderstrom, 2007, Golinkoff et al., 2015] for a review).

The hypothesis (which we refer to as the Hyper Learnability Hypothesis; HLH) was advanced by [Kuhl et al., 1997]. The authors in this study analysed the acoustics of the vowels located at the extremities of the vowel triangle (i.e., /i, a, u/). Analyses showed an increase of the vowel triangle area (in formant space) for IDS compared to ADS. The authors interpreted this as an enhancement of phonemic contrasts, which might help infants identify and acquire phonemic categories more easily. The expansion of the vowel triangle in IDS was also attested in other studies [Andruski

---

<sup>4</sup>The equivalent of a weighted sampling procedure was preferred over MAP estimation for percept selection, since participant responses in previous experimental work on epenthesis tended to show variation and were not deterministic.

et al., 1999, Bernstein Ratner, 1984, Burnham et al., 2002, Cristia and Seidl, 2014, Liu et al., 2003, McMurray et al., 2013, Uther et al., 2007], but not systematically across the vowel inventory [Cristia and Seidl, 2014] and, importantly, IDS presented increased within-category acoustic variability [McMurray et al., 2013, Cristia and Seidl, 2014, Kirchoff and Schimmel, 2005]. With increased vowel separation and increased within-category variability being opposite effects, we wondered whether the discriminability of IDS phonemes was higher than for ADS vowels or not.

Using a computational model of the ABX discrimination task<sup>5</sup>, [Martin et al., 2015] assessed the discriminability of Japanese phonemes in a large corpus of Japanese IDS and ADS. Against expectations, phonemes in IDS were on average less discriminable than in ADS. In the Appendix A, we investigated whether the acoustic and phonological advantage of IDS may surface at level of words. However, we found that words in IDS were also less discriminable than in ADS on average.

In this set of studies, the modelling approach allowed us to quantitatively and qualitatively test the HLH, in a large scale (several millions of ABX experimental trials simulated), with systematic comparisons of all phonemes/words in the language, without assuming a specific learning algorithm, and using a richer representation of the acoustics based on a model of how speech is processed by the auditory system (as opposed to formant values in other studies). Importantly, modelling allowed us to evaluate the interaction between effects advancing opposing hypotheses, and showed us the resulting predictions in a computationally understandable format. A study of this magnitude would have not been possible with traditional experimental techniques, which makes modelling a welcomed addition to the experimental evidence gathered for and against the HLH.

In an analogous manner, we will be using computational models of nonnative speech perception in this thesis, in order to investigate the underlying mechanisms of perceptual vowel epenthesis in ways that may not be possible when only using behavioural experiments.

## 1.5 Outline

Why do people of different linguistic background sometimes perceive the same acoustic signal differently? In particular, how is this nonnative acoustic signal processed to become what the listener ends up perceiving?. How much of this process is guided by the information directly accessible in the acoustic signal? What is the contribution of the native phonology? How are these two elements combined when computing the native percept?

In order to answer these questions, various mechanisms underlying nonnative speech perception have been put forward; however, many lack formal definition that allows them to be tested empirically. In this dissertation, we select one of the proposals advanced by the psycholinguistics literature. Namely, we investigate one-step models of nonnative speech perception [Dupoux et al., 2011, de Jong and Park, 2012, Wilson and Davidson, 2013, Durvasula and Kahng, 2015], which postu-

---

<sup>5</sup>In this task, the discriminability of two categories A and B is assessed by setting triplets of tokens  $a$ ,  $b$ , and  $x$ . The first two belong to categories A, B, respectively; the third token belongs to one of the two categories. The algorithm computes the acoustic distance between  $a$  and  $x$ , and  $b$  and  $x$ , and classifies  $x$  to the category of the closest token. The more discriminable the two categories in question, the higher the classification accuracy of the algorithm.

late that acoustic match and sequence match between the nonnative input and the native percept are optimised, simultaneously. To do so, we test a proof-of-concept computational implementation of the model as defined by [Wilson and Davidson, 2013].

We present various methodologies for qualitatively and quantitatively evaluating the reverse inference proposal. We do this by focusing on the phenomenon of perceptual vowel epenthesis, namely the phenomenon by which listeners may hallucinate vowels when hearing nonnative speech that does not conform to the structural constraints of their native language. Of interest are both the rates of vowel epenthesis (i.e., how often do participants experience this?) and variations of epenthetic vowel quality (i.e., which vowel is epenthesized?).

Following on the experimental approach recommended by [Vendelin and Peperkamp, 2006], the data arising from the computational models is compared to data from psycholinguistics experiments. In these, nonnative speech perception is evaluated using psycholinguistics paradigms which tap onto online (i.e., real-time, individual) perception of nonwords, in order to reduce the influence of confounds such as orthography and semantics. In other words, we subject the proposed computational models to tasks analogous to those completed by human participants and analyse their behaviour both quantitatively and qualitatively. Do we find acoustics-based mechanisms to be necessary to predict perceptual vowel epenthesis in human listeners? If so, do they suffice?

This dissertation is divided in two main sections. First, in Chapter 2, we use an identification paradigm to investigate the influence of acoustic details on modulations of epenthetic vowel quality. We discuss the implications of our results in the context of the opposition between the two-step and one-step theories of nonnative speech perception. We find that acoustic details modulate epenthetic vowel quality, results that are in agreement with one-step theories. Building on these results, we present a basic model of speech perception exclusively reliant on acoustic matching between minimal pairs of nonnative and native speech exemplars. Namely, we build non-parametric exemplar-based models of perception. Relative to human results, we find the models to be able to reproduce some qualitative effects linked to the role of coarticulation on epenthetic vowel quality; however, the models are limited by their inability to output responses other than those derived from their specific inventory of exemplars.

In Chapter 3 we turn to a parametric implementation of a one-step proposal, using tools from the field of automatic speech recognition (ASR). We present an HMM-GMM speech recognizer composed of independent acoustic and language (i.e., phonotactic) models. These can be tweaked as necessary to test hypotheses about the underlying mechanisms of nonnative speech perception. We propose a novel methodology to test ASR systems which use language models represented by Weighted Finite State Transducers (W-FST) in identification tasks analogous to those used to test human participants. Using this method, we test the predictive power of the acoustic model on patterns of vowel epenthesis. We find that the acoustic model alone better predicts human results than when accompanied by language models, at least when the latter are  $n$ -gram based phonotactic models with phones as the unit  $n$ . We further test whether some effects traditionally attributed to phonology may actually be predicted from acoustics alone. Following promising but not perfect results, we propose future research paths for enhancing the methodology

and to further investigate the mechanisms underlying nonnative speech perception.

# Chapter 2

## Role of acoustic details in the choice of epenthetic vowel quality

<b>2.1</b>	<b>Introduction</b>	<b>11</b>
2.1.1	One-step vs two-step theories	11
2.1.2	Role of acoustics	12
2.1.3	Chapter preview	12
<b>2.2</b>	<b>Which epenthetic vowel? Phonetic categories versus acoustic detail in perceptual vowel epenthesis</b>	<b>14</b>
2.2.1	Introduction	14
2.2.2	Methods	15
2.2.3	Results	16
2.2.4	Discussion and conclusion	19
2.2.5	Annexes	21
<b>2.3</b>	<b>Predicting epenthetic vowel quality from acoustics</b>	<b>27</b>
2.3.1	Introduction	28
2.3.2	Perception experiment	28
2.3.3	Acoustic analyses	30
2.3.4	Production-based exemplar model	33
2.3.5	Discussion	36
<b>2.4</b>	<b>Predicting epenthetic vowel quality from acoustics II: It's about time!</b>	<b>37</b>
2.4.1	Introduction	37
2.4.2	Methods	38
2.4.3	Results	41
2.4.4	Discussion	45
<b>2.5</b>	<b>General Discussion</b>	<b>47</b>

## 2.1 Introduction

As presented in the Introduction, work on loanword adaptation and online speech perception shows that listeners epenthesize or delete vowels from nonnative input when it does not conform to native non-native phonotactics. While this statement seems to be generally accepted, the mechanisms underlying these phenomena are subject to more debate. In this chapter we will investigate the mechanisms underlying variations of epenthetic vowel quality.

### 2.1.1 One-step vs two-step theories

We saw that theories such as those by [Berent et al., 2007, Monahan et al., 2009] view perceptual vowel epenthesis as a two-step process. According to these proposals, the quality of the epenthetic vowel is determined by a language-specific grammar after an initial parsing of the nonnative input. In contrast, one-step theories such as those proposed by [Dupoux et al., 2011, de Jong and Park, 2012, Wilson and Davidson, 2013, Durvasula and Kahng, 2015] argue that parsing is an optimisation problem where the optimal output maximises the acoustic/phonetic match to the input and the likelihood of the phonemic sequence in the native language.

How can we confront and test these one-step and two-step proposals? For this, we can dissect the phenomenon of perceptual vowel epenthesis and split it into two subproblems:

1. When does epenthesis occur?
2. What vowel is epenthesized?

Concerning the first subproblem, neither one-step theories nor two-step theories give explicit predictions concerning the rate of epenthesis. It is even unclear if the two-step theories exposed above allow for epenthesis to *not* happen. In the case of [Berent et al., 2007], not epenthesizing a vowel would require directly yielding the phonetic form, without repairs being performed by the grammar. While [Berent et al., 2007] hypothesizes that this may happen in tasks requiring participants to pay more attention to phonetics, it is unclear in which cases listeners would directly retrieve the phonetic form within a same task, for similar stimuli. In the case of [Monahan et al., 2009], lack of epenthesis would involve a different syllabification of the input than when epenthesis happens. Therefore, a priori, epenthesis should always happen if the input is syllabified according to native phonotactics. In the case of reverse inference one-step theories [Dupoux et al., 2011, de Jong and Park, 2012, Wilson and Davidson, 2013, Durvasula and Kahng, 2015], lack of epenthesis might occur if the optimal match between the nonnative input and the native output is more strongly driven by acoustic/phonetic match than by sequence acceptability.

We now turn to the second subproblem, epenthetic vowel quality. For a given phonemic sequence containing a phonotactic violation, two-step theories would predict that epenthetic vowel quality is determined after an initial categorisation step. As such, we do not expect different tokens of a same type to yield epenthetic vowels of different quality. On the other hand, this would be possible for one-step accounts, since the acoustic details are included in the computation of the optimal output. Examining modulations in epenthetic vowel quality, therefore, allows to empirically tease apart one-step and two-step theories summarised above.



### 2.1.2 Role of acoustics

Results by [Dupoux et al., 2011] support one-step theories, since the authors were able to modulate the identity of the epenthetic vowel perceived by Japanese and Brazilian Portuguese listeners from stimuli that had the exact same segmental structure. For instance, Japanese listeners could be let to epenthesize /i/ more often instead of their default /u/ within consonant clusters (and vice versa for Brazilian Portuguese listeners). What are the factors determining whether participants more readily epenthesized /i/ or /u/?

The modulations in epenthetic vowel quality observed in [Dupoux et al., 2011] were due to acoustic cues present in the stimuli. Stimuli with the same segmental sequence were constructed by excising the medial vowel from /ebuzo/ and /ebizo/, yielding /eb(u)zo/ and /eb(i)zo/. These items differ in the coarticulation cues remaining in the consonants, but they have identical segmental structure (/ebzo/). Participants epenthesized /i/ more often from /eb(i)zo/ than from /eb(u)zo/, and similarly for /u/.

Remember that, for the two-step proposals above, the quality of the epenthetic vowel is determined in a second step, after the identity of the segments has been blocked. Both /eb(u)zo/ and /eb(i)zo/ would have /ebzo/ as a phonetic form (following [Berent et al., 2007]) or they would be parsed as /e.bV.zo/ (following [Mohan et al., 2009]). We cannot predict the modulations in epenthetic vowel from these initial parsings. However, in a one-step processing the acoustic details (in this case, coarticulation) could be taken into account when computing the acoustic match between the input and possible output phoneme sequences.

In this view, the representation used as input for the computation is acoustic in nature. This is in contrast to proposals of input as featural representation (e.g., binary, geometric). For instance, it has been hypothesized that the phenomena of epenthetic vowel copy (i.e., when the epenthetic vowel shares quality with neighbouring vowels) is due to a transfer of phonological features from neighbouring vowels and/or consonants towards an undeterminate epenthetic vowel [Rose and Demuth, 2006, Uffmann, 2006]. These phonological explanations of epenthetic vowel quality would therefore predict that, in auditory stimuli where the quality of the coarticulation and the quality of neighbouring vowels would be in conflict, the quality of the epenthetic vowel would mostly be determined by the neighbouring vowels.

### 2.1.3 Chapter preview

In this chapter we will investigate perceptual vowel epenthesis in order to tackle three main questions:

- How does the influence of acoustic details on epenthetic vowel quality compare to other influences such as those of an abstract grammar?
- Stimuli in [Dupoux et al., 2011] were made by excising vowels. Can we reproduce the modulations of epenthetic vowel quality caused by coarticulation using naturally produced stimuli?
- And finally, if acoustic factors are essential when choosing epenthetic vowel quality, does this mean that they are sufficient to do so?

In **section 2.2** a perceptual experiment aims at disentangling the contributions of phonetic categories and acoustic details on epenthetic vowel quality. Participants are asked to report their choice of epenthetic vowel (if any) within consonant clusters in stimuli where the acoustic information contained in the cluster may be in disagreement with the identity of neighbouring vowels. Information theoretic measures allow us to quantify the influence of both neighbouring phonetic categories and acoustic details.

In **section 2.3** we explore the possibility of predicting epenthetic vowel quality in Brazilian Portuguese (BP) and Japanese (JP) using a production-based exemplar model of perception. This type of model predicts the quality of a vowel epenthesized within the cluster of a stimulus based solely on the acoustic similarity of said /CC/ cluster to /CVC/ exemplars produced by native speakers of BP or JP. From this modelling approach we can evaluate the influence of pure acoustics on effects such as default epenthetic vowel quality and modulations induced by neighbouring vowels, with naturally produced stimuli that have not been manipulated.

In **section 2.4** we modify the production-based exemplar models from section 2.3. Several modifications are applied, mostly based on increased performance during the parameter optimisation phase. However, a notable modification is the normalisation of features by speaker (our input is still acoustic in nature, but it is closer to phonetics than previously). Also, we include in our models the possibility to add a duration-mismatch penalty, based on the finding that default epenthetic vowels are also those that are shorter. We examine the effect of the presence or absence of the duration penalty on default epenthetic vowel choice and modulations of epenthetic vowel quality by neighbouring vowels.

## 2.2 Which epenthetic vowel? Phonetic categories versus acoustic detail in perceptual vowel epenthesis

*The following section is a modified version of the following journal article:*

*Guevara-Rukoz, A., Lin, I., Morii, M., Minagawa, Y., Dupoux, E., & Peperkamp, S. (2017). Which epenthetic vowel? Phonetic categories versus acoustic detail in perceptual vowel epenthesis. Journal of the Acoustical Society of America, 142(2), EL211-EL217.*

*Stimuli were designed and recorded by I. Lin. Experimental data for the identification task were collected by M. Morii and Y. Minagawa, using scripts by A. Guevara-Rukoz. The ABX experiment was designed and run by I. Lin. Statistical analyses, phonetic transcriptions, and acoustical analyses were performed by A. Guevara-Rukoz. The initial manuscript draft was prepared by E. Dupoux, S. Peperkamp, and A. Guevara-Rukoz. E. Dupoux and S. Peperkamp supervised the entirety of the study.*

*Modifications with respect to the original paper: additional figures, annexes.*

*We thank Alexander Martin and Alejandrina Cristià, our American English and Argentinian Spanish speakers, respectively.*

**Abstract** This study aims to quantify the relative contributions of phonetic categories and acoustic detail on phonotactically-induced perceptual vowel epenthesis in Japanese listeners. A vowel identification task tested whether a vowel was perceived within illegal consonant clusters and, if so, which vowel was heard. Cross-spliced stimuli were used in which vowel coarticulation present in the cluster did not match the quality of the flanking vowel. Two clusters were used, /hp/ and /kp/, the former containing larger amounts of resonances of the preceding vowel. While both flanking vowel and coarticulation influenced vowel quality, the influence of coarticulation was larger, especially for /hp/.

### 2.2.1 Introduction

Our auditory perceptual system is tuned to the sound system of our native language, resulting in impoverished perception of nonnative sounds and sound sequences [Sebastián-Gallés, 2005]. For instance, in Japanese, a vowel can only be followed by a moraic nasal consonant or by a geminate consonant. As a consequence, Japanese listeners tend to perceive an illusory, epenthetic, /u/ within illegal consonant clusters [Dupoux et al., 1999, Dehaene-Lambertz et al., 2000, Dupoux et al., 2001, Monahan et al., 2009, Dupoux et al., 2011, Guevara-Rukoz et al., 2017b] and it is evident in loanword adaptation as well (e.g. the word 'sphinx' is borrowed in Japanese as /sufiNkusu/). Similar effects have been documented in other languages, with different epenthetic vowels (/i/ in Korean [Kabak and Idsardi, 2007, Berent et al., 2008, de Jong and Park, 2012]; schwa in English [Berent et al., 2007, Davidson and Shaw, 2012]; /i/ in Brazilian Portuguese [Dupoux et al., 2011, Guevara-Rukoz et al., 2017b]; and /e/ in Spanish [Hallé et al., 2014]). Even within languages, there sometimes is variation in the quality of the epenthetic vowel; for instance, in Japanese, the epenthetic vowel can in certain contexts be /i/ or /o/ [Mattingley et al., 2015, Guevara-Rukoz et al., 2017b].

The factors that determine the quality of the epenthetic vowel are still unclear. There is evidence that local acoustic cues in the form of vowel coarticulation play a role. Specifically, using artificial consonant clusters obtained by completely removing an inter-consonantal vowel, [Dupoux et al., 2011] found that the quality of the removed vowel – traces of which are present in the neighboring consonants – influences the quality of the

epenthetic vowel. Other studies, however, have argued for an influence of phonological factors, such as the legality of the resulting repair at the phonotactic level [Mattingley et al., 2015] or the presence of phonological alternations in the language [Durvasula and Kahng, 2015]. Determining the source of epenthetic vowel quality is important at a theoretical level, because it can shed light on the computational mechanisms underlying the perception of speech sounds. For instance, [Dupoux et al., 2011] argued that coarticulation effects cannot be accounted for by two-step models, in which the repair of illegal sequences follows that of phoneme categorization, while they are in accordance with one-step models, in which phoneme categorization takes phonotactic probabilities into account.<sup>1</sup> However, [Dupoux et al., 2011] only assessed the presence of acoustic effects, without investigating a possible role of categorical effects. Here, our aim is to quantify the relative contributions of categorical and acoustic effects on epenthetic vowel quality by directly comparing these two types of effect.

We focus on perceptual vowel epenthesis following /h/. This case is ideally suited for our objective as in Japanese loanwords these fricatives are typically adapted by adding a ‘copy’ of the preceding vowel when they occur in a syllable coda. For instance, ‘*Bach*’, ‘(*van*) *Gogh*’, and ‘*Ich-Roman*’ are adapted as /bah:a/, /goh:o/, and /ih:iroman/. In work on loanword adaptations, cases of vowel copy in epenthesis have been explained as a result of the spreading of phonological features from the preceding vowel onto the epenthetic vowel (i.e., vowel harmony), for instance in Shona, Sranan, and Samoan [Uffmann, 2006], and Sesotho [Rose and Demuth, 2006]. In speech perception, however, this pattern could be based either on phonetic categories, i.e. the preceding vowel itself, or on acoustic detail, i.e. traces of this vowel that are present in /h/, as laryngeal fricatives such as /h/ contain acoustic information relative to formants of surrounding vowels [Keating, 1988]. Using an identification task, we tease apart these two explanations by independently manipulating the categorical context in which /h/ occurs and the acoustic realization of this segment, using cross-splicing. As a control, we also use stimuli with /k/, which are expected to give rise to more default /u/-epenthesis because they contain less coarticulation.

## 2.2.2 Methods

### 2.2.2.1 *Participants*

Twenty-five native Japanese speakers were tested in Tokyo, Japan (mean age  $24 \pm 3.5$ ; 13 female). All were students at Keio University, and none had lived abroad.

### 2.2.2.2 *Stimuli*

We constructed a set of 20 base items, 10 disyllabic ones of the form  $V_1C_1C_2V_1$  and 10 matched trisyllabic ones of the form  $V_1C_1V_1C_2V_1$ , with  $V_1$  a vowel in the set /a, e, i, o, u/ (henceforth: flanking vowel),  $C_1$  /h/ or /k/, and  $C_2$  a fixed consonant, /p/, e.g. /ahpa/, /ekpe/, /ohopo/, /ikipi/. Three trained phoneticians, native speakers of Dutch, American English and Argentinian Spanish, respectively, recorded all items with stress on the first syllable. All /kp/ stimuli presented release bursts. For each disyllabic item, we used one token per speaker as a natural control stimulus. By systematically replacing the / $C_1C_2$ /-cluster in these items by the same cluster out of the other disyllabic items produced by the same speaker but with a different vowel, we created spliced test stimuli such as /ah<sub>o</sub>pa/, and /ek<sub>i</sub>pe/, where the small vowel denotes vowel coarticulation present in the consonant cluster. Similarly, by replacing the / $C_1C_2$ /-cluster in the disyllabic items by the same cluster out of the second token of the same items, we created spliced

---

<sup>1</sup>Note that due to a typo the summary in the first-to-last paragraph of this article erroneously states the opposite.

control stimuli in which the vowel coarticulation matched the flanking vowel, e.g. /ah<sub>a</sub>pa/, /ek<sub>e</sub>pe/. We also created trisyllabic fillers in which the middle vowel either matched or mismatched the flanking vowel, e.g. /ahapa/, /ekepe/, /ahopa/, /ekipe/ (these were also created by splicing, as they served as test stimuli in an experiment not reported in this article). Overall, each speaker thus contributed 40 test stimuli (5 flanking vowels x 4 vowel coarticulations x 2 consonant clusters), 20 control stimuli (5 flanking vowels x 2 consonant clusters, all both in a natural and a spliced form), and 50 fillers. Ten additional training items were recorded by a fourth speaker. Their structure was similar, but included only phonotactically legal nasal + stop sequences with or without an intervening copy vowel (e.g., /ampa/, /enepe/).

### 2.2.2.3 Procedure

Participants were tested individually in a soundproof room. At each trial, they heard a stimulus over headphones and were asked to identify the vowel between the two consonants, if any. They were provided with a transcription of the item on screen, containing a question mark between the two consonants (e.g. “ah?pa”) in latin characters (as non-CV syllables cannot be transcribed using Japanese characters), as well as the list of possible responses: “none, a, i, u, e, o”. Participants responded by pressing labelled keys on a keyboard. Participants were familiarised with the procedure with 10 training trials in which they received on-screen feedback.

The 330 stimuli were presented in a pseudo-randomised order: Consecutive stimuli were produced by different speakers, and a stimulus could not be followed by a stimulus with the same combination of vowel coarticulation and consonant. Trials were presented in two blocks, with each stimulus appearing once per block, for a total of 660 trials. The experiment lasted approximately 40 minutes.

## 2.2.3 Results

Test and control trials with responses that were either too fast (before the medial portion of the stimulus could be perceived and processed, <400 ms) or too slow (> 3 SD: 3238 ms) were excluded from the analyses. This concerned 736 trials (4.5%).

### 2.2.3.1 Control items

Participants experienced perceptual epenthesis in 57% of control items in which the flanking vowel and coarticulation are of the same quality (/hp/: 52%, /kp/: 61%). Recall that in loanwords, the default epenthetic vowel is /u/, while after voiceless laryngeal fricatives it is a copy of the preceding vowel. Focusing on trials with an epenthetic response, we examined whether the choice of epenthetic vowel reflected this pattern.

First, a generalised mixed-effects model with a declared binomial distribution [Bates et al., 2015] was used to examine a possible effect of consonant cluster on default /u/-epenthesis. Thus, we analyzed the proportion of default /u/, using participant, speaker, experimental block, and trial as random effects, and consonant cluster (/kp/ vs. /hp/; contrast coded) as fixed effect. This model was compared to a reduced model with no fixed effect. The full model was found to explain significantly more variance than the reduced model ( $\beta = -4.2$ ,  $SE = 1.2$ ,  $\chi^2(1) = 9.9$ ,  $p < 0.01$ ), showing that participants experienced significantly less default /u/-epenthesis in /hp/- than /kp/-items (39% vs. 86% of all trials with epenthesis, respectively).

Next, we examined whether epenthetic vowels shared the quality of the flanking vowel more often in /hp/- than in /kp/-clusters. Given that for items with flanking vowel /u/ it is impossible to know if /u/-epenthesis is due to vowel copy or to default

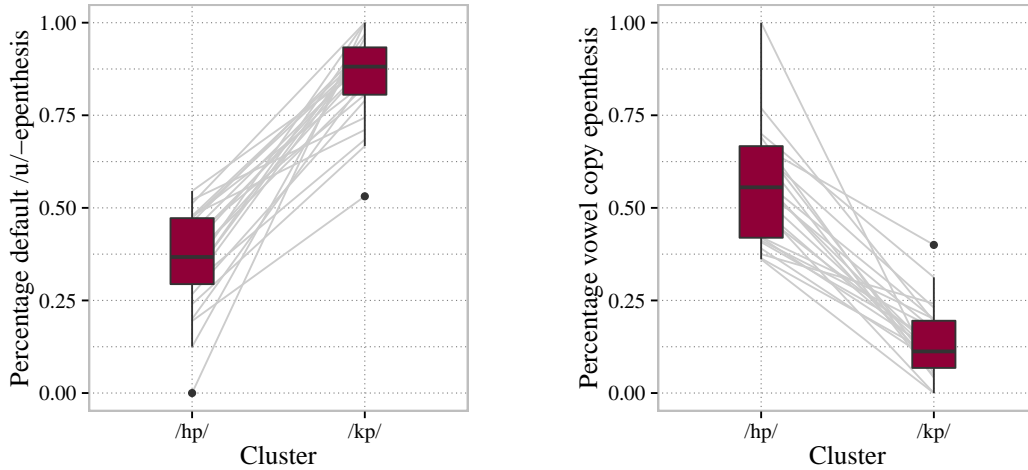

Figure 2.1: *Percentage of default /u/-epenthesis (left) and vowel copy epenthesis (right) for control items. Box plots display the distribution of the scores across speakers (median, quartiles and extrema), with gray lines connecting data points corresponding to a single participant.*

epenthesis, these items were excluded. As before, a generalised mixed-effects model with a declared binomial distribution was used. We analyzed the proportion of vowel copy (i.e., whether the flanking vowel and epenthetic vowel shared quality), using participant, speaker, experimental block, and trial as random effects, and consonant cluster (/kp/ vs. /hp/; contrast coded) as fixed effect. Comparing this full model to a reduced model with no fixed effects revealed a significant effect of consonant cluster ( $\beta = 3.7$ ,  $SE = 1.2$ ,  $\chi^2(1) = 7.4$ ,  $p < 0.01$ ). Therefore, participants epenthesized a vowel that matched the flanking vowel more often in /hp/-clusters (53%) than in /kp/-clusters (13%).

Thus, analysis of control items revealed that, similarly to the loanword pattern, participants perceived the vowel /u/ more often in /kp/- than in /hp/-clusters, and they perceived a vowel copy more often in /hp/- than in /kp/-clusters.

### 2.2.3.2 Test items

Figure 2.2 shows trial counts, separated according to response category, consonant cluster, flanking vowel, and vowel coarticulation for test and control trials. Within the individual rectangles, vertical lines are indicative of a larger influence of flanking vowels compared to vowel coarticulation. Horizontal lines, by contrast, are indicative of a larger influence of vowel coarticulation. Finally, uniform colouring indicates that neither flanking vowels nor vowel coarticulation have the upper hand in influencing the quality of the epenthetic vowel. Note that except for the rectangles with “none” and “u” responses where colouring is more uniform, horizontal lines are more visually prominent than vertical lines. Thus, the epenthetic vowel’s quality generally depends mostly on acoustic details present in the consonant cluster.

Focusing on the test trials eliciting epenthesis (/hp/: 62%, /kp/: 66%), we quantify the respective influence of flanking vowel and vowel coarticulation (explanatory variables, EV) on the epenthetic vowel (response variable, RV), using two measures from information theory, **mutual information** (MI) and **information gain** (IG) (for a comprehensive description of these measures, see [Daland et al., 2015]). MI and IG are derived from **entropy**, which is the ‘uncertainty’ in the value of a RV at a given trial. The lower the entropy  $H[X]$  of a variable  $X$ , the easier it is to predict the outcome of a trial. The **MI**

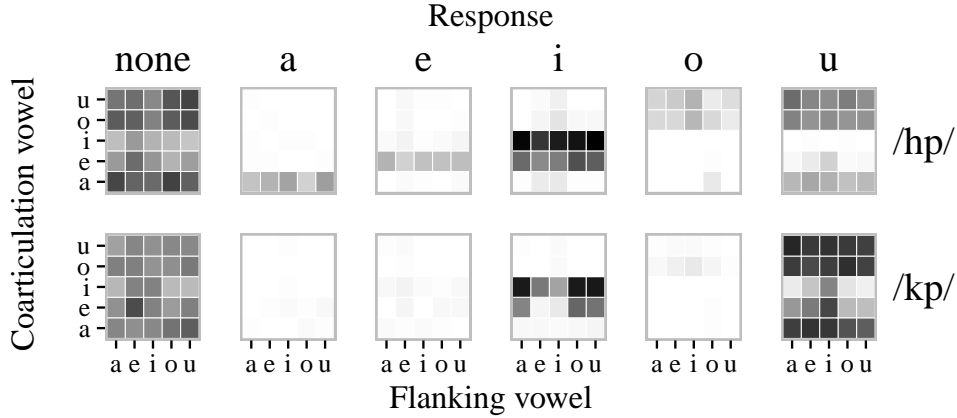

Figure 2.2: Counts of responses for the test items and spliced control items. Top: /hp/-items; bottom: /kp/-items. Within each rectangle, flanking vowels and vowel coarticulation are given in the horizontal and vertical axes, respectively. Darker colours indicate higher counts.

$I[X; Y]$  of variables  $X$  and  $Y$  represents the reduction in ‘uncertainty’ of the trial outcome for RV  $X$ , given that the value of EV  $Y$  is known (and vice versa). This corresponds to the maximum amount of influence that  $Y$  can have over  $X$ , without removing contributions from other variables. **IG**  $H[X|Z] - H[X|Y, Z]$  represents the minimum amount of influence of variable  $Y$  on  $X$ . This corresponds to the reduction in uncertainty as to the value of  $X$  that arises from knowing the value of  $Y$ , after removing all uncertainty explained by variable  $Z$ .

As in [Daland et al., 2015], we compute **accidental information** introduced to MI and IG, which corresponds to inaccuracies introduced to our measurements by the process of inferring underlying probability distributions from samples, i.e., sampling error (as when one does not obtain 50 tails and 50 heads when flipping a fair coin 100 times). We can estimate the accidental information by recomputing MI and IG after having removed the dependencies between the EV and the RV. We can do so by shuffling the values of the EV within each participant. For instance, in order to compute the accidental information introduced to MI and IG for the EV “vowel coarticulation”, we randomly shuffle the vowel coarticulation labels of all of our trials, per participant, while leaving the EV “flanking vowel” untouched. We then compute MI and IG as for the real data. In order to obtain a better estimate of accidental information from an average value, we do this 1000 times (i.e., Monte Carlo shuffling process).

To recapitulate, for both coarticulation vowel and flanking vowel, we compute ‘sample’ and ‘accidental’ MI and IG. The ‘true’ values of these measures are obtained by removing mean accidental information from sample information. Following [Daland et al., 2015], we consider the set of shuffled datasets (i.e., ‘accidental’ MI and IG) as probability distributions given by the null hypotheses that neither coarticulation nor the flanking vowel influence the responses.

As shown in Table 2.1, all sample lower bounds are greater than their respective accidental information gains on all 1000 shufflings, for which the ranges are given in parentheses. Therefore, the ‘true’ lower bounds for both coarticulation and flanking vowel influence on epenthesis are greater than 0 with  $p < 0.001$ , showing that both coarticulation and flanking vowel quality influence participant responses. However, the amount of influence differs greatly: a larger information gain is yielded by considering vowel coarticulation than by considering the flanking vowel. This is true both for /hp/-items, which

Table 2.1: *Quantified influence of vowel coarticulation and flanking vowel on vowel epenthesis measured with information gain (IG) and mutual information (MI). Ranges for Monte Carlo simulations of the null hypothesis (i.e. accidental information) are given in square brackets. Values are given in bits.*

	Vowel coarticulation				Flanking vowel							
	IG		MI		IG		MI					
	data	null	data	null	data	null	data	null				
/hp/	.90	.04	[.02, .05]	.93	.01	[0, .02]	.07	.03	[.02, .05]	.09	.01	[0, .02]
/kp/	.47	.03	[.02, .05]	.53	.01	[0, .02]	.07	.03	[.02, .04]	.13	.01	[0, .02]

are heavily coarticulated, and for /kp/-items, where coarticulation is mainly only present in the burst, even though the influence of coarticulation on epenthetic vowel quality is higher for the former (/hp/: [0.86, 0.92] *vs.* /kp/: [0.44, 0.52]). (The range of variation within shuffles of accidental information was about .03; thus any difference of .06 or bigger is significant, including differences between MI and IG values, respectively). In summary, both vowel coarticulation and the flanking vowel influence epenthetic vowel quality, but this influence is greater for vowel coarticulation; response patterns are more predictable when the value of this variable is known than when the value of the flanking vowel variable is known.

## 2.2.4 Discussion and conclusion

We used an identification task to assess the quality of epenthetic vowels perceived by Japanese listeners in illegal consonant clusters with varying amounts of coarticulation. Our findings can be summarized as follows: First, we were able to replicate the perception of illusory vowels within phonotactically illegal clusters by Japanese listeners (64% of all test trials).<sup>23</sup> Second, when the flanking vowel and coarticulation match, the quality of the perceived vowel patterned in the same way as in loanword adaptation data. That is, for /kp/-clusters, the predominant epenthetic vowel was the standard default vowel for Japanese (/u/), while for /hp/-clusters, it was a copy of the flanking vowel. Finally, and most importantly, in items where the coarticulation and flanking vowel differed, the quality of the epenthetic vowel was significantly influenced by both variables, but the influence of the former was much larger than that of the latter, especially in the case of /hp/. Our discussion focuses on this last finding.

Before discussing its theoretical relevance, let us comment on the numerically small – yet significant – influence of flanking vowel on epenthesis for /hp/-clusters, where vowel coarticulation is maximal. This result suggests a contribution of categorical variables on epenthetic vowel quality (i.e., copy effect). A similar effect, though, was also found for /kp/-clusters, for which loanword adaptation patterns provide no particular reason to propose the existence of a categorical copy phenomenon; indeed, in loanwords, coda-/k/

<sup>2</sup>Note that whereas previous studies examined perceptual epenthesis within clusters with at least one voiced consonant, we presently focused on completely voiceless clusters, a context in which the high vowels /i/ and /u/ may be devoiced in Japanese [Han, 1962, Vance, 1987]

<sup>3</sup>As pointed out by an anonymous reviewer, the differences in rates of epenthesis by speaker (Dutch: 68%, Am. English: 58%, Arg. Spanish: 66%) are consistent with an important role for acoustic factors in epenthesis, suggesting that participants interpret speakers' acoustic cues instead of responding based on abstract phonological categories (also cf [Wilson et al., 2014]). This can also be seen in more detail when decomposing Figure 2.2 by speaker, as in the annex Figure 2.3



generally triggers default /u/-epenthesis. Therefore, it is possible that this effect results from a response bias due to task demands: given a perceptually uncertain stimulus, the flanking vowel could prime a ‘copy’ response, for instance, because it was visually available on-screen at each trial (e.g. “ah?pa”). Further work using different tasks is necessary to examine the perceptual reality of this ‘vowel copy’ effect.

Keeping in mind that this work focuses on the choice of epenthetic vowel, while not directly addressing questions related to why phonologically-illegal clusters are repaired, or what the role of phonotactics in epenthesis is, the finding that the quality of the epenthetic vowel is influenced more by coarticulation than by the flanking vowel calls for a perceptual repair mechanism in which acoustic details are taken into consideration. Two-step models in which epenthetic repair is performed after the consonant cluster in the acoustic input has been represented in terms of discrete phonetic categories are therefore ruled out. Rather, like [Dupoux et al., 2011], we argue in favor of one-step models, in which epenthetic vowel quality is based on the similarity between local acoustic cues and prototypical properties of each vowel in the language, such that the closest matching vowel gets selected for insertion. This mechanism can account both for the coarticulation-induced vowel copy effect in items with a /hp/-cluster, as the voiceless glottal fricative /h/ contains strong coarticulation from the adjacent vowels [Keating, 1988] also see Annex Figure 2.4, and for the default /u/-epenthesis effect in items with a /kp/-cluster – which exhibit a lower degree of coarticulation – as /u/ is the phonetically shortest vowel in the language [Han, 1962] and is prone to be devoiced in certain contexts (see footnote).

Focusing on cases where the quality of the epenthetic vowel varies *within language* as a function of the type of cluster, previous studies have investigated whether language-specific phonotactic or phonological properties play a role for the quality of the epenthetic vowel. In Japanese, for instance, dental stops cannot be followed by /u/, and in loanwords this phonotactic constraint gives rise to adaptation by means of /o/-epenthesis (e.g. ‘batman’ → ‘batoman’). Using identification tasks, both [Mattingley et al., 2015] and [Guevara-Rukoz et al., 2017b] report that the perceptual equivalent of this effect is only marginally present in Japanese listeners (10-12% of /o/-epenthesis in /d/-initial clusters; see also [Monahan et al., 2009] for the absence of such an effect in a discrimination task). Thus, so far there is only weak evidence that the mechanism of phonotactic repair takes into account the legality of the resulting CVC-sequence. A stronger effect of cluster-dependent perceptual epenthesis has been reported in Korean listeners, who repair /ɛjma/ and – to a lesser extent – /ɛc<sup>h</sup>ma/ with an epenthetic /i/ instead of the default epenthetic vowel /i/ [Durvasula and Kahng, 2015]. This is argued to be due to the existence of an allophonic rule that palatalizes /s/ and /t<sup>h</sup>/ before /i/, yielding [ʃi] and [c<sup>h</sup>i], respectively. It is also possible, however, that this effect is (partly) due to coarticulation; for instance, acoustic cues in /ʃ/ and /c<sup>h</sup>/ might be more suggestive of /i/ than of /i/.

To conclude, we directly compared the relative contributions of acoustic and categorical effects on epenthetic vowel quality, and found that the former override the latter. This result thus strengthens those of [Dupoux et al., 2011], who also established the presence of acoustic effects but without investigating possible categorical effects. More research is needed to investigate whether our findings generalize to other cases of perceptual epenthesis. This question can be addressed by two complementary approaches. One would be to run additional experiments with cross-spliced stimuli, as in the present study. Another one would be to measure the effective amount of coarticulation in experimental stimuli of previous studies, using a computational implementation of a one-step repair mechanism (see [Dupoux et al., 2011] and [Wilson and Davidson, 2013] for propositions, and [Schatz, 2016] and later chapters of this thesis for implementations using Hidden Markov Models).

## 2.2.5 Annexes

Here we provide additional results for (a) differences in patterns of epenthesis for items recorded by different speakers, (b) acoustic analyses of coarticulation, and (x) an ABX discrimination task.

### 2.2.5.1 Identification results separated by speaker

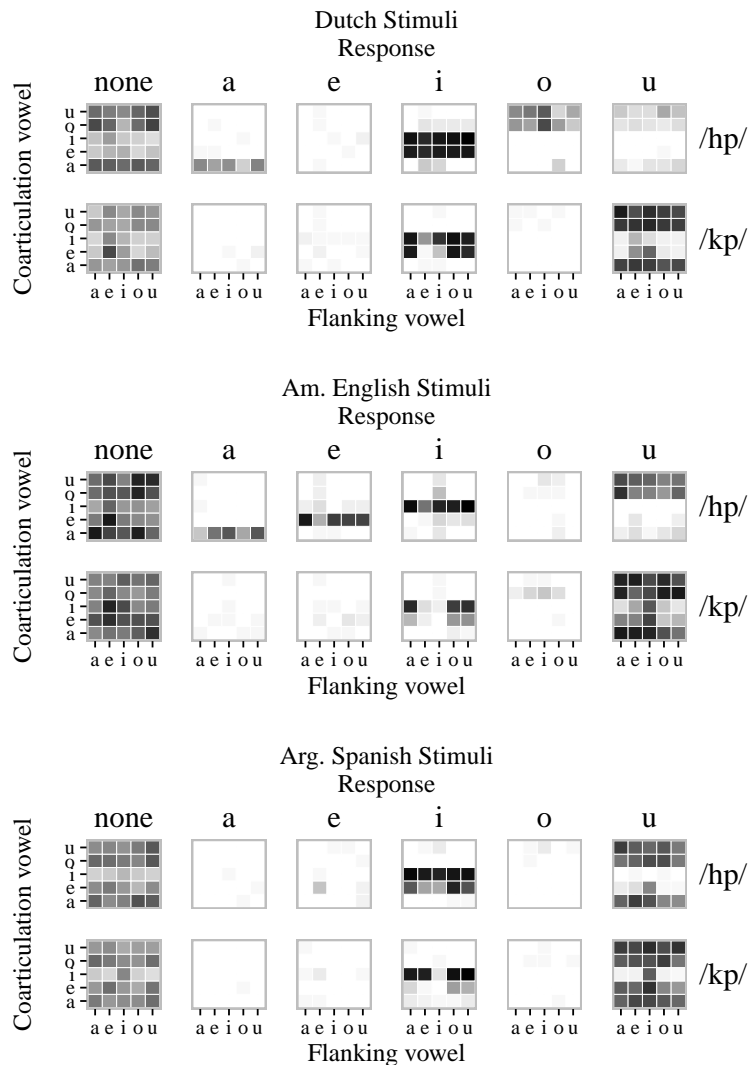

Figure 2.3: Counts of responses for the test items and spliced control items, separated by speaker. For each speaker: top: /hp/-items; bottom: /kp/-items. Within each individual rectangle, flanking vowels and vowel coarticulation are given in the horizontal and vertical axes, respectively. Darker colours indicate higher counts, with colours normalized within each speaker.

Our three recorded speakers did not share the same native language, causing their recorded items to differ in their acoustic details. A consequence of this is that response patterns of Japanese participants had subtle differences according to the speaker producing the stimuli, as seen in Figure 2.3. For instance, most “o” responses were prompted by stimuli recorded by the Dutch speaker, while most “e” responses arose from stimuli by the

American English speaker. Importantly, as mentioned in the discussion, rates of epenthesis and choice of epenthetic vowel varied according to speaker, which further supports our hypothesis that Japanese participants attended to acoustic details when experiencing perceptual epenthesis. It would be interesting to see whether these differences are due to phonetics specific to the native language of the speakers or to personal idiosyncracies, since here we only recorded one speaker per native language.

### 2.2.5.2 Acoustic analyses

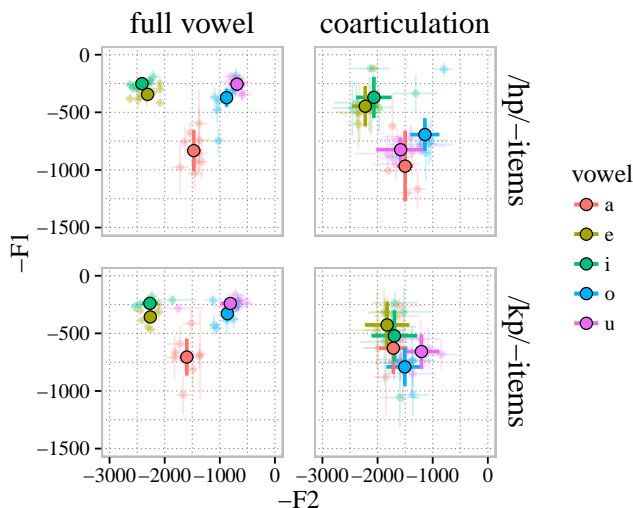

Figure 2.4: *Visualisation in  $F1 \times F2$  space of vowels (left panels), and coarticulation found in the first consonant of  $C_V C$  clusters (right panels), of items used in the experiment. Dimmer dots and lines respectively show median formant values and median formant bandwidths within the vowel or consonant. Dots circled in black and thicker lines show global means.*

In order to examine the acoustic properties of our stimuli, we annotated them using Praat [Boersma et al., 2002] and we automatically extracted the first three formants from all vowels in the stimuli ( $V_{1a}$  and  $V_{1b}$  from  $V_{1a}CpV_{1b}$  items, and  $V_2$  from  $CV_2p$  items used to construct  $V_1CV_2pV_1$  items), and also from /h/ and /k/ in /Cp/ clusters (coarticulation). Their distribution in  $F1 \times F2$  space can be seen in Figure 2.4. As might be expected, the vowel triangle formed by vowels /i, a, u/ is discernible when plotting full vowels in  $F1 \times F2$  space. This is not the case, however, when plotting coarticulation contained by consonants /h/ and /k/. Visually, it appears that the distinction between front vowels /i, e/ and the rest (/a, o, u/ is better maintained in /h/ than in /k/. We used Linear Discriminant Analysis (LDA) to perform classification of the points plotted in Figure 2.4, using as input features a vector containing the first three formants  $F1$ ,  $F2$ , and  $F3$  of each datapoint. We trained the LDA classifier first using data from full vowels as training data, in order to classify coarticulation from the consonants. The classifier accuracy is 38.0% for coarticulation in /h/ and 33.3% for coarticulation in /k/. The corresponding classification patterns can be found in the top part of Figure 2.5. As we can see, classification patterns are similar; /i, e/ coarticulation is classified as /e/, while /a, o, u/ are mostly classified as /a/. Furthermore, we used LDA with cross-validation (i.e., from a set of  $n$  items, an item is classified based on LDA performed on all other  $n - 1$  items). When the set of interest was that of coarticulation in /h/, the accuracy was of 51.7%, while it was 36.7%

for coarticulation in /k/. The resulting classifications can be seen in the lower section of Figure 2.5; for /h/ the classification patterns are more similar within members of a taxonomic group (e.g., /i, e/) than for /k/. Thus, while coarticulation from both types of clusters can be mapped onto the original vowel space similarly well (or badly, depending on the perspective), it would be easier to deduce the quality of neighbouring vowels from the coarticulation cues contained within an /hp/ rather than a /kp/ cluster, especially with regards to the separation of the front vowels /i, e/ from /a, o, u/, as can be seen in the lower part of Figure 2.5 and the right panels of Figure 2.4.

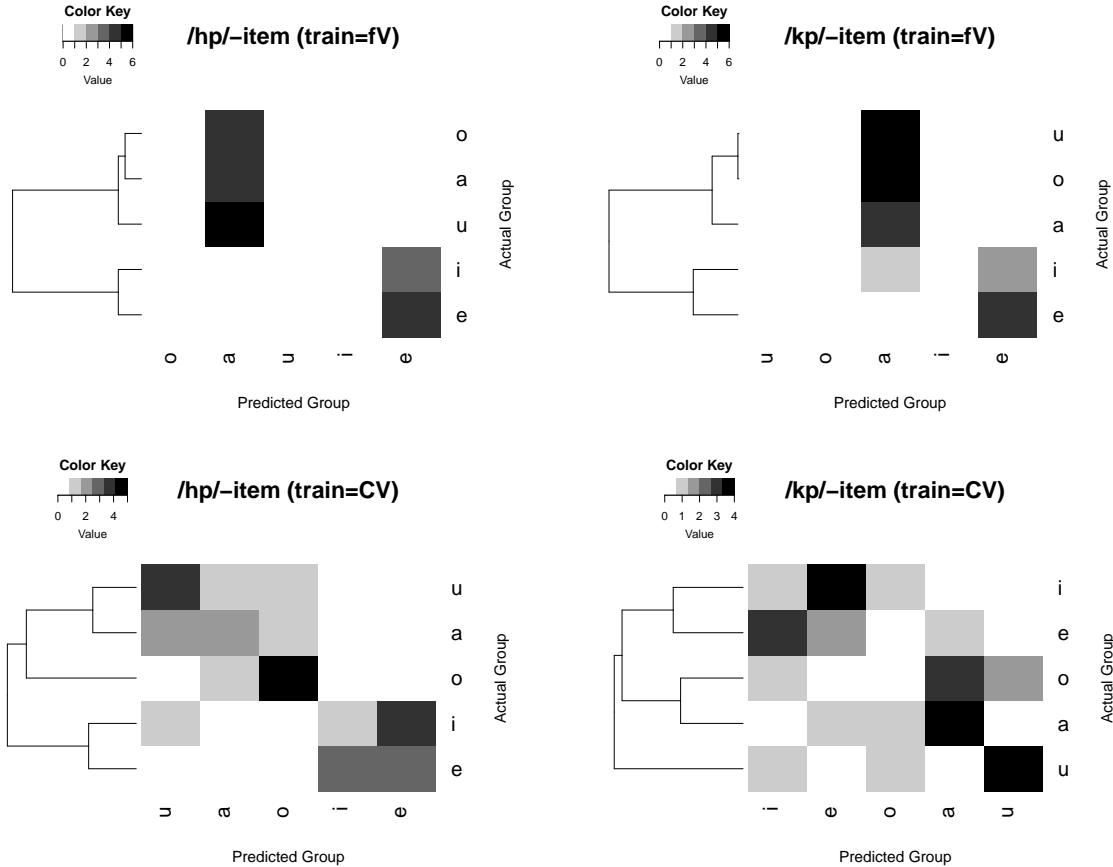

Figure 2.5: *Classification of consonants /h/ and /k/ based on formant values of their coarticulation cues. Classification was performed based on category descriptions dictated by formant values of full vowels (top) or in a cross-validation manner (bottom). Consonants are labeled according to the quality of coarticulation cues, therefore of neighbouring vowels (“Actual Group”, rows). Classification labels are shown in columns (“Predicted Group”), with darker colours indicating higher counts. Dendrograms on the left-hand side of each heatmap show the grouping of consonants according to their similarity in the classification patterns. Diagonals show identity. Please note that the order of the vowels differs between the four panels, since it is set by the dendrograms.*

### 2.2.5.3 Supplementary experiment: ABX task

In this additional experiment we assessed the perception of illegal consonantal clusters in Japanese using an ABX discrimination task, which, contrary to the vowel identification task used in Experiment 1, does not require an explicit categorization of the item’s segments. As in previous work [Dupoux et al., 1999, Dupoux et al., 2011], we used different

speakers for stimuli A, B, and X, such that the task could not be performed on the basis of low-level acoustic information.

**Participants** Twenty-six native Japanese listeners were recruited in Paris, France. While testing for this experiment was done outside of Japan, we recruited only participants with little experience with French or other languages in which consonant clusters are allowed. For instance, many participants were recently arrived exchange students or family members of professionals that had been transferred to Paris.

**Stimuli** From the stimuli used for the identification task, we extracted items relevant for pairs shown in Table 2.2. We defined four types of AB pairs with constant flanking vowels, based on the nature of the items in the pair:

- Natural cluster items (N) correspond to natural control stimuli from the identification task, disyllabic  $V_1C_1C_2V_1$  items which have not been spliced.
- Spliced cluster items (Sp) correspond to the identification task test stimuli, disyllabic  $V_1C_1(V_2)C_2V_1$  items for which the  $C_1(V_2)C_2$  cluster has been spliced from a  $V_2C_1C_2V_2$  item.
- Full vowel items (FV) correspond to trisyllabic fillers from the identification task,  $V_1C_1V_2C_2V_1$  items for which the  $C_1V_2C_2$  cluster has been spliced from a  $V_2C_1V_2C_2V_2$  item

Table 2.2 also shows how well participants are predicted to discriminate items in the AB pairs depending on how phonotactically illegal stimuli might be repaired. Participants might break the illegal consonant cluster by adding a vowel identical to flanking vowels (FLANK.), by adding a vowel of the same quality as the coarticulation (COART.), or they might simply add /u/ by default (DEFAULT). Participants might also not experience epenthesis at all (NO EPENTH.).

Table 2.2: Types of AB pairs for Experiment 2. The discrimination accuracy is predicted according to the following hypotheses about epenthetic vowel quality: (1) it is determined by flanking vowel quality (Flank.); (2) it is determined by coarticulation cues (Coart.); (3) participants experience default /u/ epenthesis (Default) epenthesis; (4) participants do not experience epenthesis (No Epenth.). Cases of good discrimination are marked with plus signs.

Type	A	B	# pairs	Example	Flank.	Coart.	Default	No Epenth.
N-Sp	natural	spliced	40	/ahpa/ – /ah <sub>i</sub> pa/	–	+	–	–
Sp-Sp	spliced	spliced	100	/ah <sub>i</sub> pa/ – /ah <sub>e</sub> pa/	–	+	–	–
N-FV	natural	full V	10	/ahpa/ – /ahapa/	–	–	+	+
Sp-FV	spliced	full V	50	/ah <sub>i</sub> pa/ – /ah <sub>i</sub> pa/	+	–	+	+

**Procedure** Participants were tested in a soundproof room wearing headphones. On each trial, participants heard two different stimuli of categories A and B, followed by a third stimulus X, belonging to either category A or B. Within each trial, all three stimuli had a  $V_1C(V_2)pV_1$  structure, with  $V_1$  and  $C$  remaining constant. The three tokens were produced by different speakers and were presented with an ISI of 500 ms. An ITI of 1 s separated a participant’s response from the following trial.

Within each triplet, A always contained either a natural or a spliced cluster, while B always contained either a full vowel or a spliced cluster. Table 2.2 shows the four different types of AB pairs that were thus tested, together with the expected discrimination accuracy based on different hypotheses about how epenthetic vowel quality is determined.

In total, there were 200 AB pairs. Since there are four possible presentation orders for each pair and its corresponding third item X (i.e.,  $ABX_A$ ,  $BAX_A$ ,  $ABX_B$ ,  $BAX_B$ ), there are 800 possible unique trials. In order to reduce the duration of the experiments, participants were divided into two groups exposed to counterbalanced halves of the total set of trials.

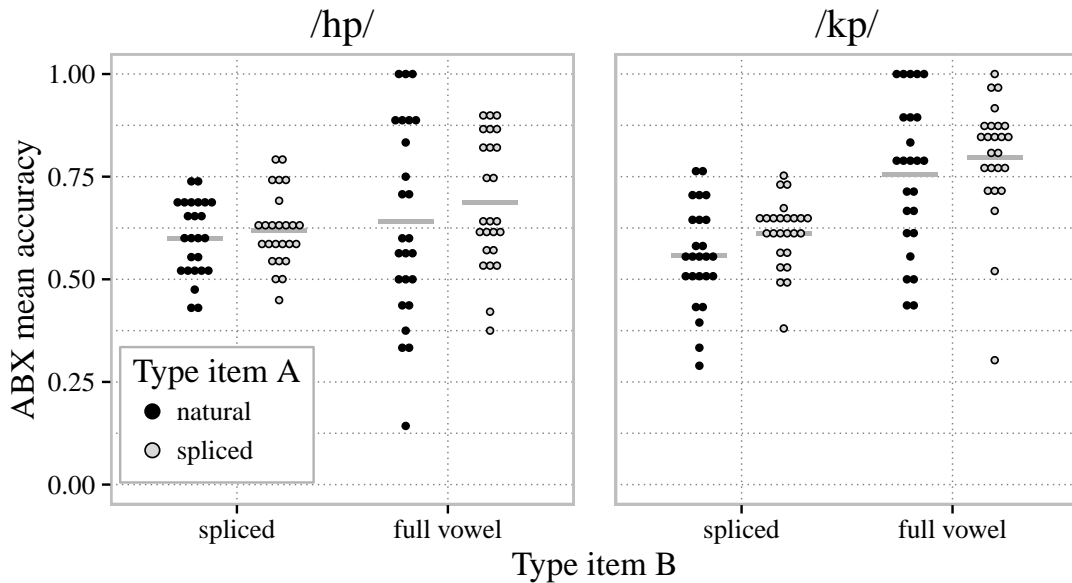

Figure 2.6: *Discrimination accuracy at the ABX task on /hp/ (left) and /kp/ (right) items. Dot plots show the distribution of average scores (one dot per participant). Horizontal grey lines show mean accuracy for each AB pair type.*

**Results** Trials in which the response was given before all items in the ABX triplet had been played were excluded (1063 trials representing 11% of all trials). The remaining data were analysed using a generalised linear mixed-effects model in R (*lme4*; [Bates et al., 2015]) with a declared binary distribution. The binomial response variable of interest for each trial was ACCURACY (*correct vs. incorrect*); were included as fixed effects CONSONANT (*/h/ vs. /k/*), TYPE A (*natural vs. spliced*), TYPE B (*full vowel vs. spliced*), as well as the interactions between every pair of fixed effects. All fixed effects were contrast-coded. PARTICIPANT, ITEM A, ITEM B, and TEST GROUP were included as random effects. Significance testing was done through model comparison: the full model including all fixed and random effects was compared to reduced models, in which one of the fixed effects was absent.

The full model did not explain significantly more data variance than a model excluding the fixed effect CONSONANT, suggesting that participant accuracy was not significantly different for /hp/ and /kp/ trials ( $\beta = 0.17$ ,  $SE = 0.16$ ,  $\chi^2(1) = 1.1$ ,  $p > 0.05$ ).

We did not find evidence of accuracy being lower or higher when an ABX trial contained a natural cluster item instead of a spliced cluster item (TYPE A;  $\beta = 0.20$ ,  $SE = 0.12$ ,  $\chi^2(1) = 2.52$ ,  $p > 0.05$ ). Moreover, there was no significant interaction

between CONSONANT and TYPE A ( $\beta = -0.10$ ,  $SE = 0.17$ ,  $\chi^2(1) = 0.37$ ,  $p > 0.05$ ), nor between TYPE A and TYPE B ( $\beta = 0.08$ ,  $SE = 0.15$ ,  $\chi^2(1) = 0.26$ ,  $p > 0.05$ ).

By contrast, accuracy was significantly enhanced by the presence of an item with a full vowel cluster (i.e., *Sp-FV* and *N-FV* pairs) (TYPE B,  $\beta = 0.93$ ,  $SE = 0.16$ ,  $\chi^2(1) = 29.8$ ,  $p < 0.0001$ ). This increase in accuracy appears to be exacerbated in pairs with /kp/-containing items relative to pairs with /hp/-containing items, as the interaction between CONSONANT and TYPE B was also significant ( $\beta = -0.7$ ,  $SE = 0.15$ ,  $\chi^2(1) = 19.0$ ,  $p < 0.0001$ ).

These results are compatible with predictions given by the DEFAULT and NO EPENTH. hypotheses in Table 2.2, i.e., better discrimination for N-FV and Sp-FV pairs. After looking at response patterns from the identification task, this should come as no surprise. Indeed, most of participant responses were “none” (36% of test trials) and “u” (32% of test trials). This ABX task is therefore not sensitive enough to detect differences between the more subtle modulations in epenthetic vowel quality caused by flanking vowels and coarticulation cues. However, we can examine the correlation between ABX discriminability and response patterns for the identification task, in order to verify that results from the latter experiment are not solely due to task-specific demands (e.g., participants focusing on phoneme identity).

**Correlation with identification results** In order to assess the role of perceptual assimilation on stimulus discrimination, we derived a measure of perceptual distance from response patterns given in the identification task, and examined if this distance predicted the outcome in the ABX discrimination task. To do so, we computed for each item a six-dimensional numerical vector of the shape  $x = [x_1, \dots, x_6]$ , with values corresponding to the percent responses to categories a, e, i, o, u, and *none*, respectively. The distance  $d(x, y)$  between two items  $x$  and  $y$  was computed as the normalized Euclidian distance between their associated vectors:

$$d(x, y) = \frac{\sqrt{\sum_i (x_i - y_i)^2}}{\sqrt{2}}$$

One data point was obtained per AB pair, giving a total of 200 datapoints (cf. Table 2.2).

Multiple regression analysis was used to test if assimilation patterns from the identification task significantly predicted participants’ accuracy during the ABX task. A scatterplot summarizes the results in Figure 2.7. The model included as independent variables the normalized perceptual distance between two items (range = [0;1]), and the consonant cluster (/hp/ or /kp/). These two predictor variables explained 52% of the variance ( $R^2 = 0.52$ ,  $F(3, 196) = 73.63$ ,  $p < 0.0001$ ). Consonant cluster ( $t < 1$ ) and the interaction of the two independent variables ( $t < 1$ ) were not significant. On the other hand, perceptual distance significantly predicted accuracy during the ABX task ( $t = 13.8$ ,  $p < 0.0001$ ); the less similar the response patterns to both items in the AB pair, the easier their discrimination in the ABX task. These results suggest that adaptation patterns attested in the identification task are not task-dependent.

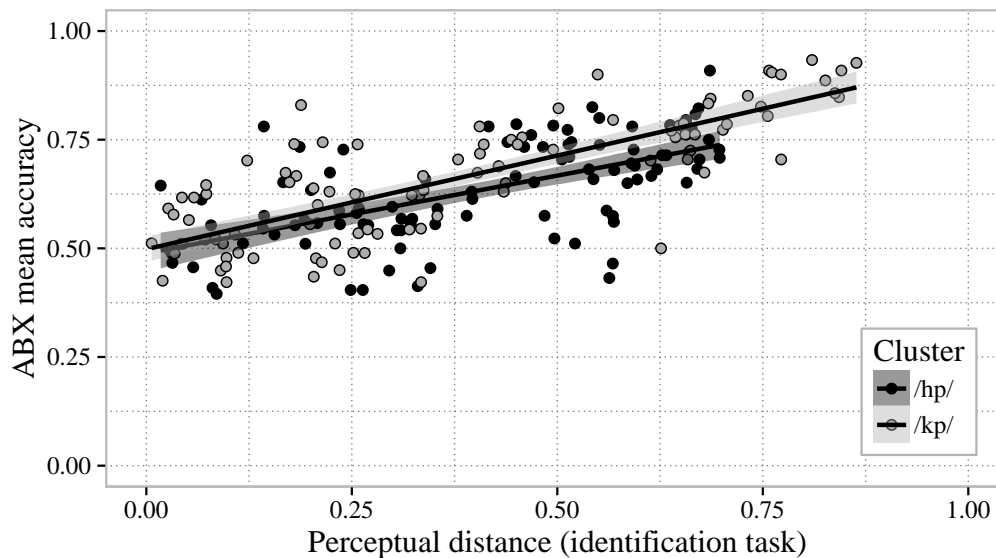

Figure 2.7: Correlation between the perceptual distance derived from the identification task responses and the accuracy at the ABX discrimination task.

## 2.3 Predicting epenthetic vowel quality from acoustics

The following section is a modified version of the following article:

Guevara-Rukoz, A., Parlato-Oliveira, E., Yu, S., Hirose, Y., Peperkamp, S., and Dupoux, E. (2017). Predicting epenthetic vowel quality from acoustics. *Proceedings of Interspeech*, 596-600.

Stimuli were designed and recorded by E. Parlato-Oliveira and E. Dupoux. Experimental and production data were collected by E. Parlato-Oliveira and Y. Hirose. Phonetic transcriptions were provided by S. Yu. Statistical analyses and exemplar-based models were run by A. Guevara-Rukoz. The initial manuscript draft was prepared by E. Dupoux, S. Peperkamp, and A. Guevara-Rukoz. E. Dupoux supervised the entirety of the study. Modifications with respect to the original paper: additional figures.

**Abstract** Past research has shown that sound sequences not permitted in our native language may be distorted by our perceptual system. A well-documented example is vowel epenthesis, a phenomenon by which listeners hallucinate non-existent vowels within illegal consonantal sequences. As reported in previous work, this occurs for instance in Japanese (JP) and Brazilian Portuguese (BP), languages for which the ‘default’ epenthetic vowels are /u/ and /i/, respectively. In a perceptual experiment, we corroborate the finding that the quality of this illusory vowel is language-dependent, but also that this default choice can be overridden by coarticulatory information present on the consonant cluster. In a second step, we analyse recordings of JP and BP speakers producing ‘epenthesized’ versions of stimuli from the perceptual task. Results reveal that the default vowel corresponds to the vowel with the most reduced acoustic characteristics and whose formants are acoustically closest to formant transitions present in consonantal clusters. Lastly, we model behavioural responses from the perceptual experiment with an exemplar model using dynamic time warping (DTW)-based similarity measures on MFCCs.



### 2.3.1 Introduction

When languages borrow words from one another, the borrowed words tend to be adapted to the local phonology. For instance, Brazilian Portuguese phonotactic constraints disallow most obstruent-obstruent and obstruent-nasal sequences, while those of Japanese disallow consonant clusters and consonants in coda position (with the exception of geminates and nasal consonants). Foreign words containing these illegal sequences may be broken up by the insertion of so-called ‘epenthetic’ vowels (e.g., BP: ”football” → /futibol/, JP: ”ice cream” → /aisukuri:mu/). This phenomenon has been shown to also happen during on-line perception: listeners *perceive* vowels within illegal consonantal sequences [Dupoux et al., 1999, Dehaene-Lambertz et al., 2000, Dupoux et al., 2001, Berent et al., 2007, Kabak and Idsardi, 2007, Monahan et al., 2009, Dupoux et al., 2011, Mattingley et al., 2015, Durvasula and Kahng, 2015]. This suggests that phonotactic constraints of the native language play an active role during speech perception and induce repair of illegal forms such that they are recoded into the nearest legal one. The specific mechanisms of this repair process are still largely unknown. In particular, what determines the quality of the epentheticized vowel? Past work has shown that perceptual epenthesis is language-dependent (e.g., /i/ in BP, /u/ in JP), but also that it may be influenced by local acoustic properties, i.e., by coarticulation [Dupoux et al., 2011]. Here, we study these two effects together, and report, firstly, on a perception experiment with BP and JP listeners. Next, we conduct acoustic analyses of the production of possible epenthetic vowels in a subset of the same participants. Lastly, we present an exemplar-based computational model of speech perception which attempts to model phonotactic repairs based on acoustics.

### 2.3.2 Perception experiment

We assess patterns of perceptual epenthesis by BP and JP native listeners on stimuli containing an illegal cluster. We investigate (1) the preferred epenthetic vowel in the two languages (/i/ vs. /u/), and (2) the influence of flanking vowels on responses.

#### 2.3.2.1 Methods

Fifty-four items with the structure  $V_1C_1C_2V_2$ , with  $V_1$  and  $V_2$  vowels from the set {/a/, /i/, /u/}, and  $C_1C_2$  a cluster from the set {/bg/, /bn/, /db/, /dg/, /gb/, /gn/}, e.g. /abgi/, were recorded by a native speaker of French. Twenty-two native BP listeners and 17 native JP listeners were tested in São Paulo and Tokyo, respectively. None had extensive exposure to languages that allow complex consonantal clusters. At each trial, participants heard a stimulus and had to indicate within 3 seconds which vowel from the set {/a/, /e/, /i/, /o/, /u/ and *none*} they perceived within the consonant cluster.

#### 2.3.2.2 Results

Statistical analyses were performed with the R statistical software [R Core Team, 2016], using MCMC glmm [Hadfield, 2010, Plummer et al., 2006]. Effects were considered statistically significant if the 95% highest posterior density (HPD) interval estimated for the variable of interest did not include zero. Please note that we only report effects relevant to hypotheses tested in this work. A full report of all analyses conducted in this section (as well as additional information) can be found in: <https://osf.io/zr88w/>.

In order to assess the influence of  $V_1$  and  $V_2$  (henceforth: flanking vowels) on epenthetic vowel quality (/i/ or /u/), we fitted models with fixed effects Language (BP *vs.* JP), Number of Same Flanking Vowels (NSFV) (*none vs.* 1; *none and 1 vs.* 2) and their interaction, with Participants as random effect. We also included the fixed effect Coronal  $C_1$  (non-coronal *vs.* coronal) and the resulting interactions when analysing /u/ responses, as the

insertion of default /u/ after coronal consonants yields phonotactically illegal sequences in Japanese. Fixed effects were contrast coded with deviance coding and, in the case of the trinomial variable NSFVs, comparisons were achieved by creating dummy variables "none vs 1" with weights [-0.5, 0.5, 0] for levels *none*, 1 and 2, respectively, and "Less than 2 vs. 2" with weights [-0.25, -0.25, 0.5] for levels *none*, 1 and 2.

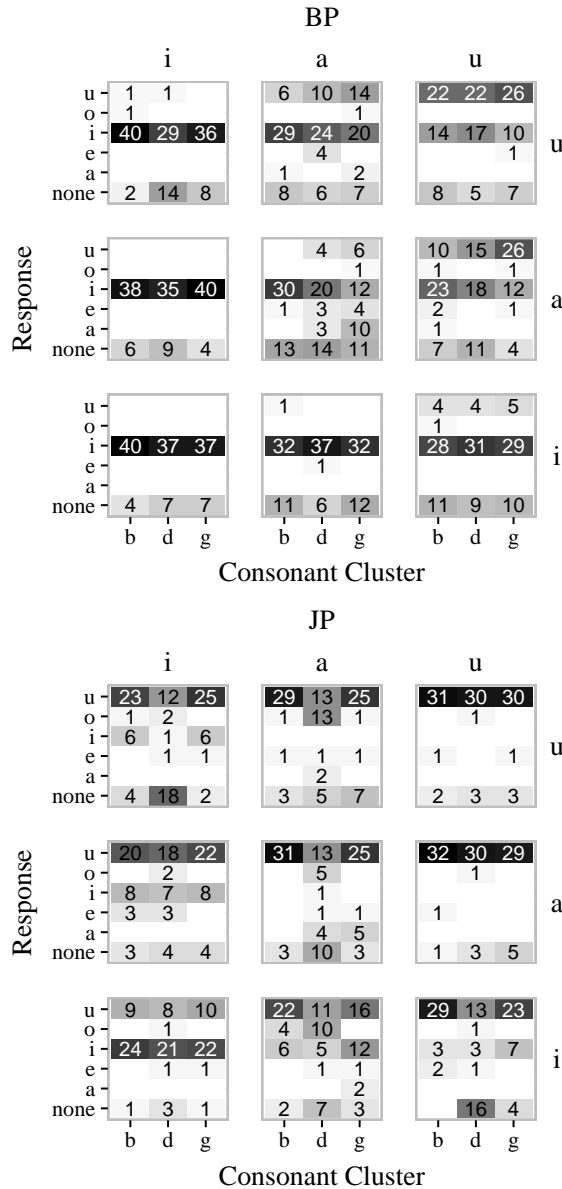

Figure 2.8: Responses for all trials from the perception experiment for both BP (top) and JP (bottom), including trials with responses not given by the exemplar model (“none”, “a”, “e”). Numbers indicate trial counts, with darker cell backgrounds representing higher values. Within each of the two 3 x 3 grid, trials are separated according to  $V_1$  (columns) and  $V_2$  (rows). Within each individual rectangle, the horizontal axis shows the first consonant of the consonant cluster, while the vertical axis corresponds to possible responses.

Response patterns are shown on Figure 2.8. Overall, BP and JP participants experienced vowel epenthesis in 81% and 87% of the trials, respectively. We focus our analysis on these trials and, in order to allow for comparisons with the model from Section 4 below,

we exclude trials for which the reported epenthetic vowel was /a/ (1%) or /e/ (BP: 1%, JP: 3%). Percentages for the remaining responses of interest (/i/, /o/, and /u/) can be seen in the lefthand part of Table 2.3.

Table 2.3: Percentage of responses.

	Human data			Model		
	i	o	u	i	o	u
BP	80.39	0.64	18.97	52.73	6.22	41.05
JP	18.37	5.64	75.98	49.34	0.13	50.52

**/i/-epenthesis** Figure 2.9 shows the proportion of /i/-epenthesis. A main effect of Language shows that BP participants perceived an epenthetic /i/ more often than JP participants (posterior mode:  $-277.1$ , HPD interval:  $[-389.2, -167.1]$ ). Moreover, the propensity to respond /i/ was influenced by flanking vowels, as indicated by a main effect of NSFV: Participants gave more /i/ responses when one flanking vowel was /i/ (204.1,  $[80.8, 283.7]$ ), and even more so when both flanking vowels were /i/ (368.9,  $[208.4, 443.4]$ ).

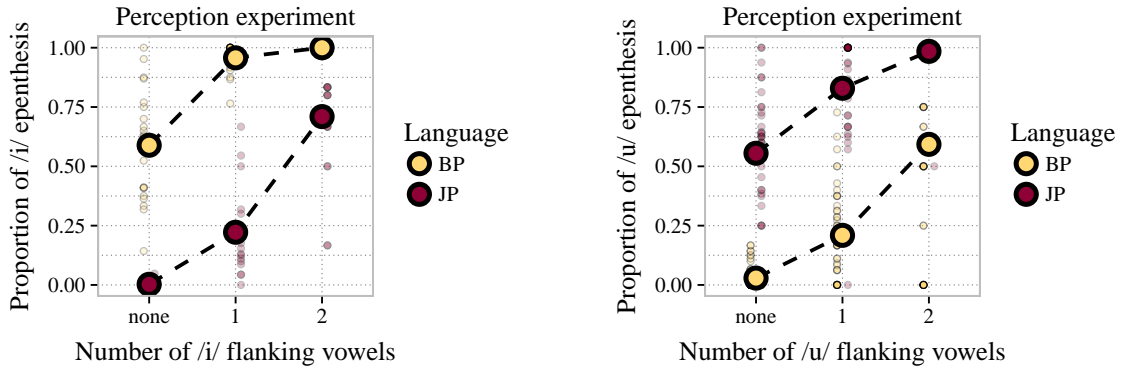

Figure 2.9: *Proportion of /i/-epenthesis (left) and /u/-epenthesis (right) exhibited by BP and JP participants in the perception experiment. Big dots show mean values, while smaller dots show individual values for human participants.*

**/u/-epenthesis** Figure 2.9 shows the proportion of /u/-epenthesis. We found a main effect of Language; BP participants epenthesized /u/ less often than JP participants (265.2,  $[191.0, 347.2]$ ). The significant main effect of NSFV shows that participants were overall more prone to perceiving an epenthetic /u/ if one (137.0,  $[90.6, 185.4]$ ) or both (300.3,  $[230.4, 387.7]$ ) flanking vowels were /u/. Lastly, there was also a main effect of Coronal  $C_1$  ( $-43.0$ ,  $[-75.8, -9.8]$ ): participants perceived /u/ less often after coronal than after labial and velar consonants. However, neither the interaction between Coronal  $C_1$  and Language ( $-63.9$ ,  $[-132.1, 3.0]$ ), nor the triple interactions with NSFV ( $-17.8$ ,  $[-124.9, 84.1]$ ,  $-14.8$ ,  $[-238.4, 304.3]$ ) were significant; thus, JP participants were not more prone to avoiding /u/-epenthesis after coronal consonants than BP participants.

### 2.3.3 Acoustic analyses

In both BP and JP, the shortest vowel corresponds to the default epenthetic vowel, i.e. /i/ in BP [Escudero et al., 2009] and /u/ in JP [Han, 1962]. Here, we compare epenthetic

vowels /i/, /u/, and /o/ on three acoustic parameters: (1) vowel duration, (2) vowel intensity, and (3) Euclidean distance between vowel formants and formant transitions in consonant clusters. We hypothesize that, for both languages, the default vowel is the one (1) that is shortest, (2) that has the lowest intensity, and (3) whose formants are closest to the formant transitions present in consonantal clusters.

### 2.3.3.1 Methods

Seventeen BP and 17 JP participants from the perception experiment were also recorded producing 162 stimuli obtained by crossing the 54  $V_1C_1-C_2V_2$  frames of the experimental items with the three vowels /i/, /o/, and /u/ (e.g. /ab\_gi/ → /abigi/, /abogi/, /abugi/). Items were read aloud in carrier sentences, with stress and pitch accent on the first syllable for BP and JP speakers, respectively. The recordings were manually segmented and transcribed by a trained phonetician. Recordings with errors or unwanted noise were excluded from the analyses. Acoustic measurements were automatically extracted from the speech signal using the R package wrassp [Bombien et al., 2016].

### 2.3.3.2 Results

For each of the continuous response variables examined in this section, we fitted an MCMC glmm with fixed effects Language (BP *vs.* JP), Medial Vowel (/i/ *vs.* /u/; /i/ and /u/ *vs.* /o/) and their interaction, with Participant and Item as random effects. Fixed effects were contrast coded with deviance coding and, in the case of the trinomial variable Medial Vowel, the comparisons were achieved by creating a dummy variable "/i/ *vs.* /u/" with weights [-0.5, 0, 0.5] for levels /i/, /o/ and /u/, respectively, and one for "High Vowels *vs.* /o/" with weights [-0.25, 0.5, -0.25]. Multiple pairwise comparisons, using Least Squares Means (LSMEANS) and Tukey's adjustment, were performed using the R package lsmeans [Lenth, 2016].

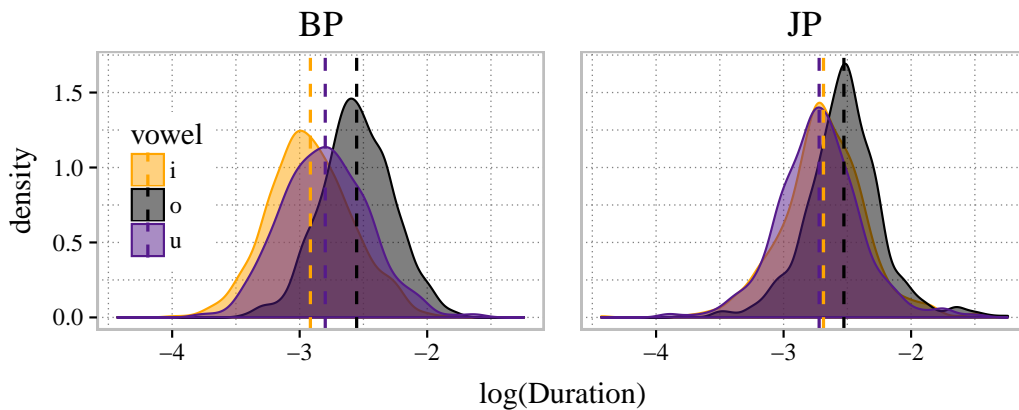

Figure 2.10: *Distribution of log'd vowel duration (in s) of medial vowels /i, o, u/ produced by BP and JP participants. Dashed lines show mean values.*

**Vowel duration** The measured duration of each medial vowel  $V_3$  (in seconds) was log-transformed to account for distribution skewness. The resulting distributions can be seen in Figure 2.10. We found a main effect of Medial Vowel ("i/ *vs.* /u/": 0.04, [0.02, 0.06]; "High Vowels *vs.* /o/": 0.32, [0.30, 0.34]), showing that, overall, /o/ is longer than /u/, which is longer than /i/. The interaction of Language and Medial Vowel was also significant ("i/ *vs.* /u/": -0.15, [-0.18, -0.10]), reflecting the fact that in BP, /i/ is shorter than

/u/ (mean /i/: 57.2 ms; mean /u/: 64.5 ms; adjusted  $p < 0.05$ ) while in JP, /u/ is shorter than /i/ (mean /u/: 69.6 ms; mean /i/: 72.0 ms; adjusted  $p < 0.05$ ).

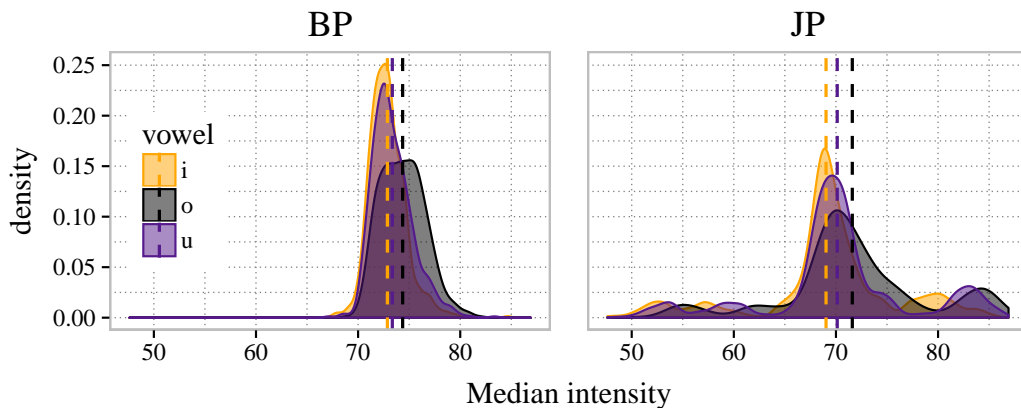

Figure 2.11: *Distribution of median intensity (in dB) of medial vowels /i, o, u/ produced by BP and JP participants. Dashed lines show mean values.*

**Vowel intensity** We compared the mean intensity of the medial vowels  $V_3$  in decibels (dB). The associated distributions can be seen in Figure 2.11. There was a main effect of Medial Vowel, with /i/ having on average lower intensity than /u/ (0.8, [0.7, 1.1]), and high vowels having lower intensity than /o/ (2.1, [1.9, 2.4]). Of interest is the fact that the former effect is larger for JP than for BP (Language  $\times$  "/i/ vs /u/": 0.38, [0.09, 0.90]), meaning that while /i/ is the vowel with least intensity in BP (mean: 72.8 dB vs. 73.2 for /u/; adjusted  $p < 0.05$ ), the reverse is not true for JP (mean: 69.7 dB for /u/ vs. 68.7 for /i/, adjusted  $p < 0.05$ ). This might be due to an overall higher degree of vocal constriction during the production of /i/ compared to /u/.

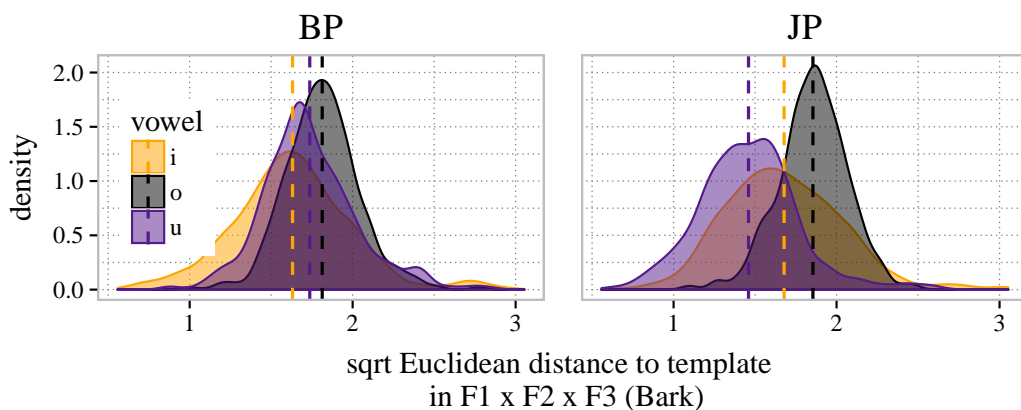

Figure 2.12: *Distribution of square root Euclidean distance to template in  $F1 \times F2 \times F3$  space (frequencies in Bark) of medial vowels /i, o, u/ produced by BP and JP participants. Dashed lines show mean values.*

**Vowel formants** We extracted median formant values (F1, F2, and F3, in Bark) from medial vowels  $V_3$  and computed their Euclidean distance to the transitions found within their respective clusters (e.g. the /i/ in /abiga/ was compared to transitions in /bg/ from

the French recording of /abga/). The resulting distributions can be seen in Figure 2.12. These Euclidean distances were square-root transformed to account for skewness. There was a main effect of Medial Vowel, as on average distance was shorter for /u/ than for /i/ ( $-0.06$ ,  $[-0.08, -0.04]$ ), while it was longer for /o/ relative to both /i/ and /u/ ( $0.28$ ,  $[0.25, 0.30]$ ). Of interest is the significant interaction between Language and Medial Vowel ”/i/ vs /u/” ( $-0.31$ ,  $[-0.36, -0.28]$ ), reflecting the fact that in BP /i/ formants were closer to cluster transitions than /u/ formants (mean: /i/ 2.8 vs. /u/ 3.1, adjusted  $p < 0.05$ ), while the reverse held in JP (mean: /i/ 2.9 vs. /u/ 2.2, adjusted  $p < 0.05$ ).

### 2.3.4 Production-based exemplar model

We built an exemplar model of the perception of phonotactically illegal consonant clusters by BP and JP listeners, exclusively based on acoustics. We used all participants’ productions from Section 3 as the inventory of exemplars available to our model. This is a simple way of representing the acoustics that a BP/JP native listener may have been exposed to during language development. As an analogy to the perception experiment from Section 2, the model classified each  $V_1C_1C_2V_2$  template as  $V_1C_1iC_2V_2$ ,  $V_1C_1oC_2V_2$ , or  $V_1C_1uC_2V_2$ , based on the similarity of the template to exemplars of these three categories available in the inventory. We examined whether the model was able to predict participants’ epenthetic patterns, in particular, whether it was able to mimic preferences for default vowels and capture the modulation of these preferences induced by flanking vowels.

#### 2.3.4.1 Methods

Recordings from Section 3 were converted into sequences of 39-dimensional feature vectors consisting of 12 Mel-frequency cepstral coefficients (MFCCs) and energy features<sup>4</sup>, with delta and delta-delta coefficients. Coefficient values were standardised. We computed the optimal alignment between all  $V_1C_1C_2V_2$  templates (e.g. /abgi/) and their corresponding  $V_1C_1V_3C_2V_2$  epenthesized versions (e.g. /abigi/, /abogi/, /abugi/) using Dynamic Time Warping (DTW) [Sakoe and Chiba, 1978, Giorgino, 2009]. In order to ensure that the resulting distances were not mainly influenced by spectral differences of flanking vowels  $V_1$  and  $V_3$ , we only compared  $C_1C_2$  clusters to  $C_1V_3C_2$  sections. Note, however, that coarticulation cues from flanking vowels are expected to be present within the clusters.

For the simulation, we built a classifier that assigns any given template to one category in the set  $\{V_1C_1iC_2V_2, V_1C_1oC_2V_2, V_1C_1uC_2V_2\}$ , based on acoustic similarity. Similarity  $s$  between templates and epenthesized versions was defined as

$$s = e^{-cd} \tag{2.1}$$

where  $d$  is the DTW distance, and  $c$  is a parameter determining the weight of the DTW distance on classification [Nosofsky, 1992]. When  $c = 0$ , DTW is disregarded and all possible classification categories are equally probable. Higher values of  $c$  result in higher probabilities being given to items with smaller  $d$ . In order to control for unequal number of tokens in each category, classification was performed by computing the mean similarity within each category. From there we sampled a classification label weighting category probabilities by the resulting mean similarity weights. Parameter  $c$  was individually optimised for each language by performing leave-one-out cross-validation (maximum accuracy: 0.50 with  $c = 0.5$  for BP, and 0.63 with  $c = 2.2$  for JP; chance level at 0.33).

<sup>4</sup>Due to a mistake in the feature computation pipeline, this meant that the log energy and the 12 first MFC coefficients were concatenated, not that the first coefficient of 13 coefficients was replaced by the log energy, as was originally intended.

### 2.3.4.2 Results

The same statistical models from Section 2, but without a random effect for Participant, were used.

The perception model was able to accurately predict participant responses for 59.1% (BP) and 58.4% (JP) of trials. Figure 2.14 shows a detailed distribution of the responses. As shown in the righthand part of Table 2.3, the model rarely predicted /o/ responses, as expected based on acoustic analyses; however, it is surprising that most /o/ responses were predicted for BP rather than for JP. This might be due to overlap of /u/ and /o/ in the formant space of BP, which is visible in Figure 2.13.

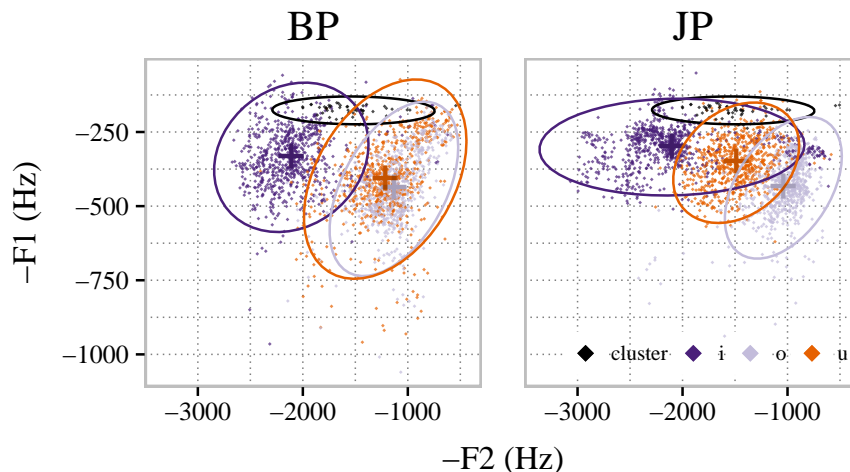

Figure 2.13: *Medial vowels and clusters in F1 x F2 space.*

Concerning /i/ and /u/, numerically the model predicted more /i/ responses than /u/ responses for BP, and the opposite for JP. However, these differences are not as clear as they are for our human data, where in both languages the default vowel is chosen four times more often than the non-default high vowel.

**/i/-epenthesis** The left panel of Figure 2.15 shows the proportion of /i/-epenthesis for human participants and the corresponding exemplar models. We found a main effect of Language ( $-52.0$ ,  $[-86.9, -23.8]$ ) and a main effect of NSFV (*none vs. 1*:  $93.3$ ,  $[53.0, 125.0]$ ; *Less than 2 vs. 2*:  $245.7$ ,  $[150.8, 328.2]$ ). Thus, our model is able to reflect the higher frequency of /i/ as epenthetic vowel in BP compared to JP participants, as well as the influence of flanking vowels on /i/-epenthesis in both BP and JP.

**/u/-epenthesis** The right panel of Figure 2.15 shows the proportion of /u/-epenthesis for human participants and the corresponding exemplar models. We found a main effect of NSFV (*none vs. 1*:  $37.8$ ,  $[16.0, 62.3]$ ; *Less than 2 vs. 2*:  $190.7$ ,  $[131.0, 240.6]$ ) but not of Language ( $-15.9$ ,  $[-50.2, 10.1]$ ). Thus, while our model was able to qualitatively reproduce the influence of flanking vowels on epenthetic vowel quality for /u/, it was unable to reflect the fact that JP listeners perceive /u/ more often than BP listeners.

There was also a main effect for Coronal  $C_1$  ( $-66.7$ ,  $[-95.6, -39.5]$ ) but no interaction of this effect with Language ( $40.2$ ,  $[-28.0, 91.8]$ ); similarly to the perception data, this reflects an overall lower propensity for the model to ‘epenthesize’ /u/ after coronal consonants. The triple interaction NSFV x Coronal  $C_1$  x Language was significant for both “levels” of NSFV ( $94.1$ ,  $[19.9, 210.6]$ ,  $525.8$ ,  $[275.5, 666.1]$ ). Closer inspection suggests that this reflected the model’s inability to predict higher percentages of /u/-responses by

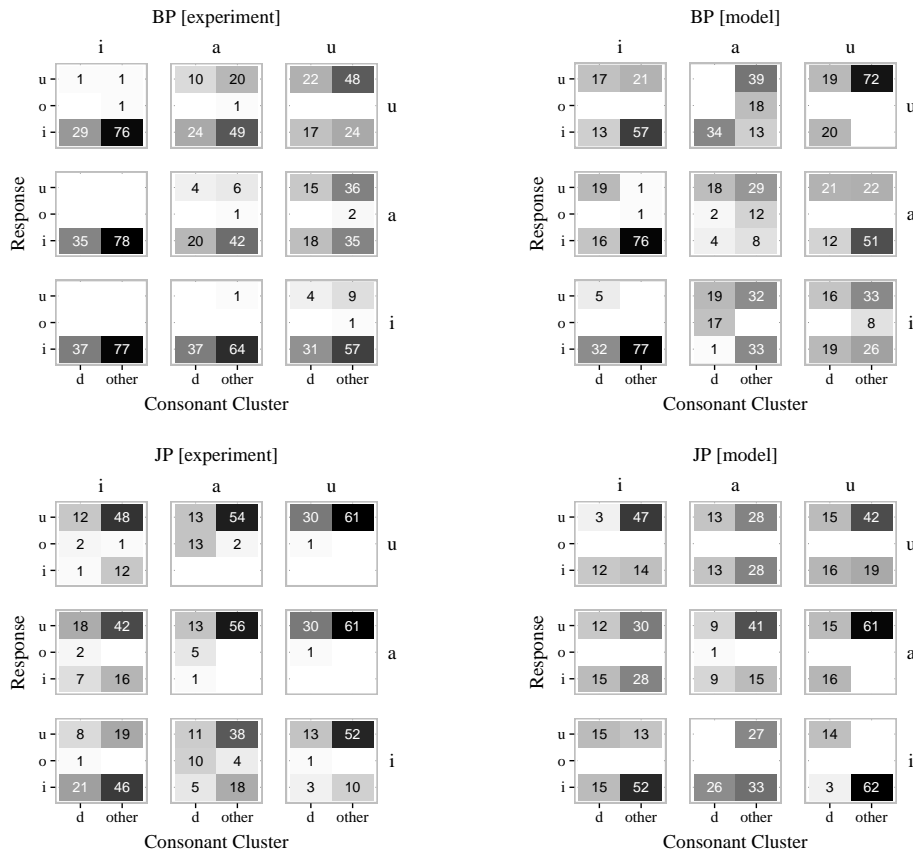

Figure 2.14: Responses from the perception experiment (left) and model predictions (right), for both BP (top) and JP (bottom), on trials common to the human and model experiments. Numbers indicate trial counts, with darker cell backgrounds representing higher values. Within each 3 x 3 grid, trials are separated according to  $V_1$  (columns) and  $V_2$  (rows). Within each individual rectangle, the horizontal axis relates to whether  $C_1$  is coronal (/d/) or not, while the vertical axis corresponds to possible responses. For instance, BP participants experienced /i/-epenthesis in all 78 trials involving /iC<sub>1</sub>C<sub>2</sub>a/ stimuli for which  $C_1$  was not the coronal consonant /d/.

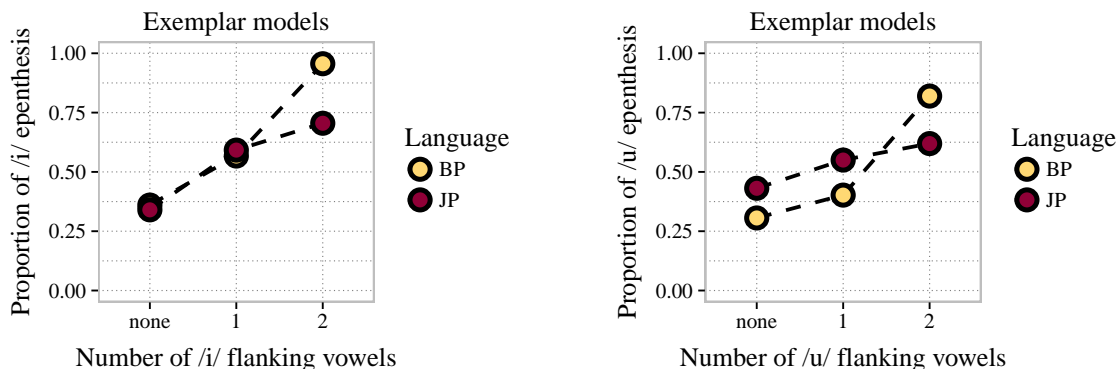

Figure 2.15: Proportion of /i/-epenthesis (left) and /u/-epenthesis (right) exhibited by exemplar-based models. Dots show mean values.



both BP and JP participants after coronal consonants when both flanking vowels were /u/.

### 2.3.5 Discussion

Examining epenthetic vowel quality preferences by BP and JP speakers in a perception task, we corroborated previous findings ([Dupoux et al., 1999, Dupoux et al., 2011]) that, like in loanword adaptations, the default epenthetic vowel during speech perception is /i/ for BP and /u/ for JP. Our acoustic analyses suggest that the choice of epenthetic vowel is acoustically driven. That is, in BP, /i/ is shorter and spectrally closer to the formant transitions in our stimuli than /u/ (and /o/), while the reverse holds in Japanese. As such, it may not be necessary to rely on phonological explanations of epenthetic vowel quality as in [Rose and Demuth, 2006, Uffmann, 2006], were we to find that these are shared characteristics of default epenthetic vowels in a variety of languages. We also found an influence of flanking vowels on epenthetic vowel quality, similar to what was reported in [Dupoux et al., 2011]. Indeed, participants gave fewer default responses when the quality of the flanking vowels was in disagreement with the default choice, resulting in more “vowel copy” epenthesis (i.e. perceiving a vowel of the same quality as that of a flanking vowel). Furthermore, we found that this effect of flanking vowels is additive, as it is even more prominent when both flanking vowels are of the same quality.

Interestingly, phonotactics did not influence JP participants’ responses as may have been expected; while /o/ was almost exclusively perceived after coronal consonants, this was almost always the case for stimuli with  $V_1 = /a/$  (cf Figure 2.8). In fact, for all combinations of flanking vowels, participants responded /i/ and/or /u/ more often than /o/ in coronal contexts, even though both /du/ and /di/ are phonotactically illegal sequences in JP. These results, which are reminiscent of previous work [Monahan et al., 2009, Mattingley et al., 2015], suggest that constraints on perception given by surface phonotactics can be overruled by constraints relative to matching input acoustics [Dupoux et al., 2011]. In fact, if this were not the case, novel sound sequences would have never arisen in JP loanwords (e.g. *party* is adapted as /parti/, not /partɕi/).

Finally, we presented results from one exemplar model per language, based on productions by BP and JP participants, respectively. These models reproduced some effects found in the perception experiment — mainly the influence of flanking vowels — although with a high level of noise. This noise level may be due to the relatively low number of tokens that were available as exemplars, the fact that the DTW procedure removes temporal cues (recall that we found that default vowels tend to be of shorter duration), and/or the fact that MFCC features do not appropriately capture speaker invariance. We interpret the results as providing a proof of principle that some of the salient effects regarding perceptual epenthesis can be accounted for on purely acoustic grounds. Future research is needed to improve on the model, whose predictions deviated from the perceptual data on several counts (e.g., 6% /o/-epenthesis for BP, but less than 1% for JP; failure to produce more /u/-epenthesis for JP than BP). These improvements could involve more phonetically and/or temporally informed features (e.g., spectrotemporal representations [Chi et al., 2005]), state-of-the art large-scale approaches with HMM or DNN systems, or physiologically-inspired models of speech perception (e.g., based on cortical oscillations [Hyafil et al., 2015]).

To conclude, a triple approach combining perception experiments, acoustic analyses, and modeling allows us to gain insight into the mechanisms underlying perceptual epenthesis, and, more generally, repairs of illegal phonological structure during speech perception.

## 2.4 Predicting epenthetic vowel quality from acoustics II: It’s about time!

### 2.4.1 Introduction

In the previous section we introduced a production-based exemplar model of perception for which input representations were solely acoustic. We used this relatively primitive model to simulate a perceptual experiment probing perceptual vowel epenthesis by BP and JP listeners. We showed that results from the model shared some qualitative similarities with those from the perceptual experiment, the most notable being the models’ ability to reproduce modulations of flanking vowels on the quality of the epenthetic vowel. Putting these results together with the main results from section 2.2 (i.e., higher influence of coarticulation than flanking vowel quality on epenthetic vowel quality), we concluded that modulations of epenthetic vowel quality such as those observed in our perceptual task and in [Dupoux et al., 2011] were due to acoustic details. On the other hand, the production-based exemplar models were not able to adequately reproduce effects related to default epenthetic vowels. Recall that for human participants we saw a majority of /i/- and /u/-epenthesis for BP and JP, respectively.

However, acoustic analyses of recordings made by native BP and JP speakers showed that default epenthetic vowels were not only the closest in formant space to acoustic cues contained in cluster transitions, but they were also the shortest vowels in the inventory /i, o, u/. As such, we can hypothesize that what is particular about default epenthetic vowels is not limited to their spectral characteristics; vowel duration may be as important, if not more, when computing the less costly vowel insertion. Viewing nonnative speech misperceptions as an optimisation problem, where the output is obtained by applying the phonetically minimal modification to the nonnative input [Peperkamp and Dupoux, 2003, Dupoux et al., 2011, Steriade, 2001], we can posit the importance of duration match. In the case of perceptual vowel epenthesis, where the output presents additional segments relative to the input, it would seem logical that, for hypothetically equal spectral properties, shorter segments would be preferred compared to longer segments. For instance, we wouldn’t expect JP listeners to epenthesize long vowels instead of short vowels.

We would therefore want our models to take duration mismatches into consideration when computing the similarity between the nonnative input and stored exemplars. This was not the case for models in section 2.3, because the distance between two items was computed using Dynamic Time Warping (DTW), which by design disregards duration mismatch. The goal of the following section was to introduce a duration-mismatch score that could be combined with the original distance score provided by DTW, in order to produce a distance metric that reflects both the spectral and durational proximity of two items.

Additionally, we performed various changes (highlighted throughout the methods section). Most notably, feature standardisation was performed by speaker in the version of the model described below, which in a way equates to the model being aware of speaker identity when computing item similarity. As a consequence, this newer version of the model is not purely acoustic, as it is a step towards speaker invariant auditory representations. Considering these changes, we will address the following questions: First, before even introducing a duration-mismatch penalty, can our newer models reproduce default epenthetic vowels and flanking vowel-related modulations of epenthetic vowel quality? Secondly, what about models with a duration-mismatch penalty?

## 2.4.2 Methods

### 2.4.2.1 Features

In order to ensure feature compatibility with future experiments (due to differences in file formats), features were recalculated using the Kaldi speech recognition toolkit [Povey et al., 2011], introducing slight changes regarding the parameters used in section 2.3. As in section 2.3, audio recordings of items used as stimuli in the perceptual experiment and those used for the acoustic analyses were converted into sequences of 39-dimensional feature vectors consisting of 13 Mel-frequency cepstral coefficients (MFCCs), with delta and delta-delta coefficients. In contrast to our previously used features, here our first coefficient did not correspond to the log of the total frame energy, but to the zeroth cepstral coefficient. Since the zeroth coefficient corresponds to the sum of the log of the 40 mel values, it is roughly equivalent to the log energy. We applied this change purely due to the change in the tools used for computing features.<sup>5</sup> Additionally, we added 3 coefficients (and their corresponding delta and delta-delta coefficients) adding pitch information to our features: normalized-pitch, delta-pitch, voicing-feature. The final 48 coefficient values were standardised to have zero-mean and unit-variance within coefficient and within each speaker.<sup>6</sup> While pitch features and delta and delta-delta coefficients were computed, their use in the model was evaluated according to whether performance was better or not during parameter optimisation (see below).

### 2.4.2.2 Classification

For the simulation, we built a classifier that assigns any given template to one category in the set  $\{V_1C_1iC_2V_2, V_1C_1oC_2V_2, V_1C_1uC_2V_2\}$ , based on acoustic similarity to the exemplars recorded by native speakers of BP and JP. We simulated the perception experiment by classifying each template  $n$  times,  $n$  being the number of total valid trials for that template in the perceptual experiment. Details of the classifier are given below.

**Dynamic Time Warping** As in section 2.3, we computed the optimal alignment between all  $V_1C_1C_2V_2$  templates (e.g. /abgi/) and their corresponding  $V_1C_1V_3C_2V_2$  epenthesized versions (e.g. /abigi/, /abogi/, /abugi/) using Dynamic Time Warping (DTW) [Sakoe and Chiba, 1978] with the R package *dtw* [Giorgino, 2009]. In order to ensure that the resulting distances were not mainly influenced by spectral differences of flanking vowels  $V_1$  and  $V_3$ , we only compared feature frames corresponding to  $C_1C_2$  clusters and  $C_1V_3C_2$  sections. Note, however, that coarticulation cues from flanking vowels are expected to be present within the clusters.

As input for the DTW distance computation at each speech frame, we used either the entire 48-dimensional feature vectors (MFCCs + pitch features + delta + delta-delta), or we omitted pitch features and/or delta + delta-delta coefficients. The final selection of the features to be used for our models was determined during parameter optimisation.

Concerning DTW specifics, in section 2.3 we used the commonly used step pattern for which, at position  $x_{i;j}$ , the only possible steps are towards positions  $x_{i+1;j}$  (horizontal step),  $x_{i;j+1}$  (vertical step), or  $x_{i+1;j+1}$  (diagonal step). In this default setting (named “symmetric2” in the R package *dtw*), a diagonal step is twice as costly as a horizontal or a vertical step, which favours template-query matches with compressions/stretching over

<sup>5</sup>As a reminder, however, due to a mistake when computing features in section 2.3, those unconventional features consisted of the log energy, the first 12 MFCCs (including the zeroth coefficient) and the corresponding deltas and delta-deltas.

<sup>6</sup>Normalisation had not been done within speakers in the previous version of the model, as we aimed to have acoustics-based models with the least amount of abstraction.

more direct matches. Therefore, in this section we chose to opt for a step pattern with the same three possible steps as before (i.e., horizontal, vertical, diagonal), but for which diagonal steps cost as much as horizontal/vertical steps on the final DTW distance. Since distances obtained with this step pattern (“symmetric1”) cannot be normalised by being divided by the sum of the lengths of the template and query, we normalise by dividing the cumulative distance by the length of the optimal path.

From the DTW we extract two values per template-query combination: (1)  $DTW_{dist}$ , the normalised DTW distance between the template and the query, and (2)  $DTW_{time}$ , the proportion of non-diagonal steps taken in the optimal path. This latter value, which was not present in the previous version of the model, is an indicator of the proportion of time dilation and time compression that was required to match the template and the query.

**Similarity function** We use the same similarity function as in section 2.3, inspired by the exemplar-based generalized context model (GCM) detailed by [Nosofsky, 1992], and make modifications to accommodate for the inclusion of the duration mismatch penalty  $DTW_{time}$ . Our goal is to classify the  $V_1C_1C_2V_2$  template into a category from the set of vowels /i, o, u/, through the similarity of the template to exemplars  $V_1C_1iC_2V_2$ ,  $V_1C_1oC_2V_2$ , and  $V_1C_1uC_2V_2$ , respectively. We obtain  $P(R_J|S_i)$ , the evidence favouring category  $J$  given stimulus  $i$ , by averaging the similarity of said stimulus  $i$  to all recorded exemplars of category  $J$ . Since we do not aim to introduce a language model to the exemplar model, as we want it to be based entirely on acoustics, we do not introduce a term for response bias for category  $J$ . All exemplars are weighted equally.

$$P(R_J|S_i) = \frac{\frac{1}{n_J} \sum_{j \in C_J} \eta_{ij}}{\sum_K \frac{1}{n_K} \sum_{k \in C_K} \eta_{ik}} \quad (2.2)$$

where  $n_J$  is the number of exemplars of category  $J$  and with  $\eta$  defined as in equation 2.3,

$$\eta_{ij} = e^{-c \cdot d_{ij}} \quad (2.3)$$

where  $c$  is a parameter determining the weight of  $\eta_{ij}$  on classification. When  $c = 0$ , DTW is disregarded and all possible classification categories are equally probable. Higher values of  $c$  result in higher sampling probabilities being given to items with smaller distance  $\eta_{ij}$ .

$\eta_{ij}$  is defined as in equation 2.4

$$\eta_{ij} = DTW_{dist} + \alpha \cdot DTW_{time} \quad (2.4)$$

where  $\alpha$  is a scaling factor for  $DTW_{time}$ . Setting  $\alpha = 0$ , gives an equation equivalent to the one used in section 2.3.

### 2.4.2.3 Parameter estimation

We used grid search in order to optimise parameter  $c$  for each language, as well as the format of our acoustic features. We classified all  $V_1C_1V_3C_2V_3$  exemplars from the BP and JP recordings in section 2.3 to a category within /i, o, u/ in a leave-one-out cross-validation method. Namely, we assessed the accuracy in the classification of these tokens with known labels, using the classification procedure described above: using DT, we measured their respective similarity to all other exemplars with the same  $V_1C_1 - C_2V_3$  skeleton, then for each we sampled the classification label from the three possible categories, weighting the sampling probability by the average distance to exemplars of the three categories.

We assessed the optimality of parameter values based not only on mean classification accuracy, but also by inspecting median classification accuracy. Indeed, while these

two measures are positively correlated, an improvement in median accuracy might not be obvious when inspecting mean accuracy alone. In other words, combinations of parameters with similar mean classification accuracy could differ greatly in median classification accuracy. As a curious side note, while we aimed to optimise parameters when setting  $\alpha = 0$  (baseline models with no duration penalty), increasing the value of  $\alpha$  during cross-validation with BP and JP recordings decreased classification accuracy. However, the resulting degradation in accuracy tended towards zero when increasing values of parameter  $c$  such as those chosen for this work.

We found that classification accuracy was worse when including pitch features, delta + delta-delta coefficients, and both, than when only using 13 MFCCs. Therefore, for all experiments in this section, the acoustic input given to our models consisted of 13-dimensional vectors. Concerning parameter  $c$ , we chose optimal values  $c = 60$  (mean accuracy: 64.6%; median accuracy: 1) for BP models, and  $c = 40$  (mean accuracy: 90.1%; median accuracy: 1) for JP models. This constitutes an improvement compared to the previous version of the model in section 2.3 (50% and 63% mean accuracy for BP and JP, respectively).

#### 2.4.2.4 Data analysis

Statistical analyses were performed with the R statistical software [R Core Team, 2016], using Markov chain Monte Carlo generalised linear mixed-models [Hadfield, 2010, Plummer et al., 2006]. These Bayesian models sample coefficients from the posterior probability distribution conditioned on the data and given priors. We used priors that are standard for mixed-effects multinomial models. Model convergence was assessed by visual inspection of trace plots and the Gelman–Rubin convergence diagnostic [Gelman and Rubin, 1992], using four chains with different initialisations. Effects were considered statistically significant if the 95% highest posterior density (HPD) interval estimated for the coefficient of interest did not include zero. We report both the posterior mode and the 95% HPD interval.

In order to assess the influence of  $V_1$  and  $V_2$  (henceforth: flanking vowels) on epenthetic vowel quality (/i/ or /u/), we chose as fixed effects for our models LANGUAGE (BP *vs.* JP, sum contrast coded) and NUMBER OF SAME FLANKING VOWELS (NSFV; considered as a continuous variable with values 0, 1, or 2 instead of a factor with 3 levels, in order to reduce the number of model parameters and promote convergence), as well as their interaction. As random intercepts we included CLUSTER and PARTICIPANT when analysing data from the perceptual experiment, and CLUSTER when analysing data from the exemplar models. We also added random slopes for LANGUAGE on CLUSTER, and NSFV on PARTICIPANT. The change in statistical models with respect to the previous section was motivated by a will to avoid coefficient inflation due to the sparsity of our data.<sup>7</sup> Because of these changes, we reanalysed the behavioural results using the same statistical model before analysing results from the exemplar models. This allowed a fairer comparison between effects observed in real and simulated datasets. However, we did not expect these results to be qualitatively different from those in section 2.3.

---

<sup>7</sup>Statistical models in section 2.3 had as fixed factors LANGUAGE, NSFV, CORONAL, all interactions, and random intercepts for PARTICIPANT (for the perceptual experiment only).

### 2.4.3 Results

#### 2.4.3.1 Re-analysing results from the perception experiment

**/i/-epenthesis** The left panel of Figure 2.16 shows the proportion of /i/-epenthesis for human participants, with data collapsed by  $C_1C_2$  cluster<sup>8</sup>. We report the results from our statistical analyses below, even though they are qualitatively equivalent to those presented in section 2.3. We found a significant main effect of LANGUAGE (mode:  $-6.33$ , HPD:  $[-7.94, -4.40]$ ), which reflects the fact that BP participants perceived an epenthetic /i/ more often than JP participants. The main effect of NSFV was also significant (mode:  $3.72$ , HPD:  $[3.30, 4.27]$ ); participants epenthesized /i/ more often when more flanking vowels were /i/. The interaction between the fixed effects LANGUAGE X NSFV was not significant (mode:  $-0.24$ , HPD:  $[-1.15, 0.76]$ ).

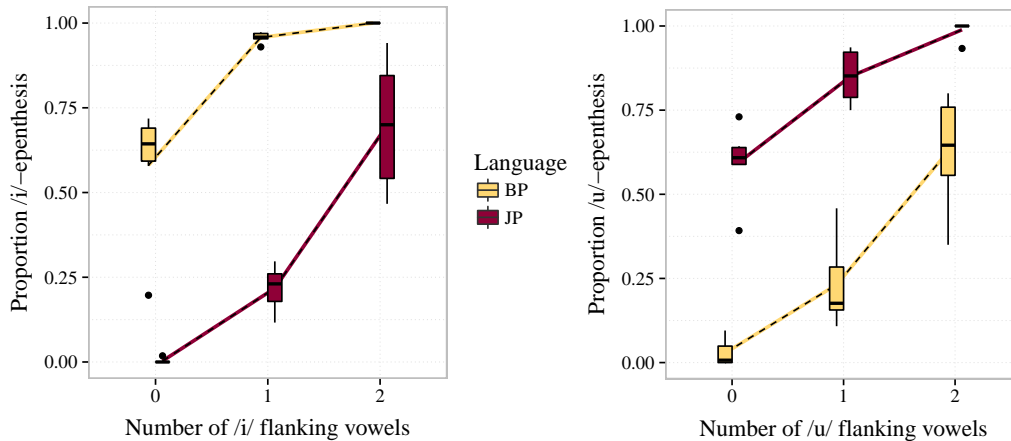

Figure 2.16: *Proportion of /i/-epenthesis (left) and /u/-epenthesis (right) exhibited by BP and JP participants in the perception experiment. The box and whiskers plots display the distribution of proportions across  $C_1C_2$  clusters (median, quartiles and extrema). Dashed lines connect mean values. This representation was preferred over showing distributions across participants, in order to have a direct visual representation of what our statistical models are evaluating, as well as to have the same amount of plotted datapoints for participants and models. Data plotted collapsed by participant can be seen in Figure 2.9*

**/u/-epenthesis** The proportion of /u/-epenthesis for human participants can be seen on the right panel of Figure 2.16. As for /i/-epenthesis, we report our results but they are qualitatively equivalent to results from section 2.3. We found a significant main effect of LANGUAGE (mode:  $5.06$ , HPD:  $[3.47, 6.41]$ ), reflecting the higher rates of /u/-epenthesis for JP participants compared to BP participants. The main effect of NSFV was also significant (mode:  $2.35$ , HPD:  $[2.02, 2.74]$ ); more /u/ flanking vowels yielded higher rates of /u/-epenthesis. The interaction between the fixed effects LANGUAGE X NSFV was not significant (mode:  $-0.57$ , HPD:  $[-1.30, 0.18]$ ).

#### 2.4.3.2 Exemplar models without duration penalty

We used our new exemplar models to simulate the perceptual experiment, setting  $\alpha = 0$ , effectively setting up models with no duration-mismatch penalty. The resulting classifica-

<sup>8</sup>Please note that, while based on the same data as Figure 2.8, here the datapoints correspond to clusters, not participants.

tion patterns can be seen in Figure 2.17.

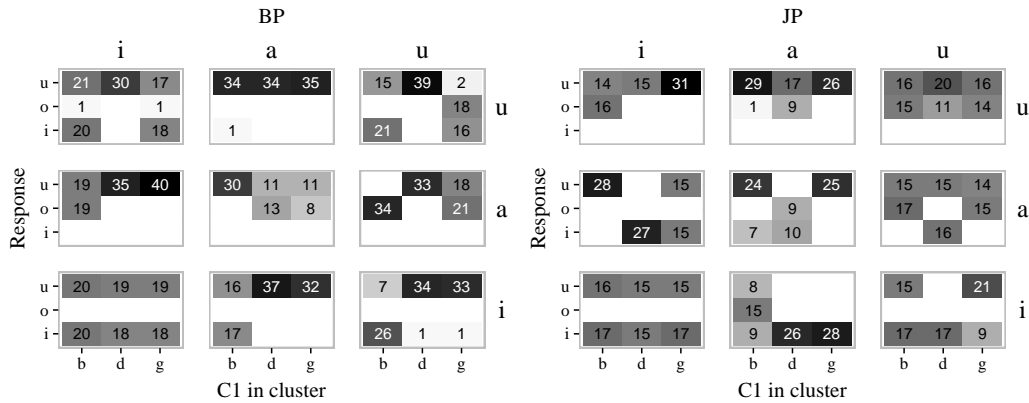

Figure 2.17: Responses given by exemplar models with no duration-mismatch penalty ( $\alpha = 0$ ) for BP (left) and JP (right). Numbers indicate trial counts, with darker cell backgrounds representing higher values. Within each  $3 \times 3$  grid, trials are separated according to  $V_1$  (columns) and  $V_2$  (rows). Within each individual rectangle, the cluster  $C_1$  is given by the horizontal axis, while the vertical axis corresponds to response categories. For instance, the BP model yielded /u/-epenthesis on 37 trials involving /adC<sub>2</sub>i/ items.

**/i/-epenthesis** The proportion of /i/-epenthesis given by these models is shown in Figure 2.18. The main effect of LANGUAGE was not significant (mode: 2.85, HPD: [-1.48, 8.70]); the models do not appear to reproduce the higher rates of /i/-epenthesis for BP than JP. We did, however, find a main effect of NSFV (mode: 2.04, HPD: [1.78, 2.35]); as for human participants, more /i/ flanking vowels result in higher rates of /i/-epenthesis by exemplar models with no duration penalty. The interaction between the fixed effects LANGUAGE x NSFV was not significant (mode: -0.26, HPD: [-0.91, 0.25]).

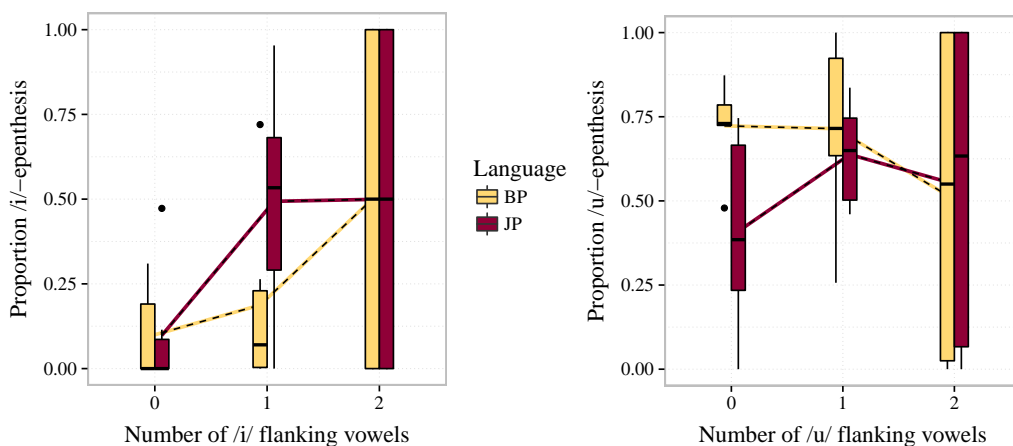

Figure 2.18: Proportion of /i/-epenthesis (left) and /u/-epenthesis (right) exhibited by BP and JP exemplar models with no duration penalty. The box and whiskers plots display the distribution of proportions across  $C_1C_2$  clusters (median, quartiles and extrema). Dashed lines connect mean values.

**/u/-epenthesis** The right panel of Figure 2.18 shows the proportion of /u/-epenthesis for exemplar models with no duration penalty. Neither the main effect of LANGUAGE (mode:  $-1.60$ , HPD:  $[-4.36, 1.16]$ ) nor the main effect of NSFV (mode:  $0.15$ , HPD:  $[-0.05, 0.34]$ ) were significant; the models do not appear to reproduce the higher rates of /u/-epenthesis for JP than BP, and they do not show significantly higher rates of /u/-epenthesis with more /u/ flanking vowels in general. However, the interaction LANGUAGE x NSFV was significant (mode:  $0.96$ , HPD:  $[0.57, 1.34]$ ). We therefore performed supplementary analyses to examine the effect of NSFV for each language independently. Using the R package *lme4* [Bates et al., 2015], for each language we fitted a generalised linear mixed model (GLMM) with a declared binomial dependent variable (/u/-epenthesis) with NSFV as the sole fixed effect and CLUSTER as a random effect. We assessed significance through model comparison with a null model without the main effect NSFV. For both the BP and the JP models, we found NSFV to be significant but with opposing effects; while the JP model yielded more /u/-epenthesis with more /u/ flanking vowels ( $\beta = 0.52$ ,  $SE = 0.12$ ,  $z = 4.48$ ,  $p < 0.001$ ), the BP model yielded less /u/-epenthesis with increasing numbers of /u/ flanking vowels ( $\beta = -0.44$ ,  $SE = 0.12$ ,  $z = -3.75$ ,  $p < 0.05$ ).

### 2.4.3.3 Exemplar models with duration penalty

**Adding the duration-mismatch penalty** In this experiment our aim was to examine, first of all, the effect of an increased duration-mismatch penalty on our models’ ability to mirror human performance at the perceptual task. Remember that, when performing parameter estimation with BP and JP items, increasing the weight of the duration-mismatch penalty  $DTW_{time}$  resulted in a decrease in classification performance. For our optimal values of parameter  $c$ , when changing from  $\alpha = 0$  to  $\alpha = 5$ , this difference was of 0.9% and 7.8% in mean classification accuracy, and 0 and 0.1% in median classification, for BP and JP, respectively. Apart from  $\alpha$ , all model parameters ( $c$ , feature coefficient selection) are set as for models without a duration-mismatch penalty.

In order to assess the effect of varying  $\alpha$  when simulating our non-native speech perception experiment, we computed the distance between response patterns given by human participants and models, for each item used in the experiment, while varying the value of  $\alpha$ . We did this by computing the Euclidean distance between  $[h_i, h_o, h_u]$  and  $[m_i, m_o, m_u]$ , vectors containing the proportion of /i, o, u/ responses given by humans and models, respectively, within each experimental item. We normalised distances in order to constrain their values to the interval  $[0, 1]$  (0 corresponding to identical response patterns). The variation of the distance between patterns as a function of  $\alpha$  can be seen in Figure 2.19.

Contrary to what we observed when classifying BP and JP items during parameter optimisation, we observe that increasing the weight of  $DTW_{time}$  increases the similarity between model and human responses until a certain value, after which the average similarity decreases. In order to examine the best case scenario for models that value duration match between templates and queries, we selected optimal  $\alpha$  values for BP and JP, based on the aforementioned response pattern similarity. Therefore, it should be noted that we select the best possible model for each language, and it is this fitted model that we will later analyse. Parameter values which minimise the distance between human responses and model responses were  $\alpha = 8$  for BP, and  $\alpha = 3$  for JP. The classification patterns obtained with these parameter values can be seen in Figure 2.20. We now turn to our main questions: Do these models better reflect default epenthetic vowel choice and flanking vowel influence than models based solely on spectral features and without duration-mismatch penalties?



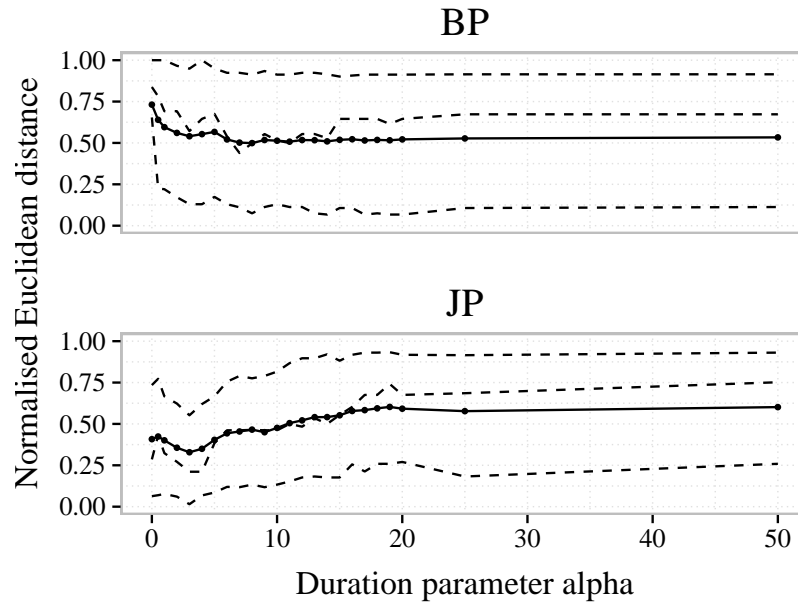

Figure 2.19: *Similarity between human and model responses for varying values of the duration-mismatch parameter  $\alpha$ . Solid lines display the mean similarity, dashed lines display the distribution of proportions across items (median and quartiles).*

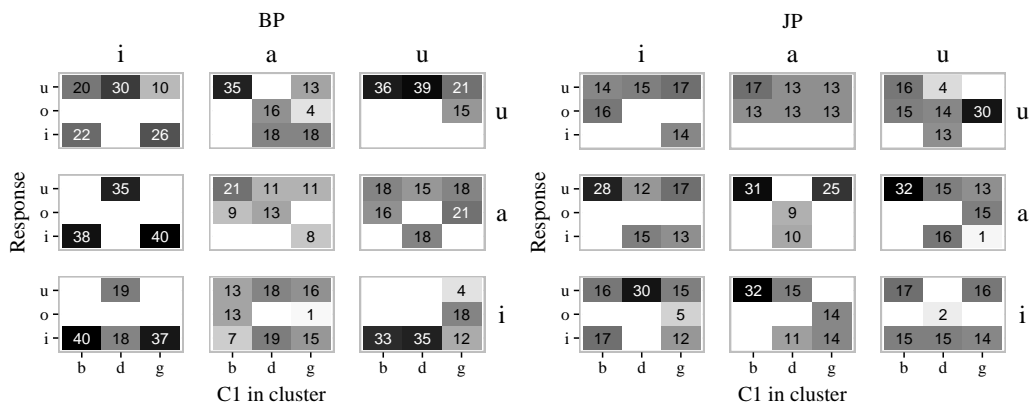

Figure 2.20: *Responses given by exemplar models with added duration-mismatch penalty for BP (left) and JP (right). Numbers indicate trial counts, with darker cell backgrounds representing higher values. Within each  $3 \times 3$  grid, trials are separated according to  $V_1$  (columns) and  $V_2$  (rows). Within each individual rectangle, the cluster  $C_1$  is given by the horizontal axis, while the vertical axis corresponds to response categories. For instance, the JP model yielded /u/-epenthesis on 28 trials involving /ibC<sub>2</sub>a/ items.*

**/i/-epenthesis** The proportion of /i/-epenthesis given by these models is shown in the left panel of Figure 2.21. The main effect of LANGUAGE was not significant (mode:  $-0.97$ , HPD:  $[-6.02, 2.40]$ ); the models do not appear to reproduce the higher rates of /i/-epenthesis for BP than JP. Note, however, the change in sign of the posterior mode and the shift in HPD interval towards more negative values, compared to values found for LANGUAGE when there was no duration penalty (mode:  $2.85$ , HPD:  $[-1.48, 8.70]$ ), reflecting the increase in /i/-epenthesis for the BP model (relative to JP) with the addition

of the duration penalty. If we look at the plot in Figure 2.21 it might seem surprising that the main effect of LANGUAGE is not significant. However, note that the interaction LANGUAGE X NSFV was significant (mode:  $-1.02$ , HPD:  $[-1.50, -0.47]$ ). The higher rates of /i/-epenthesis for the BP model relative to the JP model was estimated to be due to a greater effect of flanking vowel for the former. Additionally, we found a significant main effect of NSFV (mode:  $2.08$ , HPD:  $[1.80, 2.31]$ ); as for human participants, more /i/ flanking vowels resulted in higher rates of /i/-epenthesis by exemplar models with a duration penalty.

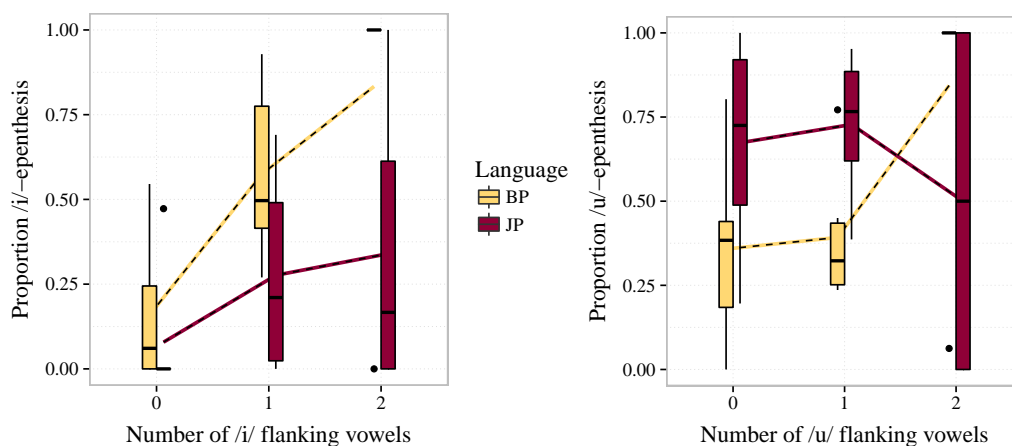

Figure 2.21: *Proportion of /i/-epenthesis (left) and /u/-epenthesis (right) exhibited by BP and JP exemplar models with duration penalty. The box and whiskers plots display the distribution of proportions across  $C_1C_2$  clusters (median, quartiles and extrema). Dashed lines connect mean values.*

**/u/-epenthesis** The proportion of /u/-epenthesis given by models with duration penalty is shown in the right panel of Figure 2.21. The main effect of LANGUAGE was significant (mode:  $2.38$ , HPD:  $[0.20, 4.36]$ ); models with duration penalty seem to reproduce the higher rates of /u/-epenthesis for JP than BP. The main effect of NSFV was also significant (mode:  $0.45$ , HPD:  $[0.23, 0.61]$ ); models with duration penalties reproduced the tendency to epenthesize /u/ more often with more /u/ flanking vowels. The interaction LANGUAGE X NSFV was also significant (mode:  $-1.21$ , HPD:  $[-1.61, -0.86]$ ).

## 2.4.4 Discussion

In this study we enhanced our production-based exemplar models of nonnative speech perception from section 2.3. Notable improvements include basic speaker adaptation, through speaker-specific standardisation of acoustic features. The newer version of the model, therefore, is not purely acoustic as it previously was. We also included the possibility to add a duration-mismatch penalty to be taken into consideration when computing the similarity between an item to be classified and exemplars used by the model for classification.

Because the statistical analyses were not identical to those in section 2.3, we re-analysed data from the perceptual experiment for a fairer comparison to the most recent version of our models. As expected, we found that BP listeners epenthesise more /i/ than JP listeners, while the opposite pattern is true with /u/-epenthesis. Participant responses are modulated by the quality of flanking vowels; more neighbouring /i/ and /u/ vowels lead to more /i/- and /u/-epenthesis, respectively, by BP and JP participants.

First we simulated the perceptual experiment with models that did not include a duration-mismatch penalty. The models were able to reproduce modulations of epenthetic vowel quality brought by flanking vowels, but they did not reproduce the higher prevalence of default epenthetic vowels. We then examined models with a duration-mismatch penalty. We did find that models with a non-null duration-mismatch penalty gave response patterns closer to that of human participants than when the penalty was absent. We then evaluated the best possible models that did incorporate a duration-mismatch penalty. As models with no duration-mismatch penalty did, these models exhibited higher rates of /i/- and /u/-epenthesis with more /i/ and /u/ flanking vowels, respectively. We also found an overall higher prevalence of /u/ for the JP model relative to the BP model, but the opposite situation with /i/ did not occur. However, the BP model seemed to be more “sensitive” to the effect of /i/ flanking vowels on /i/-epenthesis. Adding a duration-mismatch penalty appears to better approximate response patterns given by human participants in a task probing perceptual epenthesis.

One question that may arise is why adding the duration-mismatch penalty during the parameter optimisation stage (i.e., classification of BP/JP recordings in a leave-one-out method) did not increase classification accuracy if it did help approximating epenthesis patterns. It is difficult to pinpoint the exact reason. One possibility is that this is due to a difference in what “gold standards” for classification labels were in the two cases. During the experiments, a nonnative item was classified into one of three categories (/i, o, u/) by human participants. The classification labels correspond to what participants report hearing. However, for parameter optimisation, we used as labels what had been read by participants when recording the items. While the recordings were transcribed by a trained phonetician, it is not guaranteed that that label corresponds to what BP/JP listeners would report hearing. As a reminder, our items are nonwords, some of them with phonotactically illegal sound sequences (e.g., /aduga/ contains /du/, which is not phonotactically legal in Japanese). It is possible that BP and JP listeners might show variability in their classification of such stimuli.

In contrast, coming back to our experimental results, models that used duration mismatches seem to yield response patterns closer to those given by human participants, with flanking vowel modulations still being reproduced qualitatively. Yet even the best possible models were not able to correctly reproduce the prominence of default vowel epenthesis observed in psycholinguistic experiments. We expected duration mismatch to play an important role in the emergence of the default epenthetic vowel, since we found in section 2.3 that short duration is a characteristic shared by default vowels in JP and BP. We hypothesised that this short duration contributed to the insertion of these vowels being phonetically minimal. It is important to note that our models’ processing of duration can be further improved. Indeed, our models assess the percentage of DTW steps involving time dilation or contraction necessary to optimally align two items. Therefore, our models evaluate duration in absolute terms. It would be interesting for duration to be evaluated as something relative instead. For instance, we could take speech rate differences into consideration, or modulate vowel choice by also looking at how probable is the resulting duration of the consonants given the insertion of a vowel (i.e., consonant duration being allocated to said vowel). Modifications such as these would involve a higher level of abstraction than the one provided by our exemplar models, which simply compare two sequences of acoustic frames. Notably, they would require the introduction of discrete units (e.g., phonemes) when processing the acoustic input. Being aware of these limitations, we will later turn towards a very different family of models that allow for these modifications.

## 2.5 General Discussion

Similarly to what has been previously observed (e.g., [Dupoux et al., 1999, Dehaene-Lambertz et al., 2000, Dupoux et al., 2011, Monahan et al., 2009, Mattingley et al., 2015]), we find that BP and JP participants experience perceptual vowel epenthesis when presented auditory stimuli with illegal consonant clusters. For most cases, BP and JP participants insert what has been called a “default” epenthetic vowel, namely /i/ and /u/, respectively. Confirming intuitions laid out by [Dupoux et al., 2011] and reminiscent of the P-map theory in [Steriade, 2001], acoustic measurements revealed that these vowels were, within their respective languages, acoustically minimal in that they were of shorter duration and closer in formant space to cluster transitions than other candidate vowels.

In section 2.3 we were able to reproduce the effect of coarticulation on epenthetic vowel quality observed in [Dupoux et al., 2011], but this time using naturally produced stimuli. We find that the quality of epenthetic vowel is modulated by the identity of flanking vowels: we see more /u/-epenthesis by BP participants with more /u/ flanking vowels, and more /i/-epenthesis by JP participants with more /i/ flanking vowels. Were these modulations of epenthetic vowel quality due to coarticulation cues contained in the consonant clusters or were they due to a phenomenon of vowel copy based on phonological features as proposed by [Rose and Demuth, 2006, Uffmann, 2006]?

This question was addressed in section 2.2, by assessing the perception of stimuli for which the identity of the flanking vowels was in disagreement with that of the coarticulation cues contained within consonant clusters. It was found that, while both flanking vowel and coarticulation influenced epenthetic vowel quality, it was the latter that was the most determinant. This is reflected by the results of the exemplar models evaluated in sections 2.3 and 2.4. Indeed, these models compared the acoustics of non-native *CC* clusters to native *CVC* exemplars, in order to determine the quality of the vowel to be epenthesized. And while they were unable to mimic default vowel epenthesis, they *were* able to reproduce quality modulations due to neighbouring vowels. Yet, these models could not perform vowel copying in a way other than by exploiting coarticulation remnants within the clusters.

In section 2.3 we provided evidence that default epenthetic vowels are phonetically minimal both spectrally and at the level of duration. Yet we were not able to find evidence that these acoustic cues are sufficient for default epenthetic vowels to emerge, since our models were not able to mimic default epenthetic vowels. As previously stated, our proof of concept exemplar model is very limited, as it performs pure acoustic matching between *CVC* queries and a *CC* template. We showed that the models were not able to reproduce default vowel epenthesis even when taking duration into consideration or/and when adding basic speaker normalisation.

Adding to these concerns, it is important to mention that the model supposes the existence of “multiphonemic” (i.e., sequences of phonemes) exemplars to which the non-native input is compared to. Leaving aside the fact that the use of exemplar representations during speech perception may be controversial, an important side-effect of exemplar-based models is that they are unable to model lack of epenthesis. Yet we saw in both sections 2.2 and 2.3 that participants did choose the “no epenthesis” option in a non-negligible percentage of the trials. As such, in the next chapter we will focus on perception models that are flexible enough to also output illegal structures, as our participants do. Using these models we will continue investigating whether information readily available from the acoustic signal (i.e., phonetics) are sufficient to explain epenthetic vowel quality, or, rather, whether information relative to the frequency of sounds or sound combinations are necessary as well.

As a final reminder, our results are, as those by [Dupoux et al., 2011], better aligned

with one-step theories of non-native speech perception than with two-step theories. Indeed, the influence of acoustic details on epenthetic vowel quality would be lost if epenthesis occurred after an initial categorisation step; computation of the optimal output must therefore incorporate acoustics and phonotactics in a unique step. Following all of these considerations, in the future chapters we will switch from a one-step DTW-based exemplar model of non-native speech perception to more elaborate one-step Hidden Markov Models (HMM).

# Chapter 3

## Modelling speech perception with ASR systems

<b>3.1</b>	<b>Introduction</b>	<b>51</b>
3.1.1	Implementation of a one-step model	51
3.1.2	Is the acoustic match sufficient?	52
3.1.3	Chapter preview	53
<b>3.2</b>	<b>Anatomy of a HMM-based speech recogniser</b>	<b>54</b>
3.2.1	Corpora	54
3.2.2	Features	56
3.2.3	Acoustic models	58
3.2.4	Lexicon & language models	60
3.2.5	Lattices	61
3.2.6	Scoring: Assessing native performance	61
<b>3.3</b>	<b>Investigating the role of surface phonotactics</b>	<b>64</b>
3.3.1	Introduction	64
3.3.2	Experiment 1	65
3.3.3	Experiment 2	74
3.3.4	Discussion	79
3.3.5	Appendix	81
3.3.6	Bigram (phone-level) language model	84
3.3.7	Online and Retro language models	85
<b>3.4</b>	<b>Medley of epenthetic variations: Due to phonological processes or embedded in the phonetics?</b>	<b>87</b>
3.4.1	Introduction	87
3.4.2	Experiment 3: Variations due to native phonology	89
3.4.3	Experiment 4: Variations due to syllabic structure	94
3.4.4	Discussion	102
<b>3.5</b>	<b>General Discussion</b>	<b>105</b>

3.5.1	Language model contributions . . . . .	105
3.5.2	Model adequacy . . . . .	105
3.5.3	Predictive power of the acoustic model . . . . .	106
3.5.4	Model enhancements . . . . .	107
3.5.5	Data enhancements . . . . .	108
3.5.6	Conclusion . . . . .	109

## 3.1 Introduction

In the previous chapter we studied the use of exemplar-based computational models to investigate the underlying mechanisms of perceptual vowel epenthesis. While the exemplar-based models were able to reproduce modulations in epenthetic vowel quality due to coarticulation, they were unable to show a preference for default vowel epenthesis. More importantly, due to their non-parametric nature, they were entirely unable to output “no epenthesis” responses (or any response not in line with the available exemplars, for that matter). In this chapter, we will turn to parametric models, which are implementations of one-step theories of nonnative speech perception.

### 3.1.1 Implementation of a one-step model

Our experimental results from the previous chapter were supporting evidence for one-step models of nonnative speech perception, as opposed to two-step models. Recall that, according to one-step models, the perception process is a process of reverse inference in which the listener attempts to retrieve the most probable percept given the auditory evidence and language-specific phonotactic acceptability.

This proposal has been advanced by several authors [Dupoux et al., 2011, de Jong and Park, 2012, Wilson and Davidson, 2013, Durvasula and Kahng, 2015], yet as it often happens in the psycholinguistics literature, authors often fail to provide a well-defined implementable model that accurately conveys their theory. Fortunately, an mathematically-defined model of one-step nonnative perception was proposed by [Wilson and Davidson, 2013], allowing us to tweak and test this model empirically.

The proposal advanced by [Wilson and Davidson, 2013] falls within the Bayesian framework. According to it, the perceptual system computes  $P(w|X)$  the posterior probability of candidate percepts  $w$  given the auditory input  $X$ . These are estimated, for each candidate percept, from the product of  $P(X|w)$  the likelihood of the acoustics given the percept and  $P(w)$  the prior probability of the percept, defined as its phonotactic acceptability. Mathematically, this can be formulated as in equation 3.1. Then, in a maximum *a posteriori* (MAP) estimation scenario, the final percept  $\hat{w}$  corresponds to the percept with the highest posterior probability, as shown in equation 3.2. Alternatively, the final percept may be estimated by weighted sampling, where weights are defined by the posterior probabilities.

$$P(w|X) \propto P(X|w) \cdot P(w) \quad (3.1)$$

$$\hat{w} = \underset{w}{\operatorname{arg\,max}} \{P(X|w) \cdot P(w)\} \quad (3.2)$$

It so happens that a Bayesian approach is also used as the basis of models used in the field of automatic speech recognition. In this context, the speech recognizer’s decoder computes  $P(w|X)$  the posterior probability of possible words  $w$  given the acoustic input  $X$ . These are estimated, for each possible word in a lexicon, from the product of  $P(X|w)$  the likelihood of the acoustics given the word (i.e., the *acoustic model*) and  $P(w)$  the prior probability of the word, defined as frequencies of observation in the corpus used for training the model (e.g., the *language model*). Mathematically, this can be formulated exactly as in equation 3.1. Since more often than not, the goal of the recognizer is to only output the most probable transcription of an acoustic recording, the model retrieves  $\hat{w}$  the sequence of words with the highest posterior probability. This is also MAP estimation, as shown in equation 3.2. If the experimenter is interested, it is also possible to retrieve posteriorgrams from the model, which correspond to the posterior probabilities of a finite set of possible transcriptions.



As can be seen above, Bayesian speech recognizers can be used to implement the one-step proposal advanced by [Wilson and Davidson, 2013]. Importantly, since the acoustic model and the language model are separate modules that are combined in a unique optimisation step, it is possible for us to tweak them, independently, before subjecting the resulting models to experiments analogous to those used for testing nonnative speech perception in human participants. As such, we can use these models as tools for better understanding the mechanisms underlying perceptual vowel epenthesis.

### 3.1.2 Is the acoustic match sufficient?

As a continuation of the modelling work in the previous chapter (sections 2.3 and 2.4), in this chapter we will test the ability of a reverse inference model that only relies on acoustic match to account for patterns of speech perception. This is a special case of the model presented in equation 3.1, where the language model is uniform and does not intervene in the selection of the optimal percept. Considering that we have provided ample evidence of the role of acoustics in the previous chapter, we will assume that this is the most minimal testable version of the reverse inference proposal.

What exactly will we be testing in this chapter? In order to answer this question, let us reprise the dissection of the phenomenon of perceptual vowel epenthesis mentioned in the previous chapter:

1. When does epenthesis occur? (Variations in rates of epenthesis).
2. What vowel is epenthesized? (Variation in epenthetic vowel quality).

Various epenthetic patterns belonging to either of the questions above have been assumed to be the result of abstract phonological processes, from surface phonotactics to higher order grammar-related computations.

#### 3.1.2.1 Variations in rates of epenthesis

Concerning the first question, we can mention variation in rate of epenthesis resulting from cross-linguistic differences (e.g., [Dupoux et al., 1999, Dehaene-Lambertz et al., 2000, Berent et al., 2007, Kabak and Idsardi, 2007, Dupoux et al., 2011, Shin and Iverson, 2011, Durvasula and Kahng, 2015, Durvasula and Kahng, 2016, Durvasula et al., 2018], prosodic constraints [Kabak and Idsardi, 2007, Durvasula and Kahng, 2016], difference in markedness (e.g., [Berent et al., 2007, Zhao and Berent, 2018])).

But what if the elements triggering these processes are embedded in the acoustic signal, available for direct retrieval? For instance, acoustic details have been shown to modulate rates of epenthesis both in perception [Peperkamp et al., 2008, de Jong and Park, 2012] and production [Wilson and Davidson, 2013, Wilson et al., 2014]. So, while we often include phonotactics as intrinsic to the very definition of vowel epenthesis, could their role be of lesser importance than previously thought?

#### 3.1.2.2 Variations in epenthetic vowel quality

For the second question, the following effects have at least been partially given phonological explanations: cross-linguistic variations in default epenthetic vowel quality (e.g., [Dupoux et al., 2011, Guevara-Rukoz et al., 2017b]), variations due to neighbouring vowels, possibly due to phonotactics [Mattingley et al., 2015] or reverse inference of phonological rules [Durvasula and Kahng, 2015, Durvasula et al., 2018].

Again, what if these processes are directly triggered by information contained in the acoustic signal? For instance, we saw that default epenthetic vowels tend to be phonetically

minimal in their respective language-specific inventories [Guevara-Rukoz et al., 2017b] and are targets for further minimalisation processes such as vowel devoicing [Dupoux et al., 2011]. Our exemplar-based models in the previous chapter were not able to reproduce default vowel epenthesis, leaving us with uncertainties about the need for a phonological explanation in spite of the aforementioned acoustic hints. Do our parametric ASR models reproduce this effect?

### 3.1.3 Chapter preview

In this chapter we will investigate the use of ASR systems as perceptual models in order to tackle three main questions:

- Are speech recognizers a suitable tool for modelling nonnative speech perception within a one-step framework?
- What is the relative contribution of the language model to patterns of vowel epenthesis? Are phonotactics really needed to explain epenthetic patterns?
- Can the acoustic model alone account for processes attributed to phonology?

In **section 3.2** we will present the architecture of our ASR models in more detail. We will expose the various steps and models necessary to build the models, including the speech data used for training, how the information is extracted from the speech and represented in a more accessible and informative format, what the acoustic and language models are in practice, and how they are combined to decode (i.e., transcribe and align) the speech input.

In **section 3.3** we examine if combining  $n$ -gram-based language models with our acoustic models better approximates human perception than if using the acoustic model alone. To do, we present a novel manipulation of Weighted Finite State Transducers (WFST), traditionally used in the software Kaldi [Povey et al., 2011] to graphically define language models (among other components of the speech recognizer). This allows us to simulate psycholinguistics paradigms used to probe nonnative speech perception, including vowel epenthesis. We evaluate the various combinations of acoustic and language models by comparing their results to a gold standard, which is given by results from behavioural experiments described in sections 2.2 and 2.3.

In **section 3.4** we investigate a medley of epenthetic patterns attributed to underlying higher order phonological processes. We test the hypothesis that these may result from listeners incorrectly mapping the incoming acoustic signal to phonetic categories that do not correspond to the parsing intended by the nonnative source. More specifically, we study the predictive power of the acoustic model alone on cross-linguistic differences in rates of vowel epenthesis between English and Korean listeners, increased non-default /i/-epenthesis after palatal consonants in Korean, and word position-dependent differences in epenthesis by English listeners. We reprise the methodology from section 3.3 to address these phenomena.

## 3.2 Anatomy of a HMM-based speech recogniser

For the experiments described in this chapter we used Hidden Markov Model (HMM)-based speech recognisers as models of human perception. Speech audio waveforms are transformed into a sequence of **acoustic vectors**  $X_{1:T} = x_1, \dots, x_T$  in the first step, called feature extraction. In the decoding phase that follows, the trained ASR system attempts to find the sequence of words  $w_{1:L} = w_1, \dots, w_L$  which is most likely to have produced the sequence of acoustic feature vectors  $X$ . Mathematically, this equates to solving the following equation:

$$\hat{w} = \underset{w}{\operatorname{arg\,max}} \{P(w|X)\} \quad (3.3)$$

In terms of Bayesian inference,  $\hat{w}$  is the word whose posterior probability given the observed acoustic vectors  $P(w|X)$  is maximal. To facilitate modelling, this posterior probability is broken down into two components using Bayes theorem, as shown in equation ??.

$$\hat{w} = \underset{w}{\operatorname{arg\,max}} \{P(X|w)P(w)\}^1 \quad (3.4)$$

The likelihood  $P(X|w)$ , given by the **acoustic model**, is the probability of the acoustics given the sequence of words. The prior  $P(w)$ , given by the **language model**, corresponds to the probability of the word sequence, and can be derived from frequency counts. These probabilities can be extracted by training our ASR system using annotated speech corpora.

Nowadays, in the field of ASR, Neural Network (NN)-based speech recognisers are the state-of-the-art. In spite of better performance of NN-based ASR systems, we decided to use HMM-based recognisers, which are better understood than NNs while still offering good speech recognition performance. This results in vast availability of standard training and test procedures, which are reliable, well documented and implemented in open-source software packages like Kaldi [Povey et al., 2011].

Importantly for our experiments, HMMs offer a clear separation between the acoustic model (AM; i.e., mapping between phoneme categories and acoustics) and the language model (LM; i.e., frequencies of word/phoneme sequences). This allowed us to test ASR systems with different LMs while keeping the AM constant, as well as adapting LMs to mimic the experimental paradigms used when testing human participants.

We will now present the necessary components for building an HMM-based ASR system, namely the speech corpora used to train and test the system and its featural representation, as well as the decoder itself, composed of an acoustic model, a lexicon, and a language model. The interaction of these elements is depicted in Figure 3.1. In the following subsections we will present the components in more detail.

### 3.2.1 Corpora

In order to train and test our ASR system, we required transcribed speech corpora. These corpora consisted of speech recordings which have been annotated; for each utterance, we have a more or less detailed transcription of what was said. While the ideal annotation is one for which phoneticians have provided phoneme categories (or even phones), as well

<sup>1</sup>In practice  $P(X|w)P(w)$  is often computed in the log space as  $\alpha \log P(X|w) + \log P(w)$ , where  $\alpha$  is a scaling factor called acoustic scale (set to 0.1 in our models). Having  $\alpha < 1$  results in down-weighting the influence of the acoustic model relative to that of the language model. This deviation from strict Bayesian inference is traditionally used in ASR because in this context language models tend to be more reliable than the acoustic models.

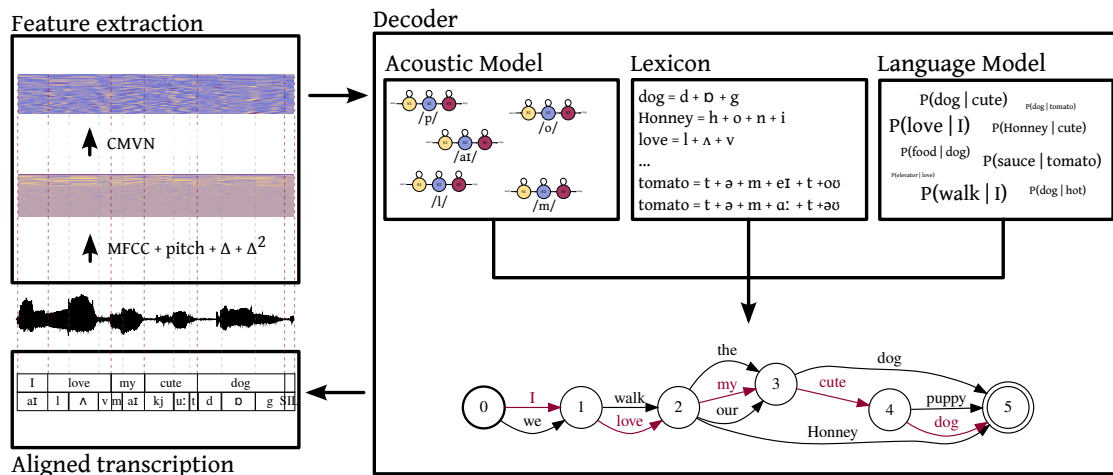

Figure 3.1: *Architecture of our ASR system, including its input (acoustic features) and output (transcription).*

as their boundaries, often we might only have access to by-utterance annotations where we are only provided with a sequence of words/phonemes for each utterance. In these cases, we rely on forced alignment, and maybe also a phonetic dictionary mapping word to phonemes, to automatically find phoneme boundaries.

In the following sections we have trained ASR systems with different “native” languages, namely Japanese (JP) and Korean (KR). These languages were of particular interest because of their relatively restrictive phonotactics with regards to consonant clusters, as well as the availability of corpora of spontaneous speech, which we will now present. We also trained an American English (EN) corpus in order to evaluate our model’s performance with respect to state-of-the-art systems.

**Corpus of Spontaneous Japanese (CSJ)** The CSJ [Maekawa, 2003] contains recordings of spontaneous Standard Japanese. The corpus is composed of two subparts: (1) academic presentation speech (APS), which consists of live recordings of academic presentations, and (2) simulated public speech (SPS), where speakers presented everyday topics in front of a small audience. For our models we only kept SPS, which is more representative of everyday conversations at the level of the lexicon, and has a more balanced population than the young, male-dominated APS. Recordings were manually transcribed by native speakers of Japanese using Japanese syllabaries, which meant that the phonetic transcriptions only included phonotactically legal phoneme sequences, even in cases where the actual acoustics might have been closer to illegal sequences. Phoneme boundaries were manually adjusted; however, this alignment was not used when training our models, as it was only available for a subset of the data that we used. Our subset of the corpus contained 400,547 utterances produced by 594 speakers<sup>2</sup> (331 female, 263 male), with an average of 674.3 utterances per speaker. The division of the corpus across training, validation, and test set are shown in Table 3.1.

<sup>2</sup>For the CSJ and KCSS, we used utterances from the same speakers for the validation and test sets, but their data was not seen during model training. For the WSJ, data from all speakers was used in the 3 corpus subsets, due to a planned comparison to another corpus not described here. Since the speakers that we used in our experiments are not from any of the corpora, this is not an issue. However, it needs to be kept in mind that error rates (%WER and %PER) for KCSS, CSJ, and WSJ are only comparable within corpus.

Table 3.1: Datasets used for training and evaluating the Japanese ASR system with the CSJ.

	Proportion	# Utterances	Duration (hh:mm:ss)	# Speakers
train	80%	322,208	152:26:33	475
valid	5%	19,566	9:12:03	119
test	15%	58,773	27:19:14	119

**Korean Corpus of Spontaneous Speech (KCSS)** The KCSS [Yun et al., 2015] consists of recordings of spontaneous Seoul Korean. Forty speakers aged 10 to 49 (5 female speakers and 5 male speakers per decade) were recorded in a quiet room, for approximately 1 hour each. Speech was elicited through questions related to the speakers’ personal opinions, habits, acquaintances, etc. Recordings were manually transcribed by native speakers of Korean. We used phonetic transcriptions faithful to actual pronunciations which, for instance, include phonetic reduction (akin to *yesterday* being transcribed as /jɛʃɛr/ instead of the canonical /jɛstɚdeɪ/). The transcription process involved the use of the main writing system of Korean (i.e., hangul) as well as a romanization, meaning that there is a possibility that acoustic sequences closer to phonotactically illegal sequences might have been transcribed as phonotactically legal counterparts. Transcriptions include manually adjusted phoneme boundaries, as well as word syllabification; however this alignment was not used when training our models, to be consistent with how other corpora were aligned by forced alignment. The corpus contains 57,504 utterances produced by 40 speakers (as explained above), with an average of 1,437.6 utterances per speaker. The division of the corpus across training, validation, and test sets is shown in Table 3.2.

Table 3.2: Datasets used for training and evaluating the Korean ASR system with the KCSS.

	Proportion	# Utterances	Duration (hh:mm:ss)	# Speakers
train	80%	46,208	18:58:15	32
valid	5%	2,824	1:16:39	8
test	15%	8,472	3:54:15	8

**Wall Street Journal - Read (WSJ)** The WSJ [Paul and Baker, 1992] is a corpus of both read and spontaneous American English. For our work, we only kept the read subset of the corpus, which consisted of recordings of read news articles. Contrary to the CSJ and KCSS, the recordings were not phonetically transcribed. However, we had access to the news articles themselves, as well as to a dictionary which mapped the standard phonetic pronunciation of words in American English to the words in the articles. In total, 338 speakers read 71,037 utterances, with an average of 210.2 utterances per speaker. The division of the corpus across training, validation, and test sets is shown in Table 3.3.

### 3.2.2 Features

In order for our ASR systems to be able to use speech as input, it is necessary to perform signal processing. This procedure transforms the continuous raw speech waveform into sequential speech features. This latter form ensures a more informative representation of

Table 3.3: Datasets used for training and evaluating the American English ASR system with the WSJ corpus.

	Proportion	# Utterances	Duration (hh:mm:ss)	# Speakers
train	80%	56,872	115:18:46	338
valid	5%	3,661	7:24:22	338
test	15%	10,504	21:12:19	338

speech, the content of which is made more accessible and easier to model. This is done by the feature extraction process mirroring early auditory processing in humans [Schatz, 2016].

In this work we used Mel-frequency cepstrum coefficients (MFCC), traditionally used for HMM-based ASR systems.

Speech is recorded with a microphone; the continuous audio signal is digitalized at a sampling rate of 16kHz. The audio is then segmented into frames of 25 ms, with a shift of 10 ms between the beginning of each frame. By using frames, we make the assumption that the signal is stationary within the 25 ms window, and we apply the following processing steps to each frame, using Kaldi [Povey et al., 2011]:

1. Pre-processing: The data is extracted and pre-processed (dithering, pre-emphasis, and DC offset removal).
2. Windowing: The data in the 25 ms frame is multiplied by a tapered window (Hamming window), to avoid discontinuities at the edges of the segment.
3. Spectral analysis: By applying a Fast Fourier Transform (FFT), we find out how much energy there is at each frequency band for this frame.
4. Nonlinear frequency scaling: In order to compensate for the fact that human hearing is less sensitive to higher frequencies, frequencies are mapped onto a Mel scale, which is linear until approximately 1000 Hz and logarithmic afterwards. This is done by applying a mel-filter bank with 23 bins, which are equally spaced in the mel-frequency domain. Each filter summarises the amount of energy in a section of the range of frequencies.
5. Cepstral analysis: The log of the energy in each bin is computed, from which we take the cosine transform. We keep 13 MFCCs, including  $c_0$ , the zeroth coefficient which represents the average of the log-frequency of the bins [Gales et al., 2008].
6. Cepstral liftering: Coefficients are scaled, ensuring that they have a reasonable range.

We therefore obtain 13 MFCCs that summarise the information at each frame of audio. To these coefficients, we add 3 coefficients carrying information about pitch: normalized-pitch, delta-pitch, voicing-feature<sup>3</sup>. To these 16 static features we add their respective dynamic features ( $\Delta$  and  $\Delta^2$ ) that describe the evolution of the coefficient values over time. Coefficient values are then standardised using Cepstral Mean Variance Normalisation (CMVN); for each speaker the distribution of each coefficient’s values has a mean value of zero and a variance of one.

<sup>3</sup>Information about pitch was added because of its contrastive relevance in Japanese at the lexical level (i.e., pitch accent) and in Korean at the phonemic level (e.g., tonogenesis in the three-way contrasts of plosives). In practice, adding pitch features resulted in a slight improvement of model performance in Japanese (from 41.3% WER to 39.6%; acoustic model with 6000 Gaussians).

### 3.2.3 Acoustic models

Now that we have extracted the acoustic features for the labelled utterances in our corpus, we are able to train the acoustic model (AM). Recall that the AM gives the likelihood  $P(X|w)$ , which corresponds to the probability of the acoustics given the sequence of words  $w$ . In order to simplify things, let's not view an utterance as a sequence of words which are sequences of phonemes themselves, but directly as a sequence of phonemes. Then, we consider the probability of the acoustics  $X$  given the sequence of phonemes  $W$ . The acoustics corresponding to a given phoneme change during the duration of the phoneme; as such, phones are not static objects but they should be described as having acoustic trajectories. By using Hidden Markov Models (HMM), we can approximate these trajectories as sequences of static states. A priori, the more states, the better the approximation to the real data. However, empirically it has been assessed that having three states is a good compromise for ASR systems. Following this, we chose to model phonemes as three-state HMMs, where the states correspond, respectively, to the beginning, middle, and end portions of the phoneme. This is particularly relevant for phonemes that can be viewed as sequences of discrete articulatory events with distinct acoustic signatures, such as plosives (e.g., /p/) which are often described as an airway closure, followed by a period of occlusion and a possibly audible release. Additionally, the separation into three states allows to account for the fact that the acoustics of the beginning and end of a phoneme may be differently affected by neighbouring phonemes (i.e., coarticulation) in comparison to the medial part.

As their name suggests, HMMs follow a Markovian process; the value of a state only depends on the value of the previous state. The transitions between states are defined by transition probabilities not only between adjacent states, but also within a state itself (i.e., self-loops). These transition probabilities are defined during AM training, based on the transitions between frames in the training corpus. While the duration of phonemes cannot be explicitly learned by the acoustic model, they are implicitly reflected by the transition probabilities in the self-loops: for a given state, the higher the self-loop probability, the longer the model will “remain” at said state and the longer the sequence of acoustic vectors assigned to the corresponding phoneme. A simplified illustration of a phoneme HMM is shown in Figure 3.2.

In sum, each phoneme is modelled by a left-to-right 3-state HMM. But what exactly is a state? Our acoustic models are HMM-GMMs, where GMM stands for Gaussian Mixture Model. Our 48-dimensional feature vectors define a 48-dimensional space where the acoustic model searches for the optimal GMMs needed to describe the three states of each phoneme. In order to better explain what we mean by this, let us focus on the box labeled “GMM” in Figure 3.2. In this simplified graphical example, the feature space is 2-dimensional, but the same concepts are transposable to our 48-dimensional space. Here we represent acoustic frames obtained during the feature extraction step as (not yet coloured) dots. Each acoustic frame exists in the feature space, located at the point defined by its feature values. In other words, the feature values (2 in the example, 48 in our models) are coordinates that place the acoustic frames in the feature space.

During training, the acoustic model's tasks are to:

1. For each phone, find three groups of acoustic frames that can be used to define the sequential states in the HMM. This equates to colouring the dots, knowing that a sequence of acoustic frames corresponding to a same phoneme exemplar cannot freely jump between states. For example, if we imagine a token of the phone [p] that has six acoustic frames **123456**, possible colouring for these frames are **123456** or **123456**, while **123456** or **123456** are not. Keep in mind that this must be true for all tokens of [p] encountered during training, as they are all sharing the

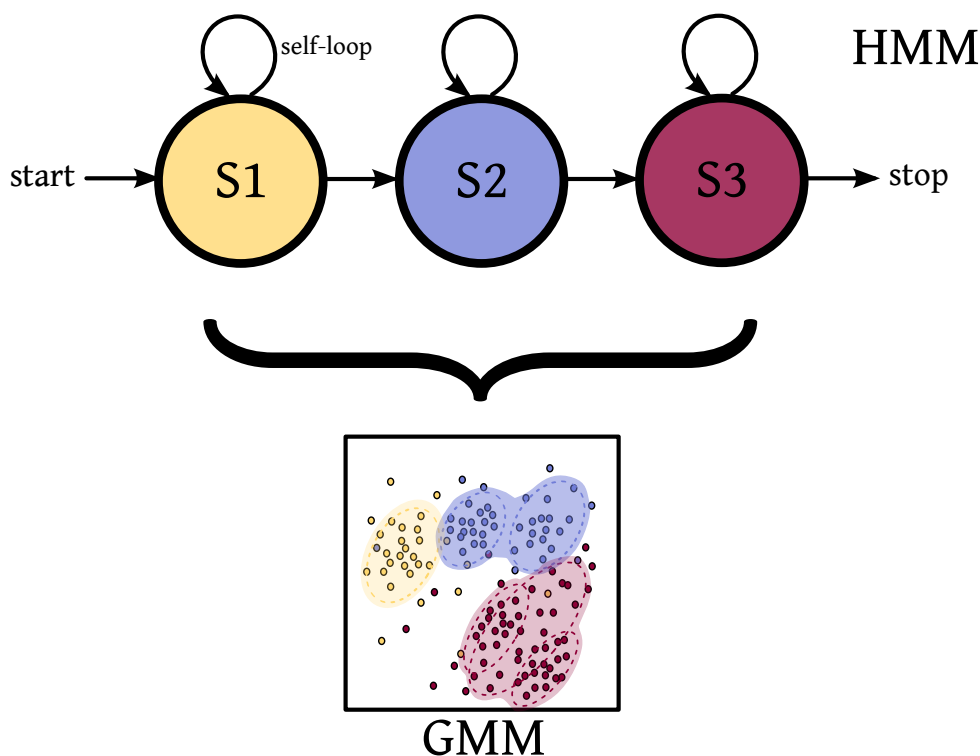

Figure 3.2: *Left-to-right 3-state phoneme HMM with simplified 2-dimensional GMM (one per state). Start and stop states connect the phoneme with the previous and next phoneme, respectively.*

same acoustic space.

2. Find combinations of Gaussian mixtures (the aforementioned GMMs), and the parameters of their respective diagonal Gaussian distributions<sup>4</sup>, that describe the sections of the acoustic space corresponding to each state. This equates to drawing the dashed ellipses around the coloured dots in order to define the more irregularly-shaped coloured areas. Indeed, GMMs are universal approximators of densities when given enough components. The number of Gaussians allocated to each phoneme state depends on the total number of Gaussians made available to the model, and the complexity of the distribution of the frames in the space. After training, after the GMMs have been defined, the AM is able to tell us, for any new acoustic frame, the likelihood that the frame originated from each GMM (i.e., phoneme state).

**Why not triphones?** If the reader is already familiar with ASR systems, they may expect us to go a step further and no longer treat phonemes as units for the HMMs (i.e., monophone acoustic models) but, instead, use context-dependent triphones. In this latter representation, an independent three-state HMM is built for each phoneme within a phonemic context. With some simplifications, this equates to no longer having an HMM for the phoneme /p/, but having all context-dependent versions of this phoneme as individual HMMs (e.g., the triphone /p<sub>a.i</sub>/, which is the phone /p/ when preceded by /a/ and followed by /i/). Traditionally, triphone-based HMM-based ASR systems perform better

<sup>4</sup>The GMMs used had diagonal-covariance.



than monophone systems. However, these more complex models are inappropriate for our experiments. Recall that we aim to use these speech recognition systems as models of nonnative speech perception, using tasks analogous to paradigms used in psycholinguistic experiments (namely, identification/forced-choice tasks). Importantly, we are focusing on modelling perceptual vowel epenthesis. This situation excludes the use of triphones because, by definition, our ASR systems will have to decode speech that does not follow native phonotactics. Decoding such stimuli implies the existence of triphones corresponding to the input, yet the model will have never encountered such triphones in the training data. While this situation might seem analogous to what listeners may experience, one must consider the fact that the ASR system *will attempt to account for said triphones* during decoding in spite of the lack of data. Importantly, poorly estimated, phony triphones (e.g., /h<sub>a.p</sub>/, when decoding /ahpa/) will be put up against well-estimated triphones (e.g., /h<sub>a.a</sub>/) during the forced-choice tasks. The well-estimated triphones might simply be preferred as transcriptions over poorly-estimated ones for this reason alone, irrespective of the actual acoustic match between the stimuli and phoneme models. In order to increase the performance of monophone models at phonetic labelling tasks such as ours, it is possible to increase the number of total Gaussians available to the model [Saraclar, 2001].

### 3.2.4 Lexicon & language models

As shown in Figure 3.1, the acoustic model is combined with two other components in order to decode speech: the Lexicon and the Language Model (LM).

The lexicon is, put simply, a pronunciation dictionary. It links the acoustic model (i.e., phoneme-level HMMs) with the language model, which is at the word level. For each word, we indicate in the dictionary the sequence of phonemes that constitute it. It is also possible to account for multiple pronunciations of a word due to dialectal differences (e.g., “tomato” pronounced as /təməʔtəʊ/ or /təmeɪrəʊ/), phonological phenomena (e.g., homorganic assimilation: “handbag” /hændbæg/ → /hæmbæg/), or suprasegmental information (e.g., stress contrasts: “record” /ˈrekərd/ (noun) vs. /reˈkɔrd/ (verb)).

At the word level, the language model specifies  $P(W)$ , the probability of occurrence of word sequence  $W$ . For this we use  $n$ -grams: we approximate the probability of a sequence

$$P(W) = P(w_1)P(w_2|w_1)P(w_3|w_1, w_2)\dots P(w_L|w_1, w_2, \dots, w_{L-1}) \quad (3.5)$$

by using the product of the probability of the component words, each conditioned on the  $n-1$  words preceding it. For instance, if  $n = 2$ , we obtain a bigram model, where the LM specifies the probability of a word depending on a single preceding word. The probability of the word sequence  $W$  can then be approximated as:

$$P(W) \approx P(w_1)P(w_2|w_1)P(w_3|w_2)\dots P(w_L|w_{L-1}) \quad (3.6)$$

In our case, these probabilities are obtained from word counts in the training corpus as follows:

$$P(w_i|w_j) \approx \frac{c(w_i, w_j)}{c(w_i)} \quad (3.7)$$

where  $c(w_i, w_j)$  is the number of observations of  $w_i$  followed by  $w_j$ , and  $c(w_i)$  is the total number of occurrences of  $w_i$ . Since not all word combinations are bound to appear in the training corpus, smoothing is performed; null probabilities are given a small probability of appearing.

Additionally to the bigram word LM, we computed a unigram phone LM in order to evaluate our models’ ability to do phonetic decoding. In this case, the lexicon is identical to the phoneme inventory and the LM consists of phoneme counts.

### 3.2.5 Lattices

When decoding speech, the ASR system builds a graph containing candidate word sequences that can serve as transcription for the audio input, based on the acoustic model, the lexicon, and the language model. In order to keep the problem computationally tractable, only the most likely transcription hypotheses are kept; this is known as pruning.

The output of the decoding step is not a single transcription but what is called a lattice. In this graphical representation only the most probable transcriptions are included, with weighted paths connecting words (a minimalistic example without weights can be seen in Figure 3.1). The weight of each path is determined by the product of the acoustic and language model scores (derived from  $P(X|w)$  and  $P(W)$ , respectively). The final score for each possible transcription is obtained by summing all the weights of the path that need to be crossed to reach the sequence of words in the transcription (“I love my cute dog”, in the example in Figure 3.1). Having access to lattices means that we are not only able to derive the most probable transcription; we can extract the  $n$ -best transcriptions, each with its corresponding alignment, and the total acoustic and language model scores. By using very constrained LMs, we will use these  $n$ -best lists and their posteriorgrams in order to model identification tasks used to test human participants.

### 3.2.6 Scoring: Assessing native performance

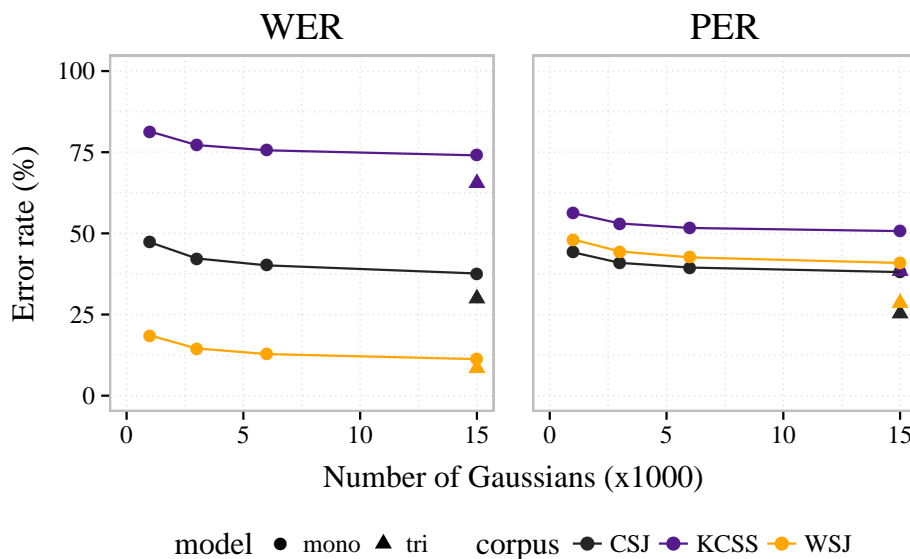

Figure 3.3: Changes in word error rate (%WER) and phone error rate (%PER) following variation of the number of total Gaussians allocated to monophone acoustic models (circles). The error rates obtained with a triphone model with 15,000 Gaussians are included as comparison (triangles). Scores correspond to decoding performed on the validation set (i.e., unseen speakers for the CSJ and KCSS; already seen speakers for the WSJ).

We tested the decoding performance on the validation set of AMs with total number of Gaussians going from 1,000 to 15,000. These values are used as default total number of Gaussians when training, respectively, monophone and triphone models in Kaldi (without speaker adaptation). In order to do so, we used the language models described in section

3.2.4, namely a word bigram LM and a phone unigram LM, which were used to obtain word error rates (%WER) and phone error rates (%PER), respectively. Note that while we provide word bigram %WER as a reference value to give a rough comparison with existing speech recognition models<sup>5</sup>, our main focus is on %PER. Indeed, we will use our models in paradigms involving phonetic decoding of non-native nonwords; the phone unigram %PER evaluation gives us an insight into how well our ASR systems can do phonetic decoding on native (non)words.

As seen in Figure 3.3, we find that the performance of our models increased (i.e., error rates decreased) when increasing the number of total Gaussians from the Kaldi default of 1,000 to 15,000, which would average to approximately 125 Gaussians per state for a language with an inventory of 35 phonemes<sup>6</sup>. Therefore, the acoustic models with the highest amount of Gaussians (i.e., 15,000) give the best performance for monophone models, both at the lexical (%WER) and phonetic (%PER) levels of decoding. We did not pursue increasing the number of Gaussians even further, as performance gain was reaching an asymptote at this point and adding more Gaussians would have increased the computational demands for each experiment. Additionally, we expect that adding “too many” Gaussians might have lead to overfitting of the models to the training set. As expected, triphone models performed better than monophone models at phonetic decoding (%PER), in spite of having the same amount of total Gaussians than our best monophone models:

- CSJ: 37.96% monophone *vs.* 25.33% triphone
- KCSS: 50.70% monophone *vs.* 38.42% triphone
- WSJ: 40.88% monophone *vs.* 28.55% triphone

Later in this chapter we will discuss how it might be possible to increase acoustic model performance in future work, without having recourse to triphone HMMs, which as explained previously are not appropriate for our experiments.

Concerning the test set (i.e., 15% of the corpora), we find stable %WER relative to the validation set, in spite of differences in the lexical items. Similarly, %PER were comparable to those obtained for the validation set:

- CSJ: 37.96% on test, 38.07% on validation
- KCSS: 50.70% on test and validation
- WSJ: 11.50 on test, 11.26% on validation

Since the validation and test sets contain utterances from the same speakers<sup>7</sup>, this information does not allow us to evaluate our models’ variability when decoding datasets

---

<sup>5</sup>To have an idea of how this performance fares, in 2015 some state-of-the-art speaker adapted HMM-GMM systems trained on 82 hours of the WSJ achieved 6.3% WER [Panayotov et al., 2015] and 5.4% WER [Chan and Lane, 2015] on the WSJ eval’92 dataset. Contemporary deep neural network-based systems achieved 3.5% WER on the same dataset [Chan and Lane, 2015]. However, recall that our WSJ training, validation, and test datasets share speakers due to a planned comparison to models not described in this thesis. Therefore the scores for our WSJ model are expected to become worse with a properly constituted training-validation-test partition of the data such as in the WSJ eval’92 dataset.

<sup>6</sup>Phoneme counts: CSJ: 37, KCSS: 36, WSJ: 39

<sup>7</sup>This would be seen as a huge red flag in speech engineering. However, remember that our real “test sets” will be the items used in the experiments. The reason why we did not just use the sum of the validation and test sets as a bigger validation set (20% of each corpus) was because of

with different sets of speakers that are not seen in the training data (recall that none of our models have any speaker adaptation; only CMVN is applied when processing the features). However, the fact that validation and test set scores are similar indicates that, while rudimentary, our acoustic models give stable performances when confronted with datasets with structurally different lexical exemplars and acoustically different phonetic exemplars.

---

the computational demands of decoding sets of such sizes, testing each combination of parameters. This was an issue particularly when decoding with phone language models, due to the huge set of transcriptions that were possible for any given utterance. We would like to emphasize that we are showing error rates to give the reader a vague idea of the performance of such models, showing that they are not as performant as state-of-the-art systems (even with a biased distribution of the data in the sets). It is not our goal to compare our models to models that have been trained, validated, and tested with properly balanced datasets.

### 3.3 Investigating the role of surface phonotactics

*The work described in this section was done in collaboration with Thomas Schatz and Emmanuel Dupoux.*

#### 3.3.1 Introduction

In the previous section we described an ASR-based implementation of one-step models of nonnative speech perception, as proposed by [Dupoux et al., 2011, Wilson and Davidson, 2013]. In these models, nonnative speech perception is a process of reverse inference; the resulting percept is the output of a process where acoustic and phonotactic match are simultaneously optimised. [Wilson and Davidson, 2013] formalises the reverse inference process as shown in equation 3.8, where  $w$  corresponds to candidate percepts and  $X$  corresponds to the stimulus acoustics.

$$\hat{w} = \underset{w}{\operatorname{arg\,max}} \{P(X|w) \cdot P(w)\} \quad (3.8)$$

Applying the ASR nomenclature, this equation can be paraphrased as follows: in one-step proposals, the resulting percept is the one that maximizes the product between the acoustic match  $P(X|w)$ , determined by an acoustic model (AM), and the phonotactic probability  $P(w)$ , which is determined by a language model (LM). While the optimisation process combines the probabilities given by the AM and LM, the two modules remain independent from one another before their product is computed. As such, it is possible to modify them in order to study their respective influences in the perception process.

As a continuation of our work on exemplar models in sections 2.3 and 2.4, a question that first arises is whether the output of the LM, namely the influence of phonotactics, is at all needed to explain the phenomenon of vowel epenthesis. We found in chapter 2 that acoustic information, such as vowel coarticulation, was essential in determining epenthetic vowel quality. One could hypothesize that the insertion of a vowel (as opposed to no insertion) is determined by how the acoustic cues are interpreted.

For instance, Japanese speakers can sometimes produce devoiced high vowels as a fricative vowel<sup>8</sup> when they are preceded by a fricative consonant. In other words, the devoiced vowel becomes a prolongation of the fricative consonant, yet keeping articulatory and spectral information corresponding to the intended vowel [Matsui, 2017]<sup>9</sup>. One could thus hypothesize that a fricative vowel is an acceptable allophone (i.e., model or exemplar) of vowels /i/ or /u/ in Japanese, while it is not in another language such as English, where the signal will be interpreted as a fricative instead. In this case, the difference in the interpretation of the same acoustic information could lead to epenthesis in Japanese but not in English. In a similar fashion, English listeners may interpret releases of stop consonants as reduced vowels, resulting in increased rates of epenthesis with increased release duration [Wilson and Davidson, 2013], and Korean listeners may experience more epenthesis following consonants that give rise to salient noise [de Jong and Park, 2012].

However, are epenthetic repairs not due to cases of phonotactic illegality in the first place? Not necessarily. Indeed, Japanese listeners have been shown to perceive epenthetic vowels after certain acoustic realisations of coda [n], even though this syllabic structure is phonotactically legal in Japanese. In loanword data, word-final [n] is adapted differently according to the language of origin of the word; French /n/ may result in vowel epenthesis, becoming [n:u] or [nu] (e.g., *Cannes* /kan/ → /kan:u/) while English [n] is kept as a nasal coda consonant (e.g., *pen* adapted as /pen/). This asymmetry was observed in

<sup>8</sup>Also referred to as a syllabic fricative.

<sup>9</sup>We thank Yasuyo Minagawa and Shigeto Kawahara for this comment.

online perception with nonwords (therefore excluding the influence of orthography) and can be explained by the presence of a strong vocalic release in French [n] but not English [n] [Peperkamp et al., 2008]. Also, an identical segmental structure might elicit different amounts of epenthesis depending on the stimulus acoustics. An illustration from production is given by the imitation study on English listeners by [Wilson and Davidson, 2013]. In that study, a cluster such as /bn/, which is phonotactically illegal in English, elicited lower rates of epenthesis in one item (*bnase*, 33% epenthesis) than in another (*bnapa*, 80% epenthesis). The authors observed a correlation between the variability of certain acoustic cues in the target stimuli and the variability in the rates of epenthesis (and other errors such as prothesis and consonant deletion) in production.

In this section we investigate whether acoustic match is able to reproduce epenthetic patterns in nonnative speech. To do so, in a first step, we compare the performance, relative to human data, of ASR models that share the same AM but differ in the LM used during decoding. Notably, we assess if LMs with basic phonotactic information better approximate human behaviour than a null LM. In a second step, we assess if the best AM-LM combination is capable of mirroring qualitative effects observed in human data. As reference, we use psycholinguistic data from the identification tasks described in section 2.2 (Experiment 1) and section 2.3 (Experiment 2).

### 3.3.2 Experiment 1

In this experiment we investigated how various versions of our ASR model differing in their language models (LMs) compared to real behavioural data. While we varied the LMs, the acoustic model was kept constant; as stated in the previous section, we used HMM-GMM monophone models with 15000 Gaussians. We used our models to perform simulations of the identification task described in section 2.2, where Japanese listeners were asked to indicate whether they heard an epenthetic vowel within the consonant cluster of  $V_1C_1C_2V_1$  items (e.g., /ahpa/). For these items, the quality of the coarticulation cues either matched or mismatched the quality of the flanking vowels. We analysed the results quantitatively in order to assess if injecting additional phonotactic information allowed the model to better approximate human responses. We also performed qualitative analyses in order to see if the best version of the model reproduced the effects observed in section 2.2.

#### 3.3.2.1 Methods

**Stimuli** We used the same stimuli as in section 2.2. As a reminder, we recorded 3 speakers producing disyllabic  $V_1C_1C_2V_1$  and trisyllabic  $V_1C_1V_2C_2V_1$ , with  $V_1$  a flanking vowel in the set /a, e, i, o, u/,  $C_1$  /h/ or /k/, and  $C_2$  a fixed consonant, /p/ (e.g., /ahpa/, /ahapa/). By cross-splicing the disyllabic natural control items (e.g., /ahpa/), we obtained disyllabic spliced control items (e.g., /ah<sub>a</sub>pa/), disyllabic spliced test stimuli (e.g., /ah<sub>u</sub>pa/), and trisyllabic spliced fillers (e.g., /ahapa/), where subscripts indicate the identity of the vowels flanking the clusters in the original recording. Therefore, within each speaker, all stimuli of the same structure (in our example, /ah(V)pa/ items) have acoustically identical flanking vowels.

**Language models** In order for the decoding task to be analogous to the behavioural experiment described in section 2.2, trial-specific language models were constructed, as shown in Figure 3.4. Thus, when decoding a  $V_1C_1(V_2)C_2V_1$  stimulus, the perception model was only given the possibility to transcribe it as  $V_1C_1(V_2)(SIL)C_2V_1$ , where phones between parentheses are optional,  $V_2$  was from the set of vowels /a, e, i, o, u/, and *SIL* is

an optional silence<sup>10</sup>.

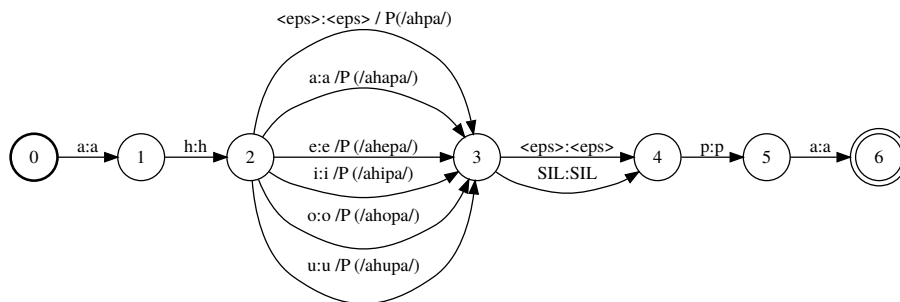

Figure 3.4: *Constrained language model used to test the models (here: LM for /ahpa/ trials). Nodes in the graph represent states, weighted edges represent transitions between states (here: phonemes). When relevant, weighted edges are labeled with the probability to choose that edge when decoding, which affects the final language model score of each possible path. When no weights are shown (e.g., between states 3 and 4), there is no preference between the paths concerned. The language model scores are combined with acoustic scores when decoding experimental items.*

In this section, we investigate the type of phonotactic information that might be used by Japanese listeners when perceiving foreign speech that does not conform to native phonotactics. We test 5 types of language models (LM) when decoding our  $V_1C_1(V_2)C_2V_1$  items; these LMs differ only in the weights given to edges between nodes 2 and 3 in the graph shown in Figure 3.4. The weights were obtained by computing frequency counts from the portion of the CSJ used for training the acoustic model. Using the same acoustic model, we compared the following LMs:

1. A null LM, which implies that listeners base their decoding of consonant clusters on phonetic match alone, without using information on phonotactics.
2. A phone-unigram LM, which implies that listeners do not take neighbouring phonemes into consideration when decoding the consonant clusters; only the frequency of the vowel  $V_2$  to be epenthesized (compared to that of  $C_2$ ) is taken into account when choosing epenthetic vowel quality.
3. An online phone-bigram language model, which implies that listeners decode the clusters as they hear them (i.e., decoding is done from the start of the item), and the choice of (no) vowel is conditioned on the presence of  $C_1$ . Therefore, the choice of epenthetic vowel is modulated by  $C_1V_2$  and  $C_1C_2$  diphone frequencies.
4. A retro phone-bigram language model, which implies that listeners decode the clusters based on the most recent information (i.e., decoding is done from the end of the item), and the choice of (no) vowel is conditioned on the presence of  $C_2$ . Thus, the choice of epenthetic vowel is modulated by  $V_{ep}C_2$  and  $C_1C_2$  diphone frequencies.
5. A batch phone-bigram language model, which implies that listeners decode the item considering the entire structure, taking into consideration the probability of having a vowel  $V_2$  given the presence of  $C_1$  and  $C_2$ . Here the choice of epenthetic vowel is modulated by the product of  $C_1V_2$  and  $V_2C_2$  (or by  $C_1C_2$ ) diphone frequencies.

<sup>10</sup>*SIL*, which corresponds to the closure of the plosive /p/, is added in order to reduce alignment artifacts. Additionally, it allows us to also model the alternative parsing of the items as a sequence of two nonwords.

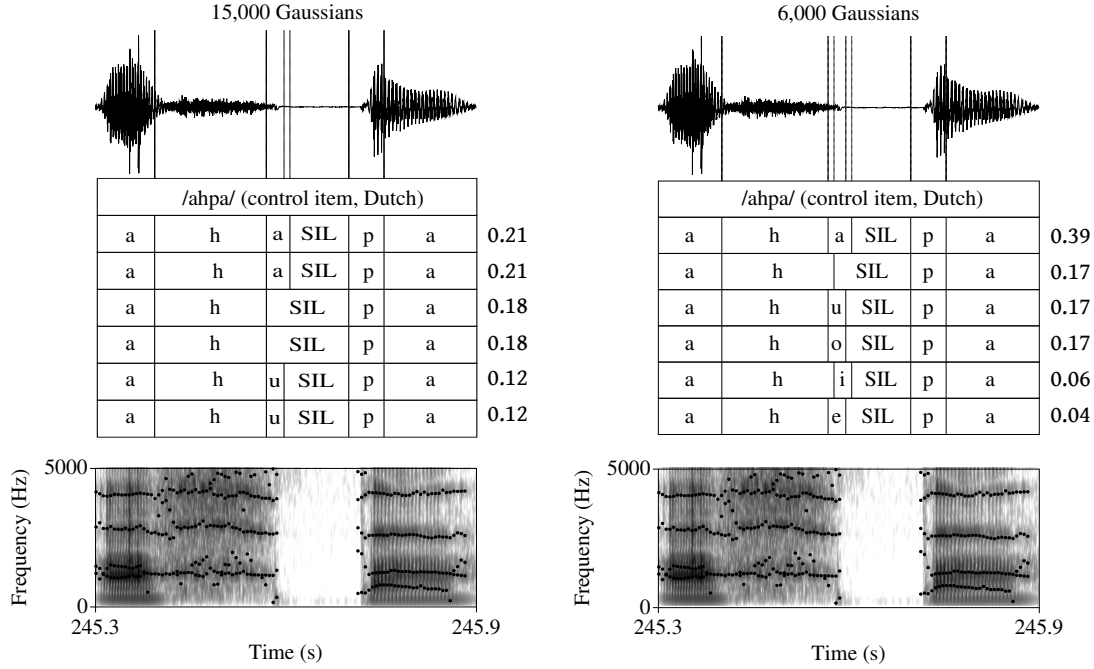

Figure 3.5: *Left: Example of how the ASR system decoded the spliced control item /ah<sub>a</sub>pa/ produced by the Dutch speaker, using the null version of the language model in Figure 3.4. The system only showed three responses (i.e., “a”, “none”, “u”) in its 6-best decodings; a null posteriorgram was assign to missing responses (i.e., “e”, “i”, “o”). Right: As a reference, the equivalent decoding by an ASR system with 6,000 Gaussians is shown. In this case, the system showed all six possible responses in its 6-best decodings. From top to bottom: original waveform, item name, aligned transcriptions given by the model (from the most probable to the least probable, with the corresponding posteriorgrams shown to their right side), and spectrogram with formant contours. SIL = silence.*

**Identification task simulation** After decoding the stimuli, we extracted from the resulting lattice each possible transcription of each item, and the corresponding acoustic and language model scores. An example of how the ASR system decodes the experimental stimuli can be seen in Figure 3.5. From the (scaled) acoustic and language model scores we derived the item posteriorgrams, which indicate how probable a given transcription was given the audio input. We used these probabilities as proxies of the probability that a listener might exploit when performing reverse inference during speech perception, and therefore, the probabilities used when responding in an identification task.

As such, for each item that was decoded, we obtained a six-dimensional vector  $ident_{model} = [p_{none}, p_a, p_e, p_i, p_o, p_u]$ , containing a discrete probability distribution, with a probability mass function linking the identification task options ‘none’, ‘a’, ‘e’, ‘i’, ‘o’, ‘u’, to their respective probabilities (i.e., posteriorgrams). We can define the human equivalent  $ident_{human} = [p_{none}, p_a, p_e, p_i, p_o, p_u]$ , which contains the percentage of responses for each item, after aggregating all participant responses.



### 3.3.2.2 Quantitative analysis

In order to perform a global evaluation of the similarity between the behavioural responses and the responses obtained with the five LMs described above, we computed the Pearson’s product-moment correlation coefficient between the human and model posteriorgrams. The model with the highest correlation to the human data was the NULL LM ( $r = 0.76$ ), followed by the UNIGRAM, BIGRAM ONLINE, and BIGRAM RETRO LMs ( $r = 0.65$ ), and lastly, the BIGRAM BATCH LM ( $r = 0.62$ ). Numerically, the NULL LM better approximated the human data.

In order to assess if the correlation differences between the NULL LM and other LMs were significant, we computed these differences and their corresponding 95% confidence intervals (CIs), using bootstrapping with 1000 samples<sup>11</sup>. As can be seen in Table 3.4, the correlation between the human data and the output of the NULL LM was significantly higher than those of other LMs.

Table 3.4: *Difference in correlation with human data between the null LM and other LMs. The lower and upper bounds of the 95% confidence intervals are given between brackets. Positive values indicate higher correlation between human data and null model output than between human data and other LM output.*

	Correlations	Difference	Significant?
null vs. unigram	0.76 – 0.65	0.10 [0.07, 0.14]	Yes
null vs. bigram online	0.76 – 0.65	0.11 [0.08, 0.14]	Yes
null vs. bigram retro	0.76 – 0.65	0.10 [0.07, 0.13]	Yes
null vs. bigram batch	0.76 – 0.62	0.13 [0.10, 0.17]	Yes

Contrary to the null and unigram LMs, the bigram models were subject to an arbitrarily set smoothing parameter, which determined the probability of choosing a sequence of phonemes that had never been observed in the training data. We set this smoothing parameter to  $10^{-8}$ , which is a strict value, as it is relatively close to zero. This was done in order to evaluate whether the acoustic match could rescue decoding options which are not supported by the language’s phonotactics. In order to evaluate the similarity between models’ outputs and human data without the influence of the value of the smoothing parameter, we computed the correlation between the human data and models’ posteriorgrams after excluding the posteriorgrams for “none” responses and re-normalising the remaining posteriorgrams. As such, we are focusing on the correlation related to epenthetic vowel quality. Here, the highest correlation still corresponded to the NULL LM ( $r = 0.77$ ), followed by the BIGRAM RETRO ( $r = 0.74$ ), the BIGRAM ONLINE ( $r = 0.73$ ), and finally the UNIGRAM and the BIGRAM BATCH LMs ( $r = 0.71$ ). As shown in Table 3.5, while the difference between the correlations diminished relative to what is shown in Table 3.4, the CIs still did not overlap with zero, meaning that the correlation between the human data and the output of the NULL LM was significantly higher than those of other LMs.

### 3.3.2.3 Qualitative analyses

**Identification accuracy** Using the set of filler items such as /ahapa/ and /okipo/ (i.e., spliced items with a full vowel between  $C_1$  and  $C_2$ ), we can assess identification accuracy relative to our item labels. Indeed, recall that while our phonetically-trained speakers were instructed to read items following “standard” IPA pronunciations, it is

<sup>11</sup>Sampling was done by item.

Table 3.5: *Difference in correlation with human data between the null LM and other LMs, after removing the “none” responses. The lower and upper bounds of the 95% confidence intervals are given between brackets. Positive values indicate higher correlation between human data and null model output than between human data and other LM output.*

	Correlations	Difference	Significant?
null vs. unigram	0.77 – 0.71	0.05 [0.03, 0.08]	Yes
null vs. bigram online	0.77 – 0.73	0.04 [0.02, 0.06]	Yes
null vs. bigram retro	0.77 – 0.74	0.02 [0.01, 0.04]	Yes
null vs. bigram batch	0.77 – 0.71	0.06 [0.03, 0.08]	Yes

possible for our human participants to not perceive the intended vowel categories due to adaptation processes (e.g., misperceiving /u/, which is not realised as [u] but as [ɯ] in Japanese), and/or due to speaker idiosyncrasies.

Overall, human participants identified the correct intended vowel category in 79.5% of the trials. As can be seen in Figure 3.6, this was mostly due to confusions between the intended /o/ and /u/ categories, with most errors consisting of /u/ being identified as /o/. Consistent with our correlation analyses, the NULL LM gave the highest accuracy out of all models (accuracy: 74%), followed by the BIGRAM RETRO (accuracy: 72.6%), the UNIGRAM (accuracy: 72.5%), the BIGRAM ONLINE (accuracy: 72.6%), and finally the BIGRAM BATCH LM (accuracy: 68.7%). As seen in Figure 3.6, like human participants, the models showed difficulty categorising /u/ items as such; in particular, these were almost always classified as exemplars of /o/ when  $C_2 = /h/$ . However, unlike human participants, models misperceived /e/ as /i/. This misperception appears to be worse for the BIGRAM ONLINE and BIGRAM BATCH language models. In sum, while the accuracy rates for the models were close to that of humans, we saw that the models showed not only quantitative but also qualitative differences in their identification of non-native full vowels, in comparison with human participants. Below we continue our qualitative analyses on what was determined to be the best model according to the correlation analyses and the filler item accuracy, namely the ASR system with a NULL LM.

**Control items** Human participants experienced vowel epenthesis in 56% (/hp/: 52%; /kp/: 61%)<sup>12</sup> of control items in which the flanking vowel and coarticulation are of the same quality. The NULL LM gave an output of 68% epenthesis, with 72% and 65% epenthesis for /hp/ and /kp/, respectively. As such, the model gave a higher percentage of epenthesis for /hp/ clusters compared to /kp/ clusters, while the opposite was true for humans.

Now we focus on epenthetic vowel quality, meaning that we perform analyses after removing “none” responses and re-normalising posteriorgrams. We find that, like humans (/hp/: 44%; /kp/: 87%; total: 66%), the model gave lower percentages of default /u/-epenthesis for /hp/- (47%) than for /kp/- (65%) clusters (total: 56%). However, this difference is not as marked as it is for Japanese listeners. Recall that in section 2.2 we

<sup>12</sup>Note that since posteriorgrams are computed by weighting items from all three speakers equally, values reported in this section might differ slightly from those in section 2.2. Indeed, due to how data was cleaned in section 2.2, some trials were removed and the number of trials per item per speaker might have differed in some cases. In order to ensure that human and model data are comparable, we re-do statistical analyses of human data when necessary and report the resulting coefficients.

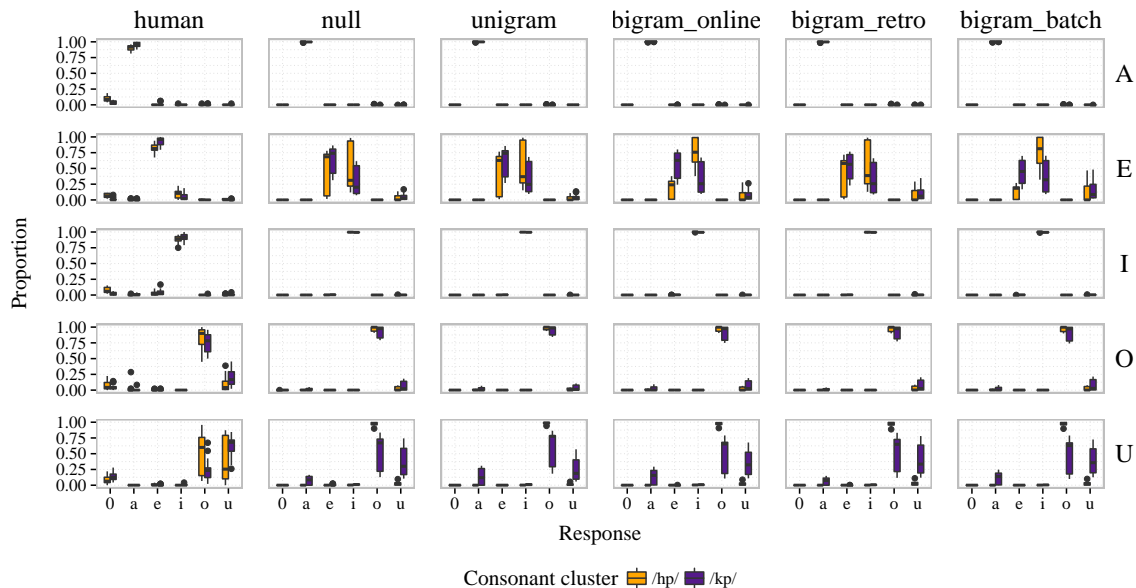

Figure 3.6: *Response patterns for the identification task on full vowel stimuli (filler items). Human and models responses are separated by columns; intended identity of the medial vowel is given by rows. Within each rectangle, the horizontal axis corresponds to possible responses from the set {“none”, “a”, “e”, “i”, “o”, “u”}. The vertical axis corresponds to proportion of responses (i.e., posteriorgrams, in the case of models). The box and whiskers plots display the distribution of the proportions across items (median, quartiles and extrema). For instance, we can see from the first row that, similar to humans, all models correctly classified most /VCapV/ items as containing a medial /a/ vowel.*

found that Japanese listeners experience significantly more default /u/-epenthesis for /kp/ clusters, and significantly more vowel copy epenthesis for /hp/ clusters. These patterns of responses mirrored loanword data. Do we find these effects in the output of our model?

We first examined possible effects of consonant cluster on default /u/-epenthesis by using the R statistical software [R Core Team, 2016], using Markov chain Monte Carlo generalised linear mixed-models [Hadfield, 2010, Plummer et al., 2006]. These Bayesian models sample coefficients from the posterior probability distribution conditioned on the data and given priors. We used priors that are standard for linear models. Model convergence was assessed by visual inspection of trace plots and the Gelman–Rubin convergence diagnostic [Gelman and Rubin, 1992], using eight chains with different initialisations. Effects were considered statistically significant if the 95% highest posterior density (HPD) interval estimated for the coefficient of interest did not include zero. We report both the posterior mode and the 95% HPD interval.

The left panel of Figure 3.7 shows the posteriorgrams of /u/-epenthesis for humans and all models. For the ASR system with the null LM, we assessed the variation of the continuous response variable “u” response POSTERIORGRAM that was caused by the fixed effect CONSONANT cluster (/kp/ vs. /hp/; contrast coded with deviance coding). We initially included random intercepts for SPEAKER and ITEM, as well as a random slope for SPEAKER on CONSONANT. However, these were removed as their addition caused the models to be singular (estimated null variances), with consequently poor trace plots. We found the main effect of CONSONANT to be significant (mode:  $-0.19$ , HPD:  $[-0.29, -0.07]$ ), meaning that as for humans (mode:  $-0.42$ , HPD:  $[-0.61, -0.26]$ ), the model gave significantly more

/u/-epenthesis for /hp/- than for /kp/-clusters. However, as evidenced by the statistical model coefficients, the magnitude of the effect is larger for humans than for the model.

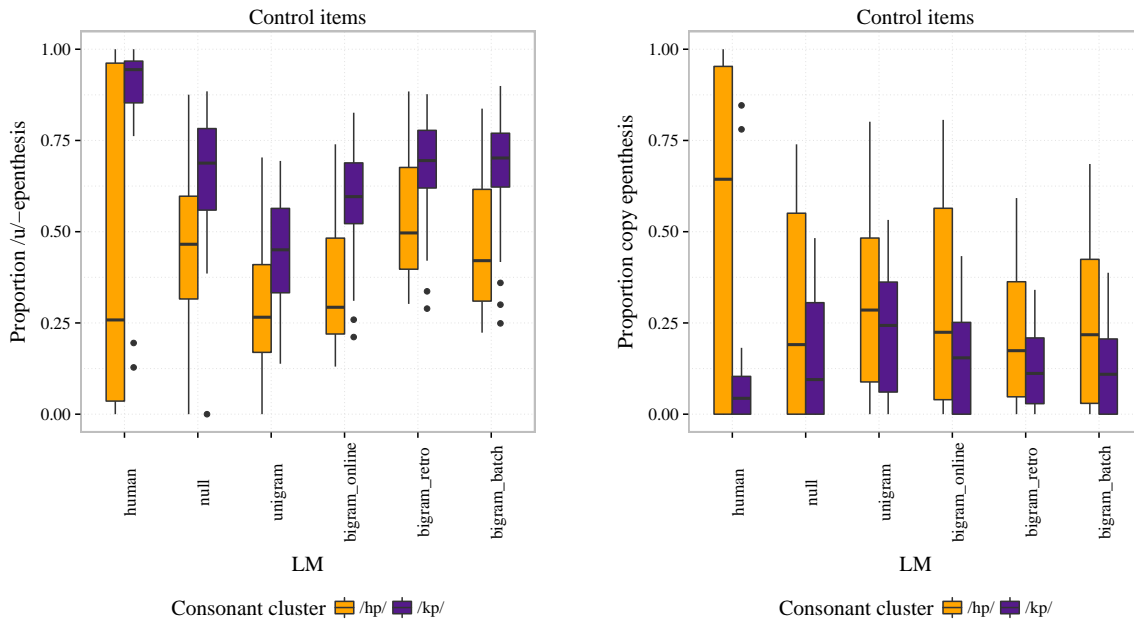

Figure 3.7: *Proportion of default /u/-epenthesis (left) and vowel copy epenthesis (right) given by human participants and models. The box and whiskers plots display the distribution of the proportions across items (median, quartiles, extrema and outliers).*

Turning to vowel copy epenthesis in control items for which the flanking vowel was not /u/, we used the same statistical models but with copy vowel POSTERIORGRAM as the continuous response variable. For instance, for the item /ek<sub>e</sub>pe/, this was the posteriorgram for the “e” response. The distribution of posteriorgrams for humans and all models is shown in the right panel of Figure 3.7. While there was a trend in the same direction for the null LM, namely higher percentages of vowel copy for /hp/- than for /kp/-clusters, we did not find a significant main effect of CONSONANT for the model (mode: 0.11, HPD: [−0.02, 0.24]) as we did for humans (mode: 0.39, HPD: [0.20, 0.58]).

**Test items** Next we examine the identification task response patterns for test items. As a reminder, for these spliced items, the vowel coarticulation was different from the flanking vowels.

As shown in Figure 3.8, reponses that were represented the most in the null model posteriorgrams were “none” (32%), “i” (16%), and “u” (40%). These were also the responses that human participants gave the most (“none” (37%), “i” (22%), and “u” (33%)).

We saw in section 2.2 that, for human participants, responses were mainly determined by the quality of the vowel coarticulation within the consonant cluster. This manifested itself in the appearance of horizontal bars, and some very faint vertical bars, in the top panels of Figure 3.9. Do we observe something similar in the output of the model with null LM?

When examining the bottom panels in Figure 3.9, we see that response patterns are noisier than for human participants. In spite of that, we can notice several similarities to human responses. We generally see that responses are mostly organised in horizontal lines, with “none” and “u” responses spread relatively uniformly across all combinations of vowel coarticulations and flanking vowels. This spread was even more uniform than

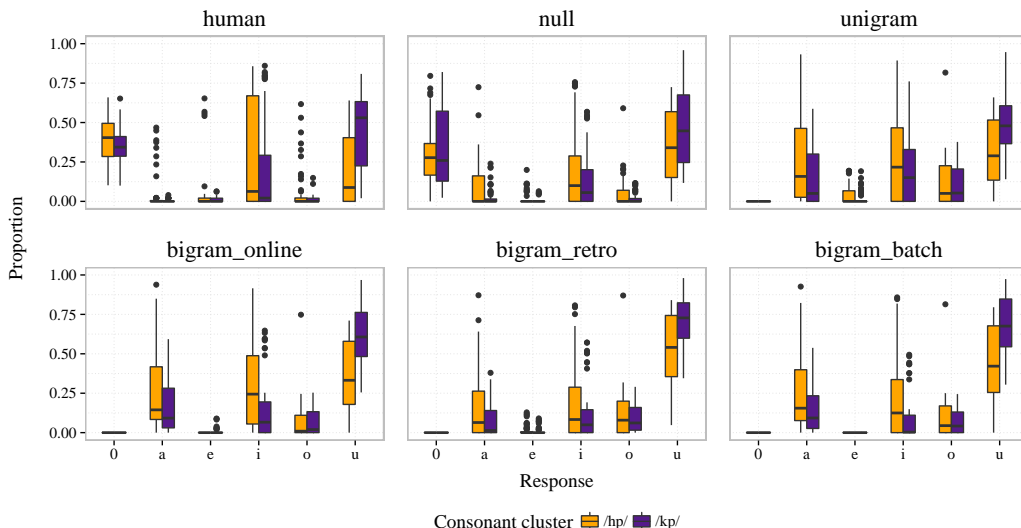

Figure 3.8: *Response patterns for the identification task on spliced test stimuli. Horizontal axes correspond to possible responses from the set {“none”, “a”, “e”, “i”, “o”, “u”}. Vertical axes correspond to proportion of responses (i.e., posteriorgrams, in the case of models). The box and whiskers plots display the distribution of the proportions across items (median, quartiles, extrema, and outliers).*

for human responses, where less “u” responses were given for items with front vowel coarticulation (i.e., [i, e]). In spite of this increase in “u” responses for items with front vowel coarticulation, the model responses show that, as for humans, most “i” responses were triggered by front vowel coarticulation.

When focusing on /hp items, we see that for human responses there is a correspondence between the quality of the vowel coarticulation and the response (e.g., most “a” responses come from items with [a] coarticulation). This correspondence is blurred in the model responses, as follows:

- “a” responses: A horizontal line is visible corresponding to [a] vowel coarticulation as it is for human responses. However, additional horizontal lines corresponding to back vowel coarticulation (i.e., [o, u]) are also visible. The source of most “a” responses are items with [u] coarticulation.
- “e” responses: These were triggered by front vowel coarticulation for the model, while for humans they were triggered specifically by [e] vowel coarticulation (horizontal line) and /e/ flanking vowel (fainter vertical line).
- “i” responses: Similar to humans, the majority of “i” responses given by the model were triggered by front vowel coarticulation. However, instead of seeing fainter vertical lines corresponding to front vowel flanking vowels as in human responses, for the model, “i” responses were also triggered to a lesser extent by non-front vowel coarticulation, even when the flanking vowel was not a front vowel.
- “o” responses: For humans, this response was triggered by back vowel coarticulation. For the model, [a] vowel coarticulation also triggered “o” responses. In other words, “o” responses were mostly triggered by non-front vowel coarticulation.

Additionally, we see that differences between model responses for /hp/-items and /kp/-items is not as apparent as it is for human responses. In the latter (top panels of

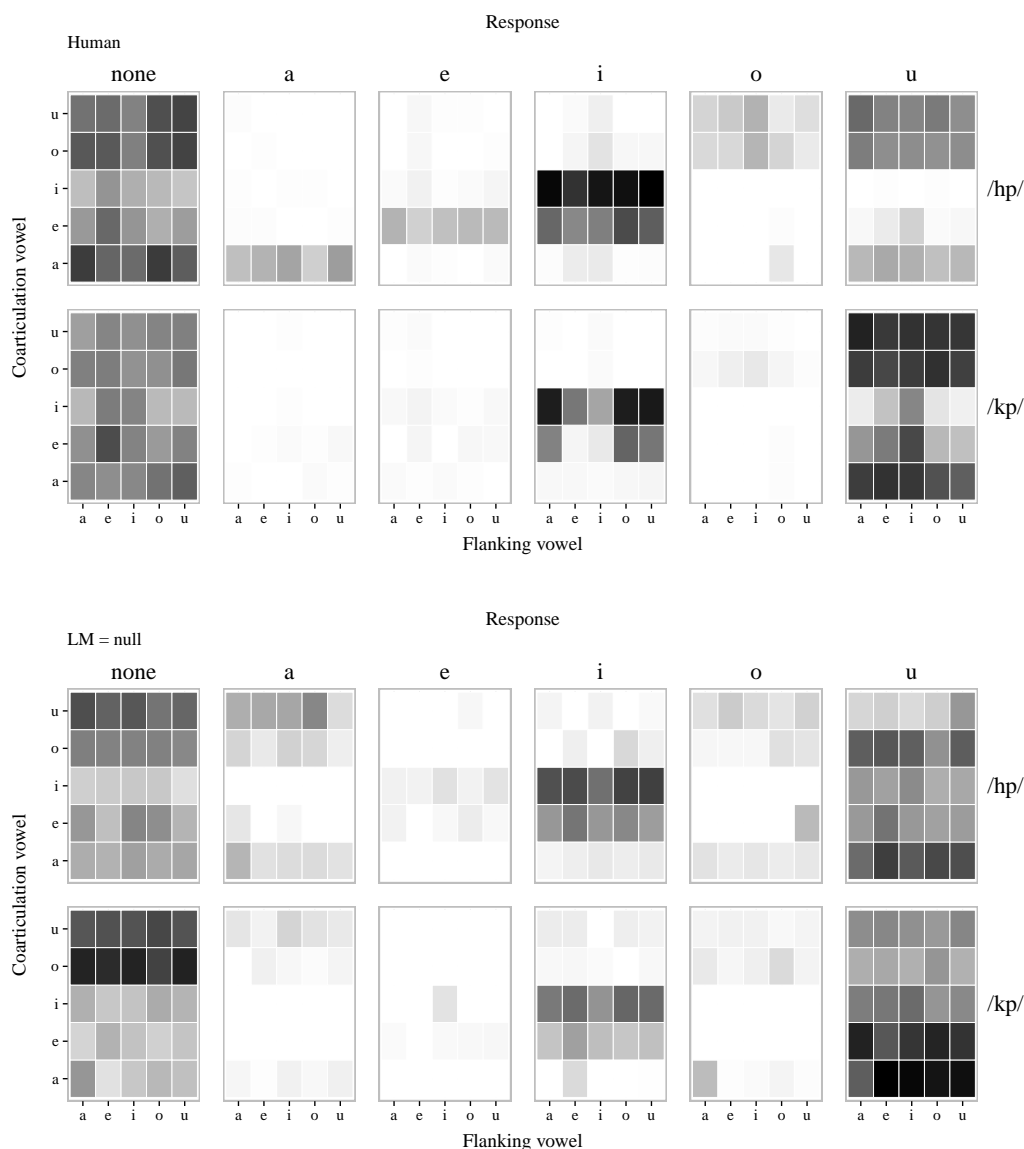

Figure 3.9: Counts of responses for the test items for human participants (top panel) and the ASR model with a null LM (bottom panel). Within each panel: Top: /hp/-items; bottom: /kp/-items. Within each rectangle, flanking vowels and vowel coarticulation are given in the horizontal and vertical axes, respectively. Darker colours indicate higher counts. Concerning human data, only test items are included here, while the very similar Figure 2.2 from section 2.2 includes test items, as well as spliced control items.

Figure 3.9), we see that participants barely responded {“a”, “e”, “o”} for /kp/-items. Meanwhile, for model responses, the rectangles for {“a”, “e”, “o”} responses for /kp/-items are fainter versions of their /hp/ counterparts.

Results from section 2.2 led us to conclude that vowel coarticulation, which was less present in /kp/ clusters, influenced response patterns less for /kp/-items than for /hp/-items. Coherent with qualitative analyses on vowel copy epenthesis in control items, the difference of the effect of vowel coarticulation on /hp/- and /kp/-items is not as marked for the model as it is for human participants.

### 3.3.2.4 Summary

In summary, through quantitative analyses, we found that, out of the different LM tested, the responses from the ASR model with a null LM better approximated human responses. Qualitative analyses showed that the null LM model responses were generally similar to human responses, but with some twists.

For the identification of full vowels, like humans, the model was accurate at identifying /a, i, o/. Like humans, the model identified /u/ as “o” in many instances; however, the specific patterns were not exactly mirroring the confusions observed in human responses. Also unlike humans, the model identified instances of /e/ as “i”.

For the identification of control items (i.e., spliced items with matching vowel coarticulation and flanking vowel), the model numerically mirrored the two effects observed in human responses: more default /u/ epenthesis for /kp/-items than /hp/-items, and more copy vowel epenthesis for /hp/-items than /kp/-items. However, the effects are damped for the model; the latter difference was not significant for the model, while the former was significant but of lower magnitude than in human responses. Also unlike humans, the model epenthesized vowels more often for /hp/-items than for /kp/-items, as the opposite was true for humans.

Concerning the test items (i.e., spliced items with mismatching vowel coarticulation and flanking vowel), like humans, most of the null LM model responses are in the set {“none”, “u”, “i”}. When examining model responses more in detail, we found that vowel coarticulation was driving responses as for humans, but the influence was less specific. One thing to note is that the differences observed in the model responses do not appear to be random; they are in line with the acoustics of the stimuli. As seen in the acoustic analyses of the items in section 2.2, vowel coarticulations in /hp/-items can be clustered as follows, based on their formant values: [[[a,u],o][e,i]]. There is a separation of front and non-front vowel coarticulations, which is also seen in the model responses. Since humans also seem to be sensitive to this acoustic proximity (e.g., “i” responses mostly triggered by [i,e] coarticulation; “o” responses mostly triggered by [o,u] coarticulation), a question that arises is if the noise observed in the model might be reduced when using a more performant acoustic model in the ASR system; indeed, we are not using state-of-the-art models (see below for further discussion). We will now present a similar analysis of the model’s ability to model Japanese listeners’ behaviour, performed on data from a different psycholinguistics experiment.

### 3.3.3 Experiment 2

As in the previous experiment, here we investigated how various versions of our ASR model<sup>13</sup> differing in their language models (LMs) compared to real behavioural data. The models were used to simulate the identification task described in sections 2.3 and 2.4, where Japanese listeners were asked to indicate whether they heard an epenthetic vowel within the consonant cluster of  $V_1C_1C_2V_2$  items (e.g., /abgi/). For human participants, we saw that (1) they mostly experienced default /u/-epenthesis, and (2) the quality of the flanking vowels  $V_1$  and  $V_2$  modulated their responses due to coarticulation. Does the output of the ASR model that best approximated human responses reflected these two aforementioned effects?

---

<sup>13</sup>Note that for this experiment, the acoustic model of the ASR system only had 6,000 Gaussians, instead of 15,000 as in the previous experiment. This was due to having mistakenly used an older version of the model when decoding the stimuli. Please be aware that this was only discovered when doing final corrections for this manuscript; as such, conclusions were written with the assumption that the ASR acoustic models used for Experiments 1 and 2 were identical.

### 3.3.3.1 Methods

**Stimuli** We used the same stimuli as in sections 2.3 and 2.4. As a reminder, a native French speaker recorded 54 items with the structure  $V_1C_1C_2V_2$ , with  $V_1$  and  $V_2$  vowels from the set  $\{/a/, /i/, /u/\}$ , and  $C_1C_2$  a cluster from the set  $\{/bg/, /bn/, /db/, /dg/, /gb/, /gn/\}$  (e.g. /abgi/).

**Language models** In order for the decoding task to be analogous to the behavioural experiment described in section 2.3.2, trial-specific language models were constructed, as shown in Figure 3.10. Thus, when decoding a  $V_1C_1C_2V_2$  stimulus, the perception model was only given the possibility to transcribe it as  $V_1C_1(V_{ep})(SIL)C_2V_2$ , where phones between parentheses are optional and  $V_{ep}$  was from the set of vowels /a, e, i, o, u/, and  $SIL$  is an optional silence. Concerning the weights between states 2 and 3, we created language models in a way analogous to the LMs in Experiment 1, adapted to the  $V_1C_1C_2V_2$  items used in this experiment.

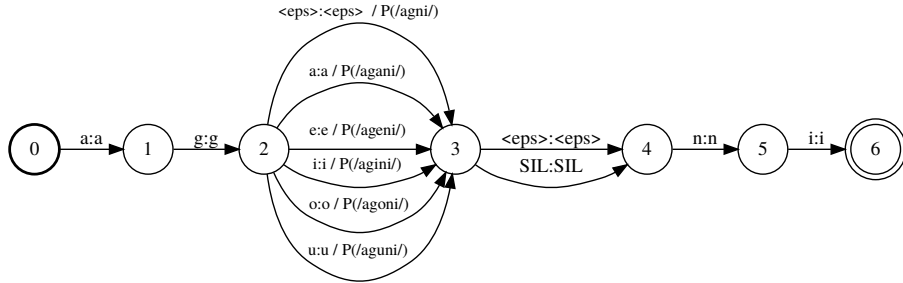

Figure 3.10: *Constrained language model used to test the models (here: LM for decoding /agni/). Nodes in the graph represent states, weighted edges represent transitions between states (here: phonemes). When relevant, weighted edges are labeled with the probability to choose that edge when decoding, which affects the final language model score of each possible path. When no weights are shown (e.g., between states 3 and 4), there is no preference between the paths concerned. The language model scores are combined with acoustic scores when decoding experimental items.*

**Identification task simulation** We used the same procedure as in Experiment 1. An example of how the ASR system decodes the experimental stimuli can be seen in Figure 3.11.

### 3.3.3.2 Results: Quantitative analysis

As in Experiment 1, we computed the Pearson’s product-moment correlation coefficient between the human and model posteriorgrams in order to assess a global measure of the resemblance between models’ outputs and human data from section 2.3.2. The model with the highest correlation to the human data was the BIGRAM RETRO LM ( $r = 0.43$ ), followed by the NULL ( $r = 0.40$ ), the UNIGRAM ( $r = 0.30$ ), the BIGRAM ONLINE ( $r = 0.23$ ) and lastly, the BIGRAM BATCH LM ( $r = 0.19$ ). Numerically, the BIGRAM RETRO LM better approximated the human data.

In order to assess if the correlation differences between the NULL LM and other LMs were significant, we computed these differences and their corresponding 95% confidence intervals (CIs), using bootstrapping with 1000 samples. As can be seen in Table 3.6, the correlation between the human data and the output of the NULL LM was significantly higher than those of the UNIGRAM, BIGRAM ONLINE and BIGRAM BATCH. While the



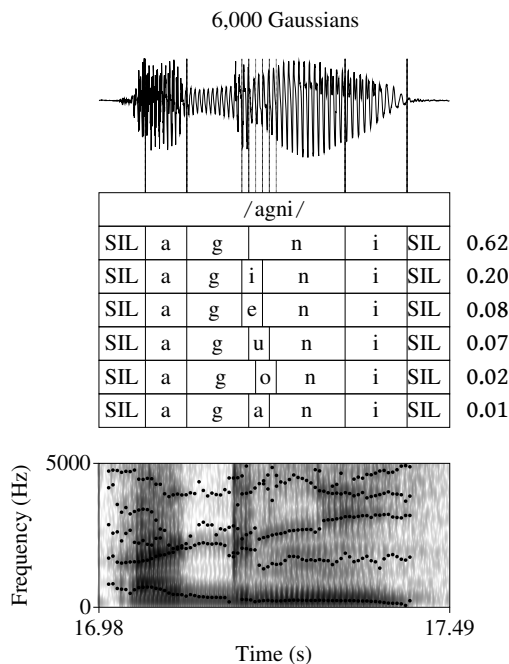

Figure 3.11: *Example of how the ASR system (with 6,000 Gaussians) decoded the item /agni/, using the null version of the language model in Figure 3.10. From top to bottom: original waveform, item name, aligned transcriptions given by the model (from the most probable to the least probable, with the corresponding posteriorgrams shown to their right side), and spectrogram with formant contours. SIL = silence.*

correlation to the human data for the BIGRAM RETRO LM was numerically higher than for the NULL LM, we did not find evidence of a significant difference between the two as the CIs of their difference overlaps zero.

Table 3.6: *Difference in correlation with human data between the null LM and other LMs. The lower and upper bounds of the 95% confidence intervals are given between brackets. Positive values indicate higher correlation between human data and null model output than between human data and other LM output.*

	Correlations	Difference	Significant?
null vs. unigram	0.40 – 0.30	0.11 [0.03, 0.18]	Yes
null vs. bigram online	0.40 – 0.23	0.18 [0.03, 0.31]	Yes
null vs. bigram retro	0.40 – 0.43	–0.03 [–0.13, 0.08]	No
null vs. bigram batch	0.40 – 0.19	0.21 [0.06, 0.35]	Yes

Similarly to how we did in Experiment 1, we evaluated the similarity between models’ outputs and human data without focusing on percentage of vowel epenthesis. For this we computed the correlation between the human data and models’ posteriorgrams after excluding the posteriorgrams for “none” responses and re-normalising the remaining posteriorgrams. Recall that, as a consequence, we are focusing on the correlation related to epenthetic vowel quality. The highest correlation corresponded to the NULL LM ( $r = 0.53$ ), followed by BIGRAM RETRO ( $r = 0.46$ ), UNIGRAM ( $r = 0.33$ ), BIGRAM ONLINE ( $r = 0.21$ ),

and BIGRAM BATCH ( $r = 0.17$ ). As can be seen in Table 3.7, the correlation between the human data and the output of the NULL LM was significantly higher than those between the human data and other LMs.

Table 3.7: *Difference in correlation with human data between the null LM and other LMs, after removing the “none” responses. The lower and upper bounds of the 95% confidence intervals are given between brackets. Positive values indicate higher correlation between human data and null model output than between human data and other LM output.*

	Correlations	Difference	Significant?
null vs. unigram	0.53 – 0.33	0.21 [0.16, 0.26]	Yes
null vs. bigram online	0.53 – 0.21	0.33 [0.18, 0.46]	Yes
null vs. bigram retro	0.53 – 0.46	0.08 [0.04, 0.12]	Yes
null vs. bigram batch	0.53 – 0.17	0.36 [0.21, 0.51]	Yes

### 3.3.3.3 Results: Qualitative analysis

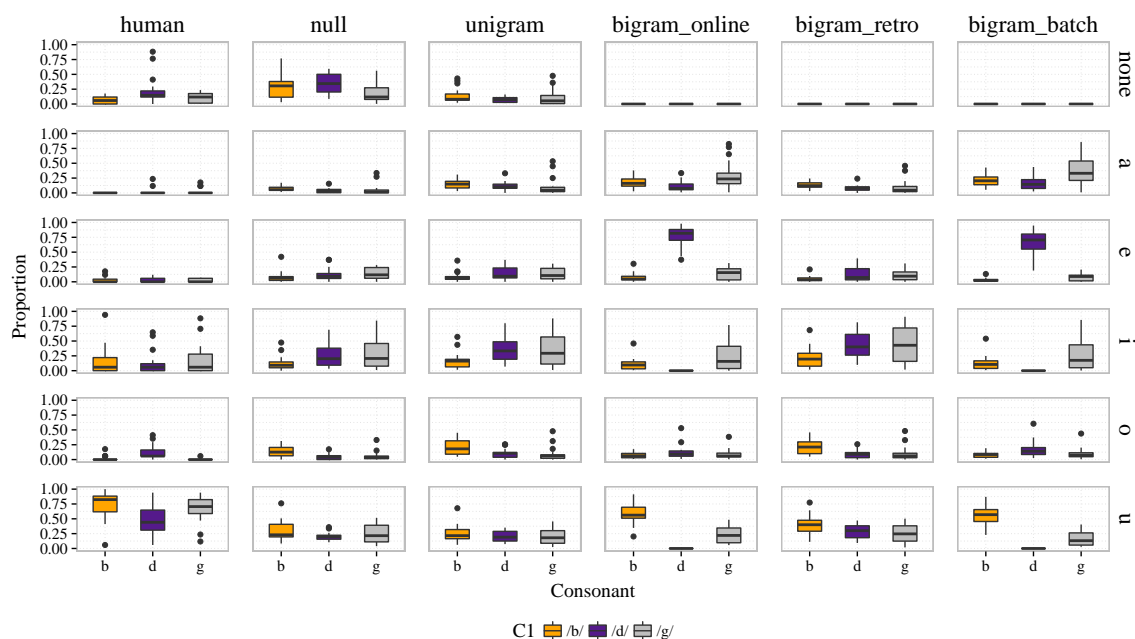

Figure 3.12: *Response patterns for the identification task. Human and models responses are separated by columns; responses are given by rows. Within each rectangle, the horizontal axis separates proportions according to  $C_1$ . The vertical axis corresponds to proportion of responses (i.e., posteriorgrams, in the case of models). The box and whiskers plots display the distribution of the proportions across items (median, quartiles and extrema).*

**Default vowel** Figure 3.12 shows response patterns from the behavioural experiment and model simulations. The most frequent responses given by Japanese listeners were “u” (63%), “i” (15%), and “none” (13%), with “o”, “e”, and “a” being infrequent responses (< 5% each). The model with the null LM shares the same three most frequent responses,

ordered as follows based on their posteriorgrams: “none” (28%), “u” (25%), “i” (23%); other responses (“e”, “o”, “a”) had posteriorgrams below 12%. While human and model responses assign most of the responses to the same three options, we saw that the model’s preferred response is not “u” but “none”. Yet, humans experienced default /u/-epenthesis in more than half of the trials. As such, the model was not able to reproduce the default epenthetic vowel preference.

**Effect of coarticulation** Next we examined if the coarticulation effect observed in human responses also appeared in model responses. Statistical analyses were performed with the R statistical software [R Core Team, 2016], using Markov chain Monte Carlo generalised linear mixed-models [Hadfield, 2010, Plummer et al., 2006]. These Bayesian models sample coefficients from the posterior probability distribution conditioned on the data and given priors. We used priors that are standard for linear models. Model convergence was assessed by visual inspection of trace plots and the Gelman–Rubin convergence diagnostic [Gelman and Rubin, 1992], using eight chains with different initialisations. Effects were considered statistically significant if the 95% highest posterior density (HPD) interval estimated for the coefficient of interest did not include zero. We report both the posterior mode and the 95% HPD interval.

In order to assess the influence of  $V_1$  and  $V_2$  (henceforth: flanking vowels) on epenthetic vowel quality (/i/ or /u/), we chose as fixed effect for our statistical models NUMBER OF SAME FLANKING VOWELS (NSFV; considered as a continuous variable with values 0, 1, or 2 instead of a factor with 3 levels, in order to reduce the number of model parameters and promote convergence). Due to the almost null variance and the consequent poor trace plot for the random intercept CLUSTER, we did not include it in the statistical models. Our response variable was the continuous variable POSTERIORGRAM.<sup>14</sup>

The left panel of Figure 3.13 shows the posteriorgrams for /i/-epenthesis given by our ASR-based model with a “null” language model. The main effect of NSFV was significant (mode: 0.14, HPD: [0.06, 0.22]). An increased number of /i/ flanking vowels resulted in higher posteriorgrams for stimuli transcriptions with /i/ epenthesis.

The right panel of Figure 3.13 shows the posteriorgrams for /u/-epenthesis given by our ASR-based model with a “null” language model. The main effect of NSFV was not significant (mode: 0.03, HPD: [−0.03, 0.09]). Therefore, an increased number of /u/ flanking vowels did not result in significantly higher posteriorgrams for stimuli transcriptions with /u/ epenthesis.

### 3.3.3.4 Summary

In summary, we compared the output of our various ASR models to responses given by Japanese listeners in the experiment described in sections 2.3 and 2.4. Quantitative analyses revealed that the ASR model using a null LM during decoding was better approximating human responses, in particular when examining epenthetic vowel quality. Focusing on the null model, it was able to capture Japanese listeners’ preference for responding “none”, “u”, and “i” during the identification task. However, while humans responded “u” in more than half of the experimental trials, the model posteriorgrams for these three options were numerically very close. As such, the model was unable to capture the “default” status of /u/-epenthesis in Japanese.

Turning to coarticulation effects observed in the behavioural task, we saw in sections 2.3 and 2.4 that Japanese listeners were more prone to epenthesizing vowels /i/ and /u/ when more flanking vowels were of the same quality. The model was able to reflect

---

<sup>14</sup>Responses by human participants and exemplar models were given by trial; therefore, in previous analyses the response variable was binomial.

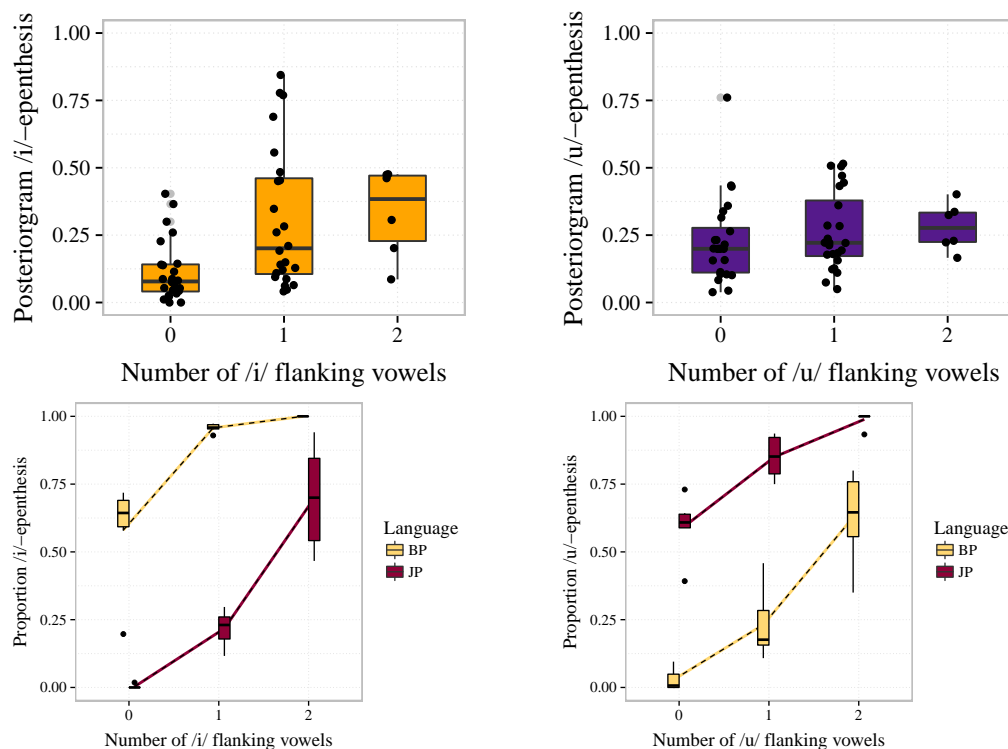

Figure 3.13: *Posteriorgrams for /i/-epenthesis (left) and /u/-epenthesis (right) obtained when decoding with a “null” language model (top panels). The box and whiskers plots display the distribution of posteriorgrams across experimental items, represented by individual dots. As a reference, the equivalent results from the behavioural experiment with Japanese listeners are given in the bottom panels (Language JP), which are a reproduction of Figure 2.16*

this coarticulation effect partially: more /i/ flanking vowels resulted in significantly more /i/-epenthesis; however, we did not find evidence for the analogous situation for /u/-epenthesis.

### 3.3.4 Discussion

In this section we investigated the role of surface phonotactics on perceptual vowel epenthesis by Japanese listeners. We used perceptual models based on ASR systems, which are each composed by an acoustic model (AM) and a language model (LM). Following the reverse inference proposal of nonnative speech perception [Wilson and Davidson, 2013] and using the terminology from [Dupoux et al., 2011], the AM determines the acoustic match between the nonnative structure and candidate native percepts, while the LM determines the phonotactic probability of the candidate percepts (i.e., sequence match). During the one-step process of reverse inference, the product of the probabilities given by the AM and LM are optimised, in order to find the optimal candidate percept.

We evaluated the hypothesis stating that the AM was not only necessary, but sufficient, to predict patterns of perceptual vowel epenthesis. This was done by comparing the results of the identification tasks completed by Japanese listeners (cf. sections 2.2 and 2.3) to model results in analogous identification tasks. We built various ASR systems by pairing up a unique AM with different decoding LMs, one of which was a null LM and the others being LMs including basic phonotactic information (unigram/bigram frequency). Did these phonotactic LMs outperform the null LM?

Quite the contrary, quantitative analyses revealed that the identification results from the ASR system with the null LM better approximated behavioural data. Response patterns from the null LM showed a preponderance of responses “none” (i.e., no epenthesis), “u”, and “i”. This preponderance was present in responses given by Japanese listeners. However, human participants showed a distinct preference for /u/-epenthesis; indeed, this is often referred to as the “default epenthetic vowel in Japanese” both in the psycholinguistics and loanword literature. The model was not fully capable of reflecting this preference, as it was observed in Experiment 1 but not in Experiment 2. Concerning other qualitative effects observed in human responses patterns, the model was able to reproduce some effects (e.g., higher /u/-epenthesis for /kp/- than for /hp/-items), while in others the patterns were opposite to those observed in humans (e.g., higher rates of epenthesis for /hp/- than /kp/-clusters). Coarticulation effects, in particular, were always at least numerically present, yet not always statistically significant. Indeed, for all effects observed in the model that were coherent with effects seen in human responses, we noticed a dampening of the effects and an increase in noise. It seems that the null LM was the best of the tested LMs, yet it was not good enough. Why not? We will discuss two possibilities.

### 3.3.4.1 Need for a better acoustic model

The presence of filler items in Experiment 1 enabled us to see that the ASR systems (all LMs comprised) were generally able to identify nonnative medial vowels /a, i, o/ similarly to how humans did. However, the identification patterns of full vowels /e, u/ by the models did not match Japanese listeners’ identification patterns. Therefore, the ASR system’s current acoustic model, while mostly good, is not a perfect model of Japanese listeners’ perception of stimuli from Experiment 1. Concerning Experiment 2, the correlation between model and human data ( $r \approx 0.4$ ) was much lower than in Experiment 1 ( $r \approx 0.7$ ). Unfortunately, there were no full vowel items available for Experiment 2, so we are unable to make educated guesses about the causes of the lower correlation values and how they may be due to acoustic model quality<sup>15</sup>.

It is also possible that the current acoustic model is not fully mirroring human data due to bad duration modelling. Indeed, recall that we saw in section 2.4 that adding duration information to an exemplar model increased the closeness of its response patterns to that of humans. By definition, in HMMs the observed emission at state  $n$  is only determined by the previous state  $n-1$ . These types of models are therefore not ideal for modelling duration effects, even though some duration information is encoded in the self-loop probabilities (i.e., probabilities determining whether to remain in state  $n$ ).

In sum, in order to continue testing the hypothesis that the acoustic model is sufficient to predict patterns of vowel epenthesis<sup>16</sup>, an even better acoustic model is required. Indeed, recall that we are using relatively primitive ASR models that have a phoneme error rate (%PER) of 50% on “native”, Japanese data. In the future, it would be a good idea to investigate whether other types of acoustic models (e.g., neural network-based ASR systems) better approximate native perception and, as a consequence, nonnative perception. But what if the AM quality is not the source of the problem?

### 3.3.4.2 Need for phonotactics and/or abstract grammar

We assessed how language models with basic phonotactics would fare against a null model. More precisely, we used a unigram LM and three versions of bigram LMs. However, it is always possible to improve our primitive models.

---

<sup>15</sup>It goes without saying that we recommend including full vowel items in future research.

<sup>16</sup>Or, in other words, falsify the fact that the language model is necessary

Due to how probabilities were computed in this identification task, the probability of choosing the non-epenthetic response depended greatly on how the corpus probability of  $C_2$  (e.g., /p/ in /ahpa/) compared to the probabilities of the five Japanese vowels. However, since participants had access to a partial transcription of the stimulus (e.g., visual prompt *ah?pa* for /ahpa/), the probability<sup>17</sup> of  $C_2$  was in practice equal to 1 for all responses. The probability of epenthesizing  $x$  in /ahpa/ is

$$P(ahxpa) = P(a) * P(h) * P(x) * P(p) * P(a) \quad (3.9)$$

with  $P(a) = P(h) = P(p) = P(a) = 1$  because of the orthographic prompt, meaning that

$$P(ahpa) = P(a) * P(h) * P(p) * P(a) = 1 \quad (3.10)$$

or put differently,

$$P(ahpa) = \frac{P(ahxpa)}{P(x)} = \frac{P(x)}{P(x)} = 1 \quad (3.11)$$

An alternative way of setting the probabilities would be to, for instance, weight  $P(ahpa)$  and  $P(ahxpa)$  by the corpus frequencies of words with 4 and 5 phonemes, respectively<sup>18</sup>.

Another possible modification relates to how the LMs dealt with bigrams never seen in the corpus (i.e., nonnative sequences). In order to examine the effect of strict LMs, the probabilities assigned to unseen bigrams was extremely small. This equates to viewing the native phonotactics filter as a binary process (i.e., legal versus illegal structures). It would be possible to find an optimal smoothing parameter (i.e., setting the threshold of the binary filter), or even infer gradient probabilities of the unseen sequences based on natural classes, their occurrence across intonational phrases (cf [Durvasula and Kahng, 2016]), etc. It would also be possible to tune the acoustic scale, which determines the weight of the output of the AM with respect to the LM.

It would be important to also assess the validity of using probabilities derived from a corpus, as some patterns of epenthetic response might be more in line with native phonotactic knowledge rather than with frequency counts (e.g., [Kabak and Idsardi, 2007]). An example of how frequency introduced unexpected response patterns is how our non-null models showed higher rates of /a/-epenthesis compared to the null model, simply because this is the most frequent vowel in our Japanese corpus, yet Japanese listeners rarely epenthesized [a].

An obvious next step would be to test the language models used in [Wilson and Davidson, 2013], where the authors found that most LMs performed better than the null LM at predicting data from a production task. In that work, the favoured LMs were the ones where phonotactic legality was a gradient process, where phones were represented with featural descriptions (e.g. [Albright, 2009]) or where weights given to grammatical constraints were derived from the principle of maximum entropy (e.g. [Boersma and Pater, 2007, Hayes and Wilson, 2008]). In parallel, we can also explore whether our ASR system’s acoustic model (accompanied by a null language model) is able to explain effects attributed to abstract grammatical processes. We will experiment this in the next section.

### 3.3.5 Appendix

#### 3.3.5.1 Unigram (phone-level) language model

The central idea in a unigram model is to have the probability of a word be proportional to the product of the probabilities of the individual phones composing it.

<sup>17</sup>Here we do not specify whether the probability is unigram, bigram, or other.

<sup>18</sup>Please refer to the appendix of this section for a more thorough explanation on how to enhance the computation of  $n$ -gram-based phonotactics.

Translating this formally, for a word  $w$  formed from the  $N_w$  phones  $\rho_1^w, \rho_2^w, \dots, \rho_{N_w}^w$ , we have:

$$p_1(w) = \frac{1}{K} \prod_{i=1}^{N_w} p(\rho_i^w),$$

where  $p_1(w)$  is the probability of occurrence of  $w$  according to a unigram language model,  $p(\rho)$  is the probability of occurrence of phone  $\rho$  and  $K$  is a normalization constant (the same for all words).

There is a difficulty with this definition however: if we want to allow words of arbitrary length, it becomes impossible to find an appropriate normalization constant (i.e. one such that  $p_1$  is a proper probability distribution, whose sum over all possible words equals one)<sup>19</sup>

Next, we consider three different ways of solving this problem and get a properly defined unigram language model.

**Finite language** The simplest solution consists in defining the language model only on a finite set of possible words, for example by considering a language consisting only of words of length less than a specified limit.

If we note  $L$  the finite set of possible words considered, then:

$$K = \sum_{w \in L} p_1(w)$$

is finite and:

$$p_1(w) = \frac{\prod_{i=1}^{N_w} p(\rho_i^w)}{K} = \frac{\prod_{i=1}^{N_w} p(\rho_i^w)}{\sum_{w \in L} \prod_{i=1}^{N_w} p(\rho_i^w)}$$

defines a proper unigram language model over  $L$ .

**Application to the ah(V?)pa language** Let us note  $f_a, f_e, f_i, f_o, f_u, f_p$  the respective probabilities of phones  $a, e, i, o, u, p$  (typically obtained as the frequency of occurrence of these phones in a representative corpus).

After simplification, we get<sup>20</sup>:

$$p_1(ahpa) = \frac{1}{1 + f_i + f_a + f_e + f_o + f_u}$$

and, for any  $V \in \{a, e, i, o, u\}$ :

$$p_1(ahVpa) = \frac{f_V}{1 + f_i + f_a + f_e + f_o + f_u}.$$

### 3.3.5.2 ‘Word-end’ phone

The previous solution defines a unigram language model for a finite language. One way to define a proper unigram language model for potentially infinite languages is to introduce a special ‘word end’ phone  $\pi$  with its own probability of occurrence  $p(\pi)$ <sup>21</sup>.

<sup>19</sup>To see this notice that for any integer  $l \geq 1$ , the sum of  $p_1(w)$  over all words of length  $l$  is  $1/K$ . Thus, if  $K > 0$ ,  $\sum p_1 = \sum_{l \in \{1, 2, \dots\}} 1 = +\infty$  and if  $K = 0$ ,  $\sum p_1 = 0$ .

<sup>20</sup>In the language models used in this work, we have erroneously used  $p_1(ahpa) = \frac{f_p}{f_p + f_i + f_a + f_e + f_o + f_u}$  instead

<sup>21</sup>Typically estimated from a representative corpus, like the other phone probabilities. For example, for a corpus containing the single sentence {He has.} with the phonetic transcript {hi hæz}, out of seven phones (including word-ends), two are word-ends, so  $p(\pi) = 2/7$ .

We can then define a proper unigram language model over all words as:

$$p_1(w) = \frac{p(\pi)}{1 - p(\pi)} \prod_{i=1}^{N_w} p(\rho_i^w),$$

where the special ‘word-end’ phone is not included in the decomposition of  $w$  into  $\rho_1^w, \rho_2^w, \dots, \rho_{N_w}^w$ .

The key is that now the total probability of the ‘normal’ phones is  $1 - p(\pi) < 1$ . As a consequence, the sum of the probability over all words of length  $l$  becomes  $p(\pi)(1 - p(\pi))^{l-1}$ .

We can check that the sum of the probability over all possible words is 1 by recognizing:

$$\sum_w p_1(w) = \sum_{l=1}^{+\infty} p(\pi)(1 - p(\pi))^{l-1}$$

as the sum of terms of a geometric series with reason  $1 - p(\pi) < 1$ , so that:

$$\sum_w p_1(w) = p(\pi) \frac{1}{1 - (1 - p(\pi))} = 1.$$

This defines a proper unigram language model over all possible words. To obtain a unigram language model for a more restricted language  $L$ , we simply compute the conditional probabilities:

$$p_1(w|w \in L) = \frac{p_1(w)}{\sum_{w \in L} p_1(w)}.$$

**Application to the ah(V?)pa language** We can easily check that the formula remain the same as in Section 3.3.5.1, but the procedure to estimate the phone probabilities is now different. As we start counting word-ends as a special phone, the probability of occurrence for the other phones mechanically decreases (it gets multiplied by a factor of  $1 - p(\pi)$ ).

**Explicit word length modeling** One limit of the previous solutions is that they do not allow a realistic modeling of the distribution of word lengths observed in natural languages (by which we mean the distribution of length of word tokens not word types). In English for example, according to Miller, Newman & Friedman (1958), the probability of words first increases with length up to words of length three before decreasing. This pattern cannot be properly captured by the two previous solutions<sup>22</sup>.

A simple way to avoid these shortcomings consists in estimating the distribution of word lengths from a corpus and combine it with the individual phone probabilities to define a language model, as follows:

$$p_1^*(w) = p_1(w)p_\lambda(N_w),$$

where  $p_\lambda(N_w)$  is an estimate of the probability for word tokens to have length  $N_w$  and, as before:

$$p_1(w) = \prod_{i=1}^{N_w} p(\rho_i^w).$$

$p_1^*$  defines a proper probability distribution over all possible words as long as  $p_\lambda$  is a proper probability distribution, because, as we have mentioned already the sum of  $p_1$  over all possible words of length  $l$  for any integer  $l \geq 1$  is equal to 1.

<sup>22</sup>With the first solution, long words are just as likely as shorter words. With the second solution, word probability decreases with word length according to a power law.



As in the previous Section, this defines a unigram language model over all possible words and we can obtain language models for a more restricted language  $L$  by conditioning over  $L$ .

### 3.3.5.3 Application to the ah(V?)pa language

We use the same notation as before. Let us define in addition  $q_4$ , respectively  $q_5$ , the estimated probability that word tokens have length 4, respectively 5. Then:

$$p_1^*(ahpa) = \frac{q_4}{q_4 + q_5(f_i + f_a + f_e + f_o + f_u)}$$

and, for any  $V \in \{a, e, i, o, u\}$ :

$$p_1^*(ahVpa) = \frac{q_5 f_V}{q_4 + q_5(f_i + f_a + f_e + f_o + f_u)}.$$

### 3.3.6 Bigram (phone-level) language model

For a bigram language model, the central idea is to obtain word probabilities from transition probabilities between pairs of consecutive phones.

One way to instantiate this formally is to have for a word  $w$  formed from the  $N_w$  phones  $\rho_1^w, \rho_2^w, \dots, \rho_{N_w}^w$ :

$$p_2(w) = \frac{1}{K} p(\rho_1^w) \prod_{i=2}^{N_w} p(\rho_i^w | \rho_{i-1}^w),$$

where  $p_2(w)$  is the probability of occurrence of  $w$  according to a bigram language model,  $p(\rho)$  is the probability of occurrence of phone  $\rho$ ,  $p(\rho_a | \rho_b)$  is the probability of occurrence of phone  $\rho_a$  *immediately after* phone  $\rho_b$  and  $K$  is a normalization constant (the same for all words).

As for the unigram model, this first approach gives probability  $1/K$  to word of length  $l$  for any integer  $l \geq 1$  and thus does not define a proper language model over all possible words.

The three ideas we presented to solve this problem in the unigram case translate to the bigram case relatively easily.

#### 3.3.6.1 Finite language

As in the unigram case, it is straightforward to apply our definition to a finite language. If we note  $L$  the finite set of possible words considered, then:

$$K = \sum_{w \in L} p_2(w)$$

is finite and:

$$p_2(w) = \frac{p(\rho_1^w) \prod_{i=2}^{N_w} p(\rho_i^w | \rho_{i-1}^w)}{\sum_{w \in L} p(\rho_1^w) \prod_{i=2}^{N_w} p(\rho_i^w | \rho_{i-1}^w)}$$

defines a proper bigram language model over  $L$ .

**Application to the ah(V?)pa language** Let us note  $p_{S_1 S_2}$ , the bigram transition probability between phones  $S_1$  and  $S_2$  and  $\mathcal{V}$  the vowel set  $\{a, e, i, o, u\}$ .

After simplification, we get:

$$p_2(ahpa) = \frac{p_{hp}}{p_{hp} + \sum_{V \in \mathcal{V}} p_{hV} p_{Vp}}$$

and, for any  $V \in \mathcal{V}$ :

$$p_2(ahVpa) = \frac{p_{hV} p_{Vp}}{p_{hp} + \sum_{V \in \mathcal{V}} p_{hV} p_{Vp}}.$$

### 3.3.6.2 ‘Word-beginning’ and ‘Word-end’ phones

The second idea can also be adapted, but this is more involved and the distribution of probability for word lengths becomes hard to characterize. One difference in the bigram case is that it becomes natural to also introduce a special ‘Word-beginning’ phone here. This approach was not used, so we do not give more detail here.

**Application to to the ah(V?)pa language** The formula are the same as in Section 3.3.6.1, but the way the bigram transition probabilities are estimated changes following the introduction of the special ‘word beginning’ and ‘word end’ phones.

### 3.3.6.3 Explicit word length modeling

The reasoning we applied to the unigram case extend directly to the bigram case. We obtain the formula:

$$p_2^*(w) = p_2(w) p_\lambda(N_w),$$

where, as before,  $p_\lambda(N_w)$  is an estimate of the probability for word tokens to have length  $N_w$  and:

$$p_2(w) = p(\rho_1^w) \prod_{i=2}^{N_w} p(\rho_i^w | \rho_{i-1}^w).$$

**Application to to the ah(V?)pa language** Keeping the same notations as before, we get:

$$p_2(ahpa) = \frac{q_4 p_{hp}}{q_4 p_{hp} + q_5 \sum_{V \in \mathcal{V}} p_{hV} p_{Vp}}$$

and, for any  $V \in \mathcal{V}$ :

$$p_2(ahVpa) = \frac{q_5 p_{hV} p_{Vp}}{q_4 p_{hp} + q_5 \sum_{V \in \mathcal{V}} p_{hV} p_{Vp}}.$$

### 3.3.7 Online and Retro language models

Until now, we have considered the probability provided by the language model to whole words in the ah(V?)pa language. Let us call this condition the *batch* condition. We are also interested in an *online* condition, where the language model is applied to obtain information at a moment where only the beginning of the word, up to the ambiguous middle part (one of the 5 vowels or nothing) has been presented. We also consider a *retro* condition as a control, where the language model is applied based only on the word information presented *after* the the ambiguous middle part of the ah(V?)pa stimuli. The word probability given by our various unigram models are the same in all three conditions (batch, online, retro), so we only distinguish these conditions for the bigram models.

We give the bigram language model probabilities for the ah(V?)pa stimuli in the Online and Retro conditions below for the Finite Language case defined in Section 3.3.6.1

and for the Explicit word length modeling case defined in Section 3.3.6.3, as these are the case we have investigated in practice.

### 3.3.7.1 Finite Language

We keep the same notations as in previous sections.

For the Online condition, we get:

$$p_2(ahpa) = p_2(ahp) = \frac{p_{hp}}{p_{hp} + \sum_{V \in \mathcal{V}} p_{hV}}$$

and, for any  $V \in \mathcal{V}$ :

$$p_2(ahVpa) = p_2(ahV) = \frac{p_{hV}}{p_{hp} + \sum_{V \in \mathcal{V}} p_{hV}}.$$

For the Retro condition, we get:

$$p_2(ahpa) = p_2(hpa) = \frac{p_{hp}}{p_{hp} + \sum_{V \in \mathcal{V}} p_{Vp}}$$

and, for any  $V \in \mathcal{V}$ :

$$p_2(ahVpa) = p_2(Vpa) = \frac{p_{Vp}}{p_{hp} + \sum_{V \in \mathcal{V}} p_{Vp}}.$$

### 3.3.7.2 Explicit word length modeling

We keep the same notations as in previous sections.

For the Online condition, we get:

$$p_2(ahpa) = p_2(ahp) = \frac{q_4 p_{hp}}{q_4 p_{hp} + q_5 \sum_{V \in \mathcal{V}} p_{hV}}$$

and, for any  $V \in \mathcal{V}$ :

$$p_2(ahVpa) = p_2(ahV) = \frac{q_5 p_{hV}}{q_4 p_{hp} + q_5 \sum_{V \in \mathcal{V}} p_{hV}}.$$

For the Retro condition, we get:

$$p_2(ahpa) = p_2(hpa) = \frac{q_4 p_{hp}}{q_4 p_{hp} + q_5 \sum_{V \in \mathcal{V}} p_{Vp}}$$

and, for any  $V \in \mathcal{V}$ :

$$p_2(ahVpa) = p_2(Vpa) = \frac{q_5 p_{Vp}}{q_4 p_{hp} + q_5 \sum_{V \in \mathcal{V}} p_{Vp}}.$$

## 3.4 Medley of epenthetic variations: Due to phonological processes or embedded in the phonetics?

### 3.4.1 Introduction

In the previous section we explored the hypothesis that the acoustic model (AM) might not only be necessary to explain patterns of vowel epenthesis, but that it might even be sufficient. We tested  $n$ -gram implementations of local phonotactics through the ASR systems' language models (LMs), as these are typically the type of phonotactic models used in ASR when doing phonetic decoding. We saw that LMs in that format did not add any predictive value to the perception models, compared to just letting the AM decide of the optimal decoding. We propose then, to find ways to implement alternative phonotactic models to ASR systems in order to continue testing the relative importance of acoustic and phonotactics.

In the meantime, it is also possible to further investigate the predictive power of the AM alone. Many phenomena encountered in the field of perceptual vowel epenthesis have been assigned a grammatical explanation; in this section we select a few of them in order to test whether these effects can be elicited by our AMs, without an abstract grammar component that has been defined in the model explicitly. In other words, can some of these seemingly abstract effects be accounted for by how the acoustic information is interpreted by the acoustic model?

We will study three effects at least partially attributed to abstract grammars: (1) cross-linguistic differences in epenthesis (Experiment 3), (2) variations of epenthetic vowel quality due to neighbouring consonants (Experiment 3), and (3) variations in epenthesis due to syllabic structure (Experiment 4).

#### 3.4.1.1 Cross-linguistic differences in epenthesis

There is often a control group in experiments probing epenthesis, in most cases constituted of native listeners of the language used to create the experimental stimuli. This allows to ensure that observed effects of epenthesis are due to the difference in linguistic experience, and not due to idiosyncrasies in the items used in the experiment. Both the control group and the test group are processing the same acoustic input, yet only the test group experiences epenthesis. It has been argued that this is evidence against the hypothesis that phonetic properties drive perceptual distortions (e.g., [Berent et al., 2007]).

However, the acquisition of native phonetic categories has been described as a process of partitioning the phonetic space in an optimal way, respective to the phonemic needs of the native language [Best, 1994, Kuhl and Iverson, 1995]. Phonemic misperceptions can then result from mapping the nonnative input to a native category that is not congruent with the original, intended nonnative category, or that lacks finer grained separations that specify additional phonemic contrasts. Can we explain cross-linguistic differences in perceptual vowel epenthesis within a similar framework? Each language has its partition of the acoustic space specified (i.e., the acoustic model in our ASR systems). The differences between languages at the level of the mapping between their respective AMs and the stimulus acoustics may then trigger vowel epenthesis. We will investigate this possibility in Experiment 3.

### 3.4.1.2 Variations of epenthetic vowel quality due to neighbouring consonants

Within a given language, most episodes of epenthesis involve a “default” epenthetic vowel (e.g., [ɯ] in Japanese, [i] in Korean, [ə] in English and Mandarin Chinese). Aside from variations in epenthetic vowel quality due to coarticulation [Dupoux et al., 2011, Guevara-Rukoz et al., 2017b, Guevara-Rukoz et al., 2017a], variations have also been triggered by changes in neighbouring consonants [Mattingley et al., 2015, Durvasula and Kahng, 2015, Durvasula et al., 2018].

For instance, previous work has highlighted the fact that palatalized consonants may increase the rate of /i/-epenthesis in languages with a different default epenthetic vowel, as follows:

- For Japanese listeners tested by [Mattingley et al., 2015], the voiced alveolo-palatal affricate /d͡z/ mostly triggered [i]-epenthesis (92%), with very few cases of default [ɯ]-epenthesis (6%).
- For Mandarin Chinese listeners tested by [Durvasula et al., 2018], the aspirated alveolo-palatal affricate /t͡ʃ<sup>h</sup>/ elicited more [i]-epenthesis than other vowels (including the “default” [ə]).
- For Korean speakers tested by [Durvasula and Kahng, 2015], palatal consonants /c<sup>h</sup>/ and /ʃ/ mostly elicited [i]-epenthesis, with very low rates of default [i]-epenthesis.

We will now shift our focus to this latter work. The authors interpreted the higher rates of /i/-epenthesis after palatal consonants as listeners taking into consideration phonological alternations when using reverse inference to parse the stimuli. More specifically, palatal consonants are allophonic variants of alveolar consonants preceding the vowel /i/, as shown in Figure 3.14: in front of /i/, /t<sup>h</sup>/ surfaces as [c<sup>h</sup>], while /s/ surfaces as [ʃ]. According to the hypothesis proposed by the authors, Korean listeners may interpret palatal consonants in a cluster as suggestive of the presence of the vowel /i/.

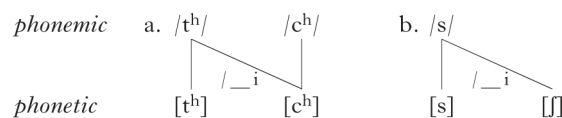

Figure 3.14: *Mappings and neutralisations resulting from the palatalisation process in front of the vowel /i/. Reproduced from [Durvasula and Kahng, 2015].*

Given how we found front vowel coarticulation to be particularly salient at triggering /i/-epenthesis for both humans and ASR models (cf. Figure 3.9), we could hypothesize that similar acoustic cues may be found in palatal consonants. Similarly, [de Jong and Park, 2012] observed variation in rates of epenthesis by Korean listeners that could be explained in part by the acoustic salience of the consonants in the clusters. Therefore, can our AM-only ASR model reproduce the palatal effects observed by [Durvasula and Kahng, 2015], without explicit knowledge about phonological alternations? We will study this in Experiment 3.

### 3.4.1.3 Variations in epenthesis due to syllabic structure

There has been evidence of syllabic structure being taken into consideration by the perceptual system when listening to nonnative speech. For instance, [Kabak and Idsardi, 2007] observed that Korean listeners experienced different rates of epenthesis following a

pattern that seemed to be dictated by syllable structure violations. They were tested on their discrimination of items with clusters and their “epentheticized” equivalents. Korean listeners performed better on stimuli with an illegal cluster with a  $C_1$  legal in coda position, than on the stimuli that also had an illegal cluster but with a  $C_1$  that is not allowed in coda position in Korean.

A theory of word recognition, posited by [Church, 1987], hypothesized that low level cues could be used in a parsing step, allowing a rough segmentation of speech in lexical chunks that could then be looked up in a lexicon. Some of the low level cues suggested by the author were acoustic cues: allophonics, suprasegmental cues (duration, pitch, intensity, etc). Concerning allophonics, consider the case of an English listener parsing a sentence with unknown words. The presence of aspiration in a stop consonant may be used to find syllable boundaries, since in English it only occurs syllable-initially. Therefore, looking at it the other way around, syllable boundaries have an influence on the acoustic realisation of phones.

We could then hypothesize that the acoustic model in the perceptual system is aware of certain allophonic variations, instead of just having a single model per phoneme. In this case, phonotactics have an influence on the acoustic model while it is established, helping the clustering of phones into positionally-relevant groups, for instance. During perception, acoustic match may be considered between the acoustic input and the independent allophones of all phonemes. At the time of perception, a same nonnative phoneme may contain different acoustic cues in different realisations, depending on its position on the word (akin to the aspiration example in syllable-initial stops in English). The acoustics of a Serbian cluster such as /gm/ produced in syllable-initial position may be more suggestive of acoustics in English [gəm], while the word-medial realisations of Serbian /gm/ might actually better approximate English [gm] acoustically.

We expect English listeners to be able to correctly perceive certain Serbian clusters such as /gm/ word-medially but not word-initially, as they are phonotactically illegal in this latter position. Can our AM-only ASR system reproduce this effect? We will investigate this in Experiment 4.

### 3.4.2 Experiment 3: Variations due to native phonology

*The work described in this section was done in collaboration with Emmanuel Dupoux. We thank Karthik Durvasula and Jimin Kahng for kindly sharing with us the stimuli used in the work described in [Durvasula and Kahng, 2015]. We also thank Rory Turnbull and Jeffrey Holliday for providing the K-SPAN database used for frequency analyses [Holliday et al., 2017].*

In this experiment, we investigate if our ASR models are able to reproduce qualitative effects observed in previous work by [Durvasula and Kahng, 2015]. More specifically, we trained ASR models using Korean and English data to model the perception of consonant clusters by Korean and American English listeners, respectively. The American English listeners, who served as the control population, did not experience vowel epenthesis, unlike their Korean counterparts. Additionally, the authors observed that Korean listeners epentheticized /i/ more often when the first consonant of the cluster was a palatal consonant, at the expense of the default epenthetic vowel /i/<sup>23</sup>. The authors attributed this to listeners taking into consideration phonological alternations when using reverse inference to decode the stimuli. More specifically, palatal consonants are allophonic variants

---

<sup>23</sup>Following the original article, we use [i] to denote the close back unrounded vowel found in the Korean vowel inventory. However, the notation [u] has also previously been used (e.g., in [Kabak and Idsardi, 2007])

of alveolar consonants preceding the vowel /i/. Therefore, according to their hypothesis, Korean listeners may interpret palatal consonants in a cluster as suggestive of the presence of the vowel /i/. Since our models were not explicitly made aware of these phonological alternations, to what extent were they able to reproduce these effects? Can our models reproduce the cross-linguistic differences in rates of vowel epenthesis without explicit information about native phonological alternations?

### 3.4.2.1 Methods

**Stimuli** The stimuli, which have been previously used in [Durvasula and Kahng, 2015], were kindly provided by the authors from said paper. They consist of 12 items of the form /eC(V)ma/, with C either a consonant from the set of alveolar consonants {/t<sup>h</sup>, s/} or their palatal counterparts {/c<sup>h</sup>, ʃ/}, and V a vowel from the set {/i, i/}. Each item was recorded twice by a male trained phonetician. The speaker is a native speaker of Indian English and Telugu, also a near-native speaker of standard Hindi. The clusters present in the items are phonotactically legal in these two latter languages. All items were produced with stress on the first syllable. The organisation of the stimuli, based on place of articulation of C, is shown on Table 3.8.

Table 3.8: *Experimental items. Reproduced from [Durvasula and Kahng, 2015] (Table I).*

		vowels		
		[i]	[i]	none
alveolar		et <sup>h</sup> ima	et <sup>h</sup> ima	et <sup>h</sup> ma
		esima	esima	esma
palatal		ec <sup>h</sup> ima	ec <sup>h</sup> ima	ec <sup>h</sup> ma
		efima	efima	efma

**ASR system** Two populations of listeners were simulated in this experiment, based on [Durvasula and Kahng, 2015]: we simulated an English-listening control group using the acoustic model trained on English data (WSJ corpus), and a Korean-listening target group using the acoustic model trained on Korean data (KCSS). As a reminder, we selected the HMM-GMM monophone models with the best performance, namely the models with 15000 Gaussians.

Concerning the language models used during the decoding, in order for the decoding task to be analogous to the behavioural experiment described in [Durvasula and Kahng, 2015], trial-specific language models were constructed, as shown in Figure 3.15. Thus, when decoding the stimulus /eC<sub>1</sub>(V<sub>2</sub>)ma/, the perception model was only given the possibility to transcribe it as /eC<sub>1</sub>(V<sub>2</sub>)(*SIL*)ma/, where phones between parentheses are optional, V<sub>2</sub> was from the set of vowels /i, i/<sup>24</sup>, and *SIL* is an optional silence.

**Identification task simulation** After decoding the stimuli with the ASR models, we extracted from the resulting lattices each possible transcription of each item, and

<sup>24</sup>In [Durvasula and Kahng, 2015] it was assumed that English listeners would associate the grapheme ⟨u⟩ to the phoneme /ʊ/. It is unclear to us if English listeners would, in a similar fashion, associate the grapheme ⟨i⟩ to the phoneme /ɪ/ instead of /i:/. Since English /i:/ is probably the closest vowel to [i] in the stimuli, and since the choice is arbitrary without behavioural testing, we chose its back counterpart /u:/ for “u” instead of /ʊ/. However, it would have also been possible to build language models that account for more than one possible mapping between native and nonnative phonemes (cf. experiment below).

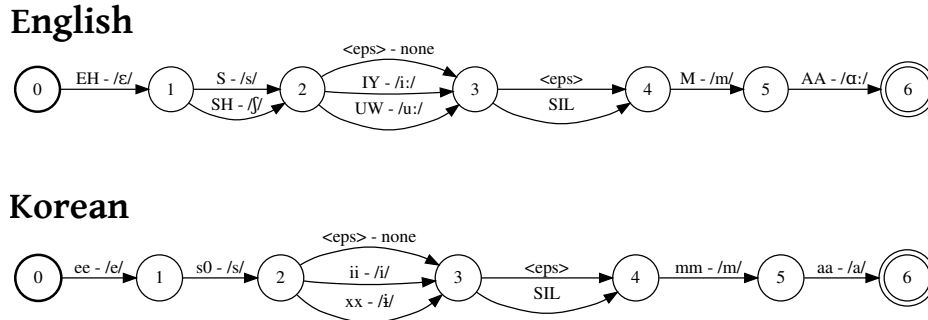

Figure 3.15: *Constrained language model used to decode stimuli with the English (top) and Korean (bottom) acoustic models. The models here were used to decode items /es([i̠i̠])ma/, as well as /ɛʃ([i̠i̠])ma/. This is because there is only one /s/ phoneme in Korean. As a consequence, we neutralised /s/ and /ʃ/ for the English model to use either phoneme in a similar way. However mismatches between the intended consonant and the transcriptions rarely happened in practice. Nodes in the graph represent states, edges represent transitions between states (here: phonemes). WSJ/KCSS labels are shown on edges, along with their IPA transcriptions. The LMs are null, as they only constrain the possible decoding outputs without assigning higher or lower probabilities to certain edges. The optimal decoding path is therefore only dependent on the acoustic scores.*

the corresponding acoustic and language model scores. From the (scaled) acoustic and language model scores we derived the item posteriorgrams, which indicate how probable a given transcription was given the audio input. We used these probabilities as proxies of the probability that a listener might exploit when performing reverse inference during speech perception, and therefore, the probabilities used when responding in an identification task.

As such, for each item, we obtained a three-dimensional vector  $ident_{model} = [p_{none}, p_i, p_{i-bar}]$ , containing a discrete probability distribution, with a probability mass function linking the identification task options {‘none’, ‘i’, ‘i’}, to their respective probabilities (i.e., posteriorgrams). We can define the human equivalent  $ident_{human} = [p_{none}, p_i, p_{i-bar}]$ , which contains the percentage of responses for each item, after aggregating all participant responses.

### 3.4.2.2 Results

**Identification accuracy** Figure 3.16 shows human and model accuracy when identifying medial full vowels, such as [i̠] in /et<sup>h</sup>ima/. While English listeners showed an almost perfect performance (mean accuracy: [i]: 98%; [i̠]: 96%), the English model had difficulty identifying vowels, especially after palatal consonants (mean accuracy: [i]: 71%; [i̠]: 85%). This may be due to an acoustic mismatch between the nonnative vowels in the stimuli and the native vowels in the training corpus.

Contrary to their English-speaking counterparts, Korean listeners showed more difficulty identifying [i̠] (61% accuracy) while achieving good performance for [i] (93%). Numerically, we found a similar pattern in model results (mean accuracy: [i]: 89%; [i̠]: 81%). However, unlike Korean listeners, the Korean model did not consistently perform better in [i]-trials than in [i̠]-trials.



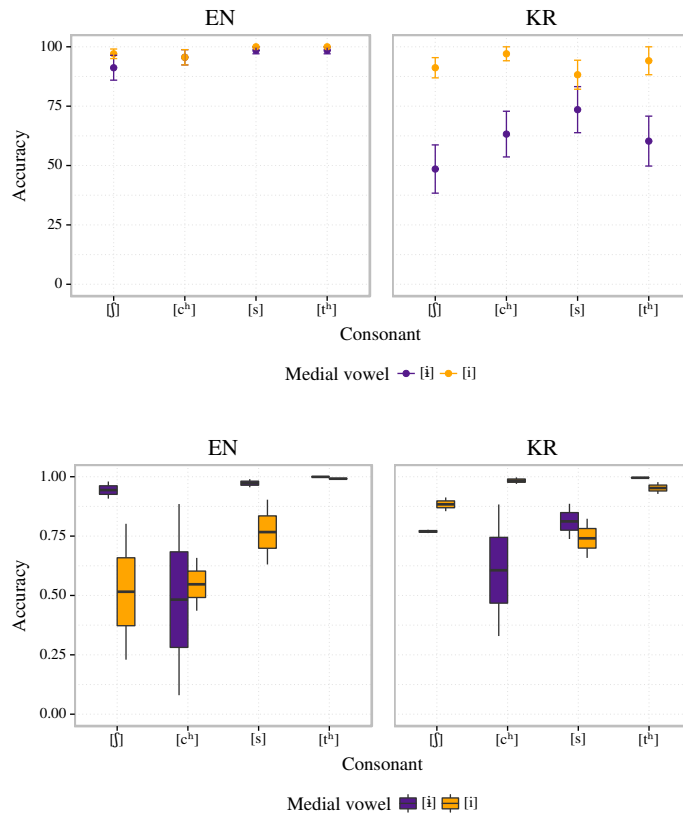

Figure 3.16: *Identification accuracy on items with a full medial vowel, for human listeners (top, data from [Durvasula and Kahng, 2015]) and the respective simulations (bottom). Results are shown for a model trained on American English (left) and a model trained on Korean (right). Points with error bars show the mean and standard deviation, respectively. The box and whiskers plots display the distribution of the proportions across items (median, quartiles, extrema and outliers).*

**Proportion of epenthesis** Human and model response patterns for items with consonant clusters are given in Figure 3.17. Concerning the control English human and model responses, as expected, the predominant case is not experiencing epenthesis. English listeners experienced epenthesis in only 1% of the trials, while the English model’s average posteriorgram for epenthesis was 15%. The model’s data was noisier than for humans, but the performances for both human and model in English surpassed the Korean equivalents.

Indeed, Korean listeners experienced epenthesis in 78% of the trials, and the Korean model’s posteriorgrams for epenthesis averaged to the equivalent of 66% of the trials. Mirroring the higher rates of epenthesis for the English model, the Korean model outputs lower rates of epenthesis than Korean listeners.

Overall, we saw that the models were able to show the crosslinguistic difference in rates of epenthesis, with low rates for English and high rates for Korean.

**Effect of palatalisation on /i/-epenthesis** Focusing on epenthetic vowel quality, [Durvasula and Kahng, 2015] found that Korean listeners mostly epenthesized [i] after palatal consonants, while they epenthesized the “default” vowel [ɪ] after alveolar consonants. This can be seen for Korean listeners in Figure 3.17, but a similar effect is not visible for the Korean model, for which the rates of /i/- and /ɪ/-epenthesis are at similar values around 25% – 50%. Figure 3.18 shows the proportion of trials with epenthesis for

3.4. Medley of epenthetic variations: Due to phonological processes or embedded in the phonetics?

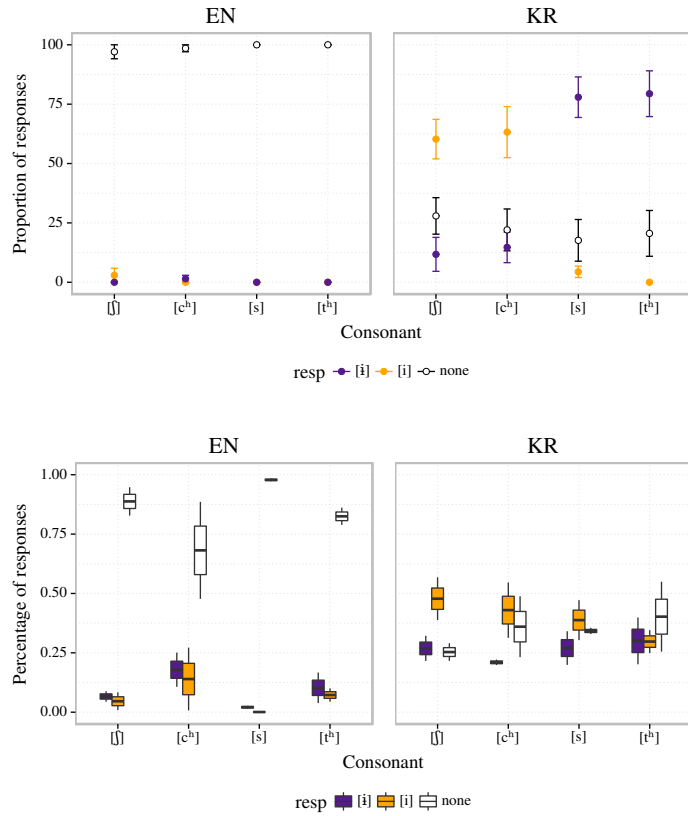

Figure 3.17: Identification patterns on items with consonantal clusters, for human listeners (top, data from [Durvasula and Kahng, 2015]) and the respective simulations (bottom). Proportion of “none”, “i”, and “u”/“ɪ” responses given by the American English (left) and Korean (right) ASR systems. Points with error bars show the mean and standard deviation, respectively. The box and whiskers plots display the distribution of the proportions across items (median, quartiles, extrema and outliers).

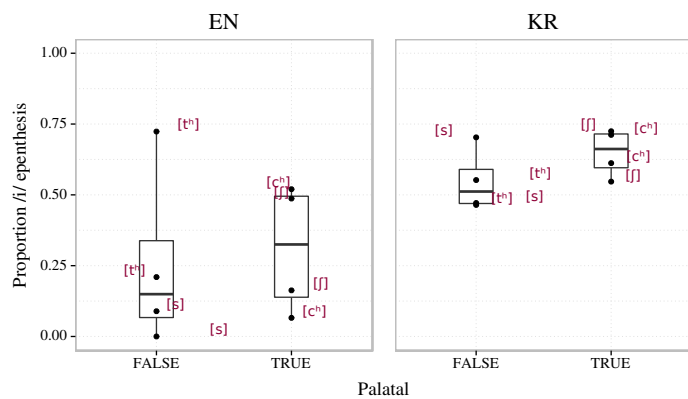

Figure 3.18: Proportion of /i/-epenthesis on trials with epenthesis in cluster items, separating according to whether  $C_1$  is a palatal or alveolar consonant. The box and whiskers plots display the distribution of the proportions across items (median, quartiles, extrema and outliers).

which the epenthetic vowel quality was /i/. Indeed, the difference between palatal (65%) and alveolar (55%) consonants observed in the Korean model is negligible compared to that observed in human responses (over 30% difference).

### 3.4.2.3 Summary

In this experiment, we investigated if ASR systems with a null language model could reproduce psycholinguistic effects attributed to native phonotactics. More precisely, we based ourselves on a study on the perception of consonant clusters by Korean listeners, where their performance was compared to that of American English listeners.

The first question related to when listeners experience vowel epenthesis when listening to nonnative speech. The English group served as a control group; the authors expected low rates of epenthesis, as English phonotactics are less restrictive than Korean phonotactics. Indeed, this was the case, with Korean speakers experiencing epenthesis in most trials, unlike English speakers. Thought not as clear cut as for humans, we found a similar effect when comparing cluster decoding by Korean and American English ASR systems.

Concerning trials where there was a full medial vowel between the consonants, the models diverged from human behaviour; in general, the identification accuracy was lower than for humans (especially the English one).

A second question referred to phonological influences on epenthetic vowel quality. The authors observed higher rates of /i/-epenthesis in palatal allophones of alveolar consonants, in detriment of the default vowel /i/. This prompted them to hypothesize that phonological alternations were influencing epenthetic vowel selection during perception. We examined this hypothesis by investigating if our models, which lack explicit abstract phonological rules or constraints, could reflect this palatal effect. The hypothesis being that palatal consonants might contain acoustic cues more similar to the front vowel /i/ than to /i/. However, we did not find evidences of the effect in the output of our models. It would be interesting to see if the effect might come from phoneme co-occurrences as, for instance, the diphone [c<sup>h</sup>i] is more frequent than [c<sup>h</sup>i] (Figure 3.19). This might explain, in part, higher rates of /i/- than /i/-epenthesis in /c<sup>h</sup>m/ clusters. However, we remain skeptical, following the discussion about the low predictive power of *n*-gram-based phonotactic models in the previous section.

### 3.4.3 Experiment 4: Variations due to syllabic structure

*The work described in this section was done in collaboration with Ewan Dunbar, Paul Andrey, Amelia Kimball, Clara Delacourt, Antoine Hedier, and Emmanuel Dupoux. We thank Milica Denić, our Serbian speaker.*

In this experiment, we introduced basic allophony to the acoustic models of our ASR system, and evaluated whether this modification resulted in a better approximation of human responses in a task probing epenthesis. More specifically, we trained two different acoustic models which differed in whether phones were word-position-dependent (i.e., different HMM-GMMs depending on the position within the word) or not. We trained the models using the WSJ American English corpus, in order to model the perception of phonotactically illegal Serbian clusters by American English listeners. The clusters were either word-initial or word-medial. Based on results by [Kabak and Idsardi, 2007], we expected American English listeners to experience epenthesis less frequently with word-medial clusters, when the consonant clusters could be syllabified as a coda followed by an onset consonant. On the other hand, these clusters were not phonotactically legal word-initially, where the only syllabification possible is as a complex onset cluster. We examined

### 3.4. Medley of epenthetic variations: Due to phonological processes or embedded in the phonetics?

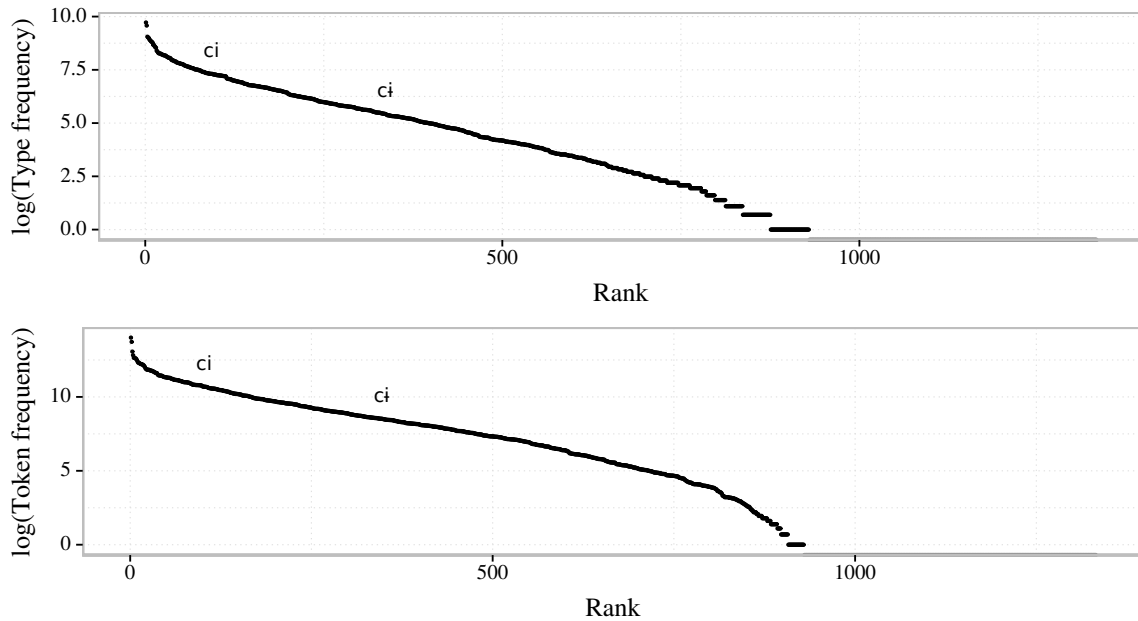

Figure 3.19: *Diphone frequency of [c<sup>h</sup>i] and [c<sup>h</sup>i], relative to all diphones in Korean. Frequencies are computed from the frequencies of word types (top) and word tokens (bottom), as documented in K-SPAN [Holliday et al., 2017].*

whether American English listeners showed differences in rates of epenthesis according to word position and, if so, whether word-position-dependent models better approximated participants’ rates of epenthesis than word-position-independent ones.

#### 3.4.3.1 Methods

**Stimuli** We recorded a female native speaker of Serbian from Kruševac in a sound proof room reading a list of 136 items containing one of 34  $C_1C_2$  cluster either in word-initial position ( $C_1C_2V_1C_3V_1$ , e.g., /znapa/) or word-medial position ( $V_1C_1C_2V_1$ , e.g., /azna/).  $V_1$  and  $C_3$  were always set to /a/ and /p/, respectively. We also recorded the “epenthesized” equivalents of said stimuli, namely  $C_1V_{ep}C_2V_1C_3V_1$  (/zənapa/) and  $V_1C_1V_{ep}C_2V_1$  (/azəna/) with  $V_{ep}$  set as [ə]. For all stimuli stress fell on the first  $V_1$ . The list of  $C_1C_2$  clusters is given in Table 3.9.

**Behavioural experiment** We recruited 38 monolingual native listeners of American English through the online platform Amazon Mechanical Turk. An additional 43 participants were also tested, but they were excluded from the analyses if they met at least one of the following conditions: did not finish all trials, extensive exposure to languages other than English, auditory problems, dyslexia, unable to use headphones or earbuds during the experiment. This information was retrieved from pre-test and post-test questionnaires.

After audio setup<sup>25</sup> and a few training trials, in each experimental trial participants heard an item (e.g., /azna/). Since the grapheme-to-phoneme mapping is not as transparent in English as it is in Japanese or Korean, and because the position of the cluster in the item was not fixed, the task was slightly altered compared to other experiments described in previous sections. Participants were not asked if they had heard a vowel between the consonants; instead, they were given a 2-alternative forced choice task with orthographic transcriptions: if the auditory stimulus was /azna/, participants would be

<sup>25</sup>Participants were given the opportunity to setup the audio to comfortable hearing levels.

Table 3.9: *Clusters used to construct the experimental stimuli, ordered by increasing rates of epenthesis given by humans (word-initial position). We indicate the sonority contour, as well as whether the cluster is a legal onset in English.*

Cluster	Sonority	Legal word-initially?
/tk/	plateau	No
/zg/	plateau	No
/br/	largerise	Yes
/dl/	largerise	No
/dg/	plateau	No
/kl/	largerise	Yes
/ks/	plateau	No
/bl/	largerise	Yes
/fl/	largerise	Yes
/zd/	plateau	No
/pʃ/	plateau	No
/zn/	smallrise	No
/kr/	largerise	Yes
/zm/	smallrise	No
/zl/	largerise	No
/kv/	plateau	No
/zb/	plateau	No
/pl/	largerise	Yes
/gd/	plateau	No
/bd/	plateau	No
/gl/	largerise	Yes
/pn/	smallrise	No
/km/	smallrise	No
/tm/	smallrise	No
/kn/	smallrise	No
/pt/	plateau	No
/zr/	largerise	No
/tl/	largerise	No
/mn/	plateau	No
/gm/	smallrise	No
/ml/	smallrise	No
/dn/	smallrise	No
/gn/	smallrise	No
/mr/	smallrise	No

given the options “*azna*” and “*azana*”. Since online participants are not as immersed in the experiment as participants tested in a laboratory setting, the experiment was self-paced and participants were able to listen to the stimuli as many times as necessary.

Each participant completed 81 trials. For each item, participants heard either the cluster version (e.g., /azna/) or the “epenthesized” version (e.g., /azəna/). Presentation of trials was counterbalanced between participants.

**ASR systems** We simulated perception of nonnative nonwords by English listeners using acoustic models trained on American English data (WSJ corpus). As in previous experiments, we used HMM-GMM monophone models with 15000 Gaussians. However, we tested two types of acoustic models:

1. WPD-False (word-position-independent) acoustic models: These are the type of models that have been used in all previous sections. For these models, all acoustic realisations of a phoneme are grouped together in a unique HMM. Therefore, for instance, in these models there is only one HMM corresponding to the phoneme /p/.
2. WPD-True (word-position-dependent) acoustic models: In these models, different HMM-GMMs are built for phones, according to their position in a word (initial, medial, final, isolate). Therefore, there will be four separate HMM-GMMs for the phoneme /p/.

WPD-False and WPD-True acoustic models are allocated the same number of Gaussians, even though the latter have more phones (up to four times more than WPD-False models). This means that it is almost certain that the average number of Gaussians per phone HMM-GMM is lower in WPD-True than in WPD-False acoustic models. Also, since now acoustic realisations are separated according to their position in a word, we expect Gaussians to be distributed differently amongst HMM-GMMs. As a matter of reference, phonetic transcription on the test set revealed the word-position-independent model to be numerically less performant (41.3%*PER*) than the word-position-dependent model (40.9%*PER*).

Concerning the language model used for decoding stimuli, item-specific language models were constructed, as shown in Figure 3.20. For instance, when decoding an item / $C_1C_2$ apa/, the perception model was only given the possibility to transcribe it as / $C_1(V_{ep})C_2$ apa/, where phones between parentheses are optional and  $V_{ep} = [ə]$ . While all non-medial vowels were intended to be /a/ phonologically, we allowed the model to transcribe them as any phoneme associated with the grapheme ⟨a⟩. This allowed us to account for phonetic reduction in our stimuli, but also to account for the possibility that these alternative transcriptions might also be considered by English-speaking participants in the psycholinguistic experiment, due to item transcriptions being presented orthographically on-screen.

We use a null language model as shown in Figure 3.20, meaning that the decoding process is entirely dependent on the acoustic model, without using information on phonotactics. Note that since we did not constrain the WPD-T model to only transcribe WPD allophones in their respective positions (e.g., allowing only the word-initial allophone of /z/ between states 1 and 2 of the LM for /znapa/, but not the isolated /z/ allophone), we are only comparing the two AMs based on their catalogues of phones, not on word-position matching of said phones.

**Identification task simulation** After decoding the stimuli, we obtained for each possible transcription of each item the corresponding acoustic and language model scores. From these we derived the item posteriorgrams; we collapsed together responses with and without epenthesis, respectively. As such, posteriorgrams indicated the probability of epenthesizing [ə] given the acoustic input. We used these probabilities as proxies of the probability that a listener might exploit when performing reverse inference during speech perception, and therefore, the probabilities used when responding in an identification task. In other words, for each item, we obtained a percentage of vowel epenthesis<sup>26</sup>.

---

<sup>26</sup>For simplicity reasons, the term “epenthesis” will sometimes be used for items with full medial vowels (e.g., /azəna/), even though this is technically incorrect.

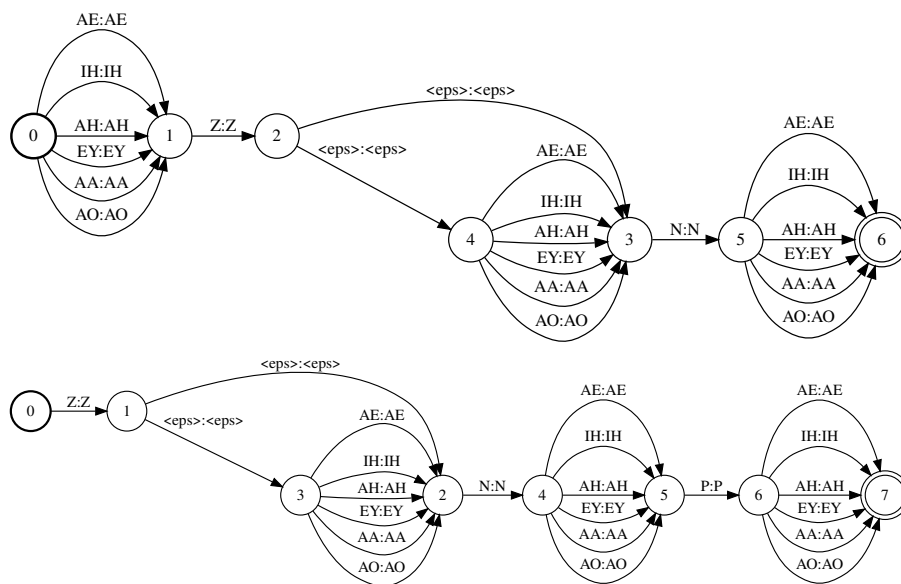

Figure 3.20: Constrained language model used for stimulus decoding (here: LMs for /zna/ (top) and /znapa/ (bottom) trials). Nodes in the graph represent states, edges represent transitions between states (here: phonemes, transcribed in WSJ notation). Models were given the choice to transcribe the phoneme /a/ with any of the phonemes linked to the grapheme ⟨a⟩, as English listeners might have also done so during the task. The LMs are null, as they only constrain the possible decoding outputs without assigning higher or lower probabilities to certain edges. The optimal decoding path is therefore only dependent on the acoustic scores.

### 3.4.3.2 Results

**Qualitative analysis** The left panel of Figure 3.21 shows the average percentage of epenthesis given by human participants for each item. Clusters are ordered according to the ranking of word-initial  $C_1C_2$  clusters. We see that human participants were generally good at detecting [ə] between two consonants, but their performance was not perfect, in particular when the target phonemes were word-initial. Concerning  $C_1C_2$  clusters, there is a large range of rates of epenthesis for word-initial items, going from almost no epenthesis for /tk/ to almost 75% epenthesis for /mr/. For word-medial clusters we do not see the same variation in epenthesis, as most clusters elicited epenthesis less than 25% of the times. However, we do see that clusters are ordered relatively similarly to word-initial counterparts (e.g., the lowest and highest rates of epenthesis are for /tk/ and /mr/, respectively). Note that, while most of the clusters are phonotactically illegal as syllable onsets in English, clusters that elicited less epenthesis are not necessarily only the few clusters that are indeed legal (range from /br/: 6% to /gl/: 31%). Indeed, as can be seen in Figure 3.22, most syllable-initial illegal clusters elicit rates of epenthesis similar to those elicited by legal clusters.

Next we examined if, as predicted based on phonology, English listeners experienced lesser amounts of misperceptions when the clusters can be parsed as a sequence of a coda and an onset (word-medial cluster), instead of a complex onset (word-initial cluster). Statistical analyses were performed with the R statistical software [R Core Team, 2016], using Markov chain Monte Carlo linear models [Hadfield, 2010, Plummer et al., 2006]. These Bayesian models sample coefficients from the posterior probability distribution conditioned on the data and given priors. We used priors that are standard for

### 3.4. Medley of epenthetic variations: Due to phonological processes or embedded in the phonetics?

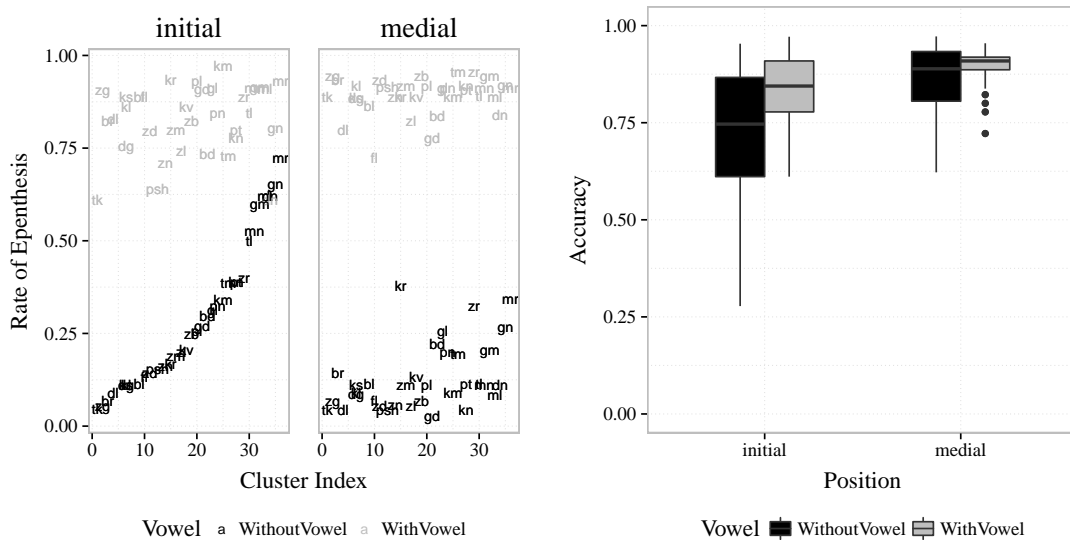

Figure 3.21: *Experimental results for American English listeners. Left: Proportion of epenthesis, collapsed across participants. Clusters are ordered according to rates of epenthesis in word-initial clusters. Right: Identification accuracy, according to the position of the cluster within the word and presence or absence of a vowel between the consonants. The box and whiskers plots display the distribution of the proportions across items (median, quartiles, extrema and outliers).*

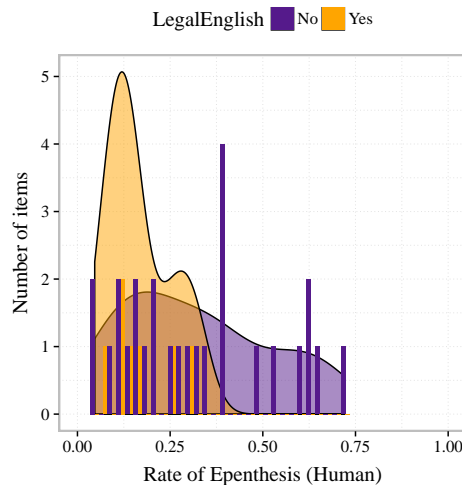

Figure 3.22: *Distribution of rates of epenthesis for human responses on word-initial clusters, according to phonotactic legality in onset position. Densities show the distributions normalised within each category of phonotactic legality.*

linear models. Model convergence was assessed by visual inspection of trace plots and the Gelman–Rubin convergence diagnostic [Gelman and Rubin, 1992], using eight chains with different initialisations. Effects were considered statistically significant if the 95% highest posterior density (HPD) interval estimated for the coefficient of interest did not include zero. We report both the posterior mode and the 95% HPD interval.

Our response variable was the continuous variable %ACCURACY. We chose as fixed effect for our statistical models POSITION (categorical variable with 2 levels: medial *vs.* initial, contrast coded with deviation coding) and VOWEL (categorical variable with 2



levels: true *vs.* false, contrast coded with deviation coding), as well as their interaction.

The right panel of Figure 3.21 shows the percentage of accuracy for human participants. We found a significant main effect for POSITION (mode:  $-0.11$ , HPD:  $[-0.15, -0.07]$ ), VOWEL (mode:  $-0.07$ , HPD:  $[-0.11, -0.03]$ ), as well as their interaction (mode:  $-0.12$ , HPD:  $[-0.18, -0.02]$ ). English listeners were generally better at detecting a present vowel (i.e., no incorrect elision) than at correctly parsing clusters (i.e., no incorrect epenthesis). They experienced more misperceptions at trials where the cluster was word-initial, even more so for  $C_1C_2$ -items than for  $C_1[\text{ə}]C_2$ -items.

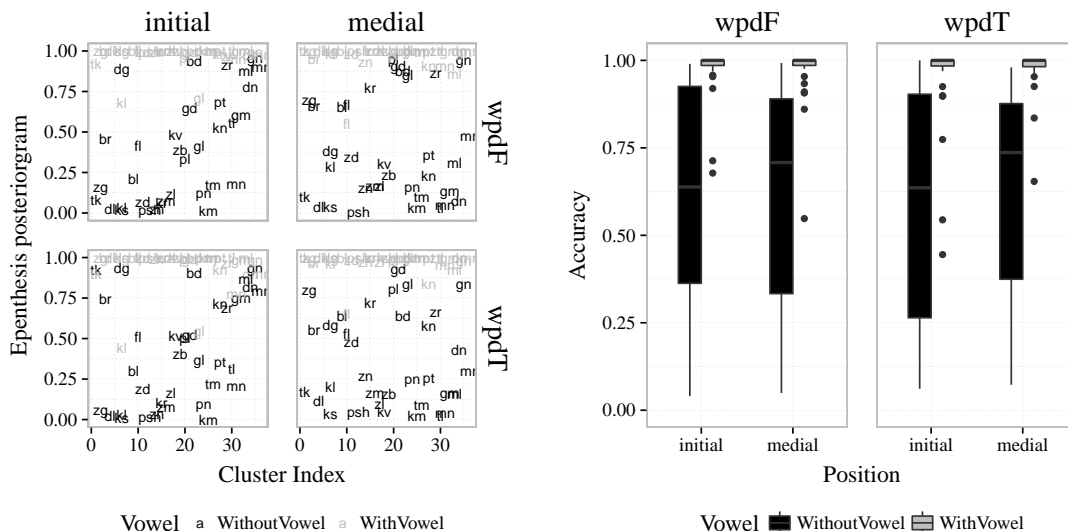

Figure 3.23: *Simulation results for ASR models. Left: Epenthesis posteriorgrams. Clusters are ordered according to rates of epenthesis in word-initial clusters given by human participants. Right: Identification accuracy, according to the position of the cluster within the word and presence or absence of a vowel between the consonants. The box and whiskers plots display the distribution of the proportions across items (median, quartiles, extrema and outliers).*

Model responses can be seen in Figure 3.23. On the left panel, we can see that the models almost never elide full vowels (light gray datapoints). This results in almost perfect performance for these items, as seen in the right panel. On the other hand, there is large variability in the posteriorgrams for  $C_1C_2$  clusters, even for word-medial items. This is also visible from the elongated black boxplots on the right panel. Recall that English listeners gave a large range of percentages for word-initial items only, while they experienced lower rates of epenthesis for word-medial clusters. Closer examination of epenthesis rates according to the ranking of the clusters in the left panel reveals that for word-initial clusters the models generally agree with humans as to which clusters elicit more (e.g., /gn/, /mr/, /dn/) or less (e.g., /zg/, /dl/, /kl/) epenthesis. We did not analyse the model data as we did for human data, due to issues related to highly skewed distributions for full vowel items, and too much variability for cluster items (almost uniform distribution in the  $[0,1]$  interval). However, from looking at both panels from Figure 3.23, we can hypothesize that models also misperceived  $C_1C_2$ -items more often than  $C_1[\text{ə}]C_2$ -items. Yet, it is difficult to find evidence for lessened misperception of clusters in word-medial position.

**Quantitative analysis** The relationship between human responses and model estimation can be visualized in Figure 3.24. In order to perform a global evaluation of the

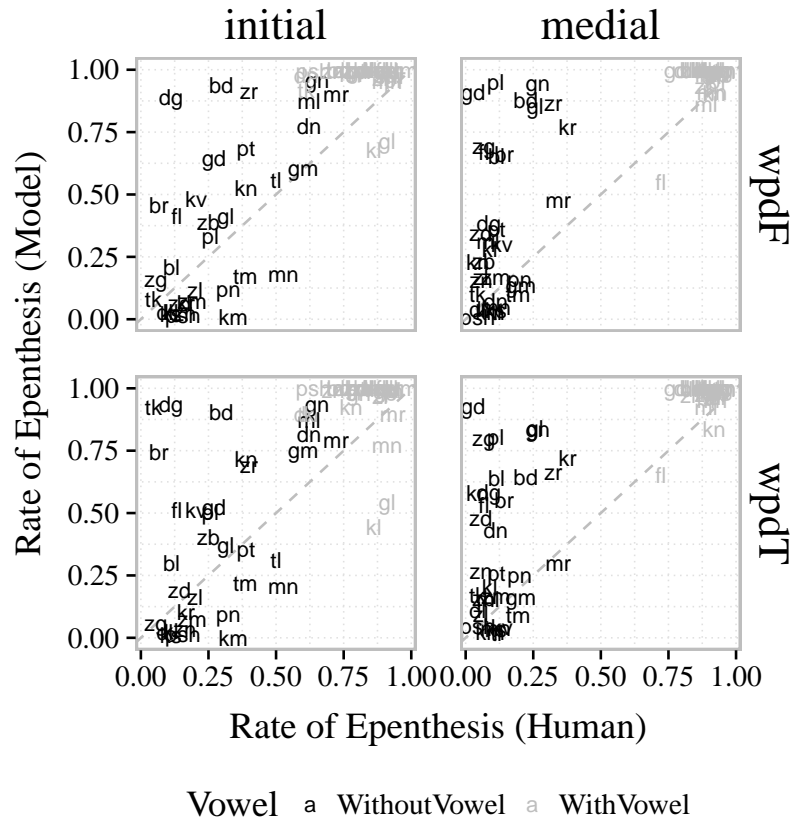

Figure 3.24: Models’ epenthesis posteriorgrams as a function of the percentage of epenthesis given by humans for a given  $C_1C_2$  cluster (black) or  $C_1[a]C_2$  (light gray) item. Dashed lines indicate identity.

similarity between human responses and the responses given by the WDP-F and WPD-T models, respectively, we used leave-one-out cross-validation. This method consists of computing CV, the average prediction error on an item  $i$  by a statistical model trained on all items except  $i$ . We used the following linear models (one per AM) as predictive models:

$$\%EPENTH_{human} = \%EPENTH_{model} \times POSITION \times VOWEL + \epsilon \quad (3.12)$$

In other words, we compared the predictive power of linear models using as predictor variables the model posteriorgrams ( $\%EPENTH_{model}$ ), the cluster position (POSITION; medial *vs.* initial), the presence of a full vowel (VOWEL; true *vs.* false), their interactions, and residuals ( $\epsilon$ ). The data to be predicted were human percentages of epenthesis per item ( $\%EPENTH_{human}$ ). Contrary to expectations, we found the ASR system with the WPD-F acoustic model to have lower average prediction error (CV = 0.014) than the ASR system with the WPD-T acoustic model (CV = 0.016).

### 3.4.3.3 Summary

In this experiment we tested the perception of Serbian clusters (and their “epenthésized” counterparts) by native listeners of English. Most of these clusters were phonotactically illegal syllable-initially in English. We found that while English listeners were better at detecting the presence of a full vowel than detecting its absence, they still experienced elision on items with full vowels between the consonants of interest. However, the predominant

category of mistakes is epenthesis. In particular, listeners experienced misperceptions more often when the clusters were word-initial than when they were word-medial. Additionally, amongst clusters that elicited the least amount of epenthesis in word-initial position we find clusters that are phonotactically legal in this position, and other that are illegal.

We simulated the experiment above using ASR systems with two types of acoustic models: a WPD-F model, which groups all acoustics related to one phoneme within a unique phone, and a WPF-T model, which groups acoustics according to whether they originate from a word-initial, word-medial, word-final, or isolated phone. We found that, globally, the WPD-F model better approximated human results. However, it appears that neither model is able to reproduce the lower accuracy for word-medial than for word-initial  $C_1([\text{ə}])C_2$  items.

### 3.4.4 Discussion

In this section we investigated whether some epenthetic effects attributed to phonological rules/grammars could be explained by the processing of the acoustic signal by an acoustic model (AM) agnostic to such abstract rules/grammars. In particular, as a perceptual model, we used ASR systems for which the AM in question was accompanied by a language model (LM) that only constrained the set of possible percepts, without adding any phonotactic information to the decoding process. The models' patterns of item decoding were compared to results from psycholinguistics experiments in order to tackle three main questions, as follows: (1) cross-linguistic differences in epenthesis, (2) variations of epenthetic vowel quality due to neighbouring consonants, and (3) variations in epenthesis due to syllabic structure.

#### 3.4.4.1 Cross-linguistic differences in epenthesis

We tested the hypothesis that cross-linguistic difference in rates of epenthesis might be due not to interference from a higher order native grammar, but due to how the acoustic space is partitioned during the acquisition of the native phonology. In order to do so, we compared the rates of epenthesis of an American English-native and a Korean-native ASR systems when decoding stimuli containing consonant clusters that are phonotactically illegal in Korean. Indeed, in the original study by [Durvasula and Kahng, 2015], American English listeners almost never experienced epenthesis, while rates of epenthesis were high for Korean listeners.

We found that this asymmetry was also evident in the results from our models, albeit with more nuance: the English model showed low rates of epenthesis but not the near-perfect performance shown by English listeners; the Korean model showed high rates of epenthesis but not as numerically high as Korean listeners did.

Therefore, we provide evidence supporting the hypothesis that cross-linguistic differences in rates of vowel epenthesis may be driven by how the acoustic input is processed and mapped onto a native phonetic inventory. A confound remains in our comparison, however; the corpora used to train the English and Korean models were very different in nature:

- English speech was read speech while Korean speech was spontaneous. The next step would be to re-do the same experiment with a corpus of spontaneous American English (e.g., Buckeye corpus [Pitt et al., 2007]) and a corpus of read Korean speech (e.g., Globalphone Korean corpus [Schultz, 2002]). It then becomes possible to disentangle the roles of speech register and native language on the observed cross-linguistic effect.

### 3.4. Medley of epenthetic variations: Due to phonological processes or embedded in the phonetics?

---

- The phonetic transcriptions in the WSJ corpus were automatically derived from a lexicon of English words. In order to ensure higher fidelity between the transcriptions and the acoustics, it would have been better for it to be manually transcribed, possibly by trained linguists, as it was the case for the Korean corpus. Unfortunately, this is very costly in terms of time and human resources.
- The corpus of Korean was much smaller than the English corpus. This was the case when looking both at the length of the recordings and the number of different speakers. It is therefore possible that the Korean AM is noisier and less mature than its English counterpart. Carefully match the corpora sizes remains a possibility in future work.

#### 3.4.4.2 Variations of epenthetic vowel quality due to neighbouring consonants

Certain variations of epenthetic vowel in Korean have been attributed to a role of phonological alternations during reverse inference [Durvasula and Kahng, 2015]. Specifically, the authors hypothesized that listeners mentally undo native phonological rules during perception (here: use of the palatal allophone of an alveolar consonant before the vowel /i/ → a palatal consonant is suggestive of a vowel /i/ following it). The behavioural evidence for this was an increase of /i/-epenthesis after palatal consonants, disfavoured default /i/-epenthesis. We tested the hypothesis that this may be due to acoustic cues relative to palatalisation being more suggestive of the acoustics of the vowel /i/ than the vowel /i/. In that case, we expected our Korean model to show a similar pattern of results. This was not the case; while the average rate of /i/-epenthesis was numerically higher for palatal than for alveolar consonants, this difference was negligible compared to the magnitude of the difference observed in human listeners.

While data from our models does not support the hypothesis that the effect observed by [Durvasula and Kahng, 2015] is driven by the acoustic content of the stimuli, there is an alternative hypothesis involving phonology that does not necessarily go as deep as suggesting the retrieval of an underlying representation. Indeed, work on loanword adaptation by [Uffmann, 2006] advanced the influence of neighbouring consonants on variations of epenthetic vowel quality in loanwords in Shona, Samoan, Sranan. For instance, the author observed that labial and front/coronal consonants increased the rates of /u/- and /i/-epenthesis, respectively. They proposed that this was a case of consonantal spreading, where the consonantal features were spread onto the epenthetic vowel. Future work should aim to disentangle various phonology-based explanations.

It is also possible that our task-specific null LMs may have been too restrictive, as they assume that all phonemes (except medial vowels) will be correctly identified by the listeners that it is emulating. We used this type of LM in continuation of the work in the precedent section, however there is no mention of Korean listeners having been shown a partial orthographic transcription of the stimuli during the identification task in [Durvasula and Kahng, 2015]. As such, there is no guarantee that Korean listeners' perception of consonants in the items is as intended by the authors. It is possible that the choice of epenthetic vowel quality may have been influenced by the consonants imposed to the model. Indeed, a less-than-ideal fit at the level of the  $C_1$  consonant could cause abnormal boundaries (e.g., suboptimal assignment of acoustic frames to [ʃ] due to the language model imposing that it is [s] instead), meaning that acoustic frames that would have otherwise been interpreted as a given vowel (here, [i]) might be included to a different segment purely by artifact.

Therefore, the next step to have a more comparable task with less assumptions about Korean perception would be to see how the Korean model transcribes the stimuli when

given an unconstrained null model. In this scenario, the model finds the optimal combination of phonemes that match the acoustics. However, this may impair the analysis of the results as the model might be able to input transcriptions such as [et<sup>h</sup>it<sup>h</sup>ma]. Does this constitute a case of epenthesis or not? It would be up to the experimenter to prepare for such ambiguous transcriptions. An intermediate solution might be to construct a semi-constrained LM, where the number of phonemes are set, but not their identity.

### 3.4.4.3 Variations in epenthesis due to syllabic structure

In English, certain consonantal clusters are legal in word-medial position while they are illegal in word-initial position. This is because in the former situation it is often possible to parse the two consonants as part of different adjacent syllables, while in the latter case, the only possibility is for the cluster to be a complex syllable onset. In other words, phonotactic legality of a consonant cluster is not absolute and the exact environments of phonotactic illegality need to be defined. In this case, the clusters studied in this section were phonotactically illegal as a syllable onset.

We tested the hypothesis that acoustics tuned by positional differences in the nonnative language might be interpreted differently by the native listener, resulting in clusters being misperceived in certain positions only. For the case of clusters illegal as onset in English, which are legal in Serbian, this would equate to the acoustic realisations of a given cluster being different according to syllabification, for instance. Then, English listeners might epenthesize vowels more readily when the cluster is a complex onset in Serbian due to a poorer acoustic match to the exemplars of the cluster in English relative to epenthesized alternatives, while the opposite may be true when the acoustic realisation corresponds to a word-medial cluster in Serbian.

We tested the perception of an array of Serbian clusters by American English participants and American English ASR models. The asymmetry in rates of epenthesis between word-initial and word-medial clusters was apparent in human responses, but not in model responses.

An interesting remark is that, for many clusters that are phonotactically illegal in onset position, English listeners reported low rates of epenthesis in word-initial position, comparable to those of legal clusters. When ordering word-initial clusters by increasing rates of epenthesis, we saw that this order was grossly mimicked by the acoustic models. This is in line with the hypothesis advanced by [Wilson and Davidson, 2013, Wilson et al., 2014], stating the influence of phonetic properties on cluster misproductions and the possible preservation of phonotactically illegal representations in perceptual and productive processes. Whether participants in our task were able to perceive word-initially illegal clusters as accurately as rates of epenthesis may suggest requires further investigation. Indeed, vowel epenthesis may have been blocked by other misperception processes such as deletion/cluster simplification (e.g., /tkapa/ → /kapa/) or perceptual adaptation (e.g., /tl/ → /kl/, as already attested by [Hallé and Best, 2007]).

### 3.4.4.4 Conclusion

In conclusion, our purely acoustic ASR models were able to mirror cross-linguistic effects linked to rates of vowel epenthesis in nonnative clusters. However, they were not able to capture variations in epenthetic vowel quality due to neighbouring consonants (i.e., /i/-epenthesis after palatal consonants in Korean), or to capture asymmetries in how a same nonnative cluster might elicit more epenthesis in one syllabic configuration and not in another. This suggests that, at least for our current models, more abstract phonological information may be needed to be injected to the models in order to be able to account for all of the effects studied in this section.

## 3.5 General Discussion

In this chapter we used parametric models from the field of automatic speech recognition (ASR) as models of (nonnative) speech perception. In particular, we focused on empirically testing one-step theories of speech perception. We selected these models as they are defined within a Bayesian framework, akin to the one-step reverse inference proposal by [Wilson and Davidson, 2013].

Notably, we introduced a methodology for simulating the identification paradigm commonly used when studying nonnative speech perception when using ASR systems as models of speech perception. This consists in limiting the set of possible decoding options by manually constraining weighted Finite State Transducer (W-FST) used as a language model for decoding. This is done by configuring the W-FSTs according to the response alternatives given to human participants during the identification task. As the name suggests, it is possible to alter the weights in the W-FST based on, for instance, corpus frequency statistics, to inject a more informative LM to the system. It is then possible to run the simulation with various LMs, using the same AM, in order to test hypothesis about phonotactic information, for example. The model results are evaluated by comparison with human results from an analogous experiment.

### 3.5.1 Language model contributions

In section 3.3 we asked whether injecting information to the LM about  $n$ -gram probabilities would enhance the predictive power of our ASR, with respect to behavioural data. We found that, contrary to expectation, the best performing ASR system was the one combining the AM with a null LM, i.e., a LM which only constrained the set of responses, without favouring certain responses over others. Does this mean that the reverse inference proposal should be simplified to a purely acoustic version? We do not think so. At least not yet. Indeed, while standard in the ASR field,  $n$ -gram-based models, where the unit for  $n$  is a phone, have not been supported by previous work as a good model of phonotactics [Hayes and Wilson, 2008]. Thus, our work is in line with these previous findings. The next step would be to modify our models in order for them to accept other types of phonotactic models [Hayes and Wilson, 2008, Albright, 2009].

### 3.5.2 Model adequacy

Continuing our work with the ASR systems, we focused on a purely acoustic model (i.e., AM combined with a null LM) for the remaining of the chapter. Before dwelling into the perception of nonnative structure, let us discuss results on a more straightforward task: identification of full vowels. Three out of our four experiments had a subset of stimuli containing a medial vowel, in the position where test items would otherwise have a nonnative cluster. How did our models fare in full vowel identification? In Experiment 1 of section 3.3, we saw that the Japanese models' identification accuracy was generally at ceiling as were human responses, except for vowel /e/ and /u/. For these vowels, the model responses did not match the responses of Japanese listeners. Similarly, the English model in Experiment 3 of section 3.4 mimicked the near-perfect identification performance seen in human responses only for half of the items with full vowels. The Korean model also showed noisy in its performance, as did Korean listeners, but the matching between the two sets of responses is not stellar as humans accurately identified the vowel /i/ and the model did so for a couple of items. In Experiment 4 of section 3.4 identification of full vowels did not focus on vowel quality; the models were generally very good at detecting a vowel when present, even more consistently than human participants.

### 3.5.3 Predictive power of the acoustic model

Now let us turn to how the ASR system decodes items containing consonant clusters that are phonotactically illegal in its “native language”. We will divide the epenthetic variations studied in this chapter depending on whether they relate to rate of epenthesis or epenthetic vowel quality. Within each groups, we will see what were the models’ successes and other lessons learned (i.e., “failures” from which we can build upon to guide future research).

#### 3.5.3.1 Variations in rates of epenthesis

**Successes** In both experiments in section 3.3, (along with high vowels /i, u/) the response “none” was within the set of responses preferentially given by the Japanese (null) model, similar to human responses. In a similar vein, the English models in the Experiment 4 in section 3.4 were able to show similar rankings on which clusters elicited more or less epenthesis, relative to responses by English listeners. Finally, and against expectations, the English model and the Korean model showed opposite patterns of rates of epenthesis, with the English model outputting low rates and the Korean model outputting high rates. While the difference was of lesser magnitude for the models than for humans, this pattern is what was observed in human data from [Durvasula and Kahng, 2015]. A very important finding is that even null models, which do not have constraints regarding phoneme sequences, are able to experience epenthesis. In other words, the model will prefer to epenthesize a vowel when the input’s acoustics better match an epenthetic percept following the native phonetic mappings. This suggests that crosslinguistic differences in rates of epenthesis might have an acoustic basis.

**Lessons** Our Japanese models epenthesized vowels more often for items with /hp/- than for /kp/-clusters, while the opposite pattern was true for humans. It was hypothesized that the behaviour observed in humans might be due to release cues in the stop consonant /k/ being interpreted as vowels (similar to what was observed in [de Jong and Park, 2012]). For the model, we can hypothesize that the silent closure periods of the stops in the /kp/ clusters are very salient, long-lasting cues that can be readily matched to the SIL (i.e., silence) phone and the stop phones themselves. The release burst of /k/, on the other hand, was more subtle and very short in duration. It is possible that the model was not sensitive to less salient acoustic cues as such. On the other hand, /hp/ clusters show long-lasting sections of noise that is spectrally similar to devoiced vowels that the model may have encountered in the training data. This may explain why the model epenthesized more readily after /h/.

On another topic, the English models in Experiment 4 of section 3.4 was not able to capture the difference in rates of epenthesis for a same cluster depending whether it is in word-initial position (resulting in more epenthesis) or word-medial position (resulting in less epenthesis). As such, it seems that the acoustic properties of the Serbian clusters did not vary in a way that would have allowed the models to correctly parse one positional allophone and not the other. This suggests that the process may indeed require a phonological explanation, such as the syllable boundary violations that [Kabak and Idsardi, 2007] advanced to explain their results. However, in order to totally rule out an acoustic explanation, one possibility would be to use syllable position-sensitive allophones.

#### 3.5.3.2 Variation in epenthetic vowel quality

**Successes** As highlighted above, in both experiments in section 3.3, the Japanese (null) model’s preferred vowels for epenthesis were high vowels /i/ and /u/. These happen to be vowels prone to devoicing in Japanese [Han, 1962, Vance, 1987]. They are also,

respectively, vowels used for vowel epenthesis in Japanese loanwords. Consistent with how /i/ is epenthesized after palatal consonants in loanwords (e.g., “peach” → /pitci/) and in online perception [Mattingley et al., 2015], the model epenthesized the vowel /i/ in cluster with coarticulation cues proper of front vowels. This was also the pattern observed in human data. Concerning /u/, acoustic analyses in section 2.3 showed it to be acoustically minimal compared to other vowels used for epenthesis in loanwords (/i, o/). The model is able to reflect the resulting abundance of the default /u/-epenthesis that is seen in humans, at least in Experiment 1 of section 3.3. In particular, the model is able to mirror higher rates of /u/-epenthesis for clusters with less amounts of coarticulation (/kp/ than clusters with more salient remnants of (previously) flanking vowel coarticulation (/hp/). This is coherent with the hypothesis that the choice of epenthetic vowels is primarily driven by acoustic factors, not phonological ones.

On the topic of coarticulation and continuing on section 3.3, in Experiment 1, response patterns from the Japanese model showed sensitivity to the front/back vowel coarticulation distinction that we observed in human data and in acoustic analyses of the items in section 2.2. Additionally, in Experiment 2, the model showed higher rates of /i/-epenthesis in the presence of more /i/ vowels flanking the clusters. This shows that the model was sensitive to coarticulation cues that were also exploited by humans, at least for the more salient case of front (high) vowels.

**Lessons** Surprisingly, the same model that reproduced default /u/-epenthesis in Experiment 1 in section 3.3 was unable to show the same effect for stimuli in Experiment 2 of the same section. It is unclear why this happened, and we can only enumerate candidates for exploration (e.g., differences between speakers, speaker native language, etc). In the same vein, and contrary to what was found for /i/ coarticulation, the model only showed a numerical, non-significant increase in /u/-epenthesis. It is possible that /u/-coarticulation was not salient enough for the model to catch it. Additionally, the model was not able to explain processes that we hypothesized to be due to coarticulation readily available in the acoustic signal: higher percentages of vowel copy in clusters with greater amounts of coarticulation (Japanese model, Experiment 1 in section 3.3), and /i/-epenthesis following palatal consonants (Korean model, Experiment 3 in section 3.4). The latter is particularly surprising since we saw that coarticulation cues from /i/ were salient enough for the Japanese model to capture them and use them during decoding. It remains to be seen if these inconsistencies indicate fundamental limits to the acoustic hypothesis, in which case the choice of epenthetic vowels would require more underlying abstract mechanisms, or whether they would disappear when using more performant acoustic models (i.e., models that are better able to mimic adult nonnative vowel perception results; see section 3.5.2).

### 3.5.4 Model enhancements

In sum, the acoustic model studied in this chapter was only able to partially mirror epenthetic patterns from behavioural experiments. Some effects were only reproduced numerically but non statistically significantly; it was only a few phenomena where the model showed patterns opposite to those shown by human participants. Critically, however, we observed that for the effects that the models succeeded at replicating, the effect sizes were smaller than for humans. We used the words “damped down” to qualify the positive effects of the model, as indeed they were of lesser intensity.

Interestingly, some of the effects that were damped down or not found for the parametric ASR model were of greater magnitude in the output of non-parametric exemplar-based models in sections 2.3 and 2.4 (e.g., higher rates of /u/-epenthesis even if still not at default levels, modulations in rates of /i/- and /u/-epenthesis due to increased coarticulation for



both high vowels ...). This indicates that the models' failures to reproduce these specific effects cannot be interpreted as the immediate need to find a non-acoustic/phonetic origin for them. In order to approach that conclusion in a safer way, it would be necessary to test models that are compromise between our parametric models (able to have phones as its unit, can output any combination of phones, including those resulting in no epenthesis...), and our non-parametric models (can account for duration mismatches, is more sensitive to coarticulation cues...). It might be possible that newer generation neural network (NN)-based acoustic models may be able to be more performant than our deprecated monophone HMM-GMM acoustic models. In particular, Long Short Term Memory (LSTM) networks might be promising, as they are able to learn long-term dependencies. However, one must be careful when choosing NN-based models as the acoustic model: if one is to study how some effects might be AM- or LM-specific, one must make sure that the two components are completely independent from each other (e.g., as triphone HMM-GMMs were *not*). This is maybe difficult to assess in NNs, often referred to as "black boxes".

### 3.5.5 Data enhancements

But before getting carried away with trendy NNs, there is a more pressing issue; the corpora used to train the acoustic models (no matter what architecture) must be cleaned up for future experiments. A badly paraphrase of a saying often heard in the field of Machine Learning is that it does not matter how good or complex your model is if the data quality is poor. Indeed, we found several issues with the different corpora that we used.

The transcription process is not standardised across corpora: corpora built by linguists are often (painfully) carefully annotated, with manual alignments, transcription of allophones and sometimes acoustic details, validated by comparing transcriptions done by several linguists, etc. This is the ideal situation, and the corpus that more closely matches this description is the Korean corpus (KCSS). However, this elaborate annotations also mean that corpora created in this format are often of much smaller in size (as is the KCSS). On the other extreme, corpora from the speech engineering side may prioritize having larger volumes of data, as for their applications detailed transcriptions are not needed. As an example, the WSJ was not even manually transcribed. Since the recordings were based on people reading text, the transcriptions were assumed to be the very same texts used to elicit speech. It is possible that there are artifacts due to a person not saying exactly what is in the text (e.g., in cases of stuttering, word replacement...). The phonemic transcriptions were automatically obtained from a dictionary, which could have also introduced audio-transcription mismatches.

The CSJ is located between the two, in that it has been manually annotated and aligned. However, annotations were provided by Japanese annotators using the Japanese writing systems. This means that, even if acoustically the signal produced by a Japanese speaker presents phonotactically illegal productions such as non-nasal consonant codas or clusters (due to high vowel deletion, for instance), this may not be reflected in the transcriptions. Even if the transcriber were to be able to correctly perceive the illegal structure, the use of the Japanese writing system automatically blocks any chance of seeing cases like this in the corpus. This matters because the "transcription epenthesis" introduces mismatches between the audio and the transcriptions, adds noise to the representations of the phonemes in question, and biases corpus frequency statistics to not presenting gradient phonotactics. It is highly probable that this directly impacted the results in section 3.3. It also matters conceptually, keeping in mind results by [Dupoux et al., 2011]. They showed that listeners of two dialects of Portuguese, that had the same phonotactics, showed very different rates of epenthesis when hearing items with phonotactically illegal clusters (lis-

teners from Portugal did not experience epenthesis, while listeners from Brazil did). It was hypothesized that this was due to vowel deletion processes in European Portuguese that caused the phonotactically illegal clusters to surface in speech. Since we know Japanese (and Korean) have vowel devoicing and even deletion processes as well, the corpora might not be good enough to reflect the kind of effects seen by [Dupoux et al., 2011].

A way to bypass transcription irregularities would be to iteratively train the acoustic models initially with the accompanying transcription, and later with a null language model and its own decoding output as the transcriptions for the next training. We hypothesize that the model would eventually converge to a transcription that is more faithful to the acoustic signal. Another possibility requiring more effort would be to find exemplars of speech segments of interest (e.g., for /hp/, instances of [hVp]) and checking that they have been correctly transcribed. From then, it is possible to adapt language model probabilities to account for cases of erroneous transcriptions (e.g., proportionally increase the weight of the “none” path and decrease the weight of the “u” path if many [hup] are actually [hp])<sup>27</sup>.

### 3.5.6 Conclusion

In this chapter we modelled nonnative speech perception with a relatively simple monophone HMM-GMMs speech recognizer. This model was a direct implementation of the one-step reverse inference model proposed by [Wilson and Davidson, 2013]. Using a novel methodology we tested the perception of our models in tasks analogous to vowel identification tasks used to probe vowel epenthesis in human participants. In particular, we investigated whether a purely acoustic version of the model could account for various patterns of epenthesis. Results are mixed, and cannot yet deny the need for phonological processes to explain epenthetic patterns studied in this chapter. However, results are also promising, as the purely acoustic models were able to mimic certain processes attributed to phonology such as crosslinguistic differences in rates of vowel epenthesis. In order to continue the investigation further, we propose exploring better alternatives for the acoustic models, and whenever possible, standardisation and clean-up of the data used to train the models.

---

<sup>27</sup>We thank Thomas Schatz for this comment.

# Chapter 4

## Conclusion

In this thesis, we investigated the mechanisms underlying perceptual vowel epenthesis, by combining experimental and modelling approaches. We specifically focused on the processing steps underlying vowel epenthesis during perception, and the acoustic, phonetic, and phonological factors influencing vowel epenthesis. All proposals in the two-step and one-step subgroups of theories accept that these multiple factors may explain the phenomenon of vowel epenthesis. It is in how these factors are weighted and integrated that lie the differences between the two families of theories.

Two-step theories posit that the epenthetic vowel is inserted by the phonological grammar after segment categorisation has been performed, while one-step theories propose that all influencing factors are integrated simultaneously in a probabilistic manner. As of now, it is difficult to formally compare these two hypotheses, due to lack of data that allows to disentangle them, but mostly because of the lack of quantitative model implementations of the theories that would allow us to generate detailed predictions, to be compared to experimental data.

In this thesis, we contributed to filling this gap by providing more experimental data and by developing quantitative models that are implementations of one-step theories. Two such models were developed: an exemplar-based model that compares nonnative input to minimally different native exemplars stored in memory (Chapter 2), and a speech recogniser that transcribes speech without relying on exemplars, but relying on models of phonemes instead (Chapter 3).

In particular, we focused on two main questions:

1. Is perceptual vowel epenthesis a one-step or two-step process?
2. How does a computational implementation of a one-step proposal fare when quantitatively and qualitatively compared to behavioural results?

In Chapter 2, we investigated the role of acoustics in determining epenthetic vowel quality in cases where the epentheticized vowel is of the same quality as its neighbours, as opposed to attributing this phenomenon to a phonological process such as flanking vowel copy. We specifically examined how coarticulation cues present in speech items, either naturally or by splicing, modulated the quality of epenthetic vowels perceived by Brazilian Portuguese and Japanese listeners. In the case of spliced items, we were able to tease apart the individual contributions of acoustic/phonetic factors on the one hand, and phonological factors on the other hand. Based on results from two identification experiments, we found that participants' response patterns could be better explained by variations in coarticulation, with only a small contribution from flanking vowels. We were

---

able to confirm the importance of acoustic detail on epenthetic vowel quality by simulating the behavioural experiments with exemplar-based models of perception. These models only had access to acoustic information and were able to reproduce modulations of epenthetic vowel quality observed in human results. These results were in support of one-step models of nonnative speech perception, in which the acoustic match and sequence match between the nonnative stimulus and the native percept are optimised simultaneously. On the contrary, two-step models in which sequence match is evaluated after an initial categorisation step, are unable to account for acoustic cues modulating epenthetic vowel quality.

In Chapter 3, given the evidence in the previous chapter, we turned to evaluating one-step models specifically. To do so, we recruited tools from the field of speech engineering and automatic speech recognition (ASR). Namely, we built an implementation of a “reverse inference” one-step proposal ([Wilson and Davidson, 2013]) by using HMM-GMM speech recognizers. These systems are composed of two independent modules: the acoustic model and the language model, which provide the computations necessary to retrieve the acoustic match and sequence match of a speech input and possible parses, respectively. The optimal transcription can be found by combining the two in a one-step optimisation process. We proposed a novel way of testing such ASR models in an identification task analogous to those used when probing perceptual vowel epenthesis in human participants. We do this by building language models for decoding that are constrained to only output the response options given to human participants in the forced choice identification task. Depending on the type of phonotactic model that is used, different options may have different weights, i.e., different probabilities. The model outputs responses by integrating the acoustic probabilities given by its acoustic model, and the probabilities found in the constrained forced choice language model.

Considering the findings from the previous chapter, we used this method to evaluate the predictive power of the acoustic model. Following the result that the ASR system with a null model better approximated human responses than ASR systems with more phonotactically elaborate language models, we assessed whether the speech recogniser with the null language model was able to mirror effects of variation in epenthesis. The underlying hypothesis being that the acoustic model may be sufficient to explain these effects, without contributions of more abstract phonological processes. We found that the output from our model was, however, not perfect; the model was not able to faithfully reproduce certain effects that are of acoustic/phonetic origin such as nonnative vowel assimilation, and modulations of the epenthetic vowel quality by coarticulation that the exemplar-based model was able to capture. It was also unable to account for variations of rates of epenthesis due to the syllabic position of the clusters. Importantly, the effects that the model was able to reproduce (e.g., modulations of the epenthetic vowel quality by /i/ coarticulation) were of lower magnitude, compared to their human equivalents.

These results from using relatively simple ASR models suggest that the acoustic model component of the ASR system must be enhanced in order to better evaluate which effects are due to acoustics and which ones may be due to phonological processes. The use of language models should also be explored further by testing language models that incorporate concepts of higher level than bigram transition probabilities. Connectionist models made available by deep learning implementations offer the opportunity to enhance models at the level of both the acoustic and language models, and are therefore a promising avenue of future research, in spite of their need for large volumes of data for training. Recall, however, that we highlighted that the quality of the data used for training should also be improved, if possible, even when used more elaborate ASR models.

Aside from improving our model implementation with more state-of-the-art ASR sys-

tems, future work should involve a combination of various psycholinguistic paradigms, to ensure that effects observed in both human and model data are not solely due to the specific task used. While we focused on modelling identification tasks (i.e.,  $n$ -forced choice paradigms), it is also possible to evaluate ASR models using non-metalinguistic tasks, such as the ABX discrimination task [Schatz et al., 2018]. Testing as many combinations of parameters (e.g., acoustic features, model architectures, input data, experimental paradigms, ...), in a search of replicability, is a necessary step towards elucidating the mechanisms underlying speech perception.

A modelling approach combined with the availability of behavioural data, such as how it was presented in this thesis, allows us to quantitatively and qualitatively test well-defined theories of nonnative speech perception. Importantly, the same model architecture can be used to study the phenomenon of interest (here: vowel epenthesis) in a crosslinguistic fashion. Not only by cross-referencing to existing behavioural data, but also by allowing to derive new predictions about nonnative speech perception. Moreover, our modelling approach can be easily adapted and extended to fields outside of the field of nonnative speech perception. We encourage future research to combine experimental and modelling approaches in order to evaluate mathematically- and/or algorithmically-defined psycholinguistic theories.

# Bibliography

- [Albright, 2009] Albright, A. (2009). Feature-based generalisation as a source of gradient acceptability. *Phonology*, 26(1):9–41.
- [Andruski et al., 1999] Andruski, J. E., Kuhl, P. K., and Hayashi, A. (1999). The acoustics of vowels in Japanese women’s speech to infants and adults. In *Proceedings of the 14th International Congress on Phonetic Sciences*, volume 3, pages 2177–79.
- [Bates et al., 2015] Bates, D., Mächler, M., Bolker, B., and Walker, S. (2015). Fitting linear mixed-effects models using lme4. *Journal of Statistical Software*, 67(1):1–48.
- [Berent et al., 2008] Berent, I., Lennertz, T., Jun, J., Moreno, M. A., and Smolensky, P. (2008). Language universals in human brains. *Proceedings of the National Academy of Sciences*, 105(14):5321–5325.
- [Berent et al., 2007] Berent, I., Steriade, D., Lennertz, T., and Vaknin, V. (2007). What we know about what we have never heard: Evidence from perceptual illusions. *Cognition*, 104(3):591–630.
- [Bernstein Ratner, 1984] Bernstein Ratner, N. (1984). Patterns of vowel modification in mother–child speech. *Journal of child language*, 11(03):557–578.
- [Best, 1994] Best, C. T. (1994). The emergence of native-language phonological influences in infants: A perceptual assimilation model. *The development of speech perception: The transition from speech sounds to spoken words*, 167(224):233–277.
- [Best and Strange, 1992] Best, C. T. and Strange, W. (1992). Effects of phonological and phonetic factors on cross-language perception of approximants. *Journal of Phonetics*.
- [Boersma et al., 2002] Boersma, P. et al. (2002). Praat, a system for doing phonetics by computer. *Glott international*, 5(9/10):341–345.
- [Boersma and Pater, 2007] Boersma, P. and Pater, J. (2007). Constructing constraints from language data: The case of canadian english diphthongs. *Handout, NELS*, 38.
- [Bombien et al., 2016] Bombien, L., Winkelmann, R., and Scheffers, M. (2016). *wrassp: an R wrapper to the ASSP Library*. R package version 0.1.4.
- [Burnham et al., 2002] Burnham, D., Kitamura, C., and Vollmer-Conna, U. (2002). What’s new, pussycat? On talking to babies and animals. *Science*, 296(5572):1435–1435.
- [Chan and Lane, 2015] Chan, W. and Lane, I. (2015). Deep recurrent neural networks for acoustic modelling. *arXiv preprint arXiv:1504.01482*.
- [Chi et al., 2005] Chi, T., Ru, P., and Shamma, S. A. (2005). Multiresolution spectrotemporal analysis of complex sounds. *The Journal of the Acoustical Society of America*, 118(2):887–906.

- [Church, 1987] Church, K. W. (1987). Phonological parsing and lexical retrieval. *Cognition*, 25(1-2):53–69.
- [Cristia and Seidl, 2014] Cristia, A. and Seidl, A. (2014). The hyperarticulation hypothesis of infant-directed speech. *Journal of Child Language*, pages 1–22.
- [Daland et al., 2015] Daland, R., Oh, M., and Kim, S. (2015). When in doubt, read the instructions: Orthographic effects in loanword adaptation. *Lingua*, 159:70–92.
- [Davidson and Shaw, 2012] Davidson, L. and Shaw, J. A. (2012). Sources of illusion in consonant cluster perception. *Journal of Phonetics*, 40(2):234–248.
- [de Jong and Park, 2012] de Jong, K. and Park, H. (2012). Vowel epenthesis and segment identity in korean learners of english. *Studies in Second Language Acquisition*, 34(01):127–155.
- [Dehaene-Lambertz et al., 2000] Dehaene-Lambertz, G., Dupoux, E., and Gout, A. (2000). Electrophysiological correlates of phonological processing: a cross-linguistic study. *Journal of Cognitive Neuroscience*, 12(4):635–647.
- [Dupoux et al., 1999] Dupoux, E., Kakehi, K., Hirose, Y., Pallier, C., and Mehler, J. (1999). Epenthetic vowels in Japanese: A perceptual illusion? *Journal of experimental psychology: human perception and performance*, 25(6):1568.
- [Dupoux et al., 2001] Dupoux, E., Pallier, C., Kakehi, K., and Mehler, J. (2001). New evidence for prelexical phonological processing in word recognition. *Language and cognitive processes*, 16(5-6):491–505.
- [Dupoux et al., 1997] Dupoux, E., Pallier, C., Sebastian, N., and Mehler, J. (1997). A distressing “deafness” in french? *Journal of Memory and Language*, 36(3):406–421.
- [Dupoux et al., 2011] Dupoux, E., Parlato, E., Frota, S., Hirose, Y., and Peperkamp, S. (2011). Where do illusory vowels come from? *Journal of Memory and Language*, 64(3):199–210.
- [Dupoux et al., 2010] Dupoux, E., Peperkamp, S., and Sebastián-Gallés, N. (2010). Limits on bilingualism revisited: Stress ‘deafness’ in simultaneous french–spanish bilinguals. *Cognition*, 114(2):266–275.
- [Dupoux et al., 2008] Dupoux, E., Sebastián-Gallés, N., Navarrete, E., and Peperkamp, S. (2008). Persistent stress ‘deafness’: The case of french learners of spanish. *Cognition*, 106(2):682–706.
- [Durvasula et al., 2018] Durvasula, K., Huang, H.-H., Uehara, S., Luo, Q., and Lin, Y.-H. (2018). Phonology modulates the illusory vowels in perceptual illusions: Evidence from mandarin and english. *Laboratory Phonology: Journal of the Association for Laboratory Phonology*, 9(1).
- [Durvasula and Kahng, 2015] Durvasula, K. and Kahng, J. (2015). Illusory vowels in perceptual epenthesis: the role of phonological alternations. *Phonology*, 32(03):385–416.
- [Durvasula and Kahng, 2016] Durvasula, K. and Kahng, J. (2016). The role of phrasal phonology in speech perception: What perceptual epenthesis shows us. *Journal of Phonetics*, 54:15–34.

- [Escudero et al., 2009] Escudero, P., Boersma, P., Rauber, A. S., and Bion, R. A. (2009). A cross-dialect acoustic description of vowels: Brazilian and European Portuguese. *The Journal of the Acoustical Society of America*, 126(3):1379–1393.
- [Flege et al., 1995a] Flege, J. E., Munro, M. J., and MacKay, I. R. (1995a). Factors affecting strength of perceived foreign accent in a second language. *The Journal of the Acoustical Society of America*, 97(5):3125–3134.
- [Flege et al., 1995b] Flege, J. E., Takagi, N., and Mann, V. (1995b). Japanese adults can learn to produce english/i/and/l/accurately. *Language and Speech*, 38(1):25–55.
- [Gales et al., 2008] Gales, M., Young, S., et al. (2008). The application of hidden markov models in speech recognition. *Foundations and Trends® in Signal Processing*, 1(3):195–304.
- [Gelman and Rubin, 1992] Gelman, A. and Rubin, D. B. (1992). Inference from iterative simulation using multiple sequences. *Statistical science*, pages 457–472.
- [Giorgino, 2009] Giorgino, T. (2009). Computing and visualizing dynamic time warping alignments in R: The dtw package. *Journal of Statistical Software*, 31(7):1–24.
- [Golinkoff et al., 2015] Golinkoff, R. M., Can, D. D., Soderstrom, M., and Hirsh-Pasek, K. (2015). (baby) talk to me: The social context of infant-directed speech and its effects on early language acquisition. *Current Directions in Psychological Science*, 24(5):339–344.
- [Goto, 1971] Goto, H. (1971). Auditory perception by normal japanese adults of the sounds "L" and "R". *Neuropsychologia*.
- [Guevara-Rukoz et al., 2017a] Guevara-Rukoz, A., Lin, I., Morii, M., Minagawa, Y., Dupoux, E., and Peperkamp, S. (2017a). Which epenthetic vowel? phonetic categories versus acoustic detail in perceptual vowel epenthesis. *The Journal of the Acoustical Society of America*, 142(2):EL211–EL217.
- [Guevara-Rukoz et al., 2017b] Guevara-Rukoz, A., Parlato-Oliveira, E., Yu, S., Hirose, Y., Peperkamp, S., and Dupoux, E. (2017b). Predicting epenthetic vowel quality from acoustics. In *INTERSPEECH*.
- [Hadfield, 2010] Hadfield, J. D. (2010). MCMC methods for multi-response generalized linear mixed models: The MCMCglmm R package. *Journal of Statistical Software*, 33(2):1–22.
- [Hallé et al., 2014] Hallé, P., Seguí, J., Domínguez, A., and Cuetos, F. (2014). Special is especial but stuto is not astuto: Perception of prothetic /e/ in speech and print by speakers of spanish. In Jaichenco, V. and Sevilla, Y., editors, *Psicolingüística en Español. Homenaje a Juan Seguí.*, pages 31–47. Buenos Aires: Secretaría de Publicaciones, Facultad de Filosofía y Letras, Universidad de Buenos Aires.
- [Hallé and Best, 2007] Hallé, P. A. and Best, C. T. (2007). Dental-to-velar perceptual assimilation: A cross-linguistic study of the perception of dental stop+/l/clusters. *The Journal of the Acoustical Society of America*, 121(5):2899–2914.
- [Han, 1962] Han, M. S. (1962). Unvoicing of vowels in Japanese. *Onsei no kenkyuu*, 10:81–100.
- [Hayes and Wilson, 2008] Hayes, B. and Wilson, C. (2008). A maximum entropy model of phonotactics and phonotactic learning. *Linguistic inquiry*, 39(3):379–440.



- [Holliday et al., 2017] Holliday, J. J., Turnbull, R., and Eychenne, J. (2017). K-span: A lexical database of korean surface phonetic forms and phonological neighborhood density statistics. *Behavior research methods*, 49(5):1939–1950.
- [Hyafil et al., 2015] Hyafil, A., Fontolan, L., Kabdebon, C., Gutkin, B., and Giraud, A.-L. (2015). Speech encoding by coupled cortical theta and gamma oscillations. *Elife*, 4:e06213.
- [Iverson et al., 2005] Iverson, P., Hazan, V., and Bannister, K. (2005). Phonetic training with acoustic cue manipulations: A comparison of methods for teaching english /r/-/l/ to japanese adults. *The Journal of the Acoustical Society of America*, 118(5):3267–3278.
- [Kabak and Idsardi, 2007] Kabak, B. and Idsardi, W. J. (2007). Perceptual distortions in the adaptation of English consonant clusters: Syllable structure or consonantal contact constraints? *Language and Speech*, 50(1):23–52.
- [Keating, 1988] Keating, P. A. (1988). Underspecification in phonetics. *Phonology*, 5(02):275–292.
- [Kirchhoff and Schimmel, 2005] Kirchhoff, K. and Schimmel, S. (2005). Statistical properties of infant-directed versus adult-directed speech: Insights from speech recognition. *The Journal of the Acoustical Society of America*, 117(4):2238–2246.
- [Kuhl et al., 1997] Kuhl, P. K., Andruski, J. E., Chistovich, I. A., Chistovich, L. A., Kozhevnikova, E. V., Ryskina, V. L., Stolyarova, E. I., Sundberg, U., and Lacerda, F. (1997). Cross-language analysis of phonetic units in language addressed to infants. *Science*, 277(5326):684–686.
- [Kuhl and Iverson, 1995] Kuhl, P. K. and Iverson, P. (1995). Linguistic experience and the. *Perceptual Magnet Effect*,” in W. Strange ed., *Speech Perception and Linguistic Experience: Issues in Cross-language Research*, pages 121–154.
- [Lenth, 2016] Lenth, R. V. (2016). Least-squares means: The R package lsmeans. *Journal of Statistical Software*, 69(1):1–33.
- [Liu et al., 2003] Liu, H.-M., Kuhl, P. K., and Tsao, F.-M. (2003). An association between mothers’ speech clarity and infants’ speech discrimination skills. *Developmental Science*, 6(3):F1–F10.
- [Lively et al., 1993] Lively, S. E., Logan, J. S., and Pisoni, D. B. (1993). Training Japanese listeners to identify English /r/ and /l/. II: The role of phonetic environment and talker variability in learning new perceptual categories. *The Journal of the Acoustical Society of America*, 94(3):1242–1255.
- [Logan et al., 1991] Logan, J. S., Lively, S. E., and Pisoni, D. B. (1991). Training Japanese listeners to identify English /r/ and /l/: A first report. *The Journal of the Acoustical Society of America*, 89(2):874–886.
- [Maekawa, 2003] Maekawa, K. (2003). Corpus of spontaneous japanese: Its design and evaluation. In *ISCA & IEEE Workshop on Spontaneous Speech Processing and Recognition*.
- [Martin et al., 2015] Martin, A., Schatz, T., Versteegh, M., Miyazawa, K., Mazuka, R., Dupoux, E., and Cristia, A. (2015). Mothers speak less clearly to infants than to adults: A comprehensive test of the hyperarticulation hypothesis. *Psychological science*, 26(3):341–347.

- [Matsui, 2017] Matsui, M. F. (2017). On the input information of the *c/d* model for vowel devoicing in Japanese. *Journal of the Phonetic Society of Japan*, 21(1):127–140.
- [Mattingley et al., 2015] Mattingley, W., Hume, E., and Hall, K. C. (2015). The influence of preceding consonant on perceptual epenthesis in Japanese. In *Proceedings of the 18th International Congress of Phonetic Sciences*, pages 888:1–5.
- [McMurray et al., 2013] McMurray, B., Kovack-Lesh, K. A., Goodwin, D., and McEchron, W. (2013). Infant directed speech and the development of speech perception: Enhancing development or an unintended consequence? *Cognition*, 129(2):362–378.
- [Miyawaki et al., 1975] Miyawaki, K., Jenkins, J. J., Strange, W., Liberman, A. M., Verbrugge, R., and Fujimura, O. (1975). An effect of linguistic experience: The discrimination of [r] and [l] by native speakers of Japanese and English. *Perception & Psychophysics*, 18(5):331–340.
- [Monahan et al., 2009] Monahan, P. J., Takahashi, E., Nakao, C., and Idsardi, W. J. (2009). Not all epenthetic contexts are equal: Differential effects in Japanese illusory vowel perception. *Japanese/Korean linguistics*, 17:391–405.
- [Munro et al., 1996] Munro, M. J., Flege, J. E., and MacKay, I. R. (1996). The effects of age of second language learning on the production of English vowels. *Applied psycholinguistics*, 17(3):313–334.
- [Nosofsky, 1992] Nosofsky, R. M. (1992). Similarity scaling and cognitive process models. *Annual review of Psychology*, 43(1):25–53.
- [Panayotov et al., 2015] Panayotov, V., Chen, G., Povey, D., and Khudanpur, S. (2015). Librispeech: an ASR corpus based on public domain audio books. In *Acoustics, Speech and Signal Processing (ICASSP), 2015 IEEE International Conference on*, pages 5206–5210. IEEE.
- [Paul and Baker, 1992] Paul, D. B. and Baker, J. M. (1992). The design for the wall street journal-based CSR corpus. In *Proceedings of the workshop on Speech and Natural Language*, pages 357–362. Association for Computational Linguistics.
- [Peperkamp, 2005] Peperkamp, S. (2005). A psycholinguistic theory of loanword adaptations. In *Annual Meeting of the Berkeley Linguistics Society*, volume 30, pages 341–352.
- [Peperkamp and Dupoux, 2003] Peperkamp, S. and Dupoux, E. (2003). Reinterpreting loanword adaptations: the role of perception. In *Proceedings of the 15th international congress of phonetic sciences*, volume 367, page 370.
- [Peperkamp et al., 2008] Peperkamp, S., Vendelin, I., and Nakamura, K. (2008). On the perceptual origin of loanword adaptations: experimental evidence from Japanese. *Phonology*, 25(1):129–164.
- [Pitt et al., 2007] Pitt, M. A., Dilley, L., Johnson, K., Kiesling, S., Raymond, W., Hume, E., and Fosler-Lussier, E. (2007). Buckeye corpus of conversational speech (2nd release)[www.buckeyecorpus.osu.edu] columbus, oh: Department of psychology. *Ohio State University (Distributor)*.
- [Plummer et al., 2006] Plummer, M., Best, N., Cowles, K., and Vines, K. (2006). CODA: Convergence diagnosis and output analysis for MCMC. *R News*, 6(1):7–11.

- [Povey et al., 2011] Povey, D., Ghoshal, A., Boulianne, G., Burget, L., Glembek, O., Goel, N., Hannemann, M., Motlicek, P., Qian, Y., Schwarz, P., Silovsky, J., Stemmer, G., and Vesely, K. (2011). The kaldi speech recognition toolkit. In *IEEE 2011 Workshop on Automatic Speech Recognition and Understanding*. IEEE Signal Processing Society. IEEE Catalog No.: CFP11SRW-USB.
- [R Core Team, 2016] R Core Team (2016). *R: A Language and Environment for Statistical Computing*. R Foundation for Statistical Computing, Vienna, Austria.
- [Rose and Demuth, 2006] Rose, Y. and Demuth, K. (2006). Vowel epenthesis in loanword adaptation: Representational and phonetic considerations. *Lingua*, 116(7):1112–1139.
- [Sakoe and Chiba, 1978] Sakoe, H. and Chiba, S. (1978). Dynamic programming algorithm optimization for spoken word recognition. *IEEE transactions on acoustics, speech, and signal processing*, 26(1):43–49.
- [Saraclar, 2001] Saraclar, M. (2001). *Pronunciation modeling for conversational speech recognition*. The Johns Hopkins University.
- [Schatz, 2016] Schatz, T. (2016). *ABX-Discriminability Measures and Applications*. PhD thesis, Ecole Normale Supérieure, Paris.
- [Schatz et al., 2018] Schatz, T., Bach, F., and Dupoux, E. (2018). Evaluating automatic speech recognition systems as quantitative models of cross-lingual phonetic category perception. *The Journal of the Acoustical Society of America*, 143(5):EL372–EL378.
- [Schultz, 2002] Schultz, T. (2002). Globalphone: a multilingual speech and text database developed at karlsruhe university. In *Seventh International Conference on Spoken Language Processing*.
- [Sebastián-Gallés, 2005] Sebastián-Gallés, N. (2005). Cross-language speech perception. *The handbook of speech perception*, pages 546–566.
- [Shin and Iverson, 2011] Shin, D.-J. and Iverson, P. (2011). Individual differences in vowel epenthesis among korean learners of english. In *(Proceedings) International Congress of Phonetic Sciences*, pages 1822–1825.
- [Soderstrom, 2007] Soderstrom, M. (2007). Beyond babytalk: Re-evaluating the nature and content of speech input to preverbal infants. *Developmental Review*, 27(4):501–532.
- [Steriade, 2001] Steriade, D. (2001). The phonology of perceptibility effects: the p-map and its consequences for constraint organization. *Ms., UCLA*.
- [Takagi and Mann, 1995] Takagi, N. and Mann, V. (1995). The limits of extended naturalistic exposure on the perceptual mastery of english /r/ and /l/ by adult japanese learners of english. *Applied Psycholinguistics*, 16(4):380–406.
- [Tsuchida, 2001] Tsuchida, A. (2001). Japanese vowel devoicing: Cases of consecutive devoicing environments. *Journal of East Asian Linguistics*, 10(3):225–245.
- [Uffmann, 2006] Uffmann, C. (2006). Epenthetic vowel quality in loanwords: Empirical and formal issues. *Lingua*, 116(7):1079–1111.
- [Uther et al., 2007] Uther, M., Knoll, M. A., and Burnham, D. (2007). Do you speak E-NG-LI-SH? A comparison of foreigner-and infant-directed speech. *Speech Communication*, 49(1):2–7.

- [Vance, 1987] Vance, T. J. (1987). *Introduction to Japanese phonology*. Albany, N.Y.: State University of New York Press.
- [Vendelin and Peperkamp, 2006] Vendelin, I. and Peperkamp, S. (2006). The influence of orthography on loanword adaptations. *Lingua*, 116(7):996–1007.
- [Wang and Munro, 2004] Wang, X. and Munro, M. J. (2004). Computer-based training for learning english vowel contrasts. *System*, 32(4):539–552.
- [Wilson and Davidson, 2013] Wilson, C. and Davidson, L. (2013). Bayesian analysis of non-native cluster production. In *Proceedings of NELS*, volume 40.
- [Wilson et al., 2014] Wilson, C., Davidson, L., and Martin, S. (2014). Effects of acoustic-phonetic detail on cross-language speech production. *Journal of Memory and Language*, 77:1–24.
- [Wong, 2012] Wong, J. W. S. (2012). Training the perception and production of English /e/ and /ae/ of Cantonese ESL learners: A comparison of low vs. high variability phonetic training. In *Proceedings of the 14th Australasian International Conference on Speech Science and Technology*. Sydney, Australia, pages 3–6.
- [Ylinen et al., 2010] Ylinen, S., Uther, M., Latvala, A., Vepsäläinen, S., Iverson, P., Akahane-Yamada, R., and Näätänen, R. (2010). Training the brain to weight speech cues differently: A study of finnish second-language users of english. *Journal of Cognitive Neuroscience*, 22(6):1319–1332.
- [Yun et al., 2015] Yun, W., Yoon, K., Park, S., Lee, J., Cho, S., Kang, D., Byun, K., Hahn, H., and Kim, J. (2015). The korean corpus of spontaneous speech. *Daegu: Industry-Academic Cooperation Foundation, Keimyung University (Distributor)*.
- [Zhao and Berent, 2018] Zhao, X. and Berent, I. (2018). The basis of the syllable hierarchy: Articulatory pressures or universal phonological constraints? *Journal of psycholinguistic research*, 47(1):29–64.

# Appendix A

## Example of research based on computational modelling



Cognitive Science (2018) 1–32

Copyright © 2018 Cognitive Science Society, Inc. All rights reserved.

ISSN: 0364-0213 print/1551-6709 online

DOI: 10.1111/cogs.12616

# Are Words Easier to Learn From Infant- Than Adult-Directed Speech? A Quantitative Corpus-Based Investigation

Adriana Guevara-Rukoz,<sup>a</sup> Alejandrina Cristia,<sup>a</sup> Bogdan Ludusan,<sup>a,b</sup>  
Roland Thiollière,<sup>a</sup> Andrew Martin,<sup>c</sup> Reiko Mazuka,<sup>b,d</sup> Emmanuel Dupoux<sup>a</sup>

<sup>a</sup>Laboratoire de Sciences Cognitives et Psycholinguistique, ENS/EHESS/CNRS/PSL

<sup>b</sup>Laboratory for Language Development, RIKEN Brain Science Institute

<sup>c</sup>Faculty of Letters, Department of English Literature and Language, Konan University

<sup>d</sup>Department of Psychology and Neuroscience, Duke University

Received 15 July 2016; received in revised form 4 December 2017; accepted 26 February 2018

---

## Abstract

We investigate whether infant-directed speech (IDS) could facilitate word form learning when compared to adult-directed speech (ADS). To study this, we examine the distribution of word forms at two levels, acoustic and phonological, using a large database of spontaneous speech in Japanese. At the acoustic level we show that, as has been documented before for phonemes, the realizations of words are more variable and less discriminable in IDS than in ADS. At the phonological level, we find an effect in the opposite direction: The IDS lexicon contains more distinctive words (such as onomatopoeias) than the ADS counterpart. Combining the acoustic and phonological metrics together in a global discriminability score reveals that the bigger separation of lexical categories in the phonological space does not compensate for the opposite effect observed at the acoustic level. As a result, IDS word forms are still globally less discriminable than ADS word forms, even though the effect is numerically small. We discuss the implication of these findings for the view that the functional role of IDS is to improve language learnability.

*Keywords:* Speech perception; Psycholinguistics; Language development; Word learning; Infant-directed speech; Hyperspeech

---

## 1. Introduction

Infants' language acquisition proceeds at an amazing speed despite the inherent difficulties in discovering linguistic units such as phonemes and words from continuous

---

Correspondence should be sent to Adriana Guevara-Rukoz, Laboratoire de Sciences Cognitives et Psycholinguistique, 29 rue d'Ulm, 75005 Paris, France. E-mail: [adriana.guevara.rukoz@ens.fr](mailto:adriana.guevara.rukoz@ens.fr)

speech. A popular view holds that part of the problem may be alleviated by the infants' caregivers, who may simplify the learning task when they speak to their infants in a particular register called infant-directed speech (IDS). In this paper, we compare IDS and adult-directed speech (ADS) in terms of dimensions that are relevant to the learnability of sound categories. We first review alternative hypotheses about a possible facilitatory role of IDS.

### *1.1. IDS-ADS differences in the context of learnability*

The notion that particular speech registers may have articulatory and acoustic properties that enhance speech perception may have been first introduced by Lindblom in the context of his Hyper and Hypo-articulation (H&H) theory (1990). In the case of hyper-articulation, the resulting listener-oriented modifications are referred to as 'hyperspeech'. Here, the priority is to enhance differences among contrasting elements, and it runs counter the speaker-oriented tendency to produce more economical articulatory sequences.

Fernald (2000) proposed a more general definition of hyperspeech in the context of language acquisition. The idea is that parents may manipulate linguistic levels other than articulatory ones, such as information relating to word frequency or neighborhood density, resulting in facilitated perception:

[T]he hyperspeech notion should not be confined to articulatory factors at the segmental level, but should be extended to a wider range of factors in speech that facilitate comprehension by the infant.

While the hyperspeech notion initially refers to a modification of language as to enhance perception, Kuhl et al. (1997) go one step further, positing that IDS register-specific modifications may also enhance *learning*:

Our findings demonstrate that language input to infants has culturally universal characteristics designed to promote language learning.

We call this last hypothesis the *Hyper Learnability Hypothesis* (HLH). It goes beyond the hyperspeech hypothesis in that it refers not to perception but to the language learning processes operating in the infant. Importantly, these two notions may not necessarily be aligned. In some instances, both hyperspeech and HLH are congruent with the usually reported properties of IDS: exaggerated prosody and articulation (Fernald et al., 1989; Soderstrom, 2007), shorter sentences (Fernald et al., 1989; Newport, Gleitman, & Gleitman, 1977; Phillips, 1973), simpler syntax (Newport et al., 1977; Phillips, 1973), and slower speech rate (Englund & Behne, 2005; Fernald et al., 1989) (see Golinkoff, Can, Soderstrom, & Hirsh-Pasek, 2015; Soderstrom, 2007, for more comprehensive reviews). All of these properties are plausible candidates for facilitating both language perception and language learning at the relevant linguistic levels—namely phonetic, prosodic, lexical and

syntactic—by making these features more salient or more contrastive to the infant. Yet, in other instances, perception and learning may diverge. As Kuhl (2000) notes:

Mothers addressing infants also increase the variety of exemplars they use, behaving in a way that makes mothers resemble many different talkers, a feature shown to assist category learning in second-language learners.

In this case, increase in variability, which is known to negatively affect speech perception in both adults and children (see Bergmann, Cristia, & Dupoux, 2016; Mullennix, Pisoni, & Martin, 1989; Ryalls & Pisoni, 1997) is nevertheless hypothesized to positively affect learning in infants. Work by Rost and McMurray (2009) suggests that this might be the case for 14-month-old infants learning novel word-object mappings. However, it appears that not any kind of variability will do; only increased variability in certain cues—specifically those irrelevant to the contrasts of interest—promoted learning of word-object mappings (Rost & McMurray, 2010). This illustrates the very important point that HLH cannot be empirically tested independently of a specific hypothesis or theory of the learning process in infants. Ideally, the hypothesis or theory should be explicit enough that it could be implemented as an algorithm, which derives numerical predictions on learning outcomes when run on speech corpora of ADS and IDS (Dupoux, 2016). Unfortunately, as of today, such algorithms are not yet available for modeling early language acquisition in infants. Yet a reasonable alternative is to resort to measurements that act as a *proxy* for learning outcomes within a given theory.

In the following, we focus on a component of language processing which has been particularly well studied: speech categories. For this component, a variety of theories have been proposed, which can be separated in two types: bottom-up theories and top-down theories. We review these two types in the following sections and discuss possible proxies for them.

### 1.2. Bottom-up theories: Discriminability as a proxy

Bottom-up theories propose that phonetic categories emerge from the speech signal; they are extracted by attending to certain phonetic dimensions (Jusczyk, Bertoncini, Bijeljac-Babic, Kennedy, & Mehler, 1990), or by identifying category prototypes (Kuhl, 1993). More explicitly, Maye, Werker, and Gerken (2002) proposed that infants construct categories by tracking statistical modes in phonetic space. This idea can be made even more computationally explicit by using unsupervised clustering algorithms, such as Gaussian mixture estimation (De Boer & Kuhl, 2003; Lake, Vallabha, & McClelland, 2009; McMurray, Aslin, & Toscano, 2009; Vallabha, McClelland, Pons, Werker, & Amano, 2007), or self-organizing neural maps (Guenther & Gjaja, 1996; Kohonen, 1988; Vallabha et al., 2007). Given the existence of such computational algorithms, it would seem easy to test if IDS enhances learning by running them on IDS and ADS data, and then evaluating the quality of the resulting clusters.

However, this is not so simple for two reasons. First, each of the above-mentioned algorithms makes different assumptions about the number, granularity, and shape of



phonetic categories, parameters which could potentially lead to different outcomes. Even more problematic is that this subset of algorithms does not exhaust the space of possible clustering algorithms.

Since we do not know which of these assumptions and algorithms are those that best approximate computational mechanisms used by infants, applying these algorithms to data may not get us any closer to a definitive answer. Second, these particular algorithms have only been validated on artificially simplified data (e.g., representing categories as formant measurements extracted from hand-segmented data) and not on a corpus of realistic speech. In fact, when similar algorithms are run on real speech, they fail to learn phonetic categories; instead, they learn smaller and more context-dependent units (e.g., Varadarajan, Khudanpur, & Dupoux, 2008; see also Antetomaso et al., 2016). The unsupervised discovery of phonetic units is currently an unsolved problem which gives rise to a variety of approaches (see Versteegh, Anguera, Jansen, & Dupoux, 2016, for a review).

Given the unavailability of effective phoneme discovery algorithms that could test the bottom-up version of HLH, many researchers have adopted a more indirect approach using descriptive measures of phonetic category distributions as a *proxy* for learnability. Here, we review two such proxies: category *separation* and category *discriminability*.

Category separation corresponds to the distance between the center of these categories in phonetic space. Kuhl et al. (1997) measured the center of the ‘point’ vowels /a/, /i/, and /u/ in formant space, in ADS and IDS, across three languages (American English, Russian, and Swedish). Results revealed that the spatial separation between the center of these vowels was increased in IDS compared to ADS. This observation has been replicated in several studies (Andruski, Kuhl, & Hayashi, 1999; Bernstein Ratner, 1984; Burnham, Kitamura, & Vollmer-Conna, 2002; Cristia & Seidl, 2014; Liu, Kuhl, & Tsao, 2003; McMurray, Kovack-Lesh, Goodwin, & McEchron, 2013; Uther, Knoll, & Burnham, 2007; although see Benders, 2013). However, it is less clear that separation generalizes to other segments beyond the three point vowels. For instance, Cristia and Seidl (2014) attested increased separation of the point vowels in speech spoken to 4- and 11-month-old learners of American English, but not for other vowel contrasts (e.g., [i-I]). The between-category distance among the latter vowel categories was not larger in IDS than in ADS (see also McMurray et al., 2013, for similar results). This is problematic for learnability because one might argue on computational grounds that the vowels that are difficult to learn are probably not the point vowels which are situated at the extreme of the vocal space, but rather the ones that are in the middle and have several competitors with which they can be confused.

There is another reason to doubt that separation is a very good proxy in the first place. As shown in Fig. 1, categories are defined not only by their center, but also by their variability. If, for instance, IDS not only increases the separation between category centers compared to ADS, but also increases within-category variability, the two effects could cancel each other out or even wind up making IDS more difficult to learn. In fact, as we mentioned above, Kuhl et al. (1997) reported that parents tend to be more variable in their vowel productions in IDS than ADS. This was confirmed in later studies (Cristia & Seidl, 2014; Kirchoff & Schimmel, 2005; McMurray et al., 2013). If so, what is the net effect of these two opposing tendencies on category learnability?

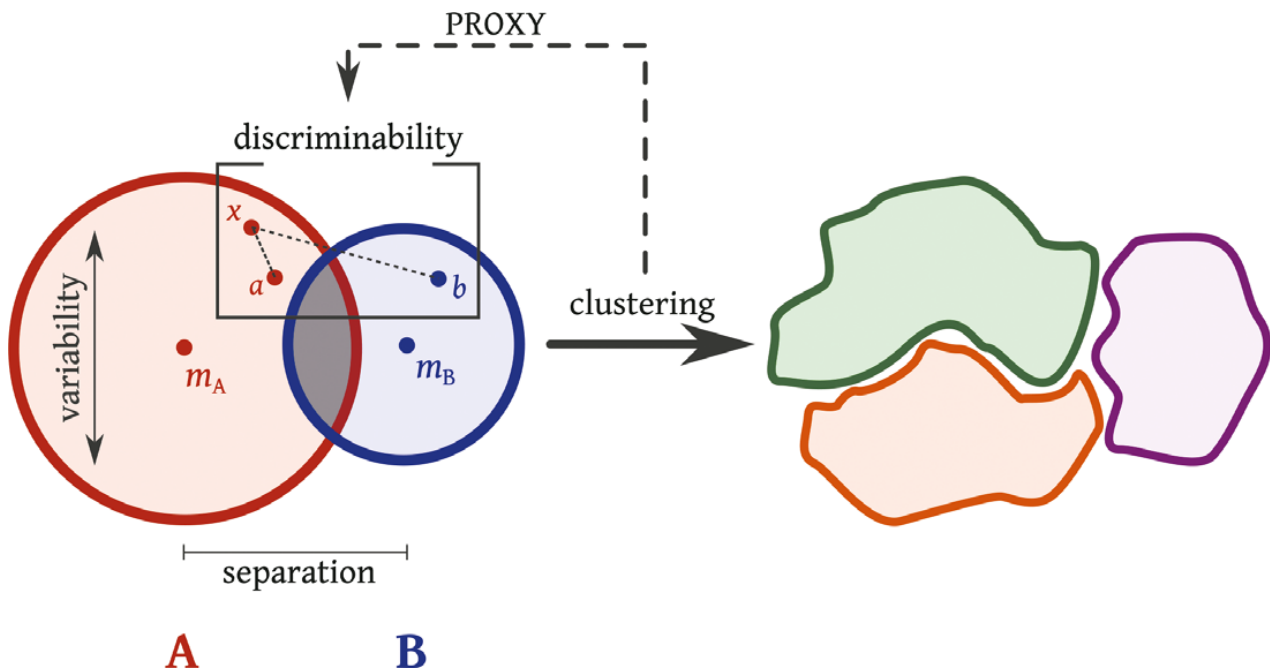

Fig. 1. Schematic view of separation, variability, and discriminability between two categories A and B (left), and a possible clustering obtained from the distributions (right). *Separation* measures the distance between the center of categories A and B; it is computed as the distance between the medoids  $m_A$  and  $m_B$ . *Variability* measures the spatial spread of tokens within a given category; it is computed as the average distance between tokens in a category. *Discriminability* depends on both variability and separation; it is quantified with an ABX score as the probability that a given token  $x$  (say, of A) is less distant to another token  $a$  of A than to a token  $b$  of B.

Previous work by Schatz (2016) has shown that the performance of unsupervised clustering algorithms can be predicted by a psychophysically inspired measure: the *ABX discrimination score*. The intuition behind this measure is illustrated in Fig. 1: it is defined as the probability that tokens within a category are closer to one another than between categories. If the two categories are completely overlapping, the ABX score is 0.5. If, on the other hand, the two categories are well segregated, the score can reach 1.<sup>1</sup> This work has demonstrated that the ABX score tends to be more statistically stable than standard clustering algorithms ( $k$ -nearest neighbors, spectral clustering, hierarchical clustering,  $k$ -means, etc.) while predicting their outcomes better than they predict each other's outcomes. All in all, this method is independent of specific learning algorithms, is non-parametric (i.e., it does not assume particular shapes of distributions) and can operate on any featural representation including raw acoustic features. It can therefore be used as a stable proxy of unsupervised clustering and, therefore, of bottom-up learnability.

Using this measure, Martin et al. (2015) systematically studied the discriminability of 46 phonemic contrasts of Japanese by running the ABX discriminability test on a speech corpus with features derived from an auditory model, namely mel spectral features. The outcome was that, on average, phonemic categories were actually *less discriminable* in IDS than in ADS. While most contrasts did not differ between the two registers, the few

that systematically differed pointed rather toward a decrease in acoustic contrastiveness in IDS at the phonemic level.

To sum up, if one uses ABX-discriminability as a proxy for bottom-up learnability, we can conclude that the HLH is not supported by the data available. However, bottom-up learning is not the only theoretical option available to account for phonetic learning in infants. Next, we examine top-down theories.

### 1.3. Top-down theories: Three learnability subproblems

Top-down theories of phonetic category learning share with linguists the intuition that phonemes are defined, not so much through their acoustic properties, but rather through their function. The function of phonemes is to carry meaning contrasts at the lexical level. Top-down theories therefore posit that phonemes emerge from the lexicon. As stated by Werker and Curtin (2005) (see also Beckman & Edwards, 2000):

As the vocabulary expands and more words with overlapping features are added, higher order regularities emerge from the multidimensional clusters. These higher order regularities gradually coalesce into a system of contrastive phonemes. (p. 217)

There are many ways to flesh out these ideas in terms of computational mechanisms. All of them involve at least the requirement that (some) word forms are learned and that these forms constrain the acquisition of phonetic categories. This can be summarized in terms of three subproblems (Fig. 2B): (a) segmenting word tokens from continuous speech, (b) clustering said word tokens into types, and (c) using said types to learn phonetic categories via a contrastive mechanism. Arguably, these three subproblems are interdependent (in fact, some models address several of them jointly, for example, Feldman, Griffiths, & Morgan, 2009, or iteratively, for example, Versteegh, Anguera, Jansen, & Dupoux, 2016), and only a fully specified model would enable to fully test the functional impact of IDS for learnability under such a theory. Yet, as above, we claim that one can develop measures that can act as proxies for learnability, even in the absence of a full model.

In what follows, we focus on the second subproblem, that is, the clustering of word types, which we take to be of central importance for phonetic category learning. Indeed, in case of a failure to solve subproblem 1 (e.g., infants undersegment “*the dog*” into “*thedog*,” or oversegment “*butterfly*” into “*butter fly*”), it is still possible to use contrastive learning with badly segmented proto-words to learn phonetic categories (Fourtassi & Dupoux, 2014). In contrast, in case of a failure to solve subproblem 2 (e.g., infants merge “*cat*” and “*dog*” into a signal word type, or split “*tomato*” into many context or speaker dependant variants), then it is much more dubious that contrastive learning can be of any help to establish phonetic categories. Our experiments therefore only address subproblem 2, and we come back to the other two subproblems in the General Discussion.

(A)

BOTTOM-UP:

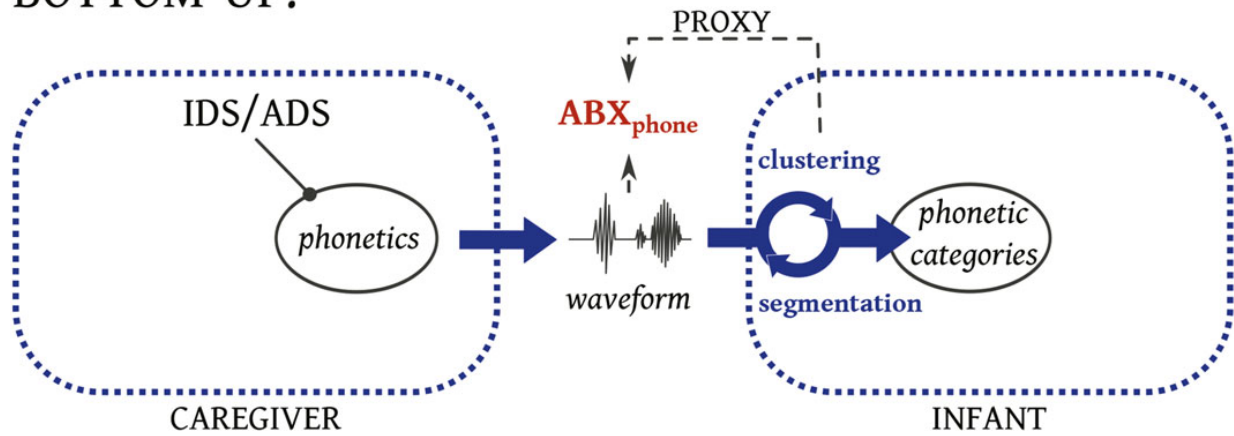

(B)

TOP-DOWN:

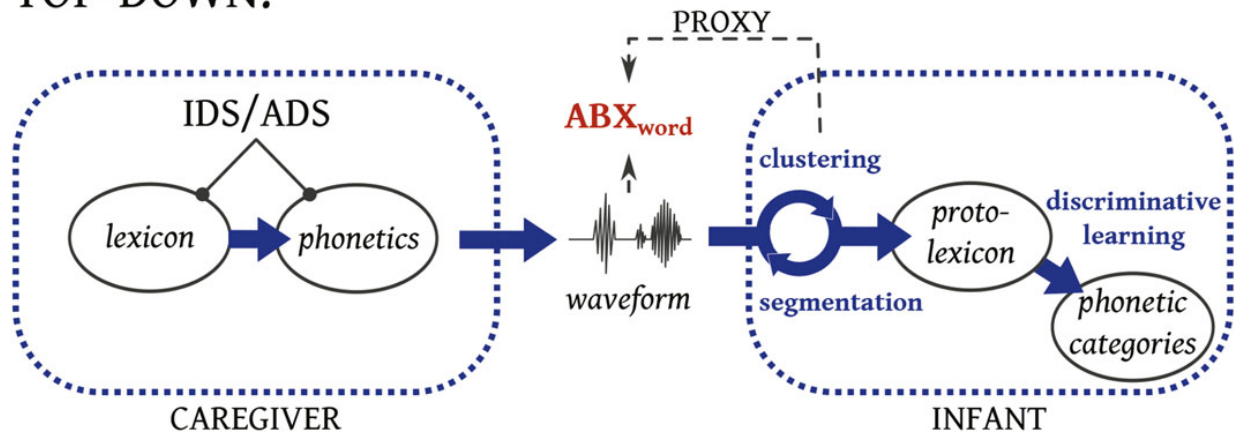

Fig. 2. Schematic view of (A) bottom-up and (B) top-down models of phonetic learning, together with ABX discriminability as a proxy for measuring the effect of adult-directed speech (ADS) versus infant-directed speech (IDS) on learnability.

#### 1.4. The present study: Word form discriminability

The construction of word form categories is a similar computational problem to the problem of constructing phonetic categories discussed above. Both can be formulated as unsupervised clustering problems, the only difference being the granularity and number of categories being formed. Instead of sorting out instances of ‘i’, ‘a’, and ‘o’ into clusters, the problem is to sort out instances of ‘cat’, ‘dog’, and ‘tomato’ into clusters. Therefore, in both instances, it is possible to use ABX discriminability as a proxy for the (bottom-up) learnability of these categories. Of course, words being composed of phonemes, one would expect a correlation between ABX discriminability on phonemes and on words. However, the word form level introduces two specific types of effects making such a correlation far from trivially true.

First, the word level typically introduces specific patterns of phonetic variability. For instance, the word ‘tomato’ can be produced in a variety of ways: /t<sup>h</sup>əˈmeɪtəʊ/, /təˈmɛɪtə/,

/tə'matəʊ/, etc. Some of these variations are dependent on the dialect but others can surface freely within speaker, or depending on context, speaking style, or speaking rate. Such phonetic effects translate into distinct acoustic realizations of the word forms, potentially complicating the task of word form category learning. Could it be that IDS limits this source of variation, thereby helping infants to construct word form categories? Some studies have shown the use of more canonical forms in IDS than ADS (e.g., Dilley, Millett, McAuley, & Bergeson, 2014), while others have not (e.g., Fais, Kajikawa, Amano, & Werker, 2010; Lahey & Ernestus, 2014), but to our knowledge no study has looked at the global effect of these variations on word discriminability, and done so systematically. This is what we will examine in Experiment 1.

Second, and setting aside phonetic realization to focus on abstract phonological characteristics, words tend to occupy sparse regions of phonological space. Put differently, there are many more unused possible word forms than actual ones. This results in minimal pairs being generally rare. For instance, a corpus analysis reveals that, in English, Dutch, French, and German, minimal pairs will concern less than 0.1% of all pairs (Dautriche, Mahowald, Gibson, Christophe, & Piantadosi, 2017); in fact, two words selected at random will differ in more than 90% of their phonemes on average. This should make word form clustering an easier task than phonetic clustering, a welcome result for top-down theories. However, it could be that IDS modulates this effect by containing a different set of words than the vocabulary directed to adults. Corpora descriptions of IDS suggest that this is the case: Caregivers use a reduced vocabulary (Henning, Striano, & Lieven, 2005; Kaye, 1980; Phillips, 1973), which often includes a set of lexical items with special characteristics, such as syllabic reduplications and mimetics (Ferguson, 1964; Fernald & Morikawa, 1993; Mazuka, Kondo, & Hayashi, 2008). May IDS boost learning by containing more phonologically distinct word forms than ADS? This is what we will examine in Experiment 2.

The overall learnability of word forms, as far as clustering is concerned, is the combined effect of phonetic/acoustic discriminability (isolated in Experiment 1) and phonological discriminability (isolated in Experiment 2). As these two factors may go in different directions, we study the global discriminability of IDS versus ADS word form lexicons in Experiment 3.

### 1.5. *Japanese IDS*

Like other variants of IDS around the globe (Ferguson, 1964), Japanese IDS is characterized by the presence of Infant-Directed Vocabulary (IDV), 'babytalk' specifically used when interacting with infants. According to a survey and corpora studies by Mazuka et al. (2008), these words are mostly phonologically unrelated to words in the ADS lexicon. In particular, IDV presents many instances of reduplications (around 65%) and onomatopoeias/mimetic words (around 40%).<sup>2</sup> Phonological structures found in IDV are, in fact, more similar to phonological patterns produced by Japanese infants earlier in development than to patterns found in the adult lexicon (Tsuji, Nishikawa, & Mazuka, 2014; a list of 50 earlier produced words is given by Iba, 2000). In addition to pattern repetition

within words, IDS also presents more content word repetition, as well as more frequent and longer pauses, making utterances in IDS shorter than in ADS (Martin, Igarashi, Jincho, & Mazuka, 2016).

Regarding the phonetics of Japanese IDS, it presents pitch-range expansion (Igarashi, Nishikawa, Tanaka, & Mazuka, 2013), but it is not slower than ADS when taking into account local speech rate (Martin et al., 2016). More related to our question of phonetic categories, vowel space expansion in F1 x F2 space has been attested in Japanese IDS (Andruski et al., 1999; Miyazawa, Shinya, Martin, Kikuchi, & Mazuka, 2017); however, IDS categories presented higher variability and overlap (Miyazawa et al., 2017), consistent with the decrease in acoustic discriminability observed by Martin et al. (2015). In fact, contrary to intuition, IDS appears to present more devoicing of non-high vowels than ADS (i.e., less canonical and identifiable tokens), due to breathiness (Martin, Utsugi, & Mazuka, 2014). This paralinguistic modification of speech, which is thought to convey affect, is more prevalent in IDS than ADS (Miyazawa et al., 2017).

### 1.6. Corpus

Most of the Japanese studies cited above, as well as the work described in this paper, have used data from the RIKEN Japanese Mother-Infant Conversation Corpus, R-JMICC (Mazuka, Igarashi, & Nishikawa, 2006), a corpus of spoken Japanese produced by 22 mothers in two listener-dependent registers: IDS and ADS (Igarashi et al., 2013).

For our study, a word was defined as a set of co-occurring phonemes with word boundaries following the gold standard for words in Japanese, roughly corresponding to dictionary entries. Lexical derivations were considered to belong to a separate type category with respect to their corresponding lemmas. For instance, *lnail* and *larul*, inflections of the verb ある *larul* (English: *to be*), were evaluated as separate words. Homophones were collapsed into the same word category in the analyses.

Because of the emphasis given to phonological structure when defining word categories, devoiced vowels were considered to be phonologically identical to their voiced counterparts, and similarly for abnormally elongated vowels or consonants that did not result in lexical modifications (i.e., use of gemination for emphasis). Additionally, fragmented, mispronounced, and unintelligible words were not included in our analyses (approximately 5% out of the initial corpus). The resulting corpus is henceforth referred to as the *base corpus*; information about its content can be found in Table 1.

Table 1  
Description of the base corpora for adult-directed speech (ADS) and infant-directed speech (IDS)

	ADS	IDS
Duration	3 h	11 h
Types	1,382	1,765
Tokens	12,248	34,253

## 2. Experiment 1: Acoustic distribution of word tokens

In this experiment, we ask whether caregivers articulate words in a more or less ‘distinctive’ manner when addressing their infants. Our aim is to answer this question at a purely acoustic level, that is, taking into account phonetic and acoustic variability, after removing influences from other aspects that vary across registers (e.g., lexical structure). Therefore, the following analyses have been restricted to the lexicon of words that are *common* to IDS and ADS for each parent.

Our main measure is ABX discriminability applied to entire words. As in Martin et al. (2015), we use the  $ABX_{score}$  which shows classification at chance with a value of 0.5, while perfect discrimination yields a score of 1. As such, a higher  $ABX_{score}$  for IDS than ADS would mean that, on average, parents make their word categories more acoustically discriminable when addressing their infants, making these words easier to learn according to top-down theories.

The ABX discriminability measure implies computing the acoustic distance between word tokens, and computing the probability that two tokens belonging to the same word type are closer to one another than two tokens belonging to two distinct word types.

Since it is the first time that such a discriminability measure is used at the word level, we validate it in a control condition in which there are a priori reasons to expect differences in discriminability between two speech registers. Namely, we assess the discrimination of words common to ADS and read speech (RS). This register is typically articulated in a slower, clearer, and more canonical fashion than spontaneous speech. Knowing this, we expect the  $ABX_{score}$  to be higher in read speech (RS) than in spontaneous speech (ADS).

Moreover, in order to further validate the application of our method to word units, two additional submeasures are explored, following the distinctions introduced in Fig. 1: between-category *separation* and within-category *variability*.

### 2.1. Methods

#### 2.1.1. Control corpus

The Read Speech (RS) subsection of the RIKEN corpus consists of recordings from a subset of 20 out of the 22 parents which had also previously been recorded in the ADS and IDS registers. Participants read 115 sentences containing phonemes in frequencies similar to those of typical adult-directed speech (Sagisaka et al., 1990). We extracted the words that were common to the read and the ADS subcorpora for each individual parent. We obtained between 19 and 32 words, each of them having between 2 and 49 occurrences. All of these word tokens were selected for subsequent analysis in the control ADS versus RS comparison.

#### 2.1.2. Experimental corpus

All 22 participants had data in the IDS and ADS registers. For each participant, we selected the words that were common to the two registers. We obtained between 43 and

64 word types (individual numbers can be seen in the Appendix Table A1). All of the word tokens for these types were selected for subsequent analyses in the experimental condition comparing ADS versus IDS. We did not match IDS and ADS on number of tokens per type to maximize the reliability of the metrics. Since ABX is an unbiased metric of discriminability, the size of a corpus will only modulate the standard error, not the average of the metric. It therefore cannot bias the discriminability score in IDS versus ADS; simply the fact that the ADS scores are estimated from a smaller corpus means that they will be noisier than the IDS scores. Matching the IDS corpus size to that of ADS would result in increasing the noise in the IDS scores. Number of total tokens per speaker are shown in Fig. 3.

### 2.1.3. Acoustic distance

The three acoustic measures that were computed, namely separation, variability, and discriminability ( $ABX_{score}$ ), all depend on a common core function which provides the measure of acoustic distance between two word tokens.

As in Martin et al. (2015), we represented word tokens using compressed Mel filterbanks, which corresponds to the first stage of an auditory model (Moore, 1997; Schatz, 2016).

Specifically, the audio file of each token was converted into a sequence of auditory spectral frames sampled 100 times per second, obtained by running speech through a bank of 13 band-pass filters centered on frequencies spread according to a Mel scale between 100 and 6855 Hz (Schatz et al., 2013). The energy of the output of each of the 13 filters was computed and their dynamic range was compressed by applying a cubic root. In summary, word tokens were represented as sequences of frames, which are vectors with 13-dimensions (i.e., 1 value per filter).

The distance between a pair of tokens was computed as follows. First, the two tokens of interest were realigned in the time domain by performing dynamic time warping (DTW; Sakoe & Chiba, 1978): This algorithm searches the optimal alignment path between the sequences of frames of the two tokens that are being compared. The distance between two aligned frames being compared was set to be the angle between the two 13-dimensional feature vectors representing said frames. Secondly, the average of the frame-wise distances along the optimal alignment path was set as the distance between that pair of tokens.

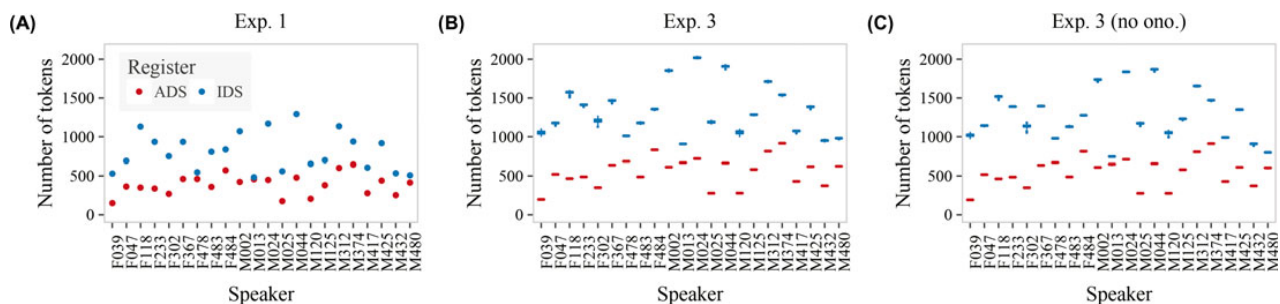

Fig. 3. Number of tokens used in Exp. 1 (A) and Exp. 3, with (B) and without (C) onomatopoeias, per speaker. For Exp. 3, boxplots show the distribution of number of tokens within the 100 sampled lexicons.



Each of the three measures was computed separately for each speaker, both for IDS and for ADS.

#### 2.1.4. Discriminability

Discriminability calculations were performed as in Martin et al. (2015) by estimating the probability that two tokens within a category are less distant than two tokens in two different categories. This score is computed for each pair of word types, and then aggregated by averaging across all of these pairs ( $ABX_{score}$ ). The calculations were done using the ABXpy package available on <https://github.com/bootphon/ABXpy>.

More specifically, for each pair of word types  $A$  and  $B$ , we compiled the list of all possible  $(a,b,x)$  triplets where  $a$  was a token of category  $A$ ,  $b$  a token of category  $B$  and  $x$  a token of either  $A$  or  $B$ . For instance, for word types  $A = /nai/$  and  $B = /arul/$ , there could be a triplet with tokens  $a = [nai]_1$ ,  $b = [aru]_1$ , and  $x = [nai]_2$ . The distance  $d(a, x)$  between tokens  $a$  and  $x$  was compared to the distance  $d(b, x)$  between tokens  $b$  and  $x$ . In this example, since both  $a$  and  $x$  are tokens of category  $A$ , we expect the acoustic distance between them to be smaller than their distance to a token belonging to a different category (i.e., token  $b$  of type  $B$ ).

As such, if  $d(a, x) > d(b, x)$  (i.e.,  $[nai]_2$  more similar to  $[aru]_1$  than to  $[nai]_1$ ), the response given by the algorithm was deemed to be incorrect and an  $ABX_{score}$  of 0 was assigned to that specific triplet. On the other hand, if as expected  $d(a, x) < d(b, x)$ , the algorithm returned a response deemed as correct and a score of 1 was given to the triplet. A final mean  $ABX_{score}$  for all triplets was then computed for each speaker, separately for IDS and ADS, only taking into account word pairs that were observed in both speech registers.

#### 2.1.5. Separation

For each pair of word types, we computed the distance between their medoids. A medoid is defined as the word token which minimizes the average distance to all of the other tokens in that word type. In case of ties, we used a set of medoids, and their scores were averaged. Separation can be viewed as a generalization of the notion of phonetic expansion, except that it applies to entire word forms instead of particular segments (e.g., vowels).

#### 2.1.6. Variability

For each word type, variability was computed as the average distance between each token and every other token within the same word type. By definition, only word types with more than one token were included in the calculation. One can view this measure as analogous to the standard deviation in univariate distributions.

### 2.2. Results and discussion

Regarding the control condition, we compared the acoustic discriminability of the word types common to ADS and RS. We obtained an average ABX discriminability

score per speaker per register (ADS or RS). A paired Student's *t*-test revealed that words were significantly more discriminable in RS than in ADS ( $t(19) = 8.74$ ;  $p < .0001$ ; Cohen's  $d = 2.68$ ), with RS having an  $ABX_{score}$  0.09 points higher than ADS, on average ( $ABX_{score}$  of 92% vs. 83%, respectively). As shown in Fig. 4 (panels D and H), all 20 parents showed this effect; individual scores can be found in the Appendix Table A1. In other words, on average the algorithm made twice as many errors classifying word tokens into categories in ADS compared to RS. This confirms that the ABX measure is able to capture the expected effects of read versus spontaneous speech on acoustic discriminability.

Focusing on the experimental condition, for each of the three measures (discriminability, separation, variability), we computed an aggregate score across word types separately for each parent and register (individual scores can be found in the Appendix Table A1). We then analyzed the effect of register by running a paired Student's *t*-test across parents.

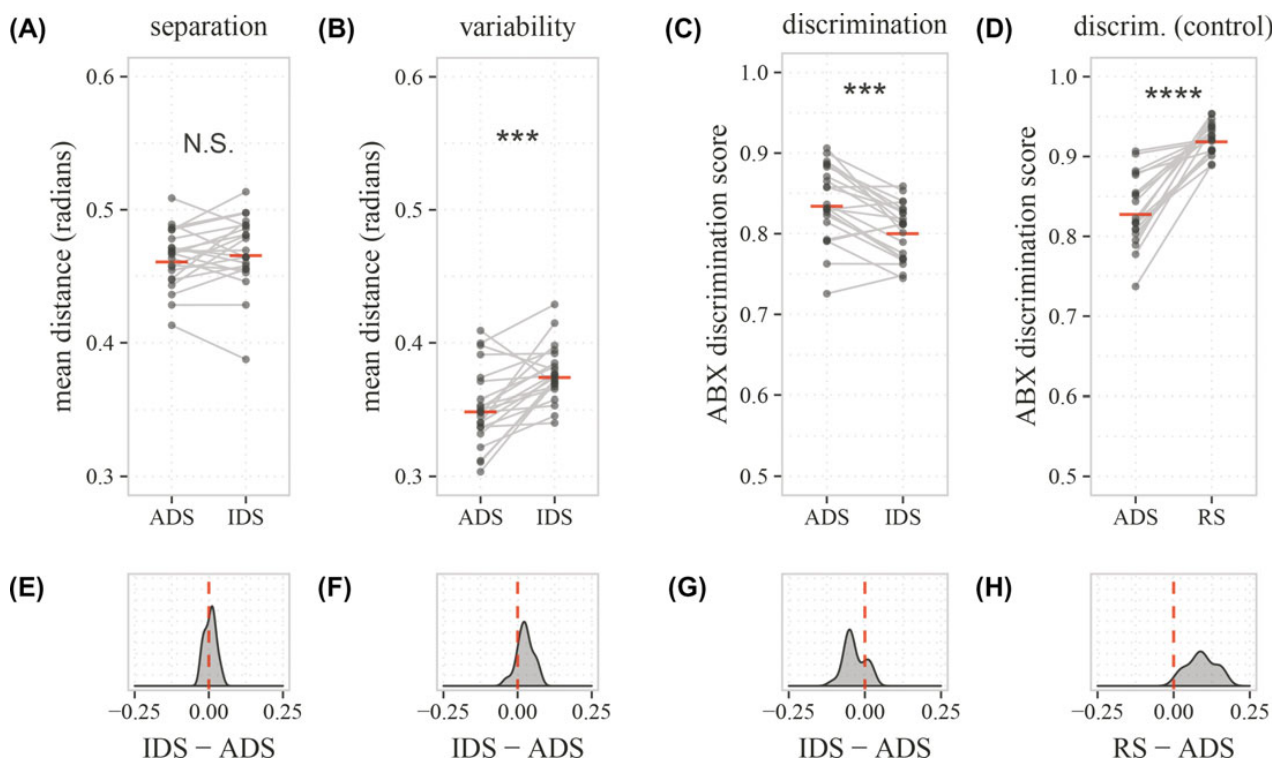

Fig. 4. Acoustic distinctiveness scores computed on word types common to infant-directed speech (IDS) and adult-directed speech (ADS) (panels A, B, C, E, F, G), or computed on word types common to ADS and RS (control condition; panels D and H). Upper panels display the distribution of the scores across speakers, as well as means within a speech register (red horizontal lines). Gray lines connect data points corresponding to the same caregiver in both registers (either ADS-IDS or ADS-RS). Bottom panels show the distribution of IDS minus ADS (or RS minus ADS) score differences. Densities to the right of the red zero line denote higher scores for IDS (or RS). A, E: Mean between-category separation (ADS vs. IDS). B, F: Mean within-category variability (ADS vs. IDS). C, G: Mean ABX discrimination score (ADS vs. IDS). D, H: Mean ABX discrimination score (ADS vs. RS; control condition). N.S., Non-significant difference. \*\*\* $p < .001$ . \*\*\*\* $p < .0001$ .

The results are visually represented in Fig. 4. First, the analysis revealed a numerically small but statistically reliable degradation in acoustic discriminability of words in IDS compared to ADS ( $ABX_{score}$  IDS: 80% vs. ADS: 84%;  $t(21) = -4.73$ ;  $p < .001$ ; Cohen's  $d = -0.84$ ). This is consistent with the degradation in discriminability previously observed at the level of individual phonemes (Martin et al., 2015; McMurray et al., 2013). Second, the trend for greater separation of word categories in IDS compared to ADS was not statistically significant (IDS: 0.47 rad vs. ADS: 0.46 rad;  $t(21) = 1.23$ ;  $p > .05$ ; Cohen's  $d = 0.21$ ). Finally, there was a reliable increase in variability in IDS relative to ADS (IDS: 0.38 rad vs. ADS: 0.35 rad;  $t(21) = 4.28$ ;  $p < .001$ ; Cohen's  $d = 1.0$ ). This increased variability is consistent with what has been observed at the level of individual phonemes (Cristia & Seidl, 2014; McMurray et al., 2013).

In sum, we found that word discrimination is more easily achieved in ADS than in IDS. This can be analyzed as being due to a large increase in variability in IDS which is not being compensated for by a necessary increase in separation. This is in contrast to predictions posited by the *HLH*, but consistent with previous work at the phonemic level (Martin et al., 2015). In a way, this is not a totally surprising result, since by virtue of matching word types across registers, the effect of register on phoneme variability and discriminability is passed on to the level of words. What is new, however, is that the IDS register does not compensate for the phonetic variability by producing more canonical word forms. Next, we examine the content of the lexicon in the two registers.

### 3. Experiment 2: Phonological density

In this experiment, we focus on the phonological structure of the IDS and ADS lexicons. The core question is whether parents would select a set of words that are somewhat more 'distinctive' in IDS, yielding a sparser lexicon. Such a sparse lexicon could compensate for the increased phonetic variability measured in Experiment 1, thereby helping infants to cluster word forms into types.

We use normalized edit distance (NED) as our main measure of the sparseness of the IDS and ADS lexicons. Normalized edit distance is defined as the proportion of changes (i.e., segmental additions, deletions, and substitutions) to be performed in order to transform one word into another. The smaller the edit distance between two words, the more structurally similar they are.

NED takes into consideration not only phonological neighbors (i.e., words that differ by one phoneme), but also higher order neighbors when evaluating variation in the phonological structure of the lexicon in a psychologically relevant way. It is the direct phonological equivalent of the *separation* metric used in Experiment 1. Indeed, both metrics measure the average distance between word categories: *separation* measures acoustic distance, while *NED* measures phonological distance. Experiment 1 showed that parents do not reliably expand the acoustic space when using IDS; Experiment 2 asks: Are they expanding the phonological space when using this register?

Before moving on to the analysis, we point out that mean NED may vary with lexicon size. Indeed, as more and more words are added to a lexicon, changes in the neighborhood structure are to be expected. Typically, short words tend to have denser neighborhoods as the lexicon size increases (as the combinatorial possibilities for constructing distinct short words quickly saturate). At the same time, the ratio between short and long words tends to decrease with lexicon size, because most new additions in a lexicon tend to be long, and long words tend to have sparser neighborhoods than short words. In order to limit the influence of such properties on our results, IDS and ADS corpora were *matched in lexicon size* before any comparison was performed.

### 3.1. Methods

#### 3.1.1. Sampling

As can be seen in Table 1, the volume of data available for both speaking registers in the *base corpus* was imbalanced; the IDS subset of the corpus contains more words (types and tokens) than its ADS counterpart. In order to account for this mismatch, we performed a frequency-dependent sampling of word types that matched their number in both speech registers. Types which were more frequently uttered by a speaker had a higher probability of being included in a sample than rarer ones. Moreover, since the measurement used in this section heavily relies on the nature of the words sampled, and as a way to increase estimation reliability, sampling was performed 100 times per speaker per register. For instance, if a speaker uttered 82 word types in ADS and 237 in IDS, we created 100 subsets of the IDS lexicon by sampling 82 types from the 237 available 100 times. The final metric for said speaker in a given speech register was the mean NED obtained from the corresponding 100 samples. On average, a sample contained  $179.64 \pm 49$  word types (see Table A2 of the Appendix for more information).

#### 3.1.2. Normalized edit distance

For each parent, within each speech register, we computed the edit distance (ED) between every possible pair of types in the sampled lexicons. ED, also called the Levenshtein distance, is defined as the minimal number of additions, deletions or substitutions needed to transform one string into another. It is computed using an algorithm very similar to the Dynamic Time Warping (DTW) algorithm used in Experiment 1; the algorithm finds a path that minimizes the total number of edits (insertions, deletions and substitutions, all of them equally weighted). The maximal number of changes  $\max(x, y)$  is defined as the maximum length of the two types  $X$  and  $Y$  under comparison. Normalized edit distances (NEDs) were therefore derived as follows:

$$\text{NED}_{XY} = \frac{\text{ED}_{XY}}{\max(x, y)}$$

where  $x$  and  $y$  correspond to the phonemic lengths of two distinct words  $X$  and  $Y$ . For instance, the ED between ‘tall’ /tɔl/ and ‘ball’ /bɔl/ is 1 (one substitution: /t/  $\Rightarrow$  /b/). Both

words are 3 phonemes long, so  $\max(x, y) = 3$ . Therefore, the NED between these types is  $\frac{1}{3}$ . The more structurally similar two types are, the closer their NED will be to zero.

### 3.2. Results and discussion

The distribution of the difference in mean NEDs for IDS and ADS across parents is shown on panels A and C of Fig. 5. Individual scores can be found in the Appendix Table A2. A pair-wise Student's *t*-test showed a systematic pattern of larger normalized edit distances in IDS than ADS (IDS: 0.877 vs. ADS: 0.871;  $t(21) = 5.00$ ;  $p < .0001$ ; Cohen's  $d = 1.38$ ). This difference shows that, overall, the IDS lexicon contains words that are phonologically more distinctive than those in the ADS lexicon. In hindsight, a difference of this sort may have been expected as IDS has been found to contain "babytalk" or infant-directed vocabulary, that is, a special vocabulary which includes onomatopoeias and phonological reduplications (Ferguson, 1964; Fernald & Morikawa, 1993). This hypothesis was verified in our dataset; we found that onomatopoeias and mimetic words (hereafter referred to solely as "onomatopoeias") constituted approximately 30% of the average sample of IDS word types used in this experiment, whereas they represented less than 2% of an average ADS sample (*cf.* Appendix Table A2), this latter frequency being consistent with the use of mimetic words in Japanese observed in previous work (Saji & Imai, 2013).

In order to study the effect of onomatopoeias on phonological discriminability, we performed a post hoc analysis by resampling words after removing all onomatopoeias from the base corpus. We then re-computed the mean NED for ADS and IDS. Individual scores can be found in the right side of the Appendix Table A2. A paired Student's *t*-test revealed that the previously noted difference between IDS and ADS mean NED scores was no longer significant after onomatopoeia removal (IDS: 0.872 vs. ADS: 0.870;  $t(21) = 1.14$ ;  $p > 0.05$ ; Cohen's  $d = 0.31$ , visual representation on panels B and D of Fig. 5). Therefore, the IDS lexicon was found to be globally sparser than the ADS lexicon, and this effect seems to be principally driven by the unequal presence of onomatopoeic sounds in both speech registers.

Infant-directed words may facilitate lexical development not only by decreasing the overall phonological density of the lexicon, which directly impacts the clustering subproblem detailed in the introduction, but also in virtue of other intrinsic learning properties that would be relevant to a more complete model of early word learning. In the introduction, we focused on the three key word learning subproblems of segmentation, word clustering, and phonetic categorization. At this point, it is imperative to point out that there are other factors that impact word learning in infancy above and beyond these particular processes.

When asked about vocabulary specifically used when addressing infants, Japanese women report a set of words of which 40% of the items are sound-symbolic (Mazuka et al., 2008). An iconic relationship between an acoustic form and the semantics of the referent (Imai & Kita, 2014) has been shown to help 14-months-old infants finding a word's referent (Miyazaki et al., 2013), and it also facilitates the identification by pre-

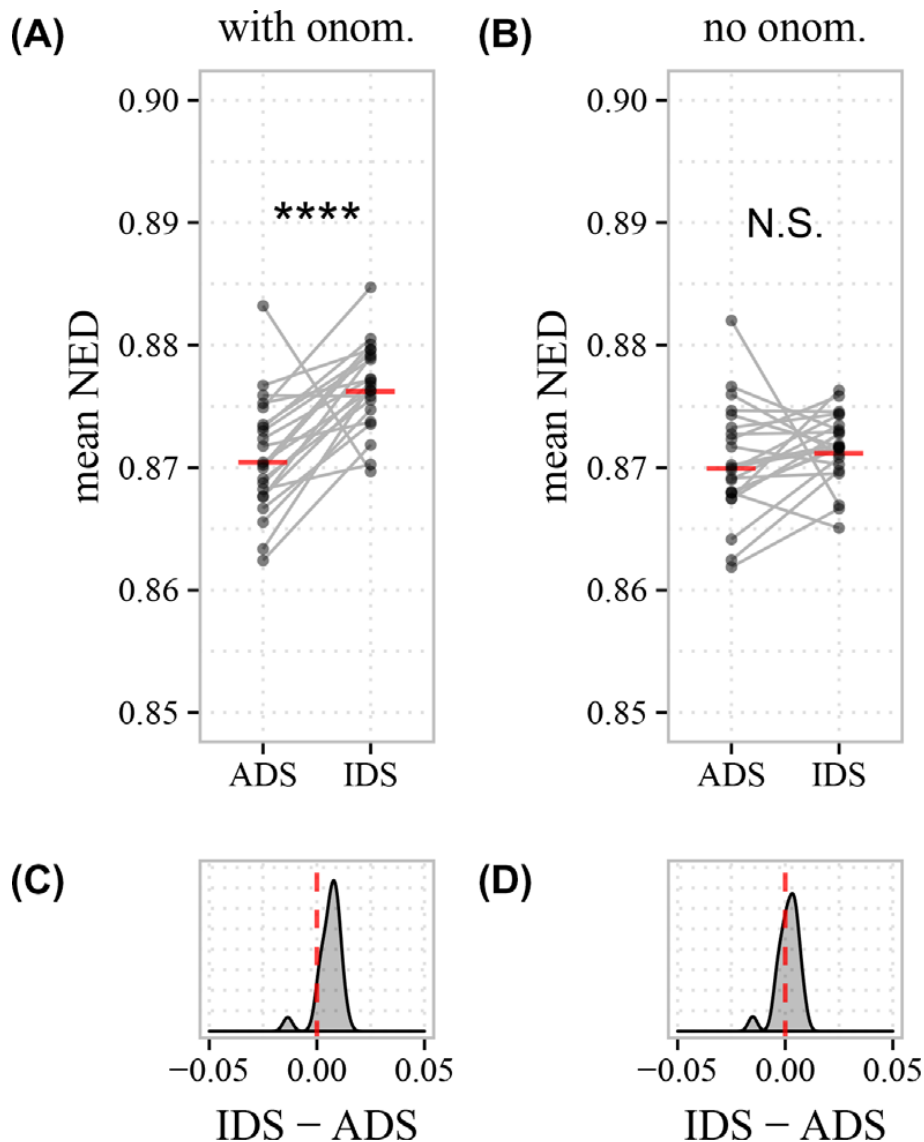

Fig. 5. Global phonological density scores (mean normalized edit distance) for adult-directed speech (ADS) and infant-directed speech (IDS), computed on lexicons matched for number of types across the two registers. Upper panels display the distribution of the scores across individual speakers, as well as means within a speech register (red horizontal lines). Gray lines connect data points corresponding to the same caregiver in both registers. Bottom panels show the distribution of IDS minus ADS score differences. Densities to the right of the red zero line denote higher scores for IDS. A, C: Samples from base corpus. B, D: Samples from base corpus after onomatopoeia removal. N.S., Non-significant difference. \*\*\*\* $p < .0001$ .

school children of the specific features of an action a verbal word form is referring to (Imai, Kita, Nagumo, & Okada, 2008; Kantartzis, Imai, & Kita, 2011). Additionally, around 65% of the reported items contain reduplication of phonological patterns (Mazuka et al., 2008), which may impact learning at a range of levels. Repetitive patterns may be more salient and generalizable than other equally complex patterns (Endress, Dehaene-Lambertz, & Mehler, 2007; Endress, Nespor, & Mehler, 2009), and this salience could facilitate lexical acquisition in infants. This is supported by recent data showing that 9-month-old English-learning infants segment words containing reduplications (e.g., *neenee*)

from running speech more easily than words without reduplications (e.g., *neefoo*) (Ota & Skarabela, 2018). Furthermore, English-learning 18-month-old infants appear to better learn novel object labels when these contain reduplications (Ota & Skarabela, 2016). In fact, reduplication has been found to be a characteristic shared by many items from the specialized set of “babytalk” words in various languages (Ferguson, 1964), in spite of the tendency to avoid such repetitive patterns in adult language (Leben, 1973).

Similarly to what was observed in the survey by Mazuka et al. (2008), the majority of the word types tagged as onomatopoeias in our IDS corpus (i.e., around 30% of the types) present reduplication and/or sound symbolism (e.g., わんわん /waNwaN/ *dog*; ころころ /korokoro/ *light object rolling repeatedly*). Since infants seem to have a learning bias for words with these phonological characteristics, the higher proportion of onomatopoeias in IDS compared to ADS may provide an additional anchor for infant word learning.

As a reviewer pointed out, it may seem counterintuitive at first to focus on the enhanced learnability of IDS-specific words, since children are expected to eventually master all words, whether they are specific to IDS or present in both IDS and ADS. However, we are not concerned here with all of language acquisition, but only with the possibility that top-down cues affecting sound category learning are more helpful in IDS compared to ADS. Thus, even if the words that are learned are not part of a general target lexicon, they might nonetheless present an easier word clustering subproblem, and in that way lead to a lexicon that can be used as seed for subsequent sound category extraction routines.

In sum, we have found that IDS contains a higher proportion of onomatopoeias and mimetic words than ADS. Aside from their remarkable distinctiveness and salience, these items seem to contribute to decreasing the global density of the IDS lexicon. While words in IDS seem to be more spread in phonological space than words in ADS, phoneme-like representations may not yet be available to infants until a larger vocabulary is amassed (Beckman, Munson, & Edwards, 2007; Lindblom, 1992; Metsala & Walley, 1998; Pierrehumbert, 2003). As such, one may wonder if, similarly, words may be more distant in the acoustic space when taking the structural differences into account. Indeed, we notice that the effect size is almost twice as large for the phonological NED (Cohen’s  $d = -1.38$ ) than for the acoustic discriminability (Cohen’s  $d = -0.84$ ). However, given that they are not based on exactly the same tokens, it remains possible that the phonological advantage does not compensate for the acoustic disadvantage. Indeed, the difference in mean NED between IDS and ADS, while statistically significant, is numerically very small, representing a difference of less than one percent of a word. The following experiment examines the question of the effect of phonological structure on acoustic discriminability, by integrating both factors in one global discriminability measure.

#### 4. Experiment 3: Net discriminability

In Experiment 1, we found that when we looked at the exact same word types in both registers, the IDS tokens were acoustically more confusable than the ADS tokens, due to

the increased variability in IDS word categories in the acoustic space. In other words, when removing the influence of structural peculiarities of the lexicons, IDS does not present an advantage over ADS in acoustic discriminability. We then saw in Experiment 2 that the lexicons of IDS and ADS differed structurally. Words from the IDS lexicon were phonologically more distinct than those in the ADS lexicon, in part due to onomatopoeias and mimetic words.

Here, we put these two previous results together and ask the following question: When accounting for register-specific lexical structure, is the IDS lexicon acoustically clearer than the ADS lexicon? In other words, if we take a random pair of word tokens from two different word types found in the IDS recordings, are these tokens more or less acoustically distinct than a like-built pair in the ADS recordings?

#### 4.1. Method

##### 4.1.1. Sampling

In order to observe the combined effects of the differences in phonological structure on acoustic discriminability, the same sampled lexicons used for Experiment 2 were used for this section, that is, 100 lexicon subsets per register per speaker, matched in number of word types across speech registers.

As it was done in Experiment 1, number of tokens per type were not matched in order to maximize the reliability of the ABX metric. Individual number of types can be seen in Table A2 of the Appendix, with total number of tokens shown in Fig. 3.

##### 4.1.2. Computing acoustic discriminability

Acoustic discriminability was computed as described in Experiment 1. A mean ABX score was computed per sampled lexicon subset. ABX scores were collapsed by computing the mean ABX score per speaker per register.

#### 4.2. Results and Discussion

We compared the mean ABX scores for ADS and IDS obtained on the sampled lexicons used in Experiment 2 (Fig. 6). Individual scores can be found in the Appendix Table A2. A paired Student's *t*-test revealed that mean  $ABX_{score}$  were significantly larger for ADS than for IDS, whether onomatopoeias were included in the lexicon subsets ( $ABX_{score}$  IDS: 86% vs. ADS: 87%;  $t(21) = -2.37$ ,  $p < .05$ ; Cohen's  $d = -0.41$ ) or not ( $ABX_{score}$  IDS: 85% vs. ADS: 87%;  $t(21) = -2.57$ ,  $p < .05$ ; Cohen's  $d = -0.43$ ). As such, similar to what was found in Experiment 1, words are less discriminable in IDS than in ADS even after taking into account the phonological specificities of the infant-directed lexicon.

This result underlines the importance of assessing effects of language acquisition enhancers not only in terms of their statistical significance across parents ( $p$  values, Cohen's  $d$ ), but also quantitatively, that is, in terms of their numerical strength when combined together. To see this more clearly, we computed the increase or decrease in the score under study as a percentage relative to the ADS score taken as a baseline.



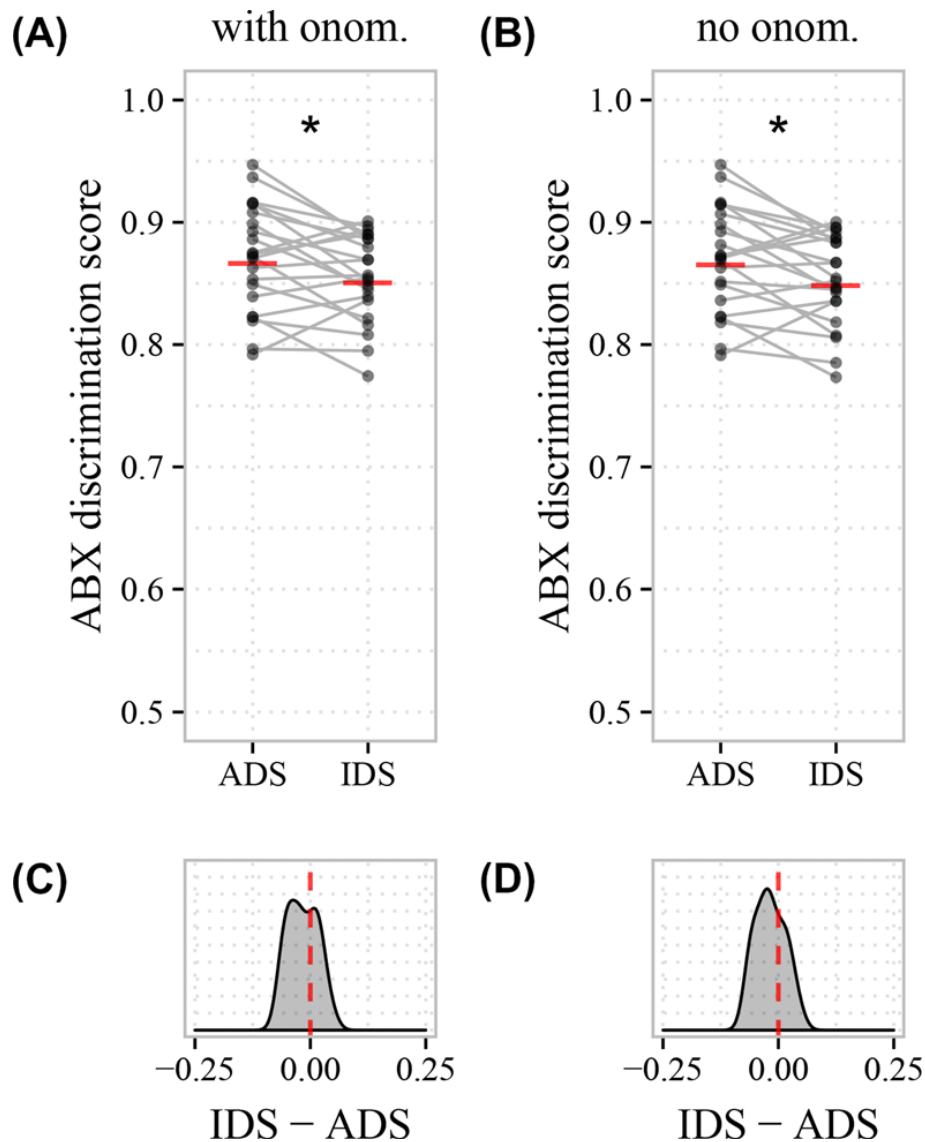

Fig. 6. Acoustic-based ABX word discrimination error in adult-directed speech (ADS) and infant-directed speech (IDS) computed on lexicons matched for number of word types across the two registers. Upper panels display the distribution of the scores across speakers, as well as means within a speech register (red horizontal lines). Gray lines connect data points corresponding to the same caregiver in both registers. Bottom panels show the distribution of IDS minus ADS score differences. Densities to the right of the red zero line denote higher error rates for IDS. A, C: Samples from base corpus. B, D: Samples from base corpus after onomatopoeia removal.  $*p < .05$ .

In Experiment 1, the decrement in discriminability in IDS was 4% relative to ADS, and this effect was robust across participants (Cohen's  $d = -0.84$ ). In Experiment 2, the increase in NED represented a numerically smaller effect of less than 1% for IDS relative to ADS. This effect was actually even more robust across participants (Cohen's  $d = 1.38$ ). Interestingly, when the two effects are combined (Experiment 3), the outcome is not determined by which effect was more statistically robust across participants, but by which one was numerically larger. Indeed, the outcome yields a numerically small (1%

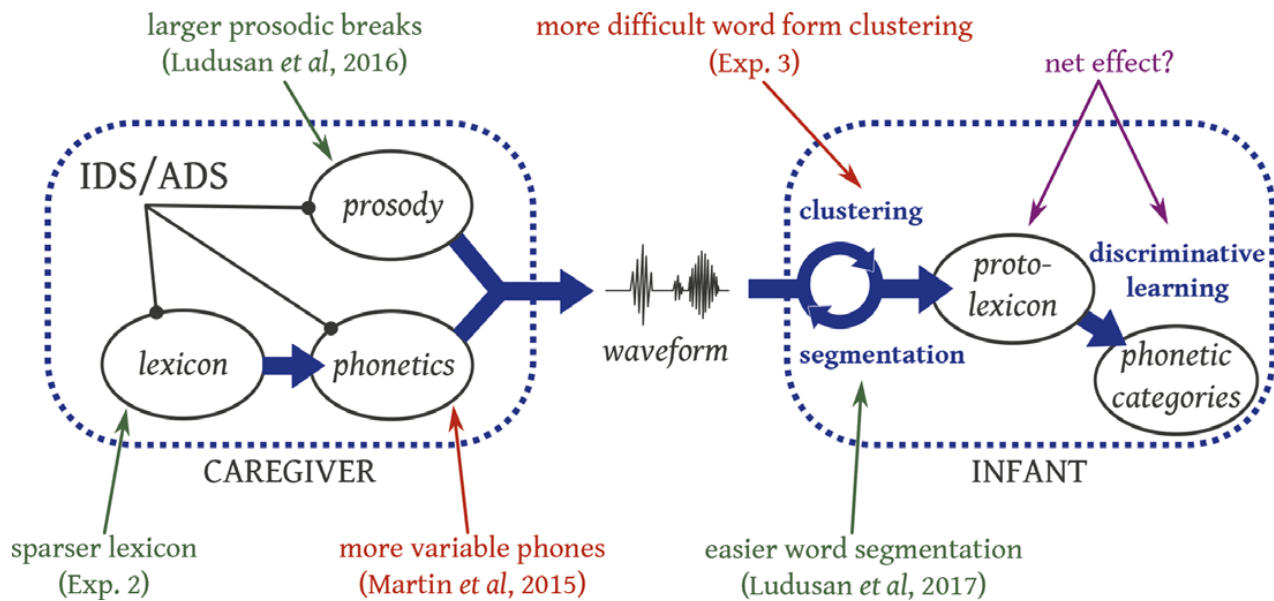

Fig. 7. Summary of infant-directed speech (IDS) characteristics relative to adult-directed speech (ADS) in a top-down model of phonetic category learning for the RIKEN corpus. Enhanced characteristics of IDS relative to ADS are shown in green, while those for which the opposite trend is observed are shown in red.

relative) decrement in discriminability, which is also much weaker across participants (Cohen's  $d = -0.41$ ).

## 5. General discussion

The Hyper Learnability Hypothesis (HLH) states that when talking to their infants, parents modify the linguistic properties of their speech in order to facilitate the learning process. In this paper, we focused on the learning of phonetic categories and reviewed two classes of theories in order to quantitatively assess the HLH: (a) bottom-up theories assume that phonetic categories emerge through the unsupervised clustering of acoustic information, (b) top-down theories assume that phonetic categories emerge through contrastive feedback from learned word types. Previous work has already addressed bottom-up theories: Martin et al. (2015) examined phonemes in a corpus of Japanese laboratory recordings and found that phonemes produced by caregivers addressing their 18- to 24-month old infants were less discriminable than ADS phonemes. This rules out the HLH for that corpus and bottom-up theories. In this study, we focused on top-down theories using the same corpus and investigated the acoustic discriminability of word types.

In Experiment 1, we compared the acoustic discriminability of words that are common to both speech registers, and found that words are *less* discriminable in IDS than in ADS (an absolute decrease in  $ABX_{score}$  of 4%), likely because of increased within-category variability. This result parallels the increase in phonetic variability found in previous studies (Cristia & Seidl, 2014; Kirchoff & Schimmel, 2005; McMurray et al., 2013), and it is consistent with the decreased phoneme discriminability measured by Martin

et al. (2015). It is not consistent, however, with the claim that words in IDS are uttered in a more canonical way than in ADS (Dilley et al., 2014; but see Fais et al., 2010; Lahey & Ernestus, 2014). In Experiment 2, we turned to the structure of the phonological lexicon. We found that the IDS lexicon was globally more spread out than that of ADS, as shown by a larger normalized edit distance between words for the former. Interestingly, this effect was attributable mostly to a higher prevalence of onomatopoeias and mimetic words in IDS. These words have idiosyncratic phonological properties, such as reduplications, which are likely responsible for the increase in global distinctiveness found in the IDS lexicon, compared to the ADS lexicon. In Experiment 3, a final analysis measured the net effect of the opposite trends found in Experiments 1 and 2, and found that, on average, words were still less acoustically discriminable in IDS than in ADS, although the effect was now considerably reduced (an absolute decrease in  $ABX_{score}$  of 1%).

Overall, then, the word form clustering subproblem is not easier to solve by using IDS input than with ADS input; quite to the contrary, there is a numerically small but consistent trend in the opposite direction. Does this undermine the HLH for top-down theories of phonetic learning as a whole? Clearly, the answer is “no,” since – as explained in the Introduction – HLH actually encompasses two other learning subproblems (cf. Fig. 7). We discuss relevant evidence on IDS-ADS differences bearing on each subproblem in turn.

Regarding the problem of finding word token boundaries, Ludusan and colleagues have started studying word form segmentation using either raw acoustics or text-like phonological representations as input. Ludusan, Seidl, Dupoux, and Cristia (2015) studied the performance of acoustic word form discovery systems on a corpus of American English addressed to 4- or 11-month-olds versus adults. The overall results are similar to those of Experiment 3; that is, the two registers give similar outcomes, if anything, with a very small difference in favor of ADS, rather than the expected IDS. Computational models of word segmentation from running speech represented via acoustics are, however, well-known to underperform compared to models that represent speech via textual representations (Versteegh et al., 2016). Thus, in Ludusan, Mazuka, Bernard, Cristia, and Dupoux (2017), we studied word form segmentation from text-like representations using the same RIKEN corpus as input, and a selection of state-of-the-art cognitively based models of infant word segmentation. Results showed an advantage of IDS over ADS for most algorithms and settings.

Beyond the question of whether segmentation is easier in IDS versus ADS, we cannot move on to the next learning subproblem without pointing out that, for future work to assess the net effect of register on word segmentation, one would need to know more about the size and composition of infants’ early lexicon. In fact, most accounts propose that the phonological system is extracted from the long-term lexicon, rather than on the fly from experience with the running spoken input (discussed in Bergmann, Tsuji, & Cristia, 2017). In the present paper, we have done a systematic study of word discriminability across the whole set of words present in the corpus, as if infants could segment the corpus exactly as adults do. This is, of course, unlikely. In fact, recent evidence suggests that infants may be using a suboptimal segmentation algorithm (Larsen, Dupoux, & Cristia,

2017), which leads them to accumulate a “protolexicon” containing not only words, but also over- or under-segmented tokens that do not belong to the adult-like lexicon (Ngon et al., 2013). Such protowords can nonetheless help with contrastive learning (Fourtassi & Dupoux, 2014; Martin, Peperkamp, & Dupoux, 2013).

Regarding contrastive learning of phonetic categories, it is too early to know whether the net effect of register will be beneficial or detrimental. For instance, a detrimental effect of phonetic variability in a bottom-up setting can become beneficial in a top-down setting, by presenting infants with more varied input, and therefore preparing them for future between-speaker variability. This is illustrated in the supervised learning of phonetic categories in adults (Lively, Logan, & Pisoni, 1993). However, as suggested by Rost and McMurray (2010), variability should be limited to acoustic cues that are not relevant to phonetic contrasts in order to promote learning. In order to fully assess the net effect of register, two important elements have to be clarified. First, one would need to have a fully specified model of contrastive learning itself. Candidate computational models have been proposed (e.g., Feldman et al., 2009; Fourtassi & Dupoux, 2014), but not fully validated with realistic infant-directed speech corpora (but see Versteegh et al., 2016, for an application to ADS corpora).

Throughout the above discussion, an important take-home message is that it is essential to posit well-defined, testable theories of infant learning, which can be evaluated using quantitative measures, even when fully specified computational models are not yet available. Individual studies focus only on a few pieces of the puzzle and the magnitude of each evaluated effect must be observed relative to other effects. For instance, in our study, even the relatively large effect of IDS versus ADS on the discriminability of word forms found in Experiment 1 has to be compared to the much larger effect (by a factor of 2) of read versus spontaneous speech found within the ADS register. What we propose as a methodology is to break down theories of language acquisition into component parts, and to derive proxy measures for each component to derive a more systematic grasp of the quantitative effects of register. Before closing, we would like to discuss two limitations of this study, one regarding the corpus and the other regarding the theory tested (the HLH).

The main limitation of the RIKEN corpus is that it was recorded in the laboratory and did not include naturalistic interactions between adults as they may occur in the home environment. The presence of an experimenter and props (toys, etc.) in the laboratory setting may induce some degree of non-naturalness in the interaction, both with the infant, and with the adult. Johnson, Lahey, Ernestus, and Cutler (2013) found that in Dutch, ADS is not a homogeneous register, and that it bears similarities with IDS when the addressed adult is familiar as opposed to unfamiliar.<sup>3</sup> It remains to be assessed whether similar results are obtained in more ecological and representative IDS and ADS samples. In addition, this study is limited by the relatively small size of the corpus. Because we analyzed each parent separately, the size of the analyzed lexicons was between 82 and 260 words, which may under-represent the range of words heard in a home setting. Finally, our analysis is limited to Japanese. There is evidence that vowel hyperarticulation varies across languages (Benders, 2013; Englund & Behne, 2005; Kuhl et al., 1997), and

more generally that the specifics of the IDS register varies across culture (e.g., Fernald & Morikawa, 1993; Igarashi et al., 2013). It would therefore be important to replicate our methods in more ecological, cross-linguistic corpora. Fortunately, the availability of wearable recording systems such as the LENA© device (Greenwood, Thiemann-Bourque, Walker, Buzhardt, & Gilkerson, 2011) increases the prospects of automatizing the collection and analysis of naturalistic speech (Soderstrom & Wittebolle, 2013).

The second limitation of this study is that we restricted our quantitative analysis to the testing of the HLH. However, the HLH is not the only hypothesis that can be addressed. Other theories have been proposed regarding the etiology and role of IDS in the linguistic development of infants (i.e., why caregivers use it, and what are the actual effects on the child). Some modifications of the input may indeed have pedagogical functions (enhancing learnability), while other modifications may decrease learnability while increasing some other factor in the parent–infant interaction. For instance, it has been documented that mothers sometimes violate the grammar of their language when teaching new words, probably in order to place the novel word in a sentence-final position (Aslin, Woodward, LaMendola, & Bever, 1996), which is salient because of properties of short-term memory. Similarly, it has sometimes been suggested that caregivers inadvertently sacrifice phonetic precision in order to make infants more comfortable and/or more receptive to the input (Papoušek & Hwang, 1991; Reilly & Bellugi, 1996). Increased phonetic variability in IDS at the phonemic level may stem from a slower speaking rate (McMurray et al., 2013), or from exaggerated prosodic variations (Fernald et al., 1989; Martin et al., 2016; Soderstrom, 2007), or possibly from gestural modifications that convey a positive affect, such as smiling (Benders, 2013), increased breathiness (Miyazawa et al., 2017) or even a vocal tract that is shortened to resemble the child’s own (Kalashnikova, Carignan, & Burnham, 2017). According to a study by Trueswell et al. (2016), successful word learning interactions tend to be those in which actions performed by both caregivers and infants are precisely synchronized, with time-locking of gaze, speech and gestures. By focusing on efficiently capturing the infant’s attention, caregivers could create an optimal learning environment, in spite of potential degradations brought upon lexical acoustic clarity. A similar interpretation is held by authors such as Csibra and Gergely (2006), who argue that one of the main roles of IDS is to inform the infant that speech is being directed to her, thus highlighting the pedagogical nature of the interaction as a whole. In this view, the goal of caregivers would not be to provide clearer input, but to make language interactions and their attached learning situations more exciting and attractive to infants.

Another direction entirely, is to propose that IDS may help infants to *produce* language. Ferguson (1964) describes “babytalk” as a subset of phonologically-simplified words due to reduced consonant clusters, use of coronals instead of velars, word shortening, etc. These adaptations would make it easier for developing infants to imitate the words, and/or they may be inspired by previous generations’ production errors. In fact, previous work performed on our corpus shows that, if anything, the structural properties of words in our IDS sample better fit early patterns of Japanese infant speech production than those of words in ADS (Tsuji et al., 2014). While the causal relationship between babytalk use and infant word production should be further assessed experimentally, the

phonological properties of our IDS corpus suggest that, to some extent, parental input may be encouraging infant word production.

In brief, while the HLH focuses on the change in informational content of IDS which may boost (or hinder) the learnability of particular linguistic structures, IDS could have a beneficial effect on completely different grounds: enhancing overall attention or positive emotions which would increase depth of processing and retention, or facilitating production, thereby counteracting the inadvertent acoustic degradation of local units of speech such as words and phonemes. For these alternative theories of HLH to be testable within our quantitative approach, we would need to formulate these theories with enough precision that they can either be implemented, or proxies can be derived to analyze realistic corpora of caregivers/infants interactions.

To conclude, the last 50 years we have learned a great deal about how IDS and ADS differ, yet much remains to be understood. We believe it is crucial in this quest to bear in mind a detailed model of early language acquisition, and to submit predictions of this model to systematic, quantitative tests.

## Acknowledgments

This work was supported by the European Research Council (Grant ERC-2011-AdG-295810 BOOTPHON), the Agence Nationale de la Recherche (Grants ANR-2010-BLAN-1901-1 BOOTLANG, ANR-14-CE30-0003 MechELex, ANR-10-IDEX-0001-02 PSL\*, and ANR-10-LABX-0087 IEC), the James S. McDonnell Foundation, the Fondation de France, the Japan Society for the Promotion of Science (Kakenhi Grant 24520446, to A. Martin), and the Canon Foundation in Europe. We thank Bob McMurray and two anonymous reviewers for helpful feedback.

## Author contributions

R. Mazuka oversaw the collection and coding of the corpus. A. Martin wrote the algorithms for extracting words and their phonological structure. R. Thiollière provided coding support with the ABX task. A. Cristia directed the literature review. B. Ludusan assisted with preparation of the ADS-RS comparison. A. Guevara-Rukoz and E. Dupoux carried out the acoustical and phonological analyses and, along with A. Cristia, produced the first draft. All authors contributed to the writing of this manuscript.

## Notes

1. Schatz (2016) has shown that an ABX score of 1 between categories A and B implies that the two categories can be discovered without error by the clustering algorithm *k*-means.

2. In a study by Fernald and Morikawa (1993), Japanese mothers used onomatopoeic words more readily than American mothers.
3. In addition to these effects, Japanese and many other languages have a set of specialized morphemes that depend on familiarity between the talkers; this could have artificially increased the difference between IDS and ADS in the present corpus.

## References

- Andruski, J. E., Kuhl, P. K., & Hayashi, A. (1999). The acoustics of vowels in Japanese women's speech to infants and adults. In J. J. Ohala, Y. Hasegawa, M. Ohala, D. Granville & A. C. Bailey (Eds.), *Proceedings of the 14th International Congress on Phonetic Sciences* (Vol. 3, pp. 2177–2179). San Francisco, CA.
- Antetomaso, S., Miyazawa, K., Feldman, N., Elsner, M., Hitczenko, K., & Mazuka, R. (2016). Modeling phonetic category learning from natural acoustic data. In M. LaMendola & J. Scott (Eds.), *Proceedings of the 41th Annual Boston University Conference on Language Development* (pp. 32–45). Somerville, MA: Cascadilla Press.
- Aslin, R. N., Woodward, J. Z., LaMendola, N. P., & Bever, T. G. (1996). Models of word segmentation in fluent maternal speech to infants. In J. L. Morgan & K. Demuth (Eds.), *Signal to syntax: Bootstrapping from speech to grammar in early acquisition* (pp. 117–134). Hillsdale, NJ: Erlbaum.
- Beckman, M. E., & Edwards, J. (2000). The ontogeny of phonological categories and the primacy of lexical learning in linguistic development. *Child Development*, 71(1), 240–249.
- Beckman, M. E., Munson, B., & Edwards, J. (2007). Vocabulary growth and the developmental expansion of types of phonological knowledge. *Laboratory Phonology*, 9, 241–264.
- Benders, T. (2013). Mommy is only happy! Dutch mothers' realisation of speech sounds in infant-directed speech expresses emotion, not didactic intent. *Infant Behavior and Development*, 36(4), 847–862.
- Bergmann, C., Cristia, A., & Dupoux, E. (2016). Discriminability of sound contrasts in the face of speaker variation quantified. In A. Papafragou, D. Grodner, D. Mirman & J. C. Trueswell (Eds.), *Proceedings of the 38th Annual Conference of the Cognitive Science Society* (pp. 1331–1336). Austin, TX: Cognitive Science Society.
- Bergmann, C., Tsuji, S., & Cristia, A. (2017). Top-down versus bottom-up theories of phonological acquisition: A big data approach. In *Proceedings of Interspeech 2017* (pp. 2103–2107). Available at <https://osf.io/vypwu/> <https://doi.org/10.21437/interspeech.2017-1443>.
- Bernstein Ratner, N. (1984). Patterns of vowel modification in mother-child speech. *Journal of Child Language*, 11(03), 557–578.
- Burnham, D., Kitamura, C., & Vollmer-Conna, U. (2002). What's new, pussycat? On talking to babies and animals. *Science*, 296(5572), 1435.
- Cristia, A., & Seidl, A. (2014). The hyperarticulation hypothesis of infant-directed speech. *Journal of Child Language*, 41, 913–934.
- Csibra, G., & Gergely, G. (2006). Social learning and social cognition: The case for pedagogy. *Processes of Change in Brain and Cognitive Development. Attention and Performance XXI*, 21, 249–274.
- Dautriche, I., Mahowald, K., Gibson, E., Christophe, A., & Piantadosi, S. T. (2017). Words cluster phonetically beyond phonotactic regularities. *Cognition*, 163, 128–145.
- De Boer, B., & Kuhl, P. K. (2003). Investigating the role of infant-directed speech with a computer model. *Acoustics Research Letters Online*, 4(4), 129–134.
- Dilley, L. C., Millett, A. L., McAuley, J. D., & Bergeson, T. R. (2014). Phonetic variation in consonants in infant-directed and adult-directed speech: The case of regressive place assimilation in word-final alveolar stops. *Journal of Child Language*, 41(01), 155–175.

- Dupoux, E. (2016). Cognitive science in the era of artificial intelligence: A roadmap for reverse-engineering the infant language-learner. *Cognition*, 173, 43–59.
- Endress, A. D., Dehaene-Lambertz, G., & Mehler, J. (2007). Perceptual constraints and the learnability of simple grammars. *Cognition*, 105(3), 577–614.
- Endress, A. D., Nespore, M., & Mehler, J. (2009). Perceptual and memory constraints on language acquisition. *Trends in Cognitive Sciences*, 13(8), 348–353.
- Englund, K. T., & Behne, D. M. (2005). Infant directed speech in natural interaction — Norwegian vowel quantity and quality. *Journal of Psycholinguistic Research*, 34(3), 259–280.
- Fais, L., Kajikawa, S., Amano, S., & Werker, J. F. (2010). Now you hear it, now you don't: Vowel devoicing in Japanese infant-directed speech. *Journal of Child Language*, 37(02), 319–340.
- Feldman, N. H., Griffiths, T. L., & Morgan, J. L. (2009). Learning phonetic categories by learning a lexicon. In N. Taatgen & H. van Rijn (Eds.), *Proceedings of the 31st Annual Conference of the Cognitive Science Society* (pp. 2208–2213).
- Ferguson, C. A. (1964). Baby talk in six languages. *American Anthropologist*, 66, 103–114.
- Fernald, A. (2000). Speech to infants as hyperspeech: Knowledge-driven processes in early word recognition. *Phonetica*, 57(2–4), 242–254.
- Fernald, A., & Morikawa, H. (1993). Common themes and cultural variations in Japanese and American mothers' speech to infants. *Child Development*, 64(3), 637–656.
- Fernald, A., Taeschner, T., Dunn, J., Papousek, M., de Boysson-Bardies, B., & Fukui, I. (1989). A cross-language study of prosodic modifications in mothers' and fathers' speech to preverbal infants. *Journal of Child Language*, 16(03), 477–501.
- Fourtassi, A., & Dupoux, E. (2014). A rudimentary lexicon and semantics help bootstrap phoneme acquisition. In R. Morante & W. Yih (Eds.), *Proceedings of the 18th Conference on Computational Natural Language Learning* (pp. 191–200). Association for Computational Linguistics.
- Golinkoff, R. M., Can, D. D., Soderstrom, M., & Hirsh-Pasek, K. (2015). (Baby) talk to me: The social context of infant-directed speech and its effects on early language acquisition. *Current Directions in Psychological Science*, 24(5), 339–344.
- Greenwood, C. R., Thiemann-Bourque, K., Walker, D., Buzhardt, J., & Gilkerson, J. (2011). Assessing children's home language environments using automatic speech recognition technology. *Communication Disorders Quarterly*, 32(2), 83–92.
- Guenther, F. H., & Gjaja, M. N. (1996). The perceptual magnet effect as an emergent property of neural map formation. *Journal of the Acoustical Society of America*, 100, 1111–1121.
- Henning, A., Striano, T., & Lieven, E. V. (2005). Maternal speech to infants at 1 and 3 months of age. *Infant Behavior and Development*, 28(4), 519–536.
- Iba, M. (2000). An analysis of the first 50 words acquired by young Japanese children. *Language and Culture: The Journal of the Institute for Language and Culture*, 4, 45–56.
- Igarashi, Y., Nishikawa, K., Tanaka, K., & Mazuka, R. (2013). Phonological theory informs the analysis of intonational exaggeration in Japanese infant-directed speech. *The Journal of the Acoustical Society of America*, 134(2), 1283–1294.
- Imai, M., & Kita, S. (2014). The sound symbolism bootstrapping hypothesis for language acquisition and language evolution. *Philosophical Transactions of the Royal Society of London B: Biological Sciences*, 369(1651), 20130298.
- Imai, M., Kita, S., Nagumo, M., & Okada, H. (2008). Sound symbolism facilitates early verb learning. *Cognition*, 109(1), 54–65.
- Johnson, E. K., Lahey, M., Ernestus, M., & Cutler, A. (2013). A multimodal corpus of speech to infant and adult listeners. *The Journal of the Acoustical Society of America*, 134, EL534–EL540.
- Juszyk, P. W., Bertoncini, J., Bijeljac-Babic, R., Kennedy, L. J., & Mehler, J. (1990). The role of attention in speech perception by young infants. *Cognitive Development*, 5(3), 265–286.
- Kalashnikova, M., Carignan, C., & Burnham, D. (2017). The origins of babytalk: Smiling, teaching or social convergence? *Royal Society Open Science*, 4(8), 170306.



- Kantartzis, K., Imai, M., & Kita, S. (2011). Japanese sound-symbolism facilitates word learning in English-speaking children. *Cognitive Science*, 35(3), 575–586.
- Kaye, K. (1980). Why we don't talk 'baby talk' to babies. *Journal of Child Language*, 7(03), 489–507.
- Kirchhoff, K., & Schimmel, S. (2005). Statistical properties of infant-directed versus adult-directed speech: Insights from speech recognition. *The Journal of the Acoustical Society of America*, 117(4), 2238–2246.
- Kohonen, T. (1988). The 'neural' phonetic typewriter. *Computer*, 21(3), 11–22.
- Kuhl, P. K. (1993). Early linguistic experience and phonetic perception: Implications for theories of developmental speech perception. *Journal of Phonetics*, 21, 125–139.
- Kuhl, P. K. (2000). A new view of language acquisition. *Proceedings of the National Academy of Sciences*, 97(22), 11850–11857.
- Kuhl, P. K., Andruski, J. E., Chistovich, I. A., Chistovich, L. A., Kozhevnikova, E. V., Ryskina, V. L., & Lacerda, F. (1997). Cross-language analysis of phonetic units in language addressed to infants. *Science*, 277(5326), 684–686.
- Lahey, M., & Ernestus, M. (2014). Pronunciation variation in infant-directed speech: Phonetic reduction of two highly frequent words. *Language Learning and Development*, 10(4), 308–327.
- Lake, B., Vallabha, G., & McClelland, J. (2009). Modeling unsupervised perceptual category learning. *IEEE Transactions on Autonomous Mental Development*, 1(1), 35–43. <https://doi.org/10.1109/TAMD.2009.2021703>.
- Larsen, E., Dupoux, E., & Cristia, A. (2017). Relating unsupervised word segmentation to reported vocabulary acquisition. In *Proceedings of Interspeech* (pp. 2198–2202).
- Leben, W. R. (1973). *Suprasegmental phonology*. (Unpublished doctoral dissertation). Cambridge, MA: Massachusetts Institute of Technology.
- Lindblom, B. (1990). Explaining phonetic variation: A sketch of the H&H theory. In Hardcastle & Marchal (Eds.), *Speech production and speech modelling* (pp. 403–439). Dordrecht, the Netherlands: Springer.
- Lindblom, B. (1992). Phonological units as adaptive emergents of lexical development. *Phonological Development: Models, Research, Implications*, 131, 163.
- Liu, H.-M., Kuhl, P. K., & Tsao, F.-M. (2003). An association between mothers' speech clarity and infants' speech discrimination skills. *Developmental Science*, 6(3), F1–F10.
- Lively, S. E., Logan, J. S., & Pisoni, D. B. (1993). Training Japanese listeners to identify English/t/and/l/. II: The role of phonetic environment and talker variability in learning new perceptual categories. *The Journal of the Acoustical Society of America*, 94(3), 1242–1255.
- Ludusan, B., Cristia, A., Martin, A., Mazuka, R., & Dupoux, E. (2016). Learnability of prosodic boundaries: Is infant-directed speech easier? *The Journal of the Acoustical Society of America*, 140(2), 1239–1250.
- Ludusan, B., Mazuka, R., Bernard, M., Cristia, A., & Dupoux, E. (2017). The role of prosody and speech register in word segmentation: A computational modelling perspective. In *Proceedings of the 55th Annual Meeting of the Association for Computational Linguistics (Volume 2: Short Papers)* (pp. 178–183).
- Ludusan, B., Seidl, A., Dupoux, E., & Cristia, A. (2015). Motif discovery in infant-and adult-directed speech. In *Conference on Empirical Methods in Natural Language Processing* (p. 93–102). Proceedings of CogACLL2015, (pp. 93–102)
- Martin, A., Igarashi, Y., Jincho, N., & Mazuka, R. (2016). Utterances in infant-directed speech are shorter, not slower. *Cognition*, 156, 52–59.
- Martin, A., Peperkamp, S., & Dupoux, E. (2013). Learning phonemes with a proto-lexicon. *Cognitive Science*, 37(1), 103–124.
- Martin, A., Schatz, T., Versteegh, M., Miyazawa, K., Mazuka, R., Dupoux, E., & Cristia, A. (2015). Mothers speak less clearly to infants than to adults: A comprehensive test of the hyperarticulation hypothesis. *Psychological Science*, 26(3), 341–347.
- Martin, A., Utsugi, A., & Mazuka, R. (2014). The multidimensional nature of hyperspeech: Evidence from Japanese vowel devoicing. *Cognition*, 132(2), 216–228.
- Maye, J., Werker, J. F., & Gerken, L. (2002). Infant sensitivity to distributional information can affect phonetic discrimination. *Cognition*, 82(3), B101–B111.

- Mazuka, R., Igarashi, Y., & Nishikawa, K. (2006). Input for Learning Japanese: RIKEN Japanese Mother-Infant Conversation Corpus. Technical report of IEICE, TL2006-16, 106 (165), 11–15.
- Mazuka, R., Kondo, T., & Hayashi, A. (2008). Japanese mothers' use of specialized vocabulary in infant-directed speech: Infant-directed vocabulary in Japanese. In N. Matasaka (Ed.), *The origins of language* (pp. 39–58). New York: Springer.
- McMurray, B., Aslin, R. N., & Toscano, J. C. (2009). Statistical learning of phonetic categories: Insights from a computational approach. *Developmental Science*, 12(3), 369–378. <https://doi.org/10.1111/j.1467-7687.2009.00822.x>.
- McMurray, B., Kovack-Lesh, K. A., Goodwin, D., & McEchron, W. (2013). Infant directed speech and the development of speech perception: Enhancing development or an unintended consequence? *Cognition*, 129(2), 362–378.
- Metsala, J. L., & Walley, A. C. (1998). Spoken vocabulary growth and the segmental restructuring of lexical representations: Precursors to phonemic awareness and early reading ability. In J. Metsala, & L. Ehri (Eds.), *Word recognition in beginning literacy* (pp. 89–120). Mahwah, NJ: Lawrence Erlbaum Associates Publishers.
- Miyazaki, M., Hidaka, S., Imai, M., Yeung, H. H., Kantartzis, K., Okada, H., & Kita, S. (2013). The facilitatory role of sound symbolism in infant word learning. In M. Knauff, M. Pauen, N. Sebanz & N. Matasaka (Eds.), *Proceedings of the 35th Annual Conference of the Cognitive Science Society* (Vol. 1, pp. 3080–3085). Austin, TX: Cognitive Science Society.
- Miyazawa, K., Shinya, T., Martin, A., Kikuchi, H., & Mazuka, R. (2017). Vowels in infant-directed speech: More breathy and more variable, but not clearer. *Cognition*, 166, 84–93.
- Moore, B. C. J. (2012). *An introduction to the psychology of hearing* (6th ed.). Leiden: Brill.
- Mullennix, J. W., Pisoni, D. B., & Martin, C. S. (1989). Some effects of talker variability on spoken word recognition. *The Journal of the Acoustical Society of America*, 85(1), 365–378.
- Newport, E., Gleitman, H., & Gleitman, L. (1977). Mother, I'd rather do it myself: Some effects and non-effects of maternal speech style. In C. Snow & C. Ferguson (Eds.), *Talking to children: Language input and acquisition*. New York: Cambridge University Press.
- Ngon, C., Martin, A., Dupoux, E., Cabrol, D., Dutat, M., & Peperkamp, S. (2013). (Non)words, (non)words, (non)words: Evidence for a protolexicon during the first year of life. *Developmental Science*, 16(1), 24–34.
- Ota, M., & Skarabela, B. (2016). Reduplicated words are easier to learn. *Language Learning and Development*, 12, 380–397.
- Ota, M., & Skarabela, B. (2017). Reduplication facilitates early word segmentation. *Journal of Child Language*, 45, 204–218.
- Papoušek, M., & Hwang, S.-F. C. (1991). Tone and intonation in Mandarin babytalk to presyllabic infants: Comparison with registers of adult conversation and foreign language instruction. *Applied Psycholinguistics*, 12(04), 481–504.
- Phillips, J. R. (1973). Syntax and vocabulary of mothers' speech to young children: Age and sex comparisons. *Child Development*, 44, 182–185.
- Pierrehumbert, J. B. (2003). Phonetic diversity, statistical learning, and acquisition of phonology. *Language and Speech*, 46(2–3), 115–154.
- Reilly, J. S., & Bellugi, U. (1996). Competition on the face: Affect and language in ASL motherese. *Journal of Child Language*, 23(1), 219–239.
- Rost, G. C., & McMurray, B. (2009). Speaker variability augments phonological processing in early word learning. *Developmental Science*, 12(2), 339–349.
- Rost, G. C., & McMurray, B. (2010). Finding the signal by adding noise: The role of noncontrastive phonetic variability in early word learning. *Infancy*, 15(6), 608–635.
- Ryalls, B. O., & Pisoni, D. B. (1997). The effect of talker variability on word recognition in preschool children. *Developmental Psychology*, 33(3), 441.

- Sagisaka, Y., Takeda, K., Abel, M., Katagiri, S., Umeda, T., & Kuwabara, H. (1990). A large-scale Japanese speech database. In *Proceedings of International Conference on Spoken Language Processing (ICSLP'90, Kobe)*, Vol. 2, pp. 1089–1092.
- Saji, N., & Imai, M. (2013). Onomatope kenkyu no shatei—chikadzuku oto to imi [The Role of Iconicity in Lexical Development]. In K. Shinohara & R. Uno (Eds.), *Onomatope kenkyu no shatei - chikadzuku oto to imi (Sound Symbolism and Mimetics)* (pp. 151–166). Tokyo, Japan: Hituji Syobo.
- Sakoe, H., & Chiba, S. (1978). Dynamic programming algorithm optimization for spoken word recognition. *IEEE Transactions on Acoustics, Speech, and Signal Processing*, 26(1), 43–49.
- Schatz, T. (2016). *ABX-Discriminability Measures and Applications* (Unpublished doctoral dissertation). Paris: Ecole Normale Supérieure.
- Schatz, T., Peddinti, V., Bach, F., Jansen, A., Hermansky, H., & Dupoux, E. (2013). Evaluating speech features with the Minimal-Pair ABX task: Analysis of the classical MFC/PLP pipeline. In F. Bimbot et al. (Ed.), *Proceedings of Interspeech* (pp. 1781–1785).
- Soderstrom, M. (2007). Beyond babytalk: Re-evaluating the nature and content of speech input to preverbal infants. *Developmental Review*, 27(4), 501–532.
- Soderstrom, M., & Wittebolle, K. (2013). When do caregivers talk? The influences of activity and time of day on caregiver speech and child vocalizations in two childcare environments. *PLoS ONE*, 8(11), e80646.
- Trueswell, J. C., Lin, Y., Armstrong, B., Cartmill, E. A., Goldin-Meadow, S., & Gleitman, L. R. (2016). Perceiving referential intent: Dynamics of reference in natural parent–child interactions. *Cognition*, 148, 117–135.
- Tsuji, S., Nishikawa, K., & Mazuka, R. (2014). Segmental distributions and consonant-vowel association patterns in Japanese infant-and adult-directed speech. *Journal of Child Language*, 41(06), 1276–1304.
- Uther, M., Knoll, M. A., & Burnham, D. (2007). Do you speak E-NG-LI-SH? A comparison of foreigner-and infant-directed speech. *Speech Communication*, 49(1), 2–7.
- Vallabha, G. K., McClelland, J. L., Pons, F., Werker, J. F., & Amano, S. (2007). Unsupervised learning of vowel categories from infant-directed speech. *Proceedings of the National Academy of Sciences*, 104(33), 13273–13278.
- Varadarajan, B., Khudanpur, S., & Dupoux, E. (2008). Unsupervised learning of acoustic sub-word units. In *Proceedings of the 46th Annual Meeting of the Association for Computational Linguistics on Human Language Technologies: Short Papers* (pp. 165–168). Association for Computational Linguistics.
- Versteegh, M., Anguera, X., Jansen, A., & Dupoux, E. (2016). The Zero Resource Speech Challenge 2015: Proposed approaches and results. *Procedia Computer Science*, 81, 67–72.
- Werker, J. F., & Curtin, S. (2005). PRIMIR: A developmental framework of infant speech processing. *Language Learning and Development*, 1(2), 197–234.

## Appendix

Table A1

Acoustic discriminability comparisons on common words in ADS versus infant-directed speech (IDS), and in adult-directed speech (ADS) versus read speech (RS) (Exp. 1). Individual scores for separation (in radians), variability (in radians) and overall acoustic discrimination

Speaker	No. of Types	ADS Versus IDS						ADS Versus RS (control)		
		Separation		Variability		ABX <sub>score</sub>		# Types	ABX <sub>score</sub>	
		ADS	IDS	ADS	IDS	ADS	IDS		ADS	RS
F039	43	0.47	0.45	0.35	0.38	0.83	0.77	19	0.82	0.94
F047	67	0.47	0.49	0.34	0.37	0.87	0.83	25	0.88	0.92
F118	66	0.49	0.50	0.39	0.39	0.79	0.81	23	0.79	0.95
F233	64	0.41	0.39	0.34	0.36	0.79	0.74	25	0.78	0.93
F302	54	0.49	0.50	0.40	0.43	0.76	0.76	24	0.74	0.89
F367	70	0.46	0.45	0.32	0.35	0.88	0.84	26	0.85	0.94
F478	71	0.44	0.48	0.35	0.40	0.82	0.78	28	0.80	0.95
F483	69	0.46	0.48	0.35	0.37	0.83	0.84	23	0.80	0.91
F484	81	0.45	0.46	0.37	0.39	0.81	0.77	32	0.82	0.95
M002	73	0.46	0.46	0.31	0.37	0.91	0.80	27	0.90	0.92
M013	67	0.45	0.46	0.30	0.37	0.89	0.81	31	0.88	0.93
M024	77	0.48	0.49	0.35	0.38	0.89	0.83	31	0.85	0.93
M025	43	0.49	0.46	0.31	0.37	0.89	0.83	21	0.88	0.91
M044	86	0.47	0.46	0.35	0.35	0.86	0.83	32	0.85	0.93
M120	46	0.45	0.49	0.34	0.41	0.84	0.79	19	0.82	0.89
M125	59	0.48	0.51	0.33	0.38	0.90	0.85	31	0.91	0.92
M312	94	0.47	0.48	0.37	0.38	0.83	0.77	29	0.81	0.91
M374	90	0.47	0.46	0.35	0.37	0.87	0.81	-	-	-
M417	57	0.43	0.43	0.40	0.38	0.73	0.75	-	-	-
M425	78	0.44	0.46	0.34	0.34	0.86	0.86	27	0.82	0.9
M432	49	0.51	0.49	0.41	0.37	0.79	0.81	23	0.81	0.91
M480	68	0.47	0.47	0.36	0.38	0.83	0.82	32	0.84	0.94
<i>M</i>	66.91	0.46	0.47	0.35	0.38	0.84	0.80	26.4	0.83	0.92
<i>SD</i>	14.41	0.02	0.03	0.03	0.02	0.05	0.03	4.3	0.04	0.02

Table A2

Phonological and acoustic discriminability comparisons in adult-directed speech (ADS) versus infant-directed speech (IDS) (Exp. 2 & 3). Individual mean normalized edit distance (NED) and overall acoustic discriminability before and after removal of onomatopoeias. Values are computed as the mean of the corresponding values from 100 word samplings per speaker

Speaker	With Onomatopoeias							No Onomatopoeias				
	No. of Types	% Onom.		NED		ABX <sub>score</sub>		No. of Types	NED		ABX <sub>score</sub>	
		ADS	IDS	ADS	IDS	ADS	IDS		ADS	IDS	ADS	IDS
F039	82	6.1	35.4	0.883	0.870	0.85	0.82	77	0.882	0.867	0.85	0.82
F047	178	2.2	20.2	0.873	0.879	0.90	0.84	174	0.873	0.873	0.9	0.84
F118	139	1.4	26.6	0.876	0.876	0.84	0.85	137	0.876	0.871	0.84	0.85
F233	167	1.8	22.2	0.869	0.876	0.82	0.77	164	0.868	0.872	0.82	0.77
F302	117	0.9	50.4	0.877	0.880	0.80	0.79	116	0.877	0.873	0.8	0.79
F367	187	1.1	39.0	0.873	0.879	0.91	0.88	185	0.872	0.876	0.91	0.89
F478	221	3.2	8.1	0.870	0.876	0.82	0.81	208	0.869	0.873	0.82	0.81
F483	168	0	37.5	0.870	0.880	0.87	0.89	168	0.870	0.872	0.87	0.90
F484	250	0.8	18.0	0.872	0.874	0.85	0.86	232	0.872	0.870	0.85	0.85
M002	194	2.1	27.3	0.868	0.876	0.92	0.85	190	0.867	0.873	0.92	0.85
M013	196	2.0	19.9	0.867	0.874	0.91	0.89	176	0.868	0.872	0.91	0.88
M024	229	1.3	31.0	0.863	0.877	0.92	0.90	226	0.862	0.870	0.91	0.90
M025	120	0.8	30.0	0.873	0.881	0.94	0.89	119	0.873	0.874	0.94	0.89
M044	212	1.9	29.7	0.875	0.877	0.87	0.89	208	0.874	0.872	0.87	0.89
M120	102	1.0	63.7	0.868	0.879	0.87	0.82	101	0.867	0.876	0.87	0.81
M125	194	1.0	24.2	0.862	0.872	0.95	0.89	192	0.862	0.867	0.95	0.88
M312	248	2.8	24.6	0.868	0.870	0.86	0.87	241	0.868	0.865	0.86	0.87
M374	260	1.9	19.6	0.866	0.875	0.89	0.87	255	0.864	0.871	0.89	0.87
M417	156	0.6	34.6	0.870	0.880	0.79	0.84	155	0.870	0.872	0.79	0.84
M425	191	3.7	20.4	0.872	0.877	0.87	0.90	184	0.870	0.874	0.87	0.90
M432	139	0.7	43.9	0.869	0.877	0.82	0.84	138	0.869	0.870	0.82	0.84
M480	202	2.0	25.7	0.875	0.885	0.89	0.85	185	0.875	0.875	0.88	0.85
<i>M</i>	179.64	1.79	29.64	0.871	0.877	0.87	0.86	174.14	0.870	0.872	0.87	0.85
<i>SD</i>	48.72	1.31	12.18	0.005	0.004	0.04	0.04	46.11	0.005	0.003	0.04	0.04









## Résumé

Pourquoi des personnes ayant grandi dans des milieux linguistiques différents ne perçoivent-elles un même signal acoustique de la même manière? Par exemple, il arrive que des auditeurs rapportent avoir entendu des voyelles non présentes dans l'acoustique de mots non-natifs, lorsque ceux-ci ne se conforment pas aux structures sonores permises dans leur langue (épenhèse vocalique perceptive). L'identité de la voyelle épenhétique varie en fonction des langues, mais aussi parmi les langues elles-mêmes. A quel point ce processus est-il dirigé par des informations directement accessibles dans le signal acoustique? Quelle est la part de contribution de la phonologie native? Comment sont combinés ces deux éléments lors du calcul du percept? Deux familles principales de théories ont été proposées: les théories à deux étapes, et les théories à une étape. Les premières proposent une analyse initiale des catégories phonétiques, suivie de réparations faites par une grammaire abstraite. De leur côté, les théories à une étape proposent que tous les facteurs acoustiques, phonétiques, et phonologiques sont intégrés simultanément de manière probabiliste.

Dans cette thèse, nous combinons expériences et de modélisation, afin d'évaluer si l'épenhèse est un processus à une ou deux étapes. En particulier, nous examinons ceci en mesurant le rôle des détails acoustiques dans les modulations de l'identité de la voyelle épenhétique. Dans un premier temps, des résultats d'expériences nous montrent que ces modulations sont influencées aussi bien par les détails acoustiques que par des processus phonologiques. Cependant, la plupart de la variation de l'identité de la voyelle épenhétique est expliquée par l'acoustique. De plus, nous présentons un modèle de perception à une étape qui utilise des exemplaires; celui-ci est capable de reproduire les effets de la coarticulation qui ont été relevés dans les données expérimentales. Ces résultats constituent de l'évidence en faveur des modèles de perception étrangère à une étape.

Dans un deuxième temps, nous présentons une implémentation du modèle à une étape proposé par [Wilson and Davidson, 2013], en utilisant des modèles HMM-GMM, issus du milieu de la reconnaissance automatique de la parole (RAP). Ces modèles se composent d'un modèle acoustique et d'un modèle de langage, qui déterminent la correspondance acoustique et phonotactique entre la parole et des transcriptions possibles, respectivement. Il nous est alors possible de les ajuster indépendamment afin d'évaluer leur influence relative dans l'épenhèse vocalique perceptuelle. Nous proposons une nouvelle manière d'utiliser ces modèles pour simuler des paradigmes de choix forcés utilisés pour étudier l'épenhèse vocalique chez des participants humains, en utilisant des modèles de langage contraints lors du processus de décodage de la parole. D'abord, nous utilisons cette nouvelle méthode afin de tester si des systèmes de RAP avec des modèles de langage à phonotactique à  $n$ -grammes donnent des résultats plus proches des résultats humains qu'un système de RAP avec un modèle de langage nul. De manière étonnante, les résultats montrent que le système à modèle de langage nul prédit le mieux la performance des participants. Puis, nous évaluons si certains effets traditionnellement attribués à des processus phonologiques peuvent être expliqués par l'acoustique. Bien que les résultats soient prometteurs, nos modèles ne sont capables de reproduire qu'une sous-partie des effets observés chez l'humain. Avant de pouvoir attribuer l'origine de ces effets à des processus phonologiques, il est nécessaire de tester des systèmes de RAP avec des modèles acoustiques plus performants. Nous énumérons des futures pistes de recherche d'utilisation de modèles améliorés, et nous soulignons les avantages de l'utilisation conjointe d'expériences comportementales et modélisations computationnelles afin d'élucider les mécanismes de la perception de la parole étrangère.

## Mots Clés

épenhèse vocalique perceptive, reconnaissance automatique de la parole, modélisation, phonotactique, phonologie, psycholinguistique

## Abstract

Why do people of different linguistic background sometimes perceive the same acoustic signal differently? For instance, when hearing nonnative speech that does not conform to sound structures allowed in their native language, listeners may report hearing vowels that are not acoustically present. This phenomenon, known as perceptual vowel epenthesis, has been attested in various languages such as Japanese, Brazilian Portuguese, Korean, and English. The quality of the epenthesized vowel varies between languages, but also within languages, given certain phonemic environments. How much of this process is guided by information directly accessible in the acoustic signal? What is the contribution of the native phonology? How are these two elements combined when computing the native percept? Two main families of theories have been proposed as explanations: two-step and one-step theories. The former advocate an initial parsing of the phonetic categories, followed by repairs by an abstract grammar (e.g., epenthesis), while one-step proposals posit that all acoustic, phonetic, and phonological factors are integrated simultaneously in a probabilistic manner, in order to find the optimal percept.

In this dissertation, we use a combination of experimental and modelling approaches in order to evaluate whether perceptual vowel epenthesis is a two-step or one-step process. In particular, we investigate this by assessing the role of acoustic details in modulations of epenthetic vowel quality. In a first part, results from two behavioural experiments show that these modulations are influenced by acoustic cues as well as phonology; however, the former explain most of the variation in epenthetic vowel responses. Additionally, we present a one-step exemplar-based model of perception that is able to reproduce coarticulation effects observed in human data. These results constitute evidence for one-step models of nonnative speech perception.

In a second part, we present an implementation of the one-step proposal in [Wilson and Davidson, 2013], using HMM-GMM (hidden Markov models with Gaussian mixture models) from the field of automatic speech recognition. These models present two separate components determining the acoustic and phonotactic matches between speech and possible transcriptions. We can thus tweak them independently in order to evaluate the relative influence of acoustic/phonetic and phonological factors in perceptual vowel epenthesis. We propose a novel way to simulate with these models the forced choice paradigm used to probe vowel epenthesis in human participants, using constrained language models during the speech decoding process. In a first set of studies, we use this method to test whether various ASR systems with  $n$ -gram phonotactics as their language model better approximate human results than an ASR system with a null (i.e., no phonotactics) language model. Surprisingly, we find that this null model was the best predictor of human performance. In a second set of studies, we evaluate whether effects traditionally attributed to phonology may be predictable solely from acoustic match. We find that, while promising, our models are only able to partially reproduce some effects observed in results from human experiments. Before attributing the source of these effects to phonology, it is necessary to test ASR systems with more performant acoustic models. We discuss future avenues for using enhanced models, and highlight the advantages of using a hybrid approach with behavioural experiments and computational modelling in order to elucidate the mechanisms underlying nonnative speech perception.

## Keywords

perceptual vowel epenthesis, automatic speech recognition, modelling, phonotactics, phonology, psycholinguistics