



**HAL**  
open science

# Distributed intelligence and heterarchical approach of distributed balancing markets in Smart Grids

Emmanuelle Vanet

► **To cite this version:**

Emmanuelle Vanet. Distributed intelligence and heterarchical approach of distributed balancing markets in Smart Grids. Electric power. Université Grenoble Alpes, 2016. English. NNT: . tel-01515280v1

**HAL Id: tel-01515280**

**<https://hal.science/tel-01515280v1>**

Submitted on 27 Apr 2017 (v1), last revised 31 Oct 2017 (v2)

**HAL** is a multi-disciplinary open access archive for the deposit and dissemination of scientific research documents, whether they are published or not. The documents may come from teaching and research institutions in France or abroad, or from public or private research centers.

L'archive ouverte pluridisciplinaire **HAL**, est destinée au dépôt et à la diffusion de documents scientifiques de niveau recherche, publiés ou non, émanant des établissements d'enseignement et de recherche français ou étrangers, des laboratoires publics ou privés.

# THÈSE

Pour obtenir le grade de

## DOCTEUR DE LA COMMUNAUTE UNIVERSITE GRENOBLE ALPES

Spécialité : **Génie Electrique**

Arrêté ministériel : 7 août 2006

Présentée par

« **Emmanuelle VANET** »

Thèse dirigée par « **Raphaël CAIRE** » et  
codirigée par « **Nouredine HADJSAID** »

préparée au sein du **Laboratoire de Génie Électrique de  
Grenoble (G2Elab)**  
dans l' **École Doctorale Électronique, Électrotechnique,  
Automatique et Traitement du Signal (EEATS)**

### **Distribution de l'intelligence et approche hétérarchique des marchés de l'énergie distribués dans les Smart Grids**

### **Distributed intelligence and heterarchical approach of distributed balancing markets in Smart Grids**

Thèse soutenue publiquement le « **27 septembre 2016** »,  
devant le jury composé de :

**Monsieur Hans AKKERMANS**

Professeur, VU University Amsterdam VUA

Rapporteur

**Monsieur Marc PETIT**

Professeur adjoint, Centrale Supélec

Rapporteur

**Monsieur Abdellatif MIRAOUI**

Professeur, Université Cadi Ayyad Marrakech

Examineur

**Monsieur Raphaël CAIRE**

Maître de conférence, Université Grenoble Alpes

Directeur

**Monsieur Nouredine HADJSAID**

Professeur, Université Grenoble Alpes

Co-Directeur





# THÈSE

Pour obtenir le grade de

## DOCTEUR DE LA COMMUNAUTE UNIVERSITE GRENOBLE ALPES

Spécialité : **Génie Electrique**

Arrêté ministériel : 7 août 2006

Présentée par

« **Emmanuelle VANET** »

Thèse dirigée par « **Raphaël CAIRE** » et  
codirigée par « **Nouredine HADJSAID** »

préparée au sein du **Laboratoire de Génie Électrique de  
Grenoble (G2Elab)**  
dans l' **École Doctorale Électronique, Électrotechnique,  
Automatique et Traitement du Signal (EEATS)**

**Distribution de l'intelligence et approche  
hétérarchique des marchés de l'énergie  
distribués dans les Smart Grids**

**Distributed intelligence and heterarchical  
approach of distributed balancing markets  
in Smart Grids**

Thèse soutenue publiquement le « **27 septembre 2016** »,  
devant le jury composé de :

**Monsieur Hans AKKERMANS**

Professeur, VU University Amsterdam VUA

Rapporteur

**Monsieur Marc PETIT**

Professeur adjoint, Centrale Supélec

Rapporteur

**Monsieur Abdellatif MIRAOUI**

Professeur, Université Cadi Ayyad Marrakech

Examineur

**Monsieur Raphaël CAIRE**

Maître de conférence, Université Grenoble Alpes

Directeur

**Monsieur Nouredine HADJSAID**

Professeur, Université Grenoble Alpes

Co-Directeur







# Preface

---

Une page se tourne, et pourtant, il en reste encore deux bonnes centaines après celle-ci. Et toutes ces pages n'existeraient pas sans le soutien de quelques personnes que j'aimerais sincèrement remercier.

Tout d'abord, je souhaiterais remercier les membres de mon jury, M. Abdellatif Miraoui, M. Marc Petit et M. Hans Akkermans, d'avoir accepté de faire partie de mon jury de doctorat mais également pour leurs retours scientifiques très intéressants sur mes travaux. J'aimerais aussi remercier Raphaël Caire pour son encadrement et son soutien, qui a su me guider tout au long de ces trois années tout en me laissant la liberté de mener comme il me semblait bon mes recherches. J'ai été plus que ravie de participer au premier projet européen que Raphaël coordonnait, et au cours duquel il m'a accordé sa confiance en me déléguant de grandes responsabilités, ainsi qu'une mission plus qu'à la hauteur de mes espérances. Enfin, j'aimerais remercier Nouredine Hadjsaid pour nos discussions enrichissantes et pour son soutien tout au long de ma thèse.

Ma participation au projet européen DREAM a contribué à l'enrichissement de mes travaux, mais aussi de ma personnalité, au travers les nombreux échanges et collaborations avec nos différents partenaires. Je remercie donc sincèrement toute l'équipe de notre « DREAM team », constituée de tous les membres qui ont participé au projet. Ce fut un réel plaisir de pouvoir rencontrer et échanger avec autant de personnes spécialisées dans différents domaines, et une vraie découverte que de participer à l'élaboration de nouvelles solutions jusqu'à leur implémentation sur les démonstrateurs. Cette première expérience de projet international multi-acteurs m'a réellement plu et m'a permis de me découvrir de nouvelles envies en termes de perspectives professionnelles. Plus particulièrement, je tiens à remercier tous les membres de l'équipe de SEA à Milan, qui m'ont toujours accueillie avec enthousiasme, et qui m'ont donné accès à des parties de l'aéroport que je n'aurai jamais imaginé exister. Je tiens également à remercier Christophe Kieny, qui m'a accompagné dans le développement des solutions pendant toute la première année du projet, mais aussi Niki et Elisabeth, avec qui j'ai adoré travailler sur le projet et partager de bons moments aux quatre coins de l'Europe, ainsi qu'au G2Elab.

Et le G2Elab, parlons-en ! Comment aurais-je pu imaginer tout ce que j'ai vécu pendant ces trois ans lorsque je suis arrivée dans le bureau de Raphaël le premier jour de mon PFE... ? Le G2Elab, ça a été pour moi tellement de rencontres, tellement de découvertes et d'apprentissage, mais surtout tellement de sourires. Et pour ce dernier point, le premier prix revient à Sellé, qui a bien voulu encadrer mon PFE - au départ un peu par hasard-, qui a conforté ma certitude de vouloir faire une thèse et de vivre cette expérience unique, et qui a toujours su me redonner confiance. Avec lui, j'ai été fière de faire partie de l'équipe du prési, Gaspi, qui entre deux coups de téléphone et un déplacement, a toujours pris le temps de m'épauler et de me préparer des pizzas, en échange de quelques conseils de bon chasseur de cervidés. Et, dans la même lignée, je remercie Alex pour nos discussions sur le Ch'Nord et sur la montagne autour de quelques (seulement quelques) bières, Archie pour avoir endossé une bonne partie du rôle de hipster-bazu à ma place, Raph pour ses petites remarques bien placées qui m'ont

toujours fait bien rire, Victor pour cette passion pour la procrastination qui n'était finalement pas si avérée, Clémentine pour ses magnifiques tests de vols en hélicoptère, Aurélien pour tous les pays du monde et pour l'ouverture de l'antenne G2Elyonnaise, Fabien pour nos jeux de post-it d'humiliations et pour nos aprêms électro déguisés en poney, Audrey pour nos discussions sur la planète, les graines, le bio et le vélo sous la pluie, Jean-Louis pour les parties de Worms et d'échecs, Guillaume et Farshid pour nos pauses café bien méritées, Corentin et Stéphane pour nos repas toujours bien animés.

Je voudrais aussi remercier tous les permanents et personnels du G2Elab, jeunes ou moins jeunes, avec qui j'ai partagé quelques idées, des cafés, des repas, et même parfois des apéros. Et je pense notamment à Florent, Damien, Vincent, Antoine, et MC.

Je remercie également mes nouveaux co-bureaux de GreEn-ER, Geoffrey, Guillaume, Andres, Antony, Baoling, et Thibaut pour cette bonne ambiance qui a toujours régné dans notre cluster « volant », et par extension, Mélissa, Quentin, Thomas, Arnaud, et les collègues du 4<sup>ème</sup>, avec qui la Presqu'île était toujours plus sympa.

Je tiens à remercier les stagiaires que j'ai eu l'occasion d'encadrer pendant ma thèse, Amritbir, Carlos et José, avec qui les échanges étaient toujours faciles et intéressants, et dans la bonne humeur. J'espère avoir été à la hauteur de l'encadrement qu'ils espéraient.

Et puis, finalement, que serais-je sans ma famille et mes amis ? Si ma vie est si belle et si simple, c'est grâce à eux. Et puisqu'à mon avis, je ne rédigerai qu'une seule fois des remerciements tels que ceux-ci, je vais en profiter pour les remercier. Tout d'abord, je remercie mes trois copines du CPP, Lauréline, Julie et Magda, pour leur soutien et pour leur inaltérable confiance en moi jusqu'à me prendre pour une génie... ! Je remercie aussi mes copines de toujours, Vio et Evo, avec qui le ski a toujours été un réel plaisir, et la neige n'avait qu'à bien se tenir ! Enfin, je souhaiterai remercier tous mes colocs, Tedz, Guillaumus, Etienne, Bast, Rom, Sam, Nono, Paulux, Marie, Jéré la graine, Math, Kasia, Samitch', Martin, avec qui la vie a toujours été facile et agréable à Grenoble. Et par extension, j'étends mes remerciements à tous mes potes qui étaient présents à ma soutenance, et à tous ceux qui auraient aimé être là, mais aussi à tous ceux avec qui j'ai pu partager des supers moments pendant ces dernières années. Enfin, je remercie plus que tout mon pap', ma mam', mon frèrot Guillaume, et mon Clément, sans qui le 'Yon n'aurait pas eu assez de courage et de force pour devenir docteur, et n'aurait pas non plus l'envie de sourire tous les jours.

Allez, c'est maintenant à votre tour de tourner la page ! En vous souhaitant une bonne lecture.

---

# General Outline

---

<b>General Outline</b> .....	<b>7</b>
<b>Abbreviations</b> .....	<b>11</b>
<b>General introduction</b> .....	<b>13</b>
Problem statement .....	13
Contributions of the work and originality claim .....	14
Thesis outline.....	15
<b>Chapter I. Context and challenges</b> .....	<b>17</b>
I.1 Introduction .....	21
I.2 From actual networks to Smarter Grids .....	22
I.2.1 Power grids basic structure .....	22
I.2.2 Transition to the Smarter Grid .....	26
I.3 Electricity markets and mechanisms: the evolving roles of the electricity sector actors .....	34
I.3.1 Evolving roles of the market actors.....	34
I.3.2 Evolving roles of the bundled actors .....	40
I.4 Conclusion .....	46
<b>Chapter II. Towards distributed energy markets and mechanisms</b> .....	<b>47</b>
II.1 Introduction .....	51
II.2 Existing solutions for distributed control in distribution networks .....	52
II.2.1 Towards the distribution of intelligence.....	52
II.2.2 Existing network's components flexibility means .....	58
II.3 Toward distributed market mechanisms for the DSOs through the definition of a new distributed architecture .....	62
II.3.1. A distributed and autonomous architecture for local resources and network's components operation.....	62
II.3.2 Distributed balancing mechanisms and constraints management tools for the DSOs .....	68
II.4 Conclusion .....	74
<b>Chapter III. Innovative methodologies to support the DSO to act as a market enabler</b> .....	<b>75</b>
III.1 Introduction .....	79

III.2 Innovative tool for local technical validation of flexibility offers.....	80
III.2.1 Concerns and existing strategies.....	80
III.2.2 Introduction to fuzzy arithmetic .....	83
III.2.3 Validation of flexibility offers using fuzzy arithmetic .....	86
III.3 A DSO tool to support the operation of LV networks and the provision of LV flexibility offers	97
III.3.1 Getting an aggregated visibility on LV network constraints .....	98
III.3.2 Through the extension of the admissible voltage margins with LV flexibility offers .....	106
III.3.3 LV4MV architecture deployment .....	115
III.4 Innovative tool for the provision of flexibility offers for DSO constraints management at a minimum cost.....	117
III.4.1 DSO risk management and contingency analysis.....	117
III.4.2 Provision of remaining MV and LV flexibility offers for DSO constraints management, at a minimum cost .....	119
III.5 Conclusion.....	140
<b>Chapter IV. Innovative tools to support the DSO for network energy efficiency improvement .....</b>	<b>141</b>
IV.1 Introduction.....	145
IV.2 Minimization of the network losses.....	146
IV.2.1 State of the art and problem positioning .....	146
IV.2.2 Optimization problem formulation .....	149
IV.2.3 Examples of application.....	162
IV.3 Addition of the flexibility procurement cost in the problem formulation .....	174
IV.3.1 Modification in the problem formulation .....	174
IV.3.2 Examples of application.....	175
IV.4 Conclusion .....	181
<b>Final conclusion.....</b>	<b>183</b>
Scientific contributions of the research work .....	183
Further works .....	184
Contributions to the DREAM project .....	185
<b>References .....</b>	<b>187</b>
<b>Publications .....</b>	<b>199</b>

Conference papers.....	199
Project deliverables .....	199
<b>Annex AI. Loadflow tools methodology .....</b>	<b>201</b>
AI.1. Loadflow method for balanced systems .....	201
AI.2. Loadflow method for unbalanced systems .....	204
<b>Annex AII. Test networks data.....</b>	<b>207</b>
All.1. 33-nodes network (MV level) .....	207
1.1 Initial case: without any DG .....	208
1.2 Modified case: with DG insertion.....	210
All.2. 72-nodes network (MV level) .....	211
2.1 Initial case: without any DG .....	212
2.2 Modified case: with DG insertion.....	215
2.3 Re-indexed nodes: correspondence matrix.....	216
All.3. Applied load curves on MV level .....	217
All.4. 12-nodes network (LV level).....	219
3.1 Initial case: without any DG .....	219
3.2 Modified case: with DG insertion.....	221
All.5. ESR network (LV level).....	222
<b>Annex AIII. Complementary results of the local technical validation of flexibility offers .....</b>	<b>223</b>
<b>Annex AIV. Complementary results of the LV4MV process .....</b>	<b>227</b>
<b>Annex AV. Example of the LV4MV process for MV DSO risk management.....</b>	<b>231</b>
AV.1. Description of the considered LV network.....	231
AV.2. LV4MV process on the considered LV network for the two loading cases.....	233
<b>Annex AVI. Complementary results of the heuristic based provision process for DSO risk management .....</b>	<b>235</b>
<b>Annex AVII. Optimization methods details.....</b>	<b>241</b>
AVII.1. Meta-heuristic method: focus on the genetic algorithm.....	241
The selection of the individuals .....	242
The cross-over of the individuals.....	243
The mutation of the individuals.....	243

Constraints representation via penalization .....	244
Determination of the shutoff parameter of the algorithm .....	244
AVII.2. Exact method: focus on the Branch-and-cut algorithm.....	245
<b>Annex AVIII. Sensitivity threshold impact in the developed heuristic methods.....</b>	<b>249</b>
<b>Résumé en français .....</b>	<b>256</b>

# Abbreviations

---

ADA	Advanced Distribution Automation
ACER	Agency for the Cooperation of Energy Regulators
AMI	Advanced Metering Infrastructures
aRTU	Advanced Remote Terminal Unit
BRP	Balancing Responsible Party
CHP	Combined Heat and Power
CPU	Central Processing Unit
DER	Distributed Energy Resource
DFS	Depth First Search
DG	Distributed Generation
DNo cell	Distribution Network optimization cell
DR	Demand Response
DRES	Distributed Renewable Energy Sources
DSO	Distribution System Operator
DSM	Demand Side Management
EEGI	European Electricity Grid Initiative
EDSO	European Distribution System Operators
ENTSO-E	European Network of Transmission System Operators for Electricity
EPEX	European Power Exchange
ERGEG	European Regulators' Group for Electricity and Gas
ESR	Electricité de Strasbourg Réseau
EU	European Union
EV	Electric Vehicles
FCR	Frequency Containment Reserve
FRR	Frequency Restoration Reserve
HV	High Voltage
ICT	Information and Communication Technologies
ILP	Integer Linear Programming
IQCP	Integer Quadratic Constraints Programming
LV	Low Voltage
MAS	Multi-Agent System
MCP	Marginal Clearing Price
MILP	Mixed Integer Linear Programming
MINLP	Mixed Integer Non Linear Programming
MIQCP	Mixed Integer Quadratic Constraints Programming
MISOCP	Mixed Integer Second Order Cone Programming
MV	Medium Voltage
NICT	New Information and Communication Technologies
OLTC	On Load Tap Changer
OTC	Over-The-Counter
p.u	Per unit
PV	Photovoltaic
r.m.s.	Root Mean Square



RT	Real-Time
RR	Restoration Reserve
RTU	Remote Terminal Unit
SGAM	Smart Grid Architecture Model
TSO	Transmission System Operator
VPP	Virtual Power Plant
VVC	Volt VAr Control

# General introduction

---

Since two decades, European electrical networks are facing new challenges due to several factors such as power industry restructuring, unbundling of energy services and incentives in renewable energy sources. In addition, the democratization of Information and Communication Technologies (ICT) has impacted the technological and digital transformation of the power industry.

Traditionally, the organizational schemes were based on monopoly situations. Indeed, the high costs of deployment and maintenance of the electrical infrastructures have been favorable to vertically integrated utilities for production, transmission and distribution of electricity. This organization was allowing the system operators to guarantee the security and the reliability of their grids while searching its optimal operation.

The liberalization of the European energy market that started in Europe with the directive EC 92/96 [EC-96] led to the introduction of competition into the power industry, especially at the level of the wholesale market and gradually at the retail market side. All the new emerging unbundled actors can now participate in electricity trades depending on their own strategies. Transmission and distribution system operators have to ease these energy exchanges while preventing discrimination and guaranteeing a fair access to the grid to all participants.

In parallel and in line with the growth of environmental and sustainable awareness, the European Union has adopted a large number of directives targeting energy savings, increase of the proportion of renewable energy resources, and reduction of the greenhouse gas emissions.

## Problem statement

These main concerns have implied the introduction of a large amount of high variable renewable sources into the generation mix, and have induced an important need of flexibility in the electrical networks to preserve the system stability at different time horizons. More particularly, due to regulatory incentives and subsidies that have been established for environmental concerns, investors and particularly end users are now encouraged to install small-scale distributed generations. The need for flexibility is even more significant especially at local levels, in order to ensure an optimized and efficient operation of distribution grids (including microgrids situations).

Improved network capacity management is thus required in order to maximize sustainable generation in the most economical way for the whole society, while maintaining network stability and reliability. Whenever it is a cost-effective and stable alternative to reinforcement's solutions, this capacity management can be increased via the operation of controllable sources and loads, allowing the grid to be more flexible at both demand and supply sides. If such solutions turn out to be more cost-

effective and do not compromise security of supply and quality of service, grid operators should be able to postpone and even reduce their investments for capacity upgrading of the grid thanks to flexibility management solutions.

In the actual situation, these flexibility opportunities are used at national level for Balancing Responsible Parties (BRPs) portfolio optimization, for balancing mechanism and for transmission contingency management. With the increasing interconnection rate of Distributed Energy Resources (DERs), more and more flexibility opportunities are available in distribution systems, which have to be transmitted up to the transmission level.

The electricity system actor's roles and responsibilities need to evolve. New tools should be elaborated in order to permit the DSOs to better operate their network, as well as to allow better interactions between Distribution System Operators (DSOs) and other stakeholders, such as Transmission System Operators (TSOs). In a context where all unbundled actors are dealing with an increasing number of local flexibility opportunities, the DSOs have to play locally a new key role. They should try to give a complete access to markets to all distributed end users and enable the transmission of local flexibility offers in the national energy exchanges places, while guaranteeing acceptable network operation conditions and ensuring the quality of supply to their customers. To allow this paradigm, the underlying New Information and Communication Technologies (NICT) architectures have to be as well re-defined.

## **Contributions of the work and originality claim**

A coordination infrastructure is needed in order to integrate in the best economical and technical way the large amount of DERs interconnected in the distribution grids. Existing grid flexibility resources such as OLTC transformers, capacitor banks and switching components can be adequately operated, as well as new emerging DERs flexibility means, for improving network energy efficiency while ensuring stability and reliability of the grid. However, in addition to their large number in the distribution system, all these flexible resources have decision variables and constraints of different natures. This makes the coordination very complex and combinatorial, leading to a NP-hard problem that cannot be optimally solved in a polynomial time.

Another scientific challenge that has to be tackled is linked to the stochastic nature of the considered variables. Indeed, the highly variable productions of the renewable DGs are adding many uncertainties in the overall coordination of the system. Moreover, some uncertainties on the availability of the considered flexibility offers have also to be taken into account, in order to avoid unexpected critical situations.

The already in place devices and exploited tools are a technologic barrier that has to be as well overcome. The developed algorithms and tools will thus have to be suitable with the already deployed network infrastructure, but also easily accessible for the DSOs and eligible for the different energy sector

stakeholders. Finally, in the same philosophy, the developed tools will have to fit with the already existing European market structure.

In this context, this PhD work is proposing a new distributed coordination of local resources and grid components control, tackling the introduction of local balancing mechanisms and network management functions for the DSOs. A new local market architecture is also investigated, which permits the design of these new DSO flexibility services.

More particularly, the developments presented in this thesis are the following:

- ✓ The instauration of local intelligence via a multi-agent system that will enable functionalities to be distributed within the network, allowing an autonomous architecture for local resources and network's components operation.
- ✓ The design of different network areas based on the objectives of the implemented functions and on the available flexibility resources in the network, ensuring the global optimality of the solution found.
- ✓ The design of a new local market architecture, facilitating the access to the market for distributed flexible end users. This architecture is based on the proposed distributed communication structure and takes into account the existing processes in the current European liberalized energy markets.
- ✓ The development of solutions to help the DSOs to validate the distributed flexibility offers that are proposed in the market, ensuring that these power exchanges are not endangering the overall network operation, taking into account its associated uncertainties.
- ✓ The introduction of new methodologies for short-term local risk management and contingency analysis for the DSOs. Several methods with different computational requirements and complexity are developed, dealing with near real-time remaining flexibility opportunities that have not been selected in the market processes.
- ✓ The development of a distributed advanced function for the DSOs in order to increase network performance while minimizing the network losses with the possible use of OLTC transformer, capacitor bank at the primary substation, reconfiguration and reactive and active powers control of the flexible DERs.

## **Thesis outline**

The PhD thesis outline is developed as follow: in the first chapter, the context of the distribution networks and the new challenges they have to face are presented. The overall processes of European

electricity markets are also described, as well as the new evolving roles of the different electricity system actors.

The assumptions of the new heterarchical distributed architecture allowing the introduction of local balancing mechanisms and network management functions are presented in the second chapter. This new structure is developed with a bottom-up approach in order to limit data transfers among the entire considered distribution network.

The developed tools to support the DSOs to act as a market enabler are then described in the third chapter. Some solutions to help the DSOs to give a wider access to end users to the energy markets are presented, via the technical validation of flexibility offers at the distribution level before their transmission to the upper voltage level and via a better consideration of the Low Voltage (LV) flexibility resources. In a second step, some solutions for near real-time distributed risk management and contingency analysis are investigated to help the DSOs to anticipate the operation of their network.

Finally, innovative tools to support DSOs for network energy efficiency improvement are proposed in the fourth chapter. Some distributed solutions are proposed in order to optimize the network losses while considering all the available flexibility resources, including remaining flexibility offers that have not been selected during the market processes and mechanisms.

# Chapter I.

---

## Context and challenges

*The first part of this chapter describes the classical power networks structures and the reasons that encourage electrical grids to become Smart(er) Grids. In the second part, the overall processes of European electricity markets and mechanisms are presented, as well as the new evolving and challenging roles of the regulated and deregulated European electricity system actors*

<b>Chapter I. Context and challenges.....</b>	<b>17</b>
I.1 Introduction .....	21
I.2 From actual networks to Smarter Grids .....	22
I.2.1 Power grids basic structure .....	22
Bulk generation.....	23
Transmission network.....	24
Distribution network.....	25
I.2.2 Transition to the Smarter Grid .....	26
New challenges in the electrical system .....	27
Distributed Generation impact.....	28
Deployment of communicating smart devices.....	31
I.3 Electricity markets and mechanisms: the evolving roles of the electricity sector actors .....	34
I.3.1 Evolving roles of the market actors.....	34
Overview of organized energy markets .....	35
The new role of the suppliers: Balancing Responsible Parties .....	36
The emerging sources of flexibility and associated semantic .....	37
The introduction of a third party: the aggregators and the VPP .....	39
I.3.2 Evolving roles of the bundled actors .....	40
Balancing and ancillary services markets .....	40
The emerging challenge of the capacity market .....	41
The evolving roles of the TSOs and the DSOs.....	42
I.4 Conclusion .....	46

---

---

**Table of figures**

Figure I-1 - Power networks basic structure .....	22
Figure I-2 - Generation mix repartition in ENTSO-E member TSO's countries in 2013 and 2014 [EUR1-15] .....	23
Figure I-3 – Characteristics of the different types of frequency control reserves [BURN-13] .....	24
Figure I-4 - Physical energy flow values in GWh in 2014 in the ENTSO-E area [ENTS-15] .....	25
Figure I-5 - Length of power lines per voltage level managed by DSOs in Europe in 2013 [EUR1-13] .....	26
Figure I-6 - Common generation technology types connected to the distribution network [EUR2-13] .....	28
Figure I-7 – Evolution trend of the cumulative DG capacity power connected to the ENEL distribution grid [ABB-16] .....	29
Figure I-8 - Evolution of installed DG capacity connected in Enedis network [ENED1-15].....	30
Figure I-9 – HV/MV sections where reverse power flow from the MV side towards the National Grid occurred in ENEL distribution grid [ABB-16].....	30
Figure I-10 – Most important Smart Grid investments according to the European DSOs in 2014 [EUR1-14] .....	32
Figure I-11 – Wide-scale roll-out of smart metering by 2020 in the different EU countries [EC-15] .....	33
Figure I-12 – Overview of organized energy markets timeframe .....	35
Figure I-13 – Procurement of energy blocks by a BRP in the different energy markets .....	37
Figure I-14 - Share of firm production and load shifting capacity participating in balancing mechanisms directly connected to the distribution network operated by Enedis in 2015 [ENED2-15] ....	39
Figure I-15 – Status of capacity remuneration mechanisms in Europe in 2015 [EY-15].....	42

---





## I.1 Introduction

The context of European electrical networks has evolved significantly during the last 20 years. These systems were originally designed to carry electricity from large generation power plants to end users in a secured, economical and efficient way. They are now facing new challenges encompassing technical, economical, regulatory and sociological issues.

The liberalization of the European energy market in 1996 [EC-96] has contributed to the unbundling of the different electrical segments. The opening of competition between European electricity actors led to the emergence of many new stakeholders. In parallel, the growth in environmental and energy awareness is driving some evolutions in the electrical grids. The new engagements adopted in the Kyoto protocol in 1998 [UNIT-98] headed to new European and national directives defining new objectives on energy savings, on the proportion of sustainable energy resources production and on the greenhouse gas emissions reduction. This encouraged the introduction of more and more renewable generators into the grid. The large integration of variable renewable sources in the generation mix induces an important need of flexibility at all levels and scales.

These main evolutions also led to a high increase of local distributed producers in the distribution grid. This situation has further highlighted local power system inadequacies and has pointed out for an increasing need of flexibility at more restricted levels for local network operation.

Today, it is necessary to think about new structural and operational solutions for the planning and for the operation of the future power networks, in order to manage them more efficiently but also to continue to guarantee and even improve security, reliability and quality of supply to the customers. To enable these new strategies, actual distribution networks have to be adapted to become active networks. New Information and Communication Technologies (NICT) are regarded as increasing opportunities for better grid observability and controllability. Overall, distribution networks are encouraged to become Smart(er) Grids.

Since the liberalization of the energy sector, the different market players can participate in electricity trades with different strategies. With the increasing need of flexibility emerging in the power system, the roles of the involved actors in the electricity sector are evolving and more and more data have to be exchanged for the optimal operation of the network. More particularly, the system operators have to play a key role, in order to ensure fairness and non-discriminatory market access, but also to continue to guarantee system stability and security of supply.

The first part of this chapter describes the classical power networks structures and the reasons that encourage electrical grids to become Smart(er) Grids. In the second part, the overall processes of European electricity markets and mechanisms are presented, as well as the new evolving and challenging roles of the regulated and deregulated European electricity system actors.

## I.2 From actual networks to Smarter Grids

Power networks were built at the beginning to guarantee the demand/supply balance economical optimum by carrying electricity from the large generation power plants to end users. They are, since approximately 20 years, undergoing tremendous changes because of new arising challenges, mainly driven by the opening of the energy market and by the new environmental policy incentives. These caused the multiplication of the electricity sector actors and the large growth of the decentralized generation, leading to some power system inadequacies and technical/economical concerns that have to be addressed. In this part, the power networks basic structure is firstly introduced. Then, the new emergent challenges which are encouraging the transition from actual network to Smart(er) Grids are presented in detail.

### I.2.1 Power grids basic structure

Power grids have been built to transfer the electricity from generation power plants to end users while guaranteeing robustness and the best possible efficiency. To limit technical losses, the best economical solution is to transport electricity at very high voltage level. Therefore, the electricity is carried at different voltage levels: at high voltage levels for large power flows over long distances, and then at lower voltage levels down to the end users connections. The basic structure of power networks is shown in Figure I-1.

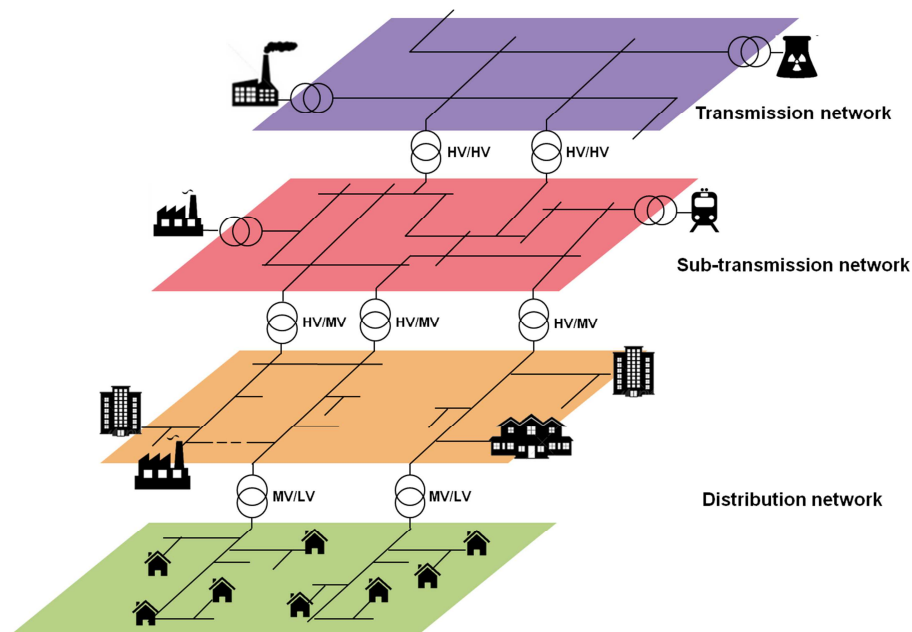

Figure I-1 - Power networks basic structure

As it is represented in the Figure I-1, power networks are generally composed of different parts which have specific characteristics and distinct voltage levels. There are described more in details in the following sections.

## Bulk generation

The electrical system slowly converged to a vertical architecture where the electricity production is generated by large generators which are connected to the transmission network through step-up transformers. These primary sources of energy are usually fossil, nuclear and hydro power plants, but they can also be off-shore wind farms or large scale solar power plants. Figure I-2 presents the evolution of the generation mix in ENTSO-E (the European Network of Transmission System Operators for Electricity) member TSO's countries between 2013 and 2014.

### Generation mix repartition in ENTSO-E member TSO's countries

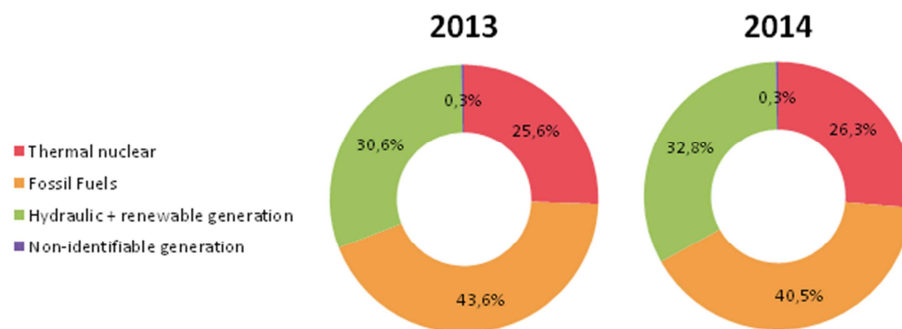

*Figure I-2 - Generation mix repartition in ENTSO-E member TSO's countries in 2013 and 2014 [EUR1-15]*

The percentage values in Figure I-2 are computed with respect to the total generated powers in the considered countries over the two years, which are respectively 3355 TWh in 2013 and 3261 TWh in 2014. Figure I-2 illustrates the fact that there is more and more hydraulic and renewable generation in the European generation mix while fossil fuels generations are tending to decrease. A large part of renewable power plants are hardly predictable because their power generations depend directly on the weather conditions. With the growing share of renewables, the demand/supply balance becomes harder to ensure, and though the stability of the entire grid is more complicated to safeguard.

The entire network stability is mainly ensured by the control of the large power plants connected in the transmission system, through frequency control. Different frequency reserve mechanisms enable, with different time constants, the balance between production and consumption to be ensured, while sharing the repartition of the reserves between the different power plants. These reserves are sized in order to stabilize the system in case of any imbalance. The characteristics of the different types of frequency control reserves are presented in Figure I-3.

	Activation	Full activation Time (Max. time for full activation)
FCR	Automatic	< 30 seconds
aFRR	Automatic	< 5 minutes
mFRR	Manual	< 15 minutes
RR	Manual	< 1 hour

*Figure I-3 – Characteristics of the different types of frequency control reserves [BURN-13]*

After a disturbance, the Frequency Containment Reserve (FCR) is activated to stabilize the frequency at a steady-state value within the permissible maximum steady-state frequency deviation. The frequency restoration process brings back the frequency towards its set point value by the activation of the Frequency Restoration Reserve (FRR) and replaces the activated FCR. Finally, the Replacement Reserve (RR) replaces the activated FRR, but it can also support the FRR activation.

### Transmission network

The transmission network transfers electric power from the largest generating units to the distribution system. It permits to transmit electricity over large distances at very high voltage levels reducing the copper losses. The European typical voltage levels of the transmission network range between 150kV and over 400kV. In order to ensure its robustness, the transmission network is operated as a meshed system. The operational procedure of this system follows generally some rules, such as the N-1 rule [HAD1-13], which ensures that the power system is always operated with sufficient safety margins in order to withstand any single fault events that could impact the entire considered power system. Given its size and its power amount, power flow optimization and network operation are very complex: a large number of remote monitoring, control and protection devices are deployed to secure and oversee the whole system.

In Europe, the transmission network allows energy and capacity exchanges between the various operators through interconnections for improved reliability and economy. The ENTSO-E (European Network of Transmission System Operators for Electricity) is connecting 41 TSOs from 34 countries across Europe. ENTSO-E's overall objective is to promote the reliable operation, the optimal management and the technical evolution of the European electricity transmission system in order to ensure security of supply and to support the implementation of EU energy policy [ENTS-15]. Figure I-4 shows the ENTSO-E country members and their physical energy flow values in GWh through their cross-frontier transmission lines.



Figure I-4 - Physical energy flow values in GWh in 2014 in the ENTSO-E area [ENTS-15]

When coming closer to the distribution network, the voltage levels are gradually adapted down to the regional transmission network (150kV) and HV distribution (or sub-transmission) network (110kV in Germany, 90-63kV in France). These types of networks are usually also operated in a loop structure.

## Distribution network

The electricity is transferred to the local MV distribution networks through step-down transformers (voltage generally between 10kV and 50kV) and finally to LV distribution networks (230V/400V). Even if most of MV networks are planned looped or meshed, they are usually operated in radial topology in order to simplify protection schemes and to reduce short-circuit currents. It means that there is a unique supply-route coming down from the primary substation (HV/MV transformer) to every consumer.

European distribution networks are made of around 10 million km of power lines and are delivering electricity to 260 million connected customers of whom 99% are residential customers and small businesses [EUR1-13]. Figure I-5 represents the length repartition of lines per voltage level managed by several European DSOs. It shows that in every country, the large majority of the power lines operated by the DSOs are in LV level. Urban and rural distribution networks have different characteristics: while urban areas are characterized by a high density of loads and a relatively high demand which require many equipment (transformers, cables, lines...), rural areas are characterized by a large geographical coverage and a low density of loads which are fed by longer lines with high network impedances.

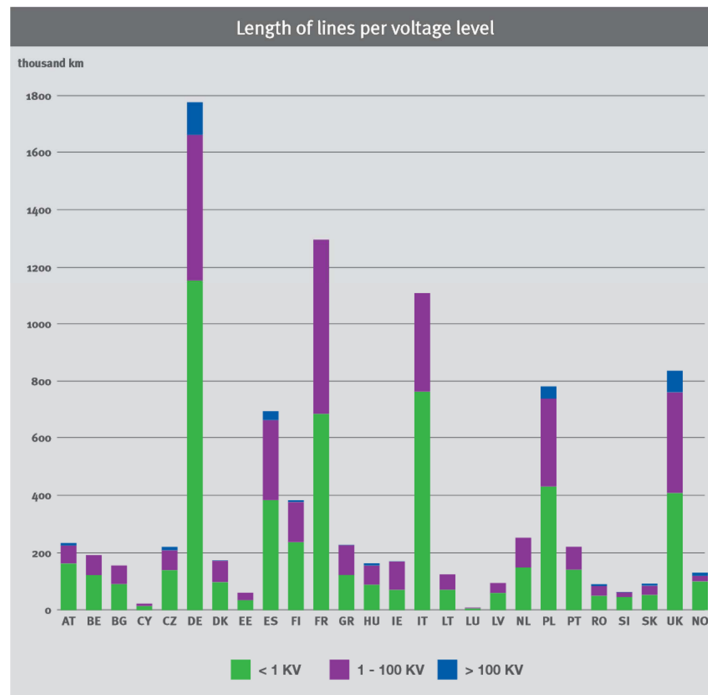

Figure I-5 - Length of power lines per voltage level managed by DSOs in Europe in 2013 [EUR1-13]

European DSOs have a wide diversity of businesses, sizes of operational areas, numbers of connected customers and network characteristics. However, DSOs have all to provide a good level of security, reliability and quality of supply to their customers. This includes, among others functionalities: control, monitoring, supervision and outage management. They are in charge of developing their network, and of designing new lines and transformers. They have to ensure the power delivery to existing connections to customers, and to ensure the connection of new loads and new distributed productions.

There are around 2400 electricity distribution companies in Europe which have to find the most efficient way of delivering energy through their network. Meanwhile, they have to cope with the new changes and challenges that are arising due to the opening of the energy market, and to the new environmental policy incentives.

### I.2.2 Transition to the Smarter Grid

Power system networks are now facing new challenges and evolutions, that have a significant impact on the planning and the operation of both transmission and distribution networks. With the opening of the energy market and because of new environmental policy incentives, new actors are appearing in the electricity system and particularly hardly-predictable sustainable energy producers. Since few years, a large increase of distributed generation in distribution networks has been observed, resulting in some needs in the distribution network operation. In parallel, the deployment of new

communicating devices in distribution networks permits all the actors to get communication and information exchanges, and so, a better vision on their operating systems. All these modifications and evolutions have to be considered in the new technical and economical frameworks of the Smart Grids.

### **New challenges in the electrical system**

European power system networks have been developed since the beginning of the 20<sup>th</sup> century following monopoly situations, where large national entities were managing the production, the transmission and the delivery of electricity. In 1992, the European commission expressed an explicit interest in the establishment of an internal energy market, with the formalization of a regulatory framework for the creation of the internal electricity and gas market [GUIB-89]. It was only in 1996 that the European Directive 96/92/EC [EC-96] relative to the liberalization of the energy sector led to the opening of the energy market. This contributed to the opening of competition between European electricity actors, to the unbundling of the different electrical segments (e.g. production, transmission, distribution), and to the emergence of new actors. According to later European directives [HEDD-07], markets for all non-household electricity customers have been liberalized in July 2004. For private households, the deadline was July 2007 [EC-07]. After these two dates, businesses and private customers have been able to choose their power and gas suppliers freely in a competitive market.

In addition, the households and services demand of electricity has steadily risen in Europe since 2004 [EUR2-15] due to the increase of house loads (e.g. air conditioning, electrical heaters and boilers, computers, among others) but also to the development of new usages (e.g. electrical vehicles, heat pumps). Actual distribution power networks will, at some point, reach their sizing limits because of this continuous increase of consumption as well as change of consumption patterns. The largest part of European power infrastructures have been built between 1960 and 1980 and designed for traditional peak consumption periods. Because of investments costs concerns, the majority of grid components such as lines, cables and transformers are becoming aged and are even more ageing when they are operated close to their nominal power load because of thermal stress, but also when large voltages fluctuations are occurring. With the development of new usages and the changes in the energy consumption, large power flows and important voltage fluctuations might occur more frequently, and might have an even worse effect on the network components.

Besides this, in order to face the causes of climate changes and to respect its engagements with the Kyoto protocol [UNIT-98], the European Union has adopted a large number of directives that are targeting energy savings and an increased use of renewable energy sources. This implies new objectives on energy efficiency, on the proportion of sustainable energy resources production and on the greenhouse gas emissions reduction. For example, in 2009, the 2020 package [EC-08] was set to ensure that the EU meets its climate and energy targets for the year 2020. The package defines three key targets: a 20% cut in greenhouse gas emissions (from the levels registered in 1990), 20% of the EU energy from renewables and 20% improvement in energy efficiency. A few years later, the 2030 climate



and energy framework [EC-14] reviewed the 2020 climate and energy package and redefined the new targets for the year 2030: At least a 40% cut in greenhouse gas emissions (from the levels registered in 1990), a 27% share for renewable energy, and a 27% improvement in energy efficiency. This new roadmap has been adopted by EU leaders in October 2014.

Other national directives have been also adopted in the different European countries, with the aim to succeed to reach these European objectives. This results in causing a large increase of sustainable energy sources and reducing fossil fuels dependency. More particularly, these new policy incentives are also inducing the large increase of integration of Distributed Generations (DGs) in the distribution networks. Because of the generally hard predictability of this type of energy sources, their integration in the distribution network is becoming really challenging, and the spatio-temporal correlation with the consumption has to be addressed.

### **Distributed Generation impact**

Distributed Generation (DG) refers to all the small power generating plants connected to the distribution network at the different voltage levels [HAD2-13]. The primary sources of energy for DG are generally renewable sources as hydro, wind, photovoltaic, geothermal or biomass, but can also be fossil fuels sources such as for the Combined Heat and Power (CHP) plants. An overview of generation types connected at the different distribution voltage levels is presented in Figure I-6.

Usual connection voltage level	Generation technology
HV (38-150 kV)	Large industrial CHP Large-scale hydro Offshore and onshore wind parks Large PV
MV (10-36 kV)	Onshore wind parks Medium-scale hydro Small industrial CHP Tidal wave systems Solar thermal and geothermal systems Large PV
LV (< 1kV)	Small individual PV Small-scale hydro Micro CHP Micro wind

*Figure I-6 - Common generation technology types connected to the distribution network [EUR2-13]*

Since approximatively 20 years, the opening of the energy market and the sustainable awareness has boosted the rise of DG interconnections in both MV and LV networks. Indeed, every local producer can now sell his electricity to the buyers through energy market platforms. Moreover, due to commercial incentives and subsidies that have been established for environmental concerns by European governments, investors and particularly end users were encouraged to install small-scale DGs. Last but not least, the technological progresses of DGs make it more and more attractive for owners, with increasing productivity and decreasing purchase and operational prices.

To illustrate this rise of DG penetration, Figure I-7 shows the trend of the evolution of the cumulative DG capacity power connected to the distribution grid managed by Enel Distribuzione, the largest Italian DSO.

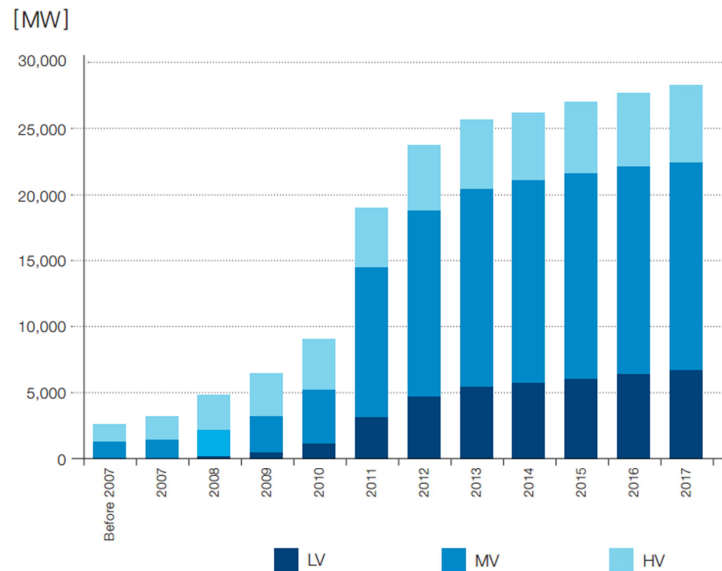

**Figure I-7 – Evolution trend of the cumulative DG capacity power connected to the ENEL distribution grid [ABB-16]**

In this distribution grid, and generally all around Europe, the DG penetration in LV level represents more than 80% of the DG penetration [ENEL-13]. However, as observed in Figure I-7, the generation power capacity in MV level is representing around 80% of the total distributed generation power capacity. This can be explained because MV generation plants are more powerful than the LV ones.

Another example is depicted in Figure I-8, which represents the evolution of connected DG capacity connected in Enedis (ex ErDF) network, the largest DSO in France. The installed DG capacity is steadily increasing since a few years, and particularly the capacity of PV power plants.

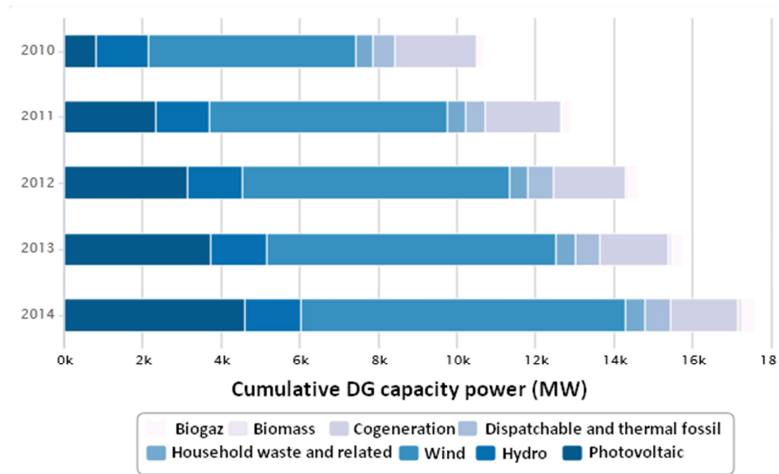

Figure I-8 - Evolution of installed DG capacity connected in Enedis network [ENED1-15]

Due to the large integration of DGs all over the distribution networks, the power delivery system has been changed gradually from a downstream unidirectional scheme to a more and more bidirectional scheme, because of reverse power flows that can occur. Indeed, as it is illustrated in Figure I-9, the percentage of HV/MV sections operating in reverse flow conditions at least 1% of the year has increased from 9% in 2010 to 32% in 2014 in the Italian ENEL distribution system. Reverse power flows imply a risk of uncontrolled islanding mode in the distribution grid, which can lead to circuit protection scheme problems.

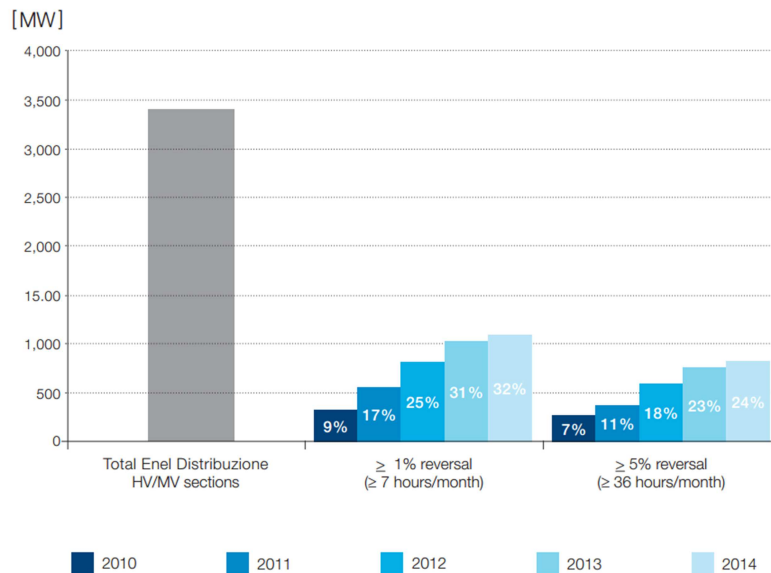

Figure I-9 – HV/MV sections where reverse power flow from the MV side towards the National Grid occurred in ENEL distribution grid [ABB-16]

Hence, the integration of DGs creates significant technical and economic challenges for transmission and distribution system operators, and particularly due to DGs production profiles and locations. Indeed, DG production is usually hardly controllable, highly variable and not always correlated in time and in space with local consumptions. During certain hours, the large amount of DG connected to the distribution network could improve the network operation, producing near the consumption and though reducing the need of network capacity for transmission over long distances. However, the need to design the distribution systems for peak load remains undiminished because of the generally non-coincident time periods of local production and consumption. It may often need more reinforcement at both distribution and transmission levels.

Because many of these productions are derived from intermittent and local energy sources, such as wind and sun, it offers less flexibility to control or schedule than usual controllable energy sources. Adequate structural solutions are proposed to solve these emerging capacity problems, such as grid reinforcement leading to new investments to get a higher network capacity, or by following new advanced planning rules that can avoid these problems in future networks [ALVA-09], [GOUI-15]. Operational solutions can also be associated with these structural solutions, in order to transform the distribution grids into active and smart(er) networks, and to limit overloads and other physical constraints violations.

In order to face these new trends and modifications, actual power networks have to be adapted and DSOs need to be able, today, to actively manage and operate their networks. These changes are going along with the evolution of actual electrical networks to the new Smart Grids. Moreover, the deployment of New Information and Communication Technologies (NICT) in power systems permits the interoperability of the networks and the coordination capacity of the DSOs to be increased.

### **Deployment of communicating smart devices**

In order to enable new strategies dealing with flexibility resources of the grid, distributed generators and flexible loads, as well as state of the network and power flows values, should be monitored and controlled. Actual distribution networks have to be adapted and seizing NICT opportunities have to be increased, permitting these communication and information exchanges. The development of reliable Smart Grid has to be in line with the deployment of communicating smart devices.

As Figure I-10 shows, the most important investments for developing Smart Grids according to the European DSOs, are network automation and communication as well as smart metering. This can be explained by the fact that if network automation, communication and monitoring are not deployed, the proposed solutions strategies and the overall global control could not be implemented.

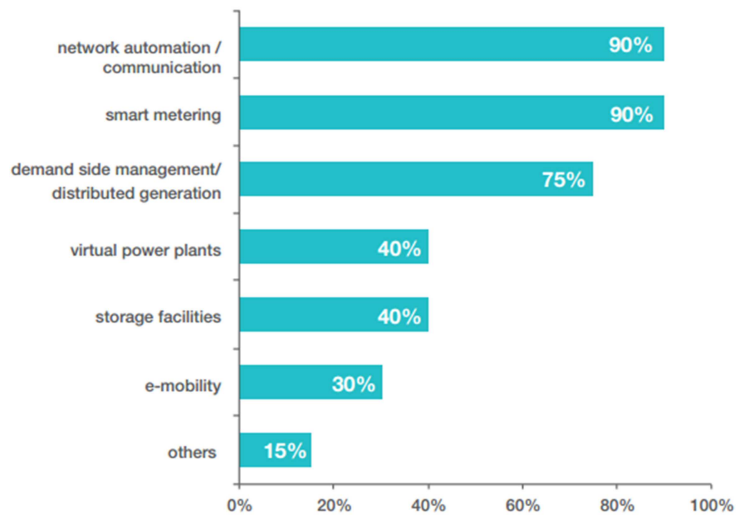
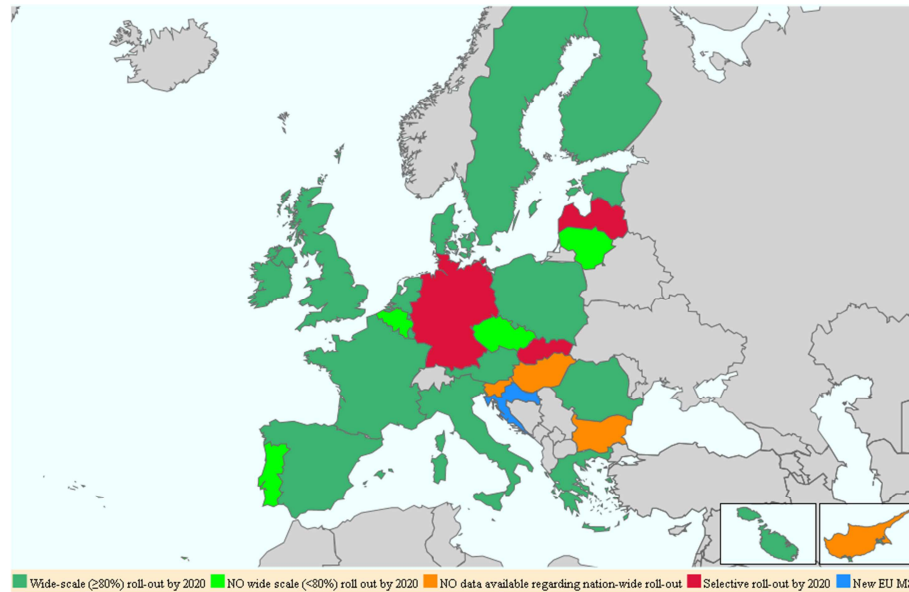

*Figure I-10 – Most important Smart Grid investments according to the European DSOs in 2014 [EUR1-14]*

Several types of smart devices are still in deployment in distribution networks, in order to increase the efficiency of the operation but also to ensure and improve communications between the several actors of the electricity sector. Smart devices include line sensors, smart meters, synchrophasors, transformers, fault interrupters, power control modules, remote terminal units (RTUs), in home controllers and many more. Through monitoring, automation and remote control, the DSOs could manage either in a centralized or in a decentralized way, the overall network operation.

More particularly, smart meters are currently deployed in end users facilities in order to support the DSO network operation. A smart meter records consumption of electric energy in intervals of an hour or less and communicates this information to the supplier through the DSO at least daily for billing concerns. This device is also generally able to measure in real-time its voltage magnitude at its connection point, as well as the consumed active and reactive power. Hence, the intensive deployment of smart meters could allow the DSO to better monitor their distribution networks and to identify the areas where constraints are often violated.

EU member states are required to ensure the implementation of smart metering in the Third Energy Package. This implementation was subjected to a long-term cost-benefit analysis. In cases where the analysis was positive, a roll-out target of 80% market penetration for electricity by 2020 is set for the country. Figure I-11 highlights the concerned European countries in this case. By 2020, it is thus expected that almost 72% of European consumers will have a smart meter for electricity (around 200 million smart meters).



*Figure I-11 – Wide-scale roll-out of smart metering by 2020 in the different EU countries [EC-15]*

The increased DG penetration poses not only a balancing challenge, but also a local network operation defey. Indeed, the security and the hosting capacity of the distribution system are mainly depending on the voltage constraints and the physical current limits of the network. DG penetration can locally emphasize system unbalance, voltage deviations and current congestions in certain cases. These new arising problems highlight an increasing need for new grid planning and operational solutions. Grid reinforcement is one of the mainly DSOs chosen solution, even though some of constraint deviations can happen in some lines only few hours per year. With the large amount of existing and projected DGs interconnections, this solution could become very expansive in the long-term. Other structural and operational solutions should emerge in line with this context in order to help the DSOs to optimize their network efficiency. The deployment of NICT in distribution networks can help the integration of these new solutions, and permit a better observability and interoperability of the networks.

Finally, with the increasing need of flexibility emerging in the power system due to the large integration of variable renewable generations, the electricity actors should have new defined responsibilities dealing with flexibility procurement, flexibility validation, flexibility exchanges and flexibility uses. Therefore, the different roles of the electricity sector actors have also to evolve. These evolutions are discussed in the next section.

## **I.3 Electricity markets and mechanisms: the evolving roles of the electricity sector actors**

Since the liberalization of the energy sector and the opening of the energy market, the different electricity market players can participate in electricity trades. Since 2007, businesses and private customers are able to choose their power and gas suppliers freely in a competitive market [EC-07]. Energy products are traded and exchanged in a deregulated system, within certain regulatory constraints such as competition and market rules. Activities such as production, supply, trade, sales, and metering (such as in UK among others, for example) are competitive.

However, physical power flows are exchanged through the same physical electrical networks which are operated by TSOs and DSOs, in a regulated system. Physical electricity flows are circulating in transmission and distribution networks within certain technical limits.

The natural monopolistic activities must be separated from the other activities in order to prevent discrimination and to guarantee fair access to the grid. Within the electrical sector, some activities based on natural monopolistic situations, and some other activities based on competitive markets, have to be carried out simultaneously while staying decoupled. Indeed, the two systems are highly related and interactions between them should be handled to ensure the operation of the whole electricity system. Within this context of separation between commodity trades and network operations, the roles and strategies of the electricity actors are continuously evolving [WER1-05]. European commission is thus adapting and consolidating legislations with the aim to improve the overall operation of the energy market.

### **I.3.1 Evolving roles of the market actors**

In electricity markets, two forms of commercial activities are possible: bilateral transactions called OTC (Over-The-Counter) and transactions in organized market places. The majority of energy is traded via bilateral transactions, which are contracts made directly between suppliers and purchasers of electricity.

In organized energy markets (also called pools or wholesale markets), offers and requests meet through a system where sellers and buyers do not know each other. This system is called the power exchange or market place. In this type of system, the sale prices are determined by a mechanism based on the Marginal Clearing Price (MCP) [HAD1-13]. Supply and demand offers are sorted into a merit order list: from the less expensive one to the more expensive one for the supply (concerning the producers) and from the more expensive one to the less expensive one for the demand (concerning the customers). The sale price or market price is corresponding to the intersection of this two merit order lists. This intersection point is corresponding also to the quantity of energy that has been selected. All the producers which propose energy blocks at a price below or equal to the MCP are selected. In the same

way, all the buyers who have a price offer higher or equal than the MCP are selected. The price of the MWh is set for all the selected participants at the price of the last MWh that is included in the selection process. The basic MCP is established without taking into account the physical constraints of the network. Mechanisms of flow-based capacity allocation are now initiated in Europe in order to get a better price convergence between the different market zones, providing a better level of reliability and stability of the entire grid [CWE-14].

## Overview of organized energy markets

The wholesale markets address the trading of bids of energy to be delivered over several years-long, to several hours-long (block bids), and in some cases to 15 minutes-long (quarter bids) periods. They can be ranked according to their timing. In the long term, electricity can be traded on forward electricity markets. In the short term, electricity can be traded on the day-ahead (also called spot market) and on the intraday markets. An overview of a simplified timeframe can be seen in Figure I-12.

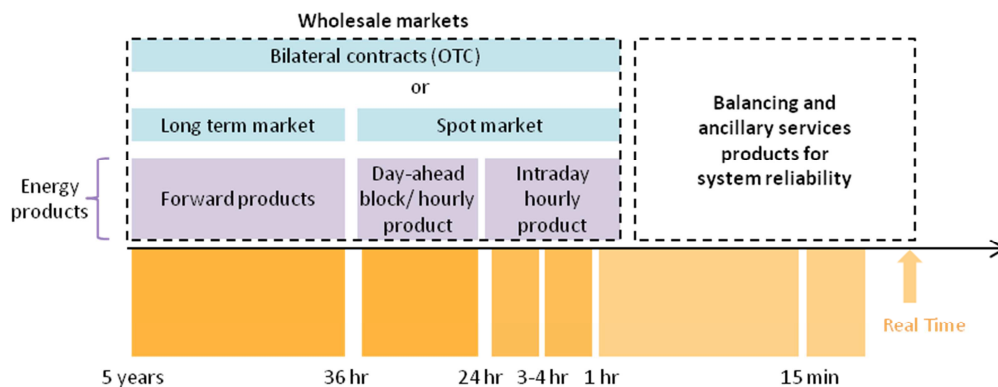

*Figure I-12 – Overview of organized energy markets timeframe*

In the forward markets, for both medium term and long term, the base load energy products are usually exchanged. Forward markets reduce risks for all the actors of the market, since they reduce the quantity of energy that trades at the more volatile spot price. Thanks to these markets, all the market players can already be in a more balanced position at the opening of the spot market [AUSU-10].

The day-ahead market is held the day before the actual operation of the system on the basis of standardized hourly schedules. Energy is negotiated for a provision 24 hours ahead, and transactions are based on hourly or half-hourly products. The market sets a spot price that reflects the production-consumption balance in the short term without considering network constraints and before the adjustment carried out by the TSO. The participants involved in this market are committed to inject or extract quantities of electricity at the time stipulated by the contract. In Europe, the largest market, in volume, traded for electrical energy is the Nord Pool Spot [NORD-16]. It operates in Norway, Denmark, Sweden, Finland, Estonia, Latvia, Lithuania, Germany and the UK. In parallel, the European Power



Exchange (EPEX SPOT) [EPEX-16] is operating in Germany, France, Austria, Switzerland and Luxembourg. The APX Group operates the spot market in Belgium, the Netherland and the United Kingdom.

Complementary to the day-ahead market, the intraday market is based on a finer consumption and production forecast because the available information is up to date and more accurate. The time horizon of the intraday market is typically between 2 hours and 45 minutes before the physical delivery. At the end of these markets, all the market players should be in a balanced position, ensuring the global balance between production and consumption. To respect the overall system stability, new responsibilities are added for all the market players.

### **The new role of the suppliers: Balancing Responsible Parties**

The role of Balance Responsible Parties (BRPs) in the liberalized European Union electricity market is described in the ENTSO-E Supporting Document for the Network Code on Electricity Balancing [EUR3-13] and refers to the fact that all the market players have an implicit responsibility to balance the system through their balanced portfolio. In other words, BRPs are financially responsible for keeping their own sum of injections, withdrawals and trades, balanced over a given timeframe. The notion and the roles of the BRP have been introduced to encourage balance between demand and offer for a certain metering point, so that overall deviations of the system are minimized.

Energy suppliers are conventionally purchasing electricity from the producers and selling it to the consumers. Usually, small end users are delegating their balancing responsibility to the supplier, who can either take it up himself or arrange a BRP for them, i.e. a market participant who would be responsible for its imbalances.

The procurement of energy blocks by a BRP is depicted in Figure I-13. Aiming to balance its portfolio, the BRP is purchasing its need of power from more than one year down to 15 minutes before delivery in an iterative process. Few years to few days in advance, he is able to buy the base power blocks (in dark grey) on the forward markets. Then, while uncertainty in the expected load profile decreases when going closer to real-time, the BRP can adjust its need of power in the day-ahead market (in light grey). Finally, he can fix its last unbalances during the intraday market, by purchasing (in orange) or reselling (in green) energy blocks until the markets gate closure. A BRP might also be a producer, adapting its production to its balancing needs.

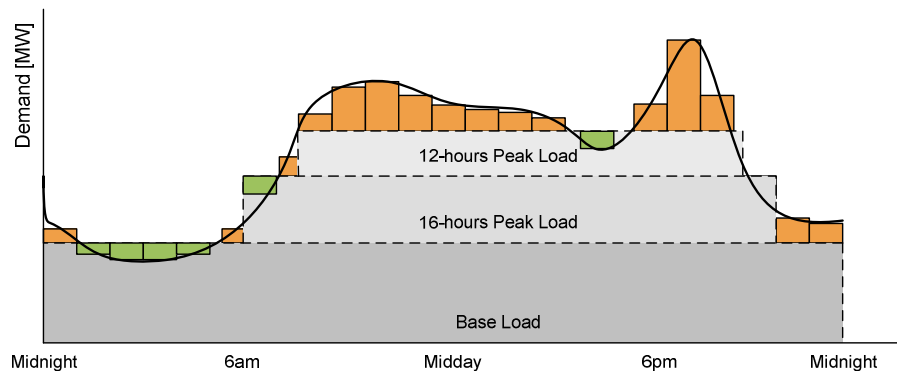

*Figure I-13 – Procurement of energy blocks by a BRP in the different energy markets [KOK-13]*

At the end of the intraday process each BRP acting on the national network should have a balanced portfolio. Any unbalance in the BRP program is penalized [EUR3-13]. Though, in order to reduce their unbalance at a minimum, the BRP sets generally contractual arrangements with their customers or with some commercial aggregators for getting enough flexibility resources and balancing services.

### **The emerging sources of flexibility and associated semantic**

In order to ensure the general balance of the system until real-time at all levels of the system, more and more flexibility resources are needed. In systems with a high share of renewable DG which are mostly non-predictable and hardly-controllable, fast responding and reliable flexibilities are all the more needed. Hence, improved network capacity management is required in order to maximize sustainable generation in the most economical way for the whole society, while maintaining network stability and reliability.

This capacity management can be increased in a more local level via the operation of controllable sources and loads, allowing the grid to be more flexible through the activation of end users' flexibility at both demand and supply side. On an individual level, flexibility is the modification of generation injection and/or consumption patterns in reaction to an external signal (price signal or activation) in order to provide a service within the energy system. The parameters used to characterize flexibility include the amount of power modulation, the duration, the rate of change, the response time and the location [EUR2-14]. A flexibility offer can refer to an energy offer if its activation is scheduled, or/and refer to a capacity offer if its use is conditional.

In order to encourage local customers to modify their patterns of electricity usage, and so to be more flexible, more and more incentives are addressed to them down to the lower levels of the distribution networks. The idea is to allow local customers to make more informed decisions about their energy consumption, adjusting both the timing and the quantity of their electricity use. This ability to control usage is called Demand Side Management (DSM). This management comprises two principal activities which are the Demand Response (DR) program, and the energy efficiency and conservation

programs [DAVI-10]. It aims to allow end users to have a greater role in shifting their own demand of electricity during load peak periods, and reducing their overall energy consumption.

The Demand Response covers the complete range of load shape objectives depending on the loading periods. It includes load shedding, load shifting but also load growth. Load shedding denominates the curtailment of interruptible loads such as air conditioning, electrical heating, pumps, and other non-essential equipment. Load shifting defines the relocating of energy consumption to another time period, through rescheduling activities. Load shifting can help end users to reduce their total demand at a given time, but may not necessarily reduce overall usage loads. Additional power may be required at other times to undertake the rescheduled processes or to return processes to the appropriate temperatures. The shifting of the load can be also useful for load growth during production peak periods, where the overall consumption of the network is low. Depending on their contract, DR participants may be dispatched from once or twice a year up to hundreds of hours per year.

Energy boxes are smart devices that are installed at the residential premises, from which end users can receive orders of DR flexibility offers activation from a cloud based infrastructure, or directly coordinate themselves in a more decentralized way. Each energy box should be able to measure, estimate and control the household loads consumption defined by the end user that has a contract of DSM. These smart devices are essential to permit end users to share their flexibility opportunities. Nowadays, they are not largely deployed but they appear as one of the major solutions for managing local flexibility resources.

Local flexibility opportunities can also come from generation capacity management via local production contracts. On the one hand, the assessment of firm capacity is important to foresee how much generation can contribute during consumption peak periods. On the other hand, if some over-producing areas are identified, some DG connections contracts could allow the interruption of the DG generation output at some moments under specific conditions. Thanks to these types of flexibility contracts, DGs outputs may be dispatched down during low demand periods. For example, DGs such as CHPs can easily modulate their production depending on their contracts.

Figure I-14 presents some key figures about firm production capacity and load shedding capacity directly connected to the distribution network operated by Enedis in 2015. More than 1000 MW of power capacity was available in France in 2015 for balancing usage and could be used as well for both transmission and distribution network management.

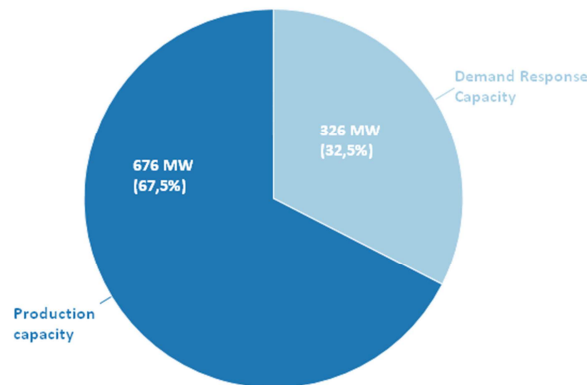

*Figure I-14 - Share of firm production and load shifting capacity participating in balancing mechanisms directly connected to the distribution network operated by Enedis in 2015 [ENED2-15]*

DR is quite successfully applying in the industry sector [PGE-16] but its application in the residential sector is challenging. Managing millions of loads from the national dispatching center is introducing more practical complexity and scalability issues. Here appear the concepts of aggregators and Virtual Power Plant (VPP).

### **The introduction of a third party: the aggregators and the VPP**

Aggregators are new entities in the electricity market that act as mediators between users and other market players [EUR2-14]. They own the technology to perform DR and are responsible for the installation of the communication and control devices at end user's premises, such as energy boxes and relays. Since each aggregator represents a significant amount of total flexibility in the market, they can negotiate on behalf of the end users more efficiently and facilitate end users participation in the market. In this way, aggregators foster competition on the electricity market, by pooling the small flexibility opportunities to make commercial or technical use of them in energy markets or in the grid operation.

Concretely, a VPP is a control and management system that aggregates DERs (including controllable loads, generations and storages), and presents them as a single entity to the energy market [EUR2-14]. The concept of VPP has been thought to enhance the visibility and control of DERs to all the electricity system actors by providing an appropriate interface between them [KIEN-09].

Thus by aggregating the capacity of many diverse DERs, the VPP creates a single operating profile from a composite of the parameters characterizing each DER. At the distribution-transmission network interface the VPP presents a single profile representing the whole local network. Through the concept of VPP, individual DER can gain access and visibility across energy markets, can optimize its position and maximize its revenue opportunities. This approach reduces the imbalance risks associated with individual market participation because of the large scale and large numbers of flexibility opportunities in the VPP [LEBE-16]. It provides the benefits of the diversity of resources and an increased capacity achievement through aggregation.

Today, the concepts of aggregators and VPP are becoming quite similar, as it represents aggregator entities of local flexible resources. An advantage of the aggregation concept is that registration, communication and settlement are performed at the level of the aggregator. A hierarchy of VPP aggregation may be created to characterize the operation of DERs at low, medium and high voltage regions of a local network. This kind of structure is an assumption of the work done in this PhD.

Thanks to aggregators, small DERs are able to participate not only in the global amount of energy exchanges in the wholesale markets but also in the responsibility for delivery of system support services for system operators. These services are very important for the regulated actors and could be, for example, system balancing or other ancillary services for the TSOs, or even local system management for the DSOs [KIEN-09].

### **I.3.2 Evolving roles of the bundled actors**

As explained in the previous parts, the energy exchanges are established without taking into account the physical constraints of the network. At the end of the intraday process each BRP acting on the national network should have a balanced set of DERs through its portfolio. However, as the offers and requests are based on forecasts, the balance between electricity supply and demand needs to be managed up to the real time. The TSO has then to validate the defined energy exchanges in order to permit the physical delivery of the energy. In case of possible constraints, the TSO will not approve the energy exchanges and will have to treat the congestions until real-time thanks to balancing mechanism and ancillary services.

#### **Balancing and ancillary services markets**

Balancing refers to the situation after the markets gate closure, in which a TSO acts to ensure that demand is equal to supply until real time. An important aspect of balancing is the procurement of ancillary services. Ancillary services refer to a range of functions which a TSO has to size and contract in order to guarantee the system security and stability [RTE-04]. These include black start capability (the ability to restart a grid following a blackout), frequency response (to maintain system frequency with automatic and very fast responses), fast reserve balancing capacities (which can provide additional energy when needed), the provision of reactive power, and various other services.

Balancing reserve capacities provide flexibility to system operators to react to sudden changes on the supply or on the demand side. They have to be made available for the TSOs with an associated payment for their participation and use. Participants in these reserve capacities must have adequate technical characteristics such as a fast dynamic response, which make them able to quickly modify their operating point. All market parties can propose their availability of reserve capacity by sending a bid to the TSO. Concerning flexibility bids connected to the distribution system, they are collected by commercial aggregators and sent to the TSO in an aggregated form. By aggregating bids in a pool, the reliability of services provided individually by end users can be improved: for example, if a particular unit

is not able to deliver the planned capacity, the commercial aggregator can still provide the service using other units of its portfolio. DG producers can also directly participate in balancing services by committing their available average production in advance. In France, in order to participate in this mechanism, the involved DG power output should be more than 1MW. An aggregation of several small DGs can also participate if their resulting aggregated power capacity is more than 1MW [ENED3-15].

Today, there are many differences between the different national balancing markets or mechanisms in Europe in terms of structures and rules, operational procedures etc. In order to unify the structure and to permit consistent and compatible exchanges between the countries, some of these differences have to be harmonized. The European commission and the two main European associations responsible in this field – ACER (Agency for the Cooperation of Energy Regulators) [ACER-16] and ENTSO-E [ENTS-16] – recently have agreed on a timeline to elaborate a common basis framework to define the foundations of a future European balancing market [ACER-15].

The introduction of an efficient European balancing market could ensure the security of supply at the least cost and could deliver environmental benefits by reducing the overall need for back-up generation. In this context, a draft of a network code proposed by the ENTSO-E has been delivered in 2013 [ENTS-13], followed by a public consultation process in recent months where several European stakeholders have been invited to submit their inputs. However, the European balancing market design is clearly not finished: it is only the beginning of continuous amendments and improvements in order to get finally a common framework.

With the increasing number of flexibility resources, it could become interesting for the entire system to introduce a capacity market where the TSOs could buy their needed reserve capacity depending on the availability of the flexibility resources [BURN-13].

### **The emerging challenge of the capacity market**

The low return on investment of peaking plants is a first motivation for the instauration of a capacity market in the power system. System operators are facing large deficiency of peaking production plants because they are generally producing only during peak periods, and are not enough profitable for their owners [MEDA-14].

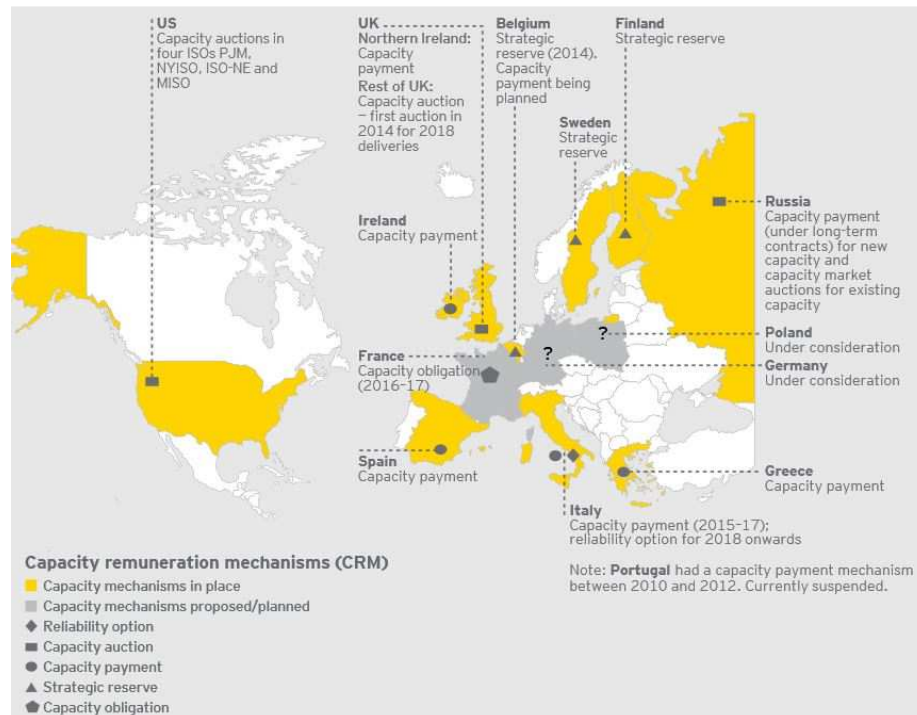

Figure I-15 – Status of capacity remuneration mechanisms in Europe in 2015 [EY-15]

In some European countries, different capacity remuneration mechanisms are already in place as depicted in Figure I-15. In France, Germany and Poland, they are considered as a potential solution to the new grid challenges [EY-15]. Indeed, the instauration of a capacity market allows the number of offers on the balancing mechanism to be increased, and the interest of using all types of flexibility at all levels of the power system for recovering the contingencies and the stress of the grid to be emphasized.

A capacity market would guarantee a specific remuneration for flexibility resources, which would be independent of the wholesale markets. This would ensure the system operators that there would be enough reserve of both active and reactive power flexibility for any envisaged scenario happening in their grids.

### The evolving roles of the TSOs and the DSOs

System operators (TSOs and DSOs) have the responsibility to operate their network in a certain given area as well as their interconnections. They also have to ensure the stability of their grid and the security of supply to their customers, while optimizing their own economic performance. Furthermore, they shall also facilitate market operation by supplying a non-discriminatory access to the grid and by providing the system users with the information they need for an efficient access to the system. They are as well in charge of maintenance and development of their power networks. Both TSOs and DSOs are finally responsible for providing system services: for example, TSOs have to provide balancing services, reserve capacity, power quality, and reactive power supply. DSOs are responsible for providing power

quality and reactive power supply. All these technical requirements and responsibilities are laid out in national laws, European standards [EC-10], and grid codes [ENTS-13].

These requirements are measured or monitored thanks to specific indicators. For example in distribution networks, indicators for continuity of supply include SAIDI (the average duration of interruptions per customer per year) and SAIFI (the average number of interruptions per customer per year). In 2013 in the large majority of countries in Europe, the total time of interruptions per customer due to unplanned long interruptions excluding exceptional events, did not exceed 200 minutes per year [CEER-15]. Another example is about power quality requirements: the European standard EN50160 [EURE-95] specifies voltage characteristics of electricity supplied by public distribution systems, including among others, the voltage ranges characteristics that have to be respected at all end users' connection points. Under normal conditions, the standard indicates that the admissible range of variation of the r.m.s magnitude of the supply voltage, whether line-to-neutral or line-to-phase, is  $U_n \pm 10\%$  or  $U_c \pm 10\%$  for 95 % of a week, where  $U_n$  is the nominal voltage magnitude value and  $U_c$  the contractual voltage magnitude value. Voltage unbalance is also limited: it consists of a loss of symmetry of the phase voltage vectors (magnitude and/or angle), created mainly by an unbalance of the load, and its r.m.s value is limited to 2% for 95% of a week. In practice the r.m.s value can be determined over a fixed interval of 20 milliseconds and the basic measurement can be made by determining the average of these values over a period of 10 minutes. Finally, some intrinsic technical requirements have also to be respected by the DSOs. For example, in order to prevent components' thermal damages, DSOs need to avoid lines or transformers overloads in their network.

With the rise of sustainable productions and their low predictable characteristics, TSOs and DSOs should need more and more system flexibility in order to keep their systems in a safe operation mode. Moreover, the growing number of DERs is enlarging the number of flexibility resources that, as for other energy products, market parties will buy or sell for energy balancing without considering the grid physical state. New innovative mechanisms are necessary in order to coordinate the system operation, to validate consumption and production plans, and to allocate some of the remaining flexibility opportunities for network management.

Today, TSOs have access to balancing services to maintain the real time balance by adjusting generation and consumption up and down, using contracted reserve capacities. The TSOs must take all measures to offset any imbalance and to resolve any congestion, by managing their margins.

DSOs also have to cope with these less predictable energy flows, and it is important that they can use flexibility opportunities as well to react to sudden changes in the system, when it is a more cost-efficient option than traditional grid reinforcement. Since a few years, a lot of projects involving European DSOs, such as the ones presented hereafter, are trying to redefine their roles and their possible new business models in this context, while respecting the already established models for TSOs.



For example, the EDSO association for Smart Grids proposed some recommendations [EDSO-14] for DSO regulations, market design and coordination with the other actors, in order to allow DSOs to also use system flexibility services. EDSO suggests that the European DSOs should be allowed not only to provide system flexibility services in all timescales and to recover their costs in an appropriate manner, but also to be able to use local flexibility opportunities for short-term constraints management. Communication standards should be also defined in order to secure the exchange of data between the DSOs and the flexibility providers, as well as between the DSOs and the TSOs.

In this context, the EDSO for Smart Grids and the ENTSO-E, in close collaboration with the European Commission and other relevant stakeholders, have prepared the European Electricity Grid Initiative (EEGI) Roadmap 2010-18 and Implementation Plan 2010-12 [EEGI-10]. This initiative proposes a 9-year European research, development and demonstration (RD&D) program to accelerate the innovation and the development of the electricity networks of the future in Europe. In the same line, the project GRID+ has been created for providing operational support for the development of the EEGI [GRID+-14]. Many European projects, such as the Grid4EU project which lasted from 2011 to 2016 [G4EU-11], have been founded by the EU to support the EEGI initiative.

In the same philosophy, the project DISPOWER which lasted from 2002 to 2004 introduced some key notes about the changing role of suppliers and DSOs in this context. The authors showed that by developing new business activities with flexibility procurement and by changing networks into active networks, the DSOs could overcome the threats that arise from the increasing penetration of DGs, incentive regulation, regulated connection charges, and unbundling [WER1-05] [WER2-05].

Finally, the THINK project which lasted from 2010 to 2013, tried to advise the European commission on a diverse set of energy policy topics, and among them, about the rethinking of regulation of the European DSOs [PERE-13].

In 2013, the European Commission launched the energy topic 2013.7.1.1 call for EU projects and selected four European projects (INCREASE [INCR-13], IDE4L [IDE4L-13], evolvDSO [EVOL-13] and DREAM [DREAM-13]), in order to propose, develop and demonstrate methods and tools for the DSOs in a situation of high network integration of DERs. Within these four projects, the roles of DSOs are also extended: the general proposal is that DSOs should take over additional and new responsibilities on the distributed market level. First of all, the common proposed idea is that the DSOs should be involved in both prequalification and activation of flexibility offers. They should have the possibility to validate or limit the flexibility offers depending on their grid state. Then, the second common principle is that the DSOs should be able to adopt a pro-active approach of flexibility management for grid constraints management and energy efficiency, by having the possibility to contract remaining flexibility resources for system reliability and for efficiency optimization. Keeping these global proposals as a common thread, different objectives are pursued in the four EU projects.

The project INCREASE focusses mainly on increasing the penetration of renewable energy sources into the grid while ensuring a reliable operation of the distribution network [INCR-13]. Following this objective, they are designing new control strategies for DGs, via a smart DG inverter that can act independently and regulate the DGs output power depending on the grid situation. Within this project, a multi agent system which permits the communication between smart inverters has also been implemented. An optimization of the distribution system based on market information and on forecasting has been developed for the global control of the smart inverters.

The main aim of IDE4L is concerning the overall energy efficiency of the distribution systems [IDE4L-13]. Different tools for the planning, the pre-operational scheduling and the real-time operation of the distribution network are investigated in order to permit the development of an ideal grid for all, enabling clean and reliable energy for the future.

The project evolvDSO aims at defining the future roles for the DSOs, encompassing planning, operational scheduling, real-time operations and maintenance [EVOL-13]. The objective of this project is to develop the tools which are required for these new roles, on the basis of future scenarios which will be driven by different Distributed Renewable Energy Sources (DRES) penetration levels, various degrees of technological progress, and different customer acceptance patterns. Another objective of this project is to establish new recommendations for the modification of the European DSO regulatory framework and for the modifications of the energy markets architectures.

The main goal of the DREAM project is to frame and demonstrate an industry-quality reference solution for DER aggregation level control and coordination, based on available ICT components. This project addresses the feasibility of a distributed and autonomous control of local resources and network's components, which would help the DSO to operate its network dealing with a high share of DERs flexibility opportunities. The major idea of the project is the creation of ad-hoc federations of agents that will flexibly adjust their hierarchy to the current needs of the distribution grid.

This PhD is clearly in line with these new global proposals of evolving roles and responsibilities of the DSOs, and some dedicated tools for these changes will be presented in the next chapters. More particularly, a new distributed architecture and new innovative strategies developed within the DREAM project are presented, compared and validated in the following chapters.

## I.4 Conclusion

This chapter presented the major reasons that encourage the evolution of classical electrical networks into Smart(er) Grids, as well as the new evolutions and challenges that the electricity system actors have to face.

New structural and operational strategies for the planning and for the operation of the power networks are needed, in order to manage more efficiently the network, but also to continue to guarantee security, reliability and quality of supply to the customers. In order to ensure the general balance of the system until real-time at all levels of the system, more and more flexibility resources are needed.

Until today, the possible market uses of flexibility offers are only for national energy markets and for TSO balancing mechanisms. A fundamental distinction has to be made between these different uses of flexibility [EDSO 14]. On the one hand, market players such as BRPs are using flexibility opportunities with a commercial interest for portfolio optimization, and focusing on satisfying the energy needs of their customers. On the other hand, TSOs are using flexibility offers to pursue an objective of efficient and reliable grid operation, ensuring the security of supply and the quality of service.

With the large increase of renewable DG interconnections and with the growing number of distributed flexible resources, flexibility services should be also accessible at the lower levels of the grid, in distribution networks. This could allow DSOs to tackle local network constraints, to maintain reliability and quality of service and to maximize the integration of DERs.

Within this new context, the DSOs can act as market enablers while verifying that all the local flexibility offers exchanged between deregulated market players are compatible with the security and the reliability of their distribution network operation. The DSOs should be also able to adopt a pro-active approach of flexibility use for grid constraints management and for energy efficiency, by having the possibility to contract remaining local flexibility resources for system reliability and for efficiency optimization.

This could be possible thanks to the instauration of new local market architectures, and with the instauration of a distributed and autonomous control of local resources and network's components. A coordination scheme between BRPs, TSOs and DSOs will then become crucial for the operation of these flexibility services. In this context, this PhD is proposing innovative methodologies to support DSOs to act as market enablers and to improve their network energy efficiency, based on distributed energy markets and mechanisms.

## **Chapter II.**

---

# **Towards distributed energy markets and mechanisms**

*The first part of this chapter describes the existing solutions for the distribution of the intelligence within the distribution grids. Then, it presents the already existing network's component flexibility means that have to be locally controlled by the developed communication and information infrastructure. In a second part, the new assumed local market architecture is described.*

---

<b>Chapter II – Towards distributed energy markets and mechanisms .....</b>	<b>47</b>
II.1 Introduction .....	51
II.2 Existing solutions for distributed control in distribution networks .....	52
II.2.1 Towards the distribution of intelligence.....	52
Organizational structures .....	53
Heterarchical approach.....	56
Multi-Agent System architecture.....	56
II.2.2 Existing network's components flexibility means .....	58
Network's flexible components at the primary substations .....	58
Reactive power control of DGs outputs .....	59
Reconfiguration within distribution networks .....	60
II.3 Toward distributed market mechanisms for the DSOs through the definition of a new distributed architecture .....	62
II.3.1. A distributed and autonomous architecture for local resources and network's components operation.....	62
LV cell .....	63
MV elementary cell .....	64
Self-healing cell .....	65
Primary substation federation.....	66
Distribution network optimization cell .....	67
II.3.2 Distributed balancing mechanisms and constraints management tools for the DSOs .....	68
A new local market architecture.....	69
The introduction of a new short time balancing mechanism.....	72
II.4 Conclusion .....	74

---

**Table of figures**

---

Figure II-1 – The three common communication organizational structures [BARA-64] .....	53
Figure II-2 - Operating principle of the on-load tap changer of a transformer [HAD2-13].....	59
Figure II-3 – LV cell representation and communication within the cell .....	63
Figure II-4 – MV elementary cell representation and communication within the cell.....	64
Figure II-5 - One possible federation of MV elementary cells representation .....	65
Figure II-6 – Self-healing cell representation and communication within the cell .....	66
Figure II-7 – One primary substation federation representation.....	67
Figure II-8 – DNo cell representation and communication within the cell.....	68
Figure II-9 – Schematic overview of the PowerMatcher agent structure [MAC 11] .....	69
Figure II-10 – The DREAM overall architecture in a two-dimension SGAM modeling .....	70
Figure II-11 – DREAM local market architecture in a two-dimension SGAM modeling .....	71
Figure II-12 – Overview of the new time frame permitting distributed balancing mechanisms and distribution constraints management .....	72

---



## II.1 Introduction

The European electricity markets and mechanisms had been principally thought to fulfill energy exchanges and capacity availabilities at transmission level. In the actual situation, flexibility opportunities are firstly used for the BRP portfolio optimization, for the balancing mechanism and for the transmission contingency management. With the increasing interconnection rate of DERs penetration, more and more flexibility opportunities are available in distribution systems, and have to be aggregated and transmitted up to the transmission level.

Therefore, with the growing number of local flexibility opportunities, the DSOs' roles and responsibilities need to evolve. New tools should be elaborated in order to make them able to validate the distributed flexibility opportunities and to enhance their transmission to national levels. New strategies are also needed to help the DSOs to operate their network in the best conditions, allowing them to use remaining local flexibility services for constraint management and for energy efficiency optimization.

In order to ensure that the entire distribution grid should be compatible with existing systems and standards, architectures and solutions applied in transmission systems could be used as guidelines to develop advanced control mechanisms in distribution systems. However, there are considerable differences between transmission and distribution systems implying that the replication could not be the best option.

In this context, this PhD work is proposing innovative methodologies based on a distributed coordination of local resources and grid components control, permitting the introduction of local balancing mechanisms and constraints management for the DSOs.

This second chapter presents the assumptions of this distributed architecture. More particularly, the first part of this chapter describes the existing solutions for the distribution of the intelligence within the distribution grids. Then, it presents the already existing network's component flexibility means that have to be locally controlled by the developed communication and information infrastructure. In a second part, the new assumed local market architecture is described. This will permit the design of new DSO flexibility services for validation and aggregation of local flexibility offers, but also for DSO constraints risk management and network operation management.



## **II.2 Existing solutions for distributed control in distribution networks**

With the increasing rate of renewable resources and due to their non-predictable and hardly-controllable outputs, more and more flexibility opportunities are needed in electrical systems. In parallel with the opening of the electricity market, a large number of flexible DERs are appearing in distribution systems, enabling local flexibility offers which can be used in the national markets and mechanisms via commercial aggregators or BRPs.

All the local flexibility offers exchanged between deregulated market players at the national level have to be compatible with the security and the reliability of distribution networks. To ensure this, the DSOs need to have some innovative tools and methodologies to validate these local flexibility offers before their exchange at the national level. Moreover, the DSOs could be also able to use local remaining flexibility offers for the increase of market access, for their own grid constraints management, and for their network energy efficiency optimization.

All these new strategies could be possible thanks to the instauration of a distributed and autonomous coordination of local resources and network's components. This has to go along with an adequate distribution of intelligence within the distribution grid. This first part presents the overall concept of the distribution of intelligence in distribution networks, describing the different existing organizational structures and the system architecture chosen in this work. Then, the already existing network's component flexibility is presented. The intrinsic characteristics of this flexibility will guide the definition of the new distributed architecture control developed in the second part of this chapter.

### **II.2.1 Towards the distribution of intelligence**

A typical approach used in distribution systems is the "fit-and-forget" planning rule [PECA-07]. It consists in designing distribution systems in a way that constraints should not appear by construction, and thus, no communication is required. This approach is quite conservative and could lead quickly to over-investments in the network. In order to monitor physical values in the distribution networks, to control distributed devices for grid operation, and to deploy innovative functionalities in the grid, NICT have to be deployed down to the lowest levels of the system. This will gradually transform distribution grids into active networks.

The idea of the thesis is to determine the best option to develop a new system architecture that will permit an optimal control of flexibility resources and network's components, helping the DSOs to face their new roles and taking into account the responsibilities of each electricity system actor. Different organizational structures for communication or computational requirements are possible.

## Organizational structures

Different organizational structures for communication and computational achievement are conceivable to manage data and to operate electrical networks. They are presented in this section.

In 1964, Baran [BARA-64] redefined the three common communication structures: centralized, decentralized and distributed approach (illustrated in Figure II-1). In a centralized communication system, the control center directly controls the operation of all the individual units by sending and receiving all information. This kind of communication architecture is really vulnerable as the destruction of the central node would stop all coordination actions.

In a hierarchical structure, each node communicates with the other nodes that are directly below it, and with the one that is directly above it. The central point can control the entire system, but the complete reliance upon a single point is not always necessary. However, the loss of a small number of communication points can destroy all the communication structure.

Finally, in a distributed communication system, all nodes are networked on the basis of equality, independence, and cooperation. The lowest level nodes can communicate with their neighboring nodes, thereby building a strong network that can be more resilient than centralized or decentralized systems. The greatest advantage of distributed structures is that the robustness of the system grows with the increase in the number of participants.

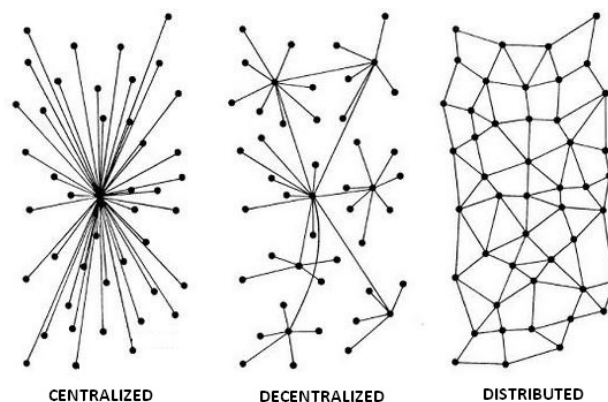

*Figure II-1 – The three common communication organizational structures [BARA-64]*

From a purely computational point of view, the algorithms can be either performed in a central operation center or be distributed among the networks. In a centralized approach, data and information can be pre-processed and aggregated at the lower levels of the system and sent to the central operation center. The optimization can lead to global optimal operation [HORS-00]. However, this kind of computational deployment generally requires a large amount of data transfers.

On the contrary, with a distributed deployment of the computational systems down to the lower levels of the grid, optimizations can be done more locally in the system. This might not lead to the global

optimum but it can permit the simplification of the problem by solving several sub-problems [HORS-00]. Depending on their defined computational area, distributed algorithms can also lead to the global optimum for the overall system [VICE-94]. Optimization outcomes can then be communicated to higher system levels.

Several possibilities are thus possible for the development and the deployment of new smart operational strategies in distribution networks. A solution could be to duplicate the organizational structure and the communication technologies that are currently used in transmission networks, so that the entire distribution grid could be compatible with already existing systems and standards. Transmission networks are equipped with a lot of communication devices (thousands of sensors are typically deployed at the transmission level), and TSOs are able to monitor data and control production reserves. In addition to generators, the TSO also controls protections, network topology, and voltage regulation devices in real-time, especially during emergency conditions [RTE-04]. The decentralized communication operation mode is well adapted for these systems where TSOs are operating their meshed networks in a hierarchical way from their national control center. Indeed, while they are usually ensuring the frequency stability and operating the 400kV voltage control in their national center, they are usually performing the large majority of their other advanced functions in their dispatching centers (such as power flows dispatch control and other voltage levels control).

This architecture could be a guideline for the Smart Grids development. However, there are considerable differences between transmission and distribution systems implying that the replication could not be the best option. Mainly because of the size of the considered distribution networks and of the number of devices to control, the deployed architecture should be well-suited, and dedicated methodologies should be adopted. Distribution systems are typically several orders larger than transmission systems. For example, the French distribution system is about 13 times larger in length of lines than the French transmission system [CRE-16]. The increasing number of DERs in distribution grids implies an increasing number of small players that could participate in the trading of energy and services and that have to be validated and coordinated thanks to communication devices. Therefore, from a communication point of view, a typical hierarchical communication structure could not be the best option.

Indeed, in order to ensure a robust and secured operation network, any advanced strategy at the distribution level should be designed while minimizing the involvement of the control center, in order to minimize data flows and to avoid communication overloading (phenomenon often referred to as “data deluge” or “data storm”) [SLAV-14].

From investments costs point of view, the initial investment in a centralized system control might be more interesting than the one in a decentralized system, because of the smaller need of advanced devices spread over the grid. Moreover, once the investment is done in a centralized system control, there is a reduced need of investments in the system when its size is growing, until a certain point. However, after this specific extension point, the evolution of the investments costs for both systems

might be completely different. While the evolution of the investments costs should stay quite linear for the decentralized system development, it might be exponential for the centralized system development if the entire system control has to be updated and extended.

These reasons are leading to the fact that the distribution of the functionalities among the whole system network could be a good alternative for the future architectures of Smart Grids. Indeed, the distribution of intelligence might permit a good share of computations among the network and avoids the reporting of all the data at a centralized level. This also could permit a better consideration of the DERs down to the lowest levels of the grid.

Some Smart Grids functions are proposed in a decentralized way. This is illustrated in [LO-13] where the distribution network is divided into a set of subnetworks aiming to decentralize the coordination of Volt and VAR regulation. In another paper, [LOIA-11] proposes the concept of a decentralized non-hierarchical voltage regulation architecture based on intelligent and cooperative smart entities. [RUJ-13] proposes a decentralized security framework for Smart Grids that supports data aggregation and access control.

Advanced strategies for distribution networks can also be established in a distributed organizational structure, with peer-to-peer communication mechanisms for example. Following this approach, [KOUK-16] presents the implementation of gossip protocol architecture in order to detect and to solve power flows limits deviations in distribution networks. In the same philosophy, the IntelliTeam SG Automatic Restoration System [S&C-16] automatically reconfigures the distribution system after a fault and quickly restores service to segments of the feeder which aren't affected by the fault. In this system strategy, no SCADA control or central monitoring is required. Decisions are made locally, based on real-time loading data.

The DREAM architecture is an inherent hypothesis of this PhD work. It is mixing the three different approaches, depending on the network situation and on the advanced coordination function necessary to the network operating point. For instance, local technical problems such as congestions or voltage profiles violations are solved in the optimal sized distributed areas. The centralized approach is then used to solve all the technical problems that cannot be resolved in a distributed way.

The decentralized communication approach is applied for market functionalities. The collection of energy offers of controllable DERs in LV and MV grids is transferred in an aggregated way (including all bids and possible technical constraints) to the local market places. No optimization of energy exchanges takes place at lower levels, but the information is concentrated and filtered for a centralized processing on the higher level markets.

This type of framework is developed via the introduction of distributed subordinate DSOs and commercial aggregators' representative entities. In order to permit the compliance of the system depending on the network state and depending on the advanced function that has to be processed, a heterarchical structure has been assumed in the framework.

## Heterarchical approach

A heterarchical system is characterized by the absence of a permanently dominant entity; such an entity, however, is supposed to appear whenever the need arises, in a form that is best suited to respond to the event that caused it. The typical characteristic of a heterarchical system is that the size of the group of entities which interacted is dynamic, and is adjusted depending on the problem. A logical organization of this intelligence based on the network topology can thus be defined.

In 1945, the neurophysiologist W. McCulloch introduced the concept of “heterarchy” into science [CULL-45]. While analyzing cognitive structures, he demonstrated that the human brain was obviously ordered, but not organized in a hierarchical manner. This concept of co-operation opened new horizons on research in neural study but also in computer science and in artificial intelligence fields. A heterarchical system can also include hierarchies; the two kinds of structure are complementary [GOLD-03]. In a heterarchical approach, the natural leader is defined depending on the state of the system and the operating function needs. More recently, network theorists studied how heterarchy could be a new organizational structure in our world where interconnections between individuals, organizations, and societies are currently rising. [STEP-09] affirms that heterarchical systems, that bring together elements of networks and hierarchies, could be the most relevant organizational structures for our times. This kind of structure is completely in line with flexible, dynamic and adaptive systems that can be developed for distribution networks operation.

Within the DREAM project, the concepts of autonomous control, autonomous cooperation and self-organization are highlighted, depending on the state and the needs of the distribution network. The control mechanisms are designed in a way that hierarchical relationships can be created and disassembled depending on the needs, without relying on a central planner.

For example, a self-healing method has been developed in a heterarchical way, and the solving of the problem relies on the dynamic of the participants’ structure [DRAY-13]. Another example of this heterarchical structure is the creation of some dynamic structures for the validation and for the aggregation of flexibility offers depending on the current configuration of the network.

Within this approach, the DSO is relying on local decisions in order not to overload its data center, but he can give orientations to the overall system in case of non-covered needs. This kind of control structure has been implemented within a Multi-Agent System, and mostly relies on the philosophy of dynamic agent federations.

## Multi-Agent System architecture

Multi-Agent System (MAS) architecture in distribution networks is a solution largely studied and investigated for many years, but not widely applied in real power systems yet. MAS architecture has several advantages for the development of Smart Grids. First of all, it enables to specify and to simplify the communication process between the different parts of the grid, by establishing which information

has to be transmitted from one agent to another. The specification of the information exchanges permits communication needs to be reduced. Moreover, in a practical point of view, the deployment of MAS for Smart Grid is a business-like architecture as it can be done step-by-step thanks to its distributed communication structure. Thus, the development of MAS is very scalable and adaptable. Distributed and parallel processing is also possible thanks to the MAS because each agent has its own computational capacity. This can largely increase the system performance.

A lot of papers have already been written aiming to integrate MAS in the Smart Grid development. For example, a MAS has been developed in [ROCH-12] in order to manage demand response in households, maintaining the demand curve below a certain threshold. In [NORD-05], the agents are representing distribution network sub-areas. The implementation of this cooperative system enables the decentralization of some dedicated functions in the distribution system such as fault management strategies. Distribution automation applications are not executed in the control center but by local substation controllers and by collaborating neighbors. The MAS is also an efficient architecture for self-healing process, including fault isolation and power restoration, as presented in [BAXE-07], [LI-08], or also in [COLS-11].

Some European projects, as CRISP (2002-2006) [CRISP-02], More MICROGRIDS (2002-2006) [KARI-10], and INTEGRAL (2007-2011) [INTE-11] have already demonstrated the potential of dynamic MAS to control DERs in Smart Grids. Within the CRISP project, a distributed architecture of agents has been implemented to carry out fault diagnosis, self-healing, intelligent load shedding, and automatic supply demand response in distribution systems. The More MICROGRIDS project aims to implement local control techniques for DGs and load controllers, in order to integrate several micro-grids into power system operation, while ensuring interactions with the central control system. Several demonstrations in different operational modes had been tested to evaluate the viability of the system.

Built in the scope of the INTEGRAL project, the PowerMatcher city [BLIE-11] is a demonstration of a multi-agent control based on a common market model. In the PowerMatcher concept, software agents are used as representatives of the devices producing and/or consuming power. Via bottom-up market algorithms, a strategy is determined to ensure that their operational schemes are coordinated in order to balance supply and demand. With this implementation, end-users can buy their electricity when the price is low, and sell their production when the price is high, while ensuring that their comfort levels are always maintained. Moreover, the DSO is also able to reduce peak loads by sending incentives to the neighborhood. In INTEGRAL, other demonstrations [PEPP-11] have been handled in France and in Spain focusing on the multi-agent control during critical conditions only (islanding modes, voltage disturbances, or unexpected grid imbalances).

Within the DREAM project, a MAS following a heterarchical approach is developed. In this system, agents are able to build federations to manage the different cases of network operations and can automatically switch from one architectural approach to another. Though, a hierarchical organization of the intelligence is conserved, based on the network topology and on the network

flexibility means. This organization is described in section II.3.1. The intrinsic characteristics of the grid structure and of its existing operational regulation's components are governing the definition and the development of this new distributed architecture control.

## **II.2.2 Existing network's components flexibility means**

The electrical distribution network itself has some resources of flexibility. They can be used to solve some cases of voltage deviations and/or congestions in real-time, to minimize network losses but also to carry out outage management. Aiming to define the best architectural structure of the developed MAS, it is important to have a clear idea of the already existing network's components flexibility means and their respective effects on the overall network operation.

The development of the heterarchical structure has to be in line with the inherent grid structure and grid flexibility means. The creation of the independent control areas and the apparition of local federations of agents should permit local optimizations for grid operation to be performed while taking into account all the possible combinations of available flexibility resources.

### **Network's flexible components at the primary substations**

Different network's components located in the primary substations can be used for operational management. Among them, On-Load Tap Changer (OLTC) transformers are a major solution for voltage regulation. It consists in transformers with controlled variable transformer ratio. This enables to adjust the voltage at the MV buses depending on the loading of the downstream part and on the upstream network fluctuations.

Two main strategies of regulation exist for OLTC transformers. The strategy without compounding is the most common solution, and keeps the voltage value of the secondary side of the transformer within a certain voltage dead band (in France usually between 1.02 and 1.04 pu). Thus, the only controlled parameter with this strategy is the voltage value at the secondary side of the transformer. These transformers have a characteristic dynamic for tap changes that can be observed in Figure II-2. The first tap change arises when a voltage limit is violated during a time longer than a defined duration  $\Delta t_1$  which is generally set at 60 seconds. This first delay is set in order to ignore fast voltage fluctuations due to connections or disconnections of large loads, but also to bypass upstream network voltage fluctuations. Other tap changes are happening after a smaller delay  $\Delta t_2$  generally set at 10 seconds if the voltage value is still not within the reference range.

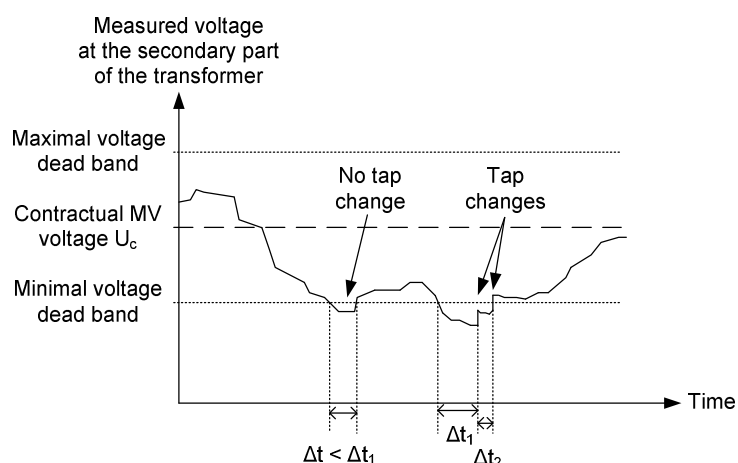

*Figure II-2 - Operating principle of the on-load tap changer of a transformer [HAD2-13]*

With the presence of DGs in distribution networks, this solution is not always well adapted [HADJ-99]. Without compounding strategy, the on-load tap changer of the transformer might not detect the local voltage rises in the downstream part of the network due to DGs. The regulation can then be flawed and over-voltages on the downstream network can occur.

The second existing OLTC regulation strategy is the solution with compounding. It permits, thanks to a measurement of the current in the transformer, to take into account the voltage drops in the downstream network [THOR-01]. Thus, it permits to regulate the voltage value at another node different from the substation. However, this strategy is also not always well-adapted in case of high DG penetration. Because of the local downstream production, the current measurement value might be decreased compared to the real one. In this case, the voltage regulation can be also inaccurate.

Other network's components usually located in the primary substations and used for operational management are capacitor banks. They represent one of the existing solutions for reactive power compensation at the primary substations, and reduce the reactive power flows at the substations to limit network losses and avoid the degradation of voltage profiles. The first objective of reactive power compensation is to decrease HV reactive power flows. However, they could also have an impact on MV voltage regulation and on distribution network losses [WYSO-06]. This kind of reactive power compensation means can also be decentralized in specific MV feeders of the downstream network, either via the installation of appropriate devices [MAJU-12] or via the reactive power control of DGs outputs.

### **Reactive power control of DGs outputs**

Reactive power flows can also be regulated at DG connection points in MV level. Depending on the considered DG technology and its installed power capacity, reactive power control of DGs is also a mean of flexibility for network operation and voltage regulation. For example in France, if the voltage value at the connection point is included between  $\pm 5\%$  of the contractual voltage value, a DG which



delivers its maximum installed active power should be able to provide also, without limitation of time, 40% of its installed active power or to consume 35% of its installed active power [ARRE-15]. This could be required to regulate the voltage on the entire MV feeder for instance.

The DG injection or consumption of reactive power on MV level network can be regulated either locally without communication with the DSO [RAMI-06], or in a synchronized way where the DSO can send instructions [RICH-06]. The contracts and regulations are different depending on the DG installed power capacity and on the grid codes. For instance in France, if the considered DG complies with one of the following conditions, it has to be connected to the DSO control center and exchange information concerning the voltage value at its connection point and about its updated production plan, but also exchange instructions concerning reactive and active power management [ARRE-15]:

- Its installed active power is equal or superior to 5 MW.
- If the DG producer is directly connected via a dedicated MV feeder and its installed active power is more than 25% of the primary substation nominal power.
- If the DG producer is connected to a MV feeder supplying also other end users and its installed active power is superior to 25% of the total average load of the feeder.

Reactive power control of DG is a real source of flexibility for the DSO operation. By managing their reactive power injection and consumption with different strategies, the DSO can solve many technical constraints violations as local voltage deviations and congestions. For example, [MERC-15] proposes decentralized and centralized reactive power control strategies in order to solve networks constraints deviations and in order to increase the DG admissible penetration rate.

These flexible network's flexibility means located at the primary substations or decentralized in the MV feeders have an independent effect on each entire MV downstream network. This is one of the reasons why the structure of the developed architecture will consider the downstream part of each primary substation as a dedicated area. Moreover, distributed flexible network devices are now appearing in LV level, such as smart MV/LV transformers [KADU-10]. The developed architecture will also consider LV level networks as devoted flexible areas.

## **Reconfiguration within distribution networks**

In distribution grids, different types of switching devices are used for different network functionalities. Remotely and manually controlled switches, as well as circuit breakers are ensuring the connectivity of lines. Remotely controlled switches can generally be operated on load, in order to realize a network reconfiguration in the context of outage management for instance [ENAC-07]. On the contrary, selectors have a dedicated protective role and can be operated only off-load to disconnect and protect an area.

All these switching devices have intrinsic different characteristics such as their mechanical durability, defining their total possible amount of switching cycles, and their electrical performance,

including their breaking capacity. Until now, reconfiguration is a source of flexibility used almost only for outage management and for seasonal load transfer, due to the high cost of switching resulting from the repetitive stress of the device. Some works as [TOUR-14] shows that it could be also an interesting source of flexibility, coupled with other regulation means, in order to better operate the electrical network with a high penetration of DG and to reduce total network losses.

In order to take into account more easily all the distribution network reconfiguration possibilities, the intrinsic non-reconfigurable areas of the network will be considered as dedicated and static parts in the developed architecture. Another specific group of areas will be defined as all the possible interconnected parts of the network. This area will permit exact local optimizations to be performed while considering all the combinations of flexibility resources, including reconfiguration. Finally, the intrinsic characteristics of these different existing flexible grid's components are guiding the definition of the new developed distributed architecture control.

## **II.3 Toward distributed market mechanisms for the DSOs through the definition of a new distributed architecture**

In this PhD work, new local strategies for the DSOs are elaborated to ensure that all the local flexibility offers exchanged between deregulated market players at the national level will be compatible with the security and the reliability of distribution networks. Moreover, new strategies are proposed to allow the DSOs to use local remaining flexibility offers for their own grid constraints management and for their network energy efficiency optimization. The instauration of local intelligence via a multi-agent system will permit these functionalities to be distributed within the network, allowing an autonomous architecture for local resources and network's components operation.

In the following sections, the communication architecture reference that is assumed for the deployment of the solutions will be described. This architecture will be used for the developments that will be presented in the next chapters. Firstly, different specific local areas are defined for the deployment of functionalities in the distribution grid. Secondly, the distributed architecture needed for the possible instauration of DSOs balancing mechanisms is introduced, allowing local information exchanges between the different involved electricity sector actors. In parallel, novel mechanism performed near real-time are introduced in order to permit the DSOs to use the remaining flexibility resources for distribution constraints management and for energy efficiency optimization.

### **II.3.1. A distributed and autonomous architecture for local resources and network's components operation**

Usually, three main levels of automation are used for functionalities distribution among the networks: substation automation, feeder automation and customer automation. These are defining clearly locations where equipment are remotely monitored or/and controlled. As it is illustrated in [ENAC-05], other different specific areas can be defined and automated in order to allow a better management of specific advanced functionalities and to minimize the need of data exchanges. The author presents a MV area that is specifically designed for reconfiguration after fault location and isolation. In the same philosophy, other dedicated areas (also called cells) have been defined for specific advanced functions during CRISP [ANDR-05] and INTEGRAL projects [LE-08]. The borders of the areas are highly depending on the electrical network constraints and on the impact of the existing flexibility means in the grid.

In this work, the same process of cell management is adopted. Different cells are designed based on the objectives of the implemented functions and on the available flexibility resources in the network. Moreover, this concept is enlarged to a new dimension away from static configurations to the point of dynamic federations of cells, which can be created for specific needs related to a given time.

The difference between a cell and a dynamic federation lies within the time behavior. Cell structures are static: they are defining given network areas. On the contrary, federations are dynamic: they are built in order to solve specific problems for a given time, and then they are dissolved. This is totally in line with the heterarchical structure presented above. There is no pre-defined top-level intelligence, but depending on the task to perform, different actors can be the coordinators.

Four different static cells have been designed for different network management functions [CAIR-13]. These cells can be dynamically federated to solve specific occurring problems.

### LV cell

The LV cell is defined as the entire downstream LV network behind a MV/LV transformer (see Figure II-3). In this cell, two local agents are introduced, and can be physically installed in a data concentrator in the secondary substation.

The main tasks of the LV DSO agent responsible of this cell are voltage control and overload management. He has also to technically validate the potential available flexibility bids that are aggregated by the LV commercial aggregator agent before their transmission to higher voltage grid levels. In the LV cell, the LV DSO agent can communicate with every LV end user equipped with a smart meter. The representative of a local market place is also present in this cell, and is called here the LV commercial aggregator agent. Each LV flexible end user equipped with an energy box can exchange data with the LV commercial aggregator agent. The LV commercial aggregator agent can as well communicate with the LV DSO agent and vice versa.

The main flexibility resources in this cell are LV end users flexibility offers. The potential presence of a MV/LV OLTC transformer can be also taken into account for LV cell management, or for LV flexibility offers validation.

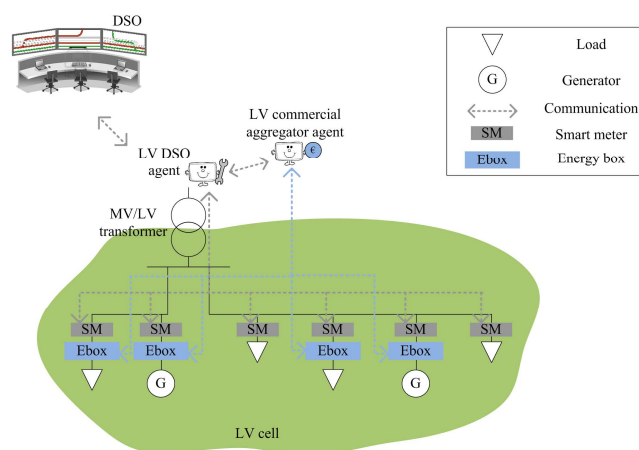

Figure II-3 – LV cell representation and communication within the cell

## MV elementary cell

The MV elementary cell is a second static cell which has been designed in the architecture (see Figure II-4). It represents the smallest entity from a reconfiguration point of view in the MV level, meaning that no remotely controlled reconfiguration is possible within this cell. Therefore, when reconfiguration process is performed in the grid, each MV elementary cell can be seen as an aggregated node.

It is defined as a MV section between two controllable switches. In this cell also, two different agents are introduced. The MV DSO agent is responsible for grid management in his cell. This agent can be physically installed into an aRTU at a remotely controlled switch location. As in the LV cell, a local market place is represented by the MV commercial aggregator agent. He can receive information from the downstream LV commercial aggregator agents as well as from its respective flexible end users directly connected to the MV network.

The main flexibility resources in this cell are MV end users active power flexibility offers, but also aggregated LV end users flexibility offers. For the management of this cell, the MV DSO agent can also use DGs reactive power output control or distributed capacitor banks reactive power control if there are some in the cell.

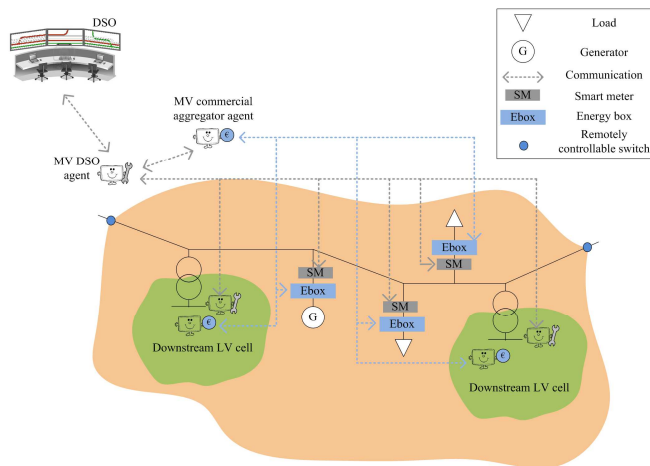

*Figure II-4 – MV elementary cell representation and communication within the cell*

It is then possible to build dynamic federated structures of MV elementary cells depending on the function that has to be fulfilled in the grid. For example, if a fault occurs in a part of the network, dynamic federations of MV elementary cells can be built. In this case, the MV DSO agent who detected the fault will start to search a solution within the intra-substation federation drawn in green dashed line on Figure II-5. It is composed of all the MV elementary cells in the feeder.

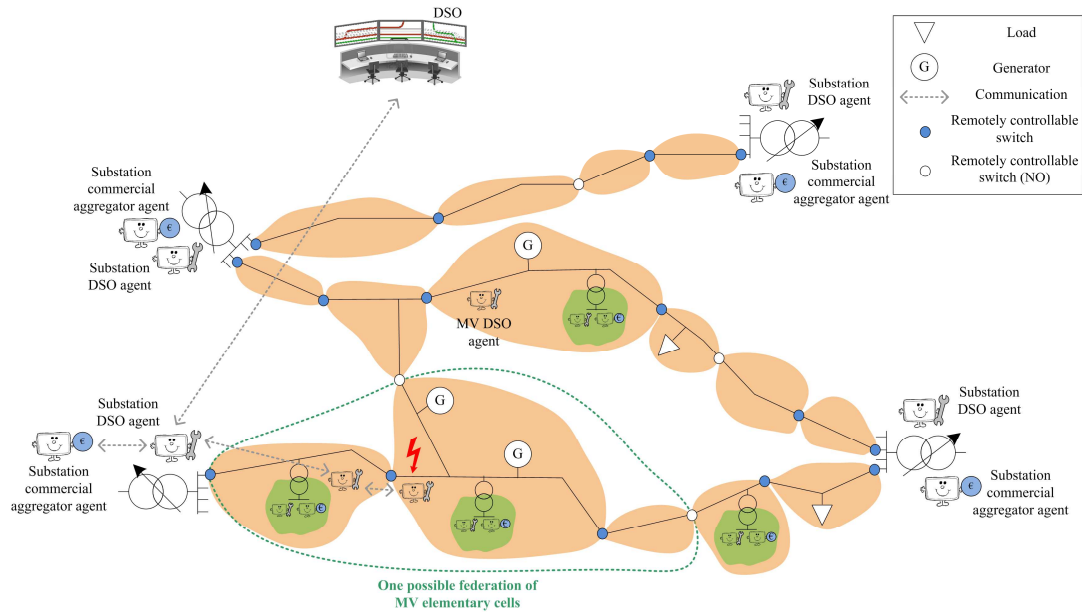

*Figure II-5 - One possible federation of MV elementary cells representation*

If no solution can be found within this federation, the union will be enlarged until it includes all the possible interconnected internal MV feeders (Figure II-6). This final federation is in fact a static cell, called the self-healing cell, and which has been designed for power restoration after an occurring fault.

### Self-healing cell

The self-healing cell is composed of all the MV elementary cells that could help for power restoration after the occurrence of a fault. The agent responsible for this cell is the substation DSO agent who detects the fault, and who is able to coordinate MV elementary cells, MV network components and all its remotely controlled resources. The self-healing cell for this exemplary network is shown in Figure II-6.

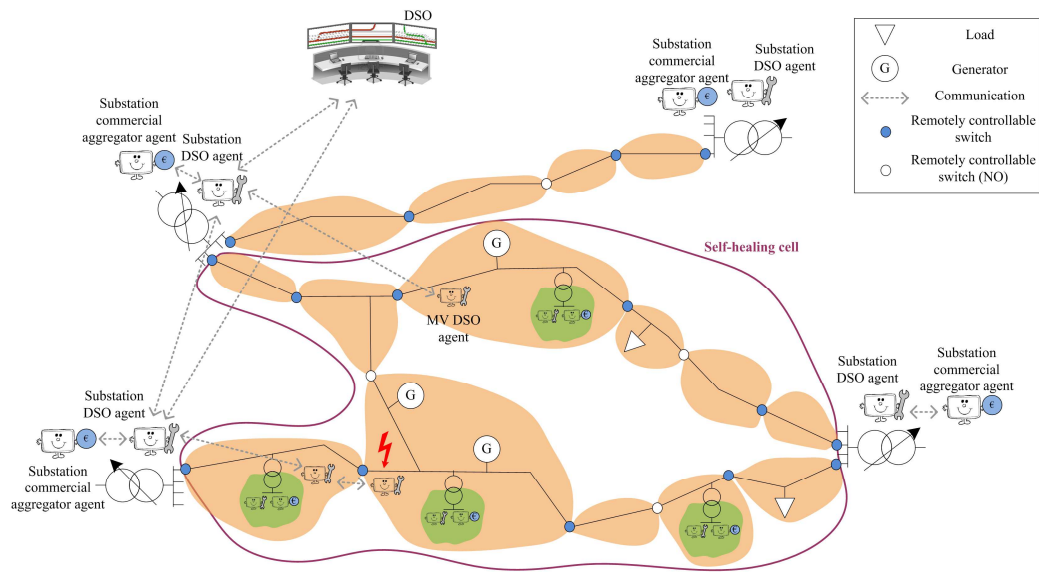

Figure II-6 – Self-healing cell representation and communication within the cell

Other MV elementary cells federations can be also created for other Smart Grids functionalities, such as for local flexibility offer activation, or for DSO risk management.

### Primary substation federation

The primary substation federation is defined as the federation of all the MV elementary cells that are fed by one substation within the actual grid configuration. This federation is in fact static when there is no reconfiguration. This federation is used for distribution network optimization, for congestion management, but also for local flexibility offers validation proposed by the substation commercial aggregator agent, when the reconfiguration is not necessary. An example of a primary substation cell is presented in Figure II-7.

The main resources of flexibility in this federation are the combinations of those present in its downstream LV cells and MV elementary cells, as well as the possible flexibility of the network's components at the considered primary substation (OLTC transformer and capacitor banks for example).

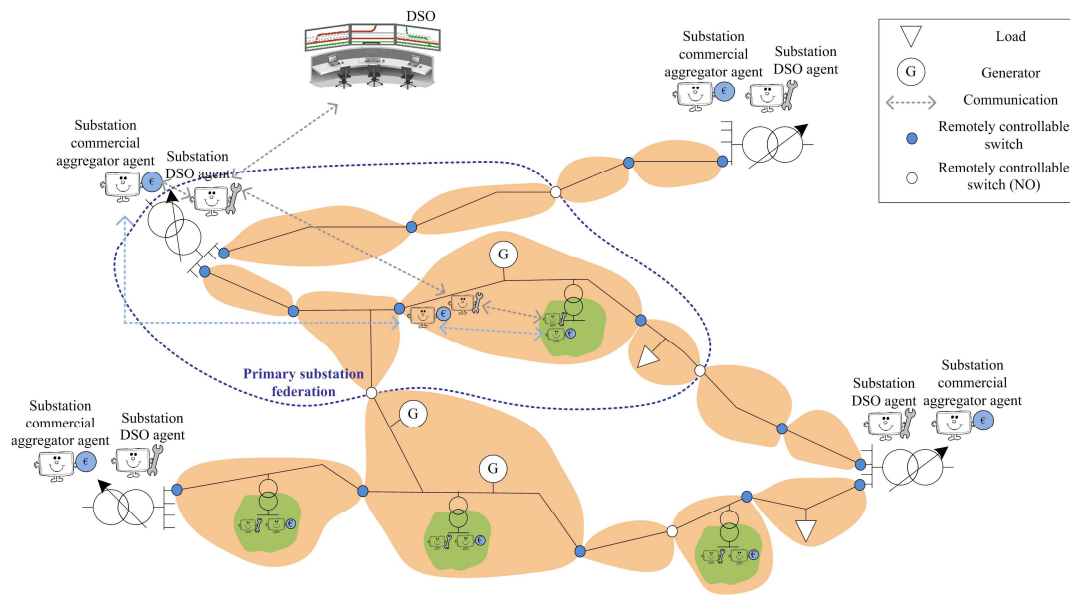

Figure II-7 – One primary substation federation representation

### Distribution network optimization cell

Finally, the last static cell that has been designed is the Distribution Network Optimization cell (DNo cell) (see Figure II-8). This cell represents all the MV elementary cells that can be connected at MV level between primary substations.

The top-level intelligence lies within the substations, and depending on what task have to be performed, the leader would be one of the substation agents. In this context, the cell could also be seen as a federation of MV elementary cell as it has no natural leader.

All the flexibility resources available within this cell, including reconfiguration, can be used for the energy efficiency optimization, but also for the optimization of the operational costs operation. Within this cell, the leader substation DSO agent can validate the aggregated local flexibility offers in order to allow their transmission on the national level.



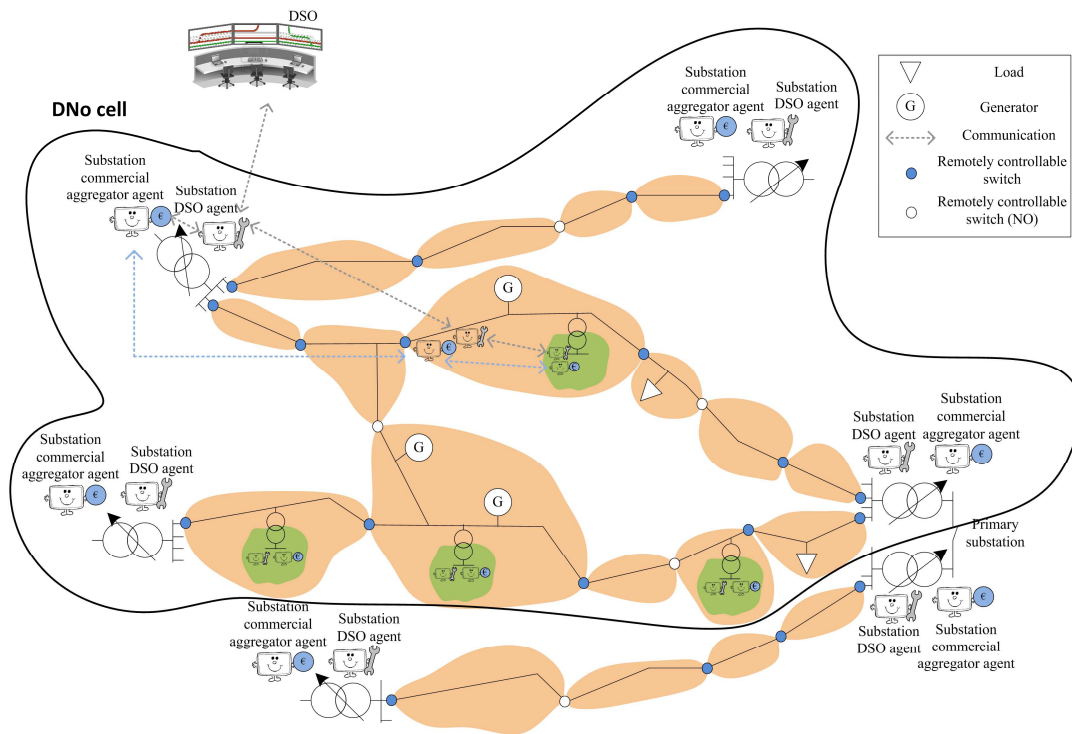

Figure II-8 – DNo cell representation and communication within the cell

Thanks to this new distribution of automation, local functionalities can now be performed at a restricted level. More communications are also possible between the distributed representatives of the electricity system actors. Therefore, all the local flexibility resources, including end users flexibility offers and network's components flexibility, are more accessible for balancing management and for grid operation. New distributed balancing mechanisms and distribution constraints management tools for the DSOs can thus be possible.

### II.3.2 Distributed balancing mechanisms and constraints management tools for the DSOs

As explained in chapter I, market clearing and balancing mechanisms are usually performed at the national level. However, the DSOs need to validate flexibility offers which are coming from their local connected flexible end users before their aggregation, in order to ensure local system stability and security of supply in their entire distribution network. They also need tools for distribution contingency risk management, which will neither affect fairness between market players, nor national energy exchanges and transmission system operation.

With this new architecture, the different roles of the electricity system actors are transferred in their local representatives. Hence, the possible communications between the local agents have to be defined and controlled in order to be compatible with existing systems and standards. The creation of a

new local market architecture using the presented cell concept has therefore to be proposed in parallel in order to develop these new DSO tools.

### A new local market architecture

In order to facilitate the access to the market for distributed flexible end users, a new local market architecture is developed. It is based on the presented distributed communication structure and takes into account the existing processes in the current liberalized energy markets.

Distributed market architecture has already been developed in the PowerMatcher concept. This consists in a general-purpose coordination mechanism for balancing demand and supply in a defined area. Several agents are organized into a logical tree: local device agents, an auctioneer agent, concentrator agents and an objective agent. Local device agents are used as representatives of the power producing and/or consuming installations. Some concentrator agents can be added to the structure for aggregation process so that scalability is obtained. The auctioneer agent is a unique agent that handles the equilibrium price over all the area. An objective agent can be optionally added to the system, which interfaces the cluster to the business logic defined by the specific use case. An example of a PowerMatcher cluster is shown in Figure II-9.

Via market algorithms, a strategy is determined to ensure that their operational schemes are coordinated in order to achieve the objective according to the business case for the considered area [KOK-13].

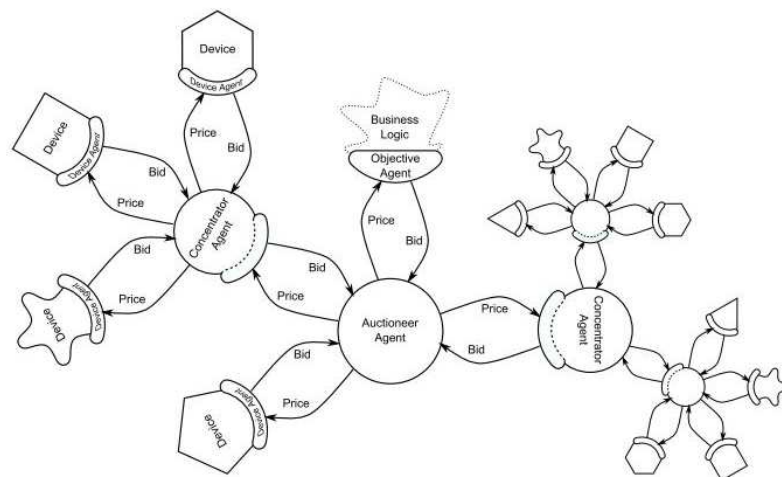

Figure II-9 – Schematic overview of the PowerMatcher agent structure [MAC 11]

In PowerMatcher, the only information that is exchanged between the local devices agents, the concentrator agents, and the auctioneer agent are energy bids and prices. There is no specific local validation of technical constraints of the grid. Locational pricing only is used to perform bids transformations in order to meet some technical requirements.

The market structure developed in this work aims to take into account the physical network before each iterative step of aggregation. The overall market architecture is depicted in a two-dimension SGAM format [CEN-12] in Figure II-10. The two dimensions represented are the Domain, which covers the complete electrical energy conversion chain, and the Zone, which represents the hierarchical levels of power system management.

At the market and operation levels, commercial aggregators, TSO and DSO control centers are represented. All the DSO and commercial aggregator representatives are pictured within the station zone, which usually represents the aggregation or concentration level of the numerous data coming from the field zone. Physically, there are mainly distributed in primary and secondary substations, but they can also be in remotely controlled switches location.

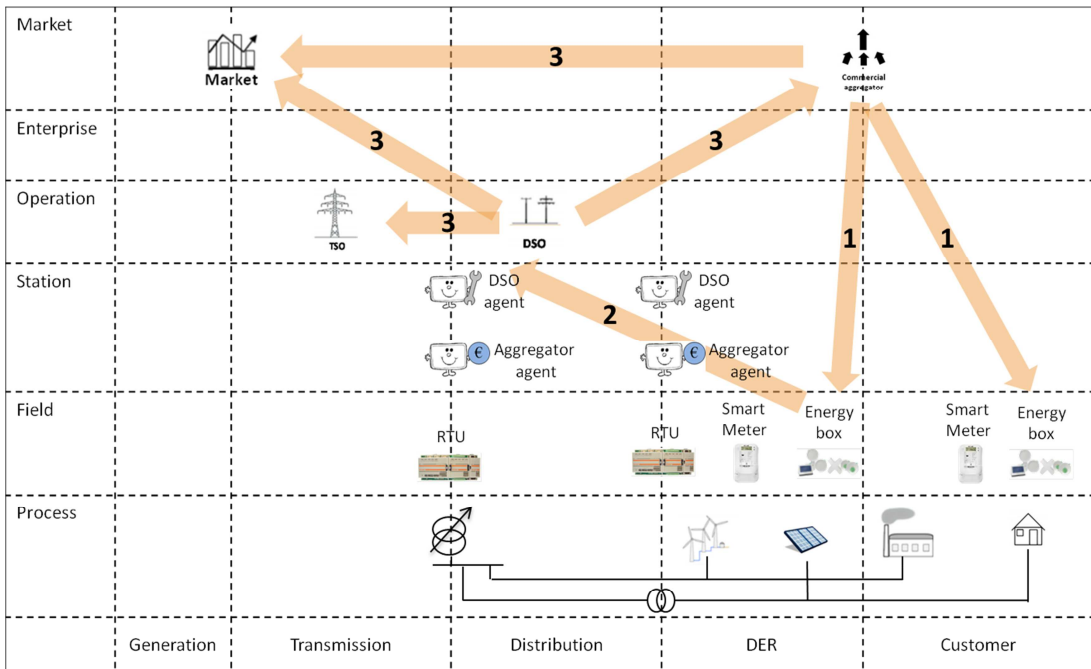

Figure II-10 – The DREAM overall architecture in a two-dimension SGAM modeling

The different phases in this market architecture are assumed to be the following. First of all, it is assumed that commercial aggregators are giving some incentives to their respective flexible end users for the elaboration of their flexibility offers through their energy boxes (1). Thus, local commercial aggregator agents can collect all their LV and MV end users flexibility offers, aggregating them in a kind of local market places (2).

Local commercial aggregator agents can then send their aggregated portfolio to local DSO agents that can validate or not the offers, depending on the situation of the grid in case of flexibility activation, and on their grid flexibility resources. To support the validation process, local DSO agents have access to physical measurement at LV and MV end users equipped with smart meters. The local DSO agents are in contact with the DSO who can also give directions for the wished behavior of each cell (2).

Each commercial aggregator agent sends its validated portfolio to the upper level commercial aggregator agent responsible for him. At the end of this iterative process, the portfolio of the validated offers is transmitted up to the TSO, to the commercial aggregators, and to the national market level (3).

This process can be seen in details on Figure II-11 for the distribution steps level.

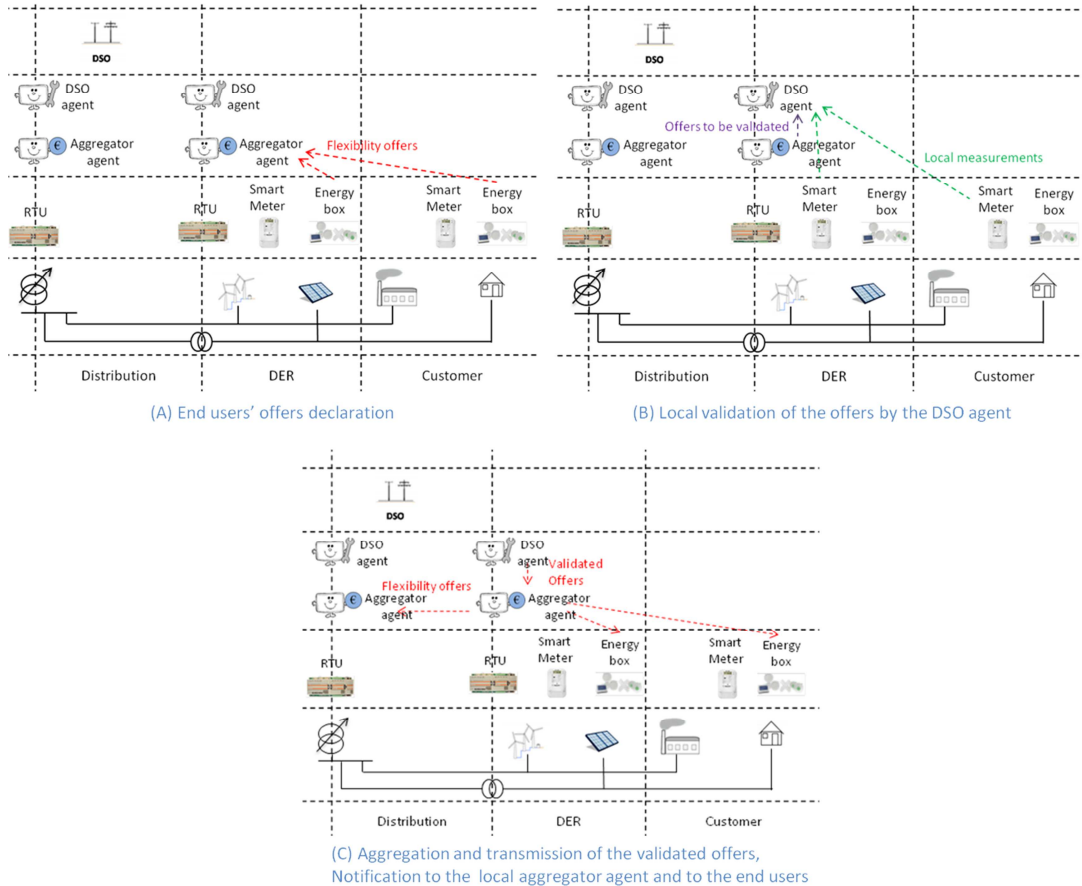

**Figure II-11 – DREAM local market architecture in a two-dimension SGAM modeling (zoom on the distribution level)**

This new local market architecture and its associated local communications between the different representatives of the electricity system actors permit the validation of the flexibility offers to be distributed. Thus, the large number of flexible DERs that are appearing in distribution systems can participate in the national markets and mechanisms via the commercial aggregators, while staying compatible with the security and the reliability of distribution networks.

Moreover, in order to allow the DSOs to use local remaining flexibility offers for their own grid constraints risk management and for their network energy efficiency optimization, new mechanisms have to be defined. To ensure that these mechanisms will not affect the fairness between all the market players, new short-time distributed mechanisms have to be introduced.

## The introduction of a new short time balancing mechanism

In this work, a new short-time balancing mechanism has been focused on: its time-frame corresponds to the time between the markets gate closure and the time of electricity delivery (also called Real-Time (RT) operation).

After the wholesale markets clearing, remaining local flexibility offers can be assessed as possible supplementary local reserves to network's components flexibility means. All these flexibility resources can help the DSOs to solve short-term and real-time distribution network constraints (congestions, voltage deviations) in case of potential contingencies, but also to optimize its network energy efficiency.

Therefore, the common market time-frame can be split into two different slots which are represented in Figure II-12.

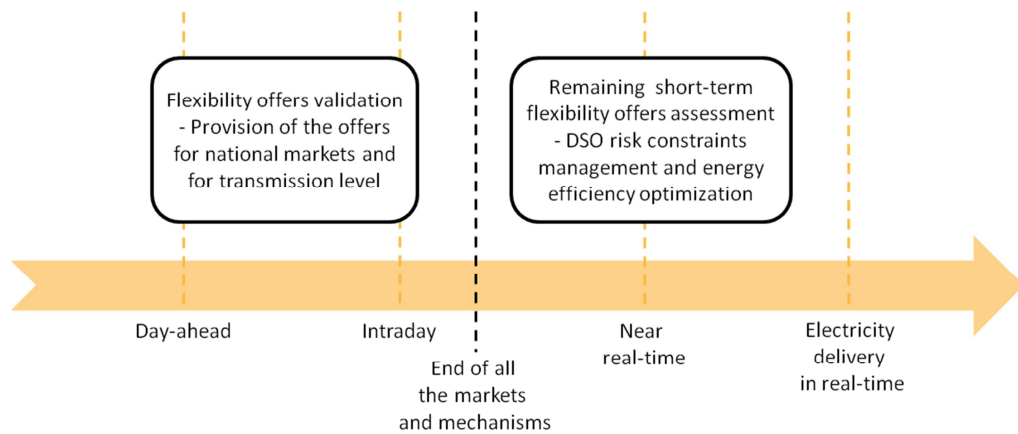

**Figure II-12 – Overview of the new time frame permitting distributed balancing mechanisms and distribution constraints management**

The first defined time slot is corresponding to market driven operations, lasting during all the wholesale markets period. During this time-frame, the aim is to arrange and validate production and consumption plans, and to enable the active participation of small-scale players in the national markets. Thanks to the previously presented local market architecture, the validated day-ahead and intraday local flexibility offers can be transmitted up to the national markets and to the transmission level for TSOs ancillary services.

The second time slot corresponds to the new period where the proposed mechanism should be performed. During this period, the day-ahead and intraday processes are assumed to be completed, leading to an optimal plan of energy exchanges and knowledge of remaining available flexibilities capacity. Taking the advantages of the distributed control, it is then possible to establish short-term distributed remaining flexibility mechanisms for DSO risk management and for grid operation optimization.

Specific rules of appropriate mechanisms for DSO flexibility use are not set up yet in the European regulation. Two alternatives for the remuneration of these mechanisms are possible: either via the instauration of local flexibility markets or via the instauration of bilateral agreements between the DSO and the aggregators [VALT-11]. In this work, the creation of short-term local remaining flexibility markets is considered.

In these near real-time market, it is assumed that the market operator is the DSO itself, and that no other electricity actor can purchase flexibility offers at the moment. In the future, other actors could also participate in this market, such as near real-time flexibility owners.

Finally, the system for price setting has to be also explored. It could follow the already applied system where a marginal pricing approach is used. However, this kind of approach will not be appropriate for the DSO because constraints management and energy efficiency optimization are really depending on the location of the flexibility opportunities. It would then imply the selection of a large number of non-sensitive flexibility offers, which would have no impact on the objective. That is the reason why the “Pay-as-bid” mechanism is proposed during this short-time period, allowing the DSO to select directly the interesting remaining flexibility offers and to pay only for these selected flexibility offers, as it is done in [GOEB-16].

To conclude, the instauration of a new distributed framework via a new architecture and a new time-frame is permitting the development of new distributed balancing mechanisms and of new network operational strategies for the DSOs that are presented in the next chapters.

## II.4 Conclusion

In this chapter, an innovative and dynamic communication infrastructure has been proposed for a better coordination and control of the DERs in order to allow the DSOs to best operate their networks. Thanks to the already existing solutions for the distribution of intelligence in distribution networks, a new architecture control has been elaborated while taking into account the intrinsic characteristics of the grid structure and of its existing operational regulation's components.

This new structure is developed with a bottom-up approach in order to in order to create a resilient and cost effective solution and, by limiting data transfers within the entire considered distribution network. The DSO, in the control center, should act as a system manager of the framework, giving orientations rather than solving local contingencies, and should have the possibility to rely on local and autonomous reactions of subparts of the distribution network.

Assuming this distributed and autonomous structure, a new local market architecture has been then proposed in order to permit the design of new DSOs mechanisms for validation of local flexibility offers for system flexibility services. Within this new context, the DSOs will become market enablers while verifying that all the flexibility offers exchanged between deregulated market players are compatible with the security and the reliability of their network operation.

Then, new DSOs strategies for local distribution constraints management and for network energy efficiency are also compatible with this local market architecture. Operational planning and network upgrading optimization will be possible for the DSOs while considering remaining local flexibility offers until near real-time.

In the next chapter, the developed tools for validation of flexibility offers at distribution level for balancing flexibility services will be presented. The designed strategies for local DSO constraints risk management in case of sudden changes in the network will be also described. Then, some distributed tools for network energy efficiency optimization will be presented, still in line with this new distributed architecture.

## **Chapter III.**

---

# **Innovative methodologies to support the DSO to act as a market enabler**

*The first part of this chapter presents and validates in some test cases some innovative methodologies for technical pre-validation of the distributed flexibility offers. In the second part of this chapter, a distributed mechanism is developed for the DSOs in order to take advantage of LV flexibility offers to give a wider access to end users to the energy markets, but also for the overall distribution network operation. Finally, new methodologies for short-term local risk management and contingency analysis are proposed in the third part of this chapter, dealing with near real-time remaining flexibility opportunities that have not been selected in the market processes.*



<b>Chapter III – Innovative methodologies to support the DSO to act as a market enabler .....</b>	<b>75</b>
III.1 Introduction .....	79
III.2 Innovative tool for local technical validation of flexibility offers.....	80
III.2.1 Concerns and existing strategies.....	80
Existing validation methods for flexibility offers .....	81
Possible strategies to model potential available flexibility offers .....	82
III.2.2 Introduction to fuzzy arithmetic .....	83
Fuzzy sets, fuzzy membership functions and $\alpha$ -cuts.....	84
Typical fuzzy membership functions.....	85
III.2.3 Validation of flexibility offers using fuzzy arithmetic .....	86
Fuzzy representation of the available flexibility offer.....	86
Presentation of the method .....	88
Examples of application .....	90
III.3 A DSO tool to support the operation of LV networks and the provision of LV flexibility offers	97
III.3.1 Getting an aggregated visibility on LV network constraints .....	98
Concept of the method .....	98
Algorithm presentation.....	99
Examples of application .....	103
III.3.2 Through the extension of the admissible voltage margins with LV flexibility offers .....	106
Extension of the admissible voltage margins thanks to LV flexibility offers activation ...	106
Examples of application .....	112
III.3.3 LV4MV architecture deployment.....	115
III.4 Innovative tool for the provision of flexibility offers for DSO constraints management at a minimum cost.....	117
III.4.1 DSO risk management and contingency analysis.....	117
Risk management and contingency analysis in transmission systems .....	117
Towards distributed risk management for the DSOs.....	118
III.4.2 Provision of remaining MV and LV flexibility offers for DSO constraints management, at a minimum cost .....	119
Heuristic based provision processes.....	119
Optimization based provision processes.....	134
Performances comparison between the methods .....	136
Advantages and drawbacks of the methods .....	138
III.5 Conclusion.....	140

---

**Table of figures**

Figure III-1 – Youngness membership functions represented by classical and fuzzy sets.....	84
Figure III-2 – Typical trapezoidal membership function representation .....	86
Figure III-3 – Fuzzy membership function representation of the active power at a flexible MV node .....	87
Figure III-4 – Flowchart of the developed validation method based on fuzzy arithmetic.....	89
Figure III-5 – Representation of a $\alpha i$ -cut of the active power at one node .....	90
Figure III-6 – Expected voltage profile and flowing currents in the 33-nodes network at 4 p.m. .	91
Figure III-7 – First set of available flexibility offers in the 33-nodes network at 4 p.m. ....	91
Figure III-8 – Fuzzy membership functions of active powers in the network .....	92
Figure III-9 – Fuzzy voltage profiles in the 33-nodes network ( $\alpha=1$ ) / first set of flexibility offers	92
Figure III-10 – Fuzzy voltage profiles in the 33-nodes network ( $\alpha=0$ ) / first set of flexibility offers .....	93
Figure III-11– Second set of available flexibility offers in the 33-nodes network at 4 p.m. ....	94
Figure III-12– Fuzzy voltage profiles in the 33-nodes network ( $\alpha=1$ )/ second set of flexibility offers .....	94
Figure III-13 - Fuzzy voltage profiles in the 33-nodes network ( $\alpha=0$ )/ second set of flexibility offers .....	95
Figure III-14 – Representation of a 4-wires line ( $i, j$ ) and of a single-phase end user connection in phase $\alpha$ .....	100
Figure III-15 – LV4MV process flowchart: Determination of the admissible voltage range .....	103
Figure III-16 – Initialization of the LV4MV process for the initial loading state of the considered LV network.....	101
Figure III-17 – Results of the LV4MV algorithm performed on the 12-nodes network in winter loading case.....	104
Figure III-18 – Voltage profiles of the 12-nodes network with the winter loading case and .....	104
Figure III-19 – Results of the LV4MV algorithm performed on the 12-nodes network in summer loading case.....	105
Figure III-20 – Voltage profiles of the 12-nodes network with the summer loading case and....	105
Figure III-21 - Flowchart of the economical step-by-step LV flexibility offers activation method	108
Figure III-22 – Flowchart of the efficient step-by-step LV flexibility offers activation method ...	109
Figure III-23 – Available LV flexibility offers in the 12-nodes network (winter loading case).....	113
Figure III-24 – Resulting MV admissible voltage ranges after step-by-step LV flexibility activation (winter loading case).....	113
Figure III-25 – Available LV flexibility offers in the 12-nodes network (summer loading case)...	114
Figure III-26 – Resulting MV admissible voltage ranges after step-by-step LV flexibility activation (summer loading case).....	114
Figure III-27 – LV4MV architecture in a primary substation federation.....	116

Figure III-28 - Illustration of the Kirchhoff 1st Law.....	122
Figure III-29 – Selection of flexibility offers for current congestion solving .....	122
Figure III-30 – Initial steps of the provision method for DSO risk management.....	125
Figure III-31 – Flexibility offers selection method for DSO risk management .....	126
Figure III-32 – Voltage profiles in the 72-nodes network (2 p.m.) – test case 1 – initial.....	128
Figure III-33 – List and status of the available flexibility offers – Sensitivity threshold set at 1% 128	
Figure III-34 – Voltage profiles in the 72-nodes network (2 p.m.) – test case 1 – final.....	129
Figure III-35 – Voltage profiles in the 72-nodes network (4 p.m.) – test case 2 – initial.....	130
Figure III-36 – Lists of the available flexibility offers selected by the heuristic methods – Sensitivity threshold set at 1% .....	130
Figure III-37 – Lists of the available flexibility offers (including LV4MV inputs offers) selected by the heuristic method based on efficiency – Sensitivity threshold set at 1% .....	131
Figure III-38 – Voltage profiles in the 72-nodes network (4 p.m.) – test case 2 – final.....	132
Figure III-39 – Flowing currents in the 72-nodes network (8 p.m.) – test case 3 – initial .....	133
Figure III-40 – List and status of the available flexibility offers.....	133
Figure III-41 – Evolution of the number of possible combinations with respect to the number of binary variables .....	136
Figure III-42 – Summary of the results of the different methods on the test cases .....	137

---

## III.1 Introduction

In a context where the interactions between the actors in the electrical system are more frequent, and where the flexibility operators are dealing with an increasing number of local flexibility opportunities, the DSOs have to play locally a new transparent key role [RIVE-15]. In the actual unbundled context, commercial aggregators are not able to assess the potential impact of flexibility activation on the distribution network. New strategies have to be established in order to allow DSOs to optimize the energy market access to all actors and to enable the exchanges processes. Meanwhile, they have to guarantee acceptable network operation conditions and to ensure a good quality of supply to their customers.

Hence, some solutions have to be developed to help the DSOs to validate the distributed flexibility offers that are proposed in the market, ensuring that these power exchanges are not endangering the overall network operation. Some innovative methodologies for technical pre-validation of the distributed flexibility offers are presented and validated in the first part of this chapter.

As discussed in chapter I, the large majority of the flexible end users in Europe are in the LV level. The DSOs have also to consider these flexibility offers that are emerging. Through the deployment of NICT in distribution systems, the distribution of the intelligence is permitting to gradually expand local functionalities that could support DSOs to better consider LV network constraints and LV available flexibility offers. A distributed mechanism could be developed for the DSOs in order to take advantage of LV flexibility offers to give a wider access to end users to the energy markets, but also for the overall distribution network operation. It could be then easier to exploit small residential and commercial end users flexibility potential. With this aim, a new mechanism is proposed in the second part of this chapter.

In addition to flexibility offers validation, DSOs still have to ensure continuously their distribution network operation in real-time, dealing with their network flexibility, but also with the available MV and LV flexibility offers that are remaining after markets gate closure. With the increasing number of unpredictable and volatile distributed generation, DSOs have to anticipate some scenarios where sudden changes in the expected network operation occur. New methodologies for short-term local risk management and contingency analysis have to be created. In this context, different methods dealing with near real-time remaining flexibility opportunities that have not been selected in the market processes are developed in the third part of this chapter.

## **III.2 Innovative tool for local technical validation of flexibility offers**

In order to permit commercial exchanges but also to increase end users full access to the energy markets and mechanisms, the DSOs have to check and ensure that the potential local offers will not affect the security and the operational reliability of the network. One of the new responsibilities of the DSOs is therefore to validate the provision of flexibility offers with respect to the security of the network and to the quality of electricity supply. These validations are based on the assessment of the impact of the proposed flexibility offers on the considered network state.

In a context of distributed architecture, these validation processes can be done at all voltage levels, and for all flexibility offers which are likely to get on the national energy markets and mechanisms.

### **III.2.1 Concerns and existing strategies**

Because of the fast increase of DG penetration and the emergent incentives for end users' participation (via DR for example), local offers of flexibility are more and more viable. In order to ensure that the potential activation of these flexibility offers will not create network operational constraints, the DSO needs to validate them before their transmission to the energy markets.

Assuming that these validations are done at all voltage levels of the distribution network, this would guarantee to all the deregulated actors that all the validated offers of flexible production and/or consumption would be technically applicable from a network point of view. At the upper level, the TSO is also ensured that any activation of the available flexibility opportunities for balancing or for transmission constraints management will not endanger the entire distribution system and will not create voltage deviations or current congestions.

These pre-validation processes are the core of a new DSO-TSO coordination, permitting a more precise BRP risk management and a safer TSO operational planning. An example of a scenario has been proposed in *evolvDSO* [BART-14], showing the need of DSO-TSO coordination for TSO balancing mechanism. This use case highlights the importance of a validation mechanism of DER's bids willing to be sold on the TSO's balancing market. The objective is to foresee DER bids that are non-transmittable and avoid their submission on the balancing market in order not to weaken the distribution grid in case of activation. In an operational planning point of view, given that the energy offers accepted on the balancing market are not full-time activated, the final grid situation must stay compliant with the grid codes regardless the activation or not of each DER bids.

With the liberalization of the energy sector, the development of some methods involving both non-competitive and competitive actors is a highly relevant topic. Some strategies for this pre-validation process which have been already proposed are presented in the following section.

### **Existing validation methods for flexibility offers**

With the growing number of the distributed flexible resources in the distribution network, the DSO has to check and validate the flexibility offers at the different levels of the grid before the commercial aggregation process. If the potential activation of the flexibility offer could endanger the security or create network constraints, the flexibility offer should be rejected.

These kinds of strategies have already been investigated in some research works. For example, the ADDRESS project [BELH-11] investigated different services that distributed active demand participation of domestic and small commercial consumers can provide to the competitive and non-competitive electricity system players. Among other solutions, the technical validation performed by system operators has been developed. In ADDRESS, the technical validation approach is performed in two steps [VALT-11]. The first proposed “ex ante” technical validation is performed before the markets closure, before each commercial aggregation process. This aims to check if the declared MV and LV flexibility offers could be effectively activated if they are selected during the different market processes and mechanisms performed at the national level, without creating any congestions or voltage deviations, nor endangering the overall system reliability. With this aim, TSO and DSO are periodically updating some “flexibility tables” which correspond to the available validated offers. This validation mechanism is mostly based on power flow computations with different activation status of the available flexibility offers.

The second step is called the “real-time” technical validation. It permits the DSO to adjust the “flexibility tables” near real-time, depending on the network state, through the computation of curtailment factors. For this process, a second power flow analysis is performed with the more accurate network and powers data. If no constraint is infringed, the validation is approved. In case of some constraints appear, the DSO has to find a solution thanks to grid flexibility to solve it (via changing tap ratio, switching shunts or SVCs for instance). Finally, if no solution is found, the algorithm updates the pre-validated flexibility offers via the computation of curtailment factors.

In the INCREASE project [GUBI-15], a similar technical validation mechanism for near real-time time scale has been also developed. Based on a traffic light system, a first expected load schedule is either accepted or potentially rejected with respect to the network status. If it is potentially rejected, another advanced traffic light system permits deciding if the available flexibility opportunities schedule can be accepted or rejected depending on the “direction” of the flexibility offers, i.e. depending on the influence of the flexibility offers on the potential network constraints.

All these proposed methodologies are based on centralized strategies, and therefore require the knowledge of the overall distribution network topology, as well as the expected consumption and production schedules of all end users. While going closer to real-time, the forecasts are becoming more precise and the pre-validation computations have to be performed again. These methods are entirely based on deterministic approaches. This type of methods is requiring significant computational capabilities and might be limited by the large amount of data needed. In the following section, other different possible strategies to model the potential available flexibility offers are discussed.

### **Possible strategies to model potential available flexibility offers**

In order to validate the potential available flexibility offers in a deterministic way, the expected load and production schedules of all end users have to be perfectly forecasted. However, consumptions and productions in the distribution network cannot be precisely predictable. Moreover, each end user who has a contract with a commercial aggregator for a certain amount of flexibility can derogate the flexibility activation at any moment [GREE-16]. Therefore, DR management is adding more uncertainties to load flow computation. Some models including uncertainties can be used to represent it.

Using deterministic methods such as exhaustive enumeration [NIEV-00] can be an option for the pre-validation of the flexibility offers. The idea of this method is to enumerate every possible network states while checking if the different combinations of flexibility offers can be validated or not. This method is quite straightforward but the full enumeration is usually not possible because of the prohibitive number of system states and flexibility offers combinations, leading to a combinatorial explosion.

Another deterministic approach can focus on the most severe states of the network over the year [ABDE-14]. A typical approach of the DSOs is to consider the critical time slots of consumption peaks periods and of production peaks periods, in order to determine the flexibility capacity needs but also the extreme limits of network operation. However, this method gives only the restricted limits and the minimum required flexibility needs that correspond to the worse network operating cases of the entire year. This is not well-suited for the validation of available flexibility offers that might be validated while considering a normal state of operation.

Fortunately, different mathematical approaches are quite efficient to represent uncertainties and are largely used for risk assessment. For example, probabilistic techniques are characterized by the use of random variables aiming to mathematically characterize the uncertainty in the system response. In the same philosophy, possibilistic techniques involve the use of fuzzy arithmetic to model uncertainty and are particularly useful, fast and simple when dealing with large and complex systems [ROBI-98].

Among probabilistic methods, two fundamental approaches can be distinguished: analytical probabilistic methods and Monte Carlo simulations method. On the one hand, analytical probabilistic methods are characterized by the use of analytical techniques to find a particular point that can be

related (at least approximately) to the probability of system failure. These mathematical techniques can be for example based on mean value and convolutions methods, response surface methods, or others reliability methods [ROBI-98]. On the other hand, the Monte Carlo method essentially uses a random sampling of the possible system states with a sampling frequency related to the probability of the state occurrence. Inputs of the method are defined as probability density functions taking into account the uncertainties. Monte Carlo simulation methods are generally flexible for complex operating conditions where system considerations are incorporated (such as bus load uncertainty and weather effects) [BILL-95]. However, in order to obtain an aggregated result that converges to a stable mean, the number of simulations can be very large, imposing heavy computational needs. A detailed analysis may be required for each sample (at least a power flow computation), therefore the computational effort can become considerable [CIGR-07]. This reason encourages searching for a faster and simpler way to deal with uncertainties in the distribution grid.

An approach based on fuzzy arithmetic has been investigated and developed. Fuzzy arithmetic is a mathematical method that can model uncertainties with fuzzy variables, which may have a truth value that ranges in degree between 0 and 1 [KLIR-95]. The fuzzy arithmetic allows uncertainties applied on input variables such as consumption or production uncertainty to be modelled. The obtained results give the upper and the lower possible boundaries of the electrical characteristics with much less computation effort [NIKO-98]. This method is a very efficient tool to model vagaries in distribution network and, as shown in the following sections, is helpful to perform local technical flexibility offers validation for large distribution networks. The following presented validation process of local flexibility offers is distributed among the distribution network and is aiming to assess the overall possibility of network constraints violations considering all the possible combinations of the available flexibility offers. Considering all the distributed results of the pre-validation method, the DSOs will be able to have a general point of view on the possible impact of the set of the available flexibility offers on their network, with a restricted computational need.

### **III.2.2 Introduction to fuzzy arithmetic**

Fuzzy sets were introduced by Zadeh and Klaua in 1965 as an extension of the classical notion of set, in order to model the imprecise and fuzzy characteristic of concepts used in common language [ZADE-78]. Classical logic only permits conclusions which are either true or false. Fuzzy logic has been extended to handle the concept of partial truth, where the truth value may range between completely true and completely false. The introduction of the fuzzy logic has been the source of much confusion in the analysis of uncertainties. Indeed, degrees of truth and probabilities ranges between 0 and 1 are often mixed up. However, they are conceptually different: the degree of truth represents the degree of veracity of the property of the set, and not the probability of occurrence of an event.

The whole concept can be illustrated with a typical example, which assesses the youngness of people. It can be assumed that people younger than 25 years old are young. The classical set function



describes the membership of the ‘young’ set as follow (see Figure III-1 (a)): people are either in the set if they are younger than 25, or they are not in the set if they are older than 25. This type of sharp edged membership functions works for binary operations and mathematics, but it does not give the best estimate when describing the human perception. This membership function makes no distinction between somebody who is 26 years old and someone who is 72 years old: they are both simply ‘not young’. The other side of this lack of distinction is the difference between a 24 years old and a 26 years old person. There is only a difference of 2 years but this membership function just says that one is young and the other is not young. A fuzzy set approach to the set of ‘young’ people can provide a much better representation of the youngness of a person. This fuzzy set is defined by a continuously decreasing function (see Figure III-1(b)). The membership function defines the fuzzy set for the possible values, set on the horizontal axis. The vertical axis, on a scale of 0 to 1, provides the membership value of the height in the fuzzy set.

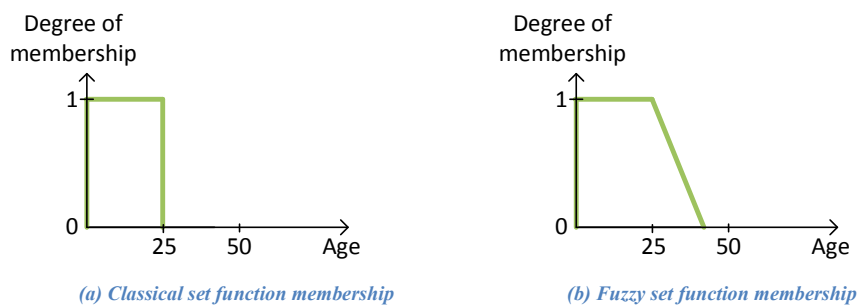

Figure III-1 – Youngness membership functions represented by classical and fuzzy sets

Considering a given person: if the person has a membership of 0.3, it means that he is not very young. If the person has a membership of 0.98, it means that he is definitely young. Hence, thanks to the fuzzy logic, it is possible to add some degree of truth in order to consider qualitative uncertainties.

In the following, the mathematical methods are based on fuzzy sets and on fuzzy logic, of which some of the basic rules are presented hereafter.

### Fuzzy sets, fuzzy membership functions and $\alpha$ -cuts

A fuzzy set  $A$  in  $X$  is characterized by a membership function  $f_A$  which associates with each point in  $X$  a real number in the interval  $[0,1]$ , with the values of  $f_A(x)$  at  $x$  representing the "grade of membership" of  $x$  in  $A$ . Thus, the nearer the value of  $f_A(x)$  to unity, the higher the grade of membership of  $x$  in  $A$  [ZADE-78]. Hence, when  $f_A(x) = 0$ , the element  $x$  is not included in the set  $A$  and when  $f_A(x) = 1$ , the element  $x$  is included in the set  $A$ . Each fuzzy set  $A$  can be defined by all the pairs composed of each element  $x$  and of its membership function value  $f_A(x)$ .

In fuzzy sets theory, each defined membership function has to respect the following properties: considering a fuzzy set  $A$ , each membership function  $f_A$  has to be normalized, meaning that it exists at least one element  $x$  in  $\mathbb{R}$  that verifies the equality  $f_A(x) = 1$ . Secondly, each membership function has

to be continuous and bounded. Finally, each membership function has to be convex, implying that all the  $\alpha$ -cuts of the set  $A$  are closed intervals in  $\mathbb{R}$ . These intervals reflect the degree of truth  $\alpha$  of the membership function of each element  $x$ . Mathematically, this can be written as in equation (III.1).

$$\forall \alpha \in [0,1], \forall (x, y) \in \mathbb{R}^2, \quad f_A(\alpha x + (1 - \alpha)y) \geq \min(f_A(x), f_A(y)) \quad (III.1)$$

A given degree of truth  $\alpha$  determines a given interval of the considered membership function. The  $\alpha$ -cuts are constituted by the elements  $x$  which have a degree of truth  $f_A(x)$  that is equal or higher than  $\alpha$ . While coming back in the classical set theory, it is possible to define an  $\alpha$ -cut as a set  $A_\alpha$  with the following characteristic function (equation (III.2)).

$$\varphi_{A_\alpha}(x) = \begin{cases} 1 & \text{if } f_A(x) \geq \alpha \\ 0 & \text{if } f_A(x) < \alpha \end{cases} \quad (III.2)$$

### Typical fuzzy membership functions

Even if fuzzy membership functions can have whichever shape respecting the previous definitions, some standard shapes are usually used to represent them [HANS-05]. For example, the Gaussian membership function is characterized by a normalized Gaussian function, presented in equation (III.3).

$$f_A(x) = e^{-\frac{(x-\mu)^2}{2\sigma^2}} \quad (III.3)$$

With the expected value  $\mu$  and the variance  $\sigma^2$  of the Gaussian function. Any  $\alpha$ -cut of this membership function can be represented as the set  $A_\alpha$  defined in equation (III.4).

$$\forall \alpha \in [0, 1], \quad A_\alpha = [\mu - 2\sigma \sqrt{\ln(\alpha^{-1})}, \mu + 2\sigma \sqrt{\ln(\alpha^{-1})}] \quad (III.4)$$

Another typical membership function shape is the trapezoidal membership function, characterized by the four parameters  $a_1, a_2, a_3,$  and  $a_4,$  and mathematically defined as in equation (III.5).

$$f_A(x) = \begin{cases} \frac{x - a_1}{a_2 - a_1}, & \text{for } a_1 \leq x \leq a_2 \\ 1, & \text{for } a_2 \leq x \leq a_3 \\ \frac{a_4 - x}{a_4 - a_3}, & \text{for } a_3 \leq x \leq a_4 \end{cases} \quad (III.5)$$

Where  $a_1$  and  $a_4$  locate the "feet" of the trapezoid ( $\alpha = 0$ ) and the parameters  $a_2$  and  $a_3$  locate the "shoulders" of the trapezoid ( $\alpha = 1$ ), as represented in Figure III-2.

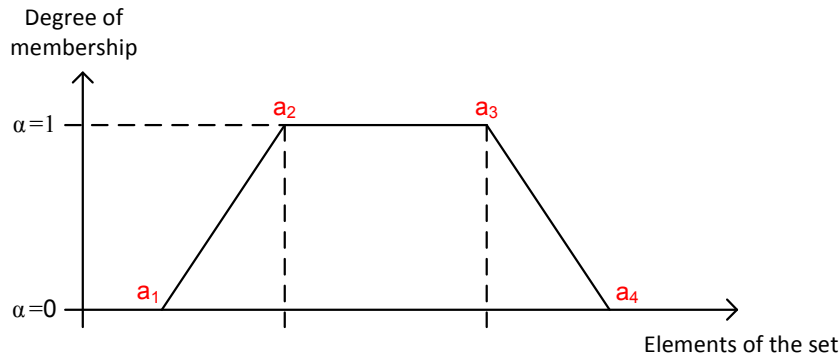

Figure III-2 – Typical trapezoidal membership function representation

Any  $\alpha$ -cut of this membership function can be determined as the set  $A_\alpha$  defined in equation (III.6).

$$\forall \alpha \in [0, 1], \quad A_\alpha = [a_1 + \alpha(a_2 - a_1), \quad a_4 - \alpha(a_4 - a_3)] \quad (III.6)$$

As in classical set theory, some mathematical operations involving fuzzy sets are also possible. They are included in the fuzzy arithmetic and enhance, among other, fuzzy complement, fuzzy union, and fuzzy intersection. In the case of trapezoidal membership functions, the operations done on the fuzzy sets are involving only the extreme values of each interval.

### III.2.3 Validation of flexibility offers using fuzzy arithmetic

Fuzzy arithmetic has already been used in some specific applications for the distribution network. For example, it has been applied to model distribution networks under uncertainties [BRIC-12], and also for power system fault diagnosis in [GAUT-11] using fuzzy model to determine the most likely fault sections. It is also used for optimal planning [RAMI-04] where fuzzy logic is associated with the uncertainties on the future demand, on the expansion cost of the distribution network, on the power flow in the feeders and substations, and on the network node voltages.

Fuzzy arithmetic is used in this thesis in order to develop a novel and efficient local flexibility offers validation algorithm for the DSO, which is considering all the flexibility offers that are likely to get on the national energy markets and mechanisms.

#### Fuzzy representation of the available flexibility offer

In the model, each active power value is represented with a fuzzy approach and is associated with a trapezoidal membership function. Figure III-3 represents the fuzzy active power of a particular MV node consuming or producing  $P_{init}$ . From an aggregated view of several LV flexible end users, or simply from a MV level flexible end user, this MV node can offer respectively either a flexible consumption dispatch down of  $\Delta P$  via DR, or a flexible production dispatch down of  $\Delta P$  via generation control. The

fuzzy model of the flexibility offer can also be created symmetrically with the similar shape for a production dispatch increase or a consumption dispatch increase at the node.

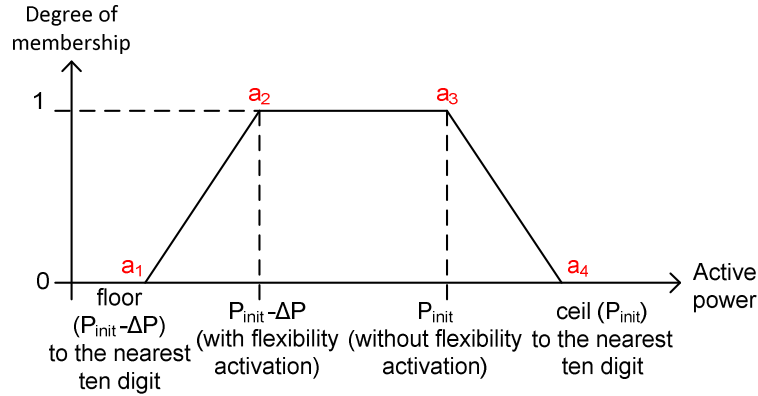

**Figure III-3 – Fuzzy membership function representation of the active power at a flexible MV node**

This trapezoidal membership function permits the different possible values of the considered active power at the node to be represented, depending on the state of activation of its available flexibility offers. The four parameters  $a_1$ ,  $a_2$ ,  $a_3$  and  $a_4$  are defined as follow.

Knowing the initial expected active power  $P_{init}$  at the node, and the available quantity of active power flexibility  $\Delta P$ , the best estimate of the effective active power at the node is between these two quantities, represented by the parameters  $a_2$  and  $a_3$ . Indeed, the whole aggregated flexibility offers at the MV node can either be activated or not. In case where the activation rate is not 100% because of possible derogations, the final active power will be also included within this interval. Hence, the fuzzy arithmetic can be used in order to surround the network characteristics obtained by the different possible combinations activations of the available flexibility offers. In the case where a node is not flexible at all meaning that  $a_2 = a_3$ , the fuzzy membership function representation of the active power at the node is triangular.

Moreover, the expected active power and the available flexibility offer at each MV node can be more or less reliable and accurate data. The two parameters  $a_1$  and  $a_4$  are representing the maximum limits of the error on the data, and can be enlarged or reduced depending on the accuracy of the forecasts. Here, it is assumed that the expected active power and the available flexibility offer at the node are quite reliable but not very accurate, and that the forecasted values are rounded to the nearest ten of the declared powers. These errors can be non-symmetric, and of different values depending on the considering node. In the case where the forecasts are 100% reliable, meaning that  $a_1 = a_2$  and  $a_3 = a_4$ , the fuzzy membership of the active power at the node is rectangular.

The same fuzzy representation can be applied on the reactive power at each node, by fixing the power factor as a constant and thus having a homothetic relation between reactive and active powers.

## Presentation of the method

Considering all the available flexibility offers in a given part of the network, it is possible to determine if they can be all validated and transmitted to upward levels. This requires that any combination of them is leading to a situation that respects local network constraints. If there are some risks of constraints violations for certain combinations of flexibility offers, the available flexibility offers cannot be validated as a whole.

In order to assess the possible impact of the different combinations of the flexibility offers on the network operation, a fuzzy loadflow computation has been developed. Several fuzzy loadflows based on different techniques are proposed in the literature. For example, [CORT-07] introduces a loadflow based on the fuzzy numbers arithmetic and on the network linear model. [DARA-11] is proposing a fuzzy loadflow based on the Newton-Raphson technique, while [SARI-03] develops a fuzzy state-estimation based on the backward-forward method. In this work, the method is based on a fast and low computational requirements loadflow method based on backward-forward iterations, presented in the *Annex I - Loadflow tools methodology*.

Internally in the loadflow tool, the computation of the resulting fuzzy parameters is considering the two worse cases of dispatch combinations for network operation. The first case is corresponding to the maximum of DR activation with a maximum of DG production, while the second case is corresponding to the maximum of DG production dispatch down with a maximum of load consumption.

A flowchart of the method is presented in Figure III-4. Considering the distributed architecture presented in section II.3.1, the proposed methodology should be distributed in all the substation DSO agents, and performed locally in MV level for each primary substation federation.

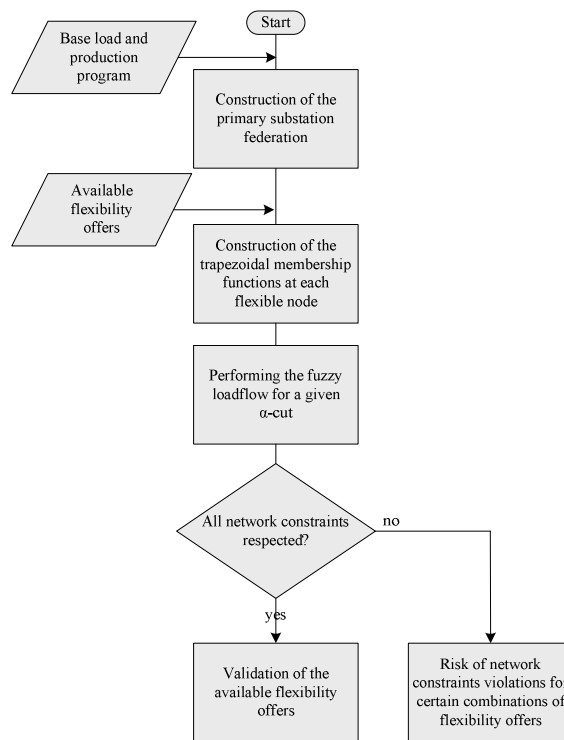

Figure III-4 – Flowchart of the developed validation method based on fuzzy arithmetic

In order to consider also LV networks, it can also be distributed in LV DSO agents and performed in each LV cell.

In the case where all the network constraints are respected for the chosen  $\alpha$ -cut, all the available flexibility offers are validated. The resulting validated flexibility offers can then be sent to the local commercial aggregator agent, who can transmit them to the upper levels of the grid.

If some network constraints are not respected, some combinations of flexibility offers activation have to be avoided. Due to the computational dependencies of the network power flows, the specific flexibility offers that cause constraint violations cannot directly be identified. Thanks to this method, it is possible to assess the risk of network constraints violations, depending on the combinations of the available flexibility offers.

The choice of the  $\alpha$ -cut is depending on the reliability of the declared data and on the error of the consumption and production forecasts. If the declared data at the node are 100% reliable, it is accurate to investigate the  $\alpha$ -cut corresponding to  $\alpha = 1$  which represents only the limited set of all the combinations of possible active powers that can be consumed or produced in any cases of activation or of non-activation of the flexibility offers. However, if the data are not fully reliable or accurate, it is also possible to consider a larger  $\alpha$ -cut corresponding to a smaller  $\alpha$ .

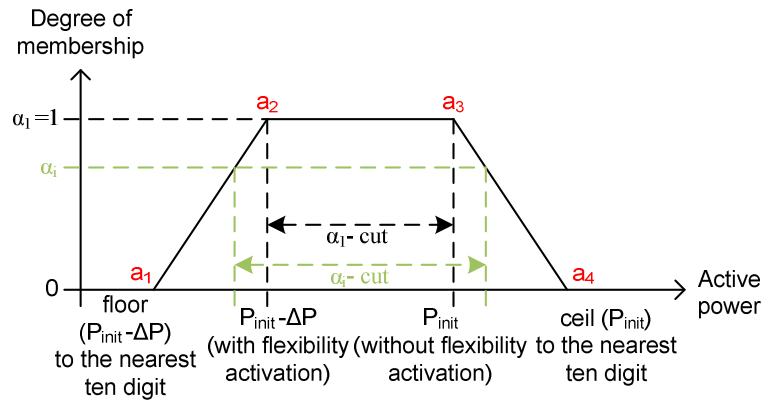

Figure III-5 – Representation of a  $\alpha_i$ -cut of the active power at one node

As shown in Figure III-5, the lower  $\alpha_i$  is considered, the more uncertainties on the declared power and on the flexibility offer are taken into account, and then, the larger  $\alpha_i$ -cut is considered.

### Examples of application

The considered cases are specific examples of this method applied on a MV 33-nodes balanced electrical network, which corresponds to a given primary substation federation. Corresponding networks characteristics are presented in *Annex II – Test networks data*. The loading curves applied on the network are corresponding to the 4 p.m loading and are also presented in the *Annex II - Test networks data*. In these cases, the voltage value at the bus-bar is set at 1.01 pu and the OLTC tap of the transformer at the primary substation is fixed.

Before the wholesale markets closure, it is assumed that some flexibility offers are available at some nodes in the 33-nodes network. The available flexibility offers in the following examples are assumed to be only decreases of active power, either of production via production dispatch down, or of consumption via DR.

They have to be validated by the DSO before being transmitted up to the upper level by the commercial aggregator agent for the intraday market processes. The validation method is performed in order to assess the risk of possible network contingencies in case of any activation of these flexibility offers. The deterministic expected voltage profile and flowing currents without any flexibility activation in the 33-nodes network at 4 p.m. are represented in Figure III-6.

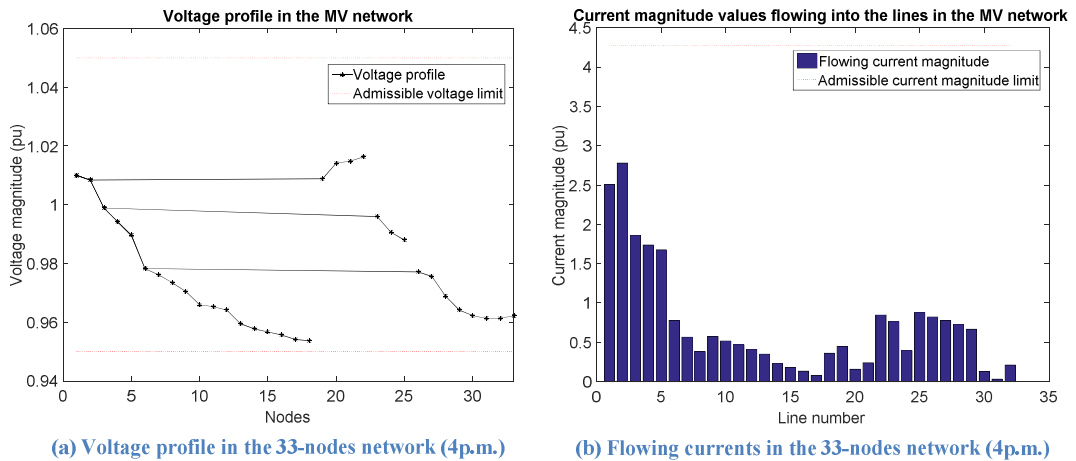

Figure III-6 – Expected voltage profile and flowing currents in the 33-nodes network at 4 p.m.

A first set of available flexibility shown in Figure III-7 is assumed to be available in the local primary substation federation. In this first set, only consumption reductions are proposed via DR management.

Flexible node	$\Delta P$ demand response (kW)
4	31
5	16
6	14
7	55
15	16
16	13
17	14
18	21
30	54
31	36

Figure III-7 – First set of available flexibility offers in the 33-nodes network at 4 p.m.

The fuzzy membership functions of the active powers at each node of the considered network are represented in Figure III-8. As explained previously, the fuzzy membership functions at the flexible nodes are trapezoidal, illustrating the possible activation of the flexibility offer and the round values of the forecasts; whereas those corresponding to non-flexible nodes are triangular, characterizing only the second digit round values of the previsions.



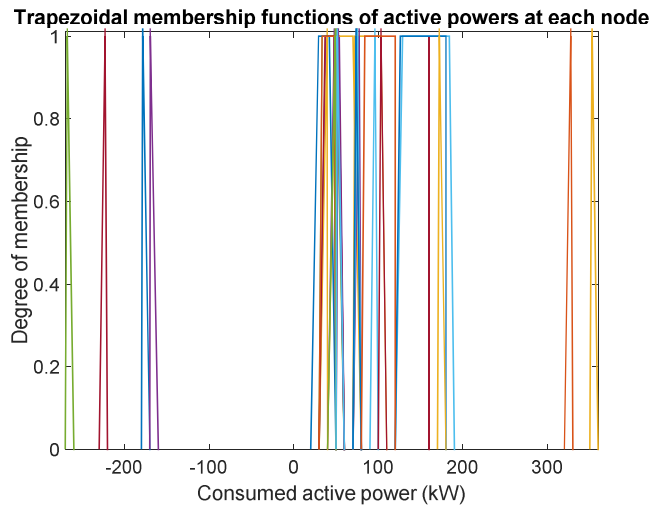

Figure III-8 – Fuzzy membership functions of active powers in the network

Two simulations are then performed for two different  $\alpha$ -cuts. In the first one,  $\alpha = 1$ , meaning that the errors on the forecasts are not taken into account, and thus, the power values are not rounded to the nearest ten. The resulting fuzzy voltage profiles are shown in Figure III-9. Dealing only with DR flexibility offers in this set, the lower cut in the membership functions is corresponding to the case where all the flexibility offers are activated. Therefore, the voltage profile corresponding to the lower cut in the membership functions is the upper limit of the possible voltage profile. The higher cut is corresponding to the case where no flexibility offer is activated. Hence, it is matching with the initial deterministic situation without any flexibility activation.

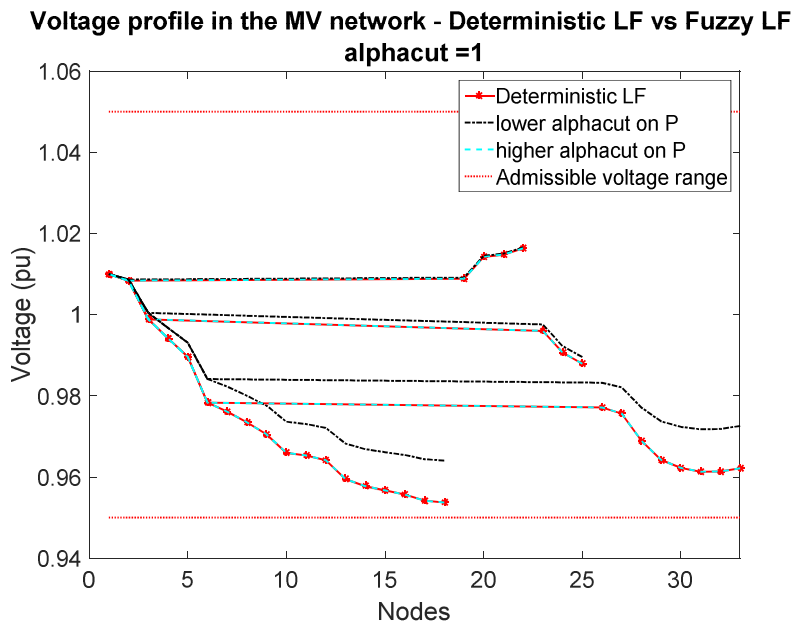

Figure III-9 – Fuzzy voltage profiles in the 33-nodes network ( $\alpha=1$ ) / first set of flexibility offers

In this case, when the errors on the forecasts are not taken into account, the voltage profiles of the two cuts are respecting all voltage constraints. Thanks to this method based on fuzzy arithmetic, the substation DSO agent can conclude on this specific case that any combination of available flexibility offers activation will lead to a given voltage profile included within these two cuts. Therefore, all the available flexibility offers can be validated and transmitted up to the upper level of the grid.

In a second simulation, some errors on the forecasts are taken into account and the values of the expected powers are rounded to the nearest ten ( $\alpha = 0$ ). The fuzzy voltage profiles for the two different cuts are represented in Figure III-10.

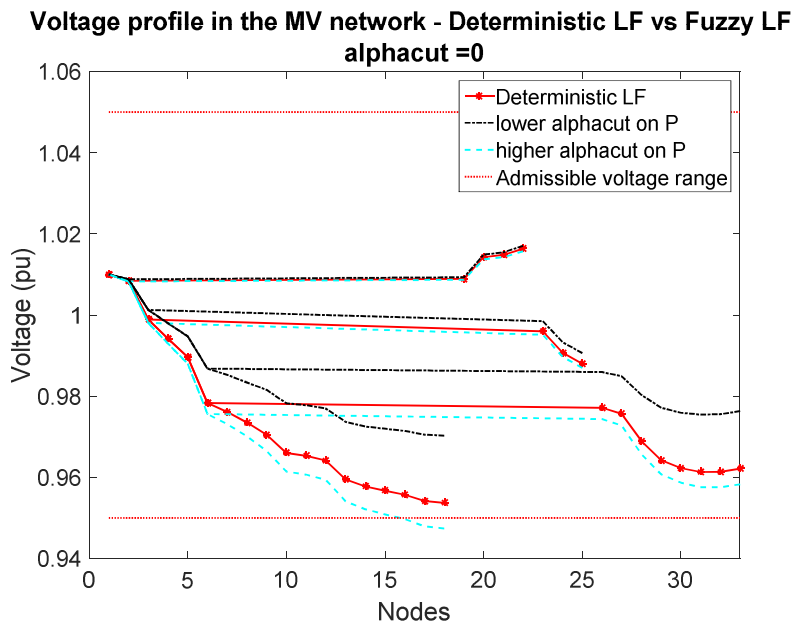

Figure III-10 – Fuzzy voltage profiles in the 33-nodes network ( $\alpha=0$ ) / first set of flexibility offers

In this case, the uncertainties on the forecasts enlarge the range between the two extreme voltage limits. If all the flexibility offers are validated, there is a risk of voltage constraints violations at nodes 16, 17 and 18 if all these flexibility offers are activated and have all a magnitude error lower than 10 kW on their values. These cases illustrate the importance for the DSO to have a good knowledge on the possible errors and accuracy on the forecasts in order to be able to anticipate the possible voltage constraints deviations and to validate the different available flexibility offers possibility.

In a second scenario, another set of available flexibility offers is proposed by the local commercial aggregator agents, shown in Figure III-11. In this second set, consumption reductions are proposed via DR management but also production dispatches down.

Flexible node	$\Delta P$ dispatch down (kW)	$\Delta P$ demand response (kW)
4	0	31
5	0	16
6	0	14
7	0	55
15	0	16
16	0	13
17	0	14
18	0	21
20	268	0
30	0	54
31	0	36
33	170	0

Figure III-11– Second set of available flexibility offers in the 33-nodes network at 4 p.m.

The same simulation is performed for the  $\alpha$ -cut corresponding to  $\alpha = 1$ , i.e. the errors on the forecasts are not taken into account. The voltage profiles are shown in Figure III-12.

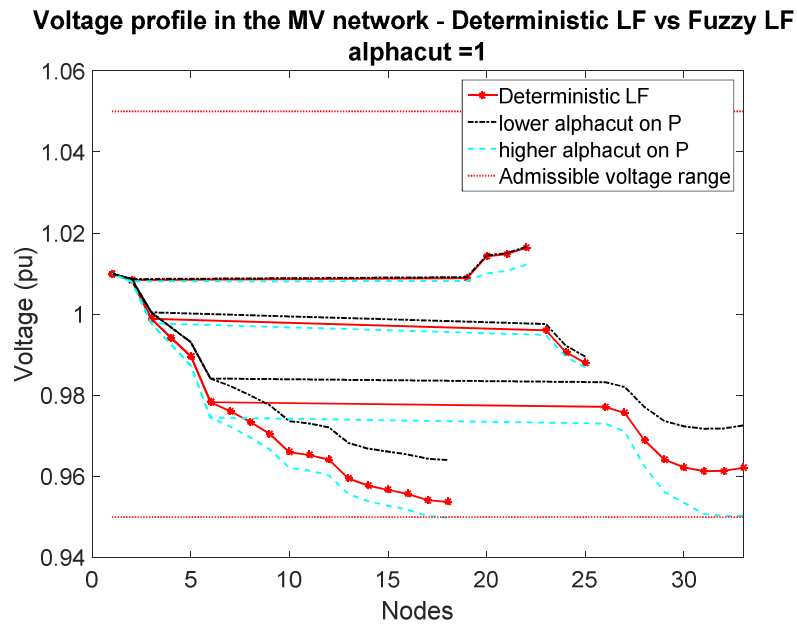

Figure III-12– Fuzzy voltage profiles in the 33-nodes network ( $\alpha=1$ )/ second set of flexibility offers

In this case, the two cuts are corresponding to the worse cases of network operation that can happen with flexibility offers activation. The lower one is illustrating the situation where only DR flexibility offers are activated whereas the upper one is representing the case where only DG production dispatch down are activated. Thanks to this method, it is very easy to consider the worse cases of network operation depending on the available flexibility offers at each time step.

If the DSO considers that the data are 100% reliable and accurate, the substation DSO agent can validate all the proposed available flexibility offers because he knows that any combination of these flexibility offers activation will lead to a voltage profile that respects network voltage constraints.

On the contrary, if the DSO considers that the data are not accurate and have to be rounded to the next 10 kW, the substation will not be able to validate all the proposed available flexibility offers in this specific case. Indeed, as represented in Figure III-13, there is a risk of under-voltages for some particular combinations of these flexibility offers.

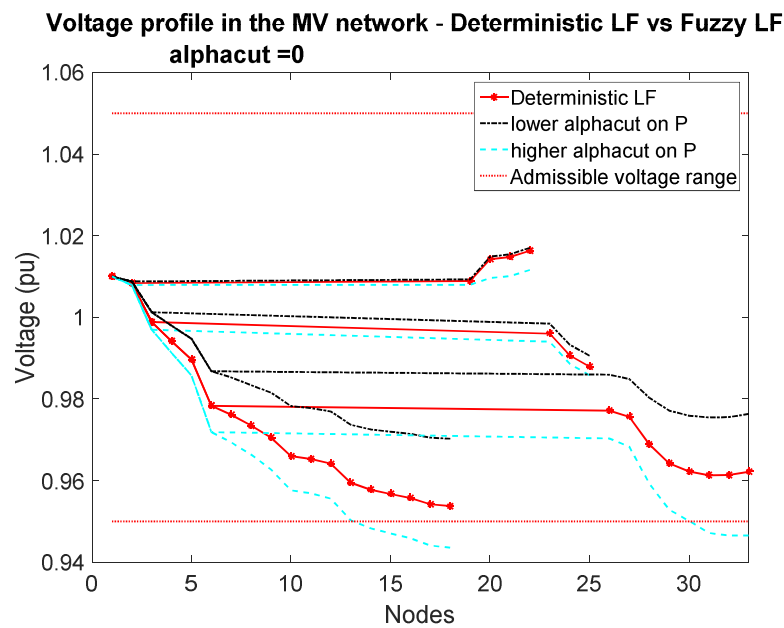

Figure III-13 - Fuzzy voltage profiles in the 33-nodes network ( $\alpha=0$ )/ second set of flexibility offers

Finally, a great advantage of the fuzzy arithmetic is the possibility to assess the effect of the forecast reliability and accuracy on the expected voltage profiles. Depending on its confidence on the data, the DSO can estimate the new limits of voltage profiles of the worse cases for network operation.

Others complementary results of this technical validation process performed on a 72-nodes network are presented in *Annex III – Complementary results of the local technical validation of flexibility offers*.

In this part, a decentralized methodology based on fuzzy arithmetic has been elaborated for the DSO. Thanks to it, the DSO can enable the provision of flexibility offers by validating them and ensuring that their potential participation will not affect the security and the operational reliability of the network in MV level. Moreover, thanks to the decentralization of the method in every primary substation cell, computational requirements remain low and the commercial aggregation of the offers can be done step by step at the different voltage levels. In order to apply this method, the message exchanges between

the DSO and the different commercial aggregators have to be formalized and controlled to avoid potential forbidden agreements between the actors.

This new methodology of technical pre-validation before the exchanges process will permit the DSOs to increase end users full access to the energy markets, by assessing the potential impacts of the potential flexibility offers on the distribution network. The presented part focused only on MV network constraints and on MV flexibility offers. A complementary tool could be also used in order to enlarge the MV network constraints where only LV networks are connected, leading to a larger validation of potential flexibility offers and to an increase of the end users access to the energy markets.

Moreover, this technical pre-validation method permits the DSOs to better manage their network risk assessment. Indeed, this kind of tool will permit the DSOs to better anticipate their network situations and thus, will permit them to check if enough remaining local flexibility opportunities will be available for potential constraints management in both MV and LV levels.

Hence, in order to increase the end users access to the energy markets, but also to provision the more remaining local flexibility opportunities for MV and LV network management, it is interesting to consider both MV and LV available flexibility offers. In the next part, a DSO tool to support the operation of LV networks and the provision of LV flexibility offers is presented.

### **III.3 A DSO tool to support the operation of LV networks and the provision of LV flexibility offers**

Until few years, the monitoring and the automation of LV networks were extremely limited. DSOs did not consider economic optimization of LV networks operation but adopted a fit and forget approach which ensured that the LV network constraints were respected in the worse cases of operation [EUR2-13]. However, the large penetration of Distributed Renewable Energy Sources (DRES) undergoing worldwide within the distribution grids, engenders a degradation of the voltage profiles on both the MV and LV levels [TRAN-03]. As operational margins are becoming smaller, DSOs are now faced to a compromise between grid reinforcement solutions and grid operational solutions.

With the development of Smart Grids, more and more cheap and reliable NICT are available in distribution systems down to the lowest levels of the grid, which enable new operational solutions. The choice of the distribution of the intelligence permits to gradually deploy local functionalities such as to support DSOs to better consider LV network constraints and LV available flexibility offers. Indeed, considering for example that there are almost 770 000 secondary substations in France [ENED1-14], the developed functionalities should be designed in a way that the DSOs can deploy them progressively.

Since a few years, monitoring techniques of the LV networks [FERD-14] and state estimation based on smart meter data [WAER-15] are largely investigated. Some techniques based on smart meter data are as well attempting to rebuild the entire topology and the characteristics of the LV networks [BENO-15].

Based on an assumed monitoring possibility and on an expected knowledge of LV networks, several papers are presenting new LV local operational functionalities. For example, the project DG DemoNet – Smart LV Grid [EINF-12] is proposing a set of different local methods for active LV grids. Strategies for intelligent monitoring and active management and control of smart MV/LV transformers and local PV inverters are investigated with the aim to ensure that LV networks constraints are always respected. In the same vein, a three-stage control model is proposed in [OERT-13] combining voltage control by use of a controllable transformer, power-factor control of individual generation, load and storage units, and active power curtailment if inevitable. Finally, [GOIK-09] analyzes the possible outcomes of the instauration of active secondary substation in critical LV grids. The contribution of different active devices such as OLTC and STATCOM with energy storage and dump-loads are investigated.

Other works are also proposing LV flexibility offers aggregation for MV network support. For example, during the INTEGRAL project, a method has been developed to aggregate all the LV flexibility offers available in each considered LV network during normal operation [LE-08]. These aggregations can be done at the scale of each household or at the scale of the LV network and are aiming to find the best power balance in the area. This solution is created in order to support the MV grid in a sense that it

permits the overall consumption or production power at a considered node to be reduced. The same methodology has been also tested in case of critical situations of the MV grid, in order to permit islanding mode of operation for the LV network for example.

All these proposed strategies are aiming to create a local and independent control of each LV network, which can lead to suboptimal network operation and to unfair local markets with high prices volatility.

In this work, the proposed strategy is aiming to get a more accurate visibility on all the equipped LV networks characteristics in order to better take them into account when operating the network at MV level. The aggregation of the LV flexibility offers is done while taking into account the LV network constraints. This tool has been thought as a pre-operational service for DSOs, permitting them to assess the available overall LV network limits during MV network optimization. Thanks to the distributed approach of the method, the solution can be gradually deployable in order to permit DSOs to focus firstly on specific critical LV networks.

### **III.3.1 Getting an aggregated visibility on LV network constraints**

In order to give an accurate aggregated visibility on critical LV networks, the basic idea of the method is to convert LV network constraints in a new dependent MV admissible voltage range.

A similar concept has been elaborated for evaluating the benefits of off-load tap changer in MV/LV substations in [GONZ-13]. A method is proposed to determine the Voltage Operational Margin, which is defined as the voltage range within which the tap changer can be kept without incurring voltage deviations all over the LV grid. This methodology permits the critical PV penetration level and the critical load level to be estimated beyond which local operations in the LV distribution grid may be required.

In the same philosophy, the aim of the developed concept is to determine a constraints-dependent voltage margin at each MV node where only LV network is connected. This new voltage margin reflects the downstream LV network loading and will help for MV network optimization.

#### **Concept of the method**

According to EN 50160 [EURE-95], it is recommended that, under normal conditions, the variations range of the r.m.s. magnitude at the supply terminals for LV levels should be  $U_n \pm 10\%$  for 95% in any period of one week, where  $U_n$  is the nominal voltage. Moreover, the European standard is also imposing that the supply voltage imbalance has to stay below 2% for 95% of the week in all European distribution networks in order to limit neutral currents. Practically the unbalance  $imb_i$  of the supply voltage at a node  $i$  is defined by the ratio between the negative sequence component  $V_{i-}$  and the positive sequence component  $V_{i+}$  (see equation (III.8)).

Until now in Europe, few DSOs were really able to monitor and operate LV networks. They generally guarantee voltage margins in MV level in order to ensure the operation in LV level. This often leads to suboptimal operation of the system network, adding oversized MV structural constraints for the DSOs due to the lack of monitoring and control in LV networks.

With the large deployment of smart meters in the LV networks, DSOs are able to monitor their LV networks and to integrate more and more DGs by operating their networks closer to their technical and regulatory limits. With this aim, the developed LV4MV tool has been designed to release the admissible MV constraints by considering downstream LV network constraints. This method is also presented in [VANE-15] and [VANE-16].

The aim of the LV4MV concept is to reflect the LV network constraints and flexibility resources in MV level, via the monitoring of LV networks and via the management of the LV DER available dispatches. The idea is to consider a specific and constraint-dependent admissible voltage range per MV node, instead of a fix MV voltage range for all the MV nodes. It enables increasing the degree of freedom of the MV nodes where only LV networks are connected: at these nodes, the voltage at the MV/LV transformer might be outside of the MV admissible voltage range commonly used in network planning, while all LV nodes fed by this connection point are respecting the LV admissible voltage constraints.

The algorithm consists in determining the admissible voltage limits  $V_{adm\ min}$  and  $V_{adm\ max}$  for every considered MV node where only LV network is connected. At this MV node, any voltage value comprised within these new limits will therefore induce that all the downstream LV connection points are respecting the LV admissible voltage ranges and that all flowing currents in LV network are below the maximum admissible current. This new aggregated MV vision of the downstream LV network allows the DSO to treat it as an aggregated MV node with specific admissible voltage limits, which are reflecting the downstream LV network constraints.

### **Algorithm presentation**

This section presents the LV4MV algorithm core. The objective of the algorithm is to determine the MV admissible voltage range interval for a given LV network in a particular loading condition. This interval is depending on the limiting LV network constraints.

- **Determination of the limiting LV network constraints**

In this research work, the considered LV limiting constraints are the supply voltage magnitude at LV end users connections and the imbalance of the LV network, as the EN 50160 suggests [EURE-95]. In European LV networks, most of the end users connections are single-phase connections. Single-phase connections are done between one phase and the neutral wire. A schematic overview of a 4-wires line  $(i, j)$  is represented in Figure III-14, as well as a single-phase end user connection on phase  $a$  at node  $i$ . If the end users power consumptions and productions are not equally spread on the three phases, some imbalances between the phases might appear and phase-to-neutral voltage profiles might be highly



impacted. In order to study this type of unbalanced systems, a dedicated loadflow tool based on backward-forward technique has been developed. It is presented in the *Annex I - Loadflow tools methodology*. In the computations, the self-impedance of each line and the mutual impedances between the four wires are considered.

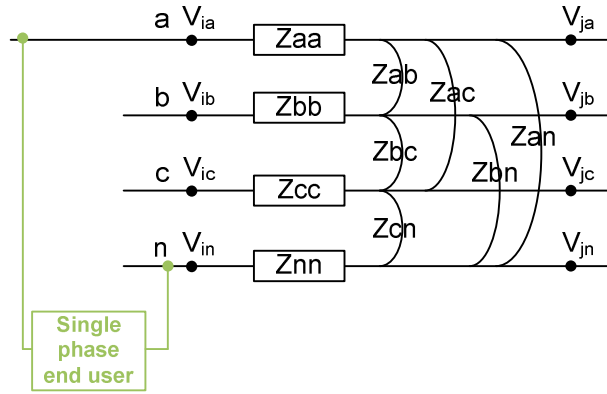

Figure III-14 – Representation of a 4-wires line ( $i, j$ ) and of a single-phase end user connection in phase  $a$

The r.m.s voltage magnitude at the supply terminals in LV level is the magnitude of the voltage between the connection phase and the neutral wire. In the case presented in Figure III-14, the supply voltage magnitude of the single-phase end user  $|V_{ian}|$  can be computed thanks to the equation (III.7).

$$|V_{ian}| = |V_{ia} - V_{in}| \quad (III.7)$$

Where  $V_{ia}$  is the complex voltage value at node  $i$  on phase  $a$ , and  $V_{in}$  is the complex voltage value at node  $i$  on the neutral wire [PHAD-99].

The voltage imbalance is defined at every node by the ratio magnitude of the negative sequence to the positive sequence of the voltage. Concerning the node  $i$ , the voltage imbalance  $imb_i$  can be computed with the equation (III.8) [HAD2-13].

$$imb_i = \left| \frac{V_{i-}}{V_{i+}} \right| = \left| \frac{V_{ia} + a^2 V_{ib} + a V_{ic}}{V_{ia} + a V_{ib} + a^2 V_{ic}} \right| \quad (III.8)$$

$$a = e^{j\frac{2\pi}{3}} \quad (III.9)$$

Where  $V_{i-}$  is the negative sequence of the voltage at node  $i$ ,  $V_{i+}$  is the positive sequence of the voltage at node  $i$ ,  $V_{ia}$  is the complex voltage value at node  $i$  on phase  $a$ ,  $V_{ib}$  is the complex voltage value at node  $i$  on phase  $b$ , and  $V_{ic}$  is the complex voltage value at node  $i$  on phase  $c$ .

- **Identification of the MV admissible voltage range interval**

The LV4MV process is based on an iterative process which checks if all the LV network constraints are still respected for the different voltage values applied at the primary side of the MV/LV

transformer. If all the LV network constraints are respected, this voltage value is part of the admissible voltage range interval. If the LV network constraints are violated, this voltage value is not included in the admissible interval.

The voltage drop due to the MV/LV transformer is considered in the method thanks to the equation (III.10).

$$\Delta V_{transfo} = Z_{transfo} \times I_{transfo} \quad (III.10)$$

Where  $\Delta V_{transfo}$  is the complex voltage drop due to the MV/LV transformer,  $Z_{transfo}$  is the transformer impedance and  $I_{transfo}$  is the complex current flowing through the transformer.

The overall LV4MV process is presented in Figure III-16 and Figure III-16. During the initialization of the process, a first loadflow is performed in order to find the initial state of the considered LV network in the initial conditions. In case of voltage imbalances or overloads in the LV network in the initial conditions, the algorithm is not performed. Hence, any voltage imbalance or overload in the LV network has minor chances to be solved by a change of voltage magnitude value at the primary part of the MV/LV transformer.

If voltage deviations are already occurring in the initial conditions, the algorithm will try to reduce or increase the initial voltage magnitude value  $V_0$ , in order to come back to the “case 1” status and to perform the whole LV4MV algorithm presented hereafter. The applied voltage offset magnitude steps  $\Delta V_0$  are computed via the subtraction between the maximum exceeding voltage value  $V_{ex}$  and the admissible LV network voltage magnitude limits  $V_{LV\_min}$  and  $V_{LV\_max}$ . These particular steps of the algorithm are presented in Figure III-15.

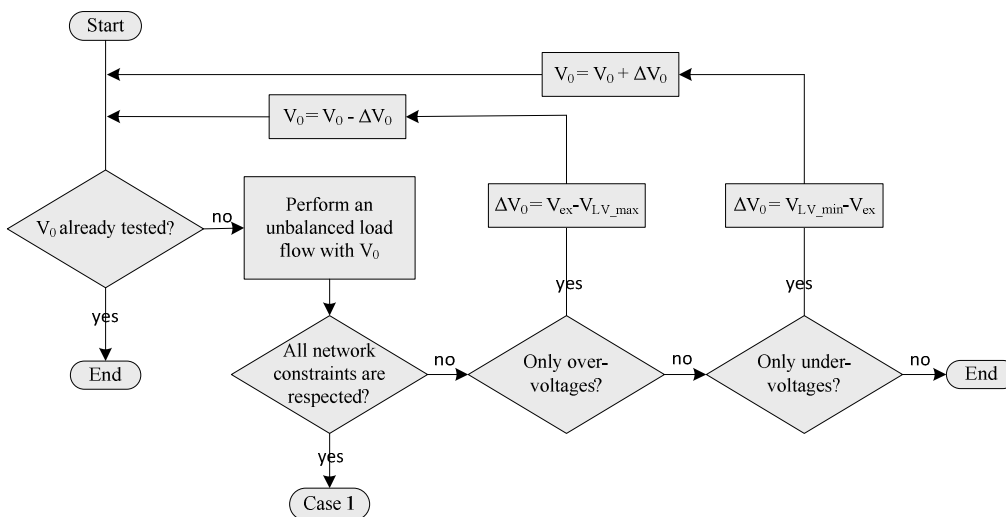

Figure III-15 – Initialization of the LV4MV process for the initial loading state of the considered LV network

In the following, it is assumed that all the LV network constraints are respected for the initial voltage value  $V_0$  at the primary part of the MV/LV transformer (case 1). The algorithm consists in changing iteratively the voltage magnitude value  $V_0$  at the primary part of the MV/LV transformer and in performing an unbalanced loadflow at each iteration. It is possible to find in parallel the admissible voltage magnitude limits  $V_{adm\ min}$  and  $V_{adm\ max}$  that ensure that all downstream LV connection points are respecting LV network constraints. The next paragraph describes the determination of  $V_{adm\ max}$  in more details.

The initialization step sets  $V_{adm\ max} = V_0$ . The increase voltage magnitude offset step  $\Delta V_{max}$  is then computed. It corresponds to the voltage magnitude difference between the highest voltage of the LV network and the maximal admissible LV voltage. If this voltage offset step  $\Delta V_{max}$  is higher than a certain threshold  $s_2$  (fixed at 0.1% of the reference voltage in this case), the voltage magnitude value  $V_0$  at the primary part of the MV/LV transformer is increased of  $\Delta V_{max}$ . The loadflow is performed again and the network constraints are checked.

If there is no over-voltage deviation or other network constraints violation, the admissible voltage magnitude limit  $V_{adm\ min}$  is set at this new  $V_0$  and the process is repeated. If there is no over-voltage deviation but other network constraints violations, the LV4MV process is stopped and  $V_{adm\ max}$  is not updated. Finally, if there are over-voltage deviations but no other network constraints violation, it means that the offset magnitude step  $\Delta V_{max}$  is too large. This offset step is then divided by two and while it remains larger than the threshold  $s_2$ , the process is repeated.

The same methodology is applied to determine the minimal admissible voltage magnitude limit  $V_{adm\ min}$ .

The computation of the applied voltage offset magnitude steps  $\Delta V_{max}$  and  $\Delta V_{min}$  corresponding to the deviation between the nearest voltages of the LV network and the LV voltage limits permits the number of iterations to be limited, and thus to gain CPU time.

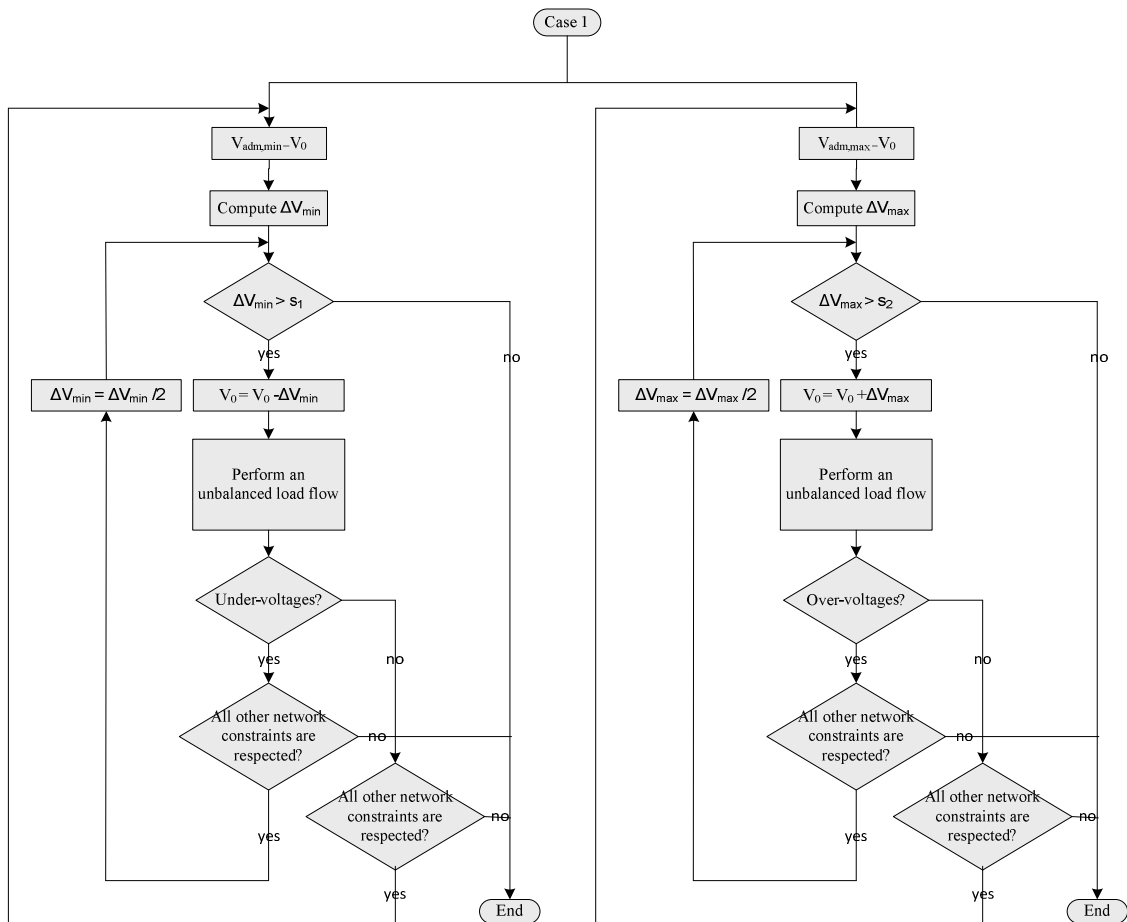

Figure III-16 – LV4MV process flowchart: Determination of the admissible voltage range

Finally, thanks to this more accurate information of the admissible voltage limits at critical MV nodes, the DSOs will be able to operate their MV network closer to their limits. This should permit them to increase end users full access to the energy markets by giving more degree of freedom in the validation process. This should also allow them to have a better flexibility for MV network risk management optimization. Finally, they could avoid some investments which they would have done without this methodology to guarantee the respect of LV network constraints.

It is important to notice that if not enough LV network data are available and particularly expected LV consumptions and/or LV productions, this method can also be based on unbalanced LV state estimation using smart meter measurements.

### Examples of application

The considered cases are specific examples of LV4MV applied on a 12-nodes LV unbalanced electrical network. Corresponding network characteristics and loading cases data are presented in *Annex II – Test networks data*. Other simulations are performed on a larger real LV network and presented in *Annex IV – Complementary results of the LV4MV process*.

- **Simulations on the 12-nodes network, winter loading case**

Considering the 12-nodes network in the winter loading case, the new computed effective MV admissible voltage ranges are presented in the table below (Figure III-17). In order to take the transformer into account, the equation (III.10) is applied where the flowing current through the transformer is equal to the flowing current through the first line of the network.

	Admissible voltage ranges
At the primary side of the MV/LV transformer (before LV4MV)	[0.95; 1.05] p.u.
At the secondary side of the MV/LV transformer (after LV4MV)	[0.980; 1.085] p.u.
At the primary side of the MV/LV transformer (after LV4MV)	[0.981; 1.086] p.u.

*Figure III-17 – Results of the LV4MV algorithm performed on the 12-nodes network in winter loading case*

In this case, the maximum admissible voltage value in MV level is enlarged up to 8.6% of the nominal voltage instead of the 5% of nominal voltage that is currently adopted in distribution network operational planning. On the other hand, the minimum admissible voltage value is fixed at around 2% of the nominal voltage instead of the currently adopted 5% value. For this loading case of the LV network, the voltage at the primary side of the MV/LV transformer can vary within the new determined range without creating any LV network constraints. If the voltage value in MV level is exceeding these limits, some LV network constraints deviations will occur. Figure III-18 represents the phases-to-neutral voltage profiles in the network, for the two extreme limits of the admissible voltage value at the secondary side of the MV/LV transformer.

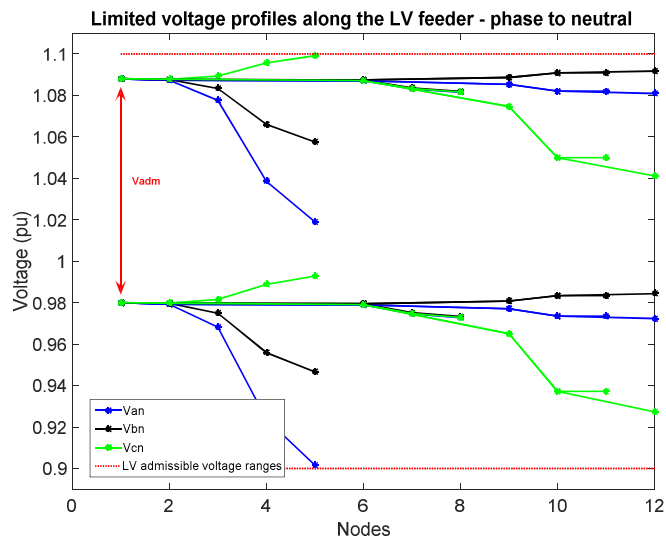

*Figure III-18 – Voltage profiles of the 12-nodes network with the winter loading case and determination of the new MV admissible voltage range*

In this case, the DSO gets a more accurate vision on this critical LV network, which can be useful for MV level operation.

- **Simulations on the 12-nodes network, summer loading case**

The same computations have been done for the 12-nodes network in the summer loading conditions. The new MV admissible voltage margins are presented in the table below (Figure III-19).

	Admissible voltage ranges
At the primary side of the MV/LV transformer (before LV4MV)	[0.95; 1.05] p.u.
At the secondary side of the MV/LV transformer (after LV4MV)	[0.927; 1.042] p.u.
At the primary side of the MV/LV transformer (after LV4MV)	[0.927; 1.042] p.u.

*Figure III-19 – Results of the LV4MV algorithm performed on the 12-nodes network in summer loading case*

Unlike the previous case, this case permits the DSOs to know that the maximum admissible voltage value in MV level is reduced to almost 4% of the nominal voltage instead of the 5% currently adopted in distribution network operational planning. However, the minimum admissible voltage value in MV level is enlarged up to more than 7%. Figure III-20 represents the phases-to-neutral voltage profiles in the network, for the two limits of the admissible voltage value at the secondary side of the MV/LV transformer.

In this case, the voltage drop inside the transformer is small because the flowing current into it is reduced due to the large participation of local DG production.

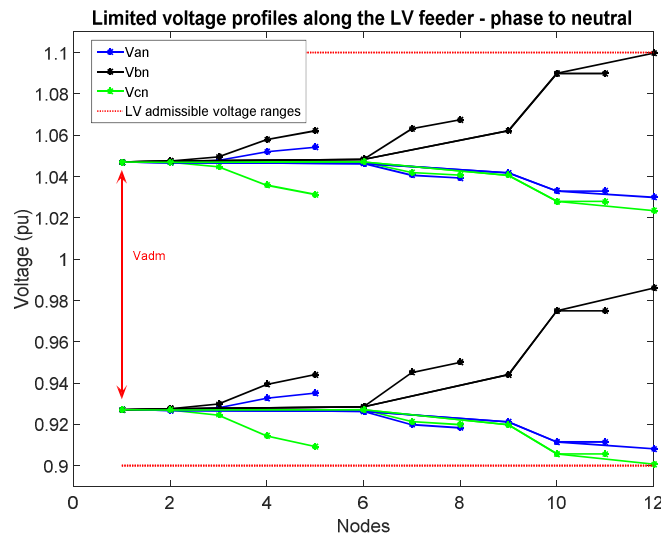

*Figure III-20 – Voltage profiles of the 12-nodes network with the summer loading case and determination of the new MV admissible voltage range*

To conclude, these new MV admissible voltage ranges are permitting to give more accurate information on the considered downstream LV networks to the DSO. Hence, this methodology could permit them to get more degree of freedom in their technical pre-validation process and thus to give a wider access to end users to the energy markets. Moreover, if some voltage constraints are potentially appearing during some specific hours over a year, this methodology could help the DSOs to get a better visibility of their downstream LV networks, and thus to reduce their network reinforcement investment costs in MV level.

Taking advantage of this distributed functionality, it would be also possible to enlarge these new MV admissible voltage margins thanks to the potential available LV flexibility offers.

### **III.3.2 Through the extension of the admissible voltage margins with LV flexibility offers**

The developed tool is aiming not only to permit DSOs to plan their network operation while considering both MV and LV networks, but also to support the provision of LV flexibility offers. The extension of the admissible voltage ranges via the activation of LV flexibility offers permits to transmit the LV flexibility resources at the MV level and thus, to increase the amount of flexible means for technical pre-validation of flexibility offers, for DSO risk management and for MV network optimization.

#### **Extension of the admissible voltage margins thanks to LV flexibility offers activation**

As explained previously, the LV4MV process is aiming first to determine the admissible voltage range for each given LV network. The voltage profile is mainly depending on the load value of the considered network. A highly loaded LV network will have large voltage drops along its feeders and thus, the voltage value at the secondary substation will have a restricted degree of freedom. On the other hand, a slightly loaded LV network will have a quasi-flat voltage profile. The voltage value at the secondary substation will have a large degree of freedom, still ensuring that all the LV network constraints are respected.

This observation is leading to the extension of the LV4MV methodology. Depending on the state of activation of the downstream LV flexibility offers, it is possible to determine several MV admissible voltage range intervals at each MV node.

This solution permits bypassing the instauration of new local markets at LV level which can be challenging nowadays: until now, LV offers are not sufficient in quantity and not enough spread over the LV network in order to solve local constraints while ensuring a fair market. High price volatility can appear between the different LV networks because of the local aspect of these flexibility offers. The LV4MV permits to aggregate the available LV flexibility offers and to make them available in MV level.

From an operational point of view, step-by-step LV flexibility offers activation in a given LV network should enlarge the MV admissible voltage range at the corresponding MV node. Several different voltage range intervals with their corresponding prices of LV flexibility offers activation can be determined. The best option for DSO operation is to determine the largest possible MV admissible voltage ranges that can be obtained with the less expensive combinations of LV flexibility offers activation.

Concerning three-phase flexibility offers, in order to use only the flexibility offers that have a good impact on the voltage drops along the feeders, a very simple rule can be followed:

- If the overall voltage profile in the LV network is increasing, the production dispatch down three-phase offers are retained as well as the increasing consumption three-phase offers, while the decreasing consumption three-phase offers will not be used.
- Inversely, if the overall voltage profile in the LV network is decreasing, the decreasing consumption three-phase offers are retained, and the production dispatch down three-phase offers and the increasing consumption three-phase offers will not be used.

From a validation point of view, this rule cannot be applied. Indeed, it is possible that the validation of a flexibility offer that has a bad impact on the margin could allow the validation of several others flexibility offers which would have not been validated otherwise. Therefore, with the aim to give access to the more end users in the distribution grid, this kind of rule cannot be applied and all the available flexibility offers have to be considered.

In the following, the general goal is only operational, for DSO risk management or for near real-time network optimization. The aim is to enlarge the MV admissible voltage ranges, and therefore to reduce the voltage variations along the considered LV network. It can be written mathematically as in equation (III.11).

$$\forall i \in N, \min | |V_0| - |V_i| | \quad (III.11)$$

Where  $N$  is the set of the nodes in the LV network,  $|V_0|$  is the voltage magnitude at the secondary side of the transformer and  $|V_i|$  is the voltage magnitude at node  $i$ .

Several methods can be investigated in order to determine the best order of flexibility offers activation to enlarge the MV admissible voltage range. An exhaustive approach could be adopted, in which all the orders are tested to find the more efficient one. However, this kind of method is requiring a lot of computational effort. In this work, two methods are proposed and tested. These retained methods are based on the prices of the flexibility offers and on their sensitivity on the voltage margin enlargement.



- **Economical step-by-step LV flexibility offers activation**

The first proposed LV flexibility offers activation order is based on a simple merit order list built with respect to the prices of the available LV flexibility offers. Considering an equipped LV network with some local available flexibility offers, the considered flexibility offers are ranked with respect to their respective prices. The MV admissible voltage range for the corresponding MV node is computed at each step of offer activation. The different stages of the method are presented in Figure III-21.

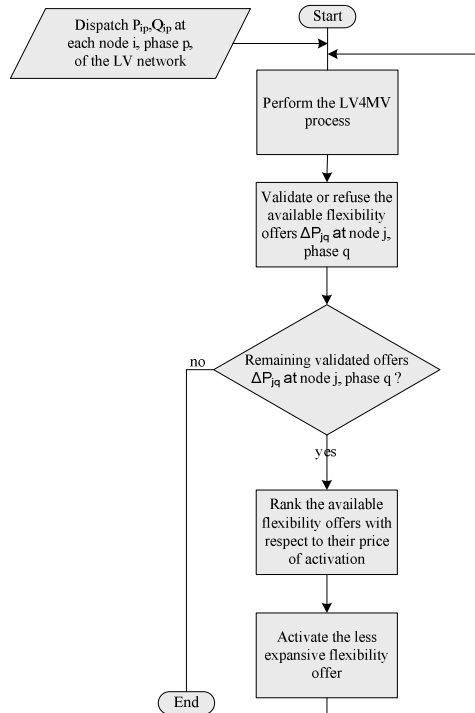

*Figure III-21 - Flowchart of the economical step-by-step LV flexibility offers activation method*

This method is very basic and can be applied easily. However, due to the imbalanced characteristic of the considered LV networks, the activation of a single-phase LV flexibility offer can increase the imbalance of the system and increase the voltage drops on the LV network. It is thus not sufficient to check only the flexibility type of the offer.

- **Efficient single-phase step-by-step LV flexibility offers activation**

A second method has been created in order to enhance the step-by-step flexibility offers activation. The concept here is to rank the LV available flexibility offers with respect to their efficiency on the enlargement of the MV admissible voltage range. Some other works are also using voltage sensitivity computation in unbalanced systems in order to permit a better integration of PV and electrical vehicles in LV networks [MERC-15] but also to implement reactive power management control methods using local PV inverters [DEMI-11].

In this case, voltage sensitivity computation is used in order to rank the different available three-phase and single-phase LV flexibility offers with respect to the possible enlargement of the MV admissible voltage range. Following an iterative process, the limited voltage constraint is first determined. The voltage efficiency coefficients of each flexibility offer with respect to this constraint are computed thanks to voltage sensitivity computation. The merit order list is then built. The method is based on an iterative process and is performed as presented in the flowchart in Figure III-22.

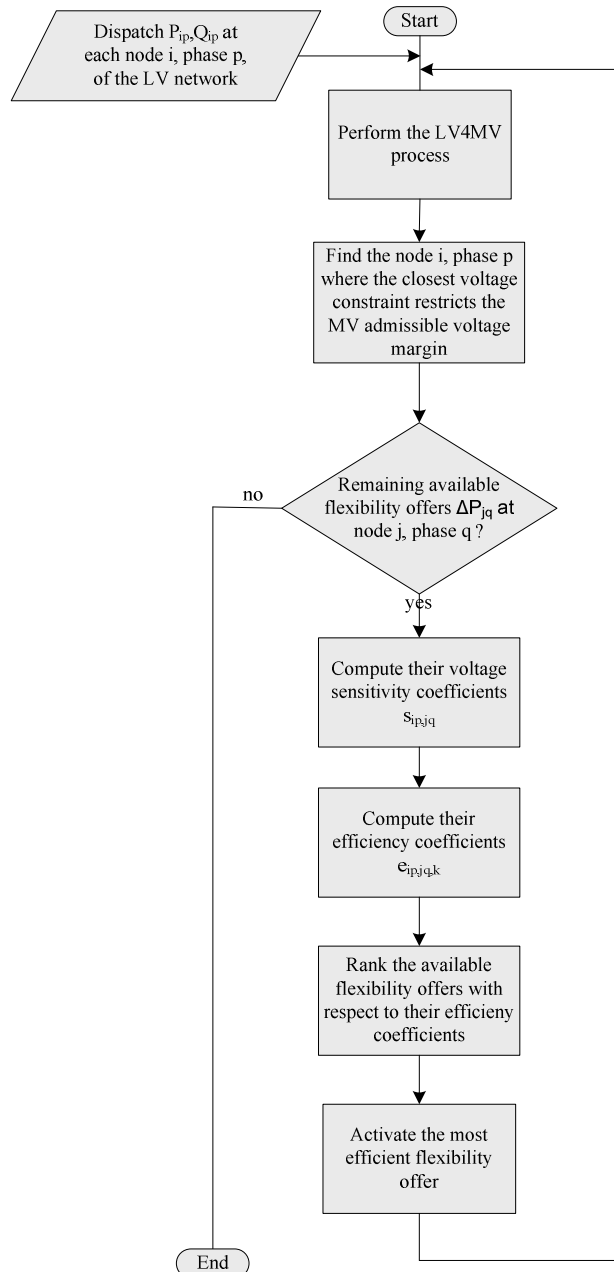

Figure III-22 – Flowchart of the efficient step-by-step LV flexibility offers activation method

In this method, the efficiency of each single-phase LV flexibility offer is introduced. Here, it is defined by the equation (III.12).

$$e_{ip,jq,k} = \frac{s_{ip,jq}}{c_{jq,k}} \quad (III.12)$$

Where  $e_{ip,jq,k}$  is the efficiency of the  $k^{th}$  flexibility offer available at node  $j$ , phase  $q$ , on the voltage constraint at node  $i$ , phase  $p$ .  $s_{ip}$  is the voltage sensitivity at the node  $i$ , phase  $p$  with respect to a flexibility activation at the node  $j$ , phase  $q$ .  $c_{jq,k}$  is the activation price of the  $k^{th}$  flexibility offer available at node  $j$ , phase  $q$ .

In order to compute the voltage magnitude sensitivity coefficients  $s_{ip,jq}$  of the constrained node  $i$ , phase  $p$ , with respect to the available flexibility offer at node  $j$ , phase  $q$ , a computational procedure based on the developed three-wire loadflow presented in *Annex I – Loadflow tools methodology*. is applied. The voltage sensitivity matrix is built with respect to the power injection in the different phases. It is then possible to assess the line-to-neutral voltage magnitude sensitivity of all nodes of the network with respect to the change of power at a single-phase of one given node of the system. The voltage sensitivity matrix is derived from the following equations (III.13)-(III.16).

$$\begin{bmatrix} S_{busan} \\ S_{busbn} \\ S_{buscn} \end{bmatrix} = \begin{bmatrix} V_{busan} \\ V_{busbn} \\ V_{buscn} \end{bmatrix} \times \begin{bmatrix} I^*_{busan} \\ I^*_{busbn} \\ I^*_{buscn} \end{bmatrix} \quad (III.13)$$

$$\begin{bmatrix} I_{busan} \\ I_{busbn} \\ I_{buscn} \end{bmatrix} = inv(DLF_{abc}) \times \left( \begin{bmatrix} V_{initan} \\ V_{initbn} \\ V_{initcn} \end{bmatrix} - \begin{bmatrix} V_{busan} \\ V_{busbn} \\ V_{buscn} \end{bmatrix} \right) \quad (III.14)$$

$$\frac{d \begin{bmatrix} S_{busan} \\ S_{busbn} \\ S_{buscn} \end{bmatrix}}{d \begin{bmatrix} |V_{busan}| \\ |V_{busbn}| \\ |V_{buscn}| \end{bmatrix}} = \frac{d \begin{bmatrix} V_{busan} \\ V_{busbn} \\ V_{buscn} \end{bmatrix}}{d \begin{bmatrix} |V_{busan}| \\ |V_{busbn}| \\ |V_{buscn}| \end{bmatrix}} \times \begin{bmatrix} I^*_{busan} \\ I^*_{busbn} \\ I^*_{buscn} \end{bmatrix} + \begin{bmatrix} V_{busan} \\ V_{busbn} \\ V_{buscn} \end{bmatrix} \times \frac{d \begin{bmatrix} I^*_{busan} \\ I^*_{busbn} \\ I^*_{buscn} \end{bmatrix}}{d \begin{bmatrix} |V_{busan}| \\ |V_{busbn}| \\ |V_{buscn}| \end{bmatrix}} \quad (III.15)$$

$$\frac{d \begin{bmatrix} S_{busan} \\ S_{busbn} \\ S_{buscn} \end{bmatrix}}{d \begin{bmatrix} \theta_{busan} \\ \theta_{busbn} \\ \theta_{buscn} \end{bmatrix}} = \frac{d \begin{bmatrix} V_{busan} \\ V_{busbn} \\ V_{buscn} \end{bmatrix}}{d \begin{bmatrix} \theta_{busan} \\ \theta_{busbn} \\ \theta_{buscn} \end{bmatrix}} \times \begin{bmatrix} I^*_{busan} \\ I^*_{busbn} \\ I^*_{buscn} \end{bmatrix} + \begin{bmatrix} V_{busan} \\ V_{busbn} \\ V_{buscn} \end{bmatrix} \times \frac{d \begin{bmatrix} I^*_{busan} \\ I^*_{busbn} \\ I^*_{buscn} \end{bmatrix}}{d \begin{bmatrix} \theta_{busan} \\ \theta_{busbn} \\ \theta_{buscn} \end{bmatrix}} \quad (III.16)$$

Where  $\begin{bmatrix} S_{busan} \\ S_{busbn} \\ S_{buscn} \end{bmatrix}$  is the complex line-to-neutral apparent power at the bus for the three phases,  $\begin{bmatrix} V_{busan} \\ V_{busbn} \\ V_{buscn} \end{bmatrix}$  is the complex line-to-neutral voltage at the bus for the three phases, and  $\begin{bmatrix} I_{busan}^* \\ I_{busbn}^* \\ I_{buscn}^* \end{bmatrix}$  is the conjugate of the complex current consumed at the bus for the three phases.

$DLF_{abc}$  is the matrix related the buses line-to-neutral voltage drops to the consumed currents at the buses, and  $\begin{pmatrix} V_{initan} \\ V_{initbn} \\ V_{initcn} \end{pmatrix} - \begin{bmatrix} V_{busan} \\ V_{busbn} \\ V_{buscn} \end{bmatrix}$  is corresponding to the line-to-neutral voltage drops at each bus for the three phases. Finally,  $\begin{bmatrix} |V_{busan}| \\ |V_{busbn}| \\ |V_{buscn}| \end{bmatrix}$  and  $\begin{bmatrix} \theta_{busan} \\ \theta_{busbn} \\ \theta_{buscn} \end{bmatrix}$  are respectively the line-to-neutral voltage magnitudes and angles at the considered bus for the three phases.

Finally, the voltage sensitivity matrix is built by the concatenation of the derivative coefficients as done in equation (III.17).

$$\begin{bmatrix} \Delta \begin{bmatrix} |V_{busan}| \\ |V_{busbn}| \\ |V_{buscn}| \end{bmatrix} \\ \Delta \begin{bmatrix} \theta_{busan} \\ \theta_{busbn} \\ \theta_{buscn} \end{bmatrix} \end{bmatrix} = \begin{bmatrix} \frac{\partial \begin{bmatrix} |V_{busan}| \\ |V_{busbn}| \\ |V_{buscn}| \end{bmatrix}}{\partial \begin{bmatrix} P_{an} \\ P_{bn} \\ P_{cn} \end{bmatrix}} & \frac{\partial \begin{bmatrix} |V_{busan}| \\ |V_{busbn}| \\ |V_{buscn}| \end{bmatrix}}{\partial \begin{bmatrix} Q_{an} \\ Q_{bn} \\ Q_{cn} \end{bmatrix}} \\ \frac{\partial \begin{bmatrix} \theta_{busan} \\ \theta_{busbn} \\ \theta_{buscn} \end{bmatrix}}{\partial \begin{bmatrix} P_{an} \\ P_{bn} \\ P_{cn} \end{bmatrix}} & \frac{\partial \begin{bmatrix} \theta_{busan} \\ \theta_{busbn} \\ \theta_{buscn} \end{bmatrix}}{\partial \begin{bmatrix} Q_{an} \\ Q_{bn} \\ Q_{cn} \end{bmatrix}} \end{bmatrix} \begin{bmatrix} \Delta \begin{bmatrix} P_{an} \\ P_{bn} \\ P_{cn} \end{bmatrix} \\ \Delta \begin{bmatrix} Q_{an} \\ Q_{bn} \\ Q_{cn} \end{bmatrix} \end{bmatrix} \quad (III.17)$$

Where  $\Delta \begin{bmatrix} \theta_{busan} \\ \theta_{busbn} \\ \theta_{buscn} \end{bmatrix}$  and  $\Delta \begin{bmatrix} |V_{busan}| \\ |V_{busbn}| \\ |V_{buscn}| \end{bmatrix}$  are changes in voltage angles and magnitudes,  $\Delta \begin{bmatrix} P_{an} \\ P_{bn} \\ P_{cn} \end{bmatrix}$  and  $\Delta \begin{bmatrix} Q_{an} \\ Q_{bn} \\ Q_{cn} \end{bmatrix}$  are changes in active and reactive powers.

Considering that angle-related problems are not a concern for voltage deviations, the voltage sensitivity can be defined as in equation (III.18).

$$\Delta \begin{bmatrix} |V_{busan}| \\ |V_{busbn}| \\ |V_{buscn}| \end{bmatrix} = \frac{\begin{bmatrix} |V_{busan}| \\ |V_{busbn}| \\ |V_{buscn}| \end{bmatrix}}{\begin{bmatrix} P_{an} \\ P_{bn} \\ P_{cn} \end{bmatrix}} \Delta \begin{bmatrix} P_{an} \\ P_{bn} \\ P_{cn} \end{bmatrix} + \frac{\begin{bmatrix} |V_{busan}| \\ |V_{busbn}| \\ |V_{buscn}| \end{bmatrix}}{\begin{bmatrix} Q_{an} \\ Q_{bn} \\ Q_{cn} \end{bmatrix}} \Delta \begin{bmatrix} Q_{an} \\ Q_{bn} \\ Q_{cn} \end{bmatrix} \quad (III.18)$$

The derivatives  $\frac{\begin{bmatrix} |V_{busan}| \\ |V_{busbn}| \\ |V_{buscn}| \end{bmatrix}}{\begin{bmatrix} P_{an} \\ P_{bn} \\ P_{cn} \end{bmatrix}}$  and  $\frac{\begin{bmatrix} |V_{busan}| \\ |V_{busbn}| \\ |V_{buscn}| \end{bmatrix}}{\begin{bmatrix} Q_{an} \\ Q_{bn} \\ Q_{cn} \end{bmatrix}}$  are the voltage sensitivity coefficients with respect to the

power modulation at the nodes. Their diagonal elements are representing the voltage magnitude sensitivity of one phase of one bus to the injection of power at the same phase, same bus. Their off-diagonal elements represent the bus voltage magnitude sensitivity to power injected at other buses and at others phases. An example of this matrix for an injection at bus  $j$  to the voltage at bus  $i$  will have the following coefficients:

$$\frac{\partial |V_i|}{\partial P_j} = \begin{bmatrix} \frac{\partial |V_{ian}|}{\partial P_{jan}} & \frac{\partial |V_{ian}|}{\partial P_{jbn}} & \frac{\partial |V_{ian}|}{\partial P_{jcn}} \\ \frac{\partial |V_{ibn}|}{\partial P_{jan}} & \frac{\partial |V_{ibn}|}{\partial P_{jbn}} & \frac{\partial |V_{ibn}|}{\partial P_{jcn}} \\ \frac{\partial |V_{icn}|}{\partial P_{jan}} & \frac{\partial |V_{icn}|}{\partial P_{jbn}} & \frac{\partial |V_{icn}|}{\partial P_{jcn}} \end{bmatrix} \quad (III.19)$$

If the forecasts of the network's loading state are not enough reliable, some techniques developed in [MERC-15] can also be used in order to determine an approximation of voltage sensitivity coefficients thanks to smart meters measurements.

## Examples of application

The two presented methodologies for the extension of the admissible voltage margins thanks to the activation of LV flexibility offers are here illustrated. They are applied on the two scenarios presented in section III.3.1. Some LV flexibility offers are assumed to be available in the considered 12-nodes network. The power factors at the LV nodes are considered as fixed power factors.

In these cases, the flexibility energy prices are based on the basic spot price which usually varies from 28€/MWh to 35€/MWh [EPEX-16]. Therefore, domestic DR prices are evaluated between 50€/MWh and 150€/MWh. On the other hand, DG dispatch down prices are assumed to be between

120€/MWh and 200€/MWh [MINI-16]. In these cases, the available flexibility offers are assumed to be equivalent to power blocks, and can only be activated entirely over one hour.

- **Simulations on the 12-nodes network, winter loading case**

In the previous section, the computed effective MV admissible voltage range for the 12-nodes network with the winter loading case was [0.981; 1.086] p.u.

The available LV flexibility offers in this case are presented in Figure III-23.

Flexible node	Phase	$\Delta P$ demand response (kW)	Activation price (€/1h)	
			€	€/MWh
5	3-phase	4	0,240	60
5	a	1,5	0,150	100
6	3-phase	1,2	0,060	50
12	3-phase	1	0,080	80
12	c	0,7	0,084	120

Figure III-23 – Available LV flexibility offers in the 12-nodes network (winter loading case)

In this specific case, the two presented methodologies for extension of the admissible voltage margins thanks to the activation of LV flexibility offers are performed. The resulting enlarged MV voltage ranges obtained with the two methods are showed in Figure III-24.

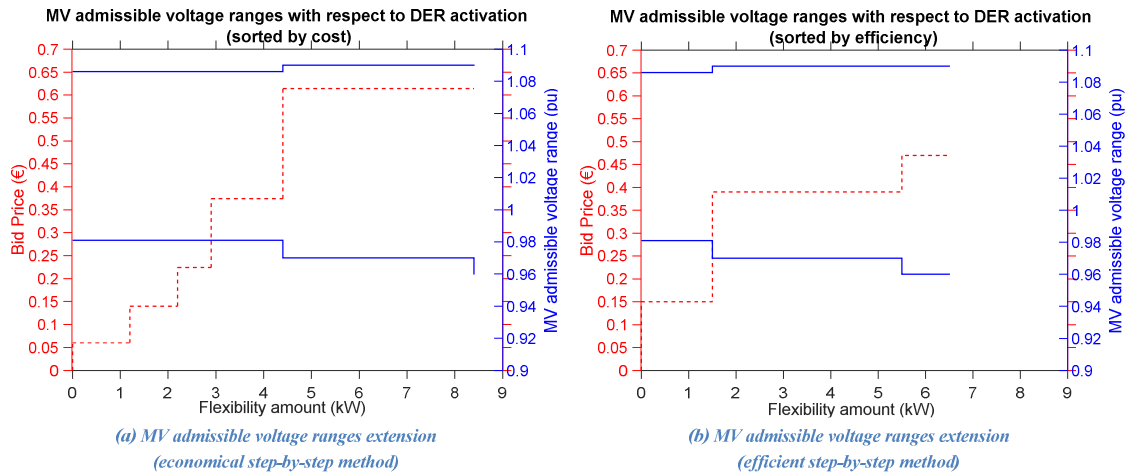

Figure III-24 – Resulting MV admissible voltage ranges after step-by-step LV flexibility activation (winter loading case)

When applying the economical step-by-step LV flexibility activation method, all the available flexibility offers are ranked with respect to their prices. They are then activated one after the other following the merit order list. As showed in Figure III-24 (a), the three first activated LV flexibility offers are not permitting to enlarge directly the MV voltage range. After having activated them, the activations of the fourth and of the fifth flexibility offers are permitting to enlarge the MV admissible voltage range

up to [0.960; 1.090] p.u. The limit of this method is that it ends only when all the flexibility offers have been activated, even if some of them have no impact on the enlargement of the MV admissible voltage range.

The methodology based on efficient step-by-step flexibility activation permits activating directly the LV activated flexibility offers that have an effective impact on the enlargement of the MV admissible voltage range. As showed in Figure III-24 (b), the MV admissible voltage range has been also enlarged up to [0.960; 1.090] p.u. However, only three flexibility offers over the five available have been activated to get this result, implying a lower total cost of LV flexibility activation.

• **Simulations on the 12-nodes network, summer loading case**

In the previous part, the computed effective MV admissible voltage range for the 12-nodes network with the winter loading case was [0.927; 1.042] p.u. In this specific case, it is assumed that some LV flexibility offers are also available. These flexibility offers are shown in Figure III-25.

Flexible node	Phase	$\Delta P$ dispatch down (kW)	$\Delta P$ demand response (kW)	Activation price (€/1h)	
				€	€/MWh
5	3-phase	0,5	0	0,030	60
5	a	0	0,3	0,036	120
5	b	0	0,3	0,045	150
8	b	0	0,2	0,026	130
12	b	0	0,5	0,090	180

Figure III-25 – Available LV flexibility offers in the 12-nodes network (summer loading case)

In this case, the two presented methodologies for extension of the admissible voltage margins thanks to the activation of LV flexibility offers are also performed. The resulting enlarged MV voltage ranges obtained with the two methods are showed in Figure III-26.

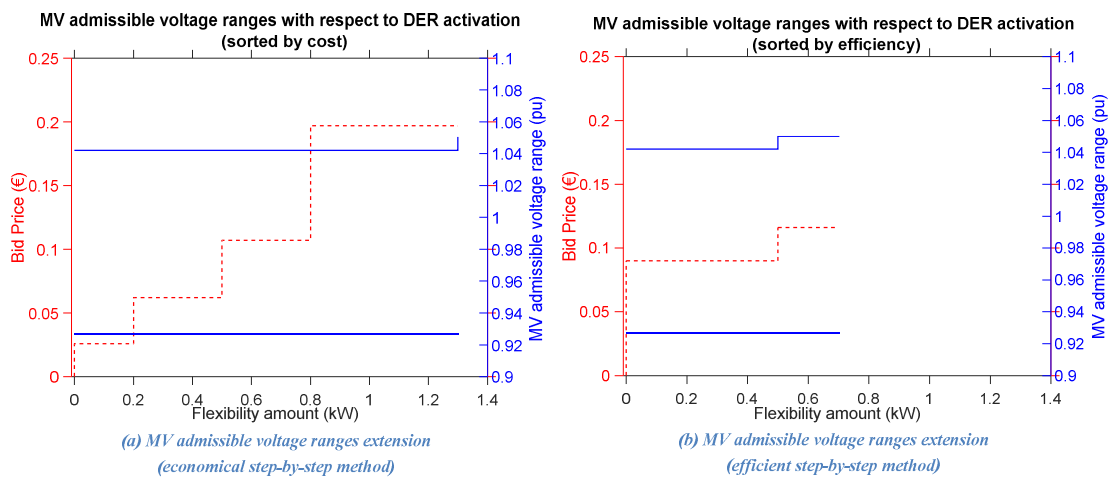

Figure III-26 – Resulting MV admissible voltage ranges after step-by-step LV flexibility activation (summer loading case)

As it can be observed in Figure III-26, the MV admissible voltage range can be enlarged up to [0.927; 1.050] p.u. thanks to the activation of the available LV flexibility offers. As observed in the previous example, following an economical merit-order list can be not as efficient as if the sensitivity voltage on the margins is considered. Here, thanks to the efficient step-by-step methodology, the most efficient flexibility offer (node 12, phase b) is activated. This implies the enlargement of the MV admissible voltage range up to [0.927; 1.050] p.u. In the second iteration, the flexibility offer at node 8, phase b is chosen to be activated but has not enough effect on the MV admissible voltage range enlargement. Then, there is no more influencing available flexibility offer and the process is ended.

To conclude on the two developed methodologies, the first one based on economic merit order list requires less mathematical development than the one based on efficiency merit order list. However, using this second methodology permits the activation of less flexibility offers to enlarge the MV admissible voltage range.

The comparison between the two developed methods shows the importance of both the price and the location of flexibility offers for network optimization. Thanks to the deployment of NICT, this information should be soon accessible by different electricity system actors, which are respectively the commercial aggregators and the DSOs. Thus, the instauration of local market places could be really interesting for the efficient aggregation of LV flexibility offers.

Finally, thanks to these methodologies, LV flexibility offers can be directly transferred to MV level in the form of a new MV admissible voltage range with a corresponding price of enlargement. They can thus be used for operational planning or for network optimization in MV level. These specific data exchanges between LV and MV levels can be made possible thanks to the developed distributed architecture presented in section II.3.

### **III.3.3 LV4MV architecture deployment**

The LV4MV mechanism rests on a distributed mode of network operation, with an architecture where functionalities are distributed among the whole system network. The dynamic infrastructure that has been proposed in chapter II permits the progressive deployment of the LV4MV mechanism over the distribution system, and will limit data transfers over the whole considered network.

Figure III-27 represents the LV4MV architecture deployment in a particular primary substation federation, as presented in section II.3.1. In this scheme, it is assumed that the primary substation and several secondary substations are equipped with advanced RTUs.

In a first step, each LV DSO agent is able to determine its effective MV admissible voltage range which depends on the loading state of the downstream LV network, monitored thanks to the deployed smart meters in each considered LV cell. Ever flexible load or generator can propose some flexibility offers via their energy boxes. The available LV flexibility offers can be transmitted via the commercial



aggregator agent to the LV DSO agent, who can therefore determine the possible enlargements of the MV admissible voltage range.

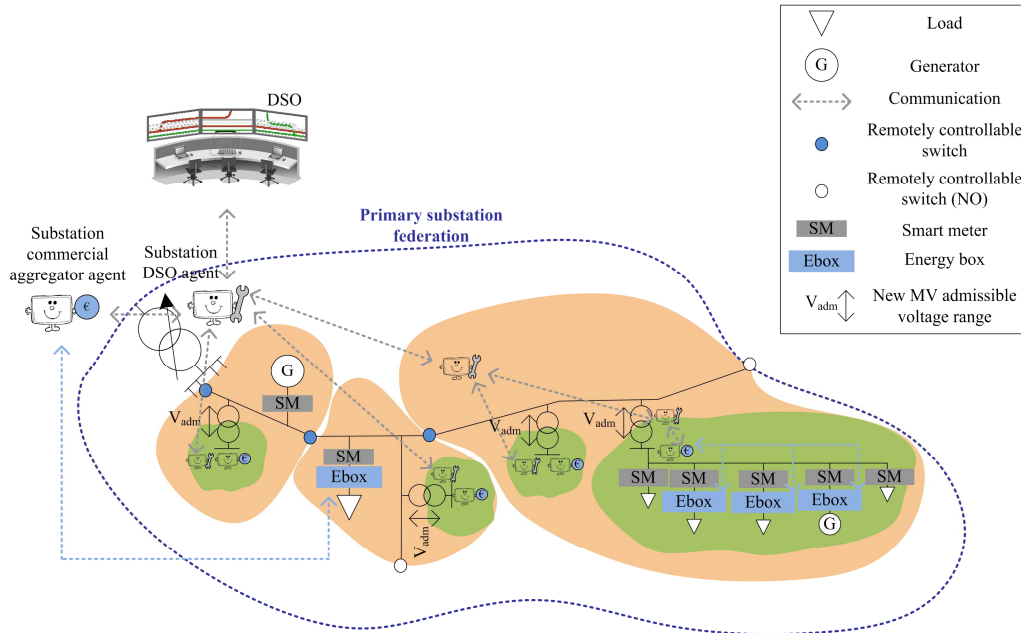

Figure III-27 – LV4MV architecture in a primary substation federation

In a second step, LV DSO agents are sending their new possible MV admissible voltage ranges to the substation DSO agent, via their respective elementary MV cell DSO agent if it exists. These new possible MV admissible voltage ranges are transmitted as other available MV flexibility offers. At the same time, the substation DSO agent can also receive the available MV flexibility offers from the substation commercial aggregator agent.

Knowing all these end users flexibility information, the substation DSO agent can have a global vision of the MV and LV flexibility offers and increase its overall flexibility resources.

From an operational point of view, the LV4MV algorithm can help the DSOs to better manage its network risk assessment while knowing all its available flexibility resources, including those coming from the LV level. The DSOs will be able to check if enough remaining local flexibility opportunities will be available for potential constraints management as it is proposed in the next part.

## **III.4 Innovative tool for the provision of flexibility offers for DSO constraints management at a minimum cost**

Thanks to the technical pre-validation process of the local flexibility offers and the LV4MV process in critical LV networks, DSOs can guarantee that any activation of MV and LV flexibility offers will not endanger their network operation. However, in order to ensure the security and the operational reliability of the distribution network until real-time, DSOs have to assess the potential risks of contingency and prepare action plans to react to potential sudden changes due to internal network failures or to weather conditions. As it is done for transmission systems, risk management and contingency analysis could be performed also for distribution networks.

### **III.4.1 DSO risk management and contingency analysis**

Power systems are conventionally planned to meet a defined level of failure of different individual system assets. Even with this inherent security, the risk is not completely mitigated: failures of power systems can and do occur [CIGR-10]. Risk management and contingency analysis are really essential for system operators, in order to ensure system security and quality of supply while limiting their operational and investments costs. It corresponds to the processes of identification, analysis and mitigation of uncertainties in investment decision-making. Energy regulators generally define risk management policies for electrical grids investments, and especially for transmission systems. A trade-off between the cost of the power system and its reliability has to be reached.

Due to the growing complexity of power system operations and electricity trading arrangements, networks are increasingly operated near to their technical limits. This drives systems operators to enhance their risk management and contingency analysis. As it is done by the TSOs, risk management and contingency analysis should be also performed by the DSOs that are willing to use their active distribution network management tool as an effective way to reduce their investments.

### **Risk management and contingency analysis in transmission systems**

To ensure the best operation of their electrical grid, system operators are generally performing contingency plans in order to prepare the possible critical states of their network. There are different kinds of disturbances which can be registered and cause contingencies in the transmission system. They include for example:

- Internal failure of transformers, lines, switchgears, or other grid components,
- Weather conditions leading to short circuits and subsequent trips of network components, especially overhead lines,
- Failure of control and/or protection systems,
- Generator or power station subsystems failure,

- Variable power output from stochastic generation (such as wind or solar),
- Changes in demand due to a connection failure, or due to users' behavior.

For transmission systems, the secured events are conventionally defined in terms of N-k scenarios where N represents the initial state of the system and, depending on the convention used in the particular standard, k represents either a number of primary components going out of service or a number of events [RTE-04]. The N-1 rule is practiced in most large transmission power systems worldwide. This rule ensures that the power system is always operated in a robust condition with sufficient safety margins in order to withstand single fault events.

The introduction of renewable generation, and particularly distributed generation, changes the performance requirements of the transmission grid. Specifically, the variable output of some renewable generation creates more uncertainty for transmission planning and investments [CIGR-07]. Moreover, the bidirectional power flows are also adding a lot of uncertainties in transmission network operation.

### **Towards distributed risk management for the DSOs**

Risk management has also to be extended to the distribution network. Indeed, consumptions at local levels are not precisely predictable, and the decentralized renewable generation plants can have unexpected behaviors. This is adding a lot of uncertainties in the network flow patterns. The principal disturbances or potential sudden changes that can occur in a distribution system include, for example:

- Variable power output from stochastic generation (due to unexpected changes in weather conditions for example),
- Short circuits and subsequent trips of network components, especially overhead lines (due to unexpected changes in weather conditions for example),
- Disconnection of some parts of the network for maintenance work, or due to network reconfiguration,
- Service restoration of a feeder by the reconnection of it on the back-up transformer,
- Failures of transformers, overhead lines or underground cables.

Distribution system operators are usually dealing with decentralized power reserves and grid reinforcements for their operational planning. They could also think about using local flexibility opportunities to contribute to their operational risk management.

However, given the size of the distribution network, it is not conceivable to think at predefining a possible solution for each potential change at the scale of a control center. Hence, some decentralized tools for DSO flexibility provision have been developed in this work. Running near real-time, these innovative tools aim at allowing the DSOs to cover their operational risks, and to prepare operational margins to ensure security and quality of supply to their end users.

In order to enable the DSOs to react to sudden changes in their network, and to permit them to fulfill their contracts concerning the production and consumption plans that have been validated before

the market processes, the following presented methods have been elaborated. The principal aim of these methods is to assess if enough flexibility offers is remaining, to solve grid constraints after a potential disturbance.

The considered set of flexibility opportunities includes grid flexibility and remaining end users flexibility offers that have not been selected during market processes.

### **III.4.2 Provision of remaining MV and LV flexibility offers for DSO constraints management, at a minimum cost**

A methodology is developed in order to provision the potential remaining flexibility offers for DSO constraint management purpose. At the end of the markets closure and before the delivery time, the reliability of the forecasted consumption and production is quite high, and the scheduled planning is almost fixed. During the near real-time scale defined in section II.3.2, the DSO can check if any network constraints will occur for the given planned load schedule in case of sudden changes in the expected network conditions. The proposed method helps the DSO to foresee if the available remaining local flexibility offers could solve the potential appearing constraints.

As proposed in section II.3.2, distributed flexibility exchanges are assumed to possibly emerge after the market clearing, involving only the remaining flexibility offers that are not selected in any market process. It is assumed that these remaining flexibility offers are 100% available and reliable.

Here, the distribution of intelligence is really crucial to limit the data exchanges and to enable the fast responsiveness needed near real-time. From an architecture point of view, the developed mechanism should be performed locally at the primary substation level by the substation DSO agent, defined in section II.3.1. In these methods, the reconfiguration of the network is not considered as a flexible resource. Therefore, the algorithms will be processed in primary substation federation, which will have to be redefined at each network reconfiguration.

From an implementation point of view, this kind of algorithm should be distributed in a local RTU located at the primary substation. Different generations of algorithms have been created so that the more accurate method corresponding to the computational specifications of the installed RTU can be chosen.

#### **Heuristic based provision processes**

Two heuristic-based methods have been investigated during this work for comparison. The first method is based on an economical merit order list, which rank the most sensitive flexibility offers with respect to their prices of activation. The second one is based on an efficiency merit order list, and provides the DSO with a vision of the remaining flexibility offers' efficiencies on its potential network constraints.

Both methods are based on the exhaustive computation of voltage sensitivity coefficients and flowing current coefficients with respect to the modification of powers at the considered nodes of the network. Several papers are using voltage sensitivity analysis for balanced system planning in order to size and to find the best location to install DG in radial distribution system [CAIR-03], [GOZE-09] and [CONT-10]. Alternative types of sensitivity coefficients such as losses sensitivity coefficients are also studied in order to optimize the sitting of new DG [POPO-05].

Knowing the voltage sensitivity with respect to the modulation of active and reactive power in a considered network enables the DSO to get a global overview of the voltage magnitude reaction after flexibility activation. This will allow the DSO to analyze and to evaluate the effect of the proposed flexibility offers on the constrained network depending on their location. According to the same logic, flowing current sensitivity coefficients can be deduced from the network topology.

- **Voltage sensitivity coefficients at the MV level**

Considering a given balanced constrained network, a load-flow based on the backward–forward sweep process is computed to obtain the individual voltages at all buses corresponding to the network specified conditions. From this state, it is then possible to compute the voltage sensitivity coefficients matrix. The matrix is constructed with the derivatives of the apparent power at the considered node with respect to the voltage magnitude and angle at the given node. The voltage sensitivity coefficients are computed based on a linear approximation at a specific operating point. Therefore, they have to be recomputed for every load state in order to be as accurate as possible.

Assuming a given expected load state, the effective apparent power consumed at a node is determined by the equation (III.20). The complex current consumed at the bus  $I_{bus}$  can be easily deduced from equation (III.21), referring to the backward-forward loadflow method presented in *Annex I – Loadflow tools methodology*. The derivatives with respect to the voltage magnitude and angle are computed thanks to the equations (III.22) and (III.23).

$$S_{bus} = V_{bus} \times I_{bus}^* \quad (III.20)$$

$$I_{bus} = inv(DLF) \times (V_{init} - V_{bus}) \quad (III.21)$$

$$\frac{dS_{bus}}{d|V_{bus}|} = \frac{d(V_{bus})}{d|V_{bus}|} \times I_{bus}^* + V_{bus} \times \frac{d(I_{bus}^*)}{d|V_{bus}|} \quad (III.22)$$

$$\frac{dS_{bus}}{d\theta_{bus}} = \frac{d(V_{bus})}{d\theta_{bus}} \times I_{bus}^* + V_{bus} \times \frac{d(I_{bus}^*)}{d\theta_{bus}} \quad (III.23)$$

Where  $S_{bus}$  is the bus complex apparent power vector,  $V_{bus}$  is the bus complex voltage vector, and  $I_{bus}^*$  is the conjugate of the consumed complex currents vectors.  $DLF$  is the complex matrix related the voltage drops with respect to the consumed currents at the nodes, and  $(V_{init} - V_{bus})$  is corresponding to the voltage drops at each node. Finally,  $|V_{bus}|$  and  $\theta_{bus}$  are respectively the voltage magnitude and angle at the considered node.

The voltage sensitivity matrix is then built by the concatenation of the derivative coefficients as depicted in equation (III.24).

$$\begin{bmatrix} \Delta|V_{bus}| \\ \Delta\theta_{bus} \end{bmatrix} = \begin{bmatrix} \frac{\partial|V_{bus}|}{\partial P} & \frac{\partial|V_{bus}|}{\partial Q} \\ \frac{\partial\theta_{bus}}{\partial P} & \frac{\partial\theta_{bus}}{\partial Q} \end{bmatrix} \begin{bmatrix} \Delta P \\ \Delta Q \end{bmatrix} \quad (III.24)$$

Where  $\Delta\theta_{bus}$  and  $\Delta|V_{bus}|$  are changes in voltage angle and magnitude,  $\Delta P$  and  $\Delta Q$  are changes in active and reactive power.

The voltage sensitivity matrix is also equals to the inverse power flow Jacobian matrix which relates changes in power modulation to changes in voltage angle and magnitude. This Jacobian matrix can also directly be derived from a Newton-Raphson load flow computation. However, performing a Newton-Raphson loadflow method requires a large amount of computational resources [BALA-11]. From a distributed point of view, fast and less CPU requirements algorithms are preferred.

Considering that angle-related problems are not a concern for voltage deviations, the voltage sensitivity can be defined as in equation (III.25).

$$\Delta|V_{bus}| = \left[ \frac{\partial|V_{bus}|}{\partial P} \right] [\Delta P] + \left[ \frac{\partial|V_{bus}|}{\partial Q} \right] [\Delta Q] \quad (III.25)$$

The derivatives  $\left[ \frac{\partial|V_{bus}|}{\partial P} \right]$  and  $\left[ \frac{\partial|V_{bus}|}{\partial Q} \right]$  are the voltage sensitivity coefficients with respect to the power modulation at the nodes. Their diagonal elements are representing the sensitivity of one node voltage magnitude to the injection of power at the same node. Their off-diagonal elements represent the node voltage magnitude sensitivity to power injected at other nodes. An example of this matrix for a 3-buses network will have the following coefficients:

$$\frac{\partial|\vec{V}|}{\partial P} = \begin{bmatrix} \frac{\partial|V_1|}{\partial P_1} & \frac{\partial|V_1|}{\partial P_2} & \frac{\partial|V_1|}{\partial P_3} \\ \frac{\partial|V_2|}{\partial P_1} & \frac{\partial|V_2|}{\partial P_2} & \frac{\partial|V_2|}{\partial P_3} \\ \frac{\partial|V_3|}{\partial P_1} & \frac{\partial|V_3|}{\partial P_2} & \frac{\partial|V_3|}{\partial P_3} \end{bmatrix} \quad (III.26)$$

In order to solve a voltage constraint appearing in the third node, it will be efficient to focus on the third line to have an idea about the influence of the injection of power at all the different nodes on the voltage at this node.

In a similar way, it is possible to focus only on the parts of the network that are constrained, and to find which flexibility offers will be of the greatest benefit for the voltage deviations.

- **Flowing current sensitivity coefficients at the MV level**

In case of a possible overload problem in a transformer or in a line, a method which computes flowing current sensitivity coefficients has also been developed, in order to help the DSO to select the remaining flexibility offers that are improving the network state. The method is based on the Kirchhoff first law, illustrated in Figure III-28, which states that at any node of an electrical network, the sum of the currents flowing into that node is equal to the sum of the currents flowing out of that node.

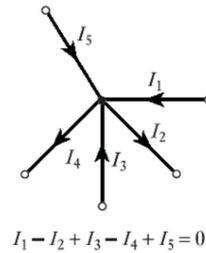

Figure III-28 - Illustration of the Kirchhoff 1st Law

As distribution networks are generally radial, a Depth First Search algorithm (DFS) can be applied in the primary substation federation in order to determine all the nodes that are downstream or upstream the potential overloaded component. Then, depending on the location of the flexibility resources, it is possible to assess their effect on the congestion.

For each flexibility offer, the corresponding flowing current coefficient is set to 1 if the flexibility offer activation can help solving of the congestion. It is set to 0 if the flexibility offer activation has no impact on the congestion. It is set to -1 if the flexibility offer activation aggravates the congestion. A small example of this topological rule is presented in Figure III-29.

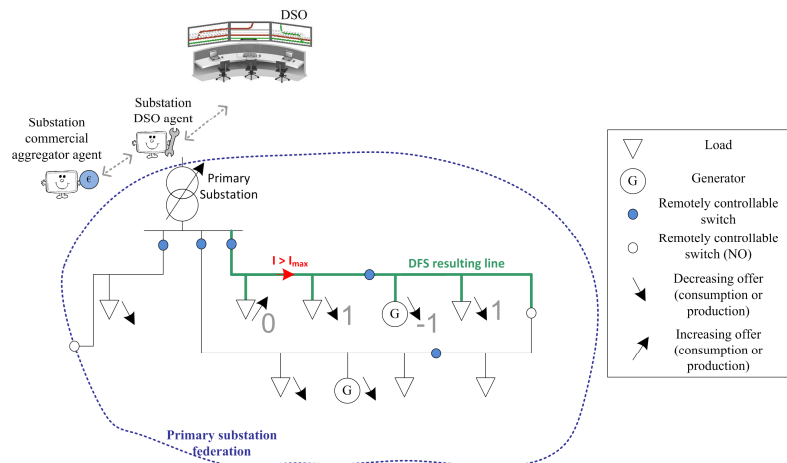

Figure III-29 – Selection of flexibility offers for current congestion solving

In this example, some flexible loads are able to decrease their consumption, some others are able to increase their consumption and some flexible DGs are able to reduce their production. The aim of this topological rule is to consider only the flexibility offers that can help the line congestion (in red).

First, the DFS algorithm permits the searching space of the solutions (in green bold type) to be found, i.e. the part of the network where flexibility offers activation might have an impact on the current congestion. Then, the developed algorithm affects a flowing current sensitivity coefficient for each flexibility offer. In this case, all the proposed decreasing consumptions flexibility offers that are downstream the congested line will have a coefficient set at 1. On the other hand, all the decreasing flexible productions or increasing flexible consumptions offers which are downstream the congested line will have a coefficient set at -1. All the flexibility offers that are upstream the congested line have no impact on the overload. Coefficients corresponding to these flexibility offers are set at 0.

All the flexibility offers that are in the other parts of the primary substation federation, which are not in the suitable ad-hoc space of solutions, are not considered by the substation DSO agent.

- **Efficiency coefficients for MV level**

As mentioned before, two heuristic based methods have been investigated for the provision of flexibility offers for DSO operational planning. The second one is based on an efficiency merit order list.

Thus, in this method, a complementary computation is performed in order to assess the efficiency of each flexibility offer and to rank them with respect to their ability to solve the considered constraints. It is assumed that the voltage efficiency of each flexibility offer can be computed thanks to equation (III.27).

$$ev_{i,j,k} = \frac{\left(\frac{\partial |V|_i}{\partial P_j}\right)}{c_{j,k}} \quad (III.27)$$

Where  $ev_{i,j,k}$  is the voltage efficiency on node  $i$  of the  $k^{th}$  flexibility offer available at node  $j$ .  $\frac{\partial |V|_i}{\partial P_j}$  is the voltage magnitude sensitivity at the node  $i$  with respect to a flexibility activation at the node  $j$ .  $c_{j,k}$  is the activation price of the  $k^{th}$  flexibility offer available at node  $j$ .

And the flowing current efficiency of each flexibility offer is computed thanks to equation (III.28).

$$ec_{ii',j,k} = \frac{s_{ii',j}}{c_{j,k}} \quad (III.28)$$

In the same manner,  $ec_{ii',j,k}$  is the flowing current efficiency on component (line or transformer)  $ii'$  of the  $k^{th}$  flexibility offer available at node  $j$ .  $s_{ii',j}$  is the flowing current sensitivity on component  $ii'$  with respect to a flexibility activation at the node  $j$ . And  $c_{j,k}$  is the activation price of the  $k^{th}$  flexibility offer available at node  $j$ .



These efficiency coefficients permit the flexibility offers to be ranked in another manner than by considering only the cost of the flexibility offers. Hence, if two flexibility offers have the same voltage sensitivity with respect to a voltage deviation, the cheapest one will have highest voltage efficiency. It will be then more interesting to activate it instead of the more expensive one. However, if one flexibility offer is quite sensitive but very expensive, its efficiency will be low. If another flexibility offer is available, less sensitive but clearly less expensive, this latter offer will be more efficient.

The ranking based on efficiency calculation is in fact a kind of transposition of what is called “locational pricing” or “local marginal prices” at the transmission system level. This mechanism is used in Europe to optimize the use of transmission systems interconnections between countries. As it is explained in [LI-05], when there is a congestion in the system, the market has to be cleared on the bus level instead of on the system level. The clearing price at each bus is called the locational marginal price and is determined at each bus considering the transmission line constraints.

In the presented case, the computation of the offer efficiency permits the offers ranking to be redefined, not only depending on the initial price but also depending on their location. This new sorting of flexibility offers is directly linked with the potential network constraints.

- **Concepts of the provision methods of MV and LV flexibility offers**

The concepts and the logical sequences of the two heuristic based provision methods of flexibility offers for DSO risk management are described in this paragraph.

The objectives of these methods are to help the DSO to determine in an operational planning phase, one of the best economic combinations of MV and LV flexibility offers to be activated in order to solve potential voltage deviations and current congestions that could occur.

The initial steps of these two methods are the same and are shown in Figure III-30. They aim at determining if there is a potential risk of voltage deviations or of congestions when a sudden non-expected change occurs. Hence, for a given forecasted base load and production plan, different contingency scenarios are simulated. Primary substation federations are constructed by the substation DSO agents in order to determine if potential constraints can occur. As reconfiguration is not taking into account in these methods, these zones represent the total areas where flexibility resources can help the solving of the potential constraints.

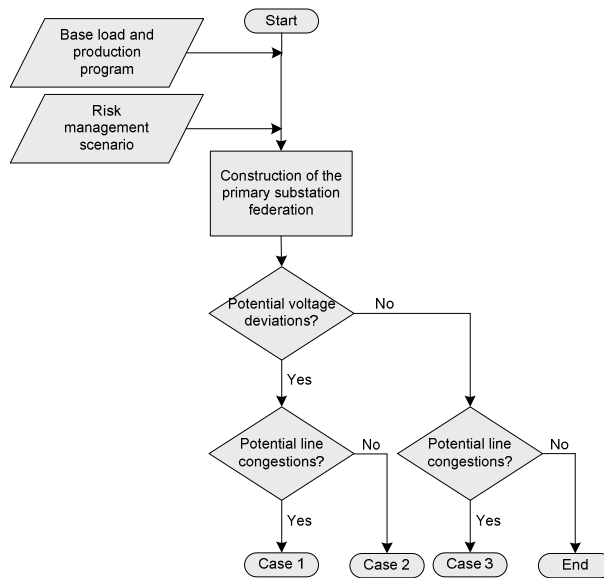

*Figure III-30 – Initial steps of the provision method for DSO risk management*

In Figure III-30, three different cases are presented. Case 1 represents a case where potential appearing network constraints are both voltage deviations and line congestions. Case 2 illustrates a case where the contingency provokes only voltage deviations. Finally, case 3 represents a case where only overloads are appearing because of the assumed contingency.

If existing grid flexibility resources such as OLTC transformer are not sufficient to solve the potential appearing constraints, the remaining available flexibility offers are taken as variables in the process. The idea is to first select or not the remaining available flexibility offers depending on their possible effects on the potential network constraints.

Thanks to the computation of the sensitivity coefficients, it is possible to assess the effect of the different flexibility offers on the considered network constraints. For each network constraint, flexibility offers that have a non-negligible positive effect on the constraint are selected. All flexibility offers which have a negative impact will not be used.

At the end of the process, the tables of the selected offers and the tables of the non-selected offers are constructed. The tables of the selected offers are then checked in order to delete the conflictual flexibility offers that are also appearing in the tables of the non-selected offers. This type of flexibility offer could typically help the operation in one part of the primary substation federation but also aggravate the situation in another part of this area. The flowchart of the selection method is depicted in Figure III-31.

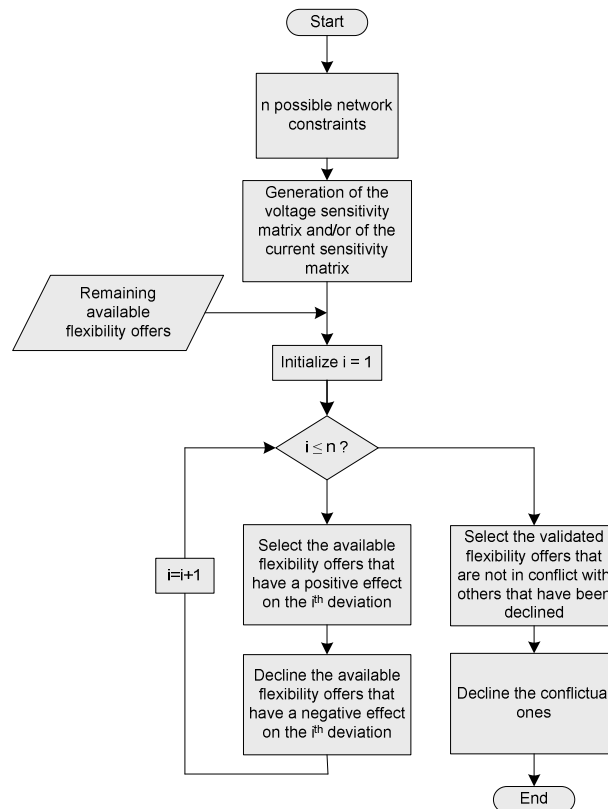

Figure III-31 – Flexibility offers selection method for DSO risk management

Once the selected offers are listed, they are sorted by cost in the first developed method, and by efficiency per constraint in the second developed method. They are then activated accordingly to the merit order list until the potential network constraints are released.

The proposed algorithms are focusing first on possible voltage deviations, and then they are treating the potential congestions. This choice can be justified by the fact that there are generally more sensitive offers to solve congestions than to solve voltage deviations by construction of the topological rule. Therefore, the retained flexibility offers for solving voltage deviations might be included in the ones that can solve potential congestions, and help the two problems solving simultaneously. For each type of constraint, the two methods focus step by step at the largest constraint to solve until there is no constraint anymore or until there is not enough sensitive flexibility offers.

At the end of these provision methods of flexibility offers for DSO risk management, a set of flexibility offers is found, ensuring the DSO that its activation would permit to avoid or restrain the potential appearing network constraints. The choice of these heuristic algorithms ensures small computational requirements because no advanced optimization processes are performed. This is well-suited for distributed methods that can be embedded directly into an RTU in the primary substation. This is a first mathematical approach to solve flexibility provision problematic for DSO risk management, which is easily apprehensible and implementable.

- **Examples of DSO risk management scenarios solved with the proposed heuristic methods**

The considered cases are specific examples of DSO risk management scenarios applied on a 72-nodes MV balanced electrical network. Corresponding networks characteristics and applied load curves are presented in *Annex II - Test networks data*.

The three following scenarios of contingency are studied:

1. Disconnection of a part of the network for maintenance work, removing suddenly a part of the connected loads of a feeder: in this case, the disconnected part of the network is recovered by another part of the network, connected in another primary substation. It is assumed that this operation can cause over-voltages in the network, due to a non-expected decrease of loading while DGs are still producing in the remaining connected feeder.

2. Sudden changes in weather conditions, decreasing suddenly the overall decentralized production: it is assumed here, that the sudden decrease of the overall decentralized production is causing under-voltages deviations in the network.

3. Service restoration of a feeder by its reconnection through a back-up transformer: it is assumed that the service restoration of the secured feeder leads to a sharp increase of the load in the securing considered network. This could imply current overloads in some lines or under-voltages in some parts of the network.

For illustration concerns, it is assumed that the tap of the OLTC transformer at the primary substation is fixed, and that there is neither capacitor bank nor possibility to control the DG reactive power outputs. Only active flexibility offers remaining after the markets closure are assumed to be available in the considered 72-nodes network, via production dispatch down and via DR management. The power factors at the MV nodes are considered as fixed power factors.

In these cases, the flexibility energy prices are based on the basic spot price which varies from 28€/MWh to 35€/MWh [EPEX-16]. Domestic DR prices are evaluated between 50€/MWh and 150€/MWh. DG dispatch down prices are assumed to be between 120€/MWh and 200€/MWh. In these cases, the available flexibility offers are assumed to be equivalent to power blocks, meaning that it is only possible to activate the entire flexibility offer over one hour.

#### **Risk management on the 72-nodes network (test case 1)**

The first contingency scenario is tested on the 72-nodes network at 2p.m. loading. The voltage value at the secondary part of the primary substation transformer is fixed at 1.03 p.u. It is assumed that a part of the network is disconnected from the considered primary substation for maintenance work. The initially expected voltage profile with the forecasted loading conditions was respecting all the network admissible voltage characteristics (see Figure III-32(a)). However, when a given part of a feeder is disconnected from the primary substation, some over-voltages deviations are appearing (see Figure

III-32(b)) because of the non-expected decrease of loading. For illustrative reasons, the nodes of the 72-nodes network have been re-indexed to plot the voltage profiles along the network. The correspondence matrix relating the initial nodes to the re-indexed ones is presented in *Annex II - Test networks data*.

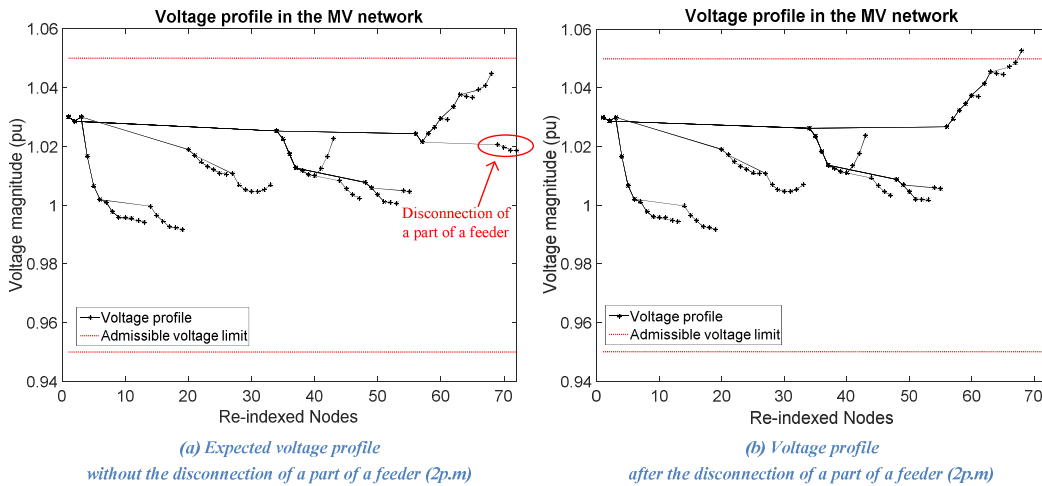

Figure III-32 – Voltage profiles in the 72-nodes network (2 p.m.) – test case 1 – initial

In order to assess if enough flexibility resources will be available if this scenario occurs, the substation DSO agent should build locally its primary substation federation, including all the possible means of regulation in this particular configuration. In this example, the only available flexibility resources are assumed to be only remaining active power flexibility offers which are presented in Figure III-33(b).

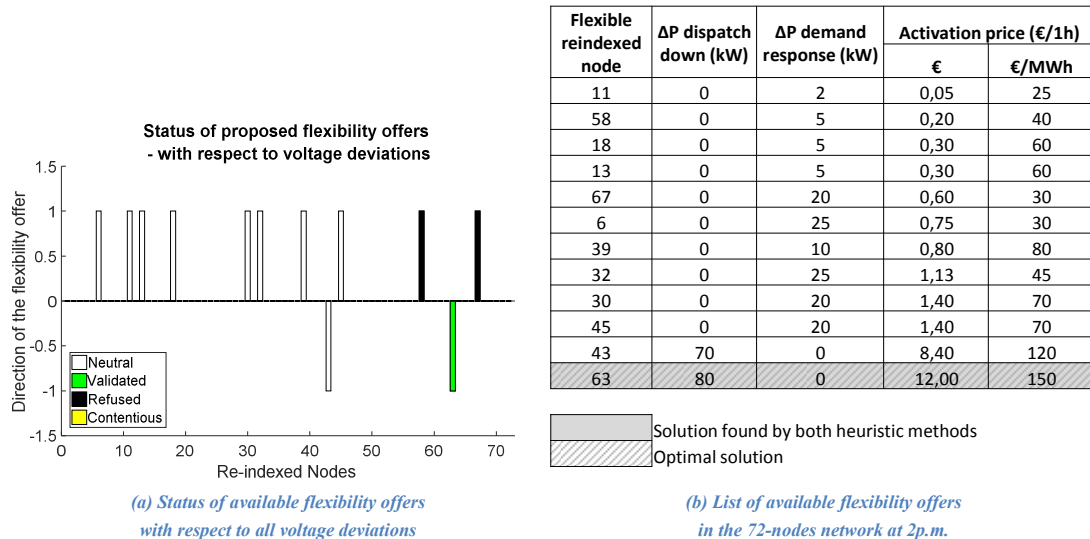

Figure III-33 – List and status of the available flexibility offers – Sensitivity threshold set at 1%

Given all the available flexibility offers in the 72-nodes network in this case, it is possible to compute their respective voltage sensitivity with respect to the potentially occurring constraints. As explained in the previous part, flexibility offers that have a non-negligible positive effect on the constraint are selected. All flexibility offers which have a negative impact are declined. The final status of the available flexibility offers are presented in Figure III-33(a).

Finally, the only selected flexibility offer that can help the potential occurring constraints is the production dispatch down proposed at node 62. Its activation permits the potential over-voltages to be solved, as shown in Figure III-34(b).

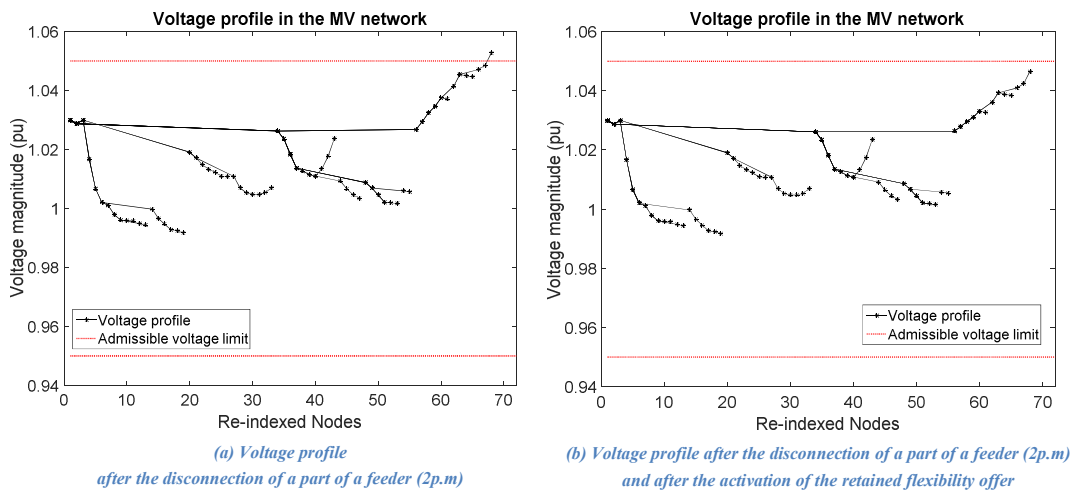

Figure III-34 – Voltage profiles in the 72-nodes network (2 p.m.) – test case 1 – final

The both developed methods, based respectively on cost merit order list and on efficiency merit order list, lead to the same solution. The activation of this flexibility offer is also the optimal economical solution found after an exhaustive computation of all the possible combinations of the available flexibility offers.

### Risk management on the 72-nodes network (test case 2)

The second contingency scenario is now tested on the 72-nodes network at 4p.m. loading. The voltage value at the secondary part of the primary substation transformer is fixed at 1.01 p.u. The expected voltage profile with the forecasted weather conditions is respecting all the network admissible voltage characteristics (Figure III-35(a)). However, if sudden changes in the weather conditions are happening, i.e. if the weather becomes suddenly cloudy, the DGs (which are only PV production in this network) are not producing anymore. Some under-voltages deviations are appearing (see Figure III-35(b)). Here again, for illustrative reasons, the nodes of the 72-nodes network have been re-indexed to plot the voltage profiles along the network. The correspondence matrix relating the initial nodes to the re-indexed ones is presented in *Annex II - Test networks data*.

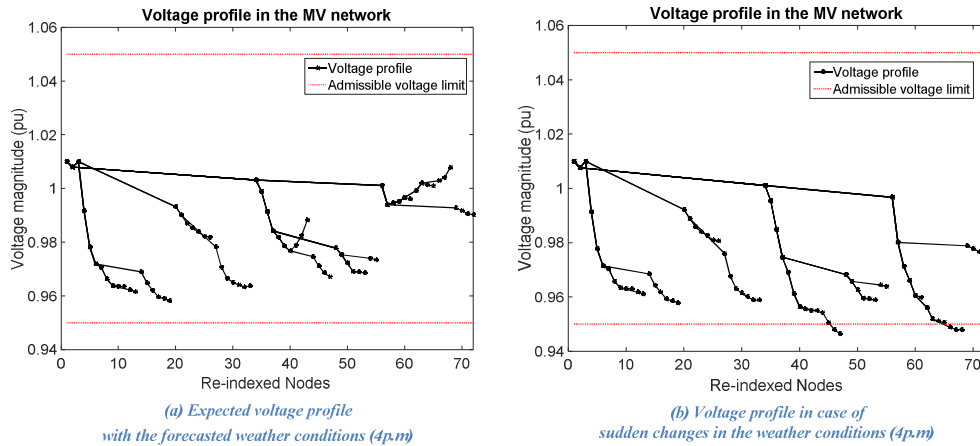



Figure III-35 – Voltage profiles in the 72-nodes network (4 p.m.) – test case 2 – initial

In this example, the only available flexibility resources are the remaining active power flexibility offers presented in Figure III-36. They are only consumption decrease offers via DR management. Given these flexibility offers, their respective voltage sensitivity coefficients with respect to the potentially occurring constraints are first computed. In this specific case, 9 flexibility offers have a non-negligible positive effect on the constraints. These flexibility offers are then ranked respectively by cost and by efficiency, and activated following the merit order lists until the potential occurring constraints are solved. The retained flexibility offers to solve the potential occurring under-voltages are presented in Figure III-36 (a) and (b), respectively found with the heuristics based on the cost, and based on the efficiency.

Flexible reindexed node	$\Delta P$ demand response (kW)	Activation price (€/1h)	
		€	€/MWh
62	1	0,05	50
11	3	0,08	25
54	2	0,10	50
22	2,5	0,15	60
58	5	0,20	40
18	5	0,25	50
13	10	0,30	30
48	12	0,36	30
65	5	0,40	80
6	20	0,60	30
44	20	0,60	30
67	10	0,60	60
32	20	0,90	45
39	12	0,96	80
30	15	1,05	70
45	20	1,40	70

 Solution found by the heuristic based on cost  
 Optimal solution

(a) List of retained available flexibility offers in the 72-nodes network at 2p.m. with the cost based method

Flexible reindexed node	$\Delta P$ demand response (kW)	Activation price (€/1h)	
		€	€/MWh
62	1	0,05	50
11	3	0,08	25
54	2	0,10	50
22	2,5	0,15	60
58	5	0,20	40
18	5	0,25	50
13	10	0,30	30
48	12	0,36	30
65	5	0,40	80
6	20	0,60	30
44	20	0,60	30
67	10	0,60	60
32	20	0,90	45
39	12	0,96	80
30	15	1,05	70
45	20	1,40	70

 Solution found by the heuristic based on efficiency  
 Optimal solution

(b) List of retained available flexibility offers in the 72-nodes network at 2p.m. with the efficiency based method

Figure III-36 – Lists of the available flexibility offers selected by the heuristic methods – Sensitivity threshold set at 1%

The both heuristic methods are not permitting the optimal solution to be found in this specific case. However, the heuristic method based on the efficiency of the flexibility offers leads to a better economical solution than the one based on their costs.

In this specific case, an illustration of the application of the LV4MV algorithm presented in part III.3 is proposed. It is assumed that two specific LV networks are connected to nodes 49 and 50 in the 72-nodes network, and that their respective secondary substations are equipped with advanced RTUs. In order to respect the respective loading cases of these nodes, the LV4MV process is performed on a particular LV network which is presented in *Annex V – Example of the LV4MV process for MV DSO risk management*.

As a reminder, the LV4MV algorithm allows getting an aggregated MV vision of a downstream LV network and its inherent flexibility opportunities. It allows the DSO to treat each LV network as a flexible aggregated MV node, with a given specific flexible power, and with specific admissible voltage limits reflecting the downstream LV network constraints.

Hence, after the LV4MV process, two new MV admissible voltage ranges are available at nodes 49 and 50. They are not associated with any flexibility activation because no downstream LV flexibility is assumed. The new resulting flexibility resources for this test case are presented in Figure III-37.

Flexible reindexed node	ΔP demand response (kW)	Activation price (€/1h)		New MV voltage range	
		€	€/MWh	Vadm min	Vadm max
46	0	0	0	0,941	1,10
47	0	0	0	0,946	1,10
62	1	0,05	50	0,95	1,05
11	3	0,08	25	0,95	1,05
54	2	0,10	50	0,95	1,05
22	2,5	0,15	60	0,95	1,05
58	5	0,20	40	0,95	1,05
18	5	0,25	50	0,95	1,05
13	10	0,30	30	0,95	1,05
48	12	0,36	30	0,95	1,05
65	5	0,40	80	0,95	1,05
6	20	0,60	30	0,95	1,05
44	20	0,60	30	0,95	1,05
67	10	0,60	60	0,95	1,05
32	20	0,90	45	0,95	1,05
39	12	0,96	80	0,95	1,05
30	15	1,05	70	0,95	1,05
45	20	1,40	70	0,95	1,05

 Solution found by the heuristic based on efficiency  
 Optimal solution

*Figure III-37 – Lists of the available flexibility offers (including LV4MV inputs offers) selected by the heuristic method based on efficiency – Sensitivity threshold set at 1%*



The heuristic methods are also considering the potential LV4MV inputs. Therefore, the new retained flexibility offers by the heuristic based on the efficiency for this test case are presented in Figure III-37. In this specific case, the LV4MV algorithm permits avoiding the activation of 4 other flexibility offers by enlarging some MV admissible voltage ranges, while ensuring that all LV network constraints are still respected. The final voltage profiles in the 72-nodes MV network are represented in Figure III-38. More particularly, Figure III-38 (a) represents the voltage profile after the activation of the retained flexibility offers by the efficiency-based heuristic method, without considering any LV downstream networks. Figure III-38 (b) represents the voltage profile after the activation of the retained flexibility offers by the efficiency-based heuristic method, when considering the two critical LV downstream networks at nodes 49 and 50 (respectively corresponding to the re-indexed nodes 46 and 47 in the figure).

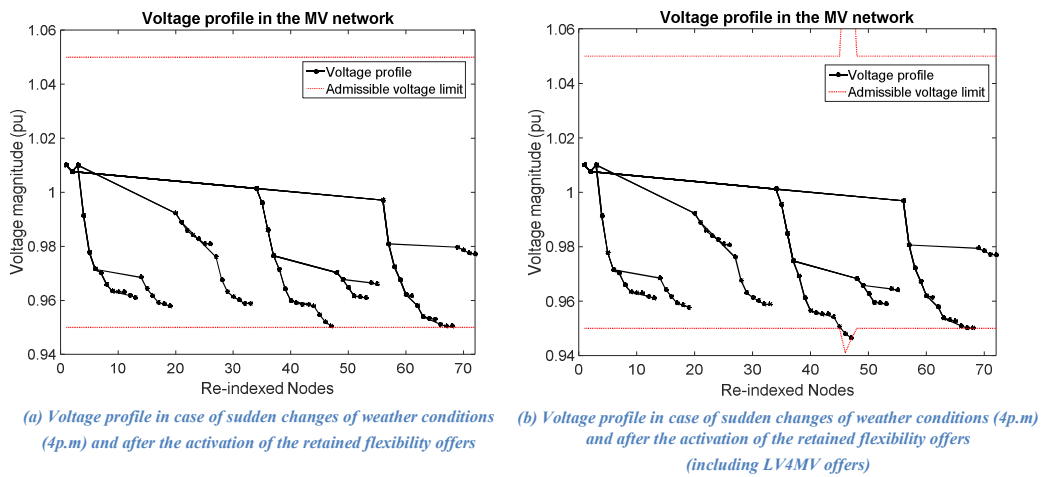

Figure III-38 – Voltage profiles in the 72-nodes network (4 p.m.) – test case 2 – final

To conclude, the two heuristic based provision processes are permitting the DSOs to determine locally if a solution exists to solve the potential occurring network constraints in case of sudden changes in their network. In this specific test case, the two methods are giving different economical results. While the heuristic method based on flexibility offers costs leads to a solution that costs 4.67€, the one based on flexibility offers efficiency leads to a solution that costs 3.51€. In this specific test case, if the LV4MV process is performed at nodes 49 and 50, the final cost of the solution is even decreasing down to 1.05€.

### Risk management on the 72-nodes network (test case 3)

Finally, the third contingency scenario is tested on the 72-nodes network at 8p.m. loading. In this case, all the flowing currents in the network are respecting their maximum admissible current rate (see Figure III-39 (a)). It is assumed that the service restoration of a secured feeder is leading to a sharp increase of the load in the securing 72-nodes network. Due to this non-expected change, the flowing current in the feeding transformer is exceeding its admissible current rate (see Figure III-39 (b)).

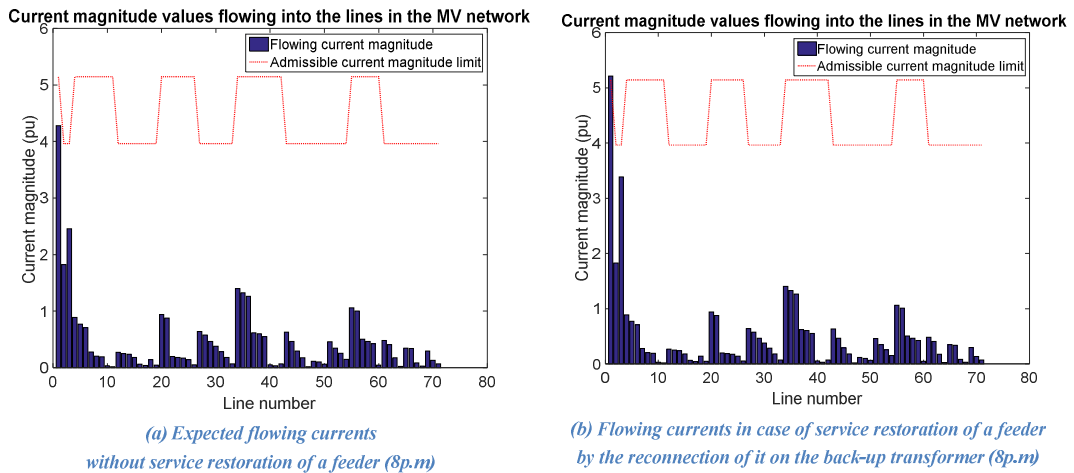

Figure III-39 – Flowing currents in the 72-nodes network (8 p.m.) – test case 3 – initial

Here again, it is assumed that some remaining flexibility offers that have not been selected during the market processes are available. They are presented in Figure III-40 (b). Given these flexibility offers, their respective current sensitivity coefficients with respect to the potentially occurring overload are first computed. Their statuses are presented in Figure III-40 (a). All the selected flexibility offers are then ranked by prices and activated following the merit order until the potential occurring overload is solved. The retained flexibility offers are presented in grey in Figure III-40 (b).

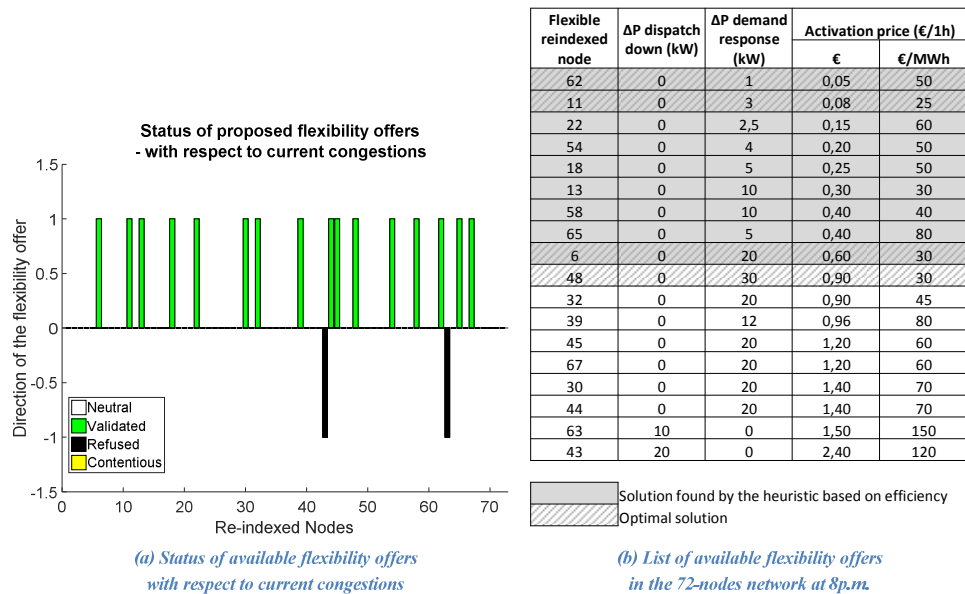

Figure III-40 – List and status of the available flexibility offers

In this specific case, all the DR flexibility offers that are proposed are taken into consideration for the optimization because the overload is occurring in the upstream feeding transformer of the network.

Hence, all the current sensitivity coefficients of these DR offers have the same sensitivity weight, and both heuristic methods based on cost and on efficiency are leading to the same solution.

These contingency scenarios have been also applied on a 33-nodes MV network and solved with the same heuristic methods. More results are provided in *Annex VI – Complementary results of the heuristic based provision process for DSO risk management*. An example of the resolution of a combination of simultaneous voltage deviations and overloads is also presented.

### **Optimization based provision processes**

The previously presented provision process method was based on simple heuristics ranking the remaining available flexibility offers and activating them while following merit order lists. These heuristic methods have been deliberately developed in a simple manner in order to be accessible by all the system operators, and to be easily deployed in the field. The same provision process is now reformulated as an optimization problem to minimize the cost of flexibility offers activation. The objective of this optimization is to determine the best economic combination of remaining available MV and LV flexibilities to be activated in order to solve the different cases of potential voltage deviations and current overloads at the MV level, ensuring also that all network constraints are respected in downstream LV networks. In this optimization process, the decision variables are:

- MV flexibility offers of MV controllable productions or loads,
- LV flexibility combinations offers in downstream networks corresponding to the new MV admissible voltage ranges and their associated prices of LV flexibility offers activation, at equipped MV/LV transformers where LV4MV can be executed,
- OLTC position at the primary substation, if existing,
- Capacitor bank position at the bus-bar, if existing.

All the non-equipped secondary substations are considered as MV aggregated non-flexible loads and their MV admissible voltage ranges are fixed at +/-5% of the nominal voltage value. The admissible voltage range at MV connection point of MV end users are as well set at +/-5% of the nominal voltage value, as the European norm EN 50160 suggests [EURE-95].

The objective function, corresponding to the total price of the flexibility offers activation can be formulated as in equation (III.29). Prices for OLTC positions and for capacitor bank positions are not considered, as they are direct DSO flexibility means.

$$\min \sum_i \sum_l (c_{il} \times x_{il}) \quad \text{(III.29)}$$

where  $i$  is the index of the MV node,  $l$  the index of the flexibility offer at node  $i$ ,  $c_{il}$  is the cost of the flexibility activation  $l$  at node  $i$ , and  $x_{il}$  is the state of activation of the flexibility  $l$  at node  $i$ . This binary variable is either equal to 0 if the flexibility offer is not activated or 1 if the flexibility offer is activated.

The problem is ruled by the classical loadflow equations, and the constraints of the problem are:

$$\forall i \in N, \quad V_{MV \min,i} \leq |V_i| \quad (III.30)$$

$$\forall i \in N, \quad |V_i| \leq V_{MV \max,i} \quad (III.31)$$

$$\forall j \in L, \quad |I_j| \leq I_{j \max} \quad (III.32)$$

$$tap \min \leq x_{tap_{OLTC}} \leq tap \max \quad (III.33)$$

$$CB \min \leq x_{CB} \leq CB \max \quad (III.34)$$

Where  $N$  is the set of nodes,  $L$  the set of lines of the considered MV network, and  $|V_i|$  is the voltage magnitude at the MV node  $i$ .

$V_{MV \min,i}$  and  $V_{MV \max,i}$  are respectively the minimum and maximum MV voltage magnitude admissible constraints at the MV node  $i$ . As presented in part III.3, the LV4MV algorithm allows the DSO to treat each LV network as a flexible aggregated MV node, with a given specific flexible power, and with specific admissible voltage limits which are reflecting the downstream LV network constraints. If information about downstream LV networks is not available, they are treated as MV aggregated load or generator. Given a node  $k$  where the LV4MV has been performed on its downstream LV network, and  $l$  the index of one LV flexibility combination activation at this node, if  $x_{kl} = 1$ , the associated MV voltage limits  $V_{MV \min,k}$  and  $V_{MV \max,k}$  are updated.

$|I_j|$  is the magnitude of the current flowing into the line  $j$ ,  $I_{j \max}$  is the maximum limit of current flowing into the line  $j$ .  $x_{tap_{OLTC}}$  is the OLTC position,  $tap \min$  and  $tap \max$  are the bounds positions of the OLTC.  $x_{CB}$  is the capacitor bank position,  $CB \min$  and  $CB \max$  are the bounds positions of the capacitor bank. These positions can be represented either directly by integer variables, or by combinations of binary variables.

The optimization problem is formulated as an Integer Quadratic Constraints Programming (IQCP) problem, which is part of Mixed Integer Quadratic Constraints Programming (MIQCP) problems [LEE-11], because all the decision variables are restricted to be integers, the objective function is linear and the constraints are all linear or quadratic (due to some quadratic loadflow equations).

This combinatorial problem is NP-hard and classical algorithms used for the resolution of this type of problems, such as cutting planes methods and branch-and-bound methods, have an exponential execution time with respect to the number of decision variables. In this case, the number of decision variables is increasing with the number of remaining available flexibility offers, and with the number of possible OLTC and capacitor bank positions. In an exhaustive approach point of view, knowing that all the decision variables are binary variables, it is possible to assess that for  $n$  given decision variables, the total number of possible combinations is equal to  $2^n$ . The exponential feature of the evolution of the number of possible combinations with respect to the number of variables is drawn on Figure III-41.

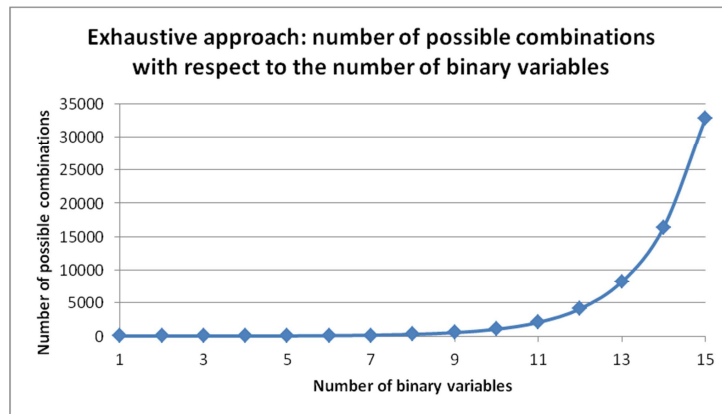

Figure III-41 – Evolution of the number of possible combinations with respect to the number of binary variables

Even if the exhaustive approach ensures to find the global optimal solution, this methodology is really time and CPU consuming, and even more for a large number of decision variables. Other methods have been investigated in order to find a good solution, and if possible, the global optimal one.

In this work, a genetic algorithm has been tested to find a solution to this optimization problem. Metaheuristic methods can be used to solve combinatorial problems in a reasonable time and without needing large computational requirements. However, they are basically based on randomness and cannot ensure to find the global optimal solution unless if the resolution time is tending to infinity [DREO-06]. The dedicated algorithm that has been developed is dealing with both discrete and binary variables, representing the OLTC and the capacitor bank positions and the flexibility offers activation status. More details on genetic algorithm can be found in *Annex VII – Optimization methods details*.

Exact algorithms can also be used to solve combinatorial problems, as cutting-plane methods, or branch-and-bound methods. The method that has been also introduced in this work is the branch-and-cut method, which is a mix of these two methods. This method is solving the problem by using the branch-and-bound method, with the progressive introduction of cuts to eliminate unrealistic solutions in the solution space. The branch-and-cut method is faster than the branch-and-bound method, and guarantees the convergence to the global optimal in the case of combinatorial problems [MITC-02]. More details about this method can be found in *Annex VII – Optimization methods details*.

### Performances comparison between the methods

The most interesting feature to compare between all the tested methods is the final objective value, which corresponds to the cost of the selected flexibility offers that have to be activated to solve the potential appearing network constraints. However, it is also important to compare the execution times of the algorithms and the number of function evaluations in the different cases, in order to have an idea on the computational requirements that are needed in the deployed RTU.

The idea is to have different methods which give acceptable solutions with different computational requirements, so it will be possible to deploy algorithms that are adapted with the available CPU in the field. In order to compare the proposed strategies, the tests have been done on a computer Intel® Core™2 Duo CPU E8400 @ 3.00GHz with 4,00 Go of RAM.

The same considered cases of DSO risk management scenarios are simulated on the MV balanced electrical networks and solved with the different presented methods. The table presented in Figure III-42 summarizes the results of the different test cases.

Test cases	Algorithm	Fobj (€)	Execution time (s)	Number of function evaluations	Number of possible combinations
<b>72-nodes network - case 1</b>	Heuristic (cost)	12	0,25	1	4096
	Heuristic (efficiency)	12	0,28	1	4096
	Metaheuristic	12	5,63	200	4096
	Branch-and-cut	12	0,70	5	4096
	Exhaustive	12	69,71	4096	4096
<b>72-nodes network - case 2</b>	Heuristic (cost)	4,67	0,65	9	65536
	Heuristic (efficiency)	3,51	0,51	7	65536
	Metaheuristic	2,85	11,98	600	65536
	Branch-and-cut	2,85	4,67	46	65536
	Exhaustive	2,85	1438,29	65536	65536
<b>72-nodes network - case 3</b>	Heuristic (cost)	2,43	0,51	9	262144
	Heuristic (efficiency)	2,43	0,46	9	262144
	Metaheuristic	1,63	15,23	1000	262144
	Branch-and-cut	1,63	8,85	123	262144
	Exhaustive	1,63	6369,22	262144	262144
<b>33-nodes network - case 2</b>	Heuristic (cost)	12,42	0,46	8	1024
	Heuristic (efficiency)	10,31	0,38	7	1024
	Metaheuristic	10,31	2,01	200	1024
	Branch-and-cut	10,31	0,89	9	1024
	Exhaustive	10,31	8,01	1024	1024
<b>33-nodes network - case 3</b>	Heuristic (cost)	8,7	0,62	11	32768
	Heuristic (efficiency)	8,70	0,54	11	32768
	Metaheuristic	6,05	9,41	1000	32768
	Branch-and-cut	6,05	1,08	27	32768
	Exhaustive	6,05	264,94	32768	32768

Figure III-42 – Summary of the results of the different methods on the test cases

As mentioned previously, the most interesting feature to compare between the methods is the final objective value. In this sense, the branch-and-cut method and the exhaustive method are the best strategies to have the guarantee to find the global optimal solution, as the problem is combinatorial.

As seen in the test cases, the heuristic method based on efficiency is generally leading to a better solution than the heuristic based on cost. However, it does not always converge to the global optimal. This is due to the gluttonous characteristic of the method, which is highly depending on the chosen sensitivity threshold, as explained in *Annex VIII – Sensitivity threshold impact in the developed heuristic methods*. The method is selecting the sensitive flexibility offers one after the other, and is not going back on its selection. This has a direct impact on the objective value which can differ from the optimal one.

The metaheuristic method based on the genetic algorithm is a random process. Depending on the shutoff criteria, the algorithm can either stop in a local optimum or find the global one. The more iterations the algorithm runs, the more chances it has to find the global optimum. However, it cannot guarantee to find the global optimal solution.

It is important to remind that these algorithms have to be performed in a decentralized architecture by the local substation DSO agents, distributed in the local advanced RTUs. They have to run the algorithm near real-time for their respective primary substation federation. Therefore, it is useful to compare not only the objective values found by the different methods, but also their respective execution time. Execution times mostly depend on the computer performances and that is the reason why it is also significant to compare their respective number of objective function evaluations.

The heuristic method is a fast method due to its mathematical low requirements. It evaluates the objective function every time it activates a new flexibility offer, until all network constraints are respected. The metaheuristic method has a fixed number of objective function evaluations which correspond to the maximum number of iterations times the size of the population. This has a direct link with the execution time of the algorithm. For each generated combination of flexibility offers, it evaluates the objective function. Here, a compromise has to be found between the maximum number of iterations and the optimal convergence of the algorithm. The number of iteration can be chosen after several observations of the convergence decay curves in different cases. These curves permit to give an idea of the minimum number of iterations to find a good solution and of the limit where the algorithm always converges to the same solution. These choices for the different test cases are justified in *Annex VII – Optimization methods details*. However, as for the adjustment of cross-over and mutations parameters, the tuning of the maximum number of iterations is really subjective. The branch-and-cut algorithm seems to be the best method to get efficiently the global optimal solution in a reasonable number of objective function evaluations. Finally, the exhaustive method is evaluating all the possible combinations of flexibility offers. As for the number of function evaluations, the execution time is growing exponentially.

### **Advantages and drawbacks of the methods**

This part presents a summary of the advantages and of the drawbacks of the presented methods, for the distribution of short-term DSO operational planning method in the advanced RTUs deployed in primary substations.

- **Heuristic method based on an efficiency merit order list**

One of the reasons to distribute short-term DSO operational planning is to reduce data transfer and computational requirements in the centralized system. A fast and simple algorithm as the developed heuristic method based on sensitivity can be easily implemented in an advanced RTU. Even if it does not guarantee to find the global optimum in case of sudden contingency, it is always converging and gives

more accurate solutions than a simple algorithm only based on cost merit order list. For simple cases with small network constraint deviations and large number of remaining available flexibility offers, it is an efficient algorithm to find a not always optimal but enough good solution. Moreover, in the case of not enough remaining flexibility offers are available to solve the occurring network constraints, it always permits the flexibility offers to be ranked depending on their potential effects on the network constraints, and it proposes a solution that can improve the network state. However, the gluttonous characteristic of the algorithm is not always favorable to find the optimal solution. Indeed, if a highly voltage efficient flexibility offer is found, it will be selected without taking into account its power quantity. In some particular cases, it could be more interesting to select a less voltage efficient flexibility offer which proposes a larger power quantity.

- **Metaheuristic method based on the genetic algorithm**

The metaheuristic method can converge to the global optimal solution with a fixed number of iterations, which is neither depending on the network constraints nor on the number of the remaining available flexibility offers. This is a good advantage in order to easily limit the CPU requirements depending on the deployed RTU. However, this type of algorithm is based on a random generation of possible combinations. The convergence of the algorithm is highly depending on the size of the initial population, on the types of cross-over, and on the rate of mutations. The shutoff parameter has to be chosen arbitrarily depending on the decay curve of convergence. In some cases, the algorithm could not converge and could give no solution.

- **Exact method based on the branch-and-cut algorithm**

The use of exact methods as the one based on the branch-and-cut algorithm seems to be a good compromise for short-term DSO operational planning, leading to the optimal solution in a quite reasonable time. However, the distribution of this kind of algorithm in all primary substations might be impossible at the moment. This method requires embedding the branch-and-cut solver in the RTU. The majority of branch-and-cut solvers requires high CPU capacity and is commercialized for industrial applications. Most probably, in few years, it is possible to think about this type of method which is the most efficient one.

- **Exhaustive method**

The exhaustive method is a simple method that guarantees finding the global optimal solution. However the combinatorial aspect of the problem is an eliminatory criterion for this method which would requires too much computational efforts and which would take too much computational time to find the solution in large networks with a large amount of flexibility resources. It can be however used as a reference for comparison purposes.



## III.5 Conclusion

In this chapter, innovative methodologies to support the DSO to act as a market enabler have been developed and presented. In a context where the flexibility operators are dealing with an increasing number of local flexibility opportunities, the DSOs have to play a key role to enable the market exchanges processes. They have also to guarantee acceptable network operation conditions and to ensure a good quality of supply to their customers, and also if non-expected changes are occurring on their network.

First, a distributed solution for the validation of the available distributed flexibility offers that will be exchanged in the market processes and mechanisms has been elaborated. This tool is based on fuzzy arithmetic in order to have the possibility to assess the effect of the forecast reliability and accuracy on the voltage profiles. Thanks to the method and depending on their confidence on the data, the DSOs are able to validate or not the available flexibility offers which are contracted by the commercial aggregators, as presented in the particular test cases.

A second method has been presented in order to support the DSOs to better consider LV network constraints and LV available flexibility offers, and to take advantage of it for the overall distribution network operation. The method helps the DSOs to get more accurate information of the admissible voltage limits at critical MV nodes where only a LV network is connected. Thanks to this tool, the DSOs will be able to operate their MV network closer to the limits while guaranteeing security and efficiency, and so to avoid some investments which they would have done without this knowledge. Moreover, two methodologies have been investigated with the aim to enlarge these new MV admissible voltage limits, by activating the available LV flexibility offers. Thanks to these methods, LV flexibility offers can be directly transferred to the MV level as a new MV admissible voltage range, and used for DSO risk management for example.

After having validated the local flexibility offers which are transmitted up to the market processes and mechanisms, by ensuring that any activation of these flexibility offers will not endanger the network operation, the DSOs have to assess their potential grid contingency risks. In order to ensure the security and the operational reliability of the distribution network until real-time, they should prepare action plans to react to potential sudden changes in their network. Several mathematical methodologies have been explored on different test cases, in order to find the best economical combinations of flexibility means to activate in case of apparition of non-expected network constraints.

All these methods have been elaborated from a market-based point of view. Another important challenge for the DSOs is to optimize their network operation, and particularly their network losses. In the next chapter, some distributed solutions are proposed in order to optimize the network losses, while considering the remaining flexibility offers which could be pre-empted by the DSOs after the market processes and mechanisms.

## Chapter IV.

---

# Innovative tools to support the DSO for network energy efficiency improvement

*The first part of this chapter introduces and validates a mathematical formulation of network loss optimization problem, taking into account all types of flexibility means that can be available in each DNo cell. The second part of this chapter is aiming at introducing the operational costs of this flexibility procurement as a constraint in the model. The evolution of the network losses optimization solutions is then evaluated for different values of admissible active power flexibility cost.*

---

<b>Chapter IV - Innovative tools to support the DSO for network energy efficiency improvement .....</b>	<b>141</b>
IV.1 Introduction.....	143
IV.2 Minimization of the network losses.....	146
IV.2.1 State of the art and problem positioning .....	146
Existing strategies to improve technical losses reduction .....	146
Problem statement .....	148
IV.2.2 Optimization problem formulation.....	149
Optimization problem.....	149
Formulation of the branch flow model .....	150
MISOCP relaxation .....	153
Formulation of the available flexibility means .....	154
IV.2.3 Examples of application.....	162
Scenario 1: Network losses optimization in normal network situations.....	162
Scenario 2: Network losses optimization in constrained network situations .....	170
IV.3 Addition of the flexibility procurement cost in the problem formulation .....	174
IV.3.1 Modification in the problem formulation .....	174
IV.3.2 Examples of application.....	175
Scenario 1: Network losses optimization in normal network situations.....	175
Scenario 2: Network losses optimization in constrained network situations .....	178
IV.4 Conclusion .....	181

---

**Table of figures**

Figure IV-1 – DNo cell representation .....	149
Figure IV-2 – Illustration of the flowing powers in a radial network.....	150
Figure IV-3 – Illustration of the MISOCP relaxation on the sets of possible solutions .....	154
Figure IV-4 – Representation of the OLTC transformer model .....	155
Figure IV-5 – Effect of the constraint (IV.49) on a meshed network without DG .....	158
Figure IV-6 – Illustration of the limit of the constraint (IV.49) if some DGs are producing .....	158
Figure IV-7 – Respective available active power flexibility offers in the cases (1.5) .....	164
Figure IV-8 – Respective available active power flexibility offers in the cases (1.6) .....	165
Figure IV-9 – The four different possible 33-nodes radial configurations found in scenario 1 ...	166
Figure IV-10 – The four different possible 72-nodes radial configurations found in scenario 1 .	167
Figure IV-11 – Results of the network losses optimization in the 33-nodes network for the different cases of the scenario 1 .....	168
Figure IV-12 – Results of the network losses optimization in the 72-nodes network for the different cases of the scenario 1 .....	169
Figure IV-13 – Results of the 33-nodes network losses optimization for the different cases of the scenario 2 .....	171
Figure IV-14 – Results of the 72-nodes network losses optimization for the different cases of the scenario 2 .....	172
Figure IV-15 – The two different possible 33-nodes radial configurations found in scenario 2..	172
Figure IV-16 – Resulting configurations in the different optimization solutions .....	176
Figure IV-17 – Evolution of the 33-nodes network losses optimization solutions with respect to the maximum admissible cost of active power flexibility procurement in cases 1.5 and 1. 6.....	177
Figure IV-18– Evolution of the 72-nodes network losses optimization solutions with respect to the maximum admissible cost of active power flexibility procurement in cases 1.5 and 1. 6.....	177
Figure IV-19 – Evolution of the 33-nodes network losses optimization solutions with respect to the maximum admissible cost of active power flexibility procurement in case 2.5 .....	179
Figure IV-20 – Evolution of the 72-nodes network losses optimization solutions with respect to the maximum admissible cost of active power flexibility procurement in case 2.5 .....	179



## IV.1 Introduction

Power losses in electrical networks are generally split into two different categories: the technical (or physical) losses and the non-technical (or commercial) losses. Technical losses are due to energy dissipation in the conductors and transformers, caused by the inherent resistance of the electrical components. More particularly, copper losses are proportional to the amount of energy that is delivered, to the distance between generation and consumption, and inversely related to the voltage level of the network. Non-technical losses are corresponding to the non-paid energy delivered for consumption. This can be a consequence of several different reasons, such as theft, non-registered consumptions or differences in billing and in metering. From an operational point of view, technical power losses are an unavoidable expense due to the transit of power through transmission and distribution networks. This results in considerable financial and environmental costs, being the consequence of a need of additional generation to cover the losses. In line with transition to sustainability, network losses reduction becomes a real challenge for the DSOs.

The improvement of DSO network energetic performance has to be duly tackled: if the reduction is substantial, this could encourage the energy cost reduction and the greenhouse gas reduction. From European Commission's point of view, the treatment of losses is a key topic which needs to be addressed in order to achieve energy efficiency improvements in electricity networks. This objective is explicitly set as one of the duties of the European network operators in the Third Energy Package adopted in July 2009 [EC-09]. In this respect, regulators have designed incentive mechanisms which continuously deliver rewards or penalties for DSOs whenever losses are below or above a pre-set target level [ERGE-08]. The aim is that DSOs face adequate incentives in order that they make an appropriate effort on evaluating the costs and benefits of reducing their network losses.

DSOs have, to some extent, the ability to mitigate network losses since they are responsible for network design and operation of the grid. Considering this large set of actions, the losses reduction has to be evaluated over long periods to be valid. In order to be comforting, the expected benefits have to be at least equivalent to the investment and operational costs that the losses reduction strategies would require. The DSOs have to find the economical tradeoff between total expenditure and network losses.

Existing grid flexibility resources such as OLTC transformers, capacitor banks and switching components can be adequately operated for network loss optimization [TOUR-14]. New emerging end users flexibility means could also improve network energy efficiency. In the first part of the chapter, a mathematical formulation of network loss optimization problem is introduced and tested, taking into account all types of flexibility means that can be available in each DNO cell. The second part of this chapter is aiming at introducing the operational costs of this flexibility procurement as a constraint in the model. The evolution of the network losses optimization solutions is then evaluated for different values of admissible active power flexibility cost. This constraint could be then extended to other means of flexibility in the model.

## IV.2 Minimization of the network losses

The electricity flow in the power networks induces technical losses, which are corresponding to the difference between the electric energy produced by the power generators and the effective energy distributed to the end users. In 2015, transmission network technical losses were evaluated to 10.3 TWh in France, representing around 2% of the total power injections (including productions and imports) [RTE-15]. In parallel, the French main DSO Enedis estimated that the distribution network technical losses in its network reached 22.9 TWh in 2015, representing 6.5% of the total energy flow in the network [ENED4-15]. These proportions can be roughly extended to all European DSOs [WOBD-16].

In this work, the considered network losses will be only the technical ones. Some technical losses reduction strategies for the DSOs are defined and evaluated at a given time, corresponding to a static operating point of the network.

### IV.2.1 State of the art and problem positioning

According to the Article 15 of the Energy Efficiency Directive (2012/27/EU) [EC-13], the European Member States have to ensure that network operators have incentives to improve the efficiency of infrastructure design and operation. Moreover, by June 2015, they have to ensure that an assessment is made of the energy potentials of their gas and electricity infrastructures, and that concrete measures and investments are identified for the introduction of cost-effective energy efficiency improvements in the network infrastructure.

In order to reduce technical losses in distribution networks, several strategies can be investigated such as an adequate regulation of the voltage in the network, different changes of the topology of the network, an adequate active control of the DERs, or any combination of these strategies.

#### Existing strategies to improve technical losses reduction

Different strategies to improve technical losses reduction have been largely investigated over the past years. With the deployment of NICT in the distribution grids, more and more advanced functions have been studied and demonstrated to regulate voltage with the use of the available flexible reactive power in the network. For example, in order to guarantee the global optimality of the solution, [RESE-16] presents a centralized optimization model for Volt VAr Control (VVC) and energy losses minimization in power distribution networks which is solved through branch-and-cut techniques. Given the size of the distribution network, [FUKU-15] developed a parallel particle swarm optimization technique for parallel local VVC computations, investigating dependability between the distributed areas. [BERS-10] chose to develop a local auto-adaptive and coordinated VVC, using decoupling mixed network optimization techniques. Other grid flexibility means, such as reconfiguration, have been quite less investigated but can also be interesting for losses minimization problem.

Usually, network reconfiguration is only used once or twice a year for seasonal changes to reduce overall network losses. The applied configurations are generally a tradeoff between network losses minimization and reliability of the network. In some research works, dynamic network reconfiguration has been explored in order to reduce network losses and to permit load balancing. Different mathematical approaches have been studied. Among others, [BAR1-89] developed a general formulation of the heuristic branch exchange problem based on the branch flow model (also called DistFlow model) in order to find the best configuration for losses reduction and load balancing. Later, [TAYL-12] proposed to derive this problem formulation into a second-order cone programming model in order to solve it to optimality. However, this reformulation is implying simplifications that affect the final solution in specific cases. In parallel, heuristic and meta-heuristic methods have been also explored for this problem. For example, [ENAC-07] compared gluttonous heuristic method based on branch exchange problem and genetic algorithm in several scenarios with the aim to find the optimal succession of network configurations to minimize the network losses. Subsequently, [AHUJ-07] and [SWAR-11] proposed to solve this optimization with the use of ant colony optimizations.

Finally, demand response and decentralized production dispatch are also flexibility means that can be used for network energy efficiency. [SHAW-09] shows that shifting domestic load to off-peak time periods can potentially reduce electrical distribution losses and associated carbon emissions. His paper provides quantitative estimates of the possible reduction in losses, for a situation where domestic energy demand is shifted in time but not reduced. In parallel, [VENK-12] determines the positive impacts that DR can have on distribution networks, and among others, quotes the network losses minimization. However, the active control of the DERs should be used only in case of highly constrained network situations, and not only for network losses optimization, because it directly impacts the end users active consumption or injection.

All these strategies have been investigated and categorized depending on their potential benefits on investment planning and on grid operation in different European networks in [TRAC-15], while considering also the different assets to deploy. This survey provides a synthetic qualitative indication of levels of benefits and costs of the different solutions. The assessment assumes only the stand-alone implementation of a given solution (it is not assuming possible synergies with other measures or other investments). Moreover, the cost-effectiveness of each measure strongly depends on the specific grid conditions where it is implemented.

The combination of these strategies, taking into account all the flexibility means of the distribution grid, is a very key topic for the improvement of distribution network energy efficiency. It can permit the minimization of the grid losses while ensuring that all the network constraints are respected. This kind of tool has been far less developed because of the complexity of the problem. Indeed, even if the final objective is still the minimization of the technical losses, the combination of all these possible strategies increases the number of constraints and the number of decision variables. This is a reason why the distribution of the intelligence is well-suited for this kind of problem. This permits the number of



decision variables to be reduced while ensuring optimal solutions if the decoupling of the problem is done in an appropriate way.

### **Problem statement**

In this work, the aim is to develop a distributed advanced function for the DSOs in order to minimize the network losses with the possible coupled use of OLTC, capacitor bank at the substation, reconfiguration, and reactive and active powers control of the flexible DERs.

In [TOUR-14], several methodologies have been tested with this aim, taking into account all these regulation means except active power flexibility offers. Regulation means have been modeled as discrete variables (representing OLTC and capacitor banks), as binary variables (representing the components connectivity for reconfiguration purpose) and as continuous variables (representing DGs reactive power output). Because of the diversity of the variables, and because of the non-linearity and non-convexity of some of the constraints, this optimization problem is included in Mixed Integer Non Linear Programming (MINLP) problems. For this kind of problems, the determination of the global optimal solution cannot be guaranteed with usual algorithms. Different meta-heuristic algorithms such as ant colony algorithm have been tested to solve this problem. In a second phase, the optimization problem has been reformulated into a convex model included in Mixed Integer Second Order Cone Programming (MISOCP) problems. Deterministic algorithms such as generalized Benders decomposition and branch-and-cut algorithm have been then used to solve it, guaranteeing the optimality of the solutions found [GEOF-72]- [JABR-12] and permitting the treatment of several problems in one without any simplifications.

The idea is to adapt the use of these powerful mathematical reformulation techniques in order to also consider the active power flexibility resources that can be available in the MV distribution network.

Following a distributed approach, the optimization has to be performed in each relevant DNo cell in order to guarantee the optimality of the solution while considering all the possible flexibility means. Indeed, by intrinsic construction of the cell, any mean of flexibility that is outside of this cell cannot influence the optimization in the considered area. As a reminder, a DNo cell representation is presented in Figure II-8.

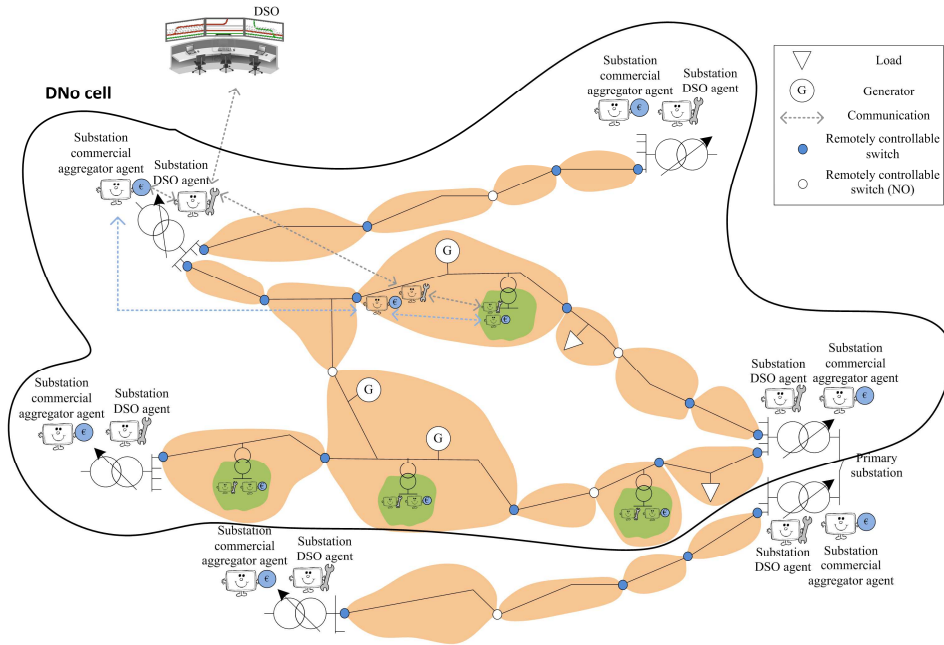

Figure IV-1 – DNo cell representation

In the next section, the formulation of the optimization problem is presented. The active power flexibility offers activations are added and modeled as binary variables. Then, the relaxation of the optimization problem into a MISOCP is explained and presented. The branch-and-cut algorithm will then permit to guarantee to find in a very efficient way the optimal solution.

## IV.2.2 Optimization problem formulation

The distributed network losses optimization problem, based on the branch flow model, is formulated in this part. First of all, the optimization problem is presented including the losses minimization objective function and the physical constraints of the network. Then, a reminder of the branch flow model is explained. The relaxation of the problem into a convex model is then described. Finally, the introduction of the different flexibility means in the problem formulation is proposed.

**NB:** In the entire document, the notation  $X^2$  is corresponding to the square of the magnitude  $|X|^2$ .

### Optimization problem

As stated previously, the objective function of the problem is the minimization of the network copper losses, which is directly related with the flowing currents into the network lines and which can be formulated as in equation (IV.1).

$$\min \sum_{(i,j) \in \Omega} r_{ij} \cdot I_{ij}^2 \quad (IV.1)$$

Where  $\Omega$  is the set of components  $(i, j)$  constituting the entire considered network,  $r_{ij}$  is the resistance of the component  $(i, j)$  and  $I_{ij}$  is the complex current flowing into the component  $(i, j)$ .

The technical network constraints on the voltages at the nodes and on the flowing currents in the components can be formulated as presented in equations (IV.2)-(IV.5).

$$|V_{sl}| = V_{spec} \quad (IV.2)$$

$$\theta_{sl} = 0 \quad (IV.3)$$

$$V_i^{min} \leq |V_i| \leq V_i^{max} \quad (IV.4)$$

$$0 \leq |I_{ij}| \leq I_{ij}^{max} \quad (IV.5)$$

Where  $|V_{sl}|$  and  $\theta_{sl}$  are respectively the voltage magnitude and the voltage angle at the slack bus. By construction, it is assumed that the voltage at the slack bus is fixed and constant, as it is the reference bus.  $|V_i|$  is corresponding to the voltage magnitude at node  $i$ , and should be included in the admissible voltage range  $[V_i^{min}; V_i^{max}]$ .  $|I_{ij}|$  is the current magnitude flowing into the component  $(i, j)$  and should be below the maximum admissible flowing current in this component  $I_{ij}^{max}$ .

In addition to these technical network constraints, the optimization problem is also ruled by some physical constraints that are related to the flows of active and reactive powers. These physical constraints can be expressed thanks to the branch flow model presented in the next section.

### Formulation of the branch flow model

In order to illustrate the following equations, a given network is represented in Figure IV-2. The network is composed of  $m$  lines included in the set  $\Omega$  and of  $n$  nodes included in the set  $\Gamma$ . Some DERs are connected at these nodes. In Figure IV-2, the slack bus is corresponding to the node 1. At the node  $i$ , the consumed active and reactive powers are respectively  $P_i$  and  $Q_i$ . This powers can be negative if there is power production at the node  $i$ .

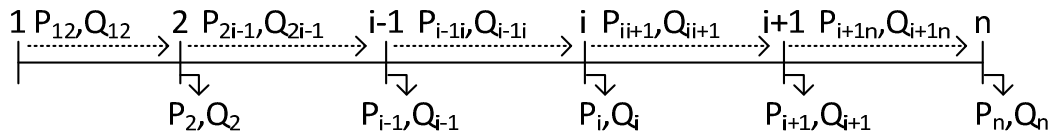

Figure IV-2 – Illustration of the flowing powers in a radial network

The system of power flow equations presented in the branch flow model [BAR2-89] is constituted of the following equations (IV.6)-(IV.8).

$$S_{ij} = V_i \cdot I_{ij}^* \quad (IV.6)$$

$$V_j = V_i - z_{ij} \cdot I_{ij} \quad (IV.7)$$

$$\sum_{i \in \Gamma^e(j)} (S_{ij} - z_{ij} \cdot I_{ij}^2) - \sum_{k \in \Gamma^s(j)} S_{jk} = S_j \quad (IV.8)$$

Where  $S_{ij}$  and  $I_{ij}$  are respectively the apparent power and the complex current flowing through the component  $(i, j)$ ,  $z_{ij}$  is the complex impedance of the component  $(i, j)$ .  $V_i$  and  $S_i$  are respectively the complex voltage at node  $i$  and the apparent power consumed at node  $i$ .  $\Gamma^e(j)$  and  $\Gamma^s(j)$  are the sets of components connected to node  $j$  where the current respectively enters and leaves the node  $j$ .

In order to work in the real domain, the previous equations (IV.6)-(IV.8) are rewritten, based on the equations (IV.9)-(IV.12).

$$S_{ij} = P_{ij} + j \cdot Q_{ij} \quad (IV.9)$$

$$S_i = P_i + j \cdot Q_i \quad (IV.10)$$

$$z_{ij} = r_{ij} + j \cdot x_{ij} \quad (IV.11)$$

$$z_{ij}^* \cdot S_{ij} + z_{ij} \cdot S_{ij}^* = 2 \cdot \text{Real}(z_{ij} \cdot S_{ij}^*) \quad (IV.12)$$

Where  $P_{ij}$  and  $Q_{ij}$  are respectively the considered active and reactive powers flowing in the component  $(i, j)$ ,  $P_i$  and  $Q_i$  are respectively the total active and reactive powers consumed by the node  $i$ , and where  $r_{ij}$  and  $x_{ij}$  are respectively the resistance and the reactance of the component  $(i, j)$ .

It is then possible to rewrite an equivalent branch flow model with the following equations (IV.13)-(IV.16), where  $P_j^c$  and  $Q_j^c$  are the active and reactive powers consumed by the node  $j$ , and  $P_j^g$  and  $Q_j^g$  are the active and reactive powers produced by the node  $j$ .

$$\sum_{i \in \Gamma^e(j)} (P_{ij} - r_{ij} \cdot I_{ij}^2) - \sum_{k \in \Gamma^s(j)} P_{jk} = P_j = P_j^c - P_j^g \quad (IV.13)$$

$$\sum_{i \in \Gamma^e(j)} (Q_{ij} - x_{ij} \cdot I_{ij}^2) - \sum_{k \in \Gamma^s(j)} Q_{jk} = Q_j = Q_j^c - Q_j^g \quad (IV.14)$$

$$V_j^2 = V_i^2 - 2 \cdot (r_{ij} \cdot P_{ij} + x_{ij} \cdot Q_{ij}) + (r_{ij}^2 + x_{ij}^2) \cdot I_{ij}^2 \quad (IV.15)$$

$$I_{ij}^2 = \frac{P_{ij}^2 + Q_{ij}^2}{V_i^2} \quad (IV.16)$$

This branch flow model is equivalent to a load flow computation which can be performed on a given operating point.

It is important to remind that the aim of this optimization problem formulation is to guarantee the global optimality of the solution found, when minimizing the network losses and by exploiting all the available flexibility means that can be used by the DSO in the network. In order to prove the global optimality, it is necessary to work in the convex optimization domain. Until now, the branch flow model equations that are ruling the power flows computations are non-linear and non-convex.

The main difficulty here is to reformulate the non-convex problem into a convex problem without restraining the initial set of possible solutions. To do so, some changes of variables are performed in order to rewrite the branch flow model, as it is done in [GAN-15] and presented in equations (IV.17)-(IV.22).

$$l_{ij} = I_{ij}^2 \quad (IV.17)$$

$$v_i = V_i^2 \quad (IV.18)$$

$$\sum_{i \in \Gamma^e(j)} (P_{ij} - r_{ij} \cdot l_{ij}) - \sum_{k \in \Gamma^s(j)} P_{jk} = P_j \quad (IV.19)$$

$$\sum_{i \in \Gamma^e(j)} (Q_{ij} - x_{ij} \cdot l_{ij}) - \sum_{k \in \Gamma^s(j)} Q_{jk} = Q_j \quad (IV.20)$$

$$v_j = v_i - 2 \cdot (r_{ij} \cdot P_{ij} + x_{ij} \cdot Q_{ij}) + (r_{ij}^2 + x_{ij}^2) \cdot l_{ij} \quad (IV.21)$$

$$l_{ij} = \frac{P_{ij}^2 + Q_{ij}^2}{v_i} \quad (IV.22)$$

After these variables substitutions, the equations (IV.13)-(IV.15) which are non-linear and non-convex are rewritten in equations (IV.19)-(IV.21) which are now linear and convex.

Here, it is important to note that the objective function has been also impacted by the variables substitution and so, the equation (IV.1) becomes equation (IV.23). The physical network constraints (IV.2)-(IV.5) are not impacted.

$$\min \sum_{(i,j) \in \Omega} r_{ij} \cdot l_{ij} \quad (IV.23)$$

The only remaining non-linear and non-convex constraint in the optimization problem is the equation (IV.22) which is relative to the flowing currents. Because of this constraint, the optimization problem is still included in MINLP problems and any use of a mathematical solver cannot guarantee the global optimal of the solution found.

The MISOCP relaxation presented in the next section is aiming at rewriting this equation into a convex constraint to finally guarantee the global optimality of the solution found.

## MISOCP relaxation

The proposed MISOCP relaxation has been used in several papers [FARI-13]-[LOW1-14] and consists in relaxing the equality (IV.22) into the inequality (IV.24).

$$l_{ij} \geq \frac{P_{ij}^2 + Q_{ij}^2}{v_i} \quad (IV.24)$$

This equation is in fact equivalent to the second order cone inequality (IV.28) that can be deduced from the following equations (IV.25)-(IV.27).

$$P_{ij}^2 + Q_{ij}^2 - l_{ij} \cdot v_i \leq 0 \quad (IV.25)$$

$$\Leftrightarrow 4 \cdot P_{ij}^2 + 4 \cdot Q_{ij}^2 - 4 \cdot l_{ij} \cdot v_i \leq 0 \quad (IV.26)$$

$$\Leftrightarrow (2 \cdot P_{ij})^2 + (2 \cdot Q_{ij})^2 - (l_{ij} + v_i)^2 + (l_{ij} - v_i)^2 \leq 0 \quad (IV.27)$$

By applying the square root on the equation (IV.27), it is finally possible to find the following second order cone inequality.

$$\left\| \begin{array}{c} 2 \cdot P_{ij} \\ 2 \cdot Q_{ij} \\ l_{ij} - v_i \end{array} \right\|_2 \leq l_{ij} + v_i \quad (IV.28)$$

The authors of [FARI-13]-[LOW2-14] proved that the relaxation is exact under certain conditions, meaning that if an optimal solution is found to the relaxed problem and if it is physically feasible, then it is also optimal for the initial problem. The proposed conditions for the exact relaxation are the following:

- (C1) The network graph is connected.
- (C2) The objective function of the problem is convex.
- (C3) The objective function is strictly increasing in  $l_{ij}$ , non-increasing in load, and independent of  $S$ .
- (C4) The optimal power flow problem is feasible.

The conditions (C1) and (C4) are directly linked to the network and to the physical feasibility of the problem. Given the objective function (IV.23), the conditions (C2) and (C3) are also satisfied. Hence, when the solution found will be a physically possible solution, the relaxation will be exact and the inequality (IV.28) will become equality, ensuring that the solution corresponds to the global optimal solution.

This relaxation can be illustrated with the Figure IV-3, where the set of possible solutions of the initial MINLP problem is represented in black. Due to the non-convexity of the problem, some local optimal solutions exist. The relaxation permits to make a mathematical projection of the set of solutions to a convex set of solutions, depicted in red. If the relaxation is exact, implying that the inequality (IV.28) is a equality, the global optimal solutions of the two problems are coincident.

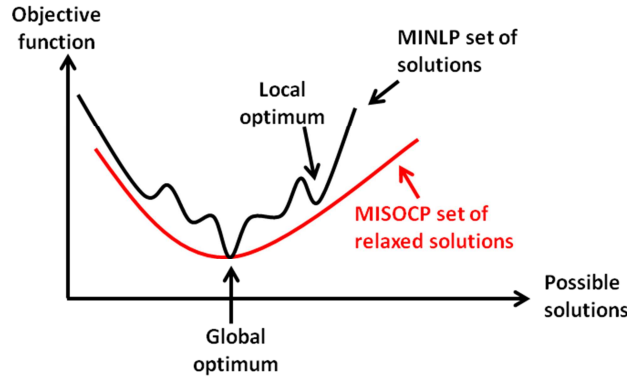

Figure IV-3 – Illustration of the MISOCP relaxation on the sets of possible solutions

Thanks to this relaxation, the branch flow model equations that are ruling the power flows computations are finally convex. If all the conditions are respected, the global optimality of the solution found with exact method will be guaranteed.

However, until now, no flexibility means has been included in the optimization problem. It means that there are no decision variables that can influence the objective function. At this point, the formulated problem optimization is in fact equivalent to a power flow computation. In order to minimize the overall network losses, all the available flexibility means of the distribution grid including OLTC position, reconfiguration, reactive power control of the GED, and available flexible active power control have to be taken into account in the model.

### Formulation of the available flexibility means

In this section, all the possible flexibility resources available in the distribution network are added in the problem formulation. A particular attention will have to be paid in order to continue to ensure that all the constraints of the problem are remaining linear or at least convex.

- **OLTC transformer model**

The OLTC transformer permits the modification of downstream voltages through the modification of the transformation ratio of the transformer. Thus, a transformer can be modeled as a connection line with a discrete variable  $k_{ij}$  which represents its transformation ratio [KUND-94]. The transformer ratio is varying with the number of turns of the transformer, and therefore is a discrete variable that can take the following values (equation (IV.29)).

$$k_{ij} = TapMax_{ij} - TapSize_{ij} \cdot (t_{ij} - 1) \quad (IV.29)$$

Where  $TapMax_{ij}$  is the maximum tap of the transformer ( $i, j$ ),  $TapSize_{ij}$  is the size of each tap change, and  $t_{ij}$  is a discrete variable that is represented the possible tap positions of the transformer, therefore that is included in  $\{TapMin_{ij}, \dots, TapMax_{ij}\}$ .

The model of an OLTC transformer connected between node  $i$  and node  $j$  is presented in Figure IV-4. The copper losses and the leakage powers of the transformer are modeled by the complex parameter  $Z_{ij}$ . Iron losses are also considered in the model even if there are negligible.

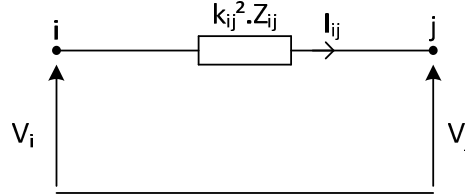

Figure IV-4 – Representation of the OLTC transformer model

It is then possible to derive the relation (IV.32) between the voltages at the two ends of the component  $(i, j)$ , as it was done for the lines in equation (IV.21). In this case, it is assumed that the transformer is not an angle-shifting transformer and therefore that the transformation ratio is real.

$$V_i - k_{ij} \cdot V_j = k_{ij}^2 \cdot Z_{ij} \cdot I_{ij} \quad (IV.30)$$

$$\Leftrightarrow |V_j|^2 = \left| \frac{V_i}{k_{ij}} - k_{ij} \cdot Z_{ij} \cdot I_{ij} \right|^2 \quad (IV.31)$$

$$\Leftrightarrow v_j = \frac{v_i}{k_{ij}^2} - 2 \cdot (r_{ij} \cdot P_{ij} + x_{ij} \cdot Q_{ij}) + k_{ij}^2 \cdot (r_{ij}^2 + x_{ij}^2) \cdot l_{ij} \quad (IV.32)$$

Adopting the same philosophy, it is needed to rewrite the previous equations (IV.19) and (IV.20) in order to take into account the effect of the transformer ratio on the flowing powers. They become therefore equations (IV.33) and (IV.34).

$$\sum_{i \in \Gamma^e(j)} (P_{ij} - k_{ij} \cdot r_{ij} \cdot l_{ij}) - \sum_{k \in \Gamma^s(j)} P_{jk} = P_j \quad (IV.33)$$

$$\sum_{i \in \Gamma^e(j)} (Q_{ij} - k_{ij} \cdot x_{ij} \cdot l_{ij}) - \sum_{k \in \Gamma^s(j)} Q_{jk} = Q_j \quad (IV.34)$$

The global set of the network connections can be considered as OLTC transformers components. When considering a basic line without any transformer, the transformer ratio is set at  $k_{ij} = 1$  and the derived equations are equivalent to the previously developed ones.

These new equations are now involving discrete variables and are therefore non-convex equations. In order to reduce the difficulty of the problem containing discrete variables, [TOUR-14] converted these discrete variables into binary variables that are linked to the possible transformation ratios. Thus, after some changes of variables,  $k_{ij}$  is redefined as follow:

$$k_{ij} \in K \text{ where } K = [d_{1-ij}, \dots, d_{nP-ij}] \quad (IV.35)$$

and where  $d_{1-ij} = TapMin_{ij}$  and  $d_{nP-ij} = TapMax_{ij}$



Here, every tap corresponds to only one transformation ratio, and the OLTC has  $nP$  taps.

Then the following reformulation is performed to reduce the complexity of the problem due to the presence of discrete variables. For each index of the tap  $q \in \Psi_{ij}$  where  $\Psi_{ij} = [1, \dots, nP]$ , a binary variable  $\omega_{qij} \in \{0,1\}^q$  is defined. It is then possible to reformulate all the discrete variables into binary variables thanks to equations (IV.36)-(IV.38).

$$k_{qij} = d_{q-ij} \cdot \omega_{qij} \quad (IV.36)$$

$$k_{ij} = \sum_{q \in \Psi_{ij}} d_{q-ij} \cdot \omega_{qij} \quad (IV.37)$$

$$\sum_{q \in \Psi_{ij}} \omega_{qij} = 1 \quad (IV.38)$$

The equation (IV.37) shows that the final transformation ratio is the sum of the transformation ratios computed in (IV.36). As the equation (IV.38) imposes the condition that only one tap should be chosen, the equation (IV.37) is valid. Thanks to this reformulation, the difficulties due to the presence of discrete variables have been overcome.

The remaining difficulties are due to the complexity of the emerging products between continuous and binary variables in equations (IV.32), (IV.33) and (IV.34) where the products  $\omega_{qij} \cdot v_i$  and  $\omega_{qij} \cdot l_{ij}$  are now appearing. They can be eliminated thanks to the following exact linearization proposed in [TOUR-14].

For each triplet  $(q, i, j)$ , two new continuous variables  $\gamma_{qij}$  and  $\delta_{qij}$  are introduced and replace respectively the products  $\omega_{qij} \cdot v_i$  and  $\omega_{qij} \cdot l_{ij}$ . The linearization is exact if the following conditions are respected.

$$V_i^{min^2} \leq \gamma_{qij} \leq V_i^{max^2} \quad (IV.39)$$

$$V_i^{min^2} \cdot \omega_{qij} \leq \gamma_{qij} \leq V_i^{max^2} \cdot \omega_{qij} \quad (IV.40)$$

$$\gamma_{qij} \leq v_i - (1 - \omega_{qij}) \cdot V_i^{min^2} \quad (IV.41)$$

$$\gamma_{qij} \geq v_i - (1 - \omega_{qij}) \cdot V_i^{max^2} \quad (IV.42)$$

$$0 \leq \delta_{qij} \leq I_{ij}^{max^2} \quad (IV.43)$$

$$0 \leq \delta_{qij} \leq I_{ij}^{max^2} \cdot \omega_{qij} \quad (IV.44)$$

$$\delta_{qij} \geq l_{ij} - (1 - \omega_{qij}) \cdot I_{ij}^{max^2} \quad (IV.45)$$

Finally, it is then possible to reformulate the equations (IV.32)-(IV.34) into the convex equations (IV.46)-(IV.48).

$$v_j = \sum_{q \in \Psi_{ij}} \frac{1}{d_{q-ij}^2} \cdot \gamma_{qij} - 2 \cdot (r_{ij} \cdot P_{ij} + x_{ij} \cdot Q_{ij}) + (r_{ij}^2 + x_{ij}^2) \cdot \sum_{q \in \Psi_{ij}} d_{q-ij}^2 \cdot \delta_{qij} \quad (IV.46)$$

$$\sum_{i \in \Gamma^e(j)} \left( P_{ij} - r_{ij} \cdot \sum_{q \in \Psi_{ij}} d_{q-ij} \cdot \delta_{qij} \right) - \sum_{k \in \Gamma^s(j)} P_{jk} = P_j \quad (IV.47)$$

$$\sum_{i \in \Gamma^e(j)} \left( Q_{ij} - x_{ij} \cdot \sum_{q \in \Psi_{ij}} d_{q-ij} \cdot \delta_{qij} \right) - \sum_{k \in \Gamma^s(j)} Q_{jk} = Q_j \quad (IV.48)$$

To summarize this section, the introduction of the possible taps of the OLTC transformer has induced some changes in the power flows equations related to the transformer sections. These changes were due to the introduction of discrete variables that are representing the taps of the OLTC transformer and made the equations nonconvex.

Two mathematical tools have been used in order to overcome this non-convexity: first, the transformation of discrete variables into binary variables and secondly, the exact linearization of the appearing products of binary and continuous variables.

- **Reconfiguration model in radial networks**

As pointed out in chapter I, distribution networks are usually designed as looped or meshed networks but they are generally exploited as radial networks. In this distributed optimization problem, the idea is to find the best configuration that will minimize the overall DNo cell copper losses while ensuring the radial topology of the network.

The common representation of electrical networks is based on graph theory representation, where the vertices are representing the nodes of the network and where the edges are representing the connection lines. Therefore, a meshed network can be seen as a connected graph, while a radial network with no isolated node can be seen as a spanning tree.

**NB:** if there is more than one transformer in the considered DNo cell, the resulting radial networks will not be a spanning tree since the different parts of the considered network will not be connected. They will be seen as several spanning trees. In the following, the examples consider each spanning tree fed by one primary substation independently but the equations can be extended to the entire DNo cell.

Let's consider again a network composed of  $m$  controllable lines, each associated with a switch, included in the set  $\Omega$  and of  $n$  nodes included in the set  $\Gamma$ . Every looped or meshed network can be decomposed in elementary loops, which are defined as the loops composed of a minimal number of lines. Here, we consider that the considered network is composed of  $n\mathcal{C}$  elementary loops. In order to ensure that the network is radial, the constraint (IV.49) is applied.

$$\sum_{(i,j) \in \Omega} e_{ij} = m - n\mathcal{C} \quad (IV.49)$$

Where  $e_{ij}$  is a binary variable representing the connectivity status of the component  $(i, j)$  which is equal to 1 if the component is closed or to 0 if the component is open.

This constraint permits ensuring a spanning tree configuration, forcing the number of connected components to be equal to the difference between the total number of lines and the number of elementary loops.

A small example is presented in Figure IV-5. A meshed network composed of 7 nodes and 8 maneuverable lines is presented in Figure IV-5(a). This network is composed of two elementary loops  $L_1$  and  $L_2$ . According to the constraint (IV.49), in order to ensure a radial topology, exactly 6 lines have to be connected. An example of a possible radial configuration of the network that respects the constraint is presented in Figure IV-5(b), where 2 lines have been opened.

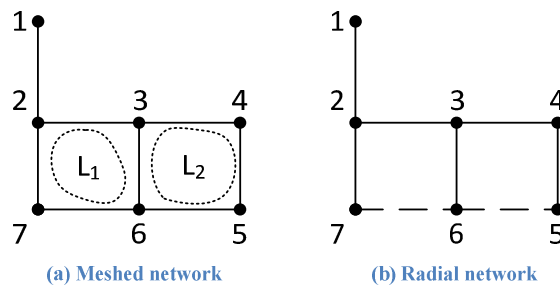

Figure IV-5 – Effect of the constraint (IV.49) on a meshed network without DG

This constraint is necessary and sufficient in the case where there are only consumption nodes. However, considering possible DGs production, a second constraint has to be added in order to prevent the network from undesired islanded mode. Indeed, if a production is sufficient to supply power to the loads close to it, a non-radial configuration can be found, as presented in Figure IV-6(b), where a part of the network is in an islanded mode.

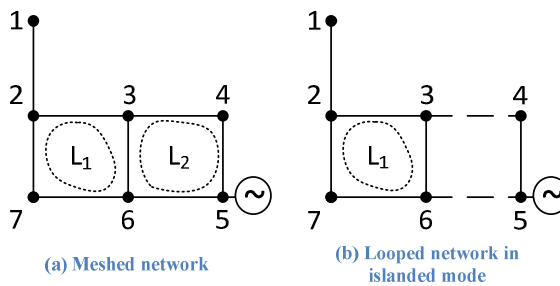

Figure IV-6 – Illustration of the limit of the constraint (IV.49) if some DGs are producing enough to supply power to the close loads

To overcome these possible cases, another constraint (IV-50) that ensures the radial topology of the network with the presence of DGs is proposed in [TOUR-14]. This topological constraint is ensuring

that all the nodes of each elementary loop of the considered network are linked together and thus, is preventing islanding modes.

$$\sum_{(i,j) \in C_b} e_{ij} \leq nC_b - 1 \quad (IV.50)$$

Where  $C_b$  and  $|C_b| = nC_b$  are respectively an elementary loop and the number of components in the loop.

In addition to these two constraints, the binary reconfiguration variables  $e_{ij}$  have to be added in the equations for active and reactive power flows, as well as in the relation linking the voltage values at the two sides of the component. Thus, equations (IV.19)-(IV.20) becomes (IV.51)-(IV.52). The same changes are applied on equations (IV.47)-(IV.48) for the OLTC transformer connection.

$$\sum_{i \in \Gamma^e(j)} e_{ij} \cdot (P_{ij} - r_{ij} \cdot l_{ij}) - \sum_{k \in \Gamma^s(j)} e_{ij} \cdot P_{jk} = P_j \quad (IV.51)$$

$$\sum_{i \in \Gamma^e(j)} e_{ij} \cdot (Q_{ij} - x_{ij} \cdot l_{ij}) - \sum_{k \in \Gamma^s(j)} e_{ij} \cdot Q_{jk} = Q_j \quad (IV.52)$$

To ensure that  $v_i \neq v_j$  when  $e_{ij} = 0$ , disjoint constraints proposed in [LIBE-09] are applied: the equation (IV.21) becomes (IV.53) and (IV.54). Here again, the same changes are applied on the equation (IV.46) for the OLTC transformer connection.

$$v_j \geq v_i - 2 \cdot (r_{ij} \cdot P_{ij} + x_{ij} \cdot Q_{ij}) + (r_{ij}^2 + x_{ij}^2) \cdot l_{ij} - (1 - e_{ij}) \cdot M \quad (IV.53)$$

$$v_j \leq v_i - 2 \cdot (r_{ij} \cdot P_{ij} + x_{ij} \cdot Q_{ij}) + (r_{ij}^2 + x_{ij}^2) \cdot l_{ij} + (1 - e_{ij}) \cdot M \quad (IV.54)$$

Where  $M \in \mathbb{R}^{*+}$ .

The addition of the two constraints (IV.49) and (IV.50), as well as the reformulation of the constraints which are impacting the connections and the power flows in the network permit to ensure that the configuration of the solution found will be radial.

- **Capacitor banks model**

The capacitor banks model can be added on the problem formulation as follow. Reactive powers of the capacitor banks are assumed to be constant reactive power outputs. They can be represented as discrete variables, which are expressing their different reactive power outputs depending on their respective positions.

Hence, it is possible to represent the reactive power output  $Q_i^{CB}$  connected at node  $i$  as presented in equations (IV.55)-(IV.56).

$$Q_i^{CB} = \sum_{N_{CB}} n_i^{CB} \cdot \Delta q_i^{CB} \quad (IV.55)$$

$$\sum_{N_{CB}} n_i^{CB} = 1 \quad (IV.56)$$

Where  $N_{CB}$  is the number of possible positions of the considered capacitor bank,  $n_i^{CB}$  is a binary variable and  $\Delta q_i^{CB}$  is the added reactive power output of each position of the capacitor bank. The equality (IV.56) permits to ensure that only one position is chosen for the considered capacitor bank connected at node  $i$ .

At any node  $j$  of the network where a capacitor bank is connected, the equation (IV.20) becomes (IV.57).

$$\sum_{i \in \Gamma^e(j)} (Q_{ij} - x_{ij} \cdot l_{ij}) - \sum_{k \in \Gamma^s(j)} Q_{jk} = Q_j - Q_j^{CB} \quad (IV.57)$$

- **Model of the DGs reactive power outputs**

Another flexibility mean that can be used by the DSOs to optimize the efficiency of their networks is the modulation of the reactive power output of the present DGs. As explained in chapter I, depending on the considered DG technology and on its installed capacity power, DGs can participate in VVC via the absorption or the injection of reactive power.

In France, if the voltage value at the connection point is included between  $\pm 5\%$  of the contractual voltage value, a DG which delivers its maximum installed active power should be able to provide reactive power, without limitation of time, until 40% of its installed active power, or to consume reactive power until 35% of its installed active power [ARRE-15]. This rule is also added in the problem formulation in a simplified way. It is assumed that any DG connected at node  $i$  which produces an amount of active power  $P_i^{GED}$  should be able to provide an amount of reactive power  $Q_i^{GED}$  such as depicted in equation (IV.58).

$$-0.35 P_i^{GED} \leq Q_i^{GED} \leq 0.4 P_i^{GED} \quad (IV.58)$$

At any node  $j$  of the network where a DG is connected, the equation (IV.20) becomes (IV.59).

$$\sum_{i \in \Gamma^e(j)} (Q_{ij} - x_{ij} \cdot l_{ij}) - \sum_{k \in \Gamma^s(j)} Q_{jk} = Q_j - Q_j^{GED} \quad (IV.59)$$

Finally, all the commonly used flexibility means of the DSOs (OLTC transformer, reconfiguration, capacitor banks, and DGs reactive power control) have been formulated in the optimization problem.

- **Remaining available active power flexibility model**

Some modifications on the equations are made in order to take into account the possible impacts of the end users flexibility resources, via DR management or DG active power output dispatch.

As modeled in chapter III, the available active power flexibility offers in the network are assumed to be equivalent to power blocks, meaning that it is possible to activate only the entire flexibility offer over one hour. If a reduction of active power consumption  $\Delta P_{jl}^c$  is activated, the power factor at the node is considered as a constant, and then, the reactive power consumption  $\Delta Q_{jl}^c$  is also subtracted. On the other hand, if a reduction or an increment of a DG production  $\Delta P_{jl}^g$  is activated, the previously presented constraints (IV.58) and (IV.59) on DGs reactive power outputs are still applied.

Hence, equations (IV.19) and (IV.20) become (IV.60) and (IV.61) in case where a reduction offer of power consumption at node  $j$  is available.

$$\sum_{i \in \Gamma^e(j)} (P_{ij} - r_{ij} \cdot l_{ij}) - \sum_{k \in \Gamma^s(j)} P_{jk} = P_j - \sum_{l \in L(j)} x_{jl} \cdot \Delta P_{jl}^c \quad (IV.60)$$

$$\sum_{i \in \Gamma^e(j)} (Q_{ij} - x_{ij} \cdot l_{ij}) - \sum_{k \in \Gamma^s(j)} Q_{jk} = Q_j - \sum_{l \in L(j)} x_{jl} \cdot \Delta Q_{jl}^c \quad (IV.61)$$

$$\Delta Q_{jl} = \Delta P_{jl} \cdot \tan(\varphi_{jl}) \quad (IV.62)$$

In case where a dispatch down offer of a DG production is available, the equation (IV.19) becomes the equation (IV.63).

$$\sum_{i \in \Gamma^e(j)} (P_{ij} - r_{ij} \cdot l_{ij}) - \sum_{k \in \Gamma^s(j)} P_{jk} = P_j + \sum_{l \in L(j)} x_{jl} \cdot \Delta P_{jl}^g \quad (IV.63)$$

On the other hand, if a DG is controllable and can increase its production, the equation (IV.19) becomes (IV.64).

$$\sum_{i \in \Gamma^e(j)} (P_{ij} - r_{ij} \cdot l_{ij}) - \sum_{k \in \Gamma^s(j)} P_{jk} = P_j - \sum_{l \in L(j)} x_{jl} \cdot \Delta P_{jl}^g \quad (IV.64)$$

Where  $L(j)$  is the set of flexibility offers available at node  $j$ ,  $x_{jl}$  is the state of activation of the flexibility  $l$  at node  $j$ , and  $\Delta P_{jl}$  and  $\Delta Q_{jl}$  are respectively the amount of available active and reactive power modulation of the flexibility  $l$  at node  $j$ . The variable  $x_{jl}$  is a binary variable and it is either equal to 0 if the flexibility offer is not activated or 1 if the flexibility offer is activated.

All these different equations are added and coupled in the formulation problem. Hence, the distributed network losses minimization problem is set, while considering all the potential flexibility that can appear in the considered DNo cell. The major advantage of this formulation is that it permits ensuring the convergence to the global optimal in the DNo cell thanks to the convex relaxation of the problem if the adequate resolution method is used.

As discussed in part IV.2.1, several methodologies have been investigated in order to reduce network losses in the distribution systems, using all or a part of the flexibility resources that the DSOs can have access to. Some of these strategies are based on heuristic controls, some others on

metaheuristic algorithms, and others are using determinist methods to ensure the optimality of their strategies.

In this work, the optimization problem has been formulated in a way such as the global optimum can be found in each DNo cell, while considering all the potential flexibility resources and while ensuring that all the network constraints are respected. To do so, deterministic methods for convex optimization are used as resolution methods, and particularly the branch-and-cut method. More details on this method can be found in *Annex VII – Optimization methods details*. Some results of the optimization are presented in the next section, focusing on two DNo cells.

### **IV.2.3 Examples of application**

This section presents some results of the network losses minimization problem solved with the branch-and-cut algorithm via the CPLEX solver. The tests are done on a computer Intel® Core™2 Duo CPU E8400 @ 3.00GHz with 4,00 Go of RAM. Different scenarios are applied on two specific DNo cells fed by two respective primary substations and where different means of flexibility are available.

The study cases are representing two different scenarios. They are applied on a 33-nodes distribution network that can be seen as a DNo cell, where 4 DGs are connected at nodes 9, 20, 22 and 33. The studied operating point of the network is corresponding to the 4 p.m. loading case. It is assumed that the voltage at the primary side of the primary substation is equal to 1.015 p.u.

The two scenarios are also applied on a 72-nodes distribution network, where 4 DGs are connected at nodes 29, 38, 62 and 67. In this specific case also, the studied operating point of the network is corresponding to the 4 p.m. loading case. The voltage at the primary side of the primary substation is equal to 1.01 p.u.

More details on the topology and on the load profiles of these networks are presented in *Annex II – Test networks data*. It is assumed that in the two networks, a 17-tap OLTC is present at the substation and that a 3-tap capacitor bank is connected at the bus-bar. For reconfiguration purpose, it is assumed that all the lines of the considered networks are controllable, meaning that each line can be either open or closed. Assuming this, there are 50751 possible radial configurations [VANE-13] of the 33-nodes network and more than 50 billion of possible radial configurations [TOUR-14] of the 72-nodes network.

#### **Scenario 1: Network losses optimization in normal network situations**

This first scenario is considering the two distribution networks when all the network constraints are respected. Six different cases of network losses optimization are studied for comparison.

The first cases (1.1) correspond to initial cases where an initial configuration (respectively C33.1 and C72.1) is fixed, the OLTC is fixed at a unitary ratio, there is no connected capacitor bank at the bus-bar, and there is no DG reactive power output control, nor available active power flexibility offers. In this

case, the optimization corresponds to a basic loadflow computation as there is no available flexibility mean. The total network losses are equal to 87.4 kW in the 33-nodes network and to 77.1 kW in the 72-nodes network.

In the second cases (1.2), the initial configurations C33.1 or C72.1 are still fixed but the OLTC and the capacitor bank positions are free. There is no DG reactive power output control, nor available active power flexibility offers. In the best possible solutions of network losses optimization, the OLTC positions are increased of one tap so that the voltage at the secondary side of the primary substation is respectively equal to 1.040 p.u and to 1.035 p.u. In the both networks, the best reactive power output of the capacitor bank is 1.5 MVar, which is corresponding to the middle position of the possible taps. By increasing the voltage in the entire considered DNO cell, and by injecting the adequate reactive power at the bus-bar to reduce reactive power flows, the total network losses are decreasing down to 73.7 kW in the 33-nodes network (decrease of around 15% compared to (1.1)) and to 72.2 kW in the 72-nodes network (decrease of around 6% compared to (1.1)).

The reconfiguration is added as network flexibility resource in the third cases (1.3). Two new configurations C33.2 and C72.2 are found as the best configurations for network losses optimization in these loading cases for these specific networks. The OLTC positions are still at the tap ratio 1.025 and the capacitor bank reactive power outputs are remaining equal to 1.5 MVar. Due to a better repartition of the power flows, the total network losses are decreasing down to 42.2 kW in the 33-nodes network (decrease of almost 52% compared to the initial case (1.1)) and to 66.6 kW in the 72-nodes network (decrease of almost 14% compared to the initial case (1.1)).

In the fourth cases (1.4), it is assumed that the DGs reactive power outputs are controllable and that any DG can provide reactive power up to 40% of its active power output or can consume reactive power up to 35% of its active power output. Here again, the network losses optimization permits to find the optimal solutions for both networks which correspond to the same than in the third cases, but where all the DGs are producing the maximum of reactive power that they regulatory have to.

Some active power end users flexibility offers are assumed to be available in the two last cases. In the fifth cases (1.5), only DR flexibility offers are considered. These flexibility offers are assumed to be the same that the ones presented in section III.3 of this thesis. Their associated prices of activation are given for an hourly basis. As a reminder, they are presented in Figure IV-7 below.



Flexible node	$\Delta P$ demand response (kW)	Activation price (€/1h)	
		€	€/MWh
4	31	1,24	40
5	16	2,11	130
6	14	0,55	38
7	55	11,04	200
15	16	0,79	50
16	13	1,20	95
17	14	0,65	45
18	21	3,37	160
30	54	6,48	120
31	36	2,52	70

(a) Available active flexibility offers in the 33-nodes network

(b) Available active flexibility offers in the 72-nodes network

Figure IV-7 – Respective available active power flexibility offers in the cases (1.5)

The best solutions in these cases are corresponding to the situations where the OLTC positions are increasing up to the tap ratio 1.025 and the capacitor bank reactive power output are equal to 1.5 MVar. All the DGs reactive power outputs are set to their maximal production and all the DR flexibility offers are activated, so that the power flows are limited. To limit this new power flows amount, the best radial configurations found are respectively the configurations C33.3 and C72.3. The total network losses at the considered operating points are equal to 28.5 kW in the 33-nodes network (decrease of around 67% compared to case (1.1)) and to 56.3 kW in the 72-nodes network (decrease of almost 27% compared to case (1.1)).

In the last cases (1.6), it is assumed that the connected DGs in the 33-nodes network are distributed 300 kW combined heat and power plants, and that they offer some possibilities of dispatch ramp up. Similarly for the 72-nodes network, it is assumed that a distributed 300kW CHP is connected at node 29. The new available active power flexibility offers are presented in Figure IV-8.

Flexible node	$\Delta P$ dispatch up (kW)	$\Delta P$ demand response (kW)	Activation price (€/1h)	
			€	€/MWh
4	0	31	1,24	40
5	0	16	2,11	130
6	0	14	0,55	38
7	0	55	11,04	200
9	122	0	7,32	60
15	0	16	0,79	50
16	0	13	1,20	95
17	0	14	0,65	45
18	0	21	3,37	160
22	77	0	5,39	70
30	0	54	6,48	120
31	0	36	2,52	70
33	130	0	11,70	90
4	0	20	0,60	30
9	0	3	0,08	25
14	0	5	0,25	50
18	0	2,5	0,15	60
26	0	15	1,05	70
28	0	20	0,90	45
29	265	0	15,90	60
34	0	12	0,96	80
39	0	12	0,36	30
44	0	2	0,10	50
47	0	20	0,60	30
48	0	20	1,40	70
53	0	5	0,20	40
61	0	1	0,05	50
64	0	5	0,40	80
66	0	10	0,60	60
69	0	10	0,30	30

(a) Available active flexibility offers in the 33-nodes network

(b) Available active flexibility offers in the 72-nodes network

Figure IV-8 – Respective available active power flexibility offers in the cases (1.6)

In these cases, all the active power flexibility offers are also activated and are used in order to balance the production and the consumption locally as much as possible. Two new configurations C33.4 and C72.4 are respectively found as the best configurations of the two respective networks. The configuration C33.4 corresponds to a configuration where all the DGs are connected to the same feeder and compensate the consumption of the majority of the loads. In the configuration C72.4, three of the four DGs are connected to the same high-loaded feeder. These two configurations permit to limit the maximum of power flows in these specific situations.

The four possible radial configurations found in the different solutions of the 33-nodes network are shown in Figure IV-9. The four possible radial configurations found in the different solutions of the 72-nodes network are shown in Figure IV-10. Each configuration is represented by the vector of respectively the 5 and the 11 open switches of the considered distribution network.

The synthesis of the results of these studies is depicted in Figure IV-11 and in Figure IV-12 below. For each case, the equality of the relaxation proposed in equation (IV.28) is checked in order to ensure that the solution is physically feasible, and therefore to ensure that the MISOCP relaxation is exact and that the solution is effectively the global optimum.

The execution time, highly related to the number of needed function evaluations, is increasing remarkably when the reconfiguration is possible. More particularly, it is becoming very high for the last different cases of the 72-nodes network, where the set of possible solutions is really large.

Finally, the different available flexibility means in an active and flexible network can provide tremendous support to the DSOs for network losses optimization. With a large amount of available flexibility resources, it is possible to reduce significantly the network losses. Moreover, the use of

mathematical reformulation techniques permitted the optimality of the solution found to be guaranteed, when the algorithm is performed in each distributed and independent DNo cell.

The objective function of the optimization problem depends only on the power flows in the DNo cell. As it can be observed in the different cases, the best solution of the algorithm is always the situation where the flows are the more locally balanced in the network, and where the voltage values at the nodes are the higher as possible. Hence, in the cases where the feeders are more consuming than producing, the minimization of the losses implies the activation of all the DR flexibility offers or the activation of the DGs production ramp up offers. Similarly, in case of high production periods, the network losses optimization will imply a reduction of the produced power or an increase of the local consumed power to balance locally the flows.

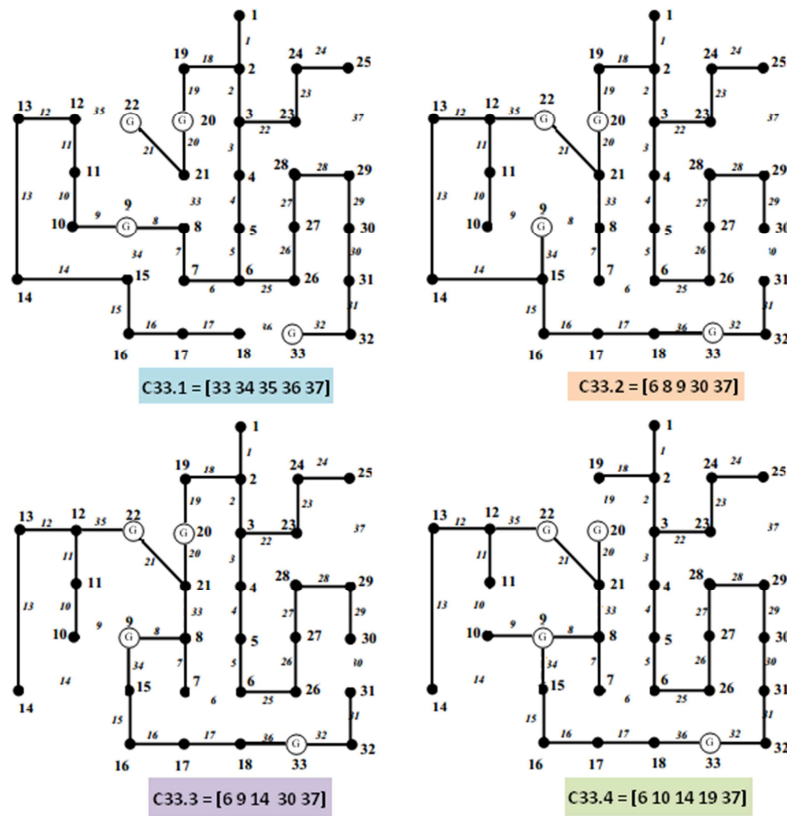

Figure IV-9 – The four different possible 33-nodes radial configurations found in scenario 1

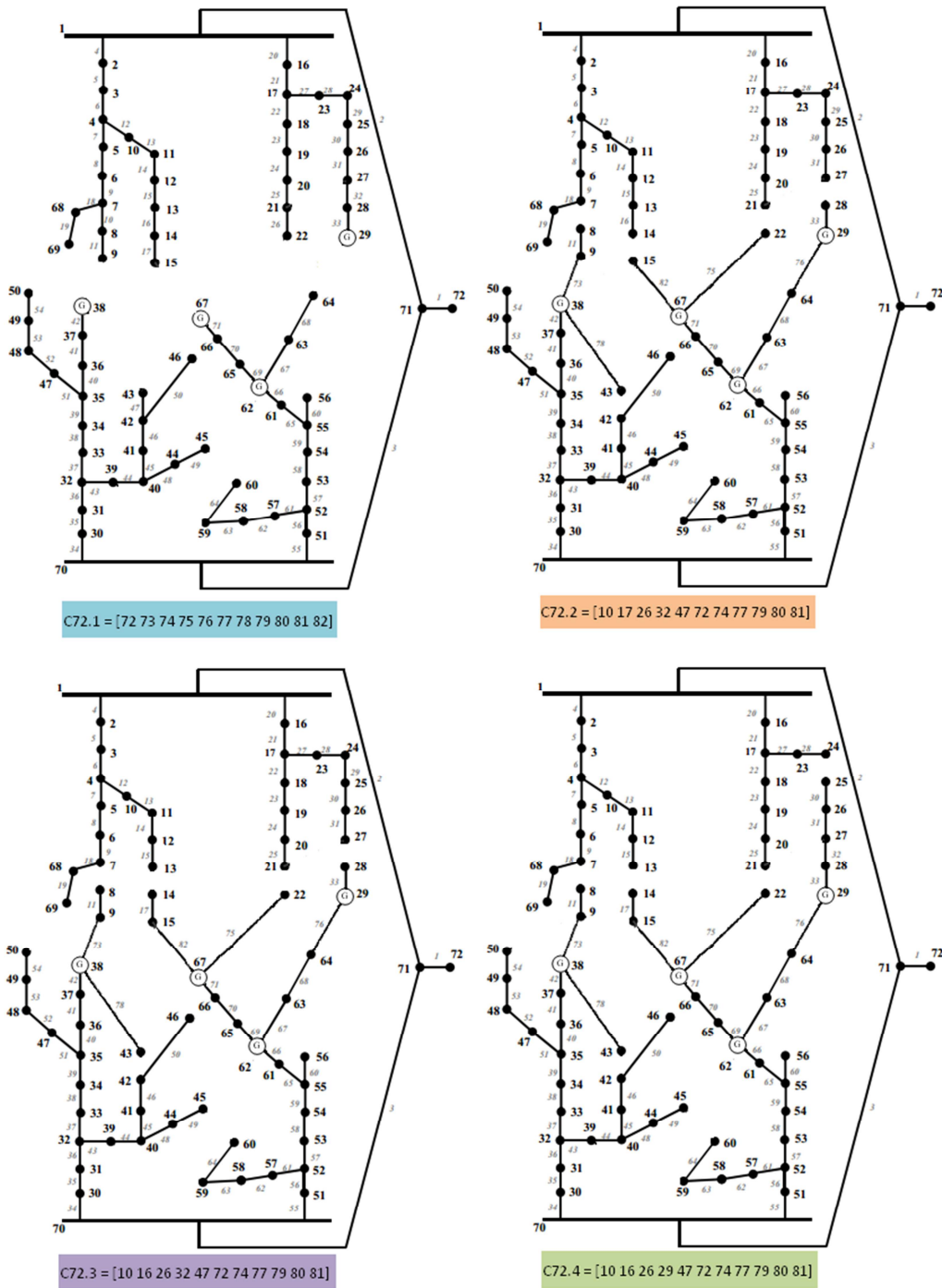

Figure IV-10 – The four different possible 72-nodes radial configurations found in scenario 1

	OLTC (ratio,V2)	Capacitor Bank	Configuration	Q <sub>GED</sub> control	Q <sub>GED</sub> control min (kVAr)	Q <sub>GED</sub> control max (KVAR)	Q <sub>GED</sub> (KVAR)	active power flex	Losses (kW)	Gain in losses resp. to (1.1) (%)	Time of execution (s)	Number of iterations	Equality (IV-28)			
Case 33 (1.1)	fixed 1	no 0	fixed C33.1 [33 34 35 36 37]	no	/	/	54	no	87,4	/	0,752	126	ok			
	V2 1,015						80							67	51	
							54							80	67	51
							54							80	67	51
Case 33 (1.2)	free 1,025	yes tap 2 1,5 MVAR	fixed C33.1 [33 34 35 36 37]	no	/	/	54	no	73,7	15,68%	0,933	423	ok			
	V2 1,040						80							67	51	
							54							80	67	51
							54							80	67	51
Case 33 (1.3)	free 1,025	yes tap 2 1,5 MVAR	free C33.2 [6 8 9 30 37]	no	/	/	54	no	42,2	51,72%	3,442	19605	ok			
	V2 1,040						80							67	51	
							54							80	67	51
							54							80	67	51
Case 33 (1.4)	free 1,025	yes tap 2 1,5 MVAR	free C33.2 [6 8 9 30 37]	yes	/	/	-62,4	no	41,0	53,09%	3,749	12375	ok			
	V2 1,040						71,4							107,0	107,0	
							-93,7							107,0	107,0	
							-78,1							89,2	89,2	
Case 33 (1.5)	free 1,025	yes tap 2 1,5 MVAR	free C33.3 [6 9 14 30 37]	yes	/	/	-62,4	yes (only DR)	28,5	67,39%	2,513	34183	ok			
	V2 1,040						71,4							107,0	107,0	
							-93,7							107,0	107,0	
							-78,1							89,2	89,2	
Case 33 (1.6)	free 1,025	yes tap 2 1,5 MVAR	free C33.4 [6 10 14 19 37]	yes	/	/	-105,0	yes (DR + prod dispatch increase)	21,5	75,40%	3,425	18223	ok			
	V2 1,040						120,0							102,0	102,0	
							-93,7							107,0	102,0	
							-105,0							120,0	-21,0	
							120,0									

Figure IV-11 – Results of the network losses optimization in the 33-nodes network for the different cases of the scenario 1

	OLTC (ratio,V2)	Capacitor Bank	Configuration	Q <sub>GED</sub> control	Q <sub>GED</sub> control min (kVAr)	Q <sub>GED</sub> control max (KVAr)	Q <sub>GED</sub> (KVAr)	active power flex	Losses (kW)	Gain in losses resp. to (1.1) (%)	Time of execution (s)	Number of iterations	Equality (IV-28)
Case 72 (1.1)	fixed 1	no 0	fixed	no	/	/	13,1	no	77,1	/	0,876	218	ok
	V2		C72.1				107,1						
	1,01		[72 73 74 75 76 77 78 79 80 81 82]				66,9						
							107,1						
Case 72 (1.2)	free 1,025	yes tap 2 1,5 MVar	fixed	no	/	/	13,1	no	72,2	6,36%	0,868	954	ok
	V2		C72.1				107,1						
	1,035		[72 73 74 75 76 77 78 79 80 81 82]				66,9						
							107,1						
Case 72 (1.3)	free 1,025	yes tap 2 1,5 MVar	free	no	/	/	13,1	no	66,6	13,60%	567,745	3903995	ok
	V2		C72.2				107,1						
	1,035		[10 17 26 32 47 72 74 77 79 80 81]				66,9						
							107,1						
Case 72 (1.4)	free 1,025	yes tap 2 1,5 MVar	free	yes	/	/	-15,2	no	63,9	17,12%	547,710	3594775	ok
	V2		C72.2				142,7						
	1,035		[10 17 26 32 47 72 74 77 79 80 81]				-78,1						
							89,2						
Case 72 (1.5)	free 1,025	yes tap 2 1,5 MVar	free	yes	/	/	-15,2	yes (only DR)	56,3	26,98%	576,770	3236912	ok
	V2		C72.3				142,7						
	1,035		[10 16 26 32 47 72 74 77 79 80 81]				-78,1						
							89,2						
Case 72 (1.6)	free 1,025	yes tap 2 1,5 MVar	free	yes	/	/	-105,0	yes (DR + prod dispatch increase)	48,1	37,61%	652,057	3356880	ok
	V2		C72.4				142,7						
	1,035		[10 16 26 29 47 72 74 77 79 80 81]				-78,1						
							89,2						

Figure IV-12 – Results of the network losses optimization in the 72-nodes network for the different cases of the scenario 1

## Scenario 2: Network losses optimization in constrained network situations

This part presents the results of the network losses optimization on the same distribution networks when the DGs are not producing anymore. In these cases, the considered networks are constrained because some under-voltages are appearing. These scenarios correspond to the second risk management scenarios that have been presented previously in section III.3. The idea here is to show how the flexibility resources can be optimally used to solve the network constraints deviations while minimizing the total network losses. Six cases for each network are studied for comparison.

The first cases (2.1) correspond to the initial cases, where the respective initial configurations C33.1 and C72.1 are fixed, the OLTC is fixed at a unitary ratio, there is no connected capacitor bank at the bus-bar, and where there is no DG production, nor available active power flexibility offers. In these cases, there is not any available flexibility mean. As under-voltage deviations are occurring in the considered distribution networks, the algorithm is not converging and no solution is found in any of the two networks.

Some flexible resources are added in the second cases (2.2), which are the OLTC transformer and the capacitor bank. Optimal solutions are found for these situations. The change of the unitary transformer tap ratio to 1.025 permits to increase the voltage in the entire DNo cells, and to solve the voltage deviations. Moreover, in both networks, the capacitor bank position is changed, permitting a reactive power injection of 1.5MVAR at the bus-bar and limiting the reactive power flows in the DNo cells. These new networks situations lead to 100.9kW of DNo cell losses in the 33-nodes network and to 106.3kW in the 72-nodes network.

In cases (2.3), only the reconfiguration is available. In the 33-nodes network, the reconfiguration helps to solve the voltage deviations. Without any other flexibility resources, the reconfiguration of the network into the best configurations C33.1' permits to release the voltage constraints deviations. The total copper losses are decreased down to 78.4 kW (decrease of around 22% compared to the case (2.2)). However, the reconfiguration only is not permitting to solve the voltage deviations in the 72-nodes network.

The combination of the OLTC transformer, the capacitor bank and the reconfiguration permits the under-voltage deviations in these situations to be solved, which are studied in cases (2.4). The combination permits the level of the losses to be decreased down to 67.9 kW in the 33-nodes network (decrease of almost 33% compared to the case (2.2)). Concerning the 72-nodes network, the configuration is remaining the same as the initial one, meaning that it was already the best configuration of the network for this loading case. Therefore, the network losses are still equal to 106.3 kW in this case.

Active power flexibility offers through DR management can also be added to the optimization problem. In this scenario, all the feeders are consuming power because no DG is producing. As it has been demonstrated in the previous scenario, all the flexibility offers will be activated in order to reduce

the power flows. In the cases (2.5), it has been chosen to consider the same active power flexibility offers that have been presented in the previous cases (1.5) in Figure IV-7.

As presented in risk management scenario in the part III.3 of this thesis, active power flexibility offers activation only permits also to solve some cases of voltage constraints. Here, the network losses minimization is kept as the objective function, and so all the available flexibility offers are activated in order to reduce the power flows. The 33-nodes network losses are decreasing down to 85.5 kW (decrease of 15% compared to the case (2.2)) and the 72-nodes network losses are decreasing down to 102kW (decrease of around 4% compared to the case (2.2)). In the case of the 33-nodes network, the possibility to reconfigure the cell without any other means of flexibility permits having a higher reduction of the losses than with the use of any other resources of flexibility.

If the reconfiguration is possible in addition to DR management (cases 2.6), the copper losses are decreasing down to 57.7kW in the 33-nodes network (decrease of around 42% compared to the case (2.2)) and are remaining the same for the 72-nodes network. The recap results of these studies are depicted in the tables below (see Figure IV-13 and Figure IV-14).

	OLTC (ratio,V2)	Capacitor Bank	Configuration	active power flex	Losses (kW)	Gain in losses resp. to (2.2) (%)	Time of execution (s)	Number of iterations	Equality (IV-28)
Case 33 (2.1)	fixed 1 V2: 1,015	no 0	fixed C33.1 [33 34 35 36 37]	no	No solution -> voltage deviations				
	free 1,025 V2: 1,040	yes tap 2 1,5 MVar	fixed C33.1 [33 34 35 36 37]	no	100,9		0,823	424	ok
Case 33 (2.3)	fixed 1 V2: 1,015	no 0	free C33.1' [7 9 14 31 37]	no	78,4	22,30%	3,025	22884	ok
	free 1,025 V2: 1,040	yes tap 2 1,5 MVar	free C33.1' [7 9 14 31 37]	no	67,9	32,71%	3,120	22323	ok
Case 33 (2.5)	fixed 1 V2: 1,015	no 0	fixed C33.1 [33 34 35 36 37]	yes (all)	85,5	15,26%	0,626	116	ok
	fixed 1 V2: 1,015	no 0	free C33.1' [7 9 14 31 37]	yes (all)	57,7	42,81%	2,881	14826	ok

Figure IV-13 – Results of the 33-nodes network losses optimization for the different cases of the scenario 2



	OLTC (ratio,V2)	Capacitor Bank	Configuration	active power flex	Losses (kW)	Gain in losses resp. to (2.2) (%)	Time of execution (s)	Number of iterations	Equality (IV-28)
Case 72 (2.1)	fixed 1	no 0	fixed C72.1	no	No solution -> voltage deviations				
	V2: 1,015		[72 73 74 75 76 77 78 79 80 81 82]						
Case 72 (2.2)	free 1,025	yes tap 3	fixed C72.1	no	106,3		0,975	916	ok
	V2: 1,040	3,4 MVar	[72 73 74 75 76 77 78 79 80 81 82]						
Case 72 (2.3)	fixed 1	no 0	free	no	No solution				
	V2: 1,015								
Case 72 (2.4)	free 1,025	yes tap 3	free C72.1	no	106,3	0%	0,975	916	ok
	V2: 1,040	3,4 MVar	[72 73 74 75 76 77 78 79 80 81 82]						
Case 72 (2.5)	fixed 1	no 0	fixed C72.1	yes (all)	102,0	4,05%	1,033	244	ok
	V2: 1,015		[72 73 74 75 76 77 78 79 80 81 82]						
Case 72 (2.6)	fixed 1	no 0	free C72.1	yes (all)	102,0	4,05%	1,033	244	ok
	V2: 1,015		[72 73 74 75 76 77 78 79 80 81 82]						

Figure IV-14 – Results of the 72-nodes network losses optimization for the different cases of the scenario 2

The two different possible radial configurations applied in the 33-nodes network in the different cases are shown in Figure IV-15.

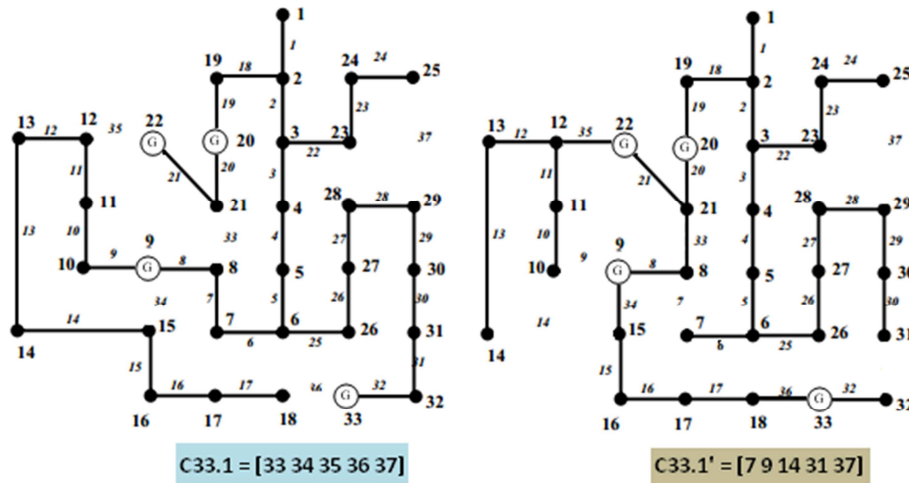

Figure IV-15 – The two different possible 33-nodes radial configurations found in scenario 2

Finally, the activation of the different available flexibility means can support DSOs for the combination of network constraint management and network losses optimization. In the two presented networks, the optimization permits the network losses to be minimized with the different available flexibility means, while solving the occurring constraints.

By construction, the network losses optimization problem is based on the reduction of the power flows in the considered DNo cell. As there are no constraints on the different flexibility resources

activation, the operational costs of the different flexibility means are not taken into account in the optimization.

However, these different flexibility means have an associated operational cost for the DSOs. Indeed, considering an OLTC transformer, each tap position change has an associated operational usage cost that can be evaluated by the DSOs. The same reasoning can be done for the capacitor banks. Hence, some constraints on the number of OLTC and capacitor banks position changes along a defined period could be interesting to add. In the same vein, each reconfiguration implies a given number of switches to perform which is depending on the difference between the two configurations. These switches have a direct impact on the switching components of the network and their operational costs can be assessed by the DSOs. A limitation may be if the switch equipment is designed for a limited number of operations per lifetime, which limits the applicability of control actions. Then, some technical constraints could be added on the total number of switches permitted along a period, but also on the number of switches allowed per component along the period.

End users power flexibility means have also a non-negligible operational cost. Indeed, DGs reactive power output control implies the overuse of the power electronic devices that are connecting the power plants. At the moment, the payment for reactive power control to the DG owner is divided in two parts: a capacity payment and a real-time payment for actual production, for which tariffs are defined in the regulation [ENED5-15] [ELIA-15].

Active power flexibility offers are the consequence of DR management or of controllable DG power dispatch. Unlike the other means of flexibility, the activation of these flexibility offers are managed by the commercial aggregators and have a direct impact on the end users comfort or/and remuneration. Therefore, if the DSOs choose to use this type of offers for constraint management and network optimization after the markets closure, they will have to remunerate the commercial aggregators for the flexibility pre-emption.

To conclude, flexibility means in active and flexible networks can provide significant support to the DSOs for constraints management and for network losses optimization. However, these flexibility means have all an associated operational cost. The DSOs will have to make a trade-off between the cost of their total network losses and the cost of their flexibility procurement.

## IV.3 Addition of the flexibility procurement cost in the problem formulation

As seen in the previous part, flexibility procurement by the DSOs can improve significantly the network energy efficiency. The deployment of NICT in the distribution systems as well as the growing number of DGs and of flexible end users could therefore help the DSOs to assess and minimize their expense due to the transit of power through their networks.

However, any type of flexibility procurement is associated with a cost for the DSOs. This cost can be described as operational if the flexibility activation implies the use of the grid components, or contractual if the flexibility activation is procured by a commercial aggregator. Hence, the DSOs will have to inevitably make a trade-off between their network losses cost and their flexibility procurement cost to optimize the overall network operation.

In this section, the idea is to illustrate the addition of a part of the flexibility procurement cost in the problem formulation. As the presented optimization is performed on particular operating points, the number of OLTC and capacitor bank position changes, as well as the number of switches between the different configurations at different time slots, cannot be taken into account in the optimization. Here, the modification of the problem formulation is only focusing on the active power flexibility that is proposed by the commercial aggregators via DR management or DG production dispatch. Therefore, as it has been done in chapter III, a price of an hourly activation is associated for each available active power flexibility offer. It is then possible to assess the cost of active power flexibility procurement for the DSOs.

### IV.3.1 Modification in the problem formulation

In order to keep the network energy efficiency as an objective, the minimization of the network losses has to remain in the objective function. The cost of the active power flexibility activation can thus be added in the objective function. To be consistent, the network losses should be characterized by their cost for the DSOs. The new objective function could be written as in equation (IV.65).

$$\min (\alpha \cdot \sum_{(i,j) \in \Omega} r_{ij} \cdot I_{ij}^2 + \sum_{i \in \Gamma} \sum_{l \in L(i)} x_{act_{il}} \cdot c_{il}) \quad (IV.65)$$

Where  $\alpha$  represents the price of the network losses,  $\sum_{(i,j) \in \Omega} (r_{ij} \cdot I_{ij}^2)$  is the total amount of the considered network losses. The set  $L(i)$  is representing a set of available active power flexibility offers at node  $i \in \Gamma$ .  $x_{act_{il}}$  is the state of activation of the active power flexibility offer  $l \in L(i)$  available at node  $i$ .  $c_{il}$  is its associated activation cost for the DSO.

Formulated as describe above, the problem formulation is becoming a weighted multi-objective optimization. Given this new multi-objective function, the necessary conditions for the exact relaxation into MISOCP problem, presented in section IV.2.2, could not be entirely respected in some cases.

Particularly, the condition C3 is stating that the objective function has to be strictly increasing with the square of the flowing currents magnitude, non-increasing in loads, and independent of the apparent powers.

The activation of an active power flexibility offer has a direct impact on the flowing currents magnitude, on the loads and on the apparent powers. Due to this fact, the relaxation might not be exact in all the cases and the verification should be done for every optimization procedure.

In order to address this limitation, another formulation of the problem is proposed in order to allow the integration of the flexibility procurement cost. The objective function is remaining the same as in equation (IV.23) and the cost of active power flexibility procurement is added in the problem as a constraint. By doing so, the relaxation of the problem into a MISOCP problem is remaining exact. Moreover, the estimated operational cost of the network losses for the considered operating point can be directly set by the DSOs as a limit in the problem.

The new constraint can be formulated as in the following equation (IV.66).

$$\sum_{i \in \Gamma} \sum_{l \in L(i)} x_{act_{il}} \cdot c_{il} \leq c_{max} \quad (IV.66)$$

Here again, the set  $L(i)$  is representing the set of available active power flexibility offers at node  $i \in \Gamma$ .  $x_{act_{il}}$  is the state of activation of the active power flexibility offer  $l \in L(i)$  available at node  $i$ .  $c_{il}$  is its associated activation cost for the DSO.  $c_{max}$  is the estimated operational cost of the network losses for the considered operating point. Some examples of application of this modified optimization problem are presented in the next section.

### IV.3.2 Examples of application

This section presents some results of the network losses minimization problem on the two DNO cells presented in the previous section, where different means of flexibility are available and where the constraint on active power flexibility procurement is added. The study cases are the same scenarios presented in the first part of this chapter. The resolution method is still the branch-and-cut algorithm.

As the constraint (IV.66) is restricting the objective value (IV.23), the evolution of the evolution of the total network losses with respect to the admissible total cost of active power flexibility activation is studied in the different cases. Given this trend line, it will be possible for the DSOs to find a trade-off between network losses minimization and active power flexibility procurement.

#### Scenario 1: Network losses optimization in normal network situations

As a reminder, this scenario is dealing with the network losses optimization on the 33-nodes network and on the 72-nodes network when all the network constraints are respected. This part is focusing on the cases (1.5) and (1.6) presented in part IV.2.3, where all the flexibility means in the DNO cells are assumed to be available, including some active power flexibility offers.

When performing the network losses optimization without any constraint on the active power flexibility procurement, all the end users flexibility offers were activated in both cases. The total network losses at the considered operating point were respectively equal to 28.5 kW in case (1.5) and to 21.5 kW in case (1.6) in the 33-nodes network. They were equal respectively to 56.3 kW in case (1.5) and 48.1 kW in case (1.6) in the 72-nodes network.

For different values of the total admissible cost of flexibility offers activation, different optimal solutions are found, as presented in Figure IV-17 and Figure IV-18. As expected, the more the flexibility procurement cost is constrained, the less power flows are compensated locally and the higher is the level of network losses. The cases where the total cost of active power flexibility activation is fixed at zero correspond to the cases (1.4) where no active power flexibility is available.

Among the different optimal solutions, several configurations are found for the two networks. Indeed, depending on the modifications of the power flows in the DNo cells which are depending on the price of activation of each flexibility offer, the best configuration is changing. These resulting configurations are all detailed in the following tables (see Figure IV-16).

33-nodes network		72-nodes network	
C33.1	[33 34 35 36 37]	C72.1	[72 73 74 75 76 77 78 79 80 81 82]
C33.2	[6 8 9 30 37]	C72.2	[10 17 26 32 47 72 74 77 79 80 81]
C33.3	[6 9 14 30 37]	C72.3	[10 16 26 32 47 72 74 77 79 80 81]
C33.4	[6 10 14 19 37]	C72.4	[10 16 26 29 47 72 74 77 79 80 81]
C33.5	[6 8 11 14 37]	C72.5	[10 16 26 47 72 74 76 77 79 80 81]
C33.6	[6 8 10 15 37]		
C33.7	[6 8 9 14 37]		
C33.8	[6 8 9 36 37]		
C33.9	[6 8 11 30 37]		
C33.10	[6 8 10 30 37]		

**Figure IV-16 – Resulting configurations in the different optimization solutions**

In this example, for the 33-nodes network, when the total admissible cost of activation is comprised between 0€ and 14€, it is more efficient to activate only the proposed DR flexibility offers and to keep the configuration C33.2 in order to minimize the DNo cell losses. Above this limit, the cogeneration dispatch offers (in case 1.6) are more profitable and their activations permit decreasing even more the total DNo cell losses.

Concerning the 72-nodes network, it is more efficient to activate only the available DR flexibility offers and to keep the configuration C72.2 in order to minimize the DNo cell losses as long as the total admissible cost of activation is lower than 4€. Then, for the available flexibility offers considered in the cases (1.5) and (1.6), it is more interesting to switch to configuration C72.3 as long as the total admissible cost of activation is lower than 19€.

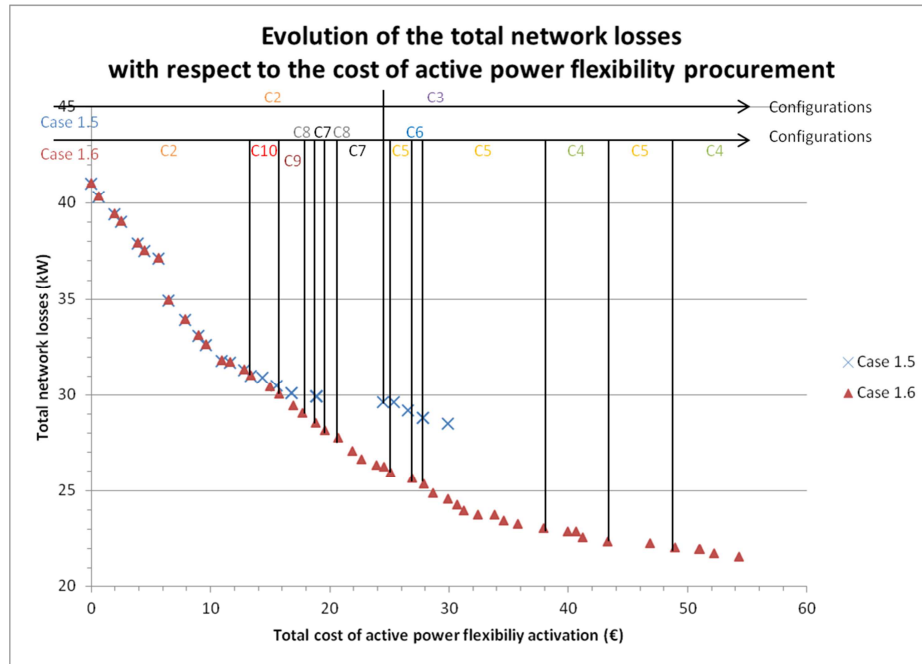

Figure IV-17 – Evolution of the 33-nodes network losses optimization solutions with respect to the maximum admissible cost of active power flexibility procurement in cases 1.5 and 1. 6

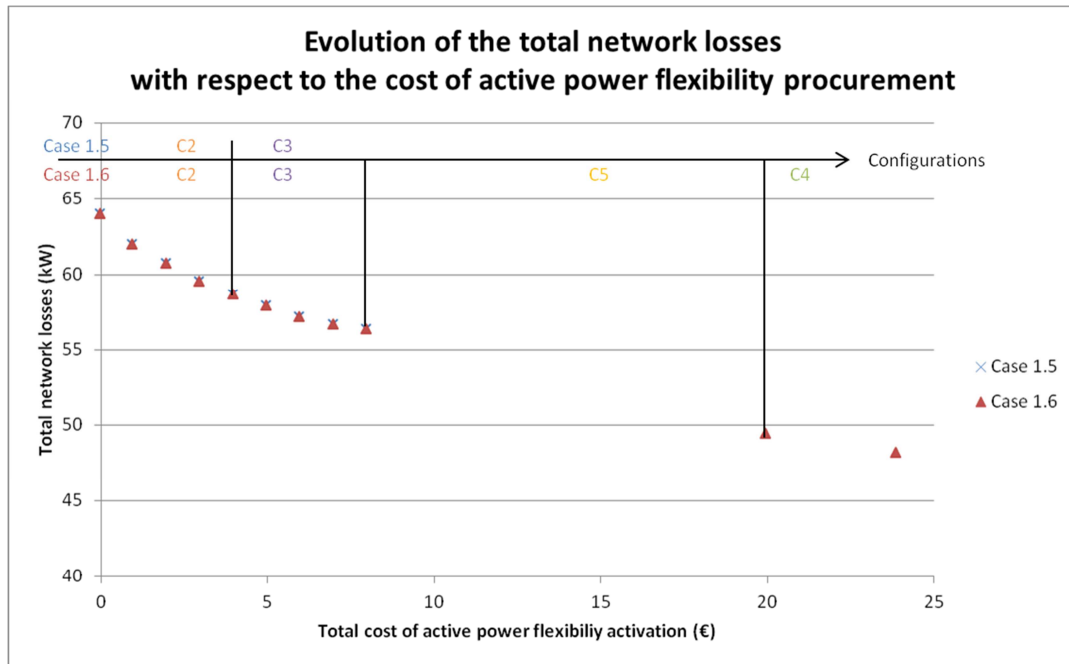

Figure IV-18– Evolution of the 72-nodes network losses optimization solutions with respect to the maximum admissible cost of active power flexibility procurement in cases 1.5 and 1. 6

Mathematically, the optimization problem is minimizing a single objective. The introduction of a new constraint on the active power flexibility activation is restricting this objective. Hence, the evolution

of the objective function with respect to the admissible total cost of active power flexibility activation can be seen as a kind of Pareto curve, where the objective function cannot be improved in value without violating the limiting constraint.

These trend curves give to the DSO an idea of the evolution of the total DNo cell losses depending on the price he is willing to pay for active power flexibility procurement. Obviously, this evolution highly depends on the location of the available flexibility offers and though, the DSO cannot generalize these curves for all its DNo cells for all the possible loading cases. This is the reason why this distributed procedure has to be performed in each DNo cell, for each operating point with the knowledge of the available flexibility offers.

The benefits of the network losses optimization compared to the associated cost of flexibility offer activation have to be evaluated on a given period, and not on a single operating point. Indeed, the considered prices of activation of the offers are given for one hour. It is therefore necessary to take into account the loading fluctuations in each DNo cell in order to evaluate more precisely the amount of network losses reduction.

This distributed algorithm can be performed not only for network efficiency optimization but also for the combination of network losses minimization with network constraints management, as described in the next section.

## **Scenario 2: Network losses optimization in constrained network situations**

This scenario is concerning the network losses optimization on the two networks when the DGs are not producing anymore. This part is focusing on the cases (2.5), where the initial configuration C1, the OLTC position and the capacitor bank position are fixed. Only some active power flexibility offers are available as flexibility resources. Here again, the evolution of the network losses optimization solutions with respect to the total admissible cost of flexibility activation is studied. It can be seen on Figure IV-19 for the 33-nodes network and on Figure IV-20 for the 72-nodes network.

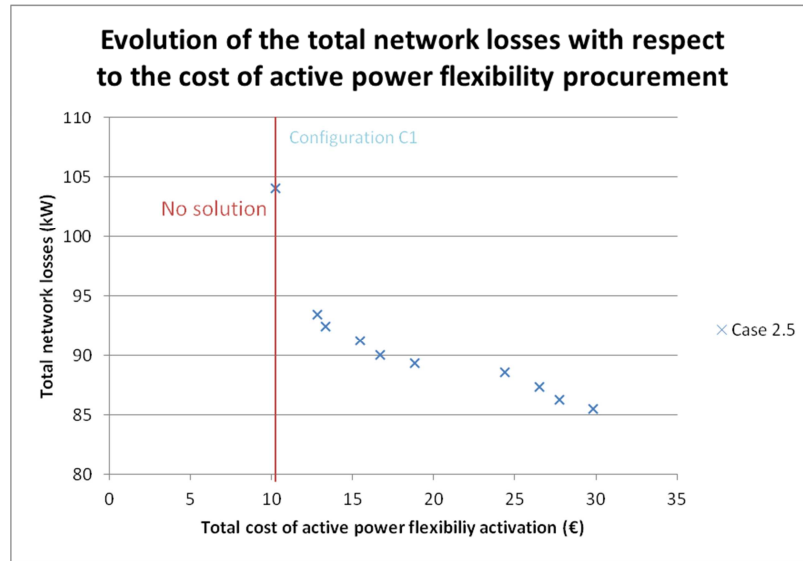

Figure IV-19 – Evolution of the 33-nodes network losses optimization solutions with respect to the maximum admissible cost of active power flexibility procurement in case 2.5

In this specific case in the 33-nodes network, 10.31€ is the minimum cost that has to be paid by the DSO in order to solve the occurring voltage constraints at this operating point. Below this price, it does not exist any combination of available flexibility offers activation that can solve the occurring network constraints. From a network losses optimization point of view, other combinations of active power flexibility offers activations permit the DNo cell losses to be decreased down to 85.5 kW for this operating point.

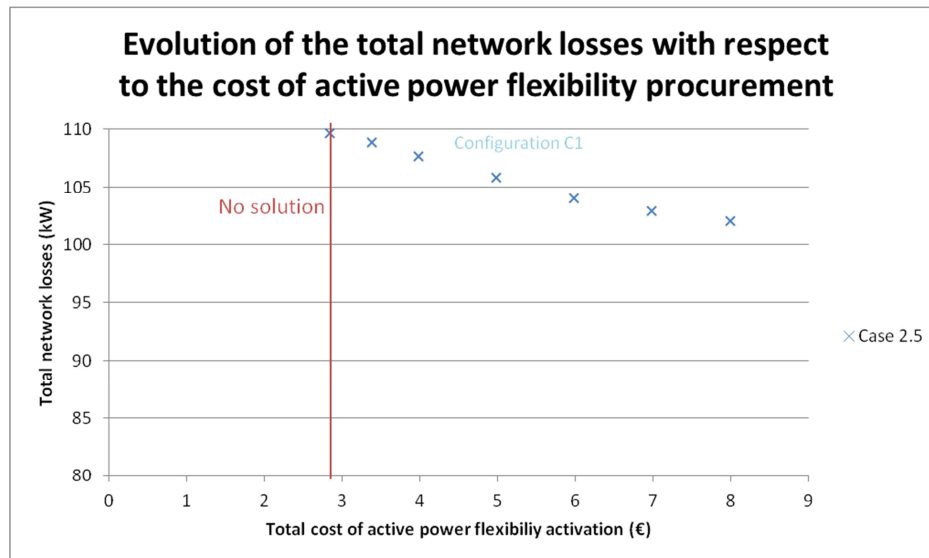

Figure IV-20 – Evolution of the 72-nodes network losses optimization solutions with respect to the maximum admissible cost of active power flexibility procurement in case 2.5



Concerning the 72-nodes network test case, the minimum cost that has to be paid by the DSO in order to solve the occurring voltage constraints at this operating point is 2.85€. With a higher price of DR flexibility activation, it is possible to reduce the network losses until 102kW.

Thanks to this method, the DSOs are able to assess simultaneously the minimum cost they have to pay to solve their occurring network constraints, and the evolution of their network losses with respect to the price they are ready to pay for additional flexibility procurement.

This kind of constraining limits can also be developed in the distributed algorithm for other flexibility means if a given period of time is considered. All that remains to be done by the DSOs is to find the best trade-off between network energy efficiency and operational cost of flexibility means procurement, depending on its network and its loading conditions.

## IV.4 Conclusion

In this chapter, a distributed advanced function for the DSOs has been developed for minimizing the network losses with the possible use of OLTC transformer, capacitor bank at the primary substation, reconfiguration and reactive and active powers control of the flexible DERs. As shown through the different examples, this method can help the DSOs optimizing their network losses, but also managing their grid constraints.

Unlike the optimization problem presented in the section III.3, the problem is not only combinatorial but cannot be directly solved to optimality with the branch-and-cut algorithm. The use of mathematical reformulation techniques permitted the optimality of the solution found to be guaranteed, when the algorithm is performed in each distributed and independent DNO cell. It is therefore assumed that some advanced RTUs are installed at the relevant primary substations and that they have enough mathematical performances to carry out this algorithm.

The application of this methodology in a more distributed context would not permit the global optimality of the solution to be guaranteed because of dependencies between the cells. Multilevel optimization techniques as proposed in [RIDE-13] would then be required in order to define new disjointed and complementary constraints in the model, to guarantee the optimality of the solution found.

The second part of this chapter has the objective of moving closer to the market schemes reality, considering that any type of flexibility procurement is associated with a cost for the DSOs. This cost can be operational if the flexibility activation implies the use of the grid components, and/or contractual if the flexibility offer is procured by an end user via a commercial aggregator. Knowing this, a specific constraint on the total cost of active power flexibility activation is added, ensuring that the mathematical relaxation is remaining exact. The evolution of the network losses with respect to this cost is determined for some particular operating points, while guaranteeing the global optimality of the solutions.

Extended on an adequate period of time, this methodology could help the DSOs to make a trade-off between their network energy losses cost and their flexibility procurement cost. More especially, the extension of this tool on a longer period of time would permit the DSOs to take into account the rebound and report effects of the active power flexibility activation. In addition, it would be also possible to introduce others dynamic constraints on flexibility resources, such as on the number of changes of OLTC positions or on the number of switches, but also on the availability of the flexibility offers that can evolve along the period. Thanks to this kind of enlargement of the proposed methodology, the DSOs could focus on more profitable investment plans and prepare a more energy efficient operation of their network.



# Final conclusion

---

With the large increase of renewable DG interconnections and with the growing number of flexible DERs in distribution systems, the electricity system operator's roles and responsibilities need to evolve. In a context where all market actors are dealing with an increasing number of local flexibility opportunities, the DSOs have to play locally a new key role. They have to ensure a complete access to the energy and capacity markets to all distributed actors. They should also enable the valorization of these offers in the national market places. They must ensure the security and the quality of supply to their customers while guaranteeing optimal network operation conditions.

## Scientific contributions of the research work

The research work carried out within this thesis proposes the definition of a new dynamic coordination and control infrastructure in order to allow the DSOs to best operate their networks with a large amount of DERs. This new structure has been developed with a bottom-up approach in order to create a resilient and cost effective solution.

The European existing markets processes, mechanisms, and standards have been firstly studied in order to propose a complementary local market architecture. New near real time distributed balancing markets have been thus introduced, in order to permit the design of new DSO mechanisms. Thanks to it, the DSOs can act as market enablers while verifying that all the flexibility offers exchanged between market players are compatible with the security and the reliability of their network operation. New DSOs strategies for local distribution constraints management and for network energy efficiency have been also proposed in this thesis. Both operational planning and enhanced network optimization are then possible while considering remaining near real-time local flexibility offers. Several mathematical tools have been investigated, compared and validated systematically on typical IEEE distribution networks in order to create these different strategies.

First of all, network modeling, power flow computations and sensitivity analysis have been considered in order to assess the behaviors of balanced and unbalanced systems characteristics with respect to the consumed and produced powers in the network.

Fuzzy arithmetic has then been used for the elaboration of a technical flexibility offer validation method, permitting uncertainties due to possible withdrawals of the proposed offers but also on the reliability of their forecasted volumes to be taken into account. Thanks to the developed method and depending on their confidence on the data, it has been showed on specific cases that the DSOs can validate or not the available flexibility offers which are contracted by the commercial aggregators.

Different types of algorithms, characterized by different mathematical complexity, have been created, investigated and validated in order to permit the DSOs to assess the potential risks of contingency in their network. In order to ensure the security and the operational reliability of the distribution network up to real-time, they have to prepare counter measures to react to potential sudden changes in their network. With the aim to be accessible and easily implemented by the DSOs, simple heuristic methods based on cost and sensitivity analysis have been first proposed. These methods are also compliant with computational performances of the actual deployed RTUs. More advanced strategies, i.e. metaheuristic and exact optimization methods, have been also validated to compare the accuracy and the performances of the different algorithms on a combinatorial problem. It has been demonstrated on specific cases, that the developed methods are able to find the best economical combinations of flexibility means (including flexibility of the grid and remaining flexibility offers) to be activated in case of apparition of non-expected network constraints.

Finally, an optimization formulation based on continuous and discrete variables have been introduced in order to support the DSOs for network losses optimization and constraints management. It considers the possible use of transformer's OLTCs, capacitor banks at the primary substation, reconfiguration, and both reactive and active powers control of the flexible DERs. The use of mathematical reformulation techniques guarantees the optimality of the solution found, when the algorithm is performed in each distributed and independent network area. This method permits also the evolution of the network losses with respect to a maximum admissible flexibility operational cost to be apprehended. While preserving the exact formulation of the optimization problem, Pareto curves have been drawn for specific cases in order to allow the DSOs to get an evolution trend of the total losses in each Distribution Network optimization (DNo) cell depending on the price of active power flexibility procurement.

## Further works

All these methodologies have been developed for a given operating point. It could be interesting to extend them on an adequate time frame, in order to consider potential rebound and report effects of the active power flexibility activation. The GreenLys project [GREE-15] quantified these rebound and report effects for essentially thermal heaters load shifting. It established that the energy report is included between 40% and 60% of the shifted energy in the next hour following the activation. More generally, the energy report is higher than 95% of the shifted energy in the next 24 hours. Concerning the rebound power, it is evaluated at around 50% of the shifted peak power.

If the rebound power is large, additional temporary power flows might occur, creating other network constraint violations, and potentially increasing the network losses. It would be interesting to introduce dynamic constraints on flexibility resources over the period, such as on the number of OLTC and switches operations, but also on the availability of the flexibility offers along the period. As the proposed algorithms are not taking into account the rebound and report effect, they can lead to non-

optimal situations for the considered period. In the same philosophy, network losses optimization over a given period can be challenged if these effects are not taken into account. This illustrates the need of considering adequate periods of time instead of specific operating points. This new type of tools could then be used for unit commitment at distribution level.

In this research work, the evolution of the flexibility resources availability between the different market time frames is not considered. Any remaining flexibility resources available near real-time could also be proposed or selected for the next day market exchanges. In this philosophy, a common framework is actually designed in order to include all the developed methodologies considering the different time frames of the algorithms as well as the needed data exchanges.

All the developed methodologies are assuming the availability of end users flexibility. However, end users flexibility acquisition appears to be really challenging and costly in the current period. New incentives should be adopted in order to permit an increase of these flexibility opportunities. Moreover, as the assumed flexibility offers are directly proposed by the end users, they cannot be always 100% reliable. Even if the aggregation concept permits some imbalance risks associated with individual market participation to be reduced, some uncertainties on the availability of the flexibility offers should be added in the methodologies.

Some research work on the potential replicability and scalability of the methods should be also done to ensure the reliability of this architecture in large power networks. The developed distributed architecture has been proposed with the aim of being highly scalable and easily deployable. Though, it would be interesting to perform robustness and cost-analysis comparisons between decentralized and centralized systems while considering large networks. Some comparisons could be also conducted to assess the potential performances of new hybrid architectures, coupling decentralized and centralized advanced functions for DSOs in Smart Grids.

Finally, all along this thesis, it has been assumed that all local flexibility exchanges were exclusively done through local market places. Other local exchanges possibilities could be imagined, such as local OTC contracts and exchanges, or even new transactions schemes including blockchain, which could interact with the proposed market architecture. Some of these kinds of exchanges can be observed within the project “Reforming the Energy Vision” (REV) [REV-16] in the New York state, aiming at empowering end users to make more informed energy choices and to reform New York State’s energy industry and regulatory practices.

## **Contributions to the DREAM project**

This work has been elaborated within the DREAM project, funded by the European Commission under FP7 grant agreement 609359. Twelve industrial and academic partners from seven different countries are currently working on this project. The DREAM project aims at laying the foundations for a novel heterarchical management approach of distribution electrical power networks. Its major goal is to

allow the economic integration of DERs and the participation of all end users in energy markets, with the development of an autonomous agent based system.

All the scientific and technical implementations done in this thesis are integrated within the DREAM project and in the common framework for demonstrations on field tests. The DREAM architecture framework consists in a number of coupled coherent packages, each covering a part of the desired functionality, in which the proposed methodologies are included and are dependent from the others.

Some of the developed methodologies are also tested in two different test fields. The MV level methodologies are partly experimented in the trial site of Milano Malpensa Airport (Italy). This field test is including a trigeneration plant and modern electrical substations, and critical equipment. Several resources of flexibility are considered in the airport, such as HVAC auxiliaries and lightning apron towers. Some of these methodologies have been also adapted for LV level operation and are partly tested in Opkamer field test, which is the PowerMatching City test site located in Groningen (The Netherlands). The considered available flexibility resources are offered by smart appliances located in the households of the site test.

---

# References

---

- [ABB-16] ABB, "Technical guide - Smart grids - The 'smart' secondary substation," 2016.
- [ABDE-14] S. Y. Abdelouadoud, "Intégration des énergies renouvelables au réseau de distribution d'électricité," ParisTech Paris Institute of Technology, 2014.
- [ACER-15] ACER, "Recommendation of the ACER No 03/2015 of 20 July 2015 on the network code on electricity balancing", 2015.
- [ACER-16] "ACER - Agency for the Cooperation of the Energy Regulators," 2016. [Online]. Available: <http://www.acer.europa.eu/en/Pages/default.aspx>.
- [AHUJ-07] A. Ahuja, S. Das, and A. Pahwa, "An AIS-ACO hybrid approach for multi-objective distribution system reconfiguration," *IEEE Transactions on Power Systems*, vol. 22, no. 3, 2007.
- [ALVA-09] M.-C. Alvarez-Hérault, "Architectures des réseaux de distribution du futur en présence de production décentralisée," Institut polytechnique de Grenoble, 2009.
- [ANDR-05] C. Andrieu, M. Fontela, B. Enacheanu, et Al., "CRISP - Distributed Network Architectures (D1.7)," 2005. [Online]. Available: <http://www.crisp.ecn.nl/documents.html>.
- [ARRE-15] "Arrêté du 23 avril 2008 relatif aux prescriptions techniques de conception et de fonctionnement pour le raccordement à un réseau public de distribution d'électricité en basse tension ou en moyenne tension d'une installation de production d'énergie électricité," 2015.
- [AUSU-10] L. M. Ausubel and P. Cramton, "Using forward markets to improve electricity market design," *Elsevier, Utilities Policy*, vol. 18, no. 4, pp. 195–200, 2010.
- [BALA-11] K. Balamurugan and D. Srinivasan, "Review of power flow studies on distribution network with distributed generation," *2011 IEEE Ninth International Conference on Power Electronics and Drive Systems*, December 2011.
- [BARA-64] P. Baran, "On Distributed Communications Networks," *IEEE Transactions on Communications Systems*, vol. 12, 1964.
- [BAR1-89] M. Baran and F. Wu, "Network reconfiguration in distribution systems for loss reduction and load balancing," *IEEE Transactions on Power Delivery*, vol. 4, pp. 1401–1407, 1989.
- [BAR2-89] M. Baran and F. Wu, "Optimal capacitor placement on radial distribution systems," *IEEE Transactions on Power Delivery*, vol. 4, 1989.
- [BART-14] G. Bartolucci, F. Naso, M. Baron, et Al., "evolvDSO - System Use Cases definition and functional and non-functional requirements for tools and methods, and definition of KPIs (D2.2)," 2014. [Online]. Available: <http://www.evoldso.eu/Home/Results>.
- [BAXE-07] I. S. Baxevanos and D. P. Labridis, "Implementing Multi-agent Systems Technology for Power Distribution Network Control and Protection Management," *IEEE Transactions on Power Delivery*, vol. 22, pp. 332–433, 2007.
- [BELH-11] R. Belhomme, R. Cerero, G. Valtorta, et Al., "The ADDRESS project: Developing Active Demand in smart power systems integrating renewables," *IEEE Power and Energy Society General Meeting*, 2011.



- [BENO-15] C. Benoit, "Models for investigation of flexibility benefits in unbalanced Low Voltage Smart Grids," Université Grenoble Alpes, 2015.
- [BERS-10] B. Berseneff, "Réglage de la tension dans les réseaux de distribution du futur," Université de Grenoble - Institut National Polytechnique de Grenoble, 2010.
- [BILL-95] R. Billinton and a Sankarakrishnan, "A comparison of Monte Carlo simulation techniques for composite power system reliability assessment," *IEEE WESCANEX 95 Communications, Power, and Computing Conference Proceedings*, pp. 145–150, 1995.
- [BLIE-11] F. Bliiek, A. Van Den Noort, B. Roossien, et Al. "Power-Matching City : a living Smart Grid demonstration," 2011.
- [BRIC-12] W. C. Briceno Vicente, "Modélisation des réseaux de distribution sous incertitudes," Université de Grenoble, 2012.
- [BURN-13] D. Burnier de Castro and T. Esterl, "Analysis of changes, risk and possibilities for cross border market opening between Austria, Italy and Slovenia - eBADGE D2.2," 2013. [Online]. Available: <http://www.ebadge-fp7.eu/deliverables/>.
- [CAIR-03] R. Caire, N. Retière, E. Morin, et Al., "Voltage management of distributed generation in distribution networks," *Proceedings of IEEE PES General Meeting*, pp. 282–287, 2003.
- [CAIR-13] R. Caire et Al., "DREAM - Reference object model and dictionary (D5.1)," 2013. [Online]. Available: <http://www.dream-smartgrid.eu/downloads/>
- [CEN-12] CEN-CENELEC-ETSI Smart Grid Coordination Group, "Smart Grid Reference Architecture," 2012.
- [CEER-15] Council of European Energy Regulators, "CEER Benchmarking Report 5.2 on the Continuity of Electricity Supply - Data update," 2015.
- [CIGR-07] CIGRE Working Group C1.2, "Maintenance of acceptable reliability in an uncertain environment," 2007.
- [CIGR-10] CIGRE Working Group C1.17, "Planning to Manage Power Interruption Events," 2010.
- [CIRI-03] R. M. Ciric, A. P. Feltrin, and L. F. Ochoa, "Power flow in four wire distribution networks – General approach," *IEEE Transactions on Power Systems*, vol. 18, no. 4, pp. 1283-1290, 2003.
- [COLS-11] C. M. Colson, M. H. Nehrir, and R. W. Gunderson, "Distributed multi-agent microgrids: A decentralized approach to resilient power system self-healing," *Proceedings - ISRCS 2011: 4th International Symposium on Resilient Control Systems*, pp. 83–88, 2011.
- [CONT-10] S. Conti, S. Raiti, and G. Vagliasindi, "Voltage sensitivity analysis in radial MV distribution networks using constant current models," *2010 IEEE International Symposium on Industrial Electronics (ISIE)*, pp. 2548–2554, 2010.
- [CORT-07] M. Cortes-Carmona, R. Palma-Behnke, and G. Jimenez-Estevez, "Fuzzy Load Flow based on alpha-Cuts Arithmetics," in *39th North American Power Symposium*, 2007, pp. 650–658.
- [CRE-16] Commission de régulation de l'énergie (CRE), "Réseaux publics d'électricité - Description générale," 2016. [Online]. Available: <http://www.cre.fr/reseaux/reseaux-publics-d-electricite/description-generale>.
- [CRISP-02] "CRISP," 2002. [Online]. Available: <http://www.crisp.ecn.nl/index.html>.

- [CULL-45] W. S. McCulloch, "A heterarchy of values determined by the topology of nervous nets," *The Bulletin of Mathematical Biophysics*, vol. 7, no. 2, pp. 89–93, 1945.
- [CWE-14] "Documentation of the CWE FB MC Solution. As basis for the formal approval-request," Brussels, 2014.
- [DARA-11] M. T. Darabadi, F. Hashemi, N. Ghadimi, et Al., "Newton-Raphson load flow with consideration of the fuzzy load and in the presence of the distributed generations in distribution network", *2011 10th International Conference on Environment and Electrical Engineering*, 2011.
- [DAS-06] D. Das, "A Fuzzy Multiobjective Approach for Network Reconfiguration of Distribution Systems," *IEEE Transactions on Power Delivery*, vol. 21, no.1, 2006.
- [DAVI-10] B. Davito, H. Tai, and R. Uhlener, "The smart grid and the promise of demand-side management," *McKinsey Smart Grid*, pp. 38–44, 2010.
- [DEMI-11] E. Demirok, P.González, K. Frederiksen, et Al., "Local reactive power control methods for overvoltage prevention of distributed solar inverters in low-voltage grids," *IEEE Journal of Photovoltaics*, vol. 1, no. 2, pp. 174–182, 2011.
- [DRAY-13] E. Drayer et al., "DREAM - Solutions and practical implementations to enable distributed direct real time control at the distribution level (D4.2)," 2013. [Online]. Available: <http://www.dream-smartgrid.eu/downloads/>
- [DREAM-13] "DREAM Innovating Electricity Distribution in Europe," 2013. [Online]. Available: <http://www.dream-smartgrid.eu/>.
- [DREO-06] Dréo, Pétrowski, Siarry, and Taillard, "Metaheuristics for Hard Optimization - Methods and Case studies", 2006.
- [DREW-09] S. Drewes and S. Ulbrich, "Mixed Integer Second Order Cone Programming," 2009.
- [EC-96] European Commission, "Directive 96/92/EC concerning common rules for the internal market in electricity," Brussels, 1996.
- [EC-07] European Commission, "Questions on the opening of the energy markets and the Charter," 2007.
- [EC-08] European Commission, "20 20 by 2020 - Europe's climate change opportunity," 2008.
- [EC-09] European Parliament and Council, "Directive 2009/72/EC of 13 July 2009 concerning common rules for the internal market in electricity and repealing Directive 2003/54/EC," 2009.
- [EC-10] European Commission, "Interpretative note on directive 2009/72/EC concerning common rules for the internal market in electricity and directive 2009/73/EC concerning common rules for the internal market in natural gas - The regulatory Authorities," Brussels, 2010.
- [EC-13] European Commission, "Guidance note on Directive 2012/27/EU on energy efficiency, amending Directives 2009/125/EC and 2010/30/EC, and repealing Directives 2004/8/EC and 2006/32/EC, Article 15: Energy transformation, transmission and distribution," Brussels, 2013.
- [EC-14] European Commission, "2030 climate & energy framework," 2014. [Online]. Available: [http://ec.europa.eu/clima/policies/strategies/2030/index\\_en.htm](http://ec.europa.eu/clima/policies/strategies/2030/index_en.htm).
- [EC-15] European Comission JRC, "Smart Metering deployment in the European Union," 2015. [Online]. Available: <http://ses.jrc.ec.europa.eu/smart-metering-deployment-european-union>.

- [EDSO-14] European Distribution System Operators for Smart Grids, "Flexibility : The role of DSOs in tomorrow's electricity market," pp. 1–16, 2014.
- [EEGI-10] ENTSO-E and EDSO for Smart Grids, "The European Electricity Grid Initiative (EEGI) – Roadmap 2010-18 and Detailed Implementation Plan 2010-12," 2010. [Online]. Available: [https://www.smartgrid.gov/files/The\\_European\\_Electricity\\_Grid\\_Initiative\\_Roadmap\\_Implementat\\_201010.pdf](https://www.smartgrid.gov/files/The_European_Electricity_Grid_Initiative_Roadmap_Implementat_201010.pdf)
- [EINF-12] A. Einfalt, F. Kupzog, H. Brunner, et Al., "Control strategies for smart low voltage grids - the project DG DemoNet - Smart LV grid," in *CIREN Workshop - Lisbon 29-30 May 2012*.
- [ELIA-15] Elia, "Produire ou absorber de l'énergie réactive pour stabiliser la tension du réseau," 2015.
- [ENAC-05] B. Enacheanu, A. Martin, C. Andrieu, et Al., "Future distribution network architectures: approach with a CRISP experimentation," *2005 International Conference on Future Power Systems (FPS)*, 2005.
- [ENAC-07] B. Enacheanu, "Outils d'aide à la conduite pour les opérateurs des réseaux de distribution," Institut National Polytechnique de Grenoble, 2007.
- [ENED-08] Enedis, "Description physique du réseau public," 2008.
- [ENED-13] Enedis, "Profilage et Profils," 2013. [Online]. Available: [http://www.enedis.fr/ERDF\\_Fournisseurs\\_Electricite\\_Responsables\\_Equilibre\\_Profils](http://www.enedis.fr/ERDF_Fournisseurs_Electricite_Responsables_Equilibre_Profils).
- [ENED1-14] Enedis, "Fonctionnement du réseau, le réseau électrique géré par Enedis en chiffres (2014)." [Online]. Available: <http://www.enedis.fr/fonctionnement-du-reseau>.
- [ENED2-14] Enedis, "Convention de raccordement au réseau public de distribution BT d'une nstallation de production de puissance comprise entre 36 et 250 kVA. Conditions générales," 2014.
- [ENED1-15] Enedis, "Open Data - Panorama des installations," 2015. [Online]. Available: <http://www.enedis.fr/open-data-panorama-des-installations>.
- [ENED-15] Enedis, "Flexibilités participant au Mécanisme d'Ajustement ou à NEBEF," 2015. [Online]. Available: <http://www.enedis.fr/flexibilites-participant-au-mecanisme-dajustement-ou-nebef>.
- [ENED3-15] Enedis, "Mécanisme de Capacité – Quel rôle pour les producteurs raccordés au réseau de distribution?," 2015.
- [ENED4-15] Enedis, "Bilan électrique ErDF - Edition 2015," 2015.
- [ENED5-15] Enedis, "Tarif d'Utilisation du Réseau Public de Distribution d'Électricité Sommaire (TURPE 4 HTA/BT)," 2015.
- [ENEL-13] F. Cazzato, "ENEL KEY WIND 2013 – Eolico e competitività - La rete di distribuzione e la Generazione Distribuita: Risultati e nuove sfide," 2013.
- [ENTS-13] ENTSO-E, "Supporting Document for the Network Code on Electricity Balancing", 2013.
- [ENTS-15] ENTSO-E, "Statistical Factsheet 2014," no. April, pp. 1–8, 2015.
- [ENTS-16] "ENTSO-E European Network of Transmission System Operators for Electricity," 2016. [Online]. Available: <https://www.entsoe.eu/Pages/default.aspx>.
- [EPEX-16] "EPEX Spot European Power Exchange," 2016. [Online]. Available: <https://www.epexspot.com/en/>.

- [ERGE-08] ERGEG (European Regulators Group for Electricity & Gas), "Treatment of Losses by Network Operators," 2008.
- [EUR1-13] Eurelectric, "Power Distribution in Europe, Facts & Figures," 2013.
- [EUR2-13] Eurelectric, "Active Distribution System Management: A key tool for the smooth integration of distributed generation," 2013.
- [EUR3-13] Eurelectric, "ENTSO-E Network Code on Electricity Balancing - A EURELECTRIC comments paper," 2013.
- [EUR1-14] Eurelectric, "Electricity Distribution Investments: What Regulatory Framework Do We Need?," 2014.
- [EUR2-14] Eurelectric, "Flexibility and Aggregation Requirements for their interaction in the market," January 2014.
- [EUR1-15] Eurelectric Facts Database, Power Generation (Power statistics 2015), Electricity Generation in Europe, 2015. [Online]. Available: <http://www.eurelectric.org/factsdb/>
- [EUR2-15] Eurelectric, "A sector in transformation: electricity industry trends and figures," 2015.
- [EURE-95] Eurelectric, "Application guide to the European Standard EN 50160 on voltage characteristics of electricity supplied by public distribution systems," 1995.
- [EVOL-13] "evolvDSO Development of methodologies and tools for new and evolving DSO roles for efficient DRES integration in distribution networks," 2013. [Online]. Available: <http://www.evoldso.eu/>.
- [EY-15] EY, "Utilities Unbundled - New perspectives on power and utilities," no. 18, 2015.
- [FARI-13] M. Farivar and S. H. Low, "Branch Flow Model: Relaxations and Convexification - Part I," *IEEE Transactions on Power Systems*, vol. 28, 2013.
- [FERD-14] M. Ferdowsi, A. Löwen, P. McKeever, et Al., "New monitoring approach for distribution systems," *IEEE Instrumentation and Measurement Technology Conference*, 2014.
- [FUKU-15] Y. Fukuyama, "Parallel Particle Swarm Optimization for Reactive Power and Voltage Control Verifying Dependability," 2015.
- [G4EU-11] "Grid4EU, Innovation for Energy Networks," 2011. [Online]. Available: <http://www.grid4eu.eu/>
- [GAN-15] L. Gan, N. Li, U. Topcu, et Al., "Exact Convex Relaxation of Optimal Power Flow in Radial Networks," *IEEE Transactions on Automatic Control*, vol. 60, pp. 72–87, 2015.
- [GAUT-11] K. Gautam and V. Bhuria, "Fuzzy Logic Application in Power System Fault Diagnosis," *Indian Journal of Computer Science and Engineering*, vol. 2, no. 4, pp. 554–558, 2011.
- [GEOF-72] A. M. Geoffrion, "Generalized Benders Decomposition," *Journal of Optimization Theory and Applications*, vol. 10, pp. 238–260, 1972.
- [GOEB-16] C. Goebel and H. Jacobsen, "Aggregator-Controlled EV Charging in Pay-as-Bid Reserve Markets With Strict Delivery Constraints," *IEEE Transactions on Power Systems*, pp. 1–15, 2016.
- [GOIK-09] A. Goikoetxea, J. Barrena, M. Rodriguez, et Al., "Active substation design to maximize DG integration," in *2009 IEEE Bucharest PowerTech*, 2009.

- [GOLD-03] E. Von Goldammer, J. Paul, and J. Newbury, "Heterarchy–Hierarchy: Two Complementary Category of Description," 2003.
- [GOMO-58] R.E. Gomory, "Outline of an algorithm for integer solutions to linear programs," *Bulletin of the American Mathematical Society*, no 64, pp. 275–278, 1958.
- [GONZ-13] C. Gonzalez, S. Weckx, N. Efkarpidis, et Al., "Constrained PV penetration level in LV distribution networks based on the voltage operational margin," in *CIREC 2013, 22nd International Conference and Exhibition on Electricity Distribution*, 2013.
- [GOUI-15] V. Gouin, "Evaluation de l'impact du Smart Grid sur les pratiques de planification en cas d'insertion de production décentralisée et de charges flexibles," Université Grenoble Alpes, 2015.
- [GOZE-09] T. Gözel and M. H. Hocaoglu, "An analytical method for the sizing and siting of distributed generators in radial systems," *Electric Power Systems Research*, vol. 79, no. 6, pp. 912–918, 2009.
- [GREE-16] "GreenLys - Les retours d'expériences, les résultats," 2016. [Online]. Available: <http://greenlys.fr/les-retours-d%E2%80%99experiences-les-resultats/>.
- [GRID+-14] "GRID+, Connecting SmartGrids Initiatives - Moving Towards 2020," 2014. [Online]. Available: [www.gridplus.eu](http://www.gridplus.eu)
- [GUBI-15] A. Gubina, A. Tuerk, T. Medved et. Al, "INCREASE – Report on common definition of Ancillary Services in the Transmission system and in the Distribution system (D5.1)," 2015. [Online]. Available: <http://www.project-increase.eu/index.php?cmd=s&id=74>
- [GUIB-89] J. C. Guibal, "The 1992 European internal energy market," *Energy Policy*, vol. 17, no. 5, pp. 518–521, 1989.
- [HADJ-99] N. Hadjsaid, J.-F. Canard, and F. Dumas, "Dispersed generation increases the complexity of controlling, protecting, and maintaining the distribution systems," *IEEE Computer Applications In Power*, vol. 12, pp. 22–28, 1999.
- [HAD1-13] N. Hadjsaid and J.-C. Sabonnadière, "Power Systems and Restructuring", John Wiley & Sons, 2013.
- [HAD2-13] N. Hadjsaid and J.-C. Sabonnadière, "Electrical Distribution Networks", John Wiley & Sons 2013.
- [HANS-05] M. Hanss, "Applied fuzzy arithmetic", *Springer-Verlag Berlin Heidelberg*, 2005.
- [HEDD-07] M. Heddenhausen, "Privatisations in Europe's liberalised electricity markets – the cases of the United Kingdom, Sweden, Germany, and France," 2007.
- [HOLL-75] J. H. Holland, "Adaptation in natural and artificial systems," *Ann Arbor, The Press University of Michigan*, 1975.
- [HORS-00] R. Horst, P. M. Pardalos, and V. T. Nguyen, "Introduction to Global Optimization," *Springer US*, 2000.
- [HUPI-08] Y. HuPing, P. YunYan, X. Ning, "Gradual Approaching Method for Distribution Network Dynamic Reconfiguration," *2008 Workshop on Power Electronics and Intelligent Transportation System*, 2008.

- [IBM-16] IBM, "CPLEX Optimizer." [Online]. Available: <https://www-01.ibm.com/software/commerce/optimization/cplex-optimizer/>.
- [IDE4L-13] "IDE4L Ideal Grid For All," 2013. [Online]. Available: <http://ide4l.eu/>.
- [INCR-13] "INCREASE," 2013. [Online]. Available: <http://www.project-increase.eu/index.php>.
- [INT E-11] "INTEGRAL," 2011. [Online]. Available: <http://www.integral-eu.com/index.php>.
- [JABR-12] R. Jabr, R. Singh, and B. Pal, "Minimum Loss Network Reconfiguration Using Mixed-Integer Convex Programming," 2012.
- [KADU-10] P. Kadurek, J. F. G. Cobben, and W. L. Kling, "Smart MV/LV transformer for future grids," *SPEEDAM 2010 - International Symposium on Power Electronics, Electrical Drives, Automation and Motion*, pp. 1700–1705, 2010.
- [KARI-10] G. Kariniotakis, "More Microgrids Project - Overview of demonstration objectives and highlight results," *Vancouver 2010 Symposium on Microgrids, 21-22 July, 2010*, 2010.
- [KIEN-09] C. Kieny, B. Berseneff, N. Hadjsaid, et Al., "On the concept and the interest of virtual power plant: Some results from the European project Fenix," *IEEE Power and Energy Society General Meeting*, pp. 1–6, 2009.
- [KLIR-95] G. Klir and B. Yuan, "Fuzzy Sets and Fuzzy Logic - Theory and Applications", 1995.
- [KOK-13] K. Kok, "The PowerMatcher: Smart Coordination for the Smart Electricity Grid," 2013.
- [KORD-14] R. Kordkheili, B. Bak-Jensen, J. R-Pillai, P. Mahat, "Determining Maximum Photovoltaic Penetration in a Distribution Grid considering Grid Operation Limits », *IEEE PES General Meeting Conference & Exposition*, 2014.
- [KOUK-16] D. Koukoulou and N. Hatziaargyriou, "Gossip Algorithms for Decentralized Congestion Management of Distribution Grids," *IEEE Transactions on Sustainable energy*, pp. 1–10, 2016.
- [KUND-94] P. Kundur, "Power System Stability and Control", *New York: Mc Graw-Hill*, 1994.
- [LAND-60] A. Land and A. Doig, "An automatic method of solving discrete programming problems," *Econometrica*, vol. 28, pp. 497–520, 1960.
- [LE-08] L. Le-Thanh, R. Caire, B. Raison, et Al., "INTEGRAL - Guidelines for practical algorithm implementation (D2.2)," 2008. [Online]. Available: <http://www.integral-eu.com/index.php?id=3>
- [LEBE-16] G. Lebel, "Concept de Centrale Virtuelle pour la fourniture de Services Systèmes," Université Grenoble Alpes, 2016.
- [LEE-11] J. Lee and S. Leyffer, "Mixed Integer Nonlinear Programming", *Volume 154 of The IMA Volumes in Mathematics and its Application*, 2011.
- [LI-05] Z. Li and H. Daneshi, "Some observations on market clearing price and locational marginal price," in *Power Engineering Society General Meeting, 2005. IEEE*, 2005, pp. 2042–2049.
- [LI-08] Z. Li, X. Chen, K. Yu, et Al., "A Novel Approach for Dynamic Reconfiguration of the Distribution Network via Multi-Agent System," pp. 1305–1311, 2008.
- [LIBE-09] F. Liberti, L. Cafieri, and S. Tarissan, "Reformulations in Mathematical Programming: A Computational Approach", *Foundations of Computational Intelligence Volume 3*, pp. 153–234, 2009.

- [LO-13] C. H. Lo and N. Ansari, "Decentralized controls and communications for autonomous distribution networks in smart grid," *IEEE Transactions on Smart Grid*, vol. 4, no. 1, pp. 66–77, 2013.
- [LOIA-11] V. Loia and a. Vaccaro, "A decentralized architecture for voltage regulation in Smart Grids," *Proc. - 2011 IEEE International Symposium on Industrial Electronics*, no. 1, pp. 1679–1684, 2011.
- [LOW1-14] S. H. Low, "Convex Relaxation of Optimal Power Flow—Part I: Formulations and Equivalence," *IEEE Transactions on Control of Network Systems*, vol. 1, pp. 15–27, 2014.
- [LOW2-14] S. H. Low, "Convex Relaxation of Optimal Power Flow—Part II: Exactness," *IEEE Transactions on Control of Network Systems*, vol. 1, pp. 177–189, 2014.
- [MAJU-12] R. Majumder, "Reactive Power Compensation in Single Phase Operation of MicroGrid," *IEEE Transactions on Industrial Electronics*, vol. 60, pp. 1403–1416, 2012.
- [MEDA-14] M. Méda, "La création dans le système électrique français d'un mécanisme de capacité et d'un marché de capacités," *REE. Revue de l'électricité et de l'électronique*, pp. p. 33–39, 2014.
- [MERC-15] A. Mercier, "Pilotage de la production décentralisée et des charges non conventionnelles dans le contexte SmartGrid et simulation hybride temps réel," Université Grenoble Alpes, 2015.
- [MINI-16] Ministère de l'environnement de l'énergie et de la mer, "Tarifs d'achats," 2016. [Online]. Available: <http://www.developpement-durable.gouv.fr/Quels-sont-les-tarifs-d-achats.html>.
- [MITC-98] M. Mitchell, "An Introduction to Genetic Algorithms, Complex adaptive systems," MIT Press 2014, 1998.
- [MITC-02] J. E. Mitchell, "Branch-and-Cut Algorithms for Combinatorial Optimization Problems," *Handbook of Applied Optimization*, pp. 65–77, 2002.
- [MYAT-68] L. J. Myatt, "Symmetrical Components," *The Commonwealth and International Library*, Pergamon Press, 1968.
- [NIEV-00] J. Nievergelt, "Exhaustive Search , Combinatorial Optimization and Enumeration : Exploring the Potential of Raw Computing Power," *SOFSEM 2000, Verlag Berlin Heidelberg 2000*, pp. 18–35, 2000.
- [NIKO-98] E. Nikolaidis, R. Haftka, and R. Rosca, "Comparison of Probabilistic and Possibility-Based Methods for Design against Catastrophic Failure under Uncertainty," 1998.
- [NORD-05] M. M. Nordman and M. Lehtonen, "An agent concept for managing electrical distribution networks," *IEEE Transactions on Power Delivery*, vol. 20, pp. 696–703, 2005.
- [NORD-16] "Nord Pool," 2016. [Online]. Available: <http://www.nordpoolspot.com/>
- [OERT-13] C. Oerter, N. Neusel-Lange, P. Sahm, et Al., "Experience with first smart, autonomous LV-grids in Germany," in *CIREN 22nd International Conference on Electricity Distribution*, 2013.
- [PECA-07] J. a Peças Lopes, N. Hatziargyriou, J. Mutale, et Al., "Integrating distributed generation into electric power systems: A review of drivers, challenges and opportunities," *Electric Power Systems Research*, vol. 77, no. 9, 2007.
- [PEPP-11] G. Peppink, "INTEGRAL Final Report- Publishable Executive Summary -D6.1," 2011. [Online]. Available: <http://www.integral-eu.com/index.php?id=3>



- [PERE-13] I.J. Pérez-Arriaga, S. Ruester, S. Schwenen, et Al., "THINK: From Distribution Networks to Smart Distribution Systems: Rethinking the Regulation of European Electricity DSOs," 2013.
- [PGE-16] Pacific Gas and Electric Company, "Commercially available aggregator programs in California," 2016. [Online]. Available: <http://www.pge.com/en/mybusiness/save/energymanagement/index.page>.
- [PHAD-99] Arun G. Phadke, "Handbook of Electrical Engineering Calculations", Marcel Dekker Inc., New York, 1999, ISBN 0-8247-1955-7
- [POPO-05] D. H. Popović, J. a. Greatbanks, M. Begović, et Al., "Placement of distributed generators and reclosers for distribution network security and reliability," *International Journal of Electrical Power and Energy Systems*, vol. 27, no. 5–6, pp. 398–408, 2005.
- [RAMI-04] I. Ramirez-Rosado and J. Dominguez-Navarro, "Possibilistic model based on fuzzy sets for the multiobjective optimal planning of electrical power distribution networks," *IEEE Transactions on Power Systems*, vol. 19, no. 4, pp. 1801–1810, 2004.
- [RAMI-06] G. Rami, "Contrôle de tension auto adaptatif pour des productions décentralisées d'énergies connectées au réseau électrique de distribution," Institut national polytechnique de Grenoble, 2006.
- [RESE-16] M. Resener, S. Haffner, L. Pereira, et Al., "Mixed-integer LP model for Volt/VAr control and energy losses minimization in distribution systems," *Electric Power Systems Research*, 2016.
- [REV-16] "Reforming the Energy Vision", New York State, 2016. [Online]. Available: <http://nyssmartgrid.com/innovation-highlights/rev-proceeding/>
- [RICH-06] O. Richardot, "Réglage Coordonné de Tension dans les Réseaux de Distribution à l'aide de la Production Décentralisée," Institut national polytechnique de Grenoble, 2006.
- [RIDE-13] M. Rider, J. Lopez-Lezama, J. Contreras, et Al., "Bilevel approach for optimal location and contract pricing of distributed generation in radial distribution systems using mixed-integer linear programming," *IET Generation, Transmission and Distribution*, January 2013.
- [RIVE-15] E. Rivero, D. Six, H. Gerard et. Al, "evolDSDO - Assessment of future market architectures and regulatory frameworks for network integration of DRES – the future roles of DSOs (D1.4)," 2015. [Online]. Available: <http://www.evolvdso.eu/Home/Results>.
- [ROBA-15] H. Robaye, "Demand Response in Practice," 2015.
- [ROBI-98] D. G. Robinson, "A survey of probabilistic methods used in reliability, risk and uncertainty analysis: Analytical techniques I," *Sandia National Lab, Report SAND98*, vol. 1189, 1998.
- [ROCH-12] R. Roche, "Agent-Based Architectures and Algorithms for Energy Management in Smart Grids: Application to Smart Power Generation and Residential Demand Response," Université de Technologies de Belfort-Montbéliard, 2012.
- [RTE-04] RTE, "Mémento de la sûreté du système électrique", 2004.
- [RTE-13] RTE, "Règles relatives à la Programmation, au Mécanisme d'Ajustement et au dispositif de Responsable d'Equilibre, Section 2, chapitre F," 2013.
- [RTE-15] RTE, "Bilan électrique 2015," 2015.
- [RUJ-13] S. Ruj and a Nayak, "A Decentralized Security Framework for Data Aggregation and Access Control in Smart Grids," *IEEE Transactions on Smart Grid*, vol. 4, no. 1, pp. 196–205, 2013.



- [S&C-16] S&C Electric company, "IntelliTeam® SG Automatic Restoration System," 2016. [Online]. Available: <http://www.sandc.com/products/automation-control/intelliteam.asp>
- [SARI-03] A. T. Saric and R. M. Ciric, "Integrated fuzzy state estimation and load flow analysis in distribution networks," *IEEE Transactions on Power Delivery*, vol. 18, no. 2, pp. 571–578, 2003.
- [SHAH-02] M. Shahidehpour, H. Yamin, and Z. Li, "Market Operations in Electric Power Systems - Forecasting, Scheduling, and Risk Management", *John Wiley & Sons*, 2002.
- [SHAW-09] R. Shaw, M. Attree, T. Jackson, et Al., "The value of reducing distribution losses by domestic load-shifting: a network perspective," *Energy Policy*, vol. 37, no. 8, pp. 3159–3167, 2009.
- [SLAV-14] K. Slavakis, G. B. Giannakis, and G. Mateos, "Modeling and optimization for Big Data analytics - learning tools for our era of data deluge," *IEEE Signal Processing Magazine*, pp. 18–31, 2014.
- [STEP-09] K. Stephenson, "Neither Hierarchy nor Network: An Argument for Heterarchy," *People & Strategy*, vol. 32, no. 1, pp. 4–13, 2009.
- [STOT-74] B. Stott, "Review of Load-Flow Calculation Methods," *Proceedings of the IEEE*, vol. 62, no.7, 1974.
- [SWAR-11] A. Swarnkar, N. Gupta, and K. Niazi, "Efficient Reconfiguration of Distribution Systems using Ant Colony Optimization Adapted by Graph Theory," 2011.
- [TAYL-12] J. Taylor and F. Hover, "Convex models of distribution system reconfiguration," *IEEE Transactions on Power Systems*, vol. 27, no. 3, pp. 1407–1413, 2012.
- [TENG-03] J. H. Teng, "A Direct Approach for Distribution System Load Flow Solutions," *IEEE Transactions on Power Delivery*, vol. 18, no. 3, pp. 882–887, 2003.
- [THOR-01] V. P. Thornley and N. J. Hiscock, "Improved voltage quality through advances in voltage control techniques," in *Development in Power System Protection*, 2001, no. 479, pp. 355–358.
- [TOUR-14] S. Touré, "Optimisation des réseaux : « réseau actif et flexible », Université de Grenoble, 2014.
- [TRAC-15] Tractebel Engineering GDF Suez and Ecofys, "Identifying Energy Efficiency improvements and saving potential in energy networks, including analysis of the value of demand response, in support of the implementation of article 15 of the energy efficiency directive (2012/27/EU), Final Report," 2015.
- [TRAN-03] T. Tran-Quoc, C. Andrieu, and N. Hadjsaid, "Technical impacts of small distributed generation units on LV networks," *2003 IEEE Power Engineering Society General Meeting*, vol. 4, pp. 2459–2464, 2003.
- [UNIT-98] United Nations, "Kyoto protocol to the united nations framework - Convention on climate change," 1998.
- [VALT-11] G. Valtorta, A. De Simone, C. Noce, et Al., "ADDRESS - Prototypes and algorithms for network management, providing the signals sent by the DSOs to the aggregators and the markets, enabling and exploiting Active Demand (D3.1)," 2011.
- [Online]. Available: [http://www.addressfp7.org/index.html?topic=config/progress\\_publications](http://www.addressfp7.org/index.html?topic=config/progress_publications)

- [VANE-13] E. Vanet, "Méthodes d'optimisation pour la reconfiguration dynamique des réseaux de distribution," Université de Grenoble, 2013.
- [VANE-15] E. Vanet, G. Lebel, R. Caire, et Al., "LV4MV : a concept for optimal power flow management in distribution grids, using DER flexibility," in *CIREN 23rd International Conference on Electricity Distribution*, 2015.
- [VANE-16] E. Vanet, G. Lebel, R. Caire, et Al., "Flexibility activation optimization for constraints management in distribution grids, using DER flexibility through LV4MV," in *CIREN Workshop - Helsinki 14-15 June 2016*, 2016.
- [VENK-12] N. Venkatesan, J. Solanki, and S. K. Solanki, "Residential Demand Response model and impact on voltage profile and losses of an electric distribution network," *Applied Energy*, vol. 96, pp. 84–91, 2012.
- [VICE-94] L. N. Vicente and P. H. Calamai, "Bilevel and multilevel programming: A bibliography review," *Journal on Global Optimization*, vol. 5, no. 3, pp. 291–306, 1994.
- [WAER-15] D. Waeresch, R. Brandalik, W. H. Wellssow, et Al., "Linear State Estimation in Low Voltage Grids Based on Smart Meter Data," *PowerTech, 2015 IEEE Eindhoven*, 2015.
- [WER1-05] M. Van Werven and M. Scheepers, "DISPOWER - The Changing Role of Energy Suppliers and Distribution System Operators in the Deployment of Distributed Generation in Liberalized Electricity Markets," June, 2005.
- [WER2-05] M. Van Werven and M. Scheepers, "The changing role of distribution system operators in liberalized and decentralizing electricity markets," *2005 International Conference on Future Power Systems*, 2005.
- [WOBD-16] The World Bank Data, "Electric power transmission and distribution losses (% of output)," 2016. [Online]. Available: <http://data.worldbank.org/indicator/EG.ELC.LOSS.ZS>.
- [WYSO-06] W. Wysocki and M. Szlosek, "Compensation of reactive power as a method for reducing energy losses," 2006.
- [ZADE-78] L. A. Zadeh, "Fuzzy Sets as a basis for a theory of possibility," *Fuzzy Sets and Systems*, vol. 1, 1978.



---

# Publications

---

## Conference papers

- ✓ E. Vanet, G. Lebel, R. Caire, N. Hadjsaid, S. Bediou, and A. Glatigny, "LV4MV : a concept for optimal power flow management in distribution grids, using DER flexibility," in *CIREC, 23rd International Conference on Electricity Distribution*, 2015.
- ✓ E. Vanet, S. Toure, N. Kechagia, R. Caire, and N. Hadjsaid, "Sensitivity analysis of local flexibilities for voltage regulation in unbalanced LV distribution system," in *2015 IEEE Eindhoven PowerTech*, 2015.
- ✓ S. Toure, E. Vanet, R. Caire, and Y. Besanger, "Assessment methods for the targeted reconfiguration in distribution networks," in *2015 IEEE Eindhoven PowerTech*, 2015.
- ✓ E. Vanet, G. Lebel, R. Caire, N. Hadjsaid, M. Gabel, and M. Lazarus, "Flexibility activation optimization for constraints management in distribution grids, using DER flexibility through LV4MV," in *CIREC Workshop 2016*, 2016.
- ✓ R. Baerenfaenger, E. Drayer, D. Daniluk, B. Otto, E. Vanet, R. Caire, T. Shamsi Abbas and B. Lisanti, "Classifying flexibility types in smart electric distribution grids: a taxonomy," in *CIREC Workshop 2016*, 2016.

## Project deliverables

- ✓ R Caire, B. Lisanti, T. Shamsi, E. Vanet, C. Kieny, M. Lazarus, M. Gabel, E. Lavignotte, R. Kamphuis, R. Baerenfaenger, E. Drayer, J.L. Garrote, F. Ramos, A. Dimeas and I. Kouveliotis-Lysikatos, "DREAM reference object model and dictionary (D5.1)," *public*, 2014.
- ✓ I. Kouveliotis, E. Vanet, C. Kieny, R. Caire, D. Koukoula, G. Asimakopoulou, R. Kamphuis and J.A. Gomez, "Scientific advances to enable distributed balancing market place at the distribution level (D3.1)," *public*, 2014.
- ✓ I. Kouveliotis, D. Koukoula, A. Dimeas, D. Wang, E. Vanet, A. Serrano, J.A. Gomez, R. Caire, "Solutions and practical implementations to enable distributed balancing market place at the distribution level (D3.2)," *confidential*, 2015.
- ✓ I. Kouveliotis, D. Koukoula, A. Dimeas, E. Vanet, " Test cases and high level algorithms for DREAM balancing marketplace (IR3.1)," *confidential*, 2014.
- ✓ D. Wang, E. Vanet, I. Kouveliotis, D. Koukoula, A. Dimeas, E. Drayer, " Algorithms and standalone simulation tests for DREAM balancing marketplace (IR3.3)," *confidential*, 2015.



## Annex AI.

# Loadflow tools methodology

In this thesis, network modeling, power flow computations and sensitivity analysis have been considered in order to appreciate the behaviors of balanced and unbalanced systems characteristics with respect to the consumed and produced powers in the network. Technically, they require the processing of independent loadflow computations for LV and MV networks.

In order to perform independent loadflow calculations in distribution level, efficient and reliable load-flow techniques should be used. Gauss-Seidel, Newton-Raphson, and Fast decoupled methods have been developed and widely used for transmission system operation, control and planning [STOT-74]. However, it has been shown [BALA-11] that these methods may become inefficient in the analysis of distribution systems with high R/X ratios or for unbalanced networks.

Generally, loadflow calculations tools do not model all three phases explicitly, but assume the three phases are balanced and simply use a single phase to represent the positive sequence components to approximate the three-phase operation. However LV distribution networks are generally unbalanced systems because LV end users are generally connected to a single phase (in case of consumption less than 36 kW in France [ENED2-14]). It causes different currents flows in all three phases which in turn induce different effects depending on the mutual impedances of the three phases' lines.

In this thesis, a backward/forward loadflow calculations technique [CIRI-03], [TENG-03] has been modified and used on both radial balanced and unbalanced distribution systems.

### AI.1. Loadflow method for balanced systems

Considering a radial balanced system, a single-phase loadflow computation can be performed to approximate the three-phase operation. It is based on an iterative process that stops when the voltage characteristics in the system are found.

The method is based on two matrixes derived from the network topology: the BIBC (Bus Injection Branch Current) matrix and the BCBV (Branch Current Bus Voltage) matrix.

For each iteration  $k$ , the complex injected current at each node  $i$  of a network composed of  $N$  nodes is depending on the connected consumed or produced power at the node, and can be assessed thanks to equation (AI.1).

$$I_i^k = \left( \frac{S_i}{V_i} \right)^{*k} \quad (\text{AI.1})$$

Where  $S_i$  is the complex apparent power produced at the node,  $V_i$  is the complex voltage at the node, and  $I_i$  is the complex injected current at the node.

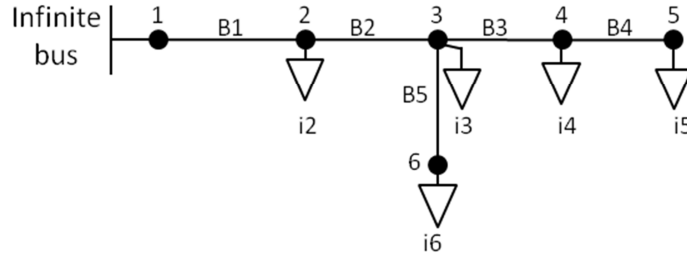

Figure AI-1 – Representation of a 6-buses radial network

Given the represented network in Figure AI-1, and knowing the complex injected current at each node thanks to equation (AI.1), it is possible to deduce the flowing currents in each branch, by applying equation (AI.2).

$$[B] = [BIBC] \times [I] \quad (AI.2)$$

$$[B] = \begin{bmatrix} B_1 \\ \dots \\ \dots \\ B_5 \end{bmatrix} \quad (AI.3)$$

$$[I] = \begin{bmatrix} I_2 \\ \dots \\ \dots \\ I_6 \end{bmatrix} \quad (AI.4)$$

$$[BIBC] = \begin{bmatrix} 1 & 1 & 1 & 1 & 1 \\ 0 & 1 & 1 & 1 & 1 \\ 0 & 0 & 1 & 1 & 0 \\ 0 & 0 & 0 & 1 & 0 \\ 0 & 0 & 0 & 0 & 1 \end{bmatrix} \quad (AI.5)$$

Where  $[BIBC]$  is the binary matrix which relates the branch flowing complex currents  $[B]$  to the injected complex currents  $[I]$  at each node of the network. The BIBC example presented in equation (AI.5) corresponds to the network represented in Figure AI-1.

Thus, the complex voltage at each node can be expressed as a function of the branch flowing currents, of the lines impedances characteristics and of the reference voltage at the infinite bus (see equation (AI.6)).

$$[\Delta V] = [V_{ref}] - [V] = [BCBV] \times [B] \quad (AI.6)$$

$$[V_{ref}] = \begin{bmatrix} V_1 \\ \dots \\ V_1 \end{bmatrix} \quad (\text{A1.7})$$

$$[V] = \begin{bmatrix} V_2 \\ \dots \\ V_6 \end{bmatrix} \quad (\text{A1.8})$$

$$[BCBV] = \begin{bmatrix} Z_{12} & 0 & 0 & 0 & 0 \\ Z_{12} & Z_{23} & 0 & 0 & 0 \\ Z_{12} & Z_{23} & Z_{34} & 0 & 0 \\ Z_{12} & Z_{23} & Z_{34} & Z_{45} & 0 \\ Z_{12} & Z_{23} & 0 & 0 & Z_{36} \end{bmatrix} \quad (\text{A1.9})$$

Where  $[\Delta V]$  is the complex voltage drops between the infinite bus and the nodes of the network,  $V_{ref}$  is the reference complex voltage at the infinite bus,  $[V]$  is the complex voltages at the different nodes of the network, and BCBV is the matrix which relates the bus voltages to the flowing branch currents. It is composed of the complex lines impedances  $Z_{ij}$  characterizing the line  $(i, j)$ . The BCBV example presented in equation (A1.9) corresponds to the network represented in Figure A1-1.

The two matrixes are elaborated thanks to the network topology and characteristics. By combining equations (A1.2) and (A1.6), it is possible to relate at each iteration  $k$  the complex voltage drop  $[\Delta V]^k$  between the infinite bus and the nodes of the network with the injected current  $[I]^k$  at each node (equation (A1.10)).

$$[\Delta V]^k = [BCBV] \times [BIBC] \times [I]^k \quad (\text{A1.10})$$

$$[\Delta V]^k = [DLF] \times [I]^k \quad (\text{A1.11})$$

$$[DLF] = [BCBV] \times [BIBC] \quad (\text{A1.12})$$

Thus, the iterative process can be handled as done in equation (A1.13), and stops when the condition (A1.14) is respected, where  $\varepsilon$  is the desired accuracy on the voltages.

$$V^{k+1} = [V_{ref}] + [\Delta V]^{k+1} \quad (\text{A1.13})$$

$$[\Delta V]^{k+1} - [\Delta V]^k < \varepsilon \quad (\text{A1.14})$$

Given that the matrix  $[DLF]$  is constant for a given network, this method is very direct and low time consuming. This method can be easily extended to unbalanced systems, as describe in the next part.



## AI.2. Loadflow method for unbalanced systems

The previously presented method is now extended for unbalanced systems. This method has thus to take into account all the three phases and the neutral wire, with different mutual impedances, in order to get the more accurate as possible results.

The current injection equations corresponding to node  $i$  at iteration  $k$  can be computed thanks to equations (AI.15) and (AI.16).

$$\begin{bmatrix} I_{ia} \\ I_{ib} \\ I_{ic} \end{bmatrix}^k = \begin{bmatrix} \left(\frac{S_{ia}}{V_{ia}}\right)^{*k-1} \\ \left(\frac{S_{ib}}{V_{ib}}\right)^* \\ \left(\frac{S_{ic}}{V_{ic}}\right)^* \end{bmatrix} \quad (\text{AI.15})$$

$$I_{in}^k = -(I_{ia}^k + I_{ib}^k + I_{ic}^k) \quad (\text{AI.16})$$

Where  $I_{ia}$ ,  $I_{ib}$ ,  $I_{ic}$ ,  $I_{in}$  are the complex current injections at node  $i$  in the three phases (a, b, c) and in the neutral wire  $n$ ;  $S_{ia}$ ,  $S_{ib}$ ,  $S_{ic}$  are the complex power injections at node  $i$  in the three phases (a, b, c) and in the neutral wire  $n$ ; and  $V_{ia}$ ,  $V_{ib}$ ,  $V_{ic}$  are the complex voltages at node  $i$  in the three phases (a, b, c) and in the neutral wire  $n$ .

The respective matrices  $[BIBC]$  and  $[BCBV]$  can be constructed considering either the 3-wires or the 4-wires systems, depending on the choice of the developer. In any chosen method, the four wires impedance matrix has to be considered.

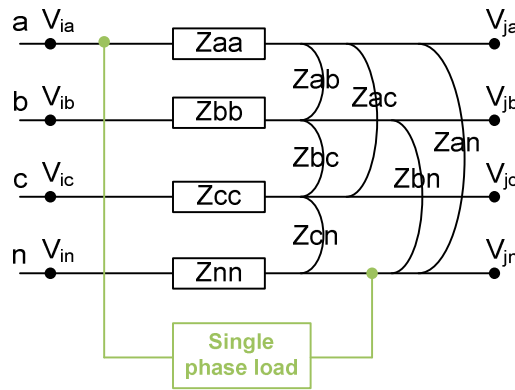

Figure AI-2 – Single-phase load connection in a three-phase system

Hence, given a four-wire line as represented in Figure AI-2, the corresponding four wires complex impedance matrix is depicted in equation (AI.17).

$$Z_{ij} = \begin{bmatrix} Z_{aa} & Z_{ab} & Z_{ac} & Z_{an} \\ Z_{ba} & Z_{bb} & Z_{bc} & Z_{bn} \\ Z_{ca} & Z_{cb} & Z_{cc} & Z_{cn} \\ Z_{na} & Z_{nb} & Z_{nc} & Z_{nn} \end{bmatrix} \quad (\text{AI.17})$$

Where  $Z_{aa}, Z_{bb}, Z_{cc}$  and  $Z_{nn}$  are the proper impedances of the line  $(i, j)$ , and where  $Z_{ab}, Z_{ba}, Z_{ac}, Z_{ca}, Z_{bc}, Z_{cb}, Z_{an}, Z_{na}, Z_{bn}, Z_{nb}, Z_{cn}$  and  $Z_{nc}$  are the mutual impedances of the line  $(i, j)$ .

Assuming a symmetrical network where the mutual impedances do not depend on the line section, the following simplifications can be done.

$$Z_{aa} = Z_{bb} = Z_{cc} = Z_p \quad (\text{AI.18})$$

$$Z_{ab} = Z_{ba} = Z_{ac} = Z_{ca} = Z_{bc} = Z_{cb} = Z_m \quad (\text{AI.19})$$

$$Z_{an} = Z_{na} = Z_{bn} = Z_{nb} = Z_{cn} = Z_{nc} = Z \quad (\text{AI.20})$$

$$Z_{nn} = Z_n \quad (\text{AI.21})$$

The corresponding three-phase line representation can be represented as in Figure AI-3.

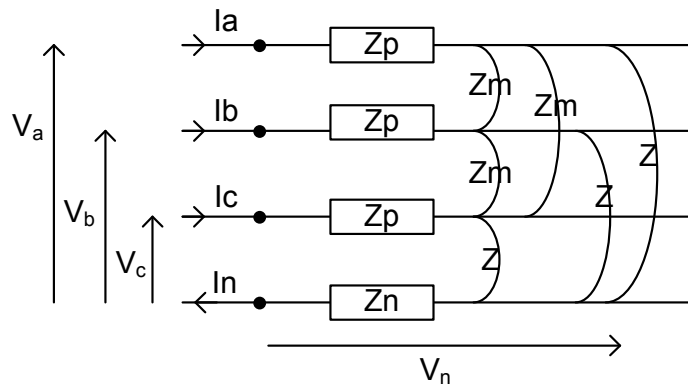

Figure AI-3 – three-phase line representation

It is also possible to reduce this four-wire matrix to a three-wire matrix by using the system of equations (AI.22), equivalent to equation (AI.23), which relates the three-phase complex voltage to the three-phase complex flowing current into a line or a cable [MYAT-68].

$$\begin{cases} V_a = I_a Z_p + (I_b + I_c)Z_m - I_n Z + I_n Z_n - (I_a + I_b + I_c)Z \\ V_b = I_b Z_p + (I_a + I_c)Z_m - I_n Z + I_n Z_n - (I_a + I_b + I_c)Z \\ V_c = I_c Z_p + (I_a + I_b)Z_m - I_n Z + I_n Z_n - (I_a + I_b + I_c)Z \end{cases} \quad (\text{AI.22})$$

$$\begin{cases} V_a = I_a (Z_p - 2Z + Z_n) + I_b (Z_m - 2Z + Z_n) + I_c (Z_m - 2Z + Z_n) \\ V_b = I_a (Z_m - 2Z + Z_n) + I_b (Z_p - 2Z + Z_n) + I_c (Z_m - 2Z + Z_n) \\ V_c = I_a (Z_m - 2Z + Z_n) + I_b (Z_m - 2Z + Z_n) + I_c (Z_p - 2Z + Z_n) \end{cases} \quad (\text{AI.23})$$

Finally, the four wires complex impedance matrix can be reduced to a three wires complex impedance matrix as depicted in equation (A1.24).

$$Z_{ij} = \begin{bmatrix} Z_p - 2Z + Z_n & Z_m - 2Z + Z_n & Z_m - 2Z + Z_n & 0 \\ Z_m - 2Z + Z_n & Z_p - 2Z + Z_n & Z_m - 2Z + Z_n & 0 \\ Z_m - 2Z + Z_n Z_{ca} & Z_m - 2Z + Z_n & Z_p - 2Z + Z_n & 0 \\ 0 & 0 & 0 & 0 \end{bmatrix} \quad (\text{A1.24})$$

Either with the four-wire or with the three-wire model, the methodology used for balanced systems can be easily applied to perform unbalance loadflow computations.

The computation of the two matrices  $[BIBC]$  and  $[BCBV]$  are based on the same logic, keeping in mind that each line connection and each line impedance  $Z_{ij}$  is a 4x4 matrix or a 3x3 matrix.

Thus, thanks to the injected complex currents at each node in each phase computed thanks to equations (A1.15) and (A1.16), it is possible to follow the same algorithm.

$$[\Delta V]^k = [BCBV] \times [BIBC] \times [I]^k \quad (\text{A1.25})$$

$$[\Delta V]^k = [DLF] \times [I]^k \quad (\text{A1.26})$$

$$[DLF] = [BCBV] \times [BIBC] \quad (\text{A1.27})$$

The iterative process can be also handled as done in equation (A1.28), and stops when the condition (A1.29) is respected, where  $\varepsilon$  is the desired accuracy on the voltages.

$$V^{k+1} = [V_{ref}] + [\Delta V]^{k+1} \quad (\text{A1.28})$$

$$[\Delta V]^{k+1} - [\Delta V]^k < \varepsilon \quad (\text{A1.29})$$

## Annex AII.

### Test networks data

Throughout the whole PhD thesis, several results are presented based on simulations performed on particular electrical networks. This annex presents the data used for the simulation of these networks.

Concerning MV balanced networks, two models are used. They are coming from the IEEE literature (*Institute of Electrical and Electronics Engineers*) and can be used in order to compare our results to other studies in this domain.

Three LV unbalanced networks are also studied. The first one is quite small and is representing a real overhead lines French LV network. The second one is larger and is based on network data made available by Electricité de Strasbourg, a French DSO involved in the DREAM project. It is representing a real LV unbalanced network located in their operating area.

#### AII.1. 33-nodes network (MV level)

The 33-nodes network data come from [BAR1-89]. This balanced MV network is composed of 33 buses, and is operated radially. Among the 37 branches, five are normally open. An overview of the network can be seen in Figure AII-1. During the simulations, it is assumed that the voltage magnitude value is always a constant value at the slack bus (node 1).

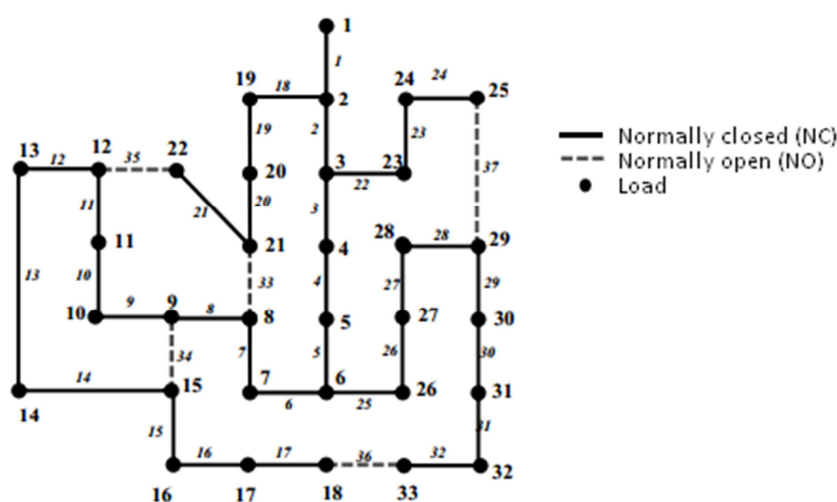

Figure AII-1 - 33-nodes network overview

In order to be able to work in the per unit system, some reference values are set in the following equations. All per unit values are therefore corresponding to this reference system.

$$S_{base} = 3 \times V_{base} \times I_{base} = 1000 \text{ kVA} \quad (\text{AII.1})$$

$$U_{base} = V_{base} \times \sqrt{3} = 12,660 \text{ kV} \quad (\text{AII.2})$$

$$I_{base} = \frac{S_{base}}{U_{base} \times \sqrt{3}} = 46 \text{ A} \quad (\text{AII.3})$$

$$Z_{base} = \frac{U_{base}^2}{S_{base}} = 160 \ \Omega \quad (\text{AII.4})$$

When available, the considered OLTC transformer (line 1) of the 33-nodes network primary substation has the following characteristics (Figure AII-2):

Reference values		OLTC characteristics			
Sn (kVA)	Un2 (kV)	dU(%)	Tap number	dU/tap (%)	Coupling
1000	12,6	±20	17	2,5	YNyn0

Figure AII-2 – 33-nodes network OLTC characteristics

The installed capacitor bank in the considered bus-bar of the primary substation is composed of two capacitor stacks of 1.5 MVAR and 1.9 MVAR. Therefore, three positions for the capacitor banks are possible: 0MVAR, 1.5 MVAR and 3.4 MVAR.

### 1.1 Initial case: without any DG

In [BAR1-89], the connected branches characteristics are defined, as well as the maximum active and reactive power consumption at each node. These values are shown in the tables of the Figure AII-4.

The tie-lines characteristics are presented in the table in Figure AII-3.

bus init	bus final	R (ohm)	X (ohm)
7	20	2,0	2,0
8	14	2,0	2,0
11	21	2,0	2,0
17	32	0,5	0,5
24	28	0,5	0,5

Figure AII-3 – 33 nodes tie-lines characteristics

bus init	bus final	R (ohm)	X (ohm)
1	2	0,092	0,047
2	3	0,493	0,251
3	4	0,366	0,186
4	5	0,381	0,194
5	6	0,819	0,707
6	7	0,187	0,619
7	8	0,711	0,235
8	9	1,030	0,740
9	10	1,044	0,740
10	11	0,197	0,065
11	12	0,374	0,124
12	13	1,468	1,155
13	14	0,542	0,713
14	15	0,591	0,526
15	16	0,746	0,545
16	17	1,289	1,721
17	18	0,732	0,574
2	19	0,164	0,157
19	20	1,504	1,355
20	21	0,410	0,478
21	22	0,709	0,937
3	23	0,451	0,308
23	24	0,898	0,709
24	25	0,896	0,701
6	26	0,203	0,103
26	27	0,284	0,145
27	28	1,059	0,934
28	29	0,804	0,701
29	30	0,508	0,259
30	31	0,974	0,963
31	32	0,311	0,362
32	33	0,341	0,530

*(a) lines characteristics*

bus	PL(kW)	QL(kVAr)
1	0	0
2	100	60
3	90	40
4	120	80
5	60	30
6	60	20
7	200	100
8	200	100
9	60	20
10	60	20
11	45	30
12	60	35
13	60	35
14	120	80
15	60	10
16	60	20
17	60	20
18	90	40
19	90	40
20	90	40
21	90	40
22	90	40
23	90	50
24	420	200
25	420	200
26	60	25
27	60	25
28	60	20
29	120	10
30	200	600
31	150	70
32	210	100
33	60	40

*(b) buses characteristics***Figure All-4 – 33-nodes network lines and buses initial characteristics**

It is assumed that the installed lines are commonly used overhead lines of section S-AL-0070, with a maximum admissible flowing current of 195A.

## 1.2 Modified case: with DG insertion

This network has not been initially planned with the aim to integrate DGs. If some end users are willing to connect some DGs in this network, a planning study would be performed in order to assess the most effective solution to adopt, between reinforcement and active solutions for example. However, in this case, in order to create use cases that are more interesting for the developed algorithms, some DGs are assumed to be inserted in the 33-nodes network. The added DGs are only PV productions and are connected at nodes 9, 20, 22 and 33. Their respective peak powers are showed in Figure All-5. Their power factors are changed and are fixed at 0.96 ( $\tan(\phi) = 0.3$ ).

bus	Pg (kWc)
9	200
20	300
22	250
33	190

Figure All-5 – Respective peak powers for the inserted DG in the 33-nodes network

With the insertion of these decentralized productions, the DG insertion rate becomes equal to around 25%, as depicted in equation (All.5) [KORD-14].

$$t_{insertion}(\%) = \frac{\sum \text{peak power}}{\sum \text{subscribed power}} = \frac{940 \text{ kWc}}{3415 \text{ kW}} = 0.27 \quad (\text{All.5})$$

A representation of the 33-nodes network in its initial configuration and with the DGs insertion is presented in Figure All-6.

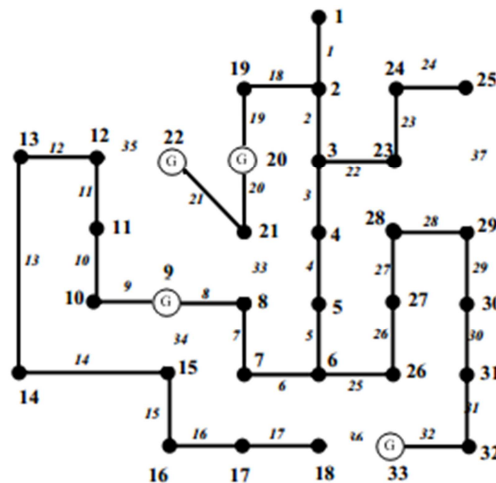

Figure All-6 – 33-nodes network overview (initial configuration, DG insertion rate = 27%)

The load type repartition and the applied load profiles on the 33-nodes network are presented in section All.3.

## AII.2. 72-nodes network (MV level)

The 72-nodes network data come from [DAS-06]. This balanced MV network is composed of 72 buses, and is operated radially. Among the 82 branches, 11 are normally open. An overview of the network representation can be seen in Figure AII-7. During the simulations, it is assumed that the voltage magnitude value is always a constant value at the slack bus (node 72).

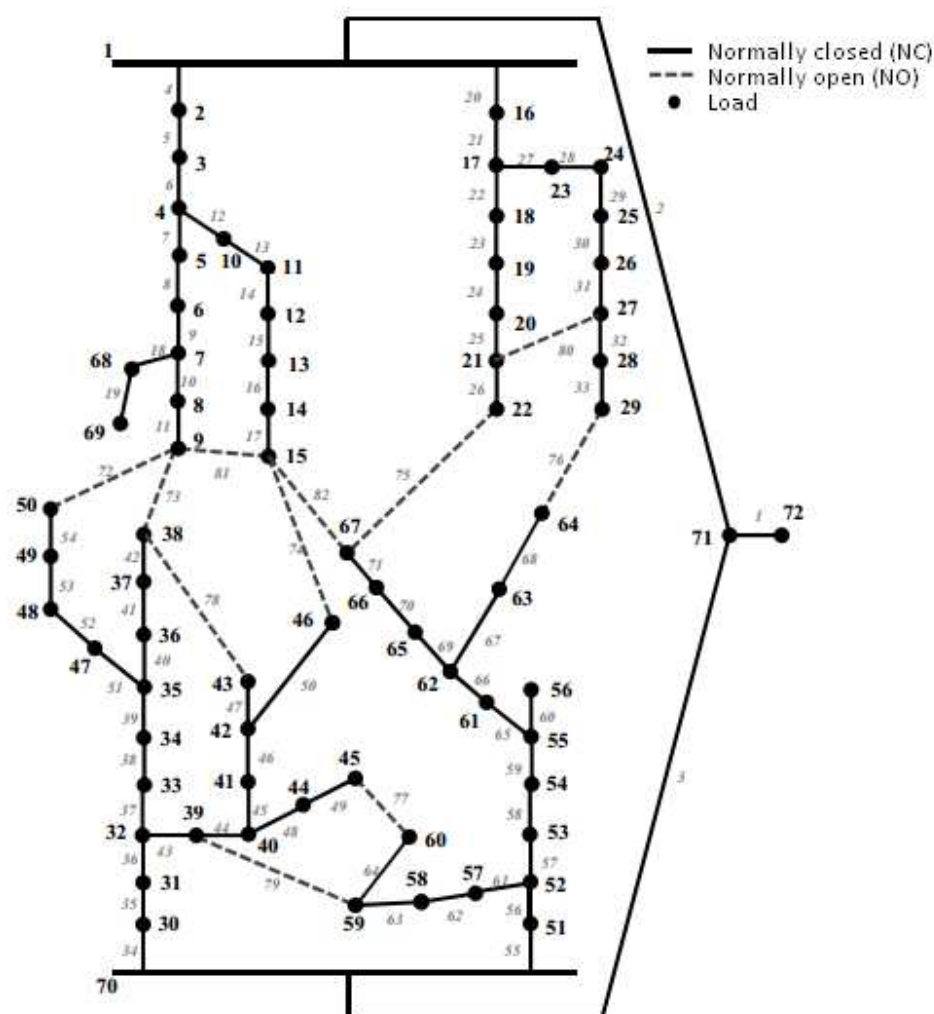

Figure AII-7 – 72-nodes network overview

In order to be able to work in the per unit system, some reference values are set in the following equations. All per unit values are therefore corresponding to this reference system.

$$S_{base} = 3 \times V_{base} \times I_{base} = 1000 \text{ kVA} \quad (\text{AII.6})$$

$$U_{base} = V_{base} \times \sqrt{3} = 11,0 \text{ kV} \quad (\text{AII.7})$$



$$I_{base} = \frac{S_{base}}{U_{base} \times \sqrt{3}} = 52,48A \quad (AII.8)$$

$$Z_{base} = \frac{U_{base}^2}{S_{base}} = 121\Omega \quad (AII.9)$$

When available, the considered OLTC transformer (line 1) of the 72-nodes network primary substation has the following characteristics (Figure AII-8):

Reference values		OLTC characteristics			
Sn (kVA)	Un2 (kV)	dU(%)	Tap number	dU/tap (%)	Coupling
1000	11	±20	17	2,5	YNyn0

*Figure AII-8 – 72-nodes network OLTC characteristics*

The installed capacitor bank in the considered bus-bar of the primary substation is composed of two capacitor stacks of 1.5 MVAR and 1.9 MVAR. Therefore, three positions for the capacitor banks are possible: 0MVAR, 1.5 MVAR and 3.4 MVAR.

## 2.1 Initial case: without any DG

In [DAS-06], the connected branches characteristics are defined, as well as the maximum active and reactive power consumption at each node. These values are shown in the tables of the Figure AII-9 and Figure AII-10.

bus init	bus final	R (ohm)	X (ohm)	I <sub>max</sub> (A)	bus init	bus final	R (ohm)	X (ohm)	I <sub>max</sub> (A)
72	71	0	0	270	32	33	0,804	0,787	270
71	1	0	0	208	33	34	1,170	1,145	270
71	70	0	0	208	34	35	0,768	0,752	270
1	2	1,097	1,074	270	35	36	0,731	0,716	270
2	3	1,463	1,432	270	36	37	1,097	1,074	270
3	4	0,731	0,716	270	37	38	1,463	1,432	270
4	5	0,366	0,358	270	32	39	1,080	0,734	208
5	6	1,828	1,790	270	39	40	0,540	0,367	208
6	7	1,097	1,074	270	40	41	1,080	0,734	208
7	8	0,731	0,716	270	41	42	1,836	1,248	208
8	9	0,731	0,716	270	42	43	1,296	0,881	208
4	10	1,080	0,734	208	40	44	1,188	0,807	208
10	11	1,620	1,101	208	44	45	0,540	0,367	208
11	12	1,080	0,734	208	42	46	1,080	0,734	208
12	13	1,350	0,917	208	35	47	0,540	0,367	208
13	14	0,810	0,550	208	47	48	1,080	0,734	208
14	15	1,944	1,321	208	48	49	1,080	0,734	208
7	68	1,080	0,734	208	49	50	1,080	0,734	208
68	69	1,620	1,101	208	70	51	0,366	0,358	270
1	16	1,097	1,074	270	51	52	1,463	1,432	270
16	17	0,366	0,358	270	52	53	1,463	1,432	270
17	18	1,463	1,432	270	53	54	0,914	0,895	270
18	19	0,914	0,895	270	54	55	1,097	1,074	270
19	20	0,804	0,787	270	55	56	1,097	1,074	270
20	21	1,133	1,110	270	52	57	0,270	0,183	208
21	22	0,475	0,465	270	57	58	0,270	0,183	208
17	23	2,214	1,505	208	58	59	0,810	0,550	208
23	24	1,620	1,110	208	59	60	1,296	0,881	208
24	25	1,080	0,734	208	55	61	1,188	0,807	208
25	26	0,540	0,367	208	61	62	1,188	0,807	208
26	27	0,540	0,367	208	62	63	0,810	0,550	208
27	28	1,080	0,734	208	63	64	1,620	1,101	208
28	29	1,080	0,734	208	62	65	1,080	0,734	208
70	30	0,366	0,358	270	65	66	0,540	0,367	208
30	31	0,731	0,716	270	66	67	1,080	0,734	208
31	32	0,731	0,716	270					

*Figure AII-9 – 72-nodes network lines characteristics*

bus	PL(kW)	QL(kVAr)	p.f	bus	PL(kW)	QL(kVAr)	p.f
1	0	0	0,00	37	40	30	0,75
2	100	90	0,90	38	30	25	0,83
3	60	40	0,67	39	150	100	0,67
4	150	130	0,87	40	60	35	0,58
5	75	50	0,67	41	120	70	0,58
6	15	9	0,60	42	90	60	0,67
7	18	14	0,78	43	18	10	0,56
8	13	10	0,77	44	16	10	0,63
9	16	11	0,69	45	100	50	0,50
10	20	10	0,50	46	60	40	0,67
11	16	9	0,56	47	90	70	0,78
12	50	40	0,80	48	85	55	0,65
13	105	90	0,86	49	100	70	0,70
14	25	15	0,60	50	140	90	0,64
15	40	25	0,63	51	60	40	0,67
16	60	30	0,50	52	20	11	0,55
17	40	25	0,63	53	40	30	0,75
18	15	9	0,60	54	36	24	0,67
19	13	7	0,54	55	30	20	0,67
20	30	20	0,67	56	43	30	0,70
21	90	50	0,56	57	80	50	0,63
22	50	30	0,60	58	240	120	0,50
23	60	40	0,67	59	125	110	0,88
24	100	80	0,80	60	25	10	0,40
25	80	65	0,81	61	10	5	0,50
26	100	60	0,60	62	150	130	0,87
27	100	55	0,55	63	50	30	0,60
28	120	70	0,58	64	30	20	0,67
29	105	70	0,67	65	130	120	0,92
30	80	50	0,63	66	150	130	0,87
31	60	40	0,67	67	25	15	0,60
32	13	8	0,62	68	100	60	0,60
33	16	9	0,56	69	40	30	0,75
34	50	30	0,60	70	0	0	0,00
35	40	28	0,70	71	0	0	0,00
36	60	40	0,67	72	0	0	0,00

Figure All-10 – 72-nodes network consumption powers characteristics

The tie-lines characteristics of the 72-nodes network are presented in the table in Figure All-11.

bus init	bus final	R (ohm)	X (ohm)	I <sub>max</sub> (A)
9	50	0,908	0,726	234
9	38	0,381	0,244	234
15	46	0,681	0,544	234
22	67	0,254	0,203	234
29	64	0,254	0,203	234
45	60	0,254	0,203	234
43	38	0,454	0,363	234
39	59	0,454	0,363	234
21	27	0,454	0,363	234
15	9	0,681	0,544	234
67	15	0,454	0,363	234

*Figure All-11 – 72-nodes tie-lines characteristics*

## 2.2 Modified case: with DG insertion

As the previously presented MV network, this network has not been initially planned with the aim to integrate DGs. However, in order to create use cases that are more interesting for the developed algorithms, four DGs are assumed to be inserted in the 72-nodes network. The added DGs are assumed to be only PV productions and are connected at nodes 29, 38, 62 and 67. Their respective peak powers are showed in Figure All-12. Their power factors are changed and are fixed at 0.96 ( $\tan(\phi) = 0.3$ ).

Node	Reindexed node	P <sub>g</sub> (kWc)
29	33	150
38	43	400
62	63	250
67	68	400

*Figure All-12 – Respective peak powers for the inserted DG in the 72-nodes network*

With the insertion of these decentralized productions, the DG insertion rate becomes equal to around 25%, as depicted in equation (All.10) [KORD-14].

$$t_{insertion}(\%) = \frac{\sum peak\ power}{\sum subscribed\ power} = \frac{1200\ kWc}{4470\ kW} = 0.27 \quad (All.10)$$

The load type repartition and the applied load profiles on the 72-nodes network are presented in section All.3.

## 2.3 Re-indexed nodes: correspondence matrix

For illustrative reasons, the nodes of the 72-nodes network have been re-indexed before each voltage profile representation. The correspondence matrix relating the initial nodes to the re-indexed ones is presented here (Figure All-13).

Initial nodes	Reindexed nodes	Initial nodes	Reindexed nodes
1	3	37	42
2	4	38	43
3	5	39	48
4	6	40	49
5	7	41	50
6	8	42	51
7	9	43	52
8	10	44	54
9	11	45	55
10	14	46	53
11	15	47	44
12	16	48	45
13	17	49	46
14	18	50	47
15	19	51	56
16	20	52	57
17	21	53	58
18	22	54	59
19	23	55	60
20	24	56	61
21	25	57	69
22	26	58	70
23	27	59	71
24	28	60	72
25	29	61	62
26	30	62	63
27	31	63	64
28	32	64	65
29	33	65	66
30	35	66	67
31	36	67	68
32	37	68	12
33	38	69	13
34	39	70	34
35	40	71	2
36	41	72	1

*Figure All-13 – Correspondence matrix of the re-indexation of the 72-nodes network*

### AII.3. Applied load curves on MV level

The previously presented consumed and/or produced powers in the 2 MV networks correspond to the maximum active and reactive consumption and/or production powers. In order to study specific cases that could correspond to a particular hour of a day, some load and generation profiles curves are applied at each bus of the network. Residential, industrial and commercial profiles are allocated as presented in the bar charts (Figure AII-14 and Figure AII-15) at each node of the networks. This concerns only the consuming nodes.

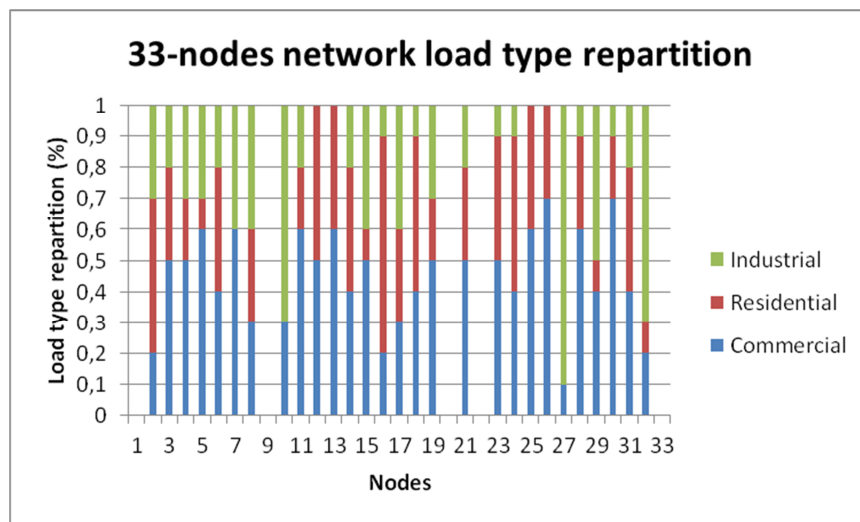

Figure AII-14 – 33-nodes network load type repartition

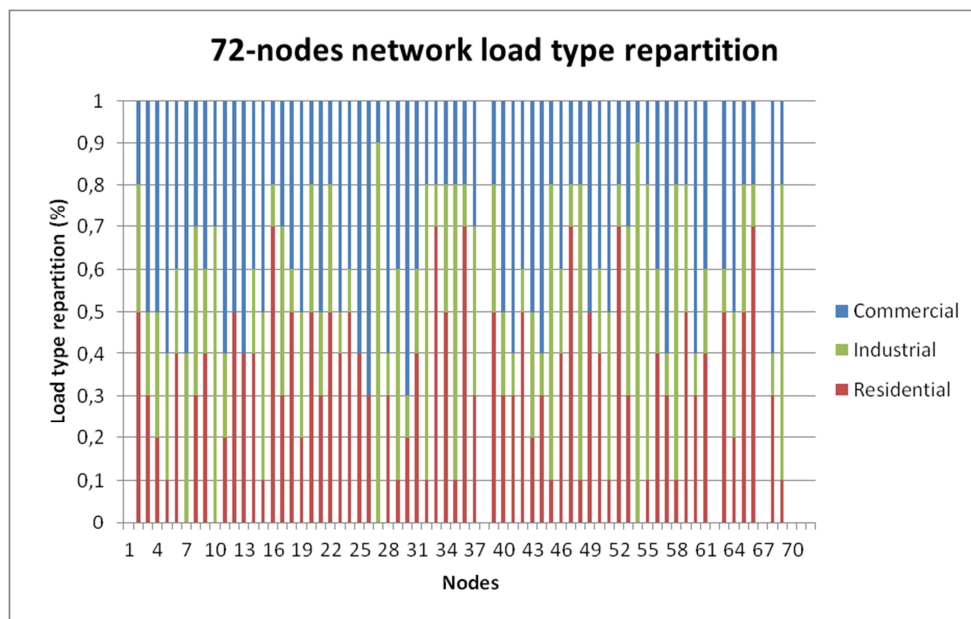

Figure AII-15 – 72-nodes network load type repartition

Figure All-16 represents the load and generation profiles coefficients that have been set at the different nodes. These profiles consumption coefficients are coming from [HUPI-08]. The profile of PV production (Figure All-17) has been constructed by the normalization of the PRD3 profile coefficients defined in [ENED-13] and in [RTE-13] for the day corresponding to the highest peak production.

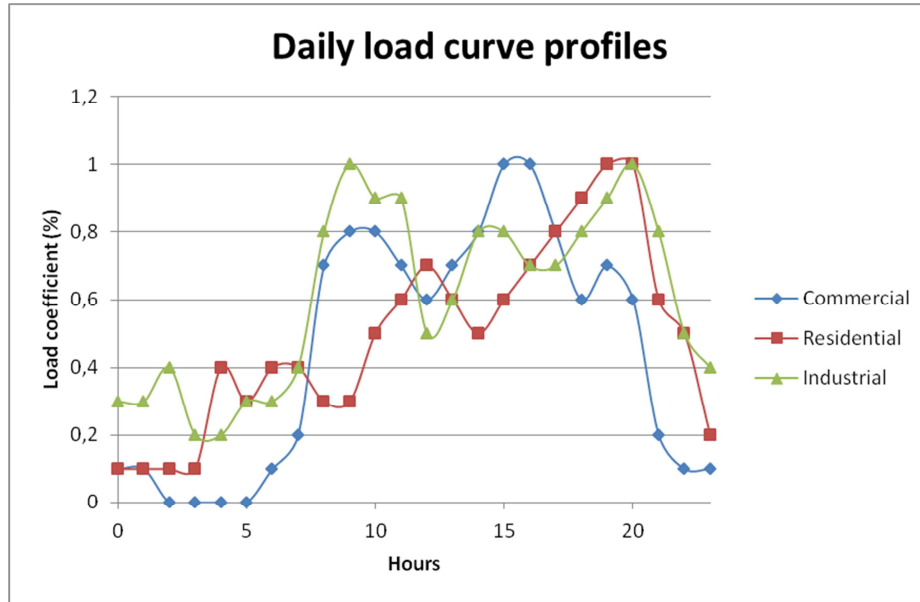

Figure All-16 – MV network daily load profiles

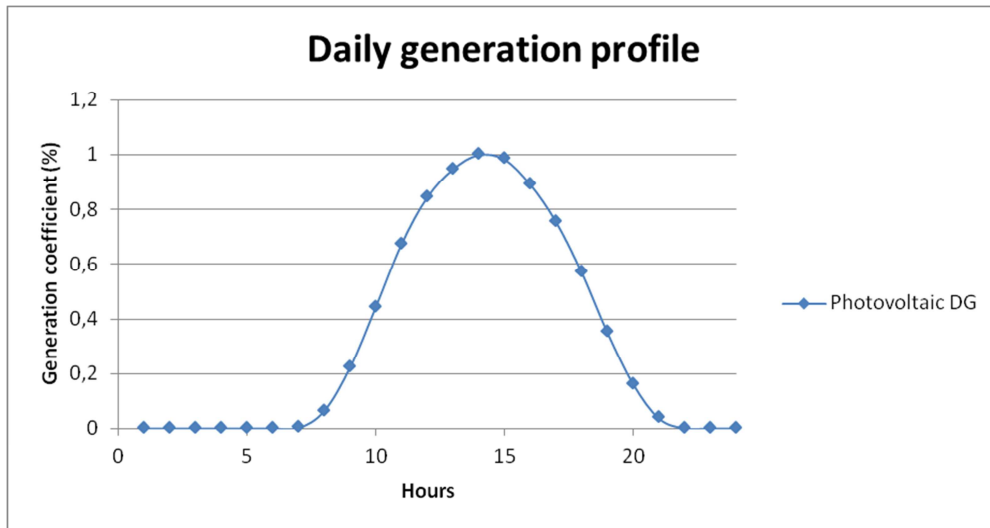
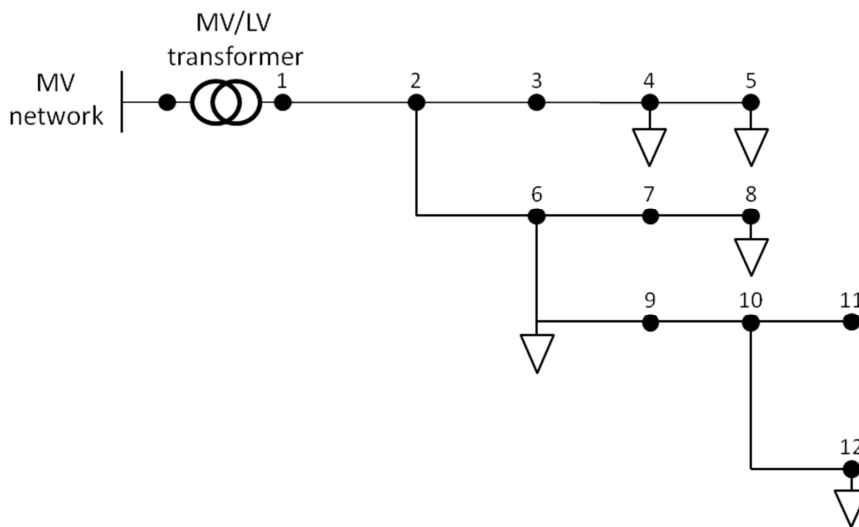

Figure All-17 – MV network daily PV production profile

## AII.4. 12-nodes network (LV level)

The 12-nodes network is representing a real small French LV network that has been used for small application examples in this PhD work. It is composed of only overhead lines and its total length is 2.217 km, supplying a total maximum load of 35.7kW. The neutral is grounded at the MV/LV transformer and at every node where a load is present, except at node 6.

A single-line representation of the network is depicted in Figure AII-18.



*Figure AII-18 – Single line representation of the 12-nodes network*

The nominal apparent power of the Dyn transformer is 50kVA, with a primary nominal voltage of 20kV and a secondary nominal voltage of 0.41kV. The short-circuit voltage is equal to 4% and the copper losses of the transformer are around 1320W.

In order to be able to work in the per unit system, some reference values are set in the following equations. All per unit values are therefore corresponding to this reference system.

$$S_{base} = 50 \text{ kVA} \quad (\text{AII.11})$$

$$U_{base} = 0.41 \text{ kV} \quad (\text{AII.12})$$

All the conductors are TAL70AM54 (70mm<sup>2</sup> section) except the one between nodes 7 and 8 which is a TAL35AM54 (35mm<sup>2</sup> section).

### 3.1 Initial case: without any DG

In the initial model, no DG are connected in the network. The characteristics of the lines and the maximum load of the connected LV end users are presented in Figure AII-19 and Figure AII-20.



**Distributed intelligence and heterarchical approach of distributed balancing markets in Smart Grids**

bus init	bus final	Z phase a	Z phase b	Z phase c	Z neutral
1	2	0,66+ 1,16i	0,07+ 1,04i	0,07+ 1,04i	0,07+ 1,04i
		0,07+ 1,04i	0,66+ 1,16i	0,07+ 1,04i	0,07+ 1,04i
		0,07+ 1,04i	0,07+ 1,04i	0,66+ 1,16i	0,07+ 1,04i
		0,07+ 1,04i	0,07+ 1,04i	0,07+ 1,04i	0,94+ 1,18i
2	3	10,54+ 18,58i	1,17+ 16,66i	1,17+ 16,66i	1,17+ 16,66i
		1,17+ 16,66i	10,54+ 18,58i	1,17+ 16,66i	1,17+ 16,66i
		1,17+ 16,66i	1,17+ 16,66i	10,54+ 18,58i	1,17+ 16,66i
		1,17+ 16,66i	1,17+ 16,66i	1,17+ 16,66i	14,99+ 18,94i
3	4	42,82+ 75,50i	4,74+ 67,67i	4,74+ 67,67i	4,74+ 67,67i
		4,74+ 67,67i	42,82+ 75,50i	4,74+ 67,67i	4,74+ 67,67i
		4,74+ 67,67i	4,74+ 67,67i	42,82+ 75,50i	4,74+ 67,67i
		4,74+ 67,67i	4,74+ 67,67i	4,74+ 67,67i	60,90+ 76,95i
4	5	21,74+ 38,33i	2,40+ 34,35i	2,40+ 34,35i	2,40+ 34,35i
		2,40+ 34,35i	21,74+ 38,33i	2,40+ 34,35i	2,40+ 34,35i
		2,40+ 34,35i	2,40+ 34,35i	21,74+ 38,33i	2,40+ 34,35i
		2,40+ 34,35i	2,40+ 34,35i	2,40+ 34,35i	30,92+ 39,07i
2	6	1,32+ 2,32i	0,15+ 2,08i	0,15+ 2,08i	0,15+ 2,08i
		0,15+ 2,08i	1,32+ 2,32i	0,15+ 2,08i	0,15+ 2,08i
		0,15+ 2,08i	0,15+ 2,08i	1,32+ 2,32i	0,15+ 2,08i
		0,15+ 2,08i	0,15+ 2,08i	0,15+ 2,08i	1,87+ 2,37i
6	7	43,48+ 76,66i	4,81+ 68,71i	4,81+ 68,71i	4,81+ 68,71i
		4,81+ 68,71i	43,48+ 76,66i	4,81+ 68,71i	4,81+ 68,71i
		4,81+ 68,71i	4,81+ 68,71i	43,48+ 76,66i	4,81+ 68,71i
		4,81+ 68,71i	4,81+ 68,71i	4,81+ 68,71i	61,84+ 78,13i
7	8	18,07+ 16,86i	1,02+ 14,57i	1,02+ 14,57i	1,02+ 14,57i
		1,02+ 14,57i	18,07+ 16,86i	1,02+ 14,57i	1,02+ 14,57i
		1,02+ 14,57i	1,02+ 14,57i	18,07+ 16,86i	1,02+ 14,57i
		1,02+ 14,57i	1,02+ 14,57i	1,02+ 14,57i	13,12+ 16,57i
6	9	36,89+ 65,04i	4,08+ 58,30i	4,08+ 58,30i	4,08+ 58,30i
		4,08+ 58,30i	36,89+ 65,04i	4,08+ 58,30i	4,08+ 58,30i
		4,08+ 58,30i	4,08+ 58,30i	36,89+ 65,04i	4,08+ 58,30i
		4,08+ 58,30i	4,08+ 58,30i	4,08+ 58,30i	52,47+ 66,29i
9	10	73,00+ 128,70i	8,07+ 115,35i	8,07+ 115,35i	8,07+ 115,35i
		8,07+ 115,35i	73,00+ 128,70i	8,07+ 115,35i	8,07+ 115,35i
		8,07+ 115,35i	8,07+ 115,35i	73,00+ 128,70i	8,07+ 115,35i
		8,07+ 115,35i	8,07+ 115,35i	8,07+ 115,35i	103,81+ 131,17i
10	11	26,49+ 46,69i	2,93+ 41,85i	2,93+ 41,85i	2,93+ 41,85i
		2,93+ 41,85i	26,49+ 46,69i	2,93+ 41,85i	2,93+ 41,85i
		2,93+ 41,85i	2,93+ 41,85i	26,49+ 46,69i	2,93+ 41,85i
		2,93+ 41,85i	2,93+ 41,85i	2,93+ 41,85i	37,67+ 47,59i
10	12	25,96+ 45,76i	2,87+ 41,02i	2,87+ 41,02i	2,87+ 41,02i
		2,87+ 41,02i	25,96+ 45,76i	2,87+ 41,02i	2,87+ 41,02i
		2,87+ 41,02i	2,87+ 41,02i	25,96+ 45,76i	2,87+ 41,02i
		2,87+ 41,02i	2,87+ 41,02i	2,87+ 41,02i	36,92+ 46,64i

*Figure All-19 – Self and mutual impedances of the 12-nodes LV network (in mOhm)*

bus	P(kW)	Q(kVAr)	phase
1	0	0	-
2	0	0	-
3	0	0	-
4	0,54	0,27	3-phase
5	12,80	6,40	3-phase
5	5,50	2,75	a
5	2,10	1,05	b
6	3,43	1,72	3-phase
7	0	0	-
8	4,94	2,47	3-phase
9	0	0	-
10	0	0	-
11	0	0	-
12	4,60	2,30	3-phase
12	1,80	0,90	c

*Figure All-20 – Maximum load of the connected LV end users (winter scenario)*

### 3.2 Modified case: with DG insertion

Another scenario has been created in order to simulate the same LV network with some DGs. The added DGs are only PV productions and are connected at nodes 5, 6, 8 and 12. The new DG insertion rate is equal to 41%. Considering a summer scenario, the consumption of the loads is set at the minimal loading. The new power data is shown in Figure All-21.

bus	P(kW)	Q(kVAr)	phase	Pg(kWc)	Qg(kVAr)	phase
1	0	0	-	0	0	-
2	0	0	-	0	0	-
3	0	0	-	0	0	-
4	0,11	0,05	3-phase	0	0	-
5	2,56	1,28	3-phase	0	0	-
5	1,10	0,55	a	3	0,6	a
5	0,42	0,21	b	3	0,6	b
6	0,69	0,34	3-phase	3	0,6	c
7	0	0	-	0	0	-
8	0,99	0,49	3-phase	2,8	0,56	b
9	0	0	-	0	0	-
10	0	0	-	0	0	-
11	0	0	-	0	0	-
12	0,92	0,46	3-phase	3	0,6	a
12	0,36	0,18	c	0	0	-

*Figure All-21– Minimum load/maximum production of the connected LV end users (summer scenario)*

## AII.5. ESR network (LV level)

This unbalanced LV network data has been made available by the French DSO Electricité de Strasbourg (ESR), and is representing a real French LV network located in the North-eastern part of their operating area. The total length of the LV network is 5.88 km, and there are 323 connection points of LV end users.

The nominal apparent power of the Dyn transformer is 630kVA, with a primary nominal voltage of 20kV and a secondary nominal voltage of 0.41kV. The short-circuit voltage is equal to 4% and the copper losses of the transformer are around 1320W.

In order to be able to work in the per unit system, some reference values are set in the following equations. All per unit values are therefore corresponding to this reference system.

$$S_{base} = 630 \text{ kVA} \quad (\text{AII.13})$$

$$U_{base} = 0.41 \text{ kV} \quad (\text{AII.14})$$

In the real case, the total subscribed power is equal to 1.690 MW, split between different LV end users with different consumption profiles, and there is only one DG of 6kWc. In order to increase the DG penetration rate, some DGs have been added in the simulation. The final total power of the DGs is 516kWc.

In order to correspond to the most realistic loading cases, the load and generation profiles are based on French profiles characteristics (data from the year 2011 [ENED-13], [RTE-13]) and depend on the subscribed powers of the LV end users. Thus, in the presented test cases, the winter scenario corresponds to the loading case of the day 2 of the week 4 at 7.30 p.m. The summer scenario corresponds to the loading case of the day 4 of the week 26 at 1.30 p.m.

## **Annex AIII.**

# **Complementary results of the local technical validation of flexibility offers**

---

In part III.2, a decentralized methodology based on fuzzy logic model has been elaborated for the DSOs in order to enable the provision of flexibility offers. It allows them to validate the flexibility offers while ensuring that their potential participation will not affect the security and the operational reliability of the network in MV level. Complementary results of the technical validation process performed on a 72-nodes network are presented here.

The considered cases are specific examples of DSO technical pre-validation of flexibility offers applied on a MV 72-nodes balanced electrical network. Corresponding networks characteristics are presented in *Annex II - Test networks data*. The loading curves applied on the network are also presented in the *Annex II - Test networks data*.

Before the markets gate closure, it is assumed that some flexibility offers are available at some nodes in the 72-nodes network at 2 p.m. They have to be validated by the DSO before being transmitted up to the upper level for the market processes.

The voltage value at the bus-bar is set at  $1.03 pu$  and no OLTC at the primary substation is considered. The expected voltage profile without any flexibility activation in the 72-nodes network at 2 p.m. is represented in Figure AIII-1. For illustrative reasons, the nodes of the 72-nodes network have been re-indexed. The correspondence matrix relating the initial nodes to the re-indexed ones is presented in *Annex II - Test networks data*.

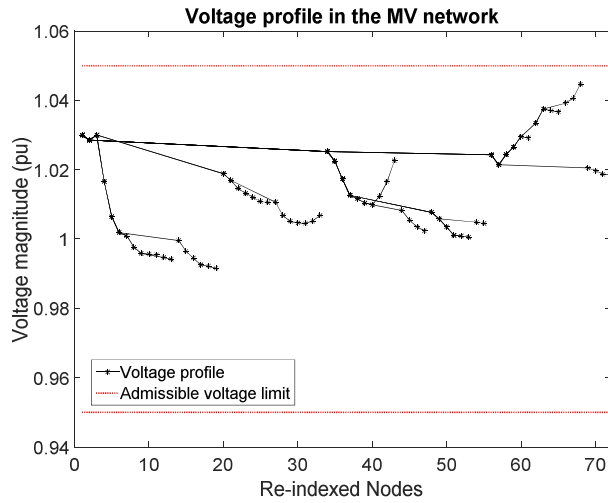
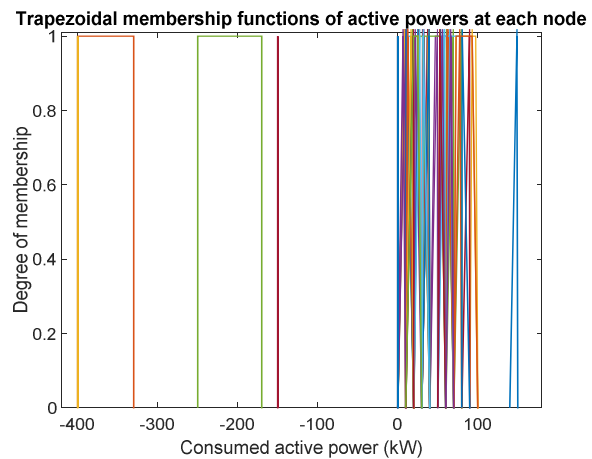

Figure AIII-1 – Expected voltage profile in the 72-nodes network at 2 p.m.

The set of available flexibility in the network is shown in Figure AIII-2 (a). In this set, consumption reductions are proposed via DR management but also production reductions are available via production dispatch down. As done in the core of the thesis, the fuzzy membership functions of the active powers at each node of the considered network are constructed and represented in Figure AIII-2 (b). Those at the flexible nodes are trapezoidal, illustrating the possible activation of the flexibility offer and the round values to the next 10 kW of the forecasts; whereas those corresponding to non-flexible nodes are triangular, characterizing only the second digit round values of the previsions.

Flexible reindexed node	$\Delta P$ dispatch down (kW)	$\Delta P$ demand response (kW)
6	0	25
11	0	2
18	0	5
30	0	20
32	0	25
39	0	10
43	70	0
45	0	20
58	0	5
63	80	0
67	0	20
13	0	5

(a) Set of available flexibility offers in the 72-nodes network at 2 p.m.



(b) Fuzzy membership functions of active powers in the network

Figure AIII-2 – Available flexibility offers in the 72-nodes network at 2 p.m. and corresponding membership functions at each node of the network

Three simulations are performed for different  $\alpha$ -cuts. In the first one,  $\alpha = 1$ , meaning that the errors on the forecasts are not taken into account, and thus, the power values are not rounded to the nearest 10 kW. The resulting fuzzy voltage profiles are shown in Figure AIII-3.

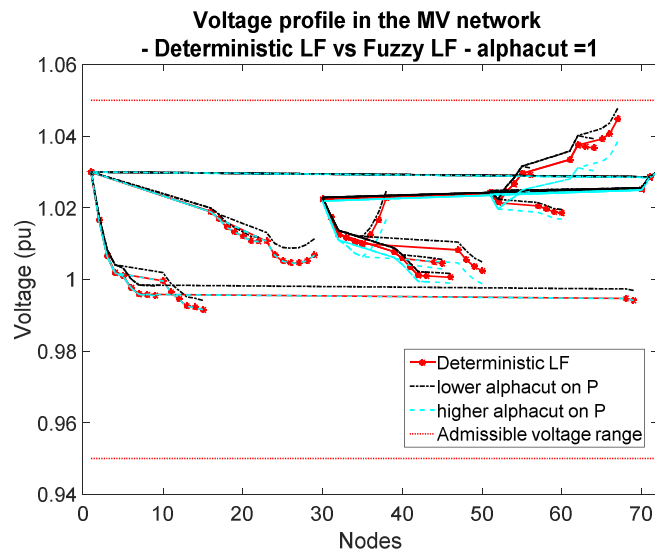

*Figure AIII-3 – Fuzzy voltage profiles in the 72-nodes network ( $\alpha=1$ )*

In this case, when the errors on the forecasts are not taken into account, the voltage profiles of the two cuts are respecting all voltage constraints. Thanks to this method based on fuzzy arithmetic, the substation DSO agent can conclude on this specific case that any combination of the available flexibility offers activation will lead to a given voltage profile included within these two cuts. Therefore, all the available flexibility offers can be validated and transmitted up to the upper level of the grid.

In a second simulation, some errors on the forecasts are taken into account and the values of the expected powers are rounded to the next 10 kW ( $\alpha = 0$ ). The fuzzy voltage profiles for the two different cuts are represented in Figure AIII-4.

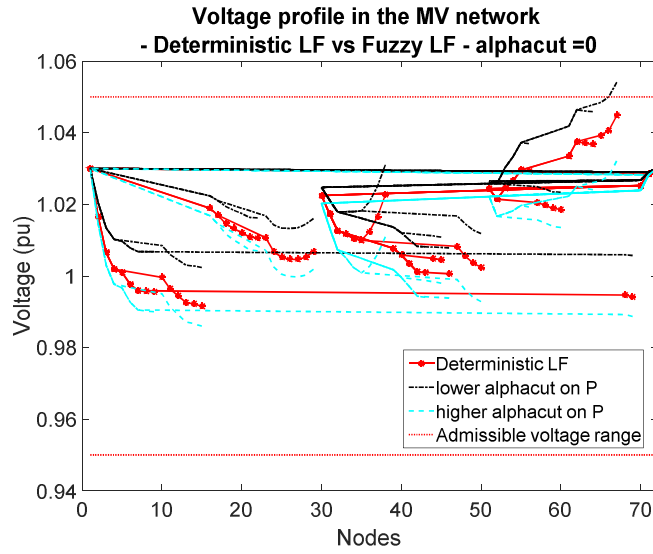

Figure AIII-4 – Fuzzy voltage profiles in the 72-nodes network ( $\alpha=0$ )

In this case, the uncertainties on the forecasts enlarge the range between the two extreme voltage limits. If all the flexibility offers are validated, there is a risk of over-voltages occurrences. Therefore, the DSO substation agent cannot validate all the available flexibility offers without taking a given risk of network operation constraints.

## Annex AIV.

# Complementary results of the LV4MV process

The objective of the LV4MV algorithm presented in part III.3 is to determine the MV admissible voltage range interval for a given LV network in a particular loading condition. This interval is depending on the limiting LV network constraints, which are LV voltage deviations constraints and LV voltage imbalances.

The LV4MV process has been applied for the real data of the LV ESR network, which are presented in *Annex II – Test networks data*. Even in the extreme loading cases, the LV ESR network is still over-sized. Indeed, there are few voltage deviations along the feeders, which permit to get directly large MV admissible voltage ranges.

**NB:** For illustrative concerns, the figures represent the voltage values at each node of the network, and not the voltage profiles along the real connections.

### Winter loading case

Figure AIV-1 represents the phases-to-neutral voltage values in the LV ESR network in the winter loading case.

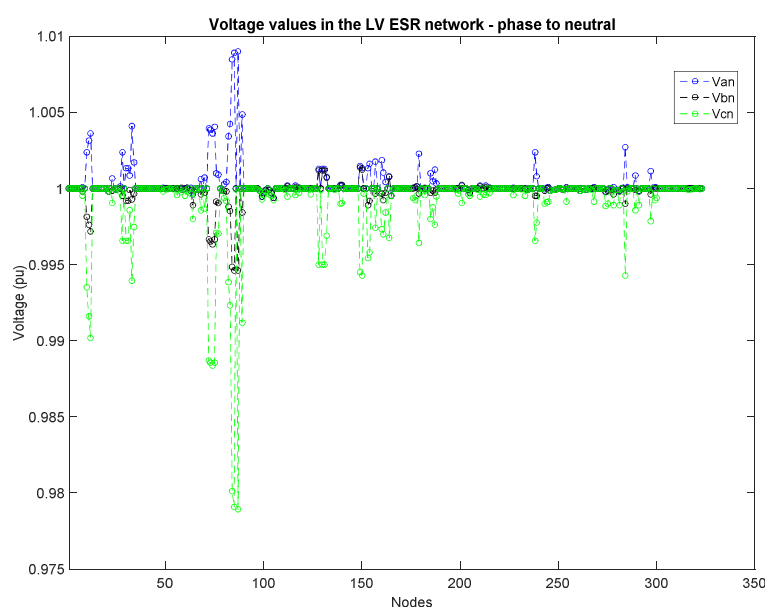

Figure AIV-1 – Voltage values in the LV ESR network – winter loading condition



After performing the LV4MV process, the new computed effective MV admissible voltage ranges are presented in the table below (Figure AIV-2).

Winter case	Admissible voltage ranges
At the primary side of the MV/LV transformer (before LV4MV)	[0.95; 1.05] p.u.
At the secondary side of the MV/LV transformer (after LV4MV)	[0.924; 1.090] p.u.
At the primary side of the MV/LV transformer (after LV4MV)	[0.924; 1.090] p.u.

*Figure AIV-2 – Results of the LV4MV algorithm performed on the ESR network in the winter loading case*

In this case, the maximum admissible voltage value in MV level is enlarged up to 9% of the nominal voltage instead of the 5% of nominal voltage that is currently adopted in distribution network operational planning. The minimum admissible voltage value is enlarged at more than 7% of the nominal voltage instead of the currently adopted 5% value. For this loading case of the LV network, the voltage at the primary side of the MV/LV transformer can vary within the new determined range without creating any LV network constraints. If the voltage value in MV level is exceeding these limits, some LV network constraints deviations will occur.

Figure AIV-3 represents the phases-to-neutral voltage profiles in the network, for the two extreme limits of the admissible voltage value at the secondary side of the MV/LV transformer.

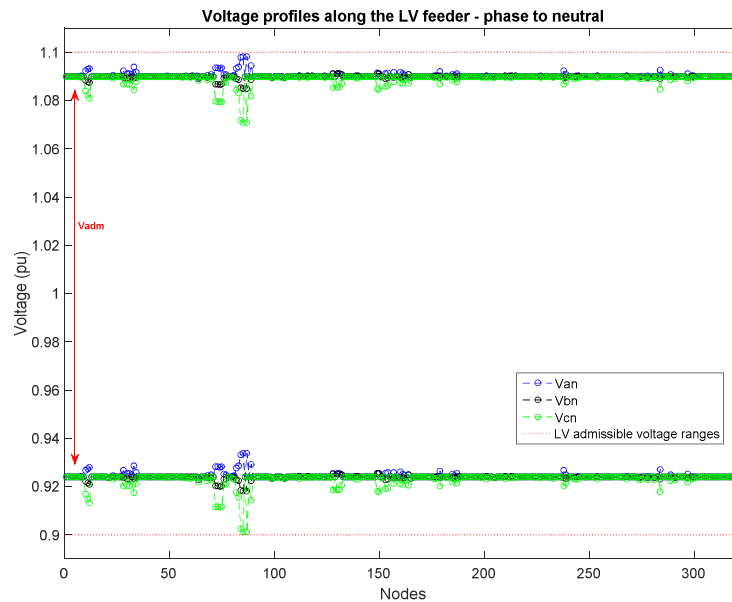

*Figure AIV-3 – Voltage profiles of the LV ESR network with the winter loading case and determination of the new MV admissible voltage range*

### Summer loading case

The phases-to-neutral voltage values in the LV ESR network in the summer loading case is presented in Figure AIV-4.

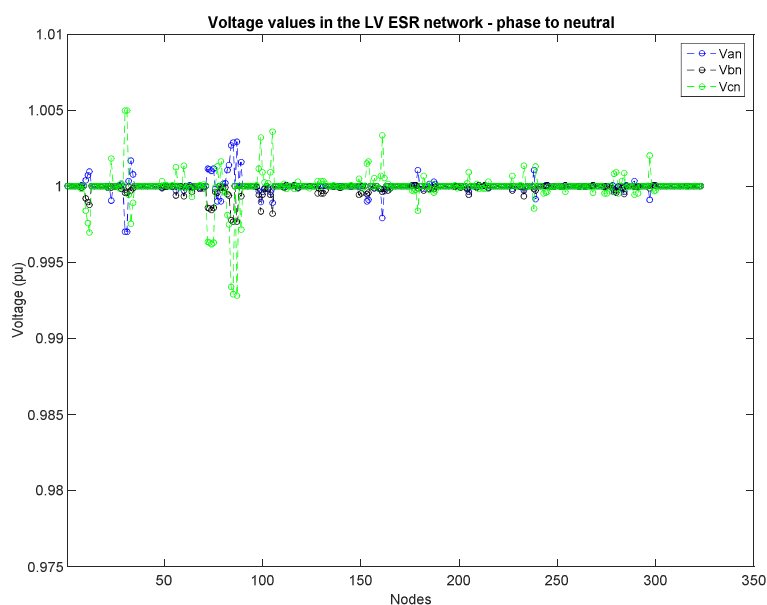

*Figure AIV-4 – Voltage values in the LV ESR network – summer loading condition*

In the summer loading case, the new defined MV admissible voltage range is enlarged up to [0.909; 1.095] p.u. representing an admissible voltage variation in MV level of  $U_n$  [-9%; +9%], as depicted in the table below (Figure AIV-5).

Summer case	Admissible voltage ranges
At the primary side of the MV/LV transformer (before LV4MV)	[0.95; 1.05] p.u.
At the secondary side of the MV/LV transformer (after LV4MV)	[0.909; 1.095] p.u.
At the primary side of the MV/LV transformer (after LV4MV)	[0.909; 1.095] p.u.

*Figure AIV-5 – Results of the LV4MV algorithm performed on the ESR network in the summer loading case*

The phases-to-neutral voltage profiles in the network for the two extreme limits of the admissible voltage value at the secondary side of the MV/LV transformer are shown in Figure AIV-6.



*Figure AIV-6 – Voltage profiles of the LV ESR network with the summer loading case and determination of the new MV admissible voltage range*

Given the already extremely large MV admissible voltage range, and the relatively flat voltage profiles for the two loading conditions, the enlargement of the MV admissible voltage range thanks to LV flexibility offers activation is not really useful and accurate in this case.

However, this particular study permits to determine the real physical limits of the network and to give more degree of freedom to the DSO, who gets a more accurate vision on its LV network for MV level operation for example.

## Annex AV.

# Example of the LV4MV process for MV DSO risk management

In part III.4.2 of the thesis, an illustration of the application of the LV4MV algorithm presented in part III.3 is proposed in a MV DSO risk management scenario. In the 72-nodes network, it is assumed that two specific LV networks are connected to nodes 49 and 50, and that their respective secondary substations are equipped with advanced RTUs, where the LV4MV is performed.

As a reminder, the LV4MV algorithm permits to have an aggregated MV vision of a downstream LV network and its inherent flexibility opportunities. It allows the DSO to treat each LV network as a flexible aggregated MV node, with a given specific flexible power, and with specific admissible voltage limits reflecting the downstream LV network constraints.

The considered LV networks connected to nodes 49 and 50 are presented hereafter. Because of a lack of available LV data, the same network is considered in the two cases, for the two different loading cases.

### AV.1. Description of the considered LV network

An 8-nodes network has been considered for these cases. It represents a real small French LV network. It is composed of only overhead lines and its total length is 630 m, with a longest feeder of 435m. It is sized in order to supply a total load of 83.6 kW. A single-line representation of the network is depicted in Figure AV-1.

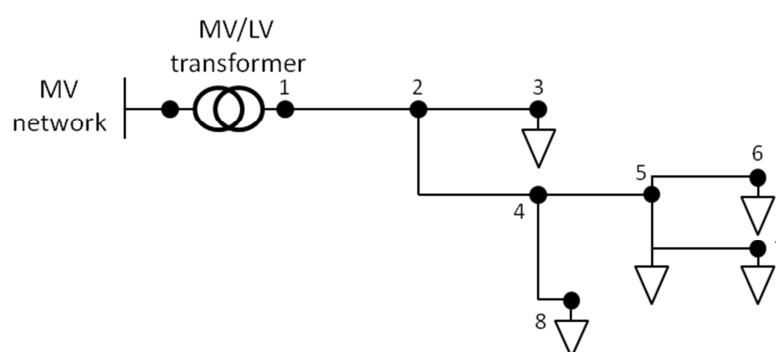

*Figure AV-1 – Single line representation of the 8-nodes network*

The nominal apparent power of the Dyn transformer is 100 kVA, with a primary nominal voltage of 20kV and a secondary nominal voltage of 0.41kV. The short-circuit voltage is equal to 4% and the copper losses of the transformer are around 1320W.

The complex impedances of the lines are presented in the table below (Figure AV-2). The consumed powers of the connected LV end users in the two loading cases are presented in Figure AV-3.

bus init	bus final	Ra (Ω)	Rb (Ω)	Rc (Ω)	Rn (Ω)	Xa (Ω)	Xb (Ω)	Xc (Ω)	Xn (Ω)	Imax (A)
1	2	0,126	0,015	0,015	0,015	0,237	0,150	0,150	0,150	134,41
1	2	0,015	0,126	0,015	0,015	0,150	0,237	0,150	0,150	134,41
1	2	0,015	0,015	0,126	0,015	0,150	0,150	0,237	0,150	134,41
1	2	0,015	0,015	0,015	0,156	0,150	0,150	0,150	0,240	134,41
2	3	0,057	0,005	0,005	0,005	0,088	0,055	0,055	0,055	106,41
2	3	0,005	0,057	0,005	0,005	0,055	0,088	0,055	0,055	106,41
2	3	0,005	0,005	0,057	0,005	0,055	0,055	0,088	0,055	106,41
2	3	0,005	0,005	0,005	0,057	0,055	0,055	0,055	0,088	106,41
2	4	0,035	0,003	0,003	0,003	0,054	0,034	0,034	0,034	106,41
2	4	0,003	0,035	0,003	0,003	0,034	0,054	0,034	0,034	106,41
2	4	0,003	0,003	0,035	0,003	0,034	0,034	0,054	0,034	106,41
2	4	0,003	0,003	0,003	0,035	0,034	0,034	0,034	0,054	106,41
4	5	0,012	0,001	0,001	0,001	0,018	0,012	0,012	0,012	106,41
4	5	0,001	0,012	0,001	0,001	0,012	0,018	0,012	0,012	106,41
4	5	0,001	0,001	0,012	0,001	0,012	0,012	0,018	0,012	106,41
4	5	0,001	0,001	0,001	0,012	0,012	0,012	0,012	0,018	106,41
5	6	0,046	0,002	0,002	0,002	0,029	0,018	0,018	0,018	39,20
5	6	0,002	0,046	0,002	0,002	0,018	0,029	0,018	0,018	39,20
5	6	0,002	0,002	0,046	0,002	0,018	0,018	0,029	0,018	39,20
5	6	0,002	0,002	0,002	0,046	0,018	0,018	0,018	0,029	39,20
5	7	0,038	0,001	0,001	0,001	0,024	0,015	0,015	0,015	39,20
5	7	0,001	0,038	0,001	0,001	0,015	0,024	0,015	0,015	39,20
5	7	0,001	0,001	0,038	0,001	0,015	0,015	0,024	0,015	39,20
5	7	0,001	0,001	0,001	0,038	0,015	0,015	0,015	0,024	39,20
4	8	0,058	0,003	0,003	0,003	0,055	0,034	0,034	0,034	61,60
4	8	0,003	0,058	0,003	0,003	0,034	0,055	0,034	0,034	61,60
4	8	0,003	0,003	0,058	0,003	0,034	0,034	0,055	0,034	61,60
4	8	0,003	0,003	0,003	0,058	0,034	0,034	0,034	0,055	61,60

Figure AV-2 – 8-nodes LV network lines characteristics

83,6 kW				90,6 kW			
bus	P(kW)	Q(kVAr)	phase	bus	P(kW)	Q(kVAr)	phase
1	0	0	-	1	0	0	-
2	0	0	-	2	0	0	-
3	35	14	3-phase	3	40	16	3-phase
4	0	0	-	4	0	0	-
5	18	7,2	3-phase	5	18	7,2	3-phase
6	11	1,1	c	6	11	1,1	c
7	10,2	1,02	b	7	10,2	1,02	b
8	9,4	1,88	a	8	11,4	2,28	a

(a) Consumed powers at the LV end users connections – loading case 83,6 kW

(b) Consumed powers at the LV end users connections – loading case 90,6 kW

Figure AV-3 – 8-nodes LV network loading characteristics

## AV.2. LV4MV process on the considered LV network for the two loading cases

The LV4MV process is applied for this LV network for the two loading cases, in order to get the new MV admissible voltage ranges associated with these networks, presented in the table below (Figure AV-4).

	Admissible voltage ranges (case 83,6 kW)	Admissible voltage ranges (case 90,6 kW)
At the primary side of the MV/LV transformer (before LV4MV)	[0.95; 1.05] p.u.	[0.95; 1.05] p.u.
At the secondary side of the MV/LV transformer (after LV4MV)	[0.941; 1.10] p.u.	[0.946; 1.10] p.u.
At the primary side of the MV/LV transformer (after LV4MV)	[0.941; 1.10] p.u.	[0.946; 1.10] p.u.

Figure AV-4 – LV4MV results for the two loading cases on the 8-nodes network

In these cases, the maximum admissible voltage value in MV level is enlarged up to 10% of the nominal voltage instead of the 5% of nominal voltage that is currently adopted in distribution network operational planning. The minimum admissible voltage value is also a little enlarged in the two cases compared to the currently adopted 5% value. This permits the enlargement of the MV admissible voltage ranges at nodes 49 and 50 of the MV 72-nodes network.

Figure AV-5 represents the phases-to-neutral voltage profiles in the network in the two different loading cases, for the two extreme limits of the admissible voltage value at the secondary side of the MV/LV transformer.

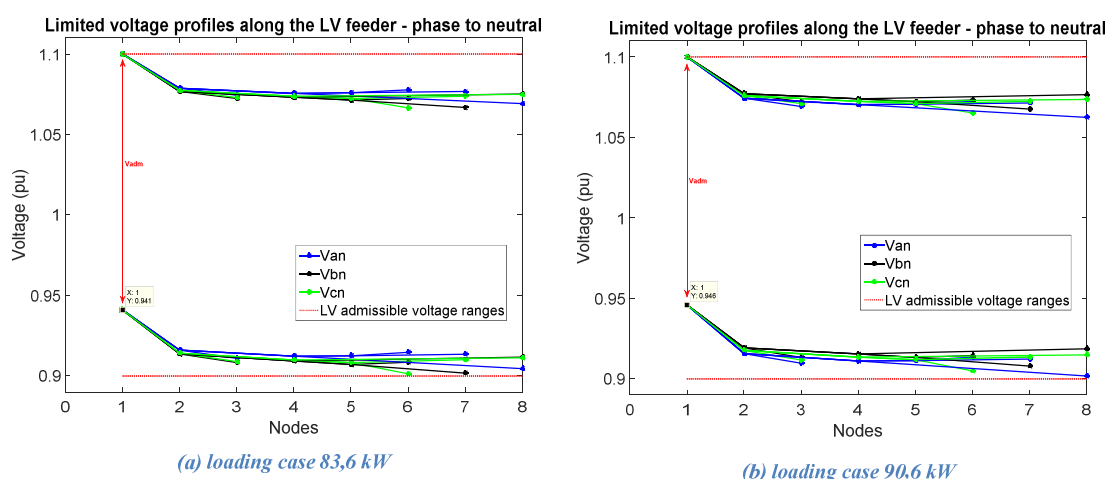

Figure AV-5 – Voltage profiles of the 8-nodes LV network and determination of the new MV admissible voltage ranges



---

# Annex AVI.

## Complementary results of the heuristic based provision process for DSO risk management

---

This annex presents some complementary test cases and results of the tools proposed for the provision of flexibility offers for DSO constraints management at a minimum cost, presented in part III.4.2.

As a reminder, the three following scenarios of contingency are studied in the test cases:

1. Disconnection of a part of the network for maintenance work, removing suddenly a part of the connected loads of a feeder: in this case, the disconnected part of the network is recovered by another part of the network, connected in another primary substation. It is assumed that this operation can cause over-voltages in the network, due to a non-expected decrease of loading while DGs are still producing in the remaining connected feeder.

2. Sudden changes in weather conditions, decreasing suddenly the overall decentralized production: it is assumed here, that the sudden decrease of the overall decentralized production is causing under-voltages deviations in the network.

3. Service restoration of a feeder by its reconnection through a back-up transformer: it is assumed that the service restoration of the secured feeder leads to a sharp increase of the load in the securing considered network. This could imply current overloads in some lines or under-voltages in some parts of the network.

In order to illustrate the heuristic algorithm based on the efficiency of the flexibility offers on more test cases, these scenarios have been simulated in the 33-nodes network, presented in *Annex II – Test networks data*. However, because of the topology and of the restricted size of this network, the first scenario is not investigated. Indeed, the disconnection of any part of the considered network is not leading to over-voltages deviations.

- **Risk management on the 33-nodes network (test case 2)**

The second test case is simulated on the 33-nodes network, with the applied load and generation profiles which are corresponding to the hour 4 p.m. For illustrative concerns, the voltage value at the bus-bar is set at 1.01 pu and the OLTC position is considered as fixed.

Locally, the substation DSO agent is building its primary substation federation, including all the possible means of regulation for this particular configuration. The expected voltage profile with the forecasted weather conditions is respecting all the network admissible voltage characteristics (Figure



AVI-1 (a)). However, if sudden changes in weather conditions are happening, i.e. if the weather becomes suddenly cloudy, the DGs (which are only PV production in this network) are not producing anymore. Some under-voltages deviations are appearing (see Figure AVI-1 (b)). In this case, all flowing currents constraints remains respected.

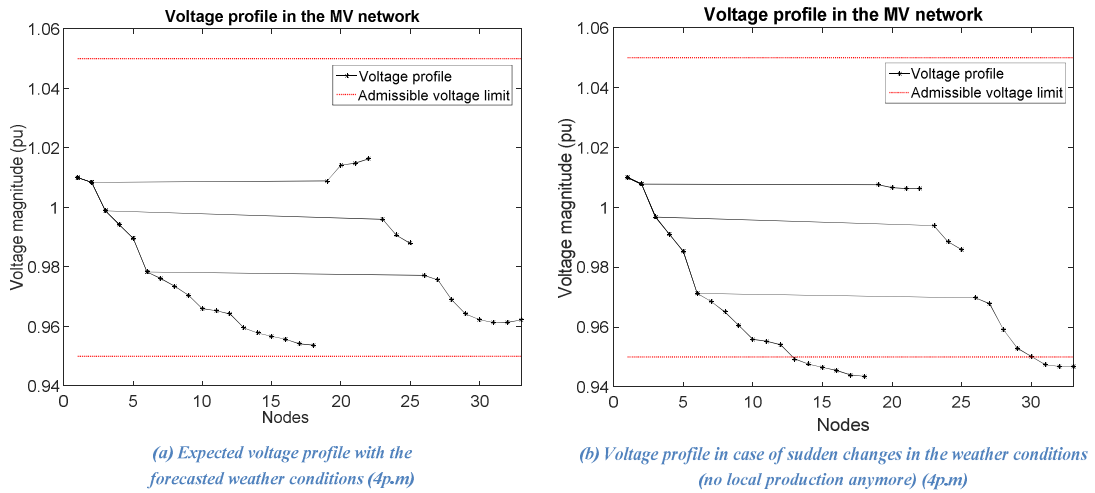

Figure AVI-1 – Voltage profiles on the 33-nodes network (4 p.m.)

The DSO needs to plan a possible solution in order to face this risk of voltage deviations. Thus, the substation DSO agent has to check if enough remaining available flexibility offers that have not been selected during the market process are available. All the remaining available flexibility offers are assumed to be the DR flexibility offers presented in the Figure AVI-2(b) and are assumed to be 100% reliable.

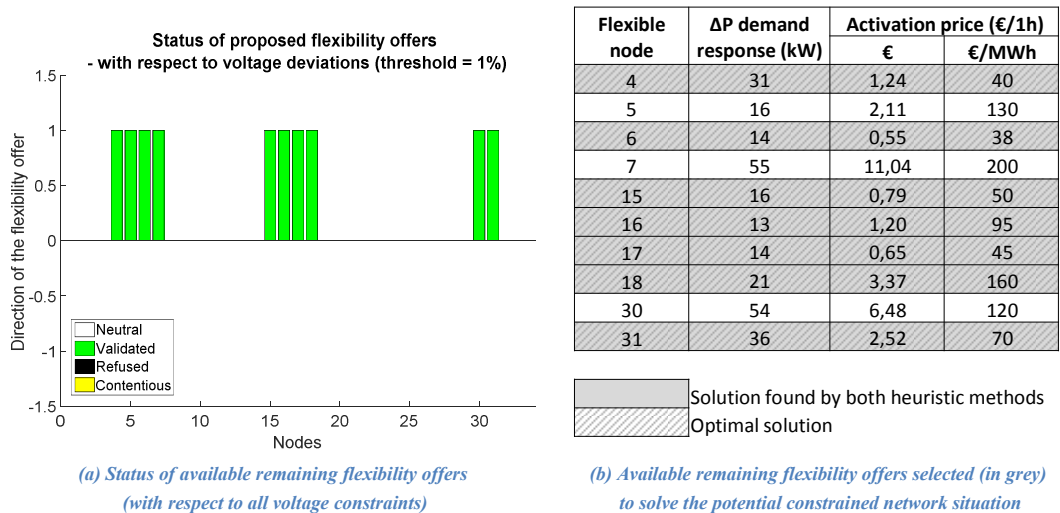
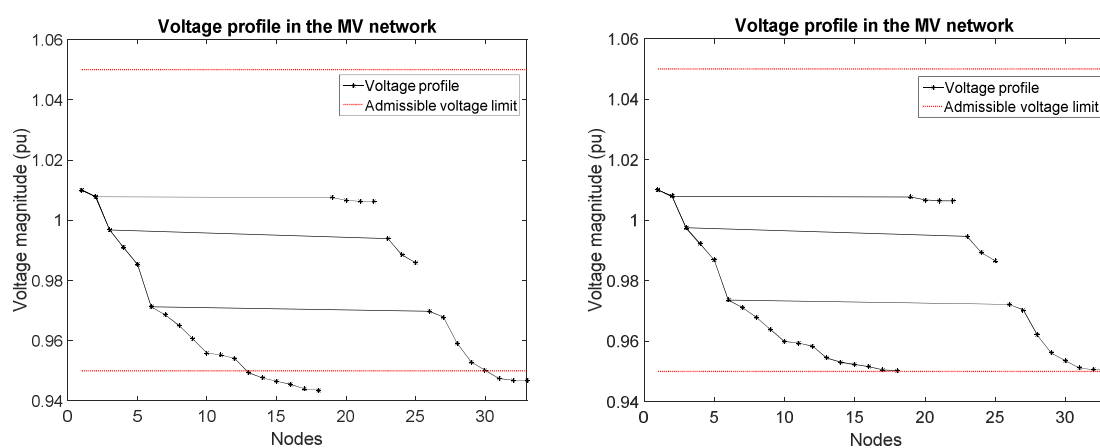

Figure AVI-2 – Description of the available remaining flexibility offers – Sensitivity threshold set at 1%

Given all the available flexibility offers in the 33-nodes network in this case, it is possible to compute their respective voltage sensitivity with respect to the potentially occurring constraints. The flexibility offers that have a non-negligible positive effect on the constraint are considered. All flexibility offers which have a negative impact are not considered. The final status of the available flexibility offers are presented in Figure AVI-2(a). After performing the heuristic method based on the efficiency of the flexibility offers, the offers that should be activated to solve the potential occurring deviations are those colored in grey in Figure AVI-2(b).

At the end, if the retained remaining available flexibility offers are activated by the DSO, voltage constraints that can appear in the network in case of sudden changes in the weather conditions will be solved, as shown in Figure AVI-3(b).



(a) Voltage profile in case of sudden changes in the weather conditions (no local production anymore) (4p.m)

(b) Voltage profile in case of sudden changes in the weather conditions after the activation of the retained flexibility offers (4p.m)

**Figure AVI-3 – Voltage profiles before and after the activation of the selected flexibility offers in case of sudden changes in the weather conditions (test case 2)**

- **Risk management on the 33-nodes network (test case 3)**

The third test case of the presented contingency plan is now simulated on the same 33-nodes network in the loading case corresponding to the period at 8 p.m, with a total active power consumption of around 2.72 MW. The voltage value at the bus-bar is fixed at 1.015 pu.

Locally, the substation DSO agent is building its primary substation federation, including all the possible means of regulation for this particular configuration. In this expected loading case, the network is in a normal state and is respecting all its regulatory and physical constraints (Figure AVI-4).

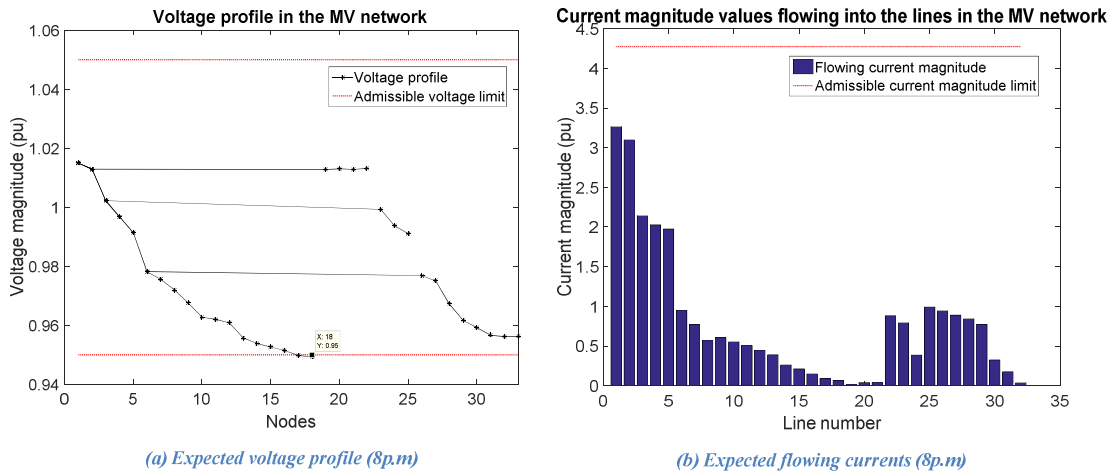

Figure AVI-4 – Expected voltage profile and flowing currents in the 33- nodes network at 8 p.m.

In case of a fault occurring in the next primary substation federation, it is assumed that the service restoration of an adjacent feeder could be done through the reconnection of it on the back-up transformer of the 33- nodes network.

The DSO has to be prepared to this alternative and has to check if the network constraints will remain respected. The addition of the secured feeder in the 33- nodes network implies the addition of an aggregated load at node 2. In this case, it is assumed that the secured feeder has 1 MW of consumed active power which is added at node 2, and that the power factor remains constant at 0.6 at node 2. In this case of possible service restoration, a line overload is appearing in line 1 and some under-voltage deviations are occurring at nodes 17 and 18, as shown in Figure AVI-5.

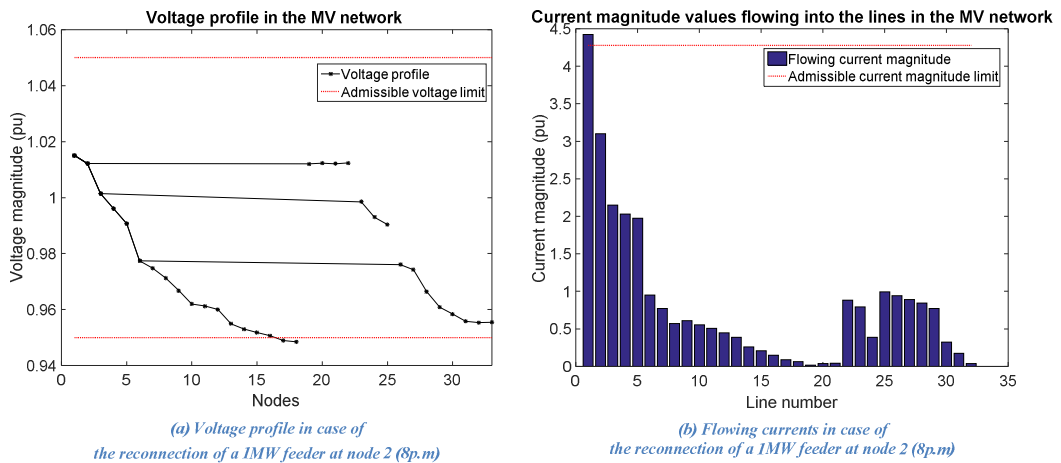

Figure AVI-5 – Potential voltage profile and flowing currents in the 33- nodes network at 8 p.m. taking into account the reconnection of a 1MW feeder at node 2

In this specific test case, it is assumed that some remaining flexibility offers which have not been selected during the market processes are available. These flexibility offers are listed in Figure AVI-6(c).

The developed provision mechanism permits to make a first sorting of the flexibility offers that can help the management of the risk. In this example, two flexible offers are coming from two DGs which are proposing a production dispatch down. The other flexible offers are representing possible decreases of consumption.

In Figure AVI-6(a) and (b), the statuses of the remaining available flexibility offers are represented with respect to the network constraints. Concerning voltage constraints, only the flexibility offers that are located in sensitive nodes with respect to the constraints (higher than the 1% threshold) are validated. The others are considered as neutral.

Concerning overloads, as all the flexibility offers are located downstream the congestion, each of them is either validated (in case of it helps the congestion) or non-validated (in case of it aggravates the congestion). As it is illustrated, there are no contentious flexibility offers in this case.

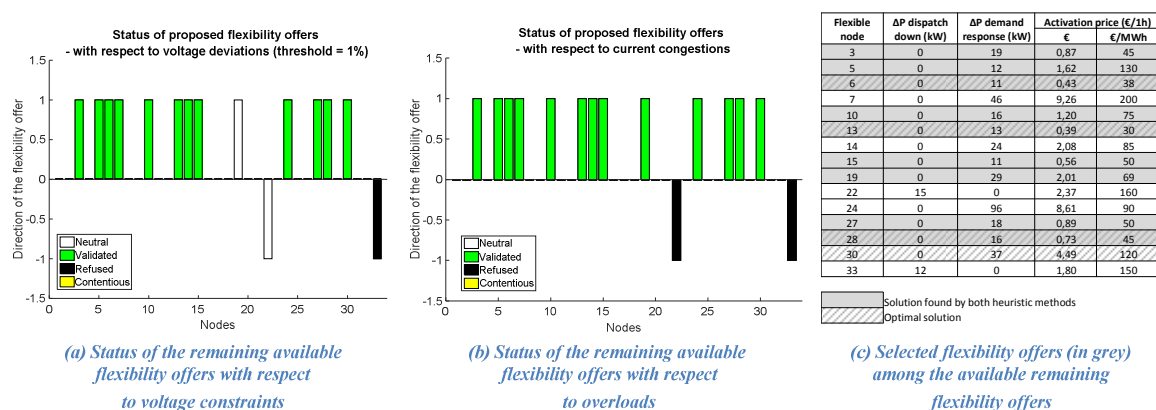

**Figure AVI-6– Statuses of the available flexibility offers with respect to network constraints and list of remaining available flexibility offers in this scenario**

Finally, after running the efficiency-based heuristic method, the selected flexibility offers that permits to solve the given network constraints in a minimal cost in case of the reconnection of a 1MW feeder at node 2 are colored in grey in Figure AVI-6(c).

After the activation of these selected flexibility offers, the network is brought back into a normal state and is respecting all its regulatory and physical constraints, as represented in Figure AVI-7.

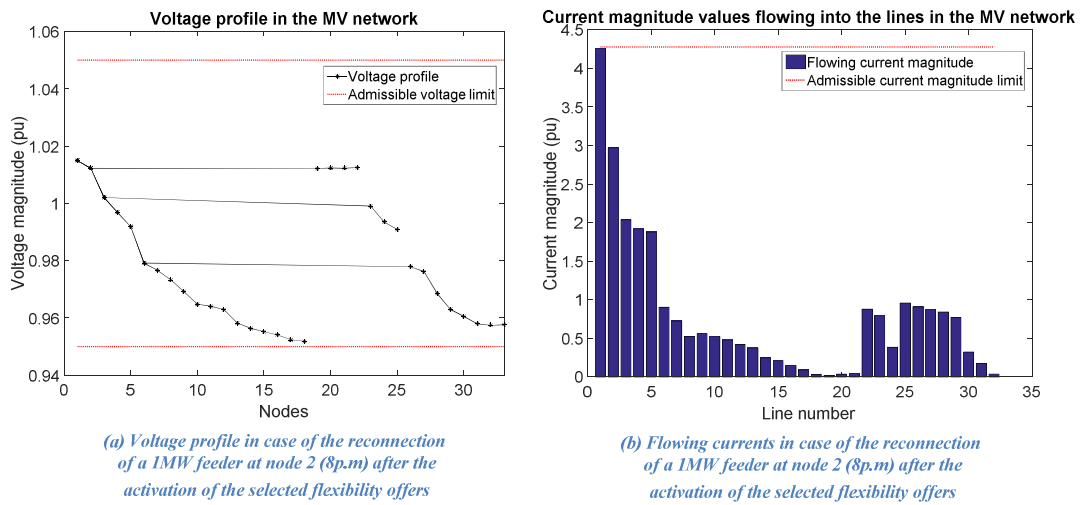

**Figure AVI-7 – Final voltage profile and flowing currents after the activation of the selected flexibility offers**

These two test cases have been also solved respectively with the genetic algorithm and the branch-and-cut algorithm presented in the thesis, and the results are depicted in part III.4.2.

---

## Annex AVII.

# Optimization methods details

---

Throughout the whole PhD thesis, different optimization problems are presented, and several methods are used to solve them in order to compare their results and performances. This annex presents the metaheuristic method used in chapter III, based on a genetic algorithm, and the exact method used in chapters III and IV, based on a branch-and-cut algorithm.

### AVII.1. Meta-heuristic method: focus on the genetic algorithm

Metaheuristic methods can be used to solve combinatorial problems in a reasonable time. They are basically based on randomness and cannot ensure to find the global optimal solution unless if the resolution time is infinite [DREO-06]. However, metaheuristic methods can find good solutions in a reasonable time, without needing large computational requirements. In chapter III, a genetic algorithm has been used to find a solution to the optimization problem for cost minimization of DSO risk management. The dedicated algorithm is dealing with both discrete and binary variables, representing the flexibility resources, namely the OLTC and the capacitor bank positions and the flexibility offers activation status.

Genetic algorithms have been firstly introduced by Holland [HOLL-75]. Genetic algorithms belong to the larger class of evolutionary algorithms that generates solutions using techniques inspired by natural evolution, such as inheritance, mutation, selection, and crossover. The basic idea is that the most efficient individuals of a given population have a higher probability to give their genetic information to the next generation. This is based on the principles of Darwin's theory.

Mathematically, the algorithm process can be described as follow. The following illustration is showing a case with 6 decision variables. In this case, the OLTC position and the capacitor bank position are encoded as two integer variables, which can vary between some fixed integer bounds. Therefore, it is assumed that there are 4 remaining available flexibility offers, encoded by 4 binary variables. In a first step, an initial population of a given number of individuals is randomly encoded, as presented in Figure AVII-1.

An individual is a possible configuration of the decision variables, which are also called the genes. Each individual is characterized by its efficiency with regards to the objective function, also called its fitness. This is corresponding to the objective function computed with these particular values of the decision variables.

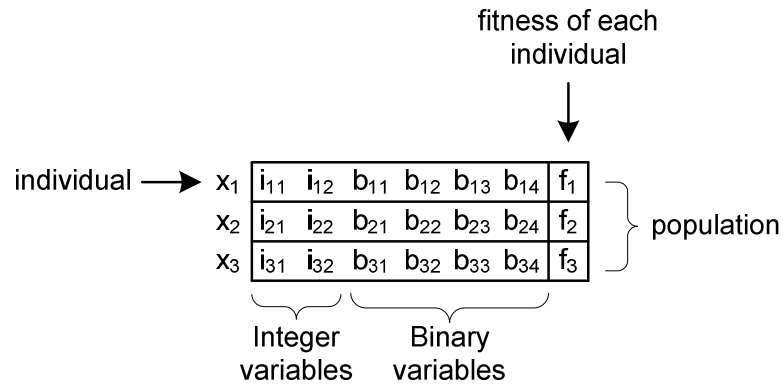

*Figure AVII-1 – Example of an initial population of 3 individuals composed of 6 genes*

It is therefore possible to find the best individual of the initial population, which corresponds to the one with the best fitness value. Then, while the total number of evaluations is below a given threshold, new populations are generated and all the individuals are evaluated. The generation process is succinctly described hereafter. More information about this algorithm can be found in [MITC-98].

If the best individual of a new population has a better fitness value than the best individual found since the beginning of the algorithm, then it becomes the best one. In order to generate the new populations, some evolutionary basic rules are followed which are the selection, the cross-over and the mutation of the individuals.

## The selection of the individuals

It is important to define a criterion to select the individuals which will become the parents of the next ones. The idea here is to classify the individuals based on their respective efficiency and to select some of the best ones, as described in Darwin's theory. Three different methods are commonly used to select the parents. It is possible to affect a proportion coefficient to use each of the three methods. The most basic one is based on elitism, where two parents are randomly chosen among a given number of the best individuals of the population.

Another method is based on the tournament between two randomly chosen individuals. The one that has the best fitness is chosen and will be one parent of the next generation. The operation is repeated two times in order to get the two parents.

The third common method is the roulette wheel selection method. The total fitness of the population is represented by an entire wheel. A proportion of the wheel is assigned to each individual depending on their fitness value. This could be achieved, for example, by dividing the fitness of an individual by the total fitness of all the population, thereby normalizing them to 1. A scheme of this kind of roulette wheel is represented in Figure AVII-2. A random selection is made similar to how the roulette





generation of a population to the next one. This permits to change suddenly some parts of the population and to explore new directions in the entire the search space, avoiding some local optimum. In the algorithm, if a large proportion of the individuals of a population has the same genes or has a lot of similarity, the mutation is preferred for at least one of these individuals.

### Constraints representation via penalization

Genetic algorithms are only using the fitness value to select the individuals and to find the best ones. The optimization constraints have to be included in this quantity and this, by penalizing the fitness in case of constraint violations. Penalization can be done either by adding a constant value to the evaluation of the individual, or by adding a penalization variable that is depending on the violation’s size of the constraint.

### Determination of the shutoff parameter of the algorithm

The metaheuristic method has a fixed number of objective function evaluations which correspond to the maximum number of iterations times the size of the population. This has a direct link with the execution time of the algorithm. The number of iteration can be chosen after several observations of the convergence decay curves in different cases. These curves permit to give an idea of the minimum number of iterations to find a good solution, and of the limit where the algorithm starts to converge to the same solution.

The choices of the number of function evaluations of the genetic algorithm for the different test cases of DSO risk management are justified hereafter. In Figure AVII-4, ten convergence decay curves are shown, corresponding to ten different runs of the genetic algorithm for each test case performed in the 72-nodes network.

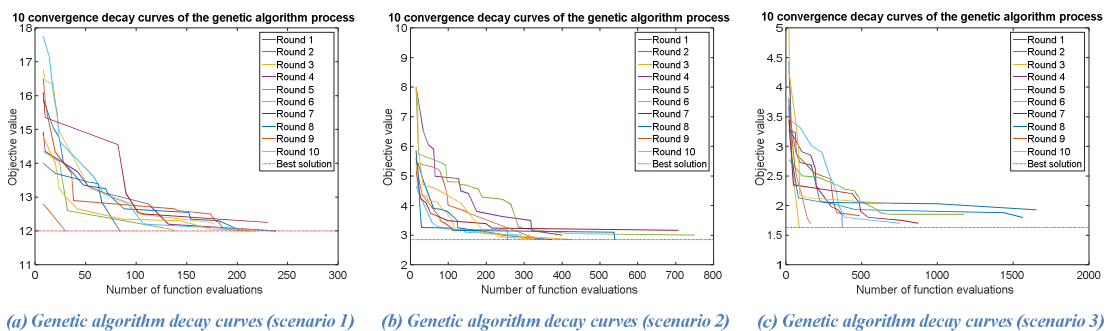
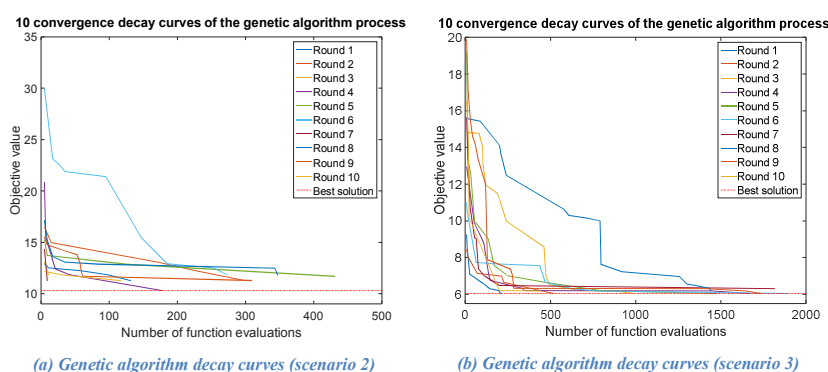

**Figure AVII-4 – Convergence decay curves obtained after performing the genetic algorithm in the 72-nodes network**

Based on these curves, it is possible to determine approximatively a compromise between the number of function evaluations to perform and the convergence of the genetic algorithm. Hence, 200,

600 and 1000 are respectively the maximum numbers of function evaluations which have been chosen for the three different scenarios.

The same procedure has been done for the test cases of the 33-nodes network. The ten convergence decay curves are shown in Figure AVII-5, corresponding to ten different runs of the genetic algorithm for the two test cases.



**Figure AVII-5 – Convergence decay curves obtained after performing the genetic algorithm in the 33-nodes network**

Here, the maximum numbers of function evaluations which have been chosen for the two different test cases are respectively 200 and 1000.

## AVII.2. Exact method: focus on the Branch-and-cut algorithm

Exact algorithms can also be used to solve combinatorial problems, as cutting-plane methods, or branch-and-bound methods.

The branch-and-bound method [LAND-60] is an iterative algorithm that uses a smart enumeration method. This method consists in eliminating partial solutions that are not leading to the optimum solution. It is often possible to find the global optimum in a quite reasonable time, and in the worst case, the exhaustive enumeration of the solutions of the problem is done. This method includes a function that bounds specific solutions either to exclude them, or to keep them as potential solutions. The branch-and-bound method guarantees the convergence to the global optimal solution but can be extremely time consuming and require lots of computations.

The cutting-plane method has been developed by Gomory in 1958 [GOMO-58]. This method aims to cut some parts of the solutions' space until finding the solution. The principal idea is to add one by one some linear constraints (called cuts) that are not excluding admissible integer points, until that

the optimal solution of the relaxation is entire. This algorithm converges generally in a little number of iterations but is not always guaranteeing the convergence to the global optimal.

Therefore, the method introduced in this work is the branch-and-cut method, which is a mix of these two methods. The algorithm works with the progressive introduction of cuts to eliminate unrealistic solutions in the solution space. The branch-and-cut method is faster than the branch-and-bound method, and guarantees the convergence to the global optimal in the case of combinatorial problems [MITC-02] and of mixed integer second order cone programming (MISOCP) problems [JABR-12]. The branch-and-cut algorithm is largely used in a wide variety of engineering and design combinatorial problems and is implemented on solvers as on CPLEX [IBM-16] for example.

The general formulation of the Branch-and-cut method is defined in details in [DREW-09]. The branch-and-cut algorithm is based on a decision tree, as depicted in Figure AVII-6. It consists in an iterative process as for the branch-and-bound algorithm, in which some cuts are introduced in order to eliminate some sets of non-realizable solutions and so, some parts of the searching space (colored in red in the Figure AVII-6).

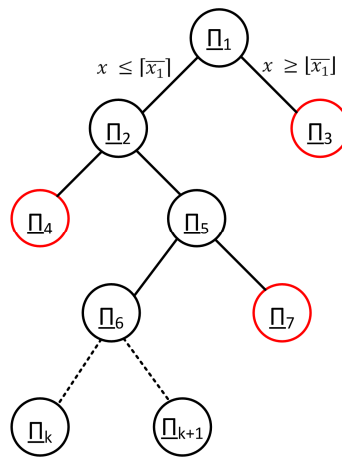

Figure AVII-6 – Example of a branch-and-cut decision tree

Given a problem  $\Pi$ , the algorithm starts by solving the continuous relaxation  $\underline{\Pi}$  which corresponds to  $\Pi$  with relaxed constraints on the integer decision variables. If the found solution  $x$  is discrete and realizable, then it is the global optimal solution of the problem  $\Pi$ . Otherwise, a smart enumeration is started with the creation of two sub-problems where the two constraints  $x \leq \lceil \bar{x} \rceil$  and  $x \geq \lfloor \bar{x} \rfloor$  are added respectively.  $\lceil \bar{x} \rceil$  and  $\lfloor \bar{x} \rfloor$  are representing respectively the next higher integer of  $x$ , and the integer part of  $x$ . Each node of this decision tree is corresponding to a sub-problem. A parent node is a node which permits to create at least one sub-problem.

Each node of the decision tree with a non-discrete solution is a lower bound of all the discrete solutions of the sub-tree at this node. Similarly, each discrete solution found during this process which is

realizable is an upper bound of the initial problem. Every new sub-problem is created with new constraints. Its objective value is always larger or equal to the objective value of its parent node.

Hence, the followed rules are the major rules that are applied during the iterative process. Without these rules, the algorithm could enumerate all the possible solutions following an exhaustive approach.

- If the solution found at a node is discrete and realizable, then all the sub-problems that are coming from this node could not find a best discrete solution. Therefore, the exploration is stopped in this direction. If an optimal solution is found for a sub-problem, it is realizable but not necessarily optimal for the entire initial problem.
- If the objective value of a node is larger than the upper bound of the general problem  $\Pi$ , then it is not needed to continue to search on this direction.
- If the sub-problem of a node is not feasible, then all the sub-problems that are coming from this node will be also not feasible. It is not necessary to search on this direction.

The cuts are some constraints that are added if needed at each node of the decision tree, in order to limit the search space. They are determining the directions of the searching path during the iterative process. They are more based on the intuition and the logic of the problem definition. The branch-and-cut search is carried on until that all the nodes are explored or eliminated.



---

## Annex AVIII.

# Sensitivity threshold impact in the developed heuristic methods

---

As seen in the different test cases in part III.4.2, the heuristic method based on efficiency is generally leading to a better solution than the heuristic based on cost. However, it does not always converge to the global optimal. This is due to the gluttonous characteristic of the method, which is highly depending on the chosen sensitivity threshold for the selection of the effective flexibility offers. The method is selecting the sensitive flexibility offers one after the other and is not going back on its selection. This has a direct impact on the objective value which can differ from the optimal one.

Indeed, for both developed heuristic methods, a threshold is set in order to select only the flexibility offers that are impacting the voltage profile at the constrained nodes with more than a given percent of the maximum voltage sensitivity coefficient. In the different test cases, the sensitivity threshold is set at 1%. This annex defines this parameter and illustrates the sensitivity threshold impact in the developed heuristic methods, in two different test cases.

The two considered test cases for this study are the test cases 2, respectively in the 72-nodes and in the 33-nodes networks. This choice is justified because there is no impact of the sensitivity threshold in the other proposed test cases: in the test case 1 in the 72-nodes network, only two flexibility offers are likely to solve the potential occurring constraints, and the more sensitive is self-sufficient to solve them. Hence, any value of sensitivity threshold will lead to the same result. The same reasoning can be applied on test cases 3 in the two different networks, as only unitary current sensitivity coefficients are decisive in these cases.

- **Risk management on the 72-nodes network (test case 2)**

In order to get a vision on the effect of potential available flexibility offers on the potential occurring network constraints, the substation DSO agent is generating a voltage sensitivity matrix corresponding to the constrained case. Based on this, it is possible to determine which flexibility offers can be investigated and which ones are not sensitive with respect to the occurring constraints.

For example, considering the test case 2 in the 72-nodes network, the voltage sensitivity profile in the constrained case is presented in Figure AVIII-1. The sensitivity coefficients have been computed in percent with respect to the maximum one.

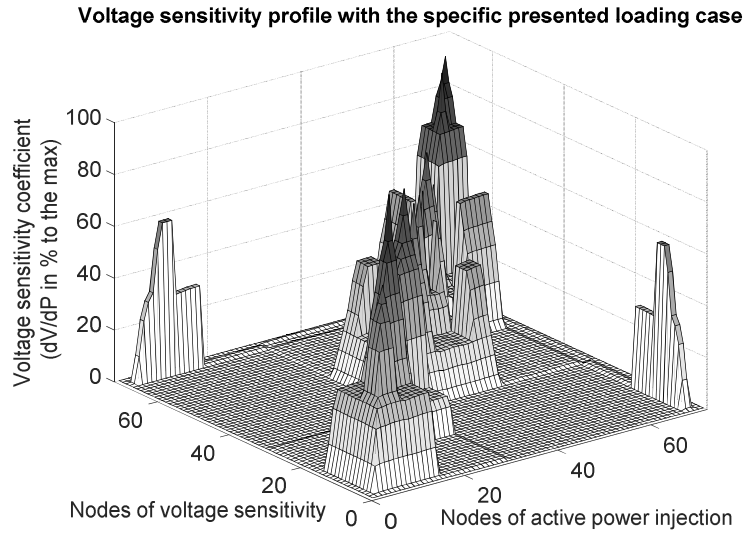
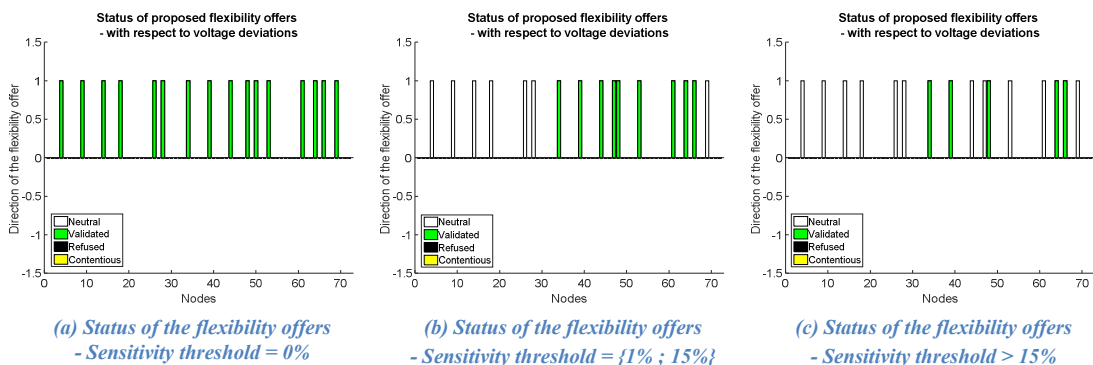

**Figure AVIII-1 – Voltage sensitivity profile for the constrained test case 2 in the 72-nodes network**

Thanks to this figure, it is possible to assess the impact of active power injection at different locations of the network on the voltage magnitude of a particular node, in this particular loading case. Hence, it is possible to evaluate which flexibility offers will have an impact on the occurring constraints.

For both developed heuristic methods, a threshold is set in order to select only the flexibility offers that are impacting the voltage profile at the constrained nodes with more than a given percent of the maximum voltage sensitivity coefficient. The threshold is thus a gluttonous parameter of the heuristic algorithm, and can be seen as a cutting plane, selecting only the flexibility offers that have a higher voltage sensitivity coefficient value with respect to at least one constraint deviation.

Different thresholds have been tested in this test case and the results are described hereafter. Depending on the chosen sensitivity threshold, the statuses of the available flexibility offers are changing, as illustrated in Figure AVIII-2.

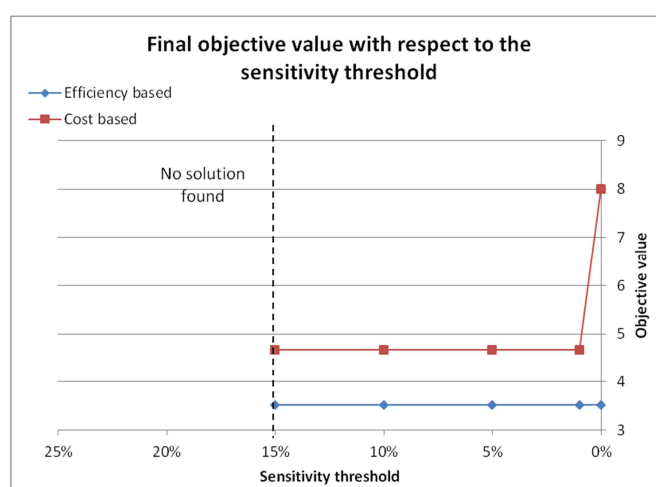

**Figure AVIII-2 – Impact of the sensitivity threshold on the statuses of the flexibility offers (72-nodes network, test case 2)**

The higher is the sensitivity threshold, the less flexibility offers are validated for the algorithm process. On the one hand, when the sensitivity threshold is set at 0%, all the flexibility offers that are susceptible to help the voltage deviations are validated and considered. Thus, the method is following only a merit order list based on the costs or on the efficiencies of the offers, without considering the impact of the flexibility on the constraints. On the other hand, when the sensitivity threshold is too high, not enough flexibility offers might be considered. The algorithm might therefore not find a solution to solve the potential occurring voltage deviations.

Even if the solution is highly depending on this threshold, the adjustment of this parameter is quite arbitrarily. It has to be chosen in order not to validate and consider all the non-sensitive flexibility offers, but while keeping in mind that the algorithm has to consider enough flexibility offers to solve the potential voltage deviations.

Concerning this test case, the evolution of the final objective value with respect to this threshold is shown in Figure AVIII-3. In this case, both heuristic methods are not finding an acceptable solution if the threshold is higher than 15%. If the threshold is equal to 0%, the cost-based heuristic method is leading to a high objective value, considering all the flexibility offers and following only a merit order list based on the costs.



**Figure AVIII-3 – Evolution of the final objective value with respect to the sensitivity threshold (72-nodes network, test case 2)**

In this case, the different steps of the choices of activations for a sensitivity threshold between 1% and 15% are depicted in the table below (Figure AVIII-4). Thanks to this focus, it is possible to understand the resulting difference between the final objective values found with both methods. In the cost-based method, the flexibility offers at nodes 34 and 53 are activated because of their low prices but are not efficient enough to help the solving of the potential occurring constraints.



Threshold	1% - 15%			
Iteration	Cost based		Efficiency based	
	Node of activated offer	Node of voltage deviations solved	Node of activated offer	Node of voltage deviations solved
1	44	none	44	none
2	39	none	39	none
3	47	49	48	49
4	34	none	47	50
5	48	50	61	none
6	61	none	64	none
7	53	none	66	65, 66, 67
8	64	none	Problem solved	
9	66	65, 66, 67	Problem solved	

Figure AVIII-4 – Focus of the different steps of the two heuristic based methods (72-nodes network, test case 2)

- Risk management on the 33-nodes network (test case 2)

The same study is done in the second test case applied on the 33-nodes network. The voltage sensitivity profile in the constrained case is depicted in Figure AVIII-5. Here also, the sensitivity coefficients have been computed in percent with respect to the maximum one. As said previously, thanks to this knowledge, it is possible to assess the impact of active power injection at different locations of the network on the voltage magnitude of a particular node. Therefore, it is possible to consider only the flexibility offers that have a non-negligible effect on the potential occurring voltage constraints.

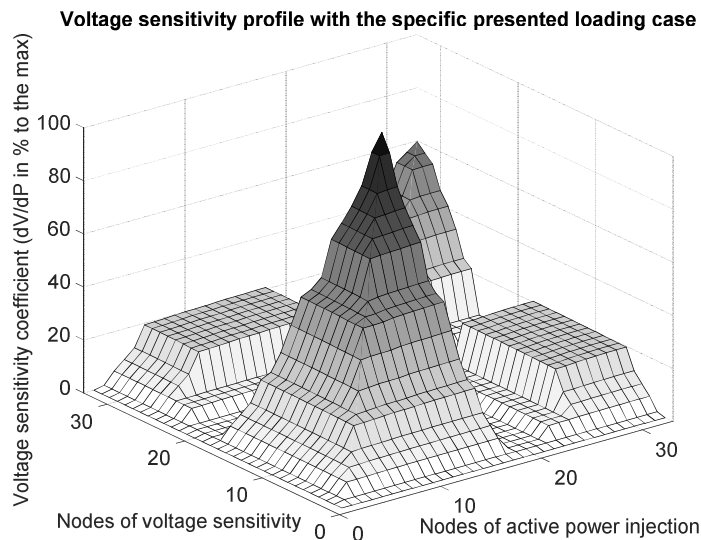
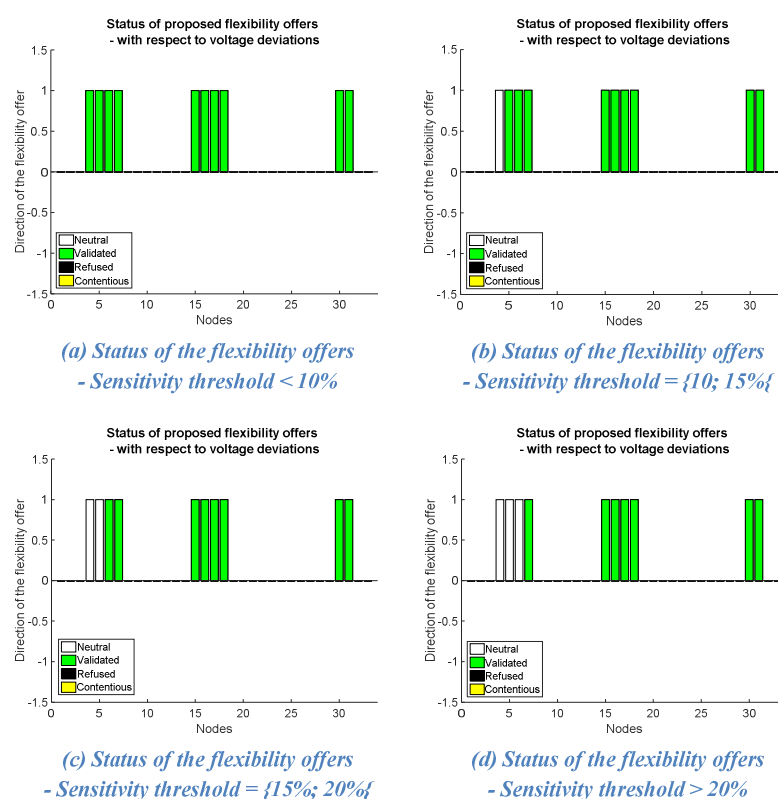

Figure AVIII-5 – Voltage sensitivity profile for the constrained test case 2 in the 33-nodes network

Here again, different thresholds have been tested in this test case and the results are described hereafter. Depending on the chosen sensitivity threshold, the statuses of the available flexibility offers are not the same, as illustrated in Figure AVIII-6.



**Figure AVIII-6 – Impact of the sensitivity threshold on the statuses of the flexibility offers (33-nodes network, test case 2)**

In this case, if the sensitivity threshold is lower than 5%, all the flexibility offers are considered for the algorithm process. While increasing the threshold, less and less flexibility offers are considered. With the sensitivity threshold set at 20%, three of the ten remaining available flexibility offers are considered as neutral, meaning that they do not have an enough important impact on the voltage constraints.

In Figure AVIII-7, the evolution of the final objective values is presented for the two heuristic methods with respect to the different sensitivity thresholds. In this particular test case, it can be observed that if the sensitivity threshold is higher than 20% of the maximum voltage sensitivity coefficient, there are not enough validated flexibility offers and no solution is found to solve the potential appearing constraints, independently of the applied method. Moreover, in this case, as long as the sensitivity threshold is higher than 10%, the final objective value is the same with the two methods.

The increases of the final objective values in the case 15% for both methods and 5% for the method based on the costs illustrate that for each iteration, any flexibility offer which is more efficient or cheaper than the others is retained in the activation list, independently of its power value quantity.

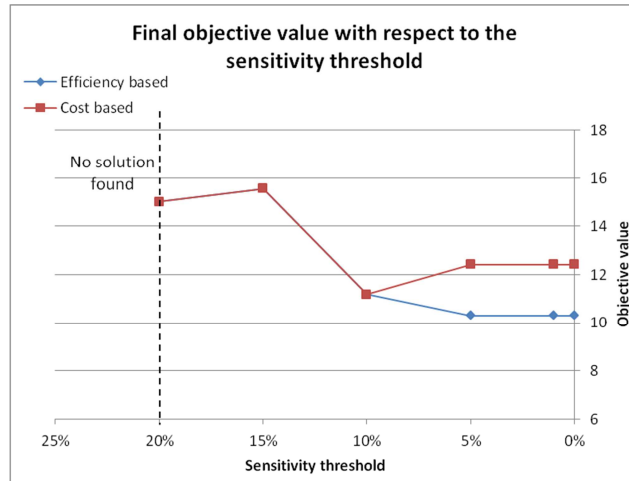

Figure AVIII-7 – Evolution of the final objective value with respect to the sensitivity threshold (33-nodes network, test case 2)

In order to give more details about the efficiency based method, two distinct cases with different sensitivity threshold are focused on in Figure AVIII-8.

Threshold	20%				Threshold	1%			
	Cost based		Efficiency based			Cost based		Efficiency based	
Iteration	Node of activated offer	Node of voltage deviations solved	Node of activated offer	Node of voltage deviations solved	Iteration	Node of activated offer	Node of voltage deviations solved	Node of activated offer	Node of voltage deviations solved
1	17	13	17	13	1	6	none	17	13
2	15	none	15	none	2	17	13	15	none
3	16	14	16	14	3	15	none	16	14
4	31	15, 31	18	15, 16	4	16	14	6	none
5	18	16, 17, 32, 33	31	17, 31, 32, 33	5	4	none	18	15, 16
6	30	18	30	18	6	5	15	31	17, 31, 32, 33
	Problem solved		Problem solved		7	31	16, 31, 32, 33	4	18
					8	18	17, 18	Problem solved	
						Problem solved			

Figure AVIII-8 – Focus of the different steps of the two heuristic based methods (33-nodes network, test case 2)

Concerning the efficiency-based heuristic method with the threshold at 20%, the order of activation is following the efficiency coefficients computation, with respect to the remaining largest voltage constraints. At the beginning of the process, the algorithm is focusing on the deviation at node 18. It activates the more efficient flexibility offers to solve the deviation, considering both the voltage sensitivity of node 18 with respect to injection at the different nodes and the cost of the flexibility offer. After the four first flexibility offers activation, the voltage deviation at node 33 is larger than the one

remaining at node 18. The flexibility offer at node 31 is then activated. Finally, the last remaining voltage deviation is at node 18. The more efficient remaining flexibility offer to solve this voltage deviation is the one that is available at node 30.

Concerning the efficiency-based heuristic method with the threshold at 1%, the only difference with the previous case is that there are more flexibility offers that are validated and therefore considered. Particularly, the flexibility offers at nodes 4 and 6 are considered in this second case, and even if they are less voltage sensitive with respect to the constraints, they are a lot less expensive than the flexibility offer at node 30, and can also be part of the combination to solve the potential appearing constraints.

To conclude, the setting of the sensitivity threshold in both developed heuristic methods might have a large impact on the final objective value, as illustrated in these two examples. The parameter has to be chosen in order to permit that enough flexibility offers are considered for the algorithm processes, while avoiding to consider all the flexibility offers in order to limit the computations and the unexpected increase of the final cost of flexibility offers activation.

## Résumé en français

---

Depuis plus de deux décennies, les réseaux électriques européens font face à de nouveaux changements. En particulier, les dérégulations du marché de l'énergie, suivies par de nombreuses privatisations, ont amené à une restructuration complète du secteur électrique.

Traditionnellement, le secteur électrique était structuré de façon monopolistique. Les coûts importants de construction et de maintenance des infrastructures électriques ont été favorables au développement d'une architecture verticalement intégrée pour la production, le transport et la distribution de l'énergie électrique. Cette structure permettait aux différents acteurs du secteur d'adapter en temps réel la production globale à la demande, et aux gestionnaires de réseaux de garantir la sécurité et la fiabilité de leur réseau.

La libéralisation du secteur électrique en 1996 a conduit à la séparation des différents secteurs et à l'ouverture de la compétition entre les nouveaux acteurs dérégulés. Tous ces acteurs peuvent maintenant participer aux échanges commerciaux d'énergie avec différents plans d'actions dépendant de leurs stratégies. Parallèlement à cela, les Gestionnaires de Réseaux de Transport (GRT) et de Distribution (GRD) doivent continuer à opérer leurs réseaux et permettre ces échanges d'énergie, tout en garantissant un plein accès au réseau et aux places de marchés à tous leurs clients.

De plus, dans un contexte de transition énergétique, l'Union Européenne a adopté de nombreuses directives visant à l'économie d'énergie, à la hausse de la proportion de la production renouvelable, et à la réduction des émissions des gaz à effet de serre.

Ces grands changements ont causé une forte hausse de la proportion des énergies renouvelables dans le mix de la production électrique. A cause de leur caractère intermittent et difficilement prévisible, ces nouvelles productions ont aussi impliquées un nouveau besoin de flexibilité dans les réseaux électrique, afin de préserver la stabilité du système jusqu'au temps réel.

De plus, dans une optique environnementale, des incitations commerciales et des subventions ont été instaurées par les gouvernements afin d'encourager les investisseurs et les utilisateurs finaux à installer des générateurs d'énergie décentralisés (GED). Ces nouvelles productions, directement raccordées sur les réseaux, augmentent également le besoin de flexibilités au niveau local, afin d'assurer l'équilibre du système jusqu'aux plus bas niveaux de tension, mais aussi pour permettre l'efficacité de l'opération du réseau.

L'amélioration de la gestion de la capacité du réseau est donc nécessaire afin de maximiser la proportion de production renouvelable de la manière la plus économique possible pour tous les acteurs, tout en maintenant la stabilité et la fiabilité du réseau. Dans le cas où il s'agit d'une alternative rentable aux solutions de renforcement, la capacité du réseau peut être augmentée par l'opération de sources et

de charges contrôlables, permettant au réseau d'être plus flexible aussi bien du côté de la consommation que de la production. Si ces solutions se révèlent être rentables, et qu'elles ne compromettent pas la sécurité d'approvisionnement et la qualité de service, les gestionnaires de réseau devraient être en mesure de réduire leurs investissements réseau grâce à des solutions combinant renforcement et gestion des ressources de flexibilité.

Dans la situation actuelle, la flexibilité est utilisée au niveau national afin de garantir l'équilibre consommation/production lors des échanges sur les marchés de l'énergie via les mécanismes d'ajustement. Avec la hausse du taux de pénétration des ressources d'énergie distribuées, de plus en plus d'offres de flexibilité locales sont disponibles dans les réseaux de distribution. Afin de permettre leur échange sur les places de marché nationales, ces dernières doivent être validées et transmises jusqu'au niveau national, tout en garantissant l'opération des réseaux de distribution.

Face à ces changements, les rôles et les responsabilités des acteurs du système électrique doivent donc évoluer. De nouveaux outils sont nécessaires pour permettre les nouveaux échanges de données et d'informations entre les différents acteurs, et particulièrement pour de meilleures interactions entre les GRD et les GRT.

Dans un contexte où les acteurs dérégulés des marchés de l'énergie mobilisent de plus en plus d'offres de flexibilités locales, les GRD doivent devenir des facilitateurs de marchés. Ils doivent pouvoir donner un plein accès aux marchés à tous leurs clients, mais aussi permettre la transmission des offres de flexibilités locales jusqu'aux places de marché nationales, tout en garantissant une bonne qualité de service et en améliorant la performance énergétique de leur propre réseau.

Pour permettre ces nouveaux échanges, les architectures d'information et de communication doivent être aussi redéfinies. Dans ce contexte, une nouvelle architecture de marchés distribués est proposée dans cette thèse, permettant la création de ces nouveaux services de flexibilités pour le GRD.

Cette thèse présente des solutions innovantes pour de meilleures interactions entre les gestionnaires de réseaux de distribution et de transport, via un mécanisme distribué de validation d'offres de flexibilités locales par le GRD. Elle propose aussi de nouveaux outils de planification opérationnelle permettant l'instauration de mécanismes d'ajustement distribués dans les Smart Grids. Des solutions sont également proposées pour une meilleure gestion des risques par le GRD, lui permettant d'activer des offres de flexibilités BT et HTA qui n'ont pas été sélectionnées dans les marchés dans le cas de situations inattendues. Enfin, des méthodes d'optimisation pour la réduction des pertes dans les réseaux de distribution sont proposées, considérant toutes les ressources de flexibilités disponibles.

La thèse est développée selon le plan suivant: dans le premier chapitre, le contexte des réseaux de distribution et les nouvelles évolutions auxquelles ils doivent faire face sont présentés. Les mécanismes des marchés européens de l'énergie sont également décrits, ainsi que les nouveaux rôles des différents acteurs du système électrique.

Dans le second chapitre, les hypothèses de la nouvelle architecture hétérarchique proposée sont présentées, permettant l'introduction de nouveaux mécanismes de marchés et d'ajustements locaux, ainsi que de nouvelles fonctions pour l'opération des réseaux de distribution. Cette nouvelle structure est développée de façon ascendante (de bas en haut), afin de limiter les transferts de données dans l'ensemble du réseau de distribution.

Les outils développés afin d'aider les GRD à agir en tant que facilitateurs de marchés sont ensuite décrits dans le troisième chapitre. Des outils de modélisation du réseau, de calcul de répartition de charges et d'analyse de sensibilités ont été explorés afin d'observer et de prévoir le comportement des systèmes électriques équilibrés et déséquilibrés, en fonction des puissances consommées et produites dans le réseau.

Puis, des solutions pour permettre aux GRD de donner un plein accès à leurs clients aux marchés de l'énergie sont présentées, via la validation technique des offres de flexibilités à un niveau local avant leur transmission à des niveaux de tension plus hauts, et via une meilleure considération des ressources flexibles distribuées en Basse Tension (BT). Ces solutions ont pour objectif de permettre aux GRD, de vérifier que toutes les offres locales échangées entre les acteurs dérégulés au niveau national sont compatibles avec la sécurité et la fiabilité du réseau de distribution. L'arithmétique floue a été utilisée pour l'élaboration de cette méthode, afin de prendre en compte les incertitudes dues aux dérogations possibles des clients flexibles, mais aussi les incertitudes sur les valeurs prévues.

Dans un second temps, des solutions pour une gestion distribuée des risques et pour l'analyse de contingences à très court terme sont proposées, pour aider les GRD à anticiper l'opération de leur réseau. En effet, afin d'assurer la sécurité et la fiabilité de l'opération des réseaux de distribution jusqu'au temps réel, ils doivent préparer des plans d'actions afin de réagir à de potentiels changements brusques dans leur réseau.

Différents types d'algorithmes, caractérisés par différentes complexités mathématiques ont été créés et testés afin de permettre aux GRD de quantifier les potentiels risques de contingences sur leur réseau. Afin d'être facilement compréhensibles et déployables par les GRD, des algorithmes heuristiques simples basés les coûts et sur des analyses de sensibilités ont été d'abord proposés. Ces méthodes sont aussi conformes avec les performances de calculs des RTUs déployés aujourd'hui.

Puis, des stratégies plus avancées (basées sur des méthodes méta-heuristiques et exactes) ont aussi été testées afin de comparer la précision et les performances des différents algorithmes sur ce problème combinatoire.

Finalement, des outils innovants pour l'amélioration énergétique des réseaux de distribution sont proposés dans le dernier chapitre. Des solutions distribuées sont proposées afin de minimiser les pertes du réseau, tout en considérant les ressources de flexibilités disponibles, incluant les offres de flexibilités restantes qui n'ont pas été sélectionnées pendant les échanges sur les marchés de l'énergie.

Dans ce chapitre, une optimisation basée sur des variables discrètes et continues a été introduite afin d'aider les GRD à minimiser leurs pertes techniques, tout en considérant les contraintes physiques et réglementaires à respecter sur leur réseau. Cette optimisation considère la possibilité d'utiliser un transformateur à régulateur en charge au niveau du poste source, différentes valeurs de bancs de capacités au poste source, la reconfiguration du réseau, ainsi que le contrôle des puissances active et réactive des charges et générations flexibles.

L'utilisation de techniques de reformulation mathématique a permis de rendre le problème convexe et de pouvoir garantir l'optimalité globale de la solution trouvée, lorsque l'algorithme considère des zones du réseau indépendantes. Cette méthode permet aussi d'appréhender l'évolution des pertes du réseau en fonction d'un coût maximal admissible d'opération des flexibilités, défini par le GRD, tout en garantissant l'optimalité globale des solutions trouvées.

Cette thèse a été élaborée au sein du projet européen DREAM, financé par la commission européenne sous la convention de subvention FP7 609359. Douze partenaires académiques et industriels venant de sept pays différents travaillent sur ce projet. L'objectif majeur de ce projet est de proposer des solutions pour une nouvelle approche hétéroarchitecturale pour la gestion des réseaux de distribution. Le but est de permettre une intégration stable et économique des ressources distribuées d'énergie, et de permettre la participation aux marchés de l'énergie pour tous les acteurs du système électrique, y compris les consommateurs, via l'instauration d'une nouvelle architecture distribuée.

Le travail présenté dans cette thèse est étroitement lié au projet DREAM. Des implémentations des stratégies développées sont actuellement en cours dans le « DREAM framework » commun au projet, mais aussi dans quelques sites de démonstrations. Le « DREAM framework » est construit afin de considérer et de permettre des interdépendances entre les différents scénarios et algorithmes définis dans le projet. Ainsi, son architecture consiste en un nombre défini de lots qui sont couplés en cohérence avec les scénarios définis dans le projet, chacun d'entre eux couvrant une partie des fonctionnalités désirées, parmi lesquelles figurent les méthodologies présentées dans cette thèse.

Quelques-unes des stratégies présentées dans la thèse sont aussi testées sur des sites expérimentaux. Par exemple, des méthodes dédiées HTA sont expérimentées à l'aéroport de Milan Malpensa, en Italie. Ce site de démonstration est caractérisé par la présence d'une centrale tri-génération. De nombreuses autres ressources de flexibilités sont également considérées dans l'aéroport, comme des systèmes pilotables pour le chauffage, la ventilation et la climatisation, ainsi que des tours d'éclairage contrôlables.

Certaines des méthodes proposées ont aussi été adaptées pour l'opération des réseaux BT et sont partiellement testées dans le laboratoire d'essai Opkamer, correspondant au site de démonstration du PowerMatcher, situé à Groningue aux Pays Bas. Les ressources disponibles de flexibilités considérées sont offertes par des équipements intelligents à l'intérieur de maisons présentes sur le site de démonstration.





## **Distributed intelligence and heterarchical approach of distributed balancing markets in Smart Grids**

---

In a context where all unbundled actors are dealing with an increasing number of local flexibility opportunities, the DSOs have to play a new transparent key role. They should give a full open access to markets to all end users and enable the transmission of the distributed offers in the national energy exchanges places, while guaranteeing acceptable network operation conditions and good quality of supply to their customers and while improving their energy efficiency.

This thesis is presenting innovative distributed solutions to allow better DSO-TSO interactions via a mechanism of DSO technical validation of distributed flexibility offers. It proposes also new operational planning tools to enable distributed balancing markets in Smart Grids. Original solutions are designed for DSO risk management and contingency analysis using remaining LV and MV flexibility resources near real-time. Finally, methods for network losses minimization are proposed considering all the available flexibility resources, including remaining flexibility offers that have not been selected during the market processes and mechanisms. The instauration of these solutions are based on the definition of a new heterarchical distributed architecture where electricity system actors are represented by local agents installed in devices spread over the whole distribution network.

**Keywords:** distributed balancing markets, distributed flexibility offers, distributed intelligence, DSO-TSO interactions, DSO risk management, operational planning, network losses optimization

## **Distribution de l'intelligence et approche hétérarchique des marchés de l'énergie distribués dans les Smart Grids**

---

Dans un contexte où les acteurs dérégulés des marchés de l'énergie mobilisent de plus en plus d'offres de flexibilités locales, les gestionnaires de réseau de distribution (GRD) doivent devenir des facilitateurs de marchés. Ils doivent pouvoir donner un plein accès aux marchés à tous leurs clients, mais aussi permettre la transmission des offres de flexibilités locales jusqu'aux places de marché nationales, tout en garantissant une bonne qualité de service et en améliorant la performance énergétique de leur réseau.

Cette thèse présente des solutions innovantes pour de meilleures interactions entre les gestionnaires de réseaux de distribution et de transport, via un mécanisme distribué de validation d'offres de flexibilités locales par le GRD. Elle propose aussi de nouveaux outils de planification opérationnelle permettant l'instauration de mécanismes d'ajustement distribués dans les Smart Grids. Des solutions sont également proposées pour une meilleure gestion des risques par le GRD, lui permettant d'activer des offres de flexibilités BT et HTA qui n'ont pas été sélectionnées dans les marchés dans le cas de situations inattendues. Enfin, des méthodes d'optimisation pour la réduction des pertes dans les réseaux de distribution sont proposées, considérant toutes les ressources de flexibilités disponibles. L'instauration de ces nouvelles fonctionnalités repose sur la définition d'une nouvelle architecture distribuée et hétérarchique, où les acteurs du système électriques sont représentés par un système distribué, déployé sur l'ensemble du réseau de distribution.

**Mots clés:** mécanismes d'ajustement distribués, offres de flexibilité distribuées, intelligence distribuée, interactions GRD-GRT, gestion du risque pour le GRD, planification opérationnelle, optimisation des pertes