



HAL
open science

Contribution to interoperable products design and manufacturing information: application to plastic injection products manufacturing

Anderson Luis Szejka

► To cite this version:

Anderson Luis Szejka. Contribution to interoperable products design and manufacturing information: application to plastic injection products manufacturing. Computer Aided Engineering. Université de Lorraine; Pontifical Catholic University of Parana (PUC-PR), 2016. English. NNT : 2016LORR0159 . tel-01501670v2

HAL Id: tel-01501670

<https://hal.science/tel-01501670v2>

Submitted on 10 Dec 2016

HAL is a multi-disciplinary open access archive for the deposit and dissemination of scientific research documents, whether they are published or not. The documents may come from teaching and research institutions in France or abroad, or from public or private research centers.

L'archive ouverte pluridisciplinaire **HAL**, est destinée au dépôt et à la diffusion de documents scientifiques de niveau recherche, publiés ou non, émanant des établissements d'enseignement et de recherche français ou étrangers, des laboratoires publics ou privés.

ANDERSON LUIS SZEJKA

**CONTRIBUTION TO INTEROPERABLE PRODUCTS DESIGN
AND MANUFACTURING INFORMATION: APPLICATION TO
PLASTIC INJECTION PRODUCTS MANUFACTURING**

**DOCTOR OF THE
PONTIFICAL CATHOLIC UNIVERSITY OF PARANA
IN INDUSTRIAL AND SYSTEMS ENGINEERING**

**DOCTEUR DE L'UNIVERSITÉ DE LORRAINE
EN AUTOMATIQUE, TRAITEMENT DU SIGNAL ET
DES IMAGES, GÉNIE INFORMATIQUE**

**CURITIBA
2016**

Anderson Luis SZEJKA

Thesis submitted in partial fulfilment of the requirements for the degree of

Doctor of the Pontifical Catholic University of Parana
in Industrial and Systems Engineering

and the degree of

Docteur de l'Université de Lorraine
en Automatique, Traitement du Signal et des Images, Génie Informatique

Contribution to interoperable products design and manufacturing information: application to plastic injection products manufacturing

Members of the jury:

Reviewers:	R. I. Young N. Moalla	Professor, Loughborough University, United Kingdom Associate Professor, HDR, University of Lyon 2 Lumière, France
Examiners:	M. Trajanovic A. Malucelli O. Canciglieri Jr. H. Panetto A. Aubry E. Rocha Loures	Professor, University of Nis, Serbia Professor, Pontifical Catholic University of Parana, Brazil Professor, Pontifical Catholic University of Parana, Brazil (Supervisor) Professor, University of Lorraine, France (Supervisor) Associate Professor, University of Lorraine, France (Co-Supervisor) Professor, Pontifical Catholic University of Parana, Brazil (Co-Supervisor)



Industrial and Systems Engineering Graduate Program – PPGEPS/PUCPR



Centre de Recherche en Automatique de Nancy, UMR 7039 Université de Lorraine - CNRS



APPROVAL TERM

Anderson Luis Szejka

CONTRIBUTION TO INTEROPERABLE PRODUCTS DESIGN AND MANUFACTURING INFORMATION: APPLICATION TO PLASTIC INJECTION PRODUCTS MANUFACTURING

Thesis submitted in partial fulfilment of the requirements for the degree of Doctor of Industrial and Systems Engineering in the Industrial and Systems Engineering Graduate Program of the Polytechnic School, Pontifical Catholic University of Parana.

Prof. Dr. Osiris Canciglieri Junior
Supervisor – PPGEPS/PUCPR

Prof. Dr. Hervé Panetto
(Supervisor – CRAN/UL)

Prof. Dr. Eduardo de Freitas Rocha Loures
(Co-Supervisor – PPGEPS/PUCPR)

Prof. Dr. Alexis Aubry
(Co-Supervisor – CRAN/UL)

Prof. Dr. Robert I. M. Young
(External Member – Loughborough University)



Pontifical Catholic University of Paraná – PUCPR
Polytechnic School
Industrial and Systems Engineering Graduate Program - PPGEPS

Prof. Dr. Néjib Moalla
(External Member – University of Lyon 2 Lumière)

Prof. Dr. Miroslav Trajanovic
(External Member – University of Nis)

Prof. Dra. Andréia Malucelli
(External Member – University of Lyon 2 Lumière)

Curitiba, 14 de Outubro de 2016.

ACKNOWLEDGEMENTS

I would like to acknowledge the supports of the following people during the period of my doctoral research.

First of all, I seize this opportunity to express my deepest gratitude to my supervisors Prof. Osiris Canciglieri Junior and Prof. Hervé Panetto and my co-supervisors Prof. Eduardo Rocha Loures and Dr Alexis Aubry. Prof. Osiris Canciglieri Junior is more than a supervisor; he is a friend that along of this journey gave me important advises not only for my work but also for my life. Under his supervision, I have benefited immensely from his positive coaching skills, continuous encouragement and critical but constructive comments. Prof. Hervé Panetto is an enthusiastic person that helps me to grow scientifically and personally across this journey in Brazil and in France. He gave me lots of useful advices and illuminating suggestions in each discussion we made. I would like to give my thanks to Prof. Eduardo Rocha Loures and Dr Alexis Aubry for their productive collaborations and inspiring encouragement during my journey. Their professional working attitudes have strongly influenced me, from which I gain benefits for my future academic life and also for my life.

I wish to thank Prof. Robert I. M. Young and Dr Nejib Moalla for accepting to be the reviewers of my thesis and Prof. Miroslav Trajanovic and Prof. Andreia Mallucelli for accepting to be the examiners of my thesis.

I would like to thank to CAPES (Coordenação de Aperfeiçoamento de Pessoal de Nível Superior) and to PUCPR (Pontifícia Universidade Católica do Parana) for their financial support during the period of my doctorate. I would like to give my sincere gratitude to the CRAN laboratory for providing me such good environment during my journey in France. Also, I would like to give my gratitude to the PPGEPS and PUC Agency for offering their support in Brazil.

Acknowledgements are due to Rosana Canciglieri for her support, assistance and patience, especially during the writing up phase, and for making possible for me to finalise my thesis. Thanks to Matheus and Arthur for comprehending my challenging. Thanks Rosana, I have no words which I could express my gratitude.

I am so glad to have a group of warm-hearted colleagues and friends who shared with me the entire or part of the doctoral path. I am grateful to Annette Ferricelli, Antonio Giovanni, Dani Czelusniak, David Gouyon, Emerson Donayski, Joselaine Valaski, Pascale Marange, Philippe Kalitine, Pierre Cocheteux, Ricardo Diogo, Rodrigo Pierezan, Yongxin Liao, and all those that direct and indirectly have helped me during my path. I would like to thank Dr Mario Lezoche for his guidance in Ontology Domain and his generous reception in Nancy. My thanks to Athon Leite and Matheus Canciglieri for your help during the software implementation. I am also greatly grateful to Dr Jean Simão for the advices in the beginning of my thesis. My acknowledgements to PUC Agency team for your comprehension and supporting during the thesis development.

I wish to say especial thanks to my wife Ana Paula whose enormous love and support anytime and anywhere have nourished me in so many ways and kept me strong throughout my journey and my new-born daughter Sophie that brings me happiness and energy.

I would like to thank my parents, Vicente and Agata, my brother and my sister-in-law, Nilton and Nilza, and my nephews, Thiago and Henrique for their love. I also would like to say thanks to my father-in-law and mother-in-law, Valdimir and Maura and my brother-in-law and sister-in-law, Alessandro and Tayrine for all the support

Finally, thank God for letting me get to the end of this journey.

“The important thing is not to stop questioning...

Never lose a holy curiosity.”

(Albert Einstein, 1925)

ABSTRACT

Global competitiveness has challenged manufacturing industry to rationalise different ways of bringing to the market new products in a short lead-time with competitive prices while ensuring higher quality levels and customisation. Modern Product Development Process (PDP) has required simultaneously collaborations of multiple groups, producing and exchanging information from multi-perspectives within and across institutional boundaries. However, it has been identified semantic interoperability issues (misinterpretations and mistakes) in view of the information heterogeneity from multiple perspectives and their relationships across product development. In this context, this research proposes a conceptual framework of an Interoperable Product Design and Manufacturing based on a set of core ontological foundations and semantic mapping approaches. The formal core foundations are modelling in Web Ontology Language (OWL) and specialised to perform multiple specific applications based on Product and Manufacturing Models. The specific applications were used to support the information sharing between product design and manufacturing and verify the satisfaction of product constraints. In addition, the framework supports the mechanism as it allows the reconciliation of semantics in terms of sharing, conversion and translation, providing knowledge sharing capability between heterogeneous domains. This framework has been particularly instantiated for the design and manufacturing of plastic injection moulded rotational products and has explored the particular viewpoints of moldability, mould design and manufacturing. The research approach explored particular information structures to support Design and Manufacture application. Subsequently, the relationships between these information structures have been investigated and the semantics reconciliation has been designed through mechanisms to convert, share and translate information from the multi-perspectives. An experimental system has been performed using the Protégé tool to model the core ontologies and the Java platform integrated with the Jena to develop the interface with the user. In addition, a SolidWorks plug-in has been implemented to capture the information from the part model and to export it into the java application, adding information from the framework to the part model. The conceptual framework proposed in this research has been tested through experiments using rotational plastic products. Therefore, this research has shown that information rigorously-defined and their well-defined relationships can ensure the effectiveness of product design and manufacturing in a modern and collaborative PDP.

Keywords: Product Design and Manufacturing; Product Development Process; Multiple Domains; Product Constraints; Semantic Interoperability; Formal Model; Model-Driven Ontology.

RÉSUMÉ

La compétitivité toujours plus importante et la mondialisation ont mis l'industrie manufacturière au défi de rationaliser les différentes façons de mettre sur le marché de nouveaux produits dans un délai court, avec des prix compétitifs tout en assurant des niveaux de qualité élevés et la customisation. Le Processus de Développement de Produit (PDP) moderne exige simultanément la collaboration de plusieurs groupes de travail qui assurent la création et l'échange d'information avec des points de vue multiples dans et à travers les frontières institutionnelles. Dans ce contexte, des problèmes d'interopérabilité sémantique (interprétation erronée et erreurs) ont été identifiés en raison de l'hétérogénéité des informations liées à des points de vue différents et leurs relations pour le développement de produits. Dans ce contexte, le travail présenté dans ce mémoire propose un cadre conceptuel d'interopération pour la conception et la fabrication de produits. Ce cadre est basé sur un ensemble d'ontologies clés, de base d'ingénierie et sur des approches de cartographie sémantique. Les informations structurantes associées sont modélisées en *Web Ontology Language* (OWL) et spécialisées en fonction du produit de façon à supporter une base d'application spécifique en modèle produit ou modèle de fabrication. Les bases spécifiques d'application sont utilisées pour soutenir le partage de l'information entre la conception et la fabrication de produits et vérifier la conformité avec les contraintes de produit. En outre, le cadre soutient les mécanismes qui permettent la conciliation sémantique en termes de partage, conversion et traduction, tout en améliorant la capacité de partage des connaissances entre les domaines hétérogènes qui doivent interopérer. La recherche a particulièrement porté sur la conception et la fabrication de produits tournants en plastique et explore les points particuliers de la *malleabilité* - la conception et la fabrication de moules. L'approche adoptée a exploré notamment des structures d'information pour soutenir l'application de la conception et de la fabrication. Par suite, les relations entre ces structures d'information sont étudiées et la réconciliation sémantique est atteinte grâce à des mécanismes pour convertir, partager et traduire des informations liées à des points de vue multiples. Un système expérimental a été proposé à l'aide de l'outil Protégé pour modéliser des ontologies de base et d'une plateforme Java intégrée à Jena pour développer l'interface avec l'utilisateur. En outre, un plug-in en SolidWorks a été mis en œuvre pour capturer les informations à partir du modèle 3D ou d'ajouter des informations au modèle. Le concept et la mise en œuvre de cette recherche ont été testés par des expériences en utilisant des produits tournants en plastiques. Les résultats ont montré que l'information et ses relations rigoureusement définies peuvent assurer l'efficacité de la conception et la fabrication du produit dans un processus de développement de produits moderne et collaboratif.

Mots clés : Conception et fabrication de Produit; Processus de Développement de Produit; Multi-Domains; Contraintes Produit, Interopérabilité Sémantique; Modèle Formel; Modèle Orienté Ontologie

RESUMO

A competitividade global tem desafiado a indústria de manufatura a racionalizar diferentes maneiras de trazer para o mercado novos produtos em um curto prazo de entrega, com preços competitivos, assegurando simultaneamente os níveis de qualidade e personalização. O moderno Processos de Desenvolvimento de Produto (PDP) tem exigido concomitantemente colaborações de vários grupos, produzindo e trocando informações de múltiplas perspectivas dentro e através das fronteiras institucionais. No entanto, tem se identificado problemas de interoperabilidade semântica (interpretações incorretas e erros) devido à heterogeneidade das informações oriundas de várias perspectivas e suas relações em todo o desenvolvimento do produto. Neste contexto, esta pesquisa propõe um *framework* conceitual para o projeto de produto e manufatura interoperáveis com base em um conjunto de conceitos e mapeamento semânticos em uma abordagem ontológica. O *framework* tem no topo conceitos fundamentais modelados formalmente em *Ontology Web Language*. Os conceitos fundamentais formais são especializados de acordo com os Modelo Produto ou Manufatura em um domínio específico de aplicação. Este domínio de aplicação específicos são utilizados para suportar as trocas de informação entre o design e manufatura do produto e para verificar a conformidade com as restrições de produtos. Além disso, o *framework* fornece mecanismos, que permitem a reconciliação semântica, em termos de compartilhamento, conversão e tradução de informações, melhorando a capacidade de troca de conhecimentos entre domínios heterogêneos que precisam interoperar. A investigação centrou-se na concepção e fabricação de produtos plásticos rotacionais moldados por injeção, explorando os pontos de vista particulares de moldabilidade e projeto e fabricação de moldes. Assim, a pesquisa explorou estruturas de informações particulares destes domínios para suportar a interoperabilidade no seus projetos e manufaturas. Além disso, as relações entre essas estruturas de informação têm sido investigados e reconciliações semânticas foram concebidas por meio de mecanismos de conversão, compartilhamento e tradução das informações oriundas de múltiplas perspectivas. Um sistema experimental foi desenvolvido, utilizando a ferramenta Protégé para modelar as ontologias dos fundamentos e a plataforma Java integrado com o Jena para desenvolver a interface com o usuário. Além disso, um plug-in para o SolidWorks foi implementado para capturar as informações dos modelo das peças e exportados para a aplicação Java, possibilitando o enriquecimento com informações e relacionamentos semânticos para suportar o projeto do produto. O *framework* conceitual proposto nesta pesquisa foi testado através de experimentos usando produtos plásticos rotacionais. Portanto, essa pesquisa mostrou que a estrutura de informações e suas relações rigorosamente definidas podem garantir a eficácia do projeto e manufatura de produtos em um ambiente moderno e colaborativo de PDP.

Palavras-Chave: Projeto e Manufatura de Produto; Processo de Desenvolvimento de Produto; Múltiplos Domínios; Requisitos de Produto (Restrições), Interoperabilidade Semântica; Modelos Formais e Modelos Dirigidos à Ontologia.

LIST OF ILLUSTRATION

Figure 1	Product Development Process, Multiple Domains of Knowledge and Product Constraints Interdependence.	31
Figure 2	Technical Procedures adopted for the research.	33
Figure 3	Chart of Global Product Cost engaged.	39
Figure 4	Unified Model.	44
Figure 5	Part of Product Model in UML.	46
Figure 6	Design Oriented Feature Structure.	50
Figure 7	Typical Scheme of Design by Features.	53
Figure 8	Typical Scheme of Feature Recognition.	56
Figure 9	Main ontologies languages.	59
Figure 10	Illustration of ontology integration.	64
Figure 11	Illustration of ontology alignment.	65
Figure 12	Illustration of ontology articulation/conversion.	65
Figure 13	Illustration of ontology transformation.	65
Figure 14	Dependence relations in the Product Development Process.	69
Figure 15	Semantic Information Interoperability Issues.	70
Figure 16	Reference View architecture.	94
Figure 17	Application Domain View Architecture.	95
Figure 18	Semantic Reconciliation View Architecture.	96
Figure 19	Architecture of the Conceptual Framework for an Interoperable Product Design and Manufacturing.	96
Figure 20	Multiple perspectives in Injection-Moulding.	98
Figure 21	Architecture of the Conceptual Framework for an Interoperable Product Design and Manufacture applied to Rotational Thin-Wall Injected Plastic Products.	99
Figure 22	Reference view in the conceptual framework.	101
Figure 23	Structure of the Reference View Core Ontologies.	102
Figure 24	Core concepts in the mouldability core to support a rotational thin wall injected plastic products.	104
Figure 25	Rotational mouldability features taxonomy based on features technology.	105

Figure 26	Mouldability data structure for rotational injected plastic products.	106
Figure 27	Geometric information needed in the mouldability of rotational plastic products.....	107
Figure 28	Detail of relationships between Rotational primary features and Rotational transition features.....	108
Figure 29	Primary features and transition features in rotational plastic products.	108
Figure 30	Relationships between rotational primary features and gate features and primary features and ejection features.	109
Figure 31	Gate and Ejection Features in Plastic Injected Products.	110
Figure 32	Detail of relationships between Rotational primary features and Parting Line features.	110
Figure 33	Variations of relationships between Rotational primary and Parting Line features.....	111
Figure 34	Knowledge Engineering Methodology.	112
Figure 35	Transition from the UML model to the Core Ontology.	113
Figure 36	Core concepts needed in the Rotational mould design core to support a Rotational thin wall injected plastic products.....	115
Figure 37	Mould Design top-level data structure highlighting the impression system.	117
Figure 38	Rotational Cavity Insert Design Data Structure.....	117
Figure 39	Rotational Core Insert Design Data Structure.	118
Figure 40	Core insert geometric information in the data structure.	119
Figure 41	Core insert geometry information.	120
Figure 42	Detail of Core insert main body geometric information in the data structure.	121
Figure 43	Core insert main body geometry information.	122
Figure 44	Detail of cavity insert geometric information in the data structure.....	122
Figure 45	Cavity insert geometry information.....	123
Figure 46	Detail of cavity insert geometric information in the data structure.....	124
Figure 47	Cavity insert main body geometry information.	124
Figure 48	Parting line location in the mould.	125
Figure 49	Rotational Mould Design Core Ontology - Cavity Insert Detail.....	127
Figure 50	Rotational Mould Design Core Ontology - Core Insert Detail.....	128

Figure 51	Mould manufacturing data structure.....	129
Figure 52	Rotational Cavity Insert (Cavity Insert Profile + Cavity Insert Main Body).....	131
Figure 53	Rotational Core Insert (Core Insert Profile + Core Insert Main Body) ..	133
Figure 54	Mould Manufacturing (Core Insert and Cavity Insert) Core Ontology...	133
Figure 55	Part of Material Data Structure.....	135
Figure 56	Material Core Ontology.	136
Figure 57	Application Domain View in the conceptual framework.....	137
Figure 58	Relationships between Reference View and Application Domain View.....	138
Figure 59	Controlled Specialisation Approach.....	141
Figure 60	Example of Individual Data Property.	141
Figure 61	Flexible Specialisation Approach.....	143
Figure 62	Simple Instantiation Approach.....	144
Figure 63	Semantic Reconciliation View in the conceptual framework.	145
Figure 64	Stages of Semantic Reconciliation View.	146
Figure 65	Adjusting Core Contexts to Specific Domains Contexts.....	147
Figure 66	Ontology Intersection Process.....	147
Figure 67	Semantic Alignment Process.....	148
Figure 68	Detailing the Semantic Mapping.....	150
Figure 69	Semantic Mapping based on Foundation Semantics.	151
Figure 70	Instance Semantic Mapping in intra-Domain Application View.	152
Figure 71	Semantic rule between Rotational primary features and Rotational wall parallel to the Parting Line.	153
Figure 72	Semantic rule between Rotational primary features and Rotational wall perpendicular to the parting line.....	154
Figure 73	Semantic rule between Rotational primary features and Rotational wall taper to the Parting Line.....	155
Figure 74	Semantic rule for the relationships between Primary Features and Transition Features.....	156
Figure 75	Example of semantic rule for the relationships between Transition Features and Primary Features.....	156
Figure 76	Semantic rule for the relationships between Offset feature and Fillet	

	feature.	157
Figure 77	Semantic rule for the relationships between Fillet Feature and Rotational Joint Wall for the minimum external radius.	159
Figure 78	Semantic rule for the relationships between Fillet Feature and Rotational Joint Wall for the minimum internal radius.	160
Figure 79	Semantic rule for the relationships between Primary features and Primary features with offset for the internal direction.	162
Figure 80	Semantic rule for the relationships between Transition features and Transition features with offset for the internal direction.	163
Figure 81	Selected Parting Line alternative (Plane) explored in the research.	164
Figure 82	Semantic rule for the relationships between Primary features and Primary features with offset for the internal direction.	165
Figure 83	Semantic rule for the relationships between Cavity insert straight line and Cavity insert perpendicular, parallel and taper straight line.	167
Figure 84	Semantic rule for the relationships between the External profile of the Cavity insert straight line with perpendicular, parallel and taper straight line.	168
Figure 85	Semantic rule for the relationships between Core insert straight line with perpendicular, parallel and taper straight line.	170
Figure 86	Semantic rule for the relationships between External core insert straight line with perpendicular, parallel and taper straight line.	171
Figure 87	Equivalence relation between Core insert main body material and Cavity insert main body material	173
Figure 88	Mould Manufacturing Core Ontology enriched with machining features.	174
Figure 89	Rotational Core Insert Manufacturing Information Detailing.....	176
Figure 90	Semantic Rules applied to Rotational Core Insert and Rotational Core Insert Main Body Manufacturing.....	176
Figure 91	Rotational Cavity Insert Manufacturing Information Detailing.	180
Figure 92	Semantic Rules applied to the Rotational cavity insert and Rotational cavity insert main body manufacturing.	180
Figure 93	Semantic Rules between Mould Manufacturing and Machining Features.	184

Figure 94	Semantic Mapping for support inter-contexts in Application Domain View.	186
Figure 95	Information to be mapped from Design for mouldability to the Cavity and Core design in the Design for tooling.	187
Figure 96	Example of translation from design for mouldability into Design for tooling (cavity insert).	189
Figure 97	Detailing of the Primary features offset profile in the Rotational plastic products.	189
Figure 98	Semantic Rule for mapping the translation of the Mouldability primary features into Cavity straight line – internal offset direction.	190
Figure 99	Semantic Rule for mapping the translation of the Mouldability primary features into Cavity straight line – external offset direction.	191
Figure 100	Detailing of Transition features offset profile in the Rotational plastic products.....	192
Figure 101	Semantic Rule for mapping the translation of the Mouldability transition features into Cavity curve line - external offset direction.	193
Figure 102	Semantic Rule for mapping the translation of the Mouldability transition features into Cavity curve line – internal offset direction.	194
Figure 103	Translation from Design for mouldability into Design for tooling (core insert).	195
Figure 104	Semantic Rule for mapping the translation of the Mouldability primary features into Core straight line – internal offset direction.	196
Figure 105	Semantic Rule for mapping the translation of the Mouldability primary features into Core straight line – external offset direction.	197
Figure 106	Semantic Rule for mapping the translation from Mouldability transition features into Core curve line – internal offset direction.....	198
Figure 107	Semantic Rule for mapping the translation from Mouldability transition features into Core curve line – external offset direction.....	199
Figure 108	Information to be mapped from Design for mouldability to Cavity and Core design in the Design for tooling.	200
Figure 109	Translation from Cavity insert design into Cavity insert manufacturing.....	201
Figure 110	Semantic Rule for mapping the relation between Cavity insert design	

	and Cavity insert manufacturing.....	202
Figure 111	Translation from Cavity insert main body design into Cavity insert manufacturing.....	203
Figure 112	Semantic Rule for mapping the relation between Cavity insert main body design and Cavity insert main body manufacturing.....	203
Figure 113	Translation from Core insert design into Core insert manufacturing. ...	205
Figure 114	Semantic Rule for mapping the relation between Core insert design and Core insert manufacturing.	205
Figure 115	Translation from Core insert main body design into Core insert main body manufacturing.	206
Figure 116	Semantic Rule for mapping the relation between core insert design and core insert manufacturing.....	207
Figure 117	Semantic Rule to the mapping the relation between Mould holes design and Mould holes manufacturing.....	208
Figure 118	Architecture of the experimental system.	211
Figure 119	Rotational mouldability core ontology modelled in Protégé Tool.	212
Figure 120	Detail of the process of loading new core ontology into the IPDMS.....	213
Figure 121	Ontology Class Hierarchy visualisation in the IPDMS.....	214
Figure 122	Overview of the Design for Mouldability interface.	215
Figure 123	Rotational primary geometric profile creation (UML activity diagram).	216
Figure 124	IPDMS Design Assistant to support the primary geometric creation....	217
Figure 125	Primary Geometric Profile Structure of the Rotational Plastic Product.	218
Figure 126	Ontology intersection in the Application Domain View.	219
Figure 127	Information input from the Primary geometric profile stored in the XML file (UML Activity Diagram).....	219
Figure 128	Demonstration of the instantiation process from the Primary geometric profile into the XML file.	220
Figure 129	Rotational primary geometric profile in the IPDMS interface.....	221
Figure 130	Semantic mapping analysis the transition features in the model.	222
Figure 131	Rotational fillet field in the IPDMS.	223
Figure 132	Transition creation between primary features (UML Activity Diagram).....	223

Figure 133	Transition features addition in the IPDMS.....	225
Figure 134	Offset addition in the plastic injected products (UML Activity Diagram).....	225
Figure 135	Offset Features addition in the IPDMS.....	226
Figure 136	Overview of the Design for Tooling Interface.....	227
Figure 137	Material selection and Features importation in the IPDMS tool.	229
Figure 138	Importing Features from Design for Mouldability to Design for Tooling (UML Activity Diagram).....	230
Figure 139	Detailing of the Design for Tooling information visualisation in the IPDMS.	231
Figure 140	Detailing of the hole features in the Design for tooling.....	232
Figure 141	Ejection hole interface in IPDMS.....	232
Figure 142	Ejection and gate holes designs in the Design for Tooling (UML Activity Diagram).	233
Figure 143	Gate hole interface in the IPDMS.....	234
Figure 144	Overview of the Design for Machining Interface.....	235
Figure 145	Importing Features from Design for Tooling into Design for Manufacturing (UML Activity Diagram).	236
Figure 146	Detailing of the Design for Machining information visualisation in the IPDMS	238
Figure 147	Detailing of the Design for Machining semantic mapping visualisation in the IPDMS	238
Figure 148	Overview of the general case study applied in this research.	240
Figure 149	Rotational Plastic Injected Part Representation.	241
Figure 150	Design for Mouldability interface in the IPDMS with Rotational Primary Geometric Information.	242
Figure 151	Design for Mouldability interface in the IPDMS with the transition features and the offset features.....	244
Figure 152	Representations of the Primary and Transition Features in the Product Part Model.....	245
Figure 153	Overview of the Test Case 1.....	247
Figure 154	Definition of the Product Material in the IPDMS Interface.....	248
Figure 155	Result of the translation process for the Cavity Insert Design.....	248

Figure 156 Cavity Insert Profiles translated from Rotational mouldability features.	250
Figure 157 Overview of the Test Case 2.....	251
Figure 158 Results of the translation process for the Core Insert Design.	252
Figure 159 Core Insert Profiles translated from rotational mouldability features.	254
Figure 160 Overview of the Test Case 3.....	255
Figure 161 Interface for translating Rotational cavity insert design into Machining features in the Cavity insert manufacturing.....	255
Figure 162 Results of the Rotational Cavity translation (Rotational Cavity Manufacturing).	256
Figure 163 Semantic Mappings in the Cavity Manufacturing (Design for Machining).....	257

LIST OF TABLE

Table 1	Approaches and authors of Product Development Process.....	38
Table 2	Product Development Process Models (Part 1).	41
Table 3	Product Development Process Models (Part 2).	42
Table 4	Inclusion/Exclusion criteria used during the systematic review development.	73
Table 5	Structure of Systematic Literature Review in Semantic Information Interoperability in Product Design and Manufacturing.....	74
Table 6	Systematic literature Review on PDP vs. Multiple Domain preliminary results.	75
Table 7	Results of the Systematic literature Review on PDP vs. Multiple Domain, organised by authors.....	76
Table 8	Systematic literature Review on PDP vs. Product Requirements preliminary results.	78
Table 9	Results of the Systematic literature Review on PDP vs. Product Requirements, organised by authors.....	78
Table 10	Related works categorization according to the proposed criteria.....	81
Table 11	References frequency distribution.	84
Table 12	Primary Geometric Profile Semantic Mapping.....	243
Table 13	Primary and Transition Features of the Rotational Plastic Product without offset (external profile) used in the case study.....	244
Table 14	Primary and Transition Features of the Rotational Plastic Product with offset (internal profile) used in the case study.	245
Table 15	Semantic Mappings in the Design for Mouldability.....	246
Table 16	Coordinates of the Cavity Insert after the translation process.....	249
Table 17	Semantic Mappings in the Cavity Insert Design (Design for Tooling)....	249
Table 18	Coordinates of the Core Insert after the translation process.....	252
Table 19	Semantic Mappings in the Core Insert Design (Design for Tooling).	253

ABBREVIATIONS

ADV	Application Domain View
ARM	Assembly Relation Model
AsD	Assembly Design
CAD	Computer-Aided Design
CAE	Computer-Aided Engineering
CAM	Computer-Aided Manufacturing
CAPP	Computer-Aided Process Planning
CAS	Computer-Aided Service
CE	Concurrent Engineering
CL	Common Logic
CLIF	Common Logic Interchange Format
CPM	Core Product Model
CV	Constraint View
DFX	Design for X
DL	Description Logic
DMM	Design Mapping Matrix
DSM	Design Structure Matrix
FOL	First Order Logic
ICT	Information and Communication Technology
IPDMS	Interoperable Product Development System
IPDP	Integrated Product Development Process
KIF	Knowledge Interchange Format
MAFRA	Mapping FRAmework
MDE	Model-Driven Engineering
MPM	Manufacturing Process Management
OKBC	Open Knowledge Base Connectivity
OLA	OWL-Lite Aligner
OWL	Web Ontology Language
PD	Product Development
PDM	Product Data Management
PDP	Product Development Process
PLM	Product Lifecycle Management
PPB	Product Based Business
QFD	Quality Function Deployment
QOM	Quick Ontology Mapping
RBAC	Role-Based Access Control
RDF	Resource Description Framework
RV	Reference View
SNM	Semantic Norm Model
SRV	Semantic Reconciliation View
STEP	Standard for The Exchange of Product model data
SWRL	Semantic Web Rule Language
UML	Unified Modelling Language
XML	eXtensible Markup Language

CONTENTS

1 INTRODUCTION.....	28
1.1 MOTIVATION	28
1.2 RESEARCH HYPOTHESIS.....	29
1.3 RESEARCH STRATEGY	31
1.3.1 Aim and objectives.....	31
1.3.2 Research Methodology.....	32
1.3.3 Research Scope	34
1.3.4 Thesis Structure.....	35
2 LITERATURE REVIEW	36
2.1 PRODUCT DEVELOPMENT DRIVEN INFORMATION INTEROPERABILITY	36
2.1.1 Product Development Process (PDP) definition	36
2.1.2 PDP Models.....	39
2.1.3 Summary of Product Development Driven to Information Interoperability	43
2.2 INFORMATION MODELLING IN PRODUCT DESIGN AND MANUFACTURING	44
2.2.1 Product Model	45
2.2.2 Manufacturing Model	45
2.2.3 Interoperable Product and Manufacturing Models	46
2.2.4 Features technologies for product design and manufacturing information modelling.....	47
2.2.4.1 Feature definition.....	48
2.2.4.2 Feature classification.....	49
2.2.4.2.1 Design-Oriented feature	49
2.2.4.2.2 Application-Oriented feature	51
2.2.4.3 Approaches to feature-based design.....	52
2.2.4.3.1 Design by features.....	53
2.2.4.3.2 Feature Recognition	55

2.2.5 Summary of Information Modelling in Product Design and Manufacturing.....	56
2.3 ONTOLOGY-DRIVEN INTEROPERABILITY	57
2.3.1 Definitions of Ontology.....	58
2.3.2 Ontology Formalisms	59
2.3.3 Components of Ontology	60
2.3.4 Ontologies in Engineering.....	61
2.3.5 Ontology Mapping.....	63
2.3.6 Summary of Ontology Model Driven Interoperability in Product Design and Manufacturing	67
3 RESEARCH CONTRIBUTION FOR SEMANTIC INFORMATION INTEROPERABILITY IN PRODUCT DESIGN AND MANUFACTURING	68
3.1 PROBLEM STATEMENT FOR SEMANTIC INFORMATION INTEROPERABILITY IN PRODUCT DESIGN AND MANUFACTURING	68
3.2 IDENTIFICATION OF THE MAIN RELATED WORKS AND MILESTONES REFERENCES FOR THIS RESEARCH THROUGH A SYSTEMATIC LITERATURE REVIEW	71
3.2.1 Presentation of the Methodology for the Systematic Literature Review.....	72
3.2.2 Systematic Literature Review Implementation.....	73
3.2.2.1 STEP 1a: Scientific papers related to PDP and Multiples Domains	74
3.2.2.2 STEP 1b: Scientific papers related to PDP and Product Requirements (Constraints).....	77
3.2.2.3 STEP 2: Analysis and classification of the papers related to Multiple Domains and Product Requirements to support PDP	80
3.2.2.4 STEP 3: Identification and analysis of the main researches and the milestone references for this research.	83
3.2.3 Synopses of main researches and guidelines to the conceptual framework	85

3.3	PROPOSAL OF CONCEPTUAL FRAMEWORK FOR SEMANTIC INFORMATION INTEROPERABILITY IN PRODUCT DESIGN AND MANUFACTURING	92
3.3.1	Conceptual framework for semantic information interoperability in Product design and manufacturing: a general approach.....	92
3.3.2	Conceptual framework for semantic information interoperability in Product design and manufacturing: specialised approach to rotational plastic injected products.....	97
4	CONCEPTUAL FRAMEWORK FOR SEMANTIC INFORMATION INTEROPERABILITY IN PRODUCT DESIGN AND MANUFACTURING: REFERENCE VIEW	101
4.1	ROTATIONAL MOULDABILITY CORE ONTOLOGY.....	103
4.1.1	Illustrating examples used in the research.....	103
4.1.2	Rotational mouldability data structure.....	105
4.1.2.1	Geometric information perspective.....	107
4.1.2.2	Mouldability Parting Line information perspective	110
4.1.3	Translation from Rotational Mouldability Data Structure into Rotational Mouldability Core Ontology.....	111
4.2	ROTATIONAL MOULD DESIGN CORE ONTOLOGY	114
4.2.1	Illustrating examples used in the research.....	115
4.2.2	Rotational mould design data structure	116
4.2.2.1	Rotational core insert geometric information perspective.....	119
4.2.2.2	Rotational core insert main body geometric information perspective	120
4.2.2.3	Rotational cavity insert geometric information perspective ...	122
4.2.2.4	Rotational cavity insert main body geometric information perspective	123
4.2.2.5	Parting Line information in the Mould design perspective	125
4.2.3	Translation from Rotational Mould Design Data Structure into Rotational Mould Design Core Ontology	125
4.3	MOULD MANUFACTURING CORE ONTOLOGY	129

4.3.1	Geometric information of the Cavity insert manufacturing perspective	130
4.3.2	Geometric information of the Core insert manufacturing perspective	131
4.3.3	Translation from Mould Manufacturing Data Structure into Mould Manufacturing Core Ontology.....	132
4.4	MATERIAL CORE ONTOLOGY	134
5	CONCEPTUAL FRAMEWORK FOR SEMANTIC INFORMATION INTEROPERABILITY IN PRODUCT DESIGN AND MANUFACTURING: APPLICATION DOMAIN VIEW	137
5.1	CONTROLLED SPECIALISATION APPROACH	140
5.2	FLEXIBLE SPECIALISATION APPROACH	142
5.3	SIMPLE INSTANTIATION APPROACH	143
6	CONCEPTUAL FRAMEWORK FOR SEMANTIC INFORMATION INTEROPERABILITY IN PRODUCT DESIGN AND MANUFACTURING: SEMANTIC RECONCILIATION VIEW	145
6.1	DOMAIN ADJUSTMENT CONTEXT PROCESS	146
6.2	ONTOLOGY INTERSECTION.....	147
6.3	SEMANTIC ALIGNMENT PROCESS.....	148
6.4	SEMANTIC MAPPING.....	150
6.4.1	Semantic Mapping to support the relationships intra-contexts in the Application Domain View	151
6.4.1.1	Foundation semantic for the semantic mapping in Design for Mouldability.....	153
6.4.1.1.1	Semantic Mapping between primary features and rotational wall parallel to the parting line	153
6.4.1.1.2	Semantic Mapping between Primary features and Rotational wall perpendicular to the Parting Line ...	154
6.4.1.1.3	Semantic Mapping between Primary features and Transition features	155
6.4.1.1.4	Semantic mapping in Modifying features.....	157

6.4.1.1.5	Semantic mapping between Primary features and Parting line.....	164
6.4.1.2	Foundation semantic for the semantic mapping in Design for Tooling.....	166
6.4.1.2.1	Semantic mapping between Cavity insert straight line and Cavity insert parallel, perpendicular and taper straight line	166
6.4.1.2.2	Semantic mapping between External cavity insert straight line and External cavity insert parallel, perpendicular and taper straight line	168
6.4.1.2.3	Semantic mapping between Core insert straight line and Core insert parallel, perpendicular and taper straight line	169
6.4.1.2.4	Semantic mapping between External core insert straight line and External core insert parallel, perpendicular and taper straight line	171
6.4.1.2.5	Semantic mapping between Core insert material and Cavity insert material	172
6.4.1.3	Foundation semantic for the semantic mapping in Design for Manufacturing.....	173
6.4.1.3.1	Semantic mapping in Core insert manufacturing and Core insert main body manufacturing.....	175
6.4.1.3.2	Semantic mapping for Cavity insert manufacturing and Cavity insert main body manufacturing	179
6.4.1.3.3	Semantic mapping between Mould manufacturing core ontology and Machining features core ontology	183
6.4.2	Semantic mapping for support the inter-contexts relationships in the Application Domain View	185
6.4.2.1	Semantic mapping between Design for mouldability and Design for tooling.....	186
6.4.2.1.1	Semantic mapping between Design for mouldability and Cavity insert design	187
6.4.2.1.2	Semantic mapping between Design for mouldability	

and Core insert design	195
6.4.2.2 Semantic mapping between Design for tooling and Design for machining	200
6.4.2.2.1 Semantic mapping between Cavity design features and Cavity manufacturing.....	201
6.4.2.2.2 Semantic mapping between Cavity design main body features and Cavity main body manufacturing	202
6.4.2.2.3 Semantic mapping between Core design features and Core insert manufacturing	204
6.4.2.2.4 Semantic mapping between Core main body design features and Core main body manufacturing	205
6.4.2.3 Semantic mapping between Mould holes design and Mould holes manufacturing	207
7 EXPERIMENTAL SYSTEM DEVELOPMENT	209
7.1 EXPERIMENTAL SYSTEM DESIGN	209
7.2 EXPERIMENTAL SYSTEM IMPLEMENTATION	211
7.2.1 Reference View Implementation	212
7.2.2 Application Domain and Semantic Reconciliation Views Implementation in Design for Mouldability	214
7.2.2.1 Rotational primary geometric profile creation	216
7.2.2.2 Specialisation in the Application Domain View to support Design for Mouldability: Addition of Primary Geometric Profile	218
7.2.2.3 Specialisation in the Application Domain View to support Design for Mouldability: Transition Features and Offset Features Addition	221
7.2.3 Implementation of the Application Domain and Semantic Reconciliation Views in the Design for Tooling	227
7.2.3.1 Product geometric profile importing process from Design for Mouldability to Design for Tooling.....	228
7.2.3.2 Core and cavity inserts information exhibition	230
7.2.3.3 Gate hole and ejection hole design in the Design for Tooling....	

.....	231
7.2.4 Implementation of the Application Domain and Semantic Reconciliation View in the Design for Machining	234
7.2.4.1 Core and Cavity insert profile importing process from Design for Tooling into Design for Machining	236
7.2.4.2 Core and cavity insert manufacturing information visualisation.	237
8 CASE STUDY	240
8.1 INITIAL EXPERIMENTAL PRODUCT DATA DEFINITION	241
8.2 TEST CASE 1: DESIGN FOR TOOLING (ROTATIONAL PLASTIC INJECTED PRODUCT VS. CAVITY INSERT DESIGN)	247
8.3 TEST CASE 2: DESIGN FOR TOOLING (PLASTIC INJECTED PRODUCT VS. CORE INSERT DESIGN)	251
8.4 TEST CASE 3: DESIGN FOR MACHINING (CAVITY INSERT VS. CAVITY MANUFACTURING)	254
8.5 EVALUATION OF THE RESULTS	257
9 DISCUSSION, CONCLUSION AND FUTURE WORK	259
9.1 DISCUSSIONS	259
9.1.1 Ontological approach for the information formalisation (Reference View)	259
9.1.2 Specialisation process for building specific Product Knowledge Bases (Application Domain View)	261
9.1.3 Semantic Structures to the information relationships (Semantic Reconciliation View)	262
9.1.4 The experimental system (Interoperable Product Development System – IPDMS)	263
9.2 CONCLUSION	264
9.3 RECOMMENDATIONS FOR FUTURE WORKS	264
PUBLICATIONS	269
REFERENCES	270

APPENDICES.....	291
A.1 CORE ONTOLOGIES.....	292
A1.1 ROTATIONAL PRODUCT MOULDABILITY CORE ONTOLOG.....	292
A1.2 ROTATIONAL MOULD CAVITY INSERT CORE ONTOLOGY.....	293
A1.3 ROTATIONAL MOULD CORE INSERT CORE ONTOLOGY.....	294
A1.4 MOULD MANUFACTURING CORE ONTOLOGY.....	295
A1.5 MACHINING FEATURES CORE ONTOLOGY.....	296
A1.6 MATERIAL CORE ONTOLOGY.....	297
A1.6 MOULD MANUFACTURING CORE ONTOLOGY ENRICHED WITH MACHINING FEATURES.....	298
B.1 PRODUCT DRAWING SHEET.....	299

1 INTRODUCTION

The manufacturing industry has been challenged to rationalise different ways of offering to the market new products in a short lead-time with competitive prices while ensuring higher quality levels and customization. Product Development Process (PDP) is used to speed up the new product launching and markets expansion while fulfilling the customer's demand and desires. Product requirements define the product's characteristics, constraints and their information that must be effectively shared across the PDP different phases without losing any meaning. However, semantic problems can be identified across the PDP as the developers do not use the same product taxonomy, which may cause requirements misinterpretation and mistakes during the product realisation due to the information heterogeneity. In this context, the research focused on the information and knowledge formalisation to support the development of a conceptual framework to provide seamless information interoperability across multiple domains in the PDP.

1.1 MOTIVATION

Product Development Process (PDP) is a set of multidisciplinary activities structured to transform market opportunities, customers' needs and technological constraints in products (ROZENFELD *et al.*, 2006). During the PDP, experts from different fields (mechanical, electrical, software, business) work together and share information, knowledge, and resources to solve the product development issues (PENCIUC *et al.*, 2014). Thus, thousands of heterogeneous information and knowledge are shared simultaneously by different groups within and across institutional boundaries using different formats and models to represent the product in development.

These issues have encouraged the improvement of Product Data Management (PDM) and more recently, the Product Lifecycle Management (PLM). PDM technology is intensively used in industry and today its application is mainly focused on particular product lifecycle phases, e.g., prototyping or production. PLM is an extension of PDM as it manages the product data during the whole product lifecycle and not only for the product definitions (BRUUN *et al.*, 2015). Although PLM

has a holistic view of the whole phases of product lifecycle, it does not consider the meaning associated to each captured information and their relationships across different phases of product lifecycle (CHUNGOORA *et al.*, 2013)

This is a typical semantic interoperability obstacle that concerns the concepts definition and semantic supporting for the communication between data and knowledge models. Interoperability is defined “as the capacity of two or more systems to exchange information and to use the information that has been shared” (IEEE, 1990). Thus, the most common way to support a semantic interoperability is to research integrated solutions through the definition of common information models formally well-defined and their relationships (CANCIGLIERI and YOUNG, 2003; MANARVI and JUSTER, 2004; BARREIRO *et al.*, 2005; ARMILLOTTA *et al.*, 2006; PANETTO, 2007; YANG *et al.*, 2008; YOUNG *et al.*, 2007; CANCIGLIERI and YOUNG, 2010; PANETTO, DASSISTI and TURSI, 2012; CHUNGOORA *et al.*, 2013; LIAO *et al.*, 2016; PALMER *et al.*, 2016).

Product Design and Manufacturing information and knowledge handled across different lifecycle phases have to be efficiently communicated in modern interoperable and collaborative PLM. The knowledge that is developed in design activities is based on Design for Function, Design for Assembly and Disassembly, Design for Manufacturing, Computer Aided Design, Computer Aided Manufacturing, etc. Seamless interoperability is not completely achievable to support an interoperable product design and manufacturing. Solving this issue is an economic lever for many globally distributed industries as the Product Design and Manufacturing impacts in 85% of the product cost (BRUNNERMEIER AND MARTIN, 2002; ROZENFELD *et al.*, 2006).

1.2 RESEARCH HYPOTHESIS

Several resourceful efforts have been fostered to integrate solutions, following product master models through the definition of common information models. This is the way that international standards have been providing the basis for product information exchange, e.g. STEP PLCS (ISO 10303-239, 2005). Related works such as OntoSTEP (BARBAU *et al.*, 2012), PRONOIA (DEMOLY *et al.*, 2012), Interoperable Manufacturing Knowledge System (IMKS) (CHUNGOORA *et al.*, 2013),

Semantic Annotation applied to PLM (LIAO *et al.*, 2015) and OntoSTEP-NC (DANJOU *et al.*, 2016) indicate that there is a tendency to explore the use of Semantic Web ontology languages, like the Web Ontology Language (OWL) to model the knowledge of product and manufacturing in core or reference concepts. Such core concepts may include the semantics associations for the definition of product features and manufacturing process from several viewpoints that may arise in design and manufacturing. However, working with multiple domains is a significant problem since it is necessary to find effective and technical methods for semantical mapping information across related domains during the PDP (SZEJKA *et al.* 2016). It was also observed that current works do not entirely address the rules to establish an analysis of PDP. In the beginning of PDP, the product characteristics and specifications are defined and must be respected across product development and must be effectively shared across different PDP phases without losing any meaning (BKCASE, 2016). These constraints have relevant information about the customer's needs, technological data, standards, etc., and create associations with different concepts. Thus, product design limitations create associations, i.e. links, to share, transform and translate information between design and manufacturing across all phases of PDP.

Figure 1 illustrates the interdependence among Product Development Process (Detail "A"), Multiple Domains of Knowledge (Detail "B") and Product Constraints (Detail "C") in the interoperable product design and manufacturing. Therefore, the information and knowledge handling in an Interoperable Product Design and Manufacturing requires **(a) formal information and knowledge structures to ensure the correct meaning associated to the captured information;** and **(b) formal well-defined relationships to ensure the correct interchangeable information and knowledge across the product development.** Two hypotheses based on these two statements are highlighted:

(H1): The framework is able to cope with heterogeneous information from multiple domains (see chapter 2 – section 2.1) in the Product Design and Manufacturing (see Chapter 3 – Detail "D" of Figure 16) based on a rigorously-defined set of shareable core concepts formalised in an ontological approach (see Chapter 3 – Detail "A" of Figure 16) and applicable in a semantically interoperable manner (see Chapter 3 – Detail "B" of Figure 16);

(H2): The framework can deal with heterogeneous information relationships from multiple domains concerning Product Design and Manufacturing (see Chapter 3 – Detail “D” of Figure 16) via sets of interoperable mapping mechanisms (semantic rules) for sharing, converting and translating information (see Chapter 3 – Detail “C” of Figure 16).

Figure 1 Product Development Process, Multiple Domains of Knowledge and Product Constraints Interdependence.

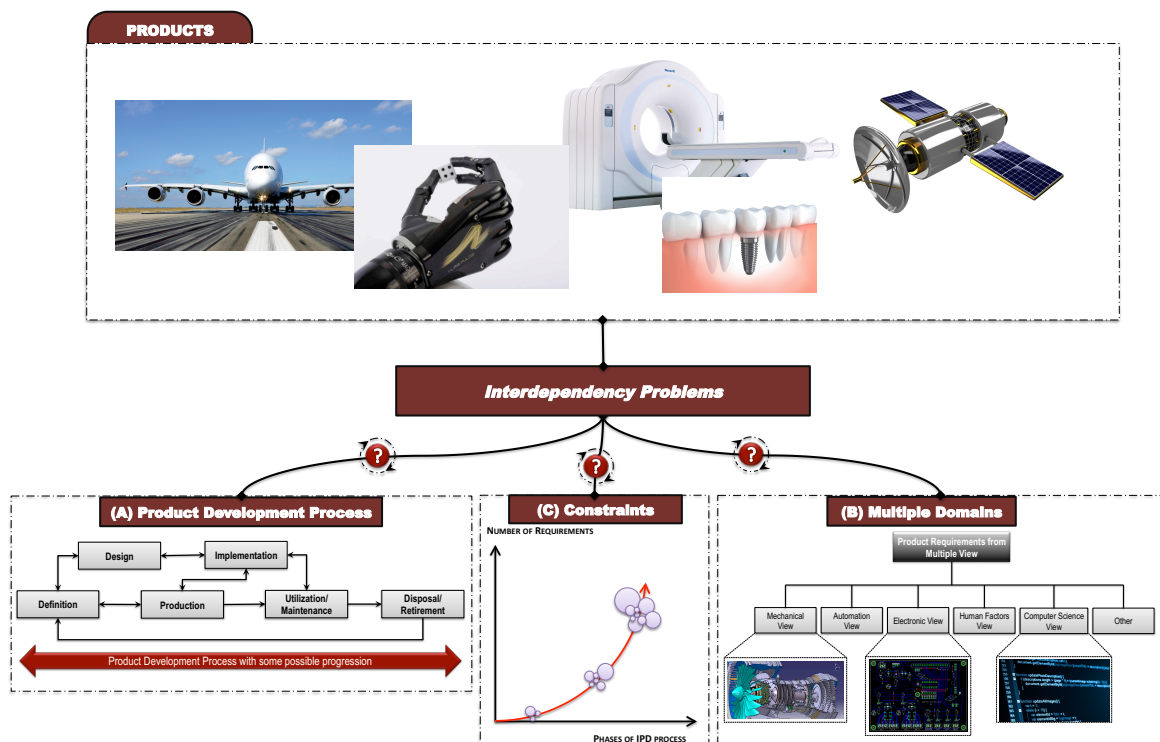

1.3 RESEARCH STRATEGY

1.3.1 Aim and objectives

The aim of this thesis is to develop a conceptual framework to support the information interoperability (sharing, conversion and translation) across multiple domains in product design and manufacturing based on an ontological approach. This research provides a contribution in the area of decision support systems based on the use of product and manufacturing model to provide seamless information interoperability for design and manufacturing activities. The

design for manufacturing of injection moulded products has been taken as the application focus for the research.

Five key objectives are defined to meet the aim of this research:

- i. To understand the key research gaps to formalise, through the literature review, the information from multiple domains in a rigorously defined set of information core concepts to support the interoperability in product design and manufacturing;*
- ii. To understand the key research gaps to well define the heterogeneous information relationships to support the interoperability in product design and manufacturing in light of the information sharing, conversion and translation;*
- iii. To propose conceptual ontology-driven interoperable mechanisms to support the information interoperability across multiple domains in product design and manufacturing;*
- iv. To develop an experimental system for implementing the framework;*
- v. To evaluate the developed experimental system through case studies, validating the framework concepts.*

1.3.2 Research Methodology

Firstly, it is important to characterise the research based on its science, approach and objective in order to define secondly the more suitable technical procedure. So, this research can be considered as applied science since it aims to understand, explain and produce knowledge, which can be applied to solve semantic information interoperability issues in manufacturing industries based on existing theories (LACERDA, 2007).

The used research approach is qualitative because qualitative studies seek to gain an in-depth understanding of a specific phenomenon through descriptions and

exploratory interpretations to provide greater familiarity about a specific problem (MIGUEL *et al.*, 2010). Furthermore, this approach makes use of interpretation techniques that describe, decode and translate any term related to the understanding of requirements. Thus, this research seeks to comprehend the key research gaps through a systematic literature review to understand the scientific issues to support the semantic information interoperability across PDP.

The scientific objective is exploratory because it provides more knowledge of the phenomenon for which the definition or problem is not explicitly stated. Additionally, new variables need to be evaluated to understand how they impact into the problem solution. All concepts about PDP, specifically product design and manufacturing, and ontology-driven interoperability must be explored through the literature review. The technical procedure was adopted based on the research characteristics and it consisted of literature review (detail “A” of Figure 2) and experimental development (detail “B” of Figure 2).

Figure 2 Technical Procedures adopted for the research.

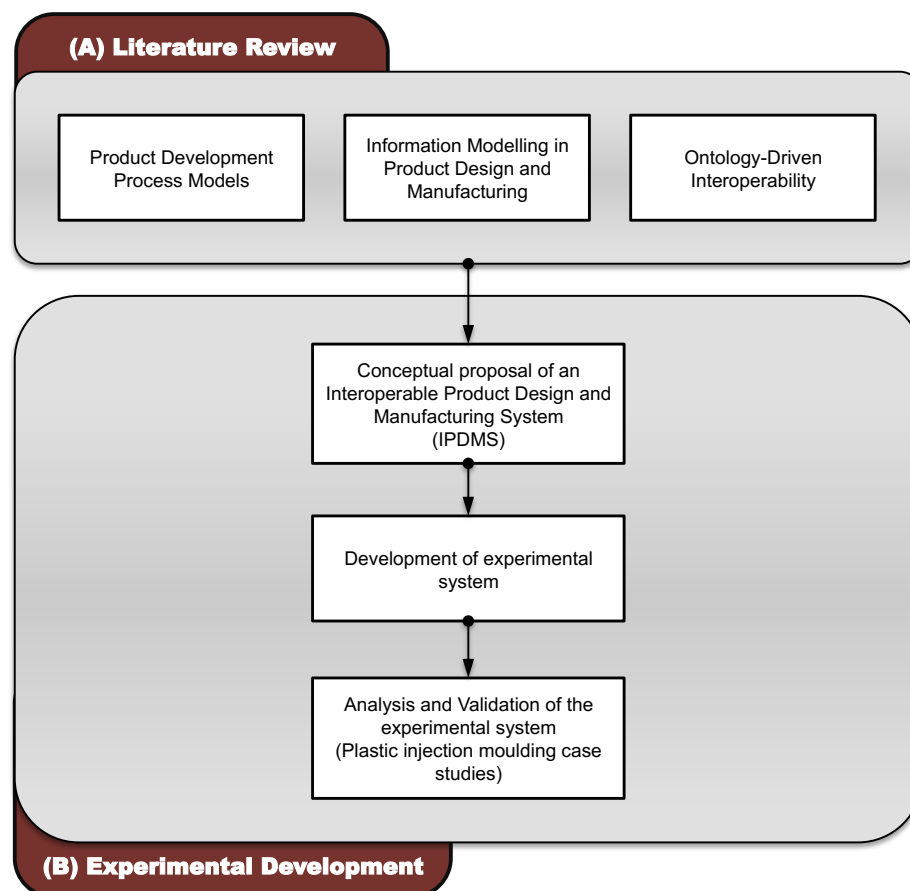

The background technologies of PDP Models, Information Modelling in Product Design and Manufacturing and Ontology-Driven Interoperability are investigated in the literature review for acquiring new insights to define the best approaches to solve the key research gaps, as shown in detail “A” of Figure 2. A conceptual framework, based on the literature review, is then proposed and validated in an experimental environment, as shown in detail “B” of Figure 2. The experimental environment was used because the object of the study must be firstly defined and then the variables controlled process must be identified to evaluate the framework performance and to validate the results (YIN, 2009).

1.3.3 Research Scope

The proposed conceptual framework for an interoperable product design and manufacturing has a general approach as it can be applied to a wide range of situations. However, nowadays, most of the product’s parts or even the products are manufactured via plastic injection moulding process. Plastic injection moulding products is a problematic and pricey process to industries since several variables and implicit information are involved during the product manufacturing and must be considered concomitantly. The shrinkage rate is an example of the process complexity as each material has a different rate and impacts directly the product mouldability design.

In this context, the research scope focused on a specific rotational thin-wall injected plastic product, taking into account the information interoperability across product design and manufacturing and their relationships. Thus, the general conceptual framework was specialised into the conceptual framework applied to the rotational thin-wall plastic injected products, using mouldability design domain, mould design domain, manufacturing domain and material domain. They constituted the key core concepts shared across design for mouldability, design for tooling and design for machining.

1.3.4 Thesis Structure

The thesis has been structured into 9 Chapters aiming the achievement of the objectives presented in item 1.3.1. This Chapter sets the research context, hypothesis and aims for the readers. Chapter 2 presents a literature review about PDP models and information modelling in Product Design and Manufacturing regarding data models, product and manufacturing models, and design for manufacturing, feature technologies and Ontology-Driven Interoperability in terms of concepts formalisation and mapping formalisation.

Chapter 3 presents the research's state-of-the-art and contributions with the most relevant works and the milestones references as well as the proposal of a conceptual interoperable product design and manufacturing framework. Moreover, the main issues relating to interoperable product design and manufacturing of injection moulded rotational product are highlighted and discussed. The development of the proposed conceptual framework architecture (Reference View, Application Domain View and Semantic Reconciliation View) is presented in the next chapters. Chapter 4 is dedicated to exploring the Reference View that defines the fundamental data structure of the rotational plastic injected products modelled in core ontologies. Chapter 5 presents the Application Domain View, which is a core ontology specialisation process according to the product characteristics, creating a product applied ontology. Semantic Reconciliation View, chapter 6, is the semantic mapping of the information in order to establish the interoperable information relationships.

Chapter 7 presents the development of the proposed framework experimental prototype. Specific tools such as Protégè, Netbeans, and Jena were used as infrastructure in the experimental prototype building. Chapter 8 presents the Case studies used to corroborate the framework concept. This validation consists in designing and manufacturing of a rotational thin-wall injected plastic product, exchanging information among the plastic moulded product design, the cavity and insert core design and the core insert machining design. Finally, Chapter 9 presents the author's discussion, conclusion and recommendations for further works.

2 LITERATURE REVIEW

This chapter surveys the relevant literature to this research. Section 2.1 discusses the Product Development Process, which supports the collaborative product engineering across the engineering lifecycle. Section 2.2 discusses the System Engineering and Requirement Engineering to provide informational support to Product Development Process in different phases of engineering life cycle. Section 2.3 presents standards and formal approaches to formalise the information and its relationships. Section 2.4 is dedicated to the concept of Ontology-Driven Interoperability.

2.1 PRODUCT DEVELOPMENT DRIVEN INFORMATION INTEROPERABILITY

2.1.1 Product Development Process (PDP) definition

A Product is an object that can be offered to a customer as something tangible (e.g. physical objects) or intangible (e.g. service and software) (MAGRAB *et al.*, 2009; KOTLER *et al.*, 2006) and it is designed to meet the customers' needs as well as the enterprises' needs (SINGH, 2002).

The Product Development Process (PDP) is responsible for transforming customers' needs, enterprises' needs, market opportunities and technological constraints in a product. It has a set of transdisciplinary-structured activities that requires the involvement of specialists with multiple viewpoints within and across the organisation boundaries (ROZENFELD *et al.*, 2006). PDP must meet all constraints initially defined either by customers' needs and enterprises' needs or technological constraints (standards, laws, technical specifications and limitations, etc.).

The PDP systematises the different phases of product lifecycle development, meeting the functional and non-functional requirements. The literature shows us different perspectives of PDP, such as:

Clark and Fujimoto (1991):

It is a process by which an organisation transforms the market information opportunities and technological possibilities in advantageous information to manufacture a product.

Urban and Hauser (1993):

It is a decision-making process of five steps: market opportunity identification, design, test, introduction to the market and life cycle management.

Pahl e Beitz (1996):

It is a multifaceted and interdisciplinary activity that results in the planning and clarification of tasks [...] for the final documentation of the product.

Smith (2002):

It is the process that converts customers' needs and requirements in information in order to produce a product or technical system.

Rosenfeld *et al.* (2006):

It is a business process consisted of a set of activities that seek, from the needs of the market and from the technological possibilities and constraints, as well as considering the companies' competitive strategies and strategies for the product, to reach a product design specifications and its manufacturing process [...] it involves the activities that accompany the product after its launching [...].

This research adopted the approach that the PDP has the continuous involvement of multiple knowledge domains and multiple relationships across all phases of the product lifecycle development. This approach was taken because the customer profile requires novel products with new technologies, shapes, characteristics, functionalities, etc. Therefore, modern PDP must be collaborative and interoperable (SOSA, EPPINGER and ROWLES, 2004).

Projects of satellites, aeroplanes, and vehicles are developed by enterprises conglomerate in different countries and the information exchanging must be effectively accurate. However, several pieces of evidence of misinterpretation and semantic obstacles are presented in the research of Penciu *et al.* (2014). PDP must have a systematised approach of the project to drive the whole phases of development (conceptual design, detail design, manufacturing design, etc.) to achieve the solution of the final product in an efficient way (costs, time, quality)

(UNGER and EPPINGER, 2011). In this context, Pereira (2014) apud El Marghani (2011) mapped different approach used in PDP, as illustrated in Table 1.

Table 1 Approaches and authors of Product Development Process.

Approach	Characteristics	Authors
Concurrent Engineering (CE)	Concatenation of interdependent steps, simultaneity between of them and process control tools adapted according to the needs.	Clark and Fujimoto (1991) Miller (1993) Prasad (1996) Hubka and Eder (1988) Pahl and Beitz (1996)
Stage-Gates	This approach has the concept of control tests (Gates) associated with the development strategies (Stages).	Cooper (1993) Cooper et al. (2001) Wheelwright e Clark (1992) Clausing (1993)
Integrated Product Development Process (IPDP)	Extend the concepts of concurrent engineering to whole domains of product development, not only to engineering functions.	Andreasen and Hein (1987) Prasad (1997) Pugh (1990) Canciglieri Jr. and Young (2010) El Marghani (2011) Rozenfeld et al. (2006) Pereira (2014) Unhru (2015)
Product Based Business (PBB)	Links the product life cycle to the innovation process	Roozenburg e Eekels (1995) Patterson e Fenoglio (1999) Crawford e Benedetto (2000) Baxter (2011)

Source: Adapted from El Marghani, 2011.

According to Pereira (2014) and Silva (2003), if the information in PDP is well defined, the number of interactions, misinterpretations and semantic obstacles are minimised to achieve the final product. Additionally, the information from the customer's needs, enterprises' needs and technological needs must be unambiguous, consistent, completed, verifiable, measurable, and unique. According to Baxter (2011), the PDP has:

- High level of uncertainties for the activities and results;
- Important decisions must be taken at the beginning of the PDP;
- High flow of heterogeneous information exchange;
- Multiple information and activities are produced by distinct specialists;
- A variety of requirements that must be met by the PDP, considering all stages of the product lifecycle development and product constraints.

The activities during the PDP are costly (85% of the final product cost) and they have high mistakes and uncertainties risks (ROMEIRO, 2010 and ROZENFELD *et al.*, 2006). When the product development is carried out, the uncertainties are reduced and transformed into precise information, but changes in the later phases of PDP are costly and affect the final results, as shown in Figure 3.

Figure 3 Chart of Global Product Cost engaged.

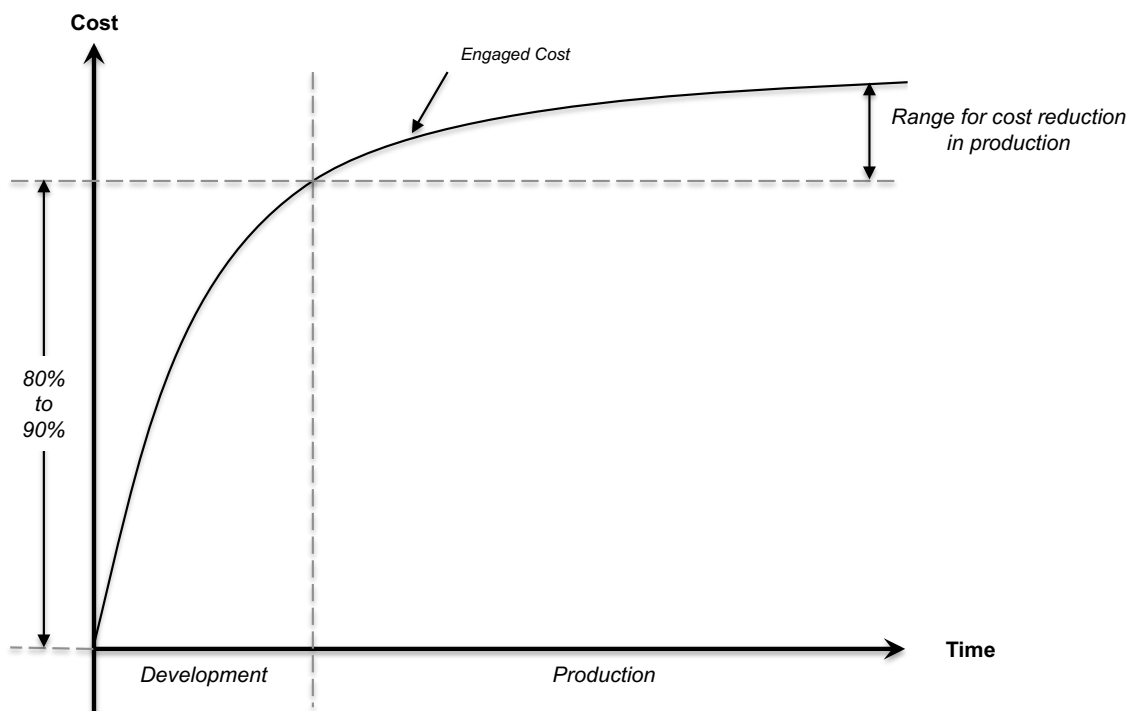

Source: Adapted from Rozenfeld *et al.* (2006).

2.1.2 PDP Models

The Manufacturing industry achieves new markets offering new products in an efficient manner, i.e., the whole customers' needs must be met in a short lead-time with competitive prices. Thus, the PDP is complex, dynamic and hard to integrate, challenging the management system of the process and information exchange mechanisms.

One way to overcome these challenges can be the systematised and well-defined information exchange structure across product development, which is done through the application of systematic and structured models for the PDP (SILVA,

2003). Models are mental constructions that conduct the development of actions to identify solutions to a given problem (MIGUEL *et al.*, 2010). A constructive Model uses known approaches for representing them such as mathematic equations, symbols, natural language descriptions and charts. These approaches enable the idea arrangement and consequently their systematisation. Additionally, according to Kindlein Júnior *et al.* (2003), models and their application are recognised for their research techniques and initiatives to generate procedures and private alternatives to each proposal, converging towards solving problems of customers' needs.

In this context, the distinct PDP approaches, as shown in table 1, have their origin based on different structures according to the application for managing the product development. These models can be simpler, limited only to the product design, or more complex, addressing the product development as a business and systematising the whole phases of development. Thus, table 2 and 3 have the key models from 1980 to 2015, found in the literature by Unruh (2015), Pereira (2014), El Marghani (2011), Romeiro Filho *et al.* (2010), Suarez *et al.* (2009), Jung *et al.* (2008), and Rozenfeld *et al.* (2006), Silva (2003). They were structured in these tables in Pre-Development, Development and Post-Development, allowing the identification of the correspondence between models and the information necessary for each of them. This structure permits the understanding of how information can be formalised to reduce the misinterpretation and mismatches as well as to track their relationships and the inconsistencies in the product development execution.

Normally, the models emphasise the systematisation process and they are oriented according to the phases, beginning with the product's idea definition or needs' definition follow by the definition detailing, creation of the conceptual and detailed design, planning of the manufacturing, launching and maintenance, and finishing with the product disposal or retirement. According to Pereira (2014), many phases are repeated in different models, diverging only in their terminologies. Thus, Table 2 and Table 3 were arranged in a way that terminologies are grouped in a unique column, allowing the identification, by comparison, of those that are equal which facilitates the formation of a general consensus about the whole product development process.

Table 2 Product Development Process Models (Part 1).

Macro Phases	Pre-Development			Development									Post-Development						
Phases	Planning			Design					Implementation				Delivery		Maintenance				
Stages	1	2	3	4	5	6	7	8	9	10	11	12	13	14	15	16			
Authors																			
Asimow (1962)	Customers Needs	Feasibility Study					Preliminary Design	Detailed Design			Manufacturing Planning		Delivery Planning			Utilization Planning	Retirement Planning		
Archer (1968)	Establish a programation			Data Survey		Analysis	Development						Communication						
Cain (1969)	Research		Conception of Design	Product Desing			Product Development			Tests	Production Documentation								
Kotler (1974)	Brainstorming	Brainstorming evaluation		Concept Development and Test		Marketing Strategy	Market Analysis	Develop Product						Market Tests	Commercialize				
Jones (1976)	Divergence			Transformation				Convergence											
Pahl & Beitz (1977)	Task	Task Planning					Concept Design	Realisation Design	Detailed Design	Solution and Documentation									
Bonsiepe (1978)	Identification of Customers Needs	Analysis	Conception of Problem	Requirements Survey	Problem Detailing		Problem Rank	Solution Analysis	Solutions Proposes	Solution Selection	Detail	Prototype	Evaluate	Prototype changing	Pre-series manufacturing				
Crawford (1983)	Opportunities Evaluation						Concept Design	Concept Evaluate	Development						Product Launch				
Back (1983)				Feasibility Study and Concept Design			Preliminary Design	Detailed Design	Review and Tests	Manufacturing Planning		Marketing Planning			Planning of Consumption and Maintenance	Retirement Planning			
VDI 2221 (1985)	Task	Task Planning	Task Checking	Elements of solution			Structure to the development	Function Customization	Product Customization	Information Detailing						Product Launch			
Andreassen & Hein (1987)	Research of Customers Needs			Elements of Product		Product Design					Manufacturing Planning				Production				
Sush (1988)	Identification of Customers Needs	Functional Requirements		Product Attributes					Prototyping				Production						
Vincent (1989)	Brainstorming			Preliminary Study					Laboratory Model	Development / Pilot Production / Engineering	Tests		Production				Product Launch		
Clark & Fujimoto (1991)	Product Conception			Product Planning					Product Design		Manufacturing Project								
Pugh (1991)	Specification of Product Design						Concept Design		Detailed Design				Manufacturing						
Wheelwright & Clark (1992)	Creation and Development of idea			Requirements Definition and Design Detailing					Development		Pilot Production				Product Launch				
Ullman (1992)	Planning						Concept Design		Product Design (Documentation)				Production						
Rosenthal (1992)	Brainstorming			Ideas Validation				Concept Design	Specification and Project			Production of Prototype and Tests							
Cooper (Stage Gate) (1993)	Brainstorming	Stage 1 Preliminary Research	Stage 2 Detailed Research	Stage 3 Development					Stage 4 Validation and Tests		Stage 5 Production and Launch								
Bürdek (1994)	Problem Identification	Situation Analysis		Problem Definition	Alternative Generate					Choice evaluate		Realize							

Source: Adapted from Pereira (2014) and Unruh (2015).

Table 3 Product Development Process Models (Part 2).

Macro Phases	Pre-Development			Development									Post-Development					
Phases	Planning			Design						Implementation			Delivery		Maintenance			
Stages Authors	1	2	3	4	5	6	7	8	9	10	11	12	13	14	15	16		
Shullmann (1994)	Preliminary Studies			Creation			3D Models	Achievement	Industrialization									
Ulrich & Eppinger (1995)	Mission Statement			Concept Development			System Design	Detailed Design	Review and Tests	Manufacturing Planning			Product Launch					
Rozenbur & Eeckles (1995)	Problem Analysis			Synthesis of solution	Simulation of Solutions				Project Evaluation									
Clausing (1995)	Concept			Design						Preparation	Production							
Prasad (1997)	Mission Definition			Concept Definition			Product Design	Engineering and Analysis	Prototyping	Planning / Operationalization of Engineering	Operationalization of Production			Production	Improvements, support and Delivery			
Magrab (1997)	Product Definition			Generation of Viable Projects					Project Evaluation	Product Design and Manufacturing	Manufacturing and Assembling							
Cooper & Edgett (1999)	Brainstorming			Informational Design	Conceptual Design	Detailed Design				Manufacturing Planning				Product Launch				
Cooper (2001)	Identification	E1 Market and Scope Definition					E2 Define the Product Specification	E3 Product Development	E4 Product Tests and Evaluation	E5 Production Set Up					Review after Product Launch			
Stuart Pug (2002)	Specification of Product Design						Conceptual Design	Detailed Design				Manufacturing						
V Model (2002)	Business Case	Requirement Definition	System Specification	System Design			Components Design											
	Validation Test	Acceptance Test	System Test	Interface Test			Components Test						Implementation					
PRODIP (2003)			Project Planning	Informational Design	Conceptual Design	Preliminary Design	Detailed Design				Manufacturing Planning			Product Launch	Validation Test			
Lean Product Development (2005)			Strategy Planning	Project Planning	Requirement Analysis	Hardware and Software Design					Elements Evaluation	Pilot Production				Production		
Pahl et al. (2005)							Conception Definition	Pre-Design and Detailed Design					Solution					
Crawford & Benedetto (2006)	Identify and Select Solutions	Concept Generation	Concepts Evaluation	Development											Product Launch			
Rozenfeld et al. (2006)			Strategy Planning	Project Planning	Informational Design	Conceptual Design			Detailed Design				Manufacturing Planning			Product Launch	Product Evaluation	Product Retirement
Cascade Model (2010)	Business Case	Stakeholders Requirements Analysis	System Specification				System and Components Design		Components Construction						Validation Test			
Pereira (2014)	Demand Statement	Scope Definition	Project Planning	Study of Principles		Conceptual Design	Preliminary Design	Detailed Design	Refinement Design	Manufacturing Project	Manufacturing and Finishing of Product	Marketing Planning	Product Launch	Review after Product Launch			Product Retirement	
Unruh (2015)	Identification of Customers Needs	Scope Definition	Strategic Project Planning	Brainstorming of Ideas	Evaluation of Ideas	Conceptual Design	Preliminary Design	Detailed Design	Refinement Design	Manufacturing Project	Manufacturing and Finishing of Product	Marketing Planning	Product Launch	Review after Product Launch	Use Assistance	Product Retirement/Reengineering		

Source: Adapted from Pereira (2014) and Unruh (2015).

As illustrates in the tables 2 and 3, there is a classification in phases and stages. For the classification, there are common consensuses that there are 5 phases, but about the stages, each model has particular characteristics. Additionally, each phase produces specific information that must be exchanged with the following phases, consuming information from the previous ones. Unruh (2015), for example, proposes a model with 16 stages based on different approaches found in the literature to support the PDP towards the ergonomics product design.

2.1.3 Summary of Product Development Driven to Information Interoperability

As discussed in the sections 2.1.1 and 2.1.2, the PDP proposes different approaches and models to structure the product realisation. The PDP has a set of transdisciplinary activities that requires information and knowledge exchange, which do not reside only in a specific phase, but considers various product cycle development phases. Additionally, multiple groups are involved and may jointly function within institutional boundaries as well as across multiple organisations (CHUNGOORA, *et al.*, 2013).

The models studied and mapped in tables 2 and 3 were designed to orient the product development, but they do not ensure the seamless information exchange, i.e., the model-driven PDP interoperability. Thus, some of them deserve special mention because they are the roots of many other models, for example, Stage-Gate model proposed by Cooper (1993) was incorporated into the Crawford and Benedetto model (2006). Other models such as Unified Model proposed by Rozenfeld *et al.* (2006) incorporates approaches developed by other fields like concurrent engineering, which had its origin in lean production systems.

The unified model proposed by Rozenfeld *et al.* (2006) has a flexible structure that can be adapted to the development of several products and industrial processes. It is composed of 9 phases and is based on the concepts proposed by Pahl and Beitz (1996) and Concurrent Engineering, as illustrate in Figure 4.

Figure 4 Unified Model.

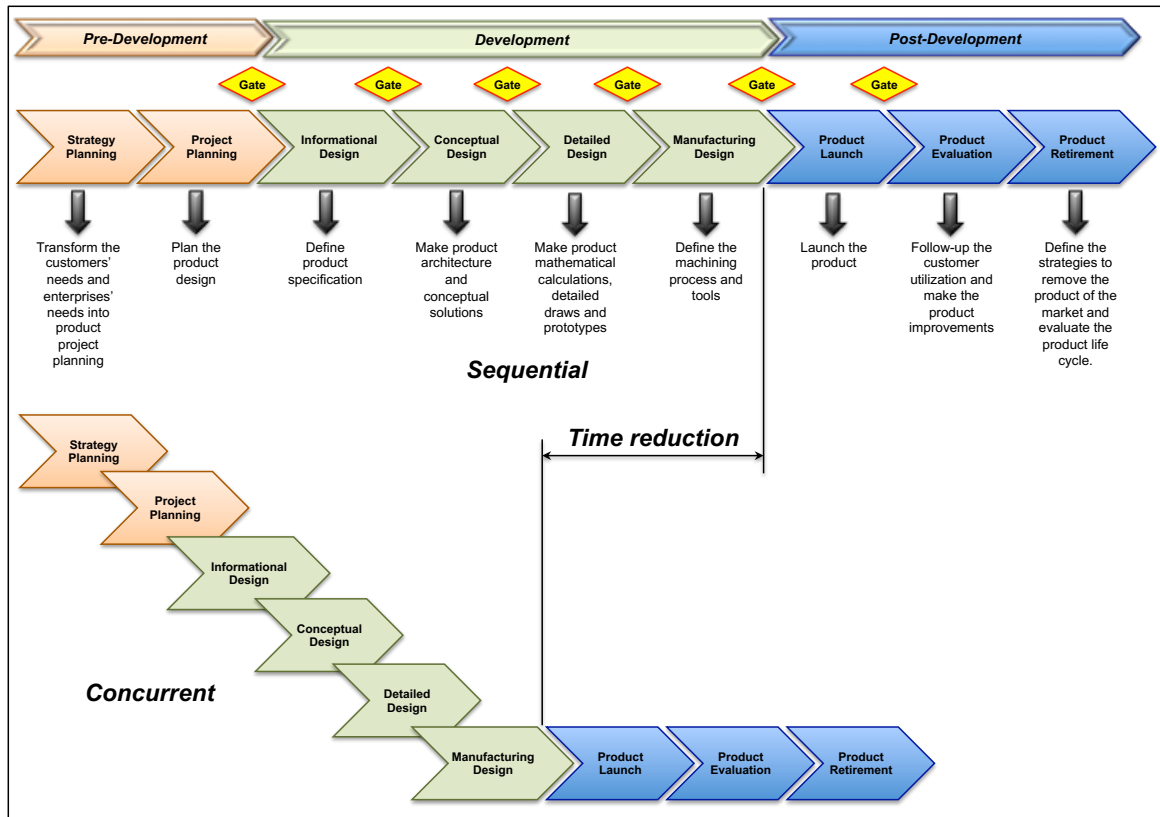

Source: Adapted from Rozenfeld *et al.*, 2006.

The concurrent engineering Unified Model approach (Rozenfeld *et al.*, 2006) requires a transdisciplinary team (engineers, marketing people, supply chain people, controllers, etc.) for its achievement and conventional models do not take into account the structure of information and their relationships. Therefore, this research is using the unified model as PDP representative due to its adaptability to different products, processes and systems.

2.2 INFORMATION MODELLING IN PRODUCT DESIGN AND MANUFACTURING

The modelling of information and knowledge structures in product design and manufacturing has a direct influence on the information capability to semantically interoperate. This occurs because the degree of formality present in the structured information in a model is analogous to the semantic enrichment of the captured model. PDP has two significant models, namely: (i) product model (BALOGUN *et al.*,

2004; SUDARSAN *et al.*, 2005; and CANGIGLIERI JUNIOR and YOUNG, 2010) and (ii) manufacturing model (AL-ASHAAB *et al.*, 2003; LIU and YOUNG, 2004; and CHUNGOORA, 2010).

2.2.1 Product Model

The Product Model is an important information model that has all information related to a specific product (MOLINA *et al.*, 1995). According to Balogun *et al.*, (2004), the product model represents a complex product from the top level of the product to the tolerance details of every feature characteristics.

Product models are the key role in the centre of the PDP (YOUNG *et al.*, 2007), as they hold and exchange product information that is generated, used and maintained over the process of design, manufacture, support and disposal (LEE *et al.*, 2007). They are composed of a number of sub-models such as (i) the structure-oriented; (ii) geometry-oriented; (iii) feature-oriented; and (iv) knowledge-oriented. Related works as Sudarsan *et al.*, (2005), Canciglieri Junior and Young (2010) and Chungoora *et al.*, (2013), had successfully applied product models to PDP. Sudarsan *et al.*, (2005) proposed the Core Product Model (CPM) that captures information from different engineering context and associates them within a common ground. Canciglieri Junior and Young (2010) proposed a product data model structure used in plastic injection products mould to support different applications, as illustrated in Figure 5. Chungoora *et al.* (2013) structured the information based on a product model to support the interoperability in the manufacturing process.

2.2.2 Manufacturing Model

Manufacturing models are common repositories of manufacturing capability information and of knowledge and constraints of the used manufacturing processes (BALOGUN *et al.*, 2004 and LIU and YOUNG, 2004). The information structures explored for this purpose comprise defined relationships between all manufacturing capability elements.

Figure 5 Part of Product Model in UML.

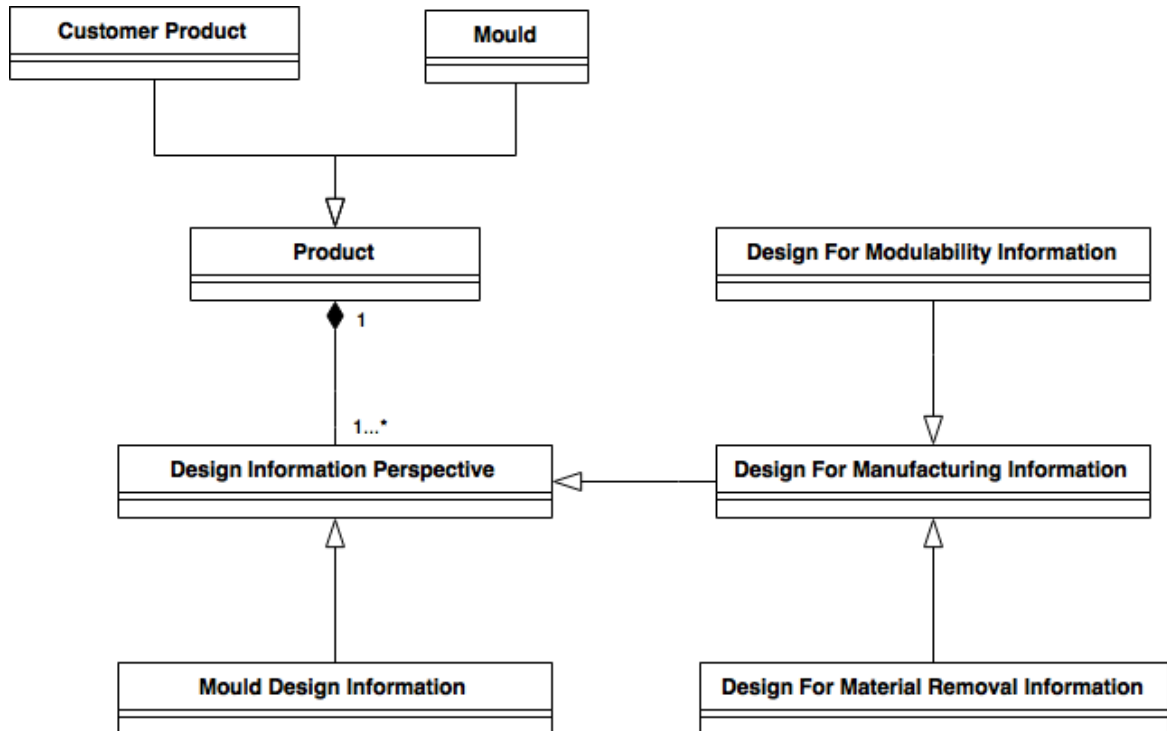

Source: Canciglieri Junior and Young, (2010).

As the product models, manufacturing models are composed of a number of sub-models such as (i) the manufacturing resource capability model which includes information about functions and characteristics of the manufacturing resources and their combination in the manufacturing processes (MOLINA *et al.*, 1995; ZHAO *et al.*, 1999); (ii) the process planning model, used to describe the information about the process planning strategy of the manufacturing process (FENG and SONG, 2003); and (iii) the manufacturing cost model, used for driving the meaningful estimation of production costs incurred during design and manufacturing. Related works such as Feng and Song (2003) used the manufacturing model to develop a “Manufacturing Object Model” that enables the interoperability of preliminary design with process planning.

2.2.3 Interoperable Product and Manufacturing Models

In light of the later discussion, it is clear that there is a need to ensure the interoperability between product and manufacturing models since there are

misinterpretation issues across multiple domains in the PDP (SZEJKA *et al.*, 2016; CANGILIERI JUNIOR and YOUNG, 2010). Panetto, Dassisti and Tursi (2012); Chungoora *et al.*, (2013); Usman *et al.*, (2013); Imran and Young (2016); and Palmer *et al.* (2016) presented a tendency to use ontology approach to formalise the information and knowledge in product or manufacturing models.

The ability to capture and reuse product design and manufacturing information and knowledge in an understandable manner is dependent on the semantic interoperability of product models and manufacturing models. In addition, it is important to establish the relationships between these models with the phases of PDP. Gunendran and Young (2007), for instance, have researched an information and knowledge framework for capturing multi-perspective design and manufacturing. They also stated that the integration knowledge between both models can contain several rules, equations and options to support the information integration of multiple views. Canciglieri Junior and Young (2010) explored information mapping across injection moulding design and manufacturing domains, but there is not a semantic interoperability analysing the impact of the information changing in the product or manufacturing model. Therefore, clear evidence is available in a different manner of structuring the information from product and manufacturing models, but there is not a full interoperation between both models, in terms of information relationships and information analysis to identify the impacts of information changing across PDP. Thus, a progression to achieve this semantic interoperability remains to be addressed.

2.2.4 Features technologies for product design and manufacturing information modelling

A feature is an information unit (element) representing a region of interest within a product and is described by an aggregation of properties of a product (BRUNETTI and GOLOB, 2000). Features have a set of technological information about characteristics or attributes belonging to a part of a model or assembly model and the information is used to improve the comprehension about their applications in design, manufacturing, assembly, production and so on.

2.2.4.1 Feature definition

The word “Feature” has its origins from the Latin “Factura”, which means the act of making or formation (CANCIGLIERI JUNIOR, 1999). However, the word feature has been adapting by different researchers over the years and it is largely applicable in Computer-Aided Process Planning (CAPP), making the manufacturing planning (BABIC, NESIC and MILJKOVIC, 2008). Recently, it was used to integrate Computer-Aided Design (CAD) and Computer-Aided Engineering (CAE) in order to simplify the part and assembly models (NIU *et al.*, 2015). Related works in terms of design and manufacturing have used the following definitions of features:

Pratt, (1991):

A related set of elements of recognition and classification, which are regarded as an entity in its own right, has some significance during of life cycle of the product.

Shah, (1991):

Features are elements used in generating, analysing, or evaluating design.

Huang and Yip-Hoi, (2002):

Machining feature recognition can extract information from 3D geometric models and enrich through a set of feature type definitions in a feature type library supporting the manufacturing stage.

Stefano, Bianconi and Angelo, (2004):

Feature-based representation is a technology for integrating geometric modelling and engineering analysis for the product life cycle.

Canciglieri Junior and Young, (2010):

Feature-based representation technology, therefore, is expected to be able to provide a better approach to integrate design and manufacturing activities following design such as engineering analysis, process planning, machining, fixturing, and etc.

Niu *et al.*, (2015):

Automatic feature recognition aids downstream processes such as engineering analysis and manufacturing planning [...]. Feature recognition purposes to extract certain substructures from a solid model [...].

Features are expected to be used in diverse ways by organisations, having a wide application in PDP such as: (i) design methods; (ii) manufacturing methods; and (iii) facilities and general organisation philosophies. They are commonly analysed as the element for interaction with CAD, CAM (Computer-Aided Manufacturing) and CAPP. The above definitions are suitable for the purpose of this research since it is focused on the information interoperability in Product Design and Manufacturing. The feature can be used to structure the information generated by different systems related to Product Design and Manufacturing.

2.2.4.2 Feature classification

There is a large number of feature types, but they can be categorised into groups or classes and are represented at various levels. Two distinct groups can be considered: Design-Oriented Features and Application-Oriented Features.

2.2.4.2.1 Design-Oriented feature

Design-Oriented Features express the relationships between functions, structure, behaviour, geometric, form, etc. However, they are not always understood since they may have various abstract interpretations and challenging graphical implementation (MA *et al.*, 2007). This issue occurs because they are often written in natural language, which can have different interpretations. The exception is the form-features where representation using low-level geometry can be well understood. Design-Oriented Feature can be divided into low-level design-oriented features and high-level oriented features, as illustrate in Figure 6.

Figure 6 Design Oriented Feature Structure.

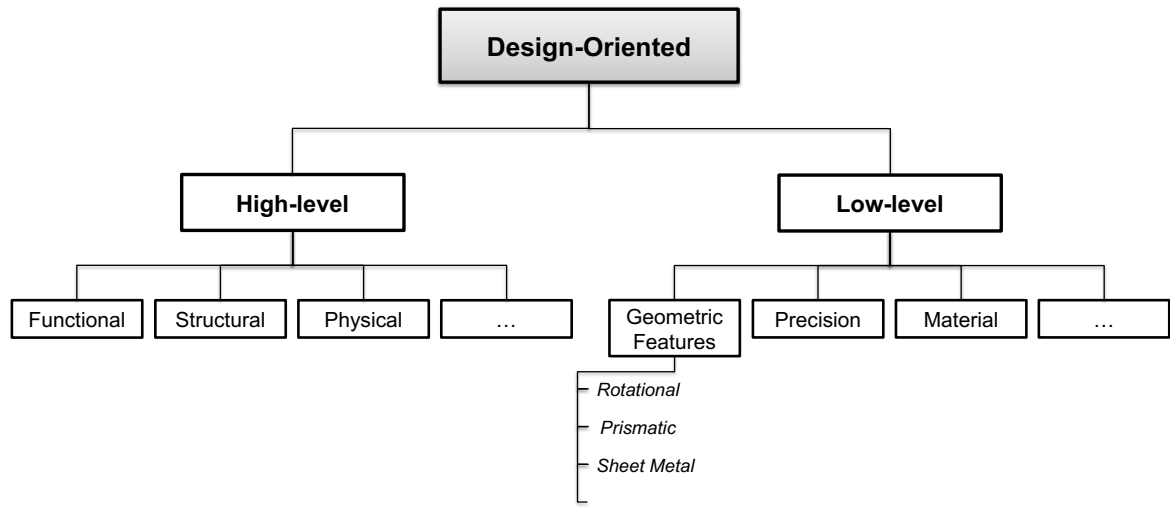

Source: Adapted from Hoque *et al.*, (2013).

Low-level Design-Oriented Features can be divided into three groups - Form and Geometry, Precision, Material Features:

- **Form and Geometry Features** – they are the most widespread kind of features used in modern experimental and commercial CAD/CAM systems. Each one has a set of possible manufacturing processes, for instance, a hole can be obtained through drilling, boring or punching processes. This interrelationship between geometry and technological information is called Manufacturing feature and it has sub-classifications, as follows: Rotational form-features (turning process); Prismatic form-features (extrusion, milling, drilling and similar processes); Sheet-Metal form-features (forming and punching processes); Casting or Moulding form-features (model investment casting, forging, injection moulding and similar processes).
- **Precision Features** – they contain explicit dimensions, surface finishes, dimensional and geometric tolerances such as size, height, diameters, roundness, straightness, flatness and etc.
- **Material Features** – these features are related to the type of material and its physical properties such as rigidity, elasticity, durability, resistance and etc.

High level of Design-Oriented Features can be divided into three groups – Physical, Functional and Structural Features:

- **Physical Features** – they provide to the designer the knowledge about physical phenomena and mechanical elements at the conceptual design stages. They consist of mechanical elements and physical phenomena that occur within the elements, for example, a wedge has two faces intersecting each other and causes forces applied to the third face to act through the former two.
- **Functional Features** - these features describe the part at an abstract level where there are several different possible geometries that could provide a specific solution, for example, bearing, sealing, etc.
- **Structural Features** – they are known as embedded or non-geometric features. These features specify the relationships among geometric features and they have no existence on their own without reference to their environment, for instance, the Assembly features. These relationships could be temporal, e.g. pre-define machining precedence constraints and/or geometric tolerances such as pattern, concentricity, symmetry, parallelism, perpendicular and centring.

2.2.4.2.2 Application-Oriented feature

Application-Oriented feature based on design systems are auxiliary and provide additional higher-level product definition to existing solid modelling system (CANCIGLIERI JUNIOR and YOUNG, 2003). The higher-level products definitions can be useful for many application and they can be classified as:

- Group Technology code;
- NC code/path generation;
- Automated machinability checking;

- Generative process planning;
- Tolerance representation;
- Automated inspection;
- Automated assembly;
- Automated grasp formulation;
- Tooling cost evaluation;
- Manufacturing Evaluation;
- Finite element method;
- Automated mould design.

2.2.4.3 Approaches to feature-based design

Features technology has three approaches based on the literature: (i) automatic feature recognition; (ii) design by feature; and (iii) interactive feature definition. The main target of the first approach is to extract the knowledge enclosed in the geometrical representation of the high-level description in terms of form, tolerance, functional, manufacturing and assembly features (STEFANO, BIANCONI and ANGELO, 2004). The second approach creates features during the design phases, in this way the information available to the designer is immediately included in the model (CANCIGLIERI JUNIOR and YOUNG, 2010). The last one considers that, firstly, a geometric model is created and then human users select the features on an image of the part.

These three different approaches, which can be used to achieve a feature-based representation scheme, are complementary and useful to develop an operative-aided design product (NIU *et al.*, 2015). However, this research is using design by feature based on the mappings proposed by Canciglieiri Junior and Young (2010) to initiate the information formalisation process in a common language across different phases of PDP, independent of the domain of knowledge. Furthermore, the application of this research is into plastic injection mould product and a common classification and taxonomy are necessary to express the relationship between the information.

2.2.4.3.1 Design by features

Design by features provides to the user a set of available features that intend to represent the designer's needs and vocabulary. During the product development process, designers interactively select features, instantiate parameters and define constraints. Figure 7 demonstrates a typical scheme of design by features.

Figure 7 Typical Scheme of Design by Features.

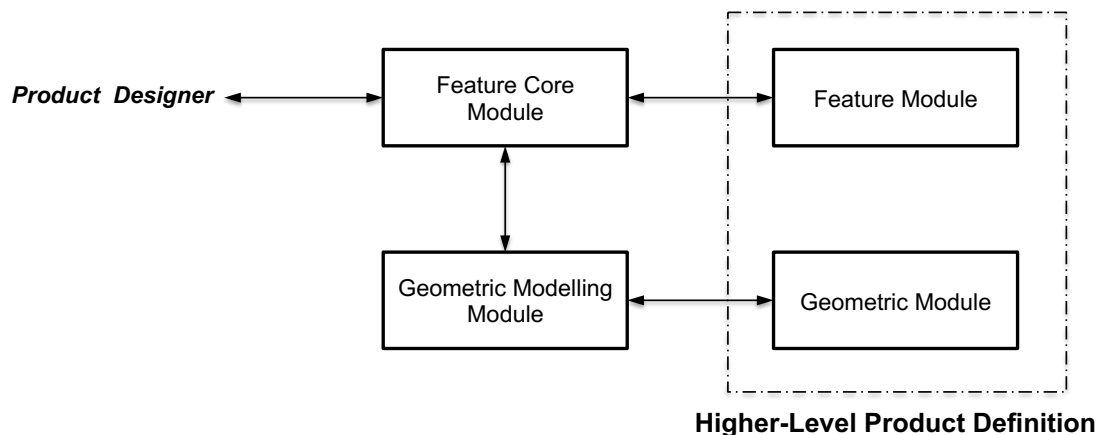

Source: Canciglieri Junior and Young, (2003).

Using this approach, the product designer generates the part model using a well-defined structure guided by specific operations and instantiating generic features at the desired position. Thus, the post-processing stage of the CAD data to interpret features for the part model is eliminated. However, the design by features approach has its own obstacles, as presented by Canciglieri Junior and Young, (2003) and Ma *et al.*, (2007) such as:

- Features validation needs to be performed every time that a new feature is added;
- The system calls for some designer's expertise to choosing the best set of primitive features to model cases of interacting and complex features;

- Design by features hinders the creativity of the product designer by restricting him and/or her to the limited set of primitives (features) present in the feature library. Also, some of the non-features related activities such as blending (edges, faces or corners) functions are absent in the design by features environment.

Nonetheless, Canciglieri Junior and Young, (2003) Ma *et al.*, (2007), Chungoora (2010) also present advantages as follows:

- Design by features can store a great variety of non-geometric information that can be manipulated alongside to the geometry itself;
- Features types can grow up towards conceptual design phases, easing the whole design process;
- More natural design language, closer to the designer's expertise, is used improving a design's expressiveness and understanding;
- The feature set available can help standardisation;
- Design by features can ease integration among design related tools and downstream applications;
- The designer's intentions at various levels can be captured, manipulated and monitored once tests and functional understanding have been performed at early stages of the design;
- A more abstract, effective, conversational and interactive user interface can be built using the design by features approach.

2.2.4.3.2 Feature Recognition

Feature recognition recognise features after the part is modelled on a solid modelling system, as shown in Figure 8, intelligent algorithms are used to extracted features from existing geometry. However, a major limitation is present on this approach and is related to the effectiveness of the explored algorithms to recognise interaction between features (MARTINO and GIANNINI, 1998). Normally, a specific geometry/topology configuration is searched in the part model to identify the presence of particular types of feature, as discusses by Niu *et al.*, (2015) and Lockett and Guenov (2005). Some of the advantages of feature recognition are:

- Conventional CAD systems can be better interfaced to other applications through feature recognition;
- There are manipulation freedom and no need to invest in training on new interface paradigms;
- Traditional CAD files can be used as input and act as a converter to design by feature systems;

But, feature recognition has some disadvantages such as:

- They are normally complex, time-consuming, difficult to achieve and sometimes incomplete for a diversity of possible interactions among features;
- There are also restriction to the number of features that the procedures were developed to deal with and, if the number of recognisable features grows, the required time grows exponentially;
- Features recognition is no single or standardised, i.e., the same geometry may produce different results by distinct implementations;

- Feature interaction makes any recognition process difficult and existing approaches only deal with interaction to a limited extent.

Figure 8 Typical Scheme of Feature Recognition.

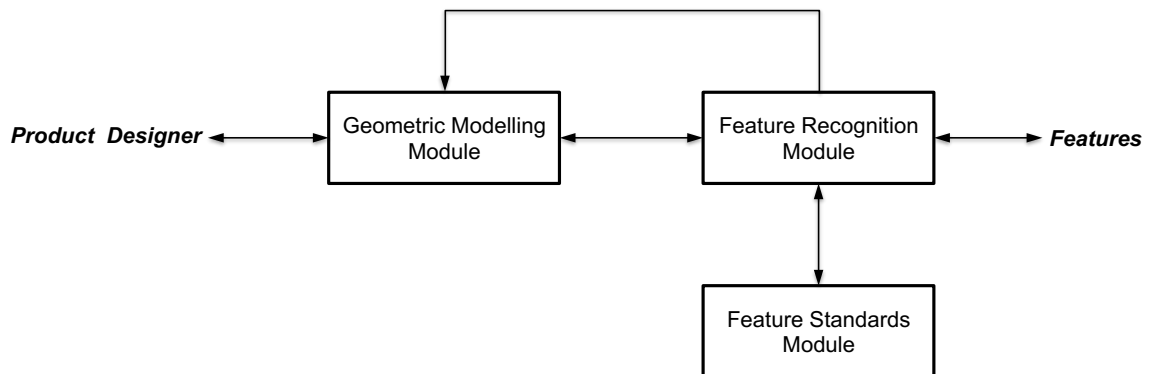

Source: Canciglieri Junior and Young, (2003).

2.2.5 Summary of Information Modelling in Product Design and Manufacturing

The interoperability between product and manufacturing is the key towards the reinforcement of the decision support capability and knowledge acquisition in modern PDPs. Several researchers such as Gu (1994), Canciglieri Junior and Young (2003), Lockett and Guenov (2005), Aifaoui *et al.*, (2006), Ma *et al.*, (2007) and Hoque *et al.* (2013) have documented the importance of the kinds sorts of features as providers of valuable integration links for design and manufacturing such as the “machining features” effort from STEP (ISO 10303-224, 2006). In addition, the ongoing significance of feature-based modelling is well established (MA *et al.*, 2007; HOQUE *et al.*, 2013).

Although features technologies have a defined structure, from a semantic interoperability perspective, there are gaps in the information relationships. Information from distinct domains, for example, can affect directly the product manufacturing. Material and tolerance choices impact in machining planning. Therefore, the well-defined structure defined by technologies features can be used to formalise the information structure across PDP and new approaches to formalise the

relationships between this information must be addressed in order to ensure the semantic information interoperability in product design and manufacturing.

2.3 ONTOLOGY-DRIVEN INTEROPERABILITY

The principles and methods for ontology representation were developed in the Artificial Intelligence field to facilitate knowledge sharing and reuse between people and application systems (MALLUCELI, 2006). The concept ontology was taken from Philosophy, where it means a systematic explanation of being (CORCHO *et al.*, 2003). In the last decade, the concept ontology has become a significant concept for Intelligent Information Integration, Internet Information Retrieval, Knowledge Management and the Semantic Web. The reason for this expansion is due to the promise of providing a shared and common understanding of a specific domain (IMRAN and YOUNG, 2016). Nowadays, ontology is recognised as a key technology to deal with semantic interoperation problem (PALMER, *et al.*, 2016).

Ontology has been developed to provide a machine-processable semantics of information sources that can be communicated between systems or human entities (FENSEL, 2004). In addition, it is also used by intelligent systems for the interoperation of heterogeneous systems. To Gruber (1993), ontologies are developed to:

- Enable a machine to use knowledge in some application;
- Enable multiple machines to share knowledge;
- Help human to understand more about some knowledge area;
- Help people to build a consensus concerning some knowledge areas.

As ontologies intend to represent consensual domain knowledge, their engineering must be developed in a cooperative process, involving people from different origins. However, ontology creation is a difficult and time-consuming task, so it is usual to build new ontologies from existing ones, i.e., using a part of an existing ontology or modelling existing knowledge in ontologies. Different ontology tools and languages are available to create ontologies.

2.3.1 Definitions of Ontology

The ontology has been applied by different fields, in which ontology is said to be an explicit specification of a conceptualization (GRUBER, 1993). The literature presents different definitions for describing ontology from this viewpoint such as:

Neches *et al.* (1991) define ontology as:

“Basic terms and relations involving the vocabulary of a domain and rules to combine terms and relations to define an extension to the vocabulary”.

Borst (1997) defines as:

“[...] a formal specification of a shared conceptualisation.”

Studer *et al.* (1998) propose that:

“An ontology is a formal explicit specification of a shared conceptualisation”.

Noy and McGuinness, (2001) say:

“Ontology is a formal explicit description of concepts in a discourse domain, where properties of each concept describe several characteristics, attributes of concepts and attributes’ constraints.”

ISO 18629 (2005), ontology is stated as:

“A lexicon of specialised terminology along with some specification of the meaning of terms in the lexicon”.

Horridge and Bechhofer (2011), affirm that:

“an ontology describes the concepts in the domain and also the relationships that hold between these concepts”.

These definitions lead towards how ontologies are realised at applications levels. These descriptions highlights that ontology is a representation or model that provides a basis for sharing meaning or knowledge (Young *et al.*, 2007). Additionally, the ontologies community distinguishes ontologies according to their degree of expressiveness, as follows:

- **Lightweight ontology** comprises concepts, the taxonomy of concepts and basic relations between these concepts and their properties.
- **Heavyweight ontology** adds to the previous definition, axioms and constraints. These axioms are used to clarify the intended meaning of the terms gathered on the ontology (GÓMEZ-PÉREZ *et al.*, 2004).

Based on these two ontological approaches, it is clear from a semantic viewpoint that lightweight ontology has some limitation over the formal meanings (CHUNGOORA, 2010). These limitations explain their inappropriateness for the formalisation of interrelations between distinct knowledge from different domains. Thus Young *et al.* (2007) have identified a need for more mathematically rigorous approaches to ensure that the true meaning behind the terminology coming from different systems is identical. This research will be pursued this direction in order to reinforce and extend the understanding behind ontological methods to drive semantic information interoperability in product design and manufacturing.

2.3.2 Ontology Formalisms

Different ontology languages are available for constructing ontologies. Figure 9, adapted from Chungoora (2010), summarised the most relevant ontological formalism. They are structured between traditional ontology language and ontology markup languages.

Figure 9 Main ontologies languages.

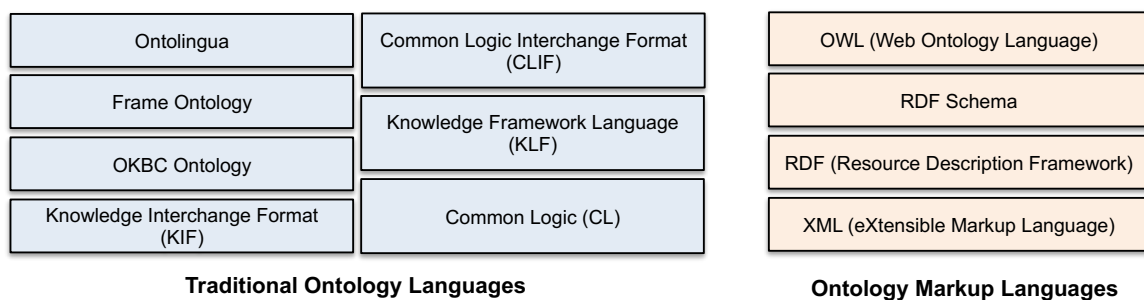

Source: Based on Chungoora, 2010.

The main difference between these two groups is in the basic structure, where the first group was initially based on First Order Logic (FOL) and later on Description Logic (DL), although DL itself corresponds to the decidable fragment of FOL. Thus, in traditional ontology languages, the Knowledge Interchange Format (KIF) (GENESERETH and FIKES, 1992) which is FOL-based supports the construction of the Open Knowledge Base Connectivity (OKBC) ontology (CHAUDHRI *et al.*, 1998), Frames-based ontology and Ontolingua (FARQUHAR *et al.*, 1997).

Common Logic (CL) (ISO/IEC 24707, 2007) was introduced recently as a language framework for knowledge interchange. Other ontological languages have been developed such as (i) Common Logic Interchange Format (CLIF) that is directly based on the CL standards; and (ii) the Knowledge Framework Language (KFL) developed by Ontology Works Inc. (ONTOLOGY WORKS INC., 2009).

Ontology markup language has their syntax based on the eXtensible Markup Language (XML) to address flexible information structuring (NURMILAAKSO *et al.*, 2002). The XML capability allows the specification of the Resource Description Framework (RDF) and RDF Schema (LASSILA and SWICK, 1999) to support the ability to process metadata for providing interoperability between applications and exchange machine-understandable information (CINGIL and DOGAC, 2001). However, RDF cannot capture more rigorous properties required for building more meaningful ontologies. In this context, Web Ontology Language (OWL) is based on RDF, but this approach can capture more properties and expand the meaningful ontologies. According to this context, it is necessary to refine the understanding of logic expressiveness level that is capable of structure knowledge of multiple domains in order to support complex product development.

2.3.3 Components of Ontology

As discussed in the later section, there are different techniques that can be used to model and represent ontologies such as frames, first-order logic (GRUBER, 1993), description logics (BAADER *et al.*, 2003), and Web Ontology Language (W3C, 2006). Although each of these techniques can represent the same knowledge with different degrees of formality, they have the same basic components:

- **Classes** model the concepts of the domain or task. They are usually organised in taxonomies and inheritance can be applied. The class taxonomy is represented in a tree structure. Since multiple inheritances are permitted, one class may have several super-classes. Classes can be concrete or abstract. In contrast to abstract classes, concrete classes may have direct instances.
- **Attributes** represent the characteristics of the concepts. Attributes are also called slots and sometimes roles or properties. They are usually distinguished from relations because their range is a data type (string, number, Boolean, etc.).
- **Relations** model types of associations between concepts. Binary relations are sometimes used to express concept attributes. However, the range of relations is different from the range of the attributes: the range of a relation is a concept.
- **Instances** represent specific elements. They are specific entities of a given class. New instances can be created and values can be assigned to the attributes and relations. A form of entering data is generated automatically when an instance is created.
- **Axioms** model sentences that are always true. Axioms are used to verify the consistency of the ontology or the consistency of the knowledge stored.

2.3.4 Ontologies in Engineering

A significant amount of work has been performed in the field of engineering, applying the ontologies to solve specific problems. Researchers have developed ontologies to support decision-making in product design and manufacturing. One such example can be seen in work developed by Chungoora (2010) who have researched a framework to support semantically the interoperability between product

design and manufacturing. A similar research was developed by Canciglieri Junior and Young (2010), but in this case, the researchers create an informational mapping to translate information from product design to manufacturing domain. Lin and Harding (2007) have defined a Manufacturing System Engineering (MSE) ontology model that has the capability of enabling communication and information exchanges between inter-enterprises in a multi-disciplinary engineering design teams.

Ontology in engineering is one of the prominent solutions that are used to capture and represent knowledge and to provide a precise description of concepts and the relationships between them (MAEDCHE and STAAB, 2000). According to Gómez-Pérez, Fernandez-Lopez and Corcho (2004), axioms are used to clarify the intended meaning of the terms gathered on the ontology. However, ontologies are usually limited to the purpose of their application and have limited reusability outside the scope of their application. Thus, ontology integration is an important task to achieve different levels of concepts integration. Ontology integration is the process of finding commonalities between two different ontologies O and O' and deriving a new ontology O'' (GÓMEZ-PÉREZ, FERNANDEZ-LOPEZ and CORCHO, 2004). Based on this, different operations for combining heterogeneous ontologies can be distinguished, as discussed by Malucelli (2006):

- **Ontology Inclusion** – the source ontology is just included within the target ontology.
- **Ontology Mapping** – it is the process of relating similar concepts or relations from different sources through some equivalent relation.
- **Ontology Merging** – it is the most complex approach, combining several data sources into a single integrated ontology through the use of a mediator to answer queries.

It can be categorised into three levels depending on the level of the knowledge that the ontology aims to represent (ROCHE, 2003):

- **Top level ontology** – it specifies only general concepts and relationships (such as time and space) and can be used in different domains;
- **Domain level ontology** – it captures the knowledge that is dedicated to a specific domain (such as production domain) and can be used and

reused for different activities in the same domain;

- **Application level ontology** – it represents the specific knowledge that is dedicated to a task in an application and normally is not reusable for other applications.

As presented in the last section, an ontology is used to explicit a knowledge. One example is portrayed in the research approach taken by Patil *et al.* (2005), where an ontology formalised in Description Logics (DL) has been explored for capturing and representing the semantics of product representations. Formal concept definitions are captured using DL axioms, which to some extent have enabled the capability for semantic data interchange, i.e. semantic interoperability. Another example appears in the work performed by Costa *et al.* (2007), where a refinement of the ISO 10303 AP236 standard, for supporting information exchange for the furniture industry, is proposed using product ontology.

A combination of Web Ontology Language (OWL) with Semantic Web Rule Language (SWRL) has been employed for solve different problems to represent constraints in these formal models. Related works such as Kim *et al.*, (2006); Rabe and Gocev, (2008); Yang *et al.*, (2008); Chang, Sahin and Terpenney, (2008); and Wei *et al.*, (2009) explored the combination of OWL and SWRL. SWRL rules offer a relatively powerful axioms layer that cooperates with OWL-based ontologies for semantic enrichment.

2.3.5 Ontology Mapping

Although ontologies create semantic formalisms, an expressive problem is how to work with multiple ontologies of multiple domains to provide effective mapping information across them (NAGAHANUMAI AH and RAVI, 2008). Ontology mapping has been a key direction to tackle semantic heterogeneity issues across ontologies, intending to promote semantic interoperability. Mapping is an important and critical operation in traditional applications such as (i) information integration; (ii) query answering; and (iii) data transformation (SHVAIKO and EUZENAT, 2008). Data or information transformation is extremely relevant for this research to establish the information relationships in Product Design and Manufacturing.

Ontology mapping is the process of finding correspondences between the concepts of two ontologies. If two concepts correspond, then they mean the same thing or closely related things (DOU *et al.*, 2003). Currently, the mapping process is considered as a promise to solve the heterogeneity problem between ontologies since it attempts to find correspondences between semantically related entities that belong to different ontologies. It takes as input two ontologies, each one consisting of a set of components (classes, instances, properties, rules, axioms, etc.), and determines as output the similarity matching.

Several categories of ontology mapping methods have been suggested by Ehrig and Sure (2004) and Kalfoglou and Schorlemmer, (2003), but there is a common consensus over the types of methods that can be applied. The main types are: (i) Integration; (ii) Transformation; (iii) Alignment; and (iv) Articulation.

- **Ontology Integration** – it is the process of creating a new ontology from two or more ontologies by overlapping the common parts, as illustrate in Figure 10. The domains of the source ontologies are different from the domain of the resulting ontology, but there is a relation between these domains.

Figure 10 Illustration of ontology integration.

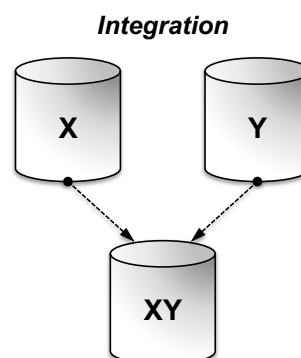

- **Ontology Alignment** - is the process of reaching global compatibility between two or more ontologies, so that the resulting ontology is consistent and coherent, as illustrate in Figure 11.

Figure 11 Illustration of ontology alignment.

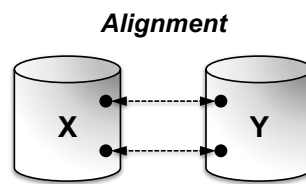

- **Ontology Articulation or Conversion** – it is the process of changing the representation formalism of the ontology while preserving its semantics, as illustrated in Figure 12.

Figure 12 Illustration of ontology articulation/conversion.

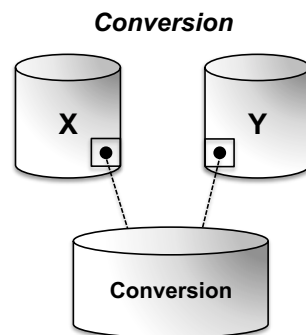

- **Ontology Transformation** - it is the process of changing the semantics of the ontology, possibly also the representation formalism, with the intent to make the new ontology suitable for different purposes from the original ones, as illustrate in Figure 13.

Figure 13 Illustration of ontology transformation.

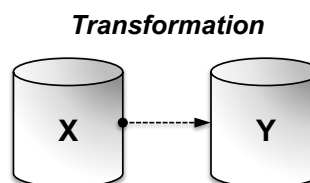

Related works as Kent, (2000); McGuinness *et al.*, (2000); Maedche and Staab, (2000); Kiryakov *et al.*, (2001); Stumme and Maedche, (2001); Kalfoglou and

Schorlemmer, (2002); Madhavan *et al.*, (2002); Noy and Musen, (2003); Euzenat and Valtchev, (2003); Bach *et al.*, (2004); Mitra *et al.*, (2004) presented significant results on using matching techniques that use the semantics of logic-based systems, which employ upper ontologies. In the literature review exposed in this work, only the most outstanding and pertinent ontology mapping methods are documented.

The ontology MApping FRAmework (MAFRA) performed by Maedche and Staab (2000) is an ontology mapping method used for the reconciliation-distributed ontologies on the Semantic Web. It is based on the idea that the best approach to complex mapping is achieved through reasoning in a decentralised environment like the Web. Following the MAFRA approach, the first phase in ontology mapping is normalisation, which all information are set onto the same representation platform. The second phase is lexical similarities, where all information is analysed and then based on the similarities found between the source and target ontologies, “Semantic Bridging” are established. The final phase is dedicated to verifying the “Sematic Bridging”.

OWL-Lite Aligner (OLA) developed by Euzenat and Valtchev, (2003) relies on the classical similarity-based paradigm for entity comparison. Firstly, the OWL ontologies are compiled into graph structures, introducing all relationships between entities. The similarity between nodes from different graphs depends on the category of the node considered and takes into account all the features of that category. Distance-based algorithms convert concepts of distances based on all input structures into a set of equations. These distances are almost linearly aggregated. Finally, the algorithm looks for a matching between the ontologies that minimises the overall distance between them.

Quick Ontology Mapping (QOM) developed by Ehrig and Staab (2004) proposes the similarity computation that is based on a wide range of ontology features and heuristic combinations. Complementing, the authors affirm that QOM avoids the complete pair-wise comparison of trees in favour of a top-down strategy. The aggregation of single methods is only performed once per candidate mapping and is therefore not critical for the overall efficiency. QOM first iterates to find mappings based on lexical knowledge and then iterates to find mappings based on knowledge structures.

Other methods and approaches can be found in the literature, but for this research, these tools indicate the potential in using mapping techniques to solve integration between heterogeneous knowledge models in the ontology. In addition, it is evident that there is no method totally adherent concerning design and manufacturing information mapping when multiple perspectives are involved them.

2.3.6 Summary of Ontology Model Driven Interoperability in Product Design and Manufacturing

Ontology has attracted a lot of attention for the development of shared representations (BARBAU *et al.*, 2012; DEMOLY *et al.*, 2012; NAEEM *et al.*, 2014; DANJOU, DUIGOU and EYNARD, 2016). It has been observed that the ability for sharing semantics across these representations is dependent on the degree of formality or logical expressiveness supported by ontological formalisms. However, it has to be appreciated that even in the deployment of ontology-based methods, semantic heterogeneity is unavoidable and for this reason, methods for ontology mapping are being developed to reconcile the semantics between ontologies that need to interoperate (FAHAD *et al.*, 2010).

Hence, this work addresses the structure of product design and manufacturing information formalising based on ontologies and mapping ontologies to extract and enrich information to support the information sharing across PDP design and manufacturing phases in a transdisciplinary environment and in accordance to the customer's needs.

3 RESEARCH CONTRIBUTION FOR SEMANTIC INFORMATION INTEROPERABILITY IN PRODUCT DESIGN AND MANUFACTURING

This chapter presents the problem statement focusing on semantic information interoperability in product design and manufacturing, moreover, a systematic literature review shows the main researches development in the research field and based on it the proposed conceptual framework is presented.

3.1 PROBLEM STATEMENT FOR SEMANTIC INFORMATION INTEROPERABILITY IN PRODUCT DESIGN AND MANUFACTURING

Modern Product Development Process (PDP) has required simultaneous collaborations of multiple groups, producing and exchanging information from multi-perspectives within and across institutional boundaries. However, semantic obstacles have been identified during this process, affecting the process of product development. To Gunendran and Young, (2007), unclear, implicit and ambiguous semantic leads to semantic obstacles, which is a typical problem of semantic interoperability. Semantic interoperability is achievable when the captured information and knowledge can be effectively exchanged in a collaborative environment without any meaning and intent loss of information and knowledge during this process (CHUNGOORA, 2010).

For any given product family that evolution follows the product lifecycle development (SUBRAHMANIAN *et al.*, 2005), several perspectives of the same object are required to exist when considered from the different phases residing in the product development such as conceptual design, detailed design, manufacturing, operation, etc.. Additionally, information from other perspectives should be used to constraint the product realisation. The perspectives include “Mouldability”, “Geometric Dimension and Tolerance”, “Function”, “Material”, “Machining Resource” and so on. Multiple perspectives associated to the same object (product) result in multi-domains models (CANCIGLIERI JUNIOR and YOUNG, 2010; PALMER *et al.*, 2016).

Therefore, multi-domains and PDP naturally overlap each other since they pertain to the same object, i.e., the same product. These relations are the constraints

that guide the evolution of the product development (SZEJKA, *et al*, 2015a; SZEJKA, *et al.*, 2015b). Figure 14 gives an example of the relations between multi-domains, PDP and constraints in the development of a plastic injection moulded product.

Figure 14 Dependence relations in the Product Development Process.

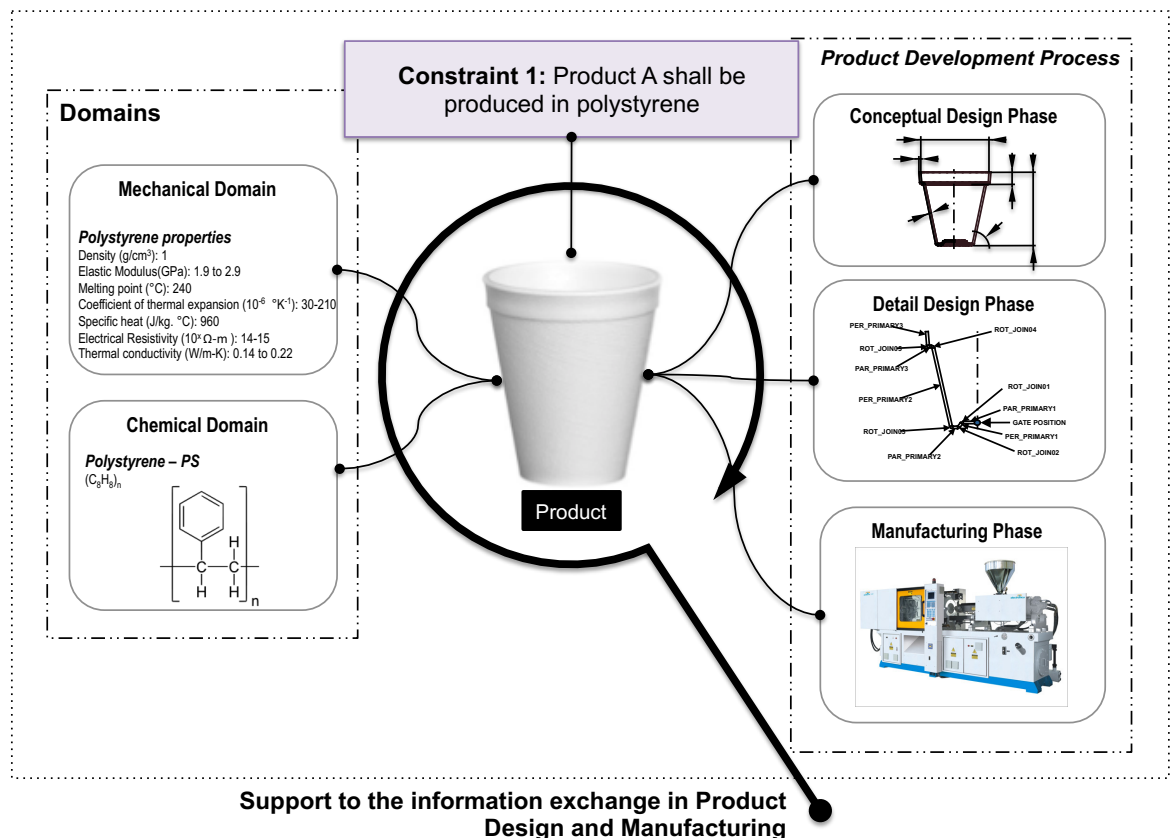

As shown in Figure 14, three perspectives must be considered simultaneously during the product design and manufacturing. These perspectives are as follows:

- **Domains perspective** – different fields are involved during the product development, for example, mechanical engineering, electrical engineering, computer science, etc. Each specialist in his/her field produces and shares information with other domains in order to design or manufacture the product;
- **PDP perspective** – this perspective refers to information sharing across different phases of the product development cycle, where each

phase has its proper constraints and specific information. In addition, each phase impacts directly in the future and previous ones. It impacts the future phase because the results of the actual phase are the input of the next phase. It affects the previous phase because any change in the actual phase needs to be tracked in the previous phases if there are changing impacts;

- **Product requirements or constraints perspective** - it concerns the consistency and coherency of the relation between requirements and/or constraints, as well as their impacts in the associated domain and PDP phase.

Each perspective has different semantic issues to provide an interoperable product design and manufacturing. However, three perspectives must be simultaneously considered to find an effective solution to a given problem. So that, Figure 15 was proposed with three axes that represent the Domain perspective, the PDP perspective and the Product Requirement and Constraint perspective.

Figure 15 Semantic Information Interoperability Issues.

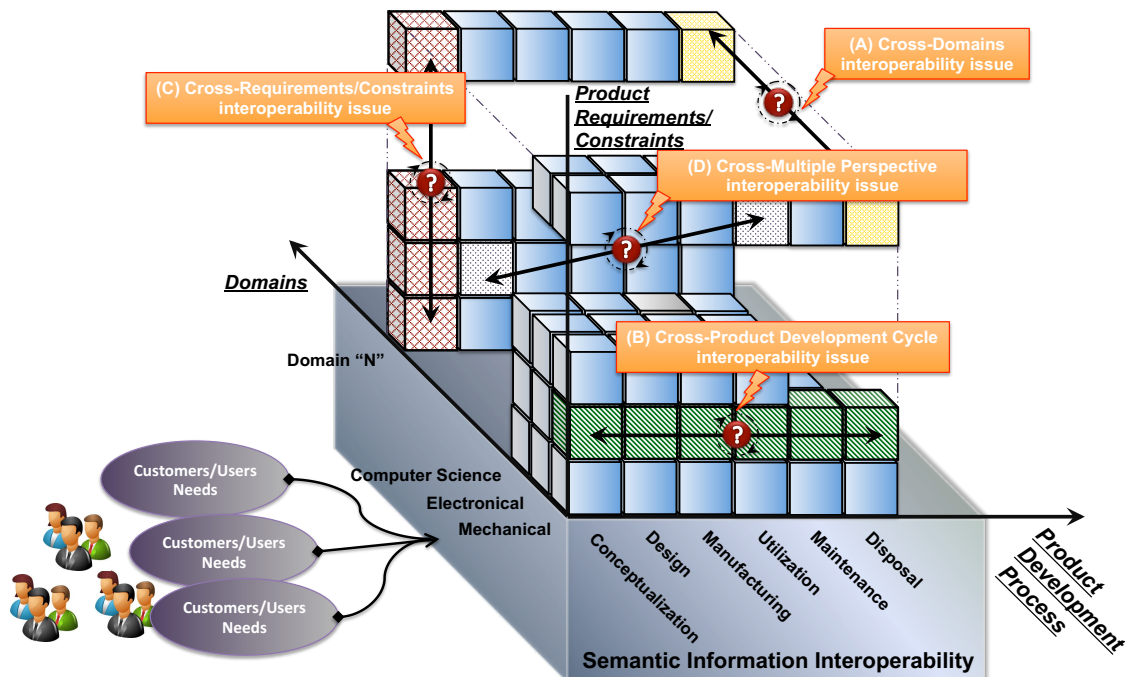

Source: Based on Szejka *et al.*, 2014.

Four information interoperability issues are identifiable in Figure 15. The first interoperability issue concerns the heterogeneity of information coming from multiple domains (Figure 15 – Detail “A”). It imposes some information and knowledge formalisation and their semantic relationships. The second interoperability issue concerns the product development cycle (Figure 15 – Detail “B”). Although information can be associated with multiple phases of PDP, it is made in a specific phase and shared with others as well as its relationships must be well defined. The third interoperability issue concerns the relations between product requirements or constraints and their properties (completeness, coherency, uniqueness, univocity, verifiability and traceability associated with each of them - Figure 15 – Detail C). Finally the last interoperability issue (Figure 15 – Detail “D”) simultaneously concerns the relationship of the three other interoperability issues in order to ensure the information consistency.

The next section is devoted to identifying and exploring the main works and milestones references in the focus of this research related to these semantic interoperability issues.

3.2 IDENTIFICATION OF THE MAIN RELATED WORKS AND MILESTONES REFERENCES FOR THIS RESEARCH THROUGH A SYSTEMATIC LITERATURE REVIEW

The problem statement depicted the main obstacles in the semantic information interoperability in product design and manufacturing. A systematic literature review based on the three identified issues (Figure 15) was proposed to identify the main studies and milestones references in the subject of this research, deepening the knowledge and understanding on the research’s issues and their solutions.

Preliminarily, a literature survey regarding researches that directly investigate the three perspectives working simultaneously showed to be unfruitful. So that, the literature survey was focused on, firstly, Multiple Domains vs. PDP; and secondly, it was focused on Product Requirements (Constraints) vs. PDP. Based on the results, a categorization for the found studies was proposed to identify the ones that were more adherent to the objective of this research.

This section was structured in three sub-sections: the first was the definition of the method to be used on systematic literature review (section 3.2.1). In the second topic, the systematic literature review was carried out and the main authors and researches were identified (section 3.2.2). The last one was dedicated to studying the main selected literature approaches and discussing the contributions and limitations of this research (section 3.2.3).

3.2.1 Presentation of the Methodology for the Systematic Literature Review

A systematic literature review is a research method that achieves the results from information already described in the published literature to minimise distortions and errors (JESSON and LACEY, 2006). The structure of the research's systematic literature review was proposed taking into account the methods used in the following studies of: "Preferred Reporting Items for Systematic Review" (MOHER *et al.*, 2009); "Determining the principal references of the social life cycle assessments of products" (MATTIODA, CANGIOLIERI JUNIOR and SCIPIONI, 2015) and "Systematic literature review in social life cycle assessment" (PETTI, UGAYA and DI CESARE, 2016).

This systematic review was conducted according to the following steps:

- Step 1 – Survey: searching, analysis and selection of recent researches;
- Step 2 - Categorization: a categorization of the papers selected in the previously step was performed;
- Step 3 – Authors Analysis: the selected papers were analysed and identified the main authors and milestones references for this research.

The systematic literature review starting point was two questions, which were aligned to the main research's aims:

- *What are the recent papers regarding the formalisation of heterogeneous information and product requirements (constraints) in order to provide a seamless semantic interoperability across PDP?*
- *What are the recent papers regarding the formalisation of information relationships from multiple domains in order to support a seamless semantic interoperability across PDP?*

The definition of the parameters for including or excluding a paper was based on the problem statement and the research main questions. The parameters sought to reduce the probability of bias in the searching. Table 4 presents the inclusion and exclusion criteria used in this systematic review development.

Table 4 Inclusion/Exclusion criteria used during the systematic review development.

Inclusion Criteria	Exclusion criteria
<ul style="list-style-type: none"> • Product Development Process keywords • Multiple Domains keywords • Product Requirements (Constraints) keywords • Studies published between January 2005 and October 2015 • Primary studies 	<ul style="list-style-type: none"> • Secondary studies • Duplicated studies • Non-English written papers • Specific domain papers • Redundant paper of the same author

The main inclusion conditions are the keywords relating to the problem statement and to the two research questions: (i) Product Development Process (PDP); (ii) Multiple Domains; and (iii) Product Requirements (Constraints). The main keywords were identified for each of the three perspectives, as shown in the footnotes of Table 5. The survey was carried out through the following search engines: Science Direct, Springer, IEEE and Taylor & Francis accessed at the Pontifical Catholic University of Parana. Table 5 summarises the research structure with the objectives and methodological criteria for each of the research steps.

3.2.2 Systematic Literature Review Implementation

This section presents the execution of the systematic literature review methodology for searching the relevant researches and references to support the semantic interoperability in a product development process. Therefore, section 3.2.2.1

presents the search results regarding PDP and Multiples Domains, section 3.2.2.2 presents the search results regarding PDP and Product Requirements (Constraints) and section 3.2.2.3 presents the categorization of the results from section 3.2.2.1 and 3.2.2.2 regarding the scientific papers that concern PDP, Multiple Domains and Product Requirements (Constraints) simultaneously.

Table 5 Structure of Systematic Literature Review in Semantic Information Interoperability in Product Design and Manufacturing.

Question of research/Papers	Research Steps	Databases for the Research	Type Analysis	Research Keys
(i) What are the recent papers regarding the formalisation of heterogeneous information and product requirements (constraints) in order to provide a seamless semantic interoperability across PDP?	<p>Step 1a: Selection and analysis of recent researches related to PDP and Multiple Domains.</p> <p>Step 1b: Selection and analysis of recent researches related to PDP and Product Requirements (Constraints).</p>	Science Direct, Springer, IEEE, Taylor & Francis.	Documental Survey of the researches published in scientific journals during the period 2005 to 2015.	Searching for some specific terms (1), (2) e (3) on titles, abstracts, keywords and on the main body of the researches published.
(ii) What are the recent papers regarding the formalisation of information relationships from multiple domains in order to support a seamless semantic interoperability across PDP?	<p>Step 2: Categorization of the relevant researches</p> <p>Step 3: Analysis of the selected references cited on the recent researches related to Multiple Domains and Product Requirements (Constraints) to support PDP</p>	All scientific researches selected in steps (1a), (1b) and (2).	<p>Analysis of titles and abstracts.</p> <p>Analysis of all researches published.</p> <p>Analysis of the cited references in the researches published.</p>	<p>Selection of specific case studies.</p> <p>Type of publication and years.</p>

(1) *PDP* – (i) Integrated Product Development; (ii) Product Development Process; (iii) Product Design; (iv) Manufacturing Design; and (v) Design for Manufacturing and Assembly.

(2) *Multiple Domains* – (i) Multiple Domains; (ii) Heterogeneous Domains; and (iii) Multiple Perspective.

(3) *Product Requirements (Constraints)* – (i) Requirements; (ii) Specification.

3.2.2.1 STEP 1a: Scientific papers related to PDP and Multiples Domains

In light of the methodology, the searching for scientific papers related to PDP and Multiple Domain was performed according to the inclusion criteria, presented in Table 4, which were applied to the article title, abstract and keywords. As a condition

for selection, the articles must cite the terms: a) regarding PDP - Integrated Product Development, Product Development Process, Product Design, Manufacturing Design, Design for Manufacturing and Assembly; and b) regarding Multiple Domains - Multiple Domains, Heterogeneous Domains, and Multiple Perspective. The article search was applied in a period of 10 years, from 2005 to 2015. The searching resulted in 775 articles and their distribution is showed in Table 6 according to the keywords crossing.

Table 6 Systematic literature Review on PDP vs. Multiple Domain preliminary results.

Keywords			Results from the databases
"Product Development Process"	AND	"Multiple Domains"	42
"Integrated Product Development"	AND	"Multiple Domains"	20
"Product Design"	AND	"Multiple Domains"	114
"Manufacturing Design"	AND	"Multiple Domains"	100
"Design for Manufacturing and Assembly"	AND	"Multiple Domains"	8
"Product Development Process"	AND	"Heterogeneous Domains"	13
"Integrated Product Development"	AND	"Heterogeneous Domains"	8
"Product Design"	AND	"Heterogeneous Domains"	8
"Manufacturing Design"	AND	"Heterogeneous Domains"	31
"Design for Manufacturing and Assembly"	AND	"Heterogeneous Domains"	5
"Product Development Process"	AND	"Multiple Perspective"	114
"Integrated Product Development"	AND	"Multiple Perspective"	23
"Product Design"	AND	"Multiple Perspective"	145
"Manufacturing Design"	AND	"Multiple Perspective"	138
"Design for Manufacturing and Assembly"	AND	"Multiple Perspective"	6
Total researches found			775

Following, the exclusion criteria proposed in Table 4 was applied on the 775 articles titles, abstracts, and keywords, resulting in 37 selected works, as shown in Table 7. In this context, the main exclusion criterion was the specific domain papers since many articles were focused, for example, on medicine, business, and marketing. For the criterion of specific domain papers, every title, abstract and keywords of the articles were analysed according to the aim and question of this research and focus on the fields of Product Design and Manufacturing.

Table 7 Results of the Systematic literature Review on PDP vs. Multiple Domain, organised by authors.

Authors	Year	Title
Augustine <i>et al.</i>	2012	Cognitive map-based system modelling for identifying interaction failure modes
Bartolomei <i>et al.</i>	2012	Engineering Systems Multiple-Domain Matrix: An organising framework for modelling large-scale complex systems
Brusoni and Prencipe	2006	Making Design Rules: A Multi-domain Perspective
Canciglieri Jr. and Young	2010	Information mapping across injection molding design and manufacture domain
Chen, Wang and Huang	2014	A negotiation methodology for multidisciplinary collaborative product design
Christiansen <i>et al.</i>	2010	Living Twice: How a Product goes through Multiple Life Cycles
Chungoora, Canciglieri Jr. and Young	2010	Towards expressive ontology-based approaches to manufacturing knowledge representation and sharing
Colombo, Dell'Era and Frattini	2015	Exploring the contribution of innovation intermediaries to the new product development (NPD) process: a typology and an empirical study
Danilovic and Browning	2007	Managing complex product development projects with design structure matrices and domain mapping matrices
Danilovic and Sandkull	2005	The use of dependence structure matrix and domain mapping matrix in managing uncertainty in multiple project situations
Demoly <i>et al.</i>	2013	Product relationships management enabler for concurrent engineering and product lifecycle management
Demoly <i>et al.</i>	2010	Multiple viewpoint modelling framework enabling integrated product-process design
Driessen and Hillebrand	2013	Integrating Multiple Stakeholder Issues in New Product Development: An Exploration
Elgh and Sunnersjo	2007	An Ontology Approach to Collaborative Engineering For Producibility
Fan <i>et al.</i>	2008	Development of a distributed collaborative design framework within peer-to-peer environment
Froehle and Roth	2007	A resource-process framework of new service development
Govindaluri and Cho	2007	Robust design modelling with correlated quality characteristics using a multi-criteria decision framework
Gunendran and Young	2007	An information and knowledge framework for multi-perspective design and manufacture
He, Hou and Song	2015	Integrating engineering design and analysis using a parameter constraint graph approach
Inoue <i>et al.</i>	2012	Decision-making support for sustainable product creation
Lagrosen	2005	Customer involvement in new product development; A relationship marketing perspective
Lee and Kim	2007	A distributed product development architecture for engineering collaborations across ubiquitous virtual enterprises
Lennartson <i>et al.</i>	2007	Sequence Planning for Integrated Product, Process and Automation Design
Liao <i>et al.</i>	2015	Semantic annotation for knowledge explicitation in a product lifecycle management context: a survey
Lin <i>et al.</i>	2012	A systematic approach for deducing multi-dimensional modelling features design rules based on user-oriented experiments
Luh, Chu and Pan	2010	Data management of green product development with generic modularized product architecture
Nelson	2011	Tackling multiple domains
Ouertani and Gzara	2008	Tracking product specification dependencies in collaborative design for conflict management
Pasqual and Weck	2012	Multilayer network model for analysis and management of change propagation
Rasoulifar, Eckert and Prudhomme	2014	Supporting communication between product designers and engineering designers in the design process of branded products: a comparison of three approaches

Riou and Mascle	2009	Assisting designer using feature modelling for lifecycle
Seki and Nishimura	2011	A module-based thermal design approach for distributed product development
Sommer, Dukovska-Popovska and Steger-Jensen	2013	Barriers towards integrated product development — Challenges from a holistic project management perspective
Subramani and Gurumoorthy	2005	Maintaining associativity between form feature models
Tseng, Kao and Huang	2008	A model for evaluating a design change and the distributed manufacturing operations in a collaborative manufacturing environment
Vosinakis <i>et al.</i>	2008	Virtual environments for collaborative design: requirements and guidelines from a social action perspective
Zhou, Lin and Liu	2008	Customer-driven product configuration optimization for assemble-to-order manufacturing enterprises

The analysis of the 37 selected articles revealed that the research subject is concentrated in 9 journals which contain 70.3% of the explored bibliography: International Journal of Computers in Industry, Computer-Aided Design, International Journal of Project Management, International Journal of Advanced Manufacturing Technology, Research in Engineering Design, Journal of Advanced Engineering Informatics, International Journal of CoCreation in Design and the Arts, International Journal of Computer Integrated Manufacturing and Journal of Product Innovation Management. The remaining 29.7% is distributed among 13 other journals. A growing trend of 51.4% was observed after 2010, which highlights the relevance of the research in this domain.

3.2.2.2 STEP 1b: Scientific papers related to PDP and Product Requirements (Constraints)

Similarly to step 1a, in this step the searching for scientific papers related to PDP and Product Requirements (Constraints) was performed according to the inclusion criteria, presented in Table 4, which were applied to the article title, abstract and keywords. The following keywords must be mentioned in the article as the premise of selection: ii) regarding PDP - Integrated Product Development, Product Development Process, Product Design, Manufacturing Design, Design for Manufacturing and Assembly; and ii) regarding Product Requirements (constraints) - Requirements and Specification. The time period covered 10 years, from 2005 to 2015, was the same as the previous searching. The searching resulted in 2,830

selected articles, as illustrated in Table 8, and are distributed according to the keywords crossing.

The exclusion criteria proposed in Table 4 was applied on the 2,830 selected papers, resulting in 29 articles that were related to the research subject and fields of Product Design and Manufacturing, as shown in Table 9. As the previous searching, the main exclusion criterion was the specific domain papers since many articles had different focuses from this research. Table 9 organises the 29 selected articles by authors.

Table 8 Systematic literature Review on PDP vs. Product Requirements preliminary results.

Keywords			Results from the databases
"Product Development Process"	AND	"Requirements"	1,515
"Integrated Product Development"	AND	"Requirements"	293
"Product Design"	AND	"Requirements"	797
"Manufacturing Design"	AND	"Requirements"	27
"Design for Manufacturing and Assembly"	AND	"Requirements"	2
"Product Development Process"	AND	"Specification"	21
"Integrated Product Development"	AND	"Specification"	1
"Product Design"	AND	"Specification"	168
"Manufacturing Design"	AND	"Specification"	6
"Design for Manufacturing and Assembly"	AND	"Specification"	0
Total researches			2,830

Table 9 Results of the Systematic literature Review on PDP vs. Product Requirements, organised by authors.

Authors	Year	Title
Baïna <i>et al.</i>	2009	New paradigms for a product oriented modelling: Case study for traceability
Baxter <i>et al.</i>	2008	A framework to integrate design knowledge reuse and requirements management in engineering design
Belkadi <i>et al.</i>	2012	A meta-modelling framework for knowledge consistency in collaborative design
Bereketli and Genevois	2013	An integrated QFDE approach for identifying improvement strategies in sustainable product development
Chang, Sahin and Terpenney	2008	An ontology-based support for product conceptual design
Chen	2010	Knowledge integration and sharing for collaborative moulding product design and process development
Chen	2006	Classification of product requirements based on product environment
Darlington and Culley	2008	Investigating ontology development for engineering design support

Huang and Liang	2006	Explication and sharing of design knowledge through a novel product design approach
Juan, Ou-Yang and Lin	2009	A process-oriented multi-agent system development approach to support the cooperation-activities of concurrent new product development
Käkölä, Koivulahti-ojala and Liimatainen	2011	An information systems design product theory for the class of integrated requirements and release management systems
Kim <i>et al.</i>	2012	Product life cycle information and process analysis methodology: Integrated information and process analysis for product life cycle management
Kim, Manley and Yang	2006	Ontology-based assembly design and information sharing for collaborative product development
Krishnapillai and Zeid	2006	Mapping Product Design Specification for Mass Customization
Lee and Lin	2011	An integrated fuzzy QFD framework for new product development
Lehto <i>et al.</i>	2011	Benefits of DFX in requirements engineering (Design for X)
Lin, Chen and Chen	2009	An integrated component design approach to the development of a design information system for customer-oriented product design
McFarlane and Cuthbert	2012	Modelling information requirements in complex engineering services
Ouertani	2009	Engineering change impact on product development processes
Ouertani <i>et al.</i>	2011	Traceability and management of dispersed product knowledge during design and manufacturing
Parameshwaran, Baskar and Karthik	2015	An integrated framework for mechatronics based product development in a fuzzy environment
Pernstål, Magazinius and Gorschek	2012	A study investigating challenges in the interface between product development and manufacturing in the development of software-intensive automotive systems
Wang, Chan and Li	2015	A case study of an integrated fuzzy methodology for green product development
Wu <i>et al.</i>	2013	A distributed collaborative product design environment based on semantic norm model and role-based access control
Xu <i>et al.</i>	2007	A decision support system for product design in concurrent engineering
Xu <i>et al.</i>	2011	Developing a knowledge-based system for complex geometrical product specification (GPS) data manipulation
Yin, Qin and Holland	2011	Development of a design performance measurement matrix for improving collaborative design during a design process
Zeng <i>et al.</i>	2011	Product collaborative design method based on a sharing information model
Zha and Sriram	2006	Platform-based product design and development: A knowledge-intensive support approach

The analysis of the 29 selected articles shown that the research subject is concentrated in 6 journals which contain more than 48.0% of the explored bibliography: Advanced Engineering Informatics, Computer-Aided Design, Computers in Industry, Concurrent Engineering – Research and Applications, Knowledge Based System and Robotics and Computer Integrated Manufacturing. The remaining 51.7% is distributed among 15 other journals. A growing trend of 50.0% was observed after 2010.

3.2.2.3 STEP 2: Analysis and classification of the papers related to Multiple Domains and Product Requirements to support PDP

Following the methodology proposed for the systematic literature review, the analysis and categorization of the articles selected in the steps 1a and 1b were performed in this step. This analysis and categorization aimed to investigate the articles correlations, solutions and limitations concerning the three perspectives of PDP, Multiple Domains and Product Requirements (constraints) working simultaneously.

The starting point to identify the criteria for the categorization were: (i) Cross-Domains (D); (ii) Cross-Product Development Phases (PD); and Cross-Product Requirements (Constraints) (R). The criteria were defined by crossing the literature information with the research's aims and issues and identifying the most relevant parameters for the articles categorization. The proposed categorization criteria that were applied in the selected 66 articles were:

- **(D1) Particular cases** – Papers/articles concerning the product information and/or requirements exchange limited to two specific domains;
- **(D2) Ability to be general** – Papers/articles concerning the product information and/or requirements exchange among different domains and that can be adapted to other domains;
- **(D3) General approach** – Papers/articles concerning the product information exchange and/or requirements among different domains which approaches do not need any adaptation;
- **(PD1) Considering PDP** – papers/articles that concern the product information and/or requirements exchange in one or between two or more phases of the product development process;

- **(PD2) Not considering PDP** – papers/articles that do not concern the product information and/or requirements exchange in one or between two or more phases of the product development process;
- **(R1) Requirements Traceability** - Papers/articles regarding the product information and/or constraints traceability in one or more phases of product development process;
- **(R2) Requirements Interoperability** – Papers/articles regarding the exchange of product information and/or constraints between one or more phase of product development process and different domains;
- **(R3) Requirements Inconsistency Analysis** - Papers/articles regarding the product information and/or constraints exchange between one or more phase of product development process and different domains. This sub-issue considers the impacts analysis caused by any product information and/or constraints changes during the product development process.

Table 10 Related works categorization according to the proposed criteria.

Authors and Publication Year	Multiple Domains issue			PDP issue		Requirements issue		
	(D1)	(D2)	(D3)	(PD1)	(PD2)	(R1)	(R2)	(R3)
Augustine et al. (2012)	✓			✓				
Baïna, Panetto and Morel (2009)	✓			✓		✓		
Bartolomei et al. (2012)	✓				✓	✓		
Baxter et al. (2008)	✓	✓	✓	✓			✓	
Belkadi et al. (2012)	✓	✓	✓	✓		✓	✓	
Bereketli and Genevois (2013)	✓			✓				
Brusoni and Prencipe (2006)	✓	✓		✓			✓	
Canciglieri Jr. and Young (2010)	✓	✓		✓			✓	
Chang, Sahin and Terpenny (2008)	✓	✓		✓				
Chen (2010)	✓	✓		✓			✓	
Chen (2006)	✓			✓		✓		
Chen, Wang and Huang (2014)	✓			✓			✓	
Christiansen et al. (2010)	✓			✓				
Chungoora, Canciglieri Jr. and Young (2010)	✓			✓			✓	
Colombo, Dell'Era and Frattini (2015)	✓				✓			
Danilovic and Browning (2007)	✓	✓		✓		✓	✓	
Danilovic and Sandkull (2005)	✓	✓		✓		✓		
Darlington and Culley (2008)	✓			✓		✓		
Demoly et al. (2010)	✓	✓			✓		✓	
Demoly et al. (2013)	✓				✓			

Driessen and Hillebrand (2013)					✓	✓		
Elgh and Sunnersjo (2007)	✓			✓		✓		
Fan et al. (2008)	✓			✓				
Froehle and Roth (2007)	✓				✓			
Govindaluri and Cho (2007)	✓				✓			
Gunendran and Young (2006)	✓			✓			✓	
He, Hou and Song (2015)	✓				✓			
Huang and Liang (2006)	✓				✓		✓	
Inoue et al. (2012)	✓				✓			
Juan, Ou-Yang and Lin (2009)					✓		✓	
Käkölä, Koivulahti-ojala and Liimatainen (2011)					✓			
Kim et al. (2012)	✓			✓		✓	✓	
Kim, Manley and Yang (2006)	✓	✓		✓		✓	✓	
Krishnapillai and Zeid (2006)					✓		✓	
Lagrosen (2005)	✓			✓				
Lee and Lin (2011)				✓			✓	
Lee and Kim (2007)	✓				✓			
Lehto et al. (2011)					✓	✓		
Lennartson et al. (2010)	✓			✓				
Liao et al. (2015)	✓	✓		✓			✓	
Lin et al. (2012)	✓				✓			
Lin, Chen and Chen (2009)	✓				✓		✓	
Luh, Chu and Pan (2010)	✓				✓	✓		
McFarlane and Cuthbert (2012)	✓				✓	✓	✓	
Nelson (2011)	✓	✓	✓		✓	✓		
Ouertani and Gzara (2008)	✓				✓	✓		✓
Ouertani (2009)	✓			✓			✓	
Ouertani et al. (2011)	✓	✓		✓		✓	✓	
Pasqual and Weck (2012)	✓			✓				✓
Parameshwaran, Baskar and Karthik (2015)	✓				✓			
Pernstål, Magazinius and Gorschek (2012)				✓		✓		
Rasoulifar, Eckert and Prudhomme (2014)	✓			✓			✓	
Riou and Mascle (2009)	✓			✓				✓
Seki and Nishimura (2011)	✓			✓				
Sommer, Dukovska-Popovska and Steger-Jensen (2013)	✓				✓			
Subramani and Gurumoorthy (2005)	✓	✓		✓				✓
Tseng, Kao and Huang (2008)	✓			✓				
Vosinakis et al. (2008)	✓			✓		✓		
Wang, Chan and Li (2015)	✓				✓			
Wu et al. (2013)	✓	✓		✓			✓	
Xu et al. (2007)	✓				✓			
Zhou, Lin and Liu (2008)	✓				✓			
Yin, Qin and Holland (2011)					✓	✓	✓	
Xu et al. (2011)					✓	✓		
Zeng et al. (2011)	✓			✓			✓	
Zha and Sriram (2006)	✓			✓		✓		

The 66 selected articles were analysed and categorised and the results are shown below:

Cross-Multiple Domains

- 86.3% of articles/papers reach the criterion D1;
- 24.2% of articles/papers reach the criterion D2;
- 4.5% of articles/papers reach the criterion D3.

Cross-Product Development Process

- 57.5% of articles/papers concern the criterion PD1;
- 42.4% of articles/papers concern the criterion PD1.

Cross-Product Requirements (Constraints)

- 33.8% of articles/papers reach the criterion R1;
- 37.8% of articles/papers reach the criterion R2;
- 6.1% of articles/papers reach the criterion R3.

The results point out that there are multiple domains issues, criteria (D2) and (D3) and requirements issue item (R3) that were poorly explored. The first lack in information interoperability concerns the *generality of the proposed approach* and made evident the problem with the semantic gap in multiples domains as well as the risk of mistakes and misinterpretation. The second observed lack concerns the *Requirements Impacts* criterion that showed a gap in the evaluation of specific requirement (constraints) influence in distinct domains and different life cycle phases. In order to ensure a complete requirements interoperation, it is necessary to consider an approach that allows: (i) information sharing between multiple domains (D3); (ii) the requirements influence analysis in different phases of engineering life cycle (PD2); and (iii) requirements traceability (R1), requirements interoperability (R2) and requirements inconsistency impacts (R3) analysis.

3.2.2.4 STEP 3: Identification and analysis of the main researches and the milestone references for this research.

This phase consisted of analysing the content of the 66 articles selected in the previous steps and identifying the main researches and the milestones references for this research. In this step, the selection criterion (C1) was the scientific articles classified in “D2 and/or D3 + PD1 + R1 and/or R2 and/or R3”. So that, the selected

articles approaches concerned: (i) Multiple Domains; (ii) PDP; and (iii-a) Requirements (constraints) traceability, (iii-b) Ability of information exchange and (iii-c) Impact analysis.

This step highlighted 14 articles as the most relevant for this research. The works of Danilovic and Sandull, (2005); Subramani and Gurumoorthy, (2005); Brusoni and Prencipe, (2006); Kim, Manley and Yang, (2006); Danilovic and Browning, (2007); Baxter *et al.*, (2008); Chang, Sahin and Terpenney, (2008); Canciglieri Junior and Young, (2010); Chen (2010), Demoly *et al.*, (2010); Ouertani *et al.*, (2011); Belkadi *et al.*, (2012); Wu *et al.*, (2013); and Liao *et al.*, (2015) were selected as their approaches involved the three perspectives simultaneously that are studied in this research.

The 14 selected articles were analysed and the citation frequency was mapped and documented, as shown in Table 11. This table shows the frequency that the authors are cited (rows) in the selected articles (columns).

Table 11 References frequency distribution.

	Danilovic and Sandkull (2005)	Subramani and Gurumoorthy (2005)	Brusoni and Prencipe (2006)	Kim; Manley and Yang (2006)	Danilovic and Browning (2007)	Baxter <i>et al.</i> (2008)	Chang; Sahin and Terpenney (2008)	Canciglieri and Young (2010)	Chen (2010)	Demoly <i>et al.</i> (2010)	Ouertani <i>et al.</i> (2011)	Belkadi <i>et al.</i> (2012)	Wu <i>et al.</i> (2013)	Liao <i>et al.</i> (2015)	Overall number of citations	Overall percentage of citations
S. D. Eppinger	7				5										12	0,9%
M. Danilovic	5				6										11	0,8%
R. I. M. Young						2	5			1	1			1	10	0,8%
H. Panetto												3		5	8	0,6%
T. R. Browning	4				3										7	0,5%
W. F. Bronsvoot		5		1						1					7	0,5%
O. Canciglieri Júnior							5							1	6	0,5%
R. D. Sriram						1				2	2	1			6	0,5%
D. E. Whitney	2			2						1					5	0,4%
D. Steward	3				2										5	0,4%
K. M. Carley					5										5	0,4%
R. Mizoguch				5											5	0,4%

Authors with 4 citations (14 authors)	7	7		2	4	9		2	3	2	3	1	8	8	56	4,2%
Authors with 3 citations (29 authors)	2	3	2	6	5	4	1	3	2	8	5	8	8	30	87	6,5%
Authors with 2 citations (118 authors)	12	19	26	9	14	27	7	2	4	19	18	27	5	46	235	17,7%
Authors with 1 citations (865 authors)	21	31	32	53	28	59	25	68	51	61	76	77	32	250	864	65,0%
Total															1,329	100,0%

This process resulted in 12 authors as most referenced authors (frequency of over 5 citations or more in order to converge to the utmost relevant authors): S. D. Eppinger, M. Danilovic, R. I. M. Young, H. Panetto, T. R. Browning, W. F. Bronsvort, O. Canciglieri Junior, R. D. Sriram, D. E. Whitney, D. Steward, K. M. Carley, and R. Mizoguch. The references articles and relevant authors from this analysis offered knowledge boundaries of their fields and therefore, supported the identification of the research main settings as their approaches impact directly in semantic interoperability solutions for the product design and manufacturing.

3.2.3 Synopses of main researches and guidelines to the conceptual framework

The systematic literature review resulted in 14 articles that are the references for this research. Thus, this section explored the approaches proposed in each work and their limitations as well as their contributions, as follows:

- **Danilovic and Sandkull, (2005)**
 - *Approach:* The authors proposed an approach to introduce dependency structure matrix and domain mapping matrix that enables the systematic identification of interdependencies and relations in a Multi-project environment. The approaches enable clarifications of assumptions, the tractability of dependencies, explores the information needed within and between different departments, projects and people. This creates a transparency and enables the synchronisation of actions through the

transformation of information and exploration of assumptions within and between domains.

- *Limitations and Contributions:* This approach only systematises the information relationships across PDP, but it does not consider the meaning associated to the information captured and their impact in other domains.

- **Subramani and Gurumoorthy, (2005)**

- *Approach:* the researchers presented an algorithm that takes multiple feature models of a part as input and modifies other feature models to reflect the changes made to a feature in a feature model. The proposed algorithm updates feature volumes in other feature models and then classifies the updated volumes to obtain the updated feature model.
- *Limitations:* The algorithm has a tendency to a general approach, but it is limited to the interaction between specific domains.

- **Brusoni and Prencipe, (2005)**

- *Approach:* the researchers investigated the organisation's process to propose a new structure to the product development with radical innovations.
- *Limitations and Contributions:* This research was limited to the process systematisation with multiple domains and thus is not address the information exchange across these heterogeneous domains.

- **Kim, Manley and Yang, (2006)**

- *Approach:* the authors developed a new paradigm of ontology-based assembly design. The authors proposed an assembly design (AsD) ontology that serves as a formal, explicit specification of assembly design, so that, it makes assembly knowledge both machine-interpretable and to be shared. An Assembly Relation Model (ARM) is enhanced, using ontologies that represent engineering, spatial, assembly and joining

relations of assembly in a way that promotes collaborative assembly information-sharing environments. In the developed AsD ontology, implicit AsD constraints are explicitly represented using OWL (Web Ontology Language) and SWRL (Semantic Web Rule Language).

- *Limitations and Contributions:* Although, this research was limited to the assembly domain, the integration of OWL plus (+) SWRL is hypothetically interesting to overcome the semantic interoperability issues in Product Design and Manufacturing. This research presents potential applicability in the use of ontology to formalise heterogeneous information and relationships

- **Danillovic and Browning, (2007)**

- *Approach:* The researchers proposed an approach to handling the complexity in the product development process and multiple domains through the Design Structure Matrix (DSM) and Domain Mapping Matrix (DMM). DSM was used to handle dependencies and relations between items of product development, but DSM allows modelling the dependencies of one type of single information with other. DMM allows relating two or more DSM.
- *Limitations and Contributions:* This approach does not enable the interoperability between information as well as the analysis the impact when information change.

- **Baxter et al., (2008)**

- *Approach:* The authors developed a framework to add requirements management capability to a knowledge reuse design method. The mapping of the various product domains links the product structure to the requirement source. The database structure provided by the knowledge reuse design system supports a dynamic management of the emergent requirements and developing design data.
- *Limitations and Contributions:* Although this framework presents a solution to establish links between requirements or constraints

and product development in order to ensure the correct design, the approach does not address the information formalisation and their relationships across other phases of the PDP.

- **Chang, Sahin and Terpenney (2008)**

- *Approach:* The researchers proposed an approach to support designers in the conceptual design stage. An ontology-based approach for knowledge management, which works along with the graphical modelling tool, to support designers in generating flexible, fast, and easy design concepts was discussed and developed. In addition, different methods are proposed to offer support to the users, such as the relationship between the ontology and databases, the data analysis process, ontology enrichment, and the ontology-based query engine.
- *Limitations and Contributions:* This research has an interesting approach (ontology plus (+) query engine) to support the semantic interoperability in the product design and manufacturing, even though it was limited in a specific phase of PDP.

- **Canciglieri Junior and Young (2010)**

- *Approach:* The researchers proposed a conceptual multiple view approach model using object-oriented model and UML to map information relationships between designs and manufacturing domains based on translation mechanisms. Each mechanism had a specific knowledge, which was responsible for translating the information from one view to another.
- *Limitations and Contributions:* Despite this solution, this research presented limited mechanisms to specific domains, but the information structure and the translation mechanisms are theoretically applicable to the interoperability in product design and manufacturing.

- **Chen (2010)**
 - *Approach:* the author presented a systematic approach for developing knowledge integration and sharing mechanism for collaborative moulding product design and process development. The proposed approach includes the steps of (i) collaborative moulding product design and process development process modelling, (ii) an ontology-based knowledge model establishment, and (iii) knowledge integration and sharing system framework design, development and implementation.
 - *Limitations and Contributions:* The relationships and changing analysis are not addressed, although this research structures the information. However, the result of this approach significantly contributes to the semantic interoperability in product design and manufacturing framework based on ontological approach.

- **Ouertani et al., (2011)**
 - *Approach:* The researchers proposed a standardised approach for tracing and sharing product knowledge. Furthermore, key constructions to support traceability during the product development process are identified and formalised. The proposed approach was implemented using the MEGA Suite tool.
 - *Limitations and Contributions:* This research does not address the information interoperability across multiple domains as well as the information changing across PDP.

- **Belkadi et al., (2012)**
 - *Approach:* The authors investigated a new meta-model in a Model-Driven Engineering (MDE) approach to managing the integration of heterogeneous experts' knowledge models in a collaborative process. This meta-model is split in a meta-model of data and in a Collaboration Meta-Model to represent the distinction between the core concepts of knowledge and additional elements serving to represent the relation between

these concepts, and between concepts of heterogeneous experts' models.

- *Limitations and Contributions:* The research allows the communication between different tools (CAD, CAS, PDM), but the information interoperability across PDP is not considered. However, the approach works with core concepts and semantic mapping that are used to support the heterogeneity of information between models, which currently occurs during the collaborative project.

- **Demoly et al., (2013)**

- *Approach:* A product relationship management approach called PROMA is proposed and implemented in a new application called PEGASUS in connection with PDM, MPM and CAD systems. The proposed approach enables the control of internal regulation procedures between product design and assembly sequence planning phases, so as to provide a proactive and interactive support for lifecycle oriented product development.
- *Limitations and Contributions:* semantic information interoperability and their relationships are not completely achieved, although the approach proposed by the researchers enriches the information based on the connection with different platforms.

- **Wu et al., (2013)**

- *Approach:* The authors proposed a Semantic Norm Model (SNM) for product design. A high-level semantic constraint system is presented in the conceptual design to link the gaps between product conceptual and detailed design and a Role-Based Access Control (RBAC) system is constructed to support distributed collaborative product design. Thus, based on the SNM and RBAC system, a distributed collaborative product design environment is established, allowing distributed designers to work collaboratively and concurrently.

- *Limitations and Contributions:* This research does not address the information interoperability across multiple domains and information changing across PDP.
- **Liao *et al.*, (2015)**
 - *Approach:* A formalisation of semantic annotation for system interoperability from the view of different domains in a Product Life Cycle Management environment is proposed. The formalisation made explicit the tacit knowledge in application models and provided support for all activities during the product life cycle.
 - *Limitations and Contributions:* Semantic links are established with different domains and potentially contributes to semantic interoperability across PDP, even though this approach did not depict the information interoperability across PDP.

The systematic literature review established the main studies and milestones references in the subject of this research, deepening the knowledge and understanding on the issues of the semantic information interoperability in product design and manufacturing and their solutions.

Firstly, the systematic review exposed 3605 articles regarding Multiple Domains vs. PDP and Product Requirements (Constraints) and PDP. Following, criteria of inclusion and exclusion were applied and resulted in the selection of the 66 articles that were directly related to the research's subject. The selected articles were analysed and categorised according to 8 criteria that evaluated the maturity level to solve the three interoperation issues of cross-domain, cross-PDP and cross-product requirements (constraints). The categorization offered subsidies for defining the main researches identification criterion (C1), resulting in 14 articles classified in the main categories related to semantic information interoperability applied to PDP.

The analysis of the 14 articles has shown that the researches of Canciglieri Junior and Young (2010); Kim, Manley and Yang, (2006); Belkadi *et al.* (2012); and Liao *et al.*, (2015) were the major references on this research scope. The approaches proposed by these researchers have demonstrated potential to solve the problems of semantic information interoperability in product design and

manufacturing, although without a holistic perception. Cancigleiri Junior and Young (2010), proposed an information data structure and relationships mechanisms well defined to the product design and manufacturing, based on the feature technology that was applied to plastic injection moulded product. Kim, Manley and Yang, (2006) used ontology in OWL and modelled semantic rules in SWRL, to formalise information in assembly design and depicted the applicability of ontology to solve semantic interoperability issues. Belkadi *et al.* (2012) used the “core concepts” to formalise foundations knowledge and established a semantic mapping to relate different core concepts. Liao *et al.*, (2015) proposed semantic annotations to enrich the information relationships across PLM that can be extended to the PDP

All the above-mentioned approaches and the interoperability issues discussed in the problem statement were taken into account into the proposal and development of the research framework for supporting the semantic information interoperability in product design and manufacturing. All the literature review analysis covered the first (i) and second (ii) research specific objectives. Next section presents the proposal of the conceptual framework.

3.3 PROPOSAL OF CONCEPTUAL FRAMEWORK FOR SEMANTIC INFORMATION INTEROPERABILITY IN PRODUCT DESIGN AND MANUFACTURING

This section contributes to this research by proposing a conceptual framework to provide support for the semantic information interoperability in product design and manufacturing. Section 3.3.1 presents the framework general approach and section 3.3.2 shows the specialised approach.

3.3.1 Conceptual framework for semantic information interoperability in Product design and manufacturing: a general approach.

Semantic Information Interoperability is achieved when the meaning associated to the information and knowledge captured in computational form can be effectively exchanged across different perspectives (CHUNGOORA *et al.*, 2013).

Additionally, interoperability is defined by IEEE (1993) as the capacity of two or more systems to exchange information and to use the information that has been shared.

Product Design and Manufacturing are phases of Product Development Process and have different stages of development, information from multiple domains and multiple systems and distinct constraints interacting in a concurrent manner. These phases are extremely critical because they represent 85% of the whole cost of the product development (ROZENFELD *et al.*, 2006). So that, all information must be effectively exchanged across perspectives.

The interoperability issues discussed in the problem statement and all the theoretical foundations were the basis for the proposed conceptual framework for supporting Semantic Information Interoperability in Product Design and Manufacturing. It is important to stress that the researches of Canciglieri Junior (1999), Canciglieri Junior and Young (2003), Canciglieri Junior and Young (2010) and Chungoora, (2010) and Chungoora *et al.* (2013) positively influenced the construction of the proposed Conceptual Framework.

The work developed by Canciglieri Junior (1999), Canciglieri Junior and Young (2003) and Canciglieri Junior and Young (2010) explored multiple views points in design and manufacturing using features technology in a concurrent engineering environment. Their research limitation was that the simultaneous information exchanging only occurs between pairs of views following a logical sequential translation. The approach taken in this study was one of the pioneers in multiple views exchanging information using translation mechanisms; in addition, the research developed a solid and effective information taxonomy structure for thin wall injected plastic products. The translation mechanism approach collaborated with the definition of the proposed Conceptual framework (see Chapter 4). The Semantic Manufacturing Interoperability Framework (SMIF) proposed by Chungoora, (2010) and Chungoora *et al.* (2013) evaluated the interoperability level only in the manufacturing domain, limited to machining holes processes, in order to overcome semantic interoperability problems. The approach taken in this study collaborated with the construction of the multiple domains simultaneous interrelationships approach proposed in the conceptual framework of this thesis, which considers an ontological approach to formalise the knowledge and semantic methods to infer the relationships.

Therefore, the Conceptual Framework for an Interoperable Product Design and Manufacturing proposed in this research uses a semantical well-defined Core and Constraints concepts in multiple domains to simultaneously instantiate information in the Application Domain View, according to the specific product information and technological limitations. In addition, semantic relationships can be established between instantiated information, allowing their semantic mappings of translation, sharing and conversion between different phases of product design and manufacturing. Thus, the conceptual framework architecture is composed of three views:

- **Reference View** (Detail “A” of Figure 19) – This view gathers and structures concepts to formally represent, in an elementary form, the product design and manufacturing taxonomy from different perspectives. Figure 16 represents different core ontologies, which has their own structures. The concepts are modelled in common logic based formalism (OWL), named core ontologies, as related in Belkadi *et al.*, (2010) and Chungoora *et al.*, (2013). Reference View (RV) may have Product Design Core, Tolerances Core, Materials Core, Manufacturing Core, etc, according to the product design and manufacturing.

Figure 16 Reference View architecture.

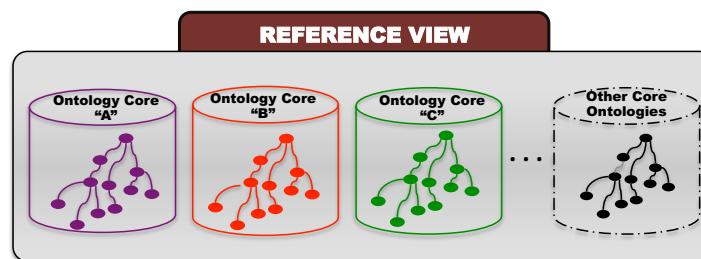

- **Application Domain View** (Detail “B” of Figure 19) – In this view the concepts from the Reference View are specialised into product ontology, according to the specific data about the product design or manufacturing. This specialisation process must respect the semantic rules to ensure the correct relationship of this information. The data are

about Product Model and Manufacturing Model, as shown in Figure 17 and comes from multiple phases of the PDP. As this information is formally defined in a common language, it is possible to compare and verify the information without losing their meaning, as discussed in Canciglieri Junior and Young (2010), in an interoperable manner with semantic rules.

Figure 17 Application Domain View Architecture.

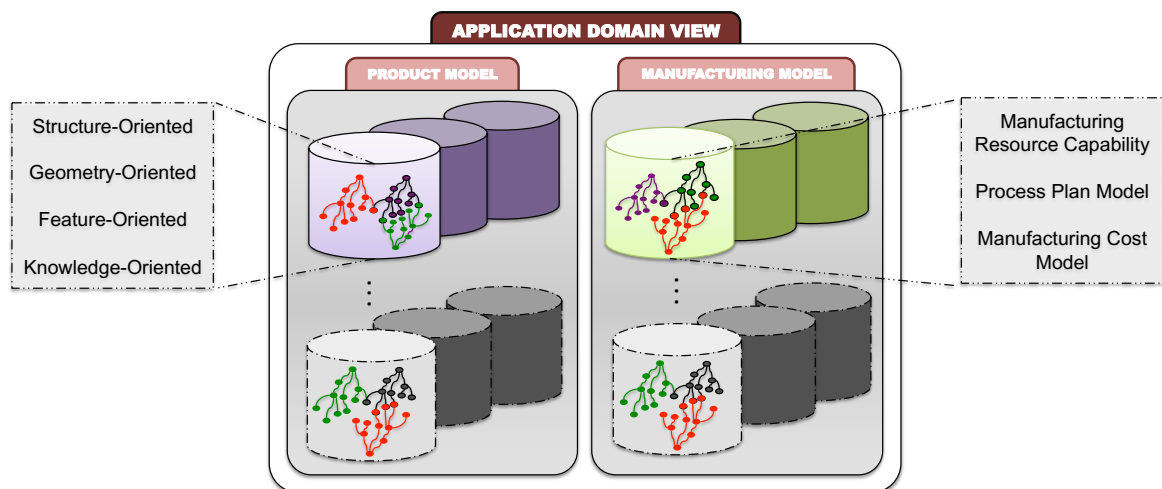

- **Semantic Reconciliation View** (Detail “C” of Figure 19) – This view establishes the semantic rules for defining the relationships of heterogeneous information, inferring the semantic mapping of sharing, conversion and translation across different phases of PDP. The Semantic Reconciliation View architecture is represented in Figure 18 and formalisation of the relationships follow the proposition of relevant works such as Kim, Manley and Yang, (2006), Chungoora *et al.*, (2013) and Liao *et al.*, (2015). These relationships are established in the Application Domain View, with the information of the Product that will be designed and manufactured. In the Semantic Reconciliation View, the semantic rules for the relationships can be intra-contexts (in a single domain) or inter-contexts (multiple domains). When the logic conditions are true, the semantic mapping of sharing, converting and translating are inferred; when the logic conditions are false, the semantic mapping of inconsistency is inferred.

Figure 18 Semantic Reconciliation View Architecture.

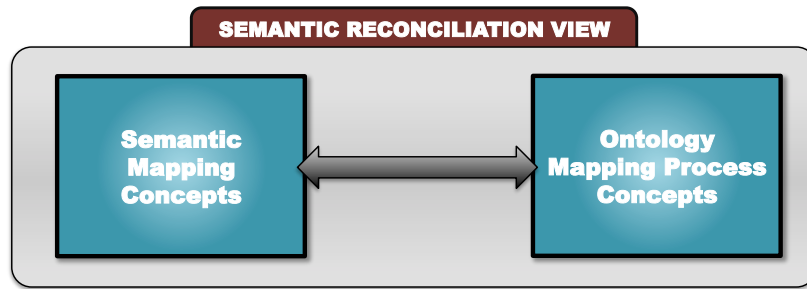

The Interoperable Product Design and Manufacturing System (IPDMS), as shown in detail “D” of Figure 19, is responsible for managing the information exchange and creating the relation link with different phases of PDP to support the Product Design and Manufacturing, respecting the different perspectives of the framework.

Figure 19 Architecture of the Conceptual Framework for an Interoperable Product Design and Manufacturing.

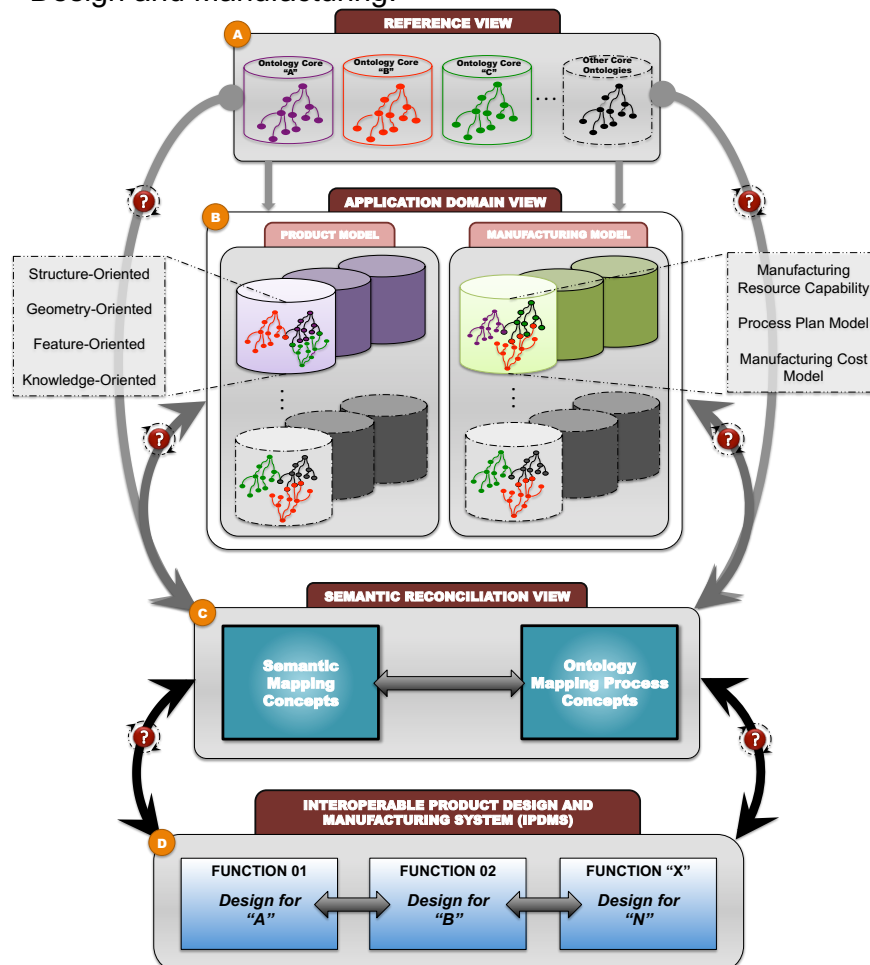

The framework is proposed in a general view as its architecture allows the design and manufacturing of different products, since the product taxonomy concepts and the knowledge of the relationships restrictions throughout the PDP phases can be inserted/provided into the Framework. However, the research scope concerns the injection moulding area and to achieve it, a conceptual framework was elaborated focusing this specific field. The next section presents the proposed framework specialized to rotational plastic injected products.

3.3.2 Conceptual framework for semantic information interoperability in Product design and manufacturing: specialised approach to rotational plastic injected products

Injection moulding is a huge area of knowledge that comprehends specialised sub-areas and has offered to researches opportunities to explore, in a multiple-perspective approach, the diverseness in the issues related to the plastic part, moulding and manufacturing.

The research scope implies the corroboration of the proposed framework within clear boundaries and constraints, taking into consideration the information interoperability across product design and manufacturing and their relationships. The conceptual framework proposed in the previous section has a general approach and can be applied to a range of situations. In this context, the proposed framework was focused on specifically onto simple product representations involving rotational thin-walled plastic injected products. Thus, three phases of the rotational plastic injected products design and manufacturing (design for mouldability, design for tooling and design for machining) were studied and provided subsidies for the semantic information interoperability.

Dealing with multiple perspectives in an injection-moulding environment requires the knowledge that each specific application has to hold an information structure within the product and manufacturing models that is able to support its function. Thus, firstly it is important to capture the information from different perspectives in a well-defined structure and instantiated to the core concepts in a specific application view. Secondly, the information relationships are defined based on the product constraints and technological constraints as well as different phase's

relations, since the relationships can support the movement of information from one application area to another. Furthermore, these relationships ensure the correct information exchange and permit the impact analysis when changing information. Thus, Figure 20 presents multiple perspectives involved during the injection moulding.

Figure 20 Multiple perspectives in Injection-Moulding.

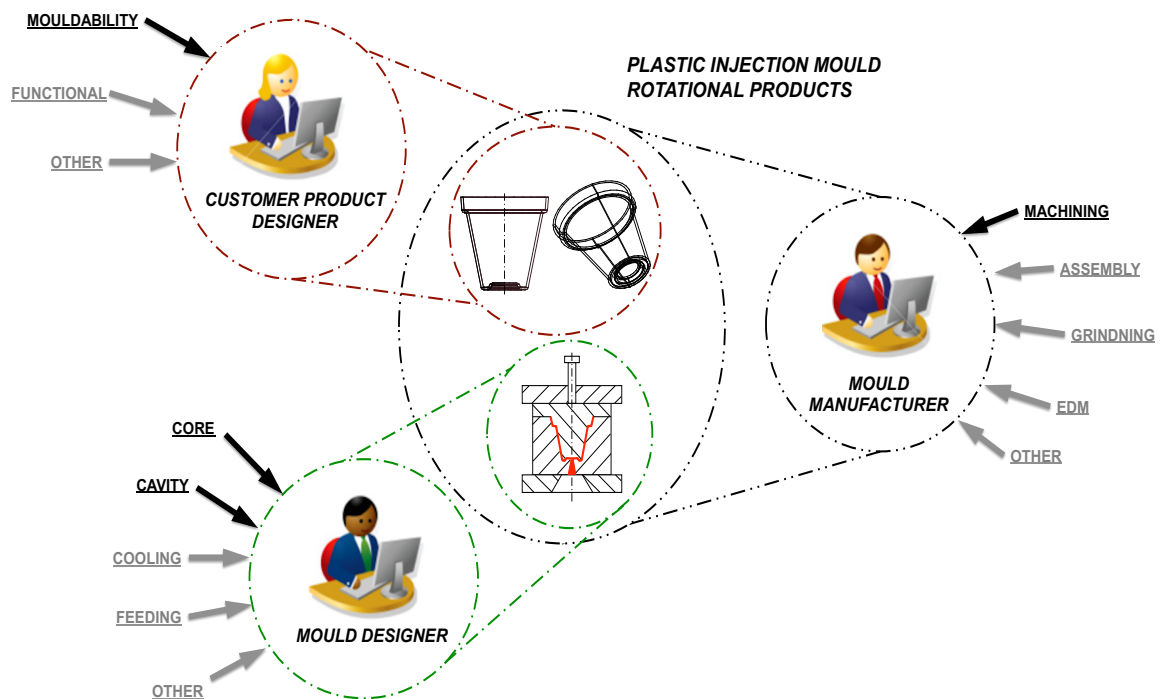

Source: Adapted from Canciglieri Junior and Young (2010).

According to Figure 20, the framework specialisation respects the multiple perspectives of Injection Moulding, where the information structure about Mouldability, Core and Cavity Insert, Machining and Materials (Reference View) must subsidize the Customer Product Designer (Design for Mouldability), Mould Designer (Design for Tooling) and Mould Manufacturer (Design for Machining). Figure 21 illustrates the conceptual framework for the semantic information interoperability in product design and manufacturing applied to plastic injection moulded rotational products.

Figure 21 Architecture of the Conceptual Framework for an Interoperable Product Design and Manufacture applied to Rotational Thin-Wall Injected Plastic Products.

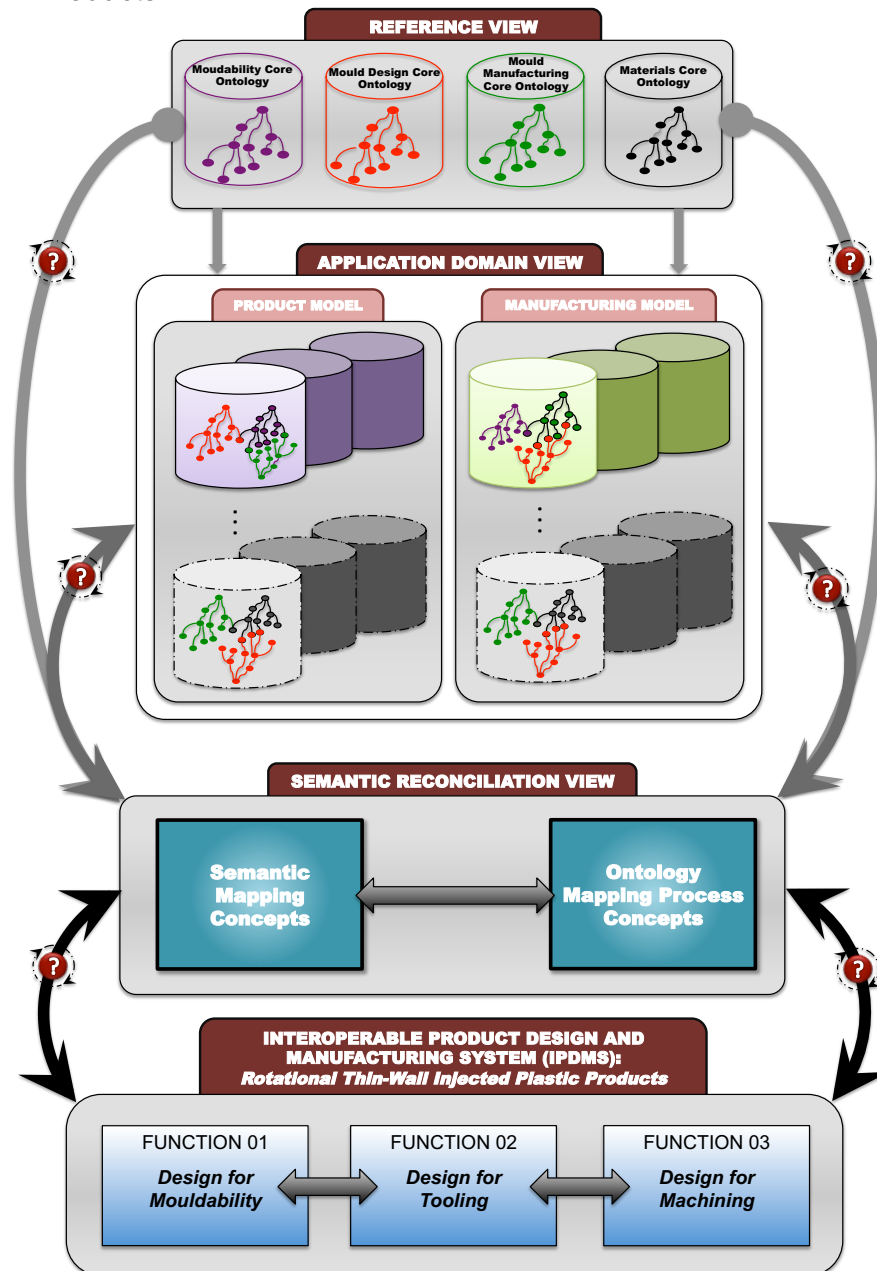

The conceptual framework to support the semantic information interoperability in product design and manufacturing applied to the rotational thin-wallet plastic injected products derived from the conceptual framework general approach that was adapted through specific core concepts of Rotational product mouldability, rotational mould design (core and cavity inserts), mould manufacturing and material. The core concepts are instantiated in the application domain view according to the information

of the plastic injected product design. Additionally, the semantic information relationships were established between the phases of design and manufacturing (Design for mouldability, design for tooling and design for machining).

The detailed development of the specialised conceptual framework applied to the rotational thin wall plastic injected product is explored in the next chapters. Chapter 4 presents the Reference View that consists in core ontologies. The Application Domain View, which is the specialisation of the core ontologies in specific ontologies dedicated to a specific product, is studied in Chapter 5. Chapter 6 focuses on the Semantic Reconciliation View that is composed by the semantic mapping of the information Intra and Inter contexts. The proposed conceptual framework experimental prototype is presented in Chapter 7.

4 CONCEPTUAL FRAMEWORK FOR SEMANTIC INFORMATION INTEROPERABILITY IN PRODUCT DESIGN AND MANUFACTURING: REFERENCE VIEW

The developed conceptual framework intends Semantic Information Interoperability in Product Design and Manufacturing based on an ontological approach to support the PDP applied in a rotational thin-wall injected plastic product (Figure 18). It is structured in Reference View, Application Domain View and Semantic Reconciliation View.

This chapter explores the Reference View (RV) concepts and is the first level of the framework, as depicted in Figure 19. It must have the essential core concepts and their relationships from different fields rigorously defined in an ontological approach to provide information support for the Application Domain View.

Figure 22 Reference view in the conceptual framework.

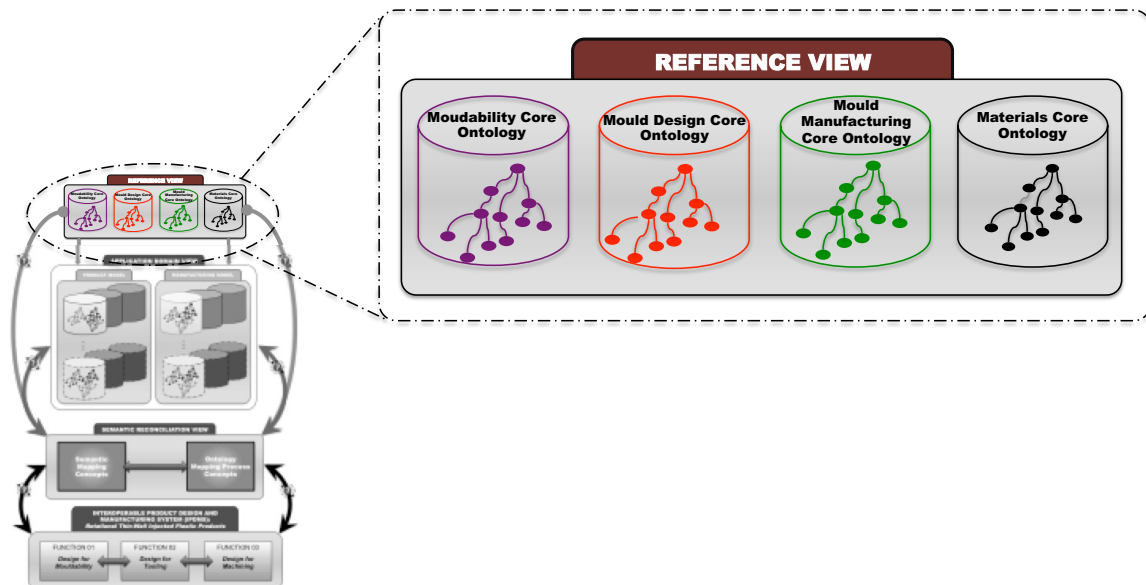

Two distinct procedures have been used to formalise the concepts based on the ontological approach. The first procedure is the standards and information modelled in Unified Modelling Language (UML) structure that was formalised in a lightweight representation. The second procedure is the representations already published in ontology libraries, such as DAML and OWL: Library, JOWL, DBpedia that were analysed and integrated to the Reference View. For both procedures, the

Web Ontology Language – OWL (W3C, 2009) is used with axioms rules in Semantic Web Rule Language – SWRL (W3C, 2004), as shown in Figure 23. In addition, Protégé is used to model the ontology. Protégé is a system dedicated to model, reasoner, infer and query ontology in different formats such as RDF, RDFS, OWL and so on.

Figure 23. Structure of the Reference View Core Ontologies

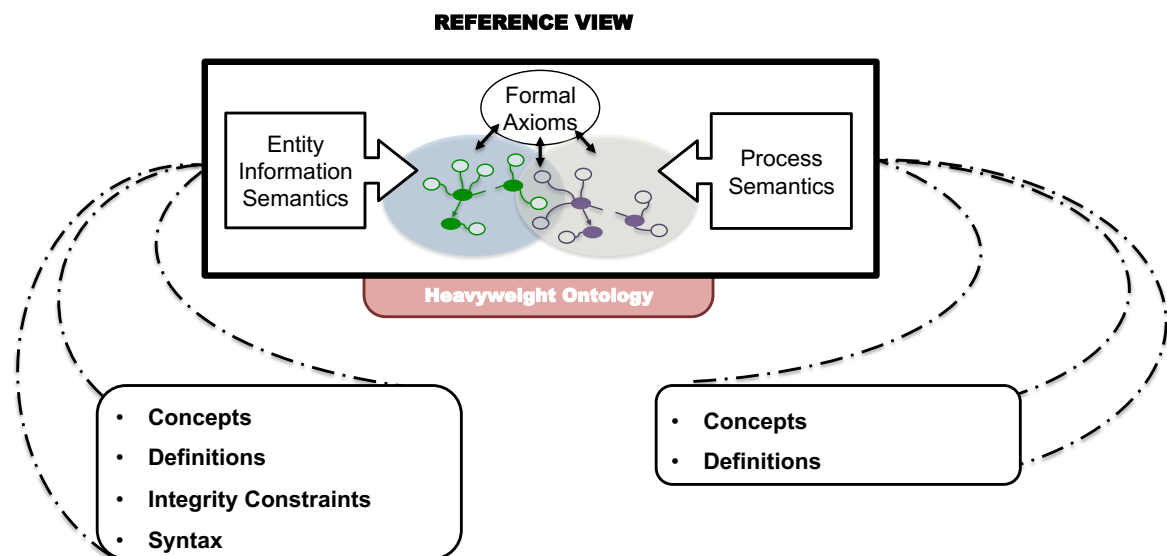

It is worth mentioning that this research is focused on using the ontology approach available in the literature or formal databases to formalise the knowledge and for this reason, it is not concentrated in ontologies engineering.

Specifically, in injected plastic products, Young *et al.* (2007) and Canciglieri Junior and Young (2010) inferred that a common way to provide information to support specific domains is by using features technology such as mouldability features, assembly features, machining features. Furthermore, materials and tolerance information directly impact the product development. Therefore, RV is composed of Rotational Mouldability Core Ontology, Rotational Mould Design Core Ontology, Materials Core Ontology, Tolerance Core Ontology, as well as others Core Ontologies according to the specific application.

The subsequent section details the core ontologies used to support the product design and manufacturing of rotational injected plastic products. The Sections 4.1, 4.2 and 4.3 explore the Rotational Mouldability Core Ontology, Mould Design Core Ontology and Mould Manufacturing Core Ontology respectively, created

based on the research developed by Canciglieri Junior (1999), Canciglieri Junior and Young (2003) and Canciglieri Junior and Young (2010). Section 4.4 explores the Material Core Ontology adapted from the research of Ashino (2010). These researches evaluated the performance of the data structure in different cases studies and the results presented a positive capability to represent the information in heterogeneous environment. For this reason, the author opted to use their well-defined data structure and the taxonomy in order to create these research core ontologies and semantic mappings.

4.1 ROTATIONAL MOULDABILITY CORE ONTOLOGY

The Rotational Mouldability Core Ontology captures and expressively represents generic feature-based entity information and process semantics together with some of the existing relationships between entities and processes. The Rotational mouldability core contains a range of information about the Rotational plastic product to ensure that the mould can be repeatedly used to satisfy the properties and engineering requirements and must be incorporated in other phases of PDP. The next sections are dedicated to exploring the information relating to the rotational plastic product mouldability, where the section 4.1.1 illustrates the Rotational product mouldability; section 4.1.2 explores the information data structure in the Rotational product mouldability; and 4.1.3 demonstrates the translation process of the data structure into the core ontology.

4.1.1 Illustrating Rotational Product Mouldability

An exemplification of the information needed in the Rotational product mouldability to support the injected plastic products design and manufacturing is presented in Figure 21, highlighting that the mouldability view information assumed readily available from the Product Model. Detail “A” shows a rotational polystyrene cup in a three-dimensional model. In this research, the features approach described in chapters 2 and 3, was adopted to model the mouldability core from the injected plastic products design. Detail “B” presents initial geometric considerations of the plastic part as being walls and its surface, ribs whenever needed, and sharp corners,

and it is the first product shape profile defined by the customer requirements in a three-dimensional CAD system environment. Finally, Detail “C” presents the same plastic product after the mouldability enrichment, based on the Mouldability core. This detailed geometric view is stored in the Application Domain View where other information can be added or/and related to them.

Figure 24 Core concepts in the mouldability core to support a rotational thin wall injected plastic products.

a) 3D model



b) Initial Geometric View

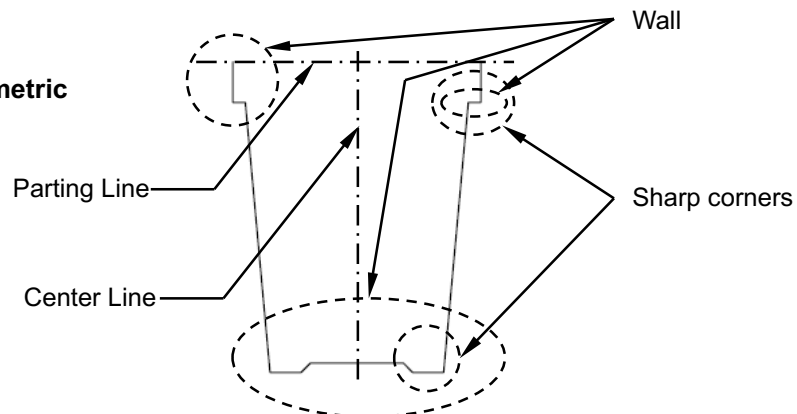

c) Detailed Geometric View

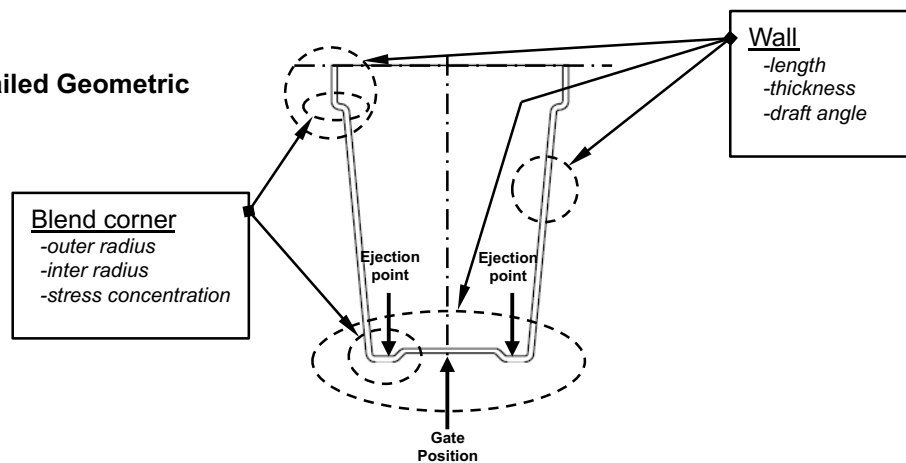

4.1.2 Rotational mouldability data structure

Mouldability features are stated as a set of characteristics, which provides support for the design for mouldability applied to the injected plastic products. The mouldability features are based on the research developed by Canciglieri Junior (1999), Canciglieri Junior and Young (2003) and Canciglieri Junior and Young (2010). The authors proposed a rigorous definition of key concepts to structure the information and characteristics that each feature must have as well as the relationships between them. Figure 25 demonstrates that the Rotational mouldability features taxonomy has four sub-types: Rotational primary features, Rotational modifying features, Rotational transition features and Rotational Parting line features. Each feature contains single semantic information that minimised semantic problems. Additionally, these features have formal relationships with other features.

Figure 25 Rotational mouldability features taxonomy based on features technology.

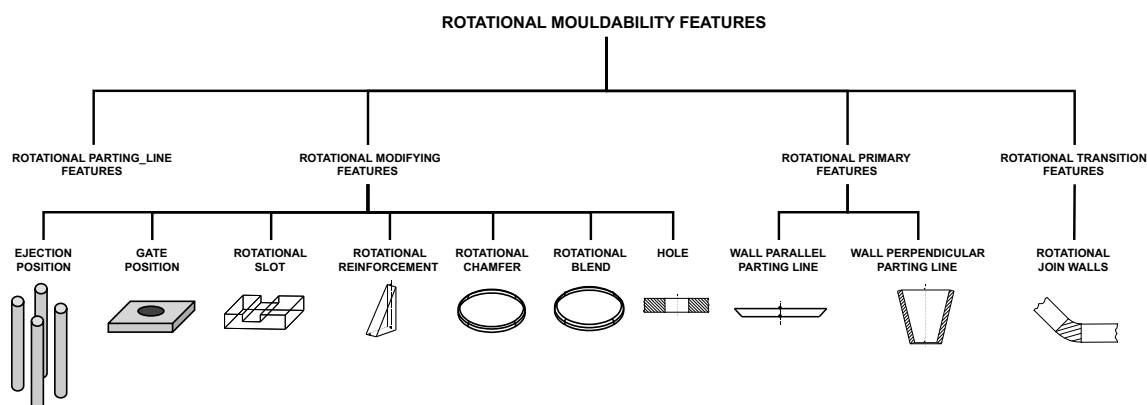

Source: Canciglieri Junior (1999) and Canciglieri Junior and Young (2010).

The mouldability information must provide support for the design for mouldability application in the rotational plastic injected product design. A rotational mouldability hierarchy class structure has been defined based on the rotational mouldability taxonomy. Figure 26 shows the top-level classes of the structure, the Rotational mouldability features as a parent class (*Rot_Mouldability_Core*). The rotational mouldability class was divided into two sub-classes, rotational plastic products design (*Rotational_Plastic_Products_Design*) and Rotational mould

consideration class (*Rot_Mould_Design*). Rotational plastic products design class are responsible for all the mouldability information related exclusively to the plastic part.

Plastic product child class was considered as the Rotational primary features (*Rot_Primary_Features*), Rotational modifying features (*Rot_Modifying_Features*) and Rotational transition features (*Rot_Transition_Features*). Mould design is responsible for all the mouldability information wholly related with the mould and its child class was considered as the Rotational parting line features (*Rot_Parting_Line_Features*), Gate features (*Gate_Features*) and Ejection features (*Ejection_Features*).

Figure 26 Mouldability data structure for rotational injected plastic products.

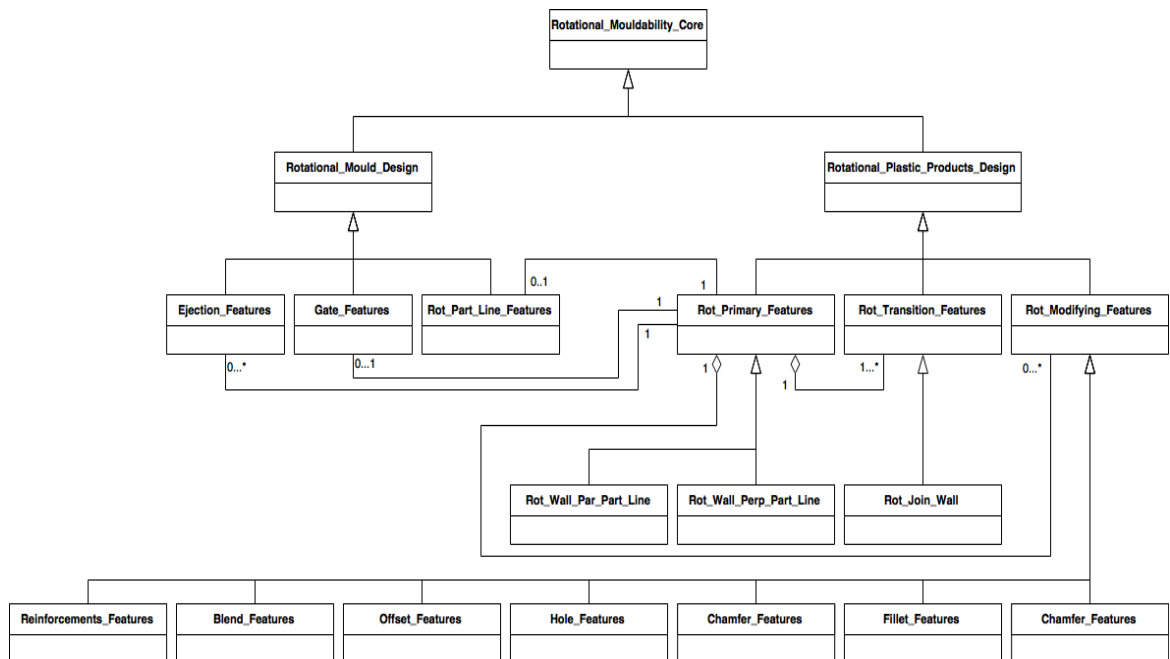

Source: Canciglieri Junior (1999) and Canciglieri Junior and Young (2010).

Two different information perspectives must be considered for the rotational plastic products mouldability according to the data structure: (i) geometric information perspective (see section 4.1.2.1); and (ii) Mouldability Parting Line information perspective (see section 4.1.2.2). The tolerance information was not discussed in this research.

4.1.2.1 Geometric information perspective

Geometric Information has all definitions about the profile or shape of each wall of the plastic product. The geometric definition for rotational plastic injected products can be considered in two-dimensions since the shape or profile is generated around an axis of revolution. Figure 27 exemplifies geometric data information, including major external diameter, minor external diameter, major internal diameter, minor internal diameter, length, etc.

Figure 27 Geometric information needed in the mouldability of rotational plastic products.

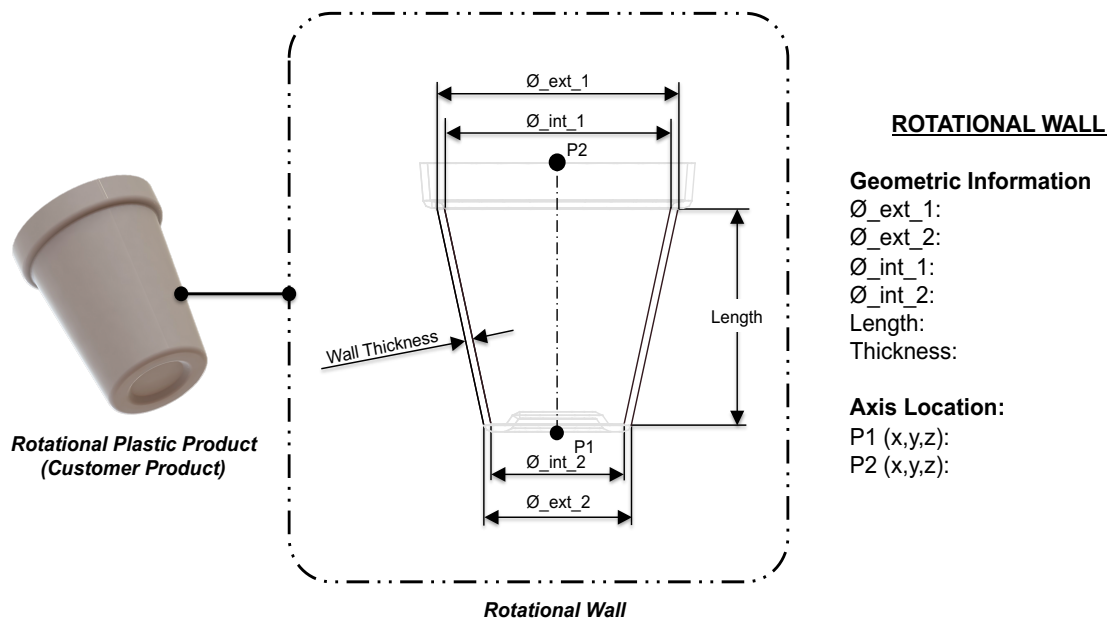

The rotational mouldability data structure is based on rotational features technology. Rotational primary features are used to create the basic shape of the rotational plastic injected products regarding the mouldability constraints. There is a necessity of connection between two primary features. This connection can be defined using transition features, which links them to generate precisely the internal and external surfaces. The Rotational primary feature can aggregate one or more rotational transition feature, as shown in the data structure of Figure 28.

Figure 28 Detail of relationships between Rotational primary features and Rotational transition features.

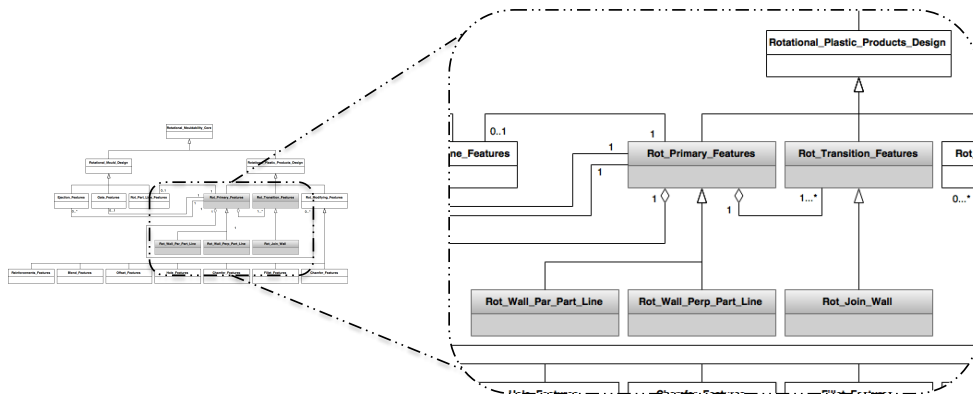
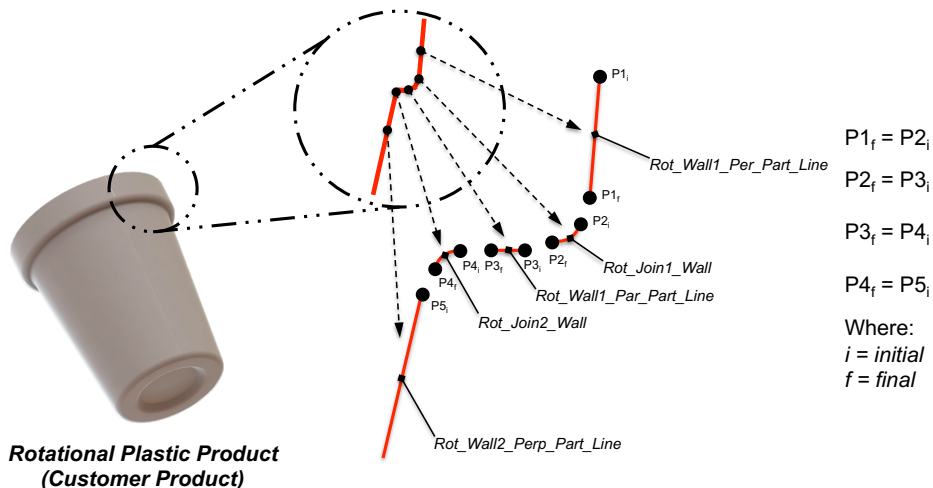

Figure 26 shows the relationships between the geometric data information and rotational mouldability features to compound the entire product representation. Each feature must be correctly connected to another. The first one is the primary feature Rotational wall 1 perpendicular to the Parting Line (*Rot_Wall1_Per_Part_Line*), aggregating only one transition feature - Rotational joint 1 wall (*Rot_Join1_Wall*). The second is the primary feature - Rotational wall 1 parallel to the Parting Line (*Rot_Wall1_Par_Part_Line*), aggregating two transition features - the Rotational joint 1 wall (*Rot_Join1_Wall*) and Rotational joint 2 wall (*Rot_Join2_Wall*), and so on. In addition, the primary feature (*Rot_Wall1_Per_Part_Line*) that holds the points $P1_i$ and $P1_f$ must be connected to the feature that holds the points $P2_i$ and $P2_f$ of (*Rot_Join1_Wall*), and so on in order to generate the internal or external profile of the plastic products.

Figure 29 Primary features and transition features in rotational plastic products.



The relation between rotational primary feature and gate features and rotational primary feature and ejection features are other important points to be explored in the geometric information perspective of mouldability view, as shown in the data structure of Figure 30.

Figure 30 Relationships between rotational primary features and gate features and primary features and ejection features.

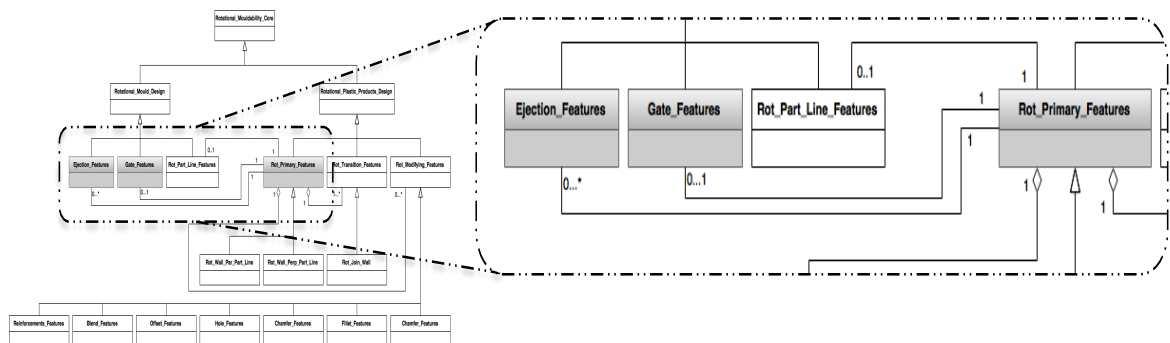

Gate features should have information about the gate such as its geometric position and the area necessary for the flowing of the melted plastic into the mould. The area of the gate is related directly to the volume of the plastic part, type of the material that the product is made of and the capacity of the injection mould machine. Figure 31 presents an example of the rotational product and the position of its gate. For this research, each plastic product can have only one gate point that will be located depending on the geometry of the product.

Ejection Features must contain the geometric coordinates of the ejection points and their respective area, according to the place where the injection pins will touch on the product to remove it out of the mould. The position of the ejection point should be located at different points of the product part to reduce problems with the product appearance. Each plastic product can have several ejection points and they have to be located only on the primary features. Figure 31 also presents an example of the rotational product and the position of its ejection points (Ejection Points 1 and 2).

Figure 31 Gate and Ejection Features in Plastic Injected Products.

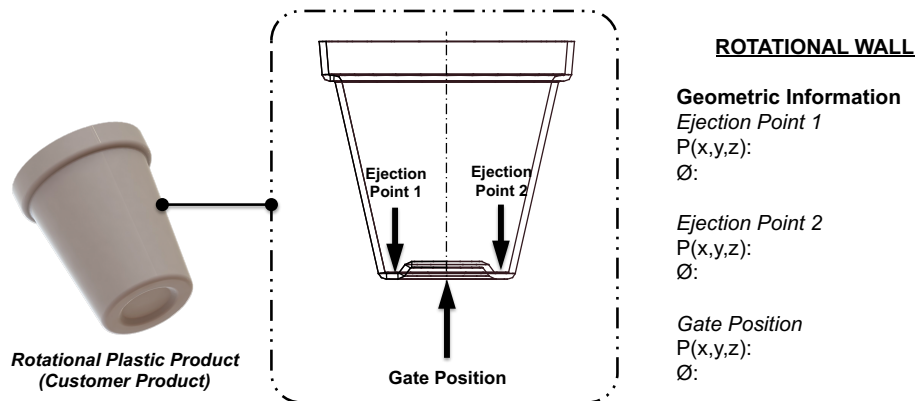

4.1.2.2 Mouldability Parting Line information perspective

The information relating to the Parting Line is relevant since from this data the designer or the mould design application jointly with the product geometric information are going to precisely define the shape of the impression system (core and/or cavity of the mould). This information is fundamental since depending on the location of the “Parting Line”, the core or the cavity will be divided into two or more parts. This division will not increase the complexity of the mould design but it may demand more accurate manufacturing process to make it. Figure 32 illustrates the relationships between Rotational mouldability primary features and Rotational parting line in the data structure.

Figure 32 Detail of relationships between Rotational primary features and Parting Line features.

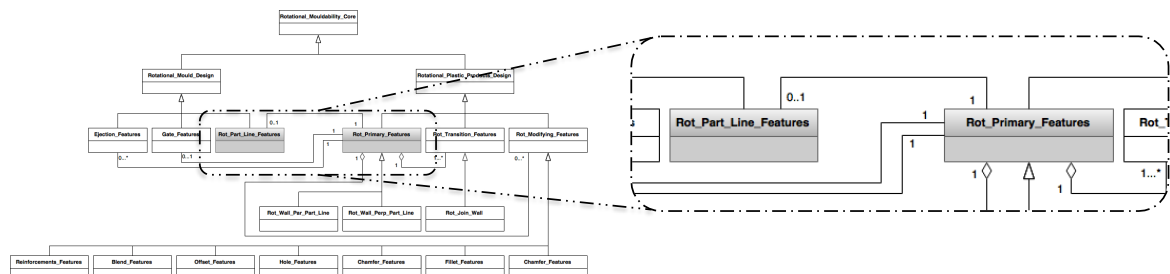
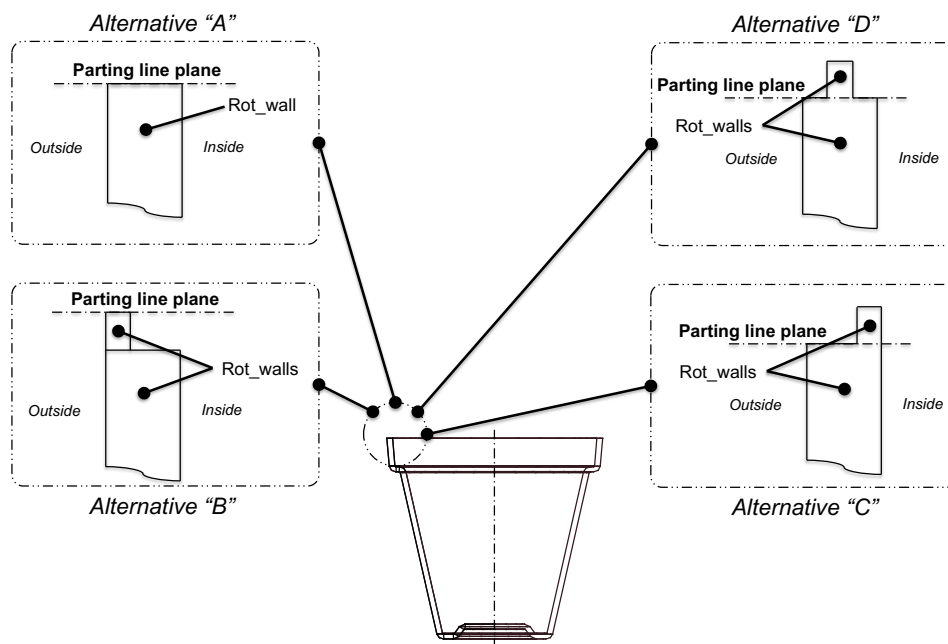

Figure 33 depicts different alternatives to the Parting Line according to the product profile. Alternative “A” illustrates the simplest relationship where a Parting Line plane was positioned on the top of a Rotational primary feature. Alternative “B”

depicts the relationship involving two different Rotational primary features forming a step on the inside surface of the product. In this case, the Parting Line was positioned on the top of the highest Rotational primary feature. Alternative “C” depicts the relation involving two different Rotational primary features forming a step on the outside surface of the product. In this case, the Parting Line was positioned on the top of the lowest Rotational primary feature. Finally, the last alternative (“D”) represents the relationships between two different Primary features forming two steps on the product that are located inside and outside of its surface. In this case, the Parting Line was positioned on the top of the lowest Rotational primary feature.

Figure 33 Variations of relationships between Rotational primary and Parting Line features



4.1.3 Translation from Rotational Mouldability Data Structure into Rotational Mouldability Core Ontology

The translation process from the Rotational mouldability data structure into the Rotational mouldability core ontology follows the Knowledge Engineering Methodology (KEM) proposed by Noy and McGuinness (2001). This methodology consists of seven steps for ontologies developing. Figure 34 illustrates a typical ontology development process following KEM.

Figure 34 Knowledge Engineering Methodology.

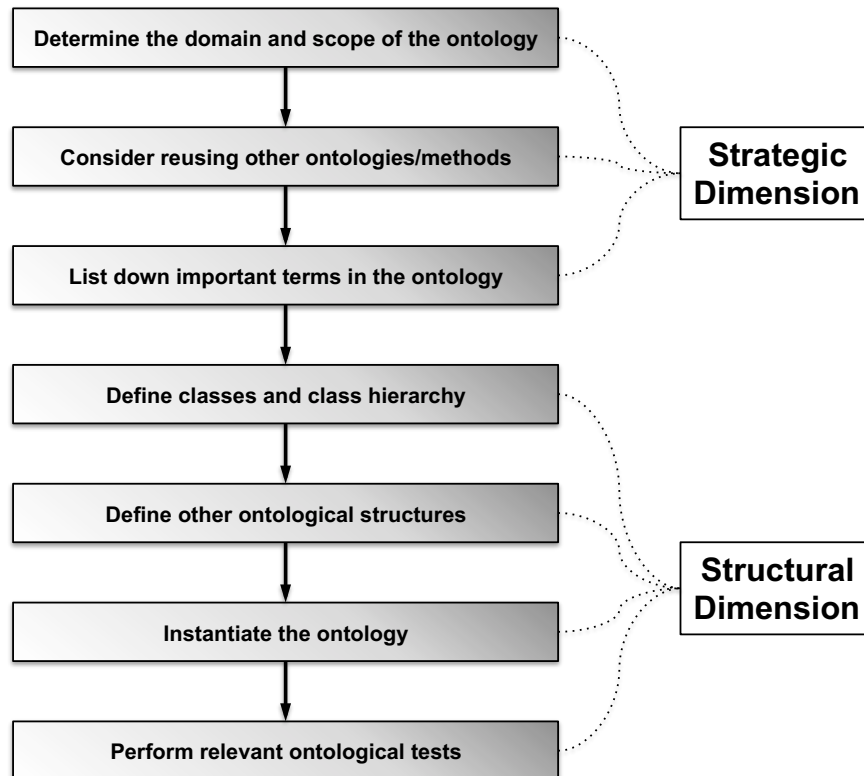

Source: Noy and McGuinness (2001).

The three first stages are dedicated to the strategic dimensions of the ontology. The first stage in the process is concerned with the specification of the domain and scope of the ontology. Based on the discussion of the section 4.1.1, questions and answers are presented in order to define the ontology scope:

- What should cover the domain and scope of the ontology?

For the research, this ontology specifically covers the rotational mouldability in plastic injected products.

- Who are the stakeholders involved in exploring the ontology?

Product designers from different domains.

- For what types of issues must the developed ontology concepts satisfy?

Geometric information and parting line information to design plastic injected products.

The second stage in the process involves the consideration for reusing other ontologies and/or methods. For this research, for example, web ontology language (OWL) has been adopted to formalise the data structure. The next stage considers the enumeration of vital terms to go into the ontology. These terms were discussed in the section 4.1.2. Rotational Plastic Products Design and Rotational Mould Design are some example of the main concepts used in this research.

The next four stages are concerning to the structural dimension. The fourth and fifth stages define the classes and the class hierarchy as well as the ontological structures. These involve definitions of the relations between classes, objects and data. In this context, Rotational mouldability data structure (Detail “A” of Figure 35) modelled in UML is well defined. Detail “B” illustrates the transition from the UML model to ontology model in OWL. Appendix A.1 presents in more details the Rotational Mouldability Core Ontology. Protégé Ontograp was used to represent the ontology structure facilitating its comprehension. Rotational Mouldability Core Ontology is available online at (<https://ipdmsblog.wordpress.com/ontologies/>).

Figure 35 Transition from the UML model to the Core Ontology.

A) Rotational Mouldability Data Structure.

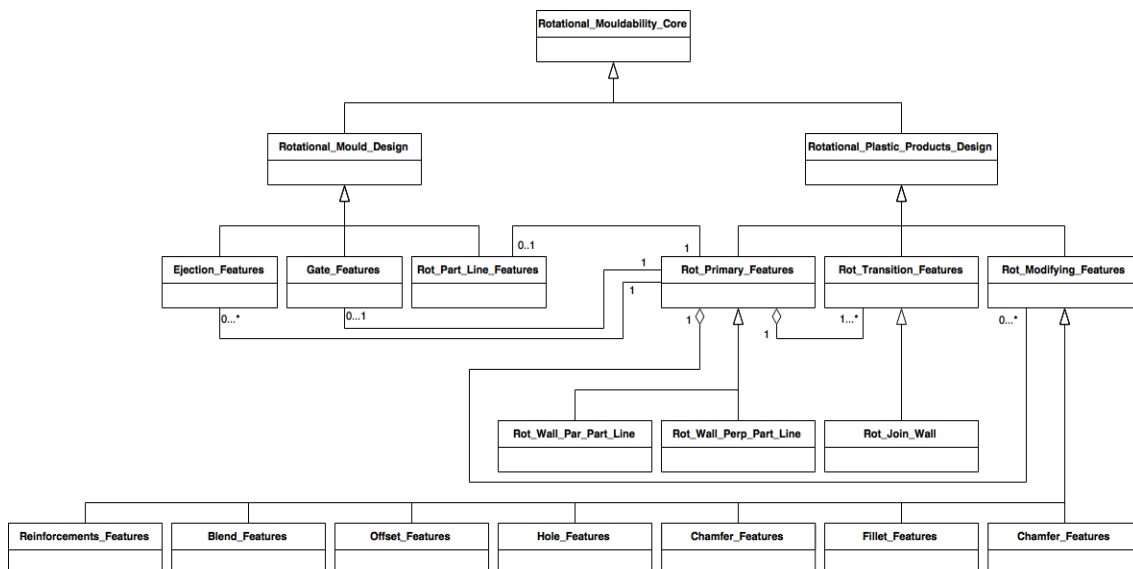

Source: Canciglieri Junior, (1999) and Canciglieri Junior and Young, (2010)

B) Rotational Mouldability Core Ontology.

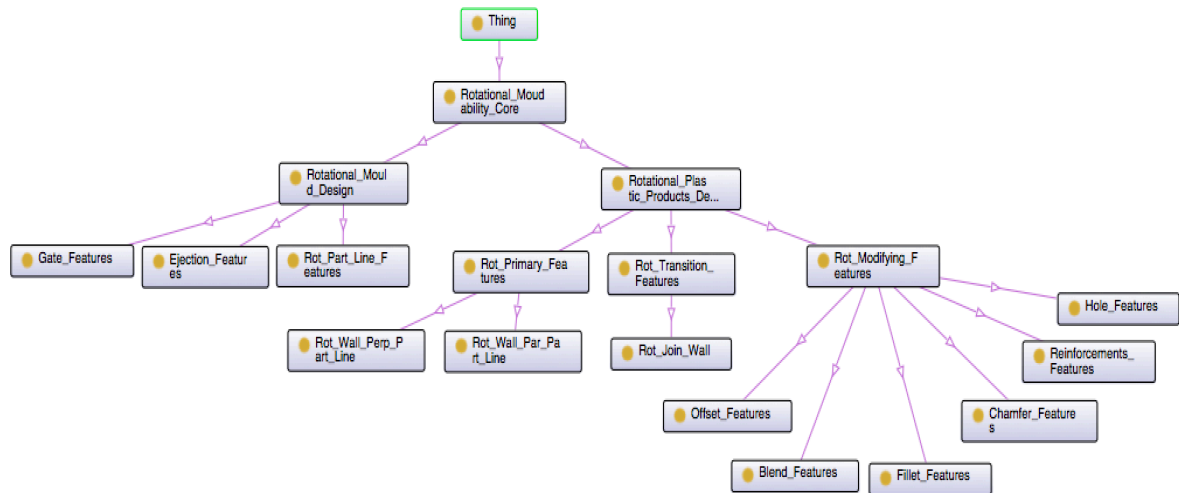

The sixth stage is the instantiation of the ontology with individuals. For the research, this stage occurs in the specialisation phase, and will be discussed in chapter 5, which also presents the detailing of the Rotational mouldability core ontology application. Finally, in the last stage, the ontology is performed to investigate to which extent the initial competency questions are satisfied.

4.2 ROTATIONAL MOULD DESIGN CORE ONTOLOGY

The Rotational Mould Design Core Ontology contains all concepts and relationships regarding the injection mould design, such as feeding domain, ejection domain, cooling domain, etc. The injection mould can be standardised with two-plate moulds, split-cavity moulds with split-follower moulds, stripper plate moulds, stack moulds and hot-runner moulds, etc. The Rotational Mould Design Core Ontology based on the research of Canciglieri Junior (1999); Canciglieri Junior and Young (2003) and Canciglieri Junior and Young (2010), concerns the information related to the impression system (core and cavity), gate system and ejection position system. The subsequent sections are dedicating to explore the information relating to the Rotational mould design. Section 4.2.1 illustrates the Rotational mould design; section 4.2.2 explores the information data structure in the Rotational mould design and 4.2.3 demonstrates the translation process of the data structure into the core ontology

4.2.1 Illustrating Rotational Mould Design

Figure 36 illustrates the impression system with its gate system and ejection system. Some information needed in the mould design view is presented to support the design of injected plastic products. It is important to highlight that some information is directly related to the Rotational mouldability core ontology. For example, the impression profile is inherited from the product profile, but other information must be added to support mould design such as technological information, fixing holes position and other relationships.

Figure 36 Core concepts needed in the Rotational mould design core to support a Rotational thin wall injected plastic products.

a) 3D model

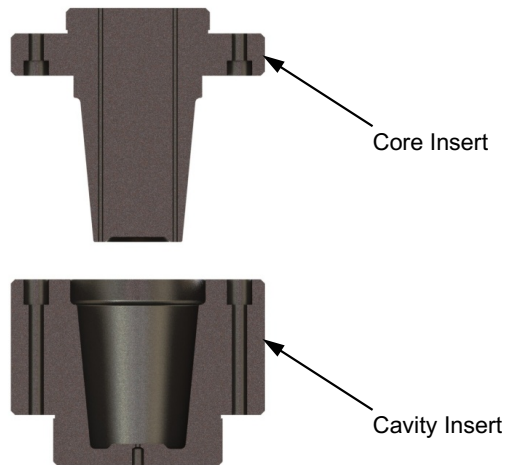

b) Detailed Geometric View

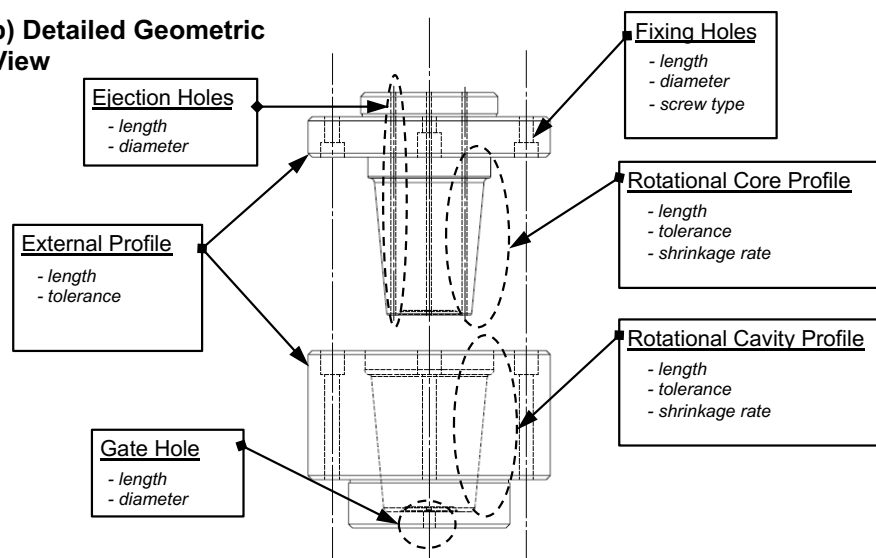

Detail “A” of Figure 36 shows the impression system in a three-dimensional model. In this research, the features technology approach, described in Chapters 2 and 3, was adopted to model the Mould design from the injected plastic products. Detail “B” of Figure 36 presents detailed geometric considerations of the mould design as being Rotational core and cavity profile, external profile, ejection holes, fixing holes and gate hole. In the Application Domain View, all specific information about the rotational plastic injected product must be added to these concepts.

4.2.2 Rotational mould design data structure

The injection mould is composed of multiple systems and each one has a range of information. Some of this information is common or can be used by more than one system because there is a correlation. Although there are different systems that can be involved during the plastic injection product design, as discussed in the last section, the data structure is focused on impression system (core and cavity), ejection system, fixing systems and gate system.

In this context, Figure 37 presents the top level classes of mould design data structure proposed by Canciglieiri Junior (1999), Canciglieiri Junior and Young (2003) and Canciglieiri Junior and Young (2010) in order to support the information of mould design application from multiple domains in design and manufacturing. Based on the data structure, some considerations about the mould design structure are highlighted such as: (i) each impression system has just one cavity and one core insert; (ii) each impression system has one material (*Insert_Material*); (iii) each impression can have one or many different types of holes (fixing, locating, gate, ejection); (iv) each hole can have one or more tolerances.

The impression system, detail A of Figure 37 is composed of Cavity Insert and Core Insert. Although both cavity and core insert are based on the plastic injected product profile, each one has some particularities. In this way, Figure 38 concerns the data structure dedicated to the Rotational cavity insert and Figure 39 shows the data structure dedicated to the Rotational core insert.

Figure 37 Mould Design top-level data structure highlighting the impression system.

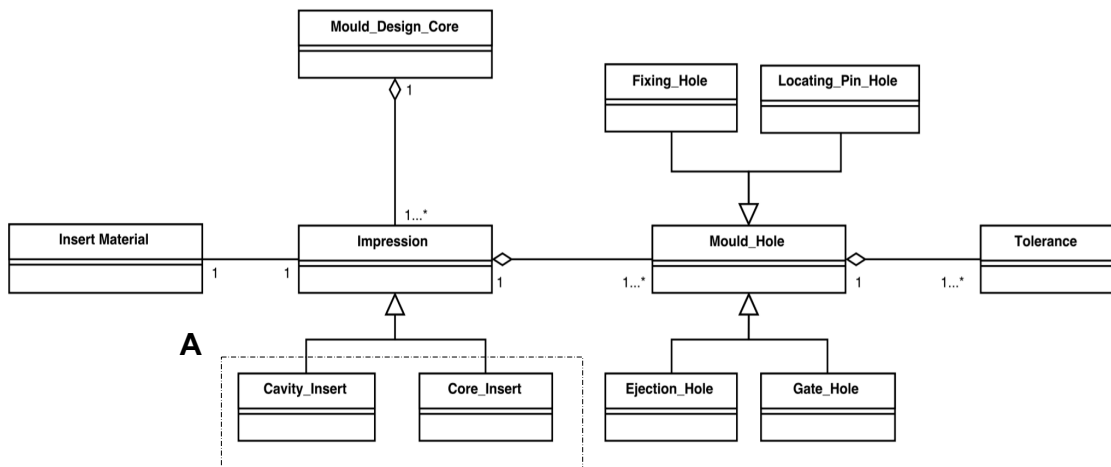

Source: Cancigleiri Junior (1999) and Cancigleiri Junior and Young (2010).

Figure 38 Rotational Cavity Insert Design Data Structure.

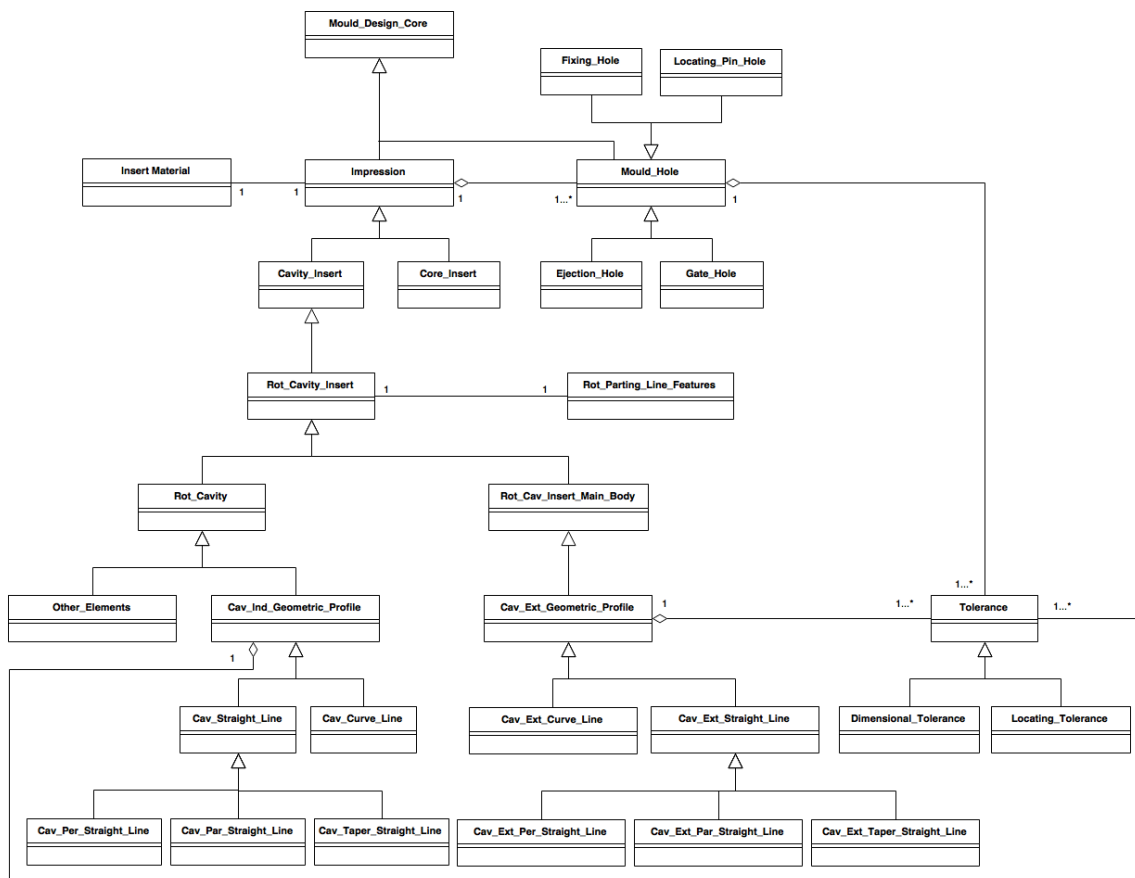

Source: Cancigleiri Junior (1999) and Cancigleiri Junior and Young (2010).

The Rotational cavity insert (*Rot_Cavity_Insert*) is associated with only one Rotational parting line feature (*Rot_Parting_Line_Features*) and it aggregates just one Rotational cavity (*Rot_Cavity*). In addition, it aggregates just one Rotational cavity insert main body (*Rot_Cav_Insert_Main_Body*). The combination of the Rotational cavity, the Rotational cavity insert main body and Mould holes will form the complete cavity insert.

Rotational cavity (*Rot_Cavity*) and Rotational cavity insert main body (*Rot_Cav_Insert_Main_Body*) aggregate one or more individual geometric profile, which can be straight line or curved line. So, the Rotational cavity and the Rotational cavity insert main body will be composed of a group of individual profile, as shown in Figure 38. But, each individual profile aggregates one or more tolerances according to the specification of the design. The same structure is used for the Rotational core insert, as shown in Figure 39.

Figure 39 Rotational Core Insert Design Data Structure.

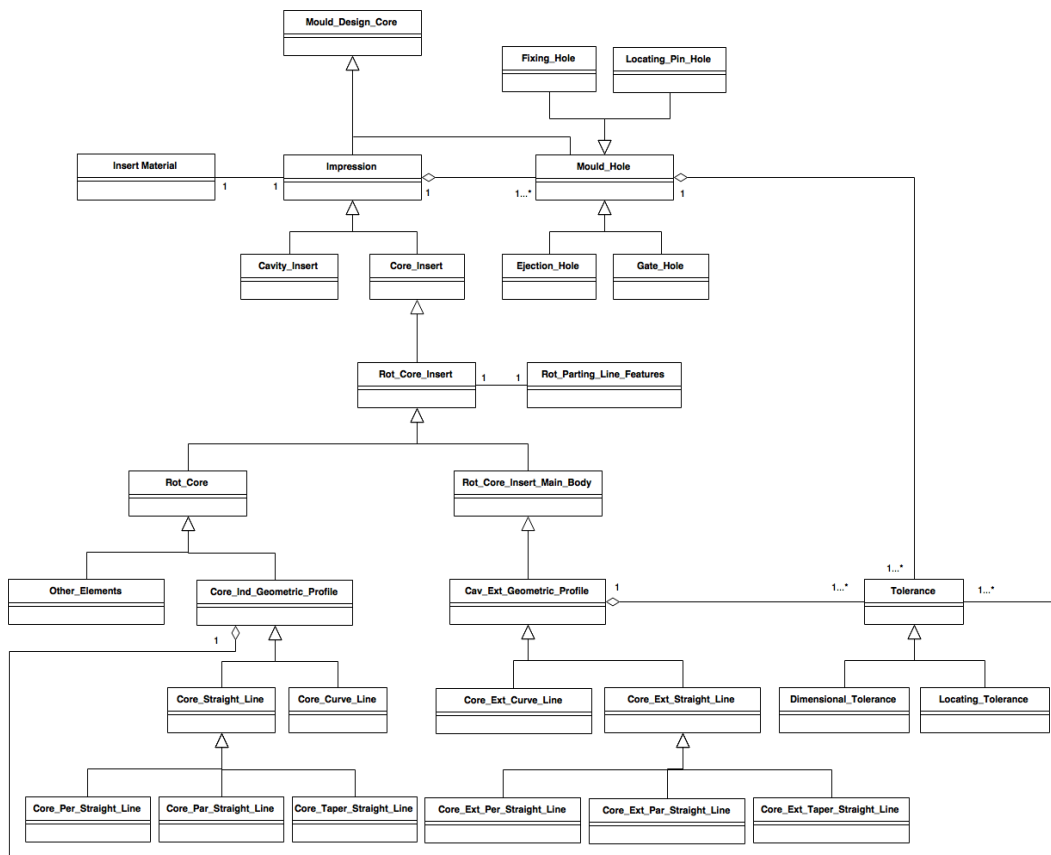

Source: Cancigleiri Junior (1999) and Cancigleiri Junior and Young (2010).

As discussed in the last section, for the Core insert and Cavity insert design is necessary to consider information about their external and internal geometry. The subsequent sections show the Rotational cavity insert geometric information perspective (see section 4.2.2.1), Rotational core insert main body geometric perspective (see section 4.2.2.2), Rotational cavity insert geometric information perspective (see section 4.2.2.3), Rotational cavity insert main body geometric information perspective (see section 4.2.2.4) and Parting line information in the mould design perspective (see section 4.2.2.5). The tolerance information is not discussed in this research.

4.2.2.1 Rotational core insert geometric information perspective

The profile of the Core insert has geometric information about the plastic product shape, which represents its internal surface or internal profile. Figure 40 illustrates the relationships in the Rotational mould design data structure of the Core insert geometric information.

Figure 40 Core insert geometric information in the data structure.

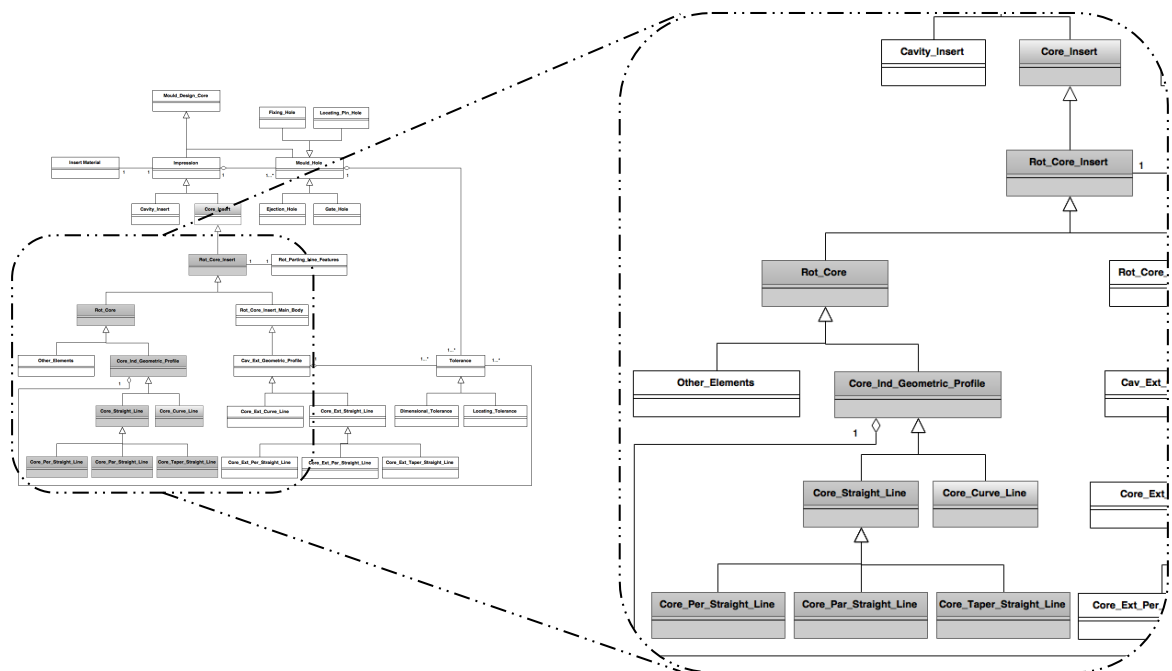

The geometry of a core insert is defined by straight or curve profiles that are associated with an axis of revolution. Figure 41 illustrates the information of the core insert. The straight profile is composed of two points - the initial point (“P1_i”, “P3_i”, etc.) and final point (“P1_f”, “P3_f”, etc.) - and it can be parallel, perpendicular or taper to the Parting Line. The curve profile is also composed of two points, the initial point - (“P2_i”, etc.) and final point (“P2_f”). Additionally, it aggregates the information about the radius, the angle (clockwise or anti-clockwise), and the centre of the arc. The complete detail information is added to the core model in the Application Domain View (see Chapter 5).

Figure 41 Core insert geometry information.

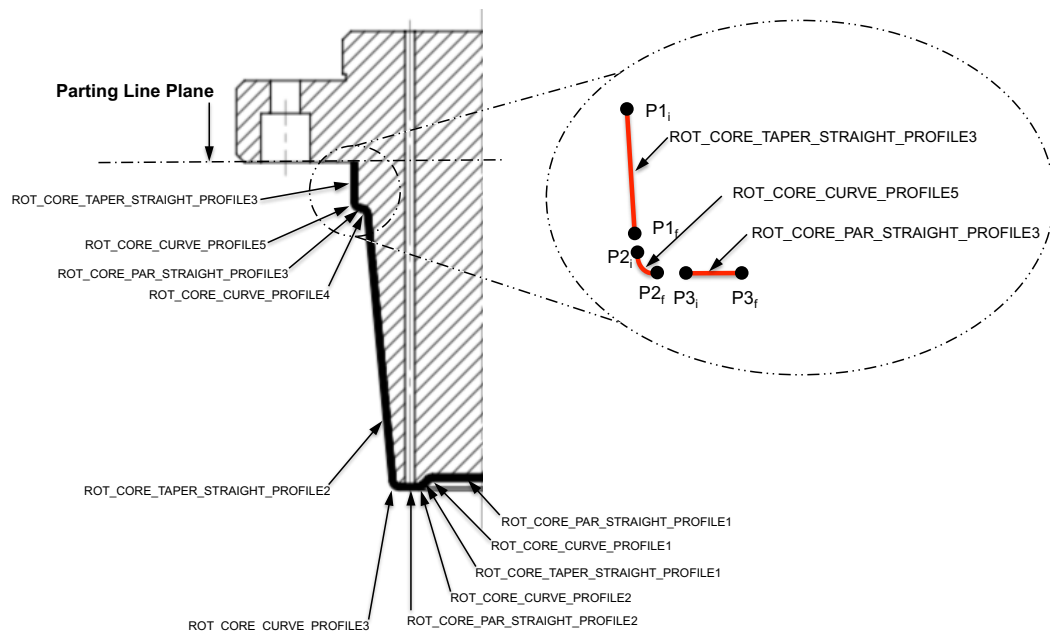

The entire Core insert geometric information can be analysed in two-dimensional space (2D) since all information is associated with an axis of revolution. The information relationships between the Rotational plastic injected product and Rotational core insert are detailed in the Semantic Reconciliation View (Chapter 6).

4.2.2.2 Rotational core insert main body geometric information perspective

The geometry of the Core insert main body is defined using the same Mould design class structure that defines the core insert. However, in this case, the Core

insert external geometry (dependable on multiples variables and on the designer experience to state the best shape for the external part of the insert) is defined. Geometrically, the external profile has the same geometric definitions of the Core insert profile, but the Core insert profile is automatically generated based on the plastic injected product profile information with the semantic reconciliations; and the Core insert main body is generated by interactions of the designer in conjunction with a mould design application. Another important point to be analysed is the geometry of the holes that impact directly in the external diameter of the profile. Figure 42 illustrates the relationship of the Core insert main body geometric information in the data structure.

Figure 42 Detail of Core insert main body geometric information in the data structure.

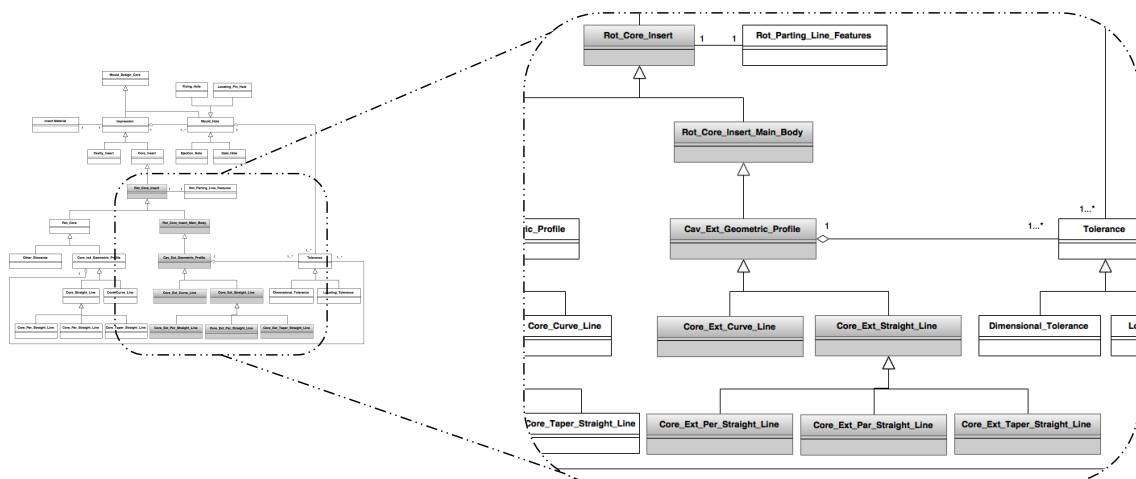
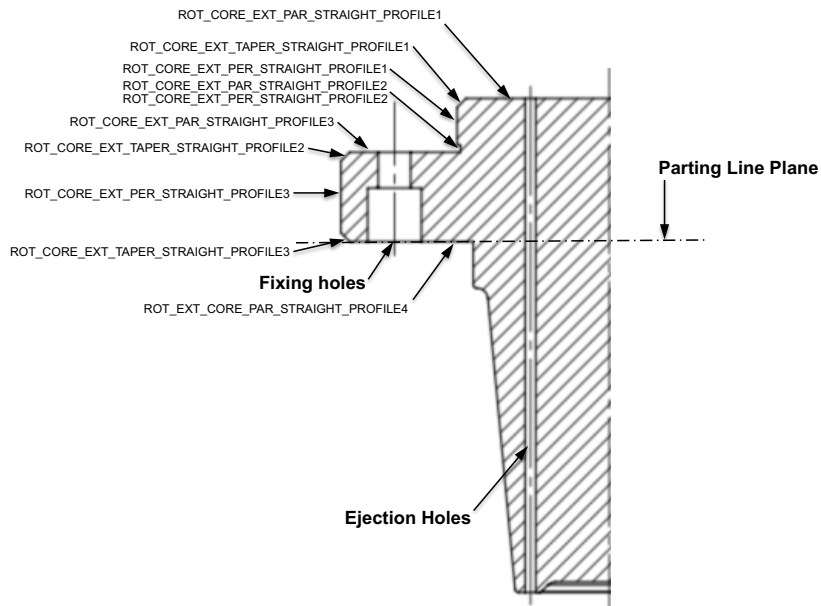

Figure 43 illustrates the information extracted from the Core insert main body. The External straight profile is composed of two points - the initial point and final point - and it can be parallel, perpendicular or taper to the Parting Line. The external curve profile is also composed of two points - the initial point and final point - and it aggregates the information about the radius, the angle (clockwise or anti-clockwise), and the centre of the arc. The fixing and ejection holes must have information about their type, for example, counterbore hole, countersink hole, drilling hole, as well as their diameters and depth. The complete detail information must be added to the core model in the Application Domain View (see Chapter 5).

Figure 43 Core insert main body geometry information.



4.2.2.3 Rotational cavity insert geometric information perspective

The geometry of the cavity includes geometric information about the shape of the plastic product that represents its external surface or external profile. Figure 44 depicts the Cavity insert geometric relationships in the data structure.

Figure 44 Detail of cavity insert geometric information in the data structure.

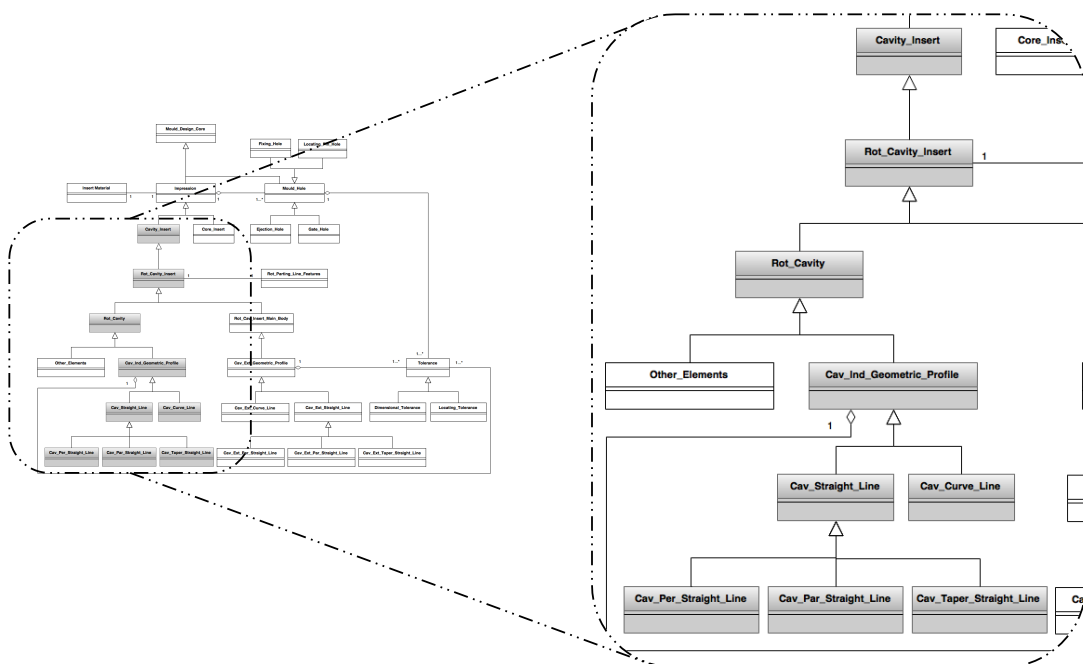
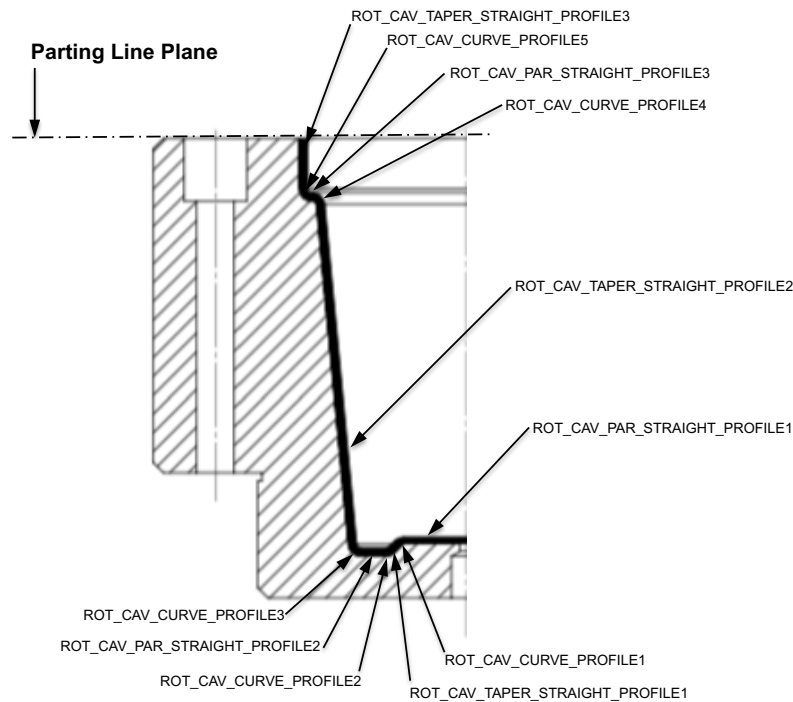

Figure 45 illustrates the Cavity insert geometry with its respective needed information. Its geometric definition for straight and curve profiles is similar to the definition described for core insert section. Cavity geometric information can be investigated in a two-dimensional space (2D).

Figure 45 Cavity insert geometry information.



In addition, the information is added according to the specific plastic injected product in the Application Domain View, which will be discussed in Chapter 5.

4.2.2.4 Rotational cavity insert main body geometric information perspective

The geometry of the Cavity insert main body is defined using the same criteria used to define the Cavity insert. Furthermore, this case is identical to the Core insert main body described in section 4.1.2.2. Figure 46 illustrates the Cavity insert geometric main body relationships in the data structure.

Figure 46 Detail of cavity insert geometric information in the data structure.

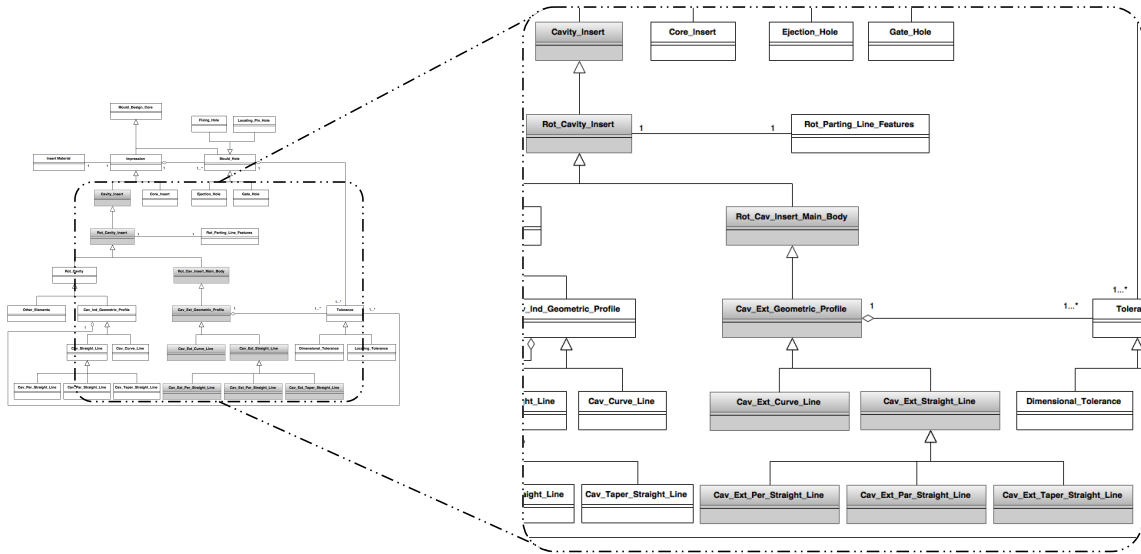
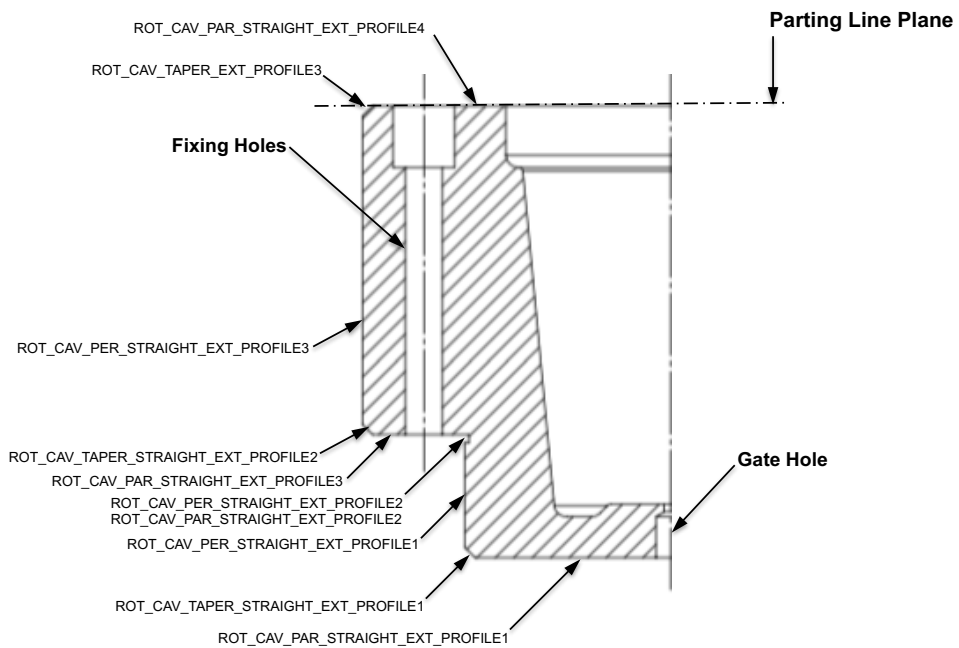

Figure 47 illustrates the geometry of the Cavity insert main body with its respective needed information. Its geometric definition for straight and curve profiles is similar to the definition described for the Core insert main body.

Figure 47 Cavity insert main body geometry information.



4.2.2.5 Parting Line information in the Mould design perspective

The Parting Line information in the Mould design is the information extracted directly from the Mouldability Parting Line information perspective. The Parting Line plane location is defined by three points (x,y,z) and is associated with an axis. Figure 48 illustrates an example of Parting Line location for the rotational inserts. This information is necessary for determining the common plane surface between Core and Cavity impression system.

Figure 48 Parting line location in the mould.

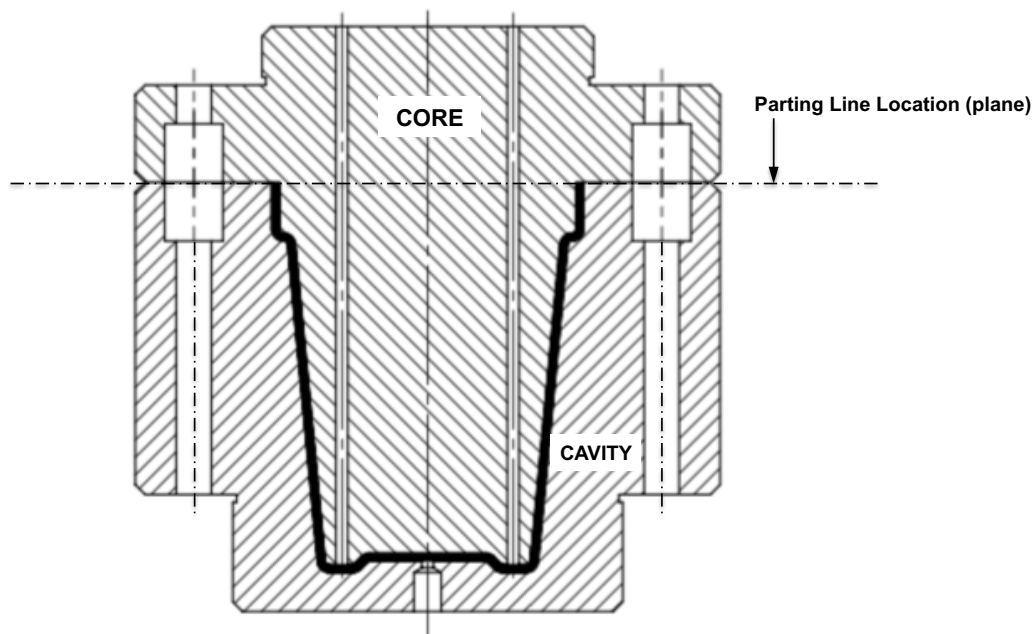

4.2.3 Translation from Rotational Mould Design Data Structure into Rotational Mould Design Core Ontology

The translation process from the Rotational mouldability data structure into the Rotational mouldability core ontology follows the KEM methodology as discussed in the section 4.1.3 and illustrated in figure 31. The first stage in the process is concerned with the specification of the domain and scope of the ontology. Based on the discussion of the mould design, questions and answers are presented in order to define the ontology scope:

- What should cover the domain and scope of the ontology?
 - *This ontology explores the concepts involved in mould design to rotational thin-wall plastic injected products.*

- Who are the stakeholders involved in exploring the ontology?
 - *Mould designers with multiple expertise.*

- For what types of issues must the developed ontology concepts satisfy?
 - *Geometric information and Parting Line information to the mould design*

The second stage in the process involves the consideration for reusing other ontologies and/or methods. As it has been discussed in the last sections, the language used was the Web Ontology Language (OWL). The third stage considers the enumeration of vital terms to go into the ontology. Some fundamental concepts are Rotational Core Insert, Rotational Core Insert Main Body, Rotational Cavity Insert and Rotational Cavity Insert Main Body.

The fourth and fifth stages define the classes and the class hierarchy as well as the ontological structures. These involve definitions of the relations between classes, objects and data. In this context, the rotational mould design data structure (Rotational mould cavity insert design (Detail “A” of Figure 46) and Rotational mould core insert design (Detail “A” of Figure 50) were translated from the UML model into ontology model in OWL, as illustrate in Detail “B” of Figure 46 and Detail “B” of Figure 50. Appendices A.2 and A.3 present in more details the Rotational mould cavity insert core ontology and Rotational mould core insert core ontology respectively. Finally, Protégé Ontograp was used to represent the ontology in order to facilitate the comprehension. Rotational Mould Design Core Ontology is available online at (<https://ipdmsblog.wordpress.com/ontologies/>).

Figure 49 Rotational Mould Design Core Ontology - Cavity Insert Detail.

A) Rotational Mould Cavity Insert Data Structure.

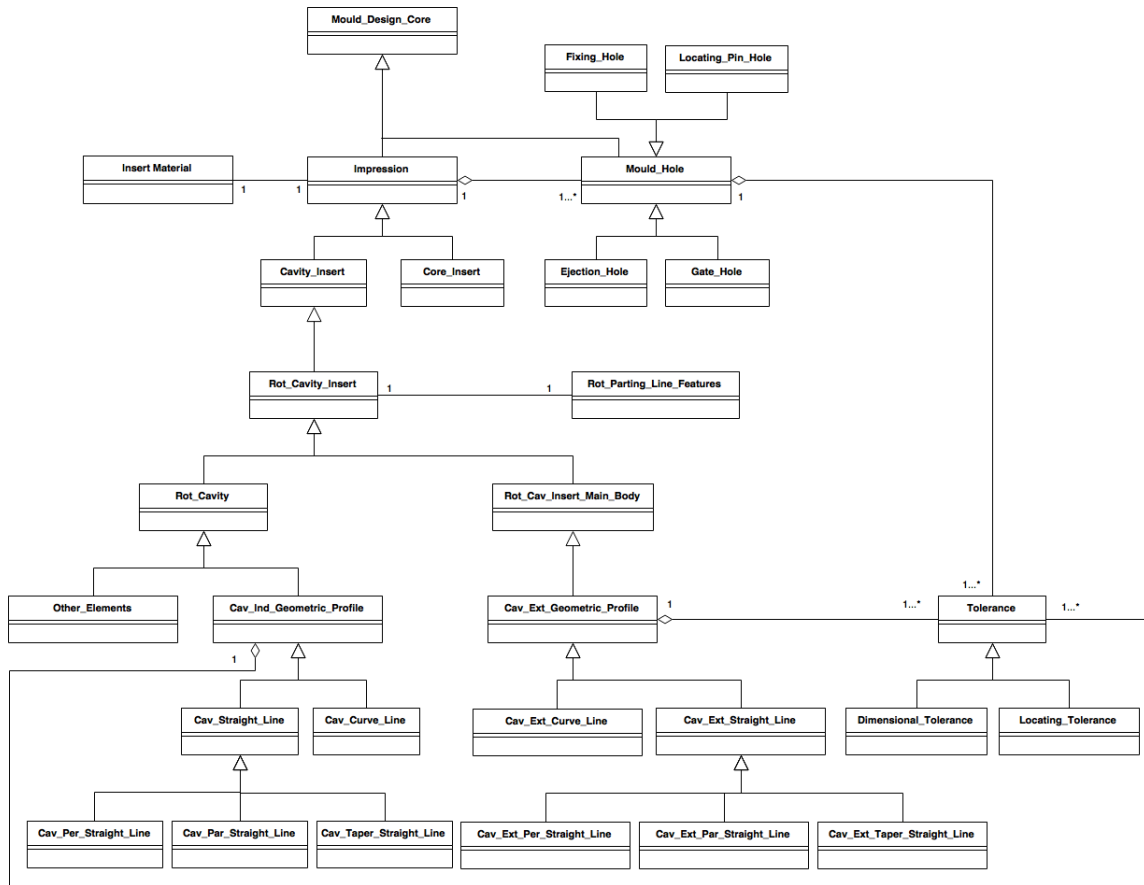

B) Rotational Mould Cavity Insert Core Ontology.

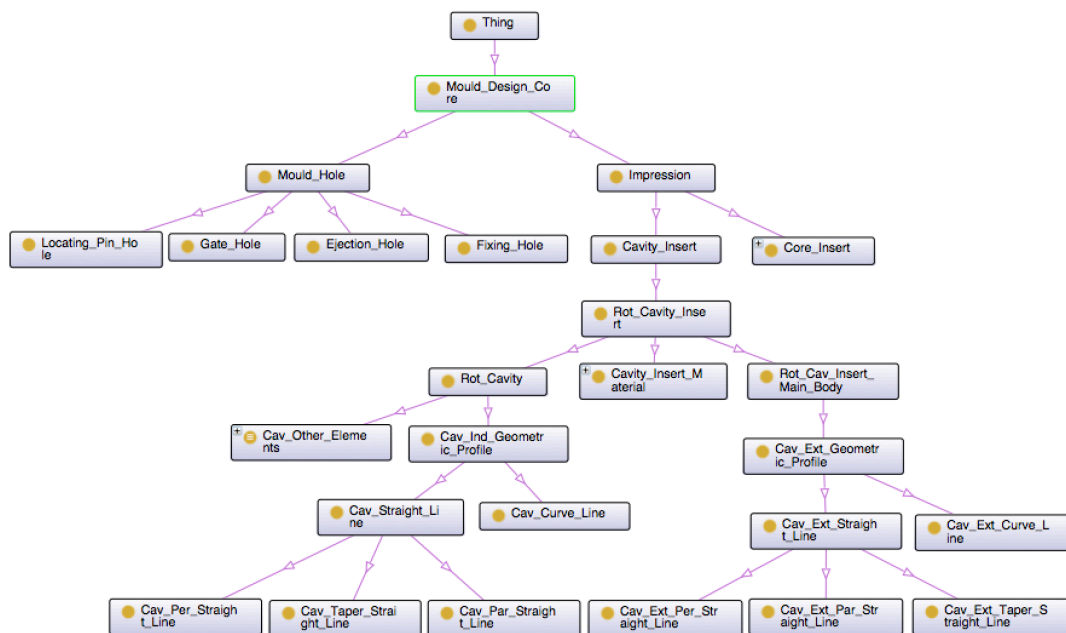
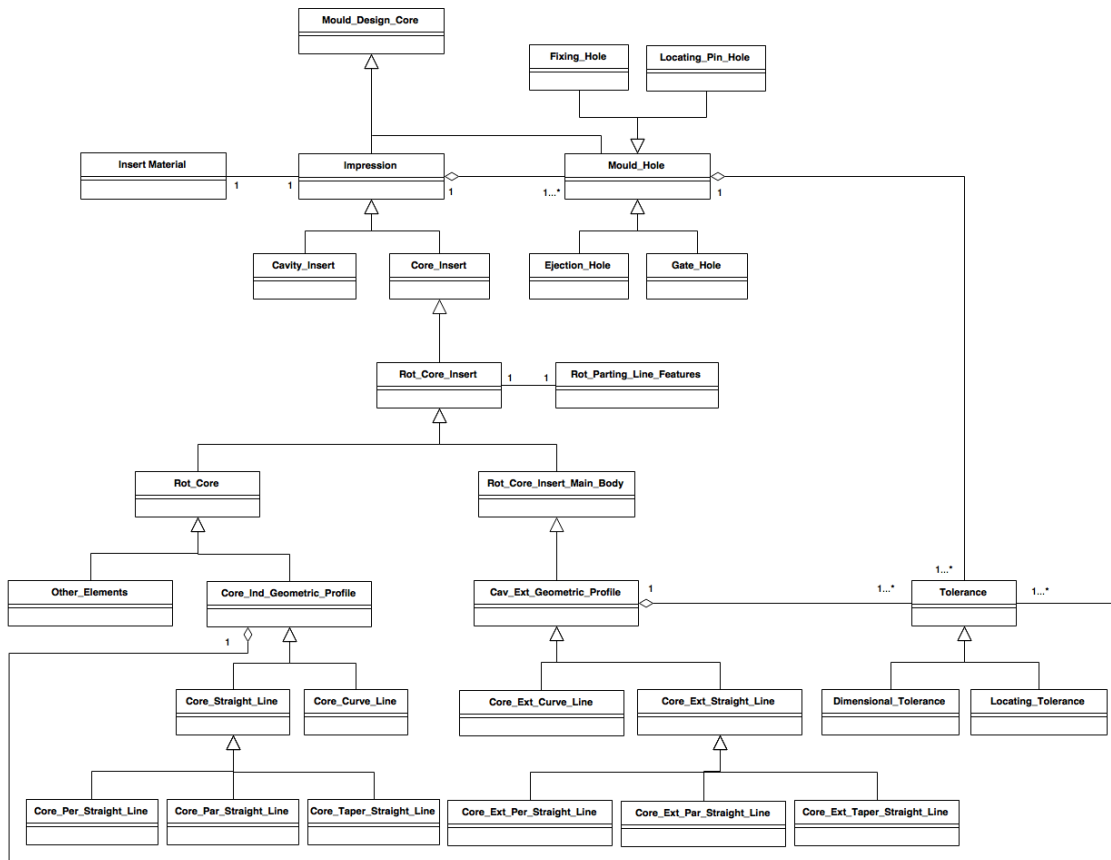
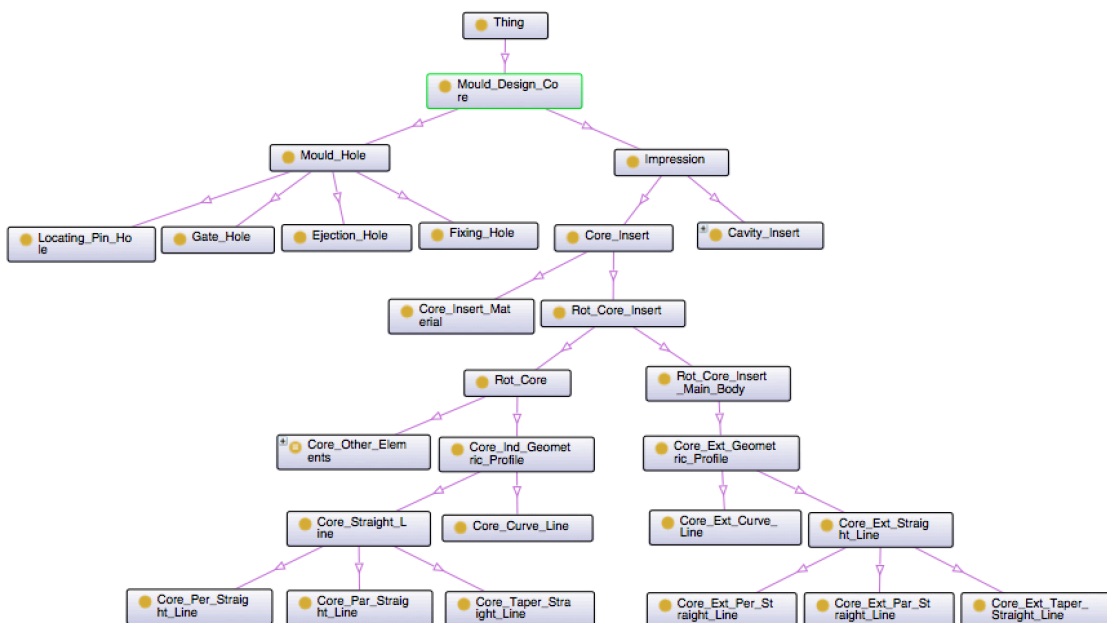

Figure 50 Rotational Mould Design Core Ontology - Core Insert Detail.

A) Rotational Mould Core Insert Data Structure.



B) Rotational Mould Core Insert Core Ontology.



4.3 MOULD MANUFACTURING CORE ONTOLOGY

An injection mould, as discussed in the last section, is composed of different systems. Each one has different concepts and information and its own characteristics of manufacturability. This knowledge provides support for the designer's decision on the manufacturing process or processes that are most suitable to produce the mould. This section is focused on the concepts required for manufacturing the impression systems (cavity insert and core insert) and the holes that belong to the inserts (fixing, positioning and gate holes) as illustrate in Figure 51.

Figure 51 Mould manufacturing data structure.

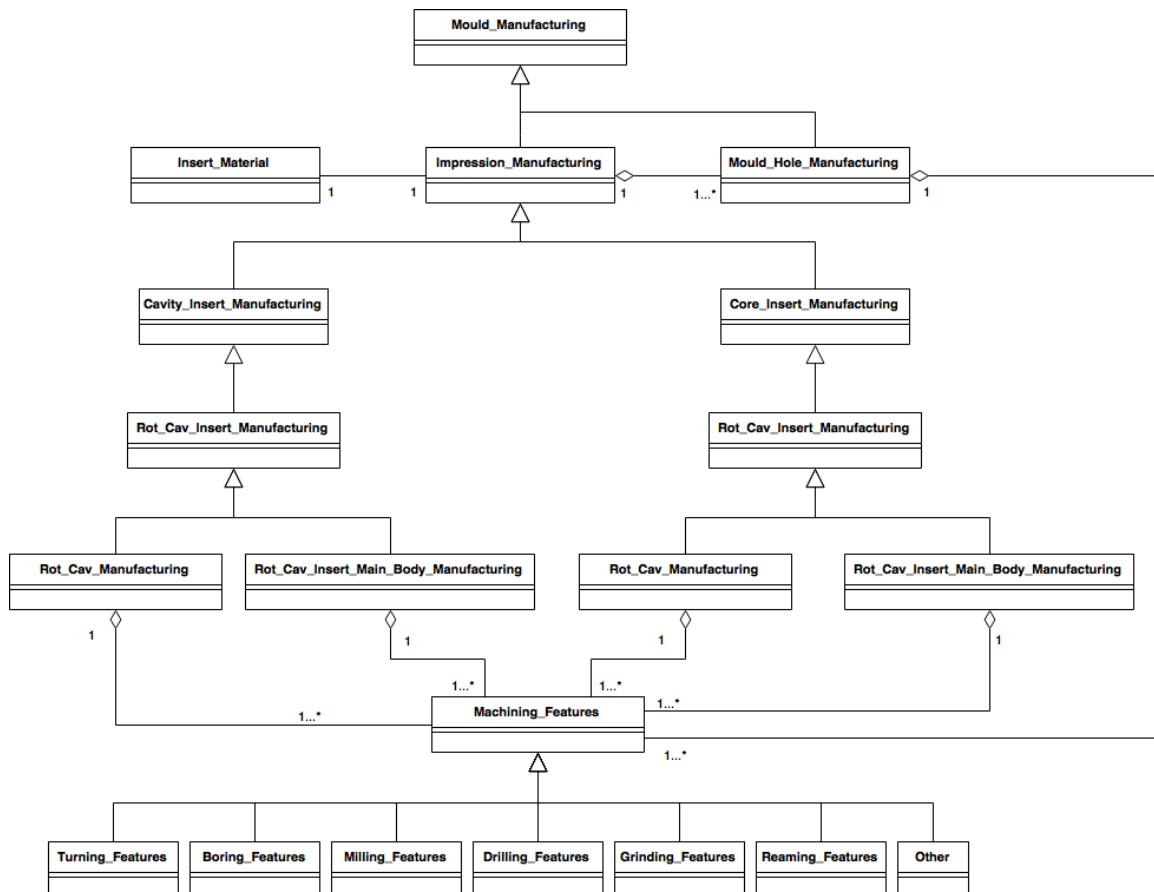

Source: Cancigleiri Júnior (1999) and Cancigleiri Júnior and Young (2010).

The cavity insert and/or core insert will be manufactured according to the plastic product shape. Figure 51 highlights the Rotational cavity insert and core insert manufacturing data. Each Rotational cavity insert (*Rot_Cav_Insert_Manufacturing*)

has just one Rotational cavity manufacturing (*Rot_Cav_Insert_Manufacturing*), just one Rotational cavity insert main body manufacturing (*Rot_Cav_Insert_Main_Body_Manufacturing*) and one or many holes for manufacturing (*Mould_hole_Manufacturing*). These three classes aggregate one or many machining features. The (*Rot_Cavity_Manufacturing*) class, *Rot_Cav_Insert_Main_Body_Manufacturing* class and (*Mould_Hole_Manufacturing*) class will hold all the manufacturing information related to the Rotational cavity insert. The same process occurs for the Core insert manufacturing.

Machining features are defined based on the tolerance specified by the mould design. This research considers only the geometry to define the machining features. The geometry is an important factor because it must represent the shape of the material that is going to be removed from the billet. This geometry must be feasible by the cutting tool machine and its tools.

The next sections will explore the geometric information for the Cavity insert manufacturing perspective (section 4.3.1) and geometric information for the Core insert manufacturing perspective (section 4.3.2) in order to determine the types of machining processes. The last section (4.3.3) is dedicated to the translation of the Mould manufacturing data structure into Mould manufacturing core ontology.

4.3.1 Geometric information of the Cavity insert manufacturing perspective

The definition of the Cavity insert manufacturing is concerned with the removal of material from the billet to produce the required Cavity insert shape. The geometric definition used for Cavity insert manufacturing is very similar to the geometric definition presented for the Cavity insert design in the section 4.2.3. The rotational geometry generated by the profile of the plastic product, i.e., cavity, is considered as negative volume and must be removed from the billet. Figure 52 illustrates the geometry of the External profiles of the cavity insert and the geometry of the fixing and gate holes. The External profile of the cavity insert is considered as positive volume because the billet dimensions are composed of the Rotational cavity main body plus the excess of solid that must be removed. Additionally, the volume of the fixing and gate hole are considered negative since they must be removed from the billet.

Figure 52 Rotational Cavity Insert (Cavity Insert Profile + Cavity Insert Main Body)

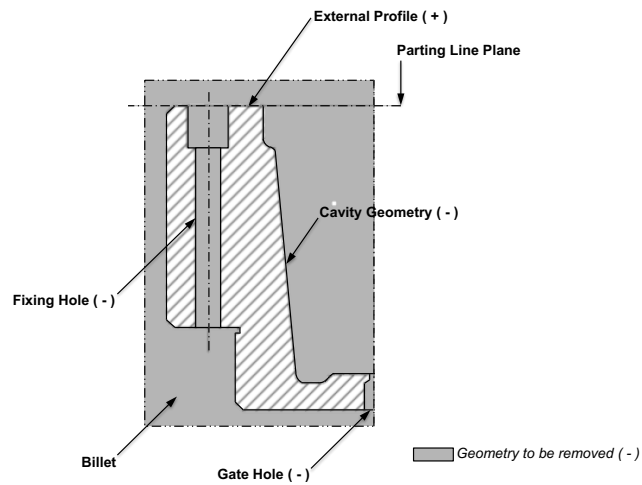

4.3.2 Geometric information of the Core insert manufacturing perspective

The definition of the Core insert manufacturing concerns the removal of material from a billet to produce the required Core insert profile. The geometric definition used for Core insert manufacturing is the same of geometric definition applied for the Core insert design (section 4.2.2.1). Figure 53 illustrates the geometry of the solid that is going to have material removed. The “core” is considered as a positive volume. In addition, the external geometry, shown in the figure, is also considered as a positive volume. The volume of the fixing and ejection holes are considered as negative volume since they must be removed.

Figure 53 Rotational Core Insert (Core Insert Profile + Core Insert Main Body)

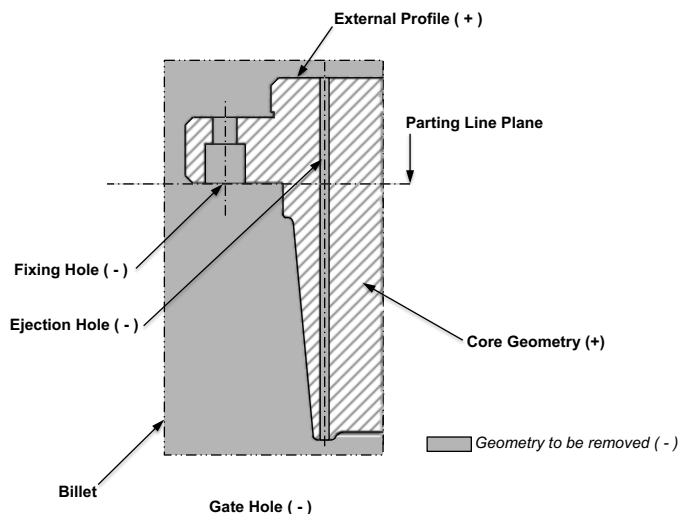

4.3.3 Translation from Mould Manufacturing Data Structure into Mould Manufacturing Core Ontology

The translation process from the Mould manufacturing data structure into the mould manufacturing core ontology follows the KEM methodology as discussed in the section 4.1.3 and illustrated in Figure 31.

The first stage in the process concerns the specification of the domain and scope of the ontology. Based on the discussion of the Mould design, questions and answers are presented in order to define the ontology scope:

- What should cover the domain and scope of the ontology?
 - *This ontology covers the concepts involved in mould manufacturing for the rotational thin-wall plastic injected products.*
- Who are the stakeholders involved in exploiting the ontology?
 - *Mould manufacturers with multiple expertises.*
- For what types of issues must the developed ontology concepts satisfy?
 - *Translation of the geometric information into the manufacturing of the mould insert.*

The second stage in the process involves the consideration for reusing other ontologies and/or methods. As it has been discussed in the last sections, the language used is Web Ontology Language (OWL). The third stage considers the enumeration of vital terms to go into the ontology. Some fundamental concepts are Rotational Core Insert, Rotational Core Insert Main Body, Rotational Cavity Insert, Rotational Cavity Insert Main Body and Machining Features

The fourth and fifth stages define the classes and the class hierarchy as well as the ontological structures. These ontological structures involve definitions of the relations between classes, objects and data. In this context, the Mould manufacturing data structure (detail “A” of Figure 54) was translated from the UML model to OWL ontology model. This translation required a division between the UML into two ontologies: (i) Mould Manufacturing Core Ontology (detail “B” of Figure 54); and (ii)

Machining Features Core Ontology (detail “C” of Figure 51). Appendices A.4 and A.5 present in more details the Mould Manufacturing Core Ontology and Mould Machining Core Ontology respectively. This occurred because the machining features do not have a direct correlation with Rotational cavity manufacturing or Rotational core manufacturing. These relations depend on the manufacturing rules to determine what kind of manufacturing process is more adequate. This research opted to create two ontologies and to establish a semantic reconciliation to link these core ontologies according to their specific application. Finally, Protégé Ontograf was used to represent the ontology in order to facilitate the comprehension. Mould Manufacturing Core Ontology and Machining Features Core Ontology are available online at (<https://ipdmsblog.wordpress.com/ontologies/>).

Figure 54 Mould Manufacturing (Core Insert and Cavity Insert) Core Ontology.

A) Mould Machining Core Ontology.

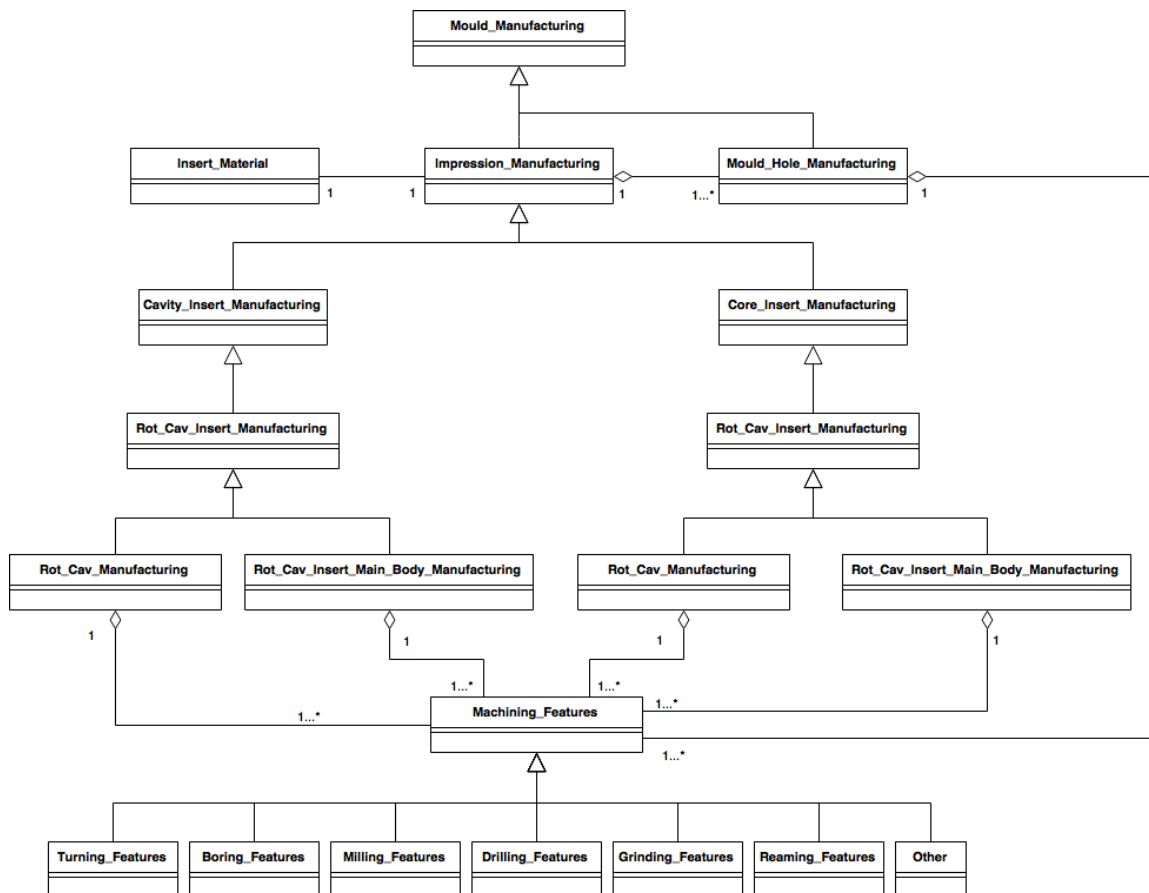

B) Mould Manufacturing Core Ontology

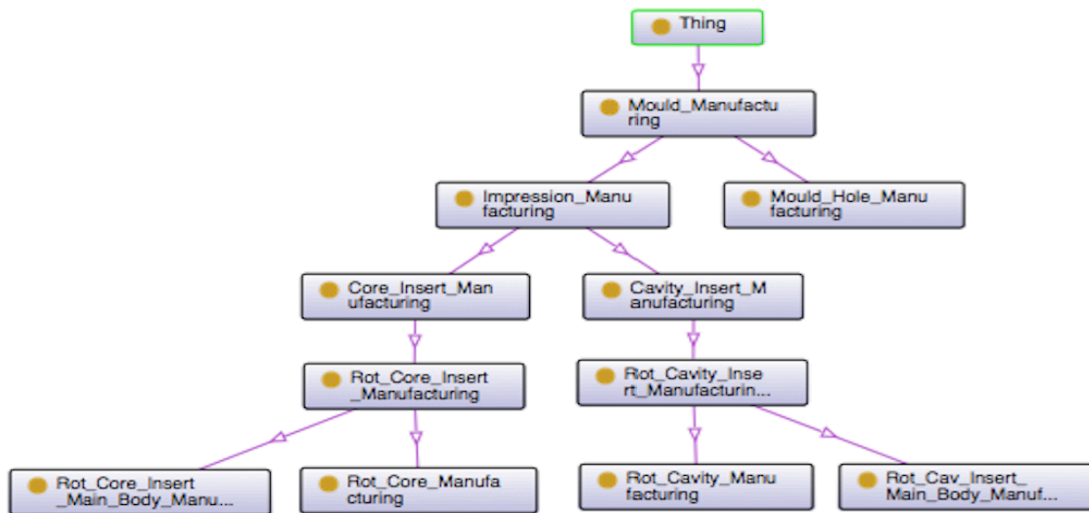

C) Mould Machining Core Ontology.

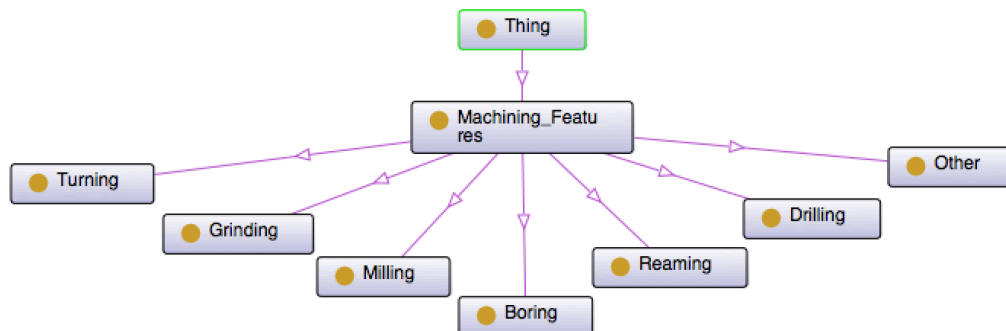

4.4 MATERIAL CORE ONTOLOGY

The Material core ontology captures and expressively represents generic concepts of materials substance, property, environment and process that can be applied for data exchange among heterogeneous materials databases. For materials science in particular, there are several related works to create Material domain ontology as following: (i) van der Vet, Speel and Mars (1995) proposed a PLINIUS knowledge-based that handles knowledge about ceramics research; (ii) Cheung, Drennan and Hunter (2008) proposed a MatONT that is designed to support information integration for new materials research; and (iii) Ashino (2010) proposed a

materials ontology as an infrastructure for exchanging materials information and knowledge. The last work is more comprehensive and was used as the Material core ontology for this research.

The material ontology proposed by Ashino (2010) is structured in three groups: (i) Core Ontologies (Substance, Process, Property, and Environment); (ii) Materials Information; and (iii) Peripheral Ontologies (Unit and Physical Dimensions). In the context of this research, the material information and properties information are important to identify the constraint for the rotational plastic injected products. Figure 55 shows the material information structure proposed in class UML diagram.

Figure 55 Part of Material Data Structure.

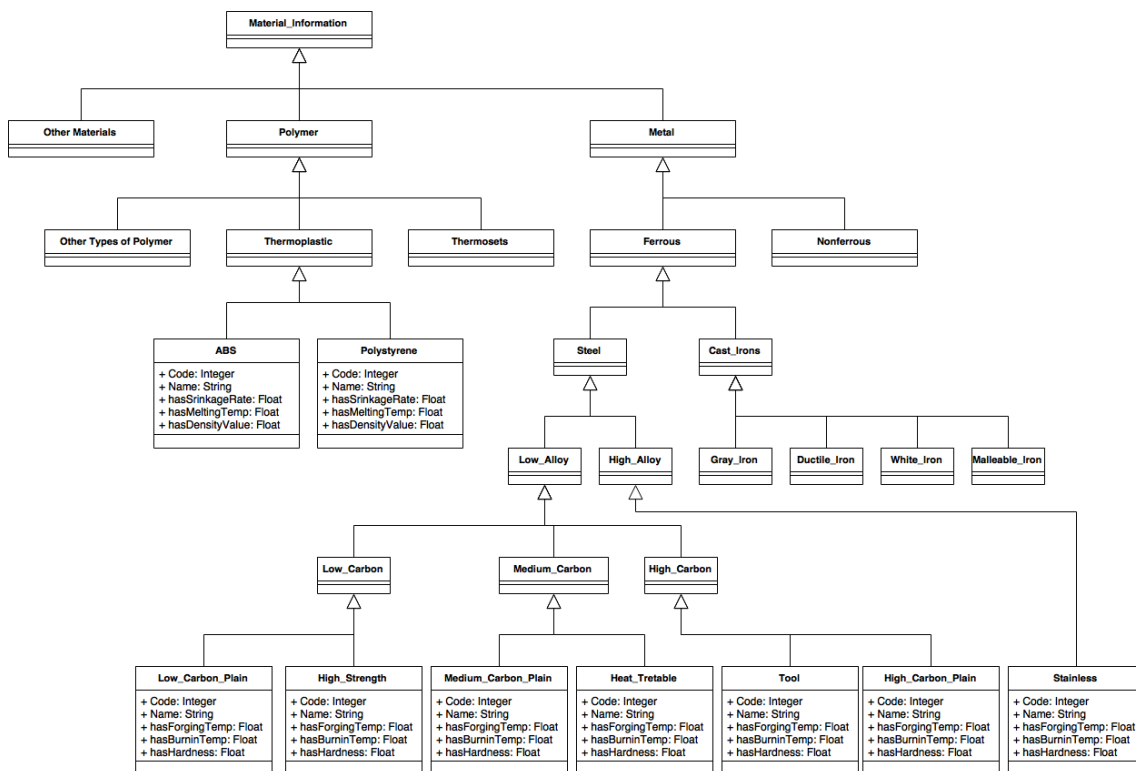

Source: Ashino (2010).

The translation process from the material data structure into the material core ontology follows the KEM methodology (Figure 31) proposed by Noy and McGuinness (2001). The first stage in the process is concerned with the specification of the domain and scope of the ontology. Based on the discussion of the mould design, questions and answers are presented in order to define the ontology scope:

- What should cover the domain and scope of the ontology?

- *This ontology covers the material application to the plastic injected products and to the mould design and manufacturing.*
- Who are the stakeholders involved in exploiting the ontology?
 - *Product and mould designers with multiple expertise.*
- For what types of issues must the developed ontology concepts satisfy?
 - *Mechanical properties of the materials.*

The second stage in the process involves the consideration for reusing other ontologies and/or methods. As it has been discussed in the last sections, the language used is Web Ontology Language (OWL). The third stage considers the enumeration of vital terms to go into the ontology. Some fundamental concepts are Polymer and Metals.

The fourth and fifth stages define the classes and the class hierarchy as well as the ontological structures. These ontological structures involve definitions of the relations between classes, objects and data. In this context, the Mould manufacturing data structure (Figure 55) was translated from the UML model to ontology model in OWL, as shown in Figure 56 and Appendix A.6 presents in more details the Material Core Ontology. Finally, Protégé Ontograp was used to represent the ontology in order to facilitate the comprehension. Material Core Ontology is available online at (<https://ipdmsblog.wordpress.com/ontologies/>).

Figure 56 Material Core Ontology.

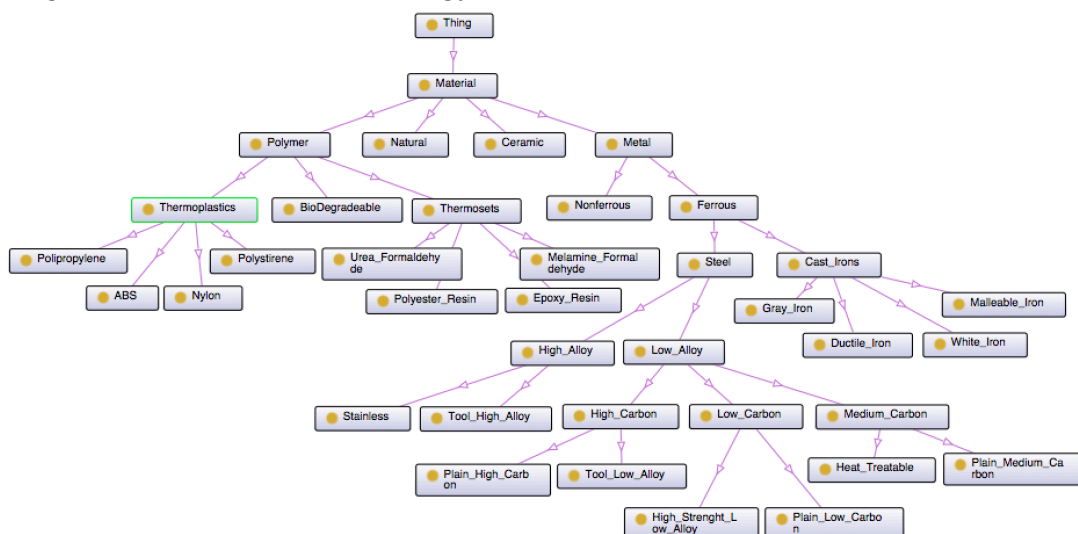

5 CONCEPTUAL FRAMEWORK FOR SEMANTIC INFORMATION INTEROPERABILITY IN PRODUCT DESIGN AND MANUFACTURING: APPLICATION DOMAIN VIEW

The application Domain View (ADV) is the second level in the conceptual framework for an Interoperable Product Design and Manufacturing, as depicted in Figure 57. At this level, the core ontologies from the Reference View can be specialised for the development of domain-specific ontology. The domain-specific ontology has the information and knowledge about a specific product design and/or product manufacturing. Thus, as discussed in Chapter 4, the concepts explored in the Reference View contribute to formalise the information as well as add new knowledge, establishing links with different concepts. In this way, this chapter discusses the specialisation process results in the formal product ontology, which consists of the addition of specific product information into the formal core ontologies. This specialisation provides a formal environment for a semantically interoperable product design and manufacturing.

Figure 57 Application Domain View in the conceptual framework.

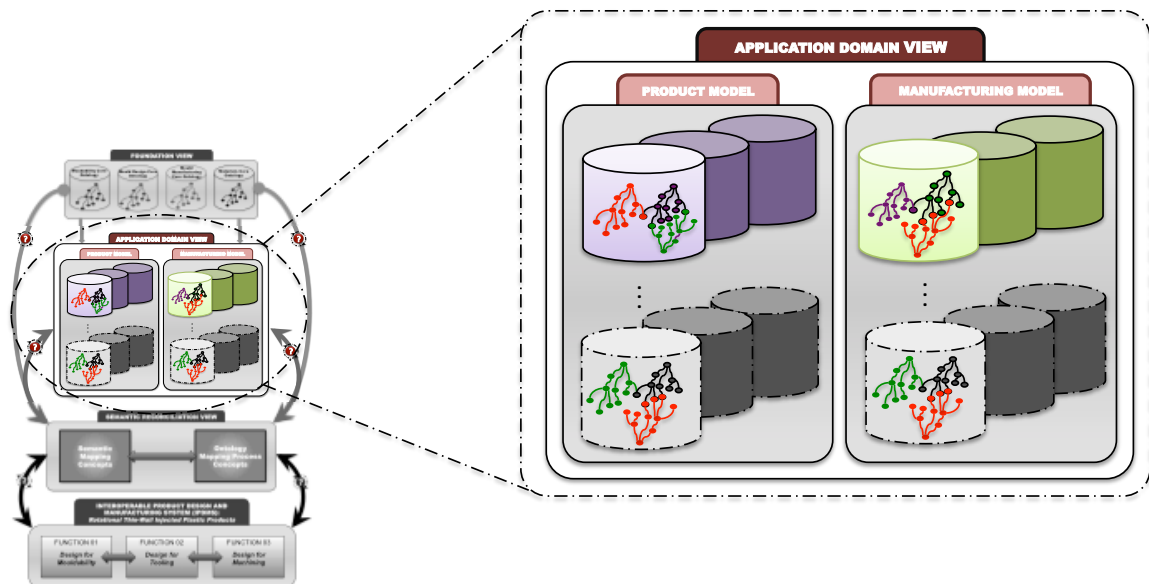

The Application Domain View was structured in Product Model and Manufacturing Model. A Product Model can be defined as an information model that stores information related to a specific product. The same occurs with the

Manufacturing Model that has specific information related to the method to produce the product. According to Young *et al.*, (2007), product and manufacturing model have a key role on PDP because they hold and share product information that is generated, used and maintained over the process of design, manufacturing, production, maintenance and disposal.

Figure 58 illustrates an example of three specialisations from the Reference View to the Application Domain View to create the semantic links between concepts and a specific product.

Figure 58 Relationships between Reference View and Application Domain View.

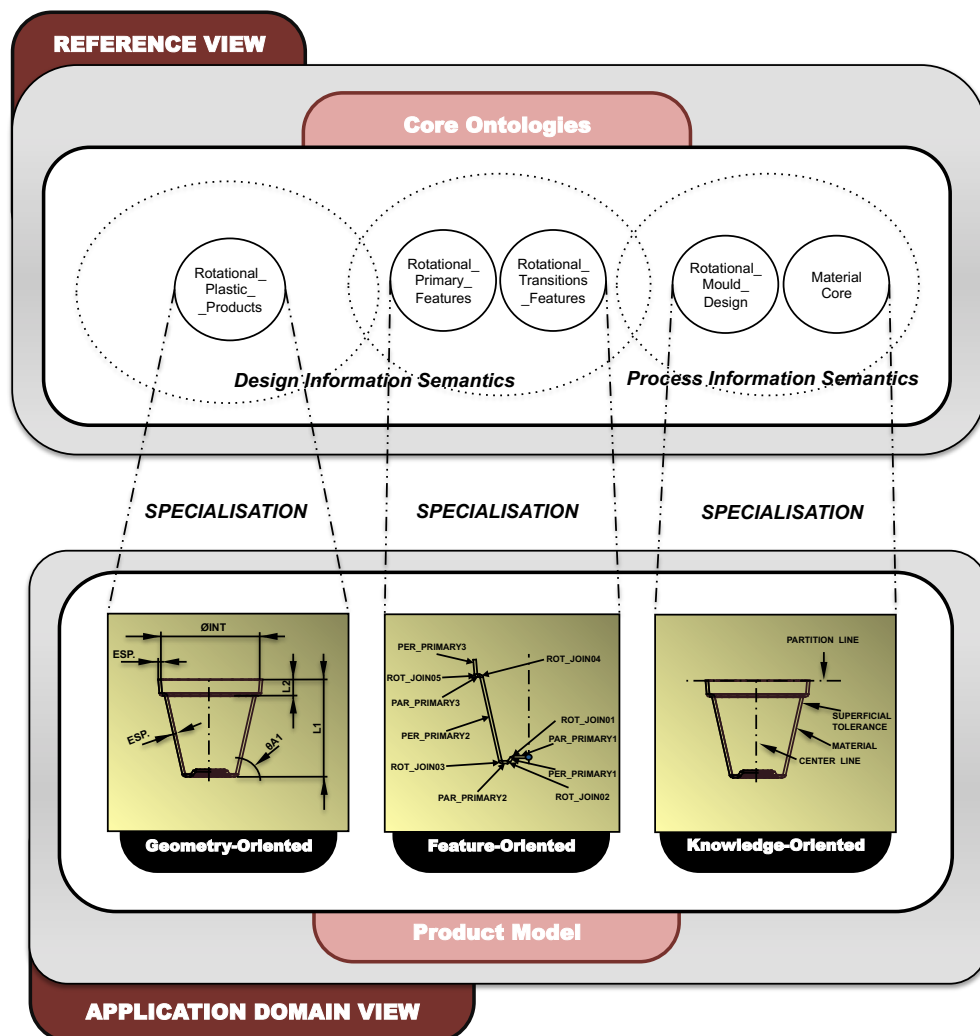

The specialisation dimension between the Reference View and the Application Domain View is fundamental to the conceptual framework and consists of:

- The ability to instantiate domain and/or reference concepts in the Application Domain View;
- The use of the specialised knowledge in a specific domain to support the specialisation of other domain, for example, the product profile is the input of the cavity insert and core insert mould design;
- The identification of the conflicts in the Application Domain View based on an ontology reasoner, according to new constraints added in the application.

A specialised ontology is developed for each phase of the product design and manufacturing. Thus, ontological relationships between the Reference View and the Application Domain View must be defined. According to Rector (2003) and Chungoora (2010), the principle of specialisation can be made through subsumption. Two subsumptions relations that enable taxonomies of classes and relations to exist are: (1) super/subclass relation; and (2) super/sub-relation relation. The third ontological relationship, which is not a subsumption relation, is (3) the instance-of, which makes the population of facts possible through the class instantiation.

These three ontological relations are key to the internal structure of any ontology-based approach and they are accounted for meta-model ontology such as the Ontology Works Upper-Level Ontology (ONTOLOGY WORKS, 2009), Protégé knowledge model (NOY *et al.*, 2000). Thus, this research used this taxonomy and proposed three types of possible specialisation approaches: (i) **Controlled Specialisation Approach** (See Section 5.1); (ii) **Flexible Specialisation Approach** (See Section 5.2); and (iii) **Simple Instantiation Approach** (See Section 5.3). These three processes are detailed in the subsequent sections and have important repercussion on the capability of the information interoperability between classes and instantiated facts from multi-domains.

5.1 CONTROLLED SPECIALISATION APPROACH

The Controlled Specialisation Approach adds super/subclass, super/sub-relation and instances of the product design and manufacturing originated from different applications using concepts based on well-defined semantic rules. These semantic constraints are from data model defined in the Reference View and allow the specialisation of the core ontology. Equations 5.1, 5.2 and 5.3 depict some examples of semantic constraint that can be added to the core ontology.

$$\text{"class_x"} \text{ isSubClassOf } \text{"class_y"} \quad (5.1)$$

$$\text{"class_x"} \text{ isEquivalentOf } \text{"class_z"} \quad (5.2)$$

$$\text{"individual_a"} = \text{model.createIndividual} (\text{"name"}, \text{"instanceclass"}) \quad (5.3)$$

The core ontologies (class, relations and axioms) are entirely imported from the Reference View to the Application Domain View in a "name"_ontology. In addition, this ontology application can be built based on one or more ontologies intersection according to product design and manufacturing information requirements. In this context, Figure 59 presents an example of the controlled specialisation from the "Rotational mouldability core ontology" (detail "B") into "Design for Mouldability specialised ontology" (detail "C"). Thus, the detail "A" presents data information from the geometric view of the rotational plastic injected product, where "Per1" (Wall Perpendicular 1 to Parting Line), "Per2" (Wall Perpendicular 2 to Parting Line) and "Par1" (Wall Parallel 1 to Parting Line) are the walls of the product model. "Per1", "Per2" and "Par1" are added as new instances in "WallPerpendicularPartingLine" and "WallParallelPartingLine", as shown in detail "D", due to reconciliation semantic (Equation 5.3). The semantic reconciliation will be explored Chapter 6. "Per1", "Per2" and "Par1" have data instance that can be added as individuals of each new class, as shown in detail "E".

Figure 59 Controlled Specialisation Approach.

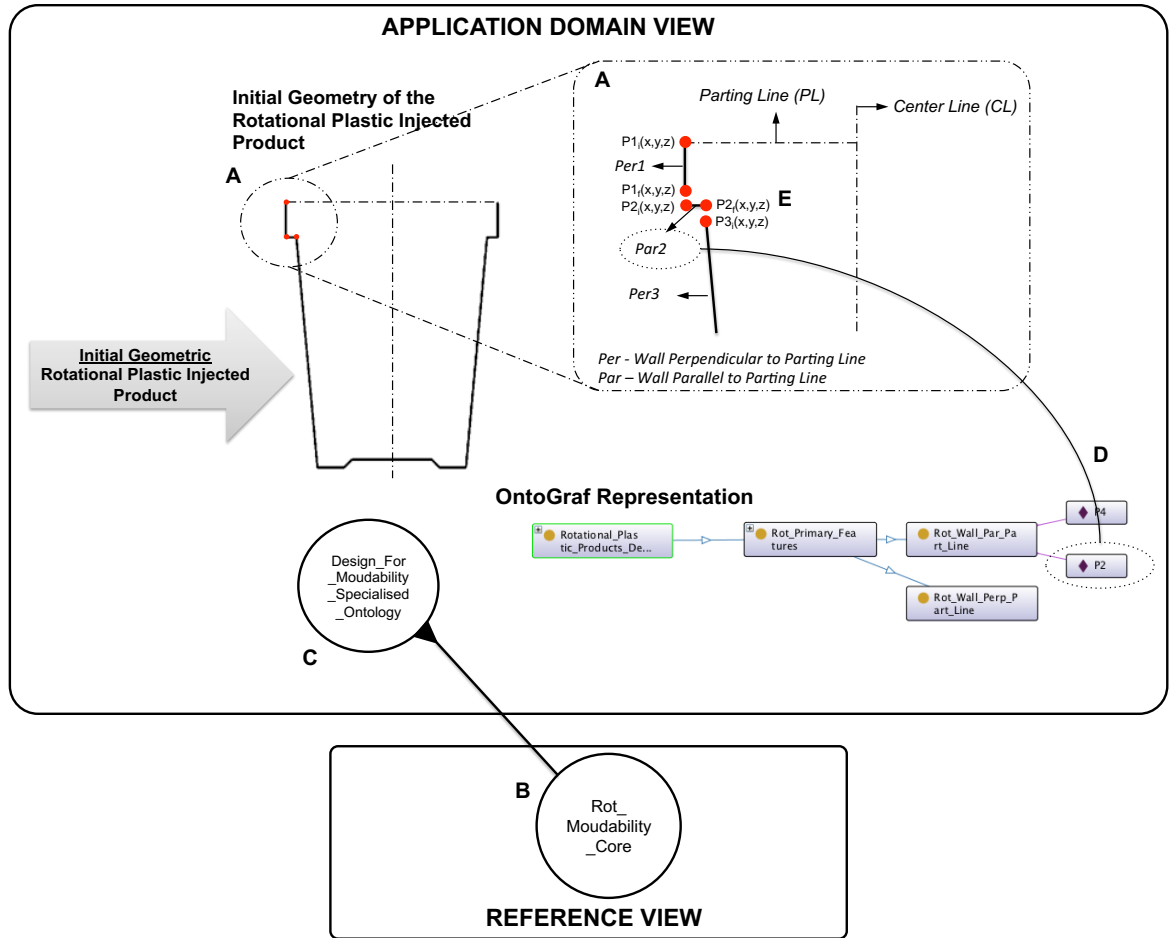

Additionally, each individual profile can have associations with data properties. These data properties are axioms that can be used for the reasoner systems to analyse the inconsistencies in the models. Figure 60 shows an example of the data properties related to the coordinates of the point “ $P1_f(x,y,z)$ ” of Figure 59. Thus, “ $P1_f(x,y,z)$ ” has Coordinate Z (“*HasDimensionZ*”) equal to “0”, “ $P1_f(x,y,z)$ ” has Coordinate Y (“*HasDimensionY*”) equal to “15”, “ $P1_f(x,y,z)$ ” has Coordinate X equal to “100”.

Figure 60 Example of Individual Data Property.

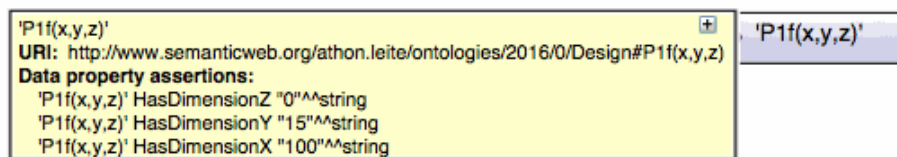

5.2 FLEXIBLE SPECIALISATION APPROACH

The Flexible Specialisation Approach enables specific application domain to reuse references core ontologies without imposing strict rules. However, this approach required a semantic alignment through semantic reconciliation (see Chapter 6) to reduce any misinterpretation or mistake with the associated information. The subsumption relations between classes are fully permitted as the declaration of instances. The consequence of creating relation taxonomies using subsumption relations is a main concern to the reconciliation of instantiated facts across multi-domains. Thus, a rigorous control with the semantic alignment is necessary for minimising the interoperability problems with this specialised information. Figure 61 shows an example of the flexible specialisation approach application.

Considering the example illustrated in Figure 61, the “Offset” class is already declared in the Rotational Mouldability Core Ontology (Detail “B” of Figure 61), but the “Thickness” class is not. “Offset” and “Thickness” are equivalent terms (Detail “A” of Figure 61), where the offset is a technical term of design and manufacturing domain and thickness is a common term in material and other domains. So, there is no equivalence between concepts but only subsumption or only semantics intersection. In such case, extra information is necessary to characterise the semantic relation and map the concepts, as demonstrated in Yahia, Aubry and Panetto (2012). In the flexible specialisation approach, the core ontology is specified in the specialised ontology (Detail “C” of Figure 61) and semantic relation (Detail “F” of Figure 61) is created in order to establish the semantic link between both of the concepts (Detail “D” of Figure 61) based on the extra information stated by the user to define these semantic relations. After these definitions, the individuals’ instantiated in one class can be inferred in other class (Detail “E” of Figure 61).

Figure 61 Flexible Specialisation Approach.

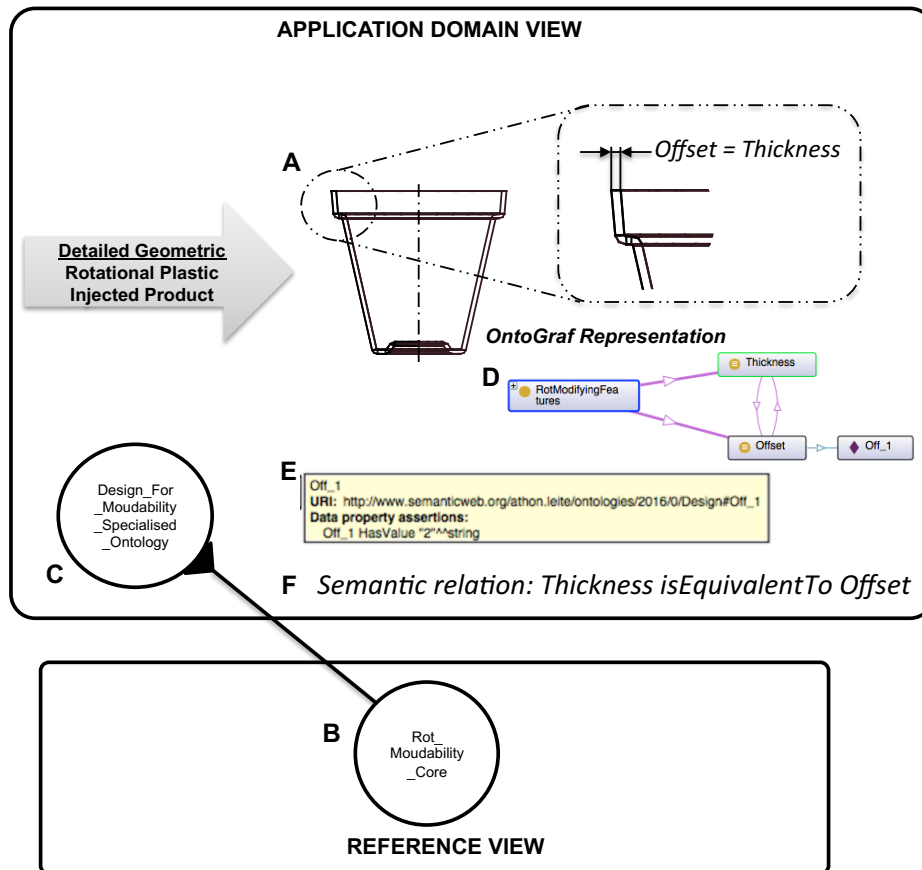

5.3 SIMPLE INSTANTIATION APPROACH

For this research, the instantiation approach is the most important process for specialisation because all features about the product model or manufacturing model are added into the ontology. Individual instances are the most specific concepts represented in a Knowledge Base (KB).

It is important to highlight that there is a fine line between ontology as a logical theory and as a Knowledge Base (KB). Ontology aims to capture the conceptual structures of some field while KB aims to specify a concrete state of the field, i.e., an ontology consists of intentional logical definitions (characteristics that distinguish concepts) while KB comprises of extensional parts (instances) (CHUNGOORA, 2010). KB may be observed as a form of database dedicated to the effective management of knowledge, which is facilitated through the classification, and mechanisms that came from the ontology core that the KB is associated with. But KB

does not allow the establishment of semantic relationships with other KB as well as inference relationships between instances.

Figure 62 illustrates how the information or facts from the product model can be represented, through the instantiation, from a Rotational mould design core ontology (*Rot_mould_desing_core* – Detail “B”) into Design for tooling specialised ontology (*Design_For_Tooling_Ontology_Specialised* – Detail “C”). The example takes into account the instantiation of the material to manufacture the cavity insert (Detail “A”). The material used for mould manufacturing was “AISI P20” (Detail “D”), that was instantiated as Cavity Insert Material (*Cavity_Insert_Material*).

Figure 62 Simple Instantiation Approach.

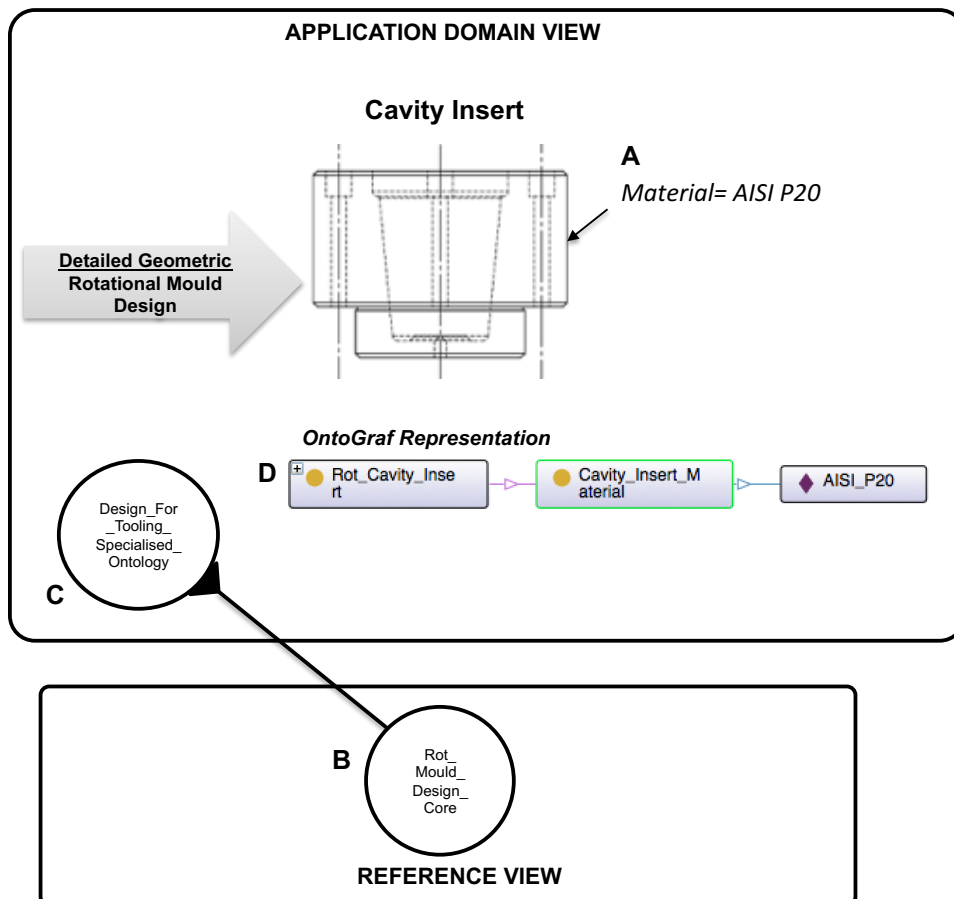

6 CONCEPTUAL FRAMEWORK FOR SEMANTIC INFORMATION INTEROPERABILITY IN PRODUCT DESIGN AND MANUFACTURING: SEMANTIC RECONCILIATION VIEW

Several transdisciplinary information is shared across different phases of the PDP and needs to be integrated to other models in the ADP to verify possible inconsistencies. Domain semantics need to be reconciled in the event that these models need to interoperate with the intention of sharing knowledge. Semantic Reconciliation View (SRV) covers relevant applied ontology-based techniques enabling the reconciliation of domain semantics, as depicted in Figure 63.

Figure 63 Semantic Reconciliation View in the conceptual framework.

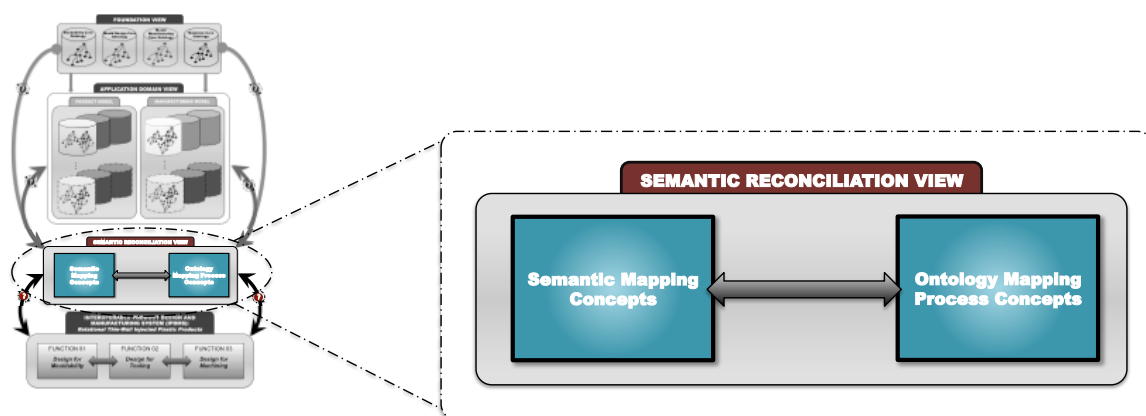

The techniques work segments of known ontology matching methods such as: (i) the computation of contexts for domain ontologies (STUMME and MAEDCHE, 2001); (ii) ontology intersection (KALFOGLOU and SCHORLEMMER, 2003; EHRIG and SURE, 2004; ARNOLD and RAHM, 2014; MECCA et al., 2015); and (iii) semantic alignment (EUZENAT and SHVAIKO, 2007; ARCH-INT and ARCH-INT, 2013). Figure 64 illustrates the basic concepts involved in the mapping of domain models at the SRV. The process of semantic reconciliation can be performed between pairs of models at a time, as can be encountered in almost all current ontology mapping frameworks and methodologies (KALFOGLOU and SCHORLEMMER, 2003). Adjustment Context involves the first stage of the two domain models contexts adjustments (namespaces in this case), which are going to

be reconciled. Following this stage, there is a simple ontology intersection process, where both models are intact loaded into a single specialised ontology. The last procedure in the SRV is the semantic alignment, where semantic mapping concepts are loaded into the intersected models.

Figure 64 Stages of Semantic Reconciliation View.

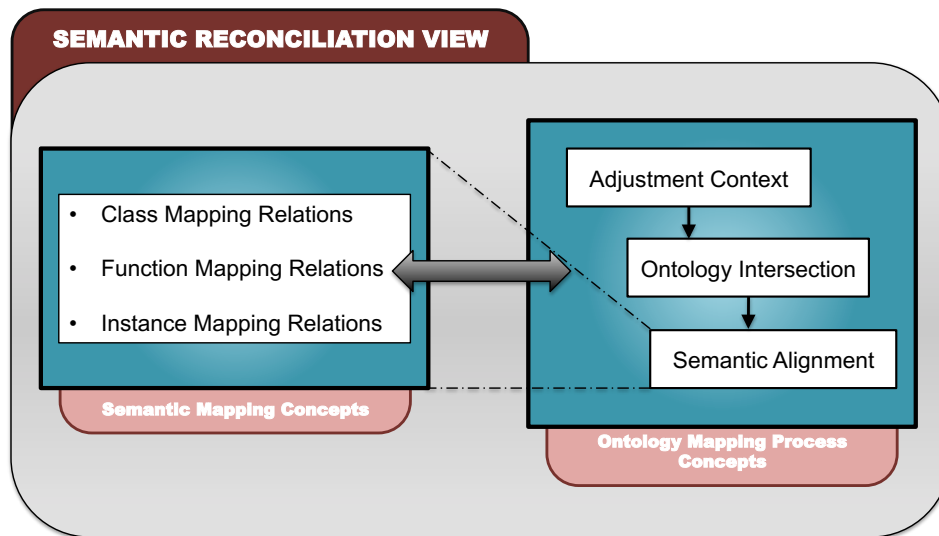

6.1 DOMAIN ADJUSTMENT CONTEXT PROCESS

The adjustment context process is the first stage of semantic reconciliation. Different core ontology has their contexts adjusted to the specific domain application, i.e., their contexts are aligned according to the product that will be developed. From the limits established in this research, any core ontology has their contexts adjusted to the standard contexts "Design for Mouldability (DFMould)", "Design for Tooling (DFTool)" and "Design for Machining (DFMch)".

The first phase of product design are concerning the Rotational mouldability information, for example, the material properties directly impacts in the thickness of the product and minimum radius fillet (internal and external). Thus, the Material core ontology is inserted in the context of the Design for Mouldability, renaming the "Material Core Ontology" to "DFMould_Material".

The adjustment context procedure is important because of the semantic alignment process, which takes place later on during ontology mapping, involves

semantic mapping concepts based on the predefined contexts. The process of context adjustment is straightforward and only requires the substitution of the domain contexts names.

Figure 65 Adjusting Core Contexts to Specific Domains Contexts

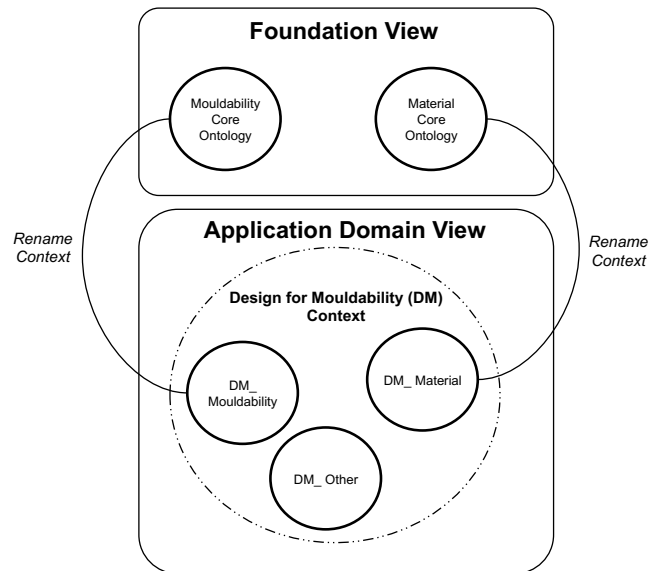

6.2 ONTOLOGY INTERSECTION

The second stage in the Reconciliation View is concerned with an ontology intersection procedure, which loads the ontologies according to their contexts in a single ontology. This single ontology has the entire knowledge about the product and is enriched with the information from the Reference Views in order to support the semantic interoperability across different phases of its design and manufacturing. The domains of ontology are preserved during this intersection and semantic mapping is established to ensure the correct information relationships. Additionally, the ontology intersection applied to the instances level, if these instances exist.

Figure 63 illustrates the intersection process with two core ontologies. The simple intersection process is applied to the ontology “A” and the ontology “B”, resulting in the ontology “AB” (a central concept that integrates both ontologies). New information and knowledge can be added in order to enrich the semantic interoperability across the product design and manufacturing. However, the classes’

hierarchy, object properties and data properties are preserved in this process, ensuring the structure of information from the core ontologies.

Figure 66 Ontology Intersection Process.

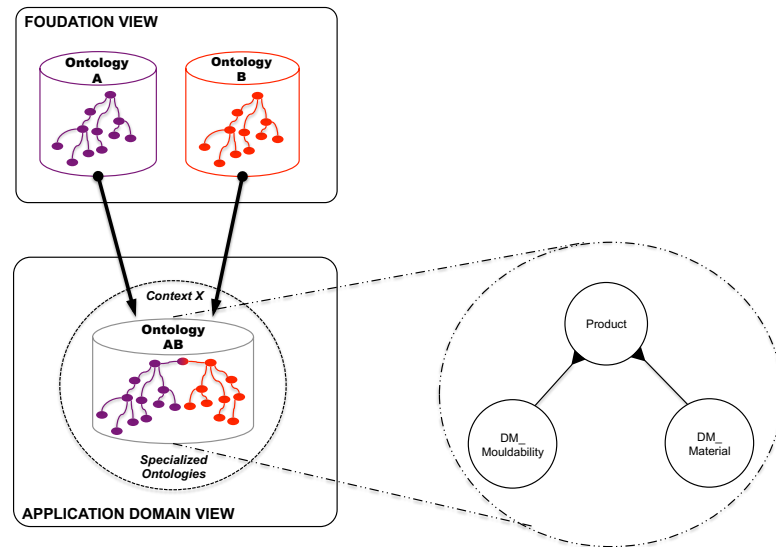

6.3 SEMANTIC ALIGNMENT PROCESS

The semantic alignment process is the heart of the semantic Reconciliation View because it allows the establishment of the relationships with information from multiple perspectives. The alignment process is enabled by semantic mapping (concepts and/or instance) specialised ontologies in the Application Domain View, as illustrated in Figure 67.

Figure 67 Semantic Alignment Process.

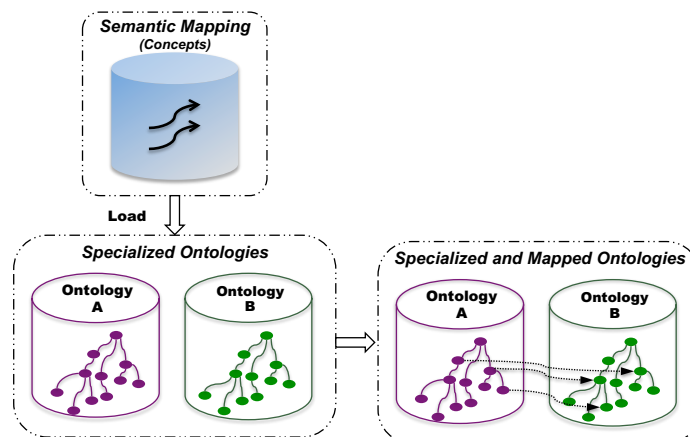

The relations in the semantic alignment process must satisfy the logical conditions. This research considers three logical conditions for the information relationships: (i) information sharing; (ii) information conversion; and (iii) information translation. The information sharing has the function to exchange information with the same unit scale and/or same meaning, i.e., it establishes a relationship of equivalence, without any additional information. One information sharing example is the exchange of the material name (*material_name*) between the “*DFMould_Mouldability*” and “*DFMould_Material*”.

The information unit conversion relates information based on strict rules, for example, the unit conversion mathematic equation (Eq. 6.1) is applied if dimension information in millimetres is exchanged with the dimension information in inches, ensuring the correct information exchanging.

$$f(x)(in) = \frac{x(mm)}{25,4} \quad 6.1$$

Where: “ $f(x)$ ” is the solution of mathematic conversion from millimetre to inches and “ x ” is the variable in millimetres.

Finally, the last logical condition is the information translation. This one is the most important and complex condition of the semantic alignment. The information translation requires the addition or comparison with other information in order to generate the results. One information translation example is the information exchange between the product profiles from design for mouldability and the core profiles in design for tooling. This translation requires extra information, the material shrinkage rate, in order to correct the profile of the core and ensure the correct release of the product during the injection process.

The semantic alignment has two distinct conditions as follows: (i) the intra-context semantic alignment, i.e., the information is exchanged in the same design for mouldability context; (ii) the inter-context semantic alignment, when the information is exchanged across contexts, for example, between design for mouldability and design for tooling or design for tooling and design for manufacturing.

The subsequent sections discuss in details the semantic mapping concepts to support the intra and inter-context semantic alignments in terms of sharing, comparing and translating logical conditions.

6.4 SEMANTIC MAPPING

The semantic mapping consists of formally defining semantic relationships (using logic programming) between concepts and instances across different core ontologies and different contexts. These relations are logical conditions that support the information exchange without losing meaning associated to the information captured. Additionally, semantic mapping also includes the statement of informal remarks for human interpretation (MAEDCHE *et al.*, 2002). The alignments produced by matching variables may not be intuitively obvious to human-use and, therefore, need to be explained.

Figure 65 summarises the above-mentioned components of semantic mapping concepts. The diagram shows that if the argument “?a” satisfies certain conditions and is defined within the “Domain A” context and the argument “?b” satisfies certain conditions and is defined within the “Domain B” context, then the “Semantic Mapping Relation” holds true between “?a” and “?b” where “?a” is interpreted in the first argument position and “?b” in the second argument position for the “Semantic Mapping Relation”.

Figure 68 Detailing the Semantic Mapping.

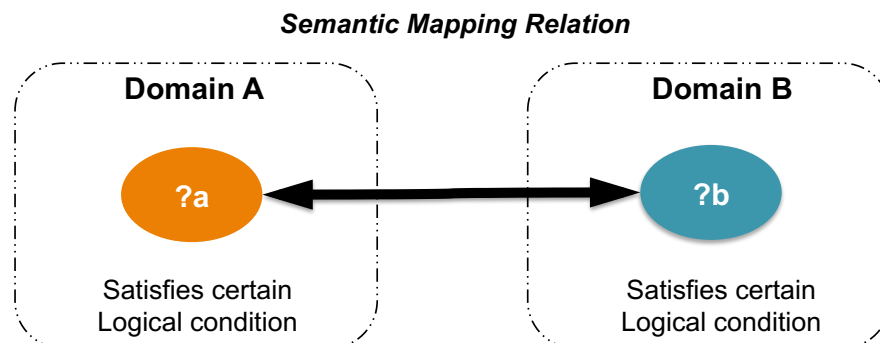

In this research, the semantic mapping is established in the Application Domain View in order to ensure the correct product design and manufacturing of rotational plastic injected products. Semantic mapping has different levels of granularity based on the semantics foundations and the user's knowledge of semantics domains. This leads to the ability to define: (1) the use of semantic mapping based directly on foundation relations; (2) the use of the semantic mapping that is relevant to the domain that will be reconciled. Complementary, the ability (1) is used to establish the semantic relations intra-contexts and the ability (2) is used to establish the semantic relations inter-contexts. These different implications are discussed in the next sections.

6.4.1 Semantic Mapping to support the relationships intra-contexts in the Application Domain View

The foundation semantics has a set of pre-defined mapping according to the knowledge of the process and allows the information exchange intra-contexts, as depicts in Figure 69. Different reconciliation scenarios can reuse this set of mapping concepts since all specialised ontologies in the Application Domain View are specialisations of the Reference View and share a common semantic ground.

Figure 69 Semantic Mapping based on Foundation Semantics.

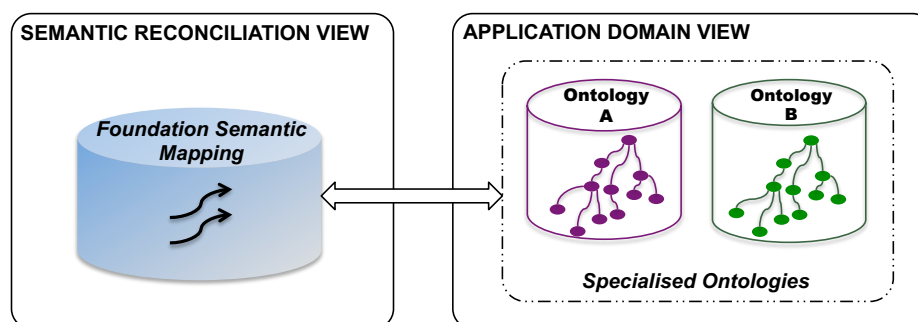

The semantic mapping uses the SWRL (Semantic Web Rule Language) approach to establish the relationships. SWRL is an expressive OWL-based rule language that allows users to write rules that can be expressed in terms of OWL 2 concepts to provide more powerful deductive reasoning capabilities (HORROCKS *et al.*, 2004). Figure 70 illustrates how a semantic mapping can be specified for the

reconciliation of instances in the Application Domain View in the design for mouldability context. These instances are data information from the Primary geometry profile (Detail A) of the product to be moulded and they must be mapped in Rotational wall parallel to the Parting Line (Detail B and D) or in a Rotational wall perpendicular to the Parting Line (detail C). Rules for mapping the parallel or perpendicular to the parting line are presented in Detail E, F and G and they were modelled according to SWRL taxonomy represented in Detail H, I, J.

Figure 70 Instance Semantic Mapping in intra-Domain Application View.

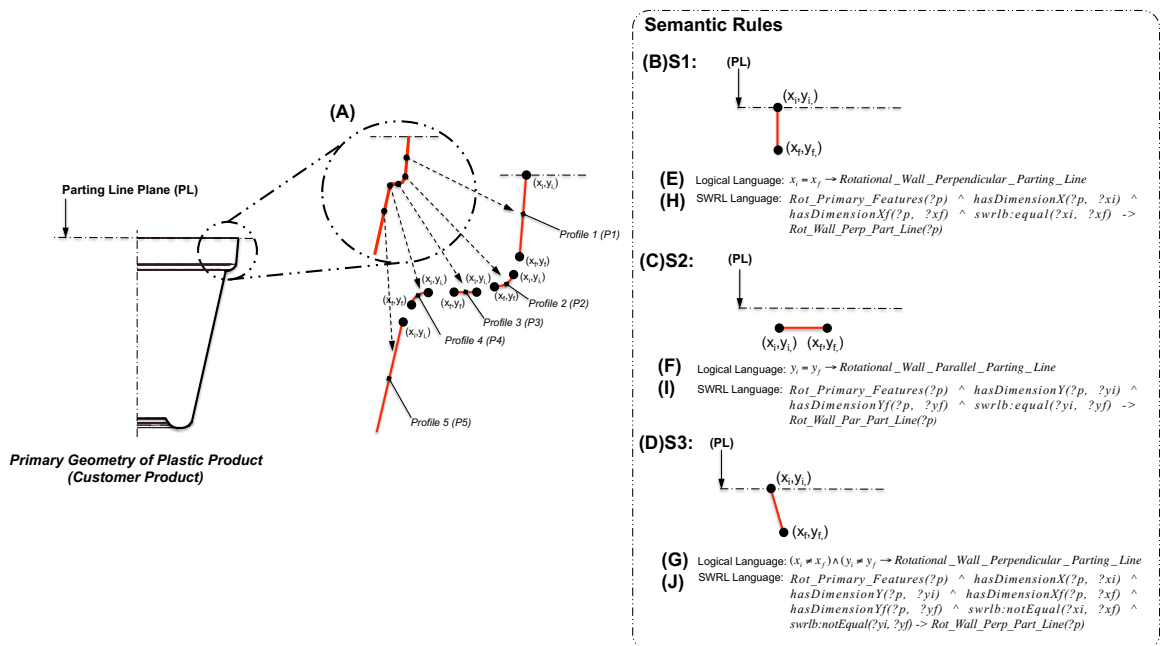

Horrocks *et al.*, 2004 presented a detailed SWRL taxonomy that is used in this research to establish the semantic mapping. Foundation semantics can have information for to the semantic mapping intra-context (“design for mouldability”, “design for tooling” and “design for machining”) or inter-context (“design for mouldability and design for tooling” and “design for tooling and design for machining”). The subsequent sections discuss in details the semantic mapping based on the semantic rules, which were created according to the concepts and their relationships explored by Canciglieri Junior (1999), Canciglieri Junior and Young (2003) and Canciglieri and Young (2010).

6.4.1.1 Foundation semantic for the semantic mapping in Design for Mouldability

Several aspects have to be discussed in terms of semantic mapping in Design for Mouldability context because there are relationships between the specialised core ontologies from Mouldability Core Ontology and Material Core Ontology. In addition, the controlled specialisation requires semantic mapping with the information instantiated in the ontology, as discussed in section 4.1.

The sub-section are structured in semantic mapping between: (i) primary features and rotational wall parallel to the parting line; (ii) primary features and rotational wall perpendicular to the parting line; (iii) primary features and transitions features; (iv) primary features and modifying features; and (v) primary features and parting line.

6.4.1.1.1 Semantic Mapping between primary features and rotational wall parallel to the parting line

This semantic mapping associates the instances of the primary features from the profile of the plastic injected product (created by the designer) with the type of rotational wall (parallel and perpendicular). In this section, it is mapped if the primary features are parallel to the parting line. Figure 71 illustrates an example of the parallel profile to the Parting Line and its semantic rule.

Figure 71 Semantic rule between Rotational primary features and Rotational wall parallel to the Parting Line.

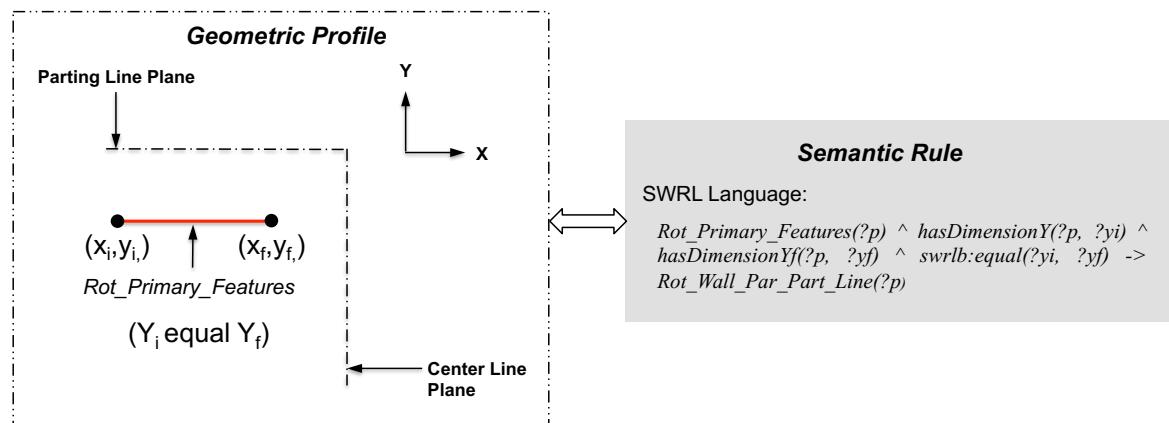

The semantic rules that support the definition of the semantic mapping to partially reconcile the Primary features and Rotational wall parallel to the Parting Line presented in Figure 71 state that:

- There are a commonality between the instance “?p” that has “Yinitial” coordinate [*hasDimensionY(?p,?yi)*] equal to the same instance that has “Yfinal” coordinate [*hasDimensionYf(?p,?yf)*]. The “Xinitial” and “Xfinal” coordinates might be different.

6.4.1.1.2 Semantic Mapping between Primary features and Rotational wall perpendicular to the Parting Line

This semantic mapping associates the instances of the primary features from the profile of the plastic injected product (created by the designer) with the type of Rotational wall (parallel and perpendicular to the Parting Line). In this section, it is mapped if the Primary features are perpendicular to the Parting Line as exemplified in Figure 72 or taper to the Parting Line, as shown in the example of Figure 73.

Figure 72 Semantic rule between Rotational primary features and Rotational wall perpendicular to the parting line.

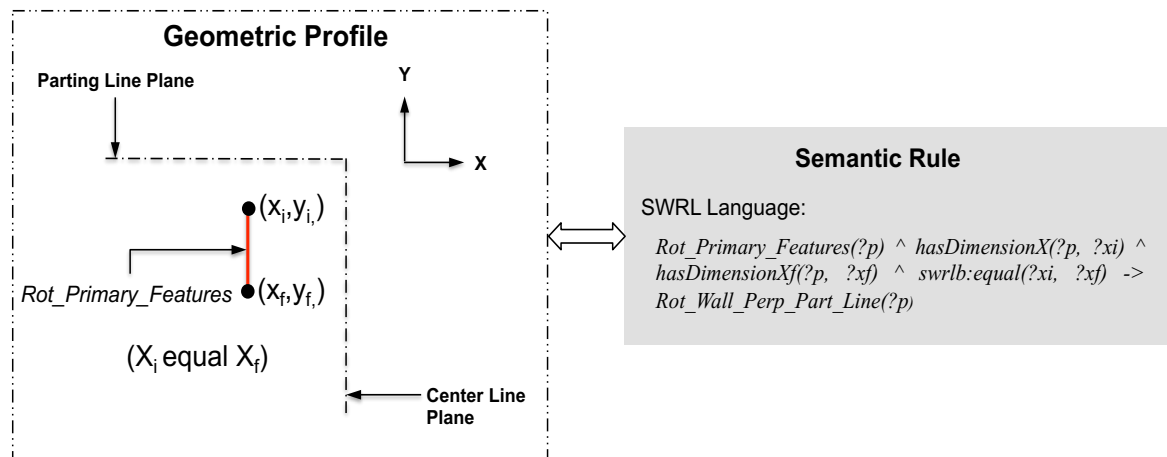

The semantic rules that support the definition of the semantic mapping to partially reconcile the Primary features and Rotational wall perpendicular to the Parting Line presented in Figure 72, state:

- There are a commonality between the instance “?p” that has “Xinitial” coordinate [*hasDimensionX*(?p,?xi)] equal to the same instance that has “Xfinal” coordinate [*hasDimensionXf*(?p,?xf)]. The “Yinitial” and “Yfinal” might be different.

Figure 73 Semantic rule between Rotational primary features and Rotational wall taper to the Parting Line.

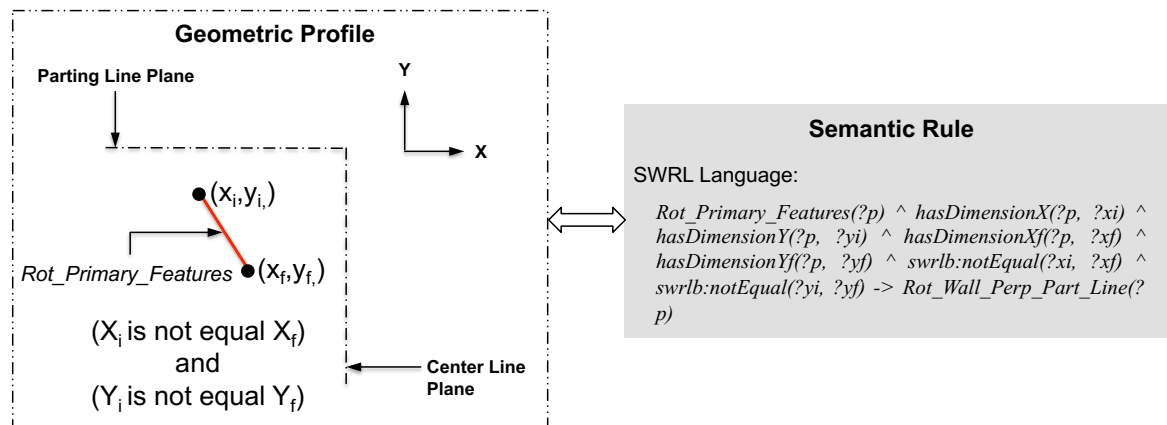

The formal remarks that support the definition of the semantic mapping to partially reconcile the Primary features and Taper rotational wall presented in Figure 73, state:

- There are a commonality between the instance “?p” that has “Xinitial” coordinate [*hasDimensionX*(?p,?xi)] not equal to the same instance “?p” that has “Xfinal” coordinate [*hasDimensionXf*(?p,?xf)] and the instance “?p” has “Yinitial” coordinate [*hasDimensionY*(?p,?yi)] not equal to the same instance “?p” that has “Yfinal” coordinate [*hasDimensionYf*(?p,?yf)].

6.4.1.1.3 Semantic Mapping between Primary features and Transition features

Rotational primary features are used to create the basic shape of the rotational plastic injected products concerning the mouldability constraints. Between two primary features must have a connection via transitions features, linking them to generate precise internal and external surfaces, as discussed in the section 4.1.2.1.

These transition features are joints of the fillet type that must respect the minimum and maximum radius of the plastic injected products. The minimum and maximum radius equations are defined by constraints that are presented in the section 6.4.1.1.4. The semantic mapping associates the instances of the primary features from the profile of the plastic injected product (created by the designer) with the type of rotational wall (parallel or perpendicular). Figure 74 presents an example of the semantic mapping between “Primary Features” and “Transition Features”.

Figure 74 Semantic rule for the relationships between Primary Features and Transition Features.

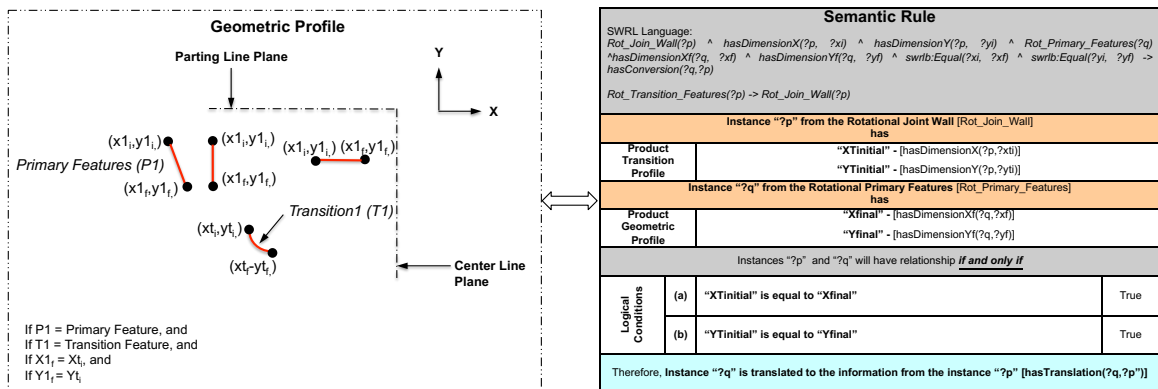
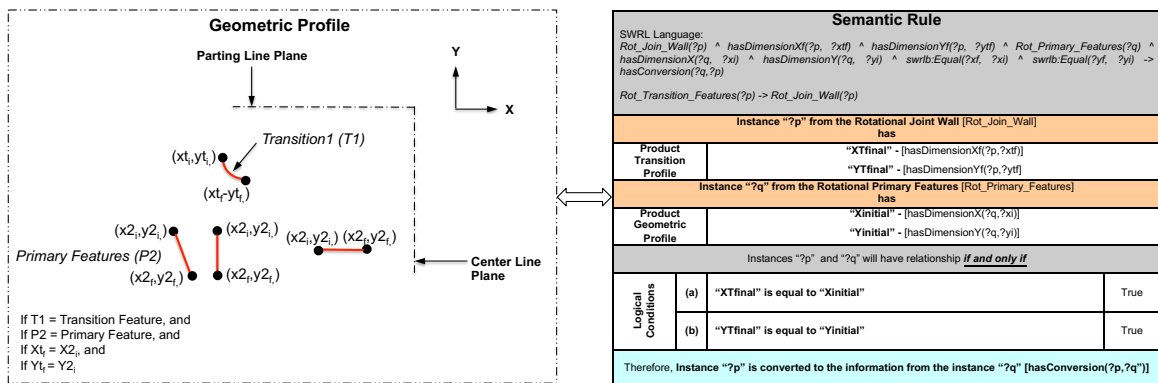

Figure 75 Semantic mapping between “Transition Feature” and “Primary Features”.

Figure 75 Example of semantic rule for the relationships between Transition Features and Primary Features.



6.4.1.1.4 Semantic mapping in Modifying features

This semantic mapping ensures the relations between the Primary features or Transition features and modifying features as well as the relationships between modifying features. This research considers three mapping relations: (i) Offset features and Fillet Features Rotation; (ii) Fillet Features and Joint Wall; and (iii) Offset and Rotational Primary Features.

(i) Offset Features and Fillet Features

The first relation ensures the correct calculus of the minimum radius for the internal and external profile used in the plastic product mouldability. According to the General Electric Plastics (2012), the minimum internal radius follows the equation 6.2 and the minimum external radius follows the equation 6.3. Both radii (internal and external) are directly proportional to the offset of the plastic injected product.

$$\text{minimum internal radius} = \frac{1}{2} * \text{offset} \quad (6.2)$$

$$\text{minimum external radius} = \frac{3}{2} * \text{offset} \quad (6.3)$$

Where: “*minimum internal radius*” means the fillet in the internal direction, “*minimum external radius*” means the fillet in the external direction, and “*offset*” means the thickness of the product. The minimum internal and external radius in plastic injected products and the semantic rule is exemplified in Figure 73.

Figure 76 Semantic rule for the relationships between Offset feature and Fillet feature.

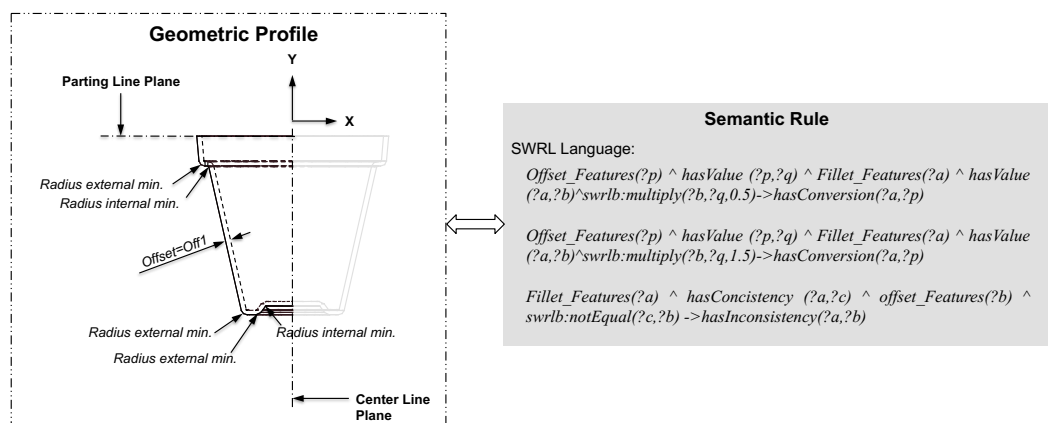

The formal remarks that support the definition of the semantic mapping to partially reconcile the offset feature and fillet feature presented in Figure 76, state:

- The instance “?a” from the “Fillet features” (*Fillet_features*) has value “?b” [*hasValue(?a,?b)*] and must be equal to the multiplication of “?p”, that has value “?q” [*hasValue(?p,?q)*] by 0.5, resulting in its conversion in relation to the offset.
- The instance “?a” from the “Fillet feature” (*Fillet_features*) has value “?b” [*hasValue(?a,?b)*] and must be equal to the multiplication of “?p”, that has value “?q” [*hasValue(?p,?q)*] by 1.5, resulting in its conversion in relation to the offset.
- If one of them is not correctly converted, it is automatically remarked as an inconsistency between these relations.

(ii) Fillet Features and Rotational Joint Wall

The second relation creates the semantic mapping between the minimum internal and external radius and the Rotational joint wall of the plastic injected product. The radius of the Rotational joint wall must be greater or equal than the minimum internal or external radius to be coherent according to the profile of the product. An inconsistent relation is realised if the radius applied in the Rotational joint wall is lesser than the minimum radius. Figure 74 presents an example of the minimum external radius of the Rotational injected product in the geometric profile and its semantic rules.

Figure 77 Semantic rule for the relationships between Fillet Feature and Rotational Joint Wall for the minimum external radius.

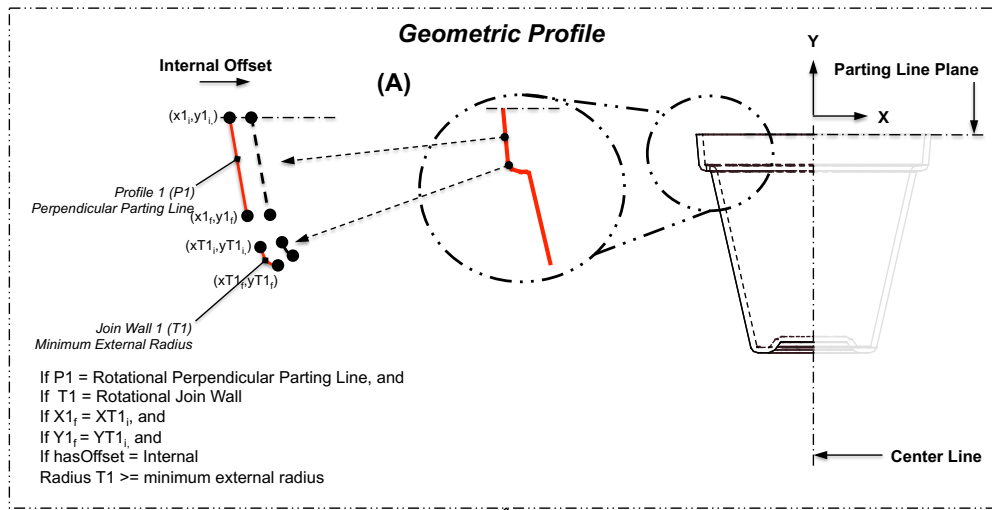

Semantic Rule			Semantic Rule			
SWRL Language: Rot_Join_Wall(?p) ^ hasRadius(?p,?) ^ hasDimensionX(?p,?x) ^ hasDimensionY(?p,?y) ^ Rot_Wall_Perp_Part_Line(?q) ^ hasDimensionX(?q,?x) ^ hasDimensionY(?q,?y) ^ swrlb:equal(?x,?x) ^ swrlb:equal(?y,?y) ^ Offset_Features(?t) ^ hasOffset(?t,?off_dir) ^ swrlb:equal(?off_dir, "Internal") ^ hasValue(Radius_ext_min,?d) ^ swrlb:greaterThanOrEqual(?r,?d) -> hasConversion(?p, Radius_ext_min)			SWRL Language: Rot_Join_Wall(?p) ^ hasRadius(?p,?) ^ hasDimensionX(?p,?x) ^ hasDimensionY(?p,?y) ^ Rot_Wall_Perp_Part_Line(?q) ^ hasDimensionX(?q,?x) ^ hasDimensionY(?q,?y) ^ swrlb:equal(?x,?x) ^ swrlb:equal(?y,?y) ^ Offset_Features(?t) ^ hasOffset(?t,?off_dir) ^ swrlb:equal(?off_dir, "Internal") ^ hasValue(Radius_ext_min,?d) ^ swrlb:lessThan(?r,?d) -> hasInconsistency(?p, Radius_ext_min)			
Instance "?p" from the Rotational Joint Wall [Rot_Join_Wall]			Instance "?p" from the Rotational Joint Wall [Rot_Join_Wall]			
has			has			
Product Transition Profile	"XTinitial" - [hasDimensionX(?p,?x)]		Product Transition Profile	"XTinitial" - [hasDimensionX(?p,?x)]		
	"YTinitial" - [hasDimensionY(?p,?y)]			"YTinitial" - [hasDimensionY(?p,?y)]		
	"Radius" - [hasRadius(?p,?)]			"Radius" - [hasRadius(?p,?)]		
Instance "?q" from the Rotational Perpendicular Features [Rot_Wall_Perp_Part_Line]			Instance "?q" from the Rotational Perpendicular Features [Rot_Wall_Perp_Part_Line]			
has			has			
Product Geometric Profile	"Xfinal" - [hasDimensionX(?q,?x)]		Product Geometric Profile	"Xfinal" - [hasDimensionX(?q,?x)]		
	"Yfinal" - [hasDimensionY(?q,?y)]			"Yfinal" - [hasDimensionY(?q,?y)]		
Instance "?t" from the Offset Features [Offset_Features]			Instance "?t" from the Offset Features [Offset_Features]			
has			has			
Offset Features	"Offset_direction" - [hasOffset(?t,?off_dir)]		Offset Features	"Offset_direction" - [hasOffset(?t,?off_dir)]		
Instance Min Ext Radius - [Radius_ext_min]			Instance Min Ext Radius - [Radius_ext_min]			
has			has			
Fillet Features	"Min_Ext_Radius_Value" - [hasValue(Radius_ext_min,?d)]		Fillet Features	"Min_Ext_Radius_Value" - [hasValue(Radius_ext_min,?d)]		
Instances "?p" and "Min_Ext_Radius" will have relationship <i>if and only if</i>			Instances "?p" and "Min_Ext_Radius" will have relationship <i>if and only if</i>			
Logical Conditions	(a)	"Xfinal" is equal to "XTinitial"	True	(a)	"Xfinal" is equal to "XTinitial"	True
	(b)	"Yfinal" is equal to "YTinitial"	True	(b)	"Yfinal" is equal to "YTinitial"	True
	(c)	"Offset_direction" is equal to "Internal"	True	(c)	"Offset_direction" is equal to "Internal"	True
	(d)	"Radius" is greater than or equal to "Min_Ext_Radius_Value"	True	(d)	"Radius" is lesser than "Min_Ext_Radius_Value"	True
Therefore, instance "?p" is converted to the information from the instance "Min_Ext_Radius" [hasConversion(?p, Radius_ext_min)]			Therefore, instance "?p" has inconsistency with the information from the instance "Min_Ext_Radius" [hasInconsistency(?p, Radius_ext_min)]			

Figure 78 presents an example of the minimum internal radius in the Rotational plastic injected product in the geometric profile and its semantic rules.

Figure 78 Semantic rule for the relationships between Fillet Feature and Rotational Joint Wall for the minimum internal radius.

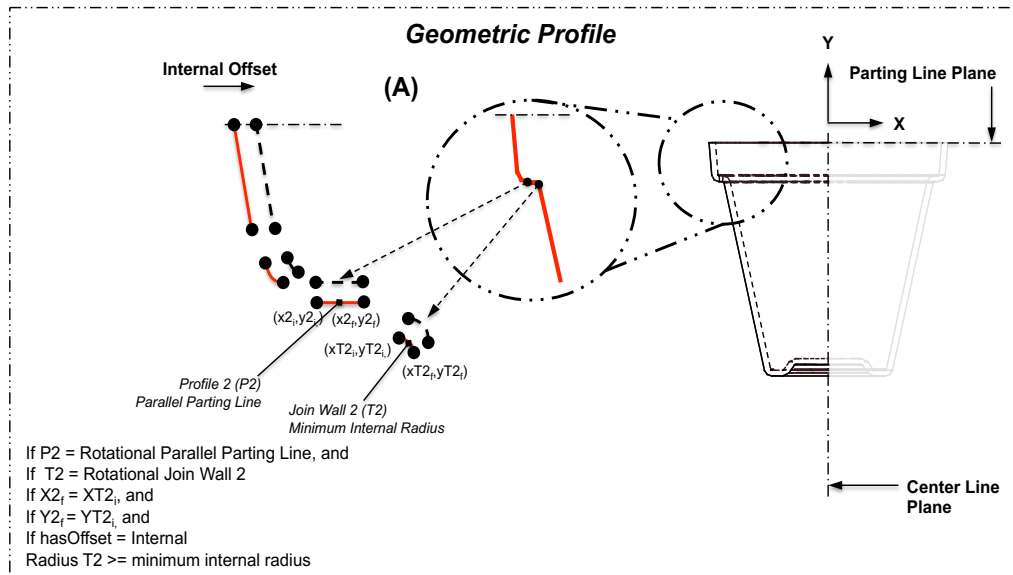

Semantic Rule			Semantic Rule			
SWRL Language: $Rot_Join_Wall(?p) \wedge hasRadius(?p, ?r) \wedge hasDimensionX(?p, ?xti) \wedge hasDimensionY(?p, ?yti) \wedge Rot_Wall_Par_Part_Line(?q) \wedge hasDimensionX(?q, ?xf) \wedge hasDimensionY(?q, ?yf) \wedge swrb:equal(?xf, ?xti) \wedge swrb:equal(?yf, ?yti) \wedge Offset_Features(?i) \wedge hasOffset(?i, ?off_dir) \wedge swrb:equal(?off_dir, "Internal") \wedge hasValue(Radius_int_min, ?d) \wedge swrb:greaterThanOrEqual(?r, ?d) \rightarrow hasConversion(?p, Radius_int_min)$			SWRL Language: $Rot_Join_Wall(?p) \wedge hasRadius(?p, ?r) \wedge hasDimensionX(?p, ?xti) \wedge hasDimensionY(?p, ?yti) \wedge Rot_Wall_Par_Part_Line(?q) \wedge hasDimensionX(?q, ?xf) \wedge hasDimensionY(?q, ?yf) \wedge swrb:equal(?xf, ?xti) \wedge swrb:equal(?yf, ?yti) \wedge Offset_Features(?i) \wedge hasOffset(?i, ?off_dir) \wedge swrb:equal(?off_dir, "Internal") \wedge hasValue(Radius_int_min, ?d) \wedge swrb:lessThan(?r, ?d) \rightarrow hasInconsistency(?p, Radius_int_min)$			
Instance "?p" from the Rotational Joint Wall [Rot_Join_Wall]			Instance "?p" from the Rotational Joint Wall [Rot_Join_Wall]			
Product Transition Profile	"XTinitial" – [hasDimensionX(?p, ?xti)]		Product Transition Profile	"XTinitial" – [hasDimensionX(?p, ?xti)]		
	"YTinitial" – [hasDimensionY(?p, ?yti)]			"YTinitial" – [hasDimensionY(?p, ?yti)]		
	"Radius" – [hasRadius(?p, ?r)]			"Radius" – [hasRadius(?p, ?r)]		
Instance "?q" from the Rotational Parallel Features [Rot_Wall_Par_Part_Line]			Instance "?q" from the Rotational Perpendicular Features [Rot_Wall_Perp_Part_Line]			
Product Geometric Profile	"Xfinal" – [hasDimensionX(?q, ?xf)]		Product Geometric Profile	"Xfinal" – [hasDimensionX(?q, ?xf)]		
	"Yfinal" – [hasDimensionY(?q, ?yf)]			"Yfinal" – [hasDimensionY(?q, ?yf)]		
Instance "?i" from the Offset Features [Offset_Features]			Instance "?i" from the Offset Features [Offset_Features]			
Offset Features	"Offset_direction" – [hasOffset(?i, ?off_dir)]		Offset Features	"Offset_direction" – [hasOffset(?i, ?off_dir)]		
Instance Min Int Radius – [Radius_int_min]			Instance Min Int Radius – [Radius_int_min]			
Fillet Features	"Min_int_Radius_Value" – [hasValue(Radius_int_min, ?d)]		Fillet Features	"Min_Int_Radius_Value" – [hasValue(Radius_int_min, ?d)]		
Instances "?p" and "Min_Int_Radius" will have relationship if and only if			Instances "?p" and "Min_Int_Radius" will have relationship if and only if			
Logical Conditions	(a)	"Xfinal" is equal to "XTinitial"	True	(a)	"Xfinal" is equal to "XTinitial"	True
	(b)	"Yfinal" is equal to "YTinitial"	True	(b)	"Yfinal" is equal to "YTinitial"	True
	(c)	"Offset_direction" is equal to "Internal"	True	(c)	"Offset_direction" is equal to "Internal"	True
	(d)	"Radius" is greater than or equal to "Min_Int_Radius_Value"	True	(d)	"Radius" is lesser to "Min_Int_Radius_Value"	True
Therefore, Instance "?p" is converted to the information from the instance "Min_Int_Radius" [hasConversion(?p, Radius_int_min)]			Therefore, Instance "?p" has inconsistency with the information from the instance "Min_Int_Radius" [hasInconsistency(?p, Radius_int_min)]			

The semantic rules presented in Figure 77 and Figure 78 are focused on the offset of the internal direction. The semantic rules for the offset in external direction follow the same idea of the internal one. They were implemented in the Interoperable Product Design and Manufacturing System that will be evaluated in Chapter 7.

(iii) *Offset and Rotational Primary Features*

The third relation creates the semantic mapping between the Primary features and the Offset of the product. The offset is related to the thickness of the Rotational wall of the plastic injected product. The relation between the primary features and the primary feature of the offset follows mathematic equations based on a geometric plane, found in the literature. These equations change according to the direction of the offset (Internal or External) and the profile direction (vertical = perpendicular to the Parting line profile or horizontal = parallel to the parting line profile). The equations 6.4 and 6.5 show the formula of the “ X_{offset} ” and “ Y_{offset} ” to the “internal” direction of the offset and perpendicular to the Parting Line profile. The equations 6.6 and 6.7 demonstrate the formula of the “ X_{offset} ” and “ Y_{offset} ” to the “internal” direction of the offset and parallel to the Parting Line profile.

$$X_{offset(perp/int)} = X - offset * \cos(\theta) \quad (6.4)$$

$$Y_{offset(perp/int)} = Y - offset * \sin(\theta) \quad (6.5)$$

$$X_{offset(parallel/int)} = X - offset * \sin(\theta) \quad (6.6)$$

$$Y_{offset(parallel/int)} = Y - offset * \cos(\theta) \quad (6.7)$$

Where: “ X ” and “ Y ” mean the coordinates of the Primary features and “ θ ” means the angle between the Primary feature and the centre line of the product.

The equations 6.8 and 6.9 present the formula of the “ X_{offset} ” and “ Y_{offset} ” to the “external” direction of the offset and perpendicular to the Parting Line profile. The equations 6.10 and 6.11 show the formula of the “ X_{offset} ” and “ Y_{offset} ” to the “external” direction of the offset and parallel to the Parting Line profile.

$$X_{offset(perp/ext)} = X + offset * \cos(\theta) \quad (6.8)$$

$$Y_{offset(perp/ext)} = Y + offset * \sin(\theta) \quad (6.9)$$

$$X_{offset(parallel/ext)} = X + offset * \sin(\theta) \quad (6.10)$$

$$Y_{offset(parallel/ext)} = Y + offset * \cos(\theta) \quad (6.11)$$

Where: “ X ” and “ Y ” mean the coordinates of the Primary features and “ θ ” means the angle between the primary feature and the centre line of the product.

According to these equations, Figure 79 illustrates the geometric profile and the semantic rule applied to the semantic mapping of the offset for the internal direction.

Figure 79 Semantic rule for the relationships between Primary features and Primary features with offset for the internal direction.

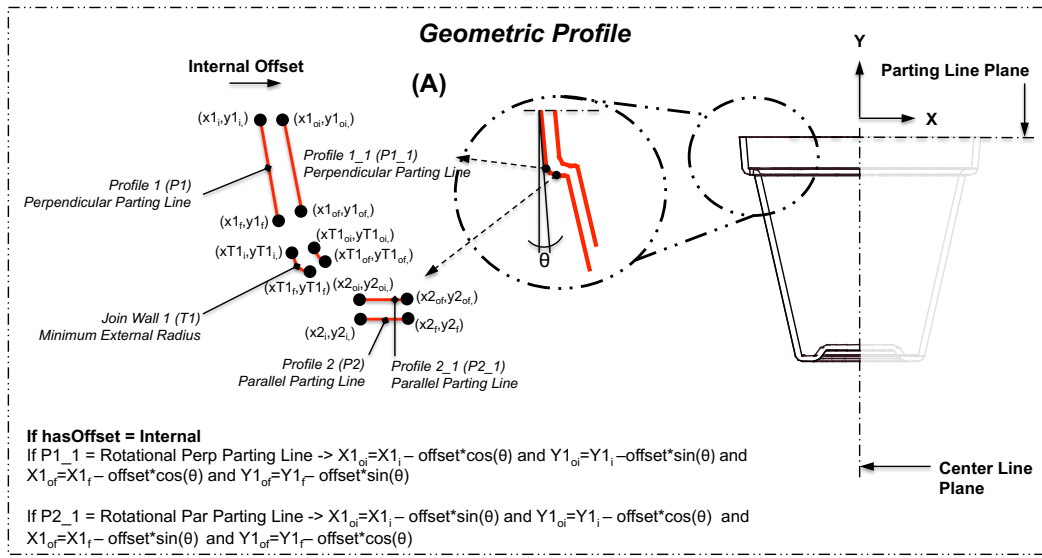

Semantic Rule			Semantic Rule			
SWRL Language: $Rot_Wall_Perp_Part_Line(?p) \wedge hasOffsetX(?p, ?off_value_a) \wedge hasDimensionX(?p, ?xio) \wedge hasDimensionY(?p, ?yio) \wedge hasDimensionX(?p, ?xfo) \wedge hasDimensionY(?p, ?yfo) \wedge swrlb:equal(?off_value_a, "offset*cos(a)") \wedge Rot_Wall_Par_Part_Line(?q) \wedge hasOffsetX(?q, ?off_value_b) \wedge hasDimensionX(?q, ?xi) \wedge hasDimensionY(?q, ?yi) \wedge hasDimensionX(?q, ?xf) \wedge hasDimensionY(?q, ?yf) \wedge swrlb:equal(?xi, ?xio) \wedge swrlb:equal(?yi, ?yio) \wedge swrlb:equal(?xf, ?xfo) \wedge swrlb:equal(?yf, ?yfo) \wedge swrlb:equal(?off_value_b, "?") \rightarrow hasConversion(?p, ?q)$			SWRL Language: $Rot_Wall_Par_Part_Line(?p) \wedge hasOffsetY(?p, ?off_value_a) \wedge hasDimensionX(?p, ?xio) \wedge hasDimensionY(?p, ?yio) \wedge hasDimensionX(?p, ?xfo) \wedge hasDimensionY(?p, ?yfo) \wedge swrlb:equal(?off_value_a, "offset*sin(a)") \wedge Rot_Wall_Perp_Part_Line(?q) \wedge hasOffsetY(?q, ?off_value_b) \wedge hasDimensionX(?q, ?xi) \wedge hasDimensionY(?q, ?yi) \wedge hasDimensionX(?q, ?xf) \wedge hasDimensionY(?q, ?yf) \wedge swrlb:equal(?xi, ?xio) \wedge swrlb:equal(?yi, ?yio) \wedge swrlb:equal(?xf, ?xfo) \wedge swrlb:equal(?yf, ?yfo) \wedge swrlb:equal(?b, "?") \rightarrow hasConversion(?p, ?q)$			
Instance "?p" from the Rotational Wall Perpendicular Features [Rot_Wall_Perp_Part_Line] has			Instance "?p" from the Rotational Wall Parallel Features [Rot_Wall_Parallel_Part_Line] has			
Product Geometric Profile with offset	"Xwithout_off_initial" – [hasDimensionX(?p, ?xio)]	"Xwithout_off_initial" – [hasDimensionX(?p, ?xio)]	"Xwithout_off_initial" – [hasDimensionX(?p, ?xio)]	"Xwithout_off_initial" – [hasDimensionX(?p, ?xio)]	"Xwithout_off_initial" – [hasDimensionX(?p, ?xio)]	
	"Ywithout_off_initial" – [hasDimensionY(?p, ?yio)]	"Ywithout_off_initial" – [hasDimensionY(?p, ?yio)]	"Ywithout_off_initial" – [hasDimensionY(?p, ?yio)]	"Ywithout_off_initial" – [hasDimensionY(?p, ?yio)]	"Ywithout_off_initial" – [hasDimensionY(?p, ?yio)]	
Product Geometric Profile	"Xwithout_off_final" – [hasDimensionX(?p, ?xfo)]	"Xwithout_off_final" – [hasDimensionX(?p, ?xfo)]	"Xwithout_off_final" – [hasDimensionX(?p, ?xfo)]	"Xwithout_off_final" – [hasDimensionX(?p, ?xfo)]	"Xwithout_off_final" – [hasDimensionX(?p, ?xfo)]	
	"Ywithout_off_final" – [hasDimensionY(?p, ?yfo)]	"Ywithout_off_final" – [hasDimensionY(?p, ?yfo)]	"Ywithout_off_final" – [hasDimensionY(?p, ?yfo)]	"Ywithout_off_final" – [hasDimensionY(?p, ?yfo)]	"Ywithout_off_final" – [hasDimensionY(?p, ?yfo)]	
Instance "?q" from the Rotational Wall Perpendicular Features [Rot_Wall_Perp_Part_Line] has			Instance "?q" from the Rotational Wall Parallel Features [Rot_Wall_Parallel_Part_Line] has			
Product Geometric Profile	"Xinitial" – [hasDimensionX(?q, ?xio)]	"Xinitial" – [hasDimensionX(?q, ?xio)]	"Xinitial" – [hasDimensionX(?q, ?xio)]	"Xinitial" – [hasDimensionX(?q, ?xio)]	"Xinitial" – [hasDimensionX(?q, ?xio)]	
	"Yinitial" – [hasDimensionY(?q, ?yio)]	"Yinitial" – [hasDimensionY(?q, ?yio)]	"Yinitial" – [hasDimensionY(?q, ?yio)]	"Yinitial" – [hasDimensionY(?q, ?yio)]	"Yinitial" – [hasDimensionY(?q, ?yio)]	
Product Geometric Profile	"Xfinal" – [hasDimensionX(?q, ?xf)]	"Xfinal" – [hasDimensionX(?q, ?xf)]	"Xfinal" – [hasDimensionX(?q, ?xf)]	"Xfinal" – [hasDimensionX(?q, ?xf)]	"Xfinal" – [hasDimensionX(?q, ?xf)]	
	"Yfinal" – [hasDimensionY(?q, ?yf)]	"Yfinal" – [hasDimensionY(?q, ?yf)]	"Yfinal" – [hasDimensionY(?q, ?yf)]	"Yfinal" – [hasDimensionY(?q, ?yf)]	"Yfinal" – [hasDimensionY(?q, ?yf)]	
"Offset_value_a" – [hasOffsetX(?p, ?off_value_a)]			"Offset_value_a" – [hasOffsetY(?p, ?off_value_a)]			
"Offset_value_b" – [hasOffsetX(?q, ?off_value_b)]			"Offset_value_b" – [hasOffsetY(?q, ?off_value_b)]			
Instances "?p" and "?q" will have relationship if and only if			Instances "?p" and "?q" will have relationship if and only if			
Logical Conditions	(a)	"Xwithout_off_initial" is equal to "Xinitial"	True	(a)	"Xwithout_off_initial" is equal to "Xinitial"	True
	(b)	"Ywithout_off_initial" is equal to "Yinitial"	True	(b)	"Ywithout_off_initial" is equal to "Yinitial"	True
	(c)	"Xwithout_off_final" is equal to "Xfinal"	True	(c)	"Xwithout_off_final" is equal to "Xfinal"	True
	(d)	"Ywithout_off_final" is equal to "Yfinal"	True	(d)	"Ywithout_off_final" is equal to "Yfinal"	True
	(e)	"Offset_value_a" is equal to "offset*cos(a)"	True	(e)	"Offset_value_a" is equal to "offset*sin(a)"	True
	(f)	"Offset_value_b" is equal to ""	True	(f)	"Offset_value_b" is equal to ""	True
Therefore, Instance "?p" is converted to the information from the instance "?q" [hasConversion(?p, ?q)]			Therefore, Instance "?p" is converted to the information from the instance "?q" [hasConversion(?p, ?q)]			

Additionally, according to the equations, it is possible to relate the information of the transition features as shown in Figure 80 and it creates the semantic rule applied to the semantic mapping of the transition offset for the internal direction.

Figure 80 Semantic rule for the relationships between Transition features and Transition features with offset for the internal direction.

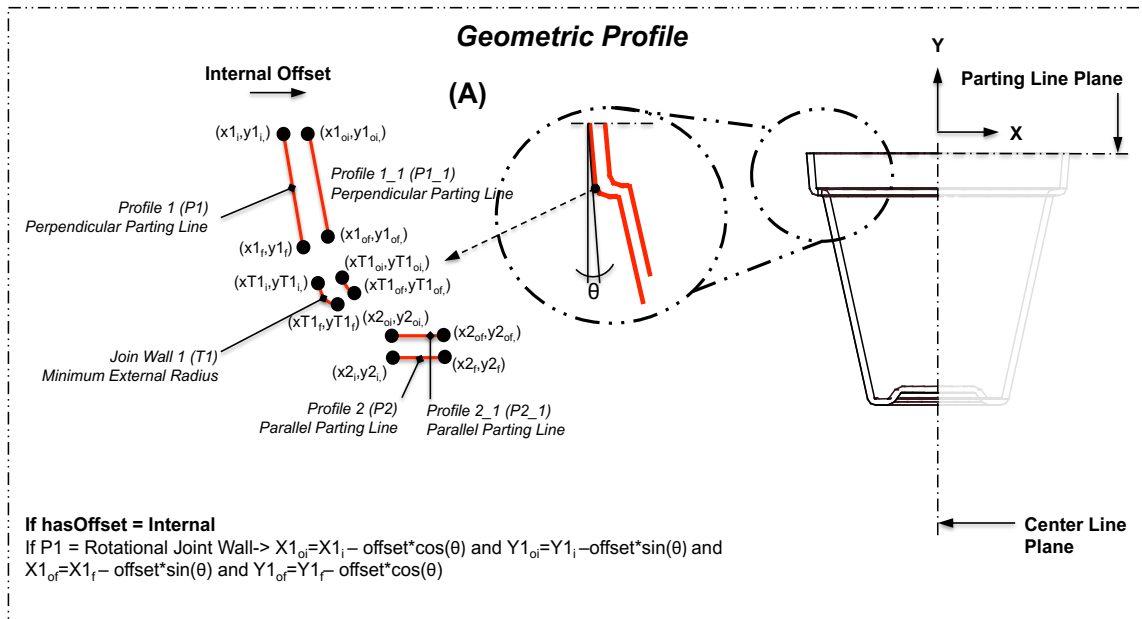

Semantic Rule		
SWRL Language: $Rot_Join_Wall(?p) \wedge hasOffsetX(?p, ?off_value_xo) \wedge hasOffsetY(?p, ?off_value_yo) \wedge hasDimensionX(?p, ?xtio) \wedge hasDimensionY(?p, ?ytio) \wedge hasDimensionX(?p, ?xtfo) \wedge hasDimensionY(?p, ?yfto) \wedge swrb:equal(?off_value_xo, "offset*cos(a)") \wedge swrb:equal(?off_value_yo, "offset*sin(a)") \wedge Rot_Join_Wall(?q) \wedge hasOffsetX(?p, ?off_value_x) \wedge hasOffsetY(?p, ?off_value_y) \wedge hasDimensionX(?q, ?xti) \wedge hasDimensionY(?q, ?yti) \wedge hasDimensionX(?q, ?xtf) \wedge hasDimensionY(?q, ?ytf) \wedge swrb:equal(?xti, ?xtfo) \wedge swrb:equal(?yti, ?yfto) \wedge swrb:equal(?xti, ?xtfo) \wedge swrb:equal(?yti, ?yfto) \wedge swrb:equal(?xtf, ?yfto) \wedge swrb:equal(?ytf, ?xtfo) \wedge swrb:equal(?off_value_x, "?") \wedge swrb:equal(?off_value_y, "?") \rightarrow hasConversion(?p, ?q)$		
Instance " p " from the Rotational Joint Wall [Rot_Join_Wall]		
Product Transition Profile with offset	has	"XTwithout_off_initial" – [hasDimensionX(?p, ?xtio)] "YTwithout_off_initial" – [hasDimensionY(?p, ?yti)] "XTwithout_off_final" – [hasDimensionX(?p, ?xtfo)] "YTwithout_off_final" – [hasDimensionY(?p, ?yfto)] "Offset_value_xo" – [hasOffsetX(?p, ?off_value_xo)] "Offset_value_yo" – [hasOffsetY(?p, ?off_value_yo)]
	has	Instance " q " from the Rotational Joint Wall [Rot_Join_Wall]
Product Transition Profile	has	"XTinitial" – [hasDimensionX(?q, ?xti)] "YTinitial" – [hasDimensionY(?q, ?yti)] "XTfinal" – [hasDimensionX(?q, ?xtf)] "YTfinal" – [hasDimensionY(?q, ?ytf)] "Offset_value_x" – [hasOffsetX(?q, ?off_value_x)] "Offset_value_y" – [hasOffsetY(?q, ?off_value_y)]
	Instances " p " and " q " will have relationship if and only if	
Logical Conditions	(a)	"XTwithout_off_initial" is equal to "XTinitial" True
	(b)	"YTwithout_off_initial" is equal to "YTinitial" True
	(c)	"XTwithout_off_final" is equal to "XTfinal" True
	(d)	"YTwithout_off_final" is equal to "YTfinal" True
	(e)	"Offset_value_xo" is equal to "offset*cos(a)" True
	(f)	"Offset_value_yo" is equal to "offset*sin(a)" True
	(g)	"Offset_value_x" is equal to "" True
	(h)	"Offset_value_y" is equal to "" True
Therefore, Instance " p " is converted to the information from the instance " q " [hasConversion (?p, ?q)]		

The semantic rules presented in Figure 79 and Figure 80 are focused on the offset in the internal direction. The semantic rules for the offset in the external

direction follow the same idea of the internal one. They were implemented in the Interoperable Product Design and Manufacturing System that will be evaluated in chapter 6.

6.4.1.1.5 Semantic mapping between Primary features and Parting line

The Parting line is fundamental to the plastic injected products because it determines the design of the cavity insert and core insert. The section 4.1.2.2 presented the information data structure that concerns the different types of Parting line. There are four alternatives for determining the Parting line location, but this research focused on the Parting line plane, as illustrate in Figure 81.

Figure 81 Selected Parting Line alternative (Plane) explored in the research.

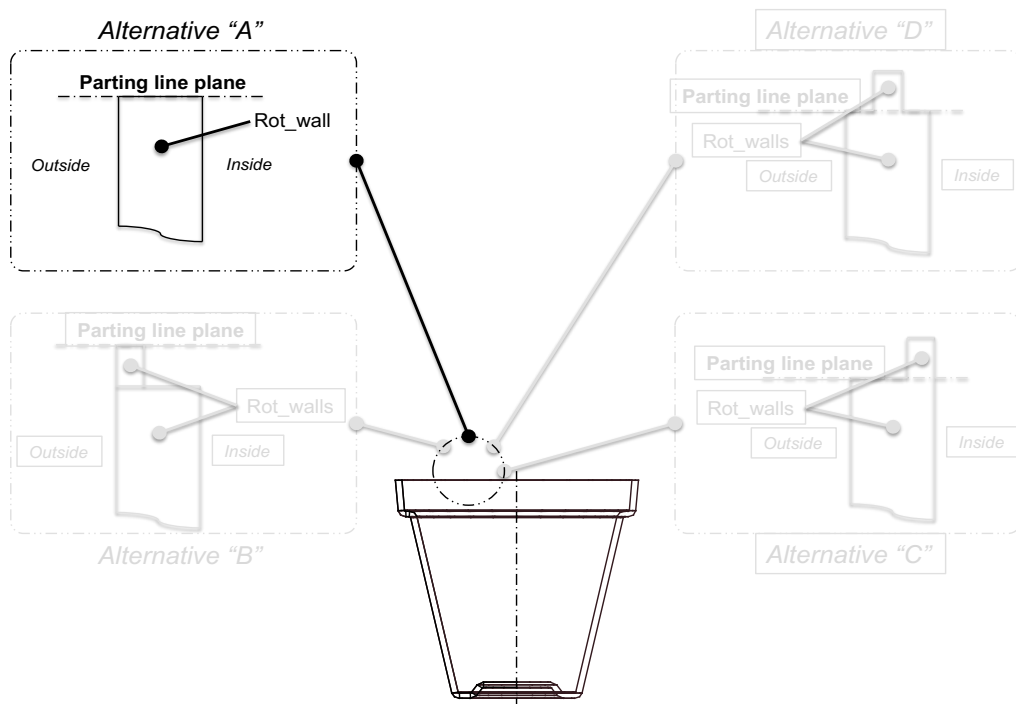

Source: Canciglieri Junior and Young, 2010.

The semantic rules mapped the Primary features that have direct interactions with the Parting Line. The Parting Line is extremely important for the mapping between contexts in order to limit the core insert profile and the cavity insert profile. Figure 82 depicts the geometric profile and semantic rule.

Figure 82 Semantic rule for the relationships between Primary features and Primary features with offset for the internal direction.

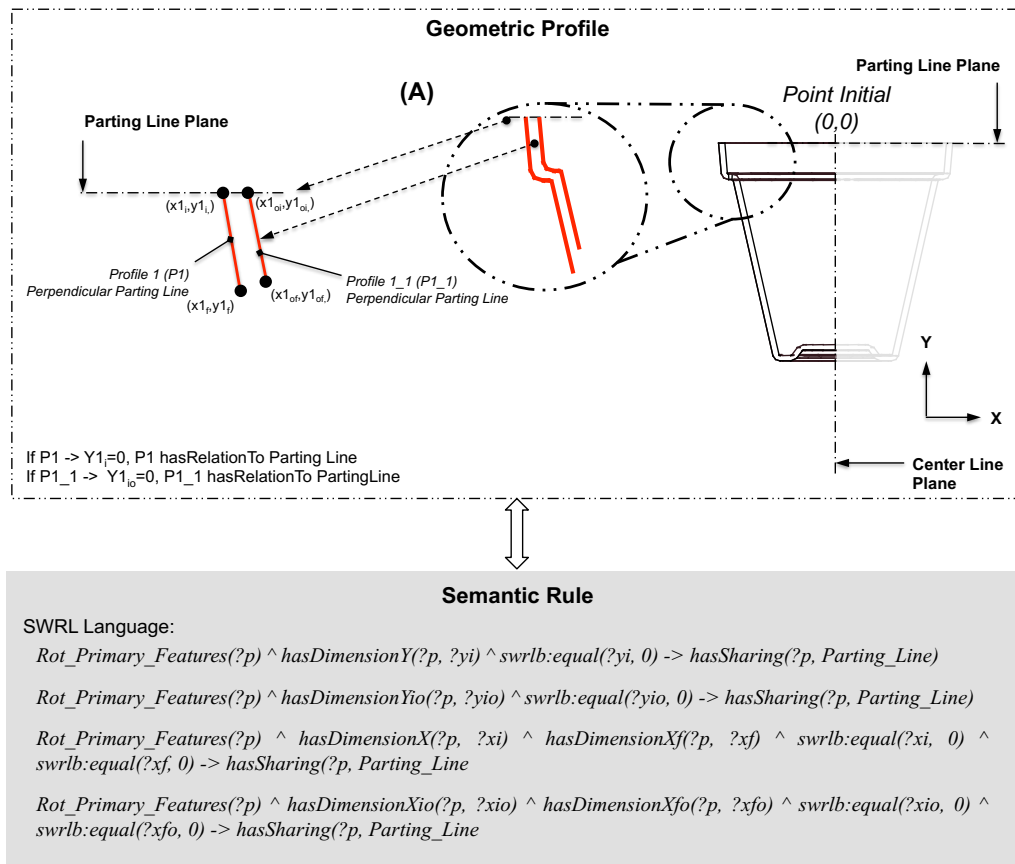

The formal remarks that support the definition of the semantic mapping to partially reconcile Primary features and Primary features with offset for the internal direction presented in Figure 82, state:

- If the instance “?p” from the “Rotational primary features” has “Y_{initial}” coordinate $[hasDimensionY(?p, ?yi)]$ is equal to “0”, the instance “?p” has “sharing information” with the Parting Line $[hasSharing(?p, Parting_Line)]$.
- If the instance “?p” from the “Rotational primary features” has “Y_{offset initial}” coordinate $[hasDimensionYio(?p, ?yio)]$ is equal to “0”, the instance “?p” has “sharing information” with Parting Line $[hasSharing(?p, Parting_Line)]$.
- If the instance “?p” from the “Rotational Primary Features” has:

- a) “Xinitial” coordinate $[hasDimensionX(?p, ?xi)]$ is equal to “0”;
 - b) “Xfinal” coordinate $[hasDimensionXf(?p, ?xf)]$ equal to “0”,
the instance “?p” has “sharing information” with the Parting Line $[hasRelation(?p, Parting_Line)]$.
- If the instance “?p” from the “Rotational Primary Features” has:
 - a) “X” offset initial coordinate $[hasDimensionXio(?p, ?xio)]$ equal to “0”;
 - b) “X” offset final coordinate $[hasDimensionXfo(?p, ?xfo)]$ equal to “0”,
the instance “?p” has “sharing information” with the Parting Line $[hasRelation(?p, Parting_Line)]$.

6.4.1.2 Foundation semantic for the semantic mapping in Design for Tooling

This section discusses the different aspects relating to the mapping in the Design for Tooling based on the specialised core ontologies from Mould Design Core Ontology. It is structured in semantic mapping between (i) Cavity insert straight line and Cavity insert parallel, perpendicular and taper straight line; (ii) Cavity insert external straight line and Cavity insert external parallel, perpendicular and taper straight line; (iii) Core insert straight line and core insert parallel, perpendicular and taper straight line; (iv) Core insert external straight line and Core insert external parallel, perpendicular and taper straight line; and finally (v) Core insert material and Cavity insert material.

6.4.1.2.1 Semantic mapping between Cavity insert straight line and Cavity insert parallel, perpendicular and taper straight line

This semantic mapping associates the instances of the Cavity insert straight line (from the design for mouldability) with the type of alignment (parallel, perpendicular or taper) in relation to the Parting line. Figure 83 illustrates the geometric profile and semantic rules for the relations between Cavity insert straight line and Cavity insert parallel, perpendicular and taper straight line.

Figure 83 Semantic rule for the relationships between Cavity insert straight line and Cavity insert perpendicular, parallel and taper straight line.

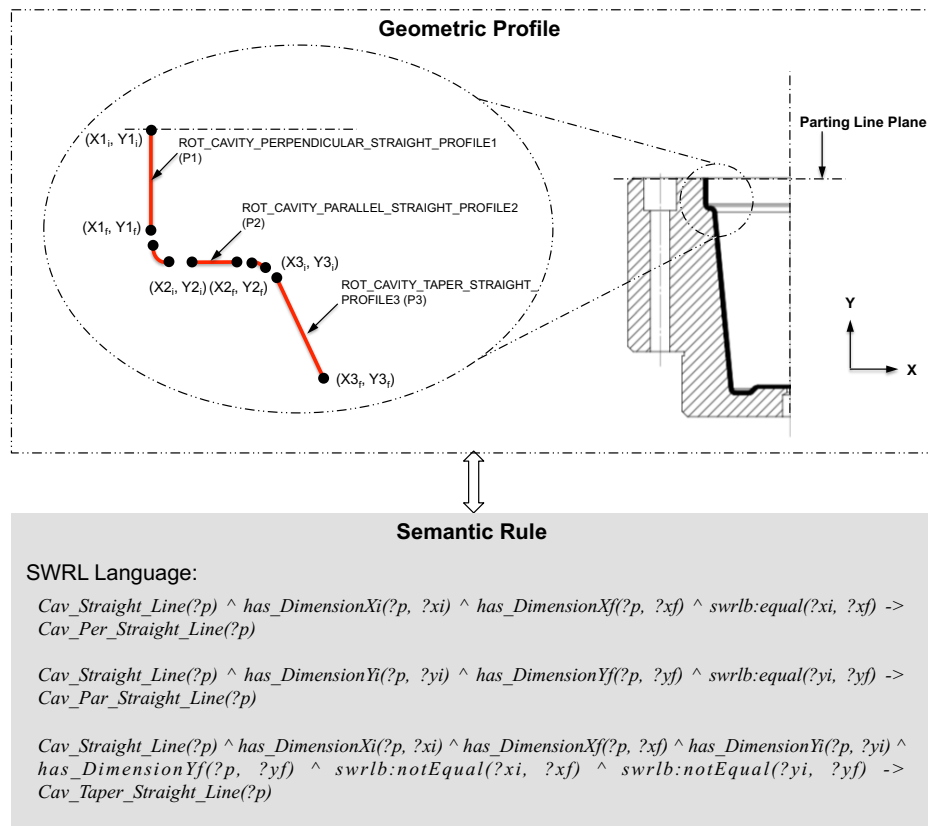

The semantic rules that support the definition of the semantic mapping to partially reconcile Cavity insert straight line and Cavity insert parallel, perpendicular and taper straight line presented in Figure 83, state:

- The instance “?p” from the “Cavity insert straight line” is mapped as Cavity perpendicular straight line if and only if the instance “?p” with “Xinitial” coordinate $[hasDimensionX(?p, ?xi)]$ is equal to the “Xfinal” coordinate $[hasDimensionXf(?p, ?xf)]$.
- The instance “?p” from the “Cavity insert straight line” is mapped as Cavity parallel straight line if and only if the instance “?p” with “Yinitial” coordinate $[hasDimensionY(?p, ?yi)]$ is equal to the “Yfinal” coordinate $[hasDimensionYf(?p, ?yf)]$.
- The instance “?p” from the “Cavity insert straight line” is mapped as Cavity taper straight line if and only if the instance “?p”:

- a) with “Xinitial” coordinate $[hasDimensionX(?p, ?xi)]$ is not equal to the “Xfinal” coordinate $[hasDimensionXf(?p, ?xf)]$;
- b) “Yinitial” coordinate $[hasDimensionY(?p, ?yi)]$ is not equal to the “Yfinal” coordinate $[hasDimensionYf(?p, ?yf)]$.

6.4.1.2.2 Semantic mapping between External cavity insert straight line and External cavity insert parallel, perpendicular and taper straight line

This semantic mapping associates the instances of the External profile of the Cavity insert straight line with the type of alignment (parallel, perpendicular or taper) in relation to the Parting line. Figure 84 illustrates the geometric profile and semantic rules for the relations between External cavity insert straight line and External cavity insert parallel, perpendicular and taper straight line

Figure 84 Semantic rule for the relationships between the External profile of the Cavity insert straight line with perpendicular, parallel and taper straight line.

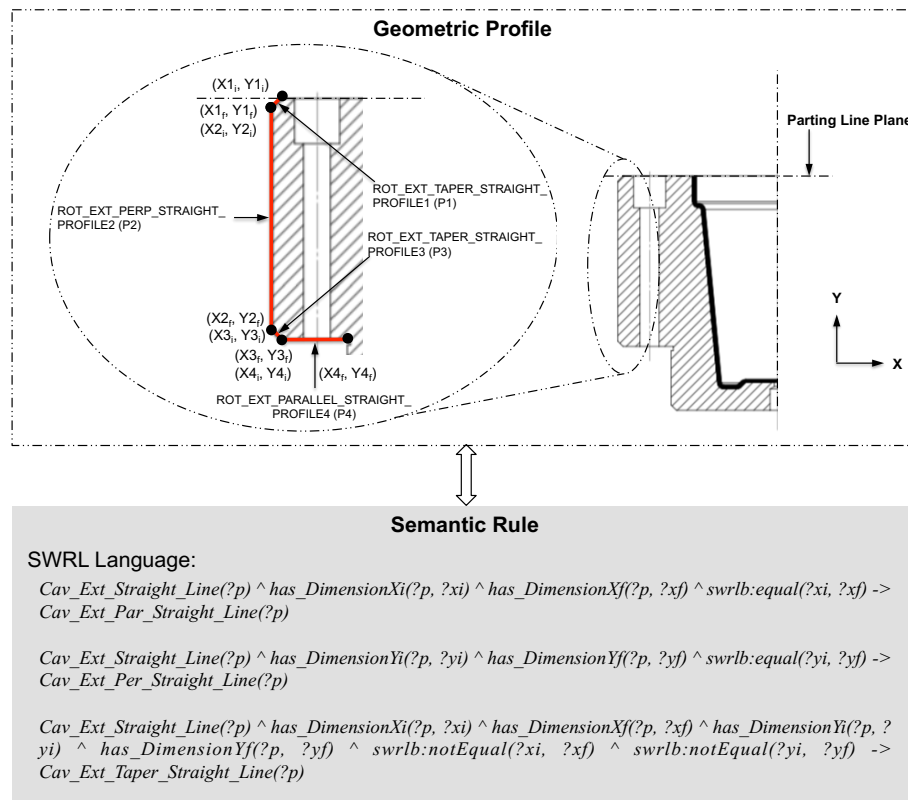

The formal remarks that support the definition of the semantic mapping to partly reconcile the External cavity insert straight line and External cavity insert parallel, perpendicular and taper straight line presented in Figure 84, state:

- The instance “?p” from the “External cavity insert straight line” is mapped as external Cavity perpendicular straight line if and only if the instance “?p” with “Xinitial” coordinate $[hasDimensionX(?p, ?xi)]$ is equal to the “Xfinal” coordinate $[hasDimensionXf(?p, ?xf)]$.
- The instance “?p” from the “External cavity insert straight line” is mapped as Cavity parallel straight line if and only if the instance “?p” with “Yinitial” coordinate $[hasDimensionY(?p, ?yi)]$ is equal to the “Yfinal” coordinate $[hasDimensionYf(?p, ?yf)]$.
- The instance “?p” from the “External cavity insert straight line” is mapped as External cavity taper straight line if and only if the instance “?P”:
 - a) with “Xinitial” coordinate $[hasDimensionX(?p, ?xi)]$ is not equal to the “Xfinal” coordinate $[hasDimensionXf(?p, ?xf)]$;
 - b) “Yinitial” coordinate $[hasDimensionY(?p, ?yi)]$ is not equal to the “Yfinal” coordinate $[hasDimensionYf(?p, ?yf)]$.

6.4.1.2.3 Semantic mapping between Core insert straight line and Core insert parallel, perpendicular and taper straight line

This semantic mapping associates the instances of the Core insert straight line (from the design for mouldability) with the type of alignment (parallel, perpendicular or taper) in relation to the parting line. Figure 85 illustrates the geometric profile and semantic rules for the relationships between Core insert straight line and Core insert parallel, perpendicular and taper straight line.

Figure 85 Semantic rule for the relationships between Core insert straight line with perpendicular, parallel and taper straight line.

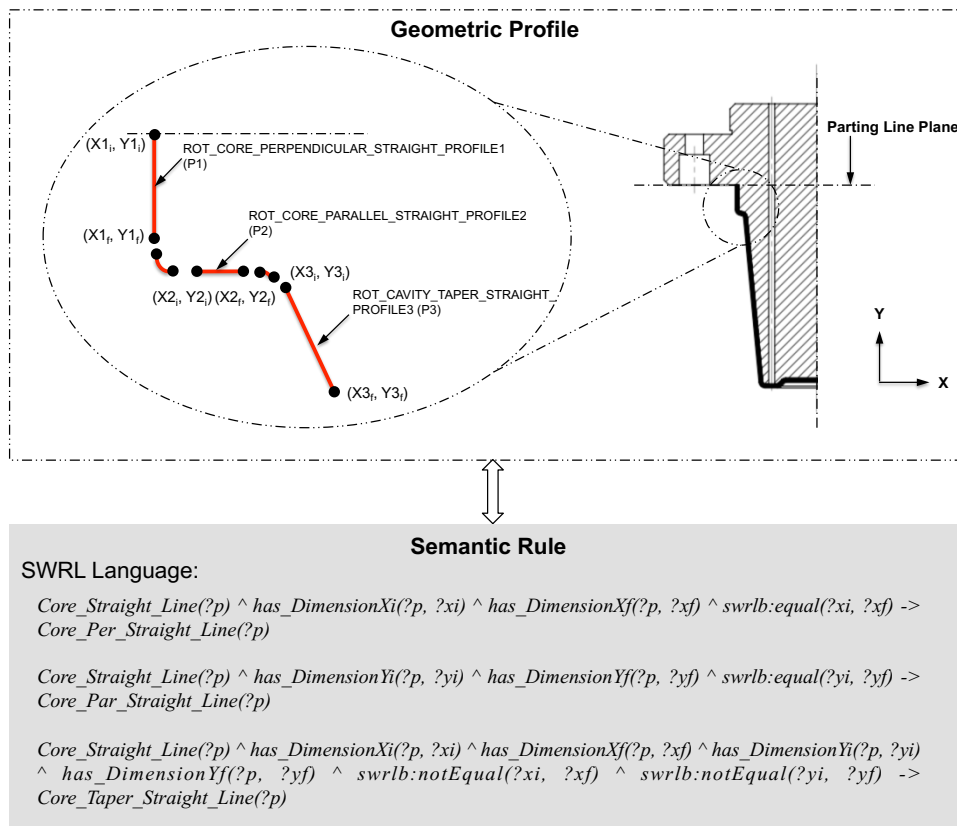

The formal remarks that support the definition of the semantic mapping to partly reconcile Core insert straight line and Core insert parallel, perpendicular and taper straight line presented in Figure 85, state:

- The instance “?p” from the “Core insert straight line” is mapped as Core insert perpendicular straight line if and only if the instance “?p” with “Xinitial” coordinate $[hasDimensionX(?p, ?xi)]$ is equal to the “Xfinal” coordinate $[hasDimensionXf(?p, ?xf)]$.
- The instance “?p” from the “Core insert straight line” is mapped as Core insert parallel straight line if and only if the instance “?p” with “Yinitial” coordinate $[hasDimensionY(?p, ?yi)]$ is equal to the “Yfinal” coordinate $[hasDimensionYf(?p, ?yf)]$.
- The instance “?p” from the “Core insert straight line” is mapped as Core insert taper straight line if and only if the instance “?p” with:

- a) “Xinitial” coordinate $[hasDimensionX(?p, ?xi)]$ is not equal to the “Xfinal” coordinate $[hasDimensionXf(?p, ?xf)]$;
- b) “Yinitial” coordinate $[hasDimensionY(?p, ?yi)]$ is not equal to “Yfinal” coordinate $[hasDimensionYf(?p, ?yf)]$.

6.4.1.2.4 Semantic mapping between External core insert straight line and External core insert parallel, perpendicular and taper straight line

This semantic mapping associates the instances of the External core insert straight line with the type of alignment (parallel, perpendicular or taper) in relation of the Parting Line Plane. Figure 86 illustrates the geometric profile and semantic rule for the relationships between the External core insert straight line and External core insert parallel, perpendicular and taper straight line.

Figure 86 Semantic rule for the relationships between External core insert straight line with perpendicular, parallel and taper straight line.

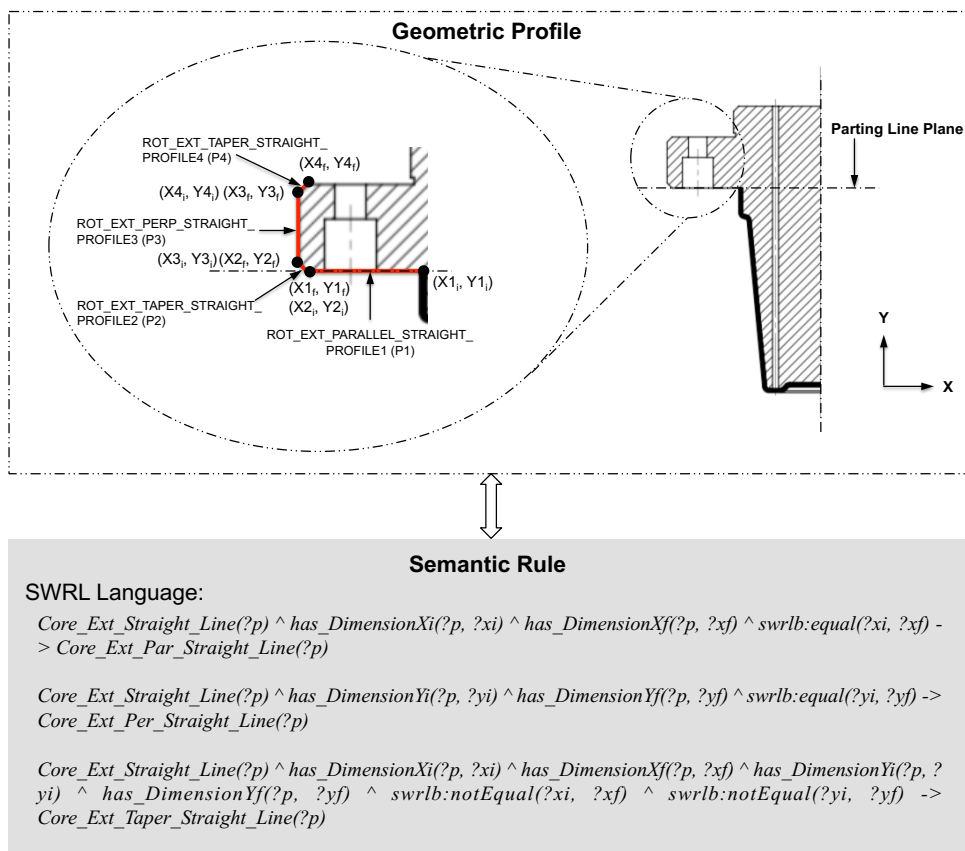

The formal remarks that support the definition of the semantic mapping to partly reconcile External core insert straight line and External core insert parallel, perpendicular and taper straight line presented in Figure 86, state:

- The instance “?p” from the “External core insert straight line” is mapped as External core insert perpendicular straight line if and only if the instance “?p” with “Xinitial” coordinate $[hasDimensionX(?p, ?xi)]$ is equal to the “Xfinal” coordinate $[hasDimensionXf(?p, ?xf)]$.
- The instance “?p” from the “External core insert straight line” is mapped as External core insert parallel straight line if and only if the instance “?p” with “Yinitial” coordinate $[hasDimensionY(?p, ?yi)]$ is equal to the “Yfinal” coordinate $[hasDimensionYf(?p, ?yf)]$.
- The instance “?p” from the “External core insert straight line” is mapped as External core insert taper straight line if and only if :
 - (a) the instance “?p” with “Xinitial” coordinate $[hasDimensionX(?p, ?xi)]$ is not equal to the “Xfinal” coordinate $[hasDimensionXf(?p, ?xf)]$;
 - (b) “Yinitial” coordinate $[hasDimensionY(?p, ?yi)]$ is not equal to the “Yfinal” coordinate $[hasDimensionYf(?p, ?yf)]$.

6.4.1.2.5 Semantic mapping between Core insert material and Cavity insert material

The Rotational core insert main body and the Rotational cavity insert main body must be defined with the same material in order to avoid any modifications of the dimensions due to the variations of the material properties. Material properties may change according to the environmental temperature or operational temperature. In this context, the relation of equivalence is established between the materials of Core insert main body and Cavity insert main body, as shown in Figure 87.

Figure 87 Equivalence relation between Core insert main body material and Cavity insert main body material

$$(Core_Insert_Material) \equiv (Cavity_Insert_Material)$$

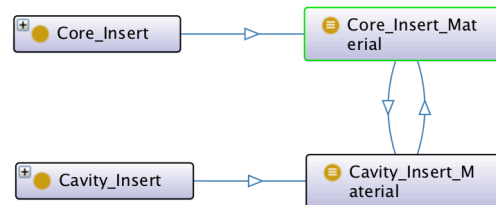

6.4.1.3 Foundation semantic for the semantic mapping in Design for Manufacturing

This section explores the semantic mapping in the design for manufacturing that was created by the Manufacturing core ontology and Machining features core ontology. The design for manufacturing is responsible for planning the whole mould fabrication process in order to identify the machining process.

Specifically, this research has been focused on the Rotational plastic injected products that are manufactured by Rotational mould injection. Different machining processes (turning, milling, boring, etc.) can be used to manufacture the Rotational mould. According to Degen *et al.*, (2014), the turning and boring are the main machining processes employed to manufacture the external and internal profiles of the rotational parts respectively. Thus, these processes are adopted in this research to manufacturing the Cavity insert, Cavity insert main body, Core insert and Core insert main body. Others manufacturing processes would be used in this research, however, the research scope is the semantic information interoperability in the product design and manufacturing and not in the identification of the suitable manufacturing process for the product, which were correctly defined by Canciglieri Junior (1999), Canciglieri Junior and Young (2003) and Canciglieri Junior and Young (2010). The drilling machining process is used for manufacturing the fixing, gate and ejection holes.

In this context, the Mould manufacturing core ontology, proposed in the section 4.3.3, was adapted including specific sub-classes concerning the turning and boring features in the Rotational cavity insert manufacturing and Rotational core insert manufacturing. The Rotational core insert manufacturing can have four different profiles for the turning machining: (i) Rotational core horizontal turning

(*Rot_Core_Horizontal_Turning*); (ii) Rotational core taper turning (*Rot_Core_Taper_Turning*); (iii) Rotational core facing turning (*Rot_Core_Facing_Turning*); and (iv) Rotational core curve turning (*Rot_Core_Curve_Turning*). The same happens to the Rotational core insert main body manufacturing and Rotational cavity insert main body. The machining process is different for the Rotational cavity insert manufacturing since negative impression system needs to be manufactured. The most suitable machining process is the boring machining process. Therefore, the Rotational cavity insert manufacturing uses the boring process and that can also have four different profiles as follows: (i) Rotational cavity horizontal boring (*Rot_Cav_Horizontal_Boring*); (ii) Rotational cavity taper boring (*Rot_Cav_Taper_Boring*); (iii) Rotational cavity facing boring (*Rot_Cav_Facing_Boring*); and (iv) Rotational cavity curve boring (*Rot_Cav_Curve_Boring*). Figure 88 depicts the Mould manufacturing core ontology adapted with new relations to support the machining features and Appendix A.7 presents in more details the Mould Manufacturing Core Ontology with machining features.

Figure 88 Mould Manufacturing Core Ontology enriched with machining features.

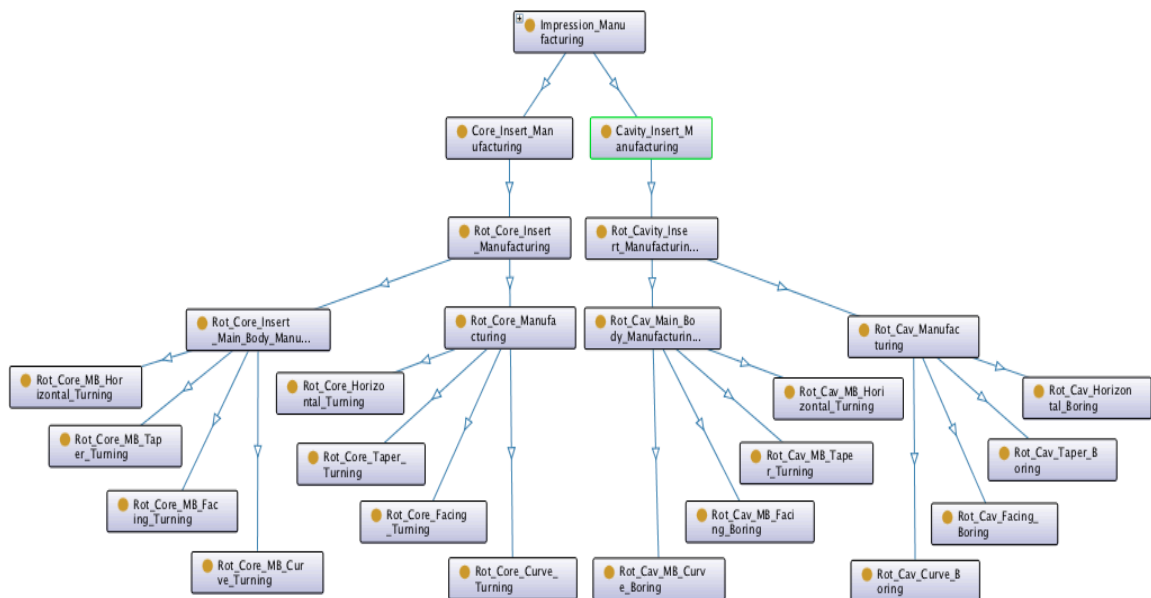

The subsequent sections establish the semantic mapping between: (1) Rotational core insert manufacturing and Rotational core horizontal turning,

Rotational core taper turning, Rotational core facing turning and Rotational core curve turning; (2) Rotational core insert main body manufacturing and Rotational core main body horizontal turning, Rotational core main body taper turning, Rotational core main body Facing turning and Rotational core main body curve turning; (3) Rotational cavity insert main body manufacturing and Rotational cavity main body horizontal turning, Rotational cavity main body taper turning, Rotational cavity main body facing turning and Rotational cavity main body curve turning; and (4) Rotational cavity insert manufacturing and Rotational cavity horizontal boring, Rotational cavity taper boring, Rotational cavity facing boring and Rotational cavity curve boring. Additionally, it is realized the semantic mapping between (5) the turning machining from Machining features core ontology and the entire turning machining in the Mould manufacturing core ontology, (6) the boring machining from Machining features core ontology and the entire boring machining in the Mould manufacturing core ontology; and finally (7) the drilling machining from Machining features with mould hole manufacturing in the Mould manufacturing core ontology.

6.4.1.3.1 Semantic mapping in Core insert manufacturing and Core insert main body manufacturing

This semantic mapping associates the instances of the (i) Core insert manufacturing and (ii) Core insert main body manufacturing with the type of turning machining process (facing, horizontal, taper or curve turning). The Core insert manufacturing considers the whole information, as shown in the detail “A” of Figure 89 and the Core insert main body manufacturing contemplates the whole information as illustrated in the detail “B”. Additionally, the orientation used in this case and shown in Figure 89 is in accordance with the turning manufacturing process (Detail “C”) and detail “D” presents the system coordination adopted in this research.

Figure 89 Rotational Core Insert Manufacturing Information Detailing.

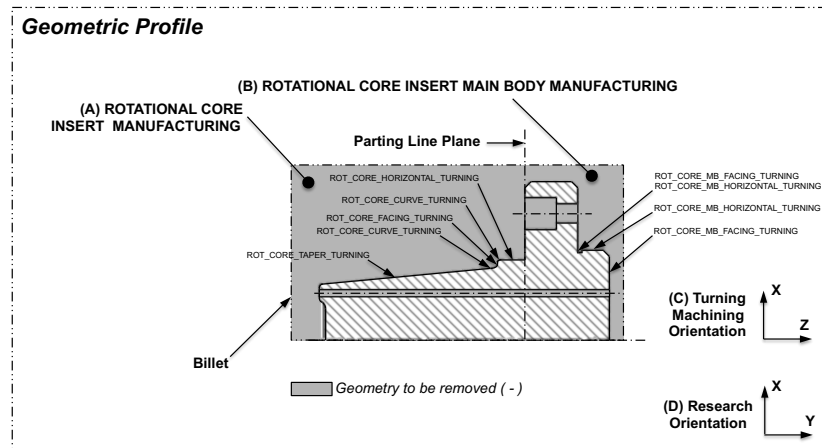

Figure 90 presents the semantic rule employed to define the turning machining type for the Rotational core insert manufacturing (detail “A”) and Rotational core insert main body manufacturing (detail “B”).

Figure 90 Semantic Rules applied to Rotational Core Insert and Rotational Core Insert Main Body Manufacturing.

(A) Semantic Rule: Rotational Core Insert Manufacturing	(B) Semantic Rule: Rotational Core Main Body Insert Manufacturing
<p>SWRL Language:</p> <pre> Rot_Core_Manufacturing(?p) ^ hasDimensionY(?p, ?yi) ^ hasDimensionYf(?p, ?yf) ^ hasRadius(?p, ?r) ^ swrlb:equal(?yi, ?yf) ^ swrlb:equal(?r, 0) -> Rot_Core_Horizontal_Turning(?p) Rot_Core_Manufacturing(?p) ^ hasDimensionX(?p, ?xi) ^ hasDimensionXf(?p, ?xf) ^ hasRadius(?p, ?r) ^ swrlb:equal(?xi, ?xf) ^ swrlb:equal(?r, 0) -> Rot_Core_Facing_Turning(?p) Rot_Core_Manufacturing(?p) ^ hasDimensionX(?p, ?xi) ^ hasDimensionXf(?p, ?xf) ^ hasDimensionY(?p, ?yi) ^ hasDimensionYf(?p, ?yf) ^ hasRadius(?p, ?r) ^ swrlb:notEqual(?xi, ?xf) ^ swrlb:notEqual(?yi, ?yf) ^ swrlb:equal(?r, 0) -> Rot_Core_Taper_Turning(?p) Rot_Core_Manufacturing(?p) ^ hasDimensionX(?p, ?xi) ^ hasDimensionXf(?p, ?xf) ^ hasDimensionY(?p, ?yi) ^ hasDimensionYf(?p, ?yf) ^ hasRadius(?p, ?r) ^ swrlb:notEqual(?xi, ?xf) ^ swrlb:notEqual(?yi, ?yf) ^ swrlb:greaterThan(?r, 0) -> Rot_Core_Curve_Turning(?p) </pre>	<p>SWRL Language:</p> <pre> Rot_Core_Insert_Main_Body_Manufacturing(?p) ^ hasDimensionY(?p, ?yi) ^ hasDimensionYf(?p, ?yf) ^ hasRadius(?p, ?r) ^ swrlb:equal(?yi, ?yf) ^ swrlb:equal(?r, 0) -> Rot_Core_MB_Horizontal_Turning(?p) Rot_Core_Insert_Main_Body_Manufacturing(?p) ^ hasDimensionX(?p, ?xi) ^ hasDimensionXf(?p, ?xf) ^ hasRadius(?p, ?r) ^ swrlb:equal(?xi, ?xf) ^ swrlb:equal(?r, 0) -> Rot_Core_MB_Facing_Turning(?p) Rot_Core_Insert_Main_Body_Manufacturing(?p) ^ hasDimensionX(?p, ?xi) ^ hasDimensionXf(?p, ?xf) ^ hasDimensionY(?p, ?yi) ^ hasDimensionYf(?p, ?yf) ^ hasRadius(?p, ?r) ^ swrlb:notEqual(?xi, ?xf) ^ swrlb:notEqual(?yi, ?yf) ^ swrlb:equal(?r, 0) -> Rot_Core_MB_Taper_Turning(?p) Rot_Core_Insert_Main_Body_Manufacturing(?p) ^ hasDimensionX(?p, ?xi) ^ hasDimensionXf(?p, ?xf) ^ hasDimensionY(?p, ?yi) ^ hasDimensionYf(?p, ?yf) ^ hasRadius(?p, ?r) ^ swrlb:notEqual(?xi, ?xf) ^ swrlb:notEqual(?yi, ?yf) ^ swrlb:greaterThan(?r, 0) -> Rot_Core_MB_Curve_Turning(?p) </pre>

The formal remarks that support the definition of the semantic mapping to partly reconcile Core insert manufacturing and the Turning machining presented in Detail A of Figure 90, state:

- The instance “?p” from the “Core insert manufacturing” is mapped as Rotational core horizontal turning (“Rot_Core_Horizontal_Turning”) *if and only if*:

- (a) the instance “?p” with “Yinitial” coordinate [hasDimensionY(?p,?yi)] is equal to the “Yfinal” coordinate [hasDimensionYf(?p,?Yf)];
 - (b) the radius value of the curve “?r” [hasRadius(?p,?r)] is equal to “0”.
- The instance “?p” from the “Core insert manufacturing” is mapped as Rotational core facing turning (“Rot_Core_Facing_Turning”) *if and only if*:
 - (a) the instance “?p” with “Xinitial” coordinate [hasDimensionX(?p,?xi)] is equal to the “Xfinal” coordinate [hasDimensionXf(?p,?Xf)];
 - (b) the radius value of the curve “?r” [hasRadius(?p,?r)] is equal to “0”.
- The instance “?p” from the “Core insert manufacturing” is mapped as Rotational core taper turning (“Rot_Core_Taper_Turning”) *if and only if*:
 - (a) the instance “?p” with “Xinitial” coordinate [hasDimensionX(?p,?xi)] is not equal to the “Xfinal” coordinate [hasDimensionXf(?p,?xf)];
 - (b) “Yinitial” coordinate [hasDimensionY(?p,?yi)] is not equal the “Yfinal” coordinate [hasDimensionYf(?p,?yf)];
 - (c) the radius value of the curve “?r” [hasRadius(?p,?r)] is equal to “0”.
- The instance “?p” from the “Core insert manufacturing” is mapped as Rotational core curve turning (“Rot_Core_Curve_Turning”) *if and only if*:
 - (a) the instance “?p” with “Xinitial” coordinate [hasDimensionX(?p,?xi)] is not equal to the “Xfinal” coordinate [hasDimensionXf(?p,?xf)];
 - (b) “Yinitial” coordinate [hasDimensionY(?p,?yi)] is not equal to “Yfinal” coordinate [hasDimensionYf(?p,?yf)];

- (c) the radius value of the curve “?r” [hasRadius(?p,?r)] is greater than “0”.

The same formal remarks with some adaptation which supports the definition of the semantic mapping partially reconcile Core insert main body manufacturing and the turning machining, as presented in detail B of Figure 90, can be stated as follow:

- The instance “?p” from the “Core insert main body manufacturing” is mapped as Rotational core main body horizontal turning (“Rot_Core_MB_Horizontal_Turning”) *if and only if*:
 - (a) the instance “?p” with “Yinitial” coordinate [hasDimensionY(?p,?yi)] is equal to the “Yfinal” coordinate [hasDimensionYf(?p,?Yf)];
 - (b) the radius value of the curve “?r” [hasRadius(?p,?r)] is equal to “0”.

- The instance “?p” from the “Core insert main body manufacturing” is mapped as Rotational core main body facing turning (“Rot_Core_MB_Facing_Turning”) *if and only if*:
 - (a) the instance “?p” with “Xinitial” coordinate [hasDimensionX(?p,?xi)] is equal to the “Xfinal” coordinate [hasDimensionXf(?p,?Xf)];
 - (b) the radius of the curve “?r” [hasRadius(?p,?r)] is equal to “0”.

- The instance “?p” from the “Core insert main body manufacturing” is mapped as Rotational core main body taper turning (“Rot_Core_MB_Taper_Turning”) *if and only if*:
 - (a) the instance “?p” with “Xinitial” coordinate [hasDimensionX(?p,?xi)] is not equal to the “Xfinal” coordinate [hasDimensionXf(?p,?xf)];
 - (b) “Yinitial” coordinate [hasDimensionY(?p,?yi)] is not equal to “Yfinal” [hasDimensionYf(?p,?yf)];
 - (c) the radius value of the curve “?r” [hasRadius(?p,?r)] is equal to “0”.

- The instance “?p” from the “Core insert main body manufacturing” is mapped as Rotational core main body curve turning (“Rot_Core_MB_Curve_Turning”) *if and only if*:
 - (a) the instance “?p” with “Xinitial” coordinate [hasDimensionX(?p,?xi)] is not equal to the “Xfinal” coordinate [hasDimensionXf(?p,?xf)];
 - (b) “Yinitial” coordinate [hasDimensionY(?p,?yi)] is not equal to “Yfinal” coordinate [hasDimensionYf(?p,?yf)];
 - (c) the radius value of the curve “?r” [hasRadius(?p,?r)] is greater than “0”.

6.4.1.3.2 Semantic mapping for Cavity insert manufacturing and Cavity insert main body manufacturing

This semantic mapping associates the instances of the (3) Rotational cavity insert manufacturing with the type of boring machining process (facing boring, horizontal boring, taper boring or curve boring) and (4) Rotational cavity insert main body manufacturing with the type of turning machining process (facing turning, horizontal turning, taper turning or curve turning). The Cavity insert manufacturing considers the whole information as shown in detail “A” of Figure 91 and the Cavity insert main body manufacturing contemplates the entire information as shown in the detail “B” of Figure 91. Additionally, the orientation used in Figure 91 is in accordance with the turning manufacturing process (Detail “C”) and detail “D” presents the system coordination adopted in this research.

Figure 91 Rotational Cavity Insert Manufacturing Information Detailing.

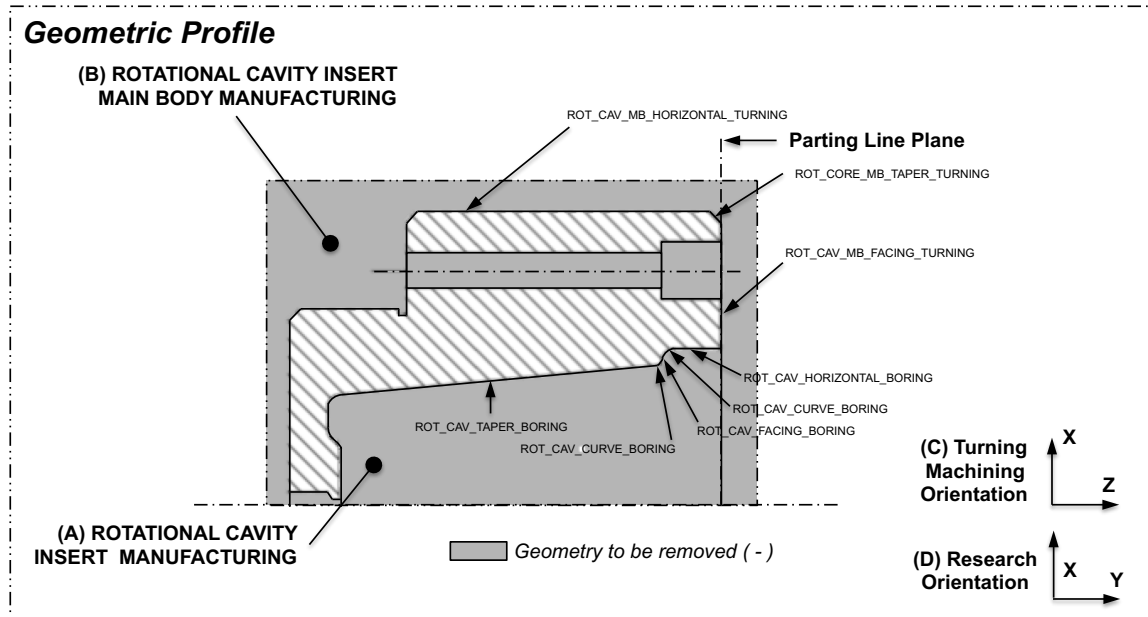

Figure 92 presents the semantic rule employed to define the turning machining type for the Rotational cavity insert manufacturing (detail “A”) and Rotational cavity insert main body manufacturing (detail “B”).

Figure 92 Semantic Rules applied to the Rotational cavity insert and Rotational cavity insert main body manufacturing.

(A) Semantic Rule: Rotational Cavity Insert Manufacturing	(B) Semantic Rule: Rotational Cavity Main Body Insert Manufacturing
<p>SWRL Language:</p> <pre> Rot_Cav_Manufacturing(?p) ^ hasDimensionY(?p, ?yi) ^ hasDimensionYf(?p, ?yf) ^ hasRadius(?p, ?r) ^ swrlb:equal(?yi, ?yf) ^ swrlb:equal(?r, 0) -> Rot_Cav_Horizontal_Boring(?p) Rot_Cav_Manufacturing(?p) ^ hasDimensionX(?p, ?xi) ^ hasDimensionXf(?p, ?xf) ^ hasRadius(?p, ?r) ^ swrlb:equal(?xi, ?xf) ^ swrlb:equal(?r, 0) -> Rot_Cav_Facing_Boring(?p) Rot_Cav_Manufacturing(?p) ^ hasDimensionX(?p, ?xi) ^ hasDimensionXf(?p, ?xf) ^ hasDimensionY(?p, ?yi) ^ hasDimensionYf(?p, ?yf) ^ hasRadius(?p, ?r) ^ swrlb:notEqual(?xi, ?xf) ^ swrlb:notEqual(?yi, ?yf) ^ swrlb:equal(?r, 0) -> Rot_Cav_Taper_Boring(?p) Rot_Cav_Manufacturing(?p) ^ hasDimensionX(?p, ?xi) ^ hasDimensionXf(?p, ?xf) ^ hasDimensionY(?p, ?yi) ^ hasDimensionYf(?p, ?yf) ^ hasRadius(?p, ?r) ^ swrlb:notEqual(?xi, ?xf) ^ swrlb:notEqual(?yi, ?yf) ^ swrlb:greaterThan(?r, 0) -> Rot_Cav_Curve_Boring(?p) </pre>	<p>SWRL Language:</p> <pre> Rot_Cav_Main_Body_Manufacturing(?p) ^ hasDimensionY(?p, ?yi) ^ hasDimensionYf(?p, ?yf) ^ hasRadius(?p, ?r) ^ swrlb:equal(?yi, ?yf) ^ swrlb:equal(?r, 0) -> Rot_Cav_MB_Horizontal_Turning(?p) Rot_Cav_Main_Body_Manufacturing(?p) ^ hasDimensionX(?p, ?xi) ^ hasDimensionXf(?p, ?xf) ^ hasRadius(?p, ?r) ^ swrlb:equal(?xi, ?xf) ^ swrlb:equal(?r, 0) -> Rot_Cav_MB_Facing_Turning(?p) Rot_Cav_Main_Body_Manufacturing(?p) ^ hasDimensionX(?p, ?xi) ^ hasDimensionXf(?p, ?xf) ^ hasDimensionY(?p, ?yi) ^ hasDimensionYf(?p, ?yf) ^ hasRadius(?p, ?r) ^ swrlb:notEqual(?xi, ?xf) ^ swrlb:notEqual(?yi, ?yf) ^ swrlb:equal(?r, 0) -> Rot_Cav_MB_Taper_Turning(?p) Rot_Cav_Main_Body_Manufacturing(?p) ^ hasDimensionX(?p, ?xi) ^ hasDimensionXf(?p, ?xf) ^ hasDimensionY(?p, ?yi) ^ hasDimensionYf(?p, ?yf) ^ hasRadius(?p, ?r) ^ swrlb:notEqual(?xi, ?xf) ^ swrlb:notEqual(?yi, ?yf) ^ swrlb:greaterThan(?r, 0) -> Rot_Cav_MB_Curve_Turning(?p) </pre>

The formal remarks that support the definition of the semantic mapping to partly reconcile Cavity insert manufacturing and the boring machining presented in Detail “A” of Figure 92, state:

- The instance “?p” from the “Cavity insert manufacturing” is mapped as Rotational cavity horizontal boring (“Rot_Cav_Horizontal_Boring”) *if and only if*:
 - (a) the instance “?p” with “Yinitial” coordinate [hasDimensionY(?p,?yi)] is equal to “Yfinal” coordinate [hasDimensionYf(?p,?Yf)];
 - (b) the radius value of the curve “?r” [hasRadius(?p,?r)] is equal to “0”.

- The instance “?p” from the “Cavity insert manufacturing” is mapped as Rotational cavity facing boring (“Rot_Cav_Facing_Boring”) *if and only if*:
 - (a) the instance “?p” with “Xinitial” coordinate [hasDimensionX(?p,?xi)] is equal to the “Xfinal” coordinate [hasDimensionXf(?p,?Xf)];
 - (b) the radius value of the curve “?r” [hasRadius(?p,?r)] is equal to “0”.

- The instance “?p” from the “Cavity insert manufacturing” is mapped as Rotational cavity taper boring (“Rot_Cav_Taper_Boring”) *if and only if*:
 - (a) the instance “?p” with “Xinitial” coordinate [hasDimensionX(?p,?xi)] is not equal to the “Xfinal” coordinate [hasDimensionXf(?p,?xf)];
 - (b) “Yinitial” coordinate [hasDimensionY(?p,?yi)] is not equal to “Yfinal” coordinate [hasDimensionYf(?p,?yf)];
 - (c) the radius value of the curve “?r” [hasRadius(?p,?r)] is equal to “0”.

- The instance “?p” from the “Cavity insert manufacturing” is mapped as Rotational cavity curve boring (“Rot_Cav_Curve_Boring”) *if and only if*:
 - (a) the instance “?p” with “Xinitial” coordinate [hasDimensionX(?p,?xi)] is not equal to the “Xfinal” coordinate [hasDimensionXf(?p,?xf)];
 - (b) “Yinitial” coordinate [hasDimensionY(?p,?yi)] is not equal to “Yfinal” coordinate [hasDimensionYf(?p,?yf)];

- (c) the radius value of the curve “?r” [hasRadius(?p,?r)] is greater than “0”.

The same formal remarks with some adaptation, which supports the definition of the semantic mapping to partially reconcile Cavity insert main body manufacturing and turning machining, as presented in detail “B” of Figure 92, can be stated as follow:

- The instance “?p” from the “Cavity insert main body manufacturing” is mapped as Rotational cavity main body horizontal turning (“Rot_Cav_MB_Horizontal_Turning”) *if and only if*:
 - (a) the instance “?p” with “Yinitial” coordinate [hasDimensionY(?p,?yi)] is equal to the “Yfinal” coordinate [hasDimensionYf(?p,?Yf)];
 - (b) the radius value of the curve “?r” [hasRadius(?p,?r)] is equal to “0”.
- The instance “?p” from the “Cavity insert main body manufacturing” is mapped as Rotational cavity main body facing turning (“Rot_Cav_MB_Facing_Turning”) *if and only if*:
 - (a) the instance “?p” with “Xinitial” coordinate [hasDimensionX(?p,?xi)] is equal to the “Xfinal” coordinate [hasDimensionXf(?p,?Xf)];
 - (b) the radius value of the curve “?r” [hasRadius(?p,?r)] is equal to “0”.
- The instance “?p” from the “Cavity insert main body manufacturing” is mapped as Rotational cavity main body taper turning (“Rot_Cav_MB_Taper_Turning”) *if and only if*:
 - (a) the instance “?p” with “Xinitial” coordinate [hasDimensionX(?p,?xi)] is not equal to the “Xfinal” coordinate [hasDimensionXf(?p,?xf)];
 - (b) “Yinitial” coordinate [hasDimensionY(?p,?yi)] is not equal to “Yfinal” coordinate [hasDimensionYf(?p,?yf)];

- (c) the radius value of the curve “?r” [hasRadius(?p,?r)] is equal to “0”.
- The instance “?p” from the “Cavity insert main body manufacturing” is mapped as Rotational cavity main body curve turning (“Rot_Cav_MB_Curve_Turning”) *if and only if*:
 - (a) The instance “?p” with “Xinitial” coordinate [hasDimensionX(?p,?xi)] is not equal to the “Xfinal” coordinate [hasDimensionXf(?p,?xf)];
 - (b) “Yinitial” coordinate [hasDimensionY(?p,?yi)] is not equal “Yfinal” coordinate [hasDimensionYf(?p,?yf)];
 - (c) the radius value of the curve “?r” [hasRadius(?p,?r)] is greater than “0”.

6.4.1.3.3 Semantic mapping between Mould manufacturing core ontology and Machining features core ontology

This semantic mapping associates the instances of the (5) Rotational core insert, Rotational core insert main body and Rotational cavity insert main body machining (by the turning process from the Mould manufacturing ontology) with the turning features in the Machining features ontology. The same occurs with (6) Rotational cavity insert from Mould manufacturing ontology that has an association with boring features in the Machining features ontology and (7) Mould hole manufacturing from the Mould manufacturing ontology that has an association with the drilling features in the Machining features ontology. Figure 93 presents the semantic rule to establish the relation between Mould Manufacturing and Machining Features.

Figure 93 Semantic Rules between Mould Manufacturing and Machining Features.

Semantic Rules	
SWRL Language:	
1)	<i>Rot_Cav_Horizontal_Boring(?p)->Boring(?p)</i>
2)	<i>Rot_Cav_Facing_Boring(?p)->Boring(?p)</i>
3)	<i>Rot_Cav_Taper_Boring(?p)->Boring(?p)</i>
4)	<i>Rot_Cav_Curve_Boring(?p)->Boring(?p)</i>
5)	<i>Rot_Cav_MB_Horizontal_Boring(?p)->Turning(?p)</i>
6)	<i>Rot_Cav_MB_Facing_Boring(?p)->Turning(?p)</i>
7)	<i>Rot_Cav_MB_Taper_Boring(?p)->Turning(?p)</i>
8)	<i>Rot_Cav_MB_Curve_Boring(?p)->Turning(?p)</i>
9)	<i>Rot_Core_Insert_Horizontal_Boring(?p)->Turning(?p)</i>
10)	<i>Rot_Core_Insert_Facing_Boring(?p)->Turning(?p)</i>
11)	<i>Rot_Core_Insert_Taper_Boring(?p)->Turning(?p)</i>
12)	<i>Rot_Core_Insert_Curve_Boring(?p)->Turning(?p)</i>
13)	<i>Rot_Core_MB_Horizontal_Boring(?p)->Turning(?p)</i>
14)	<i>Rot_Core_MB_Facing_Boring(?p)->Turning(?p)</i>
15)	<i>Rot_Core_MB_Taper_Boring(?p)->Turning(?p)</i>
16)	<i>Rot_Core_MB_Curve_Boring(?p)->Turning(?p)</i>
17)	<i>Mould_Hole_Manufactuirng(?p)-> Drilling(?p)</i>

The formal remarks that support the definition of the semantic mapping to partially reconcile different machining processes and Mould manufacturing ontology presented Figure 93, state:

- The instance “?p” from “Different machining processes” - (1) facing boring, (2) horizontal boring, (3) taper boring, (4) curve boring of the Cavity insert profile in Mould manufacturing ontology is shared with instance “?p” of the boring in the Machining features ontology.
- The instance “?p” from “Different machining processes” - (5) facing turning, (6) horizontal turning, (7) taper turning, (8) curve turning associated with the Cavity main body insert profile in Mould manufacturing ontology is mapped as the instance “?p” of the turning in the Machining features ontology.
- The instance “?p” from “Different machining processes” - (9) facing turning, (10) horizontal turning, (11) taper turning, (12) curve turning associated with the Core insert profile in Mould manufacturing ontology

is mapped as the instance “?p” of the turning in the Machining features ontology.

- The instance “?p” from “Different machining processes” - (13) facing turning, (14) horizontal turning, (15) taper turning, (16) curve turning associated with the Core main body insert profile in Mould manufacturing ontology is mapped as the instance “?p” of the turning in the Machining features ontology.
- The instance “?p” from “Different machining processes” - (13) facing turning, (14) horizontal turning, (15) taper turning, (16) curve turning associated with the Core main body insert profile in Mould manufacturing ontology is mapped as the instance “?p” of the turning in the Machining features ontology.
- The instance “?p” from the (17) “Mould hole manufacturing” in Mould manufacturing ontology is mapped as the instance “?p” of the drilling in the Machining features ontology.

6.4.2 Semantic mapping for support the inter-contexts relationships in the Application Domain View

The same idea of the semantic mapping to support the relationships intra-domains application view is applied in this section. Standard sets of semantic mapping concepts derive from foundation semantics to support the information relationship across multiple contexts. Specifically, inter-domains application views address the relationships between “Design for Mouldability and Design for Tooling” and “Design for Tooling and Design for Machining”.

These relationships are ruled based on a set of pre-defined mapping (domain application relationships) according to the knowledge of the process and allow the information exchange inter-contexts, as depicts in Figure 94. Different reconciliation scenarios, i.e., different products, can reuse this set of mapping concepts since all

specialised ontologies in the application domain view are from Reference View and share a common semantic ground.

Figure 94 Semantic Mapping for support inter-contexts in Application Domain View.

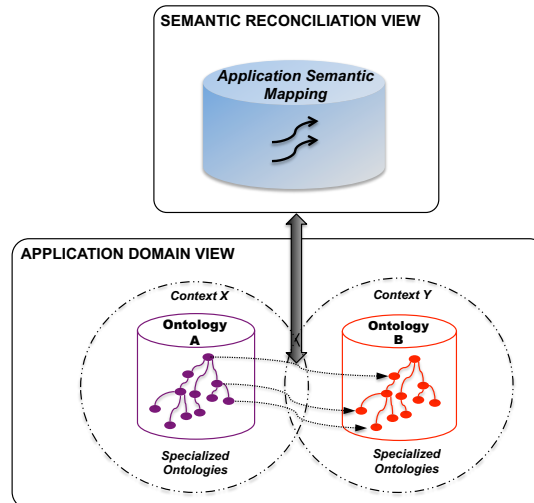

The semantic mapping inter-contexts also use the SWRL approach for establishing the relationships. The subsequent sections explore the semantic mapping between “design for mouldability and design for tooling” (cavity insert and core insert), and “design for tooling and design for machining” (cavity insert and core insert).

6.4.2.1 Semantic mapping between Design for mouldability and Design for tooling

There are several aspects to be discussed in terms of semantic mapping between the Design for mouldability and the Cavity and Core inserts design in the mould design. Figure 95 highlights the critical information that needs to be exchanged between this both contexts. In the Cavity insert design, the critical information is the geometry of the cavity, gate features and their properties. At the same time, in the Core insert design, the critical information involved are the Core insert geometry, ejection features and their properties.

Figure 95 Information to be mapped from Design for mouldability to the Cavity and Core design in the Design for tooling.

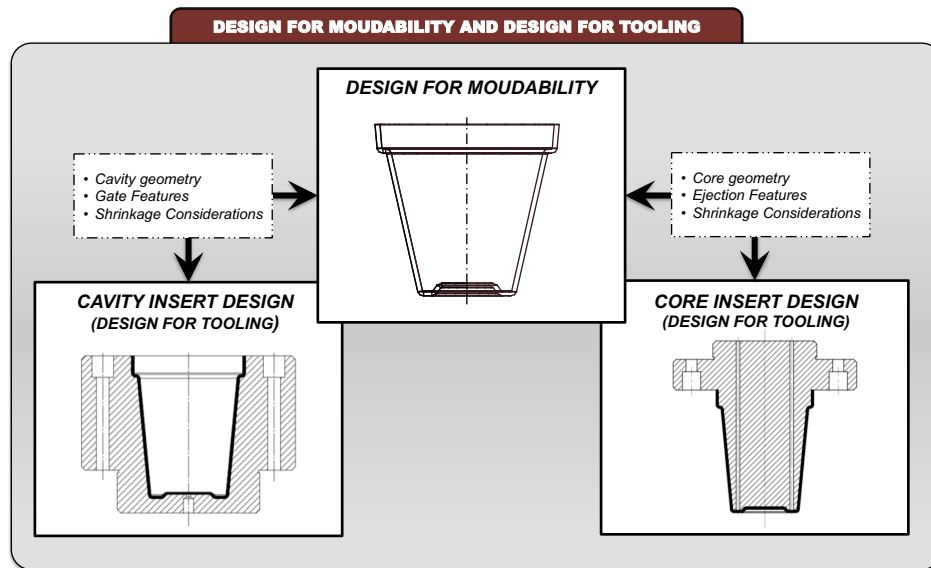

The Cavity and Core geometric profiles information are originated from the geometric profile of the plastic injected product and the position of the Parting Line of the mould. Additionally, it is important to consider the shrinkage rate of the plastic material in order to correct this rate in the cavity and core insert. The gate and ejection features are also critical because they affect the mouldability of the plastic part.

6.4.2.1.1 Semantic mapping between Design for mouldability and Cavity insert design

This section explores the mapping of the information from the product mouldability to the cavity design in order to ensure the correct information exchange between these two contexts. The information exchange between these two contexts does not directly occur, as it is necessary to consider the external geometry as well as the factor of the shrinkage of the plastic material. Shrinkage occurs because the polymer density varies from the processing temperature to the ambient temperature. According to Mohan, Ansari and Shanks (2006), the variation in shrinkage creates internal stress during the injection moulding. The product is going to warp upon ejection from the mould or crack with the external load during the extraction if the internal stress is high enough to overcome the structural integrity of the product.

Therefore, during the information exchange between Design for mouldability and Design for tooling is necessary to share and transform information of the material properties and dimensions. This is a translation process because information from different domains is necessary to ensure the correct information exchange.

In this context, the profile of the Rotational cavity insert is created by extracting the shape and dimensions of the external profile (from rotational mouldability primary and transition features) locating below the Parting line plane and multiply by one plus the shrinkage correction factor, as presented in equation 6.12. This shrinkage factor is based on the middle of the shrinkage rate, as presented in equation 6.13.

$$dimension_{sk_factor} = dimension_{product} * (1 + shrinkage_factor) \quad 6.12$$

where: “ $dimension_{product}$ ” means all coordinates of the external product geometric profile (“Xinitial”, “Xfinal”, “Yinitial” and “Yfinal”) from the primary features and transition features that are multiply by one plus the shrinkage factor, resulting in (“X’initial”, “Y’initial”, “X’final”, “Y’final”); and

$$shrinkage_{factor} = \frac{shrinkage_rate_{max} - shrinkage_rate_{min}}{2} \quad 6.13$$

where: “ $shrinkage_{factor}$ ” means the middle of the “shrinkage rate maximum” and “shrinkage rate minimum”.

The Parting line is a plane and is positioned on the top of the product which implicates that there is no geometry to be translated above the Parting line plane. Figure 96 depicts the shrinkage process in the geometric profile.

Figure 96 Example of translation from design for mouldability into Design for tooling (cavity insert).

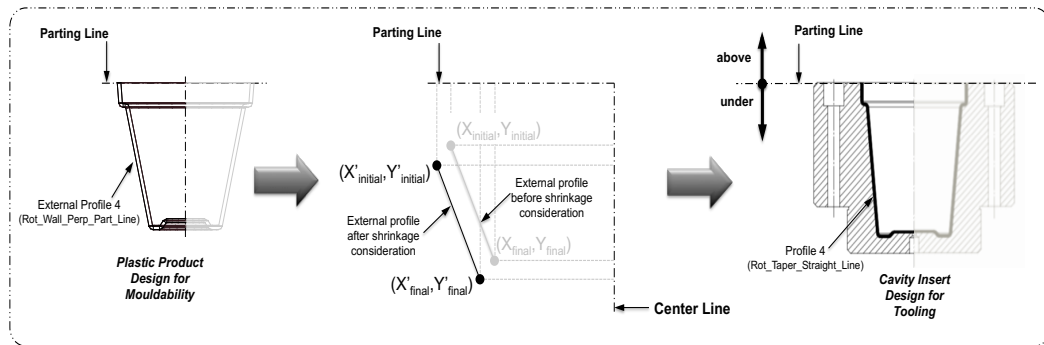

The semantic rules were proposed to map the information from the product profile in design for mouldability into the Cavity insert profile in the design for tooling, ensuring the correct interoperability. Each profile of the cavity insert must have a relation of consistency with the information of the Design for mouldability, otherwise, this information will be in conflict.

The external profile identification is in accordance with the offset rules. If “ $X_{initial}$ ” and “ X_{final} ” coordinates are greater than “ $X_{initial_{offset}}$ ” and “ $X_{final_{offset}}$ ” coordinates from the primary features of the design of mouldability, “ X ” and “ Y ” coordinates are used as an external profile, as illustrate in detail “A” of Figure 97. If “ $X_{initial}$ ” and “ X_{final} ” coordinates are lesser than “ $X_{initial_{offset}}$ ” and “ $X_{final_{offset}}$ ” coordinates from the Primary features of the design of mouldability, “ X_{offset} ” and “ Y_{offset} ” coordinates are used as an external profile, as illustrate in detail “B” of Figure 97.

Figure 97 Detailing of the Primary features offset profile in the Rotational plastic products.

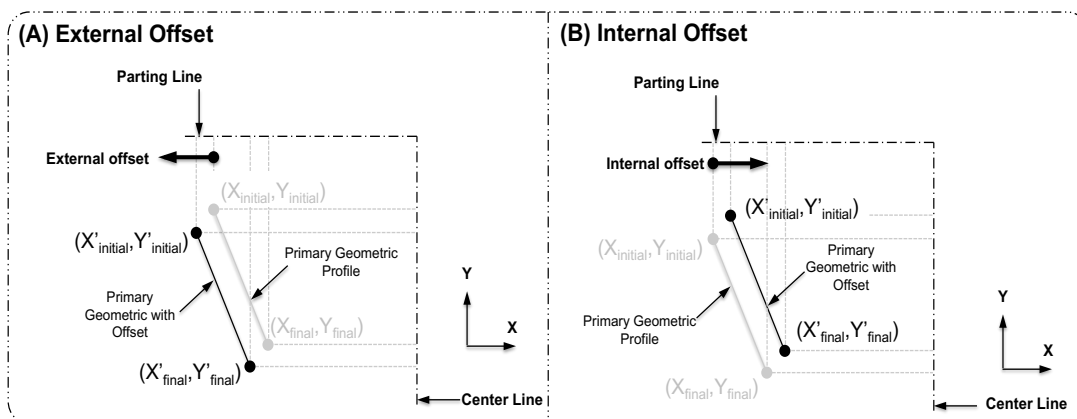

Based on this context, Figure 98 and Figure 99 depict the semantic mapping between the rotational mouldability primary features and the cavity straight line. Figure 98 represents the rule for the semantic mapping when the offset is internal.

Figure 98 Semantic Rule for mapping the translation of the Mouldability primary features into Cavity straight line – internal offset direction.

Semantic Rule			
SWRL Language: $Rot_Primary_Features(?p) \wedge hasDimensionX(?p, ?xi) \wedge hasDimensionY(?p, ?yi) \wedge hasDimensionXf(?p, ?xf) \wedge hasDimensionYf(?p, ?yf) \wedge Rot_Primary_Features(?q) \wedge hasDimensionXio(?q, ?xio) \wedge hasDimensionYio(?q, ?yio) \wedge hasDimensionXfo(?q, ?xfo) \wedge hasDimensionYfo(?q, ?yfo) \wedge Cav_Straight_Line(?u) \wedge hasDimensionX(?u, ?xci) \wedge hasDimensionY(?u, ?yci) \wedge hasDimensionXf(?u, ?xcf) \wedge hasDimensionYf(?u, ?ycf) \wedge Plastic_Product_Material(?v) \wedge hasShrinkageFactor(?v, ?SKF) \wedge swrlb:greaterThanOrEqual(?xi, ?xio) \wedge swrlb:greaterThanOrEqual(?xf, ?xfo) \wedge swrlb:multiply(?xci, ?xi, ?SKF) \wedge swrlb:multiply(?yci, ?yi, ?SKF) \wedge swrlb:multiply(?xcf, ?xf, ?SKF) \wedge swrlb:multiply(?ycf, ?yf, ?SKF) \rightarrow hasTranslation(?u, ?p)$			
Instance “?p” from the Rotational Primary Features [Rot_Primary_Features] has			
Product Geometric Profile	“Xinitial” – [hasDimensionX(?p,?xi)] “Yinitial” – [hasDimensionY(?p,?yi)] “Xfinal” – [hasDimensionXf(?p,?xf)] “Yfinal” – [hasDimensionYf(?p,?yf)]		
Instance “?q” from the Rotational Primary Features [Rot_Primary_Features] has			
Product Geometric Profile with offset	“Xoff_initial” – [hasDimensionX(?q,?xio)] “Yoff_initial” – [hasDimensionY(?q,?yio)] “Xoff_final” – [hasDimensionXf(?q,?xfo)] “Yoff_final” – [hasDimensionYf(?q,?yfo)]		
Instance “?u” from the Cavity Straight Line [Cav_Straight_Line] has			
Cavity Geometric Profile	“Xcav_initial” – [hasDimensionX(?u,?xci)] “Ycav_initial” – [hasDimensionY(?u,?yci)] “Xcav_final” – [hasDimensionXf(?u,?xcf)] “Ycav_final” – [hasDimensionYf(?u,?ycf)]		
Instance “?v” from the Plastic Product Material [Plastic_Product_Material] has			
Shrinkage factor	“Shrinkage_Factor” - [hasShrinkageFactor(?v, ?SKF)]		
Instances “?p” and “?u” will have relationship <i>if and only if</i>			
Logical Conditions	(a)	“Xinitial” is greater than or equal “Xoff_initial”	True
	(b)	“Xfinal” is greater than or equal “Xoff_final”	True
	(c)	“Xcav_initial” is equal to “Xinitial” multiplied by “Shrinkage factor” (from the material)	True
	(d)	“Ycav_initial” is equal to “Yinitial” multiplied by “Shrinkage factor”	True
	(e)	“Xcav_final” is equal to “Xfinal” multiplied by “Shrinkage factor”	True
	(f)	“Ycav_final” is equal to “Yfinal” multiplied by “Shrinkage factor”	True
Therefore, Instance “?p” is translated to the information from the instance “?u” [hasTranslation(?p, ?u)]			

Figure 99 represents the rule for the semantic mapping when the offset is external.

Figure 99 Semantic Rule for mapping the translation of the Mouldability primary features into Cavity straight line – external offset direction.

Semantic Rule			
SWRL Language: $Rot_Primary_Features(?p) \wedge hasDimensionX(?p, ?xi) \wedge hasDimensionY(?p, ?yi) \wedge hasDimensionXf(?p, ?xf) \wedge hasDimensionYf(?p, ?yf) \wedge Rot_Primary_Features(?q) \wedge hasDimensionXio(?q, ?xio) \wedge hasDimensionYio(?q, ?yio) \wedge hasDimensionXfo(?q, ?xfo) \wedge hasDimensionYfo(?q, ?yfo) \wedge Cav_Straight_Line(?u) \wedge hasDimensionX(?u, ?xci) \wedge hasDimensionY(?u, ?yci) \wedge hasDimensionXf(?u, ?xcf) \wedge hasDimensionYf(?u, ?ycf) \wedge Plastic_Product_Material(?v) \wedge hasShrinkageFactor(?v, ?SKF) \wedge swrlb:lessThan(?xi, ?xio) \wedge swrlb:lessThan (?xf, ?xfo) \wedge swrlb:multiply (?xci, ?xio, ?SKF) \wedge swrlb:multiply (?yci, ?yio, ?SKF) \wedge swrlb:multiply(?xcf, ?xfo, ?SKF) \wedge swrlb:multiply(?ycf, ?yfo, ?SKF) \rightarrow hasTranslation(?u, ?q)$			
Instance “?p” from the Rotational Primary Features [Rot_Primary_Features] has			
Product Geometric Profile	“Xinitial” – [hasDimensionX(?p,?xi)] “Yinitial” – [hasDimensionY(?p,?yi)] “Xfinal” – [hasDimensionXf(?p,?xf)] “Yfinal” – [hasDimensionYf(?p,?yf)]		
Instance “?q” from the Rotational Primary Features [Rot_Primary_Features] has			
Product Geometric Profile with offset	“Xoff_initial” – [hasDimensionX(?q,?xio)] “Yoff_initial” – [hasDimensionY(?q,?yio)] “Xoff_final” – [hasDimensionXf(?q,?xfo)] “Yoff_final” – [hasDimensionYf(?q,?yfo)]		
Instance “?u” from the Cavity Straight Line [Cav_Straight_Line] has			
Cavity Geometric Profile	“Xcav_initial” – [hasDimensionX(?u,?xci)] “Ycav_initial” – [hasDimensionY(?u,?yci)] “Xcav_final” – [hasDimensionXf(?u,?xcf)] “Ycav_final” – [hasDimensionYf(?u,?ycf)]		
Instance “?v” from the Plastic Product Material [Plastic_Product_Material] has			
Shrinkage factor	“Shrinkage_Factor” - [hasShrinkageFactor(?v, ?SKF)]		
Instances “?q” and “?u” will have relationship <i>if and only if</i>			
Logical Conditions	(a)	“Xinitial” is lesser than “Xoff_initial”	True
	(b)	“Xfinal” is lesser than “Xoff_final”	True
	(c)	“Xcav_initial” is equal to “Xoff_initial” multiplied by “Shrinkage factor” (from the material)	True
	(d)	“Ycav_initial” is equal to “Yoff_initial” multiplied by “Shrinkage factor”	True
	(e)	Xcav_final” is equal to “Xoff_final” multiplied by “Shrinkage factor”	True
	(f)	“Ycav_final” is equal to “Yoff_final” multiplied by “Shrinkage factor”	True
Therefore, Instance “?q” is translated to the information from the instance “?u” [hasTranslation(?q, ?u)]			

The same idea is applied to the transition features profiles, which external profile identification is also in accordance with the offset. If the “Xinitial” and “Xfinal”

coordinates are greater than “ $X_{\text{initial_offset}}$ ” and “ $X_{\text{final_offset}}$ ” coordinates from the transition features of the design of mouldability, “ X ” and “ Y ” are external coordinates of the product, as illustrated in detail “A” of Figure 100. If the “ X_{initial} ” and “ X_{final} ” coordinates are lesser than “ $X_{\text{initial_offset}}$ ” and “ $X_{\text{final_offset}}$ ” coordinates from the transition features of the mouldability design, “ X_{offset} ” and “ Y_{offset} ” are external coordinates of the product, as illustrated in detail “B” of Figure 100.

Figure 100 Detailing of Transition features offset profile in the Rotational plastic products.

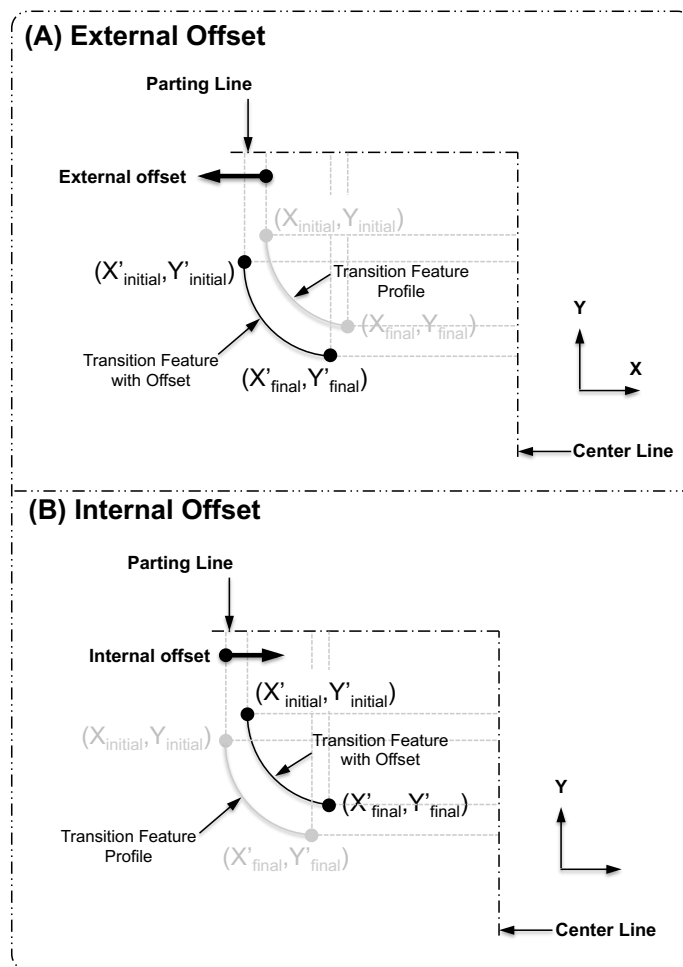

Based on this context, Figure 98 and Figure 99 depict the semantic mapping between the Rotational transition features and the Cavity curve line. Figure 101 represents the semantic rule for mapping the information when the offset is in the external direction.

Figure 101 Semantic Rule for mapping the translation of the Mouldability transition features into Cavity curve line - external offset direction.

Semantic Rule			
SWRL Language: $Rot_Transition_Features(?p) \wedge hasDimensionX(?p, ?xti) \wedge hasDimensionY(?p, ?yti) \wedge hasDimensionXf(?p, ?xtf) \wedge hasDimensionYf(?p, ?ytf) \wedge hasRadius(?p, ?r) \wedge Rot_Transition_Features(?q) \wedge hasDimensionXio(?q, ?xtio) \wedge hasDimensionYio(?q, ?ytio) \wedge hasDimensionXfo(?q, ?xtfo) \wedge hasDimensionYfo(?q, ?ytf) \wedge hasRadiusRo(?q, ?ro) \wedge Cav_Curve_Line(?u) \wedge hasDimensionX(?u, ?xci) \wedge hasDimensionY(?u, ?yci) \wedge hasDimensionXf(?u, ?xcf) \wedge hasDimensionYf(?u, ?ycf) \wedge hasRadius(?u, ?rc) \wedge Plastic_Product_Material(?v) \wedge hasShrinkageFactor(?v, ?SKF) \wedge swrlb:greaterThanOrEqual(?xti, ?xtio) \wedge swrlb:greaterThanOrEqual(?xtf, ?xtfo) \wedge swrlb:multiply (?xci, ?xti, ?SKF) \wedge swrlb:multiply (?yci, ?yti, ?SKF) \wedge swrlb:multiply(?xcf, ?xtf, ?SKF) \wedge swrlb:multiply(?ycf, ?ytf, ?SKF) \wedge swrlb:multiply (?rc, ?r, ?SKF) \rightarrow hasTranslation(?p, ?u)$			
Instance “?p” from the Rotational Primary Features [Rot_Primary_Features] has			
Product Transition Profile	“XTinitial” – [hasDimensionX(?p,?xti)] “YTinitial” – [hasDimensionY(?p,?yti)] “XTfinal” – [hasDimensionXf(?p,?xtf)] “YTfinal” – [hasDimensionYf(?p,?ytf)] “Radius” - [hasRadius(?p,?r)]		
Instance “?q” from the Rotational Primary Features [Rot_Primary_Features] has			
Product Transition Profile with offset	“XToff_initial” – [hasDimensionX(?q,?xtio)] “YToff_initial” – [hasDimensionY(?q,?ytio)] “XToff_final” – [hasDimensionXf(?q,?xtfo)] “YToff_final” – [hasDimensionYf(?q,?ytf)] “Radiusoff” - [hasDimensionRo(?p,?ro)]		
Instance “?u” from the Cavity Straight Line [Cav_Straight_Line] has			
Cavity Geometric Profile	“Xcav_initial” – [hasDimensionX(?u,?xci)] “Ycav_initial” – [hasDimensionY(?u,?yci)] “Xcav_final” – [hasDimensionXf(?u,?xcf)] “Ycav_final” – [hasDimensionYf(?u,?ycf)] “Rcav” - [hasRadius(?u,?rc)]		
Instance “?v” from the Plastic Product Material [Plastic_Product_Material] has			
Shrinkage factor	“Shrinkage_Factor” - [hasShrinkageFactor(?v, ?SKF)]		
Instances “?p” and “?u” will have relationship <i>if and only if</i>			
Logical Conditions	(a)	“XTinitial” is greater than or equal “XToff_initial”	True
	(b)	“XTfinal” is greater than or equal “XToff_final”	True
	(c)	“Xcav_initial” is equal to “XTinitial” multiplied by “Shrinkage factor” (from the material)	True
	(d)	“Ycav_initial” is equal to “YTinitial” multiplied by “Shrinkage factor”	True
	(e)	Xcav_final” is equal to “XTfinal” multiplied by “Shrinkage factor”	True
	(f)	“Ycav_final” is equal to “YTfinal” multiplied by “Shrinkage factor”	True
	(g)	“Rcav” is equal to “Radius” multiplied by “Shrinkage factor”	True
Therefore, Instance “?p” is translated to the information from the instance “?u” [<i>hasTranslation(?p, ?u)</i>]			

Figure 101 represents the semantic rule for mapping the information when the offset is in the internal.

Figure 102 Semantic Rule for mapping the translation of the Mouldability transition features into Cavity curve line – internal offset direction.

Semantic Rule			
SWRL Language: $Rot_Transition_Features(?p) \wedge hasDimensionX(?p, ?xti) \wedge hasDimensionY(?p, ?yti) \wedge hasDimensionXf(?p, ?xtf) \wedge hasDimensionYf(?p, ?ytf) \wedge hasRadius(?p, ?r) \wedge Rot_Transition_Features(?q) \wedge hasDimensionXio(?q, ?xtio) \wedge hasDimensionYio(?q, ?ytio) \wedge hasDimensionXfo(?q, ?xtfo) \wedge hasDimensionYfo(?q, ?ytf) \wedge hasRadiusRo(?q, ?ro) \wedge Cav_Curve_Line(?u) \wedge hasDimensionX(?u, ?xci) \wedge hasDimensionY(?u, ?yci) \wedge hasDimensionXf(?u, ?xcf) \wedge hasDimensionYf(?u, ?ycf) \wedge hasRadius(?u, ?rc) \wedge Plastic_Product_Material(?v) \wedge hasShrinkageFactor(?v, ?SKF) \wedge swrlb:lessThan(?xti, ?xtio) \wedge swrlb:lessThan(?xtf, ?xtfo) \wedge swrlb:multiply(?xci, ?xtio, ?SKF) \wedge swrlb:multiply(?yci, ?ytio, ?SKF) \wedge swrlb:multiply(?xcf, ?xtfo, ?SKF) \wedge swrlb:multiply(?ycf, ?ytf, ?SKF) \wedge swrlb:multiply(?rc, ?ro, ?SKF) \rightarrow hasTranslation(?q, ?u)$			
Instance “?p” from the Rotational Primary Features [Rot_Primary_Features] has			
Product Transition Profile	“XTinitial” – [hasDimensionX(?p,?xti)] “YTinitial” – [hasDimensionY(?p,?yti)] “XTfinal” – [hasDimensionXf(?p,?xtf)] “YTfinal” – [hasDimensionYf(?p,?ytf)] “Radius” - [hasRadius(?p,?r)]		
Instance “?q” from the Rotational Primary Features [Rot_Primary_Features] has			
Product Transition Profile with offset	“XToff_initial” – [hasDimensionX(?q,?xtio)] “YToff_initial” – [hasDimensionY(?q,?ytio)] “XToff_final” – [hasDimensionXf(?q,?xtfo)] “YToff_final” – [hasDimensionYf(?q,?ytf)] “Radiusoff” - [hasDimensionRo(?p,?ro)]		
Instance “?u” from the Cavity Straight Line [Cav_Straight_Line] has			
Cavity Geometric Profile	“Xcav_initial” – [hasDimensionX(?u,?xci)] “Ycav_initial” – [hasDimensionY(?u,?yci)] “Xcav_final” – [hasDimensionXf(?u,?xcf)] “Ycav_final” – [hasDimensionYf(?u,?ycf)] “Rcav” - [hasRadius(?u,?rc)]		
Instance “?v” from the Plastic Product Material [Plastic_Product_Material] has			
Shrinkage factor	“Shrinkage_Factor” - [hasShrinkageFactor(?v, ?SKF)]		
Instances “?q” and “?u” will have relationship <i>if and only if</i>			
Logical Conditions	(a)	“XTinitial” is lesser than “XToff_initial”	True
	(b)	“XTfinal” is lesser than “XToff_final”	True
	(c)	“Xcav_initial” is equal to “XToff_initial” multiplied by “Shrinkage factor” (from the material)	True
	(d)	“Ycav_initial” is equal to “YToff_initial” multiplied by “Shrinkage factor”	True
	(e)	Xcav_final” is equal to “XToff_final” multiplied by “Shrinkage factor”	True
	(f)	“Ycav_final” is equal to “YToff_final” multiplied by “Shrinkage factor”	True
	(g)	“Rcav” is equal to “Radiusoff” multiplied by “Shrinkage factor”	True
Therefore, Instance “?q” is translated to the information from the instance “?u” [hasTranslation(?q, ?u)]			

6.4.2.1.2 Semantic mapping between Design for mouldability and Core insert design

This section explores the mapping between the information from product mouldability and the Core insert design in order to guarantee the correct interoperability between these two contexts. To generate the main core profile is necessary to extract the internal profile of each Rotational mouldability primary feature, located under the Parting Line. However, this translation process does not directly occur, as discussed in the section 4.3.3.2.1.1, since the profile information must be multiply by the shrinkage factor according to the material of the plastic product that will be produced.

The profile of the Rotational core insert is created by extracting the coordinates (“X_{initial}”, “Y_{initial}”, “X_{final}”, “Y_{final}”) of the internal profile (from rotational mouldability primary and transition features) located under the Parting Line plane and multiply by one plus the shrinkage correction factor (as presented in equation 4.16) resulting in (“X’_{initial}”, “Y’_{initial}”, “X’_{final}”, “Y’_{final}”), as shown in the example of Figure 103. Specifically for this research, the Parting Line is a plane and positioned on the top of the product, which implicates in no product geometry to be translated above of it.

Figure 103 Translation from Design for mouldability into Design for tooling (core insert).

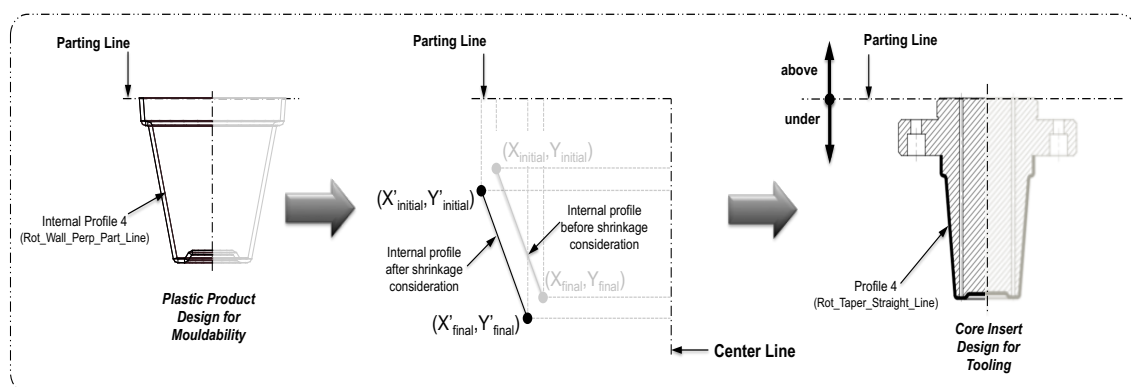

The mapping of the information translation from the product mouldability into the Core insert design profile was proposed to ensure the interoperability between these two contexts. Each Mouldability primary feature must have a relation of consistency with the Core insert design, otherwise, this information will be in conflict.

The internal profile identification is in accordance with the offset, as shown in Figure 103. The “X” and “Y” coordinates are the internal profile if the “Xinitial” and “Xfinal” coordinates are lesser than “Xinitial_{offset}” and “Xfinal_{offset}” coordinates in mouldability primary features. The “Xoffset” and “Yoffset” are the internal profile if the “Xinitial” and “Xfinal” coordinates are greater than “Xinitial_{offset}” and “Xfinal_{offset}” coordinates in Mouldability primary features. According to this context, Figure 104 represents the semantic rule for mapping the information when the offset is in the internal direction.

Figure 104 Semantic Rule for mapping the translation of the Mouldability primary features into Core straight line – internal offset direction.

Semantic Rule			
SWRL Language: $Rot_Primary_Features(?p) \wedge hasDimensionX(?p, ?xi) \wedge hasDimensionY(?p, ?yi) \wedge hasDimensionXf(?p, ?xf) \wedge hasDimensionYf(?p, ?yf) \wedge Rot_Primary_Features(?q) \wedge hasDimensionXio(?q, ?xio) \wedge hasDimensionYio(?q, ?yio) \wedge hasDimensionXfo(?q, ?xfo) \wedge hasDimensionYfo(?q, ?yfo) \wedge Core_Straight_Line(?u) \wedge hasDimensionX(?u, ?xcoi) \wedge hasDimensionY(?u, ?ycoi) \wedge hasDimensionXf(?u, ?xcof) \wedge hasDimensionYf(?u, ?ycof) \wedge Plastic_Product_Material(?v) \wedge hasShrinkageFactor(?v, ?SKF) \wedge swrlb:lessThanOrEqual(?xi, ?xio) \wedge swrlb:lessThanOrEqual(?xf, ?xfo) \wedge swrlb:multiply(?xcoi, ?xi, ?SKF) \wedge swrlb:multiply(?ycoi, ?yi, ?SKF) \wedge swrlb:multiply(?xcof, ?xf, ?SKF) \wedge swrlb:multiply(?ycof, ?yf, ?SKF) \rightarrow hasTranslation(?p, ?u)$			
Instance “?p” from the Rotational Primary Features [Rot_Primary_Features] has			
Product Geometric Profile	“Xinitial” – [hasDimensionX(?p,?xi)] “Yinitial” – [hasDimensionY(?p,?yi)] “Xfinal” – [hasDimensionXf(?p,?xf)] “Yfinal” – [hasDimensionYf(?p,?yf)]		
Instance “?q” from the Rotational Primary Features [Rot_Primary_Features] has			
Product Geometric Profile with offset	“Xoff_initial” – [hasDimensionX(?q,?xio)] “Yoff_initial” – [hasDimensionY(?q,?yio)] “Xoff_final” – [hasDimensionXf(?q,?xfo)] “Yoff_final” – [hasDimensionYf(?q,?yfo)]		
Instance “?u” from the Core Straight Line [Core_Straight_Line] has			
Core Geometric Profile	“Xcore_initial” – [hasDimensionX(?u,?xcoi)] “Ycore_initial” – [hasDimensionY(?u,?ycoi)] “Xcore_final” – [hasDimensionXf(?u,?xcof)] “Ycore_final” – [hasDimensionYf(?u,?ycof)]		
Instance “?v” from the Plastic Product Material [Plastic_Product_Material] has			
Shrinkage factor	“Shrinkage_Factor” - [hasShrinkageFactor(?v, ?SKF)]		
Instances “?p” and “?u” will have relationship <i>if and only if</i>			
Logical Conditions	(a)	“Xinitial” is lesser than or equal “Xoff_initial”	True
	(b)	“Xfinal” is lesser than or equal “Xoff_final”	True
	(c)	“Xcore_initial” is equal to “Xinitial” multiplied by “Shrinkage factor” (from the material)	True
	(d)	“Ycore_initial” is equal to “Yinitial” multiplied by “Shrinkage factor”	True
	(e)	Xcore_final” is equal to “Xfinal” multiplied by “Shrinkage factor”	True
	(f)	“Ycore_final” is equal to “Yfinal” multiplied by “Shrinkage factor”	True
Therefore, Instance “?u” is translated to the information from the instance “?p” [hasTranslation(?p, ?u)]			

Figure 105 represents the semantic rule for the mapping of the information translation from the Product mouldability into the Core insert design profile when the offset is external.

Figure 105 Semantic Rule for mapping the translation of the Mouldability primary features into Core straight line – external offset direction.

Semantic Rule			
SWRL Language: $Rot_Primary_Features(?p) \wedge hasDimensionX(?p, ?xi) \wedge hasDimensionY(?p, ?yi) \wedge hasDimensionXf(?p, ?xf) \wedge hasDimensionYf(?p, ?yf) \wedge Rot_Primary_Features(?q) \wedge hasDimensionXio(?q, ?xio) \wedge hasDimensionYio(?q, ?yio) \wedge hasDimensionXfo(?q, ?xfo) \wedge hasDimensionYfo(?q, ?yfo) \wedge Core_Straight_Line(?u) \wedge hasDimensionX(?u, ?xcoi) \wedge hasDimensionY(?u, ?ycoi) \wedge hasDimensionXf(?u, ?xcof) \wedge hasDimensionYf(?u, ?ycof) \wedge Plastic_Product_Material(?v) \wedge hasShrinkageFactor(?v, ?SKF) \wedge swrlb:greaterThan(?xi, ?xio) \wedge swrlb:greaterThan(?xf, ?xfo) \wedge swrlb:multiply(?xcoi, ?xio, ?SKF) \wedge swrlb:multiply(?ycoi, ?yio, ?SKF) \wedge swrlb:multiply(?xcof, ?xfo, ?SKF) \wedge swrlb:multiply(?ycof, ?yfo, ?SKF) \rightarrow hasTranslation(?q, ?u)$			
Instance “?p” from the Rotational Primary Features [Rot_Primary_Features] has			
Product Geometric Profile	“Xinitial” – [hasDimensionX(?p,?xi)] “Yinitial” – [hasDimensionY(?p,?yi)] “Xfinal” – [hasDimensionXf(?p,?xf)] “Yfinal” – [hasDimensionYf(?p,?yf)]		
Instance “?q” from the Rotational Primary Features [Rot_Primary_Features] has			
Product Geometric Profile with offset	“Xoff_initial” – [hasDimensionX(?q,?xio)] “Yoff_initial” – [hasDimensionY(?q,?yio)] “Xoff_final” – [hasDimensionXf(?q,?xfo)] “Yoff_final” – [hasDimensionYf(?q,?yfo)]		
Instance “?u” from the Core Straight Line [Core_Straight_Line] has			
Core Geometric Profile	“Xcore_initial” – [hasDimensionX(?u,?xcoi)] “Ycore_initial” – [hasDimensionY(?u,?ycoi)] “Xcore_final” – [hasDimensionXf(?u,?xcof)] “Ycore_final” – [hasDimensionYf(?u,?ycof)]		
Instance “?v” from the Plastic Product Material [Plastic_Product_Material] has			
Shrinkage factor	“Shrinkage_Factor” - [hasShrinkageFactor(?v, ?SKF)]		
Instances “?q” and “?u” will have relationship <u>if and only if</u>			
Logical Conditions	(a)	“Xinitial” is greater than “Xoff_initial”	True
	(b)	“Xfinal” is greater than “Xoff_final”	True
	(c)	“Xcore_initial” is equal to “Xinitial” multiplied by “Shrinkage factor” (from the material)	True
	(d)	“Ycore_initial” is equal to “Yinitial” multiplied by “Shrinkage factor”	True
	(e)	Xcore_final” is equal to “Xfinal” multiplied by “Shrinkage factor”	True
	(f)	“Ycore_final” is equal to “Yfinal” multiplied by “Shrinkage factor”	True
Therefore, Instance “?u” is translated to the information from the instance “?q” [hasTranslation(?q, ?u)]			

The same idea is applied to the translation of the Mouldability transition features into Core insert curve line. The profile of the Core insert follows the internal profile of the product. However, it is necessary to analyse the offset direction. The “X” and “Y” coordinates are the internal profile if and only if the Mouldability transition

features coordinates “Xinitial” and “Xfinal” are lesser than “Xinitial_{offset}” and “Xfinal_{offset}” are true. Otherwise, the condition will be the “Xoffset” and “Yoffset” coordinates as internal profile if the Mouldability transition features coordinates “Xinitial” and “Xfinal” are greater than “Xinitial_{offset}” and “Xfinal_{offset}” coordinates.

In this context, Figure 106 depicts the semantic mapping between the Rotational transition features and the Core curve line if the offset is internal.

Figure 106 Semantic Rule for mapping the translation from Mouldability transition features into Core curve line – internal offset direction.

Semantic Rule			
SWRL Language: $Rot_Transition_Features(?p) \wedge hasDimensionX(?p, ?xti) \wedge hasDimensionY(?p, ?yti) \wedge hasDimensionXf(?p, ?xtf) \wedge hasDimensionYf(?p, ?ytf) \wedge hasRadius(?p, ?r) \wedge Rot_Transition_Features(?q) \wedge hasDimensionXio(?q, ?xtio) \wedge hasDimensionYio(?q, ?ytio) \wedge hasDimensionXfo(?q, ?xtfo) \wedge hasDimensionYfo(?q, ?ytf) \wedge hasRadiusRo(?q, ?ro) \wedge Core_Curve_Line(?u) \wedge hasDimensionX(?u, ?xcoi) \wedge hasDimensionY(?u, ?ycoi) \wedge hasDimensionXf(?u, ?xcof) \wedge hasDimensionYf(?u, ?ycof) \wedge hasRadius(?u, ?rc) \wedge Plastic_Product_Material(?v) \wedge hasShrinkageFactor(?v, ?SKF) \wedge swrlb:lessThanOrEqual(?xti, ?xtio) \wedge swrlb:lessThanOrEqual(?xtf, ?xtfo) \wedge swrlb:multiply(?xcoi, ?xti, ?SKF) \wedge swrlb:multiply(?ycoi, ?yti, ?SKF) \wedge swrlb:multiply(?xcof, ?xtf, ?SKF) \wedge swrlb:multiply(?ycof, ?ytf, ?SKF) \wedge swrlb:multiply(?rc, ?r, ?SKF) \rightarrow hasTranslation(?p, ?u)$			
Instance “?p” from the Rotational Primary Features [Rot_Primary_Features] has			
Product Transition Profile	“XTinitial” – [hasDimensionX(?p,?xti)] “YTinitial” – [hasDimensionY(?p,?yti)] “XTfinal” – [hasDimensionXf(?p,?xtf)] “YTfinal” – [hasDimensionYf(?p,?ytf)] “Radius” - [hasRadius(?p,?r)]		
Instance “?q” from the Rotational Primary Features [Rot_Primary_Features] has			
Product Transition Profile with offset	“XToff_initial” – [hasDimensionX(?q,?xtio)] “YToff_initial” – [hasDimensionY(?q,?ytio)] “XToff_final” – [hasDimensionXf(?q,?xtfo)] “YToff_final” – [hasDimensionYf(?q,?ytf)] “Radiusoff” - [hasDimensionRo(?p,?ro)]		
Instance “?u” from the Core Straight Line [Cav_Straight_Line] has			
Core Geometric Profile	“Xcore_initial” – [hasDimensionX(?u,?xcoi)] “Ycore_initial” – [hasDimensionY(?u,?ycoi)] “Xcore_final” – [hasDimensionXf(?u,?xcof)] “Ycore_final” – [hasDimensionYf(?u,?ycof)] “Rcore” - [hasRadius(?u,?rc)]		
Instance “?v” from the Plastic Product Material [Plastic_Product_Material] has			
Shrinkage factor	“Shrinkage_Factor” - [hasShrinkageFactor(?v, ?SKF)]		
Instances “?p” and “?u” will have relationship <i>if and only if</i>			
Logical Conditions	(a)	“XTinitial” is lesser than or equal “XToff_initial”	True
	(b)	“XTfinal” is lesser than or equal “XToff_final”	True
	(c)	“Xcore_initial” is equal to “XTinitial” multiplied by “Shrinkage factor” (from the material)	True
	(d)	“Ycore_initial” is equal to “YTinitial” multiplied by “Shrinkage factor”	True
	(e)	“Xcore_final” is equal to “XTfinal” multiplied by “Shrinkage factor”	True
	(f)	“Ycore_final” is equal to “YTfinal” multiplied by “Shrinkage factor”	True
	(g)	“Rcore” is equal to “Radius” multiplied by “Shrinkage factor”	True
Therefore, Instance “?p” is translated to the information from the instance “?u” [hasTranslation(?p, ?u)]			

Figure 107 depicts the semantic mapping between the Rotational transition features and the Core curve line if the offset is external.

Figure 107 Semantic Rule for mapping the translation from Mouldability transition features into Core curve line – external offset direction.

Semantic Rule			
SWRL Language: $Rot_Transition_Features(?p) \wedge hasDimensionX(?p, ?xti) \wedge hasDimensionY(?p, ?yti) \wedge hasDimensionXf(?p, ?xtf) \wedge hasDimensionYf(?p, ?ytf) \wedge hasRadius(?p, ?r) \wedge Rot_Transition_Features(?q) \wedge hasDimensionXio(?q, ?xtio) \wedge hasDimensionYio(?q, ?ytio) \wedge hasDimensionXfo(?q, ?xtfo) \wedge hasDimensionYfo(?q, ?ytf) \wedge hasRadiusRo(?q, ?ro) \wedge Core_Curve_Line(?u) \wedge hasDimensionX(?u, ?xcoi) \wedge hasDimensionY(?u, ?ycoi) \wedge hasDimensionXf(?u, ?xcof) \wedge hasDimensionYf(?u, ?ycof) \wedge hasRadius(?u, ?rc) \wedge Plastic_Product_Material(?v) \wedge hasShrinkageFactor(?v, ?SKF) \wedge swrlb:greaterThan(?xti, ?xtio) \wedge swrlb:greaterThan (?xtf, ?xtfo) \wedge swrlb:multiply (?xcoi, ?xtio, ?SKF) \wedge swrlb:multiply (?ycoi, ?yti, ?SKF) \wedge swrlb:multiply(?xcof, ?xtfo, ?SKF) \wedge swrlb:multiply(?ycof, ?ytf, ?SKF) \wedge swrlb:multiply (?rc, ?r, ?SKF) \rightarrow hasTranslation(?q, ?u)$			
Instance “?p” from the Rotational Primary Features [Rot_Primary_Features] has			
Product Transition Profile	“XTinitial” – [hasDimensionX(?p,?xti)] “YTinitial” – [hasDimensionY(?p,?yti)] “XTfinal” – [hasDimensionXf(?p,?xtf)] “YTfinal” – [hasDimensionYf(?p,?ytf)] “Radius” - [hasRadius(?p,?r)]		
Instance “?q” from the Rotational Primary Features [Rot_Primary_Features] has			
Product Transition Profile with offset	“XToff_initial” – [hasDimensionX(?q,?xtio)] “YToff_initial” – [hasDimensionY(?q,?ytio)] “XToff_final” – [hasDimensionXf(?q,?xtfo)] “YToff_final” – [hasDimensionYf(?q,?ytf)] “Radiusoff” - [hasDimensionRo(?p,?ro)]		
Instance “?u” from the Core Straight Line [Cav_Straight_Line] has			
Core Geometric Profile	“Xcore_initial” – [hasDimensionX(?u,?xcoi)] “Ycore_initial” – [hasDimensionY(?u,?ycoi)] “Xcore_final” – [hasDimensionXf(?u,?xcof)] “Ycore_final” – [hasDimensionYf(?u,?ycof)] “Rcore” - [hasRadius(?u,?rc)]		
Instance “?v” from the Plastic Product Material [Plastic_Product_Material] has			
Shrinkage factor	“Shrinkage_Factor” - [hasShrinkageFactor(?v, ?SKF)]		
Instances “?q” and “?u” will have relationship <i>if and only if</i>			
Logical Conditions	(a)	“XTinitial” is greater than “XToff_initial”	True
	(b)	“XTfinal” is greater than “XToff_final”	True
	(c)	“Xcore_initial” is equal to “XToff_initial” multiplied by “Shrinkage factor” (from the material)	True
	(d)	“Ycore_initial” is equal to “YToff_initial” multiplied by “Shrinkage factor”	True
	(e)	Xcore_final” is equal to “XToff_final” multiplied by “Shrinkage factor”	True
	(f)	“Ycore_final” is equal to “YToff_final” multiplied by “Shrinkage factor”	True
	(g)	“Rcore” is equal to “Radius” multiplied by “Shrinkage factor”	True
Therefore, Instance “?q” is translated to the information from the instance “?u” [hasTranslation(?q, ?u)]			

6.4.2.2 Semantic mapping between Design for tooling and Design for machining

This section explores the semantic mapping between the information of Design for tooling (cavity insert and core insert) and Design for machining. Figure 108 highlights the critical information that needs to be exchanged between these two contexts. The machining features are associated with Rotational Cavity Manufacturing and Rotational Core Manufacturing. The semantic mapping occurs between the Rotational Cavity Individual Geometric Profile (*Cav_Ind_Geometric_Profile*) and Rotational Cavity Manufacturing (*Rot_Cav_Manufacturing*), Rotational Cavity Insert Main Body (*Cav_Ext_Geometric_Profile*) and Rotational Cavity Insert Main Body Manufacturing (*Rot_Cav_Main_Body_Manufacturing*), Rotational Core Individual Geometric Profile (*Core_Ind_Geometric_Profile*) and Rotational Core Insert Main Body Manufacturing (*Rot_Core_Manufacturing*), Rotational Core Insert Main Body (*Core_Ext_Geometric_Profile*) and Rotational Core Insert Main Body Manufacturing (*Rot_Core_Main_Body_Manufacturing*). The subsequent sections explore the semantic mapping to support the relationships between Design for tooling and Design for machining.

Figure 108 Information to be mapped from Design for mouldability to Cavity and Core design in the Design for tooling.

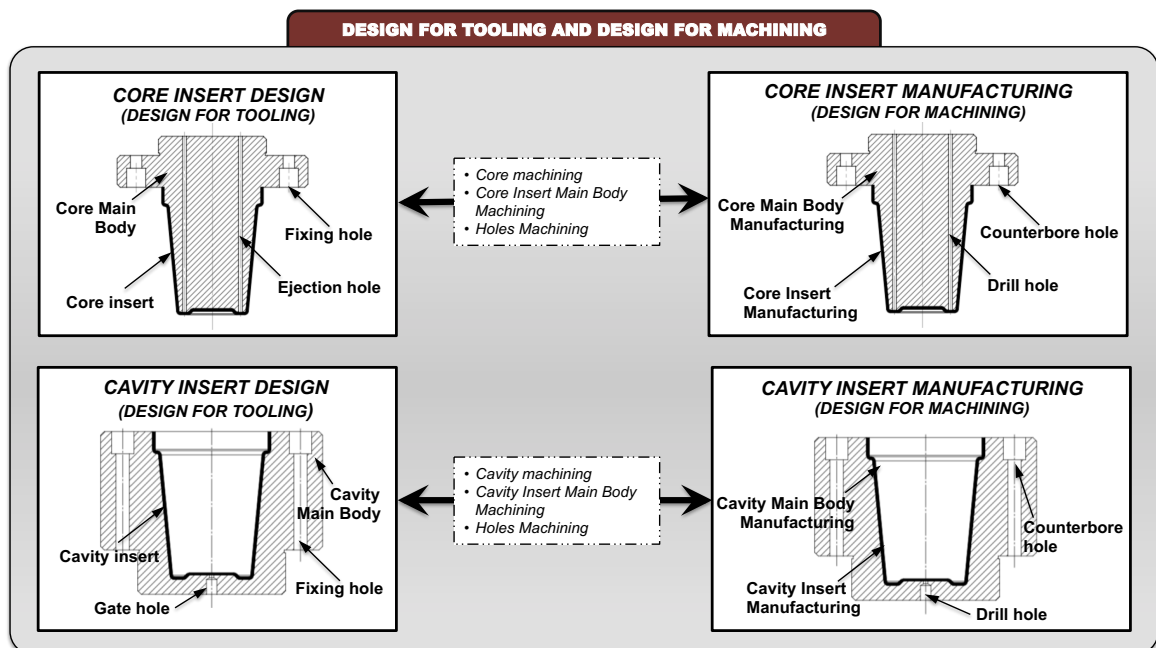

6.4.2.2.1 Semantic mapping between Cavity design features and Cavity manufacturing

This section explores the semantic mapping between the information contained in the Rotational Cavity (*Rot_Cav - Design for Tooling*) and Rotational Cavity Manufacturing (*Rot_Cav_Manufacturing - Design for Machining*). This mapping occurs with the information contained in the Cavity Individual Geometric Profiles (*Cavity_Ind_Geometric_Profile*), which has the Cavity straight line profiles, Cavity curve line profiles as well as the material of the insert.

Cavity insert design is manufactured by boring machining process as discussed in the section 6.4.2.2. The Rotational cavity straight line profiles (*Cav_Straight_Line*) and Rotational cavity curve line profiles (*Cav_Curve_Line*) are related to Rotational cavity manufacturing (*Rot_Cav_Manufacturing*) and they are associated with the boring machining process. These relationships were already established in the section 6.4.1.3.2, where the parallel profiles are related to the facing boring machining; the perpendicular profiles are related to the horizontal boring machining; the taper profiles are related to the taper boring machining; and curve profiles are related to the curve boring machining. Figure 109 demonstrates the translation process from Rotational Cavity into Rotational Cavity Manufacturing. The information in Cavity Individual Geometric is related to the Rotational Cavity Manufacturing, and automatically the semantic reconciliation established correct relations inside the specific context of the design for machining since the whole semantic mapping is already created.

Figure 109 Translation from Cavity insert design into Cavity insert manufacturing.

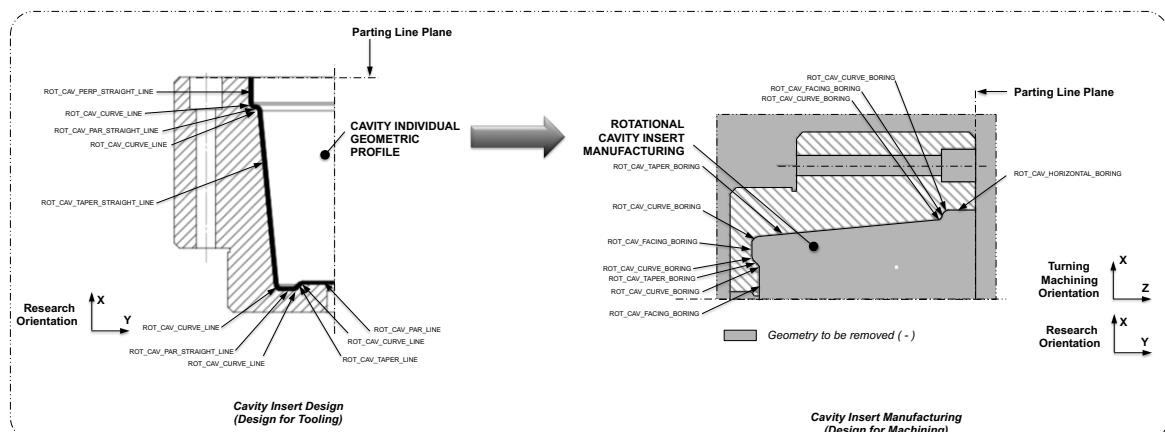

In this context, Figure 107 presents the semantic rule to establish the relation between the instances from the Cavity individual geometric profile and Cavity insert manufacturing.

Figure 110 Semantic Rule for mapping the relation between Cavity insert design and Cavity insert manufacturing.

Semantic Rule

SWRL Language:
Cav_Ind_Geometric_Profile(?p) -> Rot_Cav_Manufacturing(?p)

The formal remarks that support the definition of the semantic mapping to partly reconcile the Rotational cavity individual geometry and Rotational cavity manufacturing presented Figure 110, state:

- The instance “?p” from the Rotational cavity individual geometric profile [*Cav_Ind_Geometric_Profile*] is mapped as the instance “?p” in Rotational cavity manufacturing” [*Rot_Cav_Manufacturing*].

6.4.2.2.2 Semantic mapping between Cavity design main body features and Cavity main body manufacturing

This section explores the semantic mapping between the information contained in the Rotational Cavity Insert Main Body (*Rot_Cav_Insert_Main_Body - Design for Tooling*) and Rotational Cavity Main Body Manufacturing (*Rot_Cav_Main_Body_Manufacturing – Design for Machining*). This mapping occurs with the information contained in the Cavity External Geometric Profile (*Cavity_Ext_Geometric_Profile*), which has the Cavity external straight line profiles and Cavity external curve line profiles.

The cavity insert main body design is manufactured by turning machining process as discussed in the section 6.4.2.2 The Rotational cavity external straight line profiles (*Cav_Ext_Straight_Line*) and Rotational cavity external curve line profiles (*Cav_Ext_Curve_Line*) are related to the Rotational cavity main body manufacturing (*Rot_Cav_MB_Manufacturing*), and they are associated with the Turning machining

process. These relationships were already established in the section 6.4.1.3.2, where the parallel profiles are relating to the facing turning machining; the perpendicular profiles are related to the horizontal turning machining; the taper profiles are related to the taper turning machining; and curve profiles are related to the curve turning machining.

Figure 111 shows the translation process from Rotational Cavity Main Body into Rotational Cavity Main Body Manufacturing. The information in Cavity External Geometric is related to the Rotational Cavity Main Body Manufacturing, and automatically the semantic reconciliation is established correct relations inside the specific context of the Design for machining.

Figure 111 Translation from Cavity insert main body design into Cavity insert manufacturing.

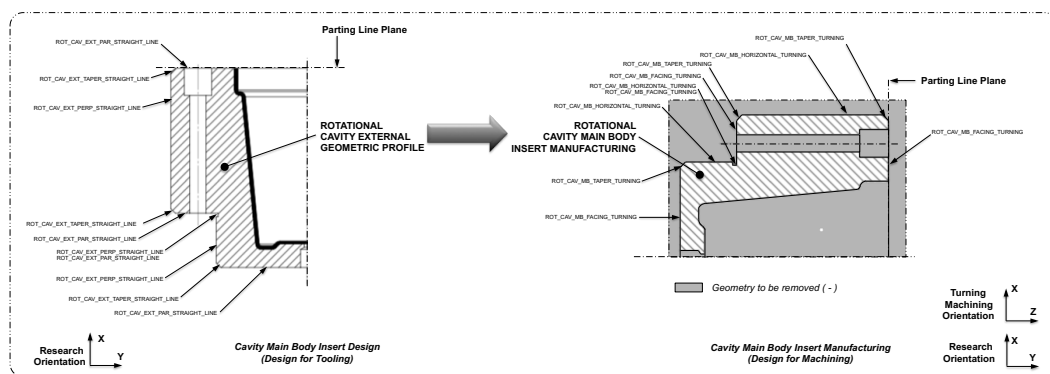

In this context, Figure 112 presents the semantic rule adopted to establish the relation between the instances from Cavity individual geometric profile and Cavity insert manufacturing.

Figure 112 Semantic Rule for mapping the relation between Cavity insert main body design and Cavity insert main body manufacturing.

Semantic Rule

SWRL Language:

Cav_Ext_Geometric_Profile(?p) -> Rot_Cav_Main_Body_Manufacturing(?p)

The formal remarks that support the definition of the semantic mapping to partly reconcile Rotational cavity external geometry profile and Rotational cavity main body manufacturing presented Figure 112, state:

- The instance “?p” from the Rotational cavity external geometric profile [*Cav_Ext_Geometric_Profile*] is mapped as the instance “?p” in Rotational cavity main body manufacturing (*Rot_Cav_Main_Body_Manufacturing*).

6.4.2.2.3 Semantic mapping between Core design features and Core insert manufacturing

This section explores the semantic mapping between the information contained in the Rotational Core Insert (*Rot_Core_Insert - Design for Tooling*) and Rotational Core Insert Manufacturing (*Rot_Core_Insert_Manufacturing – Design for Machining*). This mapping occurs with the information contained in the Core Individual Geometric Profile (*Core_Ind_Geometric_Profile*), which has the Core straight line profiles and Core curve line profiles.

Core insert main body design is manufactured by turning machining process as discussed in the section 6.4.2.2. The Rotational core straight line profiles (*Core_Straight_Line*) and Rotational core curve line profiles (*Core_Curve_Line*) are related to Rotational core insert manufacturing (*Rot_Core_Manufacturing*), and they are associated with the Turning machining process. These relationships were already established in the section 6.4.1.3.1, where the parallel profiles are related to the facing turning machining; the perpendicular profiles are related to the horizontal turning machining; the taper profiles are related to the taper turning machining; and curve profiles are related to the Curve turning machining.

Figure 113 illustrates the translation process from Rotational Core Insert Design into Rotational Core Insert Main Body Manufacturing. The information in Core Individual Geometric Profile is related to the Rotational Core Insert Manufacturing, and the semantic reconciliation is automatically established correct relations inside the specific context of the design for machining.

Figure 113 Translation from Core insert design into Core insert manufacturing.

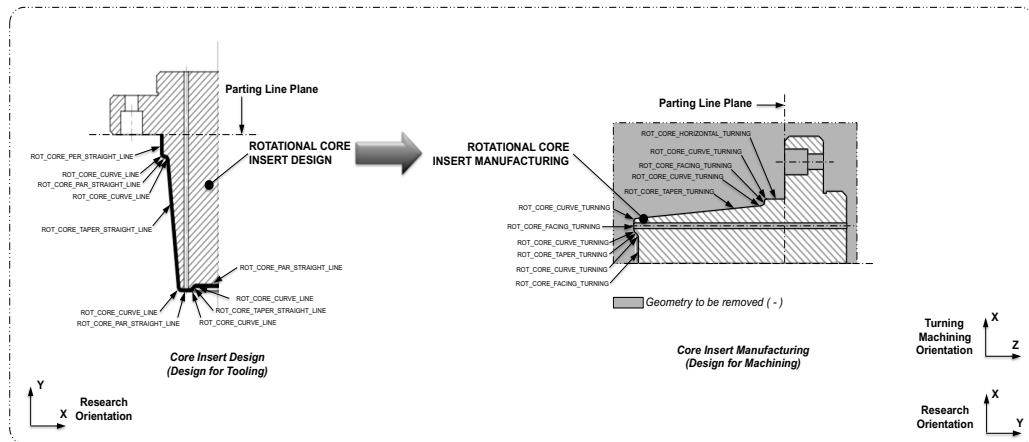

In this context, Figure 114 presents the semantic rule adopted to establish the relation between the instances from the Core individual geometric profile and Core insert manufacturing.

Figure 114 Semantic Rule for mapping the relation between Core insert design and Core insert manufacturing.

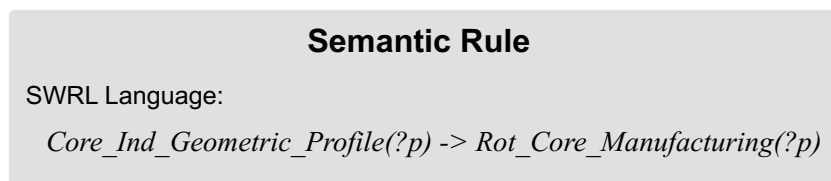

The formal remarks that support the definition of the semantic mapping to partly reconcile Rotational core individual geometry profile and Rotational core manufacturing presented Figure 114, state:

- The instance “?p” from the Rotational core individual geometric profile [*Core_Ind_Geometric_Profile*] is mapped as the instance “?p” in Rotational core insert manufacturing [*Rot_Core_Manufacturing*].

6.4.2.2.4 Semantic mapping between Core main body design features and Core main body manufacturing

This section explores the semantic mapping between the information contained in the Rotational Core Insert Main Body (*Rot_Core_Insert_Main_Body* -

Design for Tooling) and Rotational Core Insert Main Body Manufacturing (*Rot_Core_Insert_Main_Body_Manufacturing – Design for Machining*). This mapping occurs with the information contained in the Core External Geometric Profile (*Core_Ext_Geometric_Profile*), which has the Core external straight line profiles and Core external curve line profiles.

Core insert main body design is manufactured by turning machining process as discussed in the section 6.4.2.2. The Rotational core external straight line profiles (*Core_Ext_Straight_Line*) and Rotational core external curve line profiles (*Core_Curve_Line*) are related to Rotational core insert main body manufacturing (*Rot_Core_Main_Body_Manufacturing*), and they are associated with the turning machining process. These relationships were already established in the section 6.4.1.3.1, where the parallel profiles are related to the facing turning machining; the perpendicular profiles are related to the horizontal turning machining; the taper profiles are related to the taper turning machining; and curve profiles are related to the curve turning machining.

Figure 115 exemplifies the translation process from Rotational Core Insert Main Body Design into Rotational Core Insert Main Body Manufacturing. The information in Core External Geometric Profile is related to the Rotational Core Insert Main Body Manufacturing, and the semantic reconciliation is automatically established correct relations inside the specific context of the design for machining.

Figure 115 Translation from Core insert main body design into Core insert main body manufacturing.

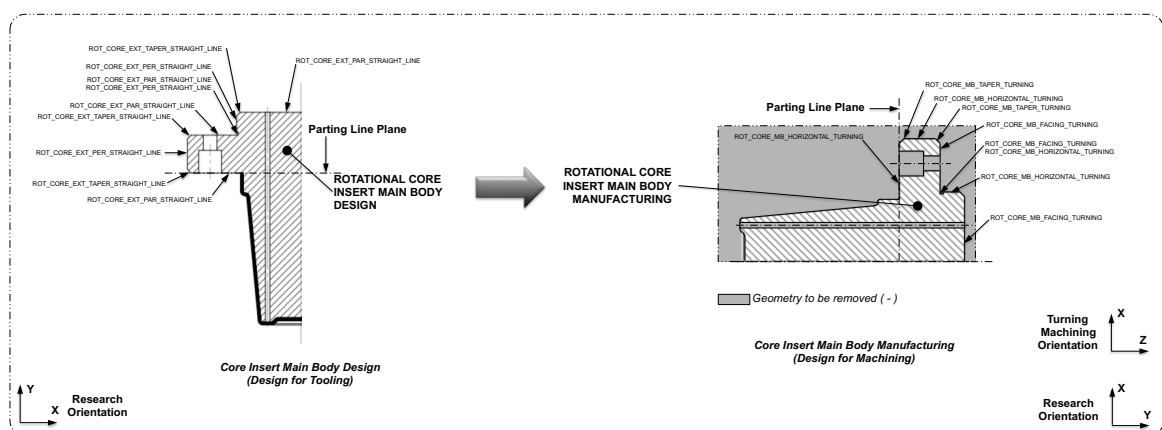

In this context, Figure 116 presents the semantic rule adopted to establish the relation between the instances from the Core external geometric profile and Core main body manufacturing.

Figure 116 Semantic Rule for mapping the relation between core insert design and core insert manufacturing.

Semantic Rule

SWRL Language:
Core_Ext_Geometric_Profile(?p) -> Rot_Core_Main_Body_Manufacturing(?p)

The formal remarks that support the definition of the semantic mapping to partly reconcile Rotational core external geometry profile and Rotational Core main body manufacturing presented Figure 116, state:

- The instance “?p” from the Rotational core external geometric profile [*Core_Ext_Geometric_Profile*] is mapped as the instance “?p” in Rotational core main body insert manufacturing [*Rot_Core_Main_Body_Manufacturing*].

6.4.2.3 Semantic mapping between Mould holes design and Mould holes manufacturing

This section explores the semantic mapping between the information contained in the Mould Holes Design (*Mould_Hole - Design for Tooling*) and Mould Hole Manufacturing (*Mould_Hole_Manufacturing – Design for Machining*). This mapping can be applied to core and cavity inserts (fixing, ejection and gate holes) and convert into Drilling Machining Process. The information from the Mould holes design is directly shared with the machining process.

In this context, Figure 117 presents the semantic rule adopted to establish the relation between the instances from the Mould holes design and Mould holes manufacturing.

Figure 117 Semantic Rule to the mapping the relation between Mould holes design and Mould holes manufacturing.

Semantic Rule

SWRL Language:

Mould_Hole(?p) -> Mould_Hole_Manufacturing(?p)

The formal remarks that support the definition of the semantic mapping to partly reconcile Mould holes and Mould holes manufacturing presented Figure 117, state:

- The instance “?p” from the Mould hole [*Mould_Hole*] is mapped as the instance “?p” in Mould hole manufacturing [*Mould_Hole_Manufacturing*].

The next chapter will present the implementation of the proposed conceptual framework experimental prototype.

7 EXPERIMENTAL SYSTEM DEVELOPMENT

The development of an experimental system to corroborate the concepts of the proposed conceptual framework is documented in this Chapter. The experimental system, called Interoperable Product Design and Manufacturing System (IPDMS) was implemented according to the framework Views (conceptually described in Chapters 4, 5 and 6) for supporting the semantic interoperability information in Product Design and Manufacturing. The IPDMS provides a formal information structure and its intra and inter contexts relationships of rotational thin-wall plastic injected products. Section 7.1 presents an overview of the Experimental IPDMS Design and Section 7.2 shows the Implementation of each View of the proposed conceptual framework and their semantic relationships.

7.1 EXPERIMENTAL SYSTEM DESIGN

There are different aspects involved in the experimental system design for evaluating the research framework as following: (i) the selection of the relevant software applications and (ii) the selection of the ontology modelling tool. The resources have been selected based on their availability for research and other preferences for this work:

- Protégé V5.0¹ was developed by Stanford Centre for Biomedical Informatics Research. Protégé is an ontological environment capable of handling and model ontology in OWL Language. Additionally, this tool allows the creation of semantic rules in SWRL. Protégé tool constitutes the primary environment for developing the experimental system core ontology creation.
- NetBeans IDE 8.02² is a free and open source software development platform developed by Oracle that allows an Integrated Development Environment (IDE). The NetBeans IDE is primarily intended for Java

¹ <http://protege.stanford.edu>

² <https://netbeans.org/downloads/>

development, but it also supports other languages such as PHP, C/C++ and HTML5. NetBeans works based on modules, providing flexibility and interoperability with different plug-in, like Apache Jena that is highly recommended for this research. Additionally, the user interface development environment is provided by Netbeans, offering user interactivity.

- Apache Jena³ is a free and open source Java framework for building semantic web and linked data applications. Jena is composed of different APIs (Applications Programming Interface) like RDF API, SPARQL API, OWL API. OWL API is fundamental for this research as it provides support for integration between the Netbeans and the core ontologies modelled in Protégé. Furthermore, Jena supports the inferences according to the semantic rules proposed in SWRL.
- SolidWorks 2012⁴ is a solid modelling computer program that associates the concepts of Computer-Aided Design (CAD) and Computer-Aided Engineering (CAE). It was developed by Dassault Systèmes and more than 230.400 organisations worldwide uses the tool, according to the SolidWorks Corporation 2016. This tool is fundamental for this research since it allows the users to create the first geometric profile and to interoperate the information of the product design and manufacturing of the rotational plastic injected products.

In this context, Figure 118 illustrates the software used to perform the experimental Interoperable Product Design and Manufacturing System for each view of the framework approach. Detail "A" presents the use of Protégé for the core ontology implementation in the Reference View. The Application Domain View and the Reconciliation View were implemented through the integration between Netbeans and Apache Jena, as shown in Details "B", "C" and "D". Detail "D" demonstrates a relation between the SolidWorks and IPDMS through the XML (eXtensible Markup

³ <https://jena.apache.org>

⁴ <http://www.solidworks.com>

Language) file. This relation is fundamental in order to provide the first information about the product as well as to represent the development of the information across different phases of the Product Design and Manufacturing.

Figure 118 Architecture of the experimental system.

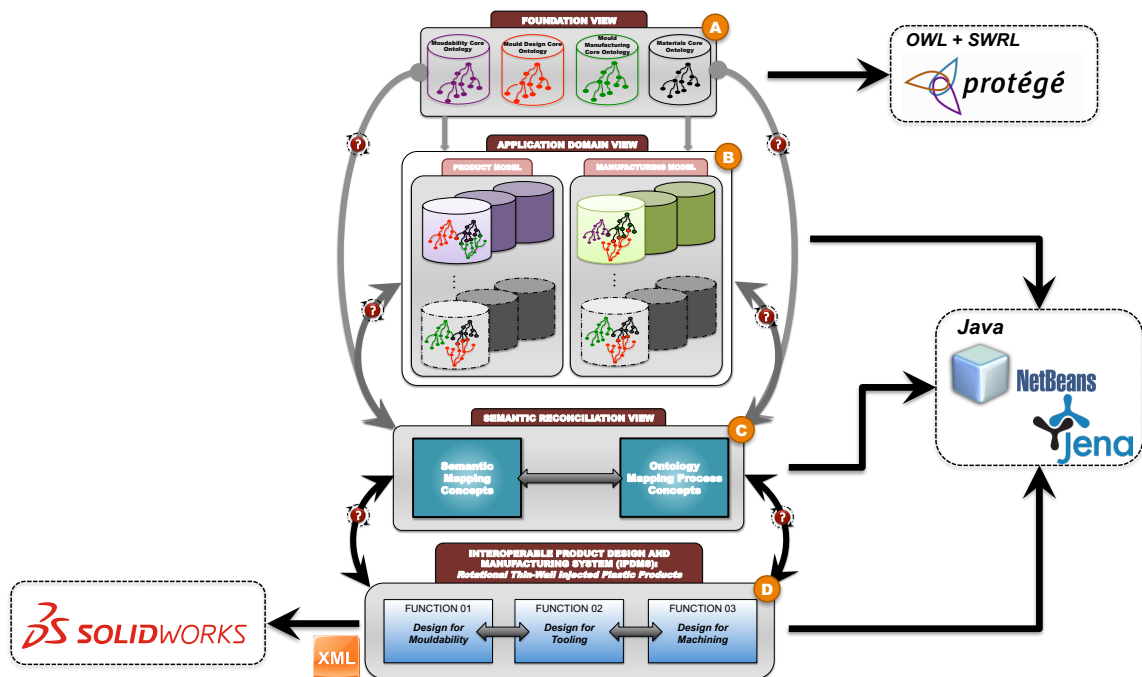

7.2 EXPERIMENTAL SYSTEM IMPLEMENTATION

This section presents in details the implementation of the Interoperable Product Design and Manufacturing System (IPDMS) oriented to the rotational thin-wall plastic injected products. Section 7.2.1 depicts the implementation of the Reference View; section 7.2.2 demonstrates the implementation of the Application Domain View and the Reconciliation View in the Design for Mouldability context. The implementation of the Application Domain view and the Reconciliation View in the Design for Tooling context is presented in section 7.2.3; and finally, section 7.2.4 demonstrates the implementation of the Application Domain View and the Reconciliation View in the Design for Machining context.

7.2.1 Reference View Implementation

The implementation of the Reference View is at the base of the Experimental System development process. All the concepts discussed in Chapter 4 have been modelled by Protégé Tool in OWL (Web Ontology Language). The concepts presented in the data structures of the Rotational Mouldability (section 4.1), Rotational Mould Design (section 4.2), Mould Manufacturing (section 4.3) and Materials (section 4.4) were converted to core ontology in OWL following the Knowledge Engineering Methodology proposed by Noy and McGuinness (2001). Figure 119 shows an example of the Rotational mouldability core ontology ("Rotational_Mouldability_Core") modelled in Protégé Tool.

Figure 119 Rotational mouldability core ontology modelled in Protégé Tool.

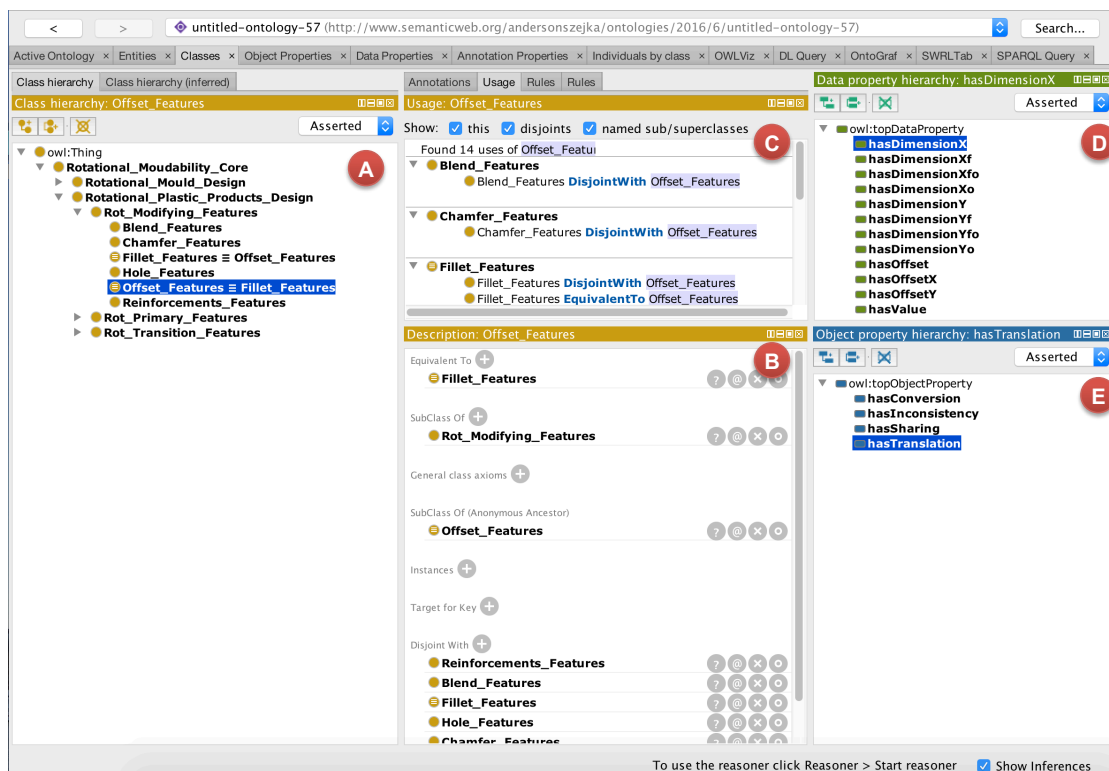

Detail "A" presents the class hierarchy of the Rotational mouldability core ("Rotational_Mouldability_Core") that was structured according to the Rotational mouldability data structure presented in the section 4.1.3. Detail "B" is the Protégé environment that allows the subclasses ("SubClassOf") definition, the equivalence of classes ("EquivalentTo"), the disjoint of classes ("DisjointWith"), as well as it allows

the association of instances to this class ("Instances"), which it is fundamental to the ontology specialisation and so on. Detail "C" shows a summary of the relations already established in the ontology. Details "D" and "E" show the datatype properties and object properties, respectively, used to establish the relations between individuals or to insert data of the individuals into the ontology, as recommended by W3C (2012).

Object properties link instance to instance while datatype properties link instances to data values. Within this research, Data properties are attributes of data from the geometric profile into the ontology while object properties are relationships of semantic mapping. The relationships can be (i) mapping translation, (ii) mapping conversion or (iii) mapping sharing. However, the datatype properties and object properties are instantiated in the Application Domain View through the ontology specialisation and in the Semantic Reconciliation View through semantic rules.

In this context, the data structures explored in Chapter 4 were converted into Rotational mouldability core ontology, Rotational mould design core ontology, Mould manufacturing core ontology, Machining features and finally, Materials core ontology. The core ontologies formalised in OWL were loaded in the IPDMS through a specific interface, named "Reference View". In the button "Insert Ontology" is possible to add new core ontology in the system, as shown in Detail "A" of Figure 117. Detail "B" shows the interface for searching the core ontology modelled in the Protégé and stored in the System.

Figure 120 Detail of the process of loading new core ontology into the IPDMS.

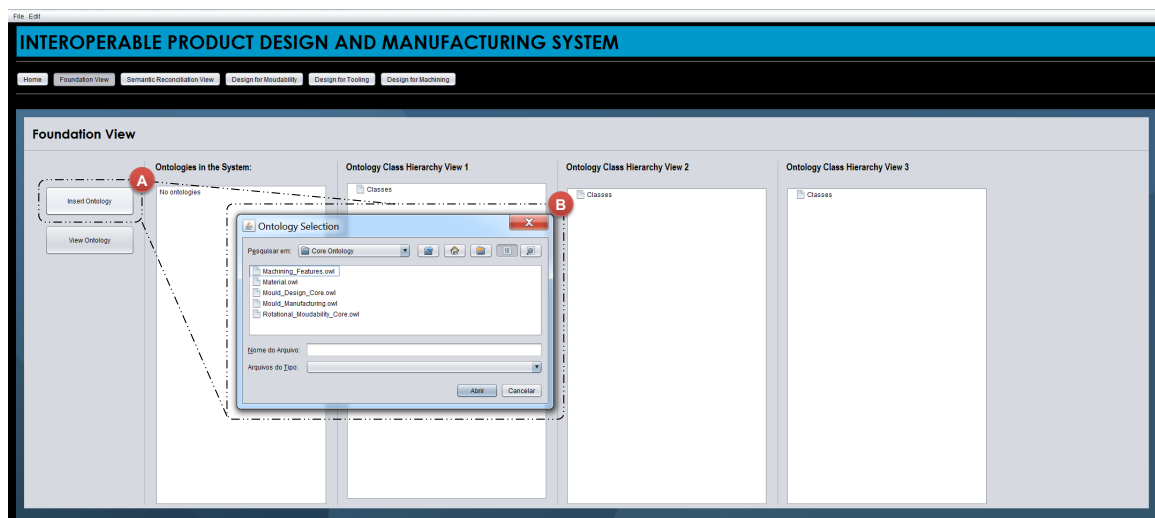

The verification of the ontologies inserted in the IPDMS is done through the field of "Ontologies in the System" (Detail "A" of Figure 121). Additionally, the Core ontology class hierarchy is visualised in details by clicking "View Ontology" on the button (detail "B"). The ontology selected in the button "Ontologies in the System" is presented in "Ontology Class Hierarchy View 1", "Ontology Class Hierarchy View 2" or "Ontology Class Hierarchy View 3" as illustrated in detail "C". Each core ontology is specialised according to the product that will be produced.

Figure 121 Ontology Class Hierarchy visualisation in the IPDMS.

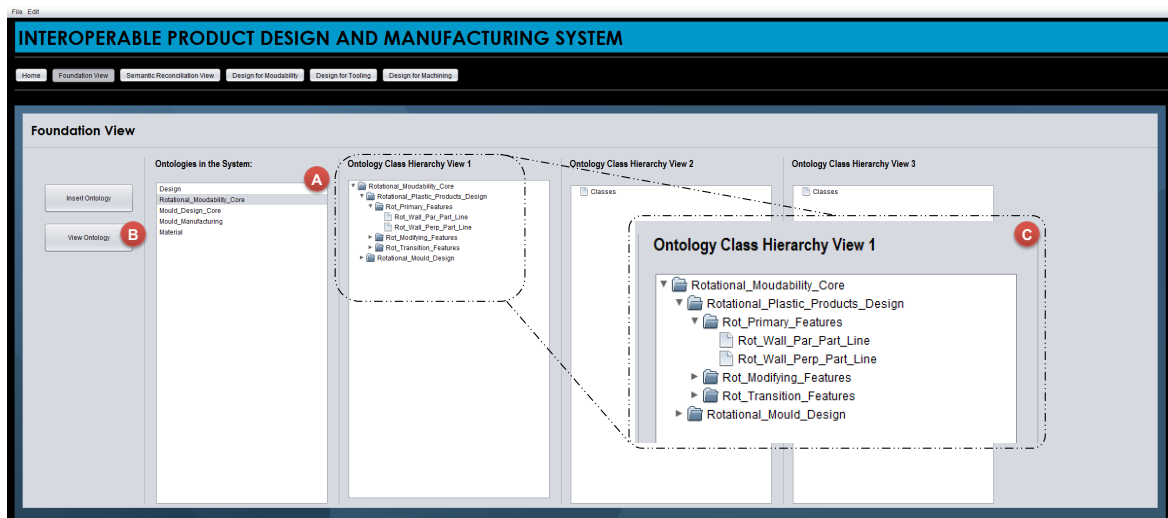

7.2.2 Application Domain and Semantic Reconciliation Views Implementation in Design for Mouldability

The implementation of the Application Domain View and Semantic Reconciliation View to support the Design for Mouldability were based on the Rotational Mouldability Core Ontology and its semantic relationships, which were conceptually explored in sections 4.1 and 6.4.1.1. Additionally, there are the semantic mappings governed by the semantic rules, ensuring the relationships between information from multiple domains. Figure 122 presents an overview of the Design for Mouldability interface in the IPDMS. It allows the interactions between the designer and the knowledge formalised about this domain in the system during the product design of the rotational thin-wall plastic injected products.

Figure 122 Overview of the Design for Mouldability interface.

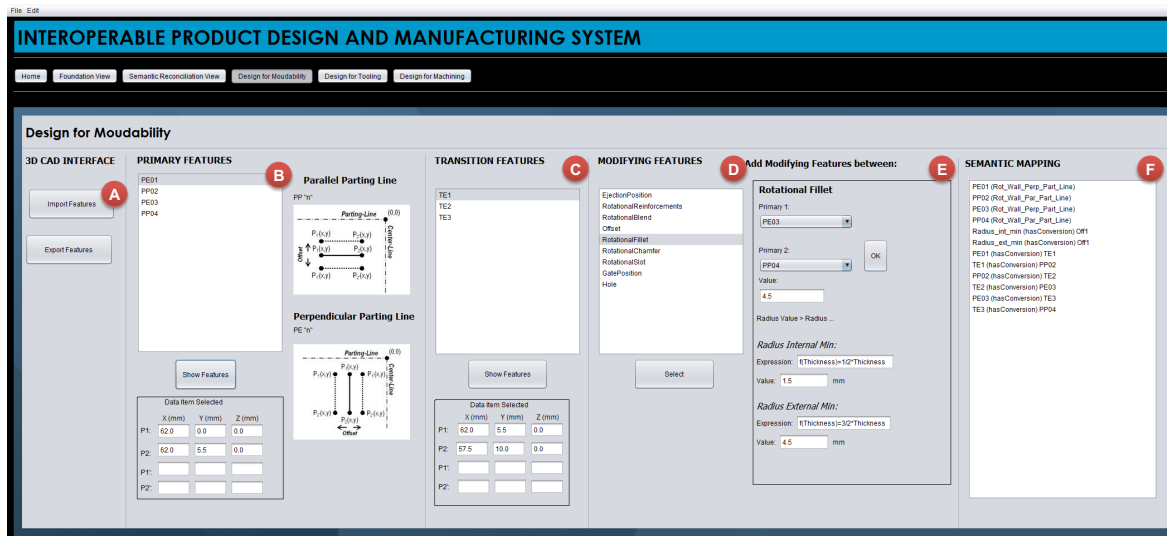

Detail "A" of Figure 122 illustrates the "3D CAD INTERFACE". The button "Import Features" loads the primary geometric file from a SolidWorks model that was produced by the designer, adding this information into the core ontologies, creating a new specialised ontology dedicated to the product that will be produced. Section 7.2.2.1 presents in details this specialisation. Detail "B" shows the primary features imported from the primary geometric file and stored in the specialised ontology. Any changing in the primary features is visualised through the button "show features", which extracts the information stored in the ontology and show the variable in the interface. Detail "C" illustrates the transition features in the specialised ontology and the variables are seen in details through the button "show features". Section 7.2.2.2 presents in details the visualisation process of the primary features and transition features of the product.

New transition features are added through the modifying features interface, detail "D" and "E" of Figure 122, where the user selects the rotational fillet parameter and the system automatically creates the semantic mapping between the primary features and transition features, respecting the semantic rules (parameter of translation - internal and external minimum radius). Section 7.2.2.3 demonstrates the application of the modifying features for building new transition features and offset features. Detail "F" of Figure 122 shows the semantic mapping according to the semantic rules presented in Chapter 6.

7.2.2.1 Rotational primary geometric profile creation

The ontology specialisation in Design for Mouldability starts with the addition of the primary geometric profile into the system, initializing the interoperable product design and manufacturing processes. As discussed in Chapter 5, this process is a controlled specialisation, where the data information are loaded according to semantic rules. The Rotational primary geometric profile was created in the SolidWorks tool in a design-oriented form. Figure 123 illustrates the UML activity diagram, which represents the structure that must be respected to construct the primary geometric profile.

Figure 123 Rotational primary geometric profile creation (UML activity diagram).

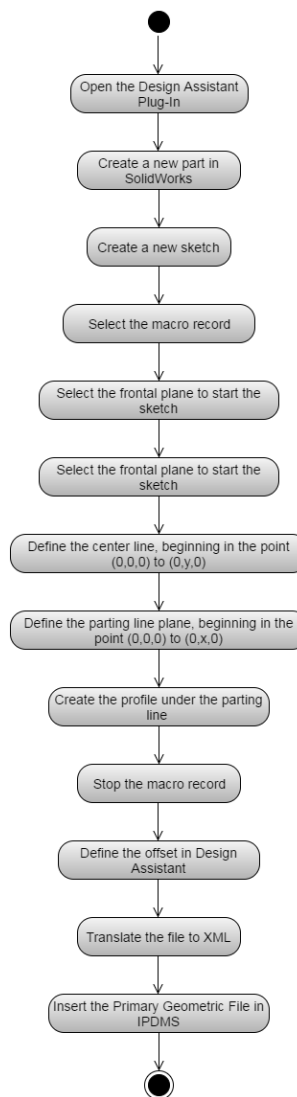

The UML activity diagram, Figure 123, shows that the user has to begin the creation of the part model through the SolidWork tool, using the IPDMS Design Assistant, as shown in Figure 124. In the SolidWorks part model creation environment, the macro record is initialized in order to store the geometric profile. The "Centre Line" and "Parting Line" must be defined by the user having the initial point as (0,0,0) for x,y,z respectively. The "Centre Line" is created in the "Y" direction and the "Parting Line" of the mould is created in the "X" direction. The user must create the product primary geometric profile, under the "Parting Line" plane with the primary features (straight lines or taper lines). After the conclusion of the modelling, the primary geometric profile is stored with the stop macro record. In the design assistant, the user must add the thickness information of the product and translate the information into the XML file that is imported into the Design for Mouldability of the IPDMS. Next, the process of analysing and complement the knowledge from the core ontologies is initialised.

Figure 124 IPDMS Design Assistant to support the primary geometric creation.

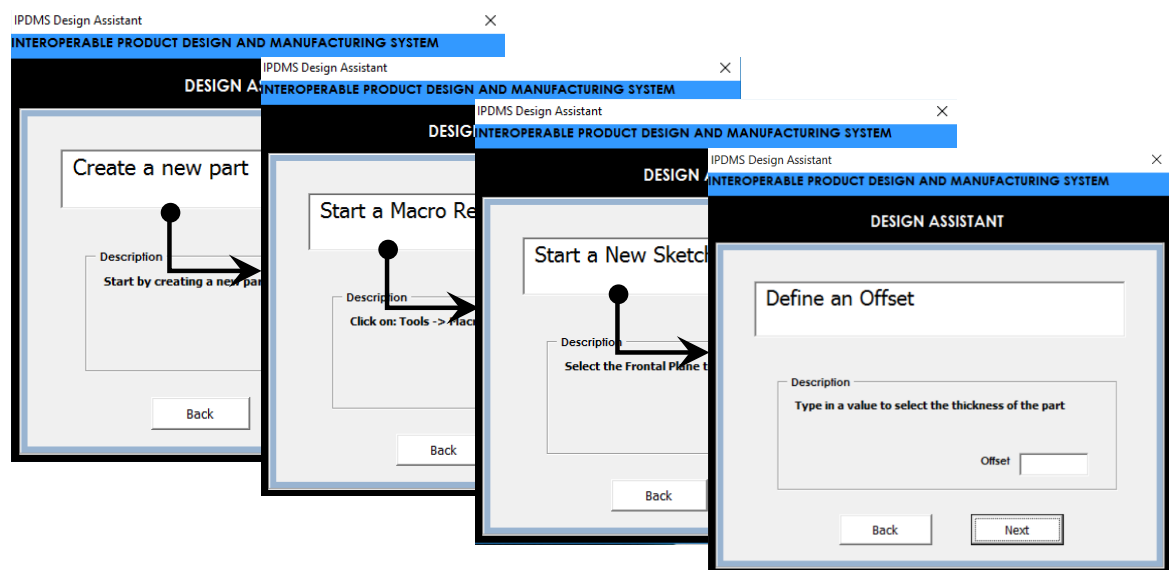
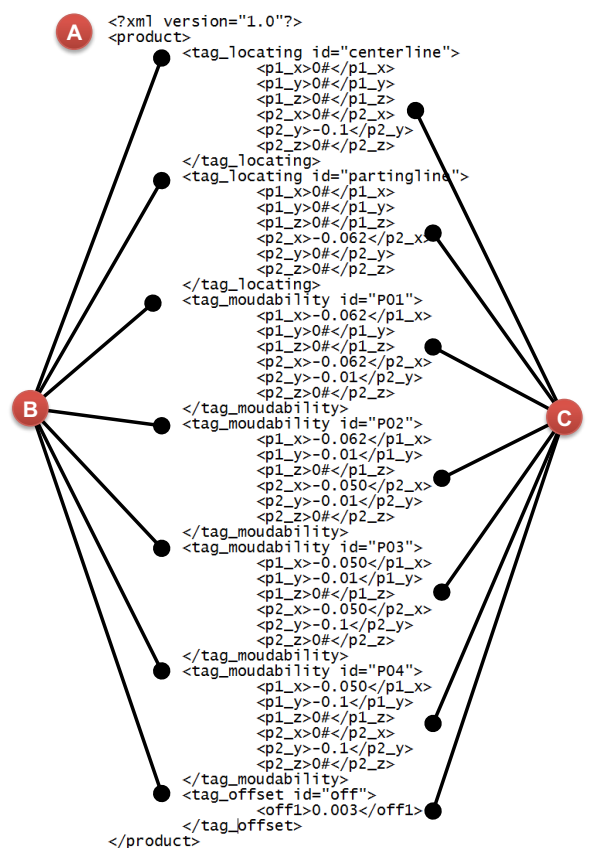

Figure 125 illustrates the XML file that has all the information about the primary geometric profile. XML (eXtensible Markup Language) is a markup language that defines a set of rules for encoding documents in a format that is both human-readable and machine-readable. This file has the information about the primary profile, centre line and parting line location and product thickness. The file is

composed of the root element (Detail "A"), tag identification (Detail "B") and elements (Detail "C"). The head of the file has the same name of the specialised ontology in the IPDMS. The tag identification represents the instances name that has the information about the primary geometric profile. Finally, the elements has the primary geometric information about the product, i.e., the coordinates "X initial" (p1_x), "Y initial" (p1_y), "Z initial" (p1_z), "X final" (p2_x), "Y final" (p2_y), "Z final" (p2_z). As this research is focused on rotational products, the coordinates "Z initial" and "Z final" are equal to "0" since it is possible to work only in an "X" and "Y" plane.

Figure 125 Primary Geometric Profile Structure of the Rotational Plastic Product.



7.2.2.2 Specialisation in the Application Domain View to support Design for Mouldability: Addition of Primary Geometric Profile

The Rotational Mouldability Core Ontology is specialised after the definition of the Primary geometric profile. The specialisation begins with the ontology intersection

process, as discussed in section 6.2. Each core ontology necessary to the Product Design and Manufacturing is declared as a subclass of the product. The class root is named as “Product” since this new specialised ontology is specific for one product in the Application Domain. In the context of the Design for Mouldability, the Rotational mouldability core ontology class root is linked as a subclass of the Product class, as depicted in Detail “A” of Figure 126.

Figure 126 Ontology intersection in the Application Domain View.

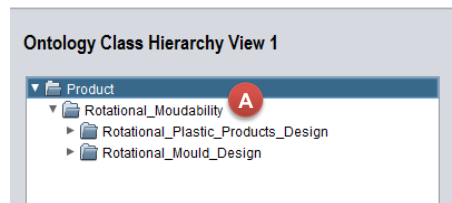

The semantic mapping is the next step of the intersection ontology, as discussed in Chapter 6. The information from the Primary geometric profile is loaded into the ontology as new instances based on the XML file. Figure 127 shows the UML activity diagram detailing the new instances creation process based on the XML file.

Figure 127 Information input from the Primary geometric profile stored in the XML file (UML Activity Diagram).

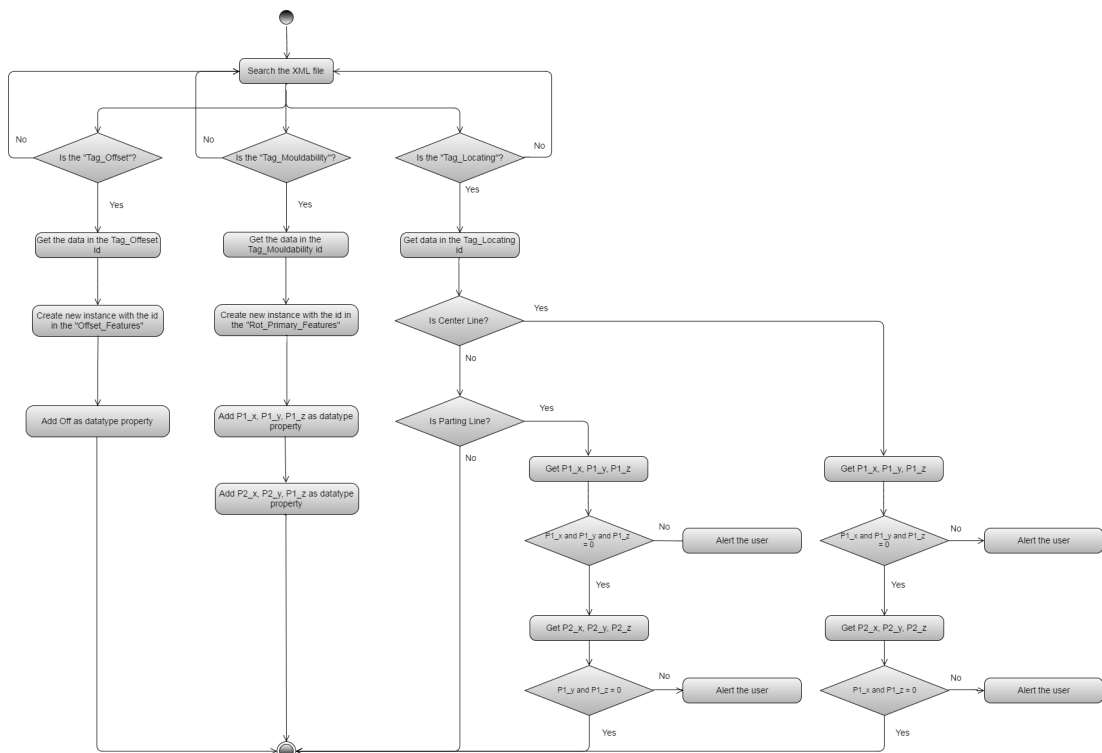

The import process begins by searching the XML file, as illustrated in Figure 124. The file is open and the tag identification is analysed. A new instance is created in the class offset features ("offset_features") if the tag identification is equal "Tag_Offset" and the name of this new individual is equal to the "id" of the identification of the elements. The elements data are inserted into the ontology as data property of the instances.

The same happens if the tag identification is equal to "Tag_Mouldability". New instances are created in the class Rotational primary features ("rot_primary_features") and the name of the new individuals is equal to the "id" of the identification of the elements. The elements data are inserted into the ontology as data property of the new instances. Finally, if the tag identification is equal to the "Tag_Locating", an analysis process is carried out to identify if the centre line and parting line are in the correct position since this information directly impacts in the semantic mapping process. Both centre line and parting line must have the initial point as (0,0,0). The centre line must be drawn in the direction of the "Y" (0,Y,0) and the parting line must be drawn in the direction of the "X" (0,X,0). Figure 128 illustrates the product specialised ontology in the Rotational primary geometric profile information imported from the XML file.

Figure 128 Demonstration of the instantiation process from the Primary geometric profile into the XML file.

The figure illustrates the instantiation process from an XML file into a Protege ontology. On the left, an XML snippet shows several `<tag_mouldability>` elements, each with an `id` attribute (e.g., "P01", "P02", "P03", "P04") and an `off1` attribute. On the right, the Protege ontology editor displays the class hierarchy, including `Rotational_Primary_Features` and `Rotational_Mould_Design`. A table of instances for the class `P02` is shown, listing dimensions like `hasDimensionX`, `hasDimensionY`, and `hasDimensionZ`. A table of property assertions for `P02` is also shown, listing values for `hasDimensionX`, `hasDimensionY`, and `hasDimensionZ`. Red circles A, B, and C mark specific elements in the XML, the class hierarchy, and the property assertions table respectively, with arrows indicating the mapping process.

Detail "A" of Figure 128 illustrates the condition verification ("Tag_Mouldability" → "Rot_Primary_Features"). Detail "B" demonstrates the creation of the "id" as a new instance in the Product ontology and Detail "C" represents the information data as data property of the instances. The data information from the XML file is in "meter" unit. The product ontology is presented in Protégé tool in order to facilitate the visualisation.

Figure 129 illustrates the Product ontology instantiated information in the IPDMS. Detail "A" shows the instances from the "id" and the detail "B" shows the data information added as data property into the ontology. In order to simplify the comprehension, the coordinates "X", "Y" and "Z" are showed in millimetres ("mm"), however, the information is kept in meters ("m") in the product ontology. Detail "C" illustrates the semantic rules inferences that are the results of the semantic mapping proposed in Chapter 6.

Figure 129 Rotational primary geometric profile in the IPDMS interface.

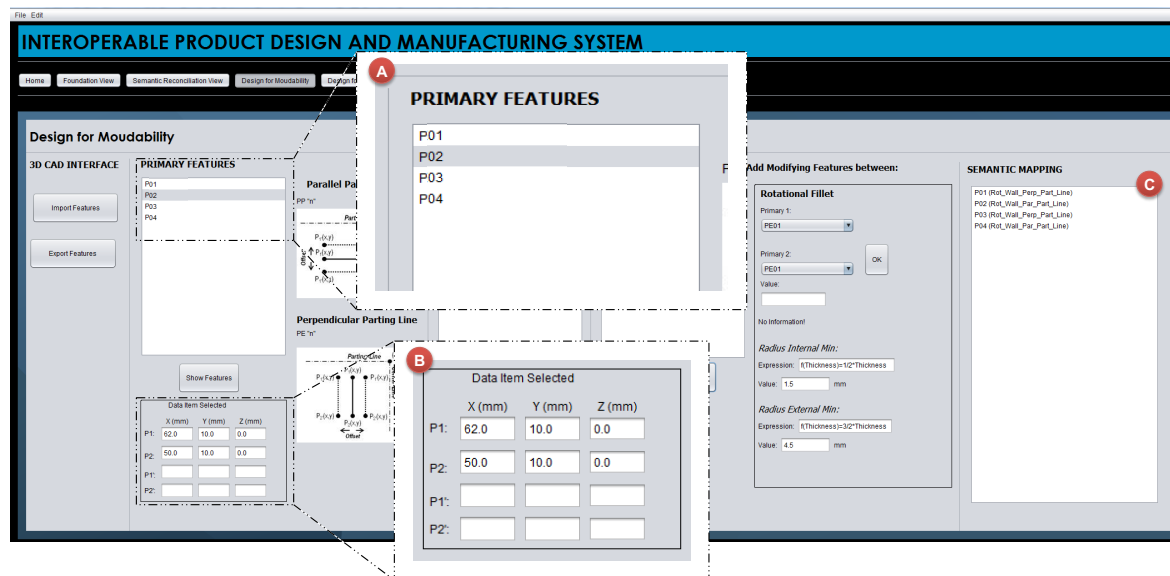

7.2.2.3 Specialisation in the Application Domain View to support Design for Mouldability: Transition Features and Offset Features Addition

In the plastic injection mould is necessary fillet in the sharp corners as discussed in Chapter 4. The inconsistency in the part model can be verified through semantic mapping by selecting rotational fillet in the interface. Figure 130 shows an

example of inconsistencies in the model, for a particular case, since it was not defined the transition features (detail “A”).

Figure 130 Semantic mapping analysis the transition features in the model.

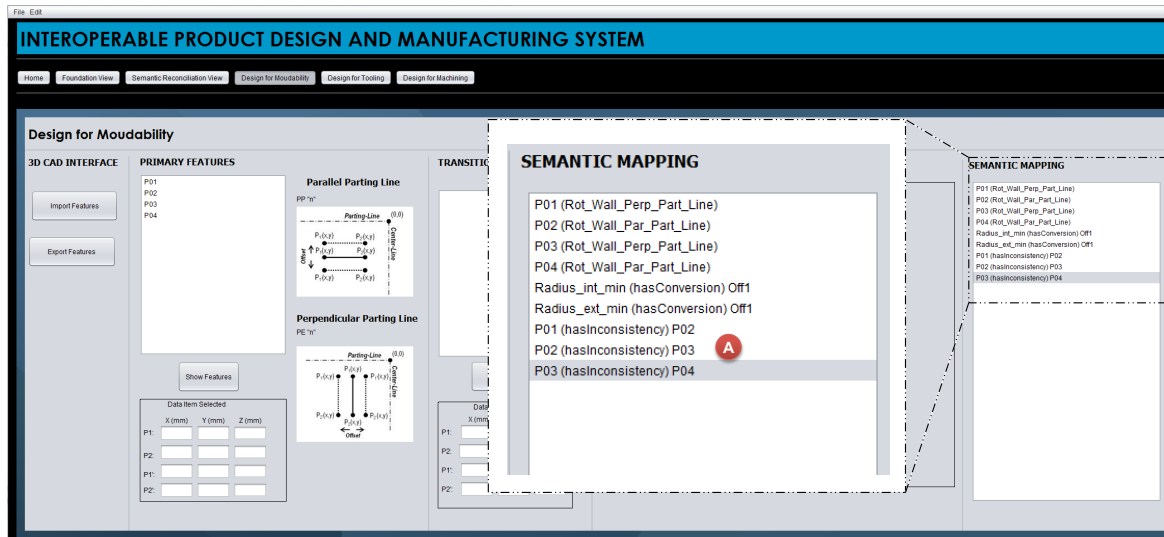

The transition features are added to the geometric profile based on the information of the minimum internal fillet radius (equation 6.2 of the section 6.4.1.1.4 (i)) and minimum external fillet radius (equation 6.3 of section 6.4.1.1.4 (i)). Both equations were based on the offset information, which was loaded into the system by the IPDMS design assistant. In Detail "A" of Figure 130, it is possible to verify that the information of the internal and external minimum radii were semantically mapped in the ontology. Therefore, through the frame "Add Modifying Features between:", it is possible to add the transition features into the model.

Detail "A" of Figure 131 presents the list of fields to be added into the transition features. The user selects the primary features that will be used and the system will automatically create the transition feature between them based on the internal and external radius of the fillet. The system automatically verifies if the profile radius condition fulfils the minimum internal or minimum external radii requirements according to the direction of the offset (internal or external). The type of the radius (minimum internal or minimum external) is defined based on the relations between the primary features, as presented in the UML activity diagram of Figure 132.

Figure 131 Rotational fillet field in the IPDMS.

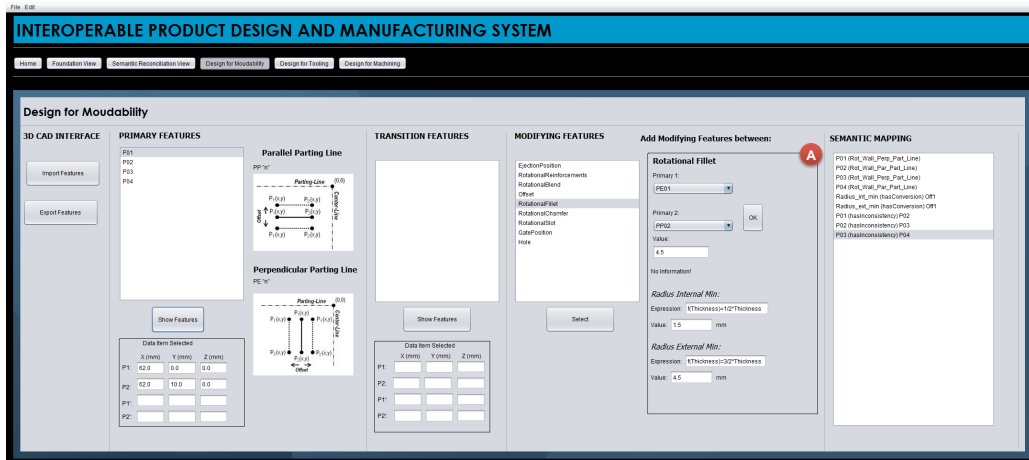

Figure 132 Transition creation between primary features (UML Activity Diagram).

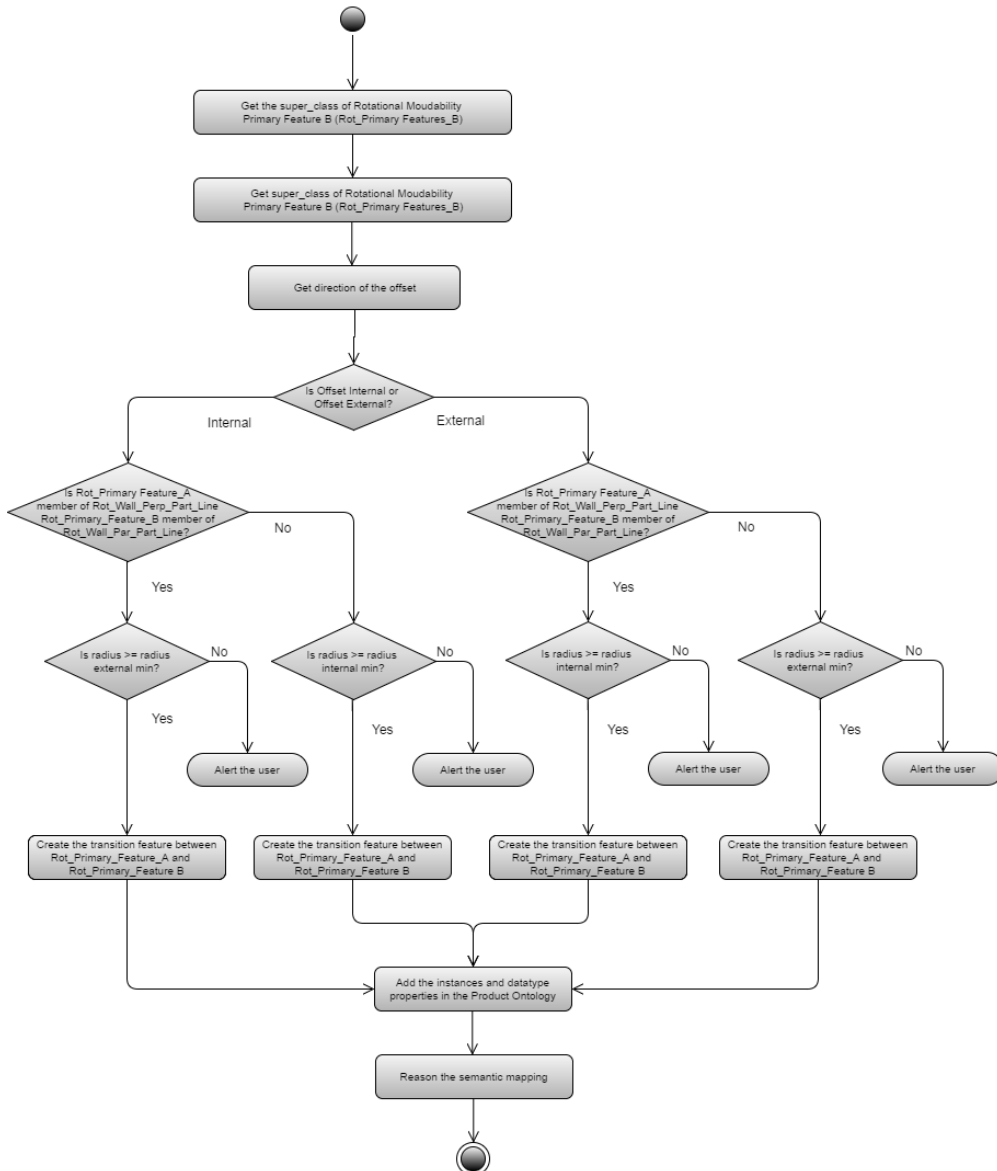
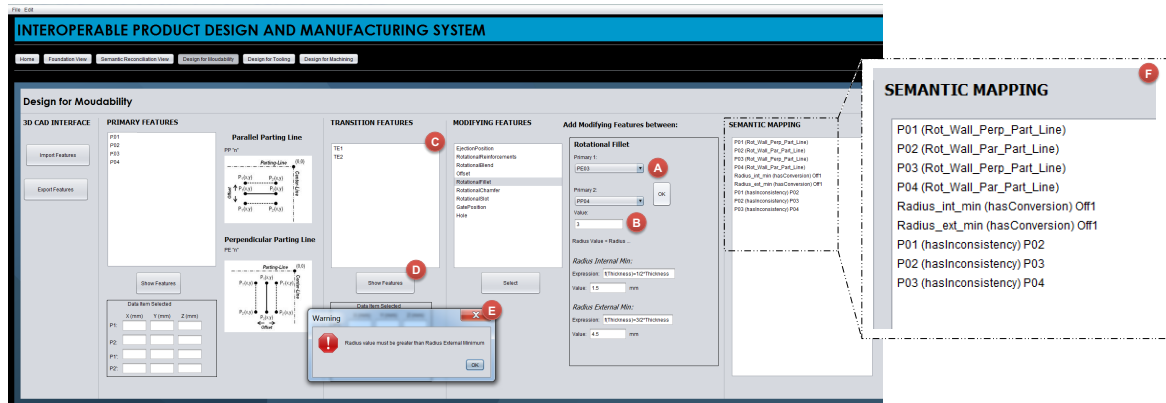

Figure 132 presents the UML activity diagram that verifies, in a semantically interoperable manner, the correct fillet radii for the transition features. Transition features must always be between two primary features and must respect the minimum fillet radius (internal or external). Therefore, the minimum fillet radius definition for the transition features are directly related to two conditions as follow: (i) offset direction (internal or external) and (ii) primary features orientation (parallel or perpendicular). The radius must be greater or equal to the minimum external fillet radius if the offset is the internal direction; the Rotational primary features "A" is perpendicular to the Parting Line; and Rotational primary features "B" is parallel to the Parting Line. The radius must be greater or equal to the minimum external fillet radius if the offset is the internal direction; the Rotational primary features "A" is parallel to Parting Line; and Rotational primary features B is perpendicular to Parting Line. The same happens for the external direction offset, but the radius must be greater or equal to the minimum internal fillet radius if the Rotational primary features "A" is perpendicular to the Parting Line and Rotational primary features "B" is parallel to the Parting Line and the radius must be greater or equal to the minimum external fillet radius if the Rotational primary features "A" is parallel to Parting Line and Rotational primary features "B" is perpendicular to the Parting Line.

Figure 133 exemplifies the transition features addition into the IPDMS. Detail "A" presents the field selection of the primary features where the transition feature will be created. The field to insert the radius value that is compared with the minimum internal fillet radius or the minimum external fillet radius is shown in Detail "B". Detail "C" presents the transition features already added into the systems while Detail "D" allows the information data visualisation in the "Data Item Selected" through the button "Show Features". Detail E shows the "Warning Message" if the radius value is lesser than the minimum radius of the system. The whole information is inserted into the ontology through the creation of the new instances and datatype properties in the ontology. Therefore, the new information added into the ontology automatically is mapped by the semantic rules. Detail "F" illustrates the semantic mapping automatically established with the transition features, such as "P01" [hasConversion] "TE1" and "TE1" [hasConversion] "P01". Additionally, if the inconsistencies were not solved according to the semantic mapping, the message continues to be displayed in the system, such as "P03" [hasInconsistency] P04".

Figure 133 Transition features addition in the IPDMS.



Offset feature is a modified feature that is related to the thickness of the rotational wall of the plastic injected product. The "X" initial, "Y" initial, "X" final, and "Y" final coordinates follow the equations from 6.4 to 6.11 and are directly related to the direction of the offset (internal or external). Semantic mapping is established in order to ensure the correct relations between the primary features and the primary features with offset ("X" initial offset, "Y" initial offset, "X" final offset, "Y" final offset). Figure 134 presents the UML activity diagram for the offset development and semantic mapping in the IPDMS.

Figure 134 Offset addition in the plastic injected products (UML Activity Diagram).

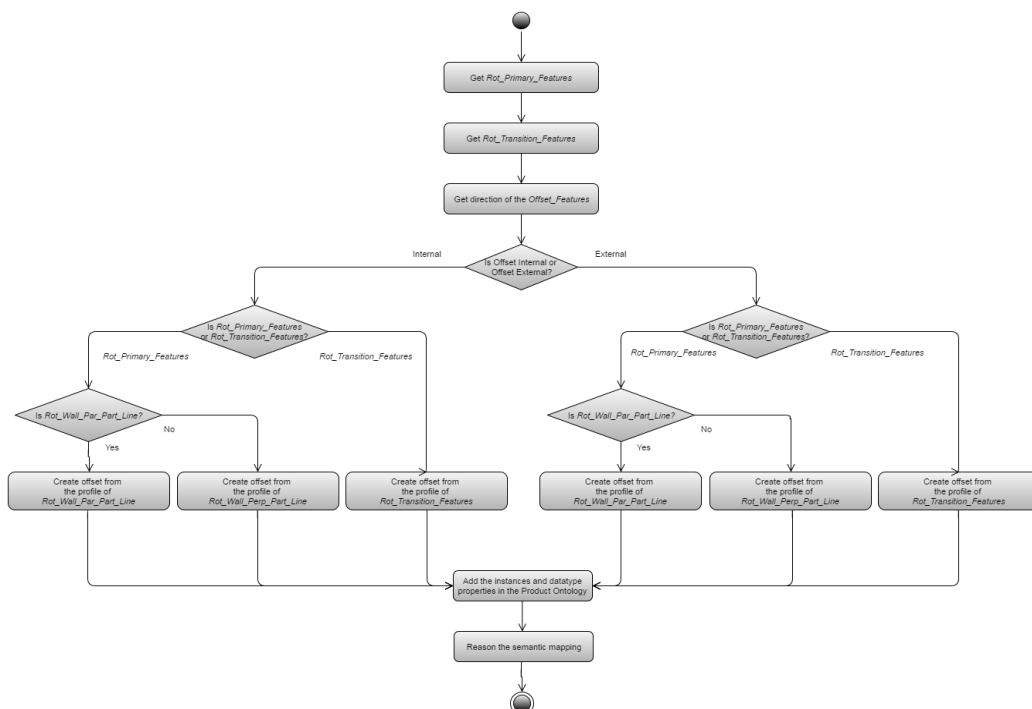

According to the UML Diagram Activity of Figure 134, the information from Rotational primary features and Rotational transition features are extracted from the Product Ontology and analysed according to their profiles (Parallel to the Parting Line, Perpendicular to the Parting Line or Rotational Transition). The offset is created based on the profile and thickness of the product defined by the user. The information is added as new instances in the product ontology and the semantic mapping is created with these new instances, as discussed in the section 6.4.1.1.4 (ii). Figure 135 demonstrates the offset feature of the modifying features in the IPDMS.

Figure 135 Offset Features addition in the IPDMS.

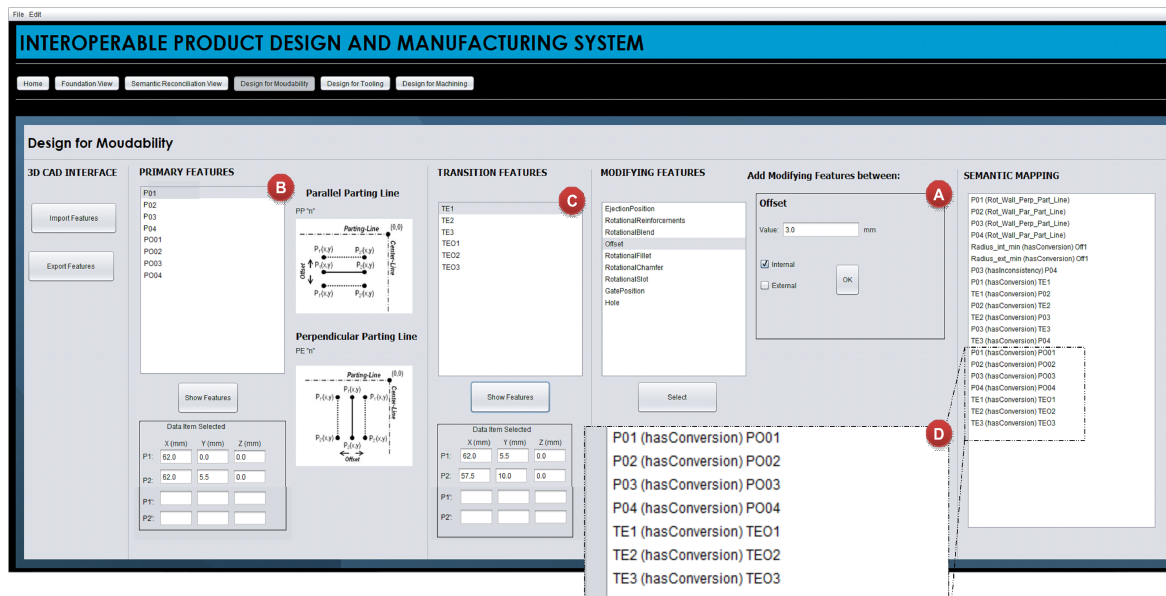

The offset feature field is presented in Detail "A". The IPDMS interface allows the selection of the direction of the offset (internal or external) by the user, but it is not possible to change the offset value since this information is imported from the Rotational geometric primary profile. Detail "B" presents new instances created based on the Rotational primary features with the offset information in the product ontology. These new instances receive the same number of the originating profile, but in order to differentiate them, a code "O" is added, for example, the profile "P01" is converted into the profile with offset "P001". The same happens with the Rotational transition features, "TE1", is converted into the "TE01", as shown in Detail "C". The semantic mapping established after the offset feature process, that ensures the correct relation between the original profile and the offset profiles, for instance,

"P02" [hasConversion] "PO02" and "TE3" [hasConversion] "TEO3" is illustrated in Detail "D".

7.2.3 Implementation of the Application Domain and Semantic Reconciliation Views in the Design for Tooling

Following the implementation process, the Application Domain View and Semantic Reconciliation View were implemented to support the Design for Tooling based on the Rotational mould design, which was conceptually explored in section 6.4.1.2. The implementation was based on the Rotational mould design core ontology and Material core Ontology that are specialised according to the specific information of the design for tooling and the design for mouldability. The specialisation adopted in the design for tooling is intra-context and inter-context. In addition to these concepts, the semantic mappings are established to ensure the correct relationships between this distinct information. The semantic mappings are performed according to the semantic rule discussed in sections 6.4.1.2.1 and 6.4.1.2.3. Figure 136 illustrates an overview of the design for tooling interface implemented in the IPDMS.

Figure 136 Overview of the Design for Tooling Interface.

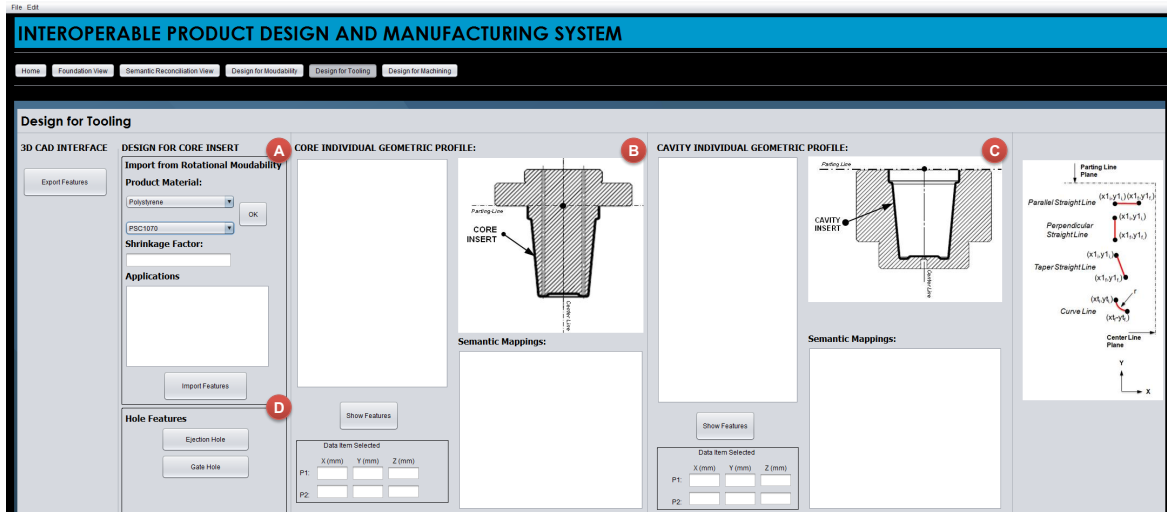

Detail "A" of Figure 136 illustrates the import process of the product geometry profile from the Rotational mouldability process for Core insert profile and Cavity

insert profile building. The information of the Core individual geometric profile and the semantic mapping established between Rotational mouldability primary features and Rotational core insert are illustrated in Detail "B". Detail "C" shows the information of the Cavity individual geometric profile and the semantic mapping established between Rotational mouldability primary features and Cavity insert geometric profile. The options for creating the features related to the hole, that concern the tooling design, in this case, "Ejection Hole" and "Gate Hole" is depicted in Detail "D".

The following sections will present the import process detailing (section 7.2.3.1), core and cavity information access detailing (section 7.2.3.2) and information addition of the "Ejection Hole" and the "Gate Hole" detailing (section 7.2.3.3).

7.2.3.1 Product geometric profile importing process from Design for Mouldability to Design for Tooling.

The design for tooling translates the Product geometric profile from the design for mouldability into the Core insert profile and Cavity insert profile. However, this translation is not direct since it is necessary to consider the shrinkage factor according to the material of the product that will be manufactured. This factor is important in order to ensure the correct dimension of the product otherwise the product will be smaller than the product modelled.

The geometric importation starts with the material definition as shown in Detail "A" of Figure 137. The material core ontology has a different material instance that must be chosen by the user, allowing the information importing. Additionally, the shrinkage factor of the selected material is shown in Detail "B" while Detail "C" shows the application of the material selected according to the material manufacturer. After the material selection, the geometric translation process is realised and new instances are created in the specialised mould design ontology through the button "Import Features". Additionally, the semantic mappings are established, ensuring the correct semantic information interoperability.

Figure 137 Material selection and Features importation in the IPDMS tool.

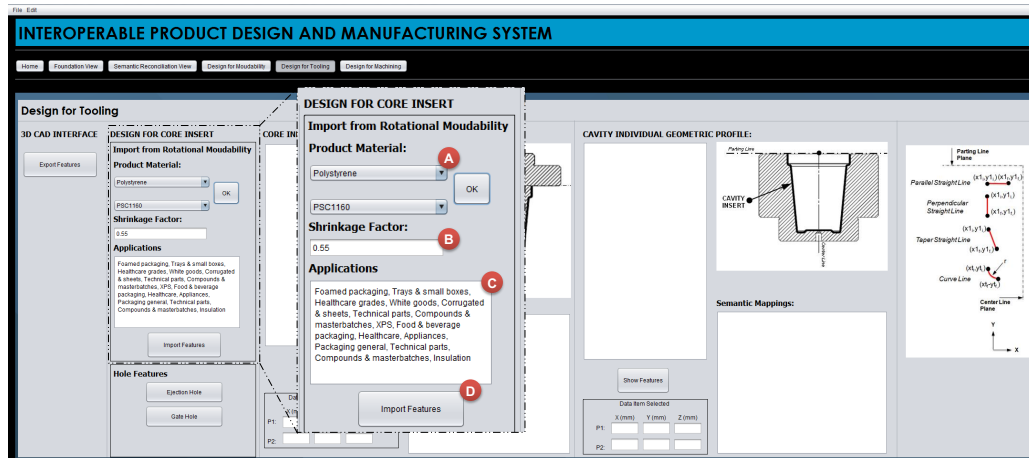
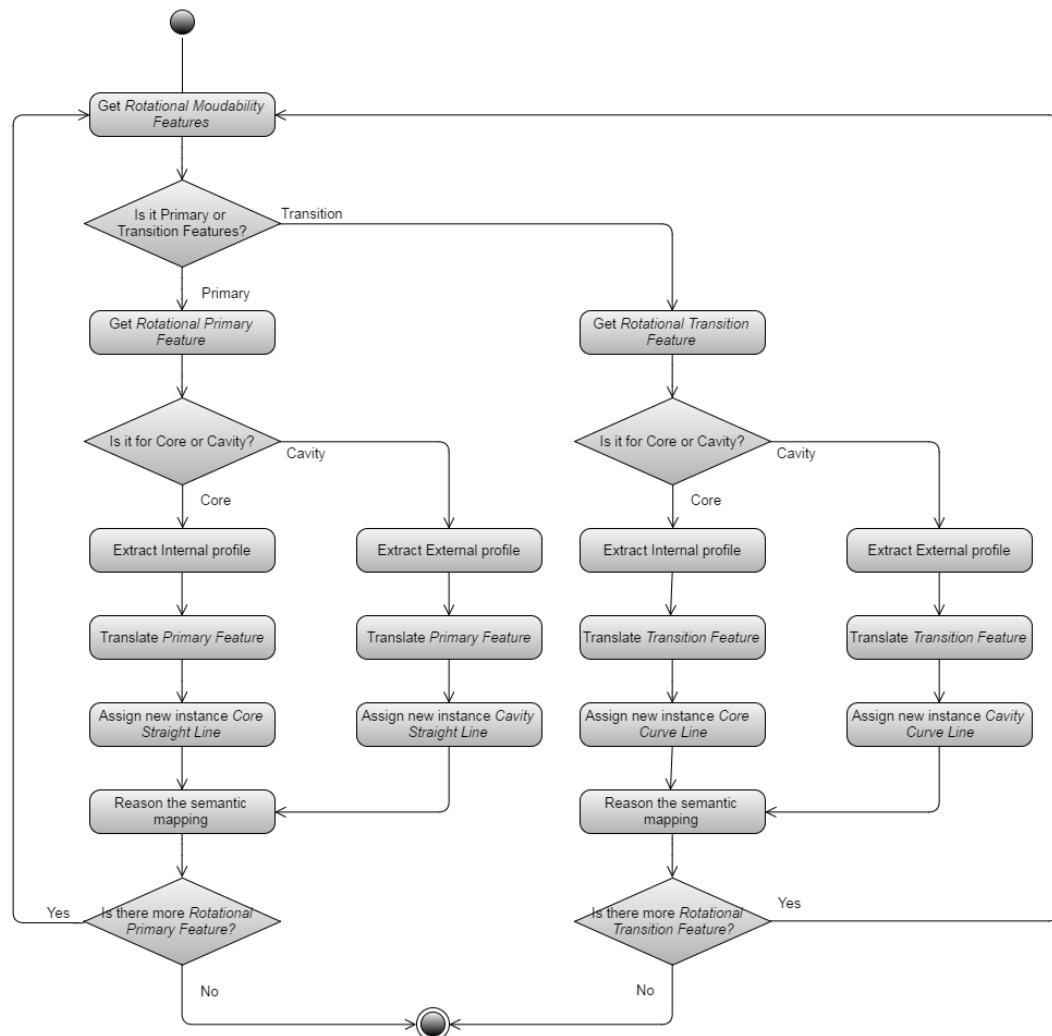

Figure 138 shows the UML activity diagram used to demonstrate the importing process to create the Core and Cavity inserts designs. According to the UML Activity Diagram, the information from Rotational mouldability features are extracted from the Product Ontology and analysed in order to be translated into the Rotational mould design.

The information of the internal primary feature is translated according to the equation 4.16 and assigned as a new instance in the core straight line if the information is a Rotational primary feature and if the translation process is for the core insert. The information of the external primary feature is translated according to the equation 6.12 and assigned as a new instance in the cavity straight line if the information is a rotational primary feature and if the translation process is for the cavity insert.

The same happens if the information is a transition feature, but the information of the internal primary feature is translated according to the equation 6.12 and assigned as a new instance in the core curve line if the translation process is for the core insert. The information of the internal primary feature is translated according to the equation 6.12 and assigned as a new instance in the cavity curve line if the translation process is for the cavity insert. The newly assigned information is semantically mapped according to the semantic rules, as discussed in the sections 6.4.2.1.1 and 6.4.2.1.2.

Figure 138 Importing Features from Design for Mouldability to Design for Tooling (UML Activity Diagram).



7.2.3.2 Core and cavity inserts information exhibition

The information about the translated profile is instantiated in the product ontology, and the semantic mapping is identified through the Inference Engine in order to infer the relations and any inconsistencies. This information is visualised in the IPDMS interface, as shown in Figure 139. Detail "A" illustrates all instances translated from the Rotational mouldability Feature into the Core insert design. The information assigned in each instance of the Core insert design is visualised through the button "Show Features", as depicts in Detail "B". Finally, Detail "C" presents the semantic mapping established with the translated information. The semantic mapping

presents the relation with the profile in the design for mouldability such as "P01 (hasTranslation) CORE_P01" as well as the information mapped in the design for tooling such as "CORE_P03 (Core_Per_Straight_Line)" or "CORE_P06 (Core_Curve_Line)". The same visualisation can be achieved for the Cavity insert design.

Figure 139 Detailing of the Design for Tooling information visualisation in the IPDMS.

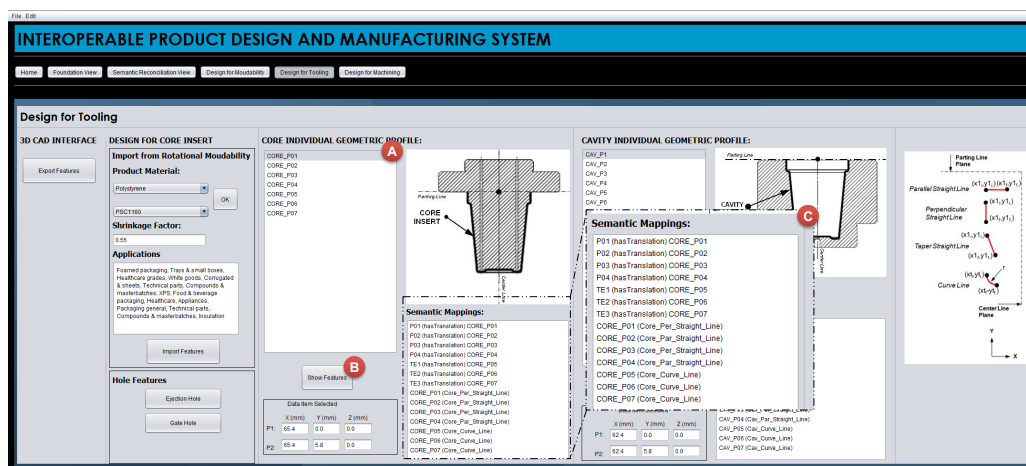

Detail "A" illustrates all the instances translated from the Rotational mouldability Feature into the Core insert design. The information assigned in each instance of the Core insert design is visualised through the button "Show Features", as depicted in Detail "B". Finally, Detail "C" presents the semantic mapping established with the translated information. The semantic mapping presents the relation with the profile in the design for mouldability such as "P01 (hasTranslation) CORE_P01" as well as the information mapped in the design for tooling such as "CORE_P03 (Core_Per_Straight_Line)" or "CORE_P06 (Core_Curve_Line)". The same visualisation can be achieved for the Cavity insert design.

7.2.3.3 Gate hole and ejection hole design in the Design for Tooling

The gate and ejection holes are fundamental in the mould design since they allow the plastic injection in the mould and the product extraction of the mould, respectively. The information about the gate and ejection holes are assigned through the buttons "Gate Hole" and "Ejection Hole", as shown in detail "A" of Figure 140.

Figure 140 Detailing of the hole features in the Design for tooling.

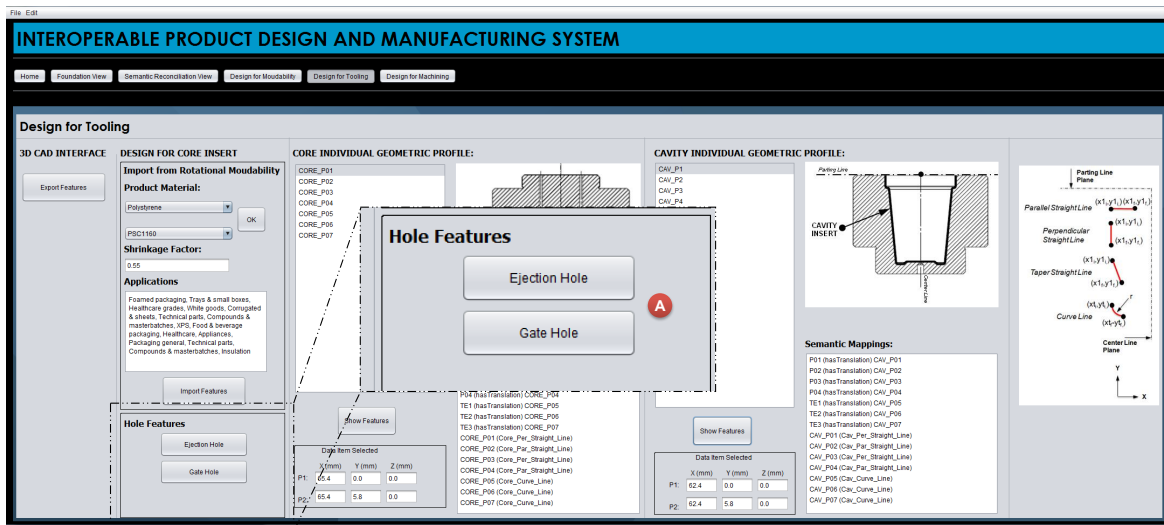

A secondary interface is opened for ejection and gate holes and it is possible to add the information of the hole diameter, hole length and the hole coordinates. Figure 141 illustrates the ejection hole interface.

Figure 141 Ejection hole interface in IPDMS.



The field to insert the hole diameter and hole length information is presented in Detail "A" and Detail "B" shows the field to insert the "X", "Y" and "Z" coordinates for

the ejection holes location. It is important to highlight that according to the holes positions, the coordinates "X" and "Y" may be negative or positive, as shown in Detail "C". This criterion was used to reduce the ambiguity problems with these coordinates. Finally, Detail "D" illustrates the insertion of the ejection hole information in the product ontology, following the UML activity diagram depicted in Figure 142.

The UML activity diagram shows that the information of the ejection hole (*Hole diameter, hole length, hole coordinates*) is extracted and assigned as new instances of the ejection hole in the mould hole of the product ontology. These instances are mapped in the ontology and will be converted into the manufacturing process to enable the ejection hole machining.

Figure 142 Ejection and gate holes designs in the Design for Tooling (UML Activity Diagram).

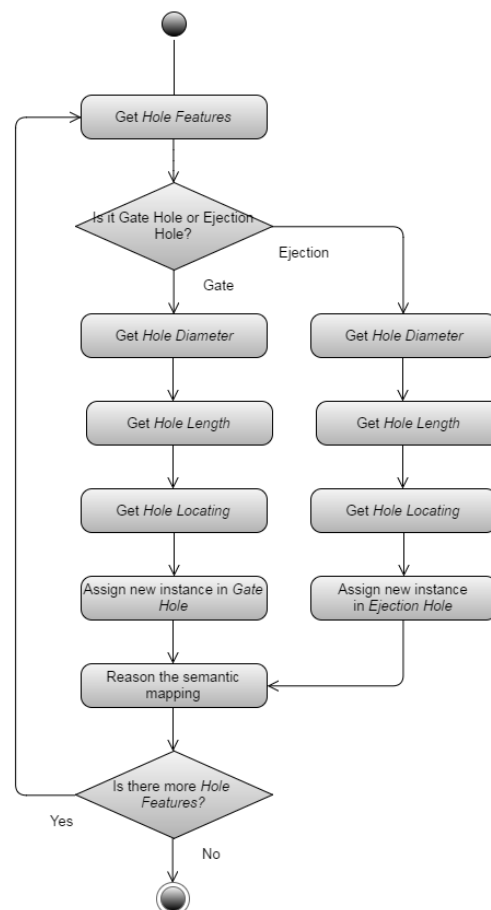

The gate hole has the same procedures as the ejection hole, as demonstrated in the UML activity diagram and illustrated in Figure 142. The gate hole needs the

hole diameter, hole length and the hole coordinates. Figure 143 illustrates the gate hole interface in the IPDMS.

Figure 143 Gate hole interface in the IPDMS.

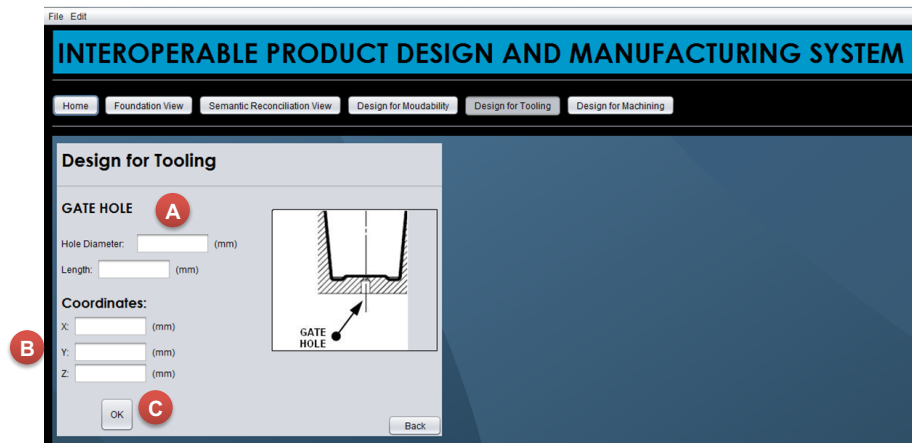

Detail "A" shows the field to insert the hole diameter and hole length information. Detail "B" illustrates the field for inserting the "X", "Y" and "Z" coordinates to locate the gate holes. It is important to highlight that according to the holes positions, the coordinates "X" and "Y" can be negative or positive, as discussed for the ejection hole. Finally, Detail "D" shows the button for inserting the information of the gate hole in the product ontology.

7.2.4 Implementation of the Application Domain and Semantic Reconciliation View in the Design for Machining

Design for Machining was implemented based on the specialisation of the Manufacturing core ontology, Machining features core ontology in the Application Domain View and the Material core ontology from Reference View. Additionally, the Semantic Reconciliation View was implemented to map the information relationships related to the context of Design for Machining, as discussed in section 6.4.1.3. and the information sharing, conversion and translation from Design for Tooling into Design for Machining, as discussed in sections 6.4.2.2 and 6.4.2.3.

Figure 144 illustrates an overview of the Design for Machining interface. Detail "A" depicts the material selection for the mould manufacturing. Both core and cavity inserts must be manufactured with the same material to avoid the unconformity with

the product dimensions. Detail "B" presents the button to import the Core and Cavity inserts geometry features from Design for Tooling into Design for Machining. Detail "C" illustrates the Core insert profiles that will be manufactured, as well as the Semantic information mapping. Additionally, on the button "Show Features", it is possible to verify the data information of each Core manufacturing profile. Similarly to the last detail, Detail "D" illustrates the Cavity insert profile that will be manufactured and the Semantic information mapping. In the button "Show Features", all data information about the profile is visualised. Finally, detail "E" depicts the coordinates orientation adopted in the research as well as the turning and boring machining orientation. The definition of the coordinates is important since they determine the translation process from the Design for Tooling into Design for Machining.

Figure 144 Overview of the Design for Machining Interface.

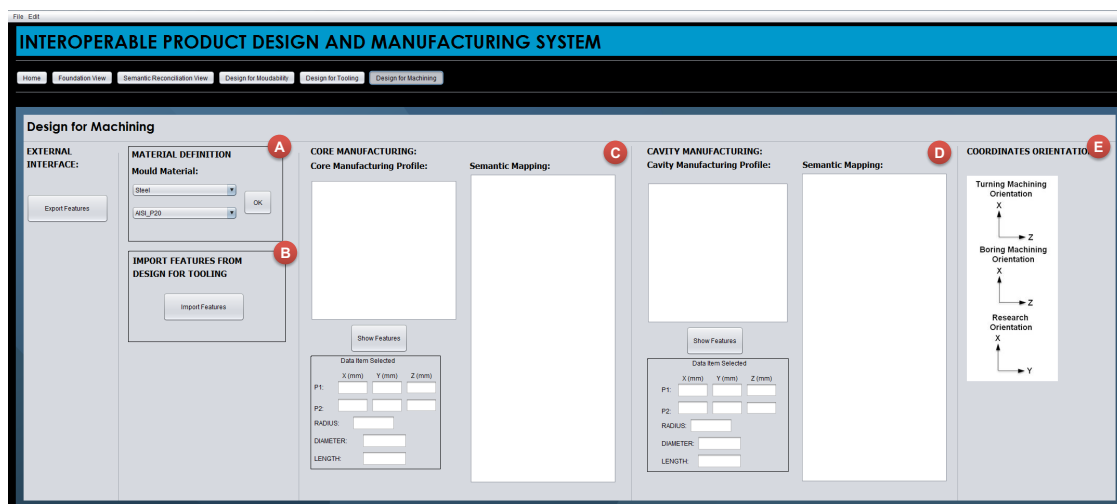

The core and cavity material definitions enrich the product ontology with information that can impact in some machining parameters, such as Cutting Speed, Feed Rate, Depth of Cut and so on. This research is not exploring the manufacturing strategy, but it explores the translation process of the information from Design for Tooling into Design for Machining as well as the most suitable manufacturing process for each profile.

The subsequent sections discuss the importing features process from Design Tooling into Design for Machining (section 7.2.4.1) and Core and Cavity manufacturing information visualisation (section 7.2.4.2) and the Semantic mapping

established between Core and Cavity Inserts Designs and Core manufacturing and Cavity manufacturing (section 7.2.4.3).

7.2.4.1 Core and Cavity insert profile importing process from Design for Tooling into Design for Machining

The Core and Cavity inserts profiles are designed in the Design for Tooling based on the information translated from Product geometry and the Material properties of the product that will be manufactured. These profiles are translated into the manufacturing process respecting the semantic rules of the semantic mapping discussed in sections 6.4.1.3, 6.4.2 and 6.4.3. Figure 145 depicts the UML activity diagram of the imported features from Core and Cavity inserts into Core and Cavity manufacturing.

Figure 145 Importing Features from Design for Tooling into Design for Manufacturing (UML Activity Diagram).

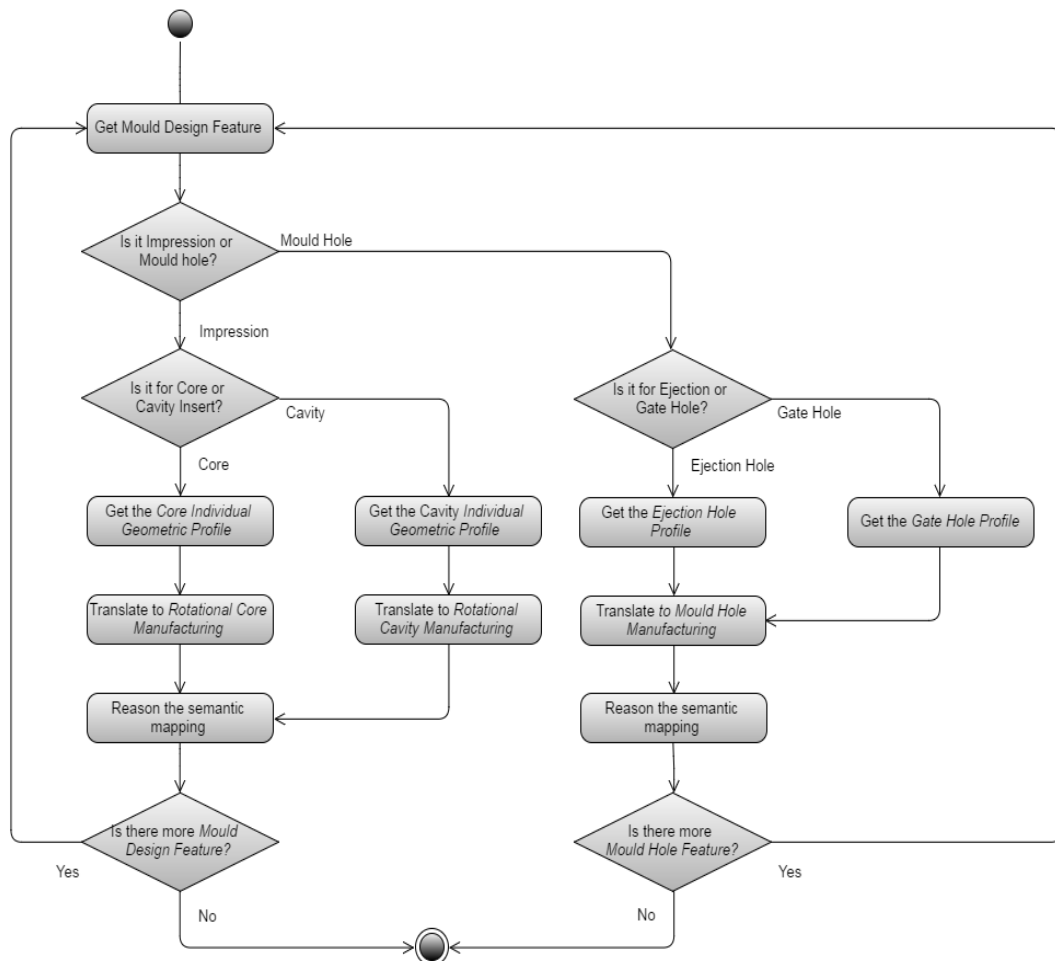

According to the UML Activity Diagram of Figure 145, the information from Rotational mould design features are extracted from the Product ontology and analysed in order to translate into the Mould Manufacturing. The information of the core individual geometric profile is translated into the Rotational Core Manufacturing if the information is an impression system and if the translation process is for the core insert. The information of the cavity individual geometric profile is translated into the Rotational Cavity Manufacturing if the information is an impression system and if the sharing process is for the cavity insert. After the translation process, both (core and cavity insert) are submitted to the semantic mapping reasoning where the inferences are established according to the semantic rules, presented in the section 6.4.1.3 and 6.4.2.2, defining if the profile will be manufactured by turning machining or boring machining.

The same happens to the information of the Mould hole where the information of the ejection hole is translated to the mould hole manufacturing if the Mould Design Feature is a mould hole and if the mould hole is ejection hole. The information of the gate hole is translated to the mould hole manufacturing if the Mould Design Feature is a mould hole and if the mould hole is gate hole. Both (ejection hole and gate hole) are submitted to the semantic mapping reasoning and inferences are established based on the semantic rules presented in the section 6.4.2.3.

7.2.4.2 Core and cavity insert manufacturing information visualisation

The information translated from Rotational mould design into Mould Manufacturing are showed in the IPDMS interface, as depicted in Figure 146. Detail "A" presents information imported from the Core insert profile and detail "B" presents the information imported from the Cavity insert profile. In addition, the data properties associated with each information profile can be visualised through the button "Show Features" as shown in Detail "C".

Figure 146 Detailing of the Design for Machining information visualisation in the IPDMS

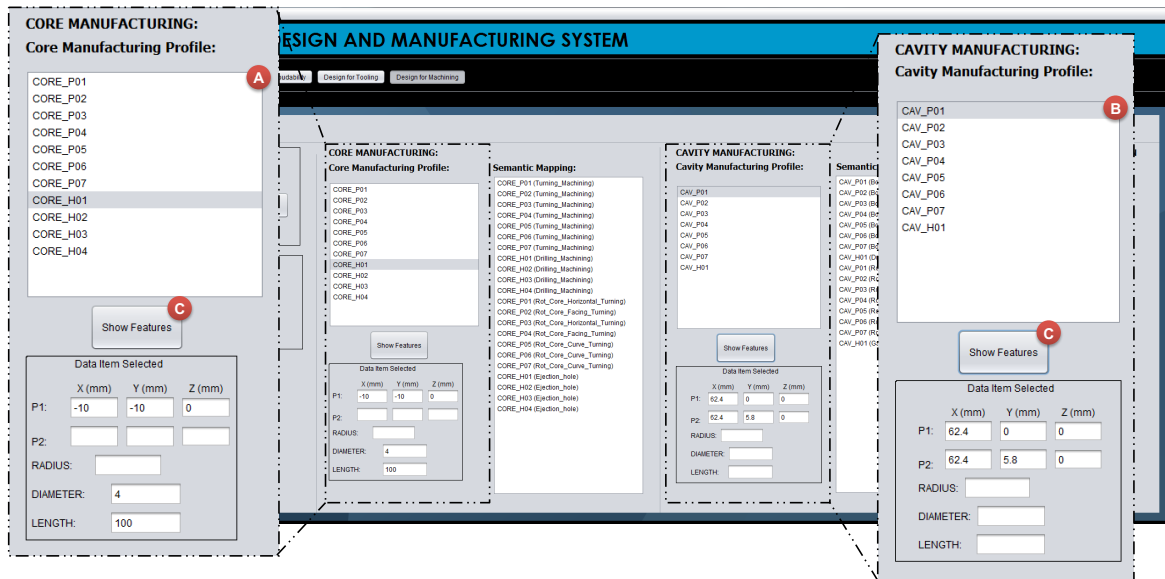

Additionally to the visualisation of the data information, all semantic mapping inferred are presented in the semantic mapping interface based on the semantic rules discussed in sections 6.4.1.3, 6.4.2.2 and 6.4.2.3. The semantic rules were implemented in the IPDMS by the Jena environment and the Inference Engine analyses the information and infers some relations according to the semantic rules. Details "A" and "B" of Figure 147 present the semantic mapping inference of the Core insert and Cavity insert, respectively.

Figure 147 Detailing of the Design for Machining semantic mapping visualisation in the IPDMS

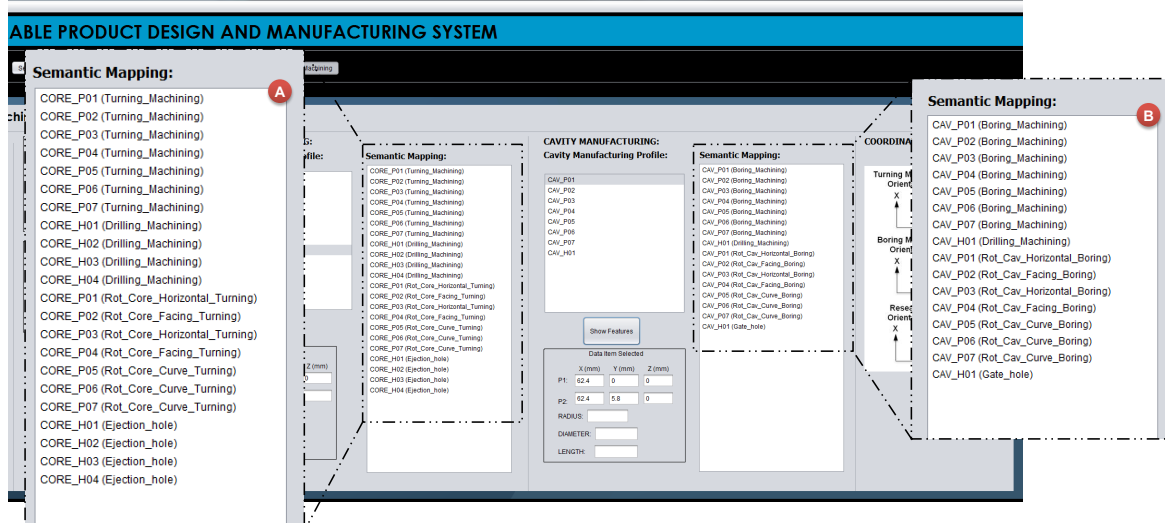

The semantic mapping, illustrated in the Detail “A”, presents the relationships between Core insert design and Core insert manufacturing. The semantic mapping concerns the manufacturing planning, for example, *CORE_P01 (Turning_Machining)* is the profile 01 of the core insert that will be manufactured by the turning machining process. Another semantic mapping is according to the type of the profile and the type of manufacturing (Horizontal, Facing, Taper and Curve Turning or Boring Machining), for example, *CORE_P03 (Rot_Core_Horizontal_Turning)* is the profile 03 of the core insert that will be manufactured by a horizontal turning process. The same mapping occurs for the cavity insert and the relationships between Cavity insert design and Cavity insert manufacturing are shown in Detail “B”.

In the next chapter, cases studies on a specific product are used to corroborate the semantic interoperability concepts applied into a rotational thin-wall injected plastic product design and manufacturing presented in Chapters 4, 5 and 6 and in the proposed IPDMS.

8 CASE STUDY

The experimental work, which aims at exploring the proposed conceptual framework for supporting the semantic information interoperability in product design and manufacturing is explained in this Chapter. Three case studies investigated a rotational thin-walled plastic injected product. These cases studies provided an analysis of all views of the conceptual framework in order to validate the information formal structure and its formal relationships across different phases of the product development. Figure 148 illustrates the overview of the product used in the three case studies to validate the research.

Figure 148 Overview of the general case study applied in this research.

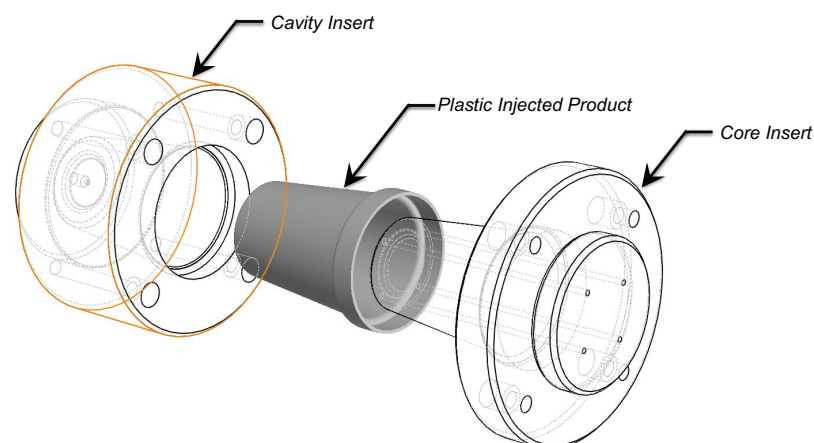

The subsequent sections evaluate the proposed conceptual framework. Section 8.1 presents the product data definition based on the primary geometry profile generated in the SolidWorks and enriched in the Design for Mouldability. According to this data definition, the intra and inter-contexts processes of sharing, converting and translating are investigated in the next sections. Section 8.2 depicts the Case Study 1 - Rotational product mouldability (*Design for Mouldability*) into Cavity Insert Design (*Design for Tooling*). Section 8.3 shows the Case Study 2 - Rotational product mouldability (*Design for Mouldability*) into Core Insert Design (*Design for Tooling*). Finally, Section 8.4 presents the Case Study 3 - Cavity Insert Design (*Design for Tooling*) into Cavity Manufacturing (*Design for Machining*).

8.1 INITIAL EXPERIMENTAL PRODUCT DATA DEFINITION

The rotational plastic part selected for exploring the semantic information interoperability in the product design and manufacturing is illustrated in Detail "A" of Figure 149. The rotational plastic product is a polystyrene thermal cup with 200 millilitres. Detail "B" presents the primary geometric profile created by the user in the SolidWorks 3D CAD tool, using the IPDMS design assistant. This primary geometric profile is converted into XML data file (detail "C") that will be inserted in the IPDMS in order to start the product design and manufacturing. The XML Data File has the coordinates (Xinitial, Yinitial, Zinitial, Xfinal, Yfinal and Zfinal) of the Centerline, Parting Line and Product Profiles. Additionally, the offset information is included in the correspondent product thickness file. Appendix B contains the product drawing sheet with all product dimensions as well as the material that will be used in its manufacturing. The product material is the Polystyrene "PSC 1160" and its respective shrinkage factor value is 0.0055. The main shape of the product is composed of six Rotational Mouldability Primary Features, being three parallel and three perpendicular to the Parting Line.

Figure 149 Rotational Plastic Injected Part Representation.

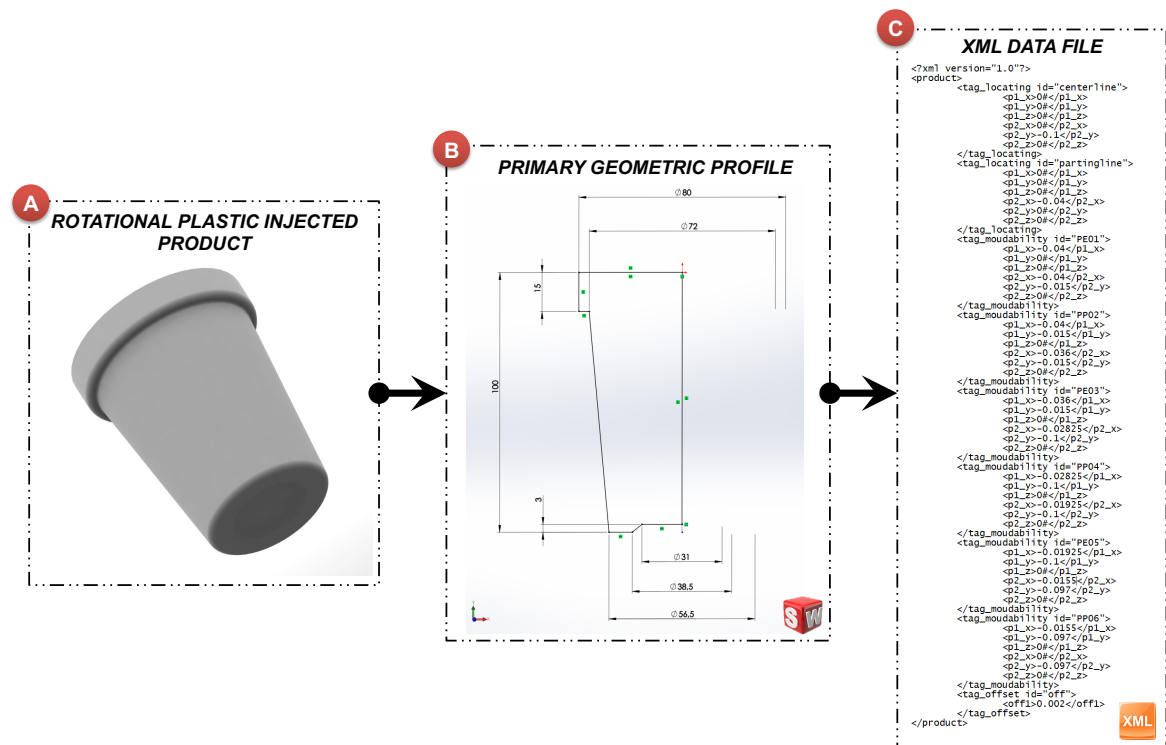

Figure 149 shows the Design for Mouldability interface in the IPDMS with the data definition of the Rotational Plastic Injected Product that was inserted in the system from the XML Data File, as shown in detail "A". The rotational primary features *P01*, *P02*, *P03*, *P04*, *P05* and *P06* are instantiated in the specialised ontology from *Rotational Mouldability Core Ontology*, as depicted in detail "B". This specialised ontology is a sub-class of the ontology named "Product", which will have all information of the product mouldability, the mould design and manufacturing process of the mould design. Detail "C" illustrates the coordinates of the the primary feature *P01* where "Xinitial" is equal to 40.0mm, "Yinitial" is equal to 0.0mm, "Zinitial" is equal to 0.0mm, "Xfinal" is equal to 40.0mm, "Yfinal" is equal to 15.0mm and "Zfinal" is equal to 0.0mm. The coordinates "Xinitial" and "Xfinal" consider the product radius and not the diameter of the product. Detail "D" presents the semantic mapping performed in the Rotational primary features and the offset.

Figure 150 Design for Mouldability interface in the IPDMS with Rotational Primary Geometric Information.

A XML DATA FILE

```

<?xml version="1.0"?>
<product>
  <tag_location id="centerline">
    <tag_location id="p01">
      <tag_location id="p02">
        <tag_location id="p03">
          <tag_location id="p04">
            <tag_location id="p05">
              <tag_location id="p06">
                <tag_location id="offset">
                  <tag_offset id="off1">
                </tag_offset>
              </tag_location>
            </tag_location>
          </tag_location>
        </tag_location>
      </tag_location>
    </tag_location>
  </tag_location>
</product>
  
```

B Mouldability Interface

The interface shows a 3D model of a rotational part with primary features *P01* through *P06* highlighted. A table below the model shows the coordinates for feature *P01*:

Data Item	X (mm)	Y (mm)	Z (mm)
P1	40.0	0.0	0.0
P2	40.0	15.0	0.0
P3			
P4			
P5			
P6			

C Coordinate Table for Feature P01

D SEMANTIC MAPPING

- P01 (Rot_Wall_Perp_Part_Line)
- P02 (Rot_Wall_Par_Part_Line)
- P03 (Rot_Wall_Perp_Part_Line)
- P04 (Rot_Wall_Par_Part_Line)
- P05 (Rot_Wall_Perp_Part_Line)
- P06 (Rot_Wall_Par_Part_Line)
- Radius_int_min (hasConversion) Off1
- Radius_ext_min (hasConversion) Off1
- P01 (hasInconsistency) P02
- P02 (hasInconsistency) P03
- P03 (hasInconsistency) P04
- P04 (hasInconsistency) P05
- P05 (hasInconsistency) P06

The primary features *P01*, *P03*, and *P05* are mapped as Rotational wall perpendicular to the Parting Line [*Rot_Wall_Perp_Part_Line*] and the *P02*, *P04* and *P06* are mapped as Rotational wall parallel to the Parting Line [*Rot_Wall_Par_Part_Line*], as shown in Table 12. The offset feature allows the definition of the minimum internal and external radii of the fillet that is applied to the product. Complementary, during the semantic mappings, the IPDMS performs

inconsistency mappings since the transition features between primary features were not defined by the user yet. So that, the relation profile between *P01* and *P02*; *P02* and *P03*; *P03* and *P04*; and *P05* and *P06* are mapped as inconsistency. After the definition features of the transition, by the user, the inconsistencies between these primary features are solved.

Table 12 Primary Geometric Profile Semantic Mapping.

-	Semantic Mappings
<i>SM1_Mouldability</i>	P01 (Rot_Wall_Perp_Part_Line)
<i>SM2_Mouldability</i>	P02 (Rot_Wall_Par_Part_Line)
<i>SM3_Mouldability</i>	P03 (Rot_Wall_Perp_Part_Line)
<i>SM4_Mouldability</i>	P04 (Rot_Wall_Par_Part_Line)
<i>SM5_Mouldability</i>	P05 (Rot_Wall_Perp_Part_Line)
<i>SM6_Mouldability</i>	P06 (Rot_Wall_Par_Part_Line)
<i>SM7_Mouldability</i>	Radius_int_min (hasConversion) Off1
<i>SM8_Mouldability</i>	Radius_ext_min (hasConversion) Off1
<i>SM9_Mouldability</i>	P01 (hasInconsistency) P02
<i>SM10_Mouldability</i>	P02 (hasInconsistency) P03
<i>SM11_Mouldability</i>	P03 (hasInconsistency) P04
<i>SM12_Mouldability</i>	P04 (hasInconsistency) P05
<i>SM13_Mouldability</i>	P05 (hasInconsistency) P06

The transition features and offset features are defined after the addition of the Rotational primary geometric profile into the system. The user inserts the most suitable fillet product radius, respecting the minimum radius constraint. The fillet radius for this product, according to the drawing sheet in Appendix A, was 1.00mm for the internal radius and 3.00mm for the external radius. Internal minimum radius and External minimum radius were defined in Section 6.4.1.1.4 - item II. Additionally, the offset feature is also defined by the user as 2.00mm for the internal direction. Figure 151 depicts the information instantiated in the IPDMS. In Detail "A" is showed all primary features in the system where from *P01* to *P06* are the primary features without offset and from *PO01* to *PO06* are the primary features with offset. It is the same with the transition features (Detail "B") where from TE1 to TE5 the transition features do not have the offset and from TEO1 to TEO5, they are the transition features with offset. Detail "C" illustrates an example of the value stored in the instances P01 after the addition of the transitions features and Detail "D" depicts all semantic mapping identified in the product.

Figure 151 Design for Mouldability interface in the IPDMS with the transition features and the offset features.

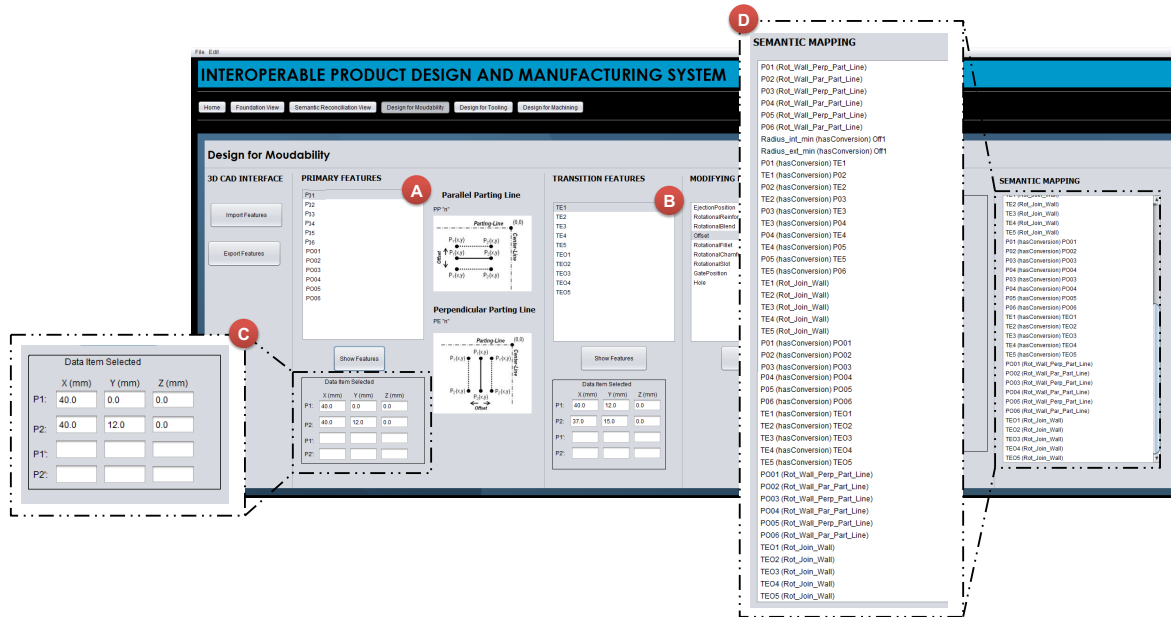

Table 13 and Table 14 present all data information about the geometry of the Rotational Plastic Injected Product with Primary Features, Transition Features and Primary and Transition Features with the offset considerations for the internal direction. So, the external profile of the product is the primary features and transition features without offset (*P01* to *P06* and *TE1* to *TE5* - Table 13) and this information is important to define the Cavity Insert Design. The internal profile of the product is the primary and transition features with offset (*P001* to *P006* and *TE01* to *TE05* - Table 14) and this information is important to define the Core Insert Design.

Table 13 Primary and Transition Features of the Rotational Plastic Product without offset (external profile) used in the case study.

	Xinitial (mm)	Yinitial (mm)	Zinitial (mm)	Xfinal (mm)	Yfinal (mm)	Zfinal (mm)	Radius (mm)
<i>P01</i>	40.00	0.00	0.00	40.00	12.00	0.00	-
<i>TE1</i>	40.00	12.00	0.00	37.00	15.00	0.00	3.00
<i>P02</i>	37.00	15.00	0.00	37.00	15.00	0.00	-
<i>TE2</i>	37.00	15.00	0.00	35.90	15.90	0.00	1.00
<i>P03</i>	35.90	15.90	0.00	28.25	97.30	0.00	-
<i>TE3</i>	28.25	97.30	0.00	25.25	100.00	0.00	3.00
<i>P04</i>	25.25	100.00	0.00	19.25	100.00	0.00	-
<i>TE4</i>	19.25	100.00	0.00	17.10	99.10	0.00	3.00
<i>P05</i>	17.10	99.10	0.00	15.50	97.30	0.00	-
<i>TE5</i>	15.50	97.30	0.00	14.50	97.00	0.00	1.00
<i>P06</i>	14.50	97.00	0.00	0.00	97.00	0.00	-

Table 14 Primary and Transition Features of the Rotational Plastic Product with offset (internal profile) used in the case study.

	Xinitial (mm)	Yinitial (mm)	Zinitial (mm)	Xfinal (mm)	Yfinal (mm)	Zfinal (mm)	Radius (mm)
PO01	38.00	0.00	0.00	38.00	12.00	0.00	-
TEO1	38.00	12.00	0.00	37.00	13.00	0.00	1.00
PO02	37.00	13.00	0.00	37.00	13.00	0.00	-
TEO2	37.00	13.00	0.00	33.90	15.90	0.00	3.00
PO03	33.90	15.90	0.00	26.25	97.30	0.00	-
TEO3	26.25	97.30	0.00	25.25	98.00	0.00	1.00
PO04	25.25	98.00	0.00	19.25	98.00	0.00	-
TEO4	19.25	98.00	0.00	18.60	97.70	0.00	1.00
PO05	18.60	97.70	0.00	16.70	95.90	0.00	-
TEO5	16.70	95.90	0.00	14.50	95.00	0.00	3.00
PO06	14.50	95.00	0.00	0.00	95.00	0.00	-

Figure 152 illustrates all primary and transition features in the 3D part model. Detail “A” represents the features without offset and Detail “B” represents the features with offset.

Figure 152 Representations of the Primary and Transition Features in the Product Part Model.

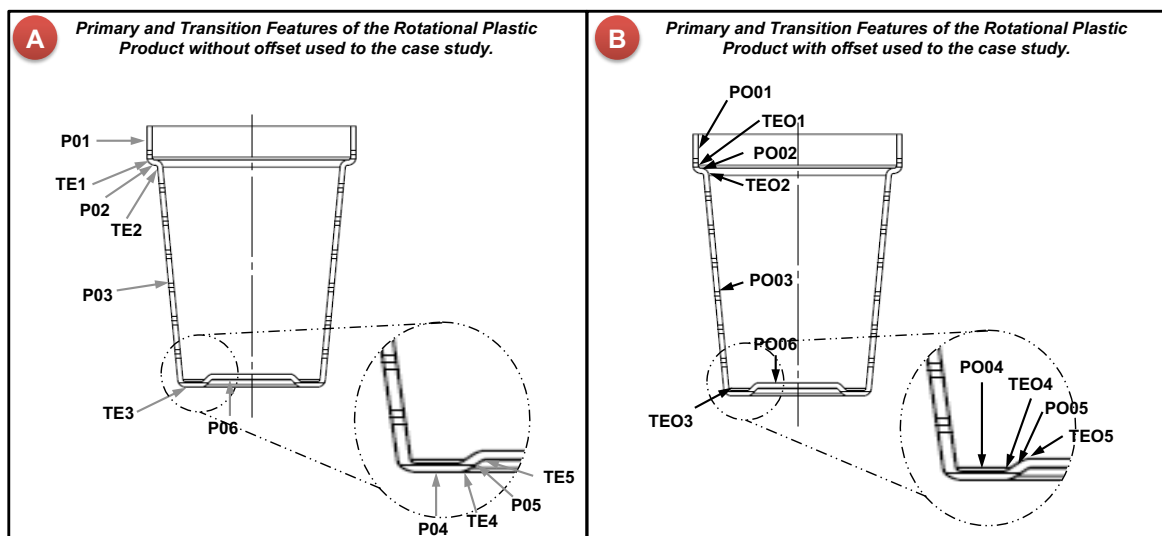

In addition to the information about the profile of the product study case, Figure 151 showed in Detail “D” the semantic mappings established across the Design for Mouldability process. Table 15 presents, in details, all semantic mapping defined in accordance with the Design for mouldability of the Rotational plastic injected product.

Table 15 Semantic Mappings in the Design for Mouldability.

-	Semantic Mappings
<i>SM9_Mouldability</i>	P01 (hasConversion) TE1
<i>SM10_Mouldability</i>	TE1 (hasConversion) P02
<i>SM11_Mouldability</i>	P02 (hasConversion) TE2
<i>SM12_Mouldability</i>	TE2 (hasConversion) P03
<i>SM13_Mouldability</i>	P03 (hasConversion) TE3
<i>SM14_Mouldability</i>	TE3(hasConversion) P04
<i>SM15_Mouldability</i>	P04 (hasConversion) TE5
<i>SM16_Mouldability</i>	TE5 (hasConversion) P06
<i>SM17_Mouldability</i>	TE1 (Rot_Join_Wall)
<i>SM18_Mouldability</i>	TE2 (Rot_Join_Wall)
<i>SM19_Mouldability</i>	TE3 (Rot_Join_Wall)
<i>SM20_Mouldability</i>	TE4 (Rot_Join_Wall)
<i>SM21_Mouldability</i>	TE5 (Rot_Join_Wall)
<i>SM22_Mouldability</i>	P01 (hasConversion) PO01
<i>SM23_Mouldability</i>	P02 (hasConversion) PO02
<i>SM24_Mouldability</i>	P03 (hasConversion) PO03
<i>SM25_Mouldability</i>	P04 (hasConversion) PO04
<i>SM26_Mouldability</i>	P05 (hasConversion) PO05
<i>SM27_Mouldability</i>	P06 (hasConversion) PO06
<i>SM28_Mouldability</i>	TE1 (hasConversion) TEO1
<i>SM29_Mouldability</i>	TE2 (hasConversion) TEO2
<i>SM30_Mouldability</i>	TE3 (hasConversion) TEO3
<i>SM31_Mouldability</i>	TE4 (hasConversion) TEO4
<i>SM32_Mouldability</i>	TE5 (hasConversion) TEO5
<i>SM33_Mouldability</i>	PO01 (Rot_Wall_Perp_Part_Line)
<i>SM34_Mouldability</i>	PO02 (Rot_Wall_Par_Part_Line)
<i>SM35_Mouldability</i>	PO03 (Rot_Wall_Perp_Part_Line)
<i>SM36_Mouldability</i>	PO04 (Rot_Wall_Par_Part_Line)
<i>SM37_Mouldability</i>	PO05 (Rot_Wall_Perp_Part_Line)
<i>SM38_Mouldability</i>	PO06 (Rot_Wall_Par_Part_Line)
<i>SM39_Mouldability</i>	TEO1 (Rot_Join_Wall)
<i>SM40_Mouldability</i>	TEO2 (Rot_Join_Wall)
<i>SM41_Mouldability</i>	TEO3 (Rot_Join_Wall)
<i>SM42_Mouldability</i>	TEO4 (Rot_Join_Wall)
<i>SM43_Mouldability</i>	TEO5 (Rot_Join_Wall)

8.2 TEST CASE 1: DESIGN FOR TOOLING (ROTATIONAL PLASTIC INJECTED PRODUCT VS. CAVITY INSERT DESIGN)

This section shows the test case to evaluate the IPDMS in order to translate, convert and share the information from Rotational Product Geometric Profile (Design for Mouldability) to Cavity Insert Design (Design for Tooling), ensuring the correct information exchange from the Rotational Plastic Injected Product to the Rotational Cavity Insert, as illustrate in Figure 153.

Figure 153 Overview of the Test Case 1.

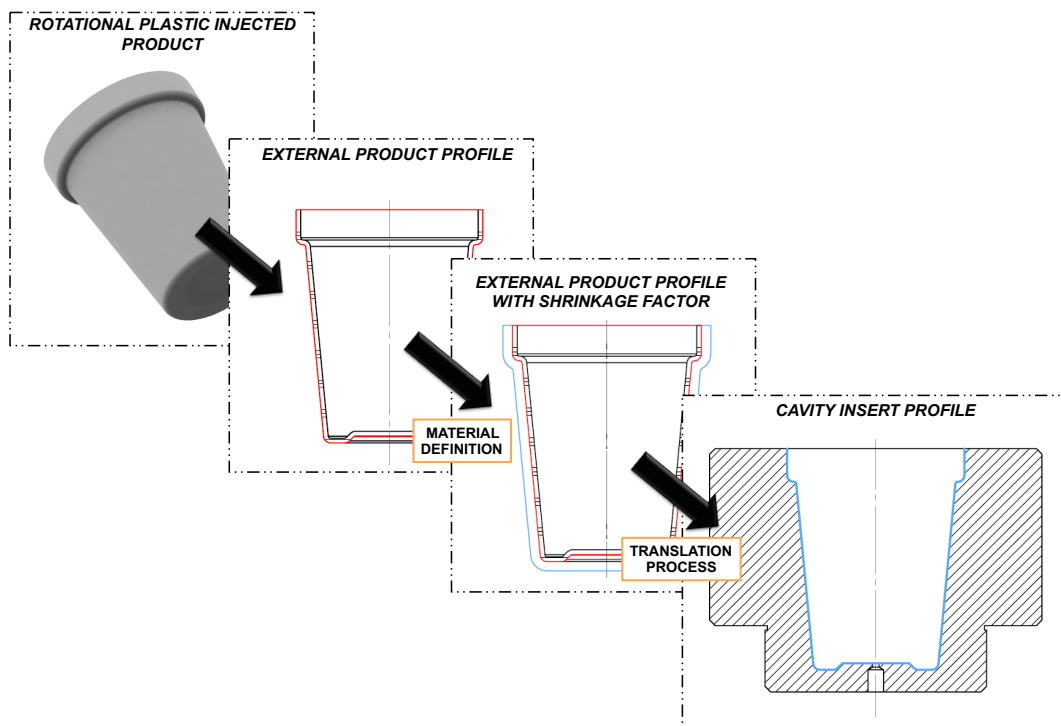
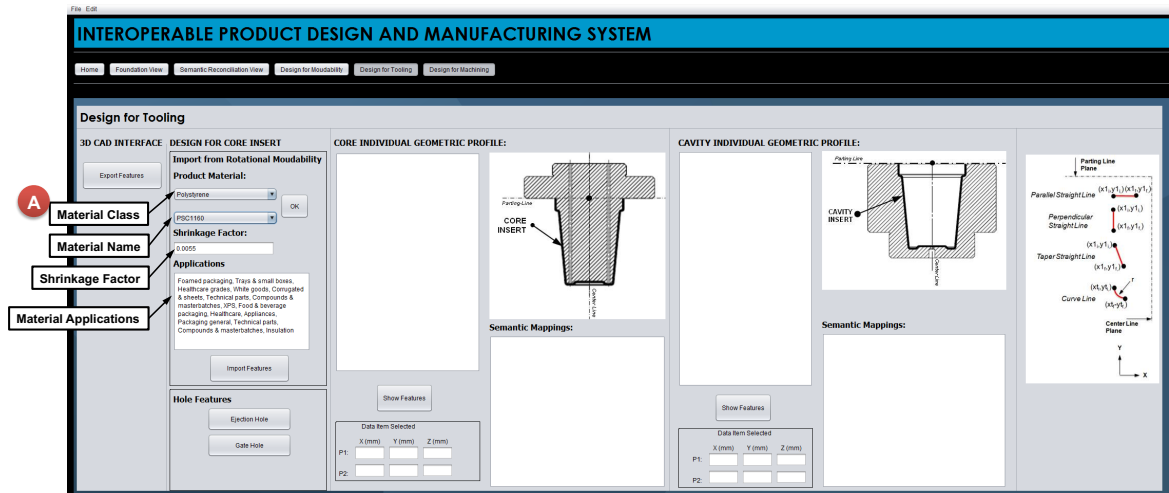

Figure 154 illustrates the screen of the Design for Tooling in the IPDMS. The Cavity insert design is totally dependent on the external profile of the product and the material. The last one is fundamental for defining the shrinkage factor, as shown in Detail "A". The shrinkage factor must be applied to the product geometry to create the impression system. As discussed in the beginning of this chapter, the thermal cup will be produced in Polystyrene PSC 1160, which has a shrinkage factor 0.0055. This information is already in the IPDMS in the Material Core Ontology and it will be inserted in the Product Ontology.

Figure 154 Definition of the Product Material in the IPDMS Interface.



The imported features from the rotational product profile can be executed after the product material definition. Figure 155 illustrates results of the translation process in the Design for Tooling – IPDMS Interface. The Cavity individual geometric profiles are highlighted in Detail “A” where all the profiles translated from the Rotational Plastic Product are instantiated in the specialised Mould design ontology. For this translation, the formal structure has captured the external profile with its associated objects from the Mouldability features and translated them in terms of Rotational cavity design information. The semantic mappings are automatically established in accordance with the semantic rules proposed in Chapter 6 and shown in detail “B”.

Figure 155 Result of the translation process for the Cavity Insert Design.

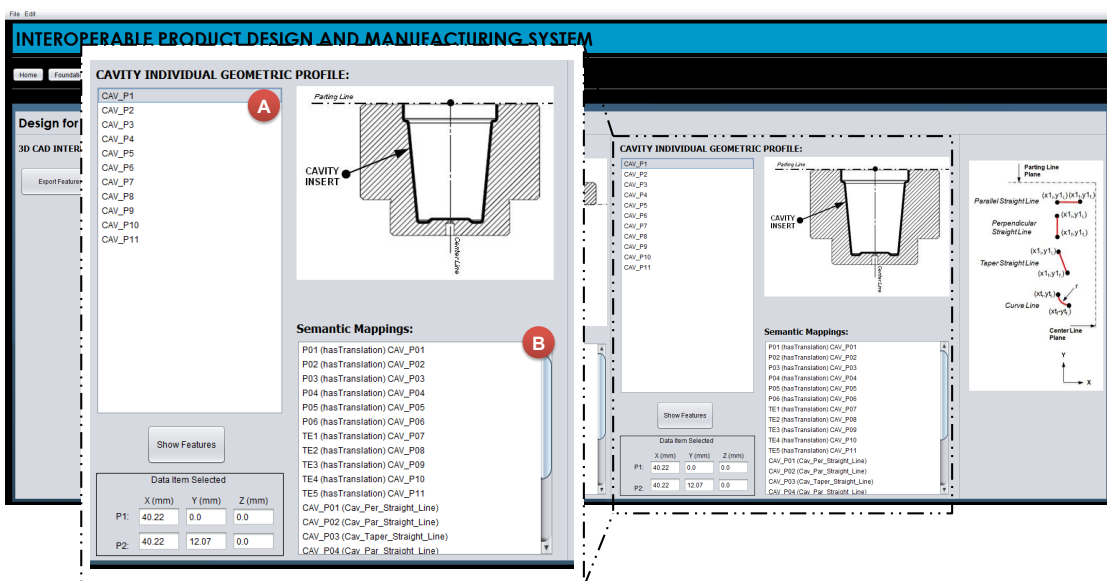

Detail "A" of Figure 155 illustrated the list of the profiles that were generated by the translation process. This process has translated each Rotational mouldability primary and Transition features into a cavity profiles in the cavity design. Table 16 presents the coordinates of the Cavity insert profile after the translation process from the Rotational plastic product design into Cavity insert design.

Table 16 Coordinates of the Cavity Insert after the translation process.

-	Xintial (mm)	Yinitial (mm)	Zinitial (mm)	Xfinal (mm)	Yfinal (mm)	Zfinal (mm)	Radius (mm)
CAV_P01	40.22	0.00	0.00	40.22	12.07	0.00	-
CAV_P02	37.20	15.08	0.00	37.20	15.08	0.00	-
CAV_P03	36.10	15.99	0.00	28.41	97.84	0.00	-
CAV_P04	25.39	100.55	0.00	19.36	100.55	0.00	-
CAV_P05	17.19	99.65	0.00	15.59	97.84	0.00	-
CAV_P06	14.58	97.53	0.00	0.00	97.53	0.00	-
CAV_P07	40.22	12.07	0.00	37.20	15.08	0.00	3.02
CAV_P08	37.20	15.08	0.00	36.10	15.99	0.00	1.01
CAV_P09	28.41	97.84	0.00	25.39	100.55	0.00	3.02
CAV_P10	19.36	100.55	0.00	17.19	99.65	0.00	3.02
CAV_P11	15.59	97.84	0.00	14.58	97.53	0.00	1.01

Detail "B" of Figure 155 depicted the semantic mapping established after the translation process. Table 17 presents, in details, all the semantic mapping realised based on the semantic rules defined in Chapter 6. The detailing shows six Cavity straight lines and five Cavity curve line of the Cavity Insert Design. From the six Cavity straight lines, one is Cavity perpendicular straight line [Cav_Perp_Straight_Line]; two are Cavity taper straight line [Cav_Taper_Straight_Line] and three are Cavity parallel straight line [Cav_Par_Straight_Line].

Table 17 Semantic Mappings in the Cavity Insert Design (Design for Tooling).

-	Semantic Mappings
SM1_Tooling	P01 (hasTranslation) CAV_P01
SM2_Tooling	P02 (hasTranslation) CAV_P02
SM3_Tooling	P03 (hasTranslation) CAV_P03
SM4_Tooling	P04 (hasTranslation) CAV_P04
SM5_Tooling	P05 (hasTranslation) CAV_P05
SM6_Tooling	P06 (hasTranslation) CAV_P06
SM7_Tooling	TE1 (hasTranslation) CAV_P07
SM8_Tooling	TE2 (hasTranslation) CAV_P08

SM9_Tooling	TE3 (hasTranslation) CAV_P09
SM10_Tooling	TE4 (hasTranslation) CAV_P10
SM11_Tooling	TE5 (hasTranslation) CAV_P11
SM12_Tooling	CAV_P01 (Cav_Perp_Straight_Line)
SM13_Tooling	CAV_P02 (Cav_Par_Straight_Line)
SM14_Tooling	CAV_P03 (Cav_Taper_Straight_Line)
SM15_Tooling	CAV_P04 (Cav_Par_Straight_Line)
SM16_Tooling	CAV_P05 (Cav_Taper_Straight_Line)
SM17_Tooling	CAV_P06 (Cav_Par_Straight_Line)
SM18_Tooling	CAV_P07 (Cav_Curve_Line)
SM19_Tooling	CAV_P08 (Cav_Curve_Line)
SM20_Tooling	CAV_P09 (Cav_Curve_Line)
SM21_Tooling	CAV_P10 (Cav_Curve_Line)
SM22_Tooling	CAV_P11 (Cav_Curve_Line)

Figure 156 illustrates, in a 3D model, the profiles translated from Rotational mouldability features (Design for Mouldability) into Cavity insert design (Design for Tooling). The profiles follow the information presented in Table 16.

Figure 156 Cavity Insert Profiles translated from Rotational mouldability features.

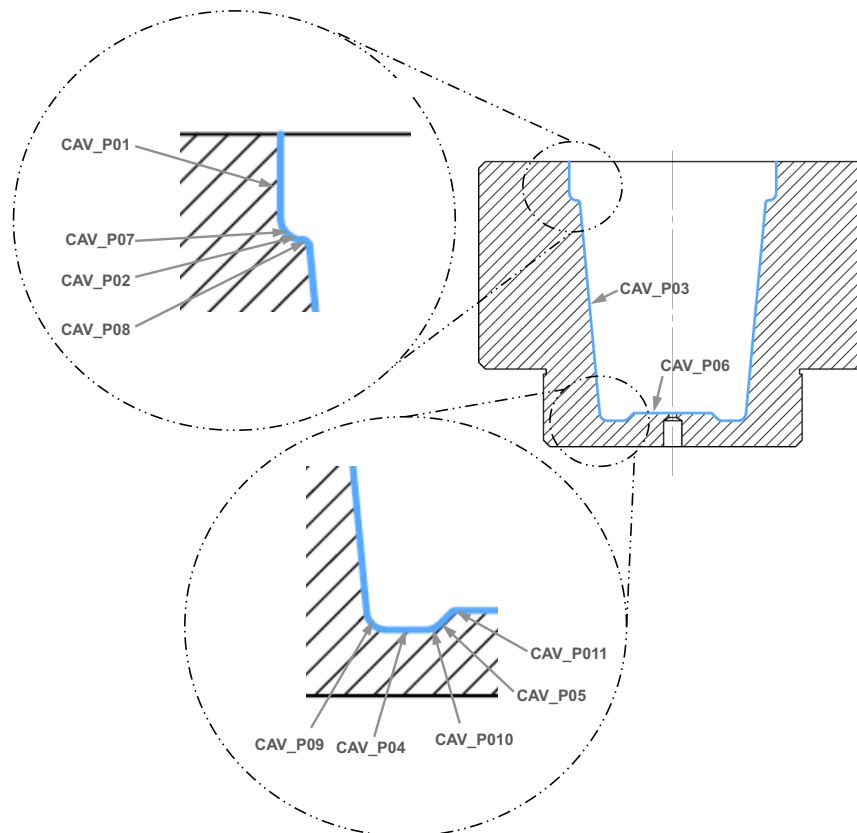

8.3 TEST CASE 2: DESIGN FOR TOOLING (PLASTIC INJECTED PRODUCT VS. CORE INSERT DESIGN)

This section shows the test case to evaluate the IPDMS in order to translate, convert and share the information from Rotational product geometric profile (Design for Mouldability) to Core insert design (Design for Tooling), ensuring the correct information exchange from the Rotational Plastic Injected Product to the Rotational Core Insert, as illustrate in Figure 157.

Figure 157 Overview of the Test Case 2.

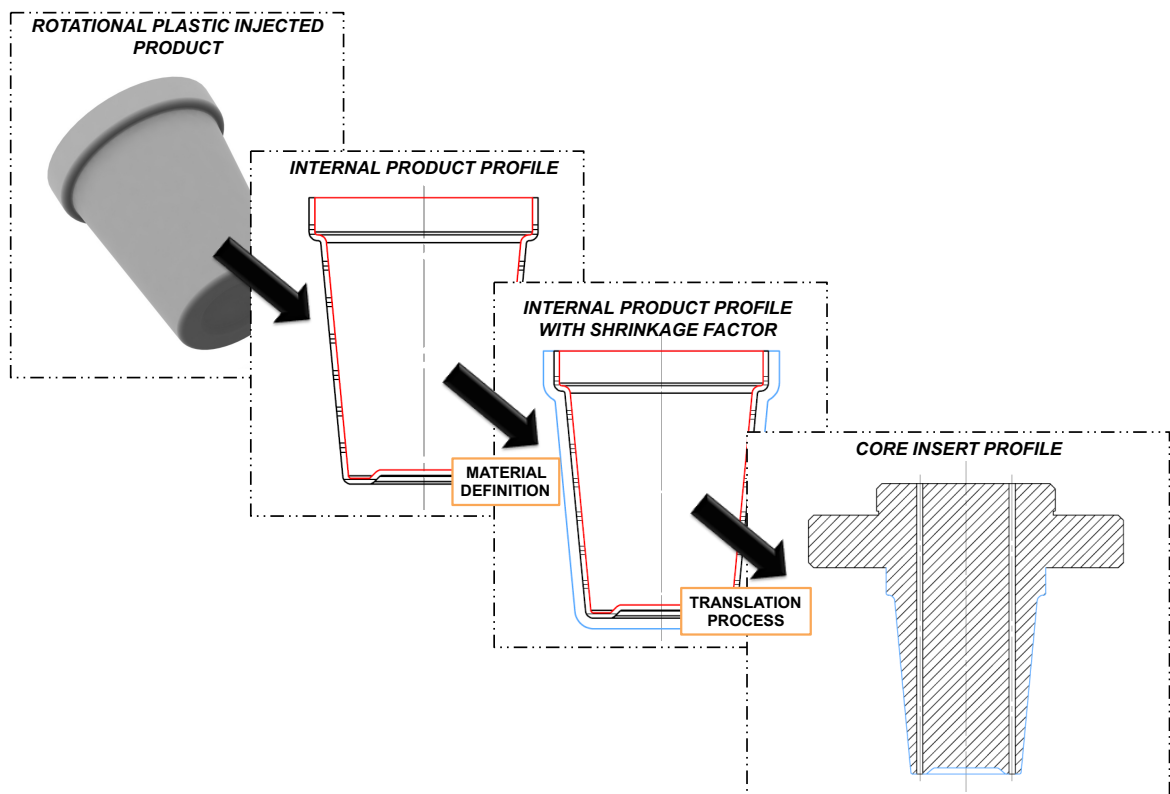

The Core insert is dependent on the internal profile of the Rotational Plastic Product and the Material. As discussed in section 8.2, the material is fundamental for the definition of the shrinkage factor, which is necessary to apply in the translation process between the Design for mouldability and design for tooling. Detail "A" of Figure 1585 presented the selection of the material by the user, shrinkage factor and the material application description. The material defined for this product was Polystyrene PSC 1160, which has a shrinkage factor equal to 0.0055.

The imported features from the Rotational product profile can be executed after the product material definition. Figure 158 illustrates the Design for Tooling interface that demonstrates the results of the translation process. In this test case, Core Individual Geometric Profiles is highlighted in Detail “A” where all profiles translated from the Rotational Plastic Product are instantiated in the specialised mould design ontology. For this translation, the formal structure has captured the internal profile of the product with its associated objects from the Mouldability features, translating them in terms of rotational core design information. Automatically, the semantic mappings are established in accordance with the semantic rules proposed in Chapter 6, as shown in Detail “B”.

Figure 158 Results of the translation process for the Core Insert Design.

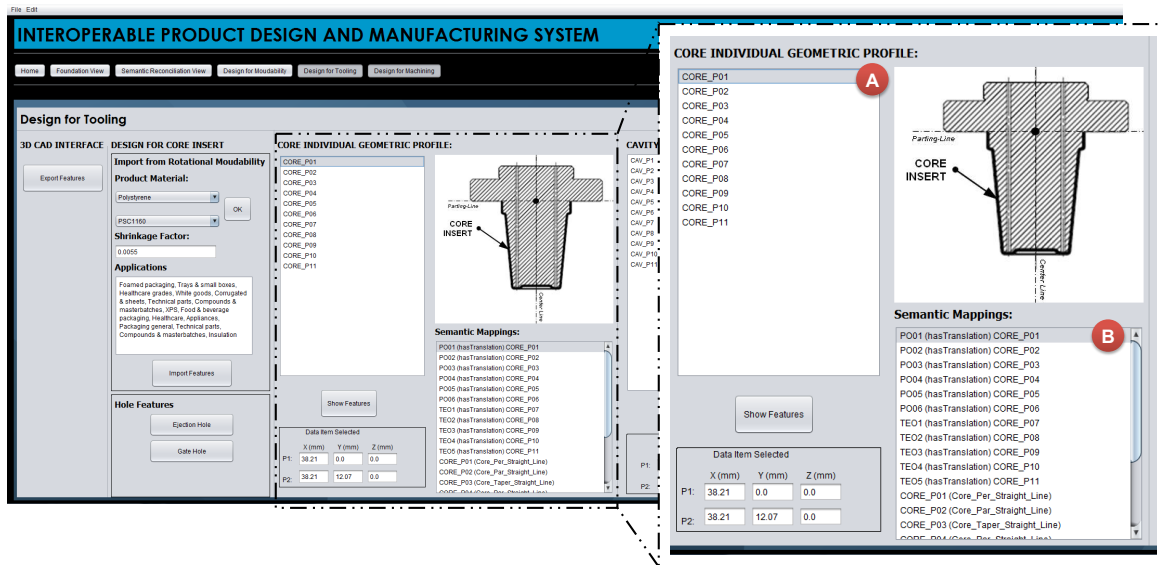

Detail "A" of Figure 158 illustrates the list of the profiles that were generated by the translation process. This process translated each rotational mouldability primary and transition features into core profiles in the core insert design. Table 18 presents the coordinates of the core insert profile after the translation process from the rotational plastic product design into core insert design.

Table 18 Coordinates of the Core Insert after the translation process.

-	Xinitial (mm)	Yinitial (mm)	Zinitial (mm)	Xfinal (mm)	Yfinal (mm)	Zfinal (mm)	Radius (mm)
CORE_P01	38.21	0.00	0.00	38.21	12.07	0.00	-
CORE_P02	37.20	13.07	0.00	37.20	13.07	0.00	-

CORE_P03	34.09	15.99	0.00	26.39	97.84	0.00	-
CORE_P04	25.39	98.54	0.00	19.36	98.54	0.00	-
CORE_P05	18.70	98.24	0.00	16.79	96.43	0.00	-
CORE_P06	14.58	95.52	0.00	0.00	95.52	0.00	-
CORE_P07	38.21	12.07	0.00	37.20	13.07	0.00	1.01
CORE_P08	37.20	13.07	0.00	34.09	15.99	0.00	3.02
CORE_P09	26.39	97.84	0.00	25.39	98.54	0.00	1.01
CORE_P10	19.36	98.54	0.00	18.70	98.24	0.00	1.01
CORE_P11	16.79	96.43	0.00	14.58	95.52	0.00	3.02

Detail "B" of Figure 158 depicted the semantic mapping established after the translation process. Table 19 presents in details the semantic mappings realised based on the semantic rules defined in Chapter 6. The detailing shows six Core Straight Lines and five Core Curve Line to the Core Insert Design. From the six Core Straight Lines, one is Core Perpendicular Straight Line [*Core_Perp_Straight_Line*], two are Core Taper Straight Line [*Core_Taper_Straight_Line*] and three are Core Parallel Straight Line [*Core_Par_Straight_Line*].

Table 19 Semantic Mappings in the Core Insert Design (Design for Tooling).

-	Semantic Mappings
SM23_Tooling	PO01 (hasTranslation) CORE_P01
SM24_Tooling	PO02 (hasTranslation) CORE_P02
SM25_Tooling	PO03 (hasTranslation) CORE_P03
SM26_Tooling	PO04 (hasTranslation) CORE_P04
SM27_Tooling	PO05 (hasTranslation) CORE_P05
SM28_Tooling	PO06 (hasTranslation) CORE_P06
SM29_Tooling	TEO1 (hasTranslation) CORE_P07
SM30_Tooling	TEO2 (hasTranslation) CORE_P08
SM31_Tooling	TEO3 (hasTranslation) CORE_P09
SM32_Tooling	TEO4 (hasTranslation) CORE_P10
SM33_Tooling	TEO5 (hasTranslation) CORE_P11
SM34_Tooling	CORE_P01 (Core_Perp_Straight_Line)
SM35_Tooling	CORE_P02 (Core_Par_Straight_Line)
SM36_Tooling	CORE_P03 (Core_Taper_Straight_Line)
SM37_Tooling	CORE_P04 (Core_Par_Straight_Line)
SM38_Tooling	CORE_P05 (Core_Taper_Straight_Line)
SM39_Tooling	CORE_P06 (Core_Par_Straight_Line)
SM40_Tooling	CORE_P07 (Core_Curve_Line)
SM41_Tooling	CORE_P08 (Core_Curve_Line)
SM42_Tooling	CORE_P09 (Core_Curve_Line)
SM43_Tooling	CORE_P10 (Core_Curve_Line)
SM44_Tooling	CORE_P11 (Core_Curve_Line)

Figure 159 illustrates, in a 3D model, the profiles translated from Rotational mouldability features (Design for Mouldability) into Core insert design (Design for Tooling). The profiles follow the information presented in Table 18.

Figure 159 Core Insert Profiles translated from rotational mouldability features.

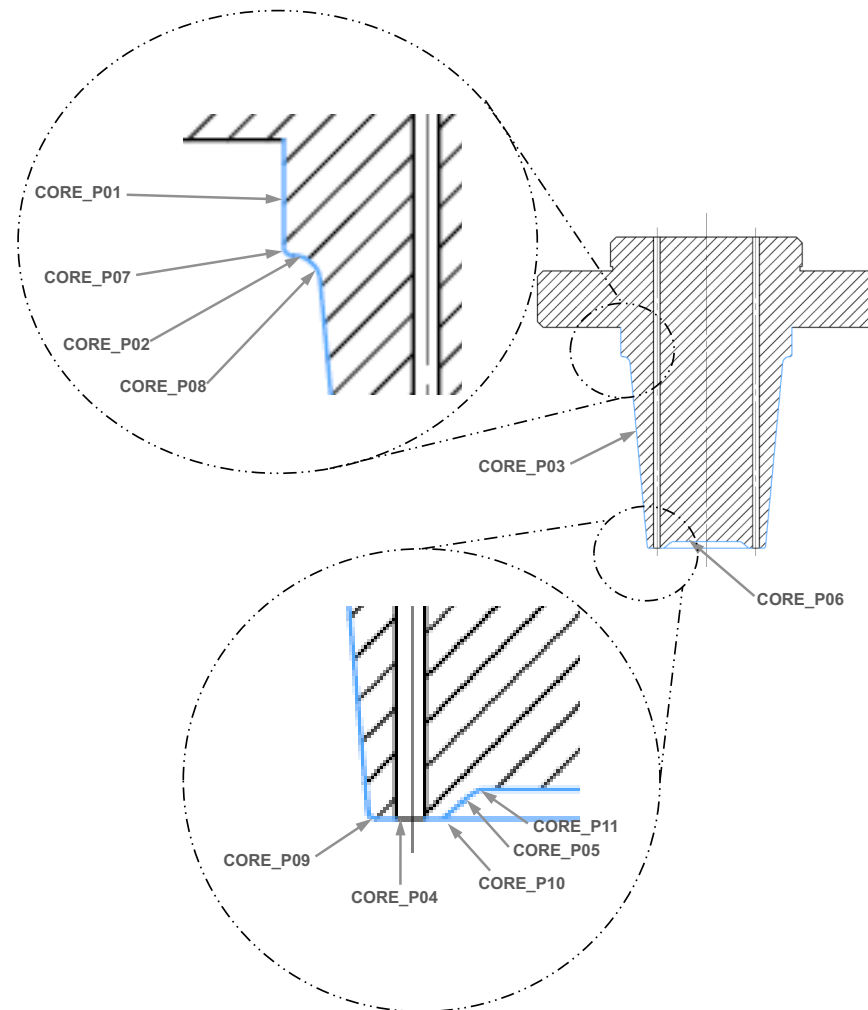

8.4 TEST CASE 3: DESIGN FOR MACHINING (CAVITY INSERT VS. CAVITY MANUFACTURING)

This section shows the test case to evaluate the IPDMS in order to translate, convert and share the information from Rotational cavity insert (Design for Tooling) into Cavity insert manufacturing (Design for Machining), ensuring the correct information exchange between these two contexts, as illustrate in Figure 160.

Figure 160. Overview of the Test Case 3.

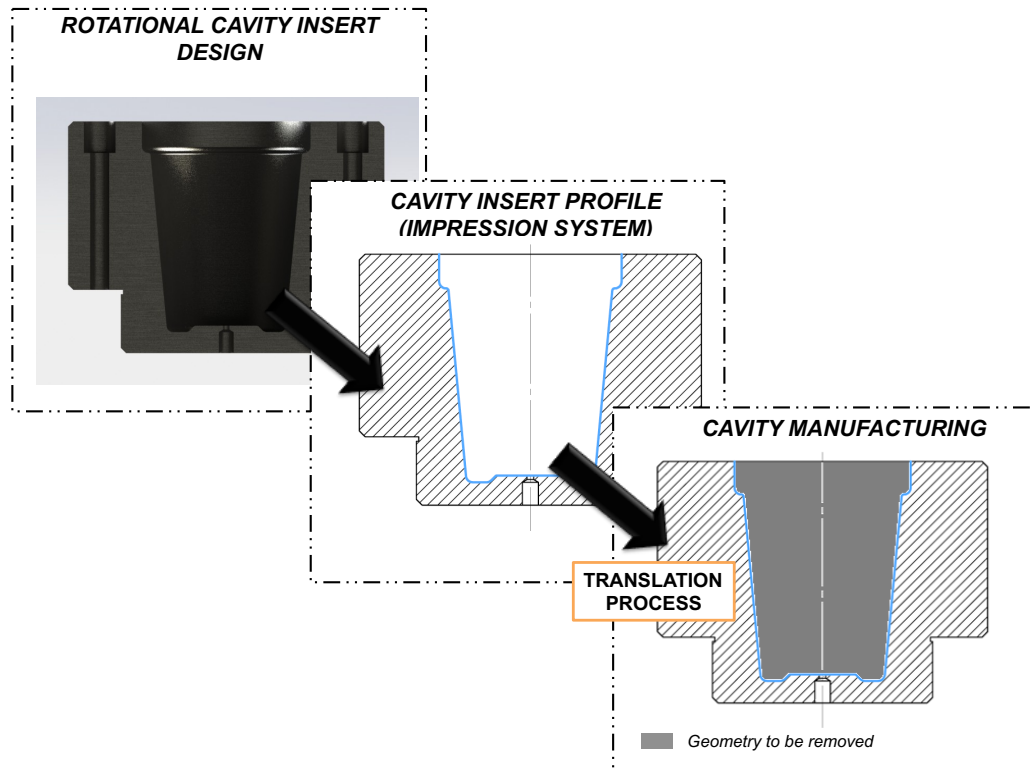

Figure 161 illustrates the Design for Machining Interface in the IPDMS to translate the information from the Cavity insert into Cavity insert manufacturing. In the Detail "A" is showed the material definition field for the Cavity and Core inserts. Detail "B" shows the button used for executing the translation process.

Figure 161 Interface for translating Rotational cavity insert design into Machining features in the Cavity insert manufacturing.

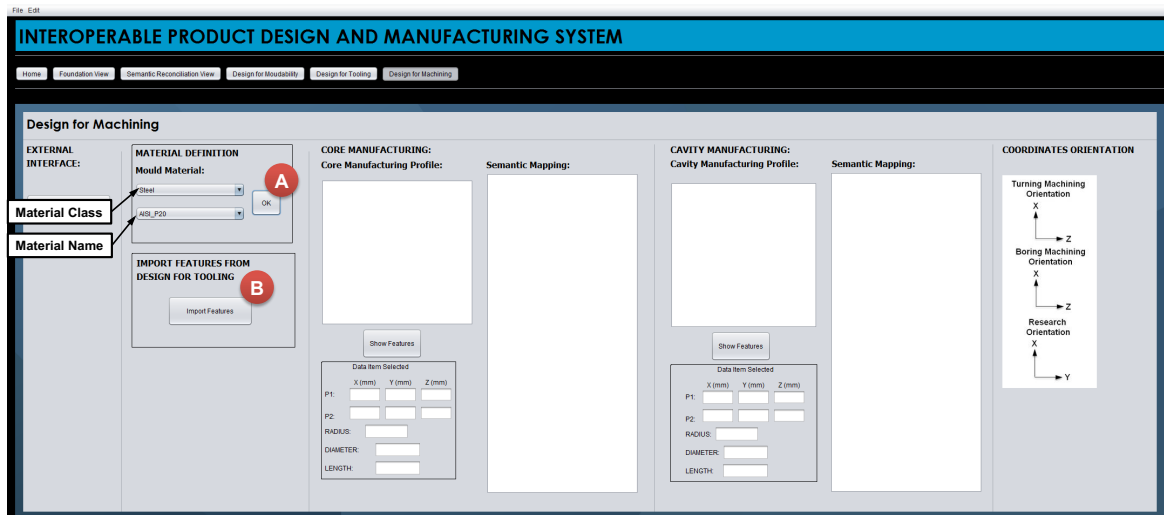

Figure 162 shows the interface that demonstrates the results of the translation of the features Cavity perpendicular straight line [*Cav_Per_Straight_Line*], Cavity taper straight line [*Cav_Taper_Straight_Line*], cavity parallel straight line [*Cav_Par_Straight_Line*] and cavity curve line [*Cav_Curve_Line*] into Rotational cavity horizontal boring [*Rot_Cav_Horizontal_Boring*], Rotational cavity taper boring [*Rot_Cav_Taper_Boring*], Rotational cavity facing boring [*Rot_Cav_Facing_Boring*] and Rotational cavity curve boring [*Rot_Cav_Curve_Boring*] respectively. Detail "A" presents the cavity profile translated between cavity insert design and cavity manufacturing. The geometry and material information are associated with each machining features. Detail "B" presents the semantic mappings established during the translation process.

Figure 162 Results of the Rotational Cavity translation (Rotational Cavity Manufacturing).

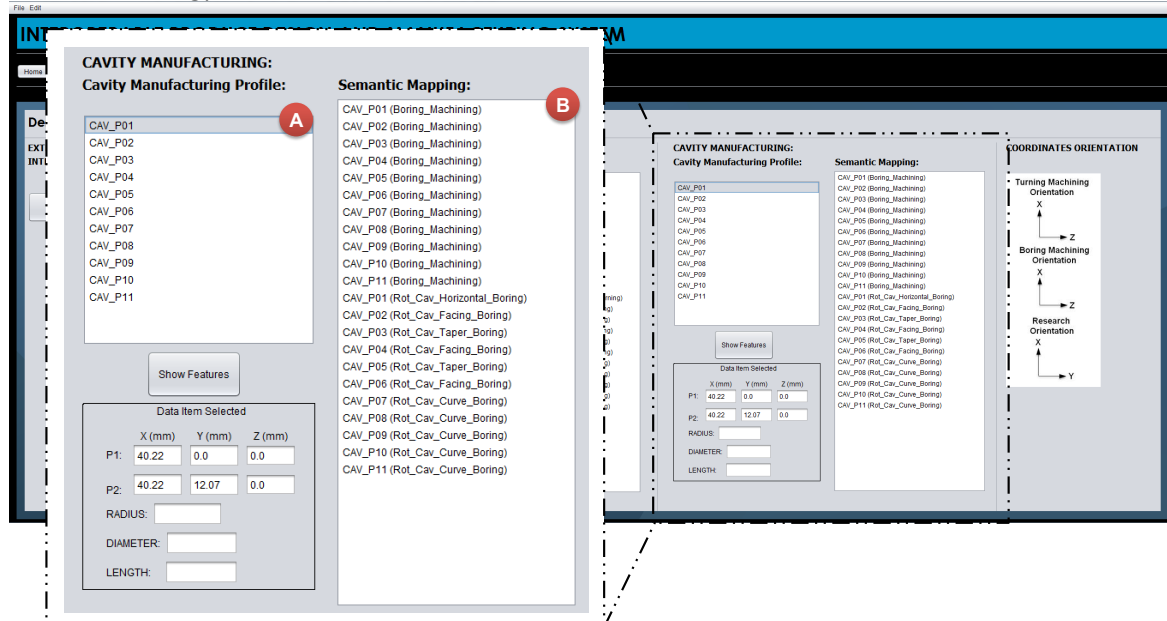

Table 20 presents, in detail, all the semantic mappings established during the translation process where one profile is Rotational cavity horizontal boring [*Rot_Cav_Horizontal_Boring* - (CAV_P01)], two profiles are Rotational cavity taper Boring [*Rot_Cav_Taper_Boring* - (CAV_P03 and CAV_P05)], three profiles are Rotational cavity facing boring [*Rot_Cav_Facing_Boring* - (CAV_P02 and CAV_P06)]

and five profiles are Rotational cavity curve boring [*Rot_Cav_Curve_Boring* (CAV_P07 - CAV_P11)].

Figure 163 Semantic Mappings in the Cavity Manufacturing (Design for Machining).

-	Semantic Mappings
<i>SM01_Machining</i>	CAV_P01 (Boring_Machining)
<i>SM02_Machining</i>	CAV_P02 (Boring_Machining)
<i>SM03_Machining</i>	CAV_P03 (Boring_Machining)
<i>SM04_Machining</i>	CAV_P04 (Boring_Machining)
<i>SM05_Machining</i>	CAV_P05 (Boring_Machining)
<i>SM06_Machining</i>	CAV_P06 (Boring_Machining)
<i>SM07_Machining</i>	CAV_P07 (Boring_Machining)
<i>SM08_Machining</i>	CAV_P08 (Boring_Machining)
<i>SM09_Machining</i>	CAV_P09 (Boring_Machining)
<i>SM10_Machining</i>	CAV_P10 (Boring_Machining)
<i>SM11_Machining</i>	CAV_P11 (Boring_Machining)
<i>SM12_Machining</i>	CAV_P01 (Rot_Cav_Horizontal_Boring)
<i>SM13_Machining</i>	CAV_P02 (Rot_Cav_Facing_Boring)
<i>SM14_Machining</i>	CAV_P03 (Rot_Cav_Taper_Boring)
<i>SM15_Machining</i>	CAV_P04 (Rot_Cav_Facing_Boring)
<i>SM16_Machining</i>	CAV_P05 (Rot_Cav_Taper_Boring)
<i>SM17_Machining</i>	CAV_P06 (Rot_Cav_Facing_Boring)
<i>SM18_Machining</i>	CAV_P07 (Rot_Cav_Curve_Boring)
<i>SM19_Machining</i>	CAV_P08 (Rot_Cav_Curve_Boring)
<i>SM20_Machining</i>	CAV_P09 (Rot_Cav_Curve_Boring)
<i>SM21_Machining</i>	CAV_P10 (Rot_Cav_Curve_Boring)
<i>SM22_Machining</i>	CAV_P11 (Rot_Cav_Curve_Boring)

The same process can be applied to the Core insert manufacturing (according to user desire), which is translated from the information of the Core insert design (Design for Tooling) into Core insert manufacturing (Design for Machining).

8.5 EVALUATION OF THE RESULTS

This chapter has explored the capability of the semantic mapping of sharing, converting and translating information intra and inter-contexts. The first test case explored the exchange information from the Rotational plastic injected product into rotational cavity insert design. The second test case explored the exchange information from the Rotational plastic injected product into Rotational core insert

design. The exchange information from the Rotational cavity insert design into Cavity insert manufacturing is explored in the third test case. This exchange process is based on the formal information data structure, as defined in Chapter 4, and which was specialised according to the specific product information (polystyrene thermal cup with 200 millilitres) in the Application Domain View, as defined in Chapter 5. The semantic mappings are inferred in the Application Domain View based on the semantic rules defined in Chapter 6.

The domain knowledge in the semantic information interoperability has done the following:

- For the first test case, the external profile of the *Rotational mouldability primary features* and *Transition features* were taken, then applied the shrinkage factor value on them. Next, they were translated into Cavity straight line and Cavity curve line profiles, respectively. This process generated eleven Cavity profiles and twenty-two semantic mappings.
- For the second case, the internal profile of the *Rotational mouldability primary features* and *Transition features* were taken, then applied the shrinkage factor value on them. Next, they were translated into Core straight line and Core curve line profiles, respectively. This process generated eleven Core profile and twenty-two semantic mappings.
- For the third case, the Cavity insert design profile of the *Rotational cavity individual geometry (Straight lines and Curve lines)* was taken. Next, they were translated into Cavity insert manufacturing, respectively. This process generated eleven Cavity profiles of manufacturing and twenty-two semantic mappings.

The results were positive since they demonstrated through a formal information data structure modelled in a formal common language and well-defined formal relationships the capability of the exchange heterogeneous information across multiple domains during the product design and manufacturing. This ensured the semantic information interoperability in a modern PDP environment.

9 DISCUSSION, CONCLUSION AND FUTURE WORK

The research work documented in this thesis has proposed and developed a conceptual framework to support the semantic information interoperability in Product Design and Manufacturing. This thesis has been focused on rotational plastic injected products, supporting the semantic information interoperability in the design for mouldability, design for tooling and design for machining as well as across this phases such as the semantic information interoperability between design for mouldability and design for tooling and design for tooling and design for machining.

The proposed conceptual framework was structured on four levels and has been explored alongside the interactions and mechanisms. The implementation of an experimental prototype system and conduction of test cases applied to the framework has converged in a valuable understanding of the potentials and limitations of the research approach.

This Chapter exposes a discussion on the proposed framework understanding and outcomes of its implementation in Section 9.2. The concluding remarks of this work are provided in Section 9.3 and Section 9.4 proposes recommendations for future work.

9.1 DISCUSSIONS

9.1.1 Ontological approach for the information formalisation (Reference View)

The Ontological approach has been the focus of recent researches, as the technology to support the semantic interoperability, and has been discussed since 2008 in INTEROP VLAB and in research works such as YOUNG *et al.*, 2007, CANGIOLIERI and YOUNG, 2010; PANETTO, DASSISTI and TURSI, 2012; CHUNGOORA *et al.*, 2013; LIAO *et al.*, 2015; LIAO *et al.*, 2016, PALMER *et al.*, 2016. Ontology presents a well-defined structure to formalise concepts and their relationships based on inferences according to semantic rules.

This research has used the ontological approach to formally structure concepts involved in the rotational plastic injected products. The core ontologies in the conceptual framework Reference View were specialised in product ontology

according to the specific information of the product that is being designed and manufactured.

The ontology formalisation method applied to this research followed the Knowledge Engineering Methodology - KEM (NOY AND MCGUINESS, 2001) accompanied by the use of Protégé for their modelling in Web Ontology Language (OWL). The two combined approaches have proved to be adequate in setting a strategic view on the ontology-based framework in order to support the semantic information interoperability in the product design and manufacturing. Chapter 4 explored the formalisation of the data structure (*Rotational Mouldability Data Structure, Rotational Mould Design Data Structure, Mould Manufacturing Data Structure and Material Data Structure*) in the core ontologies (*Rotational Mouldability Core Ontology, Rotational Mould Design Core Ontology, Mould Manufacturing Core Ontology and Material Core Ontology*).

The core ontologies offer the potential to provide a common information source to different applications domains by the specialisation process according to the specific information of the product that will be produced. This overcame the problems of information heterogeneity of the multiple domains since a common source of information supports multiple applications, that is, all applications must share the same product information avoiding data inconsistency. Thereby, the reuse of the knowledge for other applications improves the product design and manufacturing processes as well as reduces the time of product development and the misinterpretation issues during the PDP.

The research explored specific core ontologies definitions adequate to the focused area and each ontology was built for a strict proposal. Whenever a large numbers of fields is involved the approach assumes that large numbers of core ontologies will be required to formalise the whole knowledge. This requires a strong effort in order to formalise the entire concepts where sometimes it is not trivial indeed.

9.1.2 Specialisation process for building specific Product Knowledge Bases (Application Domain View)

The structure of information must be correct to support different point of view and applications. The level of detail captured in the information structure was important in order to eliminate the misinterpretation problems during the PDP. This research explored the specialisation process of core ontologies in the Application Domain ontologies based on specific product information. The product information was instantiated into the ontologies through new instances with object properties and data properties.

The semantic interoperability is at the instance level of Domain Application in order to ensure the correct information exchange across different phases of product design and manufacturing. So, the specialisation process aligned with the semantic reconciliation process (Reconciliation View) must meet strict criteria to ensure the semantic interoperability. Three specialisation approaches were explored in this research, as following: *i) controlled specialisation approach; ii) flexible specialisation approach; and iii) instantiation approach*. The first specialisation approach was considered the most important because it used strict proceeding as presented in the semantic rules and in the UML activity diagrams described in Chapters 6 and 7 respectively. The second approach enabled specific Application Domain to reuse the references core ontologies without imposing strict rules for specialisation. Finally, the last specialisation approach was the instantiation where the user can insert extra information or define information in the specialised ontology.

The specialisation in the Application Domain View presented the potential for supporting the semantic information interoperability across the PDP when the semantic rules are met during the process. Additionally, this specialisation process provides the creation of the Product Knowledge Base of a well defined, but specific domain of application. This Knowledge Base can be reused to develop other applications, improving the product engineering and reducing the time of PDP. However, the reuse of multiple Knowledge Bases implies different applied computational principles with different levels of complexity. The knowledge reusing is not trivial and requires new investigations to determine the most suitable strategy to

reuse this knowledge in a semantic interoperable manner integrating multiple platforms of applications.

9.1.3 Semantic Structures to the information relationships (Semantic Reconciliation View)

This research defined a semantic reconciliation process based on a specific set of semantic rules for supporting the information relationships in product design and manufacturing of plastic injected products. The Logical conditions were created in order to establish semantic mappings of *information translation, conversion and sharing*. The sharing mapping was defined when two concepts or instances use the same piece of information without any change in it. The conversion mapping was defined when one specific information needs the information of another perspective and the link of this information is a simple mathematical equation. Finally, the translation mapping is similar to the conversion process but requires multiples comparisons from distinct knowledges in order to establish the semantic relationships. The translation process is more complex than information sharing and conversion since the information translation must have knowledge of the relationships between the two distinct perspectives in order to map information from one to another.

In this context, the semantic rules were defined using the Semantic Web Rule Language (SWRL) and were oriented to establish the semantic mappings of translation, conversion and sharing in a formal manner when the logical conditions are satisfied. Moreover, Pellet reasoner was used as the inference engine, which is responsible for analysing the logical conditions and creating the inferences. Pellet is a complete OWL-DL reasoner with extensive support for reasoning with individuals and user-defined datatypes (SIRIN *et al.*, 2007).

The case studies developed in this research defined more than 50 semantic mappings (sharing, conversion and translation), as shown in Chapter 6, for supporting the semantic information interoperability in the product design and manufacturing of the rotational plastic injected products. The Semantic Mappings were limited to the research scope but were performed and analysed in view of providing semantic relationships from the Design for Mouldability into the Design for

Tooling and/or from the Design for Tooling into the Design for Machining. Running the inference machining, semantic mappings were automatically established across multiple domains (e.g. Core Insert or Cavity Insert Profile in the Design for Tooling were mapped as Turning or Boring Machining in the Design for Machining) and problems with information inconsistency were identified (e.g. internal or external radius of fillet are lesser than minimum internal or external radius in the Design for Mouldability).

There would be a significant value in extending this work to provide a more comprehensive set of both design and manufacturing perspectives, for example, defining the semantic mapping to support the feeding, cooling systems in the design for tooling as well as multiple manufacturing processes, such as EDM, grinding, assembly in Design for Machining.

9.1.4 The experimental system (Interoperable Product Development System – IPDMS)

The experimental system was implemented using multiple software platforms, such as Protégé 5.0, Netbeans 8.0.2, Apache Jena Framework and SolidWorks 2012. The core ontologies were modelled in OWL language, as following the data structure presented in Chapter 4. Protégé has sufficient capability for modelling the core ontologies and their evaluation. However, it does not have a very friendly interface in terms of integration with multiple platforms or the creation of a user interface. In this context, Netbeans 8.0.2 was used to create an interactive environment between the user and the IPDMS. This computational environment allowed the data insertion, information visualisation and control, guiding the user in the product development. The interface in the Netbeans was programmed in JAVA language and the Apache Jena Framework was used to create the link with the ontologies in OWL as well as to reason the semantic rules. The semantic rules were developed in SWRL and implemented in the Netbeans using the plug-in of the Apache Jena. In addition, Pellet reasoner was used as the inference engine to establish the semantic mapping across the product development. The union of Netbeans, Apache Jena and Pellet demonstrated sufficient capability for exploring the research ideas. Nevertheless, some computational limitations were found during

the modelling of the semantic rules since SWRL presented a rigid structure with limited commands.

SolidWorks was the CAD system used to generating the geometric profiles, enabling the user to define the initial geometric profile and insert into the IPDMS as well as the visualisation of the information produced during the process. However, the visualisation is not in a real time, since there is not a direct connectivity between the SolidWorks and IPDMS.

9.2 CONCLUSION

1. The conceptual framework for supporting the information interoperability across multiple domains in product design and manufacturing based on an ontological approach have been defined contributing to the decision support systems area and providing the mapping information for design and manufacturing activities.
2. The product design and manufacturing information can be semantically interoperated in an interoperable manner via formal information originated in well-defined structure data and relationships mechanisms (translation, conversion and sharing).
3. The literature review about PDP, Features Technology and Ontology clearly contributed to identify the existing problems across the product development field. This contribution aided: (i) to propose a conceptual defined information structure capable to support the interoperability in multiple activities in Product Design and Manufacturing; and (ii) to define the mechanism for relating information across the multiple phases of Product Design and Manufacturing (translation, conversion and sharing).
4. For the Product Design and Manufacturing domains, structuring information in elementary concepts responsible for representing the product, modelled in the core ontologies (Reference View of the Conceptual Framework), creates a common language structure, which can be recognise by the others framework views, without losing the information meaning throughout the PDP phases.

5. Heterogeneous data from multiple views of the Product Design and Manufacturing are instantiated in the core concepts, in a well-defined manner, through semantic rules (Application Domain View of the Conceptual Framework), which enables the creation of an interoperable environment for the product information.
6. Knowledge of the relationships between multiple views has been captured in semantic mapping mechanisms for translating, converting and sharing information across multiple views (Semantic Reconciliation View of the Conceptual Framework), which certifies the semantic information mapping interoperability in the product design and manufacturing.
7. While some information can be directly shared between applications or converted based on mathematical equations, the translation mechanism required knowledge from multiple domains to calculate, analyse and compare information in order to define new meaningful information.
8. To fulfil the research scope, the conceptual framework views were specialised to support the semantic information mapping interoperability of a specific rotational thin-wall plastic injected product. Particular core ontologies (mouldability core ontology, mould design core ontology, mould manufacturing core ontology and material core ontology) and semantic rules have been defined to support the design for mouldability, design for tooling and design for machining.
9. The Reference View core concepts and the specific product data structure were specialized within the Application Domain View using one of the three approaches - Controlled Specialisation Approach, Flexible Specialisation Approach and Instantiation Approach – according to the information type inserted in the system. These approaches ensure that the formal information contained in the core concepts and the informal information of the product data are formally

structured and integrated, which states the data comprehension by different PDP perspectives.

10. The information interoperability can be achieved through the conceptual framework specific relationships (i) intra-context and (ii) inter-context. While intra-context infers the semantic mapping of conversion and sharing within a single domain, the inter-context uses the knowledge of the relationships to infer the semantic mapping of translation across multiple domains. Although the interoperability of information is shown in both framework specific relationships, the inter-context emphasises and strongly corroborates the novelty of information interoperability in multiple domains proposed in this thesis.
11. An experimental system based on the multiple view concepts and semantic rules have been implemented using an ontological approach with Protégé, Netbeans, Apache Jena and SolidWorks and successfully explored the research ideas, confirming the intra and inter domains information interoperability during the Product design and manufacturing.
12. The hypothesis (i) is true, once semantic information interoperability in the framework can be achieved when the heterogeneous information from multiple domains are rigorously defined in an explicit common formal language. This allows their relationships based on the defined semantic mapping across different phases of the PDP. This has been shown through the relationships between the product design and product manufacturing of a specific rotational thin-wall plastic injected product. This hypothesis statement was proved in the exploration in the Chapters 4 and 5 and applied in the Chapters 7 and 8 where the core ontologies were implemented and applied for modelling specific rotational thin-wall plastic injected.
13. The hypothesis (ii) is true, since the semantic relationships in the framework are continually and dynamically processed as the logic conditions are inferred based on specific semantic rules. The semantic rules establish: (a) the semantic information mapping of sharing, conversion and translation when the defined conditions were true; or (b) the information inconsistency mapping when the

conditions were false. These hypothesis statements were demonstrated in the investigation of Chapters 6 where semantic rules for modelling specific rotational thin-wall plastic injected product were defined and in the Chapters 7 and 8 where the defined semantic rules were implemented and applied for their evaluation.

14. The proposed Conceptual Framework ensures the semantic information interoperability (intra and inter contexts) during the sequential evolution of the Product Design and Manufacturing, since the information is formally structured, traceable and the semantic rules are cyclically analysed. Furthermore, the framework architecture allows the information interoperability, both forward and backward, throughout all PDP phases. The impacts of the alterations in the further phases of the product design and manufacturing permit analyses of the previous phases, inferring in the information mapping, sharing, conversion and translation. These integrated, interoperable and simultaneous analyses ensure the information consistency during the different PDP phases and allow efficient interventions in the process.

9.3 RECOMMENDATIONS FOR FUTURE WORKS

The discussions section of this chapter has helped to orientating appropriate attention onto relevant areas where future work could be defined, as following:

1. as the developed concept was applied in a simple product, there is potential applications for more complex and/or diverse products;
2. There is a requirement to evaluate the framework with more complex plastic injected products, including products parts with multiple assemblies;
3. The proposed framework should be applied and evaluated in products with complex geometry that directly impact the mould design and manufacturing, for example, split core/cavity insert, etc;

4. From the conceptual level consideration, it is necessary to develop intelligent knowledge libraries (NOH, 2015; URWIN and YOUNG, 2014) in order to provide subsidies to the core concepts and to support the semantic information interoperability in more complex issues;
5. There is a requirement to evaluate the general conceptual framework in other domains of application, e.g. medicine and dentistry, providing support to the decision-making. The integration between the engineering and health areas has grown over the years and there are problems of semantic interoperability due to the heterogeneity of information involved in this process.

PUBLICATIONS

- SZEJKA, A. L., AUBRY, A., PANETTO, H., CANCEGLIERI JR., O., LOURES, E. R. Towards a Conceptual Framework for Requirements Interoperability in Complex Systems Engineering. In: Meersman R., Panetto, H., Mishra A., Valencia-García, R., Soares, A.L, Ciuciu I., Ferri F., Weichhart G., Moser T., Bezzi, M., Chan, H. (eds.) OTM 2014. Springer, **On the Move to Meaningful Internet Systems: OTM 2014 Workshops**. Amantea, Italy. Proceedings of the 9th International Workshop on Enterprise Integration, Interoperability and Networking (EI2N 2014). Amantea, Italy, October 27-31, 2014. **LNCS**, vol. 8842, pp. 229-240. Springer, Heidelberg, 2014.
- SZEJKA, A.L., CANCEGLIERI JÚNIOR, O., RUDEK, M. PANETTO, H. A Conceptual Knowledge-link model for supporting Dental Implant Process. **Advanced Materials Research**, vol. 945-949, n. 3424-3429, 2014.
- SZEJKA A.L., CANCEGLIERI JR. O., LOURES E.R., PANETTO H., AUBRY A. Requirements Interoperability Method to Support Integrated Product Development. In: **45th Computers and Industrial Engineering**, vol. 147, pp. 1-8, Metz, 2015.
- SZEJKA, A.L., AUBRY, A., PANETTO, H., CANCEGLIERI JÚNIOR, O., ROCHA LOURES, E. A method for formalizing requirements interoperation in complex systems engineering. **INSIGHT. Willey**, vol. 18, n. 2, 28-30, 2015.
- SZEJKA A.L., CANCEGLIERI JR. O., LOURES E.R., PANETTO H., AUBRY A. Proposal of a model-driven ontology for product development process interoperability and information sharing. In: Harik R., Rivest L., Bernard A., Bouras A., Eynard B. (eds.) PLM 2016. Product Lifecycle Management: PLM 2016. Columbia, USA. **Proceedings of the 13th IFIP International Conference on Product Lifecycle Management (PLM 2016)**. Columbia, USA, July 11-13, 2016. Springer, **IFIP and LNCS**. Springer, Heidelberg, 2016. (in-press)
- SZEJKA A.L., CANCEGLIERI JR. O., PANETTO H., LOURES E.R., AUBRY A. Determining the principal references to support semantic interoperability in an integrated product development process. *International Journal of Production Research*. (*Submitted*)

REFERENCES

ARCH-INT, N., and ARCH-INT, S. Semantic Ontology Mapping for Interoperability of Learning Resource Systems using a rule-based reasoning approach. **Expert Systems with Applications**, vol. 40, n. 18, pp. 7428–7443, 2013.

AIFAOU, N., DENEUX, D. and SOENEN, R. Feature-based interoperability between design and analysis processes. **Journal of Intelligent Manufacturing**, vol. 17, pp. 13-27, 2006.

AL-ASHAAB, A.H., RODRIGUEZ, K., MOLINA, A., CARDENAS, M., ACA, J., SAEED, M. and ABDALLA, H. Internet-based collaborative design for an injection-moulding system. **Concurrent Engineering Research And Applications**, vol. 11, pp. 289-299, 2003.

ARMILLOTTA, A., MORONI, G., and RASELLA, M., Computer-aided assembly planning for the diemaking industry. **Robotics and Computer-Integrated Manufacturing**, vol. 22, 409–419, 2006.

ARNOLD, P. and RAHM, E. Enriching ontology mappings with semantic relations. **Data & Knowledge Engineering**, vol. 93, pp. 1–18, 2014.

ASHINO, T., Materials Ontology: An Infrastructure for Exchanging Materials Information and Knowledge. **Data Science Journal**, vol. 9, pp. 54-61, 2010.

AUGUSTINE M., O. YADAV, R. JAIN, and A. RATHORE. Cognitive map-based system modeling for identifying interaction failure modes. **Research in Engineering Design**, vol. 23, n. 2, 105-124, 2012.

BAADER, F., MCGUINNESS, D., NARDI, D., PATEL-SCHIEDER, P. The Description Logic Handbook: Theory, implementation and application. **Cambridge University Press**, Cambridge, United Kingdom, 2003.

BABIC, B. R., NESIC, N., MILJKOVIC, Z. A review of automated feature recognition with rule-based pattern recognition. **Computers in Industry**, vol. 59, pp. 321-337, 2008.

BACH, T.L., DIENG-KUNTZ, R. and GANDON, F. On ontology matching problems for building a corporate semantic web in a multi-communities organization. In: **Proceedings of the 6th International Conference on Enterprise Information Systems**. Porto, Portugal, 2004.

BAÏNA, S., H. PANETTO, and G. MOREL. New paradigms for a product oriented modelling: Case study for traceability. **Computers in Industry**, vol. 60, n. 3, pp. 172-183, 2009.

BALOGUN, O., HAWISA, H. and TANNOCK, J. Knowledge management for manufacturing - the product and process database. **Journal of Manufacturing Technology Management**, vol. 15, n. 7, pp. 575-584, 2004.

BARBAU, R., KRIMA, S., RACHURI, S., NARAYANAN, A., FIORENTINI, X., FOUFOU S., and SRIRAM R. D. OntoSTEP: Enriching product model data using ontologies. **Computer-Aided Design**, vol. 44, n. 6, pp. 575–590, 2012.

BARREIRO, J., *et al.*. Validation of an information model for inspection with CMM. **International Journal of Machine Tools & Manufacture**, vol. 45, pp. 819–829, 2005.

BARTOLOMEI, J., D. HASTINGS, R. DE NEUFVILLE, and D. RHODES. Engineering Systems Multiple-Domain Matrix: An organising framework for modelling large-scale complex systems. **Systems Engineering**, vol. 15, n. 1, pp. 41-61, 2012

BAXTER, D., GAO, J., CASE, K., HARDING, J., YOUNG, B., COCHRANE, S., and DANI, S. A framework to integrate design knowledge reuse and requirements management in engineering design. **Robotics and Computer-Integrated Manufacturing**, vol. 24, n. 4, pp. 585–593, 2008.

BAXTER, M. Projeto de produto: guia prático para o design e novos produtos, 3. ed. São Paulo: Edgard Blücher, 2011.

BELKADI, F., N. DREMONT, A. NOTIN, N. TROUSSIER, and M. MESSADIA. A meta-modelling framework for knowledge consistency in collaborative design. **Annual Reviews in Control**, vol. 36, n. 2, pp. 346–358, 2012.

BEREKETLI I. and GENEVOIS, M. E. An integrated QFDE approach for identifying improvement strategies in sustainable product development. **Journal of Cleaner Production**, vol. 54, pp. 188–198, 2013.

BKCASE, Editorial Board. The Guide to the Systems Engineering Body of Knowledge (SEBoK). Version 1.6. R.D. Adcock (EIC), Hoboken, **The Trustees of the Stevens Institute of Technology**. [Online] Available at <http://www.sebokwiki.org>. Accessed 28 March 2016.

BORST, W. N. **Construction of Engineering Ontologies**. University of Twente.

Enschede, The Netherlands - Centre for Telematica and Information Technology, 1997.

BRUNETTI, G. and GOLOB, B. A feature-based approach towards an integrated product model including conceptual design information. **Computer Aided Design**, vol. 32, n. 14, pp. 877-887, 2000.

BRUNNERMEIER, S.B. and MARTIN S.A. Interoperability costs in us automotive supply chain. **International Journal Supply Chain Management**, v. 7, n. 2, pp. 71-82, 2002.

BRUSONI, S., and PRENCIPE, A. Making Design Rules: A Multi-Domain Perspective. **Organization of Science**, vol.17, n. 2, pp. 179-191, 2006.

BRUUN, H. P. L., MORTENSEN, N. H., HARLOU, U., WÖRÖSCH, M., and PROSCHOWSKY M., PLM system support for modular product development, *Computers in Industry*, vol. 67, pp. 97–111, 2015.

CANCIGLIERI JUNIOR, O., and YOUNG, R. I. M. Information mapping across injection moulding design and manufacture domains. **International Journal of Production Research**, vol. 41, n. 7, pp. 4437–4462, 2010.

CANCIGLIERI JUNIOR, O., and YOUNG, R. I. M. Information sharing in multiviewpoint injection moulding design and manufacturing. **International Journal of Production Research**, vol. 41, n. 7, pp. 1565-1586, 2003.

CANCIGLIERI JUNIOR, O. **Product model based translation mechanism to support multiple viewpoints in the design for manufacture of injection moulded products**. (1999). 374 P. Thesis (Ph.D.) – University of Loughborough, Loughborough, 1999.

CHANG, X., A. SAHIN, and J. TERPENNY. An ontology-based support for product conceptual design. **Robotics and Computer-Integrated Manufacturing**, vol. 24 n. 6, pp. 755–762, 2008.

CHAUDHRI, V.K., FARQUHAR, A., FIKES, R., KARP, P.D. and RICE, J.P. OKBC: a programmatic foundation for knowledge base interoperability. In: **Proceedings of the 15th National Conference on Artificial Intelligence AAAI-98 and the 10th Conference on Innovative Applications of Artificial Intelligence IAAI-98**, pp. 600-607, 1998

CHEN, L., W. WANG, and B. HUANG. A negotiation methodology for multidisciplinary collaborative product design. **Advanced Engineering Informatics**, vol. 28, n. 4, pp. 469–478, 2014.

CHEN, Y.-J. Knowledge integration and sharing for collaborative molding product design and process development. **Computers in Industry**, vol. 61, n. 7, pp. 659–675, 2010.

CHEN, Z. Classification of product requirements based on product environment. **Concurrent engineering: research and applications**, vol. 14, n. 3, pp. 219-229, 2006.

CHEUNG, K., DRENNAN, J., and HUNTER, J. Towards an Ontology for Data-driven Discovery of New Materials. In: **AAAI Workshop on Semantic Scientific Knowledge Integration, Stanford University**, pp. 26-28, 2008.

CHRISTIANSEN, J. K., C. J. VARNES, M. GASPARIN, D. STORM-NIELSEN, and E. J. VINTHER. Living Twice: How a Product Goes through Multiple Life Cycles. **Journal of Product Innovation Management**, vol. 27, pp. 797-828, 2010.

CHUNGOORA, N., O. CANGIOLIERI JR., and R. I. M. YOUNG. Towards expressive ontology-based approaches to manufacturing knowledge representation and sharing. **International Journal of Computer Integrated Manufacturing**, vol. 23, n. 12, pp. 1059-1070, 2010.

CHUNGOORA, N., R. I. M. YOUNG, G. GUNENDRAN, C. PALMER, Z. USMAN, N. A. ANJUM, A.-F. CUTTING-DECELLE, J. A. HARDING, and K. CASE. A model-driven ontology approach for manufacturing system interoperability and knowledge sharing. **Computers in Industry**, vol. 64, n. 4, pp. 392–401, 2013.

CINGIL, I. and DOGAC, A. Architecture for supply chain integration and automation on the Internet. **Distributed and Parallel Databases**, vol.10, pp. 59-102, 2001.

CLARK, K. and FUJIMOTO, T. **Product development performance: strategy organization and management in the world auto industry**. Boston: Harvard Business School Press, 1991, 413 p.

COLOMBO, G., DELL' ERA, C., and FRATTINI, F. Exploring the contribution of innovation intermediaries to the new product development (NPD) process: a typology and an empirical study. **R&D Management**, vol. 45, n. 2, pp. 126-146, 2015.

COOPER, R. G. **Winning at new products: Accelerating the process from idea to launch**. 2nd edn. Wesley, USA, 1993.

CORCHO, O.; FERNÁNDEZ-LÓPEZ, M.; GÓMEZ-PÉREZ, A. Methodologies, tools and languages for building ontologies. Where is their meeting point? **Data & Knowledge Engineering**, vol. 46, n. 1, pp. 41-64, 2003.

COSTA, C.A, SALVADOR, V.L, MEIRA, L.M., RECHDEN, G.F. and KOLIVER, C., 2007. **Product ontology supporting information exchanging in global furniture industry**. Enterprise interoperability II: new challenges and approaches, London: Springer-Verlag, pp. 278-280.

CRAWFORD, C. M.; BENEDETTO, C. A. **New product management**. Boston: MacGraw Hill, 2006.

DANILOVIC M., and B. SANDKULL. The use of dependence structure matrix and domain mapping matrix in managing uncertainty in multiple project situations. **International Journal of Project Management**, vol. 23, n. 3, pp. 193–203, 2005.

DANILOVIC, M., and T. R. BROWNING. Managing complex product development projects with design structure matrices and domain mapping matrices. **International Journal of Project Management**, vol. 25, n. 3, pp. 300–314, 2007.

DANJOU, C., LE DUIGOU, J., EYNARD B. Closed-loop Manufacturing, a STEP-NC Process for Data Feedback: A Case Study. In: **Proceedings of the 48th CIRP Conference on Manufacturing Systems**, Tokyo, vol. 41, pp. 852-857. Elsevier, 2016.

DARLLINGTON, M. J. and S. J. CULLEY. Investigating ontology development for engineering design support. **Advanced Engineering Informatics**, vol. 22, n. 1, pp. 112-134, 2008.

DEMOLY F., D. MONTICOLO, B. EYNARD, L. RIVEST, and S. GOMES. Multiple viewpoint modelling framework enabling integrated product–process design. **International Journal on Interactive Design and Manufacturing (IJIDeM)**, vol. 4, n. 4, pp. 269-280, 2010.

DEMOLY, F., MATSOKIS, A., KIRITSIS, D., GOMES S. Mereotopological description of product- process information and knowledge for PLM. In: Rivest L., Bouras A., Louhichi B. (eds) **PLM 2012 - Towards Knowledge-Rich Enterprises**, vol. 388, pp. 70–84, Springer, Heidelberg, 2012.

DEMOLY, F., O. DUTARTRE, X.-T. YAN, B. EYNARD, D. KIRITSIS, and S. GOMES. Product relationships management enabler for concurrent engineering and product lifecycle management. **Computers in Industry**, vol. 64, n. 7, pp. 833–848, 2013.

DEGEN, F., KLOCKE, F., BERGS, T. and GANSER, P. Comparison of rotational turning and hard turning regarding surface generation. **Prod. Eng. Res. Devel**, vol. 8, n. 3, pp. 309–317, 2014.

DOU, D., MCDERMOTT, D., QI, P. Ontology Translation on the Semantic Web. Proceedings of International Conference on Ontologies. **Databases and Applications of Semantics (ODBASE 2003)**, LNCS 2888, Springer-Verlag. Berlin Heidelberg, pp. 952-969, 2003.

DRIESSEN, P. H., and B. HILLEBRAND. Integrating Multiple Stakeholder Issues in New Product Development: An Exploration. **Journal of Product Innovation Management**, vol. 30, n. 2, pp. 364-379, 2013.

EHRIG, M., SURE, Y. Ontology mapping – An integrated approach. In: **The Semantic Web: Research and Applications**. Bussler C.J., Davies, J., Fensel, D., Studer, R. (eds.) ESWS2004. LNCS, vol. 3053, pp. 76--91. Springer, Heidelberg 2004.

EL MARGHANI, V. G. R. **Modelo de processo de design**. 1 ed. São Paulo: Edgard Blucher, 2011. 240 p.

ELGH, F., and S. SUNNERSJO. An Ontology Approach to Collaborative Engineering for Producibility. **International Journal of e-Collaboration**, vol. 3, n. 4, pp. 21-45, 2007.

EUZENAT, J. and SHVAIKO, P. Ontology Matching. Berlin Heidelberg: Springer-Verlag, 2007.

EUZENAT, J. and VALTCHEV, P. Similarity-based ontology alignment in OWL-lite. In: **Proc. 16th European Conference on Artificial Intelligence (ECAI)**, Valencia, Spain, pp. 333-337, 2004.

FAHAD, M, MOALLA, N., BOURAS, A., QADIR, M. A. and FARUKH, M. Disjoint-Knowledge Analysis and Preservation in Ontology Merging Process. In: **Proceedings of the 5th International Conference on Software Engineering Advances (ICSEA)**, Nice, IEEE, pp. 852-857, 2010.

FAN L. Q., A. SENTHIL KUMAR, B. N. JAGDISH, and S. H. Bok. Development of a distributed collaborative design framework within peer-to-peer environment. **Computer-Aided Design**, vol. 40, n. 9, pp. 891–904, 2008.

FARQUHAR, A., FIKES, R. and RICE, J. The Ontolingua server: a tool for collaborative ontology construction. **International Journal of Human Computer Studies**, vol. 46, n. 6, pp. 707-727, 1997.

FENG, S.C. and SONG, E.Y. A manufacturing process information model for design and process planning integration. **Journal of Manufacturing Systems**, vol. 22, n. 1, 2003.

FENSEL, D. **Ontologies: A Silver Bullet for Knowledge Management and Electronic Commerce**, Second Edition, Springer, 2004.

FROEHLE, C. M., and ROTH, A. V. A resource-process framework of new service development. **Production and Operations Management**, vol. 16, n. 2, pp. 169-188, 2007.

GE PLASTIC. **Guidelines for Injection Molded Design**. 2012. [Online] Available at http://plasticwright.com/files/8314/0476/4159/GE_plastic_design.pdf. Accessed in May 23th, 2016.

GENESERETH, M. R. and FIKES, R.E. Knowledge Interchange Format. Version 3.0. Reference Manual. **Technical Report Logic-92-1**. California: Stanford University, 1992.

GÓMEZ-PÉREZ, A., FERNÁNDEZ-LÓPEZ, M. and CORCHO, O. **Ontological engineering: with examples from the areas of knowledge management, e-commerce and the semantic web**. London, UK: Springer-Verlag, 2004.

GOVINDALURI, S. and CHO, B. Robust design modeling with correlated quality characteristics using a multicriteria decision framework. **International Journal of Advanced Manufacturing Technology**, vol. 32, n. 5, pp. 423-433, 2007.

GRUBER, T.R. A translation approach to portable ontology specification. **Knowledge Acquisition**, v. 5, n. 2, p. 199-220, 1993.

GU, P. A feature representation scheme for supporting integrated manufacturing. **Computers and Industrial Engineering**, vol. 26, n. 1, pp. 55-71, 1994.

GUNENDRAN, A. G., and R. I. M. YOUNG. An information and knowledge framework for multiple-perspective design and manufacture. **International Journal of Advanced Manufacturing Technology**, vol. 32, n. 5, pp. 423-433, 2007.

HE, B., S. HOU, and W. SONG. Integrating engineering design and analysis using a parameter constraint graph approach. **Simulation**, vol. 91, n. 7, pp. 625-647, 2015

HOQUE, A. S. M., Halder P. K., Parvez M. S., and Szecsi T. Integrated manufacturing features and Design-for-manufacture guidelines for reducing product cost under CAD/CAM environment. **Computers & Industrial Engineering**, vol. 66, n. 4, pp. 988–1003, 2013.

HORRIDGE, M. and BECHHOFFER, S. The OWL API: A java API for OWL Ontologies. **Semantic Web**, vol. 2, n. 1, pp. 11-21, 2011.

HORROCK, I., PATEL-SCHNEIDER, P. F., BOLEY, H., TABET, S., GROSOFF, B. DEAN, M. SWRL: A Semantic Web Rule Language Combining OWL and RuleML. 2004. [Online] Available in <http://www.w3.org/Submission/SWRL/>. Accessed in 15 July 2016.

HUANG Z. and YIP-HOI D. High-level feature recognition using feature relationship graphs. **Computer-Aided Design**, vol. 34, pp. 561–582, 2002.

HUANG, C-C., and LIANG, W. Y. Explication and sharing of design knowledge through a novel product design approach. **IEEE Transactions on Systems, Man, and Cybernetics - Part C** vol. 36, n.3, pp. 426-438, 2006.

IMRAN, M. and YOUNG, R.I.M. Reference ontologies for interoperability across multiple assembly systems. **International Journal of Production Research**, vol. 54, n. 18, pp. 1-21, 2016.

INOUE, M, K. LINDOW, R. STARK, K. TANAKA, Y-E. NAHM, and H. ISHIKAWA. Decision-making support for sustainable product creation. **Advanced Engineering Informatics**, vol. 26, n. 4, pp. 782-792, 2012.

INSTITUTE OF ELECTRICAL AND ELECTRONICS ENGINEERS. IEEE Standard Computer Dictionary: A Compilation of IEEE Standard Computer Glossaries. **IEEE**, 1990. ISBN: 1559370793.

INTERNATIONAL ORGANIZATION FOR STANDARDIZATION. ISO/IEC 10303-224:2006 – STEP – Mechanical product definition for process planning using machining features. **ISO/IEC**, 2006.

INTERNATIONAL ORGANIZATION FOR STANDARDIZATION. ISO/IEC 10303-239:2006 – STEP – Product data representation and exchange, application protocol: Product Life Cycle Support (PLCS). **ISO/IEC**, 2005.

INTERNATIONAL ORGANIZATION FOR STANDARDIZATION. ISO/IEC 24707:2007 - Information technology – Common Logic (CL): a framework for a family of logic-based languages. **ISO/IEC**, 2007.

INTERNATIONAL ORGANIZATION FOR STANDARDIZATION. ISO/IEC/IEEE 18629:2005 - Industrial automation systems and integration - Process Specification Language (PSL). **ISO/IEC**, 2005.

JESSON, J., and LACEY, D. How to do (or not to do) a critical review. **Pharm Educ** vol. 6, pp. 139-148, 2006.

JUAN, Y-C., OU-YANG, C., and LIN, J-S. A process-oriented multi-agent system development approach to support the cooperation-activities of concurrent new product development. **Computers & Industrial Engineering**, vol. 57, n. 4, pp. 1363-1376, 2009.

JUNG, C. F. *et al.* Uma discussão de modelos de desenvolvimento de produto e suas características lineares e sistêmicas. In: SEMANA DE ENGENHARIA DE PRODUÇÃO SUL-AMERICANA, 8., 2008. Bento Gonçalves. **Anais VIII SEPROSUL – Semana de Engenharia de Produção Sul-Americana**. Bento Gonçalves, 2008.

KÄKÖLÄ, T., KOIVULAHTIOJALA, M. and LIIMATAINEN, J. An information systems design product theory for the class of integrated requirements and release management systems. **Journal of Software Maintenance and Evolution: Research and Practice**, vol. 23, n. 6, pp. 443-463, 2011.

KALFOGLOU, Y., SCHORLEMMER, M. Ontology mapping: the state of the art. **The knowledge engineering review**, vol. 18, n. 1, pp. 1-31, 2003.

KENT, R.E. The information flow foundation for conceptual knowledge organization. In: **Proceedings of the 6th International Conference of the International Society for Knowledge Organization**. Toronto, Canada, 2000.

KIM, G.-Y, LEE, J.-Y, PARK, Y. H., and NOH, S. D. Product life cycle information and process analysis methodology: Integrated information and process analysis for product life cycle management. **Concurrent Engineering**, vol. 20, n. 4, pp. 257-274, 2012.

KIM, K.-Y., MANLEY, D. G., and YANG, H. Ontology-based assembly design and information sharing for collaborative product development. **Computer-Aided Design**, vol. 38, n. 12, pp. 1233–1250, 2006.

KINDLEIN JÚNIOR, W.; CÂNDIDO L. H.; PLATCHECK, E. Analogia entre as metodologias de desenvolvimento de produtos atuais, com a proposta de uma metodologia com ênfase no ecodesign. In: Congresso Internacional de Pesquisa Em Design, 2., 2003, Rio de Janeiro. **Anais do II Congresso Internacional de Pesquisa em Design**. Rio de Janeiro, 2003.

KIRYAKOV, A.K., SIMOV, K. IV. and DIMITROV, M. OntoMap: ontologies for lexical semantics. In: **Proceedings of the Euro Conference Recent Advances on Natural Language Processing**. pp. 142-148. Bulgaria, 2001

KOTLER, P., BROWN, L., ADAM, S., BURTON, S., and ARMSTRONG, G. **Principles of Marketing**. 14 ed. Sydney: Pearson Education Australia, 2006, 744 p.

KRISHNAPILLAI R., and ZEID, A. Mapping Product Design Specification for Mass Customization. **Journal of Intelligent Manufacturing**, vol. 17, n. 1, pp. 29-43, 2006.

LACERDA, P.; SILVA, E. R. P.; NAVARRO, L. L.L.; OLIVEIRA, N. N. P. and CAULLIRAUX, H. M. Algumas caracterizações dos métodos científicos em engenharia de produção: uma análise de periódicos nacionais e internacionais. **Anais do XXVII Encontro Nacional de Engenharia de Produção**, v. 1, n. 125, p. 1-10, 2007.

LAGROSEN, S. Customer involvement in new product development: A relationship marketing perspective. **European Journal of Innovation Management**, vol. 8, n. 4, pp. 424-436, 2005.

LASSILA, O. and SWICK, R.R. **Resource Description Framework (RDF) model and syntax specification**. W3C Recommendation. Cambridge: World Wide Web Consortium, 1999.

LEE J., and KIM, K.. A distributed product development architecture for engineering collaborations across ubiquitous virtual enterprises. **International Journal of Advanced Manufacturing Technology**, vol. 33, n. 1, pp. 59-70, 2007.

LEE, A., and LIN., C-Y. An integrated fuzzy QFD framework for new product development. **Flexible Services and Manufacturing Journal**, vol. 23, n. 1, pp. 26-47, 2011.

LEHTO, J., J. HARKONEN, H. HAAPASALO, P. BELT, M. MOTTONEN, and P. KUVAJA. Benefits of DFX in requirements engineering. **Technology and Investment**, vol. 2, n. 1, pp. 27-38, 2011.

LENNARTSON, B., BENGTSSON, K., CHENGYIN YUAN, K., ANDERSSON, M., FABIAN, P., FALKMAN, K., and AKESSON, K. Sequence Planning for Integrated Product, Process and Automation Design. **IEEE Transactions on Automation Science and Engineering**, vol. 7, n. 4, pp. 791-802, 2010.

LIAO, Y., LEZOCHÉ, M., PANETTO, H., BOUDJLIDA, N., and LOURES, E. R. Semantic annotation for knowledge explicitation in a product lifecycle management context: a survey. **Computers in Industry**, vol. 71, pp. 24-34, 2015.

LIAO, Y., M. LEZOCHÉ, H. PANETTO and N. BOUDJLIDA. Semantic annotation for semantic interoperability in a product lifecycle management context. **International Journal of Production Research**, vol. 54, n. 18, pp. 5534-5553, 2016.

LIN L., M.-Q. YANG, J. LI, and Y. WANG. A systematic approach for deducing multi-dimensional modeling features design rules based on user-oriented experiments. **International Journal of Industrial Ergonomics**, vol. 42, n. 4, pp. 347–358, 2012.

LIN, H. K. and HARDING, J. A. A manufacturing engineering ontology model on the semantic web for inter-enterprise collaboration. **Computers in Industry**, vol. 58, n. 5, pp. 428-437, 2007.

LIN, M.-C., L.-A. CHEN, and M.-S. CHEN. An integrated component design approach to the development of a design information system for customer-oriented product design. **Advanced Engineering Informatics**, vol. 23, n. 2, pp. 210-221, 2009.

LIU, S. and YOUNG, R.I.M. Utilizing information and knowledge models to support global manufacturing coordination decisions. **International Journal of Computer Integrated Manufacturing**, vol. 17, n. 4, pp. 479-492, 2004.

LOCKETT H. L. and GUENOV M. D. Graph-based feature recognition for injection moulding based on a mid-surface approach. **Computer-Aided Design**, vol. 37, n. 2, pp. 251–262, 2005.

LUH, Y.-P., C.-H. CHU, and C.-C. PAN. Data management of green product development with generic modularized product architecture. **Computers in Industry** vol. 61, n. 3, pp. 223–234, 2010.

MA, Y.-S., BRITTON, G.A., TOR, S.B. and JIN, L.Y. Associative assembly design

features - concept, implementation and application. **International Journal of Advanced Manufacturing Technology**, vol. 32, pp. 434-444, 2007.

MADHAVAN, J., BERNSTEIN, P.A., DOMINGOS, P. and HALEVY, A., Representing and reasoning about mappings between domain models. **In: Proceedings of the 18th National Conference on Artificial Intelligence**. Edmonton, Alberta, Canada, 2002.

MAEDCHE, A. and STAAB, S. Semi-automatic engineering of ontologies from texts. **In: Proceedings of the 12th International Conference on Software Engineering and Knowledge Engineering**, pp. 231-239. Chicago, IL, USA, 2000.

MAEDCHE, A., MOTIK, B., SILVA, N. AND VOLZ, R. A MApping FRAmework for distributed ontologies. **In: Proceedings of the 13th International Conference on Knowledge Engineering and Knowledge Management**, Ontologies and the Semantic Web. LNCS 2473, pp. 235-250, 2002.

MAGRAB, E. B.; GUPTA, S. K.; MCCLUSKEY, F. P.; SANDBORN, P. **Integrated product and process design and development: the product realization process**. 2 ed. Boca Raton: CRC Press, 2010, 304 p.

MALUCELLI A. **Ontology-based Services for Agents Interoperability**. (2006). 266 p. Thesis (Ph.D) - University of Porto, Porto, 2006.

MANARVI, I., and JUSTER, N. P. Framework of an integrated tolerance synthesis model and using FE simulation as a virtual tool for tolerance allocation in assembly design. **Journal of Materials Processing Technology**, vol. 150, n. 1, pp. 182-193, 2004.

MARTINO, T.D. and GIANNINI, F. Feature-based product modelling in concurrent engineering. **In: Proceedings of the 10th International Conference on Information Technology in the Product Realisation Process**, Trento, Italy, 1998.

MATTIODA, R. A., A. MAZZI, O. CANCIGLIERI JR., and A. SCIPIONI. Determining the principal references of the social life cycle assessment of products. **International Journal of Life Cycle Assessment**, vol. 20, pp. 1155-1165, 2015.

MCFARLANE, D., and R. CUTHBERT. Modelling information requirements in complex engineering services. **Computers in Industry**, vol. 63, n. 4, pp. 349-360, 2012.

MCGUINNESS, D., FIKES, R., RICE, J. and WILDER, S. An environment for

merging and testing large ontologies. In: **Proceedings of the 17th International Conference on Principles of Knowledge Representation and Reasoning**. Colorado, USA, 2000.

MECCA, G., RULL, G., SANTORO, D., and TENIENTE, E. Ontology-based mappings. **Data & Knowledge Engineering**, vol. 98, pp. 8–29, 2015.

MIGUEL, P. A. C. et. al. **Metodologia de pesquisa em engenharia de produção e gestão de operações**. 1 ed. Rio de Janeiro: Elsevier, 2010, 226 p.

MITRA, P., NOY, N.F. and JAISWAL, A.R. OMEN: a probabilistic ontology mapping tool. In: **Workshop on Meaning Coordination and Negotiation at the 3rd International Conference on the Semantic Web**. Hiroshima, Japan, 2004.

MOHAN, M., ANSARI M.N.M., SHANKS, R. A. Review on the Effects of Process Parameters on Strength, Shrinkage, and Warpage of Injection Molding Plastic Component. **Polymer-Plastics Technology and Engineering**, 2016, in press.

MOHER, D., A. LIBERATI, J. TETZLAFF, and D. G. ALTMAN. Preferred reporting items for systematic review and meta-analyses: the PRISMA statement. **Ann Intern Med** vol. 151, pp. 264-270, 2009.

MOLINA, A., ELLIS, T.I.A., YOUNG, R.I.M. and BELL, R., Modelling manufacturing capability to support concurrent engineering. **Concurrent Engineering Research and Applications**, vol. 3, n. 1, pp. 29-42, 1995.

NAGAHANUMAI AH, K.S. and RAVI, B. Computer aided rapid tooling process selection and manufacturability evaluation for injection mold development. **Computers in Industry**, v. 59 n. 2/3, p. 262–276, 2008.

NAEEM, M., MOALLA, N., OUZRUT, Y. and BOUARAS, A. An ontology based digital preservation system for enterprise collaboration. **11th International Conference on Computer Systems and Applications (AICCSA)**, Doha, IEEE, pp. 691-698, 2014.

NECHES, R., FIKES, R. E., FININ, T., GRUBER, T. R., SENATOR, T., SWARTOUT, W. R. Enabling technology for knowledge sharing. **AI Magazine**, vol.12 n.3, pp. 36-56, 1991.

NELSON, R. Tackling multiple domains. **Test & Measurement World**, vol. 31, n. 9, pp. 22-26, 2011.

NIU, Z., MARTIN, R. R., LANGBEIN F. C., and SABIN M. A. Rapidly finding CAD features using database optimization. **Computer-Aided Design**, vol. 69, pp. 35–50, 2015.

NOH, Y. Imagining Library 4.0: Creating a Model for Future Libraries. *The Journal of Academic Librarianship*, vol. 41, pp. 786-797, 2015.

NOY, N.F. and MCGUINNESS, D.L.. Ontology development 101: a guide to creating your first ontology. **Knowledge Systems Laboratory**, Stanford University, pp. 1-25, 2001.

NOY, N.F. and MUSEN, M.A. The PROMPT suite: interactive tools for ontology merging and mapping. **International Journal of Human-Computer Studies**, vol. 59, pp. 983-1024, 2003.

NURMILAAKSO, J.-M. Supply chain scheduling and distributed parallel simulation. **Journal of Manufacturing Technology Management**, vol. 15, n. 8, pp. 756-770, 2004.

ONTOLOGY WORKS INC. 2009 [Online] Available at: <http://www.ontologyworks.com>. Accessed in Feb. 2nd, 2015.

OUERTANI, M. Z. Engineering change impact on product development processes. **Systems Research Forum**, vol. 3, n. 1, pp. 25-37, 2009.

OUERTANI, M. Z., S. BAÏNA, L. GZARA, and G. MOREL. Traceability and management of dispersed product knowledge during design and manufacturing. **Computer-Aided Design**, vol. 43, n. 5, pp. 546–562, 2011.

OUERTANI, M.Z., and GZARA, L. Tracking product specification dependencies in collaborative design for conflict management. **Computer-Aided Design**, vol. 40, n. 7, pp. 828-837, 2008.

PAHL, G.; BEITZ, W. **Engineering design: a systematic approach**. 2 ed. Darmstadt: Springer, 1996, 617 p.

PALMER, C., URWIN, E. N., PINAZO-SÁNCHEZ, J. M., CID F. S., RODRÍGUEZ E. P., PAJKOVSKA-GOCEVA S., and YOUNG R. I. M., Reference ontologies to support the development of global production network systems. **Computers in Industry**, vol. 77, pp. 48–60, 2016.

PANETTO, H., DASSISTI M., and TURSI A., ONTO-PDM: Product-driven ONTOlogy for Product Data Management interoperability within manufacturing process environment. **Advanced Engineering Informatics**, vol. 26, n. 2, pp. 334–348, 2012.

PANETTO, H., GONÇALVES, R. and MOLINA, A. Enterprise Integration and Networking: theory and practice. **Annual Reviews in Control**, vol. 36, n. 2, pp. 284-290, 2012.

PANETTO, H. Towards a Classification Framework for Interoperability of Enterprise Applications. **International Journal of Computer Integrated Manufacturing**, vol. 20, n. 8, pp. 727-740, 2007.

PARAMESHWARAN, R., C. BASKAR, and T. KARTHIK. An integrated framework for mechatronics based product development in a fuzzy environment. **Applied Soft Computing Journal**, vol. 27, pp. 376-390, 2015.

PASQUAL, M. and WECK, O. Multilayer network model for analysis and management of change propagation. **Research in Engineering Design**, vol. 23, n. 4, pp. 305-328, 2012.

PATIL, A. A.; OUNDHAKAR, S.A.; SHETH, A.P.; and VERMA, K. Meteor-s web service annotation framework. In: Proceedings of the 13th international conference on World Wide Web. 2005. **13th international conference on World Wide Web**, p. 553–562, 2005.

PENCIUC, D., A. DURUPT, F. BELKADI, B. EYNARD, and H. ROWSON. Towards a PLM Interoperability for a Collaborative Design Support System. **Procedia CIRP** 25: 369–376, 2014.

PEREIRA, J. A. **Modelo de desenvolvimento integrado de produto orientado para projetos de P&D do setor elétrico brasileiro**. (2014). 306 p. Thesis (Ph.D.) - Pontifical Catholic University of Parana, Curitiba, 2014.

PETTI, L., UGAYA, C. M. L., and DI CESARE, S. Systematic review of social life-cycle assessment (S-LCA) case studies impact assessment method. In: **Macombe, C., and Loeillet D. (eds.) Pre-proceedings of the 4th International Seminar in Social LCA FruiTrop Thema**, pp. 34-41, 2014.

PRATT, M. J. Aspects of form feature modeling. In H. Hagen and D. Roller (eds), **Geometric Modeling: Methods and Application**, Springer - Verlag, Berlin, pp 227 - 250, 1991.

QUINTANA-GARCÍA, C. and C. A. BENAVIDES-VELASCO. Innovative competence, exploration and exploitation: The influence of technological diversification. **Research Policy**, vol. 37, n.3, pp. 492–507, 2008.

RABE, M. and GOCEV, P. Semantic web framework for rule-based generation of knowledge and simulation of manufacturing systems. In: Mertins, K., Ruggaber, R., Popplewell, K. and Xu, X., eds. **Enterprise interoperability III: new challenges and industrial approaches**. pp. 397-409. London, UK: Springer-Verlag, 2008.

RASOULIFAR, G., C. ECKERT, and G. PRUDHOMME. Supporting communication between product designers and engineering designers in the design process of branded products: a comparison of three approaches." **CoDesign**, vol. 10, n. 2, pp. 135-152, 2014.

RIOU, A. and C. MASCLE. Assisting designer using feature modeling for lifecycle. **Computer-Aided Design**, vol. 41, n. 12, pp. 1034–1049, 2009.

ROCHE, C. Ontology: A Survey. **Presented at the 8th Symposium on Automated Systems Based on Human Skill and Knowledge IFAC**, 2003.

ROMEIRO FILHO, E. *et al.* **Projeto do Produto**. 1. ed. Rio de Janeiro: Elsevier, 2010, 400 p.

ROZENFELD, H., F. A. FORCELLINI, D. C. AMARAL, J. C. TOLEDO, S. L. SILVA, D. H. ALLIPRANDINI, and R. K. SCALICE. Gestão de desenvolvimento de produtos: uma referência para a melhoria do processo **Product Development Management: a reference to improve the process**. São Paulo: Saraiva, 2006.

SEKI, K., and H. NISHIMURA. A module-based thermal design approach for distributed product development. **Research in Engineering Design**, vol. 22, n. 4, pp. 279-295, 2011.

SHAH J. J. Assessment of features technology. **Computer Aided Design**, vol. 23, pp. 331-343, 1991.

SHVAIKO, P. and EUZENAT, J., Ten challenges for ontology matching. In: Proceedings of the 7th International Conference on Ontologies, **Databases and Applications of Semantics**. Monterrey, Mexico. 2008.

SINGH, N. Integrated product and process design: a multi-objective modeling framework. **Robotics and Computer Integrated Manufacturing**, vol. 18, pp. 157–168, 2002.

SILVA, M. M. **Aprendizagem organizacional no processo de desenvolvimento de produtos**: investigação do conhecimento declarativo no contexto da sistemática de stage-gates. (2003). 170 p. Dissertation (Master Science) – Federal University of São Carlos, São Carlos, 2003.

SIRIN, E., PARSIA, B., GRAU, B. C., KATZ, Y. Pellet: a practical OWL-DL reasoner. **Journal of Web Semantics**, vol. 5, n. 2, pp. 51-52, 2007.

SMITH, D. W. Introducing EDG students to the design process. In: **2002 annual midyear meeting of the engineering design graphics division of the american society for engineering education**. 2002, Berkeley. Proceedings of the 2002 Annual Midyear Meeting of the Engineering Design Graphics Division of the American Society for Engineering Education, pp. 1-6, 2002.

SOMMER, A. F., I. DUKOVSKA-POPOVSKA, and K. STEGER-JENSEN. Barriers towards integrated product development — Challenges from a holistic project management perspective. **International Journal of Project Management**, vol. 32, n.6, pp. 970–982, 2014.

SOSA M. E.; EPPINGER S. D.; ROWLES C. M. The Misalignment of Product Architecture and Organizational Structure in Complex Product Development. **Journal of Management Science**, v. 50, n. 12, p. 1674–1689, 2004.

STEFANO, P. D., BIANCONI F., and ANGELO L. D. An approach for feature semantics recognition in geometric models. **Computer-Aided Design**, vol. 36, pp. 993–1009, 2004.

STUDER, R.; BENJAMINS, V.R. and FENSEL, D. Knowledge engineering: principles and methods. **Data and Knowledge Engineering**, v. 25, p. 161-197, 1998.

STUMME, G. and MAEDCHE, A. Ontology merging for federated ontologies on the semantic web. In: **Proceedings of the International Workshop for Foundations of Models for Information Integration**. Viterbo, Italy, 2001.

SUAREZ, T. M.; JUNG, C. F.; CATEN, C. S. Adaptação e aplicação de um método de desenvolvimento de produtos em uma microempresa de manufatura de produtos decorativos. **Revista P&D em Engenharia de Produção**, Itajubá, v. 7, n. 1, 2009.

SUBRAHMANIAN, E., RACHURI, S., FENVES, S.J., FOUFOU, S. and SRIRAM, R.D. Challenges in supporting product design and manufacturing in a networked economy: a PLM perspective. In: **Proceedings of the International Conference on Product Lifecycle Management**, pp. 495-506, 2005.

SUBRAMANI, S. and GURUMOORTHY, B., Maintaining associativity between form feature models. **Computer-Aided Design**, vol. 37, n. 13, pp. 1319–1334, 2005.

SUDARSAN, R., FENVES, S.J., SRIRAM, R.D. and WANG, F. A product information modelling framework for Product Lifecycle Management. **Computer Aided Design**, vol. 37, pp. 1399-1411, 2005.

SZEJKA, A.L., AUBRY, A., PANETTO, H., CANCEGLIERI JR., O., LOURES, E.R. Towards a Conceptual Framework for Requirements Interoperability in Complex Systems Engineering. In: Meersman R., Panetto, H., Mishra A., Valencia-García, R., Soares, A.L, Ciuciu I., Ferri F., Weichhart G., Moser T., Bezzi, M., Chan, H. (eds.) OTM 2014. Springer, **On the Move to Meaningful Internet Systems: OTM 2014 Workshops**. Amantea, Italy. Proceedings of the 9th International Workshop on Enterprise Integration, Interoperability and Networking (EI2N 2014). Amantea, Italy, October 27-31, 2014. **LNCS**, vol. 8842, pp. 229-240. Springer, Heidelberg, 2014.

SZEJKA A.L., CANCEGLIERI JR. O., LOURES E.R., PANETTO H., AUBRY A. Requirements Interoperability Method to Support Integrated Product Development. In: **45th Computers and Industrial Engineering**, vol. 147, pp. 1-8, Metz, 2015 (a).

SZEJKA, A. L., AUBRY, A., PANETTO, H., CANCEGLIERI JR., O., and LOURES, E. R. A method for formalizing requirements interoperation in complex systems engineering. **INSIGHT – International Council on Systems Engineering (INCOSE)** Willey, vol. 18, n. 4, pp. 28-30, 2015 (b).

SZEJKA, A.L., CANCEGLIERI JR., O., LOURES, E. R., PANETTO, H., AUBRY, A. Proposal of a model-driven ontology for product development process interoperability and information sharing. In: Harik R., Rivest L., Bernard A., Bouras A., Eynard B. (eds.) PLM 2016. Product Lifecycle Management: PLM 2016. Columbia, USA. **Proceedings of the 13th IFIP International Conference on Product Lifecycle Management (PLM 2016)**. Columbia, USA, July 11-13, 2016. Springer, **IFIP and LNCS**. Springer, Heidelberg, 2016. (in-press)

TSENG, Y-J., Y-W. KAO and F-Y HUANG. A model for evaluating a design change and the distributed manufacturing operations in a collaborative manufacturing environment. **Computers in Industry**, vol. 59, n. 8, pp. 798-807, 2008.

UNGER, D. and EPPINGER, S. Improving product development process designs: a method for managing information flows, risks, and iterations. **Journal of Engineering Design**, v. 22, n. 10, p. 689–699, 2011.

UNRUH, G. U. **Método de Processo de Desenvolvimento Integrado de Produtos Eletrodomésticos Orientado para a experiência do usuário.** (2015). 63 p. Dissertation (M.Sc.) - Pontifical Catholic University of Parana, Curitiba, 2015.

URBAN, G. L.; HAUSER, J. R. **Design and marketing of new products.** 2. ed. Englewood Cliffs: Prentice Hall. 1993.

URWIN, E. N. and YOUNG, R. I. M. The reuse of machining knowledge to improve designer awareness through the configuration of knowledge libraries in PLM. **International Journal of Production Research**, vol. 52, n. 2, pp. 595-615, 2014.

USMAN, Z., YOUNG, R.I.M., CHUNGOORA, N., CASE, K., PALMER, C., HARDING J.A. Towards a formal manufacturing reference ontology. **International Journal of Production Research**, vol. 51, n. 22, pp. 6553–6572, 2013.

VAN DER VET, P. E., SPEEL, P-H., and Mars, N. J. I. Ontologies for very large knowledge bases in materials science: A case study. In: **Proceeding of the second International Conference on Building and Sharing Very Large-Scale Knowledge Bases**, University of Twente, pp. 73-83, 1995.

VOSINAKIS, S., P. KOUTSABASIS, M. STAVRAKIS, N. VIORRES and J. DARZENTAS. Virtual environments for collaborative design: requirements and guidelines from a social action perspective. **CoDesign**, vol. 4, n. 3, pp. 133-150, 2008.

W3C. Web Ontology Language (OWL). 2009. [Online] Available at <http://www.w3.org/TR/owl-features/>. Accessed in April 2nd, 2016.

W3C. SWRL - A Semantic Web Rule Language Combining OWL and RuleML. 2004. [Online] Available at <http://www.w3.org/Submission/SWRL/>. Accessed in April 2nd, 2016.

WANG, H. W. and H. M., ZHANG. An integrated and collaborative approach for complex product development in distributed heterogeneous environment. **International Journal of Production Research**, vol. 46, n. 9, pp. 2345-2361, 2008.

WANG, X., H. K. CHAN, and D. LI. 2015. A case study of an integrated fuzzy methodology for green product development. **European Journal of Operational Research**, vol. 241, n. 1, pp. 212-223, 2015.

WEI, S., QIN-YI, M., TIAN-YI, G. An ontology-based manufacturing design system. *Information Technology Journal*, vol. 8, n. 5, pp. 643-656, 2009.

WU, T., X. PEI, Y. LU, C. CHEN, and L. GAO. A distributed collaborative product design environment based on semantic norm model and role-based access control. **Journal of Network and Computer Applications**, vol. 36, n. 6, pp. 1431–1440, 2013.

XU Y., Z. XU, X. JIANG, and P. SCOTT. 2011. Developing a knowledge-based system for complex geometrical product specification (GPS) data manipulation. **Knowledge-Based Systems**, vol. 24, n. 1, pp. 10-22, 2011.

XU, L., Z. LI, S. LI, and F. TANG. A decision support system for product design in concurrent engineering. **Decision Support Systems**, vol. 42, n. 4, pp. 2029–2042, 2007.

YAHIA, E., AUBRY, A., PANETTO, H. Formal measures for semantic interoperability assessment in cooperation enterprise information systems. **Computers in Industry** vol. 63, n. 5, pp. 443-457, 2012.

YANG, A., BRAUNSCHWEIG, B., FRAGA, E. S., GUESSOUM, Z., MARQUARDT, W., NADJEMI, O., PAEN D., PIÑOL D., ROUX P., SAMA S., SERRA M., STALKER I. A multi-agent system to facilitate component-based process modeling and design. **Computers & Chemical Engineering**, vol. 32, n. 10, pp. 2290-2305, 2008.

YIN, R. **Case study research – design and methods**. 4. ed. London: SAGE, 2009, 219 p.

YIN, Y., S. QIN, and R. HOLLAND. Development of a design performance measurement matrix for improving collaborative design during a design process. *International Journal of Productivity and Performance Management*, vol. 60, n. 2, pp. 152-184, 2011.

YOUNG, R. I. M.; GUNENDRAN, A. G.; CUTTING-DECELLE, A. F.; and GRUNINGER, M. Manufacturing knowledge sharing in PLM: a progression towards the use of heavy weight ontologies. **International Journal of Production Research**, vol. 45, n. 7, p.1505-1519, 2007.

ZENG, M. L. and L. M. CHAN. *Semantic Interoperability*. Encyclopaedia of Library and Information Sciences Taylor & Francis, 2009.

ZENG, P., Y. HAO, W. SHAO, and Y. LIU. Product collaborative design method based on a sharing information model. **Journal of Advanced Manufacturing Systems**, vol. 10, n. 1, 191-198, 2011.

ZHA, X. F. and R. D. SRIRAM. Platform-based product design and development: A knowledge-intensive support approach. **Knowledge-Based Systems**, vol. 19, n. 7, pp. 524-543, 2006.

ZHAO, J., CHEUNG, W.M. and YOUNG, R.I.M. A consistent manufacturing data model to support virtual enterprise. **International Journal of Agile Management Systems**, vol. 1 n. 3, pp. 150-158, 1999.

ZHOU, C., Z. LIN and C. LIU. Customer-driven product configuration optimization for assemble-to-order manufacturing enterprises. **International Journal of Advanced Manufacturing Technology**, vol. 38, n.1, pp. 185-194, 2008.

APPENDICES

A.1 CORE ONTOLOGIES

A.1.1 ROTATIONAL PRODUCT MOUDABILITY CORE ONTOLOGY

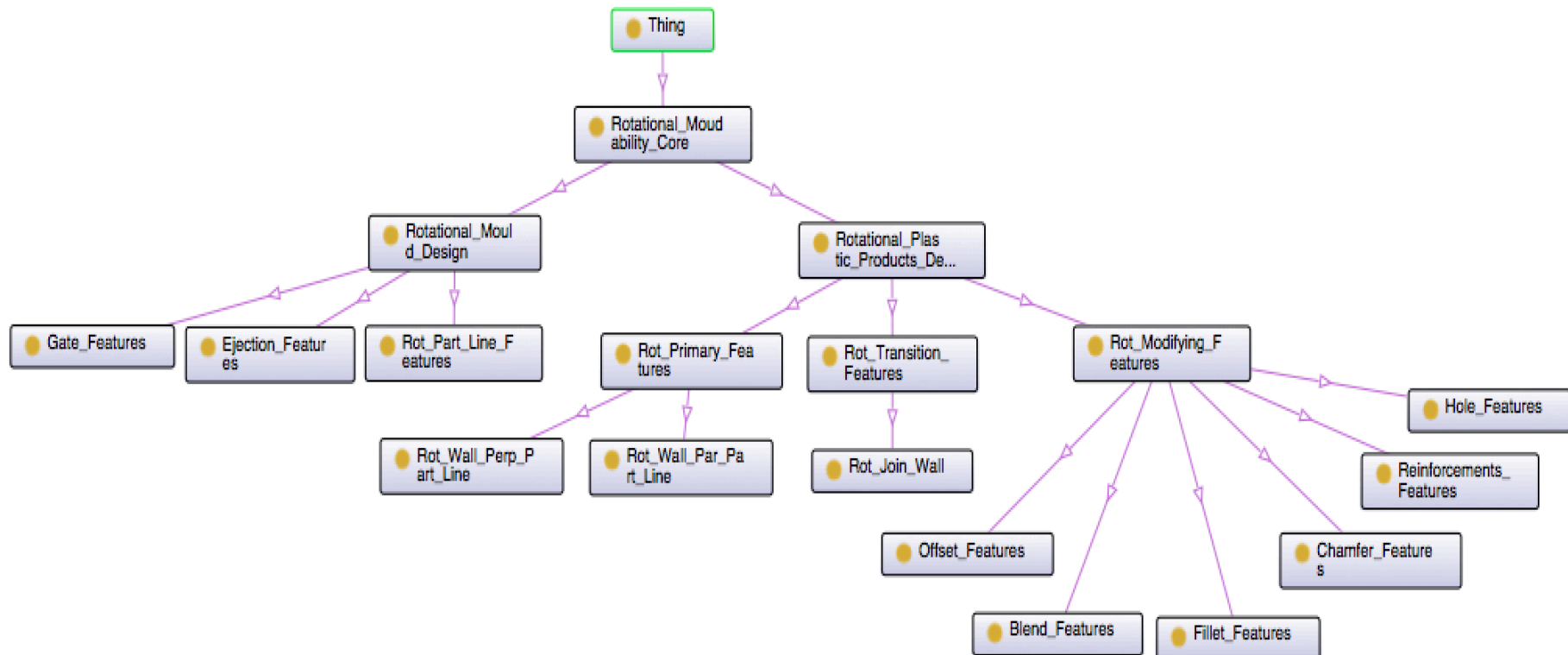

A1.2 ROTATIONAL MOULD CAVITY INSERT CORE ONTOLOGY

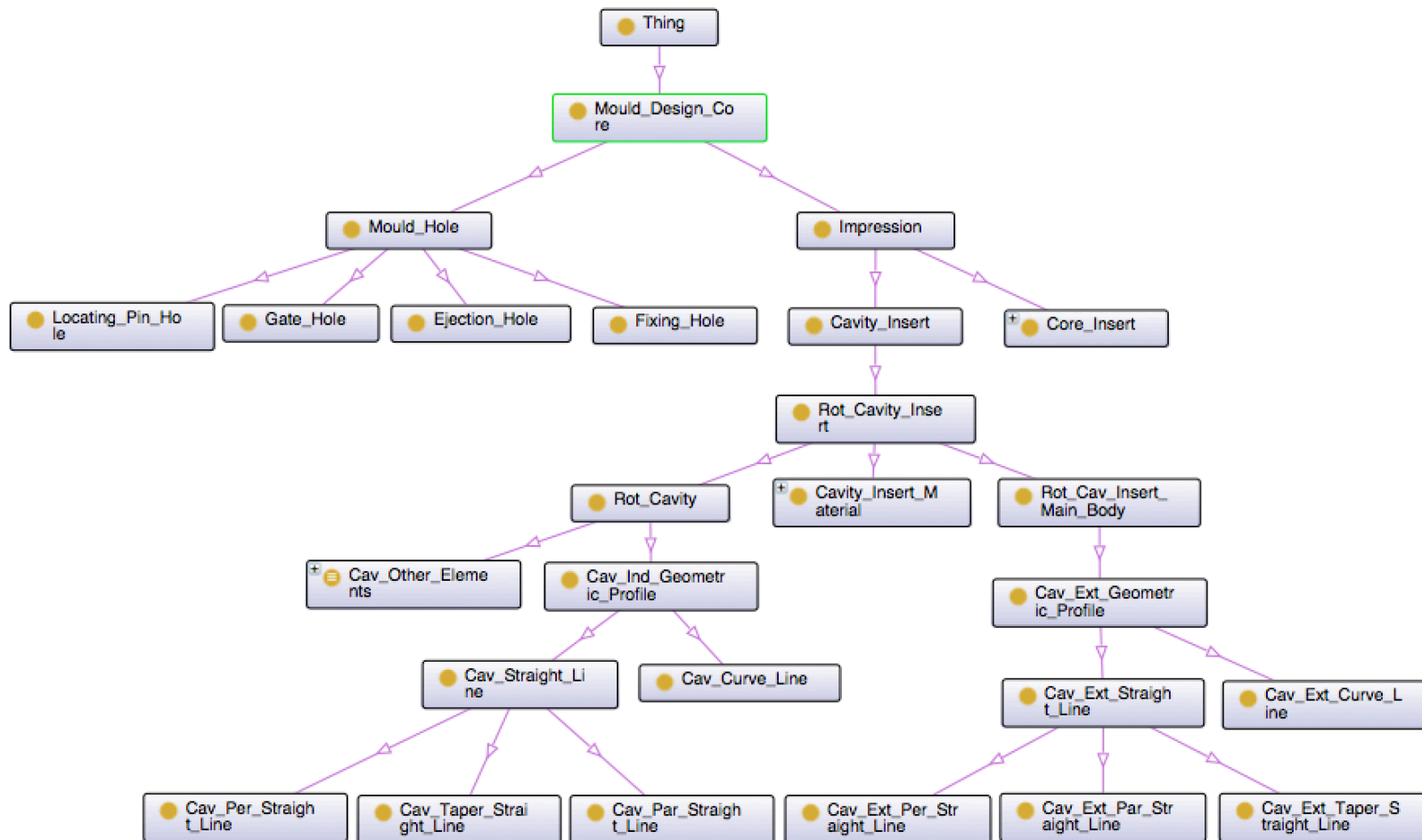

A1.3 ROTATIONAL MOULD CORE INSERT CORE ONTOLOGY

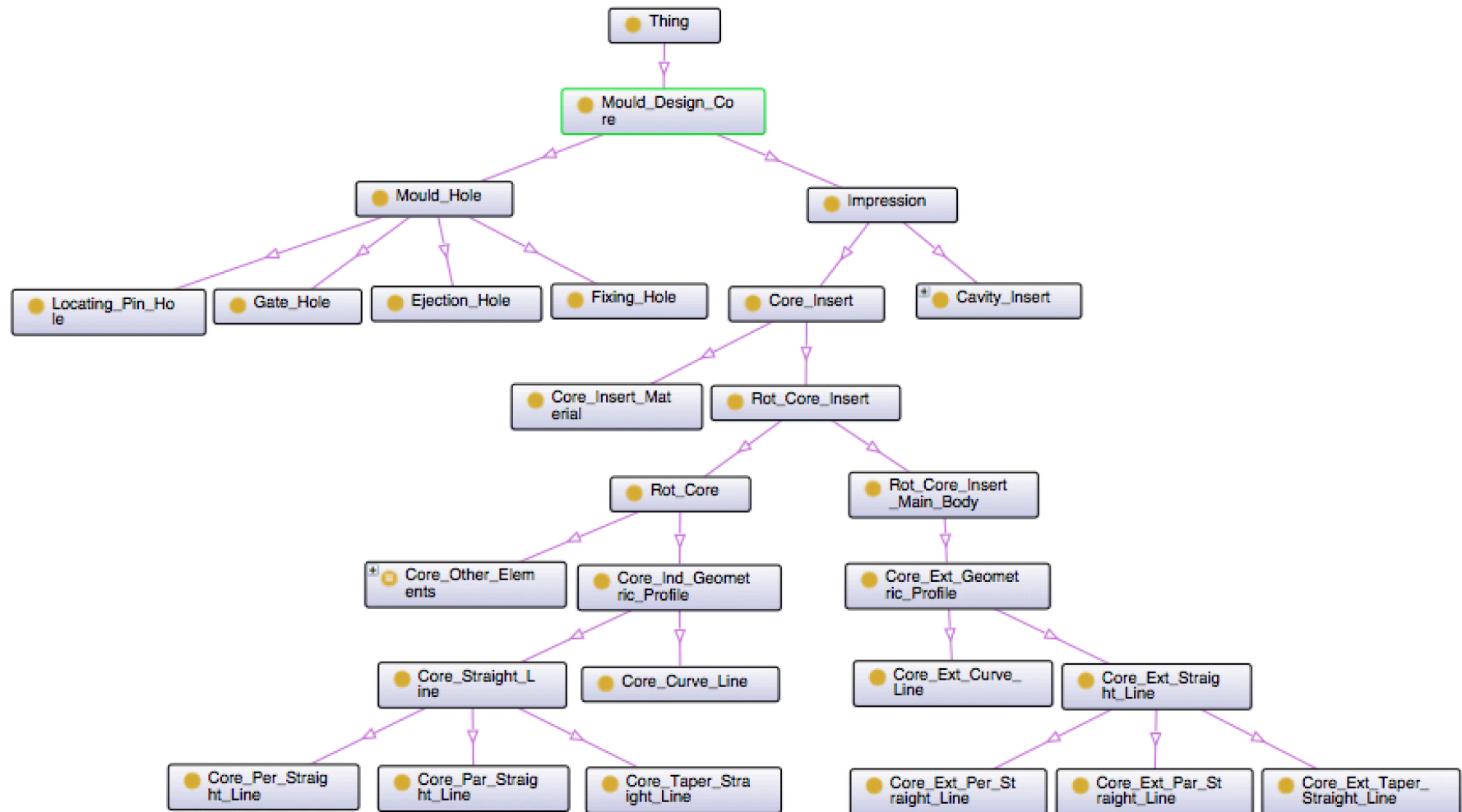

A1.4 MOULD MANUFACTURING CORE ONTOLOGY

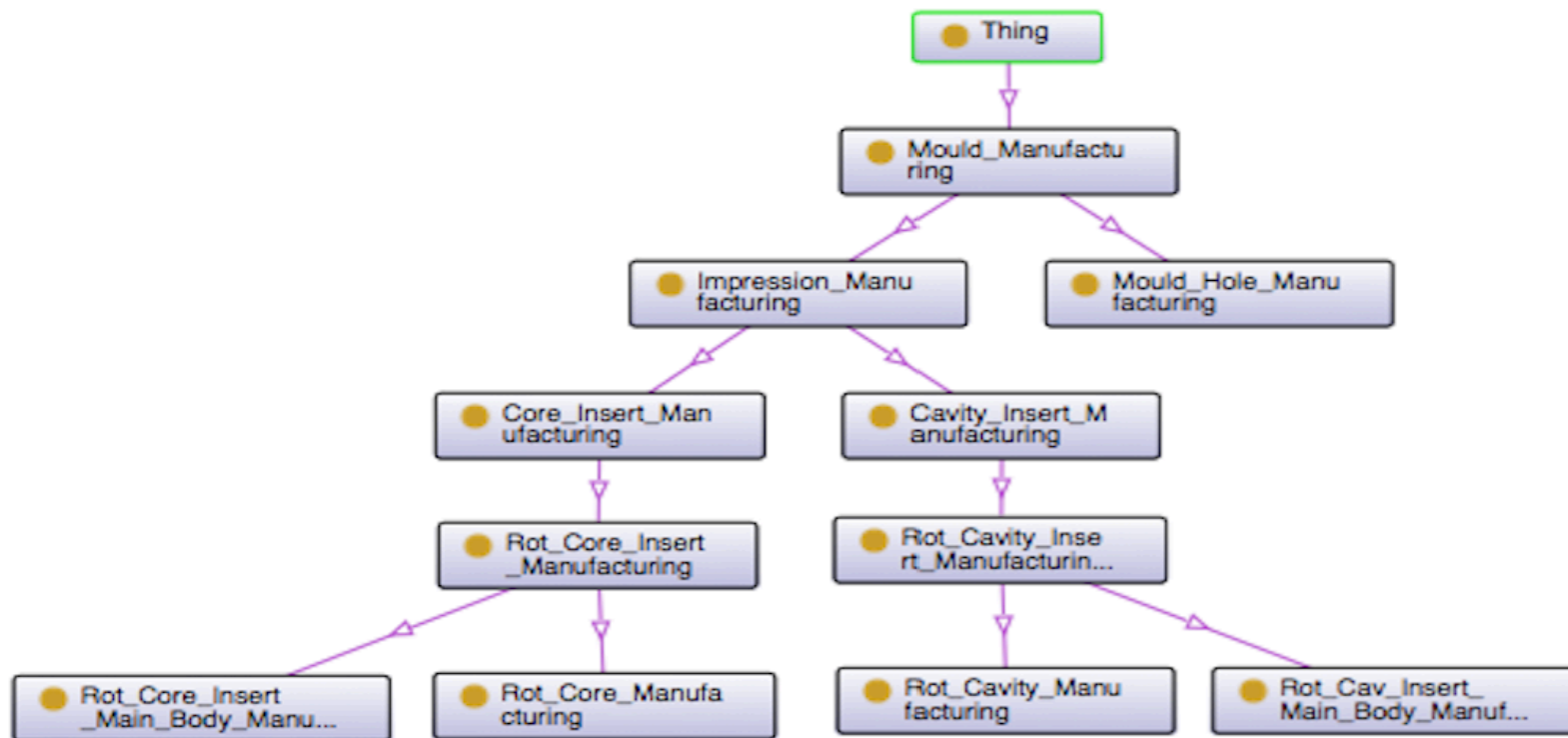

A1.5 MACHINING FEATURES CORE ONTOLOGY

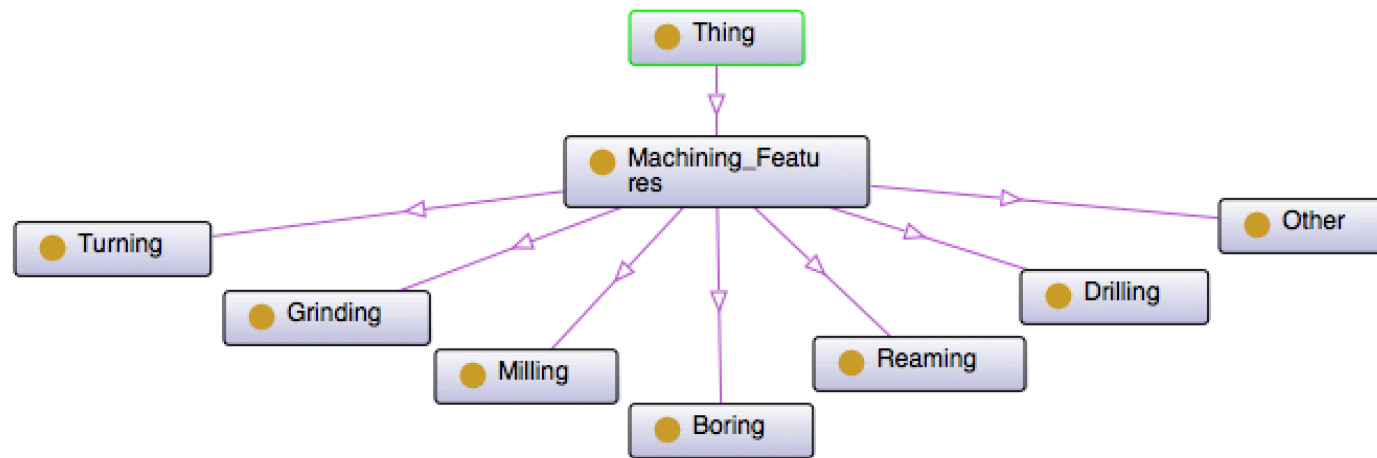

A1.6 MATERIAL CORE ONTOLOGY

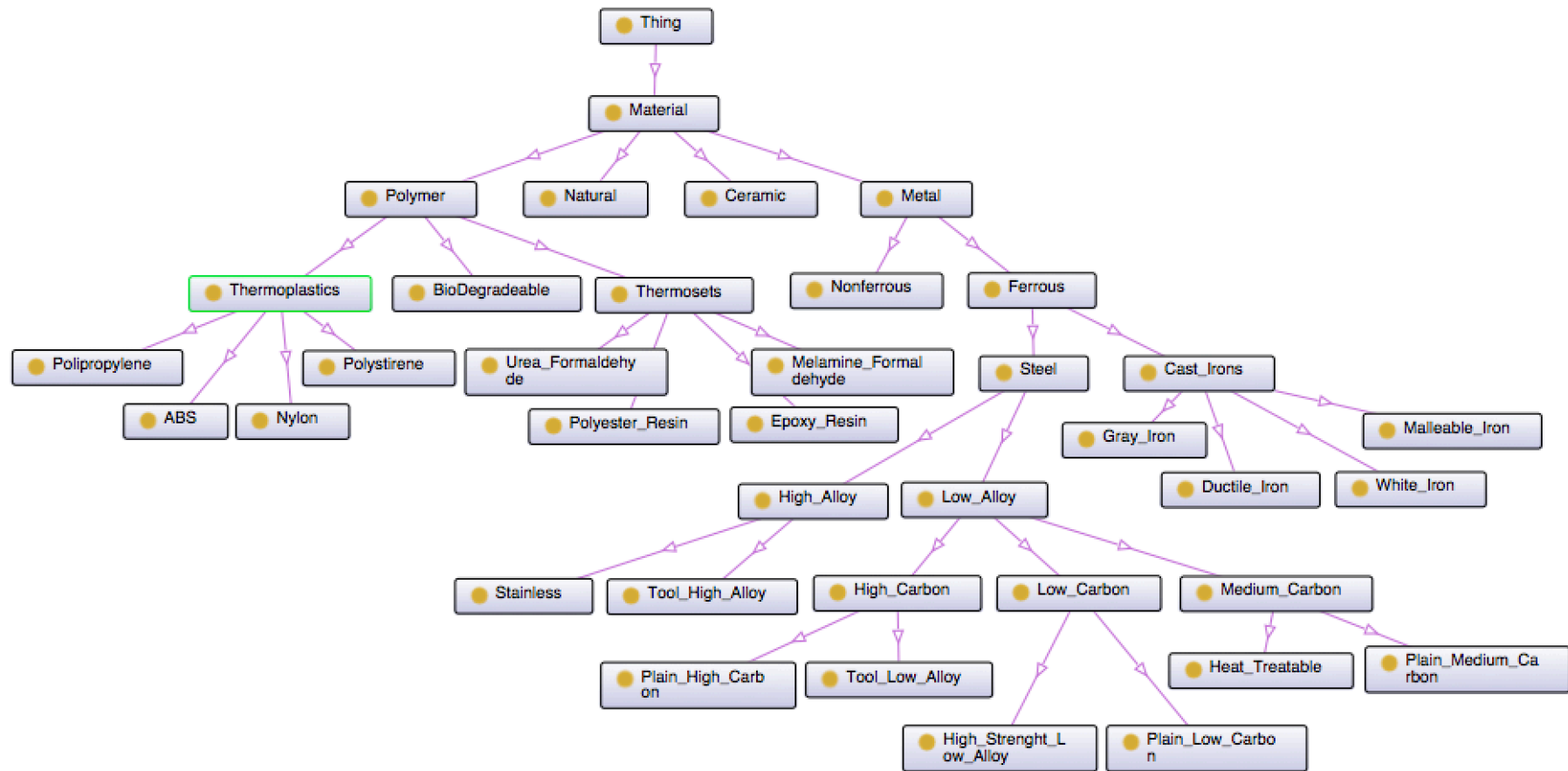

A1.7 MOULD MANUFACTURING CORE ONTOLOGY ENRICHED WITH MACHINING FEATURES

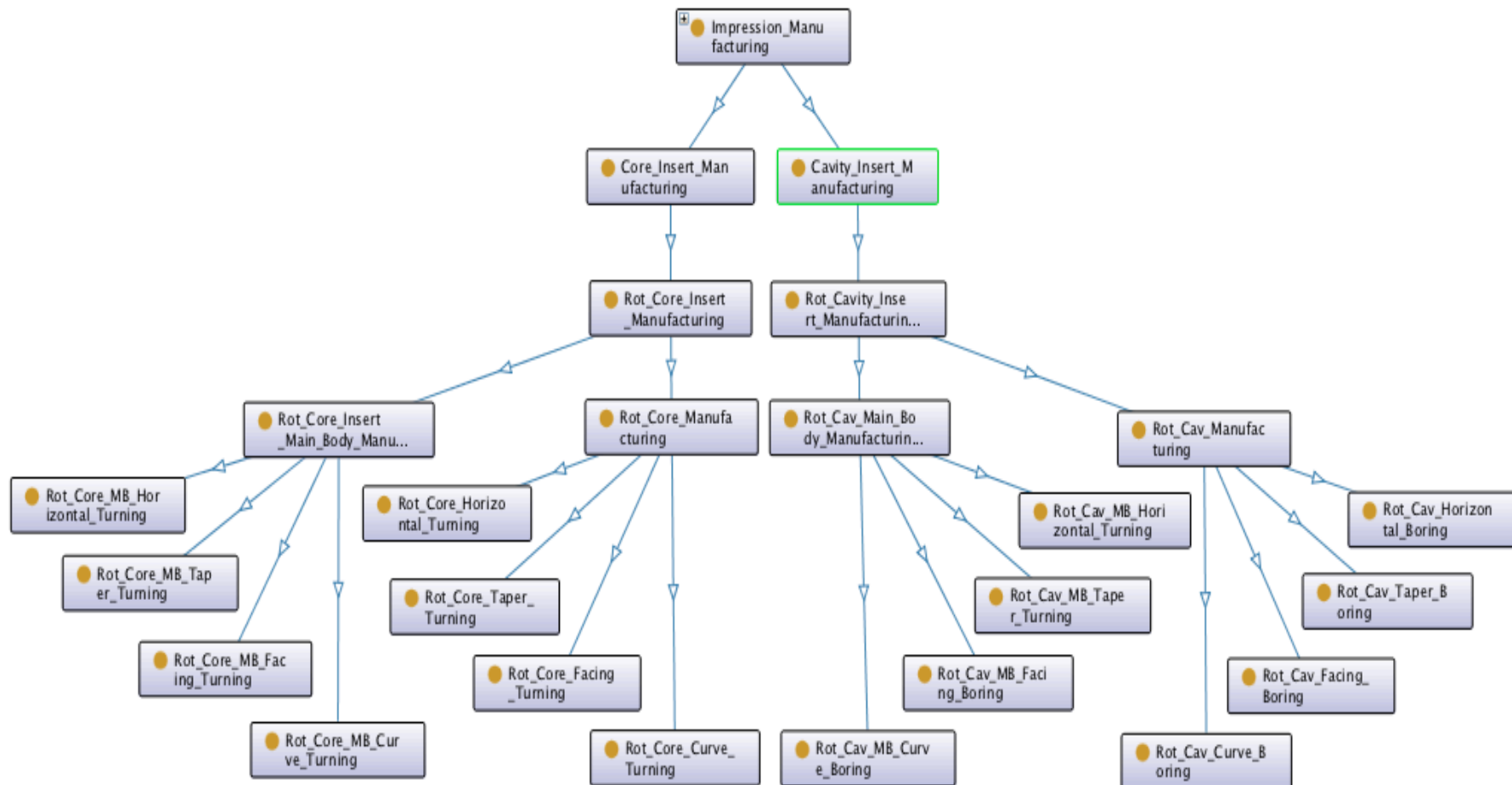

B.1 PRODUCT DRAWING SHEET

