



**HAL**  
open science

## Parametric LCA approaches for efficient design

Michal Kozderka

► **To cite this version:**

Michal Kozderka. Parametric LCA approaches for efficient design. Eco-conception. Université de Strasbourg; Technical University of chemistry and technology (Prague), 2016. English. NNT: 2016STRAD050 . tel-01482915v2

**HAL Id: tel-01482915**

**<https://hal.science/tel-01482915v2>**

Submitted on 3 Jul 2017

**HAL** is a multi-disciplinary open access archive for the deposit and dissemination of scientific research documents, whether they are published or not. The documents may come from teaching and research institutions in France or abroad, or from public or private research centers.

L'archive ouverte pluridisciplinaire **HAL**, est destinée au dépôt et à la diffusion de documents scientifiques de niveau recherche, publiés ou non, émanant des établissements d'enseignement et de recherche français ou étrangers, des laboratoires publics ou privés.



UNIVERSITÉ DE STRASBOURG



UNIVERSITY OF CHEMISTRY  
AND TECHNOLOGY PRAGUE

Department of  
Environmental  
Chemistry,  
UCT Prague

*ÉCOLE DOCTORALE MATHÉMATIQUES,  
SCIENCES DE L'INFORMATION ET DE L'INGÉNIEUR  
ICUBE - UMR 7357*

**cotutelle de THÈSE** présentée par :  
**Michal KOZDERKA**

soutenue le : **13 décembre 2016**

pour obtenir le grade de : **Docteur de l'université de Strasbourg**  
to obtain : **Doctoral degree at University of Chemistry and Technology, Prague**  
Discipline/ Spécialité : Génie Industriel / Ecoconception

## **Parametric LCA approaches for efficient design**

**THÈSE dirigée par :**

**M. CAILLAUD Emmanuel**  
**M. KOČÍ Vladimír**

Professeur, Université de Strasbourg  
Docent, University of Chemistry and Technology, Prague

**RAPPORTEURS :**

**Mme ZWOLINSKI Peggy**  
**M. KURAŠ Mečislav**

Professeur, Université Grenoble Alpes  
Professeur, University of Chemistry and Technology, Prague

---

**AUTRES MEMBRES DU JURY :**

**Mme BAHLOULI Nadia**  
**Mme REYES Tatiana**  
**Mme QUARANTA Gaetana**  
**M. ROSE Bertrand**

Professeur, Université de Strasbourg  
MCF, Université de Technologie Troyes  
HDR, Université de Strasbourg  
HDR, Université de Strasbourg



## ACKNOWLEDGEMENTS

First of all I would like to thank my supervisors. I thank Bertrand Rose for his kindness and his ever present help, even when he is entirely saturated with other work. I thank professor Emmanuel Caillaud for his direction and for his surprisingly gentle yet efficient methods of motivation. I thank professor Vladimír Kočí for his help and for his support that made my thesis possible. They are all professionals, kind, helpful and pleasant. It was a great luck to meet them and I really enjoyed being their student.

I thank from the bottom of my heart my girlfriend Herminie Henriet, for her love and support through the whole duration of this thesis, as well as for all the grammar checks.

I thank professor Bahlouli for the study of High Impact Polypropylene's mechanical properties and my colleagues Ahmed Werfali and Neuman Elouariaghli for their work on the study of workflows factorization.

I thank Dr. Gaetana Quaranta, for a precious help with my thesis and to Loïs Moreira for consultations, besides being a good friend.

I thank all my colleagues from our French and Czech workgroups for their collaboration and for being good friends. I thank all my colleagues from the faculty of Physics and Engineering as well.

I thank my family and friends whom I love and who supported me through and through.

And I also need to thank all my previous teachers who put a lot of energy into my education, and all my students, who taught me more than I would have guessed.



## PODĚKOVÁNÍ

Především bych chtěl poděkovat svým školitelům. Děkuji Bertrandu Rosovi za jeho laskavost a všudypřítomnou pomoc i ve chvílích, kdy je sám prací zcela saturovaný. Děkuji profesoru Emmanuelu Caillaudovi za jeho vedení a za sotva postřehnutelnou, leč velmi účinnou motivaci. Děkuji docentu Vladimíru Kočímu za pomoc a za podporu, která mi doktorskou práci umožnila. Všichni tři jsou profesionálové, milí a ochotní. Považuji za velké štěstí, že jsem mohl být jejich studentem.

Z celého srdce děkuji své přítelkyni Herminie Henrietové za její lásku a za podporu během celého doktorátu, stejně jako za několikrát vyčerpávající kontroly pravopisu.

Děkuji profesorce Nadie Bahlouliové za spolupráci na studii vysokopevnostního polypropylenu a kolegům Ahmedu Werfalimu a Neumanovi Elouariaghlimu za spolupráci na metodě rekonstrukce referenčního scénáře za použití Kingova algoritmu.

Děkuji doktorce Gaetaně Quarantové za cennou pomoc s mojí doktorskou prací a kolegovi Loïsovi Moreirovi za přátelství a za konzultace.

Děkuji všem kolegům jak z Icube, tak z Ústavu chemie ochrany prostředí za jejich spolupráci a za přátelství. Taktéž děkuji i kolegům z fakulty Fyziky a inženýrství ve Štrasburku.

Děkuji rodině a přátelům, za jejich lásku a podporu.

Děkuji také všem mým předešlým vyučujícím za vzdělání, do něž vložili mnoho energie a děkuji i všem mým studentům, od nichž se učím víc než bych původně čekal.



## REMERCIEMENTS

Avant tout je voudrais remercier mes tuteurs. Je remercie Bertrand Rose pour sa gentillesse et pour son aide omniprésente même quand il est déjà saturé de travail. Merci au professeur Emmanuel Caillaud pour sa direction et pour la motivation délicate, mais très performante. Merci au professeur Vladimír Kočí pour son aide et pour le soutien qui a rendu ma thèse possible. Tous les trois sont des professionnels, gentils et agréables. J'ai de la chance de pouvoir être leur étudiant.

Je remercie de tout coeur ma copine Herminie Henriet pour son amour et son soutien au cours de toute la durée de cette thèse aussi bien que pour tous les contrôles de grammaire qu'elle a fait pour moi.

Merci au professeur Nadia Bahlouli pour son étude sur les aspects mécaniques du recyclage du High impact polypropylène et merci à mes collègues Ahmed Werfali et Neuman Elouariaghli pour leur travail sur l'étude de modélisation du cycle de vie assistée.

Je remercie la Dr. Gaetana Quaranta pour son aide avec ma thèse et Lois Moreira pour son amitié et ses consultations.

Merci à tous mes collègues d'Icube et du Département de chimie environnementale à Prague pour leur amitié et leur collaboration. Je remercie également tous mes collègues de la faculté de Physique et Ingénierie à Strasbourg.

Merci à ma famille et à mes amis pour leur amour et leur soutien de chaque jour.

Et je voudrais remercier tous mes anciens enseignants qui ont mis beaucoup d'énergie dans mon éducation. Je remercie aussi tous mes étudiants qui m'ont appris beaucoup plus que ce à quoi je m'attendais.



# Parametric LCA approaches for efficient design



## ABSTRACT

This work addresses the different issues that put a brake to using Lifecycle assessment (LCA) in product design by answering the main question of the research: How to make Lifecycle assessment faster and easier accessible for manufactured product design?

In the LCA methodology we have identified two issues to deal with and their consecutive scientific locks:

- Research of missing data
  - How to organize missing data
  - How to respect quantitative and qualitative dimensions?
- Modeling of the lifecycle scenario
  - How to translate methodological choices into the lifecycle scenario model?
  - How to transform the reference scenario into a new one?

We have dealt with these issues using the scientific approach Case study according to Robert Yin. Our contributions are based on three case studies, between which the most important is study of High Impact Polypropylene recycling in the automotive industry. We have published it in the Journal of Cleaner Production.

As result of our research we present two methods to improve efficiency of the Lifecycle Inventory Analysis (LCI):

To organize the missing data: Preliminary sensitivity analysis with LCA Poka-Yoke

To help with scenario modeling: Method of workflows factorization, based on Reverse engineering.

For further research we propose eight perspectives, mostly based on integration of our methods into Product Category Rules (PCR)-based platforms, like EPD<sup>®</sup> International or the European PEF.

## SOUHRN

Tato práce je zaměřena použití Analýzy životního cyklu (LCA) v konstrukci a odpovídáme v ní na základní otázku výzkumu: Jak zrychlit a zlepšit dostupnost Analýzy životního cyklu pro obor konstrukce výrobků?

V metodice LCA se zabýváme dvěma problémy, jenž způsobují časové ztráty v Inventáři životního cyklu (LCI):

- Hledání nedostupných dat
  - Jak uspořádat chybějící data podle jejich důležitosti?
  - Jak se vyrovnat s propojením kvalitativních a kvantitativních vlastností chybějících dat?
- Modelování scénáře životního cyklu
  - Jak vytvořit scénář životního cyklu na základě předchozích rozhodnutí týkajících se metodiky LCA?
  - Jak vytvořit nový model z předem vybraného referenčního modelu?

Pro nalezení řešení zmíněných problematik jsme použili přístup Případové studie podle Roberta Yina. Naše kontribuce jsou výsledkem tří případových studií, z nichž nejdůležitější je studie recyklace vysokopevnostního polypropylenu (HIPP) v automobilovém průmyslu. Výsledky studie jsme publikovali v odborném periodiku Journal of Cleaner Production.

Výsledky našeho výzkumu jsou dvě metody pro zlepšení efektivity práce v LCI:

Pro organizaci chybějících dat představujeme metodu předběžné studie citlivosti dat s kvalitativním přístupem LCA Poka-Yoke.

Pro pomoc s tvorbou modelu životního cyklu představujeme metodu rekonstrukce referenčního scénáře za použití Kingova algoritmu.

Pro pokračování výzkumu nabízíme osm perspektiv, většinou založených na integraci představených metod do systémů, založených na normě ISO 14025, nebo na projektu PEF.



## RÉSUMÉ

Ces travaux de recherche portent sur la problématique de la mise en pratique de l'analyse de cycle de vie (ACV). La question principale est : comment faire une ACV plus rapide et plus facilement accessible pour la conception des produits ? Nous nous concentrons sur deux problématiques qui prolongent l'Inventaire de Cycle de Vie (ICV):

- recherche des données manquantes
  - Comment ranger les données manquantes selon leur importance?
  - Comment traiter l'intersection des aspects qualitatifs et les aspects quantitatifs des données manquantes?
- Modélisation du cycle de vie
  - Comment réutiliser le cycle de vie existant pour un nouveau produit?
  - Comment développer un modèle de référence?

Pour la recherche des solutions nous avons utilisé l'approche „Case study“ selon Robert Yin. Nos contributions font résultat de trois études de cas, dont la plus importante est l'ACV du High Impact Polypropylene (HIPP) recyclé. Nous avons publié les résultats de celle-ci dans la revue scientifique Journal of Cleaner Production.

Suite aux études de cas nous proposons deux approches d'amélioration d'efficacité en ICV:

nous proposons l'analyse de sensibilité préalable pour classifier les données manquantes selon leur impact sur les résultats d'ACV. L'approche combine les aspects qualitatifs avec les aspects quantitatifs en protégeant le respect des objectives d'étude. Nous appelons cette protection „LCA Poka-Yoké“.

La modélisation du cycle de vie peut être assistée grâce à la méthode basée sur l'algorithme de King. Pour la continuation de la recherche nous proposons huit perspectives, dont six font l'objet d'intégration des nouvelles approches d'amélioration dans les concepts d'ACV basés sur la norme ISO 14025 ou dans le projet de la Commission Européenne PEF.





## RÉSUMÉ ÉTENDU

### 1 Introduction

Ces travaux de recherche portent sur la problématique de développement de l'Analyse de cycle de vie (ACV) dans l'industrie, notamment dans la conception de produits.

Ils ont été réalisés dans le cadre d'une thèse en cotutelle entre l'Université de Strasbourg et University of Chemistry and Technology, Prague (UCT Prague). L'intersection des domaines est cohérente avec l'expertise des deux laboratoires : l'ingénierie et la production pour le laboratoire Icube à l'Université de Strasbourg et l'ACV et la chimie environnementale pour le Département of Environmental Chemistry de l'UCT de Prague.

La question principale de la recherche porte sur les freins à la propagation de l'ACV dans l'industrie : Comment faire une ACV plus rapide et plus facilement accessible pour la conception des produits ?

### 2 Etat de l'art

#### 2.1 Orientation de la recherche

Pour répondre à cette problématique, nous devons d'abord identifier la partie de la méthodologie de l'ACV sur laquelle il est le plus pertinent d'agir et ensuite trouver les verrous scientifiques à lever.

Nous identifions la phase d'Inventaire du cycle de vie (ICV) comme la problématique à résoudre car c'est la partie la plus longue de l'ACV et également celle qui est la plus générique quel que soit le cas d'étude contrairement à la définition des objectifs, le champ d'étude ou l'interprétation des résultats. (Baumann and Tillman, 2004)

Dans l'ICV nous trouvons cinq problèmes non-résolus, pertinents à résoudre. (Reap et al., 2008) Voir *Figure 1*.

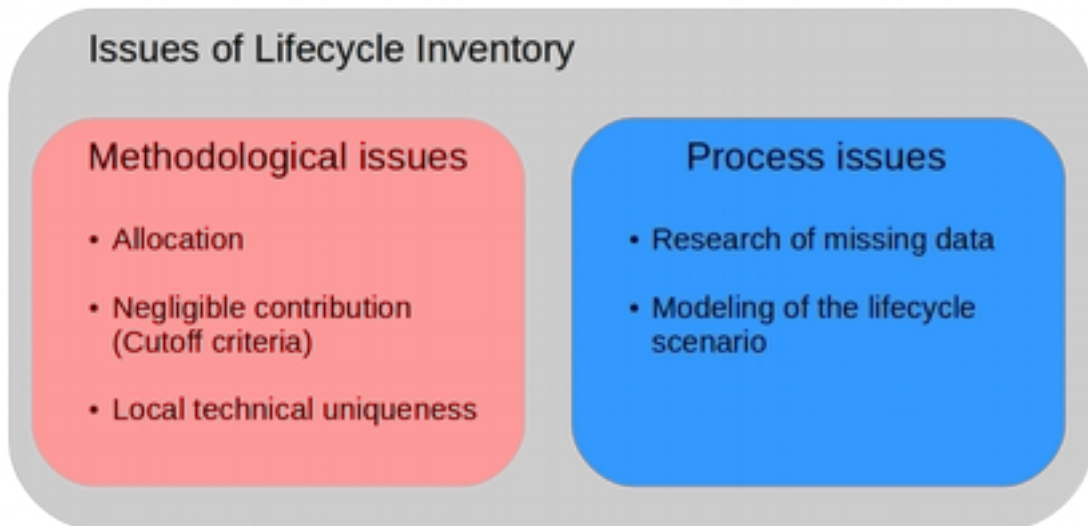

*Figure 1 : Problématiques de l'Inventaire du cycle de vie*

Nous divisons les problèmes en deux familles :

- Les « problèmes méthodologiques » se définissent par un manque de clarté dans la méthode ou par l'existence de plusieurs modes d'exécution de celle-ci.
- Les « problèmes de processus » apparaissent lorsque la méthode est bien définie mais son exécution est longue et désorganisée.

Suite à notre premier cas d'étude (*voir l'annexe 1*), nous nous sommes orientés vers les problèmes de processus.

## 2.2 Approches d'améliorations potentielles

Nous identifions trois voies d'améliorations : les simplifications, l'intégration des plateformes basées sur les Product Category Rules (PCR) et les approches paramétriques.

Les simplifications représentent la première solution intuitive mais elles comportent trois désavantages majeurs : la dégradation de la qualité des données (Lasvaux et al., 2014), la nécessité d'orienter les simplifications sur un type de produit et un objectif d'étude (Bereketli Zafeirakopoulos and Erol Genevois, 2015) et finalement les outils pour les non-experts qui augmentent le risque de mauvaise interprétation des résultats.

Les plateformes à base de PCR ont récemment accéléré la propagation de l'ACV dans l'industrie. Leur but étant la comparabilité des différentes études via la standardisation des ACV selon des catégories de produits. (International Organization for Standardization, 2006a) Ce qui a également comme effet secondaire positif de permettre des études plus rapides.

L'approche paramétrique a l'avantage d'être systématique. Même si elle n'a pas de définition exacte dans l'ACV, d'un point de vue mathématique on considère qu'un processus paramétrique est tout processus qui dépend d'un certain nombre de paramètres (Jazar and Dai, 2014). Dans la littérature nous avons identifié 6 modèles différents de processus paramétriques plus précis . Voir *Figure 2*.

Le premier modèle introduit la modularisation des processus afin de les rendre réutilisables et de simplifier leur modélisation. (Borland, 1998) Aujourd'hui, tous les logiciels d'ACV sont basés sur ce principe. De même que tous les autres modèles d'ACV paramétrique.

Les trois modèles suivants représentent la base des ACV simplifiées. La différence entre eux se situe dans la rigidité des scénarios. Le deuxième modèle possède un scénario rigide utiles pour les débutants. Le troisième modèle permet l'échange de processus mais il garde la forme du scénario. Alors que le quatrième modèle permet aussi

certaines évolutions de la conception du scénario lui-même. En pratique, il ressemble aux plateformes basées sur les PCR.

Les modèles cinq et six ont pour but la recherche de combinaisons idéales des paramètres à l'entrée de l'étude. Le cinquième modèle possédant un scénario rigide tandis que le sixième modèle est plus libre.

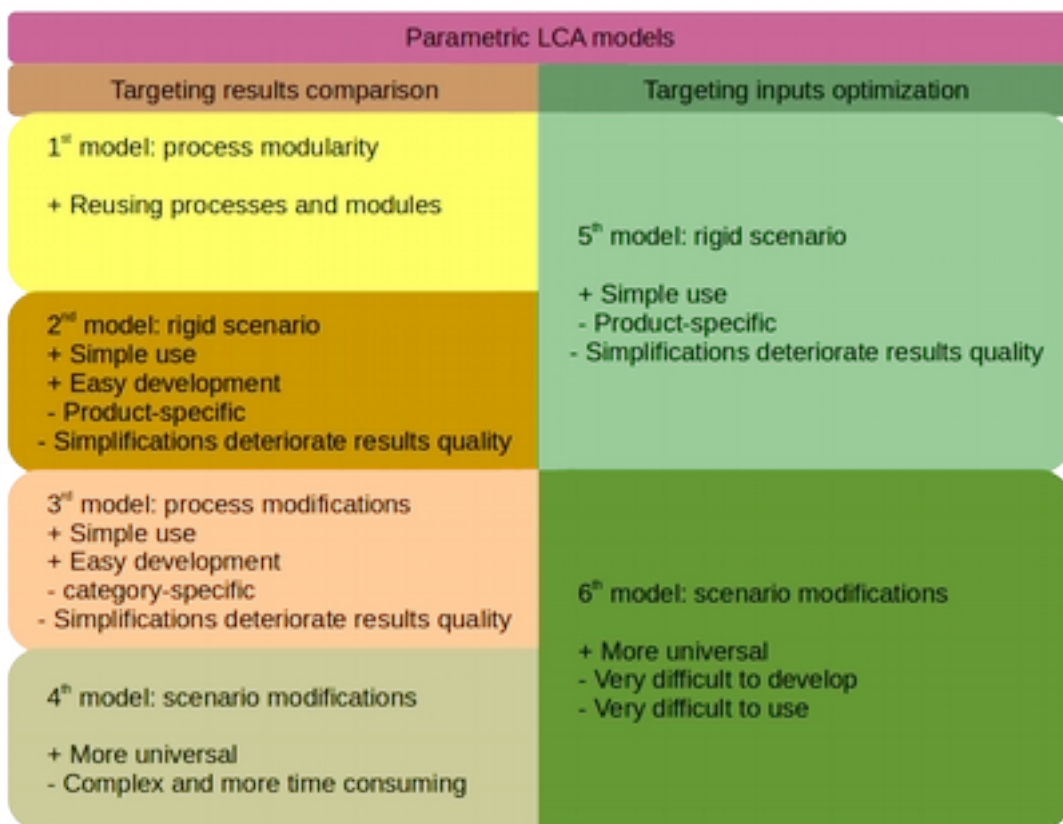

Figure 2 : 6 modèles paramétriques

### 2.3 Méthode de recherche

L'ACV est une démarche complexe, largement influencée par les circonstances rencontrées dans des situations réelles. C'est pourquoi, nous avons adopté la méthode de recherche « Case study » selon R. K. Yin.

### 2.4 Positionnement de la recherche

La *Figure 3* synthétise le déroulement de la recherche de la question principale jusqu'aux conclusions. La question principale de la recherche traite de la méthodologie de l'ACV. Au sein de celle-ci, nous nous sommes tout particulièrement focalisés sur l'ICV, qui est la partie la plus longue de la méthodologie.

Dans l'ICV nous trouvons des problématiques méthodologiques aussi bien que des problèmes de processus, c'est à dire des activités bien définies mais longues à exécuter.

Une première étude de cas nous a orientés vers les deux problématiques liés au processus d'écoconception, c'est à dire :

- « Comment organiser la recherche des données manquantes ? » et;
- « Comment traduire les décisions méthodologiques en modèle de cycle de vie ? »

Nous avons ainsi développé une méthode pour chacune des deux problématiques, ce qui correspond à une contribution par méthode.

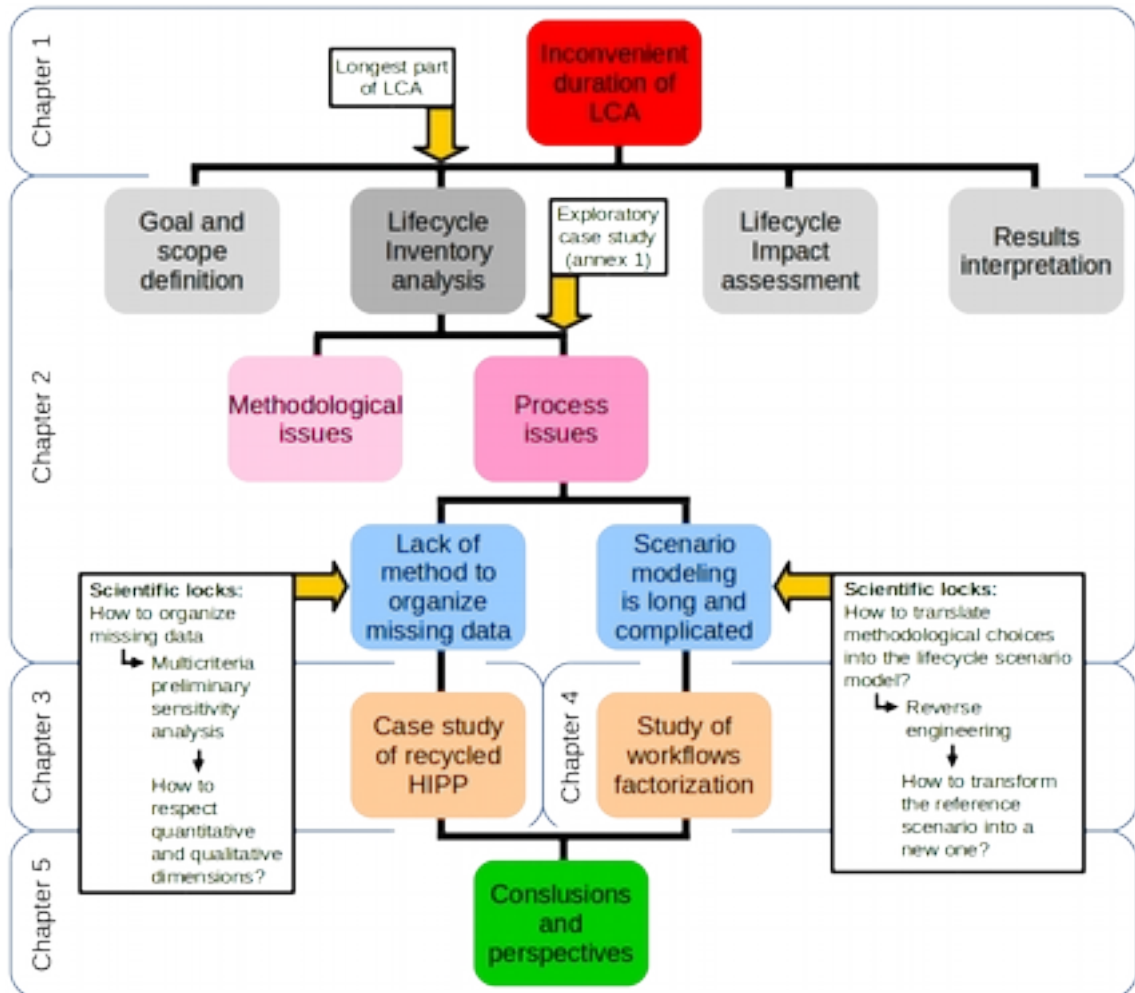

Figure 3 : Déroulement de la recherche

La première contribution consiste en une ACV du recyclage du High Impact Polypropylene (HIPP) dans l'industrie automobile, alors que la deuxième utilise une ACV existante pour tester la méthode de modélisation du cycle de vie assistée que nous avons développée.



### **3 Contribution: Recyclage du High impact polypropylene (HIPP) – Propriétés mécaniques et Analyse de cycle de vie (ACV) en intégrant la méthode d'analyse de sensibilité préliminaire**

Notre première contribution a deux objectifs : découvrir les impacts du recyclage dans l'industrie automobile et tester la méthode d'analyse de sensibilité préalable.

L'étude du HIPP s'appuie sur la situation actuelle dans l'industrie automobile. Les entreprises concernées sont obligées légalement à augmenter la part de la matière recyclée dans leurs nouveaux modèles (European Commission, 2005) et dans le même temps doivent réduire leur consommation d'énergie. Cela passe en partie par l'allègement des nouveaux modèles de voitures qui implique une augmentation de la part des plastiques dans les nouveaux véhicules et un besoin accru de recycler les plastiques les plus utilisés. Dans ce cas, nous étudions le HIPP qui est la matière la plus courante dans les parechocs.

Tout d'abord, le recyclage des plastiques est plus délicat que celui des métaux ou du verre car il change leurs propriétés mécaniques. (Bahlouli et al., 2012) Ensuite, alors que le recyclage est d'habitude considéré comme ayant moins d'impacts environnementaux, il s'avère que les technologies de recyclage sont aussi des consommatrices d'énergie car la boucle de recyclage nécessite des transports supplémentaires des déchets et de la matière recyclée. Donc nous ne pouvons pas déclarer que le recyclage diminue les impacts environnementaux sans les étudier plus en détail.

La contribution est composée de trois parties :

#### Etude des impacts du recyclage sur la microstructure et les propriétés mécaniques du HIPP :

Cette étude a été réalisée par l'équipe du prof. Bahlouli au sein du laboratoire Icube. Dans un premier temps nous nous sommes intéressés à l'impact du recyclage sur la



## Parametric LCA approaches for efficient design



matière et le mécanisme de la détérioration éventuelle. C'est la raison pour laquelle nous avons étudié le HIPP recyclé consécutivement 0, 3, 6, 9 puis 12 fois.

### ACV du recyclage du HIPP dans l'industrie automobile :

Nous avons réalisé cette étude grâce à une collaboration entre les équipes d'Icube et du Département of environmental chemistry d'UCT Prague. Contrairement à la première partie, nous avons besoin de connaître les impacts des pratiques les plus courantes dans l'industrie automobile. En pratique, il n'est pas commun de recycler le plastique consécutivement mais plutôt de mélanger le granulat recyclé avec le granulat vierge pour compenser la détérioration des propriétés mécaniques. C'est pourquoi, nous avons donc modélisé un circuit fermé de recyclage en variant le ratio entre granulat recyclé et granulat vierge.

### Analyse de sensibilité préalable :

Il est assez habituel, au début d'une ACV de faire face au manque d'un certain nombre de données. Normalement, nous devrions gérer les données manquantes comme égales (Baumann and Tillman, 2004) mais les données n'ont pas toutes la même importance. Pour travailler de manière plus efficace, nous avons donc besoin de pouvoir trier les données manquantes et privilégier les plus importantes. Pour ce faire, nous utilisons une combinaison entre une analyse de sensibilité préalable (Steen, 1997), une analyse de sensibilité multicritères (Björklund, 2002) et notre approche vérifiant les aspects qualitatifs que nous avons appelé *LCA Poka-Yoke*.

Les résultats de ce cas d'étude démontrent la détérioration du HIPP causée par le raccourcissement mécanique des chaînes du polypropylène (PP) pendant le recyclage. Du point de vue du comportement mécanique, la détérioration n'est significative qu'au bout du 6<sup>ème</sup> recyclage.





## Parametric LCA approaches for efficient design



L'ACV a démontré la réduction des impacts grâce à un grand écart entre les impacts de la production de la matière vierge et la somme des transports et des impacts du recyclage. Nous constatons la réduction dans la plupart des catégories d'impacts sauf le potentiel d'irradiation ionisante, qui augmente avec la consommation d'électricité lors du recyclage. Les résultats en toxicité et écotoxicité sont proches et ils ne permettent pas de faire une conclusion définitive.

L'analyse de sensibilité préliminaire a prouvé son utilité. Néanmoins elle possède encore deux verrous. Un premier verrou à lever lors de chaque étude est l'ajustement du *LCA Poka-Yoke*. Son principe est de séparer les données participantes aux objectifs d'ACV des données complémentaires. Cette séparation doit être soigneusement définie. Dans l'avenir, nous pourrions développer une librairie des Poka-Yoke basés sur des PCR.

Le deuxième verrou est la relation mathématique entre les données d'entrée et les résultats. Dans notre cas, cette relation a été linéaire mais elle peut prendre la forme de n'importe quelle fonction. Dans les prochaines études, nous devrions identifier un modèle de détection de cette fonction pour un calcul automatisé d'un indicateur d'importance des données manquantes.

### **4 Contribution: Modélisation du cycle de vie assistée**

La deuxième contribution porte sur la problématique de modélisation du cycle de vie. Il n'est pas évident de traduire les choix méthodologiques en modèle et souvent il y a même plusieurs façons possibles de les modéliser qui pourraient donner des résultats différents. Comme exemple, nous pouvons prendre le transport de deux produits d'une entreprise à un même client. Voir *Figure 4*.



Figure 4 : Exemple de problème de modélisation d'un scénario de cycle de vie

Dans certains cas, ces deux modèles ne seraient pas égaux mais le processus de transport routier dans la base des données ELCD contient une allocation par poids et taux de remplissage indépendants, ce qui fait que les résultats dans les deux cas sont identiques.

Cette problématique a été traitée dans notre laboratoire dans le cadre du stage de deux étudiants en master Génie Industriel : Ahmed Werfali et Neuman Elouariaghi.

Pour résoudre cette problématique nous avons utilisé le concept de « Reverse engineering ». (Eilam, 2005) Nous nous inspirons des études existantes pour la reconstruction d'un nouveau scénario. Ceci amène au verrou scientifique suivant: **comment transmettre la logique et la suite du scénario de référence à un nouveau scénario recherché ?**

Nous répondons à ce verrou en utilisant le principe de l'Algorithme de King qui est habituellement utilisé pour l'optimisation des flux dans l'entreprise. Dans l'ACV nous l'utilisons pour identifier les processus identiques entre le scénario de référence et le nouveau modèle. Ensuite, il nous aide à reconstruire le nouveau scénario en préservant les flux pertinents.

Nous avons expérimenté la méthode sur un modèle de cycle de vie existant de recyclage du béton. Nous pouvons constater une légère économie de temps mais celle-ci est compromise par la préparation du scénario de référence. Néanmoins, nous voyons une perspective d'amélioration dans les PCR. Dans des recherches futures nous pourrions

tester la préparation du scénario de référence à partir d'un PCR. Celui-ci serait réutilisable et la méthode pourrait enfin accélérer la modélisation du cycle de vie.

## 5 Perspectives

Lors de ces travaux de recherche nous avons identifié huit perspectives, que nous divisons en perspectives industrielles et perspectives de recherche. Ensuite, nous les subdivisons d'après leur orientation en perspectives concernant le produit ou les méthodes. Voir *Figure 5*.

|         | Industrial perspectives  | Research perspectives  |
|---------|--|--|
| Product | Creation of library for LCA Poka-Yoke, based on PCRs                   | Possibilities of light LCA for Lean and Green approach   |
| Process | Design of a workflows database for scenario reconstruction             | Development of metrics for performance of LCA  |
|         | Integration of LCA into ISO 14001 (2015) Simplified LCA based on PCRs  | Application of preliminary sensitivity analysis to the issue of negligible contribution  |
|         | Find a fast link between the LCI databases and reconstructed scenarios | Mathematical modeling of relation between input data and results of an LCA → mathematical model for preliminary sensitivity analysis |

*Figure 5 : Perspectives des travaux de thèse*

En majorité, nous identifions les perspectives industrielles dans l'intégration de nos méthodes dans les plateformes basées sur des PCRs.

Ensuite, nous pourrions profiter des PCRs pour développer une série d'ACV simplifiées à intégrer dans la démarche de la dernière norme ISO 14001 (2015). Nous pourrions



## Parametric LCA approaches for efficient design



aussi chercher un moyen de lier des databases LCI avec la méthode de reconstruction des scénarios pour permettre l'automatisation.

Dans les perspectives de recherche, nous identifions deux outils mathématiques : un pour mesurer la performance d'une ACV, le deuxième pour permettre l'automatisation de la méthode d'analyse de sensibilité préliminaire.

Par la suite, nous voudrions découvrir les possibilités pour une analyse de sensibilité préliminaire de résoudre une autre problématique d'ICV : les contributions négligeables. Notre méthode pourrait servir à vérifier si les données qui sont considérées comme négligeables n'auraient pas un impact inattendu.

Enfin, en complément des travaux menés au Laboratoire Icube, nous pourrions explorer la possibilité d'intégrer l'ACV ou l'ACV simplifiée dans le concept industriel Lean and Green.

### **6 Références**

Bahlouli, N. et al., 2012. Recycling effects on the rheological and thermomechanical properties of polypropylene-based composites. *Materials & Design*, 33, pp.451–458. Available at: <http://www.sciencedirect.com/science/article/pii/S0261306911003189> [Accessed January 25, 2015].

Baumann, H. & Tillman, A.-M., 2004. *The Hitch Hiker's Guide to LCA*, Lund: Studentlitteratur.

Bereketli Zafeirakopoulos, I. & Erol Genevois, M., 2015. An Analytic Network Process approach for the environmental aspect selection problem — A case study for a hand blender. *Environmental Impact Assessment Review*, 54, pp.101–109.

Björklund, A.E., 2002. Survey of approaches to improve reliability in lca. *The International Journal of Life Cycle Assessment*, 7(2), pp.64–72.



## Parametric LCA approaches for efficient design



Borland, N., 1998. Integrating environmental impact assessment into product design. Massachusetts Institute of Technology. Available at: <http://dspace.mit.edu/handle/1721.1/46239?show=full>.

Eilam, E., 2005. Reversing: Secrets of Reverse Engineering, Indianapolis: Willey Publishing Inc.

European Commission, E., 2005. DIRECTIVE 2005/64/EC OF THE EUROPEAN PARLIAMENT AND OF THE COUNCIL of 26 October 2005 on the type-approval of motor vehicles with regard to their reusability, recyclability and recoverability and amending Council Directive 70/156/EEC, Bruxelles. Available at: <http://eur-lex.europa.eu/legal-content/EN/TXT/?uri=CELEX:32005L0064>.

International Organization for Standardization, 2006. ISO 14025:2006: Environmental labels and declarations -- Type III environmental declarations -- Principles and procedures, Geneva. Available at: [http://www.iso.org/iso/catalogue\\_detail%3Fcsnumber%3D38131](http://www.iso.org/iso/catalogue_detail%3Fcsnumber%3D38131).

Jazar, R.N. & Dai, L., 2014. Nonlinear Approaches in Engineering Applications 2, New York: Springer Science & Business Media. Available at: <https://bu.unistra.fr:443/.do?idopac=BUS2168574>.

Lasvaux, S. et al., 2014. Influence of simplification of life cycle inventories on the accuracy of impact assessment: application to construction products. *Journal of Cleaner Production*, 79, pp.142–151. Available at: <http://www.sciencedirect.com/science/article/pii/S0959652614005885> [Accessed December 4, 2014].

Reap, J. et al., 2008. A survey of unresolved problems in life cycle assessment. *The International Journal of Life Cycle Assessment*, 13, pp.374–388. Available at: [http://download.springer.com/static/pdf/544/art%253A10.1007%252Fs11367-008-0009-9.pdf?auth66=1427317804\\_5d02f586b0d735eef20f18a6d23f0328&ext=.pdf](http://download.springer.com/static/pdf/544/art%253A10.1007%252Fs11367-008-0009-9.pdf?auth66=1427317804_5d02f586b0d735eef20f18a6d23f0328&ext=.pdf).

Steen, B., 1997. On uncertainty and sensitivity of LCA-based priority setting. *Journal of Cleaner Production*, 5(4), pp.255–262. Available at: <http://www.sciencedirect.com/science/article/pii/S0959652697000395> [Accessed May 9, 2015].

**SUMMARY**

|   |    |
|---|----|
| 1: Introduction.....  | 21 |
| 1.1 History of environmental issues and their relationships with industry:<br>Historical and empirical evidences.....   | 22 |
| 1.2 LCA methodology.....  | 24 |
| 1.3 Orientation of the research.....  | 25 |
| 2: State of the art and work positioning.....   | 29 |
| 2.1 Main issues of Lifecycle assessment (LCA) in production industry.....   | 30 |
| 2.2 Orientation of research within the LCA methodology.....   | 32 |
| 2.3 Unresolved issues.....  | 33 |
| 2.3.1 Methodological issues.....  | 34 |
| 2.3.2 Process issues.....   | 36 |
| 2.4 Existing solutions.....   | 37 |
| 2.5 Parametric LCA.....   | 39 |
| 2.6 Parametric LCA models presentation.....   | 40 |
| 2.7 PCR-based platforms.....  | 48 |
| 2.8 Research method.....  | 49 |
| 2.9 Work positioning.....   | 50 |
| 2.10 Contributions.....   | 52 |
| 3: Contribution: High impact polypropylene (HIPP) recycling – Mechanical resistance<br>and Lifecycle Assessment (LCA) case study with improved efficiency by preliminary<br>sensitivity analysis..... | 54 |
| 3.1 Introduction.....   | 57 |
| 3.2 Implementation in practice.....   | 59 |
| 3.2.1 Mechanical properties.....  | 60 |
| 3.2.2 LCA.....  | 60 |
| 3.2.3 Preliminary sensitivity analysis.....   | 61 |
| 3.3 Methodology.....  | 61 |
| 3.3.1 Mechanical and rheological properties.....  | 61 |
| 3.3.2 LCA.....  | 64 |



# Parametric LCA approaches for efficient design



|  |     |
|--|-----|
| a) Goal and scope definition.....  | 64  |
| b) Lifecycle inventory (LCI).....  | 65  |
| c) Lifecycle impact assessment (LCIA).....                                     | 67  |
| 3.3.3 Preliminary sensitivity analysis.....                                    | 68  |
| 3.4 Interpretation of the results - mechanical and rheological properties..... | 71  |
| 3.4.1 Rheological properties.....  | 71  |
| 3.4.2 Mechanical properties.....   | 74  |
| 3.5 LCA results interpretation.....  | 78  |
| 3.5.1 Preliminary sensitivity analysis.....                                    | 78  |
| 3.5.2 General results.....   | 81  |
| 3.5.3 Dominance analysis.....  | 84  |
| 3.5.4 Sensitivity analysis.....  | 88  |
| a) Choice of the LCIA methodology.....   | 88  |
| b) Choice of the recycling model.....  | 90  |
| 3.5.5 Uncertainty analysis.....  | 92  |
| 3.5.6 Improved efficiency through preliminary sensitivity analysis.....        | 95  |
| 3.6 Conclusions.....   | 96  |
| 4: Contribution: Assisted scenario modeling by factorization of workflows..... | 99  |
| 4.1 Introduction.....  | 101 |
| 4.2 State of the art.....  | 102 |
| 4.3 Methodology.....   | 104 |
| 4.4 Experimentation.....   | 110 |
| 4.5 Results.....   | 111 |
| 4.6 Conclusions and perspectives.....  | 112 |
| 5: Conclusions and perspectives.....   | 113 |
| 5.1 General conclusions.....   | 114 |
| 5.2 High Impact Polypropylene recycling.....                                   | 116 |
| 5.3 Preliminary sensitivity analysis.....                                      | 117 |
| 5.4 Assisted scenario modeling by factorization of workflows.....              | 118 |
| 5.5 Perspectives.....  | 119 |



# Parametric LCA approaches for efficient design



|                                    |     |
|------------------------------------|-----|
| 5.5.1 Industrial perspectives..... | 119 |
| 5.5.2 Research perspectives.....   | 120 |



**Plan of the dissertation: Figure 1**

The dissertation begins with general introduction (1) which clarifies history of ecodesign, our choice of the research domains and the main question of the research.

State of the art (2) gives details on the issues we are interested in and on present situation in the concepts of potential solutions: parametric Lifecycle assessment (LCA) and simplified LCAs. Work positioning describes our use of chosen research method and it gives the roadmap of the research – from the main question of the research through case studies to conclusions.

The core of the research are two contributions: Case study of recycled High Impact Polypropylene (HIPP) (3) and method of workflows factorization. (4)

The last chapter (5) concludes on results and gives perspectives of further research.

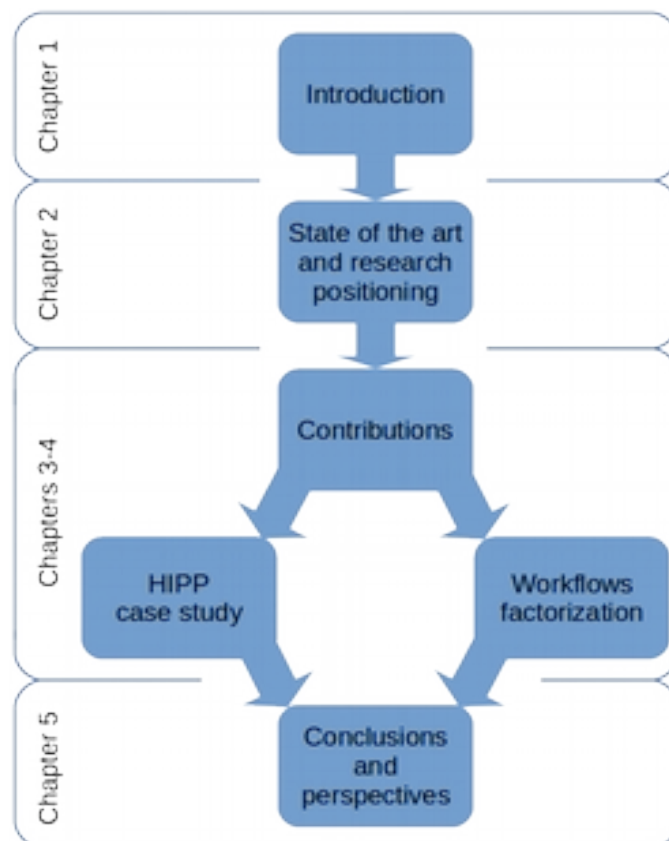

*Figure 1: Plan of the dissertation*

# 1 INTRODUCTION

In the beginning, Lifecycle Assessment (LCA) is introduced by brief history of environmental issues and their solutions, followed by introduction of the LCA and its link to the production industry. In this part benefits of LCA to the industry are underlined and followed by description of the main aspects of the LCA methodology.

Presentation of both laboratories that participated on the research introduce explanation of choosing LCA as a subject of the research and the question of the research.

## **1.1 History of environmental issues and their relationships with industry: Historical and empirical evidences**

Environmental issues troubling human societies are as old as humans themselves. We tend to see pollution and resources withdrawal as something new, but it was already faced by ancient empires thousands years ago. We have proofs of anthropogenic water withdrawal standing behind the fall of ancient Egypt (Yeakel *et al.*, 2014), metallurgy polluting ancient Greece (Hughes, 1975; Markham, 1994) or heavy metals in ancient Rome. (Patterson, Shirahata and Ericson, 1987; Markham, 1994) And today with exponential growth of populations we face more environmental problems than ever.

But with problems come also solutions. Since 550 when the Byzantine emperor Justinian emitted the first limitation of water consumption (Getzler, 2004), societies protect their strategic resources and ecosystems. Until now protection of the environment is done on several levels by isolation, limitation of emissions and limitation of resources.

Environmental management went through history from suffering from unexpected problems to careful and respectful design of new products and projects. *Figure 2*

From the earliest industrial activities, production of goods is related to pollution. But if antique and medieval pollution got absorbed thanks to their rareness, they became ever present in the late 18<sup>th</sup> century cities. In 1905 we gave name to smog in London and in 1913 Ford Motor Company launched the first mechanized assembly line, giving birth to mass production. (Markham, 1994)

Growing volumes of production brought also growth of pollution and the biggest polluters came soon under pressure of public, institutions and of course customers.

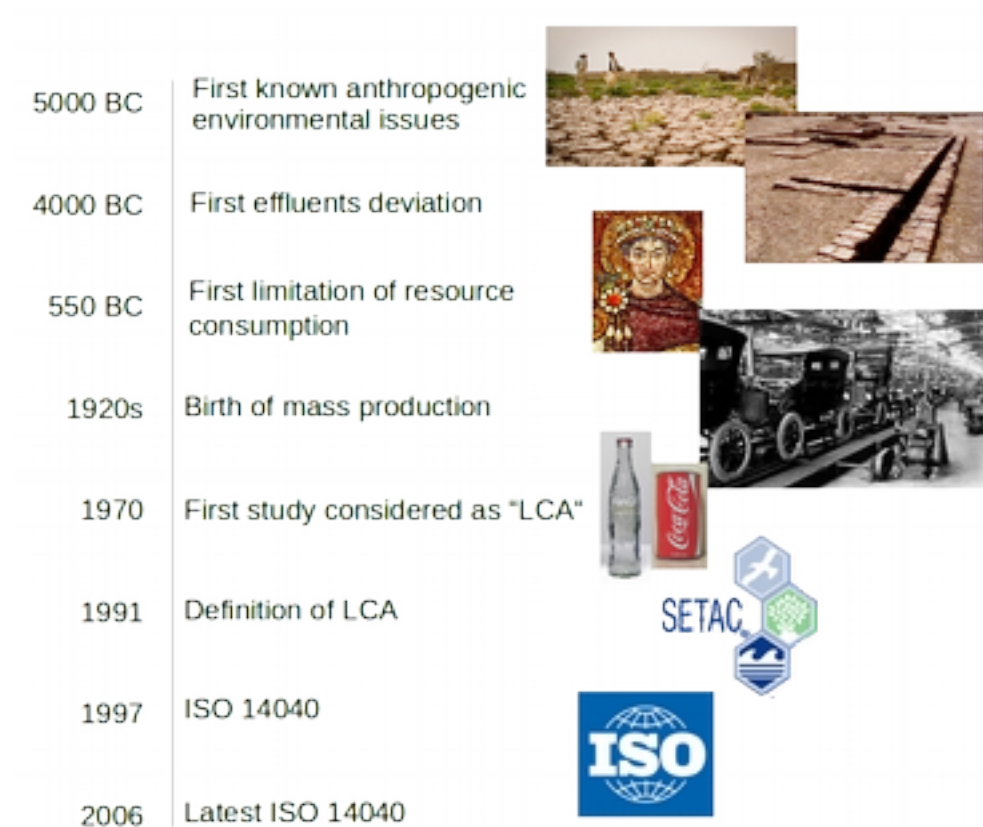

Figure 2: History of environmental issues and LCA

Today environmental protection is in close relation with industries. Either by legal limitations, by preferences of customers or by voluntary activities of industries themselves. (European Parliament, 2009a; Guinée *et al.*, 2011; Curran, 2015)

In this work we focus on the voluntary activities in industry, in particular on product design.

The concept is called Ecodesign – product design with respect of environmental issues. It builds on links between industry and ecology. One reason are clients who became sensitive to image of the brand, but there are much more reasons to reduce environmental impacts: costs of material and energies, progressive limitations and taxes on the most polluting energies, materials and technologies and of course motivation of employees.

Ecodesign requires investments of time for analyses, often supplementary work on redesign and changes of materials, new competences of employees. In most cases it is rewarded by growth of client's interest or economies on materials, energies or waste treatment. Study on 30

French and Canadian companies shows most cases of ecodesign use gives benefits back. (Plouffe *et al.*, 2011) Like quality management, which is often perceived by employees as an unnecessary break but in fact it is motor of productivity, ecodesign can be the motor of development.

Ecodesign helps to change the point of view and find solutions to reduce the environmental impacts. The basic tool to do so is Lifecycle Assessment: an analysis of a product's environmental impacts throughout its lifecycle. It is not the only tool of impact assessment, but most of them contain the principle of considering the whole lifecycle, which is helping to find new innovative solutions. In 2015 we had the opportunity to discover an excellent example of innovation through ecodesign in a small French company Sewosy: producer of electromagnetic locks. Their simplified LCA pointed on the biggest weak point of their product: electricity consumption. Thanks to their orientation to the consumption issues of their lock they found a smart solution to decrease the product's energy consumption by 70% and made the most efficient electromagnetic lock on the market.

Like previously other industrial concept: Product Lifecycle Management (PLM), LCA helps to put the product into the circumstances of the pre-production phases, use and end of life. Although in LCA the point of view is not based on economy and finances. It focuses on material and energy flows and product's lifecycle is regarded from the physical point of view: From extraction of raw materials to physical destruction, recycling or some way of return to the environment.

## **1.2 LCA methodology**

LCA is standardized by ISO 14040 (2006), defining the principles and framework (International Organization for Standardization, 2006b) and by ISO 14044 (2006), which precise requirements and guidelines. (International Organization for Standardization, 2006c)

*“LCA is an engineering tool in the sense that technical systems and potential changes in them are studied. At the same time, the tool is multi-disciplinary in the sense that also impacts on the natural environment and even people's relation to such impacts are modelled.”* The Hitch Hiker's guide to LCA (Baumann and Tillman, 2004) Our focus is mostly on the engineering

part of LCA, in particular on the product system modeling and on goals of LCA in the field of product design.

During the product design phase, LCA is used as a source of information. What is the weakest point of the intended product? Which technological solution is less polluting? Which material is less polluting? Which is the least harmful combination of transports? Or Is it relevant to reduce impacts of packaging in scale of the whole product lifecycle? Usually the study has to respond to a combination of more different questions and in the end it should give support for promotional communication.

For most of these purposes LCA is not alone in a larger family of tools. Besides LCA designers use simplified LCAs, eco-indicators, checklists, guidelines, environmental policies and lots of others. Each tool has different purpose, typical situation or exigence on resources. (Bovea and Pérez-Belis, 2012)

Yet the problem is its requirements. Bovea et al. considers that LCA is the longest and most sophisticated of the ecodesign tools. (Bovea and Pérez-Belis, 2012) Duration of LCA starts on one to two months for the easiest and quickest ones, overgrowing duration of simple product's design.

### **1.3 Orientation of the research**

Research in field of LCA stands at intersection between engineering and sciences of environmental protection. Being the most complete tool for environmental impact analysis, it stands at the top of the family of ecodesign tools. (Bovea and Pérez-Belis, 2012) The intersection of fields in case of LCA is coherent with the intersection of the two laboratories that participated on it. For the field of engineering it is Icube at University of Strasbourg, for environmental impacts it is Department of environmental chemistry at University of Chemistry and Technology, Prague (UCT Prague).

This research, realized as a double diploma, or cotutelle PhD program, is the link between this two laboratories:

### **Laboratory Icube, University of Strasbourg:**

Icube, The Engineering science, computer science and imaging laboratory, created in 2013, the laboratory brings together researchers of the University of Strasbourg, the CNRS (French National Center for Scientific Research), the ENGEES and the INSA of Strasbourg in the fields of engineering science and computer science, with imaging as the unifying theme.

With around 580 members, ICube is a major driving force for research in Strasbourg whose main areas of application are biomedical engineering and the sustainable development.

We are part of the work group CSIP under direction of professor Denis Cavallucci and associated professor Virginie Goepp. The main domains of research are:

- Inventive design
  - Standardization and optimization of inventive phases in product design
  - Development of inventive design approaches applied to complex systems
- Information and production systems
  - Technical information systems
  - Design of production systems

Our research in LCA stands in optimization of inventive phases in product design. The main strength of this position is the point of view “inventive design” on LCA, which puts us in the perspective of design efficiency in the industry.

### **Department of environmental chemistry, University of Chemical Technology, Prague:**

Department of Environmental Chemistry is part of the Faculty of Environmental Technology. Department aims to prepare experts on environmental protection for the industry, state administration, and business, with a particular emphasis to waste management and treatment.

The main research activities of the department include:

- Development of new soil remediation techniques and increasing efficiency of the techniques, which are currently in use. The research effort is mainly directed to soil flushing, soil vapour extraction, phytoremediation, membrane separation, in-situ chemical oxidation, thermal desorption and reactive barriers.
- Development of special instrumental techniques for soil analysis, such as for example analysis of volatile contaminants and analysis of polychlorinated biphenyls.
- Developments of terrestrial ecotoxicological tests (the tests, which can be performed directly on the soil samples).
- Assessment of environmental impacts, using the LCA methodology. Specialty of the research group are particular difficult cases in relation to chemical technologies, like choice of method for polychlorinated biphenyl decontamination or assessment of nuclear power plant.

We are part of the work group of ecotoxicology and environmental impact assessment under direction of associated professor Vladimír Kočí.

Strength of collaboration with Department of environmental chemistry is in their expertise in the LCA methodology use in difficult situations and in deep knowledge in mechanics of undesirable consequences of pollution that we call generally “environmental impacts”.

At the intersection of industry and LCA our interest is on use of LCA in the design process. Even if LCA is a powerful tool that has already proved its qualities, it is not yet a standard and one of the reasons is its length. For the sake of technological advance and efficient environmental protection we search for ways of improvement that would make LCA more accessible to the production industries. Therefore the question of the research is:

**How to make Lifecycle assessment faster and easier accessible  
for manufactured product design?**

*Figure 3* Shows the the approach from the question of the research through the main issue (detailed in the chapter: state of the art and research positioning) to the results of our research.



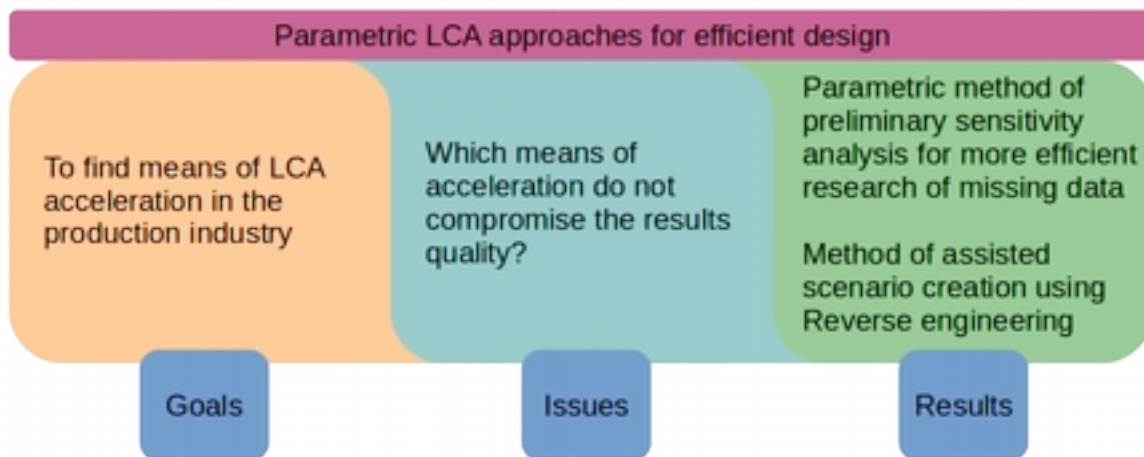

Figure 3: Schema of the the research orientation

In this work we target means to make use of LCA in the production industry easier. Expertize of the Icube work group help us in finding and applying methods that are helpful in product design. Department of environmental chemistry on the other hand, is helpful in confrontation with the LCA methodology.

## 2 STATE OF THE ART AND WORK POSITIONING

State of the art explain which are the main issues of LCA in the production industry, how we chose orientation of the research, which are the possible solutions and how they lead to our contributions.

Objectives of the chapter are treated in ten sections in following order:

2.1: Section justifies our choice of issues that slow down use of LCA in product design.

2.2: We divide the issues into two groups: resources and duration. Our focus lands on duration of LCA, so it explains choice of the target of our research: Being the longest part of LCA we focus on Lifecycle Inventory (LCI).

2.3: Section lists the unresolved issues of LCI, among which we find subjects of our contributions. We divide them into two groups – methodological and process issues.

2.4: Two concepts have potential to resolve the chosen issues: Simplifications and parametric approach. Both concepts help to accelerate the study and open new possibilities of use in product design, but we prefer parametric approach as more universal concept with less negative impact on results of LCA studies.

2.5: Section presents the concept of parametric approach. Parametric LCA does not have a clear and widely accepted definition. We have found 6 models, we use some of them in our contributions.

2.6: Presentation of all six models of parametric LCA

2.7: Section presents the Product category rules (PCR)-based platforms with focus on EPD<sup>®</sup> International and on the European PEF/OEF.

2.8: Section presents the research method we have applied: Case study

2.9: Section presents evolution of our research from the main question to conclusions.

2.10: Section introduces our contributions

## 2.1 Main issues of Lifecycle assessment (LCA) in production industry

Ecodesign and LCA are born in the industry in the 70's. Knowledge on product's environmental impacts is a powerful base for communication and improvement of the company's image, but also to decision making. (Guinée *et al.*, 2011; Curran, 2015) Today many industries report also other advantages of ecodesign, which LCA is part of. (Plouffe *et al.*, 2011) Outside the field of industry, LCA is often used to take or validate decisions in public sector, in construction or infrastructure projects.

LCA is an excellent tool not only to reduce the product's environmental impacts, but also to look at the product from the lifecycle perspective, which often leads to improvement of its qualities. Several studies show better use of the engineering methods when adding the lifecycle point of view into the product design. Some of them do consider LCA as the key factor of product design improvement. (Dombrowski, Schmidt and Schmidtchen, 2014; Bonou, Olsen and Hauschild, 2015; Laso *et al.*, 2016) But even though the methodology exists since more than 40 years, it is still not a standard procedure in the product design. (Ortiz, Castells and Sonnemann, 2009; Peças *et al.*, 2016) Concerning production industry, three key factors are playing the most important role in adopting LCA. Willingness to adopt ecodesign, time and resources, see *Figure 4*. Even though the length of LCA decreased to a matter of months, it is still a very long procedure from the point of view of industries: In the automotive industry, where a car design is a matter of 24 to 36 months, LCA represents 5 to 10 percent of the whole duration. (Jasiński, Meredith and Kirwan, 2016) Naturally LCA goes simultaneously with the car's design, but if the results are to be used in the car's design, the whole process becomes hard to organize. In case of simple products LCA can easily overgrow the whole product's design duration.

In term of resources the main issue is availability of experts. Tools for LCA modeling are today well developed, integrating specific features such as Life-Cycle costing, which can be a very useful contribution to the product design.

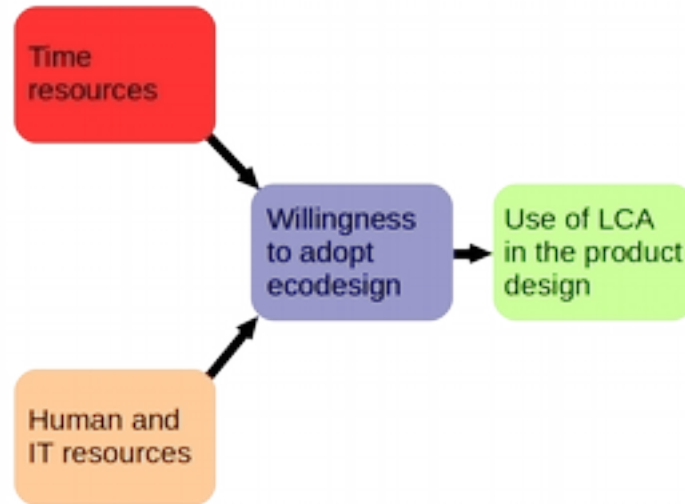

Figure 4: Main issues in adopting LCA

The most appropriate issue to focus on in this work is the question of time resources. The specific aim of this research is to develop engineering and mathematical methods to reduce the duration of LCA. *Figure 4*

In the research we want to keep in mind new approaches that gain popularity in the industry and have big impact on the practice of LCA. Research of communication harmonization gave birth to a platforms based on Product Category Rules (PCR). (European Commission, 2012; The International EPD®System, 2013) In many ways the PCRs simplified the practice, mainly thanks to availability of clear guidance, relevant to the studied product. And in the past years they boosted use of LCA in the industry. (Minkov *et al.*, 2015; Ibáñez-Forés *et al.*, 2016; Strazza *et al.*, 2016) On one hand in our improvements research we want respect their principles in order to preserve the positive trends and on the other hand we can build on the existing PCRs and results for development of our own approaches.

## 2.2 Orientation of research within the LCA methodology

LCA is iterative methodology composed of four basic phases in interaction. Each phase is important for the study and none can be underestimated without compromising the quality of the whole study.

The methodology is iterative, the previous phase is often influenced by the results of the following one. The general order is represented on *Figure 5*.

Purpose of the first stage: Goal and scope definition, is to characterize the studied product, purpose of the study, to whom the results are intended to be communicated and how is the study going to be performed. (International Organization for Standardization, 2006b) Choices of the main methodologies for Lifecycle inventory (LCI) and impact assessment are decided already in this stage. (Baumann and Tillman, 2004)

“Inventory analysis means to build a systems model according to the requirements of the goal and scope definition.” (The Hitch Hiker's guide to LCA (Baumann and Tillman, 2004)) LCI consists of three principal activities:

- Construction of the flow model
- Data collection
- Calculation of the resources procurement and emissions.

“Lifecycle Impact Assessment (LCIA) aims to describe, or at least to indicate, the aspects of environmental loads quantified in the inventory analysis.” (The Hitch Hiker's guide to LCA (Baumann and Tillman, 2004)). In this study we consider mostly the ready-made LCIA methodologies, which present an easy and quick way to deal with LCIA in the process of product design.

Every study is not only quantitative, but presents also several qualitative dimensions. Besides responses to the goal and scope definition it can be origin of the most important impacts or which is the relation between the impacts and the geographical location. Interpretation has to answer to all of them.

Goal and scope definition and interpretation are very individual and they depend on the purpose of the study, on the intended public and on the client. On the contrary, in case of a PCR-based platforms, like Environmental Product Declarations (EPD<sup>®</sup> International)<sup>1</sup> or the European Product Environmental Footprint (PEF)<sup>2</sup>, they are fully defined for particular product categories. The most of the potential of improvement lies theoretically in the LCI.

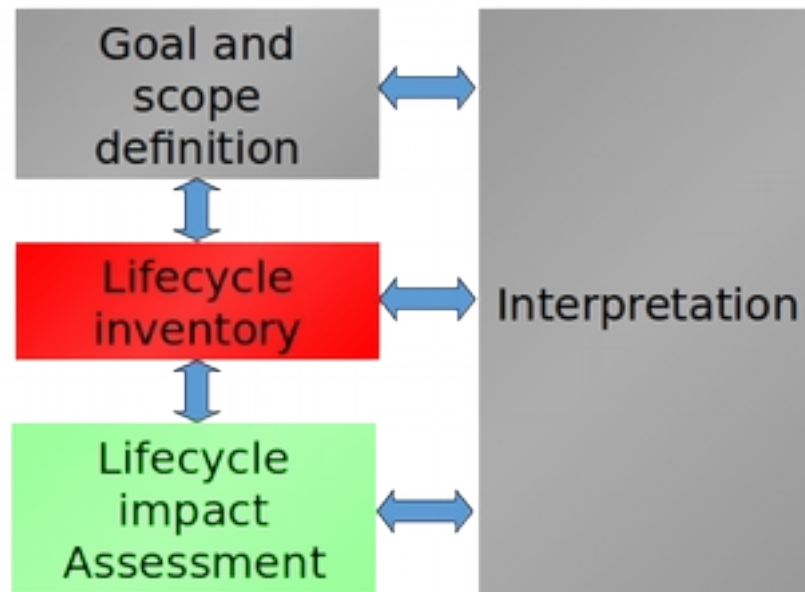

Figure 5: LCA methodology

### 2.3 Unresolved issues

In LCI we find methodological and process issues. *Figure 6* Into the **methodological issues** we classify the situation when choice of the right method or its use are not clear or when the existing methods does not satisfying results.

According to Reap et al. the unresolved methodological problems in LCI are allocation, negligible contribution and local technical uniqueness. (Reap *et al.*, 2008)

1 [www.environdec.com](http://www.environdec.com)

2 <http://ec.europa.eu/environment/eussd/smgp/index.htm>

We call **process issues** the time consuming activities, where the method is clear, but execution is complicated or simply long with potential of improvement.

Based on our first and second case studies (annex 1; chapter 3) we have identified following two process issues: research for unavailable data and modeling of the lifecycle scenario.

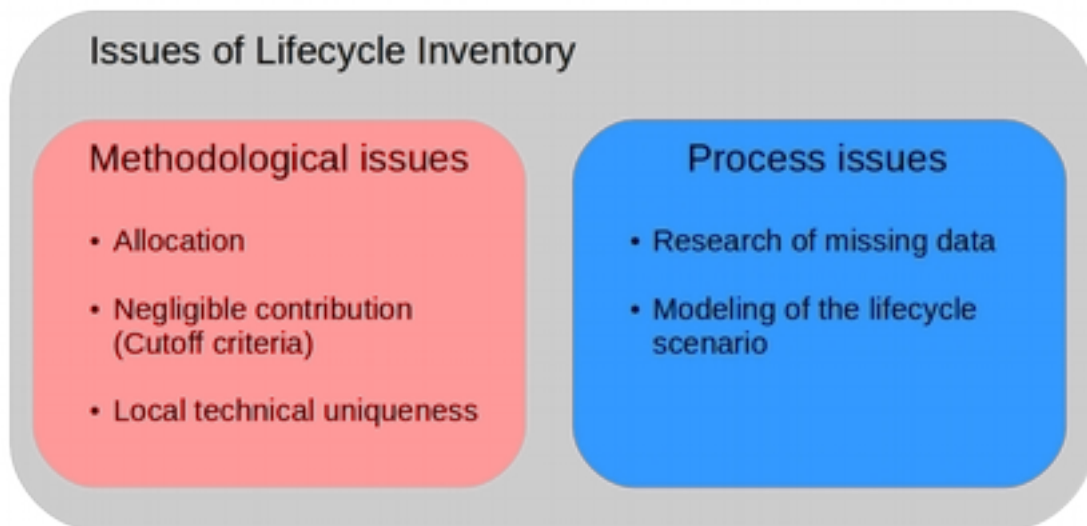

Figure 6: Unresolved issues of the Inventory analysis

### 2.3.1 Methodological issues

#### Allocation

Allocation consists of attribution of impacts or consumption to two or more processes. ISO 14044 states that if possible, allocation shall be avoided by dividing the process into sub-processes or by extending the product system boundaries, otherwise it shall be based on physical relationships. But it admits that in some cases even those may not be available and the allocation has to be done by other relationships.

The allocation problem is common and often even perceived controversial. (Rebitzer *et al.*, 2004; Russel, Ekvall and Baumann, 2005) Firstly, if it is not avoided, from some point of view it will always be wrong. And secondly, according to Baumann and Tillmann, in some cases, other than physical relationships may be more appropriate than the physical ones and

the analyst stays before the question whether he follows the norm or he does what is the best for the study. (Baumann and Tillman, 2004)

#### Negligible contribution (“cutoff” criteria)

Like in any other analyses, not all the physical flows are included in LCAs. In order to decide which ones are to be neglected and which shall be included, the norm allows specification of criteria for negligible contribution in the beginning of the study. (International Organization for Standardization, 2006b) Neglecting may cause two problems. Firstly some flows of little quantity may still have important impact and secondly even a negligible impact of a negligible flow can grow into a significant one in sum of all the neglected flows. (Baumann and Tillman, 2004; Reap *et al.*, 2008) On the other hand, lifecycle models are often polluted with processes and flows that fall into the system's boundaries, but which are of no significance. This problem does not have any direct impact on the results quality, but work on insignificant flows consumes time and resources that one could spend on work on the significant ones.

#### Local technical uniqueness

Every process, flow or impact has some local specificities, whether the spatial, temporal, political, technical or other dimension is considered. But the product system modeling is mainly based on average data or theoretical description of processes, which may differ from the practices in the industry. Like in any other case of simplification, neglecting of local uniqueness has negative impact on the results quality. Finnveden *et al.* shows that differences between regions, companies or even production lines may lead to order of magnitude differences in emissions. (Finnveden, 2000)

We can show example of a snow-melting airport pavement study. (Shen, 2015) As a main power source for the heating they use electricity. In this case, electric energy consumption happens to be also the main consumer and main source of pollution. Authors provide very good model of the local energy sources, they go much further than to the national average, yet they have no choice but use of average fuel consumption of modeled power plants. And this is the problem: The purpose of the pavement heating is to melt snow, so most of the electric



energy consumption is going on winter. But the grid mix is not the same during the summer or during the winter. Composition of power grid mix vary in function of geographic location, season, hour, weather and the lifecycle model should respect these variations. (Ke *et al.*, 2016) Unfortunately precise data are usually not available.

### 2.3.2 Process issues

#### Research of missing data

Gathering the missing data is the longest part of LCA. (Baumann and Tillman, 2004) For use in the industry, the situation is getting better with growing databases and growing number of EPDs. And even if the EPD's completeness is lower than is usual in the scientific databases (Lasvaux *et al.*, 2014), they represent a precious data source and advanced basis for the data research.

There are three mayor problems in the data research. Willingness to give information, work organization and interference between more and less important flows.

The first one is mostly in relationship with the local technical uniqueness problem. On one side there is the analyst who should trace the source of all used materials and energies in the modeled product system, on the other one there are suppliers for whom the identity of their material supplier is often perceived as sensible information from the point of view of industrial purchases. In such cases the analyst has to rely on less relevant data.

Issue of work organization is individual for each study. In classical LCA the analyst may model the product system and than manage to find all the missing information. Some simplified LCAs guide the analyst step by step through the lifecycle scenario, (*See annex 1*) which is a comprehensible way, but it makes one return several times to the same process, as the methods are adapted for the study of impacts, not to the particular studied technologies. (Beccali *et al.*, 2016)

The last problem is in relation to the negligible contribution methodological problem. The analyst shall use the best available data, which when possible, is often a very long process. But the data has not all the same importance. Some of them may have only minimal influence to the results of the study, some of them might not be relevant to the goals of the study.

Analyst risks spending his limited time and resources on unimportant processes, while the important ones get less attention.

### Modeling of the lifecycle scenario

Construction of the flow model has two sides. One is translation of methodology into the flow model, the second one is mechanical activity of creating, choosing, placing and connecting the processes and defining parameters. More problematic is the first one, because there are often more ways to represent reality in the model and each may give different results or have influence on further work with the model. For example if transport of two products to the same client should be modeled as one transport with sum of their weight or twice the same type of transport. *Figure 7* In reality the two ways are different, but for instance processes of truck transport in the ELCD database are defined using allocation by weight with filling rate of the truck as an independent parameter. It means that using ELCD database, one way or another gives the same results.

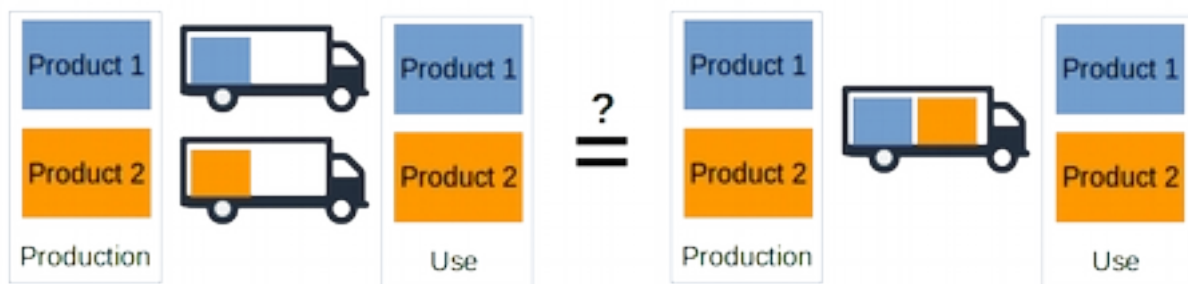

*Figure 7: Example of modeling issue*

## 2.4 Existing solutions

When searching for solutions to decrease duration of the LCA studies, we find three ways. Simplifications, parametric approach and standing apart: PCR-oriented platforms. See *Figure 8* We put the PCR-oriented platforms apart, because their initial purpose is not making LCA

shorter. They have been invented to allow results comparability and time-saving is only their positive side effect.

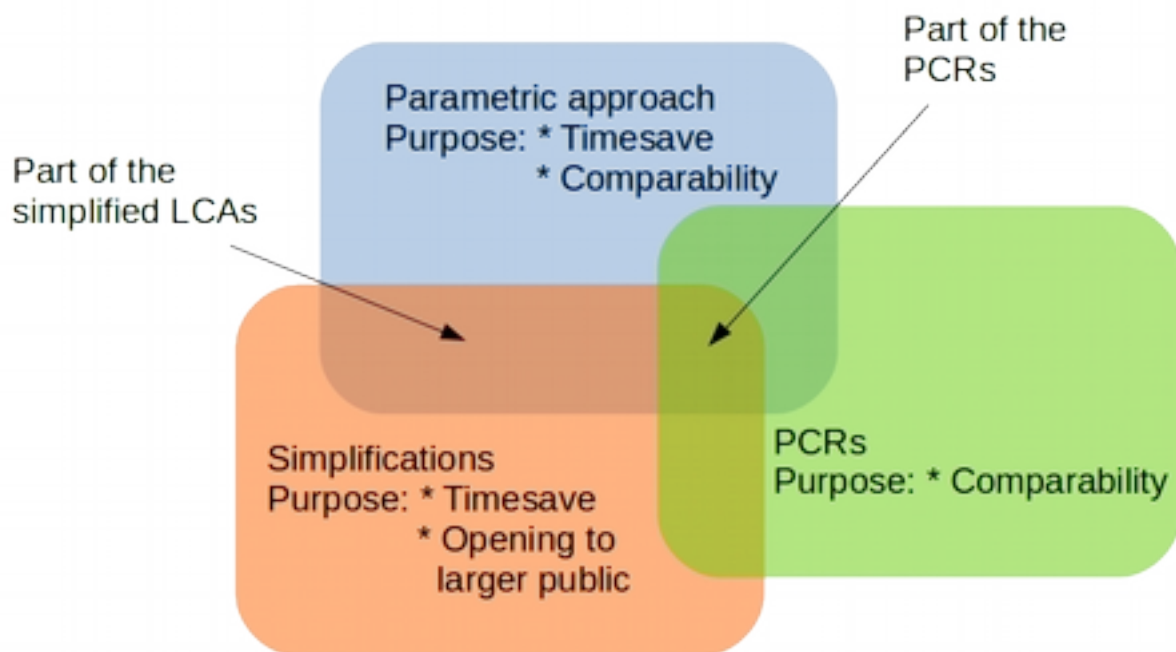

Figure 8: Positioning of three solutions of long duration of LCA

An intuitive first way of methodology acceleration is simplification. In LCA we can find many cases of simplification, whether we are speaking of simplified LCA or about simplifications concerning the general methodology. (See annex 1) In some cases if they are well prepared and relevant to the studied product, they can be very useful and help to focus on the most important issues, neglecting the least relevant parts of the product's lifecycle. (Kellenberger and Althaus, 2009; Soust-Verdaguer, Llatas and García-Martínez, 2016)

But on the other hand simplifications bring several disadvantages.

Firstly general simplifications cause important deterioration to the results quality, so they have to be product-specific. (Bereketli Zafeirakopoulos and Erol Genevois, 2015)

Secondly it is some degradation of results quality even if the simplifications are individual. (Lasvaux *et al.*, 2014) If simplifications goes too far, they can even reverse the whole results. A recent simplified LCA of a passenger car shows sustainability (based on the CO<sub>2</sub> emissions) nearly constant over the last 20 years (Danilecki, Mrozik and Smurawski, 2017), while more

complete studies show clear improvement of the newer models (Spielmann and Althaus, 2007; Volkswagen AG, 2010; Bauer *et al.*, 2015). The obtained results in the four studies are not contradictory. Only the simplified study concentrates on global warming and forgets other important impacts.

And finally the simplified methods for non-experts increase risk of misinterpretation.

Second way is the parametric approach. Besides part of particular cases, parametrization is a systematic approach. This is the biggest change in comparison with simplifications. Most often parametrization is a way of efficient modeling with possibility to preserve processes and modules for further use. The term parametric LCA is not defined in norms and in this work it is described in chapter 2.5 *Parametric LCA* and 2.6 *Parametric LCA models presentation*.

In recent years a different way of simplification brought new dimension in form of Product Category Rules (PCR) according to ISO 14025. (The International EPD®System, 2013) Besides the comparability issues, each PCR works also as a simple guide to LCA of a precise type or category of products. Simplification in this case is in the methodological issues – giving the analyst direct guidelines instead of making him choose the right method. The new European methodology PEF/OEF goes even further. In the first place it brings a simplified methodology, which is more rigid than ISO 14040 (European Commission, 2012) and combines it with PCRs for different types of products. The PCR-based platforms are more closely described in chapter 2.7.

## **2.5 Parametric LCA**

One of the solutions to LCA's complexity and duration is parametric approach. Its base is in defining processes as parametric modules, that can be easily saved and reused.

ISO 14040 nor ISO 14044 does not define or mention parametric LCA or parametric model. (Baumann and Tillman, 2004; International Organization for Standardization, 2006b; Kočí, 2009) By definition a parametric model is any model based on fixed set of parameters. (Jazar and Dai, 2014) In fact we could call any LCA that is modeled in one of the available LCA softwares a parametric LCA. But in a common use the term “Parametric LCA” is more specific.

In his work on integration of LCA into product design, Nicholas Borland introduces the term “parametric model” in the mathematical way. (Borland, 1998) It means a larger term for any model which is only dependent on a fixed set of parameters, which is compatible with any lifecycle model realized in today's LCA software. Parametric LCA is perceived in the same way by Martínez-Rocamora et al. (Martínez-Rocamora, Solís-Guzmán and Marrero, 2016) In other works the term is mostly attributed to a stable models which are not modified by the user. The user can change only a reduced number of free parameters. (Borland and Wallace, 1999; Sousa and Wallace, 2006; Paraskevas *et al.*, 2015)

Azari et al and Hollberg apply the term in a more specific situation - for a parametric analysis within LCA, when searching for an optimal technical solution. (Azari, 2014; Hollberg, 2014; Azari *et al.*, 2016; Hollberg and Ruth, 2016)

Dalara et al present Parametric LCA as a preset model with several free parameters, but also with possibility to change several processes. This model contains also impact assessment. (Dallara, Kusnitz and Bradley, 2013)

Cluzel et al remain between the last two, using parametrization as a tool of simplification of LCA and as a tool for research of an optimal solution. (Cluzel *et al.*, 2011)

In the work of Fantin et al. parametrization allows comparison of results from existing LCAs. (Fantin *et al.*, 2014)

## 2.6 Parametric LCA models presentation

In the gathered works using parametrization in the LCA we can find six different models that are corresponding to six goals for which parametrization is actually used.

**1<sup>st</sup> model:** The principle of the first model is to define processes as parametric modules. These modules can be saved and reused in further studies. *Figure 9*, (Borland, 1998) Borland uses it in a concept of collaborative approach, targeting quick growth of knowledge basis of material, products and industrial processes. Slightly different variation of this concept came to life with

ISO 14025 in the EPD® International system. The difference is, that EPDs are not based on the parametric approach. But they do gather information on environmental impacts from a large number of industries and the base is growing.

This model is the oldest and most universal in parametric approach, all the other parametric models are based on it.

Besides specific models of parametric LCA it is used in every LCA software. For them, parametrization is the way how to make computer assisted LCA even possible. For users it presents a facility allowing to save previously modeled processes and scenarios, modify and reuse them in further studies.

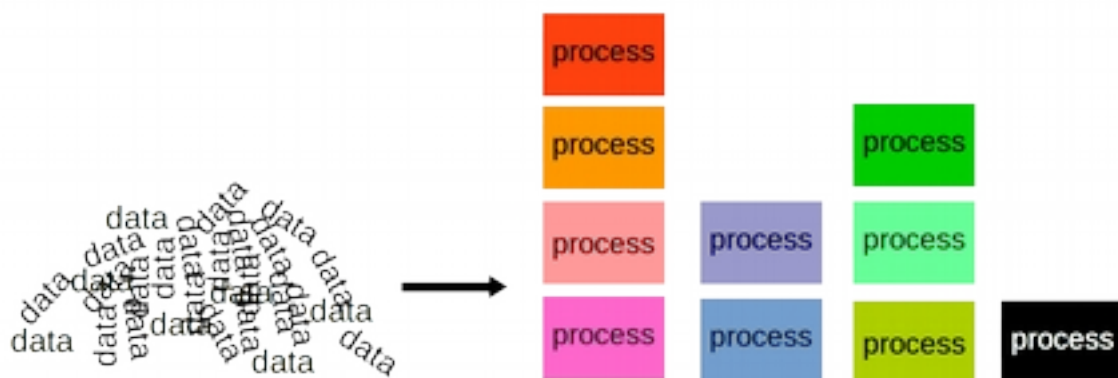
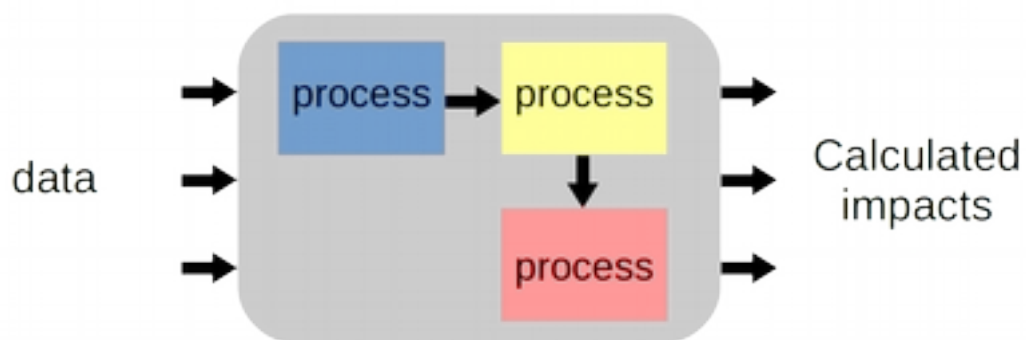

Figure 9: First model of parametric LCA – Process modularity

**2<sup>nd</sup> model:** The second model is a rigid scenario, assessing impact within a limited group of products. *Figure 10* It is the basic type of simplification. Even though the product system may be composed of several processes, the links between them are permanent and it becomes finally a single parametric process, depending on input data, defined by user. The process itself is not to be changed. (Dallara, Kusnitz and Bradley, 2013; Bonamente *et al.*, 2014; Hollberg, 2014; Danilecki, Mrozik and Smurawski, 2017) The difference between studied products is made on the level of material and energy inputs and comparison is based on quantitative results.

This kind of models can be easily integrated into programs or websites and it does not allow any changes. It is usually made for non-expert users and its objective is to compare two or more products or solutions.

This model has often other use than simplified LCA, it typically takes form of educational games. One example was published by the French public society of environment and energy ADEME. (ADEME, 2010) In the game player is supposed to organize development of a fictive town or quarter in function on qualitative and quantitative environmental, as well as social and economical impacts. Even though the game is fictive, environmental assessment has a realistic base in a simple parametric model with several free input parameters. The impacts are displayed in real time in categories of waste production and carbon footprint. The advantage of a rigid scenario is assured comparability without any compromise and it can be useful for repetitive comparisons concerning variable conditions in one particular product or activity, like transport.



*Figure 10: Second model of parametric LCA – rigid scenario*

**3<sup>rd</sup> model:** The third model has a rigid concept of lifecycle, but it allows some changes of processes. *Figure 11* This makes it more universal than the 2<sup>nd</sup> model. Main principle and advantage of this model is in modularity. The system contains a fixed number of processes, which may be assembled in the product system. But they have always the same place in the lifecycle scenario. This combination allows comparisons of a larger number of products, but preserve user friendly simplicity and possibility of automation. (Sousa, Wallace and

Eisenhard, 2000; Sousa and Wallace, 2006) This model offers the possibility of integrating simplified LCA into the computer assisted design (CAD) programs, like in Solidworks since 2012.

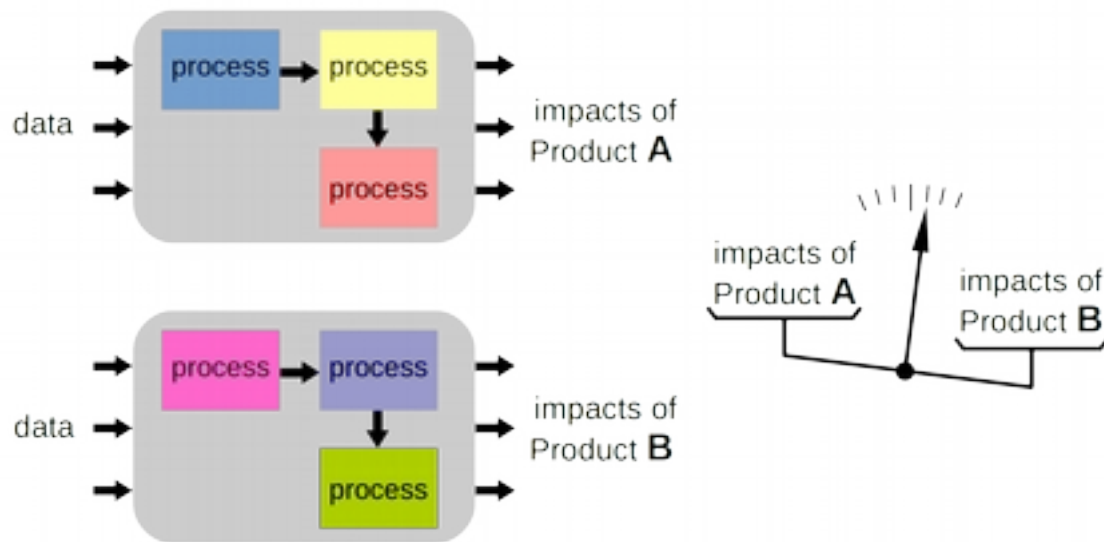

Figure 11: Third model of parametric LCA - Exchangeable processes

Rigidity of the scenario concept is often limiting factor for use in more impact categories. The tool called “BE”, introduced by the society EcoEmballages, helps engineers to design packagings. User has liberty of choice of material, transports and recycling ratio, but the processes are always assembled in the same way, convenient for packaging.

**4<sup>th</sup> model:** The fourth model goes further in variability, as it allows even changes to the concept of the lifecycle scenario. *Figure 12* This is possible through additional limitations related to the category of the studied product.

Objective of this model is still comparability. The study still has to be of the same type – accounting (Baumann and Tillman, 2004). Compared products has to have the same functional unit and reference flow, well defined boundaries and type of allocation, if it is to be used. Some cases homogenize the data sources, some have only recommendations. (Borland and Wallace, 1999; Niero *et al.*, 2014; Martínez-Rocamora, Solís-Guzmán and Marrero, 2016)



Practice of this model is close to EPDs and PEFs. But in this model we don't mean the platform, only the concept of product category rules. The analyst has a lot limitations, but has still the liberty of scenario construction, which can be important for radical changes in the product design.

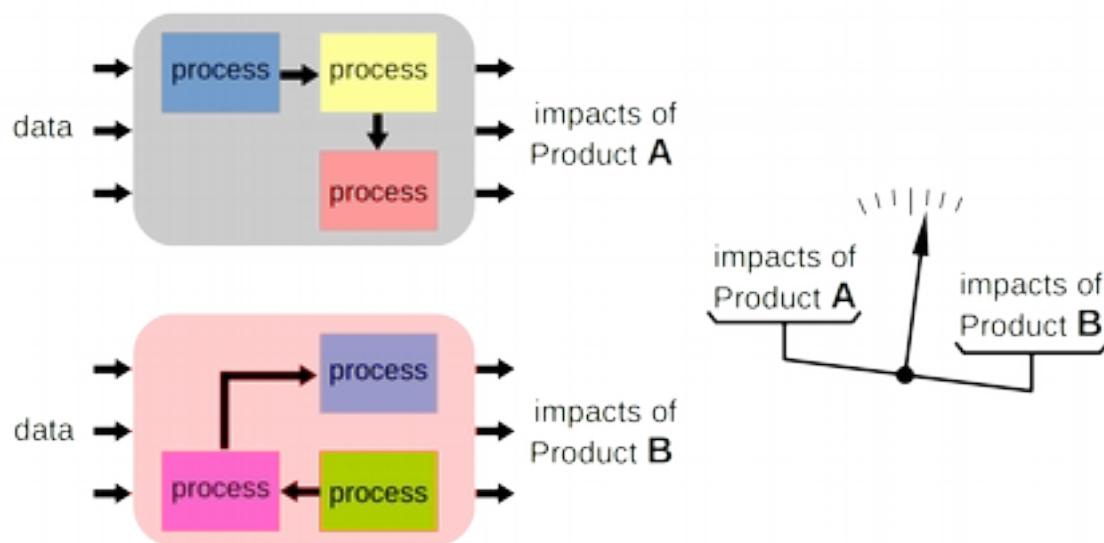
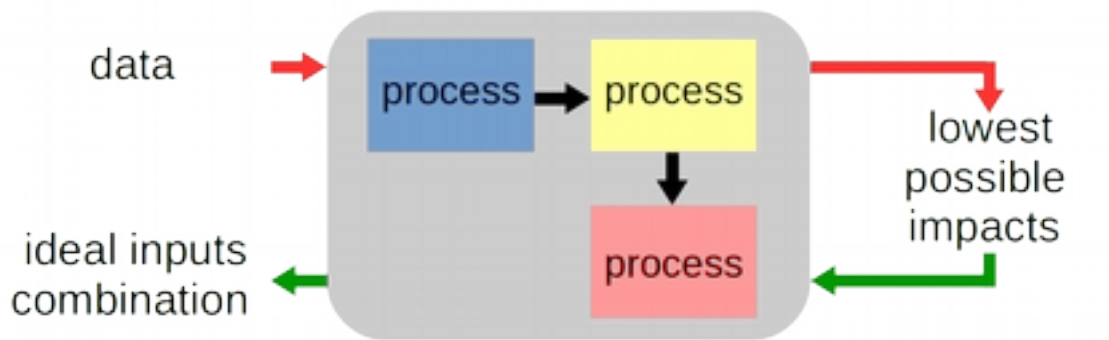

Figure 12: Fourth model of parametric LCA - limited "liberty" of scenario design

**5<sup>th</sup> model:** The fifth model has a rigid scenario just like the second one, but it has different purpose. Its goal is to calculate the ideal combination of input data, leading to the smallest possible environmental impacts. *Figure 13*

In ecodesign the three previous models help to pick the best one of the compared solutions. The 5<sup>th</sup> model's objective is to optimize a particular technical solution. Their common point is that they do not allow changes to the lifecycle scenario. Besides introduction a new technology, this model is interesting for repetitive dimensioning of the same product or service. (Paraskevas *et al.*, 2015; Azari *et al.*, 2016; Posada *et al.*, 2016)



*Figure 13: Fifth model of parametric LCA - Rigid scenario, research of ideal parameter combination*

**6<sup>th</sup> model:** The last model is a combination of numbers 4 and 5. *Figure 14* Its objective is research of the least polluting combination of inputs, but it does not imply a rigid lifecycle model.

Unlike the 2<sup>nd</sup>, 3<sup>rd</sup> and 4<sup>th</sup> models, which are made to simplify the analyst's work, the 6<sup>th</sup> model combines completeness of LCA with the possibility of quantitative research of the best possible design. Practice of this model is long and complicated, which is suitable for big projects, rather than design of a simple product. (Cluzel *et al.*, 2011)

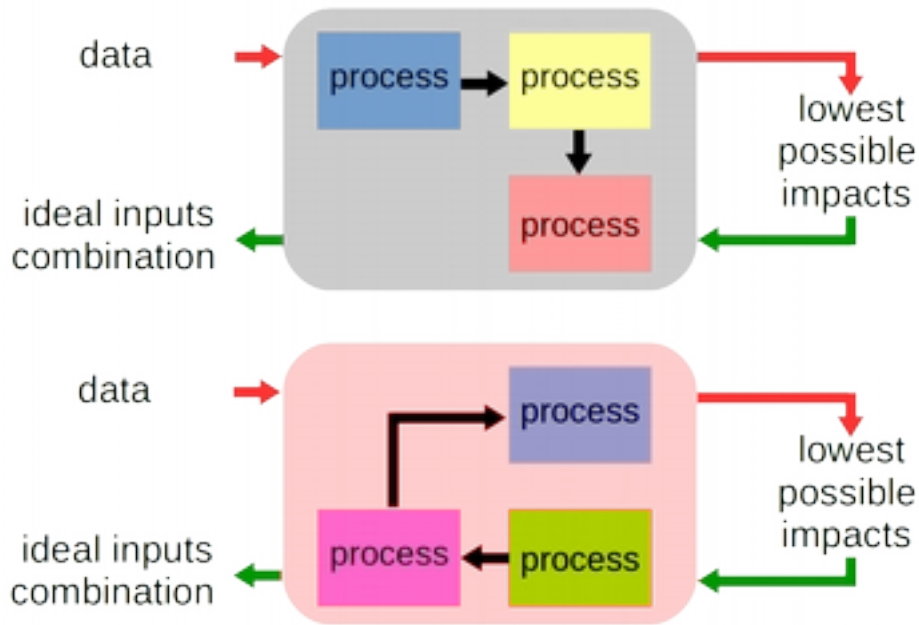

*Figure 14: Sixth model of parametric LCA - Variable scenario, research of ideal parameter combination*

**Conclusion:** In all the cases parametric approach is used to create a reusable model of a product's lifecycle. Either to repeat in for design of other products in models 2, 3 and 4, or to recalculate the impacts of one product in order to find ideal combination of the product's parameters. See the division of parametric models on *Figure 15*. The parametric approach is defined in the first model and today it is used in most LCAs. Than the models exploit the possibility of results comparison either to compare two solutions, either to find an ideal combination of the free parameters.

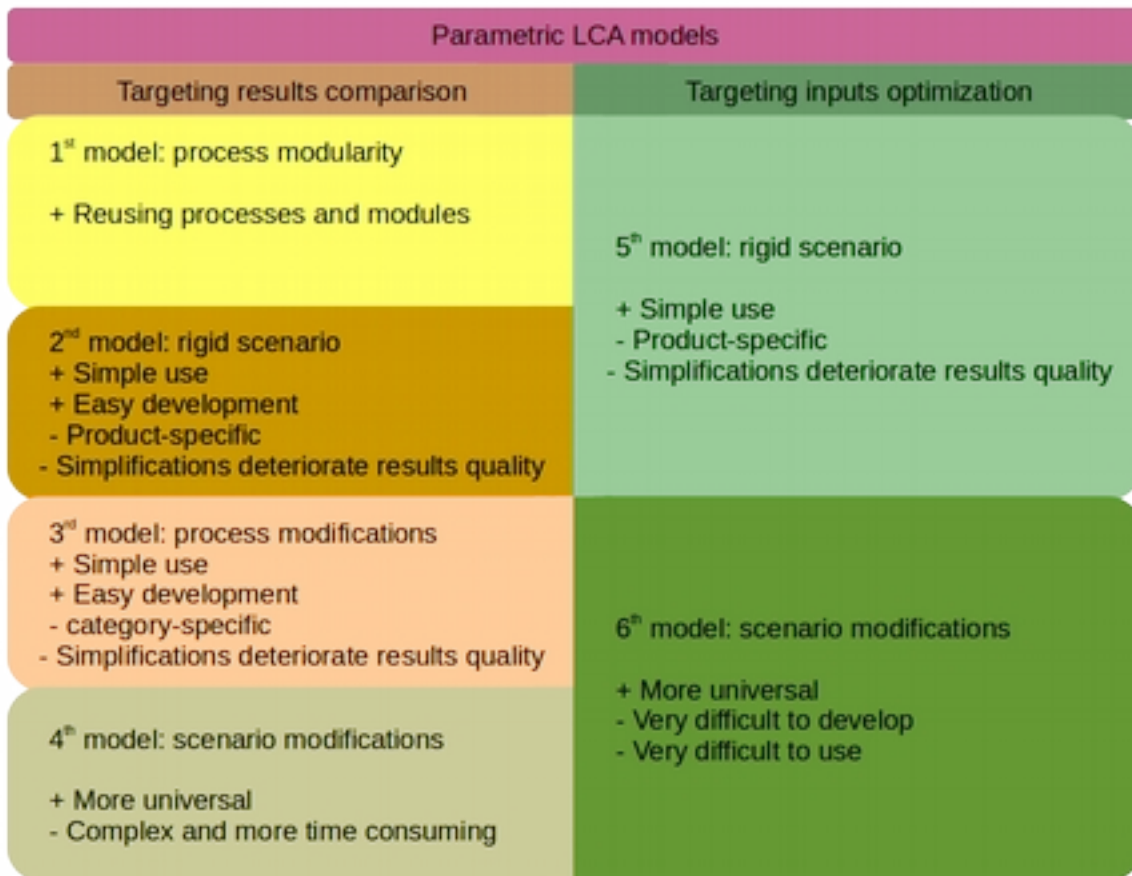

Figure 15: Six parametric models with their advantages and inconvenients

There are differences between intended audience, which influence the design of the methods. Models 2 and 3 are intended for non-experts. Users are not meant to modify the lifecycle, only in the third model they are allowed to exchange a part of processes. This approach require many simplifications. We can see the same in most cases of the simplified or streamlined LCA (SLCA). (Todd and Curan, 1999) But not all the SLCA are parametric. Very often the simplification aims in some way automation, for which parametrization is unavoidable. An excellent example of parametric simplified LCA is French ADEME's tool Bilan Produit, which guides the user step by step through the product's lifecycle and adjusts processes in a rigid scenario. In the end the user is only confronted to the quantitative results. The same concept, but one step further was presented by Dassault Systems in their tool Solidworks Sustainability, which constructs a simplified lifecycle model directly from the CAD modeling. The approach is called "Screening-Level Life Cycle Assessment". These

approaches are oriented on effectiveness. Their inconvenient is in a rigid lifecycle scenario, which does not always correspond to the engineer or company's needs. Also simplifications may lead to deterioration of the result's quality. (Lasvaux *et al.*, 2014)

Models 1, 4, and 6 are different. They target users with good knowledge of practices in LCA and environmental impacts. Therefore they may preserve “liberty” of lifecycle construction and be open to larger number of products. These models are time consumer, but they do not suffer of disadvantages introduced by simplifications.

## 2.7 PCR-based platforms

When searching means to accelerate LCA and integrate it deeper in the production industry, we can not fail to mention the PCR-based platforms. Raised from the idea of collaborative LCA databases, they were defined by ISO 14025 in 2006. (International Organization for Standardization, 2006a)

The concept did not rise to accelerate LCA. That is only its side effect. The target of PCR-based platforms is comparability. For the sake of comparability the platform gather product-specific Product Category Rules (PCRs), which define functional unit, scope of the study, typical scenario, mandatory impact categories, etc. so the results of two products made by two different institutions could be comparable.

Now we have one big and still quickly growing PCR-based platform: The EPD<sup>®</sup> International, and one concurrent for the markets of European Union: The Product Environmental Footprint (PEF) and Organization Environmental Footprint (OEF). These are currently being launched by the European Commission. (European Commission, 2012; Minkov *et al.*, 2015) The difference between these two platform is, that EPDs are based on ISO standards and PEF/OEF are based on independent methodology. While EPD communicate only through complete documents, PEF/OEF are intended to provide quantitative comparisons within the product categories. This comes also with differences between the intended public. While EPDs are for industrials and experts, PEFs shall provide information for customers.

As a side effect of comparability, these platforms come with simplifications, acceleration and boost of integration of the methodology in the industries. As the PCRs impose most of the

methodological choices, they simplify the work for the analysts. Suddenly their work is streamlined and much faster. But still they keep sufficient requirements to preserve quality of the studies.

## 2.8 Research method

As described in introduction, the objective of this research is to find means to make LCA easier accessible for the production industry.

LCA modeling is a complicated process, influenced by real circumstances as well as methodological choices. For research method we chose the Case study, as it is defined by Robert K. Yin in term of studying existing phenomenons and their real context. (Yin, 2008) Next to the Case study we took literature survey, see *Figure 16*.

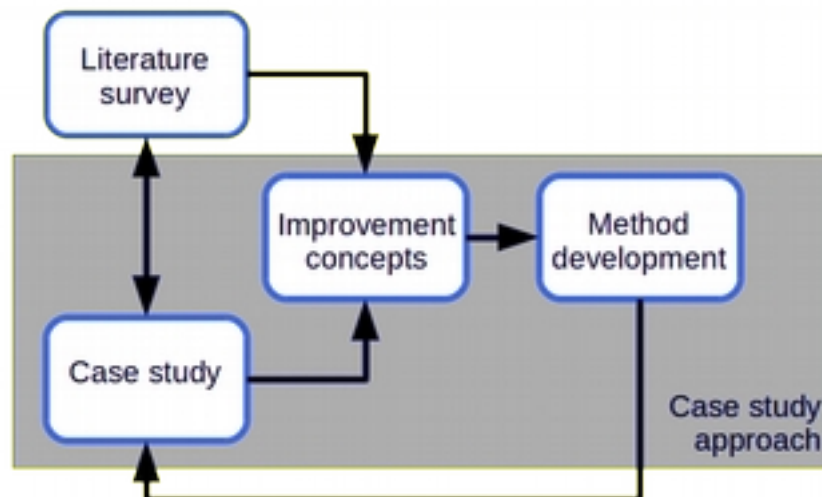

*Figure 16: Case study approach*

We have used exploratory case study to find or confirm methodological issues and testing case study to verify use of proposed methods. The first one is a case simplified LCA of

threads, we have realized with an innovative startup. (*See annex 1*) In the case study we have used the second parametric model, inspired by a PCR from the EPD International® system. (The International EPD®System, 2013) However, the method led to potential misinterpretation and transfer of impacts in case of extrapolation of the thread's results on a final product.

The study helped us to treat the issue of unavailable data in the beginning of the LCI phase. Consequently to this first case we have developed the method of preliminary sensitivity analysis, which we could experiment in the study of High Impact Polypropylene. From the preliminary sensitivity analysis point of view it was a testing case study.

The last contribution: Factorization of workflows, was realized in our laboratory in form of internship of two master's degree students – Ahmed Werfali and Neuman Elouariaghli. In the limited schedule of the internship we chose to use an existing model for the testing case study. The case of recycled concrete is an adaptation of the recycled concrete lifecycle schema we can find in the Ecoinvent 2 database.

## **2.9 Work positioning**

We are addressing slow growth of LCA use in production industry with the question: How to make Lifecycle assessment (LCA) faster and easier accessible for product design?

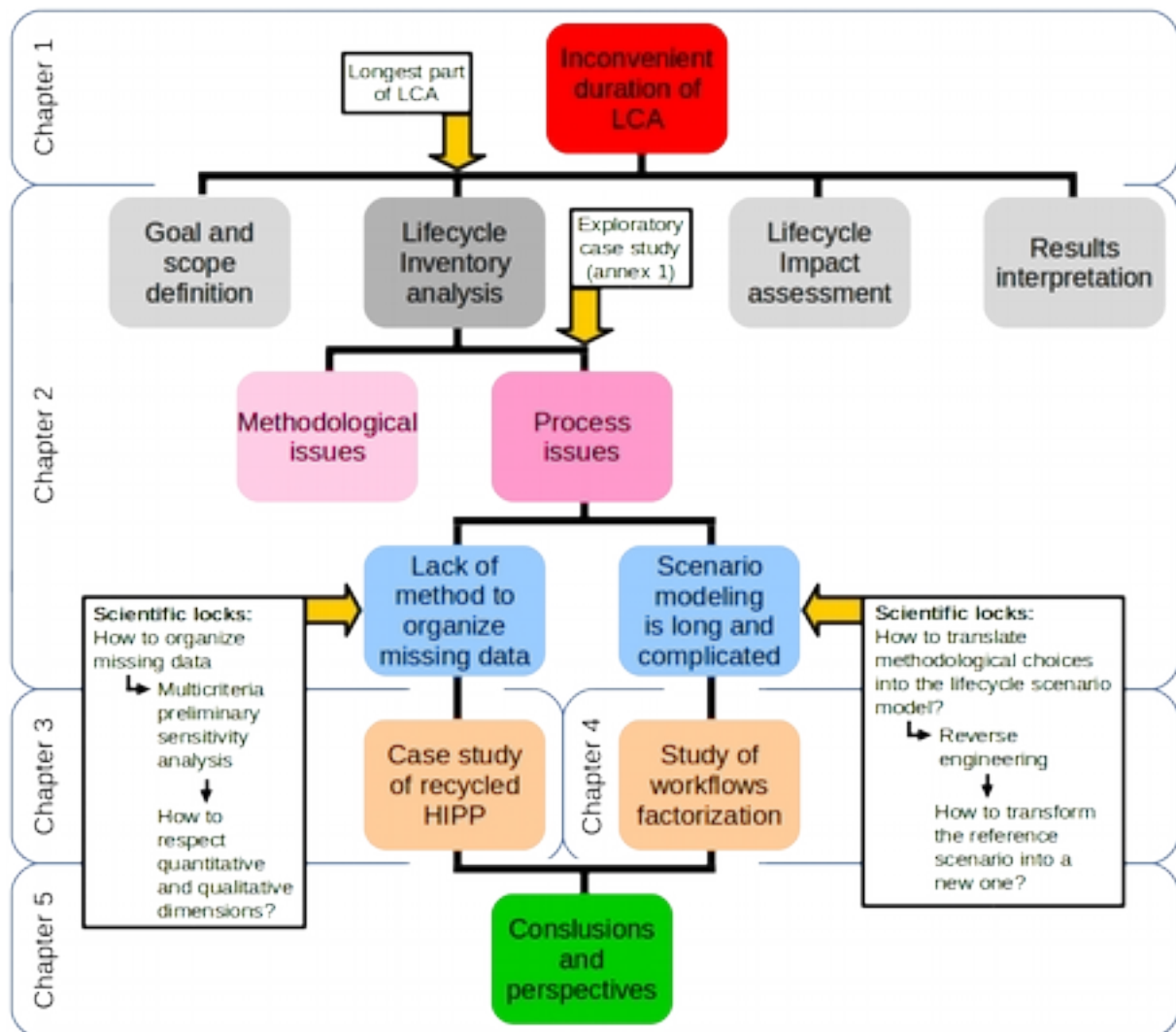

Figure 17: Organization of the research: The first two chapters start with introduction and choice of orientation the issue of long duration of LCA. In the second chapter, aside the present situation in the field we proceed to focus on organization of missing data and lifecycle modeling. Chapters 3 and 4 describe the work in the two fields and chapter 5 summarize conclusions and perspectives of the research we have done.

Figure 17 Shows evolution of the research from the main question through identification of precise scientific locks to their solution and conclusions.

From the main question of the research we pass to the longest part of LCA, in which we could find issues to improve. We could find five unresolved issues of LCI, two of them came out of our first exploratory case study.



The issues are: “Unorganized missing data at the beginning of the study” and “long, complicated and repetitive scenario modeling”.

For the missing data the scientific locks are: “How to organize data which are unknown?” and when we find out how to do that, “How to deal with both, quantitative and qualitative dimensions of the missing data?”

For the scenario modeling the scientific lock is given by the bare issue: “How to translate the methodological choices into the scenario?” We found solution in reverse engineering: inspiration by existing reference scenario. That opened a technical lock: “How to translate the reference scenario onto a new one?”

## 2.10 Contributions

Our contributions deal with the issues listed on *Figure 17* and *Figure 18*. They both respond to the main question of the research by giving means to accelerate the LCI phase. Besides difference in the methodological aspects they are both oriented on long and repetitive work with input data. Preliminary sensitivity analysis helps to organize the ones that are missing and the method of workflows factorization helps to assemble them easier into the right lifecycle scenario.

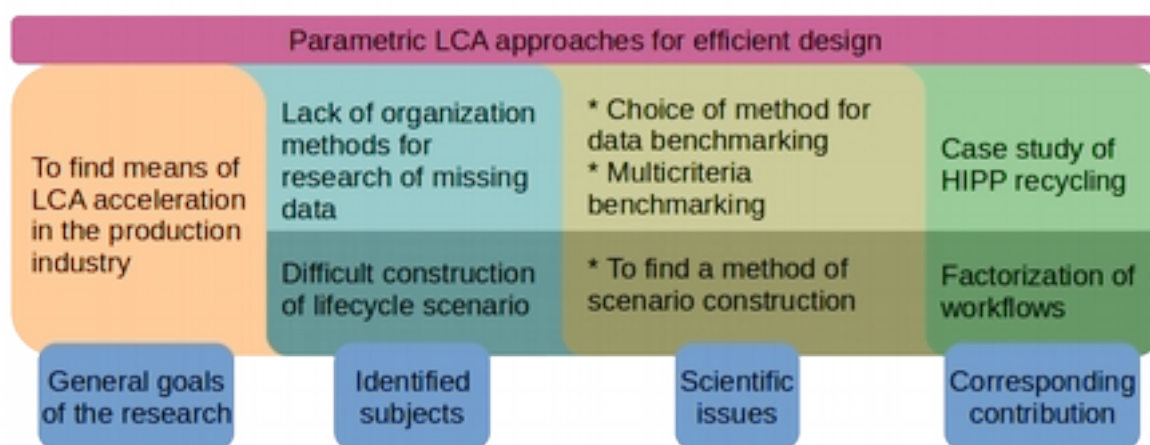

Figure 18: Schema of the scientific approach

The first contribution, preliminary sensitivity analysis, deals with the issue of missing data by classing them according to their impact on the quantitative results and according to their relevance to goals of the study. The quantitative part combines the first and sixth parametric models.

We have used this approach in a case study of High Impact Polypropylene (HIPP) recycling. The study is taken from environmental as well as mechanical point of view and it targets use of HIPP in the automotive industry.

In relation to classification of missing data the case study helped us to improve the qualitative approach. Classification of missing data proved itself useful with potential to improve efficiency of the time and resources use during the LCI phase. With the missing data classified, we can use more time for the most important data and rationalize on time for the least important of them.

The second contribution deals with the lifecycle scenario construction. We are building on the first parametric model and Reverse engineering (Eilam, 2005) to build a method to help analysts with rebuilding a scenario based on an existing LCA.

We have tested the method on a case of concrete recycling. Time save in this case is compromised by research of appropriate reference LCA and by preparatory stage of the method.

On the other hand this method may become useful if used with a PCR-based platform like EPD<sup>®</sup> International or PEF.

### 3 CONTRIBUTION: HIGH IMPACT POLYPROPYLENE (HIPP) RECYCLING – Mechanical resistance and Lifecycle Assessment (LCA) case study with improved efficiency by preliminary sensitivity analysis<sup>3</sup>

This contribution joins together two works. One is study of the recycled HIPP behavior, the other is testing case study for the preliminary sensitivity analysis.

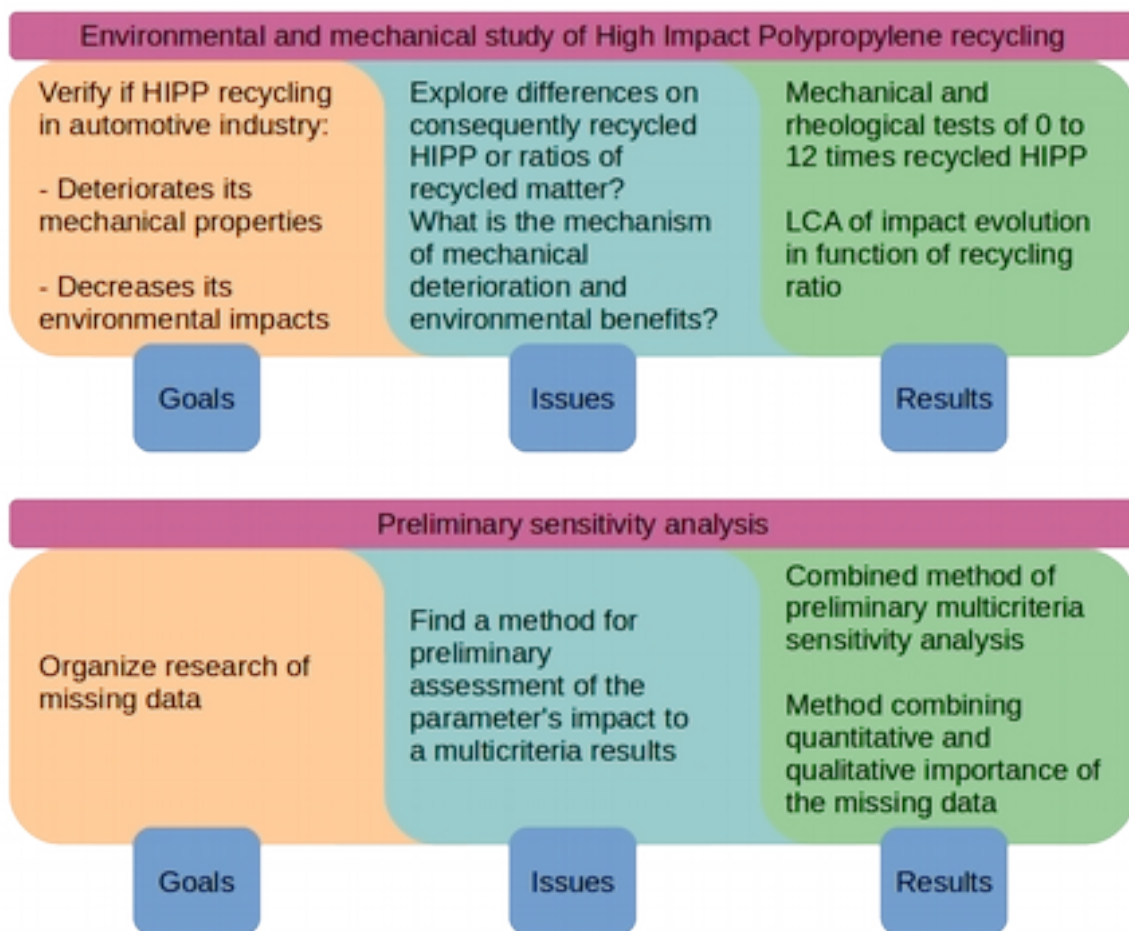

Figure 19: Purpose and contributions of the HIPP recycling case study

<sup>3</sup> The study made object of publication: Kozderka, M.; Rose, B.; Kočí, V.; Caillaud, E.; Bahlouli, N.; High impact polypropylene (HIPP) recycling – Mechanical resistance and Lifecycle Assessment (LCA) case study with improved efficiency by preliminary sensitivity analysis; Journal of Cleaner Production; Volume 137; 20 november 2016; pages 1004–1017

**The study of recycled HIPP behavior** is a response to a need of knowledge on recycled HIPP in the automotive industry. European norms are forcing on one hand to improve fuel efficiency, which is partly done by lightweighting of new cars by increasing use of plastics, on the other hand they rise the requirements of recycled contents of new vehicles. (European Parliament, 2005)

The main study has two dimensions. Firstly mechanical and rheological properties deterioration due to recycling, secondly environmental impacts of recycling.

Mechanical and rheological properties were studied within the laboratory Icube, by the team MBM – Multi-scale materials and Biomechanics under direction of prof. Nadia Bahlouli.

The LCA of HIPP recycling was done in collaboration of the two teams – the team of Prof. Kočí at UCT Prague and the team of Prof. Caillaud at the University of Strasbourg.

*Figure 19* Shows progress of the study from the initial question through the means to achieve it to the results. We start the study with two initial statements to be verified and explained: “Recycling of HIPP deteriorate its mechanical properties.” and “Recycling decreases the HIPP's environmental impacts.”

We have verified these statements by studying mechanical behavior of consequently recycled HIPP and by assessing environmental impacts of different ratios of recycled HIPP.

**The testing case study of preliminary sensitivity analysis** puts into real circumstances a method of LCA efficiency improvement.

The method faces the problem of missing data organization. We benchmark the initially unavailable data according to their impact on quantitative results and according to their relevance to the goals of the LCA study.

*Figure 19* Shows progress of the study from the initial question through the means to achieve it to the results. We have treated the initial problem: “lack of mean to organize work with missing data” as a research of benchmarking method for estimated values of these data and we could develop and apply a method of preliminary sensitivity analysis.

The whole chapter is divided into six main parts:

3.1 Introduction of the issue of HIPP recycling in the automotive industry

3.2 Implementation in practice – this part specifies the scientific approach we have used to deal with the subject

3.3 Methodology describes closely the methods of mechanical testing, LCA and the preliminary sensitivity analysis

3.4 Results of the mechanical study

3.5 Results of the LCA

3.6 Conclusions and perspectives

As the preliminary sensitivity analysis takes part of the LCA, we have kept it in the chapters concerning LCA. The preliminary sensitivity analysis is in following paragraphs:

3.2.3 Preliminary sensitivity analysis: introduces the concept

3.3.3 Preliminary sensitivity analysis: describes details of the methodology

3.5.6 Improved efficiency through preliminary sensitivity analysis: discuss results of the method

4.6 Conclusions: discuss outcome of the methodology and perspectives of further research

### 3.1 Introduction

Today, the European automotive industry is under pressure to ensure the vehicle price, safety, energy efficiency and increasing mandatory recycling ratio. (European Parliament, 2000, 2005) Already existing demand for smaller fuel consumption is intensified by obligations from the European regulation No443/2009. The regulation allows the average CO<sub>2</sub> emissions of an average passenger car to be 130 g CO<sub>2</sub>/km by 2015 and 95 g CO<sub>2</sub>/km by 2020. (European Parliament, 2009b) The car producers response to this regulation is based on developing more efficient engines and lightening the new car models weight.

Weight reducing leads to increasing use of plastics for cars production. The less load-bearing metal parts are replaced by plastic ones. Plastic injection is also an easy way of getting a complicated shape for new parts. The quantity of plastic parts is growing as well for the sake of users' comfort and to reach better aerodynamics. The part of plastics in an average car's weight has risen from 6% in 1970 to 16% in 2010 and it is expected to increase up to 18% in 2020. (Miller *et al.*, 2014)

In the meantime, car producers are to keep an eye on the new cars recycling capacity . The European directive 2000/53/EC does not allow introducing a new car on the market, unless it can be considered reusable and/or recyclable to a minimum of 85% by mass. By “recyclable” it is understood, that closed or open loop recycling is possible and it is up to the manufacturer to prescribe the most suitable recycling technology. (European Parliament, 2000; Gerrard and Kandlikar, 2007) This is the case of the High Impact Polypropylene (HIPP) which is common in bumpers and body panels. We can even find producers who use recycled HIPP in the new parts, such as Faurecia who participated in this study.

Car industries suffer from a lack of information on HIPP from the mechanical point of view as well as the environmental perspective. The mechanical properties are important for designing new parts, especially to decide whether the recycled plastic is suitable or not. From an environmental perspective, it is important to apply the good practices in ecodesign and verify whether the recycled plastic is environmentally friendlier than the virgin one or not. Since, It is usually considered that recycled matter is environmentally friendlier than virgin material. (European Parliament, 2000; Gerrard and Kandlikar, 2007; Biron, 2014) However, this statement is less obvious if we take a closer look at recycling technologies and related

infrastructures. If a plastic part is not recycled, it is landfilled or incinerated in a local waste treatment center, producing a small amount of electricity or energy for district heating; (Lazarevic *et al.*, 2010; Biron, 2014) whereas recycling involves additional transports and energy-consuming recycling technologies. Therefore, one cannot state without a closer study whether recycling really is the best solution.

Another point of interest is the mechanical properties of recycled plastics. While recycled glass or metals has the same properties as virgin ones, the quality of recycled plastics is not as obvious. There are several studies dealing with the reprocessing of thermoplastics, (Bahlouli *et al.*, 2006) some of them concerning the recycling of polypropylene alone. They conclude that five different reprocessing cycles are necessary to observe a significant degradation in mechanical properties (D’Orazio *et al.*, 1983; Guerrica-Echevarría, Eguiazábal and Nazábal, 1996; Marrone and La Mantia, 1996; González-González, Neira-Velázquez and Angulo-Sánchez, 1998; Aurrekoetxea *et al.*, 2001; Rust, Ferg and Masalova, 2006; Pessey *et al.*, 2010). They also show that the yield stress and the Young Modulus increase until the fifth cycle of reprocessing before reaching a maximum, after which they start to decrease. This improvement in properties is attributed to the crystallization rate which increases with recycling. But Da Costa *et al.* (da Costa, Ramos and Rocha, 2005) shows that the rheological and physical properties of High Impact Polypropylene (HIPP) degraded after reprocessing. They observed an increase of the melt flow index (MFI) and of the crystallinity rate ( $\chi_c$ ), with a continuous reduction of the molar mass, and of the melting temperature ( $T_m$ ) as the number of extrusion runs increased.

If there is little literature on recycled HIPP's mechanical aspects, there is a real lack regarding its environmental properties. We can find information about polypropylene in general or even in the automotive industry (Puri, Compston and Pantano, 2009) but these polymers are not exactly the same. Presence of Ethylene-propylene rubber can change not only mechanical but also environmental qualities of the final plastic.

Hence the choice to carry out this study by combining tests on recycled HIPP mechanical and rheological properties along with tests on recycling impacts on its environmental profile.

## 3.2 Implementation in practice

Using the current technology, plastics cannot be recycled endlessly without changing their properties unlike glass or metals. Even though their reprocessing looks alike : the material is melted and reshaped in a new product. But plastic structure has one important particular aspect : polymerization does not create crystals, it is made of long fibers. And just as paper recycling, these fibers are cut during the recycling process which affects the recovered material properties.

In literature we can find two ways of dealing with the analysis of recycling impacts. Either change the reprocessing number or modify the ratio between virgin and recycled material. Each approach answers a different question and can be applied in several situations.

When searching for recycled granulate, one cannot find any material with clear recycling history. Tracing back every part would be much more complicated than useful, so one can only estimate if and how many times the material has already been recycled. Besides, mixing virgin material with recycled one is very common.

From a practical standpoint, it seems more suitable to test different ratios of virgin/recycled material, as it is closer to reality. Indeed, it hides the influence of recycling itself. If we want to know what happens to the material due to recycling process, we need to study a homogeneous material while keeping other variations to a minimum.

But since various studies demonstrate that plastics deterioration regarding the number of reprocessing cycles is a result of the scission of the polymer chain, we wanted to confirm and explore furthermore their potential interdependence. That's why we chose to study the recycling impacts on mechanical and rheological properties following the first approach based on how many times reprocessing happens.

Regarding the environmental impacts study we chose the other approach since the study's goal definition would not even allow us to choose the number of reprocessing as a parameter. We need to know if recycling can be an environmentally friendlier option compared to using virgin HIPP. Therefore, we must study a scenario corresponding to the industry current practices. As a matter of fact, this very approach can be found in existing plastics recycling studies.



### 3.2.1 Mechanical properties

The material was processed 0, 3, 6, 9 and 12 times and two characteristics were observed each time: from a material point of view – the molecular weight and rheological characteristics; and from a mechanical one – the tensile behavior in the low and high stress specters.

The object of the study is an unfilled high impact polypropylene. Referenced as SABIC®PP, grade 108MF97, composed of a Polypropylene (PP) matrix containing 22% of ethylene propylene rubber (EPR) particles. A small amount of talc was also detected (<0.5%), and thus the material was assumed to be two-phase.

### 3.2.2 LCA

Regarding the environmental impacts assessment we opted in favor of the Lifecycle Assessment (LCA) (Baumann and Tillman, 2004; International Organization for Standardization, 2006b; Kočí, 2009). The Lifecycle assessment is considered to be the most complete methodology to evaluate a product or technology environmental impacts. (Chomkhamsri and Pelletier, 2011; Gaussin *et al.*, 2013), It covers the whole product's lifecycle, preventing any impact transfer. This can be seen as an anti-error approach which is especially important in assessing recycling environmental friendliness. The assessment is not limited only to the common point of view that recycling save part of the material. It considers also the parts usual users don't think about, such as transport of the material to be recycled or compensation of the impacts of the end-of-life by use of heat from incineration for household heating and production of electricity.

LCA offers the possibility of expression of environmental impacts in various categories of environmental impacts, preventing unfair comparisons, such as petrol versus electricity consuming process, evaluated only by their carbon footprint.

The goal of the LCA study is therefore to identify the environmental impact of products made of virgin HIPP and those made of recycled HIPP. The only product available for studying was a testing rod, which is not a part normally used in the automotive industry. However, after consultation with a car body parts manufacturer who collaborated on the study, it was decided that the testing rod would be suitable, as its lifecycle is similar to most HIPP-produced parts – that is plastic and parts produced in the region, transport by truck and shredding of the used parts to produce parts for the same or a similar purpose. This is defined as closed-loop recycling. (Baumann and Tillman, 2004; Gehin, Zwolinski and Brissaud, 2009; Kočí, 2009). Ideally, the results should be applicable not only to the studied product, but to most simple HIPP-injected parts.

As the lifecycle of the testing rod is similar, but not exactly the same as most car parts, two hypothetical scenarios are added to the study to more closely simulate a serial production.

### **3.2.3 Preliminary sensitivity analysis**

The iterativity of LCA allows the study to be made in a more efficient way. The sensitivity analysis is used to test the hypothesis and its impact on the results of the study. But it can even work in the opposite way. We should be able to estimate the amount of unavailable data at the start and thus consider their potential importance for the study. (Steen, 1997; Reap *et al.*, 2008) This approach helps to define the order of priority of the unavailable parameters.

## **3.3 Methodology**

### **3.3.1 Mechanical and rheological properties**

Reprocessing consists in shredding off a product at the end of its life, granulating it and then re-injecting it into a new one. Except for possible pollution, all these processes does not

change the chemical structure at all but they do imply mechanical tensions on the material that cause breaking of the polymer fibers. Reprocessing not only influences the length of the fibers themselves but also the material micro-structure. According to previous studies about recycling of different plastics, we are supposed to witness a significant degradation starting from the 5th reprocessing. (Guerrica-Echevarría, Eguiazábal and Nazábal, 1996; González-González, Neira-Velázquez and Angulo-Sánchez, 1998; Aurrekoetxea *et al.*, 2001; Rust, Ferg and Masalova, 2006) In order to explore the modifications' impacts caused by multiple reprocessing, we chose to recycle the HIPP 0, 3, 6, 9 and 12 times in a row without adding any virgin material. The 12th time should ensure getting a significant recycling impact and linear scale could help us uncover potential mathematical sequence of impacts base on the number of reprocessing cycles. Each time, we observed the evolution of two parameters. First, on the material level, we assessed the molecular weight and rheological characteristics. Secondly, on the mechanical level we measured the tensile behavior in low and high stress specters. For the study, we chose the HIPP referenced as SABIC®PP, grade 108MF97, composed by a PP matrix containing 22% of ethylene propylene rubber (EPR) particles. A small amount of talc was also detected (<0.5%), thus the material was assumed to be two-phase. This particular polymer is used by a car bumpers and plastic body panels manufacturer who collaborated on the study.

Tensile behavior and mechanical properties are characterized in the small and large stress fields with the Videotraction® system (G'Sell and Hiver, 2002) for the large plastic strain domain.

The mechanical tensile parameters are defined as shown on the *Figure 20*. The elastic modulus (Young's Modulus) is the initial slope of the stress-strain curve; Yield strength ( $\sigma_y$ ) is assumed to be the maximum stress observed in each stress-strain curve at the beginning of yielding and the yield strain is the corresponding strain value. Failure properties (failure stress  $\sigma_r$  and failure strain  $\epsilon_r$ ) as well as the volume strain response were obtained using the Videotraction® system. All these parameters are defined from stress-strain curves on an average of five specimens at a strain rate of  $10^{-3}$  s<sup>-1</sup> and at a temperature of 25°C. Prior to testing, the specimens were conditioned at 65°C for 8 hours so as to eliminate the internal stress caused by the process and possible moisture; they were then kept at room temperature

in desiccators. The impact test was achieved with an instrumented impact resilience machine. A striking energy of 4 J, testing time of 4–8 minutes and final velocity of 2.9 m/s were applied. Impact tests were performed at  $-20^{\circ}\text{C}$  and  $+20^{\circ}\text{C}$ , respectively. The low temperature test was achieved by immersing the specimens into cold ethylic alcohol for at least 30 minutes. The cold bar was then tested immediately (less than 5 seconds). Measurements were performed on at least ten specimens and the average values, with standard deviations, were noted.

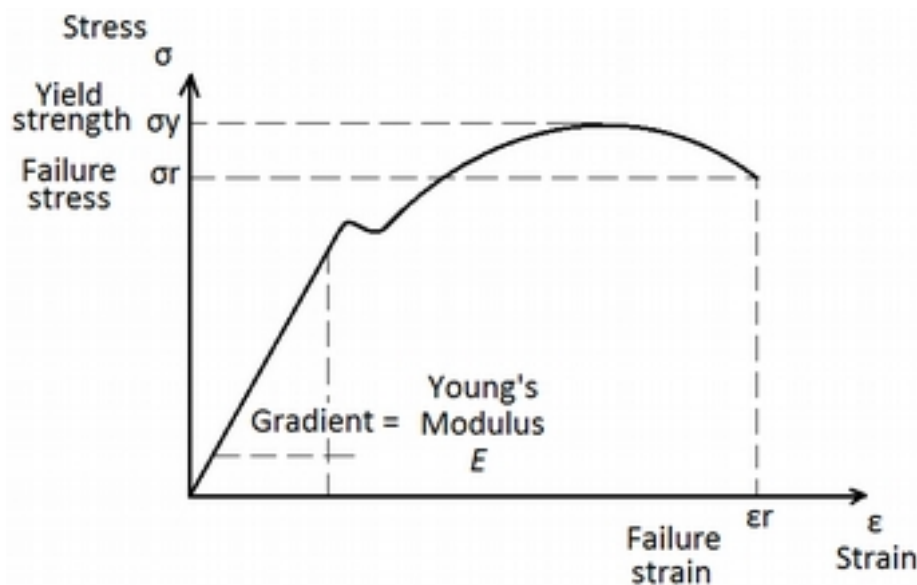

Figure 20: Typical stress-strain curve

As seen earlier, plastics microstructure can be modified by reprocessing, that's why we performed micrographs to observe modifications on morphological aspects. We evaluated the molar weight, polydispersity index and melt flow index. HIPP is a two-phase material so it is important to understand the role of both phases in the reprocessing-induced microstructure changes. Therefore, we measured the rubber component state of dispersion and the interfacial adhesion using the SEM technique (da Costa, Ramos and Rocha, 2005). The liquid nitrogen-cooled samples were fractured by percussive fracture (Split Hopkinson Pressure Bar).

### 3.3.2 LCA

#### a) Goal and scope definition

The goal and scope definition is an essential part of the LCA. It defines the purpose of the study and the way of dealing with it. Outside of the comparison oriented platforms like Product Environmental Footprint/Organization Environmental Footprint (PEF/OEF) or Environmental Product Declaration (EPD® International) (European Commission, 2012; The International EPD®System, 2013; Minkov *et al.*, 2015), the results of different LCAs are not comparable and the goal and scope definitions usually explain the differences in results of products that should be otherwise alike. The goal was to identify the differences between virgin and recycled HIPP in term of environmental impacts. The situation is slightly different from the mechanical impacts study. The current recycling and use model does not distinguish once or more times recycled HIPP. The recovered HIPP is mixed with the virgin one to become a product. Financially the recycled granulate has the same value no matter how many times it was recycled. It is the ratio between virgin and recycled HIPP that changes the price, quality and impacts of the whole product. Our aim is not to explore different ways of how the market could work. In this study we try to give the environmental impacts of an existing way of HIPP recycling and use. Therefore, instead of the number of reprocessing, we analyzed impacts of virgin and recycled HIPP on different ratios.

For Lifecycle Impact Assessment (LCIA) we chose the CML methodology. It is well adapted to the production industry (Baumann and Tillman, 2004) and widely used in the automotive industry (The International EPD®System, 2005; Daimler AG Mercedes-Benz Cars, 2009; Volkswagen AG, 2010; Renault, 2011).

The intended studied products are car parts, typically bumpers and panels or covers. Some plastic parts may be part of mechanisms, other parts may have influence on aerodynamics of the car. Yet any influence on friction is neglected in this study and we consider that the main function of the final products consists in their simple existence. As the core of our study is the material, we defined the reference flow as 1kg of HIPP, which in case of need can be easily extrapolated to any precise number of real parts.

## **b) Lifecycle inventory (LCI)**

For the study we used the LCA software GaBi version 4 with Lifecycle inventory (LCI) databases from PE-International and European ELCD. For virgin HIPP we took Polypropylene-EPDM granulate mix (at customer, located to Germany) from PE-International database. It shall be noted that contrary to the general belief, choice of the LCA software may have influence on the quantitative results. (Steen, 1997) Unfortunately we had not enough resources for verification of our results using other existing softwares.

To be consistent with other LCAs in the automotive industry and the Product category rule (PCR) describing studies within the EPD® International platform, we considered the processes and flows relevant to the product's manufacture, use phase and additionally the end of life (The International EPD®System, 2005).

We didn't have access to the precise data from the car parts production. The cooperating car parts producer gave us only the general model of production and lifecycle of a bumper. For the precise data we used a known product: a testing rod that we produced with the very same technologies. With the help of our automotive parts producer we expanded the scenario to three versions in order to get more information relevant to the real production. The first scenario is the real lifecycle of a testing rod. The second one replaces an unusual air transport by a truck and the third scenario simulates a hypothetical serial production.

The scenarios correspond to a closed loop recycling, where the recovered material from a product is used to produce the same new product. This scenario reflects the reality thanks to a relative cleanness of the used material and to the dimensions of bumpers and body panels. In other words, the parts to recycle are easy to recognize and dismantle and they make a big volume. Separation is easy and makes recycling economically viable. The main life cycle of the product is represented on the *Figure 21*.

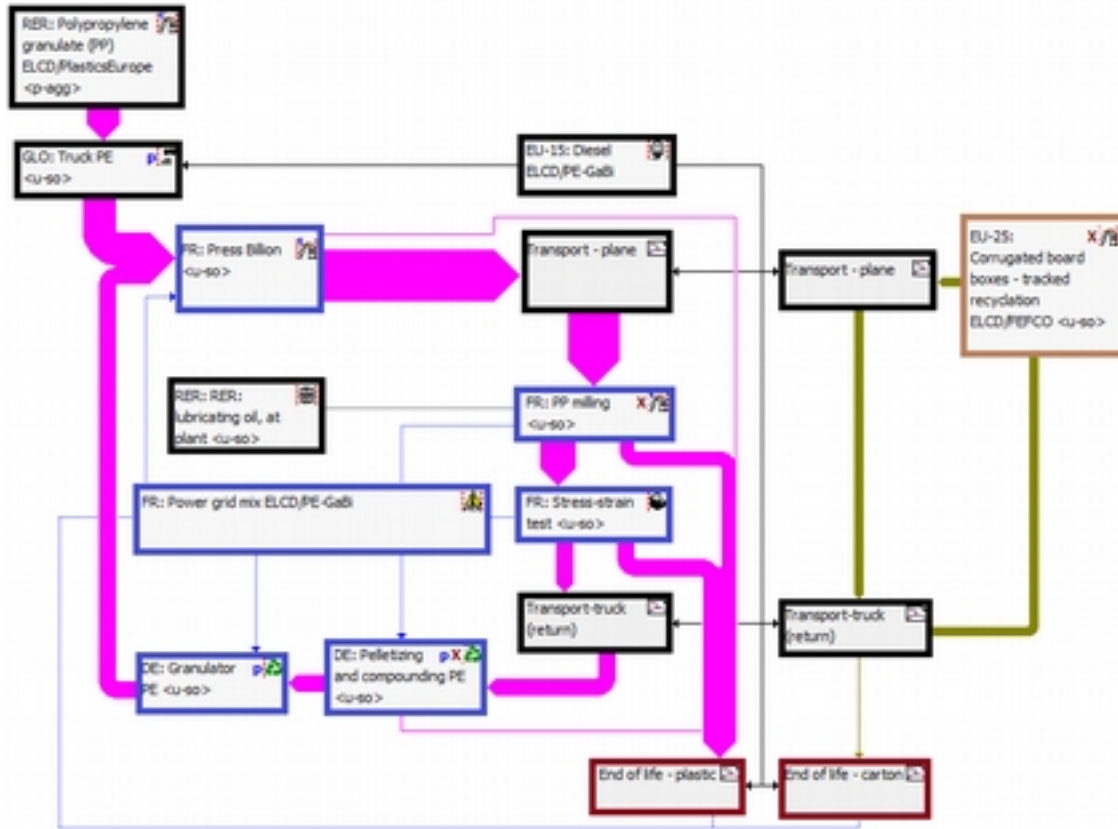

Figure 21: Lifecycle model – initial scenario and 50% ratio of recycling. Thickness of the flashes represents weight of the concerned flows. Colors of flows are: Rose for HIPP, black for petrol and petrol products, blue for electricity and green for packaging.

The main lifecycle consists of production-injection, followed by finishing of the new product, than transport to the use phase, separation at the end of life and finally transport to a recycling unit, where the old product is shredded and granulated in order to make a new entry for the injection. In our model there is always an entry of some virgin material. There are always some minor or bigger losses in the production and recycling processes, which exclude the possibility of recycling 100% of the original material. The inputs are energies and virgin material - Polypropylene-EPDM granulate mix (at customer, located to Germany) from PE-International database. Unfortunately the supplier wouldn't reveal the source of material, which is a common problem in LCA – some retailers consider it as confidential information. Therefore the transport was estimated to be 600 km with a truck. The outcome is, besides the modeled recycling, the French average of landfill and incineration. We considered the production of heat and electricity in both of them in order to avoid giving any unnecessary

advantage to recycling. Parallel to the lifecycle of the product is the lifecycle of its packaging. The packaging is represented by a carton boxes, corresponding to those of the testing rod. Its quantity does not change in function of ratio between the virgin and recycled HIPP. It has therefore no effect at all on the goal of the study. It only places the results in the scale of the real use.

All the energies, transports and end of life scenarios are located to the target country – France. Although, French processes were unavailable for the processes of truck transports, incineration, injection and recycling processes. According to the practices recommended in the Product category rules (PCR) of a car, for the process of truck transports we chose the closest available average – global. (The International EPD®System, 2005) For the other processes we chose the closest location – Germany. In incineration we changed the average trash composition for the French one and in the process of injection we were able to change the energy consumption according to the data from the producer of the injection press, used for production of our testing rod. The machine is well adapted for a mass serial production and therefore perfectly suitable for the two complementary hypothetical scenarios.

### **c) Lifecycle impact assessment (LCIA)**

For Lifecycle Impact Assessment (LCIA) we chose the CML methodology. It is well adapted to the production industry (Baumann and Tillman, 2004) and widely used in the automotive industry (The International EPD®System, 2005; Daimler AG Mercedes-Benz Cars, 2009; Volkswagen AG, 2010; Renault, 2011). In The International EPD system CML characterization models and factors are recommended to be used for the default impact categories. (The EPD International System, 2016) The aim of the comparison between virgin and recycled HIPP is to give to the engineers from the automotive industry a decision support for the choice between use of virgin or recycled HIPP. Therefore we use CML, which is most likely to give the results in the same format as other LCA studies the engineers already got.

We have found two disadvantages of this characterization and impact assessment method. Firstly, the latest update we have used dates from 2009. CML is often replaced by newer ReCiPe and especially for the toxicity and at present, ecotoxicity impact categories USEtox® is mostly recommended. (European Commission, 2012) Although it still remains a valid



choice as the most LCAs in the automotive industry uses CML and we want to present the results in the same categories as those the industries are used to.

We verified the choice of CML methodology in comparison with several other available methodologies, ReCiPe (midpoint and endpoint approach), I02+ v2.1 and EDIP 2003/1997.

We found a very good coherence between the LCIA methodologies in most impact categories. On the other hand, in the categories of abiotic or metal depletion and freshwater ecotoxicity, the LCIA methodologies does not even agree whether the use of recycled HIPP has a positive or negative impact. The reason of non-coherence is mostly in the differences in characterization factors (Dreyer and Hauschild, 2003). We decided to keep the CML, which does not exceed the lowest and highest results, with exception of human toxicity. *Figure 41*

The second inconvenient is lack of an impact category for the potential of ionizing irradiation, which may be important in the light of a major part of nuclear power in the French power grid mix.

We decided to present the results of this impact category separately, using the ReCiPe LCIA method.

### **3.3.3 Preliminary sensitivity analysis**

The case study helped us to develop an approach to benchmark the missing data according to their importance.

The problem is that in the beginning of the LCI phase of the study we fall usually on undocumented or missing processes. Research of them is an important time consumer during which the analysts risks loss of precious time and underestimation of some important data. In the beginning we usually don't know how much important the missing data are and usually we give the same effort to reach every one of them. But given the premise that the importance of each missing data is not equal, we would surely spend too much on the least important data and not give enough to the most important of them.

To get help in this situation we would need a benchmark of missing data in order to privilege the most important ones.

We could find one method to do so. Bengt Steen in 1997 presented a method of priority setting based on preliminary sensitivity analysis. (Steen, 1997)

The concept profits of the first parametric approach presented in the state of the art of the thesis, introduction of parametrized processes that can be reassembled and reused in the lifecycle scenario. Steen proposes to perform sensitivity analysis in the earliest state of the lifecycle modeling and for the missing data he uses estimated values. Naturally with more precision during the LCI phase the position of missing data in the benchmark can change, but once the mode prepared, second and further preliminary sensitivity analysis are easy to repeat.

However, there are two disadvantages of the Steen's method. Firstly it is applicable only at one impact category at a time. This could be only suitable for unidimensional simplified LCAs of single score studies, which are not allowed according to the last version of ISO 14040. (International Organization for Standardization, 2006b; Kočí, 2009; Curran, 2015)

Solution to the impact categories problem can be found in the work of Anna E. Björklund (Björklund, 2002). The concept is defined as setting a proportional scale of significant impact and searching for the critical variation of input parameter that provoke the significant evolution in any impact category. This concept corresponds to the 6th model of parametric LCA, because it searches for the parameter quantity in function of defined result. *Figure 22*

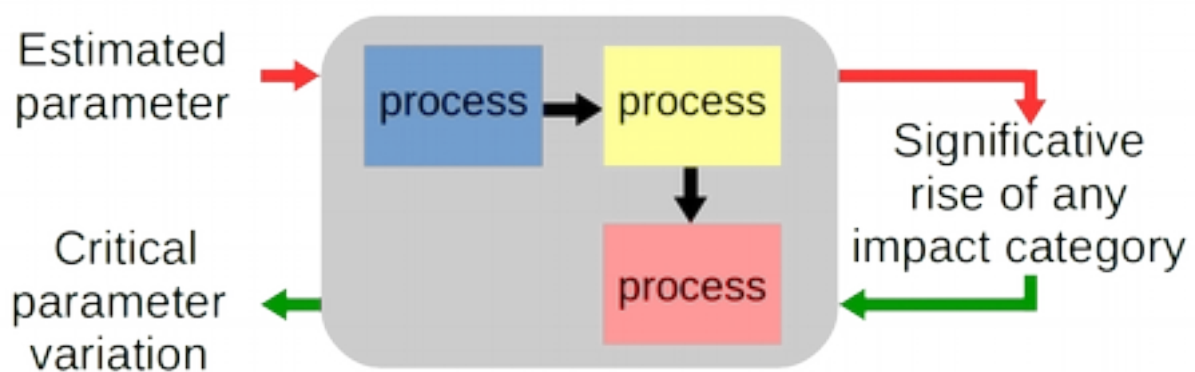

*Figure 22: Schema of parametric model, used in the combined method of preliminary sensitivity analysis*

The combined Steen-Björklund approach deals with quantitative dimension of missing data. But it still lacks qualitative dimension. None of the data is to be neglected. Once it does not meet the cut-off criteria it is protected by the ISO methodology. But in some cases the data might have big impact to the results, but no relation to the goals of the study.

To prevent this situation we need to introduce a qualitative test. Benchmarking of the data according to qualitative dimensions would be variable, because it would have to respond to the goal definition of every study. On the other hand, a yes-no decision whether the data contributes to any goals of the study, can be done in any LCA.

In quality management when we have doubt about certain aspect of a product, we introduce a Poka-Yoke. A Poka-Yoke is any mechanism that helps an equipment operator avoid (yokeru) mistakes (poka). (Shingo, 1987) The same thing is also our objective. We want to prevent any underestimation of data that participate on the goals of the study.

We stick to a separation into two groups and no more, because qualitative dimensions are hard to benchmark, but a clear preference to one group of data can not be misleading.

We decided to call this qualitative part of the preliminary sensitivity analysis LCA Poka-Yoke, because it expresses very good its principle and its purpose.

We define the Poka-Yoke as a simple separation into two groups. Related and non-related to the goals of the study. Therefore in result we will get two benchmarks. One for data contributing to the goals of the study and the other for any other complementary data. No matter the quantitative results the data participating on the goals of the study have priority over the complementary ones.

In a comparative LCA, like our case of HIPP recycling, we may even introduce a supplementary control mechanism. The goal of our study is to find difference between virgin and recycled HIPP. Therefore any radical variation of the non-participating parameter must not lead to a variation of the absolute difference between results of virgin and recycled HIPP.

## 3.4 Interpretation of the results - mechanical and rheological properties

### 3.4.1 Rheological properties

The average molar weight decreases significantly with the number of extrusion runs. This is a consequence of the rupture of the polymer chains by the so-called beta-scission mechanism. The polydispersity index is also reduced because the probability of chain scission is higher for the high molar weight species.

*Figure 23* represents the variations of the viscosity versus the shear rate for the virgin material and its recycled derivatives. Within the investigated shear rate range, strong differences are detectable between the flow curves especially at low shear rates. This trend is confirmed by the evolution of the MFI. Actually, the *Figure 24* report the evolution of this index with the number of extrusion runs. It is clear that increasing of the number of runs actually results in higher MFI value in agreement with the Size Exclusion Chromatography (SEC) observations.

The melting point of PP matrix decreases as a consequence of the lowering of the average molar mass. The glass transition temperature ( $-47^{\circ}\text{C}$ ) of the elastomer phase and the crystallinity rate remain constant. This last observation is very important because any change in the mechanical properties observed in the next section will not be linked to these parameters.

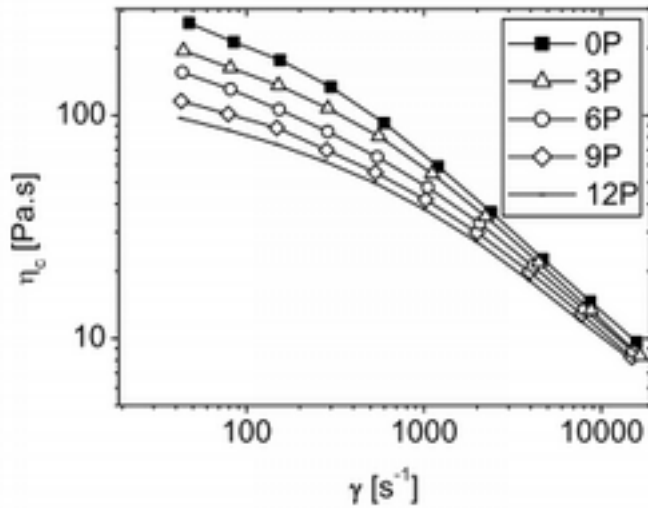

Figure 23: Flow curves show drop of viscosity in function of growing number of reprocessing.

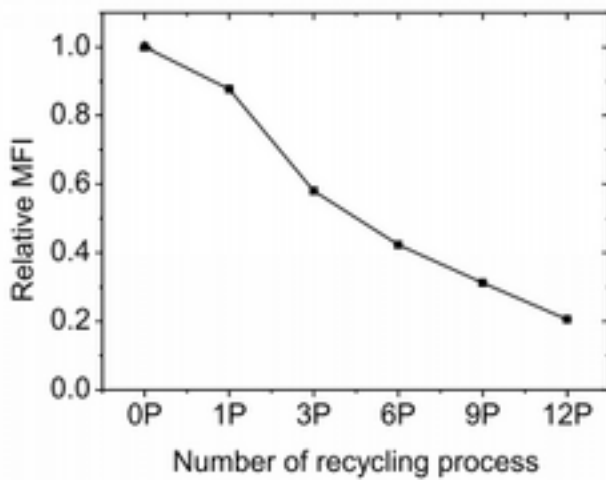

Figure 24: Relative melt flow index (MFI) based on number of recycling

In order to understand the principle of HIPP deterioration as a two-phase material, we separated the PP fibers from the rubber parts using selective dissolution in trichlorobenzene (TCB). We analyzed the two phases by Size Exclusion Chromatography (SEC). *Table 1* shows the results. We can see a deterioration of the PP matrix while the rubber parts remain intact.

| Phase                   | Mn (g/mol) | Mw (g/mol) | IP = Mw / Mn |
|-------------------------|------------|------------|--------------|
| PP phase – virgin HIPP  | 31000      | 166000     | 5,35         |
| EPR phase – virgin HIPP | 24000      | 92000      | 3,80         |
| PP phase – 6P HIPP      | 21000      | 69000      | 3,30         |
| EPR phase – 6P HIPP     | 24000      | 95000      | 3,95         |

*Table 1: average number molar mass, average weight molar mass and polydispersity index for the two different phases of virgin HIPP and 6 times reprocessed HIPP*

Cavitation is typical for polymers exposed to critical constraint. This phenomenon is due to shorter chains and embrittlement of the amorphous matrix due to reprocessing, as explained by Fayolle et al. (Fayolle, Audouin and Verdu, 2004) *Figure 25* shows the difference between virgin HIPP and 6th recycled HIPP.

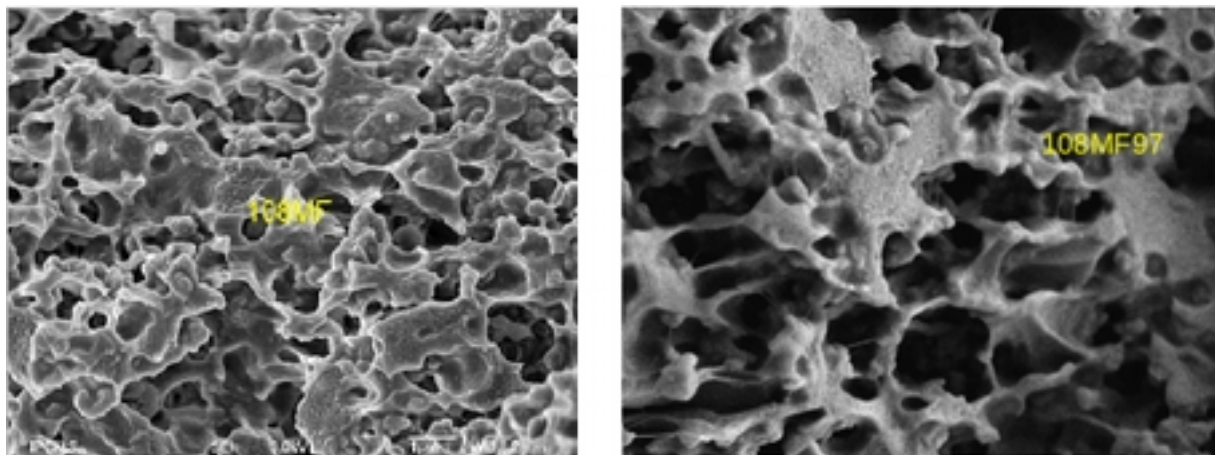

*Figure 25: Growth of cavitation with recycling. On the left – virgin HIPP 108MF97, on the right the same material 6 times recycled. Scale is identical on both sides.*

### 3.4.2 Mechanical properties

The material exhibits classic mechanical behavior under tensile loading (Bahlouli *et al.*, 2006) after a linear elastic response, a small viscoelastic response appears before the yielding point. From this point on, the material deforms plastically. *Figure 26 Figure 27*

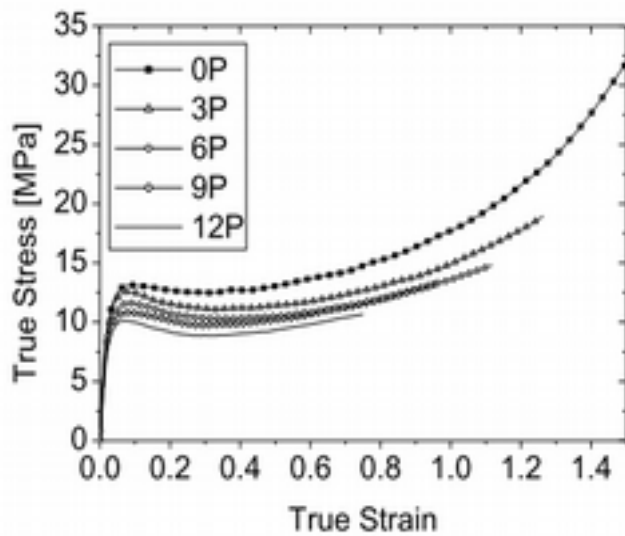

Figure 26: Large domain stress strain

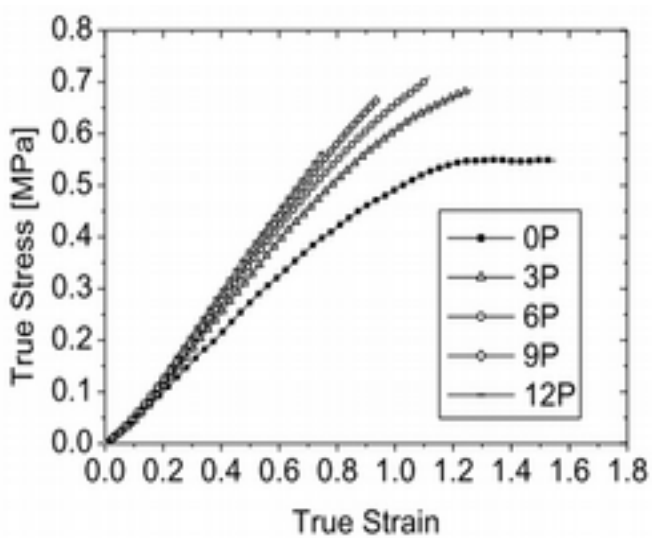
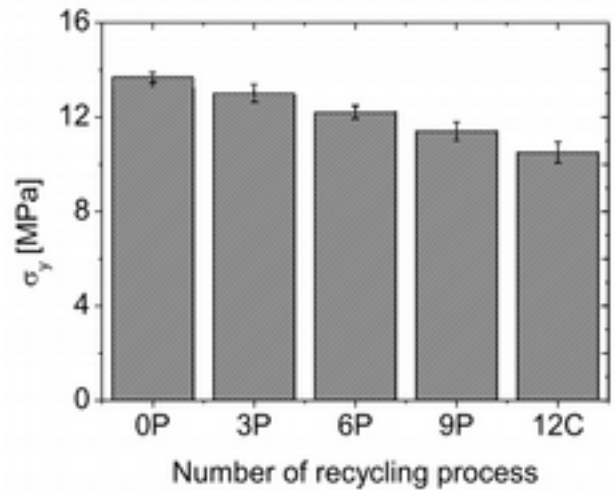
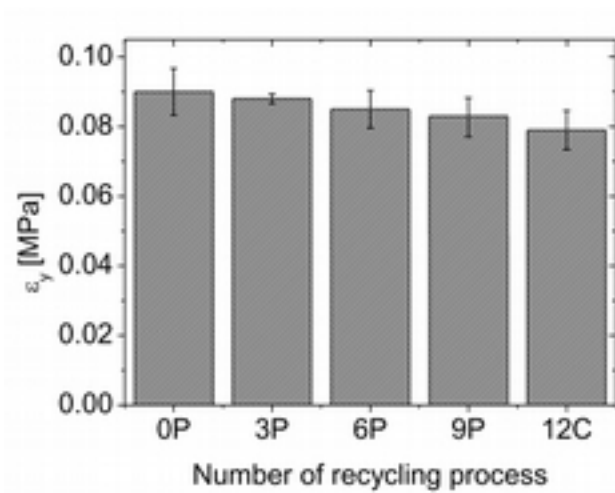

Figure 27: Small domain stress strain

For the yield stress and the yield strain respectively, it can be observed that the recycling process decreases the yield stress. *Figure 28 Figure 29*



*Figure 28: Yield strain*



*Figure 29: Yield stress*

It seems from the results obtained that the mechanical recycling process has no effect on the Poisson ratio. *Figure 30*



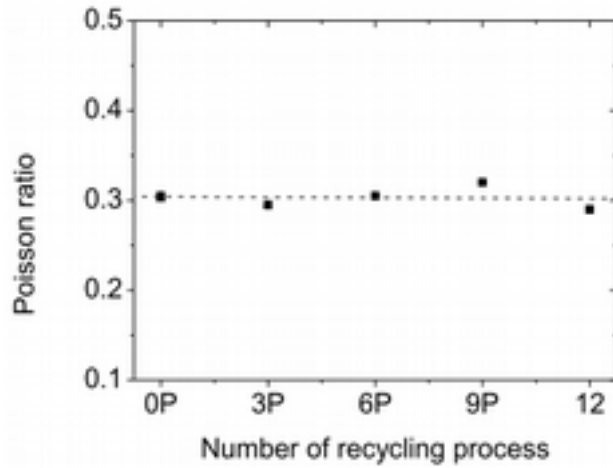

Figure 30: Poisson ratio

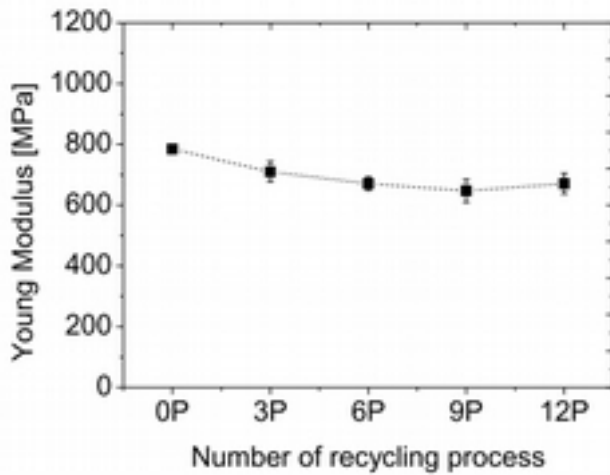

Figure 31: Young modulus

It can be observed that the variation in the Young Modulus values is of the same order of magnitude as the experimental errors. It can thus be concluded that a slight difference may be detected between the virgin material and its respective (12 times recycled) derivatives. *Figure 31*

It can be observed that the failure stress decreases linearly, with degradation after several cycles. *Figure 32* At the same time, the failure strain decreases also significantly and linearly in function of number of reprocessing. *Figure 33*

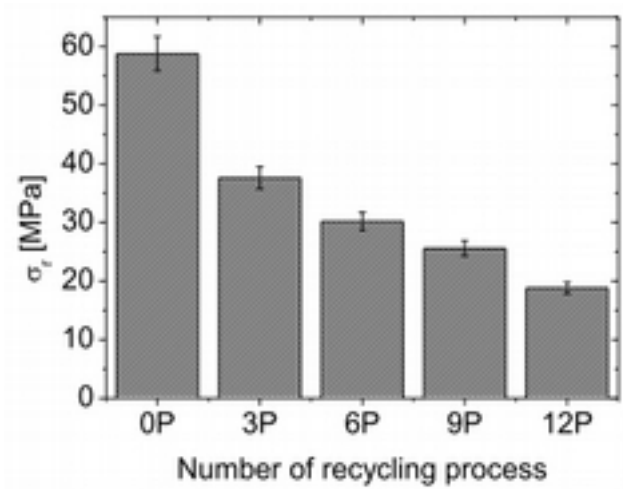

Figure 32: Failure stress

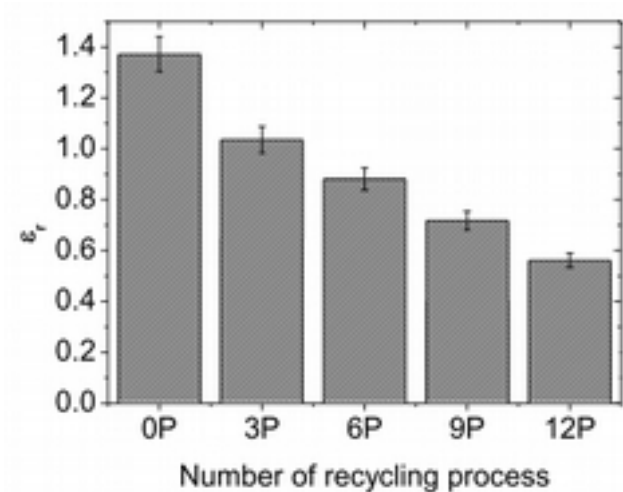

Figure 33: Failure strain

No necking can be observed on any of the tested samples. However, a white zone appear at the sample's center at a relatively low strain. This white zone grow until failure of the specimen. This is characteristic of a significant amount of cavitation that has often been observed (Fayolle, Audouin and Verdu, 2004; Addiego *et al.*, 2006) caused by the plastic deformation of polymers near the yield point. Growth of cavitation with reprocessing is confirmed by micrographs on *Figure 25*. This phenomenon corresponds to the evolution of the initial porosity and the initiation of crack-type damage.

## 3.5 LCA results interpretation

### 3.5.1 Preliminary sensitivity analysis

During the LCI phase of the case study we observed seven missing parameters.

- Transport of virgin granulate to the production unit.  
We have learned that the transport is done by a common truck, but the location of supplier was considered to be confidential. We have found several refineries in the rang of 200 to 3000 km. We have estimated rather shorter distance of 500 km in order to prevent prioritizing of the expected results of the study.
- Transport of product to the client by an aircraft.  
From the transport society who was involved in the product scenario we have learned that the transport is done by a plane. The distance made object of further precisions.
- Return of the product to the recycling unit.  
Main part of the way was done by a truck, but on an unknown distance
- Return of the product to the recycling unit.  
The end of the journey was done by a small truck, but on an unknown distance
- Milling – energy consumption  
We had no mean to measure the consumption and milling of plastic does not figure in any database we had at disposition. The electricity consumption made object of further precision.
- Milling – consumption of lubricating oil  
We had no mean to measure the consumption and milling of plastic does not figure in any database we had at disposition. The lubricating oil consumption made object of further precision.

- Stress-strain test – energy consumption

We had no mean to measure the consumption the process does not figure in any database we had at disposition. The electricity consumption made object of further precision.

The only process that we discovered that participated to the defined goal was the transport from the producer of HIPP granulate to the parts producer. The dimensions of the other unavailable processes did not change in any way between scenarios with different ratios of recycled HIPP.

Table 2 shows the undocumented, their estimated values and their critical variance according to the combined methods of Steen and Björklund. (Steen, 1997; Björklund, 2002) As there is only one process participating on the goals of the study, we distinguish it in the table the by font – bold.

| 1st estimation                               | chosen important variance: 5% variation of normalized global impact CML 2001-09, EU-25 |   |   |
|--|--|---|---|
| dimension                                    | Estimated value  | Critical variance of a single dimension | Critical % variance of a single dimension |
| <b>HIPP transport to the production unit</b> | <b>500 km</b>  | <b>3067 km</b>                          | <b>613%</b>                               |
| Stress-strain test                           | 1,00 kWh   | 0,15 kWh                                | 15%                                       |
| Transport - plane                            | 1000 km  | 185 km                                  | 19%                                       |
| Milling                                      | kg of<br>0,010 lubricating oil   | kg of<br>0,005 lubricating oil          | 52%                                       |
| Milling                                      | 0,100 kWh  | 0,145 kWh                               | 145%                                      |
| Transport - truck 24t                        | 500 km   | 5905 km                                 | 1181%                                     |
| Transport - small truck                      | 100 km   | 2467 km                                 | 2467%                                     |

Table 2: Missing data arranged according to the critical variance of estimated values.

In our scenario we found definition of all the processes linear. The CML characterization method is also linear, therefore the results variation was linear too. Figure 34 shows evolution of results in function of changes to the first estimated parameter. We chose to explore 4 points. Origin and three times added half of the original estimated value.

The graph shows easily the most sensitive impact category and comparison to the other ones.

Further studies might contain non-linear definitions. Automation of the preliminary sensitivity analysis must take into account the possibility of nonlinear results evolution.

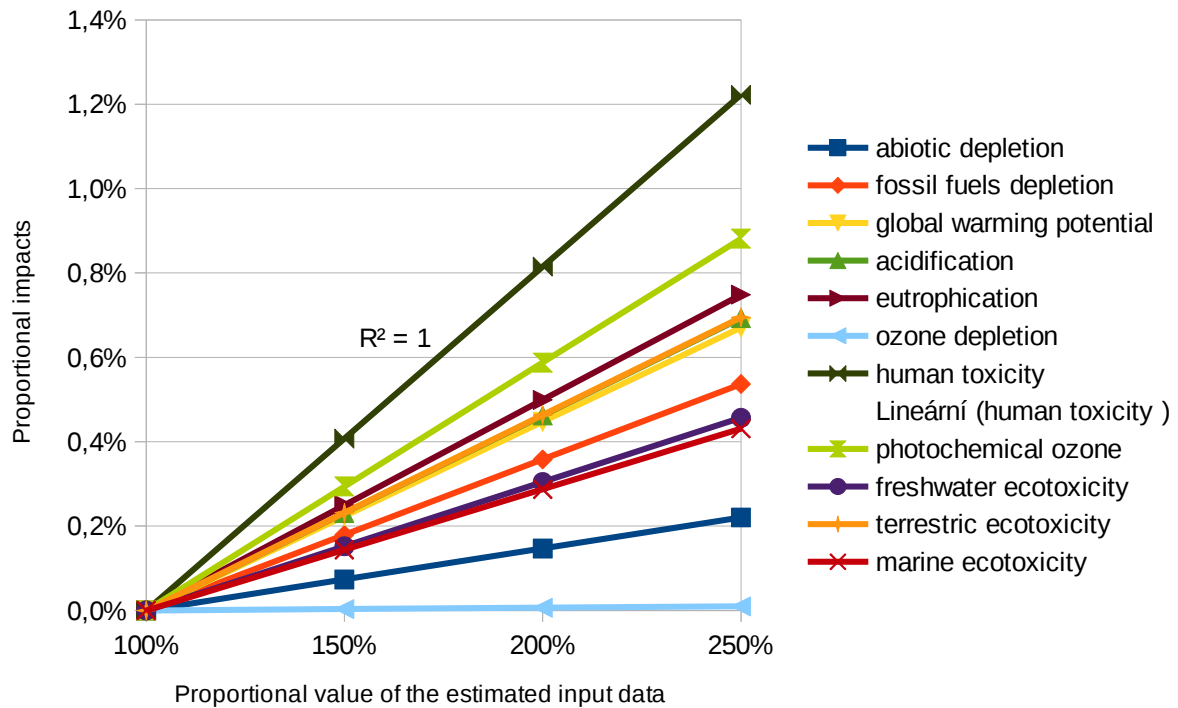

Figure 34: Evolution of impacts in function of input parameter evolution: Distance of transport of virgin granulate

At the end of the LCI phase we have re-evaluated the difficult data in order to verify eventual movement of their position, see *table 3*. With precisions of the missing data during the LCI phase evolution of critical variances is inevitable. The change is proportional to the size of precisions. In our case precisions did not change the order of evaluated data, even if one of the precisions exceeded its critical variance.

| Scenario: Plane                              | chosen important variance: 5% variation of normalized global impact CML 2001-09, EU-25 |   |   |
|--|--|---|---|
| dimension                                    | Value  | Necessary quantity variance of a single dimension | Critical % variance of a single dimension |
| <b>HIPP transport to the production unit</b> | <b>500 km</b>  | <b>3075 km</b>                                    | <b>615%</b>                               |
| Stress-strain test                           | 1,20 kWh   | 0,11 kWh  | 9%  |
| Transport - plane                            | 1300 km  | 165 km  | 13%                                       |
| Milling                                      | kg of<br>0,010 lubricating oil   | kg of<br>0,005 lubricating oil                    | 48%                                       |
| Milling                                      | 0,096 kWh  | 0,111 kWh   | 115%                                      |
| Transport - truck 24t                        | 535 km   | 4030 km   | 753%                                      |
| Transport - small truck                      | 80 km  | 1683 km   | 2104%                                     |

*Table 3: Reevaluation of missing data at the end of the LCI phase.*

It is irony that we could find more precisions for all the processes but the one that participates on the goal of the study. Even though the research of this data got the most of our available time, we couldn't take unfounded arbitrary decision of the HIPP's origin. Therefore we have kept the initial estimation, preventing unnecessary advantages in favor of recycling. The quantitative approach helped us to define uncertainty due to this process, which is 200 to 3000km, therefore in the most sensitive impact category, human toxicity, the results might vary between -0,163% to +4,076%.

### 3.5.2 General results

The LCIA methodology testing *Figure 41* gives different results, depending on the choice of the LCIA methodology, in the categories of abiotic depletion, human toxicity and ecotoxicities. We cannot therefore draw a definite conclusion as to whether recycling is better or not in these categories. However, in the other categories (fossil fuels depletion, global warming potential, acidification, eutrophication, ozone depletion, photochemical ozone and particulate matter formation) all the available methodologies (CML, ReCiPe, I02 and EDIP) show the same tendency and also more or less the same quantities. The CML methodology

does not have an ionizing radiation impact category. However, all the other methodologies agree on a higher impact with a higher ratio of recycled plastic.

The only CML impact category in which recycled HIPP scores worse than virgin granulate, appears to be in ozone depletion. The dominance analysis shows that the biggest contributor in this category are emissions of CFCs in the process of energy conversion in nuclear power plants. However, the use of CFCs is decreasing and their emissions have been reduced by order of 1E6 in the nuclear to electric energy conversion in the latest update of the PE-International LCI database.

In the other impact categories, the impacts of HIPP are decreasing with growing ratio of recycling. Graphs on *Figure 35*, *Figure 36* and *Figure 37* shows that the evolution of impact in terms of recycled content ratio is close to a linear function.

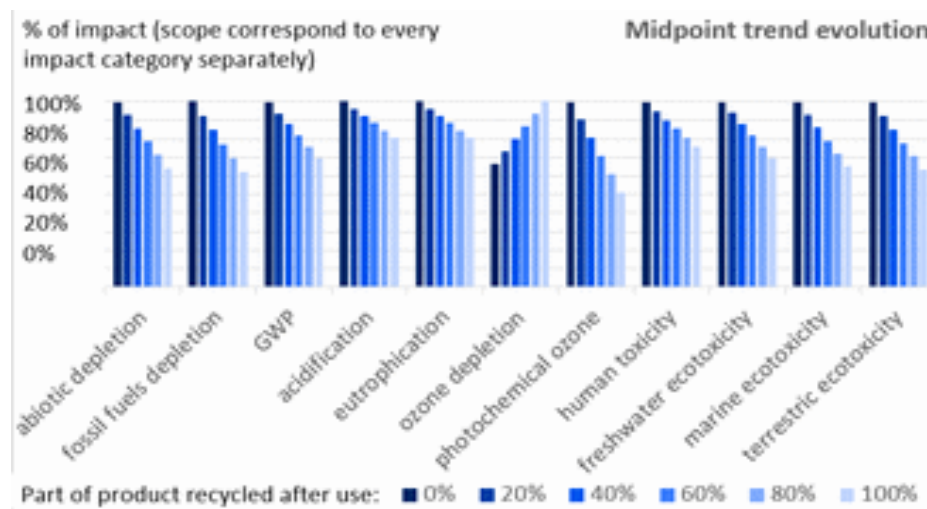

*Figure 35: Midpoint evolution in function of part of recycled mater - initial testing rod scenario*

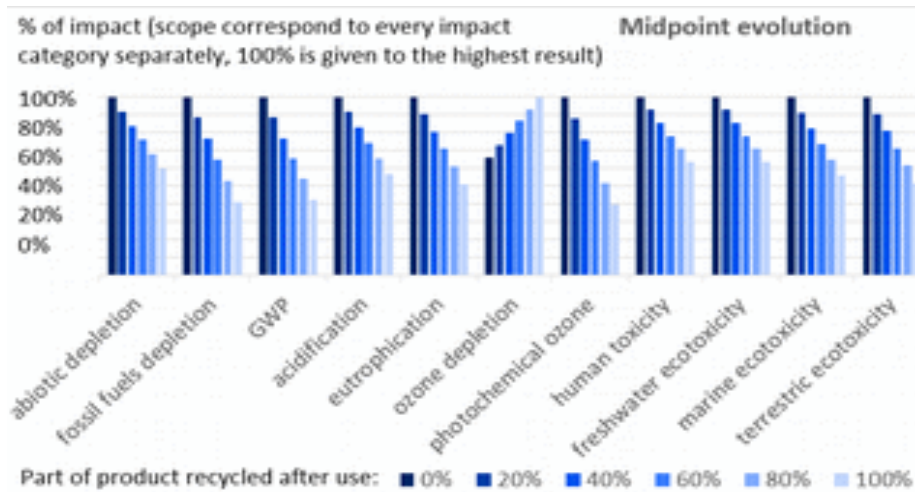

Figure 36: Midpoint evolution in function of part of recycled mater - scenario substituting aircraft transport for a truck

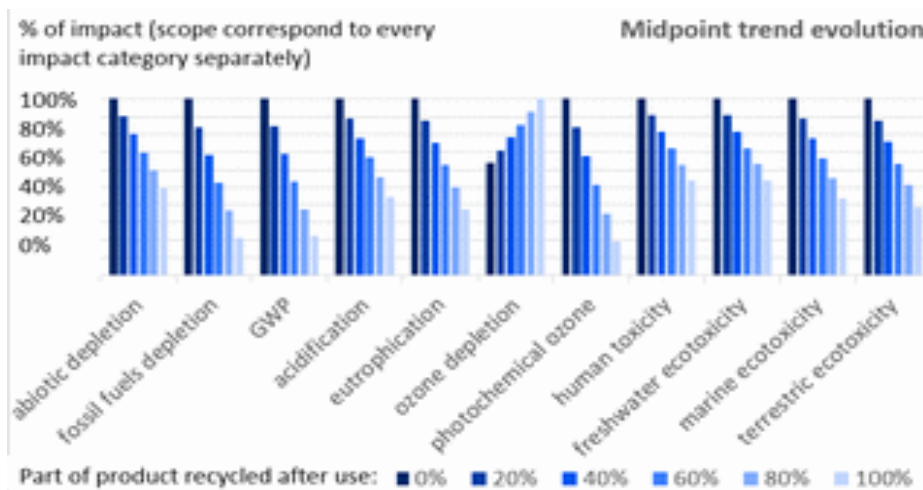

Figure 37: Midpoint evolution in function of part of recycled mater - hypothetical scenario for a bigger serial production

When comparing the results of all the three scenarios we can observe that with decreasing impact, unrelated to the HIPP production and recycling, the difference between the results of virgin and recycled HIPP is growing. Absolute differences remain alike in the whole three scenarios. This information is important for possible extrapolation to other products. Even in a scenario with a high influence of non-production-related activities, the use of recycled granulate represents a significant reduction of the impacts of the whole scenario.



### 3.5.3 Dominance analysis

In order to understand better the origin of different impacts we have analyzed the contribution of the seven lifecycle stages on the impacts. Following the approach, proposed by Baumann and Tillman, (Baumann and Tillman, 2004) we have completed the dominance analysis with a gravity analysis in order to uncover the origin of the most apparent impacts. The lifecycle stages are defined as Virgin material production, part fabrication, cumulated transports (with exception of the transport to incineration and landfill, which are modeled as a part of end of life treatment), packaging, use, recycling and finally the remaining end of life scenarios (Incineration and landfill). We have represented the contribution of the lifecycle stages on the impact of the whole scenario. When possible, we have studied the flows directly in the PE database. Otherwise we have searched in the literature on the particular processes.

Every scenario is represented in the state of exclusive use of virgin HIPP and with use of a mix, containing 50% of recycled HIPP.

In relation to our case study, the production of HIPP is one of the most interesting stages. *Figure 38, Figure 39 and Figure 40* show, that the polymer production is the source of the biggest part of most impacts, except for the scenarios with air transport, in which the virgin HIPP production shares its first place with transports.

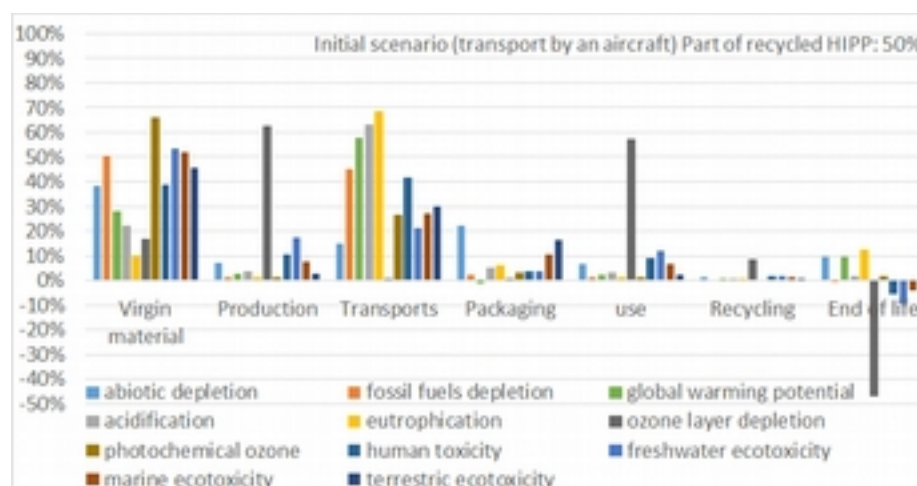

Figure 38: Distribution of impacts – initial scenario

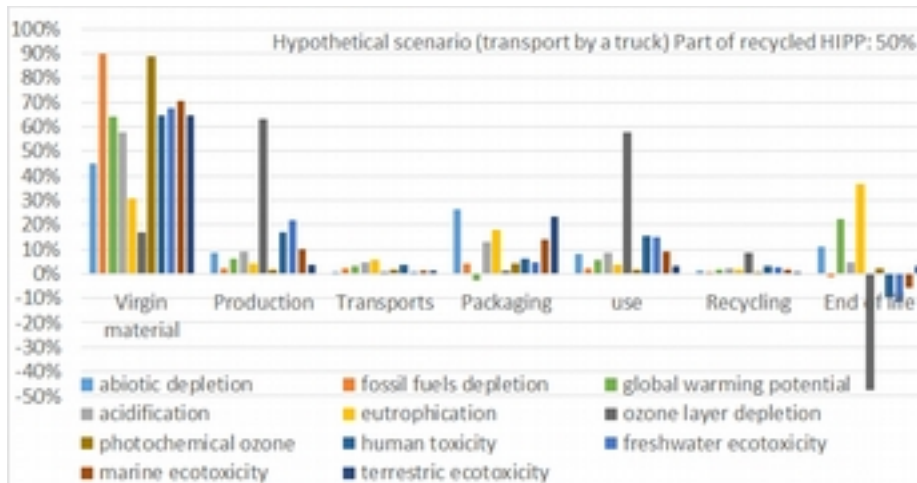

Figure 39: Distribution of impacts – hypothetical scenario with only road transports

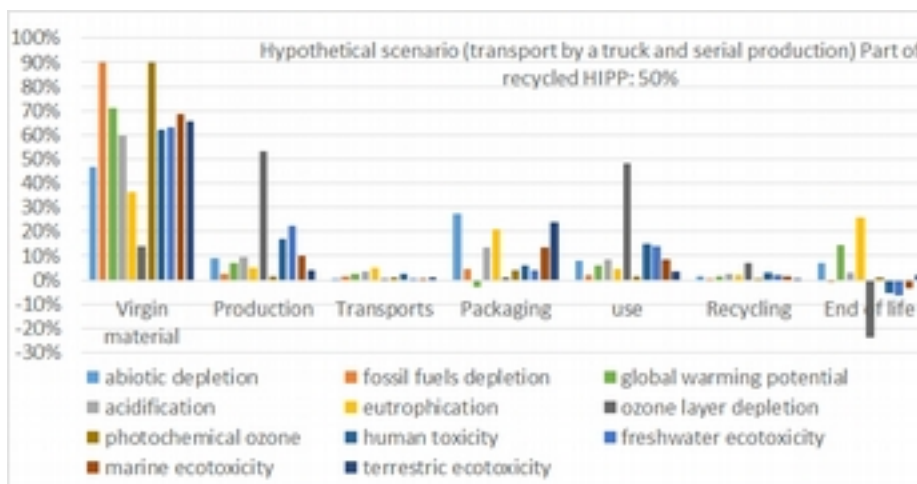

Figure 40: Distribution of impacts – hypothetical scenario of serial production

Virgin polymer production is the biggest contributor in categories, related to extraction and use of fossil fuels and in the category of Material resources depletion. In case of production of HIPP, abiotic depletion has its main origin in metals (69% of the impacts of the process), particularly lead and zinc (59% of the impacts of the process). These materials are not directly

consumed in the process of polymerization. (Biron, 2014) Strong contribution of this process is more of an image of small consumption in the other lifecycle stages.

Transports could be divided into two categories. Road and air transports. Graphs show a great difference between them. While road transports alone reach at maximum 6% of contribution on impacts in any impact category, air transports represent one of the two biggest contributors, except for ozone depletion. Air transport is the biggest contributor in global warming potential, acidification and eutrophication. 89% of greenhouse gases is Carbon dioxide from combustion of Kerosene for propulsion. A similar situation is in the category of eutrophication. 92% of the relevant emissions are Nitrogen oxides from the plane's engines. Nitrogen oxides are also the biggest contributor to the category of acidification. (76% of all relevant emissions) 23% of the emissions in this category is Sulfur dioxide from production of kerosene.

Production, or otherwise product fabrication, is marked especially by the category of ozone depletion. The origin is in use of CFCs (refrigerants R11 and R114), causing 90% of impact on ozone depletion (represented in kg R11-Equiv.) in our case study. All the emissions of CFCs are coming from one process – Power from Nuclear power plant, global average. Use of CFCs is forbidden in European Union since 31th December 2000. (Jacquard and Sandre, 2014) Since then, consumption and emissions in power plants in EU decreased significantly. In the latest PE-International database the emissions of CFCs are smaller by order of 1E11 for R11 and 1E6 for R114. Otherwise only two impact categories exceed 10% contribution. Human toxicity and Terrestrial ecotoxicity, both with the origin mostly in the emissions of heavy metals. For Human toxicity it is 88% and for the category of terrestrial ecotoxicity it is 95% of the impacts within the category. We would expect that a significant part of these emissions is due to the use of a lubricant oil at production, but it is rather a small part. Use of lubricating oil is responsible only for one of the most contributing emissions, Nickel<sup>2+</sup> to air, where it makes 34% the lifecycle stage's emissions. The main emissions are related to the energy conversion. Smaller contribution of the lubricating oil can be result of weak completeness of the data concerning lubricating oil, as mentioned in the description of the process in the PE-International database.

The flows of Packaging are constant in all the studied scenarios. The process is always constituted of the same carton box, its transport and end of life. Any evolution of contribution is only a projection of changes in other lifecycle phases. Packaging contributes the most to the

categories of abiotic resources depletion, terrestrial ecotoxicity, eutrophication, acidification and marine ecotoxicity. 71% of impact in the category of abiotic resources depletion is related to the production of adhesive. (Colemanite ore: 45% and rock salt: 26%) (Cognard, 2000) Consumption of lead-zinc ore is non-negligible in the category either (17%). In the category of Terrestrial ecotoxicity, the main contributor is Cr<sup>3+</sup> (80%). We have not found any direct link between the technologies of paper production and recycling and the consumption of lead-zinc ore or the emissions of Chromium. (Kocman, 2011; Förstner and Wittmann, 2012; Virtanen and Nilsson, 2013) We suppose that, like in the case of pollution from HIPP production, they do part of the machines, buildings and infrastructure, participating in the technology.

Use phase and recycling seems having the same profile as production, but their composition is not exactly the same. Use phase is defined only by consumption of electric energy, whether recycling contains transport of the material back to the producer. But the difference is barely visible on the results. In all scenarios, the contribution of recycling technologies does not exceed 9% for the ozone depletion and 3% for other impact categories.

The end of life has in several categories negative contribution. The model takes into account production of heat and electricity by incinerator and landfill station. Most of the negative contribution corresponds to production of electricity. Otherwise the most significant contributions of the end-of-life are in the categories of Eutrophication, Global Warming Potential and abiotic depletion. The biggest part of Eutrophication potential (76%) is due to emissions of phosphorus and ammonia by landfill. 21% of the impact in the category is attributed to the emissions of Nitrogen oxides from combustion during the process of incineration. The Global Warming Potential is due mostly to the emissions of carbon dioxide (82%) and methane (17%). The CO<sub>2</sub> is the principal domain of incineration (90%), while the methane emissions are coming mostly from the landfill centers. (93%). 91% of the impact in the category of Abiotic depletion is caused by addition of MgCl<sub>2</sub> into the process of smoke depollution in the incinerators in order to improve its efficiency. (Turlan, 2013)

### 3.5.4 Sensitivity analysis

#### a) Choice of the LCIA methodology

In order to validate the choice of the LCIA methodology, we have tested the impact of the choice of the LCIA methodology on the difference between the impacts of virgin and recycled HIPP.

The comparison might not be fair if its purpose were other than confirmation of the choice of one LCIA methodology. There are important differences, which are not always perceived the first time the reader obtains the results of an LCA.

The differences concern the categories of abiotic depletion, acidification, eutrophication and eco-toxicities. The abiotic depletion in ReCiPe is in fact accounted only for metals, for minerals in I02 and more generally for non-renewable resources excluding fossil fuels in CML. Acidification and eutrophication are general in CML and EDIP, but specified terrestrial respective aquatic in ReCiPe and I02. CML and ReCiPe distinguishes freshwater, terrestrial and marine ecotoxicity, while I02 and EDIP account only for aquatic and terrestrial ecotoxicity. For more precision, Table on *Figure 41* shows units of categories used in the comparison.

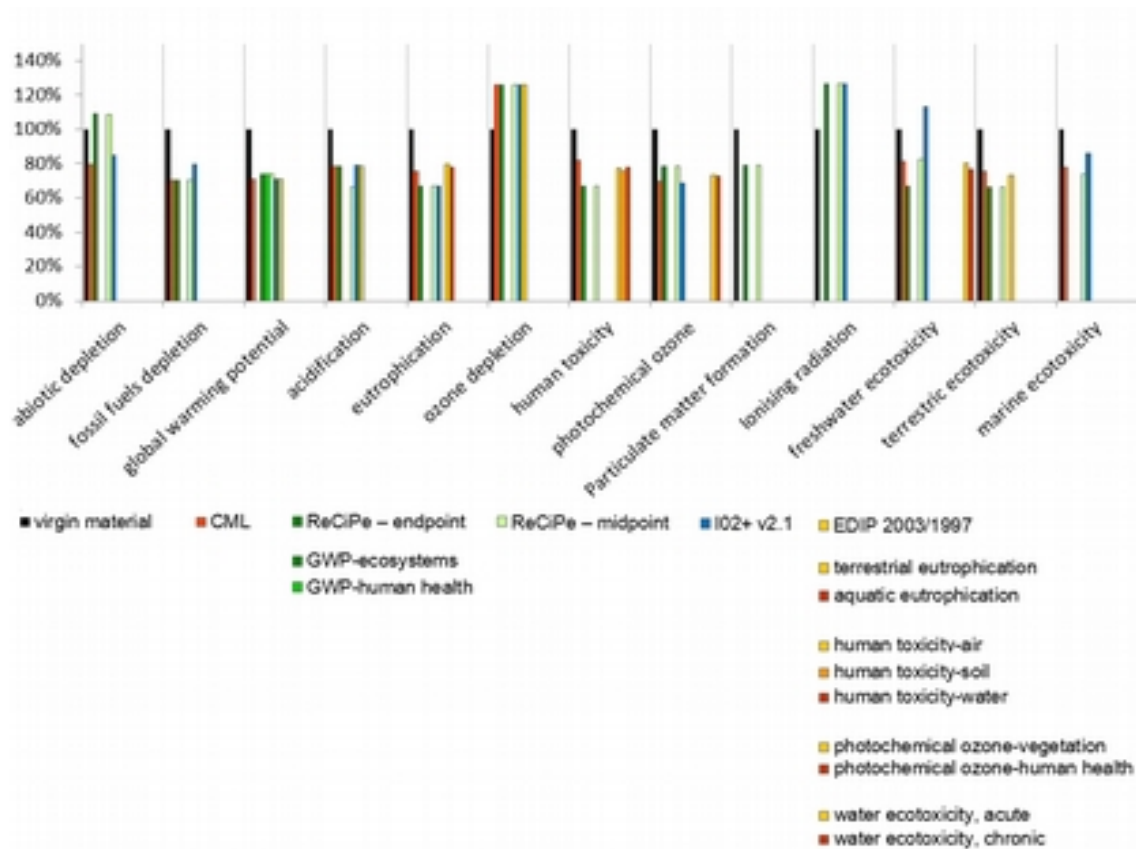

|                          | CML                       | ReCiPe<br>endpoint | ReCiPe<br>midpoint     | I02                                  | EDIP 2003/1997                |
|--------------------------|---------------------------|--------------------|------------------------|--------------------------------------|-------------------------------|
| Abiotic depletion        | kg Sb-eq.                 | \$                 | kg Fe eq               | MJ surplus                           |                               |
| fossil depletion         | kWh                       | \$                 | kg oil eq              | MJ                                   |                               |
| GWP                      | kg CO <sub>2</sub> eq.    | species.yr         | kg CO <sub>2</sub> eq. | kg CO <sub>2</sub> eq.               | kg CO <sub>2</sub> eq.        |
| acidification            | kg SO <sub>2</sub> eq.    | species.yr         | kg SO <sub>2</sub> eq  | kg SO <sub>2</sub> eq.               | m <sup>2</sup> UES            |
| eutrophication           | kg kg PO <sub>4</sub> eq. | species.yr         | kg P eq                | kg PO <sub>4</sub> eq.               | kg NO <sub>3</sub> eq.        |
| ozone depletion          | kg R11 eq.                | DALY               | kg R11 eq              | kg R11 eq.                           | kg R11 eq.                    |
| human toxicity           | kg DCB eq.                | DALY               | kg 1,4-DB eq           |                                      | m <sup>3</sup> air/water/soil |
| Photochemical ozone      | kg Ethene eq.             | DALY               | kg NMVOC               | kg C <sub>2</sub> H <sub>4</sub> eq. | kg Ethene eq.                 |
| Particul. mat. formation |                           | DALY               | kg PM10 eq             |                                      |                               |
| Ionizing radiation       |                           | DALY               | kg U235 eq             | Bq C-14 eq.                          |                               |
| freshwater ecotoxicity   | kg DCB eq.                | species.yr         | kg 1,4-DB eq           | kg TEG eq.                           | m <sup>3</sup> water          |
| terrestrial ecotoxicity  | kg DCB eq.                | species.yr         | kg 1,4-DB eq           | kg TEG eq.                           | m <sup>3</sup> soil           |
| marine ecotoxicity       | kg DCB eq.                |                    | kg 1,4-DB eq           |                                      |                               |

Figure 41: Comparison of LCIA methodologies on an intermediate scenario (truck transports) In all categories virgin material represents 100% of the impact, while the other columns represent the relative impact of 50% recycled material, calculated with various LCIA methodologies. The table shows units of characterization factors in the compared LCIA methodologies.

Figure 41 shows one information we couldn't see in the results of the CML LCIA methodology. It is the potential of ionizing irradiation, growing with the ratio of recycled HIPP. The major part of the impact in this category are coming from the nuclear power plants represented in the French power grid mix. The impacts in this category depend on the energy policy of the country where the recycling is done.

Figure 42 shows the situation of recycling hypothetically placed to a country with the power grid mix composed only of hydraulic and wind power. This particular comparison was realized using the ReCiPe LCIA methodology.

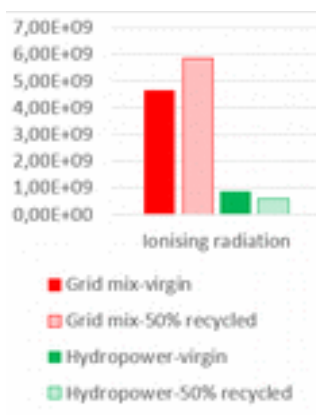

Figure 42: Impacts in the category of ionizing radiation, ReCiPe. Expression of difference between use of a classical French electric power grid mix and electric energy exclusively from hydraulic power plants.

## b) Choice of the recycling model

As described in the section 2, the scenario with recycling suppose closed-loop recycling. In the scenarios with recycling, we suppose always that the recycled part reenters the recycling process. The impact of this two hypothesis can be verified by extension as we can find in the work of Benetto et al. (Benetto, Dujet and Rousseaux, 2008)

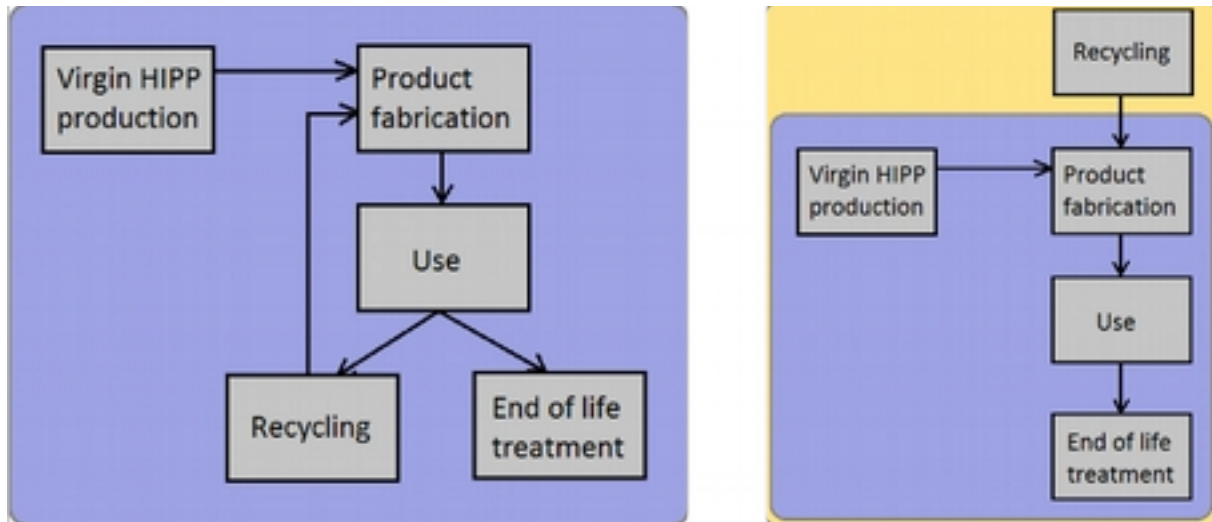

Figure 43: Schema of the initial product system and schema of the expansion of the system, where recycling stands out of the loop and all the HIPP is incinerated or landfilled after use.

As shown on the Figure 43, the extension consists in externalization of the input material for recycling. The reason for this assumption is that there are not enough recycling units to cover the demand of the automotive industry and not even to recycle all the HIPP from the EOL vehicles. It can be assumed that in some cases, the HIPP will not be recycled at the end of its life.

Another point of view is that accounting for beneficiation of heat and electricity produced during incineration and landfill gives advantage to the scenario with exclusive use of the virgin HIPP. Recycling decreases the amount of HIPP that could serve for energy beneficiation.

The proposed expansion eliminates the influence of recycling on the beneficiation. Figure 44 shows the impact of externalizing of the recycled material, which is in all the impact categories inferior to the impacts of the initial scenario. These results do not indicate that incineration and landfill would have better results than recycling. This kind of statement would require a comparative study between recycled, incinerated and landfilled material, which is not the aim of the current study.



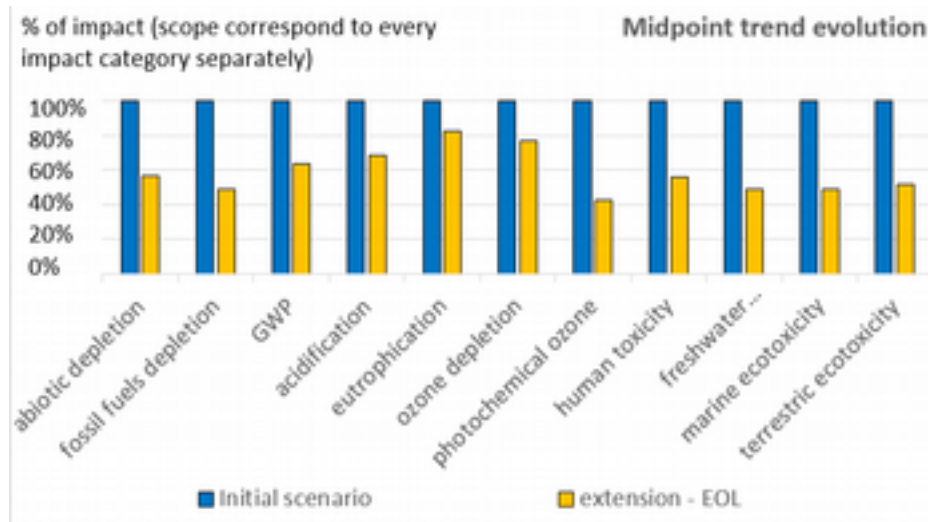

Figure 44: The relative difference between the initial and extended scenarios. Both realized on the initial scenario with air transport and recycling ratio of 50%.

### 3.5.5 Uncertainty analysis

GaBi gives the possibility to calculate the uncertainty using Monte Carlo analysis of chosen parameters. But most of the processes in our LCI databases lacks any description of uncertainty and those which do, has the uncertainty expressed only for several flows. To introduce uncertainty into our LCA model without neglecting the quality of the data from our PE/ELCD databases we chose to express the uncertainty as an additional parameter variation. An efficient way to calculate this parameter is the approach used for the Ecoinvent database. (Weidema *et al.*, 2013) The method offers a table of default variation for different types of process and their adjustment with a Pedigree Matrix, based on estimation of reliability, completeness, temporal correlation, geographical correlation and further technological correlation of the collected data. This approach is well appropriated to the data which is defined as a single value with no measured error range. (Weidema and Wesnæs, 1996; Guo and Murphy, 2012; van der Spek, Ramirez and Faaij, 2015)

The qualitative approach shows in all the scenarios, that the strongest lifecycle stages are production of virgin material and its recycling. The end of life got enough time and human resources, but the quality of the data is slightly weaker due to lack of documentation of the

process of incineration, chosen in the ELCD LCI database. In the initial scenario, the weakest parts are reliability of the use phase and packaging.

None of these three lifecycle stages participate on the difference between the virgin and recycled HIPP. But they help to place the difference between virgin and recycled HIPP into the scale of its whole lifecycle.

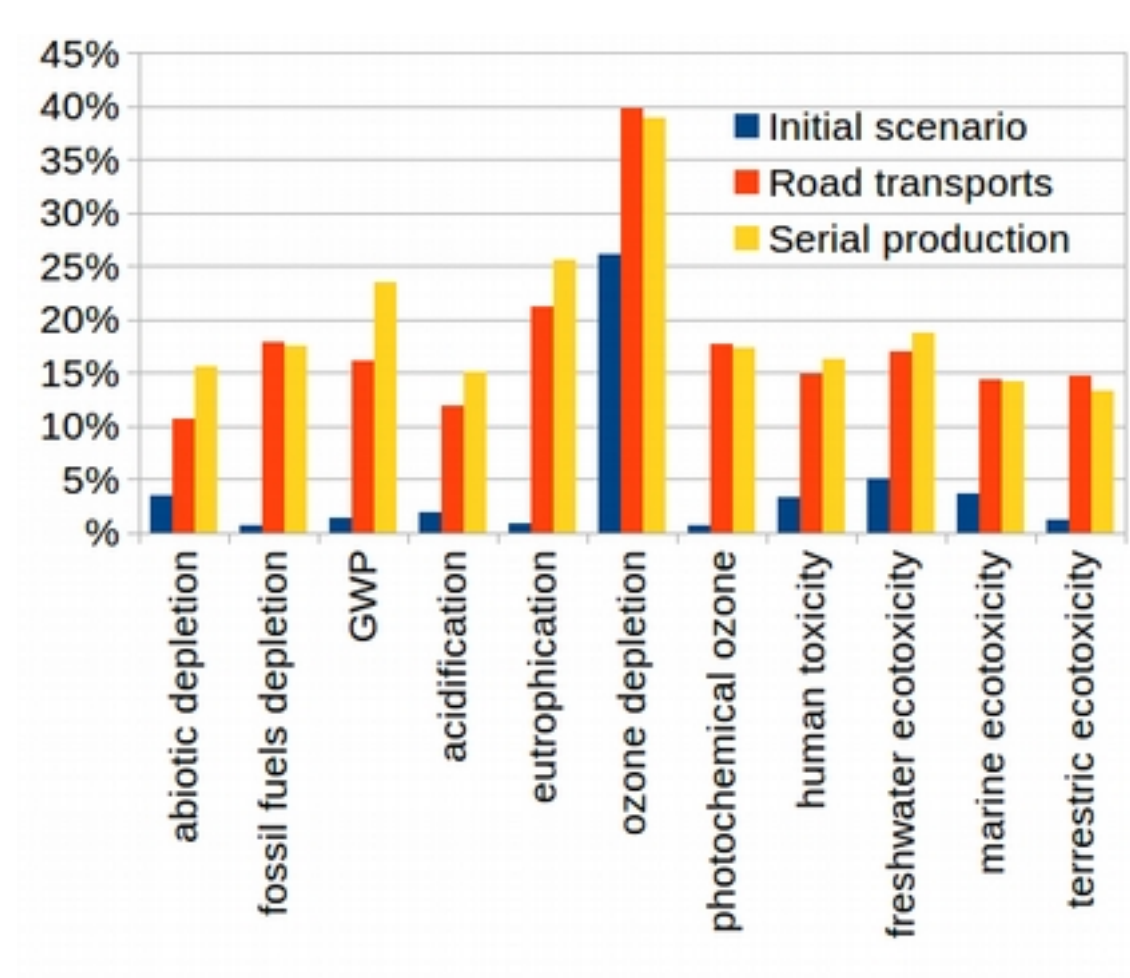

Figure 45: Relative variation of results, calculated from the standard deviation. Comparison shows difference between all the three scenarios with recycling ratio of 50%.

The graph on *Figure 45* shows the comparison of the relative variation in the three scenarios in case of the mix of 50% virgin and 50% recycled HIPP. The variation is calculated as a standard deviation, multiplied by six, following the rule of  $6\sigma$ .

The statistical probability of variation of the processes is very low. *Figure 46* But it should be mentioned, that the approach does not take into account some unresolved LCA issues. (Reap *et al.*, 2008) The quality of the lifecycle model, the choice of the LCIA method and the influence of characterization factors does not enter in the calculation. Their influence was studied in the sensitivity analysis.

Low variations can be explained by a principle of the uncertainty analysis method with regard to the contribution analysis. The method describes a statistical probability of the results variation, based on the quality of the used data. And the processes with the mayor contribution in most of the categories are consumption of virgin plastic, consumption of kerosene (in case of the initial scenario) and electric energy conversion, which represents 70% of impacts in the category of ozone layer depletion potential. Among the used processes, the HIPP granulate and kerosene production are those with the most complete and most relevant description. On the other hand the electric energy conversion cumulates the error of all the processes except virgin HIPP production, transports and packaging.

The error bars on the following graph represent variation of results with probability of 99,7%. The graph on figure 25 takes into account the results for virgin and 100% recycled HIPP. Reliability of results decreases with growing number of hypothesis and assumptions in the two additional scenarios. But except for the category of the ozone layer depletion potential, the tendency of decreasing impacts from virgin to recycled HIPP remains confirmed.

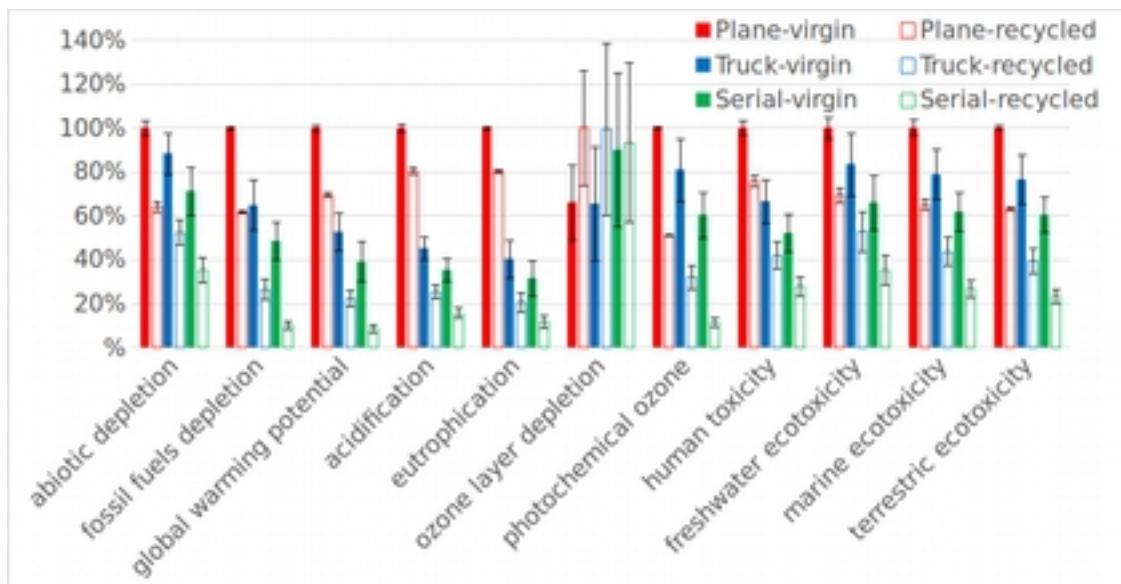

Figure 46: Comparison between the results for virgin and recycled HIPP in all three scenarios. The relative error is expressed with error bars.

### 3.5.6 Improved efficiency through preliminary sensitivity analysis

Time saving is difficult to account for due to the variability of the LCA applications. We cannot know how much time we might have spent on a parameter we did not attempt to search for.

We identified that one of the complementary parameters could never reach the level of significant change in any impact category. A quick estimation based on own experience with goods distribution could be done, without impairing the study.

Stress strain test and lubricating oil consumption were clearly identified as processes that need attention. Electricity consumption by the milling process, that has a relative critical variance higher than 100%, gives some room for substitution or estimation.

Iterativity, which is often perceived as an unpleasant quality that prolongs studies, gives an important advantage in the preliminary sensitivity analysis. Whenever indications of unavailable parameters are found, the sensitivity of the whole study to those parameters can be quickly reviewed, which can aid the decision on whether more accurate research is needed or if current knowledge is sufficient to stop and concentrate on other unknown parameters.

The most interesting result is probably the critical variance of distance from the HIPP granulate producer to the parts production unit. The combination of our qualitative and quantitative approach appears to be ambiguous: one approach indicates that the distance parameter should be given priority over the other parameters; while the other says that whatever the choice, this parameter could never make a significant change to the results.

This is a case of the qualitative criteria protecting good practices in LCA. The goal of the study can be seen as the reason why the study is done. Any other information given by the study is complementary, so even if the parameter may seem unimportant in the sensitivity analysis, we should privilege the quality of the data contributing to the goal of the study. The quantitative result could only be seen as a reassuring argument if the parameter really could not be found and we had to make an estimate.

### **3.6 Conclusions**

The study proved deterioration of HIPP with recycling. It is the polypropylene matrix that loses its qualities with shortening of its polymer chains when rubber parts seem to remain intact. The material becomes more brittle because of the decreasing length of polymer chains.

From the mechanical point of view, which was studied in the work group of professor Bahlouli, the findings agree with other studies (Guerrica-Echevarría, Eguiazábal and Nazábal, 1996; Marrone and La Mantia, 1996; González-González, Neira-Velázquez and Angulo-Sánchez, 1998; Aurrekoetxea *et al.*, 2001; da Costa, Ramos and Rocha, 2005; Rust, Ferg and Masalova, 2006) showing first significant deterioration after five reprocessings. This

concerns melt flow index and traction resistance in large stress domain. The deterioration is mostly linear. Young modulus and yield stress do not seem to show significant deterioration even after the 12th reprocessing.

Changes of melt flow index implies that recycled HIPP has an impact on injection and the material behavior inside the mold. The final product would behave more or less the same no matter if it is made of virgin or recycled HIPP. The difference comes under large constraint, where the recycled HIPP is more brittle. This is important information for parts with programmed distortion. Distortion of virgin bumper would accept more energy than distortion of slightly more brittle recycled bumper.

However, practice in the automotive industry, where recycled HIPP granulate is mixed with virgin HIPP granulate should enlarge the average length of the polymer fibers and compensate the deterioration of the mechanical properties.

Our LCA confirmed the common opinion about recycled plastics. In most impact categories, recycled HIPP shows less impact than the virgin HIPP.

From the environmental point of view, recycling of HIPP has a positive effect on most environmental impact categories except two. In France and other countries with high proportion of nuclear power plants, recycling has a negative influence on the ionizing radiation potential category. But, the increase in electric energy consumption for recycling is in the scale of units of kWh per kg of HIPP. This is negligible compared to the rest of the automotive industry consumption.

The second rising impact category is ozone depletion. The contribution analysis showed the origin of 90% of the impact in this category is the use of CFCs (refrigerants R11 and R114) in nuclear power plants. Use of CFCs is forbidden in European Union since 31th December 2000 (Jacquard and Sandre, 2014). We can suppose that up to now, if not eliminated completely, consumption and emissions in power plants in EU decreased significantly.

Whereas production, transport to client, use phase, and packaging remain constant, the difference lies in saving virgin material on one side and transports and electric energy for reprocessing on the other side. The end of life is also influenced by recycling but its role is more complicated. It participates to pollution while also producing energy and preventing other pollution from energy consumption for electricity production and heating.

The results are even more convincing in the case of estimated serial production *Figure 37*, where the difference between virgin and recycled HIPP gets bigger thanks to eliminating air transport impact from the scale.

Further studies could clarify the influences of mix ratio between virgin and recycled HIPP as an additional parameter.

From the point of view of LCA, further studies could explore deeper the origin of the virgin material and details on the HIPP parts production and transport.

Some conclusions of the LCA methodology, could be useful in other studies:

The preliminary sensitivity analysis have potential not only to benchmark missing data, but also to respond to the issue of negligible contribution. If applied to the data which fulfill cutoff criteria the preliminary sensitivity analysis could verify their potential influence on quantitative results of the study.

Further studies should explore the mathematical issue of variable relations between input data and quantitative results. Afterwards the preliminary sensitivity analysis could be easy to integrate into the LCA software and boost its efficiency.

## 4 CONTRIBUTION: ASSISTED SCENARIO MODELING BY FACTORIZATION OF WORKFLOWS

The last contribution deals with the problem of scenario construction. See *Figure 47*

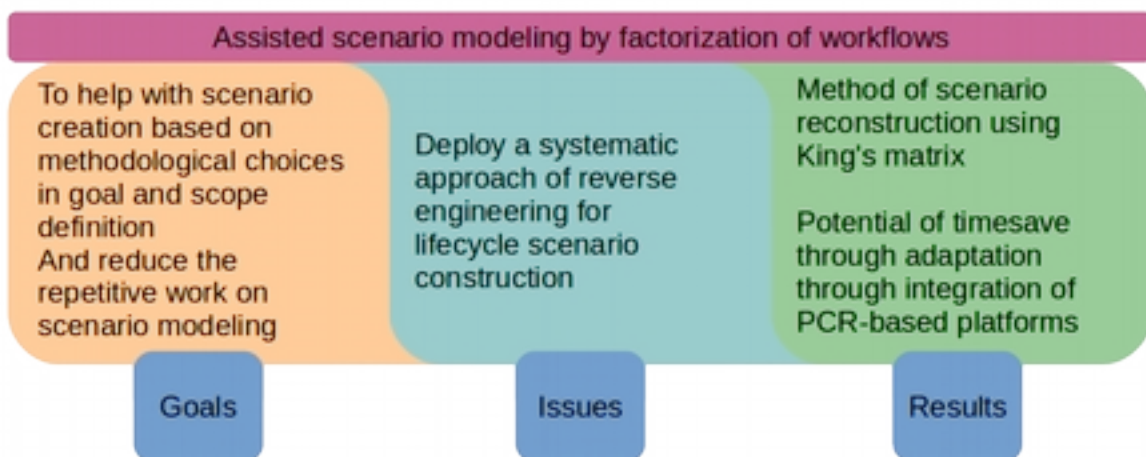

*Figure 47: Purpose and contributions of the workflows factorization method*

The method was elaborated as a part of internship of two students: Ahmed Werfali and Neuman Elouariaghli in our research team. We have used in the methodology unusual approach: Reverse engineering and assisted reconstitution of the lifecycle scenario.



The chapter is organized into six parts:

4.1 Introduction to the issue of scenario construction

4.2 State of the art that targets means of assistance at scenario construction. Besides simplification we find interesting potential in reverse engineering

4.3 Methodology describes in detail the method of flow factorization

4.4 Experimentation is in this case done on a scenario of concrete recycling from the Ecoinvent database.

4.5 Results: This section discuss the obtained results

4.6 Conclusions and perspectives, related to the results

## 4.1 Introduction

Construction of the lifecycle model is a long procedure. The whole lifecycle inventory (LCI) is usually considered to be the longest part of lifecycle assessment (LCA). (Baumann and Tillman, 2004; Kočí, 2009) LCI itself contains construction of the lifecycle model, gathering all the necessary data and making the inventory of all elementary flows. In this study we concentrate on the design of the lifecycle model. It is influenced by many factors. In each case the model represent the whole or part of the studied product's lifecycle. But there are several qualitative factors that influence the concept of the product's lifecycle model. First influence is by the goal and scope definition. Goals of the study are usually determining for the general type of the study. Baumann and Tillmann recognize three basic types of LCA. (Baumann and Tillman, 2004):

- LCA of the accounting type
- LCA of the change-oriented type
- stand-alone LCA

Each is useful in different situation. Each targets the studied product from a different point of view, each requires different level of detail and each will be interpreted different way. Besides the type, the analyst has to decide about the type of recycling he employs, or whether in case of sharing impact or sources he use allocation or he extends the system. If he use allocation, he has to decide what type of allocation, etc. All these decisions have impact on the design of the lifecycle model.

Some of the decisions are specific to the goal and scope definition, others to the studied product. The three main types of LCA are related to the goal and scope definition, other aspects may be relevant as well to the studied product, technological advance, geographical location, etc.

The decisions are very important, because they have direct impact on results, very often there is not only one option and the analyst must take into account more possibilities. For instance the recycling model in our study of HIPP is not the same for any product. In the automotive industry we can consider a closed loop, because the products are large, typically the products

are represented by bumpers. They easy to separate from the End of life vehicles (ELV) and recovered material is used again for production of bumpers or other exterior panels. On the other hand HIPP can be used in various other products, like toys or parts of sport equipment. In these cases of small quantities of the polymer that finish in the household trash, separation is much more delicate than in case of ELV. Mix of various, often polluted polymers which is difficult or economically unbearable to separate finishes in tertiary or quaternary recycling. (Lazarevic *et al.*, 2010; Singh *et al.*, 2016) It can be incinerated, but it can finish as a filler in road pavement or other construction material, rather than become a recycled granulate. (Singh *et al.*, 2016)

## 4.2 State of the art

Construction of the lifecycle scenario flow model is treated by two different ways. Manual construction using LCA software and simplified LCA. Globally, simplified LCA is used in particular cases, while traditional modeling is used in all the other cases.

Manual construction using LCA software can profit of feedback when designing evolution of existing product. Companies that perform LCA repetitively in their product design may simply reuse scenarios. Additionally they usually deal with the same goals and methods and construction of the lifecycle scenario become a routine.

Simplification on the other hand, brings the possibility to open LCA to a wider range of users, but it has four mayor disadvantages.

Firstly, quality of results decrease with growing level of simplifications even if the simplifications may be product-specific. (Lasvaux *et al.*, 2014) Conclusions of some simplified studies are even contradictory to other non-simplified ones. (Spielmann and Althaus, 2007; Volkswagen AG, 2010; Bauer *et al.*, 2015; Danilecki, Mrozik and Smurawski, 2017).

Secondly, because of the quality deterioration the simplifications have to be product-specific. (Bereketli Zafeirakopoulos and Erol Genevois, 2015) There are simplified tools like Solidworks sustainability, which is integrated into a Computer Assisted Design (CAD) software and it automatically evaluates environmental impacts of the designed product. But

their lifecycle scenario, however it is useful in ecodesign, does not allow variation and of the goals or scope of the study.

The third disadvantage is communication. ISO 14040's exigences for communication are not met in the simplified studies. If the results are intended to be communicated, they need to be supported by a traditional LCA, Environmental Product Declaration (EPD), or in the future, independently on ISO 14040, by a Product Environmental Footprint (PEF). (International Organization for Standardization, 2006b; European Commission, 2012; The International EPD®System, 2013)

The last problem is risk of misinterpretation. Non-expert users does not have other opportunities than to believe the results of the tool they are using. But some are difficult to interpret and in hands of non-experimented user they may become misleading.

We find other possibility in Reverse engineering. Inspiration in existing works is part of development. (Eilam, 2005) It is also part of a common practice in LCA. When making the qualitative decisions, analysts often turns to the Reverse engineering and seeks for help in existing studies. Choice between existing solutions and approval is much faster than design of a new solution. Once the qualitative decision taken, the model construction is a repetitive activity which open a possibility to automation.

What we are searching is inspiration and not entire copying, because our objective is to accelerate the study and eventually bring computer assistance to a part of it, but not to suppress the methodological decisions. In this study we do not search to open LCA to the non experts. On the contrary we intend to keep the same requirements for the user's knowledge and experiences with LCA.

Initial situation:

- Long LCI phase – particularly repetitive activity in the lifecycle model construction

Existing solutions:

- Solidworks – Automatic simplified LCA of a CAD model.
- Simplified LCAs – Automatic or assisted LCA of a product with fix scenario

Opportunities of the parametric approach

- Automatic reconstitution of a lifecycle based on a reference scenario

### **4.3 Methodology**

For improvements we prefer reverse engineering to simplification. Analyst searching for inspiration in existing studies work in following order:

- Search for compatible existing studies
- Considering approaches to be used in the new study
- Identification of common points between the reference case and the case of the new studied product
- Construction of the new scenario

The first two points are qualitative and individual. But the last two are mechanical and repetitive and thus they present an opportunity to be computer assisted.

Thanks to the parametric approach in the LCA software and modularity of the LCI datasets, the processes used in various lifecycle scenarios are used repetitively. We can thus compare

processes in the existing reference scenario with those that are needed for the newly studied product and simply reuse them in the new scenario.

The reference and new studies have a big part of identical processes, but never all of them. If done manually, the analyst adds new processes progressively when making the scenario. This would not be possible in automation, thus the result would always be an incomplete scenario, a schema that needs to be finished. With these particularities the automatic scenario construction would be done in following order:

- Search for compatible existing studies
- Considering of approaches to be used in the new study
- Automatic creation of new scenario, based on the reference product
- Completing the flow model – adding the particular processes

We have found two ways of dealing with the automatic scenario reconstitution.

- Two-step model with research of identical processes in the first step and copying the new ones in the second step
- Using of King's algorithm. In form of matrix it can do the identification and recopying only using one mathematical principle.

We have chosen the King's matrix as a more elegant solution. When using the King's matrix, the first thing we need is linear order of the reference scenario's processes. To do so we chose a method called process Value stream mapping. (Carreira and Trundell, 2006) This method from Lean manufacturing helps us to identify systematically linear successions of processes, which are necessary for use of the King's matrix. With the parametric approach in the LCA software it is easy to factorize the scenario into processes. In our first approach we kept only the basic information concerning the processes *Figure 48*:

- Process (any kind of transformation, like production, use, sorting, etc.)
- Transport

- Energies and raw materials

Energies and raw materials make always extremities of process stream.

Transports make always connection between processes or energies/materials

Processes may be intermediate or final.

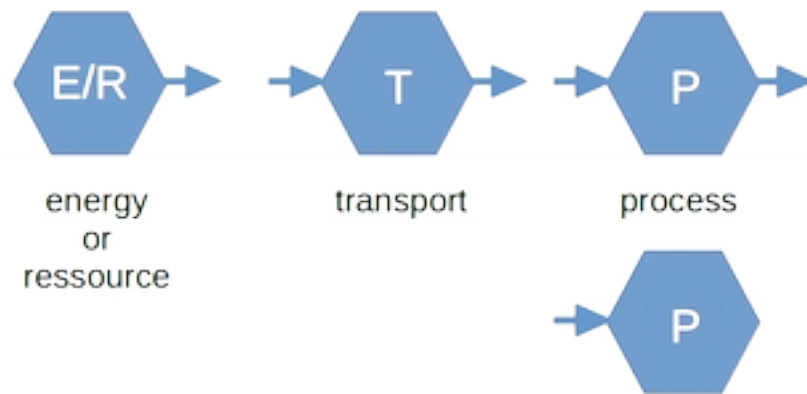

Figure 48: Typology of processes for the value stream mapping

Linear process stream can be than used in the King's matrix, making in each column (noted “*i*”) the coefficient “*w*” dependent on the process position in the reference scenario. The coefficient is calculated as:

$$w_i = 2^{m-i}$$

where “*i*” is number of the column and “*m*” is number of the process position in the process stream.

In this case we don't seek for flow optimization, therefore the index of new processes, usually noted “*v*” is set to 0 and we do not use horizontal iterations, otherwise we would change the logic of the reference scenario. *Figure 50*

In the first step the matrix is completed with reference processes in the horizontal line and new processes in the column. The cells, noted “*a<sub>ij</sub>*” gain value of 1 if the intersection corresponds to equivalent processes, otherwise its value is 0. *Figure 49*

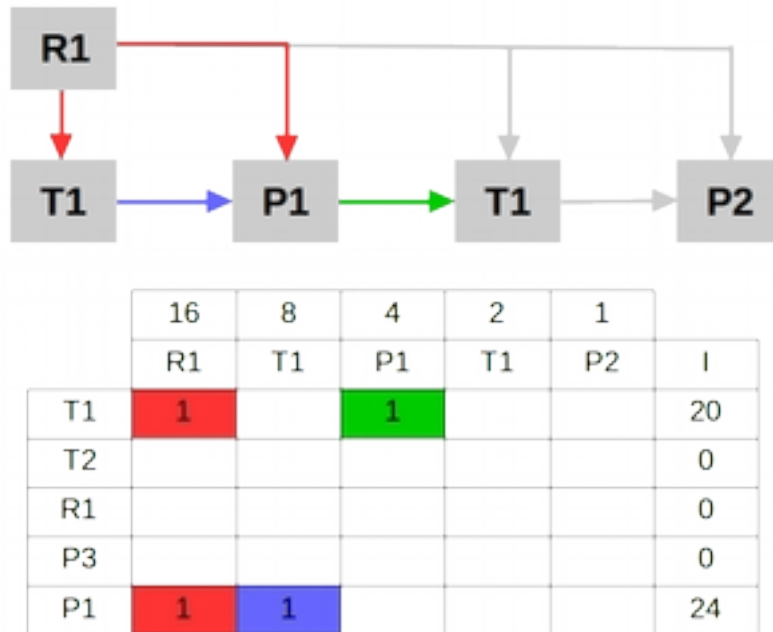

Figure 49: Construction of the King's matrix

Second step is completing indicators  $I$  and  $C$ .

The indicator  $I$  in the line  $j$  is calculated as follows:

$$I_{(j)} = \sum(a_{ij} \cdot w_i)$$

As the coefficient  $v$  is set to 1, the coefficient  $C$  corresponds only to sum of  $a_{ij}$ :

$$C_{(i)} = \sum(a_{ij})$$



|                               |    |   |            |    |    |    |   |    |
|-------------------------------|----|---|------------|----|----|----|---|----|
| Initial matrix                |    | Indicator „w” according to the position of the process in the process stream: $w_i = 2^{m-i}$ |            |    |    |    | Coefficient „I”<br>$I_{(i)} = \sum(a_{ij} \cdot w_j)$ |    |
| Reference scenario            |    | 16  | 8          | 4  | 2  | 1  |   |    |
|                               |    | R1  | T1         | P1 | T1 | P2 |   | I  |
| Processes of the new scenario | T1 | $a_{11}=1$  | $a_{12}=0$ | 1  |    |    |   | 20 |
|                               | T2 |   |            |    |    |    |   | 0  |
|                               | R1 |   |            |    |    |    |   | 0  |
|                               | P3 |   |            |    |    |    | 0   |    |
|                               | P1 | 1   | 1          |    |    |    | 24  |    |

|                 |    |    |    |    |    |    |    |
|-----------------|----|----|----|----|----|----|----|
| First iteration |    | 16 | 8  | 4  | 2  | 1  |    |
|                 |    | R1 | T1 | P1 | T1 | P2 | I  |
|                 | P1 | 1  | 1  |    |    |    | 24 |
|                 | T1 | 1  |    | 1  |    |    | 20 |
|                 | R1 |    |    |    |    |    | 0  |
|                 | P3 |    |    |    |    |    | 0  |
|                 | T2 |    |    |    |    |    | 0  |

Figure 50: Solution of the King's matrix, adapted for reconstruction of lifecycle scenarios

Third step is to organize the lines in decreasing order by the coefficient  $I$ . Contrary to the use of King's matrix for optimization, in our case the first iteration is always also the last one.

Fourth and last step is to rebuild the new scenario. We are starting always from the left column and we add a flow and the process from the corresponding line for each  $a_{ij} = 1$ . See Figure 51.

|    | 16 | 8  | 4  | 2  | 1  |    |
|----|----|----|----|----|----|----|
|    | R1 | T1 | P1 | T1 | P2 | I  |
| P1 | ←1 | ←1 |    |    |    | 24 |
| T1 | ←1 |    | ←1 |    |    | 20 |
| R1 |    |    |    |    |    | 0  |
| P3 |    |    |    |    |    | 0  |
| T2 |    |    |    |    |    | 0  |

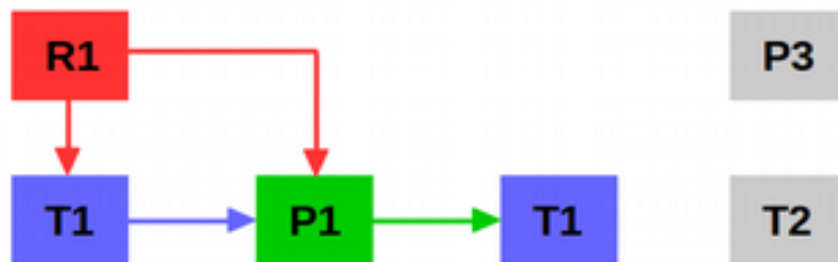

Figure 51: Construction of the new scenario

Result is incomplete linear process stream of new scenario. Incomplete, because only compatible processes are assembled in the new stream. The stream has to be reassembled into the scenario and completed with remaining processes.

This approach requires mapping of the process stream and the result is quite generic. But it is able to place the principal processes in coherence with the goals of the reference scenario. The model opens also opportunities.

In case of automation, the algorithm could directly choose processes in the geographical location of the newly modeled product and contrary to simple reuse of existing scenario the proposed method prevent forgetting any unrelated process in the new scenario.

We can find opportunity of application in the Product Category Rules (PCR)-based systems, like EPD or PEF. PCRs impose several methodological choices in order to insure comparability. (European Commission, 2012; The International EPD®System, 2013) That implies also similarities in the lifecycle scenarios. In future development we could base the

reference scenarios not on an existing product, but directly on a reference scenario, designed for the concerned PCR.

#### 4.4 Experimentation

For experimentation we borrowed two lifecycle scenarios. One concrete recycling (*Figure 52 and Figure 53*) and one of plastic recycling/ The objective of this study was to practice the method on a real case. We could therefore preserve the whole goal and scope definition of the reference LCA and focus only on the LCI phase. See the reference scenario on *Figure 52*.

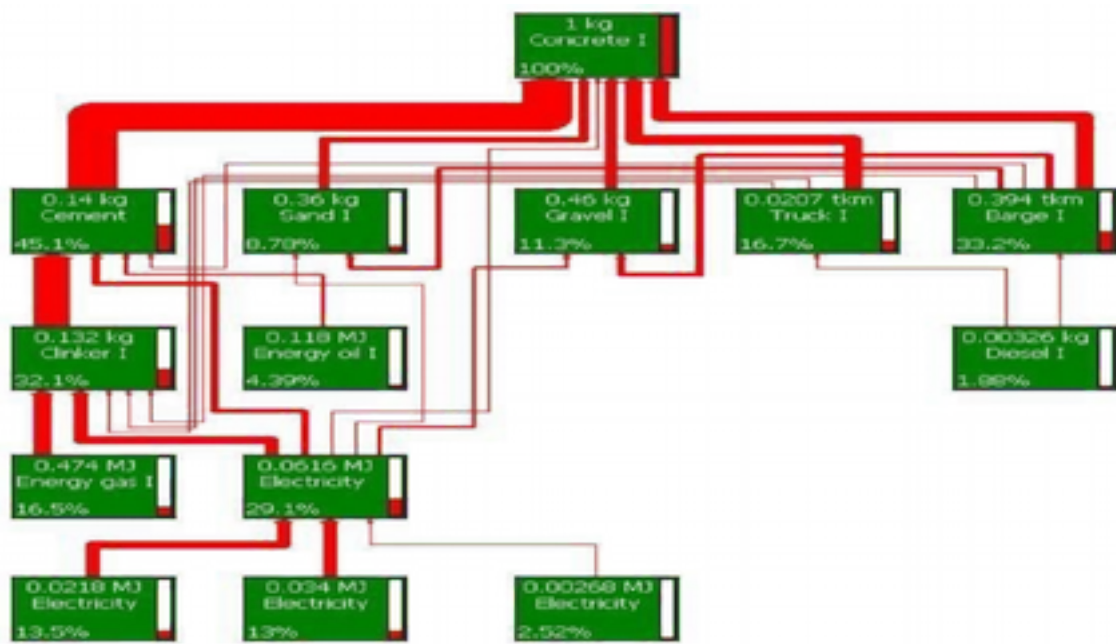

Figure 52: Reference scenario of concrete recycling

As described in the methodology we have constructed and resolved the King's matrix. *Figure 53*

|                         | RM <sub>crude oil</sub> | RM <sub>oak</sub> | P <sub>crude oil</sub> | RM <sub>electricity</sub> | TR <sub>barge</sub> | P <sub>dinker</sub> | P <sub>cement</sub> | P <sub>slag</sub> | P <sub>slag</sub> | TR <sub>truck</sub> | TR <sub>truck</sub> | P <sub>scrap iron</sub> | TR <sub>train</sub> |
|-------------------------|-------------------------|-------------------|------------------------|---------------------------|---------------------|---------------------|---------------------|-------------------|-------------------|---------------------|---------------------|-------------------------|---------------------|
| P <sub>crude oil</sub>  | 1                       | 0                 | 0                      | 0                         | 0                   | 0                   | 0                   | 0                 | 0                 | 0                   | 0                   | 0                       | 0                   |
| TR <sub>barge</sub>     | 0                       | 1                 | 1                      | 0                         | 0                   | 0                   | 0                   | 0                 | 0                 | 0                   | 0                   | 0                       | 0                   |
| TR <sub>train</sub>     | 0                       | 1                 | 0                      | 1                         | 0                   | 0                   | 0                   | 0                 | 0                 | 0                   | 0                   | 0                       | 0                   |
| TR <sub>truck</sub>     | 0                       | 1                 | 0                      | 0                         | 0                   | 0                   | 0                   | 0                 | 0                 | 0                   | 0                   | 0                       | 0                   |
| TR <sub>truck</sub>     | 0                       | 1                 | 0                      | 0                         | 0                   | 0                   | 0                   | 0                 | 0                 | 0                   | 0                   | 0                       | 0                   |
| P <sub>cement</sub>     | 0                       | 0                 | 0                      | 1                         | 1                   | 1                   | 0                   | 0                 | 0                 | 0                   | 0                   | 0                       | 0                   |
| P <sub>concrete</sub>   | 0                       | 0                 | 0                      | 1                         | 1                   | 0                   | 1                   | 1                 | 0                 | 0                   | 0                   | 0                       | 0                   |
| P <sub>scrap iron</sub> | 0                       | 0                 | 0                      | 1                         | 1                   | 0                   | 0                   | 0                 | 0                 | 1                   | 0                   | 0                       | 0                   |
| P <sub>slag</sub>       | 0                       | 0                 | 0                      | 1                         | 1                   | 0                   | 0                   | 0                 | 0                 | 0                   | 0                   | 0                       | 0                   |
| P <sub>dinker</sub>     | 0                       | 0                 | 0                      | 0                         | 1                   | 0                   | 0                   | 0                 | 1                 | 1                   | 0                   | 0                       | 0                   |
| P <sub>slag</sub>       | 0                       | 0                 | 0                      | 0                         | 1                   | 0                   | 0                   | 0                 | 0                 | 1                   | 1                   | 1                       | 1                   |

Figure 53: King's matrix of concrete recycling

The new scenario follows the logic of the reference one, but it is missing about half of the flows. See the new scenario on Figure 54.

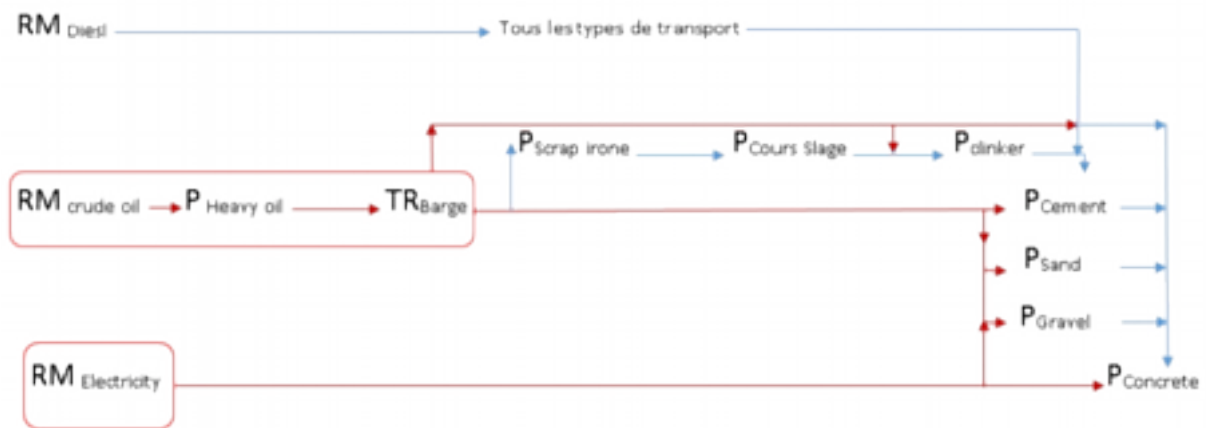

Figure 54: Reconstructed scenario of recycled concrete

## 4.5 Results

The reconstructed scenarios follow the logic of the reference ones. If methodological issues, like type of recycling or conception of transports are treated in the initial scenario and the new one contains related processes, the solution appears also in the new scenario.

On the other hand, reduction of repetitive work on the new product's scenario is less promising. For 80% of preserved processes they have lost 50% of the initial flows. The

reconstructed scenarios need to be remodeled in the LCA software and completed. If the method was integrated into the LCA software, the repetitive work would be reduced, but certainly not eliminated.

One advantage can be found in reduction of flows. Only relevant flows are kept in the reconstructed scenario, preventing the risk of leaving a flow irrelevant to the new product.

During the test we have measured modeling duration of each model. Compared to the traditional modeling, beginning with the reconstructed scenario we have saved about 30% of time.

## **4.6 Conclusions and perspectives**

The method has a strong potential of automation, but we still have to count with preparation in form of research of reference process and its process stream mapping.

In this case the method would be globally counterproductive.

On the other hand until now we have not explored the potential of integration into the PCR-oriented platforms, like EPD<sup>®</sup> International or PEF. Their orientation on comparability imply standardization of the product function definition, reference flow, cut-off criteria, allocation, global concept and several details concerning the lifecycle model. This should be sufficient for a solid ready-made reference scenario per PCR.

Further research could show explore two ways of scenario construction based on a PCR:

1. Traditional modeling with a solid reference scenario at disposition
2. Remodeling with use of the King's algorithm

If the reference model and process flow are related to the PCR, they would not compromise any more the reduction of repetitive work on the scenario construction.

## 5 CONCLUSIONS AND PERSPECTIVES

The last chapter starts with general conclusion going through the research from the main question to the results of our contributions and I continue with detailed conclusion for each of our contributions.

- Preliminary sensitivity analysis 5.2
- Workflows factorization 5.3
- HIPP recycling LCA and mechanical study 5.4

Even if the preliminary sensitivity analysis and the HIPP recycling mechanical and LCA study are part of one case study we keep them separate, because each of them has different purpose.

The session 5.5 present the perspectives in relation to the field of application: industry or research and in relation to the object of study: product or process.

## 5.1 General conclusions

*Figure 55* shows evolution of the research from the main question to the results, following the figure from top to the bottom and from left to the right:

Our preoccupation in LCA is the time schedule which is very restrictive for use of LCA in production industry. Therefore we have been searching for a response to the main **goal** of the research: “How to make Lifecycle assessment (LCA) faster and easier accessible for manufactured product design?” For this issue the most appropriate phase to improve is LCI, because goal & scope definition and interpretation are very individual and duration of LCIA is resolved by the ready-made LCIA methods.

In LCI we have identified five **issues**, two of them as direct time consumers: “Management of missing data” and “construction of the lifecycle scenario”. And we have searched for methods to respond to them, but without compromising the results quality. Each of the issues led to one of the **contributions**.

The **concepts** we have explored in research of solutions for the given issue are simplifications and parametric approach. But we only have followed the parametric approach, because simplifications are less universal and they have bad influence on the result's quality.

Parametric models we can find in the literature allowed us to build on existing concepts, like preliminary sensitivity analysis or reverse engineering. These two allowed us to develop approaches, making the LCI phase faster.

As **results** we have methods of preliminary sensitivity analysis with LCA Poka-Yoke and method of assisted scenario creation through workflows factorization.

The first contribution: LCA of HIPP recycling, brought us also to a practical use of LCA in the field of automotive industry.

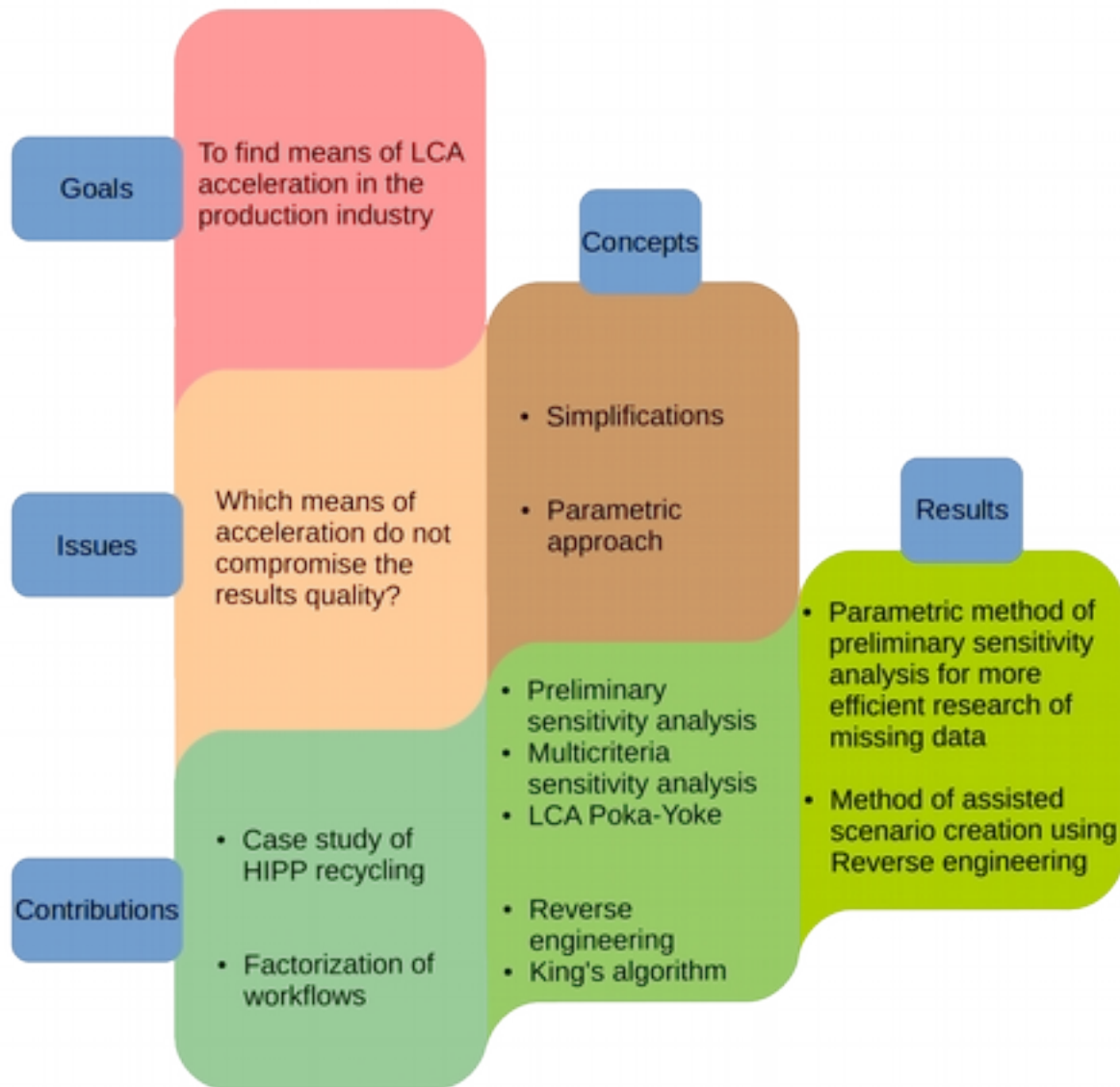

Figure 55: Development of the research

We have responded to the main question of the research by two contributions.

Parametric method of preliminary sensitivity analysis allows better time efficiency through possibility of organization. From the initial unsatisfactory situation: “Lack of a method to benchmark missing data” we arrived to a solution in: “Parametric method of preliminary sensitivity analysis”. Besides saving time on the less important missing data, focus on the most important ones contribute on improvement of the results quality.

The method of workflows factorization has less promising results. From the initial unsatisfactory situation: “Long and repetitive modeling of lifecycle scenario” we moved to a



situation where we have a method of assisted scenario creation using reverse engineering, but until now we have not managed to accelerate the study. Nevertheless the method still have interesting perspectives in integration of PCRs, which could allow a significant time-save.

In both contributions we dealt with the scientific locks in two levels.

In case of the missing data issue, multicriteria preliminary sensitivity analysis was a response to the problem “How to benchmark a missing data?” by classification according to their impact on results of the study. Using an example: A length of a transport by truck, which has to be multiplied by 1000 to make a significant difference to any result of the study, gets less priority than energy consumption, which makes a significant difference when rising only by 11%. But it opened a new lock: How to deal with quantitative and qualitative dimensions? To solve this one, we have borrowed a quality management tool: Poka-Yoke, which we have adapted to the preliminary sensitivity analysis, see the chapter 3.3.3. The LCA Poka-Yoke prevents neglecting any qualitatively important data by giving priority to these that participate on the goals of the study.

In case of the scenario construction issue, we found response to lack of methods in the concept of Reverse engineering. In fact, we have avoided the highly individual translation of methodological choices by getting inspiration in existing models. This opened a new lock: How to transform an existing reference scenario into a new one? We have dealt with this one with the King's algorithm. It allowed us to reassemble part of the processes of the new product, following the logic of the reference scenario.

## **5.2 High Impact Polypropylene recycling**

The case study confirms deterioration of HIPP during recycling process and clarify particular impacts to the HIPP's mechanical properties. It explains also mechanism of deterioration: shortening of the polypropylene chains. The rubber particles seemed unchanged even after 12th recycling. This part wouldn't be possible if we had tested different ratios between virgin and recycled HIPP. In industry, use of entirely homogeneous recycled plastic is not common. Suppliers can not guarantee origin of their material and whether it was already recycled before or not. Therefore number of recycling processes can not be influenced. But in practice,

recycled HIPP with unknown number of previous recycling cycles is mixed with virgin material. This makes grow the average length of polymer chains, but it also makes the length more heterogeneous. Therefore further study should explore the impacts of variations of the recycled matter ratio. This would be of course much more challenging, because contrary to the initial study, we are adding two more parameters: Ratio between virgin and recycled HIPP and composition of the recycled one.

The environmental study shows why recycling reduces the most impacts to the environment and its results are compatible with typical use of HIPP in the automotive industry. Results of further mechanical study could be followed by a new LCA study. Further case should respect the typical use (bumpers) more precisely, especially separation of used parts from end-of-life vehicles could be better described. Moreover, between realization and publication of the study, the LCI databases have been updated. Newer data could change some of the conclusions. We can see that on the category of ozone depletion potential. In the latest PE-International database the unit process blackbox of nuclear power plant does not have any significant emission of refrigerants R11 and R114, which are responsible for growing indicator of ozone depletion potential with growing ratio of recycled HIPP. In further study we will also use a different LCIA methodology, because CML has no update since 2009 and it is already outdated.

### **5.3 Preliminary sensitivity analysis**

Preliminary sensitivity analysis proved itself very useful in the beginning of the LCI phase. Benchmark of the missing data can help also to improve the data quality, thanks to more resources spent on the most relevant data.

We can find ways of improvement of the method itself mainly in the mathematical way. Application of the 6th parametric model is made easier by specification of the significant impact. But still it faces a problem of the tendency variability.

It is a curse and a blessing in the same time that the LCIA methods we are using in this work are based on linear equations. (Dreyer and Hauschild, 2003; Guinée *et al.*, 2004; Goedkoop *et al.*, 2013) Curse, because the world we are studying is anything but linear. Blessing, because

it simplifies work with the results. However, it is not a rule. Parametrization in the lifecycle model is not limited and the relation between the missing parameter and results of the study can take any form and eventual automation of the method has to deal with it.

An additional improvement can be including test of negligible contributions. The method is already prepared to do so and we will use it in the next case study. But treatment of missing data and negligible contribution should probably not be inseparable. The reason is in the very objective for which we have developed this method: Time schedule. While modeling the lifecycle scenario with inclusion of the missing data requires only supplementary estimations, dealing with negligible contributions might result in significant changes to the model.

Third opportunity may lie in integration with one of the PCR-based platforms. Especially the PEF/OEF, which are oriented to comparability of quantitative results, are more precise in the PCR definition and each product category could carry a predefined the qualitative part of preliminary sensitivity analysis.

#### **5.4 Assisted scenario modeling by factorization of workflows**

The method of assisted scenario modeling has certain potential to accelerate the LCI phase, but the timesave is compromised by preparations within the method itself. We do not see intended use of this method as probable. But it seems the method can be useful in use with PCR-based platforms. Orientation to a product category could allow us to prepare an universal reference scenario already in form of linear process streams, necessary for use of the King's matrix.

This means change of the initial purpose of the method, because in the PCR the methodological choices are already suggested or imposed. The new objective is saving a part of the repetitive activity in the scenario modeling.

We will also have to consider other possible principles of the scenario reconstruction, because other way may be able to preserve more than half of the relevant flows. Other approach might be total automation, like in the case of the sustainability module in Solidworks. In any way we should preserve at least the user's possibility of control and modification of the scenario.

## 5.5 Perspectives

In our research and related subjects we find eight perspectives for further research and development. We divide them according to field of their potential application to industrial and research perspectives. Second division is according to the object of the research: Product or process. See the *Figure 56*.

|         | Industrial perspectives  | Research perspectives  |
|---------|--|--|
| Product | Creation of library for LCA Poka-Yoke, based on PCRs                   | Possibilities of light LCA for Lean and Green approach   |
| Process | Design of a workflows database for scenario reconstruction             | Development of metrics for performance of LCA  |
|         | Integration of LCA into ISO 14001 (2015) Simplified LCA based on PCRs  | Application of preliminary sensitivity analysis to the issue of negligible contribution  |
|         | Find a fast link between the LCI databases and reconstructed scenarios | Mathematical modeling of relation between input data and results of an LCA → mathematical model for preliminary sensitivity analysis |

*Figure 56: List of perspectives divided by affiliation to objective and field of application*

### 5.5.1 Industrial perspectives

- **Creation of library for LCA Poka-Yoke** builds on the method of preliminary sensitivity analysis. The qualitative approach needs to set rules to separate significant parameters from the complementary ones. This is done according to the goal and scope definition, but with the existing PCRs we could make a library of product specific rules for the most common goals.
- **Design of workflows database for scenario reconstruction** builds on the second contribution: Workflows factorization method. One inconvenient of the method is long research of the reference scenario and preparation of the reference process stream. We

might build a universal database for the workflows defined in the PCRs. This research could lead to a library of reference workflows, scenarios and process streams.

At present there is no methodology to choose the right reference scenario or to make an universal reference scenario according to a PCR. Therefore the first thing to address is the process of reference scenario building and categorization with regard to the product category, but also to the most common goals of the study.

- **Integration of LCA into ISO 14001 (2015) Simplified LCA based on PCRs:** The latest norm ISO 14001 introduces mandatory lifecycle perspective into performance evaluation. (International Organization for Standardization, 2015) Implementation of LCA or similar tool could be difficult for SMEs. A lighter tool might help them. The PCR approach could allow to make a simplified LCA tool, respecting different product categories and orientation to the norm ISO 14001 could lead to homogenization of the goals of the studies. These predispositions could be sufficient for a simplified LCA tool, providing results that meets quality requirements of ISO 14001 (2015).
- **To find a fast link between the LCI databases and reconstructed scenarios:** The last industrial perspective based on the second contribution targets the problem of repetitive mechanical activity, which is the scenario modeling. Choice of processes to integrate into the modeled scenario is long and repetitive, but not independent on the product category, geographical and temporal location, used materials and other product-related properties. Link between them and computer assistance could lead to better time efficiency of LCA modeling.

### 5.5.2 Research perspectives

- **Light LCA for Lean and Green approach:** The Lean and Green approach represents an excellent opportunity of ecodesign integration to the industry. Latest approach, presented by Verrier et al. builds survey of environmental impacts on carbon footprint. (Verrier, Rose and Caillaud, 2016). But environmental impacts are much more complex and insufficiency of a single impact category can be even proved on our case

study of recycled HIPP. The research should deal with need of a quick assessment and multitude of impact categories.

- **Development of metrics for performance of LCA:** LCA is a powerful tool for decision making, searching for unknown aspects of the product and of course assessing its impacts. But we don't measure efficiency of LCA itself. Metrics could help more efficient use and development of the methodology.
- **Application of preliminary sensitivity analysis to the issue of negligible contribution:** One of the issues of negligible contribution, described in chapter 2.3.1 is, that we cannot be sure whether the data corresponding to the criteria of negligible contribution really negligible are. Cutoff criteria can not be avoided without making the study impossibly complex. But a part of them could be studied on the same principle as the preliminary sensitivity analysis – quick estimations. The research could study conceivable benefices and impact of such extension to the time schedule of the LCA studies.
- **Mathematical modeling of relation between input data and results of an LCA:** In our testing case study, the relation between the estimated input parameter and between the quantitative result, were all linear. See chapter 3.5.1. In such case it is easy to calculate the critical parameter variance to achieve a critical result variance. But linearity of this relation is not a rule. With only one free parameter at a time, we can only be sure that the relation is described by a function, but we don't know which one, as described on *Figure 57*.

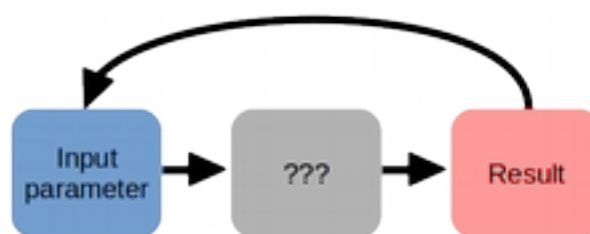

*Figure 57: Schema of the preliminary sensitivity analysis parametric model*

The research should uncover method to find the function that describe the relation between input and result, or to find an appropriate simulation.

## LITERATURE

- Addiego, F., Dahoun, A., G'Sell, C. and Hiver, J.-M. (2006) 'Characterization of volume strain at large deformation under uniaxial tension in high-density polyethylene', *Polymer*, 47(12), pp. 4387–4399. doi: 10.1016/j.polymer.2006.03.093.
- ADEME (2010) *Ecoville : Jeu de simulation et de ressources pédagogiques*. Available at: <http://www.ademe.fr/ecoville-jeu-simulation-ressources-pedagogiques> (Accessed: 11 October 2016).
- Aurrekoetxea, J., Sarrionandia, M. A., Urrutibeascoa, I. and Maspoch, M. L. (2001) 'Effects of recycling on the microstructure and the mechanical properties of isotactic polypropylene', *Journal of Materials Science*, 36(11), pp. 2607–2613. doi: 10.1023/A:1017983907260.
- Azari, R. (2014) 'Integrated energy and environmental life cycle assessment of office building envelopes', *Energy and Buildings*, 82, pp. 156–162. doi: 10.1016/j.enbuild.2014.06.041.
- Azari, R., Garshasbi, S., Amini, P., Rashed-Ali, H. and Mohammadi, Y. (2016) 'Multi-objective optimization of building envelope design for life cycle environmental performance', *Energy and Buildings*, 126, pp. 524–534. doi: 10.1016/j.enbuild.2016.05.054.
- Bahlouli, N., Pessey, D., Ahzi, S. and Rémond, Y. (2006) 'Mechanical behavior of composite based polypropylene: Recycling and strain rate effects', *Journal de Physique IV*, 134, pp. 1319–1323. Available at: <http://dx.doi.org/10.1051/jp4:2006134200>.
- Bauer, C., Hofer, J., Althaus, H.-J., Del Duce, A. and Simons, A. (2015) 'The environmental performance of current and future passenger vehicles: Life cycle assessment based on a novel scenario analysis framework', *Applied Energy*, 157, pp. 871–883. doi: 10.1016/j.apenergy.2015.01.019.
- Baumann, H. and Tillman, A.-M. (2004) *The Hitch Hiker's Guide to LCA*. Lund: Studentlitteratur.
- Beccali, M., Cellura, M., Longo, S. and Guarino, F. (2016) 'Solar heating and cooling systems versus conventional systems assisted by photovoltaic: Application of a simplified LCA tool', *Solar Energy Materials and Solar Cells*, 156, pp. 92–100. doi: 10.1016/j.solmat.2016.03.025.
- Benetto, E., Dujet, C. and Rousseaux, P. (2008) 'Integrating fuzzy multicriteria analysis and uncertainty evaluation in life cycle assessment', *Environmental Modelling & Software*, 23(12), pp. 1461–1467. doi: 10.1016/j.envsoft.2008.04.008.
- Bereketli Zafeirakopoulos, I. and Erol Genevois, M. (2015) 'An Analytic Network Process approach for the environmental aspect selection problem — A case study for a hand blender', *Environmental Impact Assessment Review*, 54, pp. 101–109. doi: 10.1016/j.eiar.2015.05.002.
- Biron, M. (2014) *Thermosets and Composites, Thermosets and Composites*. Elsevier. doi: 10.1016/B978-1-4557-3124-4.00001-8.



- Björklund, A. E. (2002) 'Survey of approaches to improve reliability in lca', *The International Journal of Life Cycle Assessment*, 7(2), pp. 64–72. doi: 10.1007/BF02978849.
- Bonamente, E., Merico, M. C., Rinaldi, S., Pignatta, G., Pisello, A. L., Cotana, F. and Nicolini, A. (2014) 'Environmental Impact of Industrial Prefabricated Buildings: Carbon and Energy Footprint Analysis Based on an LCA Approach', *Energy Procedia*. Elsevier, 61, pp. 2841–2844. doi: 10.1016/j.egypro.2014.12.319.
- Bonou, A., Olsen, S. I. and Hauschild, M. Z. (2015) 'Introducing life cycle thinking in product development – A case from Siemens Wind Power', *CIRP Annals - Manufacturing Technology*, 64(1), pp. 45–48. doi: 10.1016/j.cirp.2015.04.053.
- Borland, N. (1998) *Integrating environmental impact assessment into product design*. Massachusetts Institute of Technology. doi: 41961965.
- Borland, N. and Wallace, D. (1999) 'Environmentally Conscious Product Design: A Collaborative Internet-based Modeling Approach', *Journal of Industrial Ecology*. MIT Press, 3(2–3), pp. 33–46. doi: 10.1162/108819899569539.
- Bovea, M. D. and Pérez-Belis, V. (2012) 'A taxonomy of ecodesign tools for integrating environmental requirements into the product design process', *Journal of Cleaner Production*, 20(1), pp. 61–71. doi: 10.1016/j.jclepro.2011.07.012.
- Carreira, B. and Trundell, B. (2006) *Lean Six Sigma that works : a powerful action plan for dramatically improving quality, increasing speed, and reducing waste*. New York: Amacom. Available at: <https://bu.unistra.fr:443/.do?idopac=BUS1279702>.
- Cluzel, F., Yannou, B., Leroy, Y. and Millet, D. (2011) 'Towards Parametric Environmental Profiles of Complex Industrial Systems in Preliminary Design Stage', in *ASME 2011 International Design Engineering Technical Conferences and Computers and Information in Engineering Conference*. Washington, DC, USA: ASME, p. 10. doi: ISBN: 978-0-7918-5482-2.
- Cognard, J. (2000) *Science et technologie du collage*. Lausanne: PPUR presses polytechniques.
- da Costa, H. M., Ramos, V. D. and Rocha, M. C. G. (2005) 'Rheological properties of polypropylene during multiple extrusion', *Polymer Testing*, 24(1), pp. 86–93. doi: 10.1016/j.polymertesting.2004.06.006.
- Curran, M. A. (2015) *Life Cycle Assessment Student Handbook*. New Jersey: John Wiley & Sons. Available at: [https://books.google.fr/books?id=hCsmCgAAQBAJ&dq=Midwest+Research+Institute+\(MRI\)+coca+cola+assessment+1969&hl=cs&source=gbs\\_navlinks\\_s](https://books.google.fr/books?id=hCsmCgAAQBAJ&dq=Midwest+Research+Institute+(MRI)+coca+cola+assessment+1969&hl=cs&source=gbs_navlinks_s).
- D'Orazio, L., Greco, R., Martuscelli, E. and Ragosta, G. (1983) 'Effect of the addition of EPM copolymers on the properties of high density polyethylene/isotactic polypropylene

blends: II. Morphology and mechanical properties of extruded samples', *Polymer Engineering & Science*, 23(9), pp. 489–497.

Daimler AG Mercedes-Benz Cars (2009) *Life cycle Environmental Certificate for the S 400 HYBRID*. Sindelfingen. Available at: [https://www.daimler.com/Projects/c2c/channel/documents/2003777\\_Environmental\\_Certificate\\_Mercedes\\_Benz\\_S\\_400\\_HYBRID.pdf](https://www.daimler.com/Projects/c2c/channel/documents/2003777_Environmental_Certificate_Mercedes_Benz_S_400_HYBRID.pdf).

Dallara, E., Kusnitz, J. and Bradley, M. (2013) 'Parametric Life Cycle Assessment for the Design of Aircraft', *SAE International Journal of Aerospace*, 6(2), pp. 736–745. doi: 10.4271/2013-01-2277.

Danilecki, K., Mrozik, M. and Smurawski, P. (2017) 'Changes in the environmental profile of a popular passenger car over the last 30 years – Results of a simplified LCA study', *Journal of Cleaner Production*, 141, pp. 208–218. doi: 10.1016/j.jclepro.2016.09.050.

Dombrowski, U., Schmidt, S. and Schmidtchen, K. (2014) 'Analysis and Integration of Design for X Approaches in Lean Design as basis for a Lifecycle Optimized Product Design', *Procedia CIRP*. Elsevier, 15, pp. 385–390. doi: 10.1016/j.procir.2014.06.023.

Dreyer, L. C. and Hauschild, M. Z. (2003) 'Comparison of Three Different LCIA Methods: EDIP97, CML2001 and Eco-indicator 99 Does it matter which one you choose?', *Int J LCA*, 8(4), pp. 1–10.

Eilam, E. (2005) *Reversing: Secrets of Reverse Engineering*. Indianapolis: Willey Publishing Inc.

European Commission (2012) 'Product Environmental Footprint (PEF) Guide'. Ispra: European Commission - Joint Research Centre, Institute for Environment and Sustainability, p. 154. doi: Ares(2012)873782 - 17/07/2012.

European Parliament (2000) 'Directive 2000/53/EC of the European parliament and of the council of 18 September 2000 on end-of life vehicles', *Official Journal of the European Union*. Bruxelles, (L269), pp. 34–43. doi: ISSN 1725-2555.

European Parliament (2005) 'Directive 2005/64/EC of the European Parliament and of the Council of 26 October 2005 on the type-approval of motor vehicles with regard to their reusability, recyclability and recoverability and amending Council Directive 70/156/EEC', *Official Journal of the European Union*. Bruxelles, (L310), pp. 10–27. doi: ISSN 1725-2555.

European Parliament (2009a) *DIRECTIVE 2009/125/EC OF THE EUROPEAN PARLIAMENT AND OF THE COUNCIL*. Bruxelles. doi: L 285/10.

European Parliament (2009b) 'Regulation (EC) No 443/2009 of the European Parliament and the Council of 23 April 2009 setting emission performance standards for new passenger cars as part of the Community's integrated approach to reduce CO2 emissions from light-duty vehicles', *Official Journal of the European Union*. Bruxelles, (L140), pp. 1–15. doi: ISSN 1725-2555.

Fantin, V., Scalbi, S., Ottaviano, G. and Masoni, P. (2014) 'A method for improving reliability and relevance of LCA reviews: The case of life-cycle greenhouse gas emissions of tap and bottled water', *Science of The Total Environment*, 476, pp. 228–241. doi: 10.1016/j.scitotenv.2013.12.115.

Fayolle, B., Audouin, L. and Verdu, J. (2004) 'A critical molar mass separating the ductile and brittle regimes as revealed by thermal oxidation in polypropylene', *Polymer*, 45(12), pp. 4323–4330. doi: 10.1016/j.polymer.2004.03.069.

Finnveden, G. (2000) 'On the limitations of life cycle assessment and environmental systems analysis tools in general', *The International Journal of Life Cycle Assessment*, 5(4), p. 229. doi: 10.1007/BF02979365.

Förstner, U. and Wittmann, G. T. W. (2012) *Metal Pollution in the Aquatic Environment*. Berlin: Springer Science & Business Media. Available at: [https://books.google.fr/books?id=9PLuCAAQBAJ&dq=Metal+Pollution+in+the+Aquatic+Environment+%253B+U.+Förstner,G.+T.+W.+Wittmann,+2012&lr=&hl=cs&source=gbs\\_navlinks\\_s](https://books.google.fr/books?id=9PLuCAAQBAJ&dq=Metal+Pollution+in+the+Aquatic+Environment+%253B+U.+Förstner,G.+T.+W.+Wittmann,+2012&lr=&hl=cs&source=gbs_navlinks_s).

G'Sell, C. and Hiver, J.-M. (2002) 'Dispositif de caractérisation optique du comportement mécanique local d'une structure pouvant présenter des déformations finies non homogènes'. France. Available at: <http://bases-brevets.inpi.fr/en/document-en/FR2823849.html?s=1480488215094&p=5&cHash=1c6baab418274d145e8a77741717ddac>.

Gaussin, M., Hu, G., Abolghasem, S., Basu, S., Shankar, M. R. and Bidanda, B. (2013) 'Assessing the environmental footprint of manufactured products: A survey of current literature', *International Journal of Production Economics*, 146(2), pp. 515–523. doi: 10.1016/j.ijpe.2011.12.002.

Gehin, A., Zwolinski, P. and Brissaud, D. (2009) 'Integrated design of product lifecycles—The fridge case study', *CIRP Journal of Manufacturing Science and Technology*, 1(4), pp. 214–220. doi: 10.1016/j.cirpj.2009.05.002.

Gerrard, J. and Kandlikar, M. (2007) 'Is European end-of-life vehicle legislation living up to expectations? Assessing the impact of the ELV Directive on “green” innovation and vehicle recovery', *Journal of Cleaner Production*, 15(1), pp. 17–27. doi: 10.1016/j.jclepro.2005.06.004.

Getzler, J. (2004) *A history of Water Rights at Common Law*. New York: Oxford University Press. Available at: [https://books.google.fr/books?id=WtGTAWkeJq8C&pg=PA32&lpg=PA32&dq=ancient+law+leave+water+in+river&source=bl&ots=\\_Q3\\_Igo195&sig=OYG5JCyfnNupIG9ZKCtsqu3r748&hl=cs&sa=X&ved=0ahUK EwjZldzs96fOAhUDOBokHc48AiMQ6AEINTAD#v=onepage&q=ancient law leave water in riv](https://books.google.fr/books?id=WtGTAWkeJq8C&pg=PA32&lpg=PA32&dq=ancient+law+leave+water+in+river&source=bl&ots=_Q3_Igo195&sig=OYG5JCyfnNupIG9ZKCtsqu3r748&hl=cs&sa=X&ved=0ahUK EwjZldzs96fOAhUDOBokHc48AiMQ6AEINTAD#v=onepage&q=ancient law leave water in riv).

Goedkoop, M., Heijungs, R., Huijbregts, M., De Schryver, A., Struijs, J. and van Zelm, R. (2013) *ReCiPe 2008 A life cycle impact assessment method which comprises harmonised category indicators at the midpoint and the endpoint level*. Den Haag. Available at:

[https://35f23ee4-a-62cb3a1a-s-sites.googlegroups.com/site/lciarecipe/file-cabinet/ReCiPe\\_main\\_report\\_MAY\\_2013.pdf?attachauth=ANoY7cooIPN9MzjrGHBRdFn0G72y3ZmIPZT1Rj58mZ74UYXuN5OO\\_bB67xmKWRlRhjuoi2xwukuo2UHm4B6eyfkOz-XcrK2kDITDuqFuCbWw\\_BmZEYEfts1rMXi4C\\_bolO](https://35f23ee4-a-62cb3a1a-s-sites.googlegroups.com/site/lciarecipe/file-cabinet/ReCiPe_main_report_MAY_2013.pdf?attachauth=ANoY7cooIPN9MzjrGHBRdFn0G72y3ZmIPZT1Rj58mZ74UYXuN5OO_bB67xmKWRlRhjuoi2xwukuo2UHm4B6eyfkOz-XcrK2kDITDuqFuCbWw_BmZEYEfts1rMXi4C_bolO).

González-González, V. A., Neira-Velázquez, G. and Angulo-Sánchez, J. L. (1998) 'Polypropylene chain scissions and molecular weight changes in multiple extrusion', *Polymer Degradation and Stability*, 60(1), pp. 33–42. doi: 10.1016/S0141-3910(96)00233-9.

Guerrica-Echevarría, G., Eguiazábal, J. I. and Nazábal, J. (1996) 'Effects of reprocessing conditions on the properties of unfilled and talc-filled polypropylene', *Polymer Degradation and Stability*, 53(1), pp. 1–8. doi: 10.1016/0141-3910(96)00018-3.

Guinée, J. B., Gorrae, M., Heijungs, R., Huppes, G., Kleijn, R., Koning, A. de, Oers, L. van, Sleeswijk, A. W., Suh, S., Udo de Haes, H. A., Bruijn, H. de, Duin, R. van and Huijbregts, M. A. J. (2004) *Handbook on Life Cycle Assessment Operational Guide to the ISO Standards*. New York: KLUWER ACADEMIC PUBLISHERS.

Guinée, J. B., Heijungs, R., Huppes, G., Zamagni, A., Masoni, P., Buonamici, R., Ekvall, T. and Rydberg, T. (2011) 'Life Cycle Assessment: Past, Present, and Future', *Environmental Science & Technology*. American Chemical Society, 45(1), pp. 90–96. doi: 10.1021/es101316v.

Guo, M. and Murphy, R. J. (2012) 'LCA data quality: sensitivity and uncertainty analysis.', *The Science of the total environment*, 435–436, pp. 230–43. doi: 10.1016/j.scitotenv.2012.07.006.

Haye, S., Slaveykova, V. I. and Payet, J. (2007) 'Terrestrial ecotoxicity and effect factors of metals in life cycle assessment (LCA).', *Chemosphere*, 68(8), pp. 1489–96. doi: 10.1016/j.chemosphere.2007.03.019.

Hollberg, A. J. R. (2014) 'A PARAMETRIC LIFE CYCLE ASSESSMENT MODEL FOR FACADE OPTIMIZATION', in *Building Simulation and Optimization*. London: Alexander Hollberg, p. 8. Available at: [https://hal.archives-ouvertes.fr/hal-00794628/PDF/Cluzel\\_et\\_al.\\_2011\\_-\\_Towards\\_parametric\\_environmental\\_profiles\\_of\\_complex\\_industrial\\_systems.pdf](https://hal.archives-ouvertes.fr/hal-00794628/PDF/Cluzel_et_al._2011_-_Towards_parametric_environmental_profiles_of_complex_industrial_systems.pdf).

Hollberg, A. and Ruth, J. (2016) 'LCA in architectural design---a parametric approach', *The International Journal of Life Cycle Assessment*, 21(7), pp. 943–960. doi: 10.1007/s11367-016-1065-1.

Hughes, J. D. (1975) 'Ecology in ancient Greece', *Inquiry*. Routledge, 18(2), pp. 115–125. doi: 10.1080/00201747508601756.

Chapman, P. M. (2002) 'Integrating toxicology and ecology: putting the "eco" into ecotoxicology', *Marine Pollution Bulletin*, 44(1), pp. 7–15. doi: 10.1016/S0025-326X(01)00253-3.

Chomkhamisri, K. and Pelletier, N. (2011) *Analysis of Existing Environmental Footprint Methodologies for Products and Organizations: Recommendations, Rationale, and Alignment*. Ispra. Available at: <http://ec.europa.eu/environment/archives/eussd/pdf/Deliverable.pdf>.

Ibáñez-Forés, V., Pacheco-Blanco, B., Capuz-Rizo, S. F. and Bovea, M. D. (2016) 'Environmental Product Declarations: exploring their evolution and the factors affecting their demand in Europe', *Journal of Cleaner Production*, 116, pp. 157–169. doi: 10.1016/j.jclepro.2015.12.078.

International Organization for Standardization (2006a) *ISO 14025:2006: Environmental labels and declarations -- Type III environmental declarations -- Principles and procedures*. Geneva. doi: ICS: 13.020.50.

International Organization for Standardization (2006b) *ISO 14040: Environmental Management – Life Cycle Assessment – Principles and Framework*. Geneva.

International Organization for Standardization (2006c) *ISO 14044: Environmental management - Lifecycle Assessment - Requirements and guidelines*. Geneva.

International Organization for Standardization (2015) *ISO 14001:2015 Environmental management systems — Requirements with guidance for use*. Geneva. doi: ICS: 13.020.10; 03.100.70.

Jacquard, P. and Sandre, S. (2014) *La pratique du froid*. Dunod. Edited by P. L. Dunod. Paris.

Jasiński, D., Meredith, J. and Kirwan, K. (2016) 'A comprehensive framework for automotive sustainability assessment', *Journal of Cleaner Production*, 135, pp. 1034–1044. doi: 10.1016/j.jclepro.2016.07.027.

Jazar, R. N. and Dai, L. (2014) *Nonlinear Approaches in Engineering Applications 2*. New York: Springer Science & Business Media. Available at: <https://bu.unistra.fr:443/.do?idopac=BUS2168574>.

Ke, X., Wu, D., Rice, J., Kintner-Meyer, M. and Lu, N. (2016) 'Quantifying impacts of heat waves on power grid operation', *Applied Energy*, 183, pp. 504–512. doi: 10.1016/j.apenergy.2016.08.188.

Kellenberger, D. and Althaus, H.-J. (2009) 'Relevance of simplifications in LCA of building components', *Building and Environment*, 44(4), pp. 818–825. doi: 10.1016/j.buildenv.2008.06.002.

Kocman, J. H. (2011) *Médium papír*. Brno: Vutium.

Kočí, V. (2009) *Posuzování životního cyklu – Life Cycle Assessment – LCA*. Chrudim: Ekomonitor.

- Laso, J., Margallo, M., Fullana, P., Bala, A., Gazulla, C., Irabien, A. and Aldaco, R. (2016) 'Introducing life cycle thinking to define best available techniques for products: Application to the anchovy canning industry', *Journal of Cleaner Production*. doi: 10.1016/j.jclepro.2016.08.040.
- Lasvaux, S., Schiopu, N., Habert, G., Chevalier, J. and Peuportier, B. (2014) 'Influence of simplification of life cycle inventories on the accuracy of impact assessment: application to construction products', *Journal of Cleaner Production*, 79, pp. 142–151. doi: 10.1016/j.jclepro.2014.06.003.
- Lazarevic, D., Aoustin, E., Buclet, N. and Brandt, N. (2010) 'Plastic waste management in the context of a European recycling society: Comparing results and uncertainties in a life cycle perspective', *Resources, Conservation and Recycling*, 55(2), pp. 246–259. doi: 10.1016/j.resconrec.2010.09.014.
- Lundie, S., Huijbregts, M. A. J., Rowley, H. V., Mohr, N. J. and Feitz, A. J. (2007) 'Australian characterisation factors and normalisation figures for human toxicity and ecotoxicity', *Journal of Cleaner Production*, 15(8–9), pp. 819–832. doi: 10.1016/j.jclepro.2006.06.019.
- Markham, A. (1994) *A brief history of pollution*. New York: St. Martin's Press. Available at: <https://bu.unistra.fr:443/.do?idopac=BUS0703683>.
- Marrone, M. and La Mantia, P. (1996) 'Monopolymers blends of virgin and recycled polypropylene', *Polymer Recycling*, 2(1).
- Martínez-Rocamora, A., Solís-Guzmán, J. and Marrero, M. (2016) 'LCA databases focused on construction materials: A review', *Renewable and Sustainable Energy Reviews*, 58, pp. 565–573. doi: 10.1016/j.rser.2015.12.243.
- Miller, L., Soulliere, K., Sawyer-Beaulieu, S., Tseng, S. and Tam, E. (2014) 'Challenges and Alternatives to Plastics Recycling in the Automotive Sector', *Materials*. Multidisciplinary Digital Publishing Institute, 7(8), pp. 5883–5902. doi: 10.3390/ma7085883.
- Minkov, N., Schneider, L., Lehmann, A. and Finkbeiner, M. (2015) 'Type III Environmental Declaration Programmes and harmonization of product category rules: status quo and practical challenges', *Journal of Cleaner Production*, 94, pp. 235–246. doi: 10.1016/j.jclepro.2015.02.012.
- Niero, M., Di Felice, F., Ren, J., Manzardo, A. and Scipioni, A. (2014) 'How can a life cycle inventory parametric model streamline life cycle assessment in the wooden pallet sector?', *The International Journal of Life Cycle Assessment*, 19(4), pp. 901–918. doi: 10.1007/s11367-014-0705-6.
- Ortiz, O., Castells, F. and Sonnemann, G. (2009) 'Sustainability in the construction industry: A review of recent developments based on LCA', *Construction and Building Materials*, 23(1), pp. 28–39. doi: 10.1016/j.conbuildmat.2007.11.012.

- Paraskevas, D., Kellens, K., Dewulf, W. and Duflou, J. R. (2015) 'Environmental modelling of aluminium recycling: A Life Cycle Assessment tool for sustainable metal management', *Journal of Cleaner Production*, 105, pp. 357–370. doi: 10.1016/j.jclepro.2014.09.102.
- Patterson, C. C., Shirahata, H. and Ericson, J. E. (1987) 'Lead in ancient human bones and its relevance to historical developments of social problems with lead', *Science of The Total Environment*. Elsevier, 61, pp. 167–200. doi: 10.1016/0048-9697(87)90366-4.
- Peças, P., Götze, U., Henriques, E., Ribeiro, I., Schmidt, A. and Symmank, C. (2016) 'Life Cycle Engineering – Taxonomy and State-of-the-Art', *Procedia CIRP*, 48, pp. 73–78. doi: 10.1016/j.procir.2016.04.085.
- Pessey, D., Bahlouli, N., Raveyre, C., Guillet, J., Ahzi, S. and Hiver, J.-M. (2010) 'Characterization of contamination effects for two polypropylene-based materials', *Polymer Engineering and Science*, 50(1), pp. 1–9.
- Pizzol, M., Christensen, P., Schmidt, J. and Thomsen, M. (2011) 'Eco-toxicological impact of “metals” on the aquatic and terrestrial ecosystem: A comparison between eight different methodologies for Life Cycle Impact Assessment (LCIA)', *Journal of Cleaner Production*, 19(6–7), pp. 687–698. doi: 10.1016/j.jclepro.2010.12.008.
- Plouffe, S., Lanoie, P., Berneman, C. and Vernier, M.-F. (2011) 'Economic benefits tied to ecodesign', *Journal of Cleaner Production*, 19(6), pp. 573–579. doi: 10.1016/j.jclepro.2010.12.003.
- Posada, J. A., Brentner, L. B., Ramirez, A. and Patel, M. K. (2016) 'Conceptual design of sustainable integrated microalgae biorefineries: Parametric analysis of energy use, greenhouse gas emissions and techno-economics', *Algal Research*, 17, pp. 113–131. doi: 10.1016/j.algal.2016.04.022.
- Puri, P., Compston, P. and Pantano, V. (2009) 'Life cycle assessment of Australian automotive door skins', *The International Journal of Life Cycle Assessment*, 14(5), pp. 420–428. doi: 10.1007/s11367-009-0103-7.
- Reap, J., Roman, F., Duncan, S. and Bras, B. (2008) 'A survey of unresolved problems in life cycle assessment', *The International Journal of Life Cycle Assessment*, 13, pp. 374–388. Available at: [http://download.springer.com/static/pdf/544/art%253A10.1007%252Fs11367-008-0009-9.pdf?auth66=1427317804\\_5d02f586b0d735eef20f18a6d23f0328&ext=.pdf](http://download.springer.com/static/pdf/544/art%253A10.1007%252Fs11367-008-0009-9.pdf?auth66=1427317804_5d02f586b0d735eef20f18a6d23f0328&ext=.pdf).
- Rebitzer, G., Ekvall, T., Frischknecht, R., Hunkeler, D., Norris, G., Rydberg, T., Schmidt, W.-P., Suh, S., Weidema, B. P. and Pennington, D. W. (2004) 'Life cycle assessment part 1: framework, goal and scope definition, inventory analysis, and applications.', *Environment international*, 30(5), pp. 701–20. doi: 10.1016/j.envint.2003.11.005.
- Renault (2011) *Fluence and Fluence Z.E. Life Cycle Assessment*. Paris. Available at: <http://group.renault.com/wp-content/uploads/2014/09/fluence-acv-2011.pdf>.

- Russel, A., Ekvall, T. and Baumann, H. (2005) 'Life cycle assessment— introduction and overview', *Journal of Cleaner Production*, 13, pp. 1207–1210. Available at: [http://publications.lib.chalmers.se/records/fulltext/11745/local\\_11745.pdf](http://publications.lib.chalmers.se/records/fulltext/11745/local_11745.pdf).
- Rust, N., Ferg, E. E. and Masalova, I. (2006) 'A degradation study of isotactic virgin and recycled polypropylene used in lead acid battery casings', *Polymer Testing*, 25(1), pp. 130–139. doi: 10.1016/j.polymertesting.2005.08.009.
- Shen, W. (2015) *Life cycle assessment of heated airfield pavement system for snow removal*. Iowa State University. doi: Paper 14742.
- Shingo, S. (1987) *Le système poka-yoke : zéro défaut = zéro contrôle*. 1st edn. Paris. Available at: <https://bu.unistra.fr:443/.do?idopac=BUS0434173>.
- Singh, N., Hui, D., Singh, R., Ahuja, I. P. S., Feo, L. and Fraternali, F. (2016) 'Recycling of plastic solid waste: A state of art review and future applications', *Composites Part B: Engineering*. doi: 10.1016/j.compositesb.2016.09.013.
- Sousa, I. and Wallace, D. (2006) 'Product classification to support approximate life-cycle assessment of design concepts', *Technological Forecasting and Social Change*, 73(3), pp. 228–249. doi: 10.1016/j.techfore.2004.03.007.
- Sousa, I., Wallace, D. and Eisenhard, J. L. (2000) 'Approximate Life-Cycle Assessment of Product Concepts Using Learning Systems', *Journal of Industrial Ecology*, 4(4), pp. 61–81. doi: 10.1162/10881980052541954.
- Soust-Verdaguer, B., Llatas, C. and García-Martínez, A. (2016) 'Simplification in life cycle assessment of single-family houses: A review of recent developments', *Building and Environment*, 103, pp. 215–227. doi: 10.1016/j.buildenv.2016.04.014.
- van der Spek, M., Ramirez, A. and Faaij, A. (2015) 'Improving uncertainty evaluation of process models by using pedigree analysis. A case study on CO<sub>2</sub> capture with Monoethanolamine', *Computers & Chemical Engineering*, 85, pp. 1–15. doi: 10.1016/j.compchemeng.2015.10.006.
- Spielmann, M. and Althaus, H.-J. (2007) 'Can a prolonged use of a passenger car reduce environmental burdens? Life Cycle analysis of Swiss passenger cars', *Journal of Cleaner Production*, 15(11), pp. 1122–1134. doi: 10.1016/j.jclepro.2006.07.022.
- Steen, B. (1997) 'On uncertainty and sensitivity of LCA-based priority setting', *Journal of Cleaner Production*, 5(4), pp. 255–262. doi: 10.1016/S0959-6526(97)00039-5.
- Strazza, C., Del Borghi, A., Magrassi, F. and Gallo, M. (2016) 'Using environmental product declaration as source of data for life cycle assessment: a case study', *Journal of Cleaner Production*, 112, pp. 333–342. doi: 10.1016/j.jclepro.2015.07.058.
- The EPD International System (2016) *Characterisation factors for default impact assessment categories*. Available at: <http://www.environdec.com/en/The-International-EPD->



System/General-Programme-Instructions/Characterisation-factors-for-default-impact-assessment-categories/ (Accessed: 26 June 2016).

The International EPD®System (2005) *PCR 2005:3, Version 1.0, 2005-03-15 - Product Category Rules (PCR) for preparing an environmental product declaration (EPD) for 'Passenger vehicles'*. Available at: [http://www.environdec.com/en/PCR/Detail/?show\\_login=true&error=failure&Pcr=5738&id=158&epslanguage=en](http://www.environdec.com/en/PCR/Detail/?show_login=true&error=failure&Pcr=5738&id=158&epslanguage=en).

The International EPD®System (2013) *Product Category Rules according to ISO 14025:2006 - product group: UN CPC 263 & 264; textile yarn and thread of natural fibres, man-made filaments or staple fibres*. Available at: <http://www.environdec.com/en/PCR/Detail/pcr2013-12#.VcoMwLSkU7s>.

Todd, J. A. and Curan, M. A. (1999) *Streamlined Life-Cycle Assessment: A Final Report from the SETAC North America Streamlined LCA Workgroup*. Available at: <http://www.ce.cmu.edu/~hsm/lca2007/readings/streamlined-lca.pdf>.

Turlan, T. (2013) *Les déchets, Collecte, Traitement, Tri, Recyclage*. Paris: Dunod.

Verrier, B., Rose, B. and Caillaud, E. (2016) 'Lean and Green strategy: the Lean and Green House and maturity deployment model', *Journal of Cleaner Production*, 116, pp. 150–156. doi: <http://dx.doi.org/10.1016/j.jclepro.2015.12.022>.

Virtanen, Y. and Nilsson, S. (2013) *Environmental Impacts of Waste Paper Recycling*. Abingdon: Earthscan.

Volkswagen AG (2010) *Golf – Environmental Commendation, Model year 2011*. Wolfsburg. Available at: [http://www.volkswagenag.com/content/vwcorp/info\\_center/en/publications/2010/12/Golf\\_HB\\_bin.html/binarystorageitem/file/101129\\_VW\\_HB\\_Golf\\_GB.pdf](http://www.volkswagenag.com/content/vwcorp/info_center/en/publications/2010/12/Golf_HB_bin.html/binarystorageitem/file/101129_VW_HB_Golf_GB.pdf).

Weidema, B. P., Bauer, C., Hischier, R., Mutel, C., Nemecek, T., Reinhard, J., Vadenbo, C. O. and Wernet, G. (2013) *Data quality guideline for the ecoinvent database version 3*. St. Gallen. Available at: <http://www.ecoinvent.org/database/methodology-of-ecoinvent-3/methodology-of-ecoinvent-3.html>.

Weidema, B. P. and Wesnæs, M. S. (1996) 'Data quality management for life cycle inventories —an example of using data quality indicators', *Journal of Cleaner Production*, 4(3–4), pp. 167–174. doi: 10.1016/S0959-6526(96)00043-1.

Yeakel, J. D., Pires, M. M., Rudolf, L., Dominy, N. J., Koch, P. L., Guimarães, P. R. and Gross, T. (2014) 'Collapse of an ecological network in Ancient Egypt.', *Proceedings of the National Academy of Sciences of the United States of America*, 111(40), pp. 14472–7. doi: 10.1073/pnas.1408471111.

Yin, R. K. (2008) *Case Study Research: Design and Methods*. 4th edn. Edited by L. Bickman and D. J. Rog. Thousand Oaks: SAGE Inc.

## LIST OF ABBREVIATIONS

ELCD: European reference Life Cycle Database

ELV: End-of-life vehicle

EPD: Environmental Product Declaration

EPDM: Ethylene propylene diene monomer rubber

EPR: Ethylene propylene rubber

EU: European Union

HIPP: High Impact Polypropylene

ISO: International Organization for Standardization

LCA: Lifecycle assessment

LCI: Lifecycle inventory

LCIA: Lifecycle impact assessment

MFI: Melt flow index

OEF: Organization Environmental Footprint

PCR: Product Category Rules

PE: PE International, provider of GaBi software and LCI databases

PEF: Product Environmental Footprint

PP: Polypropylene

## LIST OF TABLES

|  |    |
|--|----|
| Table 1: average number molar mass, average weight molar mass and polydispersity index for the two different phases of virgin HIPP and 6 times reprocessed HIPP..... | 75 |
| Table 2: Missing data arranged according to the critical variance of estimated values.....   | 81 |
| Table 3: Reevaluation of missing data at the end of the LCI phase.....   | 83 |

# LIST OF FIGURES

Figure 1: Plan of the dissertation.....22

Figure 2: History of environmental issues and LCA.....25

Figure 3: Schema of the the research orientation.....30

Figure 4: Main issues in adopting LCA.....33

Figure 5: LCA methodology.....35

Figure 6: Unresolved issues of the Inventory analysis.....36

Figure 7: Example of modeling issue.....39

Figure 8: Positioning of three solutions of long duration of LCA.....40

Figure 9: First model of parametric LCA – Process modularity.....43

Figure 10: Second model of parametric LCA – rigid scenario.....44

Figure 11: Third model of parametric LCA - Exchangeable processes.....45

Figure 12: Fourth model of parametric LCA - limited "liberty" of scenario design.....46

Figure 13: Fifth model of parametric LCA - Rigid scenario, research of ideal parameter combination.....47

Figure 14: Sixth model of parametric LCA - Variable scenario, research of ideal parameter combination.....48

Figure 15: Six parametric models with their advantages and inconvenients.....49

Figure 16: Case study approach.....51

Figure 17: Organization of the research: The first two chapters start with introduction and choice of orientation the issue of long duration of LCA. In the second chapter, aside the present situation in the field we proceed to focus on organization of missing data and lifecycle modeling. Chapters 3 and 4 describe the work in the two fields and chapter 5 summarize conclusions and perspectives of the research we have done.....53

|  |    |
|--|----|
| Figure 18: Schema of the scientific approach.....  | 54 |
| Figure 19: Purpose and contributions of the HIPP recycling case study.....   | 56 |
| Figure 20: Typical stress-strain curve.....  | 65 |
| Figure 21: Lifecycle model – initial scenario and 50% ratio of recycling. Thickness of the flashes represents weight of the concerned flows. Colors of flows are: Rose for HIPP, black for petrol and petrol products, blue for electricity and green for packaging..... | 68 |
| Figure 22: Schema of parametric model, used in the combined method of preliminary sensitivity analysis.....  | 71 |
| Figure 23: Flow curves show drop of viscosity in function of growing number of reprocessing.....   | 74 |
| Figure 24: Relative melt flow index (MFI) based on number of recycling.....  | 74 |
| Figure 25: Growth of cavitation with recycling. On the left – virgin HIPP 108MF97, on the right the same material 6 times recycled. Scale is identical on both sides.....  | 75 |
| Figure 26: Large domain stress strain.....   | 76 |
| Figure 27: Small domain stress strain.....   | 76 |
| Figure 28: Yield strain.....   | 77 |
| Figure 29: Yield stress.....   | 77 |
| Figure 30: Poisson ratio.....  | 78 |
| Figure 31: Young modulus.....  | 78 |
| Figure 32: Failure stress.....   | 79 |
| Figure 33: Failure strain.....   | 79 |
| Figure 34: Evolution of impacts in function of input parameter evolution: Distance of transport of virgin granulate.....   | 82 |
| Figure 35: Midpoint evolution in function of part of recycled mater - initial testing rod scenario.....  | 84 |

|  |     |
|--|-----|
| Figure 36: Midpoint evolution in function of part of recycled mater - scenario substituting aircraft transport for a truck.....  | 85  |
| Figure 37: Midpoint evolution in function of part of recycled mater - hypothetical scenario for a bigger serial production.....  | 85  |
| Figure 38: Distribution of impacts – initial scenario.....   | 86  |
| Figure 39: Distribution of impacts – hypothetical scenario with only road transports.....  | 87  |
| Figure 40: Distribution of impacts – hypothetical scenario of serial production.....   | 87  |
| Figure 41: Comparison of LCIA methodologies on an intermediate scenario (truck transports)<br>In all categories virgin material represents 100% of the impact, while the other columns represent the relative impact of 50% recycled material, calculated with various LCIA methodologies. The table shows units of characterization factors in the compared LCIA methodologies..... | 91  |
| Figure 42: Impacts in the category of ionizing radiation, ReCiPe. Expression of difference between use of a classical French electric power grid mix and electric energy exclusively from hydraulic power plants.....  | 92  |
| Figure 43: Schema of the initial product system and schema of the expansion of the system, where recycling stands out of the loop and all the HIPP is incinerated or landfilled after use.   | 93  |
| Figure 44: The relative difference between the initial and extended scenarios. Both realized on the initial scenario with air transport and recycling ratio of 50%.....  | 94  |
| Figure 45: Relative variation of results, calculated from the standard deviation. Comparison shows difference between all the three scenarios with recycling ratio of 50%.....   | 95  |
| Figure 46: Comparison between the results for virgin and recycled HIPP in all three scenarios. The relative error is expressed with error bars.....  | 97  |
| Figure 47: Purpose and contributions of the workflows factorization method.....  | 101 |
| Figure 48: Typology of processes for the value stream mapping.....   | 108 |
| Figure 49: Construction of the King's matrix.....  | 109 |

Figure 50: Solution of the King's matrix, adapted for reconstruction of lifecycle scenarios..110

Figure 51: Construction of the new scenario.....111

Figure 52: Reference scenario of concrete recycling.....112

Figure 53: King's matrix of concrete recycling.....113

Figure 54: Reconstructed scenario of recycled concrete.....113

Figure 55: Development of the research.....117

Figure 56: List of perspectives divided by affiliation to objective and field of application...121

Figure 57: Schema of the preliminary sensitivity analysis parametric model.....123

## ANNEXES

### **ANNEX1: Comparison of environmental impacts of different threads in function of the primary material – simplified LCA study**

#### **Goal and scope of the study**

The goal of the study is to find the the most relevant environmental impacts of threads made of a virgin cotton, recycled cotton, Polyethylene Terephthalate (PET), Polyacrylonitrile (PAN) and Aliphatic polyamides (PA).

The results should serve various thread producers as an indicator. Therefore there is no producer to give exact data for the study, the used data shall represent an average production in the European Union. Data from a lifecycle inventory (LCI) databases PE International and ELCD fits for this use.

This study is an example of simplified LCA for consideration of use in the design process. In case of practical use the simplified study will be adapted to the commercial model of the user. For now it is not mentioned whether the results should be used only in the design process of if they are intended for communication.

If a further continuation of the study have commercial use, it will be probably in conformity with Environmental Product Declaration (EPD)(The International EPD®System, 2013; Minkov *et al.*, 2015) or Product Environmental Footprint (PEF)(European Commission, 2012). Therefore the actual study shall be realized in the same way as described in the existing Product Category Rule (PCR) of the EPD® International system. (Baumann and Tillman, 2004; Minkov *et al.*, 2015)



For the use on the current study, the PCR 2013:12 version 1.01 (The International EPD®System, 2013) was simplified according to the goals of the study:

- Functional unit: 1 kg of thread
- Modeled composition shall represent at least 99% of the product's weight. All substances presenting any of carcinogen, mutagen or reproductive toxicity (CMR) risks, as well as allergens BPT5 or vPB6.
- Use the unities SI. KW (MW) and kWh (MWh) are preferable.
- Allocation shall represent weight of the material.
- System expansion shall be avoided and negative flows shall be neglected.
- End of life shall not be represented.
- Basic mandatory impact categories are:
  - Global Warming Potential (GWP)
  - Acidification potential
  - Tropospheric ozone depletion potential
  - Eutrophication potential

Figure 1 shows recommended flow model.

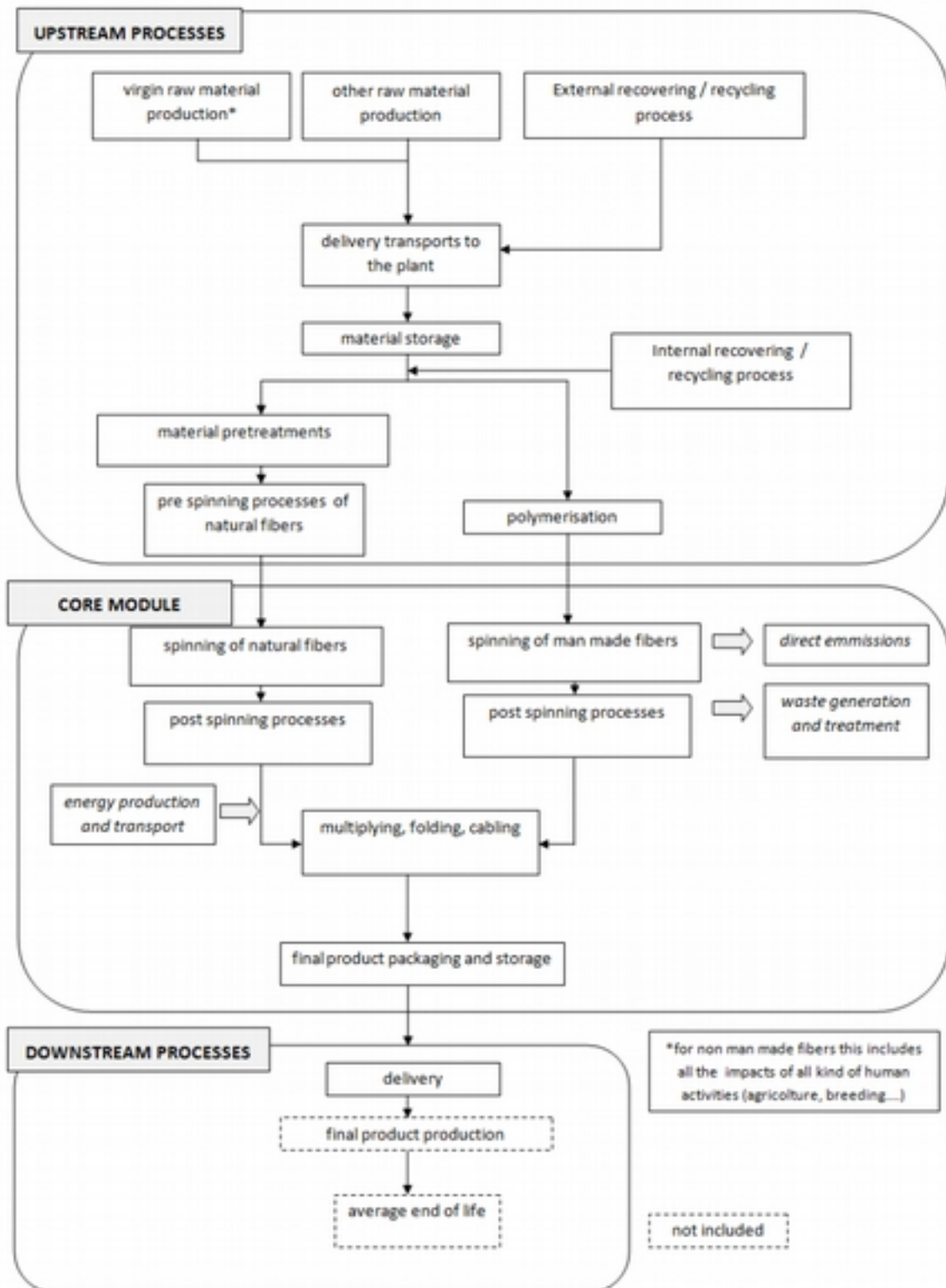

Figure 1 - Lifecycle scenario of virgin cotton

## **Lifecycle Inventory**

In coherence with the EPD 1213 we have specified for the lifecycle model:

### **CORE MODULE**

The core processes refers to the production processes and includes:

- mechanical spinning of natural fibers (e.g. ring spinning, rotor spinning)
- spinning of man-made fibers (e.g. melt spinning, wet spinning, dry spinning, gel spinning)
- External and internal transportation of raw materials and energy wares to the core
- Energy consumption
- Water consumption
- Emissions to air
- Emissions to water
- Waste water treatment

As this simplified LCA is an example which is not going to be used in the industry, we have neglected several unavailable data:

- Collection of waste
- End of life treatment of waste
- multiplying, folding and cabling of yarns
- Quality control

- any post spinning process of yarn of natural fibers (e.g. twisting, beaming)
- any post spinning process of yarn of man-made filaments (e.g. drawing, washing, texturing, scouring, twisting, air entanglement, heat setting, beaming)
- any post spinning process of yarn of man made staple fibers (e.g. drawing, carding , combing, mechanical spinning, beaming)

## **DOWNSTREAM PROCESSES**

The downstream process includes the direct company transportation from final production to an average customer/distribution platform (not beyond) according to internal market office.

Included manufacturing processes are:

- Yarn/fiber spinning
- Energy consumption with specific regard to the use of electricity and thermal energy.

As this simplified LCA is an example which is not going to be used in the industry, we have neglected several unavailable data:

- Other semi-finished products treatments/reprocessing
- Final product packaging and storage
- Emission to air – data at the stacks and fugitive emissions after treatment
- Emissions to water – data from process release

The study was modeled and assessed using the LCA software GaBi, version 4.

The most processes used in this study are taken from the PE-International and ILCD LCI databases. All the assumptions and estimations were discussed with the client of this study – company Textile LOOP.

Two processes (storage and spinning) were unavailable in the LCI databases, thus they are estimated. Both processes play a secondary role in this study. They do not change in any way between the studied scenarios, thus they do not influence the differences between the studied scenarios. Their function is to place the product into its natural circumstances. The storage is estimated as a non-heated building with a daily electricity consumption of 20 kWh for lights and with two forklifts, operating 6 h a day. The store capacity is 10 t of fibers and 30 days an average duration of storage.

The spinning machine is estimated to spin 1000m of thread in 2 minutes with electricity consumption of 1 kWh.

The transports are roughly estimated to 500 km by a truck from the fiber producers to the thread producer in case of polymers and recycled cotton. Virgin cotton is modeled as 500 km from the fiber producer to the port and then 15000 km on a container cargo ship to Europe (70% import from China, 30% import from Turkey). The distance from the port to the thread producer is estimated to 500 km.

Contrary to the PCR precautions the used model lacks downstream processes – packaging and transport to the client. The processes are the same for all the studied products and are not necessary for the intended use of the study. Quality control and maintenance are not included either.

The production process is the same for all the studied materials. Only the recycled cotton gets advantage of 30% less dyeing. In average, 30% of recycled cotton can be separated according to its color and avoid dyeing.

Geographical location of most processes is global, Europe or the first 27 states of the European Union (EU-27). As shown on the *figure 2 – Lifecycle scenario of virgin cotton*, four processes are localized differently. Recycled cotton and Acetic acid are localized in Germany, Dyeing and Wastewater treatment in Italy. Processes with more suitable localization were not available in the databases.

### Virgin cotton

GaBi 4 process plan: Mass [kg]  
The names of the basic processes are shown.

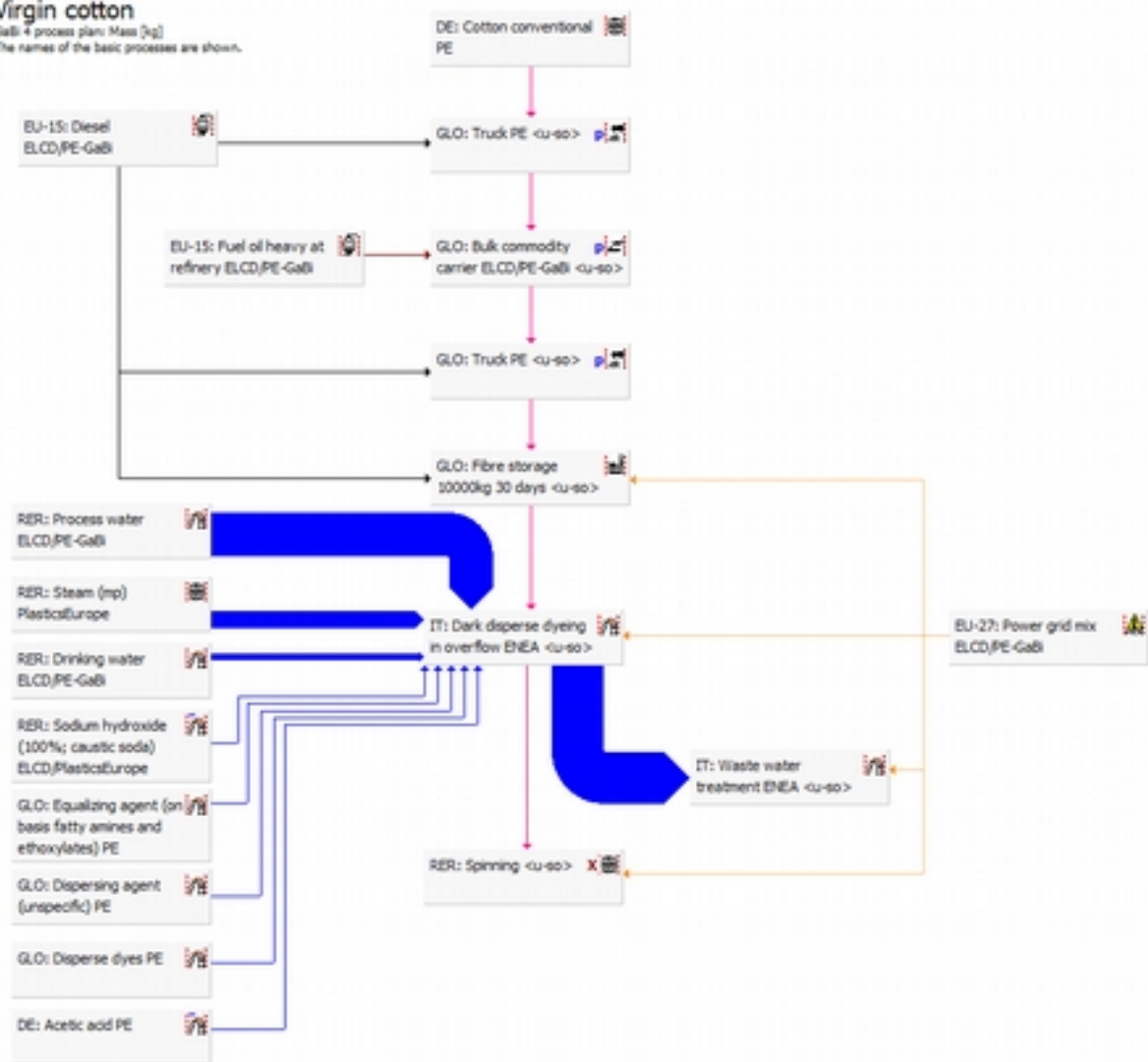

Figure 2 - Lifecycle scenario of virgin cotton

## **Lifecycle Impact Assessment (LCIA)**

Only the impacts required by PCR 1312 was assessed. The required impacts are Global warming potential (GWP), Acidification potential, Photochemical creation potential and Eutrophication potential. Toxicity and ecotoxicity are voluntary but recommended, but it was decided to not include them into results. Calculation of toxicity and ecotoxicity potentials is more delicate and requires input data of the best quality possible. (Chapman, 2002; Haye, Slaveykova and Payet, 2007; Lundie *et al.*, 2007; Pizzol *et al.*, 2011) Besides, using the recommended LCIA methodology (USETox), the differences between different threads are not big enough to make a proper conclusions whether one scenario represents more impacts than another.

The required categories was assessed using the ready-made LCIA methodology CML 2001-nov.09, which is well adapted to use in the production industry and gives all the required results in accordance with the PCR 1312. (Baumann and Tillman, 2004; The International EPD®System, 2013)

All the sinks are represented as inverse processes – in the results they are decreasing the results. In coherence with PCR 1213 any negative impacts are neglected.

## **Results interpretation**

If the client company does not produce monomers/polymers for its thread production, the PCR 2013:12 allows use of commercial LCI databases. Therefore we suppose that creators of EPDs use the same data to represent primary materials and the differences between results of virgin cotton and polymers will be close to the results of a properly done non-simplified EPD. A bigger differences may appear when comparing the recycled cotton as it gets 30% less dye than other threads. Dyeing is supposed to get more precise data in the real EPDs.

Table 1 give absolute results in the required midpoint impact categories, all expressed for the functional unit of 1 kg of thread.:

| Impact category                        | unit                  | Virgin cotton | Recycled Cotton | PET    | PAN    | PA     |
|--|-----------------------|---------------|-----------------|--------|--------|--------|
| Global Warming Potential               | [Kg CO2-Equiv.]       | 6,205         | 3,821           | 11,534 | 12,787 | 18,219 |
| Acidification potential                | [Kg SO2-Equiv.]       | 0,061         | 0,040           | 0,074  | 0,076  | 0,093  |
| Photochemical ozone creation potential | [Kg Ethene-Equiv.]    | 0,003         | 0,002           | 0,008  | 0,005  | 0,008  |
| Eutrophication potential               | [Kg Phosphate-Equiv.] | 0,009         | 0,002           | 0,004  | 0,005  | 0,007  |

Figure 3 shows comparison of impact potentials relatively to the virgin cotton and figure 4 shows all results normalized according to the LCIA methodology CML 2001-09 for EU-25+3. The graph shows contribution of one kilogram of each material on an average annual pollution of the first 28 members of the European Union. The objective of this expression is to show one point of view on the gravity of product's pollution through all the impact categories.

The results show clearly that the least environmental impacts are caused by production of thread of recycled cotton. Virgin cotton can be placed on the second place and PA as the most polluting material. The position of PET and PAN is difficult to assess.

These results are only valid for use of 1 kg of thread. Durability of the materials isn't taken into account and must be considered for a final textile products.



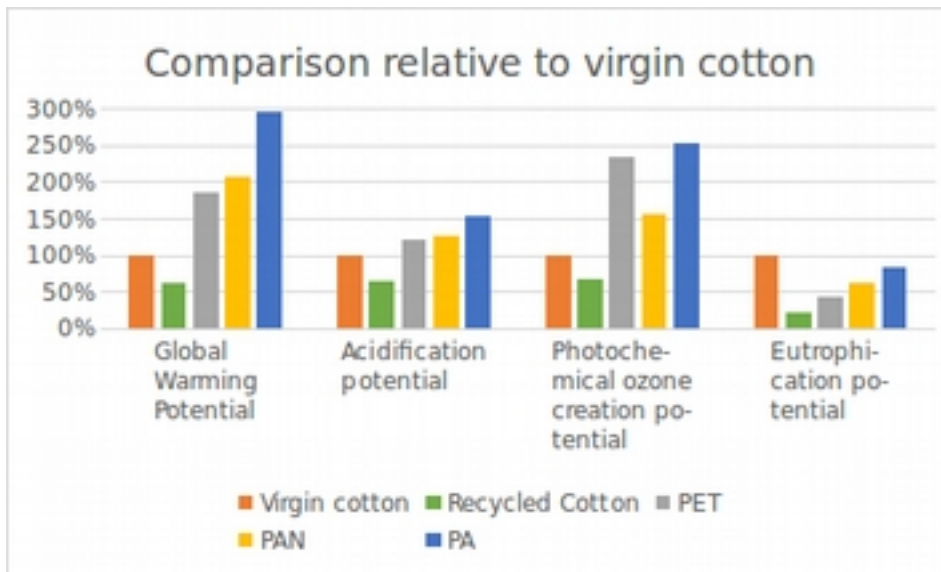

Figure 3 - Impacts on midpoint level expressed relatively to virgin cotton. Virgin cotton represents 100% of impacts in the given impact category and other columns represents how much more or less does the other materials pollute.

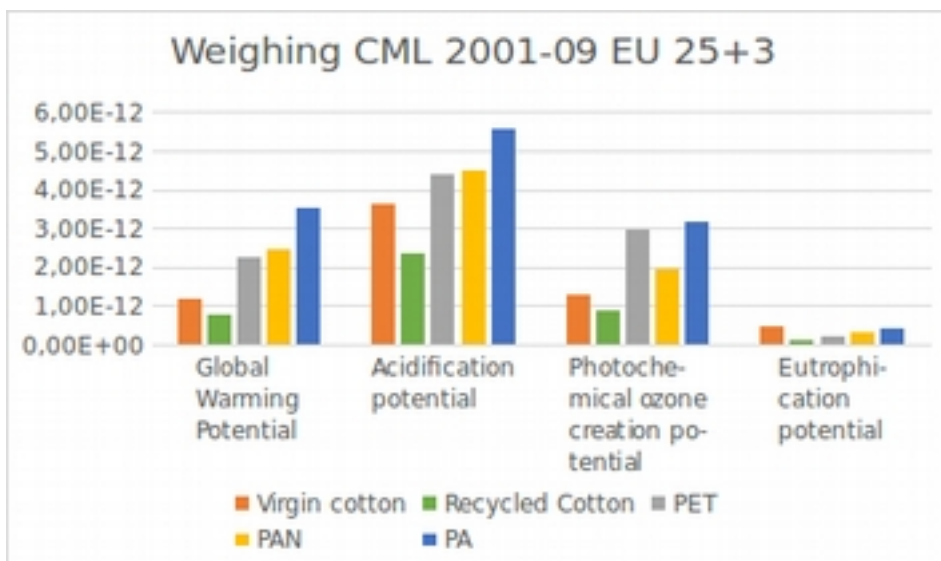

Figure 4 - Results represent how much would different materials contribute on an average annual pollution produced in the first 28 member states of the European Union.

Figure 5 shows the contribution of different lifecycle phases on the total pollution of a virgin cotton thread. Clearly the biggest contributor is dyeing. This explain partially the advantage of

recycled cotton before the virgin cotton. Without dyeing or with other technology of dyeing the impacts of recycled cotton would move relatively to the other materials.

The second biggest contributor is the virgin material. Than transports and on the last place production technologies. The difference of impacts of lifecycle phases is in order of 10. The impacts of the thread production (in this study spinning and storing) are approximately ten times smaller than impacts of transports, hundred times smaller than impacts of the primary material and thousand times smaller than the impacts of dyeing. This is a good news for the quality of results of this study – the estimated processes have the least impact on the desired results of the study.

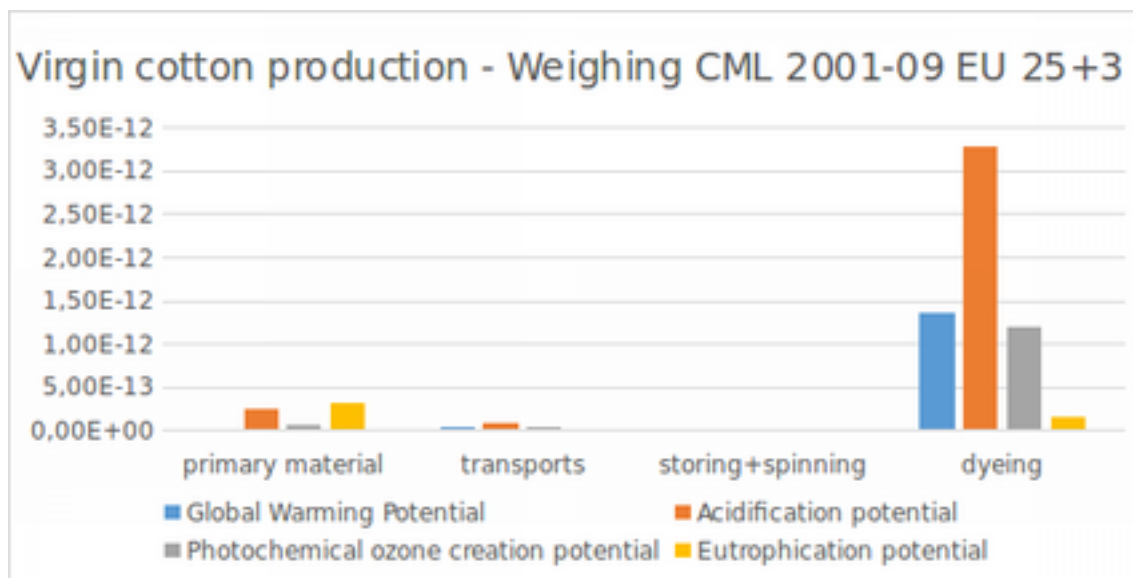

Figure 5 - Production of thread with virgin cotton. Impacts are represented separately for the four main phases of the thread's production.

## References:

- Baumann, H. & Tillman, A.-M., 2004. *The Hitch Hiker's Guide to LCA*, Lund: Studentlitteratur.
- EPD®SYSTEM, T.I., 2013. PRODUCT CATEGORY RULES ACCORDING TO ISO 14025:2006 - PRODUCT GROUP: UN CPC 263 & 264; TEXTILE YARN AND THREAD OF NATURAL FIBRES, MAN-MADE FILAMENTS OR STAPLE FIBRES, Available at: <http://www.environdec.com/en/PCR/Detail/pcr2013-12#.VcoMwLSkU7s>.
- European Commission, E., Joint Research Centre, J. & Institute for Environment and Sustainability, I., 2012. *Product Environmental Footprint (PEF) Guide*. , p.154. Available at: [http://ec.europa.eu/environment/eussd/pdf/footprint/PEF methodology final draft.pdf](http://ec.europa.eu/environment/eussd/pdf/footprint/PEF_methodology_final_draft.pdf).
- Haye, S., Slaveykova, V.I. & Payet, J., 2007. Terrestrial ecotoxicity and effect factors of metals in life cycle assessment (LCA). *Chemosphere*, 68(8), pp.1489–96. Available at: <http://www.sciencedirect.com/science/article/pii/S0045653507003888> [Accessed August 7, 2015].
- Chapman, P.M., 2002. Integrating toxicology and ecology: putting the “eco” into ecotoxicology. *Marine Pollution Bulletin*, 44(1), pp.7–15. Available at: <http://www.sciencedirect.com/science/article/pii/S0025326X01002533> [Accessed August 5, 2015].
- Lundie, S. et al., 2007. Australian characterisation factors and normalisation figures for human toxicity and ecotoxicity. *Journal of Cleaner Production*, 15(8–9), pp.819–832. Available at: <http://www.sciencedirect.com/science/article/pii/S0959652606002381> [Accessed August 7, 2015].
- Minkov, N. et al., 2015. Type III Environmental Declaration Programmes and harmonization of product category rules: status quo and practical challenges. *Journal of Cleaner Production*, 94, pp.235–246. Available at: <http://www.sciencedirect.com/science/article/pii/S095965261500116X> [Accessed May 9, 2015].
- Pizzol, M. et al., 2011. Eco-toxicological impact of “metals” on the aquatic and terrestrial ecosystem: A comparison between eight different methodologies for Life Cycle Impact Assessment (LCIA). *Journal of Cleaner Production*, 19(6–7), pp.687–698. Available at: <http://www.sciencedirect.com/science/article/pii/S0959652610004609> [Accessed March 6, 2015].

## **ANNEX 2: List of publications**

### **Publications in rated scientific journals:**

1. Kozderka, M.; Rose, B.; Kočí, V.; Caillaud, E.; Bahlouli, N.; High impact polypropylene (HIPP) recycling – Mechanical resistance and Lifecycle Assessment (LCA) case study with improved efficiency by preliminary sensitivity analysis; Journal of Cleaner Production; Volume 137; 20 november 2016; pages 1004–1017; ISO
2. Kozderka, M.; Rose, B.; Bahlouli, N.; Kočí, V.; Caillaud, E.; Recycled High Impact Polypropylene In The Automotive Industry – Mechanical And Environmental Properties; International Journal on Interactive Design and Manufacturing; available online since 5.12.2016; ISO

### **Articles in proceedings of conferences, listed in the database Conference Proceedings Citation Index**

1. Kozderka, M.; Rose, B.; Kočí, V.; Caillaud, E.; Bahlouli, N.; High Impact Polypropylene Recycling – Mechanical Resistance and LCA Case Study with Improved Efficiency by Preliminary Sensitivity Analysis; The 12th IFIP International Conference on Product Lifecycle Management (IFIP PLM15); Doha, Qatar; 18-21. october 2015

### **Articles in journals without review procedure; articles in proceedings:**

1. Mgr. Michal Kozderka, doc. Ing. Vladimír Kočí, Ph.D.; PEF (Product Environmental Footprint) a OEF (Organisation Environmental Footprint) – Návrh nástroje Evropské komise pro hodnocení environmentálních aspektů výrobků a organizací a sjednocení jejich komunikace; Průmyslová ekologie 2014; Prague, Czech Republic; 26-27. march 2014

### **Presentations on international conferences:**

1. Kozderka, M.; Rose, B.; Kočí, V.; Caillaud, E.; Bahlouli, N.; High Impact Polypropylene Recycling – Mechanical Resistance and LCA Case Study with Improved Efficiency by Preliminary Sensitivity Analysis; The 12th IFIP International Conference on Product Lifecycle Management (IFIP PLM15); Doha, Qatar; 18-21. october 2015
2. Kozderka, M.; Rose, B.; Bahlouli, N.; Kočí, V.; Caillaud, E.; Recycled High Impact Polypropylene In The Automotive Industry – Mechanical And Environmental Properties; 2016 Virtual Concept International Workshop; Bordeaux, France; 17-18. march 2016
3. Michal Kozderka, Bertrand Rose; Accelleration of LCA in stage of inventory by chosing the most relevant data; CONFERE 2015 - 22ème Colloque des Sciences de la Conception et de l’Innovation; Lisboa, Portugal; 9. - 10. july 2015

### **Presentations on national conferences:**

1. Mgr. Michal Kozderka, doc. Ing. Vladimír Kočí, Ph.D.; PEF (Product Environmental Footprint) a OEF (Organisation Environmental Footprint) – Návrh nástroje Evropské komise pro hodnocení environmentálních aspektů výrobků a organizací a sjednocení jejich komunikace; PRŮMYSLOVÁ EKOLOGIE 2014; Praha, Czech Republic; 26-27. march 2014
2. Michal Kozderka, Bertrand Rose; Capitalisation des connaissances et Analyse de Cycle de vie Produits; 19èmes journées STP du GdR MACS; Paris, France; 3- 4. april 2014;

### **Posters on international conferences:**

1. Michal KOZDERKA; Lifecycle assesement of a closed loop polypropylene recycling; SETAC Europe 20th LCA Case Study Symposium; Novi Sad, Serbia; 24 – 26. november 2014