



HAL
open science

Impact of 3D technologies and environment stimuli on stereo vision perception

Di Zhang

► **To cite this version:**

Di Zhang. Impact of 3D technologies and environment stimuli on stereo vision perception. Optics / Photonic. Télécom Bretagne; Université de Bretagne Occidentale, 2016. English. NNT: . tel-01356200

HAL Id: tel-01356200

<https://hal.science/tel-01356200v1>

Submitted on 25 Aug 2016

HAL is a multi-disciplinary open access archive for the deposit and dissemination of scientific research documents, whether they are published or not. The documents may come from teaching and research institutions in France or abroad, or from public or private research centers.

L'archive ouverte pluridisciplinaire **HAL**, est destinée au dépôt et à la diffusion de documents scientifiques de niveau recherche, publiés ou non, émanant des établissements d'enseignement et de recherche français ou étrangers, des laboratoires publics ou privés.

UNIVERSITE BRETAGNE LOIRE

THÈSE / Télécom Bretagne

sous le sceau de l'Université Bretagne Loire

pour obtenir le grade de Docteur de Télécom Bretagne

En accréditation conjointe avec l'Ecole Doctorale Sicma

Mention : Sciences et Technologies de l'Information et de la Communication

présentée par

Di Zhang

préparée dans le département Optique

Impact of 3D technologies and environment stimuli on stereo vision perception

Thèse soutenue le 13 janvier 2016

Devant le jury composé de :

Béatrice Cochener,
Professeur, CHRU - Brest / présidente

Pascal Mamassian,
Directeur de Recherche, Ecole Normale Supérieure - Paris / rapporteur

Emma Gowen,
Maître de conférences, Université de Manchester - Grande Bretagne / rapporteur

Xinzhu Sang,
Professeur, Beijing Technology and Business University - Chine / examinateur

Christian Roux,
Professeur, Institut Mines Télécom / examinateur

Jean-Louis de Bougrenet de la Tocnaye,
Professeur, Télécom Bretagne / Directeur de thèse

N° d'ordre : 2016telb0389

Sous le sceau de l' Université Bretagne Loire

Télécom Bretagne

En accréditation conjointe avec l'Ecole Doctorale Sicma

Impact of 3D technologies and environment stimuli on stereo vision perception

Thèse de Doctorat

Mention : Sciences et Technologies Information Communication

Présentée par **Di ZHANG**

Département : Optique

Directeur de thèse : Jean-Louis de Bougrenet de la Tocnaye

Soutenue le 13 janvier 2016

Jury :

M. Pascal Mamassian, Directeur de Recherche, Ecole Normale Supérieure (Rapporteur)

Mme Emma Gowen, Senior Lecturer, Université de Manchester (Rapporteur)

M. Jean-Louis de Bougrenet de la Tocnaye, Professeur, Télécom Bretagne (Directeur de thèse)

Mme Béatrice Cochener, Professeur, CHRU Brest (Examinateur)

M Xinzhu Sang, Professeur, BUPT Pékin, (Examinateur)

M. Christian Roux, Professeur, Institut Mines Télécom (Examinateur)

Acknowledgements

I have been thinking about the acknowledgements since I just started to write the dissertation. The PhD thesis is not only a research project, it is also my three years life. Every chapter I have written, there are stories and experience in it, with the people who were working with me or who had offered their disinterested help to me.

My first and the deepest gratitude belongs to my supervisor Professor Jean-Louis De Bougrenet De La Tournaye, for the continuous guidance and support of my study and research, for his patience, encouragement, trust and immense knowledge. The characteristic I appreciate the most is his inspiration, it has been always a great pleasure to discuss with him, each time I feel better understanding for my research field and gain more confidence.

My sincere thanks also goes to my team members, specifically for Miss Yulia Fattakhova, Dr. Pascaline Neveu, Miss Stephanie Ferragut, Mr Luay Ahdab, Dr Vincent Nourrit. They have given me immense help when I just entered this new research field, they explained me the basic knowledge with great patience and made so much effort when I carried out my experiments.

I am so grateful for my lovely colleagues in Optics department, every time I need voluntary guinea pigs and ask for your participations, I have never gotten a refusal. Suman, Stephen, Barbara, Ion, Maina, Samir, thank you for all your beautiful eyes and precious suggestions for my experiments! For our best secretary Miss Jennifer Romer, if I have to show my gratitude for your help and friendship in one short sentence, it will be: thank you for being one of the warmest parts in my France life.

I would like to express my thankful for my thesis reviewers Dr Emma Gowen-Senior lecture at Manchester University and Professor Pascal Mamassian – director of Laboratoire des Systèmes Perceptifs (UMR 8248 CNRS/ENS), I would not be able to finish my dissertation without your patience in correcting my thesis. I would like to thank Professor Sang Xinzhu from Beijing University of Posts and Telecommunications, for your recommendation of my PhD thesis and help during my stay at Beijing.

Last but not least, I appreciate the help and valuable discussions from professors, researchers and students at Telecom Bretagne, Manchester University, Beijing University of Posts and Telecommunications. I also thank my family and friends for their consistent support and encouragement during my study.

Abstract

Comfort viewing experience has been a permanent goal in stereoscopic research due to the development of 3D technologies. However, various parameters affect stereo vision perception. In this thesis, a series of physiological experiments have been carried out aiming at evaluating the 3D visual perception with respect to 3 of the most important factors: 3D display technology, viewing environments and motion-in-depth (MID) perception. First we measured vertical fusion amplitude (VFA) on 3D projectors and an autostereoscopic TV. VFA was chosen as an indicator for visual comfort due to our strong sensitivity to vertical disparity. Several factors have been tested (e.g. viewing distance, background luminance, crosstalk, viewing angle etc.). We compared observer performance on both 3D displays and concluded the tolerance for vertical disparity was better on 3D projector than on autostereoscopic TV. For the environment effect, we measured VFA on a 3D projector by varying the room lighting, 3D content complexity, disparity velocity. We assessed the interaction between central and peripheral fusion, by introducing a series of base-up prisms in front of one eye. We observed that the fusion balance of central and peripheral vision was broken when large peripheral disparities (>4 prism diopter) or stimulus sizes (central stimulus angle $< 15^\circ$) were induced on the peripheral vision. Finally, we investigated the interaction between sensorial and oculomotor system for MID stimulation. Preliminary results indicated that the motion aftereffect generated by sensorial cue stimulus could be partially mitigated by oculomotor cue and that MID perception performance could be improved by specific trainings. We identified some critical factors for 3D content generation to enhance the MID perception, such as background texture, fixation object dot life time.

Résumé

Le confort de visualisation a été un objectif permanent dans la recherche stéréoscopique en raison du développement des technologies 3D. Cependant, divers paramètres affectent la perception de la vision stéréo. Dans cette thèse, une série d'expériences physiologiques ont été menées visant à évaluer la perception visuelle 3D par rapport à 3 des facteurs les plus importants: la technologie d'affichage 3D, les environnements de visualisation et de mouvement en profondeur (MID). Nous avons d'abord mesuré l'amplitude de fusion verticale (VFA) sur les projecteurs 3D et une télévision autostéréoscopique. Le VFA a été choisi comme un indicateur pour le confort visuel en raison de notre forte sensibilité à la disparité verticale. Plusieurs facteurs ont été testés (e.g. distance d'observation, la luminance du fond, la diaphonie, l'angle de vue, etc.). Nous avons comparé les performances d'observateur sur les deux écrans 3D et conclu que la tolérance pour la disparité verticale était meilleure sur le projecteur 3D que sur la télévision autostéréoscopique. Pour l'impact de l'environnement sur la perception stéréo, nous avons mesuré le VFA sur un projecteur 3D en fonction de l'éclairage de la pièce, de la complexité du contenu 3D, de la vitesse de disparité. Nous avons évalué l'interaction entre la fusion centrale et périphérique, en introduisant une série de prismes en face d'un œil. Nous avons observé que l'équilibre de la fusion entre vision centrale et périphérique était rompu quand de grandes disparités périphériques (> 4 dioptries prismatiques) ou tailles de stimuli (angle central du stimulus $< 15^\circ$) étaient induites sur la vision périphérique. Enfin, nous avons étudié l'interaction entre le système sensoriel et oculomoteur en stimulation MID. Les premiers résultats indiquent que les post-effets générés par stimulation sensorielle pouvaient être partiellement atténués par des stimulations oculomotrices. Nous avons en outre identifié certains facteurs critiques pour la génération de contenu 3D pour améliorer la perception MID, comme la texture de fond, le temps de fixation objet et la durée de vie des random dots.

Contents

Acknowledgement	IV
Abstract	II
Résumé	III
List of figures	IV
List of tables	IV
Abbreviations	IV
General introduction	1
1. Chapter 1 Introduction	6
1.1. The eye & How we see.....	8
1.2. Binocular vision.....	12
1.3. Oculomotor function.....	18
1.4. Sensory function	22
1.5. 3D perception stimulation cues.....	32
1.6. 3D display technologies.....	32
1.7. Conclusion	38
2. Chapter 2 3D display technology effect on visual perception	40
2.1. Introduction.....	42
2.2. Methods.....	44
2.3. Procedures.....	49
2.4. Results and discussions.....	55
2.5. Conclusions	61
3. Chapter 3 Environmental parameters impact on visual perception of 3D stereo objects	64
3.1. Introduction.....	66
3.2. Methods.....	68
3.3. Procedures.....	72
3.4. Results and discussions.....	75
3.5. Conclusions.....	85
4. Chapter 4 Motion-in-depth perception	86
4.1. Introduction	88
4.2. Apparatus and subjects.....	93
4.3. Investigation on sensory and oculomotor system interaction in motion-in-depth perception.....	95

4.4. Corrected experiments for sensory and oculomotor system interaction investigation in motion-in-depth perception	106
4.5. Motion-in-depth perception training.....	108
4.6. How to design motion-in-depth stimulus.....	114
4.7. Conclusion.....	124
5. Chapter 5 Conclusion and perspectives.....	126
Bibliography	131
Appendix A: questionnaire A	136
Appendix B: questionnaire B.....	137
Appendix C: statistics.....	138
Sommaire	140

List of figures

Figure 1. Effect factors for 3D visual perception	2
Figure 1.1 Eye structure.	8
Figure 1.2 Relationship between illuminance regimes and photoreceptor sensitivity.	9
Figure 1.3 Distribution of cones and rods on the retina (Purves D et al, 2001).	10
Figure 1.4 Visual pathways from the eyes to the primary visual cortex.	11
Figure 1.5 The two routes of processing visual information in primate visual cortical area. ...	11
Figure 1.6. The geometry of horizontal disparity.	13
Figure 1.7 Diagram showing relative and absolute disparities of 2 points in different depth planes.	14
Figure 1.8 a) Demonstration of vertical disparity generation using 3D stereo system. b) Geometry of vertical disparity calculation.	15
Figure 1.9 Schematic representation of Horopter.	16
Figure 1.10 Schematic representations of Panum's area and Panum's space.	17
Figure 1.11 Function of accommodative stimuli and accommodation response.	19
Figure 1.12 Block diagram of the phasic-tone control and A/V interaction.	21
Figure 1.13 Static interactive dual-feedback model of the A/V system.	22
Figure 1.14 Neuroanatomic functions for binocular vision in striate cortex (V1).	23
Figure 1.15 Demonstration of crossed and uncrossed disparity.	23
Figure 1.16 The demonstration of clear single binocular vision zone.	24
Figure 1.17 a). Vergence-accommodation under natural viewing condition, b) Vergence-accommodation on stereoscopic display.	25
Figure 1.18 Schematic illustrations of motion in depth and the associated image motion.	26
Figure 1.19 Illustration of the two mechanisms describing how binocular information is processed for MID perception.....	27
Figure 1.20. Motion cue stimulus conditions.	27
Figure 1.21. A random dot kinematogram used to measure motion sensitivity.	29
Figure 1.22 stimulus, protocols and results of previous MAE study.	31

Figure 1.23 Simplified classifications of 3D display technologies.	34
Figure 1.24 Stereoscopic display demonstrations.	35
Figure 1.25 Demonstration of Multiview lenticular autostereoscopic display.	37
Figure 1.26. Examples of scales used to measure visual comfort of stereoscopic vision.	37
Figure 1.27 Perspectives of the current thesis.	39
Figure 2.1 a) 3D display platform in experiment 1, b) Autostereoscopic TV in experiment 2. .	46
Figure 2.2 Multiview lenticular autostereoscopic TV in BUPT.....	47
Figure 2.3 Stimulus used for experiments 1 and 2.	48
Figure 2.4 Experimental setup for Experiment 1.	49
Figure 2.5 Protocol to measure vertical fusion amplitude.	50
Figure 2.6 Control test schematic.	52
Figure 2.7 Optical characterization of autostereoscopic display.....	53
Figure 2.8 Averaged VFA on 3D projector. The comparison of stimulus size and viewing distance effect on VFA.....	56
Figure 2.9 Averaged VFA on autostereoscopic TV for effect factor of a). Viewing distance, b). Viewing angle, c). Luminance.	57
Figure 2.10 Averaged VFA on 3D projector and autostereoscopic TV when stimulus image is Fig. 2.3c.	59
Figure 2.11 Averaged VFA on 3D projector and autostereoscopic TV when stimulus image is Fig. 2.3c.	61
Figure 3.1 Images displayed on the screen. Inset zoom of the fixation point of image on up-right part.	68
Figure 3.2 a) Light refraction when it passes through the prism, b) The view is shifted upward when the eye look through a base-down prism.	69
Figure 3.3 a) The prism that are used in the current study, b) The prism is inserted in the right view of 3D glasses, thanks to a dedicated prism holder.	70
Figure 3.4 General experimental demonstrations.	72
Figure 3.5 Image shift definition.	73

Figure 3.6 Demonstration of control test, in this test, the right eye image is downward shifted.	74
Figure 3.7 Averaged VFA for all subjects according to different parameters.	76
Figure 3.8 average VFA under different prism values when the room lighting is off.	77
Figure 3.9 Average VFA when different prisms were induced.	78
Figure 3.10 Vertical eye motion when 4 prisms were induced in peripheral retina: 0Δ, 2Δ, 4Δ, 6Δ.....	80
Figure 3.10 Averaged fusion ratios for all subjects as function of the viewing distance.	81
Figure 3.12 Fitted functions for peripheral fusion effect as a function of stimulus size.	81
Figure 3.13 Mean value of vertical fusion capability for the dominant eye effect (with different value of induced prisms).	84
Figure 4.1 Research motivations for motion in depth perception.	91
Figure 4.2 view of the haploscope from IRBA in our laboratory.	93
Figure 4.3 a) 3D display platform and eye-tracker. b) The control software of the eye-tracker, the tracking accuracy and head motion are displayed in real time.	94
Figure 4.4 Demonstrations for Experiment 1-3.	96
Figure 4.5 Demonstration of cross motion as a function of time.	97
Figure 4.6 a) Stimulus for the binocular view; b) Side view of the stimulus when subject looks through the 3D glasses.	97
Figure 4.7 a) Example of 4s adaptation and 1s test stimulus during one trial. b) Adaptation session schedule in 1 trial.	99
Figure 4.8 The relative disparity of cross and RDS during 4s adaptation. a) 4 relative positions in depth of the cross and RDS during 4s adaptation motion-toward. b) 4 relative positions in depth of the cross and RDS during 4s adaptation motion-away.	100
Figure 4.9 a) Cross motion direction discrimination during the experiment; b-e) oculomotor system change between pre-stimulus and post-stimulus.	102

Figure 4.10 MID direction sensitivity for the motion-toward and motion-away.	103
Figure 4.11 Fitted psychometric functions (logistic functions) as a function of coherence of the test stimulus (x axis) and the toward answer percentage (y axis). Green curve corresponds to un-adapted test, blue for adaptation motion-toward, and red for motion-away. The point of subjective equality is fixed at a 0.5 threshold.	104
Figure 4.12 Fitted psychometric functions for the un-adapted tests in experiment 2 and 3. The green curve is the fitted logistic function for stable cross. The red curve corresponds to the fitted logistic function in case of cross motion away. The blue curve represents the fitted logistic function for cross moving toward.	105
Figure 4.13 Fitted psychometric functions in experiment 3, the data is an average of the case of cross motion-toward and motion-away.	106
Figure 4.14 Fitted psychometric functions for the case of un-adapted test, adaptation toward test and adaptation toward test + cross moving away during 1s test stimulus.	108
Figure 4.15 Psychometric functions for pre-and post-training session performance for all subjects.	111
Figure 4.16 Psychometric functions for retesting on subject 3 and subject 6, two and nine months after post- training sessions.	112
Figure 4.17 The improvement of MID perception accuracy of the original test and the control test. a) And b) present the data obtained from Subject 3, c) and d) present the result of subject 6.	113
Figure 4.18 Stimulus images for the test parameters for background texture, fixation and contrast.	115
Figure 4.19 Plan view of the stimulus when eye vergence effect is tested, a) the fixation cross and background is in the same position with the screen in depth volume, b) the fixation cross and background is at the bottom of depth volume, c) the fixation cross and background is at the front of depth volume.	116
Figure 4.20 Background Texture effect on MID perception.	117

Figure 4.21 Fixation effect on MID perception.	118
Figure 4.22 Stimulus contrast effect on MID perception.	119
Figure 4.23 Relative disparity effects on MID perception.	120
Figure 4.24 Gaze heat map comparison for static stimulus and dynamic stimulus. There are two subjects' data presented in this figure.	121
Figure 4.25 Eye gaze heat map when background texture and fixation are modified.....	122
Figure 4.26 Eye gaze heat map of one subject, who have great difficulty to discriminate MID during the experiment.	123

List of tables

Table 2.1 The main parameters of autostereoscopic TV	47
Table 2.2 Test parameters in experiment 1. Bold in column identifies the paired parameters with reference condition.	51
Table 2.3 Test parameters in experiment 2. Bold identifies the paired parameters. The test factors with* indicate that the test image is depicted on the whole autostereoscopic TV. The test factors without* mean that the depicted image size is modified to maintain the same stimulus size with experiment 1.	54
Table 2.4 Crosstalk and illuminance measurements at four viewing angles. Crosstalk is calculated by conventional method with adaption to eye perception.	57
Table 2.5 Recommended viewing environment configurations based on the experimental results.....	61
Table 3.1 Lighting conditions a) with room light, b) without room light.	70
Table 3.2 Viewing angles at different distances.....	74
Table 3.3 Comparison of vertical fusion amplitude with induced peripheral disparity.....	76
Table 4.1 Statistical analysis of MID perception for the effect of background texture effect...	115
Table 4.2 Statistical analysis of MID perception for the effect of background texture effect...	116
Table 4.3 Statistical analysis of MID perception for the effect of background texture effect...	117
Table 4.4 statistical analysis of MID perception for the effect of background texture effect...	118

Abbreviations

AD: absolute disparity

AC/A ratio: accommodative convergence / accommodation ratio

A/V conflict: accommodation and vergence conflict

CA/C ratio: convergence accommodation to convergence ratio

CD: changing disparity

IOVD: intraocular velocity difference

MAE: motion aftereffect

MID: motion-in-depth

PF: Psychometric Function

RD: relative disparity

VFA: vertical fusion amplitude

General introduction

3D technology has been an important approach to present to human visual system binocular parallax information for inducing the perception of the third dimensional depth since late 19th century. The depth perception which is generated by binocular disparity is more compelling and robust than depth perception stimulated by monocular cues [1, 2]. A number of 3D technology applications have been widely implemented in scientific visualization and measurement, medical imaging, telepresence, gaming, as well as movies and televisions.

A correct and appropriate perception for stereoscopic information is fundamental requirement of comfort and healthy viewing experience. However, the stereoscopic perception is affected by various aspects, and the classification of the factors is divided into many categories, as is shown in Fig. 1. On the aspect of 3D display technology, the visual perception is not the same with autostereoscopic displays, volumetric displays and holographic displays [3]. If we consider the effect of 3D content, the factors include disparity distribution, binocular mismatches, intraocular crosstalk, depth inconsistencies etc. what's more, the parameters of human vision will lead to different perception of stereoscopic, such as perceptual and cognitive Inconsistencies, the conflict of convergence and accommodation, intraocular difference in luminance and contrast, visual acuity, stereo acuity, ages etc [4, 5, 6, 7]. Even the method to evaluate visual perception experience could be objective or subjective, the measurement could be visual fatigue or discomfort. When visual fatigue is assessed, it is usually refers to a decrease in performance of the visual system presented by a physiological change. Therefore, visual fatigue could be measured with physiological response, such as changes in accommodation response [8], pupillary diameter, and eye movement characteristics [9], Visual discomfort on the other hand refers to the subjective sensation of discomfort that accompanies the physiological change. Thus, visual comfort can be measured by the means of viewers' to report the level of perceived visual comfort. Disparity is a fundamental cue for stereoscopic perception creation, it has two types: horizontal disparity and vertical disparity. Horizontal disparity is the main component to stimulate stereo vision, different visual perception could be achieved by modifying horizontal disparity characters. Various attempts have been made to explore the factors that will affect 3D visual perception, which could be grouped into four aspects: 3D display technology, 3D viewing environment, 3D content and binocular visual system characters.

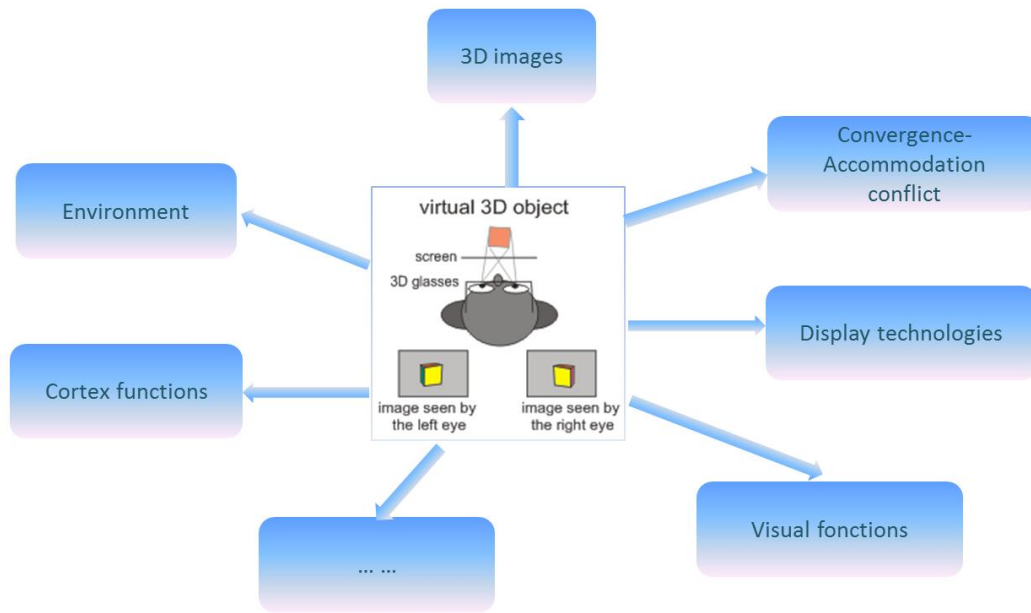

Figure 1 Effect factors for 3D visual perception.

Motivations

In the current thesis, we measured the physiological response of observer to certain stimulation to evaluate the visual perception. We chose the aspects that are most related with a perceptual process when 3D technology is applied in practice. First of all, a 3D display platform is required when we need to present some media, different display technology will result in different viewing experience. Second, a certain environment configuration is essential for any occasion, a targeted arrangement of environmental setup will significantly improve visual perception, such as how to decide the size of the screen, where is the best viewing distance, how to control the luminance of the show room, etc. Last but not the least, the introduction of an appropriate 3D content to the observers is fundamental for a successful perception, which is related to the 3D stimulus creation, including the range of depth, the velocity of motion-in-depth, and the criteria of human vision parameters should be also considered because observers' visual parameters vary widely.

Our work focus on the following three aspects:

3D display platform, nowadays, the two most popular technologies are stereoscopic display and autostereoscopic display, determined by the theoretical differences, the effects that are presented to the observers are different. For stereoscopic display, special glasses are required to deliver different images to left eye and right eye for observers in order to perceive 3D, the

synchronization of screen and glasses allowed a flexible viewing experience, which means observers could watch the screen at different viewing distances and viewing angles. For the autostereoscopic display, it is usually a lenticular lens or parallax barrier that separates the 3D source and thus images with disparity are delivered to different eyes. Due to the limitation of number of views and the structure of light splitting devices, an optimal viewing distance is fixed and the viewing experience will be largely decreased if observer are too close or too far from the screen. What's more, the crosstalk between neighbored views has always been an issue to be compensated. Given the different characters of the two display technologies, it is necessary to consider visual comfort evaluation separately for stereoscopic display and autostereoscopic display based on their specific critical factors.

Environmental configuration, since all stereoscopic perception is conducted in a certain environment, the parameters in the cinema are quite different with those at home in daily life, such as room lighting, viewing distance, screen size etc., so it is necessary to clarify which environment parameter will affect 3D perception and how to optimize these critical factors to achieve the best visual perception according to specific viewing condition.

Reaction of binocular system for motion-in-depth is also important for stereo vision. Imagine observers sitting in a cinema could not perceive strong 3D motion or some motion appeared in the movie make them headache or dizzy, it will be a failure of the 3D content designer. According to the statistics, only 90% population could perceive depth information, and individual difference is significant among these people. When one object is moving in depth, it is even more difficult for observer to perceive the motion-in-depth, since it need certain amount of response time, the depth and motion-in-depth is proceed in different part of the brain, some people could not pass stereoscopic acuity test could perceive stereo motion! So it remains still miserable about the relationship of static stereo vision and motion-in-depth perception. More research effort should focus on how to create 3D content that is easy to perceive and more comfortable to see.

In the observers' visual perception under different effect factors is generally evaluated by two parameters: vertical fusion amplitude and accuracy of motion-in-depth response. The goal of the thesis is to propose references which ensure a superior perception for stereoscopic information in real life, which could improve the 3D visual comfort.

Organization of the thesis

The following are the origination of the chapters:

The first chapter briefly reviews the history and developments of 3D display technology, binocular system and stereo vision. Some unexplored issues will also be identified in this chapter, i.e. the different effect factors of stereoscopic technology and autostereoscopic technology, the quantitative interaction of central and peripheral retina and the human response of motion-in-depth stimulation. These issues will be further explained in Chapter 2-4 by the mean of physiological experiments. In Chapter 5, the conclusion is made and suggestions for 3D content creation and 3D display configuration are proposed for practice application.

Thesis contribution

Design experiments to explore environment configuration effect on visual tolerance for vertical disparity, the factors include viewing distance, background luminance, room lighting, disparity velocity and central and peripheral fusion interaction during the fusion process.

Identify the critical environment factors that will affect visual tolerance, including viewing distance, background luminance and disparity.

Evaluate the role of central and peripheral retina during the fusion process, confirming the main role of central fusion, and propose a balance point of central and peripheral fusion interaction.

Design experiments and evaluate the visual tolerance of vertical disparity on 3D projector and lenticular autostereoscopic TV. Clarify the critical parameters that affect vertical disparity fusion on the two main 3D display technologies respectively.

Design experiments to explore how to improve visual motion-in-depth direction discrimination ability.

Identify that oculomotor cue can be used to mitigate motion aftereffect which is generated by sensorial cue stimulus.

Reference

- [1] Patterson, Robert, and Wayne L. Martin. "Human stereopsis." *Human factors* (1992).
- [2] Lambooi, Marc TM, Wijnand A. IJsselsteijn, and Ingrid Heynderickx. "Visual discomfort in stereoscopic displays: a review." *Electronic Imaging 2007*. International Society for Optics and Photonics, 2007.
- [3] Benzie, Philip, et al. "A survey of 3DTV displays: techniques and technologies." *Circuits and Systems for Video Technology, IEEE Transactions on* 17.11 (2007): 1647-1658.
- [4] Kooi, Frank L., and Alexander Toet. "Visual comfort of binocular and 3D displays." *Displays* 25.2 (2004): 99-108.
- [5] Tam, Wa James, et al. "Stereoscopic 3D-TV: visual comfort." *Broadcasting, IEEE Transactions on* 57.2 (2011): 335-346.
- [6] Pölönen, Monika, Toni Järvenpää, and Beatrice Bilcu. "Stereoscopic 3D entertainment and its effect on viewing comfort: Comparison of children and adults." *Applied Ergonomics* 44.1 (2013): 151-160.
- [7] Patterson, Robert. "Review Paper: Human factors of stereo displays: An update." *Journal of the Society for Information Display* 17.12 (2009): 987-996.
- [8] Yano, Sumio, et al. "A study of visual fatigue and visual comfort for 3D HDTV/HDTV images." *Displays* 23.4 (2002): 191-201.
- [9] Ukai, Kazuhiko, and Peter A. Howarth. "Visual fatigue caused by viewing stereoscopic motion images: Background, theories, and observations." *Displays* 29.2 (2008): 106-116.
- [10] Sexton, Ian, and Phil Surman. "Stereoscopic and autostereoscopic display systems." *Signal Processing Magazine, IEEE* 16.3 (1999): 85-99.

Chapter 1

Introduction

Table of contents

1. Introduction
 - 1.1. The eye & How we see
 - 1.1.1. The eye
 - 1.1.1.1. Light path through the eye
 - 1.1.1.2. The retina
 - 1.1.2. Beyond the eye
 - 1.2. Binocular vision
 - 1.2.1. Significance of binocular vision
 - 1.2.2. Binocular disparity
 - 1.2.2.1. Horizontal disparity
 - 1.2.2.2. Vertical disparity
 - 1.2.3. Binocular fusion
 - 1.2.3.1. Horopter
 - 1.2.3.2. Panum's area
 - 1.2.3.3. Sensory fusion and motor fusion
 - 1.2.3.4. Diplopia, binocular rivalry and suppression
 - 1.3. Oculomotor function
 - 1.3.1. Accommodation
 - 1.3.2. Vergence
 - 1.3.3. Models of the oculomotor system
 - 1.4. Sensory function
 - 1.4.1. Depth perception
 - 1.4.2. Comfort zone
 - 1.4.3. Motion-in-depth perception
 - 1.4.4. Accuracy of binocular stereo motion perception
 - 1.4.5. Motion aftereffect
 - 1.4.6. The choice of this thesis for MID exploration
 - 1.5. 3D perception stimulation cues
 - 1.6. 3D display technologies
 - 1.6.1. Stereoscopic technologies
 - 1.6.2. Autostereoscopic technologies
 - 1.6.3. 3D viewing experience evaluation and visual comfort
 - 1.7. Conclusion

1.1. The eye & How we see

The eyes are our windows to the world, and the processes of human vision are pretty complex. Although the images projected on the retina are bio-dimensional, a 3D world is perceived, besides, we have a precise discrimination of object's color, shape, location etc., we can follow a moving target while keeping a sharp focus and detect its motion direction. All these visual functions are accomplished by the cooperation of the eyes, neural system and brain.

1.1.1. The eye

Eyes are a complex optical system. They are made up of various components. They detect the light and convert it into electro-chemical impulses in neurons.

1.1.1.1. Light path through the eye

The human eyes are a complex optical structure which is sensitive to wavelength between 380 and 800 nm. As is shown in Fig. 1.1, the light entering the eye is refracted by the cornea, and then travels through the aqueous and pupil. The amount of light passing through is limited by the pupil aperture, due to constriction or expansion of the iris. The light is further refracted by the crystalline lens before reaching the retina, the crystalline lens is adjustable, it is connected with circular ring of ciliary muscles, and its thickness could be changed to achieve appropriate focal length for different observing distances. The crystalline lens and cornea are the main refractive components which work together to project the image onto the retina.

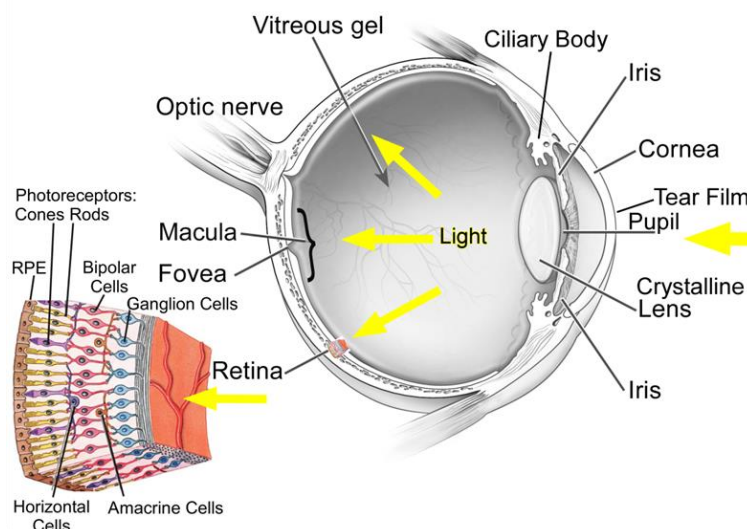

Figure 1.1 Eye structure (Fuensanta A. Vera-Díaz, 2012).

1.1.1.2. The retina

Retina is a light-sensitive layer at the back of the eye, light signal is transduced to electro-chemical impulses and sent to various visual centers of the brain through the fibers of the optic nerve, and real visual processing begins (Fig. 1.1 in the left part).

Retina is a layered structure interconnected by synapses, and light signal is transmitted by neurons called photoreceptor cells. There are mainly two types of photoreceptor cells: rods and cones. Rods work in dim light and support black-and-white vision (called scotopic vision), while cones work for daytime vision (also called photopic vision) and provide color perception. The illuminance in most cases falls between these two levels, and this intermediate illuminance range is called mesopic vision, both rods and cones are active at this illuminance level. Fig. 1.2 demonstrates the relationship of luminance regimes and sensitivity of rods and cones. The cones are spectral sensitive, for normal human vision, there are three subtypes of cones that respond to short, medium and long wavelengths respectively. The lack of one or more cone subtype will cause deficiencies in color vision or even color blindness.

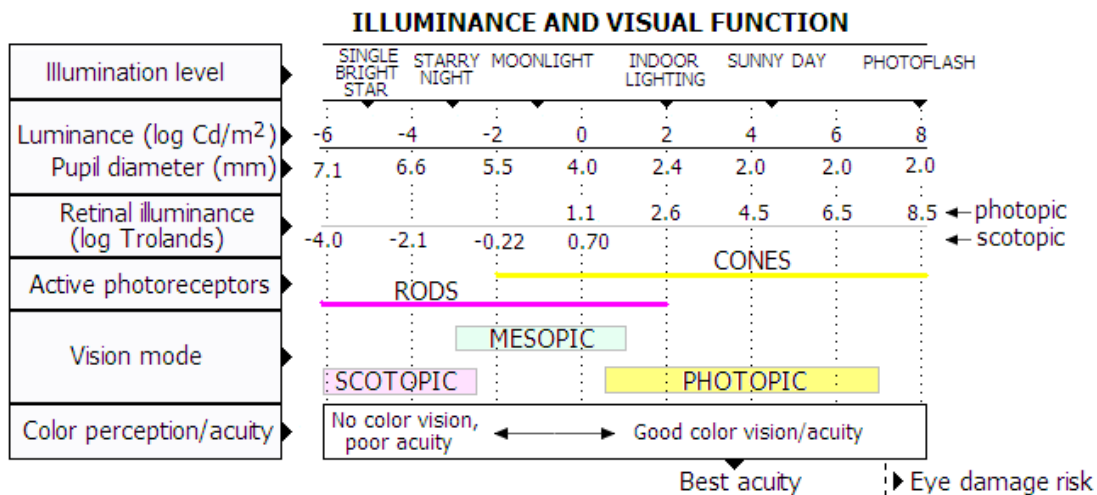

Figure 1.2 Relationship between illuminance regimes and photoreceptor sensitivity.

The cones and rods have different distributions on the retina. The fovea, which is about 1.5mm wide, is located at the very center of the retina. It is responsible for sharp central vision, which is important for activities such as reading and driving. The largest cone density is in fovea(140000 cones per mm²), and the visual acuity here is also the best across the retina [1], due to the lack of rods, fovea is less sensitive to dim light. The density of cones and rods is illustrated in Fig. 1.3. There is a blind spot located about 12°-15° from the fovea (i.e. nasal fovea), it is the place where the optic nerve passes through the optic disc, there are no photoreceptors at this area, therefore an image that falls on this region will NOT be seen.

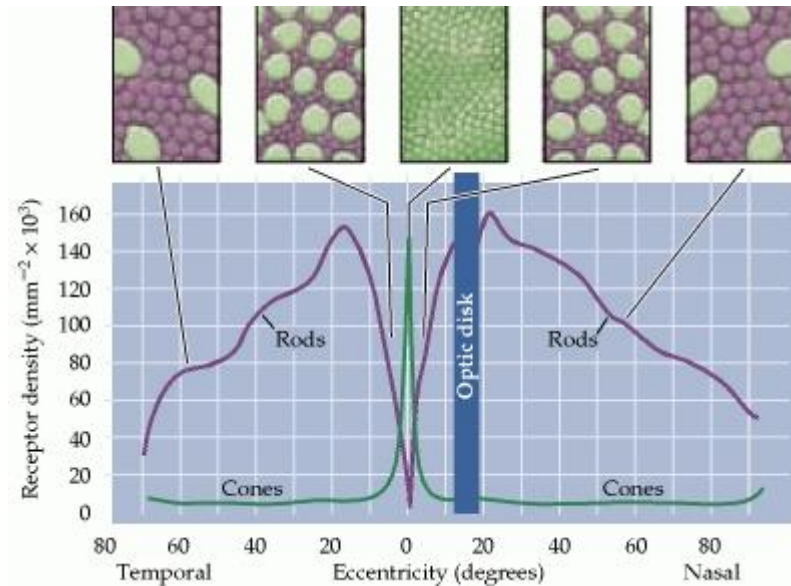

Figure 1.3 Distribution of cones and rods on the retina (Purves D et al, 2001).

The signal process in retina could be simplified into four steps: activation of the photoreceptors, transmission to bipolar cells, passing through retinal ganglion cells, the most useful information grouping into visual cortex through the optic nerve disk such as the color, shape, luminance etc.[2].

1.1.2. Beyond the eye

The electrical signals follow a path that crosses at the optic chiasma after they exit the retina through the optic nerve, they later reach the visual area of thalamus and then enter the primary visual cortex, as is shown in Fig. 1.4.

The lateral geniculate nucleus (LGN) is an important synaptic relay located in the dorsal part of the thalamus, it is the major target for each optic tract because 80% axons of the retina's ganglion cells terminated in LGN. There are six layers in LGN for each side, the right LGN processes all the visual signals from the left visual field (vice versa for the left LGN). It receives axons from the left nasal retina (cell layers 1, 4, 6) and the right temporal retina (cell layers 2, 3, 5).

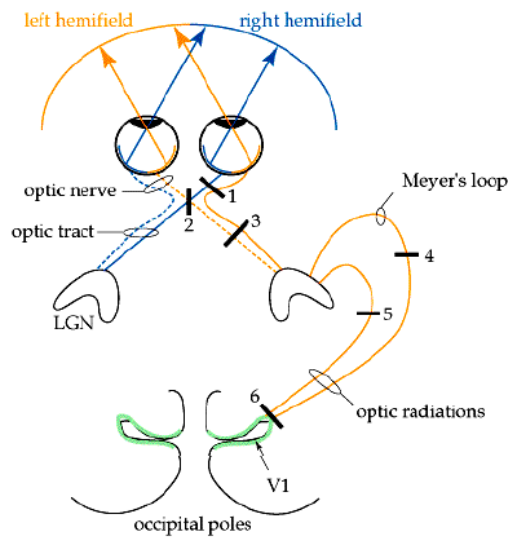

Figure 1.4 Visual pathways from the eyes to the primary visual cortex (Derrington, A., 2002).

The 3D perception of an object is achieved by the cooperation of different visual cortical areas. There are several models to describe the neural processing of vision, one widely accepted model is described in the paper of David Milner and Melvyn A. Goodale in 1992 [3, 4]. There are two major cortical systems for processing visual information: a ventral pathway and a dorsal visual pathway. The function of ventral visual pathway (known as “what” pathway) lets us consciously perceive, recognize and identify objects by perceiving the original visual properties such as shape and color. The function of dorsal visual pathway (known as “where” pathway) stimulates visual-motor system to allow us to know the spatial information of the object, such as the size or the position and orientation in space. The routes of the two parallel processing pathways are demonstrated in Fig. 1.5.

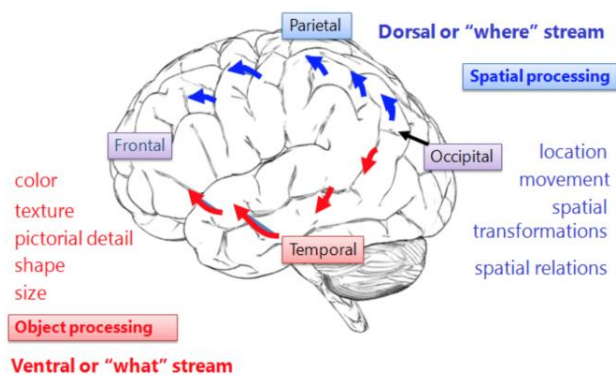

Figure 1.5 The two routes of processing visual information in primate visual cortical area.

Generally, there are five visual cortical areas, although the functions of each area have been explored since long time ago, some aspects are still in debates. The V1 area is the largest of the visual areas and very important for vision, it has several layers which have different functions, some layers receive or send back information to lateral geniculate nucleus, and some layers send information to higher visual areas. The cells in V1 are selective for orientation, complexity and trigger features, so the basic recolonization of an object is achieved in V1. However, to perceive more specific characters of the retinal image, a cooperation of different cortex areas is needed. Generally, V1, V2 are involved in basic visual features, such as color, size etc.; V3 and (medium-temporal) MT/V5 deal with motion detection, spatial localization, shape perception, hand and eye motions; V4 turns to process intermediate complex information [5-7].

1.2. Binocular vision

The binocular vision is the coordination of both eyes to achieve a simultaneous vision state, a single image is perceived by the binocular fusion of two slightly dissimilar images depicted in each eye.

1.2.1. Significance of binocular vision

The binocular vision allows a full perception of various angles of an object in the viewing field. Normal binocular vision could help to determine the target direction, speed and position in space. The binocular motor sensory system coordinates the movement of the eyes with the viewing distance or angles of the target, when the target is moving or stable, besides, the binocular system could also achieve an effective coordination of the accommodative system to keep a single, clear and comfortable perception. Binocular vision is superior to monocular vision, for instance, in the tasks of letter identification, color discrimination, needle threading etc. Besides, the visual field is enlarged by the overlap of view angle of left and right eye [8, 9]. The perception of stereopsis is the main point of binocular vision, it will be described in later sections.

1.2.2. Binocular disparity

Due to the horizontal separation of the two eyes, slightly different images of an object are seen by the left and right eye, which refers to binocular disparity. Although the images projected on the retina are two-dimension, the brain could use binocular disparity and the retinal images to perceive stereopsis. Due to the orientations of the disparity, there are two kinds of disparity: horizontal and vertical disparities.

1.2.2.1. Horizontal disparity

- **Definition**

The **horizontal disparity** (P) of a given point in objects space(x) is defined as a function of the lateral separation of the eyes divided by object distance, Fig. 1.6a, and it is quantified in angular units:

$$P = 2 \times \arctan\left(\frac{a}{d}\right) \times k \quad (1)$$

Where a = half of the inter pupil distance (IPD) (65mm), d = the distance between the object and the nodal points of the eyes, k is a conversion factor that varies depending on the angular unites of P (e.g., degree, prism diopters) [10].

Stereopsis could only be perceived when there are two or more points in object space, this refers to relative disparity. The definition of **relative disparity** is the depth interval between two objects points with the measurement in angular units, as is shown in Fig. 1.6b. Horizontal relative disparity (D) is calculated as the difference of parallax angles (P_1 and P_2) subtended by two points (x and y) in object space:

$$D = P_1 - P_2 \quad (2)$$

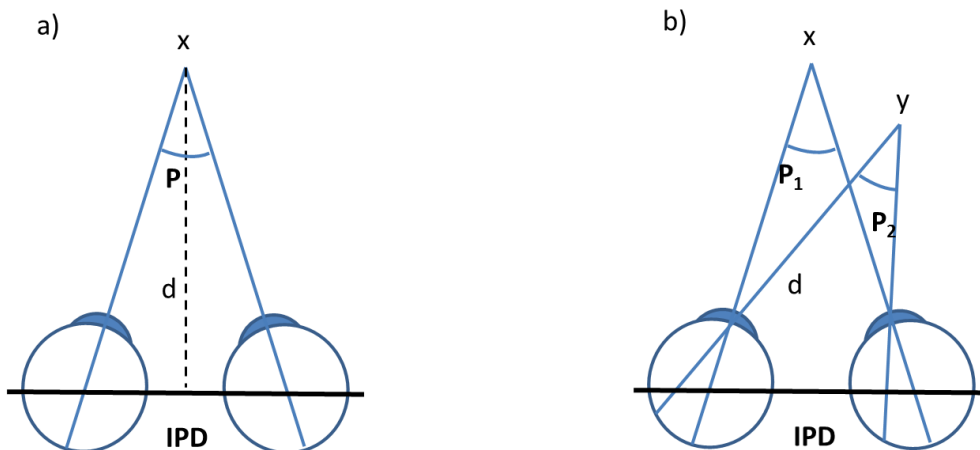

Figure 1.6. The geometry of horizontal disparity. a) The definition of binocular disparity of object x ; b) The definition of relative disparity of x and y .

- **Absolute disparity VS relative disparity**

There are two types of signal for the stereo disparity systems in the brain: absolute and relative disparities. When both eyes are focusing at a particular location in space (X , as is shown in Fig. 1.7, is called the fixation point): the image of X falls on the fovea of each eye. Y is another

object in the space, and the image of Y is projected at different positions on the left and right retina with respect to the fovea. If we switch the gaze from X to Y, the eyes have to rotate by different angles (A_1 and A_2). The difference of angles is called the absolute disparity of Y. Relative disparity is another way to present the space relationship between objects. Regardless of where the eyes are pointing, the relative disparity is calculated by $P_1 - P_2$.

The absolute disparity is an estimation of object and surface in reference to where the eyes are fixating; the relative disparity is the location relationship between two different objects, it is independent of the fixation point. The absolute disparity connects the accommodation-convergence reflex and the 3D stereo perception [11].

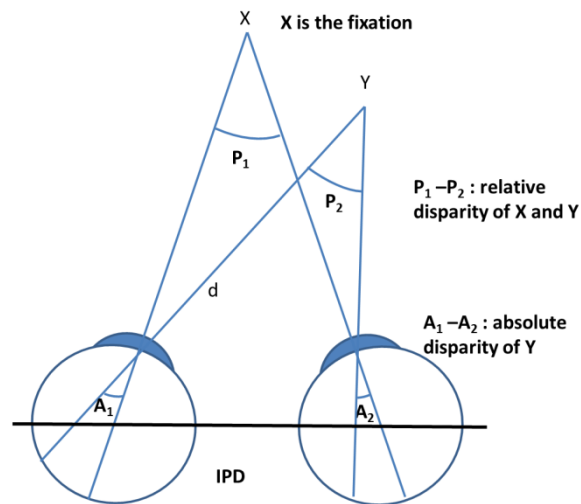

Figure 1.7 Diagram showing relative and absolute disparities of 2 points in different depth planes. Relative disparity of X and Y is the angle difference of the two points in space corresponding to the two eyes, thus $P_1 - P_2$. The absolute disparity is the angle difference for on point between two eyes, with the fixation point as a reference, since the fixation in this figure is X, the absolute disparity of Y is the angle difference of A_1 and A_2 , A_1 and A_2 are the angle of X and Y corresponding to certain eyes.

1.2.2.2. Vertical disparity

Vertical disparity can be defined as the difference of a vertical angle subtended at the right and left eyes by a given object [12].

Since the normal human eyes are supposed to locate at the head without vertical displacement, the visual tolerance for vertical disparity is consequently much weaker than it is for horizontal disparity [13]. As is shown in Fig. 1.8a, a slight vertical disparity could be

fused by the visual system, but large vertical disparity will cause diplopia or rivalry. Vertical disparity effect could also come from pathologies of patients suffering from verticality dysfunctions including alphabetical and V syndrome, strabismus in tropia. These effects cause an ocular compensation (ocular tropia or head movements to compensate), brain compensates or suppress to a given drop-out level.

The measurement of vertical disparity is illustrated in Fig. 1.8b, it is related with the viewing distance, the vertical displacement of the images. The unit is prism-diopter Δ , 1 prism diopter is defined as the deviation of light by 1 cm, observed at 1 m viewing distance.

a)

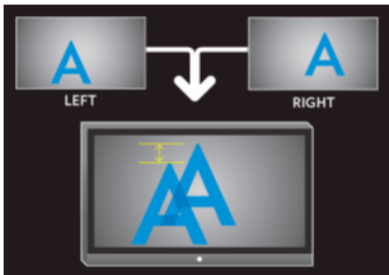

b)

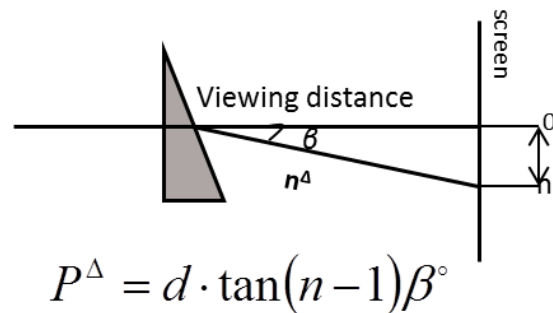

Figure 1.8 a) Demonstration of vertical disparity generation using 3D stereo system. b) Geometry of vertical disparity calculation.

1.2.3. Binocular fusion

Binocular fusion is the unification of two ocular images with disparity. It could be achieved by two different processes: sensory fusion and motor fusion. When the disparity is too large, the fusion process will be stopped, observers will perceive diplopia or one image of the stereo pairs is ignored by the brain [9].

1.2.3.1. Horopter

Horopter is defined as the locus of all object points in space that are imaged on corresponding two retinal elements at a given fixation distance. A single vision could be achieved with the objects locating along the line which makes the same angles at the two eyes with the fixation lines [14]. There are two descriptions for horopter, Fig. 1.9:

- **Geometric Vieth Muller Horopter:** According to this model of horopter if corresponding points have a regular horizontal distance from the retina the horopter would be a circle passing through the center of rotation of the two eyes and the fixation point. Thus the circle becomes smaller as the point of fixation gets nearer.
- **Empirical Horopter Curve:** The empirical horopter curve is defined by singleness of vision, it has larger area than the theoretical horopter. It is believed that any point in one retina might yield single vision with a circular region centered on the corresponding point in the other retina. The size of this curve is relative with the Panum's fusional area.

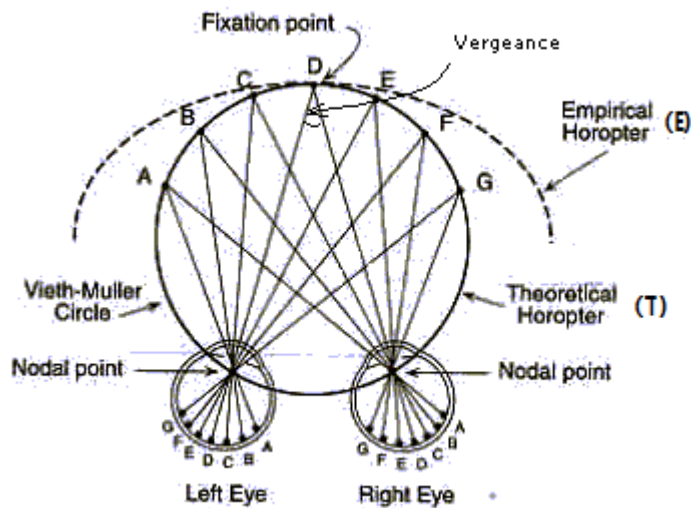

Figure 1.9 Schematic representation of Horopter. With the eyes converged in point D, the theoretical/geometrical horopter is the circle, while the empirical horopter is the arc E.

1.2.3.2. Panum's area

The range of horizontal disparities around the horopter within which the stimulus continue to be perceived as single is known as **Panum's space**, this region in space corresponds to areas on the retina, called Panum's area (no diplopia area), Fig. 1.10. Panum's space is narrowed at the fixation point and expands in periphery, due to larger receptive fields and poorer visual acuity in the periphery. Because Panum's areas are large in the periphery, larger amounts of disparity are accepted before experiencing diplopia.

Panum's area is narrowest at the fixation point and becomes broader in the periphery at a rate of 1-2 arc min per degree of visual field eccentricity. Because Panum's area has greater area in the periphery, larger amounts of disparity are accepted before experiencing diplopia. The

increase in the Panum's area towards the periphery may be related to anatomic and physiologic differences known to exist between the monosynaptic foveal cone system and the rod and cone system of the periphery. The Panum's area is smallest near the fovea, about 6-10 arc minutes on both sides of the horopter. Stereopsis begins about 2-10 arc seconds on both horopter sides, near the center of Panum's space. Panum's space expands peripherally to about 30-40 arc minutes at 12° from the fovea. In somecases, objects with up to 2-3° of disparity can be fused [15]. Panum's area expands or contracts with the test conditions and methods, such as the stimuli size, sharpness, speed, luminance etc [16].

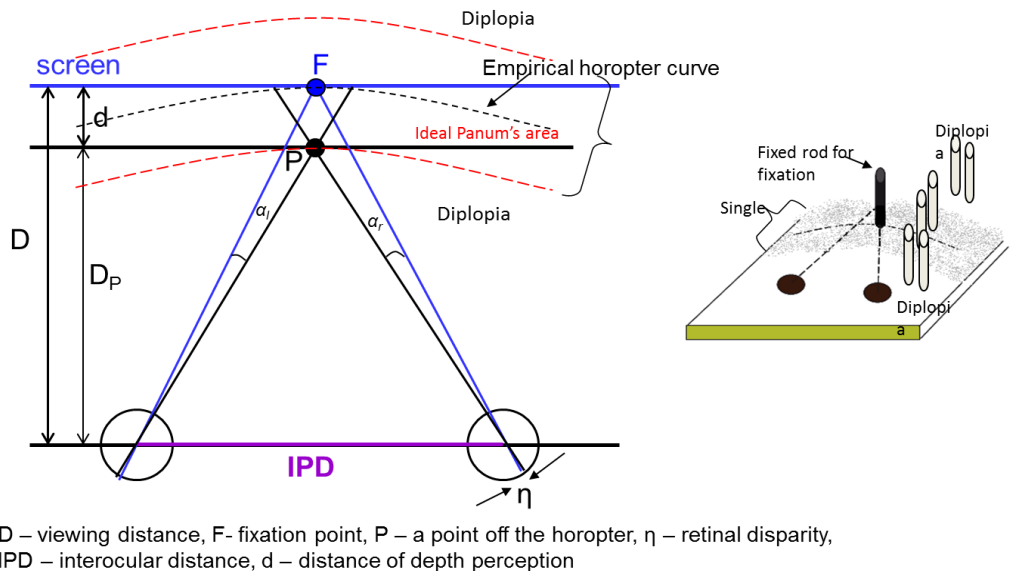

Figure 1.10 Schematic representations of Panum's area and Panum's space.

1.2.3.3. Sensory fusion and motor fusion

Sensory fusion and motor fusion are both central processes that take place in the visual cortex. Sensory fusion is the visual ability to interpret two similar images projected on the two eyes into a single visual image, the two retina images may not locate on the corresponding area, but the size, the brightness and sharpness need to reach enough threshold to allow the sensory fusion function, otherwise the fusion could be blocked. Motor fusion is the eye vergence to align the retina images to the corresponding area in order to facilitate sensory fusion. The fusional eye movements start when the disparity stimulus is outside the panum's area.

1.2.3.4. Diplopia, binocular rivalry and suppression

- **Diplopia**, known as double vision, is usually perceived when an object point appears double when it is seen in two directions simultaneously. Diplopia could come from visual dysfunctions such as strabismus or manually stimulus which induces large horizontal disparity

or distinct retina images. Diplopia could be an ophthalmologic parameter for eye defects, it is also a threshold for visual fusion process on healthy eyes.

- **Binocular rivalry** occurs when dissimilar contours are presented to corresponding retinal areas, an alternation between the different retinal images will start during the visual perception process. Binocular rivalry could be caused by the difference of paired images, such as colors, contours and brightness.
- **Suppression** is a neuro-physiological active inhibitory mechanism to avoid diplopia when dissimilar stimuli are depicted on corresponding retinal areas or when non-corresponding retinal areas are stimulated by similar stimuli, one or the other is temporarily inhibited or suppressed to prevent confusion or diplopia respectively.

1.3. Oculomotor function

The maintenance of a clear and stable perception of the world needs coordination of various elements. Accommodation (change in ocular focus) and vergence (change in ocular alignment) are two ocular motor functions interacting with each other to provide clear single binocular vision. While retinal blur mainly drives the accommodation, retinal disparity changes accommodative position through the convergence-accommodation (simply vergence accommodation, VA) crosslink. Similarly, while retinal disparity primarily drives the vergence system, a change in retinal blur alters vergence through the accommodative-convergence (AC) crosslink.

1.3.1. Accommodation

Accommodation is a visual function that ensures a sharp retina image when the eyes are focused on an object. When the eyes fixation switches from one object to another, the retina image may be blurred, and this defocus stimulates retinal cones to transmit the summed blur signals to the visual cortex through magnocellular layer of LGN. The cortical cells will respond to this sensory blurred signals and formulate motor command and transmit it to ciliary muscles via oculomotor nerves, ciliary ganglion and then to short ciliary nerves. The ciliary muscles will change the states of contraction according to the command to reform the crystalline lens to attain in-focus retinal image and clarity of vision. It should be noted that the ciliary muscle reaction is only one of the most important steps to achieve successful perception, there are other reactions such as pupil size change, corneal curvature changes or changes in the axial length of the eyeball itself to compensate the fixation distance change[10]. The accommodation state is driven by synkinetic control from vergence system.

The accommodative stimulus-response function is an important demonstration of the accommodative system, as is shown in Fig. 1.11, it provides an accurate and quantitative description of the accommodative response to accommodative stimuli. The accommodative response is generally smaller than the accommodative stimulus by an amount equal to the depth of focus. This lag or error is called the lazy lag of accommodation. The curve could be divided into one linear region and several nonlinear regions. The linear region is in the middle part of the profile, where the change of accommodative leads to a relative large and proportional change in the response, the accommodative error is also proportional in this region. For the nonlinear region, the initial non-linear portion, accommodation changes is less than the stimulus. During the non-linear transitional region, there is a soft saturation where the function slope decreases with increased stimuli amplitude.

The following zone is hard saturation region where the response has reached its full amplitude. When the stimulus exceeds the amplitude limit, the accommodation response declines below its peak. Accommodation could be affected by a multitude of factors, such as contrast, spatial frequency, retinal eccentricity retinal image velocity etc.[17, 18].

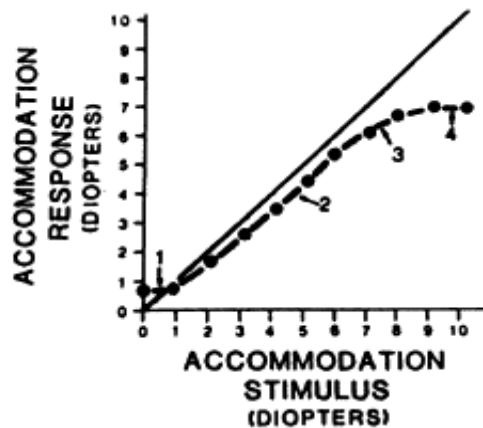

Figure 1.11 Function of accommodative stimuli and accommodation response (Clifton M., Schor, O.D., 1997).

1.3.2. Vergence

Two eyes movement in opposite directions is called **eye vergence**. Although the primary stimulus for vergence is retinal disparity, vergence is also elicited in response to proximal cues, changes in tonic innervation and through the synkinetic link from accommodation. The synkinetic link is an interaction link between accommodation and vergence. A vergence eye movement towards the midline (convergence) occurs in response to crossed retinal disparity whereas movement of the two eyes away from the midline (divergence) occurs for uncrossed

disparities. The vergence system proposed by Maddox is composed of four components: accommodative (driven by retinal blur as a synkinetic response from accommodation system), fusional (also known as disparity vergence), tonic (resting state of the eye) and proximal (awareness of a near object). Clinicians use the accommodative convergence in prism diopter (Δ) per diopter (D) of accommodation (Δ/D , or ACA) ratio from Maddox's theory. On the other hand, Fincham and Walton emphasized that accommodation may be driven as the convergence movements of the eyes with vergence as the fundamental component, and the clinical expression is convergence accommodation per convergence (D/Δ or CA/C) ratio.

1.3.3. Models of the oculomotor system

Although an oculomotor system is composed by various components, a stable and correct perception relies on cross-coupling among the components. Examples of such cross-linkages include the cross-talk between saccade-vergence, horizontal-vertical vergence and accommodation-vergence. The coupling between accommodation and vergence is the most well-known. Under normal binocular viewing conditions, accommodation and vergence interact with each other through reciprocal cross-link interactions where optically stimulated accommodation evokes convergence and disparity stimulated vergence evokes accommodation. Magnitudes of these interactions are represented by AC/A (ratio of accommodative convergence to accommodation) and CA/C (ratio of convergence induced accommodation to convergence)[19].

The respective activities of the various components of the oculomotor system and amplitude of the responses can be modeled. The models are divided into two types: static models [20, 21], and dynamic models [22, 23]. Static models help to understand the basic oculomotor mechanisms and their implications into clinical measurements, providing information about the stable state of the oculomotor response as a consequence of fixation point transfer (not a stimulation point). Dynamic models can explain the dynamic properties of oculomotor responses. The two types of models are generally developed to simulate a specific visual phenomenon as adaptation of the oculomotor system in near vision or the contribution of proximity to the oculomotor response.

A model demonstrating phasic-tone control and interaction between accommodation and vergence has been proposed by Schor in 1996, as is shown in Fig. 1.12, the model is composed by input, linear and nonlinear components, cross-coupling and cross-coupling which is enhanced by adaptation. The inputs stimuli are target distances, it passes a fast phasic component at the front of the feed-forward paths which respond to external stimuli such as perceived distance, blur and disparity. Then the signal passes a following adaptable tonic component that responds to intrinsic innervation. The phasic and tonic responses are summed linearly. The output is limited by negative feedback loop, it means when tonic adaptation

increases, the phasic response will decrease. The cross-link responses of AC/A and CA/C are included in the model to illustrate the interaction of accommodation and convergence [23].

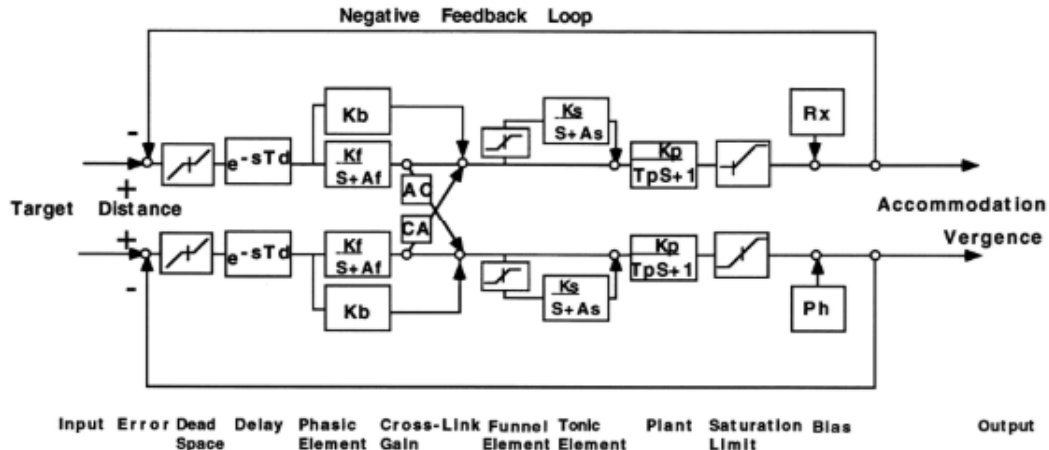

Figure 1.12 Block diagram of the phasic-tone control and interaction between A and V.

A static model of accommodation and vergence is demonstrated in Fig. 1.13, there are three branches at the left input, an accommodative branch, proximal branch and a branch associated with the convergence. The input signal of the model for each branch is the distance to target. Note that the input of accommodation and disparity vergence sum with the negative feedback response of the respective system while the proximal branch does not have a visual feedback pathway of its own, because there is no retinal information input. The operator where signal passes through the depth of focus for accommodative component and Panum's area for vergence component is called dead-space, this component allows a tolerance of some small neuro sensory-based system error, such as blur and diplopia. The operator gain represents the experimentally derived system open loop gain, it is the fast subsystem, and an immediately clear and / or fused retinal image is obtained in 1s when a blur or disparity is inputted. The slow subsystem lasts for a prolonged period, it can minimize visual system fatigue and prevent myopia development and its progression [24]. The tonic inputs have little influence on the overall closed-loop for near response and only modest influence on the far response. The summing junctions combine the gain output from crosslink output, proximal output and tonic output. The ciliary muscle and lens and extraocular muscles will be stimulated when the neural output signal comes out of the summing junction which leads to the innervation of oculomotor muscles. Motor changes are then returned to the original junction. If the residual error system is too large, the cycle is repeated until this error becomes acceptable (depth of field / Panum's area) and stable for both systems [25]. The crosslink gain represent the AC/A ratio for

accommodation while effective CA/C ratio for convergence. Abnormally high ratio from accommodation or convergence will lead to an overdriven and result in esotropia or exotropia.

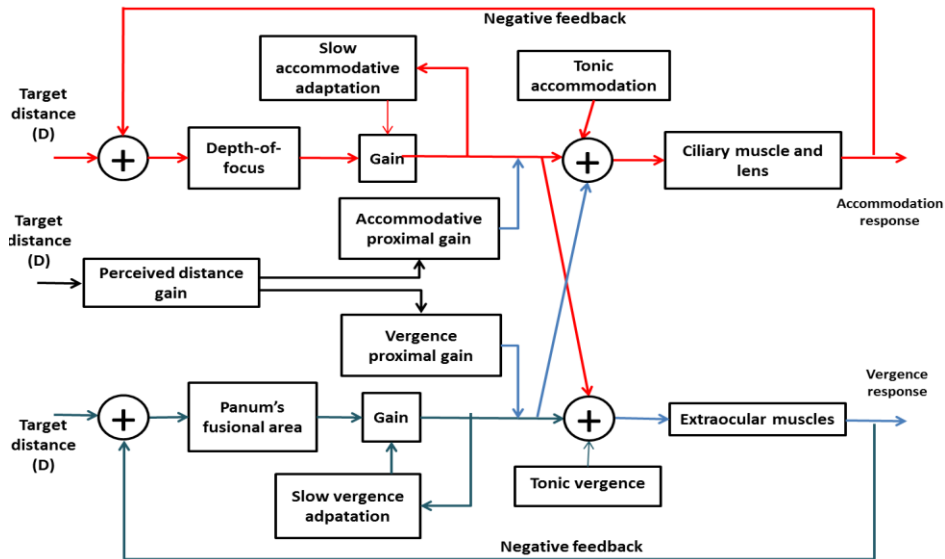

Figure 1.13 Static interactive dual-feedback model of the accommodative and vergence system(Benjamin, 2006).

1.4. Sensory function

The abilities to discriminate the object's shape, color, position, speed, directions result from the cooperation of visual sensory functions.

1.4.1. Depth perception

- Neural basis:** the ability of the human eye to see in three dimensions and estimate the distance of an object is called depth perception, it is mainly stimulated by the image disparity between eyes. When the disparity is within Panum's fusional area, it will be fused by the brain and a single vision with depth information is perceived. Similar to the color perception, the images are encoded by photoreceptors dedicated to given feature extraction, and then interpreted in the cortex. The monocular retino-geniculate projections from right eye and left eye remained separated until reaching the input layer of ocular dominance columns (ODCs) in V1, layer 4C. The binocular vision starts by the horizontal connections between ODCs of opposite jocularity in upper layers 4B (Fig. 1.14a) [26]. A successful binocular data process requires connections between input of right eye and left eye, which occurs in layers 2-4B in V1 (Fig. 1.14b), decorrelation of connections between the eyes inputs will cause loss of horizontal connections which lead to stereo blindness, exotropia and gaze asymmetries (Fig. 1.14c)[27]. There are neuro cells in V1 that fair for different disparity features, such as the disparity

magnitude, correlation of stimulus in both eyes and the cross disparity or uncrossed disparity etc. [28].

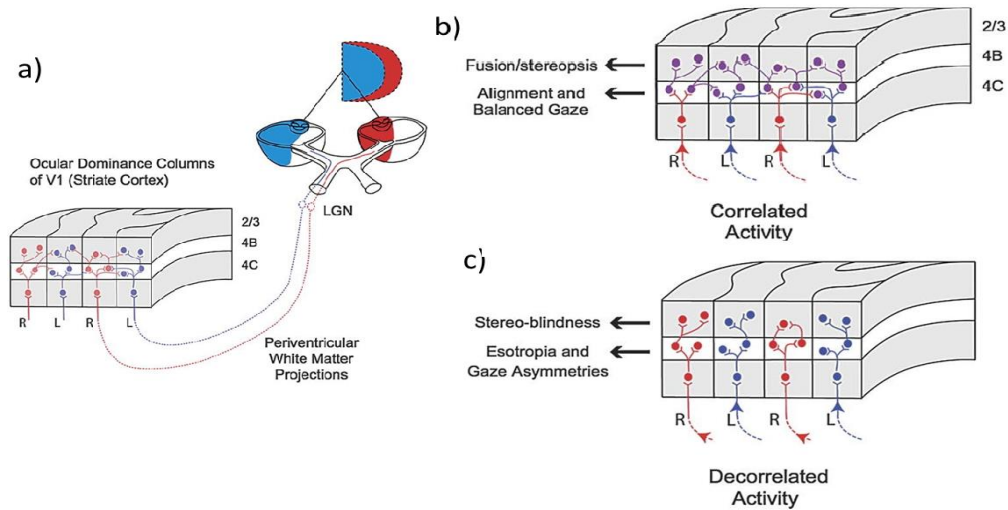

Figure 1.14 Neuroanatomic functions for binocular vision in striate cortex (V1). a). The binocular vision is achieved by the horizontal connections between ODCs of opposite ocularity. b). The horizontal connections for binocular vision to layer 2-4B of V1 in normal primates. c). The horizontal connections for binocular vision to layer 2-4B of V1 in strabismus primates (Tychsen et al., 2010).

- Crossed and uncrossed disparity:** non-zero disparities giving rise to stereoscopic depth are divided into crossed and uncrossed. As illustrated in Fig. 1.15, it presents the relative position of the observed objects and fixation point in depth. Crossed disparities are created by objects in front of the horopter (near objects). The disparity is termed "crossed" because the monocular image of the object when viewed by the right eye is displaced to the left, whereas that viewed by the left eye is displaced to the right. Uncrossed disparities are created by objects located behind the horopter (far objects). In this case the monocular image of the objects viewed by the right eye is displaced to the right and that viewed by the left eye is displaced to the left.

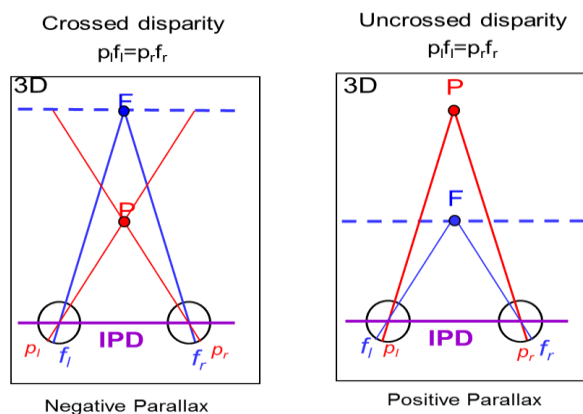

Figure 1.15 Demonstration of crossed and uncrossed disparity.

- **Stereoscopic acuity:** Stereoscopic acuity is the smallest binocular disparity that can be discriminated. It is an important parameter for eye examination. There are several generally used clinical stereoscopic acuity tests, such as stereo fly test, the frisby stereo test, keystone multi stereo test etc. The disparity threshold of coarse stereopsis is normally much higher than that of fine stereopsis. The standard stereo acuity threshold varies with examine methods, for stereo fly test, the normal observers should have better than 60 of arch stereoscopic acuity.

1.4.2. Comfort zone

In order to see a sharp and clear object, the eyes need to accommodate as close as the object's focal distance. The acceptable focus distance range is around ± 0.3 diopters. Besides, the eyes must converge to make the binocular disparity less than the range of Panum's fusion area. Accommodation and vergence responses are normally coupled: accommodative changes evoke vergence changes (accommodative vergence), and vergence changes evoke accommodative changes (vergence accommodation). **In a natural viewing condition, binocular disparity and focus distance cues provide consistent signals for object distance, so the accommodation-vergence coordinates well because the accommodation distance and vergence distance are almost always the same no matter where the observer looks at** (diagonal line in Fig. 1.16). The clear single binocular vision zone (green region in Fig. 1.16) is the range of vergence and focal distances in which the observer maintain a sharply focused single image. Percival comfort zone (yellow region in Fig. 1.16) is an approximate range of vergence and accommodation distance where the viewer can fuse stereo pairs without discomfort. To achieve a clear single vision without discomfort, vergence and accommodation distances should be as close as possible[29].

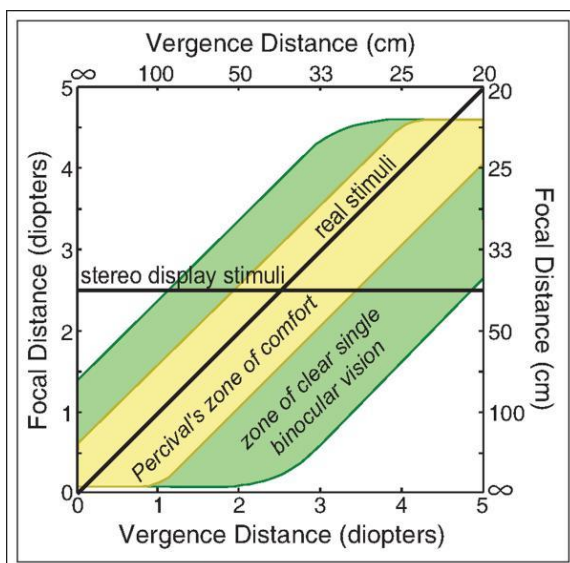

Figure 1.16 The demonstration of clear single binocular vision zone (green and yellow region), Percival's zone of comfort (yellow region), the vergence and accommodation coordination in real world (diagonal line) and the vergence and accommodation coordination on conventional

stereo displays(horizontal line)(Banks, Martin S., et al. 2008).

When stereoscopy is implemented in conventional 3D display, there is a mismatch between convergence and accommodation. On a stereoscopic display, the focus distance and vergence distance are inconsistent, because stereo images with disparities are displayed on a flat screen, the vergence distance changes with disparity, which maybe closer or farther than the screen, but the focus distance is always the distance to the screen (Fig. 1.17, Fig. 1.16 horizontal line). As described in 1.3.3, a clear and single view perception is due to the accommodation and vergence couple. The eyes simultaneously accommodate and converge to the stereo images on the 3D screen, the crosslink components between vergence and accommodation systems are stimulated, but the inconsistency of vergence and focus distance will influence the synkinesis link. **The accommodation-vergence conflict is recognized as the predominant factor entailing visual fatigue and discomfort on conventional stereoscopic display.** Long time viewing for such 3D content will lead to eyestrain, blurred vision, headache or dizziness symptoms.

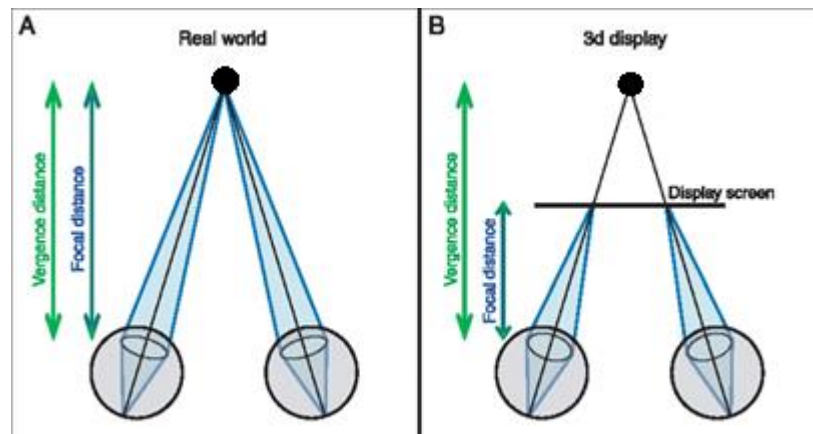

Figure 1.17 a). Vergence-accommodation under natural viewing condition, b) Vergence - accommodation on stereoscopic display (Banks, Martin S., et al., 2008).

1.4.3. Motion-in-depth perception

The ability to estimate the object motion in 3D space is essential for everyday activities. When an object moves in depth, the binocular disparity between it and a stationary object will change, as is shown in Fig. 1.18, when object is approaching or receding from the fixation point, the projected images will move in the opposite direction on the corresponding eye's retina, the binocular disparity and intraocular velocity change at the same time[30].

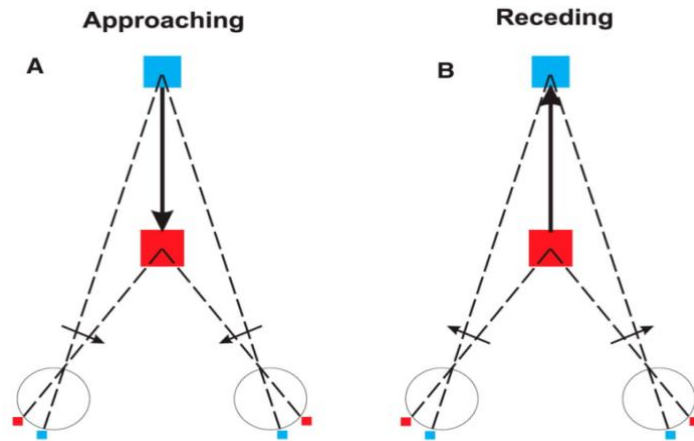

Figure 1.18 Schematic illustrations of motion in depth and the associated image motion. A) The object moves toward the middle of the eyes produces opposite directions of image motion in the two eyes. The horizontal binocular disparity changes over time as the object moves in depth. B) Receding movement of an object reverses the direction of image motion in each eye and reverses the temporal sequence of changes in binocular disparity (Sanada, T. M et al. 2014).

- Mechanisms to achieve motion-in-depth perception

The binocular vision is known to be used to perceive motion-in-depth (MID) [28], but what specific binocular cues are used to see motion-in-depth have not been completely investigated. In current opinion, two cues have been addressed for the detection of MID: **changing disparity (CD)** and **intraocular velocity difference (IOVD)**.

The models of the two cues to process MID is demonstrated in Fig. 1.19, model A demonstrated IOVD cue: To use this signal, two separate and independent monocular velocity signals must first be derived, and subsequently combined vectorially across the two eyes; model B-D illustrated the CD cue: Positional information must first be combined from both monocular images to establish a disparity signal, which can then be differentiated over time to yield the speed of the object in depth [31, 32].

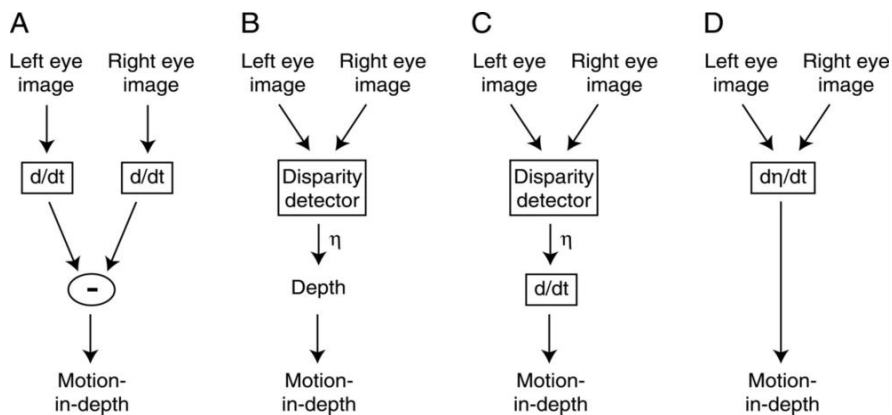

Figure 1.19 Illustration of the two mechanisms describing how binocular information is processed for MID perception (Sakano, Allison, 2012). Figure A describes the computing mechanism of CD, Figure B-D calculate the motion-in-depth perception of IOVD mechanism.

Types of stimulus for motion-in-depth perception

Three motion cue stimuli are used: **FULL**, **IOVD** and **CD**. All stimuli contain a single plan of signal dots moving toward or away from the observer through depth with presence of noise dots.

- **Full stimulus:** The stimuli consist in a moving random dot stereogram in which binocular paired signal dots moved in opposite directions in the two eyes. The signal dots are a combination of IOVD and CD cues to 3D motion, as is shown in Fig. 1.20a.
- **IOVD stimulus:** it is identical to full stimulus except that all dot pairs were binocularly anti-correlated, which means dark dot in one eye is paired with a corresponding bright dot in the other eye. The CD cue contribution is removed by the implementation of anti-correlated technique (Fig. 1.20b).
- **CD stimulus:** it is identical to FULL stimulus except that signal dots were randomly replotted in new x-y positions on each refreshed screen. This approach removed the coherent monocular velocity information insuring robust changing disparity information (Fig. 1.20c).

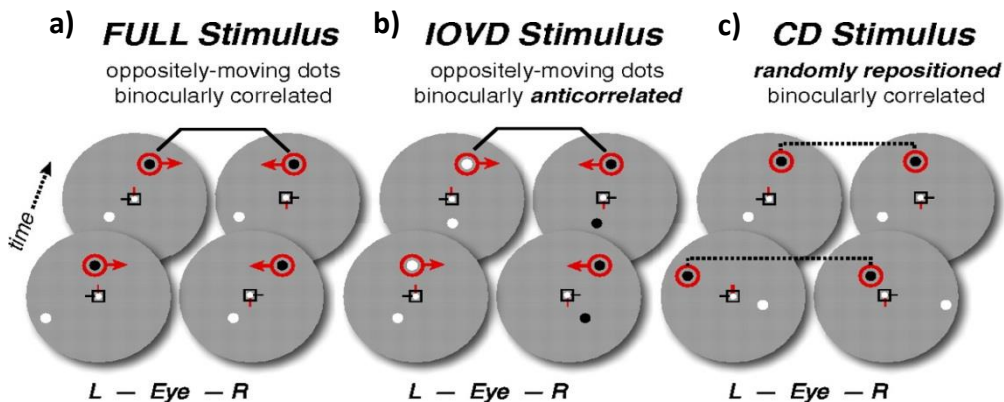

Figure 1.20. Motion cue stimulus conditions (Czuba et.al, 2010).

1.4.4. Assessment of Motion-in-depth perception

- **Accuracy of binocular stereo motion perception:** Although stereogram is widely applied in the experiments to investigate the visual perception of motion-in-depth, the accuracy of stereo motion detection is not identical with different stimulus configuration, MID direction discrimination ability varies with stimulus eccentricity, disparity speed and stimulus cues (IOVD and CD)[33]. Besides, the dot lifetime, the stereogram density could also affect MID perception precision. Apart from the parameters of stimulus, Harris and Rushton believe that the poor visibility of MID is due to early motion averaging, which is a physiological problem of the eyes when they are processing the stereoscopic information in neural level [34]. It is also indicated that later motion contributed to the detection of MID direction [35]. Stereo acuity test is a conventional step for eye examination and it is an important index for human vision. But the discrimination ability for stereo motion is rarely considered when the vision parameters are evaluated. Although stereogram is widely used in the experiments for the investigation of MID perception, results have shown a certain tendency as we expected, most of the observers are experienced or well trained and the performance could not completely represent the response from normal observers. Besides, when experienced observers are used in the experiment, the visual criterion is only normal or corrected to normal visual acuity and stereo acuity, other visual parameters effect has never been discussed. Hence, further work and future researches should be initiated to develop conventional stimulus applicable for all observers.
- **Strength of motion-in-depth perception:** Since MID perception is due to computation of cortical cells through disparity cues, the strength of MID could varies with the stimulus parameters, such as the stimulus size, disparity amplitude, stimulus time etc. **A widely applied way to evaluate the MID perception strength is the motion after effect**, it is a result of motion adaptation and it changes with stimulus configurations. We will detail the motion aftereffect in the following subsections.

1.4.5. Motion aftereffect

The motion aftereffect (MAE) is a visual illusion, the most well-known is the waterfall illusion [36], by steadfastly looking at the cascade for a few seconds, focus on the liquid drapery of the water, when suddenly direct the eyes to the rocks on the left, the rocky surface is seen as if in motion upwards, the velocity of the motion is equal to that of the descending water.

Motion aftereffect is resulted from the change of the motion sensitivity after visual adaptation. As is shown in Fig. 1.21, a random dot kinematogram is used to test motion sensitivity. In this type of stimuli, each dot is flashed briefly at random positions on the screen during one frame time. There is a rate of correlation of the dots' direction, which means the percentage of the dots that have the same direction, and other dots are given a random direction. The correlation

of the dot positions varies from frame to frame. When the correlation is zero, a dot is equally likely to appear anywhere on the screen in the next frame. At this correlation level, there will be some local motion signals, by chance, but the average motion will be zero. When the net correlation rate is increased, the global stimuli will reappear at certain direction and the motion sensitivity is increased with the correlation level.

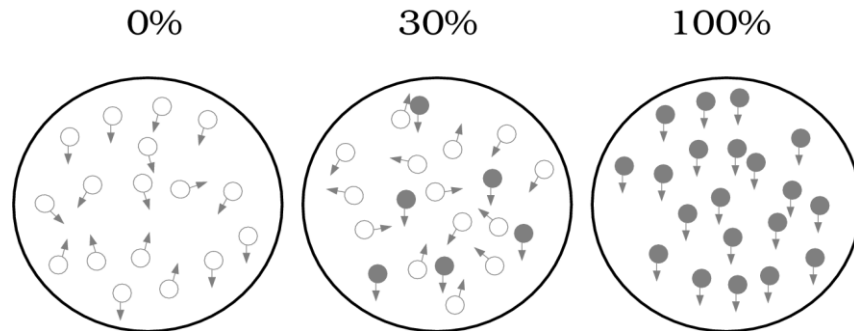

Figure 1.21. A random dot kinematogram used to measure motion sensitivity.

Motion aftereffect is caused by visual adaptation, after an adaptation period for a constant stimulus which moves in the same direction, the neural cells that respond to this direction get less sensitive, when another stimuli that have different dot correlation appear, the observers response will be affected by motion aftereffect [36]. The MAE strength is conventionally measured by the change of motion discrimination response time or the accuracy of motion perception. For example, if the dot direction is leftward during the adaptation period, when a stimulus with 30% rightward correlation is displayed, observers' will have more rightward response than the response that is gotten without adaptation.

Most of the MAE investigations are based on front parallel (2D) in early years, there is a wealth of psychophysical and physiological evidence for the existence of neurons tuned to roughly front parallel (2D) directions of motion in the primate visual system, however, relatively few studies have been made for the search of neurons tuned to 3D motion. Due to the cues that generally recognized currently for the generation of motion-in-depth (CD, IOVD), motion aftereffect has been measured by Czuba in a recent study to compare the processing mechanisms of 2D motion and 3D motion.

The interpretation of 3D motion aftereffects requires additional care, because one major interpretation for 3D motion processing is to exploit the fact that objects moving toward or away from an observer project when different horizontal velocities to the two eyes, this may induce an ambiguous evidence for the existence of 3D turned mechanism, which comes from the effect of monocular 2D mechanisms. Thus an experiment was specially addressed to clarify this issue, 2D monocular MAE and 3D MAE were both measured to compare the contribution

from both mechanisms. The basic stimulus is shown in Fig. 1.22a, the image was split into left half and right half to be sent to the left eye and right eye, and this is accomplished by a mirror stereoscope. There are equal numbers of dots on the left and right images and each dot in the image has a corresponding dot on the paired image. Observers will perceive the dots moving in front parallel (2D) or in depth (3D), depending on the disparity of the paired dots on the two images. The general experiment protocol is explained in Fig. 1.22b, in each trial, there is a 4s adaptation and a 1.5s test stimulus. During the adaptation period, all the dots move in a constant direction (2D: leftward or rightward; 3D: toward or away from observers). In the 1.5s test stimulus, a correlation rate of dots is manipulated, there are five correlation levels (± 5 , 20, 50, 80, and 95%, the “ \pm ” indicate the motion direction). In each test stimulus, a correlation rate is randomly chosen, observers are instructed to answer the general dot motion that has been perceived during this period. The observers’ responses are recorded and data were analyzed by computing observers' proportion of toward/rightward responses as a function of test motion coherence. A psychometric function is used to fit the observers’ performance across multiple runs [37]. The equation is the following, it is a 2-parameters logistic:

$$f(x) = 1/(1 + e^{(-2\alpha(x+\beta))}) \quad (1)$$

The result of MAE measurement is revealed in Fig. 1.22c, the MAE strength is considered to be the shift between non-adaptation case and adaptation case. In the right part of Fig. 1.22c, 2D motion aftereffect is observed by a prolonged adaptation to unidirectional motion left or right from the center. The y axis is the “rightward” responses percentage as a function of test stimulus coherence. The positive coherence corresponds to rightward motion direction while the negative coherence to leftward motion direction. Similar for 3D MAE representation, the y axis corresponds to “toward” response proportion and the positive coherence stands for motion toward. If we compare the MAE strength of 2D and 3D, it could be noticed that the physiological functions shift is larger in 3D MAE than it is for 2D MAE, Czuba explained that one reason for the difference could be the multiple stages of adaptation for 3D MAE, a 2D monocular stage (that processes the individual direction of motion for each eye, which are opposite between the two eyes) and a later 3D cyclopean stage (which extracts motion through depth after binocular integration). It has been proved in later experiments that there is specific mechanism that contributes to 3D MAE. In the first left three images in Fig. 1.22c, the 3D was demonstrated under three stimulus cues: Full, CD and IOVD, it could be observed easily that the adaptation of the velocity-based (IOVD) mechanism alone generates a concomitantly large 3D MAE, capable of fully accounting for aftereffects generated under normal conditions [38]. However, the contribution of CD and IOVD cues to motion-in-depth perception has been in debate in the recent studies, concerning the existence of the two mechanisms and their characteristics[39]. In these studies, due to the variation of the stimulus and the difficulty to

completely isolate the CD and IOVD information, as well as the limitation of sample size, to reach a consoled conclusion still need more exploration[40].

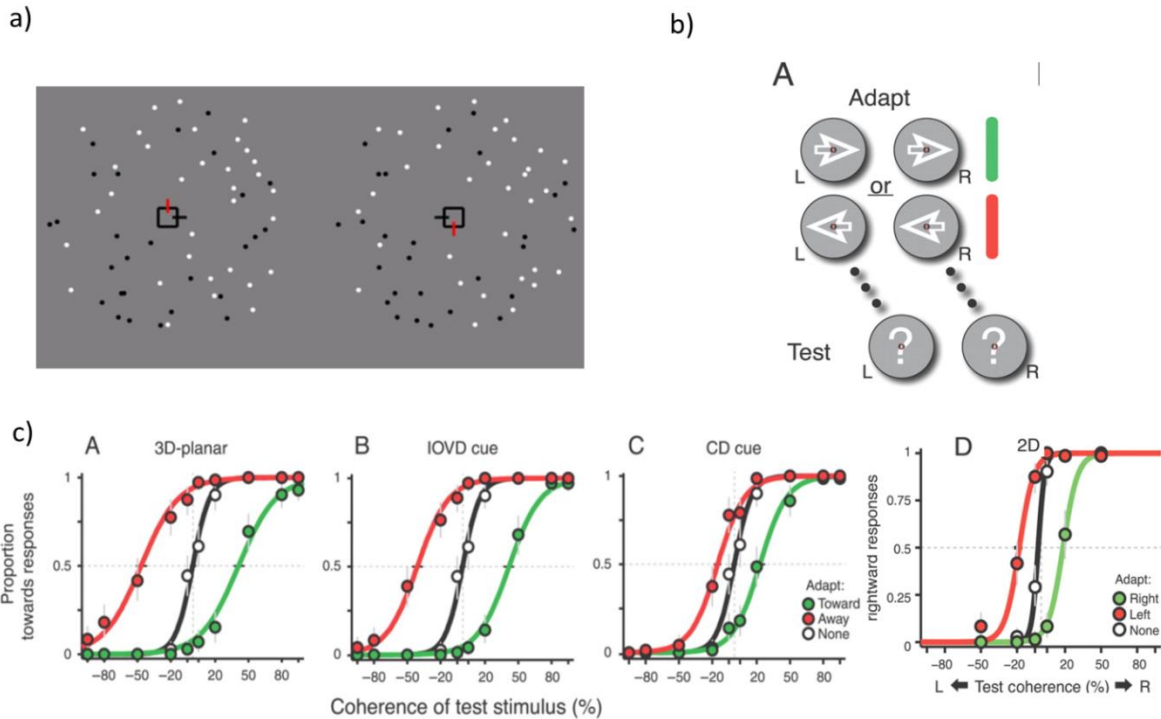

Figure 1.22 a) Basic stimulus during the experiment. The image is split into right and left halves and sent to separated channels of stereoscope. They are viewed separately by the two eyes. b) Schematic of the basic experimental paradigm, including an adaptation period (producing a constant 3D perception of dots moving) and test stimulus (observers judge the dot motion after). c) The psychometric functions under the test method of Full cue, IOVD cue, CD cue and 2D, x-axis is the coherence of the test stimulus, y-axis is the percent of trials judged as “toward” or “rightward” the observer.

1.4.6. The choice of this thesis for MID exploration

The content that detailed above is based on stimulating sensory system using non-cognitive approaches, the stimulus composed by the RDS contains no cognitive information and could only be processed by the sensory system. This kind of approach eliminates the recognizable information, where subjects’ experience and psychology perception could affect the response. In our study, we have taken the advantage of non-cognitive approaches to only stimulate the physiological sensory perception without inducing interference of cognitive system(by using a dynamic cross moving in depth to stimulate oculomotor system). By the pure stimulation of

both sensory and oculomotor, we expect to observe an interaction between the two mechanisms for MID perception.

1.5. Cues to stimulate depth perception

In nature viewing condition, a stereoscopic object is perceived by the observer due to the separation of two eyes that generating two slightly different views. The visual process begins with the acquisition of images projected in the eyes. There is more complex process in the brain which extracts the depth information from the raw data that comes from the eye. Except the cues of disparity and convergence for depth perception that have been explained before, there are other cues that are used by the brain to interpret 3D information:

- Perspective: Due to the spherical feature of the retina, the image that projected on it has a curve, so if a curving perspective lines are used to approximate the real projection on retina, 3D perception will be achieved (e.g. keystone effect).
- Shadow, texture, and shading: retinal images without disparity that are fused by the eyes could lead to 3D perception when different shadows are implemented on the two images. The texture gradients between objects on a 2D image and the light and shadows come from objects is helpful for the brain to interpret the shapes and positions in space.
- Occlusion: when the surface of one object is partially overlapped by another object, it is clear that the one that has been blocked is farther to observer. The relative nearness of objects could be interpreted by this cue.

There are still many other cues that could be used in depth perception, such as curvilinear perspective, velocity difference, aerial perspective, Doppler Effect (Pulfrich pendulum), color filtering etc. In this thesis, we concentrate on the disparity cue and the convergence cue.

Thanks to the 3D perception creation with disparity cue, various 3D displays have been designed and manufactured. The basic rule for the conventional 3D display technology is to present paired images to the right eye and left eye respectively, and a horizontal disparity is assigned to the paired images to stimulate depth perception. The features and configuration of currently developed 3D display technologies is briefly described in the following subsections.

1.6. 3D display technologies

Stereoscopic 3D display allows high resolution color images with both monocular and binocular depth cues coexisting in a single display system. The basic aim of stereoscopic displays is to present two slightly different views of a scene to the viewer, one image for each eye (the combination of these half-images is usually called a stereo pair). Viewer binocular visual system then extracts depth information by analyzing the stereopsis information. The stereoscopic theory is first understood by Euclid, but the first stereoscope is produced by Charles Wheatstone until 1832 [41]. A variety of 3D display methods are invented in nowadays, based

on the devices that are used for the display, these 3D display technologies could be divided into two fundamental categories, as is shown in Fig. 1.23, **stereoscopic display technologies that rely upon specific eyeglasses for observers to obtain 3D perception and the autostereoscopic display technologies that are glasses free, observers could gain 3D perception with naked eyes** [42, 43]. For the eyeglasses based stereoscopic displays, stereo images are transmitted by glasses from the screen to the eyes, there is only one view for the object on the screen, when observers move laterally, the perceived images will not change, unlike the perception in natural condition. For the autostereoscopic displays, multi-view viewing has been realized, this is either due to the refraction or diffraction of optics components that depicted images with different views at certain viewing position, or because the object is projected by holographic technology, with which one object is created by the projection of lights at different angles in space.

Although advantages and disadvantages of these stereoscopic display technologies have been compared in many papers and works, most of the analysis is based on mechanism characters, human performance on the currently two display platforms is rarely considered. Therefore, we made corresponding physiological experiment to evaluate observers' perception with stereoscopic and autostereoscopic displays. Since we have chosen the most commonly used 3D display platform in the experiment: time-multiplexed 3D projector and lenticular multi-view 3D display, the corresponding introduction in the later section will only related with the two techniques.

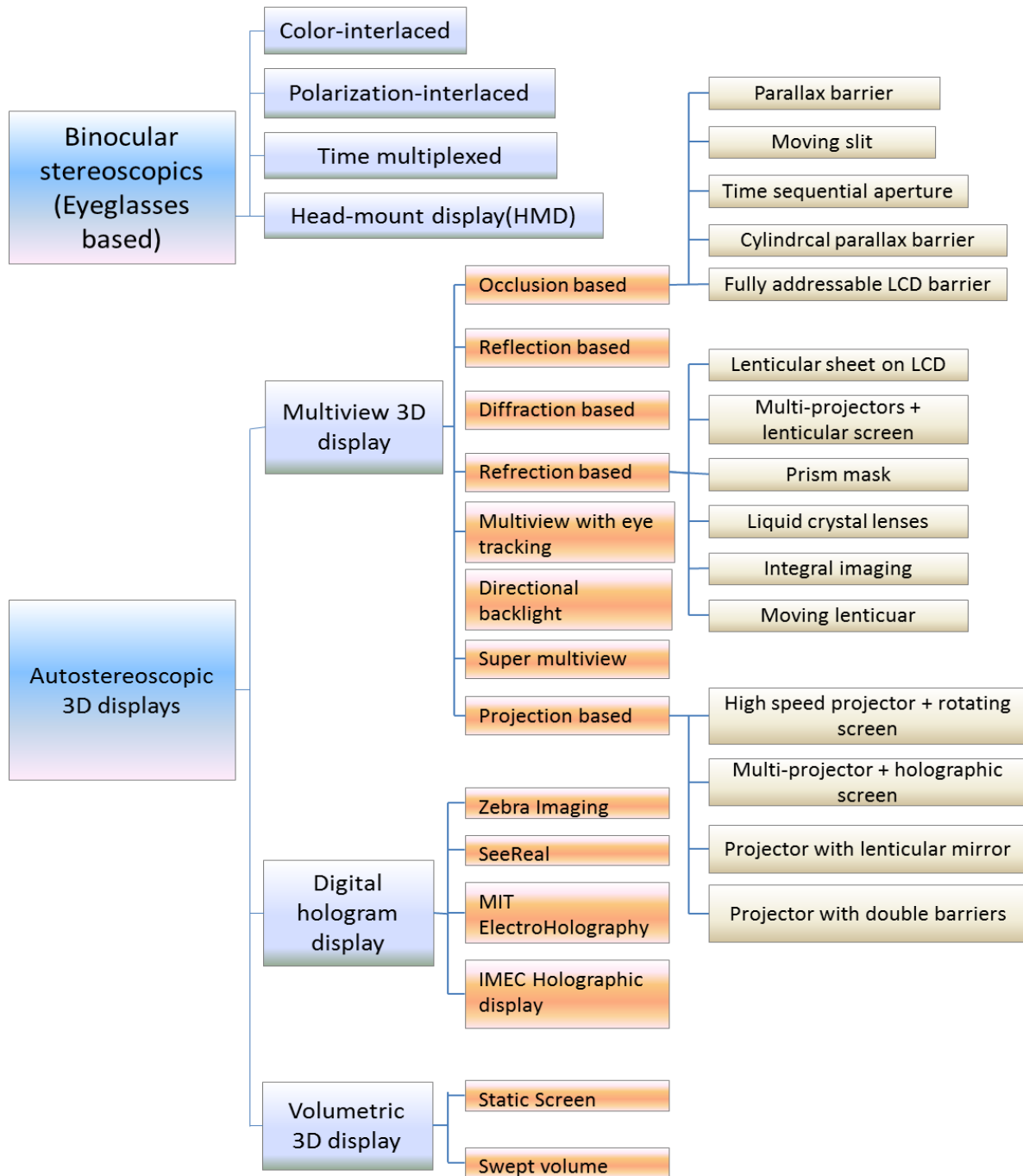

Figure 1.23 Simplified classifications of 3D display technologies (Jason Geng, "Three-dimensional display technologies," Adv. Opt. Photon. (2013)).

1.6.1. Stereoscopic display technologies

The stereoscopic display is implemented using glasses as a filter to separate the left and right views to the corresponding eyes. The glass could be active or passive, which means the glass filters the stereo pairs by synchronizing with the display or by polarization of different light frequency.

In Fig. 1.24, a time-multiplexed stereoscopic display system is shown, the two views on the glass are switching in a rapid alternation and the frequency of display is synchronized with an active LC shutter. When one image displayed on the screen for one eye, the other eye is occluded, and vice versa. Because the visual system merges a stereo pair across a time lag of up to 50ms, images repetition does not interrupt the eye fusion of both images into a single one [44].

Normally, active shutter 3D systems use liquid crystal shutter glasses, the liquid crystal layer in each eye's glass could be opaque or transparent when certain voltage is applied. A refresh rate of the screen will sent to the shutter to control the synchronization, which means each eye will be blocked alternately according to the displayed image on the screen. The synchronizing signal could be achieved via a wired signal or wireless signal by either infrared or radio frequency. The display system could be a 3D projector or 3D ready TV.

The stereo pairs are perceived at full spatial resolution on the screen, besides, since the shutter glasses are color neutral, it allows a 3D viewing in full color spectrum. However, due to the refresh mechanism of shutter, observers will notice flicker if the refresh rates are not high enough, what's more, since shutter glasses have shut out half of the light from the source, the images are darken when they are perceived by observers. Crosstalk is one of the main perceptual factors contributing to perceived image quality and visual comfort, it has been measured by many methods, it is reported that the crosstalk on shutter glasses stereo displays is roughly 0.5%-1% between the two eyes in the shutter glasses[45]. However, this range varies with the display platform, methodologies and crosstalk target [46].

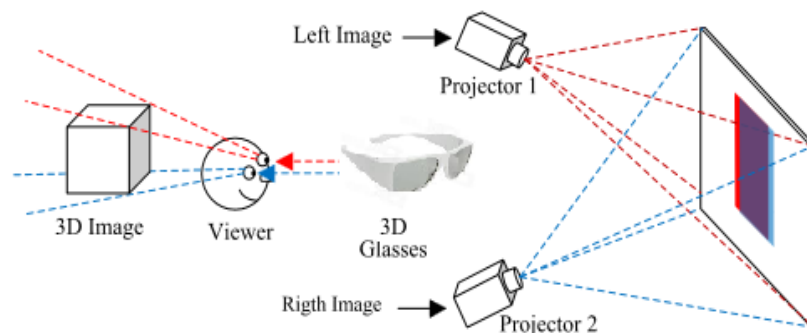

Figure 1.24 Stereoscopic display demonstrations. There are different types of 3D glasses, they could be color filtered, polarized, time synchronized etc.

1.6.2. Autostereoscopic display technologies

Autostereoscopic display technology divides the paired views to the right and left eyes by adding a lenticular or barrier on the 3D display plane. This technique was first implemented in lenticular pictures with the name of lenticular printing [47]. When a multi-view 3D display is designed, the resolution of the display screen is split according to the number of views.

Fig. 1.25 illustrates a five view lenticular display. Because the lenticular lens are vertical, it is aligned vertically with pixel columns on the screen, when the view number is five, one lens column will cover five pixel columns, the horizontal resolution of the underlying pixel is divided by five. Observers have to put their eyes in the correct view zone in order to see stereo pairs from the spatial multiplex screen, when they move their head from one zone to another, they will perceive the objects images at different angles.

The lenticular display is simple to use, because it can use the existing 2D screen fabrication structure just by adding a lenticular sheet. It offers brighter screen since there is no barrier for the illumination. However, horizontal resolution is largely decreased because of the increase of view numbers, and the alignment of lenticular sheet has always been a technical difficulty until now.

Crosstalk is one of the most annoying distortions in the visualization stage of stereoscopic and autostereoscopic systems. It is a phenomenon known as imperfect separation of the left and right images. Crosstalk will cause artifacts such as blurring and image ghosting. It is reported that already a small amount of crosstalk can lead to headache, and hence, advised to avoid crosstalk values beyond 0.3%. For the visibility threshold of crosstalk, the value is slightly higher, from 1 to 2%. Kooi found that a crosstalk level of 5% resulted in a reduction in viewing comfort in 50% of the observer [48]. These data is based on 2-view 3D displays, it is more serious for multiview autostereoscopic display, taking into account the properties of multi-view autostereoscopic 3D displays. Both pattern and amount of cross talk in this technology are more complex due to the viewing angle dependability, separated in space, creating look-around capabilities and allowing multiple viewpoints. The crosstalk will arise by the inference between neighbor views and views between left and right eyes. Such systems often suffer from the occurrence of dark bands on the screen (a phenomenon called “banding”). However, crosstalk may be helpful to get smooth transitions between the views during head movements. There are objective and subjective measures to assess system crosstalk, and various researches have been focused on crosstalk reduction to improve viewing experience.

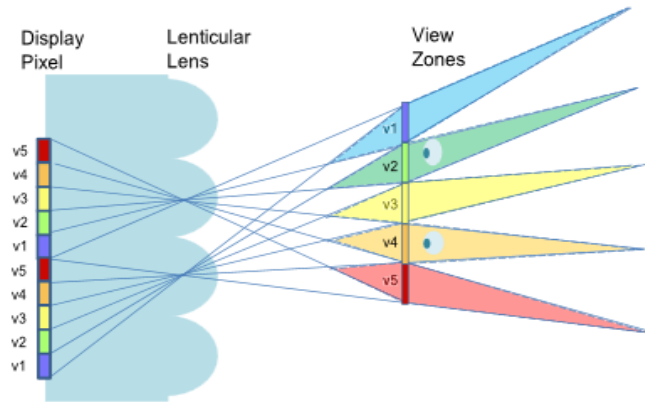

Multiview autostereoscopic 3D display using a spatial multiplex design.

Figure 1.25 Demonstration of multiview lenticular autostereoscopic display (Geng, Jason,2013).

1.6.3. 3D viewing experience evaluation and visual comfort

Concerns related to safety and health of viewing stereoscopic images plaid a more prominent role with the demand for 3D-TV services. It is even considered that intensive watching of stereoscopic imaging will bring harm to viewers, especially to children whose visual system is still under development. Problems of visual comfort should satisfactorily be addressed to facilitate the implementation of 3D-TV. Therefore, it is important to understand the underlying causes of visual discomfort to limit or even eliminate it. However, no standard methodologies for visual comfort measurement for 3D images exist. One recommendation on subjective methods for stereoscopic imaging is proposed by the International Telecommunications Union (ITU) [49], but this recommendation only considers picture and depth quality. Methods using comfort scale to evaluate visual comfort subjectively are shown in Fig. 1.26. Objective tests also exist for visual tolerance for 3D components, such as horizontal disparity threshold and vertical disparity thresholds, these methods are more often used to evaluate visual fatigue.

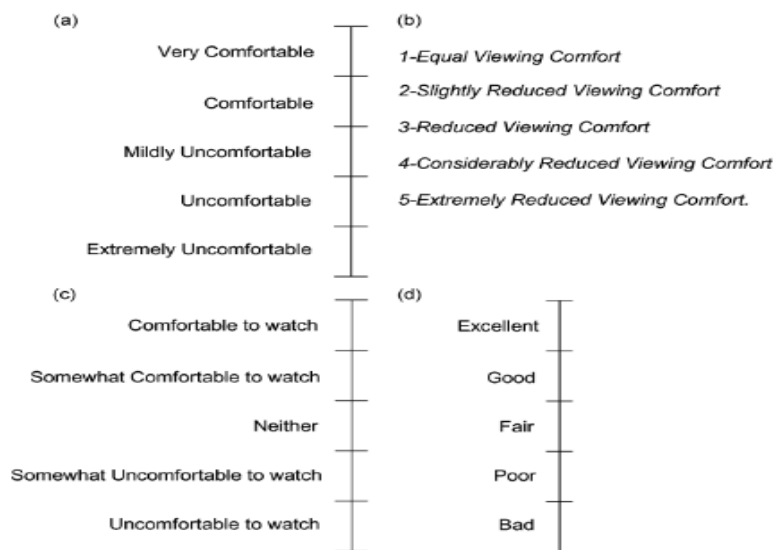

Figure 1.26. Examples of scales used to measure visual comfort of stereoscopic vision.

The factors that will affect visual comfort could be divided into the following aspects:

- Vergence-accommodation (V/A) conflicts: inconsistency of V/A coordination when observers are watching 3D content on conventional stereoscopic displays, as mentioned in 1.4.2.
- Inappropriate stereoscopic stimuli: this include disparity amplitude, velocity and distribution, binocular mismatches, depth inconsistency and perceptual and Cognitive Inconsistencies
- Crosstalk: known as ghosting, which is usually due to a stereoscopic viewing system with a single screen: a small fraction of the intensity from the left image can be seen in the right eye, and vice-versa.
- Environment configuration: related to viewing distance, room lighting, screen size etc.

1.7. Conclusion

In this chapter, the general process of visual perception has been briefly described, including the optical signal processing in the eye, the neural activity in cortical area and the neuro system. Binocular vision is a fundamental aspect of the human vision. The oculomotor system and the sensory vision have been detailed in this chapter. The most currently applied 3D technologies have been presented and the visual comfort effect factors based on the artificial 3D viewing environments presented.

3D perception on conventional displays is generated by the disparity cue which is processed by sensory system. However, concerning the accommodation/vergence conflict on oculomotor system caused by 3D stimulus, the visual comfort for 3D perception is related with both sensory and oculomotor system. There are three fundamental aspects to consider during the whole 3D viewing process: the 3D display technology, the environment configuration and the motion-in-depth stimuli. These aspects will cause sensory and oculomotor system changes, conflicts and then influence visual comfort (summarized in Fig. 1.27). In order to improve observers' viewing experience when 3D content are displayed, it is necessary to make a comprehensive exploration of the observer performance based on the above mentioned aspects. In this thesis, a series of physiological experiments have been carried out, observers' performance recorded and assessed subjectively when the sensory and oculomotor reflex are stimulated using non-cognitive cues. The goal is to clarify how oculomotor system and sensory system interact when stimulated by artificial 3D stimulus. We aim to providing practical references for 3D environment configurations, 3D display choices and 3D contents creation.

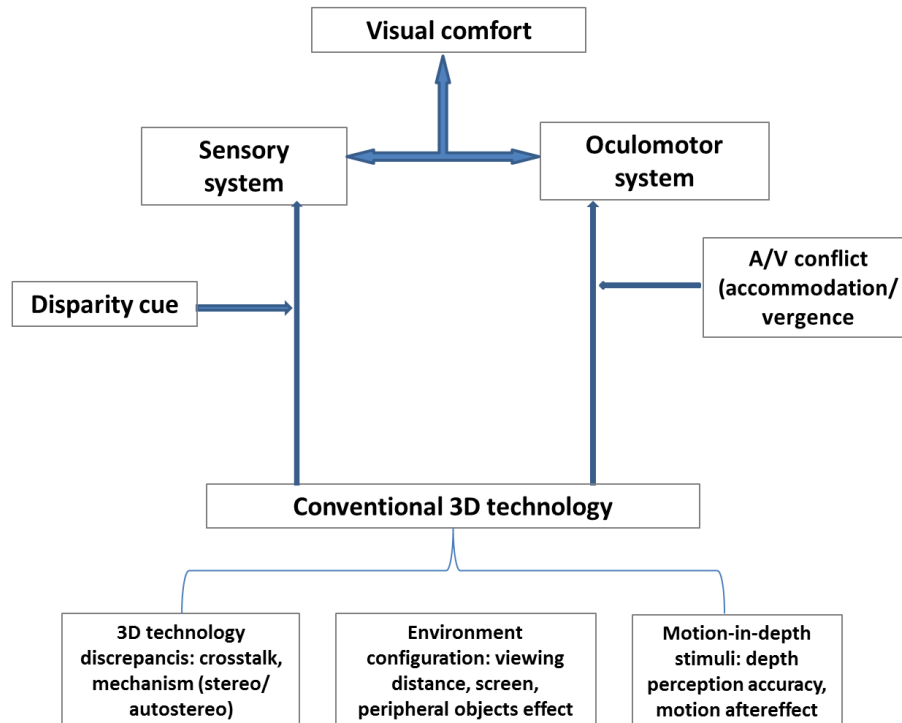

Figure 1.27 Perspectives of the current thesis. Based on the conventional 3D technology, three aspects that could affect 3D perception are investigated: 3D technology discrepancies, environment configuration and motion-in-depth stimuli. Because of the nature of the conventional 3D technology, accommodation/vergence conflict is the main issue for 3D viewing experience, potential mitigation methods are tested in the thesis.

In the next three chapters we will detail three physiological experiments separately: in Chapter 2 the visual performances on 3D projector and autostereoscopic TV is measured and compared to identify the impact of 3D display technologies on visual perception; in Chapter 3, the environment parameters are evaluated for their impact on visual tolerance to vertical disparity. In Chapter 4, an exploration is made on the investigation of interaction between oculomotor system and sensorial system for MID perception, besides, an attempt to improve the motion-in-depth perception performance is carried out: including perceptual training for subjects and how to design appropriate MID stimulus. In Chapter 5, a conclusion is made according to original objective and suggestions and perspectives for the future work are also indicated in this section.

Chapter 2

3D display technology effect on visual perception

Table of contents

2.1. Introduction

2.2. Methods

2.2.1. Subjects

2.2.2. Apparatus

2.2.2.1. Apparatus for Experiment 1

2.2.2.2. Apparatus for Experiment 2

2.2.3. Stimuli

2.2.3.1. Stimulus choice

2.2.3.2. Stimulus manipulation

2.2.3.3. Experiment configuration

2.3. Procedures

2.3.1. Experiment 1

2.3.2. Control test

2.3.3. Experiment 2

2.3.4. Statistics

2.4. Results and discussion

2.4.1. Viewing distance vs. stimulus size effect on VFA on 3D projector

2.4.2. Specific parameters effect on VFA on autostereoscopic TV

2.4.3. VFA on 3D projector vs. autostereoscopic TV

2.4.4. Crosstalk effect on VFA on autostereoscopic TV

2.4.5. Recommendation for 3D content generation and display

2.5. Conclusion

2.1. Introduction

3D display technologies have brought a wide array of facilities for entertainment, education, medical and military applications. However, visual comfort issues arise with the spread of 3D display technologies due to many concepts, including the discrepancies between natural viewing and artificial 3D display technologies, the display mechanisms such as stereo and autostereoscopic displays, the manipulation of 3D contents, even the observers vision capabilities affect 3D viewing experience. In this chapter, we focus on the effect of 3D display technologies.

Among the contemporary 3D display technologies, stereoscopic and autostereoscopic displays are the most widely used, owing to their easy and economical applications in real life. Therefore, we believe that it is interesting and meaningful to make a visual experience comparison between the two technologies in a normal viewing environment, so that the study can provide references for the choice of display target, display technology and viewing environment configurations.

In the optics department at Telecom Bretagne, we have a team working for 3D technology investigations, in the transversal 3DFovea observatory, which gathers Telecom Bretagne and the Hospital of Brest, there are all kinds of 3D display devices, including 3D projector, TV, 3D helmets etc. We chose the 3D projector to display stereoscopic technology because its better quality than 3Dready TV. Because 3D Fovea laboratory is specialized on stereoscopic display, we needed to find a laboratory that could provide autostereoscopic display, so we started cooperation with Beijing University of Posts and Telecommunications (BUPT). Before I do my thesis in Telecom Bretagne, I was a PhD candidate working in BUPT and my previous laboratory has many projects related with autostereoscopic displays. In particular, they have their own algorithm to generate autostereoscopic 3D contents and design different kinds of lenticular sheets for specific use. Thanks to their help and the support of optics department in Telecom Bretagne, I could go to Beijing and spent three weeks there to complete the study and to carry out the tests.

There are varieties of indicators to assess visual comfort, such as subjective evaluation method with which observers give their comfort score, and some visual parameters are also commonly used in viewing comfort evaluation, such as the pupil size, response accuracy or response time etc. In the current study, we chose vertical disparity fusion amplitude as the indicator for visual experience.

Since the eyes are located horizontally on the head, so there must be a slight difference between the views of the right eye and the left eye, thus perceiving a horizontal disparity is a natural mechanism for human, the depth information could be calculated by the horizontal disparity between eyes. However, it is not the same case for vertical disparity, our visual system has substantial less tolerance for vertical disparity compare with horizontal disparity. Vertical disparity is the vertical displacement of the views between right eye and left eye, normally, slight value of vertical disparity could be fused by the brain and observers could still perceive single vision. Nevertheless, when large value of vertical disparity is induced, the vertical fusion is interrupted and observer will perceive diplopia or rivalry. The maximum vertical disparity that could be fused is called vertical fusion amplitude (VFA). In particular, for persons suffering from intermittent phoria, it could result in visual decompensation and diplopia due to vertical deviation exacerbated by convergence accommodation conflicts[50].

As a vision tolerance indicator of binocular vertical misalignment, VFA is measured in plenty of studies, both in clinical and normal circumstances. For VFA in clinical application, the average threshold is between 3-5 Δ [48], generally, this value is measured using prisms. A series values of base-up prisms are presented in front of one eye, observer is instructed to focus on an object at a near distance around 30cm, the prism value continuous to increase until observer perceive diplopia, and the last value of the prism that allow observer to fuse the vertical disparity is recorded as VFA. It is reported that normal adults frequently have asymmetric directional VFA, which means vertical fusion amplitudes in the vertical left- over-right (L/R, elevation of the left eye above the right eye) pattern direction were different to the vertical fusion amplitudes in the vertical right-over-left direction pattern(R/L)[51], besides, the eye dominance and viewing distance also play a role in vertical disparity fusion[52, 53]. However, in our daily life, there are much more parameters to consider, and it has been confirmed that some factors can lead to VFA discrepancies. It has been reported that VFA varies with test conditions, such as viewing distance, target complexity, disparity velocity and eye convergence [54-57], even subject instruction and dominant eye have influence on it[51, 58]. In some laboratory research, VFA is measured using haploscope or stereoscopic displays, whose basic idea is to depict vertically misaligned images separately to right and left eyes, and these different measurements could also lead to VFA discrepancy. Ulyat measured VFA using a prism bar and reported that the VFA range was 3.5 Δ at the viewing distance of 6.0m [59]. Kertesz obtained an average VFA of 6.93 \pm 0.1 (almost 12 Δ) when stimulus angle was 57.6 $^\circ$ [54], with the stimulus displayed optically on oscilloscopes.

For the current 3D display technology, misalignment of stereo images is one of the crucial problems affecting visual experience. But the threshold of vertical disparity that leads to visual fatigue has not reached an agreement. Kooi et al. observed viewing comfort reduction when

vertical disparity was induced [48], whereas Speranza and Laurie suggested that vision system had relatively high tolerance for vertical disparity [60]. The reason for such opposite conclusions is that vertical disparity effect on visual comfort was assessed without considering test conditions and display technologies [61]. With the development of 3D display technology, various types of display have been applied in normal life, but specific investigations of vertical disparity tolerance on the main display technologies remain to be complemented.

In this chapter, we propose comprehensive psychophysical measurements of visual tolerance for vertical disparity using conventional test targets on the main current 3D technologies: 3D projectors and lenticular autostereoscopic TV. With the consideration of certain effect parameters in mind, a VFA comparison on the two contemporary display technology is conducted. The hypothesis in this experiment is that the subjects will give different performance on the two platforms due to the specific characteristics of the 3D technologies. Based on the experimental results, some recommendations for 3D display environment installation and configuration are identified.

2.2. Methods

2.2.1. Subjects

Two experiments were carried out separately at Telecom Bretagne, Brest (France) and at Beijing University of Posts and Telecommunications, Beijing (China).

In Telecom Bretagne, there are 21 normal and healthy adults participated the experiment, the mean age is 23.65 years and there are five females and 16 males. Some of them are from France, some from Arabic countries, one Indian and one Chinese. All of them passed a vision check in Brest University Hospital institute, and the vision criteria involved monocular visual acuity better than 10/10, evaluated by a decimal scale chart; with no history of ocular pathology (functional and organic); no vertical or horizontal phoria (checked by fixation test), no glasses (contact lens are acceptable) in order to avoid prismatic effect. The mean refractive error of the subjects is $0.93 \pm 0.15D$.

For the BUPT side, it was more complicated to collect enough observers. It is not an easy task to find someone with visual acuity better than 10/10, because most of the college students have glasses, since the experiment was done in a laboratory, all the students there were masters and PhDs, normally they read a lot and spend a long time in front of the computer, and their eyes suffered a lot from long term working, so it was even more difficult to have some “perfect” eyes. So the BUPT laboratory bought some contact lens for the observers to meet the vision requirement, besides, my family members who have good vision also came to help, finally, we

collected “22 precious pairs of eyes”. However, the subject number was not the only main issue for the whole experiment, since BUPT laboratory has rarely done physiological experiments, they have few experiences for this kind of measurement, and they don’t have facilities like at Brest, I could not send the observers to hospital to check their vision. I had to contact a vision specialized hospital and explain them my research goal and vision check criteria by myself. Although there are research departments in hospitals in China, but it takes long time to contact them and to persuade them to check subjects vision, so I contacted a private eye specialized hospital near BUPT, and explained which vision parameters needed to be checked. In the hospital in China, they have different equipments to measure eye vergence and phoria, and the result is quite different with the result at Brest. For example, they use a synoptophore to measure vergence and accommodation, and they consider that 10Δ is enough for normal eye vergence power while at Brest, we tested eye vergence using prisms and the threshold for near eye vergence power is 20Δ . However, most of the subjects’ eye vergence is near 10Δ , which proved the feasibility of the assessment criteria for Chinese population, so I decided to adapt the French criteria to Chinese ones. Finally, 20 subjects passed the vision check and participated in the experiment. The mean age is 25.82 years and there are 8 females and 12 males. The tests configuration and performance is shown in Table 2.1a.

Approval for the publication of subject data is obtained from Brest University Hospital and Beijing Tongren Hospital institutional review boards, according to the tenets of the Declaration of Helsinki. All subjects are naive to the experimental procedures and informed about the nature of the study.

2.2.2. Apparatus

2.2.2.1. Apparatus for Experiment 1

In experiment 1, we used a 3D projector (NEC-U310W) and 3D active glasses provided by Eyes3shut [62]. Shutters were specially customized to prevent ghosting by having very dark blocking states ($>1/1000$). The experimental installation is shown in Fig. 2.1. The experiment was conducted in a basement room, where the only light source is the room lighting and the screen. There are PCs and tables near the screen, one should notice that we try to simulate a relatively real viewing environment, like in the hall at home or in a small cinema. A head holder is implemented here to be sure that subjects’ keep a stable position during the experiment, to avoid effects from viewing posture adaptation.



Figure 2.1 3D display platform in experiment 1.

2.2.2.2. Apparatus for Experiment 2

Experiment 2 was conducted on a 50 inch lenticular autostereoscopic TV, as is shown in Fig. 2.2, it is a multi-view display without eye tracking, providing the perception of left-right movement parallax [63], the object displayed on the TV is a cube in a box, we will see different sides of the cube when we move rightward or leftward, like in a natural scene. The detail apparatus for the autostereoscopic TV is shown in Table 2.1b. A head-holder was used to maintain the head position fixed during the tests in the two experiments. Customized software for the two experiments is written using VS2010 C#, C++ and DirectX 11.0. The illuminance of the experiment environment was measured by a photometer (TES 1339 light meter Pro)

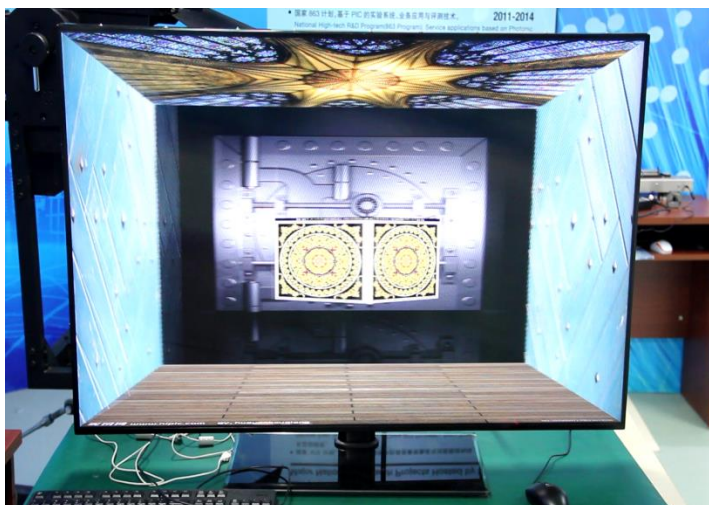

Figure 2.2 Multiview lenticular autostereoscopic TV in BUPT

Table 2.1a experiment configuration at TB and BUPT.

University	Age range	Visual acuity	Vergence ability test	race	technology	stimulus
Telecom Bretagne	20-33	Snellen chart	prisms	European , asia, north-american	3D projector	Random dots compos ed lines
Beijing University of Posts and Telecommunications	18-32	Snellen chart	synoptophore	asia	Autostereoscopic TV	Random dots compos ed lines

Table 2.1b The main parameters of autostereoscopic TV.

Parameter	
Screen resolution	3840 x 2160
Sub-pixel Width (mm)	0.096
Structure Pitch (mm)	0.4484
Lens Focus Length (mm)	2.883
Viewpoint Number	28
Viewing Zone Width (cm)	24
Viewing Distance (m)	1.8

2.2.3. Stimulus

2.2.3.1. Stimulus choice

Three images used as stimulus in the experiment are shown in Fig. 2.3a-c. This stimulus were inspired from Kertesz's study [54]. Some rationale for the stimulus used would be useful for the

stimulus choice. This particular stimulus has been criticized for horizontal-vertical anisotropy and for being a poor vergence stimulus beyond the central region since the defining features are very fine and likely not resolvable (especially in the single line variant). In the current experiment, we focus on visual response of vertical disparity, zero horizontal disparity has been induced, isolating the interaction of vertical and horizontal vergence. Besides, one of the goals of the study is to clarify the relationship of central and peripheral region in fusion process, and we modified the stimulus ratio of central and peripheral region for comparison, so the size of the original stimulus does not matter here.

2.2.3.2. Stimulus manipulation

The images are generated by a dedicated algorithm: dots are randomly located in a limited zone on a bilaterally symmetrical picture. There is a point on the image for fixation, the squares above and below the fixation point are designed to eliminate the binocular rivalry [64] (see the zoom on image in Fig. 3). In fact, Fig. 2.3 revealed what is depicted on the screen when the test just starts, zero vertical disparity is induced and the images for two eyes are overlapped. After the transmission of the 3D glasses, the right eye receives an image with a square above the fixation point while what is delivered to the left eye is an image with a square below the fixation point. The right eye and left eye images are the identical except for the location of the square.

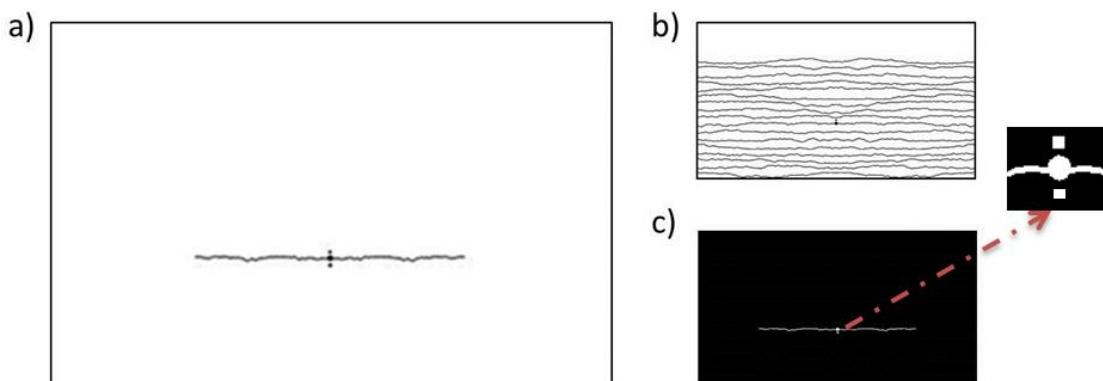

Figure 2.3 Stimulus used for experiments 1 and 2. Figure a) and b) represented the character of stimulus complexity; figure a) and c) represent the character of background luminance. The zoomed image represents what subjects see in the center of the screen without 3D glasses. The two squares below and above the fixation point is used to report visual rivalry.

2.2.3.3. Experimental configuration

In Experiment 1, the image resolution was 1280 x 800 pixels and each pixel was 1mm/pixel on the screen. Corresponding prismatic value for each pixel could be easily calculated according to a given viewing distance (Fig. 2.4). Each image on the screen subtended 44° (vertical) and 66° (horizontal) of visual angle at 1 m distance. In Experiment 2, the same images were implemented with a pixel size of 0.29 mm. The experiments were carried out in an enclosed room where the only light source was the display and room lighting. The screen of the 3D projector and lenticular autostereoscopic TV were positioned close to a white wall with a PC in each experiment. One of our goals here was to investigate visual performance in a real viewing environment, so the experiment setup was similar to normal condition. Vertical disparity was calculated by unit of prism diopter (Δ) according to the vertical distance of the paired images and the viewing distances, 1Δ is defined as the deflection of 1 cm at distance of 1 m.

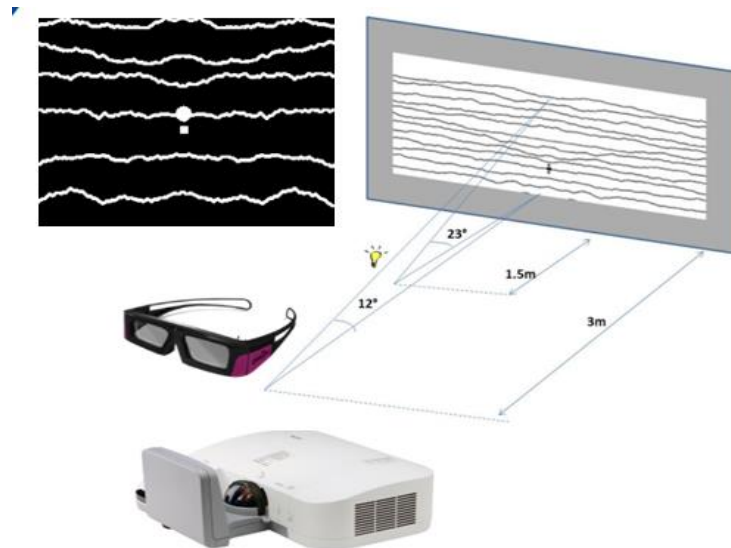

Figure 2.4 Experimental setup for Experiment 1.

2.3. Procedures

There are two experiments carried out separately in two laboratories to investigate visual tolerance for vertical disparity. Experiment 1 is conducted in 3D fovea laboratory at Telecom Bretagne (TB) in France in April, 2014. Experiment 2 is conducted in the State Key Laboratory of Information Photonics & Optical Communications (IPOC) in Beijing University of Posts and Telecommunications (BUPT) in July, 2014.

2.3.1. Experiment 1

The vertical fusion amplitude is measured on a 3D projector in experiment 1. The protocol is demonstrated in Fig. 2.5, when the stereo paired images are displayed on the screen, the

corresponding images are delivered to the right eye and left eye by the synchronization of 3D glasses and projector, thus right eye will only receive the right eye image while the left eye see the left eye image. At the beginning of each trial, the vertical disparity between the two images is zero, as shown in the top image in Fig. 2.5. Then, when the right eye image is shifted upward, the vertical disparity is induced. The vertical disparity continues to increase as long as the fusion is retained. There are two criteria to terminate one trial measurement (Fig. 2.3, bottom): one of the squares is disappeared or diplopia is perceived. The maximum distance that the right eye image has been shifted is recorded at the end of each trial as vertical fusion amplitude.

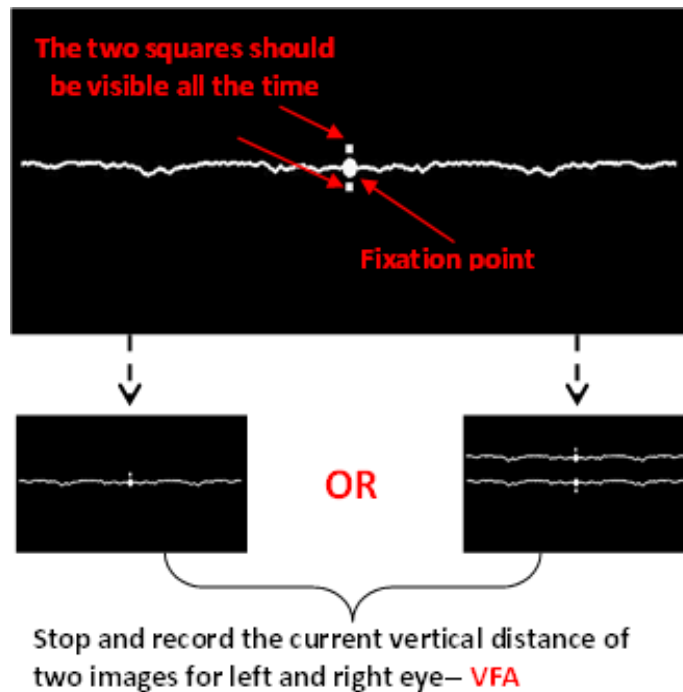

Figure 2.5 Protocol to measure vertical fusion amplitude.

In this experiment, five parameters that might affect VFA were considered: viewing distance, target complexity, background luminance, light condition (both can be related to the overall luminance) and disparity velocity. Test principles are demonstrated in Table 2. Among all the trials, there is a reference trial, the test condition is revealed in the first row in Table 2, in order to compare the test parameters effect independently, in the rest trials, there is only one parameter is changed in each trial comparing with the reference trial. For example, in the reference condition trial, subjects are at the viewing distance of 3.0m, the image depicted on the screen is Fig. 2.1a, in another trial, in order to make a paired test to evaluate the effect of viewing distance, subjects change the viewing distance to 1.5m while all other tests parameters remain the same. The disparity velocity for each trial was $0.2\Delta/s$ with a minimum increase of $0.02\Delta/step$.

The five parameters were tested in two sessions, with a rest of half an hour between sessions. The first session tested the first four factors (Table 2.2). At the beginning of each trial, the vertical disparity on the screen was zero, subjects were instructed to increase the vertical distance of images for left eye and right eye using a joystick, when subjects perceived diplopia or one of the squares disappeared, they should stop increasing the disparity immediately, the vertical misalignment of the images was recorded as VFA. During the alternation of trials, subjects kept their eyes closed. In the second session, VFA was measured under different vertical disparity velocities, and the test configuration was the same as the reference trial in Table 2, the only difference was the speed of vertical disparity, two types of vertical disparity velocities were tested, including four ramp velocities of $0.05\Delta/s$, $0.1\Delta/s$, $0.4\Delta/s$, and a step velocity: $0.02\Delta/\text{step}$. For both sessions, all factors were tested once and the total trial number was nine, the trial order was randomized in each session to eliminate potential effects.

Table 2.2 Test parameters in experiment 1. Bold in column identifies the paired parameters with reference condition.

Test factors	Viewing distance	Stimulus on screen	Room lighting	Disparity velocity
Reference condition	3.0m	Fig. 2.3a	off	$0.2\Delta/s$
Viewing distance	1.5m	Fig. 2.3a	off	$0.2\Delta/s$
Target complexity	3.0m	Fig. 2.3b	off	$0.2\Delta/s$
Background luminance	3.0m	Fig. 2.3c	off	$0.2\Delta/s$
Room lighting	3.0m	Fig. 2.3a	On/off	$0.2\Delta/s$
Disparity velocity	3.0m	Fig. 2.3a	off	$0.05\Delta/s$, $0.1\Delta/s$, $0.4\Delta/s$, $0.02\Delta/\text{step}$

2.3.2. Control test

It has been reported in numerous studies that viewing distance and stimulus size affect visual perception. One should notice that the two parameters are correlated, when viewing distance changes, stimulus size varies if the same stimulus is used. However, relatively few studies have taken the duplicated effect of viewing distance and stimulus size on vertical fusion. So, here, a control test was implemented to investigate the role of the viewing distance and stimulus size during the vertical fusion process (Fig. 2.6).

The stimulus size is defined as the viewing angle of up-down image size on the screen corresponding to the viewing distance. With a constant image size on the screen, stimulus size is larger if subjects moved from 3.0m to 1.5m ($\alpha_1 < \beta$), so the systematical viewing distance and stimulus size change might have a combined effect on vertical fusion. In the control test, we measured VFA when observers were located at 1.5m and 3.0m, with the same screen size. Then, we recorded VFA when the image size on the screen decreased to half to achieve a constant stimulus size as subject move from 3.0m to 1.5m ($\alpha_1 = \alpha_2$).

The stimulus image we used is Fig. 2.3a and seven observers participated in this experiment. The test was conducted in a dark room and the total trial number for each observer was four with randomization. The principle to measure VFA is the same with experiment 1.

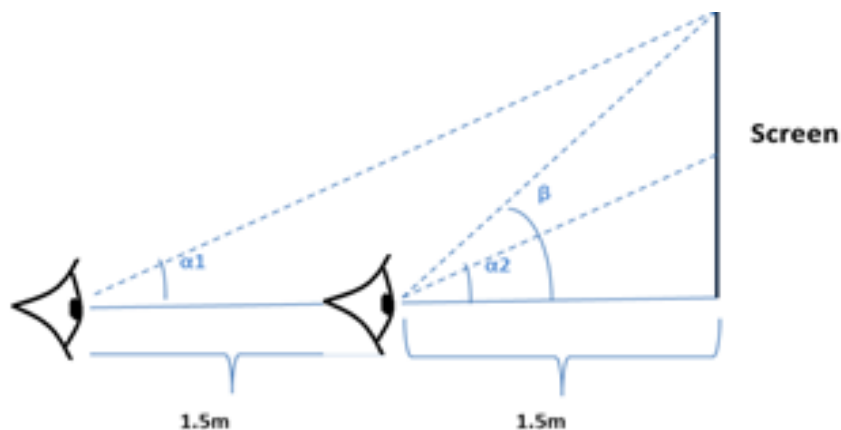

Figure 2.6 Control test schematic.

2.3.3. Experiment 2

VFA measurements were carried out on a lenticular autostereoscopic TV in this experiment, the protocol to record VFA is the same as for experiment 1. There were two sessions to investigate all the test parameters. Session 1 examined specific factors related with autostereoscopic technology, including the viewing angle and the viewing distance (both are linked). In contrast to 3D stereoscopic projection where a Lambertian screen is used (i.e. the luminance variation as

the function of the azimuthal angle is weak), in the autostereoscopic case, the luminance distribution exhibits lobes, making the observation dependent on both viewing angle and distance. The measurement for luminance lobe of autostereoscopic TV is shown in Fig. 2.7, it reveals the relationship of luminance distribution and viewing angle[65]. Session 2 is designed specifically for the comparison of vertical disparity tolerance to autostereoscopic and 3D stereo. Autostereoscopic TV image sizes in this session were modified to keep the same stimulus size as in Experiment 1. The influence factors are: target complexity, background luminance, room lighting and disparity velocity.

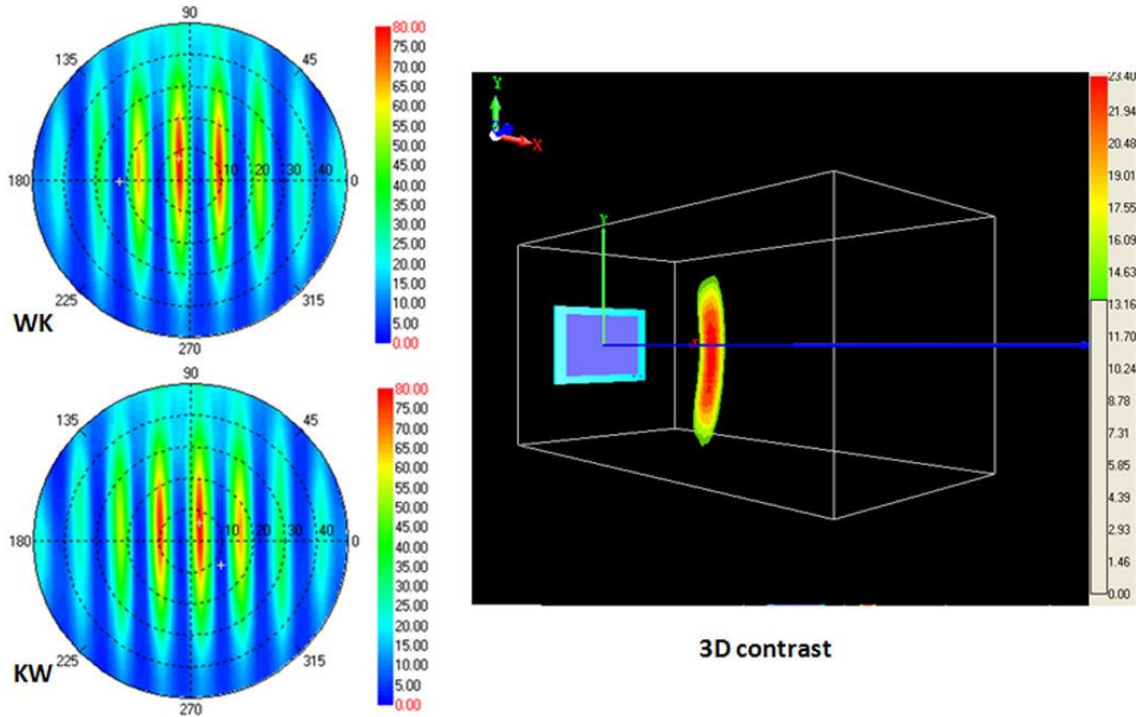

Figure 2.7 Optical characterization of autostereoscopic display. Viewing angle measurement on autostereoscopic display and computed qualified binocular viewing space (QBVP). WK stand for the left eye see white view and the right eye see black view. And the opposite: black view for the left eye and white view for the right (KW).

The test configuration for viewing distance and viewing angle is given in the first two rows in Table 2.3. Although the best viewing distance is known as 1.8m according to the display features, it is still necessary to make an additional observation of VFA changes near the best location, because observers are unlikely to seat exactly at the optimal position. Viewing angle is the angle of the viewing position and the center of the screen. It is considered as a critical factor affecting the visual fusion performance. In this experiment, four viewing angles were examined: 0°, 9°, 17°, 25°. One will notice that the luminance decrease systematically with viewing angle increase. In order to investigate VFA variations separately, we added a pilot

experiment to investigate the luminance effect on VFA. With four luminance levels, VFA was measured when subjects were just 1.8 m in front of the TV.

Table 2.3 Test parameters in experiment 2. Bold identifies the paired parameters. The test factors with* indicate that the test image is depicted on the whole autostereoscopic TV. The test factors without* mean that the depicted image size is modified to maintain the same stimulus size with experiment 1.

Test factors	Viewing distance	Viewing angle(°)	Stimulus on screen	Room lighting	Disparity velocity
Reference condition	1.8m	0	Fig. 2.3a	off	0.2Δ/s
*Viewing distance	1.6m, 1.8m, 2.0m, 2.2m	0	Fig. 2.3a	off	0.2Δ/s
*Viewing angle	1.8m	9, 17, 25	Fig. 2.3a	off	0.2Δ/s
Room lighting	1.8m	0	Fig. 2.3a	On/off	0.2Δ/s
Target complexity	1.8m	0	Fig. 2.3b	off	0.2Δ/s
Background luminance	1.8m	0	Fig. 2.3c	off	0.2Δ/s
Disparity velocity	1.8m	0	Fig. 2.3a	off	0.05Δ/s, 0.1Δ/s, 0.4Δ/s, 0.02Δ/step

There are two factors related with the viewing angles: luminance and crosstalk. The measurement of the two parameters on autostereoscopic TV is shown in Table 2.4. It reveals that crosstalk increases with viewing angles, while luminance follows the opposite trend. In order to clarify which factor plays the dominant role for VFA with respect to the viewing angle variation, we designed a pilot test to assess the luminance effect on VFA by

locating the observers at a fixed frontal viewing position while we modified the luminance in four levels. This test allows an independent evaluation of the relationship between the luminance and the VFA without interference from crosstalk, because at the same viewing position, the crosstalk is considered to be the same.

Table 2.4 Crosstalk and illuminance measurements at four viewing angles. Crosstalk is calculated by conventional method with adaption to eye perception.

Viewing angle	Crosstalk	Normalized illuminance(lux)
0°	4.86%	1
9°	10.07%	0.79
17°	13.13%	0.62
25°	31.79%	0.41

2.3.4. Statistics

Due to the complexity of parameters across two display technologies, we used both paired t-test and ANOVA as the main statistical analysis methods. In experiment 1, we used t-test to analyze the effect of viewing distance, target complexity, background luminance and room lighting. ANOVA was implemented to analyze disparity velocity. In experiment 2, we used t-test to analyze the effect of target complexity, room lighting and background luminance. For the parameters of viewing distance, viewing angle and luminance, ANOVA was carried out. Please refer to Appendix C for detail statistical analysis.

2.4. Results and Discussions

2.4.1. Viewing distance vs. stimulus size effect on VFA on 3D projector

First we demonstrated the control test result of experiment in Fig. 2.8, the solid line reveals the VFA variation with a constant image size on the screen, the effect from the correlation of stimulus size and viewing distance exist, because when observer move from the viewing distance of 1.5m to 3.0m, the stimulus size decreases systematically. The result indicates that VFA is much larger at the viewing distance of 1.5 m than it is at 3 m, the visual tolerance difference is significant according to paired t-test ($t = 5.7321$, $p < 0.001$). However, when the image size on the screen changed systematically with the viewing distance to insure an identical stimulus size, VFA varies slightly at the two viewing distance(1.5m and 3.0m), and there is no statistical significance ($t = 1.8257$, $p = 0.0829$). Previous investigations reported that closer

viewing distance leads to larger VFA, because vertical fusion capability increases with the convergence[51, 56, 66], but the stimulus size was not consistent when viewing distance varied in the experiment of Ulyat [59]. There are also other experiments that provided larger VFA with wider stimulus size[53, 55, 67].However, the effect of viewing distance and stimulus size was investigated without considering the interactions of both factors. In the current study, we eliminated the duplicated effect by comparing the result of VFA changes with and without the effect of stimulus size. **We confirmed the essential role of stimulus size in vertical fusion process.** Although the viewing distance should be considered as far distance (compared with 30 cm which is often used in clinical measurements), it could represent a normal viewing condition in daily life.

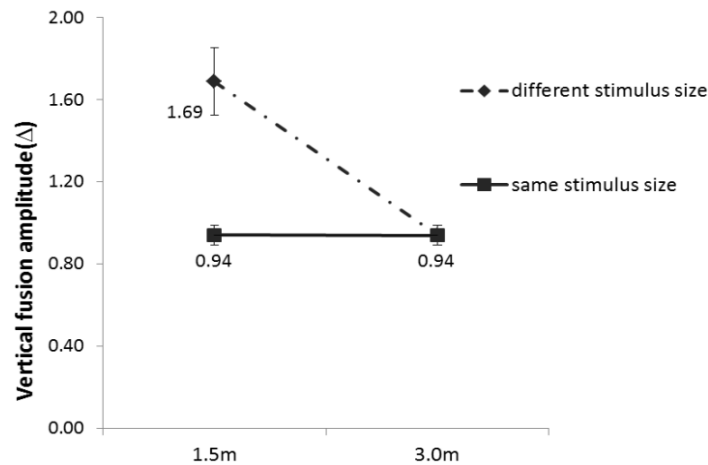

Figure 2.8 Averaged VFA on 3D projector. The comparison of stimulus size and viewing distance effect on VFA. Error bars indicate standard variation.

2.4.2. Specific parameters effect on VFA on autostereoscopic TV

Due to the characteristics of autostereoscopic display, there are some indexes for this technology, such as the maximum viewing angle, the optimal viewing distance, the crosstalk, the resolution etc. however, the best viewing condition are not often achieved in normal life, so it is important to understand how these parameters mentioned above affect the visual perception. In this part, we chose the viewing angle and viewing distance as the evaluation factor for VFA, the observers' tolerance of vertical disparity at different viewing angle and viewing distance approaching the optimal position are recorded and compared. The effect of viewing distance is shown in Fig. 2.9a. **The maximum VFA appeared at the optimal distance (1.8 m), and the effect of viewing distance is insignificantly different according to repeated measured ANOVA ($f=0.5647$, $p = 0.5730$). For the VFA observed at different viewing angles, the central viewing position allows the largest VFA (Fig. 2.9b) and this value is significantly**

different with the one obtained at other viewing angles according to repeated measured ANOVA ($f=2.7313$, $p = 0.04874$). Nevertheless, the VFA difference is not significant between 9° - 25° according to post-hoc test.

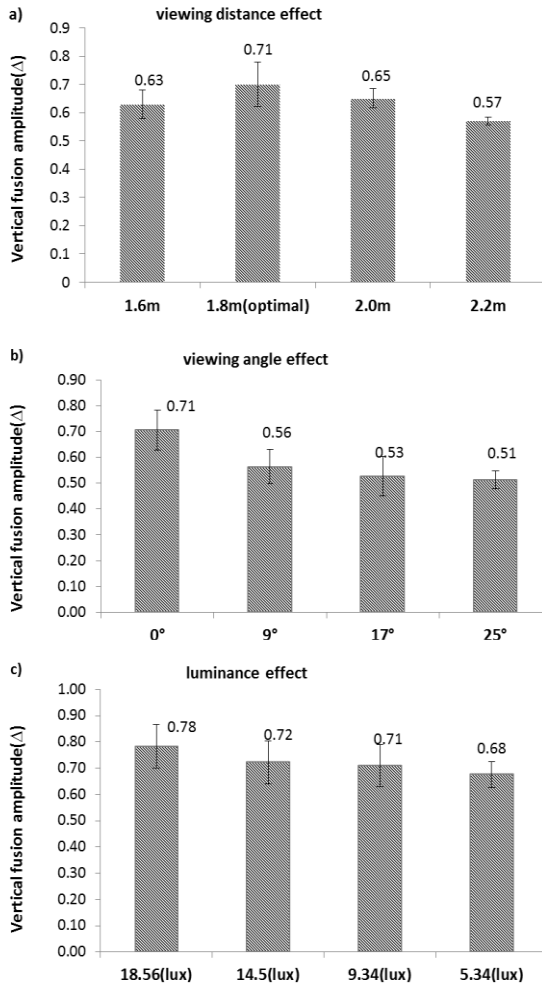

Figure 2.9 Averaged VFA on autostereoscopic TV for effect factor of a). Viewing distance, b). Viewing angle, c). Luminance. The error bars indicate the standard variation.

The result of the pilot test is shown Fig. 2.9c. **The luminance does not impact the VFA statistically significantly according to repeated measured ANOVA ($f=1.3732$, $p = 0.3123$).** Previous study reported that visual performance is closely related to luminance intensity. Berry suggested that bright luminance improves the stereo acuity [68], but recent studies demonstrated that the luminance contrast plays a more critical role in stereo perception[64, 69]. In our experiment, we used the maximum contrast (white background and black content) to measure the VFA.

If the effect of the luminance is removed according to the pilot test results, the main factor causing the VFA variation with viewing angle is the crosstalk. It is a common knowledge that crosstalk is a complex issue for autostereoscopic displays, because it depends on several factors (extrinsic such as: manufacturing flaws, misalignments etc. and intrinsic due to the multiple view [70]). In the current experiment, we notice that the crosstalk could be a crucial issue for vertical disparity tolerance on autostereoscopic TV, but how and at which level the crosstalk impacts the VFA requires specific methods, such as using crosstalk reduction image processing[71] or ghostbusting software to compare the observers' performance when crosstalk is removed or decreased on autostereoscopic display.

2.4.3. VFA on 3D projector vs. autostereoscopic TV

In order to compare observers' visual performance on 3D projector and autostereoscopic TV, we chose several parameters that could affect VFA on both 3D projector and autostereoscopic TV: target complexity, background luminance, room lighting and vertical disparity velocity. VFA was measured under the same condition on the two 3D display platforms, including the same stimulus size, illuminance etc. Averaged VFA on 3D projector and lenticular autostereoscopic TV is shown in Fig. 2.10a-d.

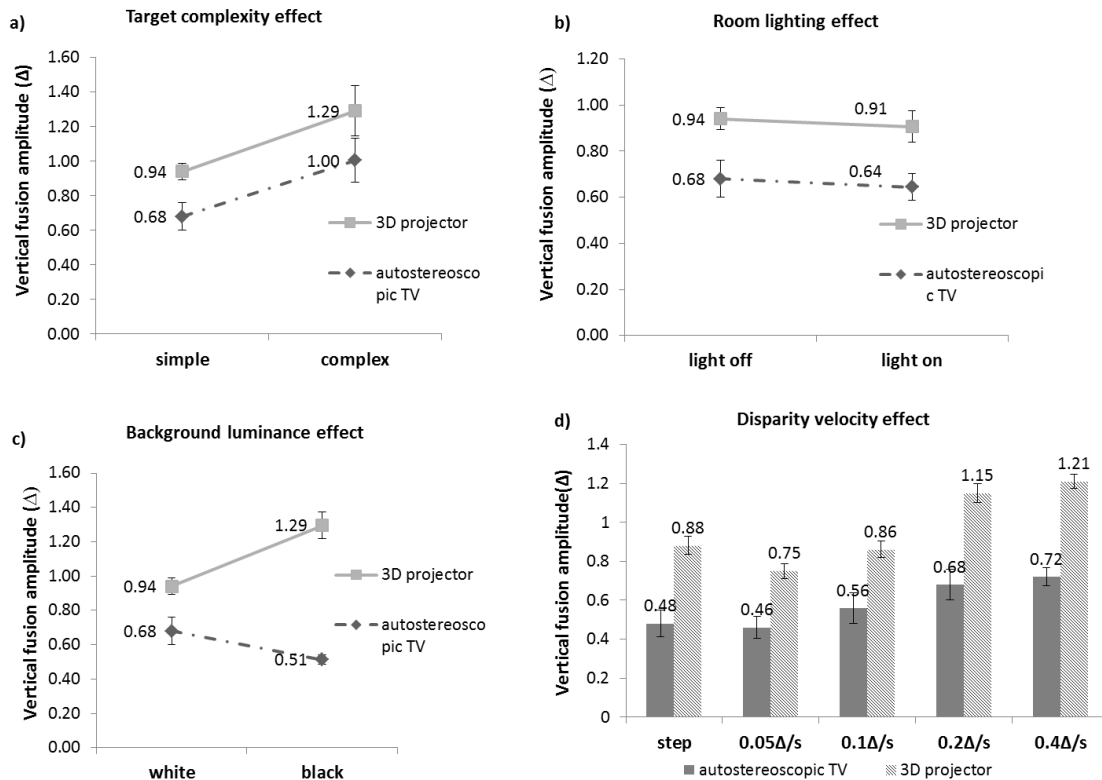

Figure 2.10 Averaged VFA on 3D projector vs autostereoscopic TV. Error bars indicate the standard variation.

According to paired t-test, **VFA is larger when complex target is used and the difference is significant both for 3D projector ($t = 4.9865$, $p < 0.001$) and autostereoscopic display ($t = 2.8202$, $p = 0.0109$) (Fig. 2.10a).** For room lighting effect (Fig. 2.10), there is slight VFA variation and the difference is not significant neither on 3D projector ($t = 0.7496$, $p = 0.4622$) nor on autostereoscopic display ($t = 1.9111$, $p = 0.0789$). Background luminance effect is significant for lenticular autostereoscopic TV ($t = 3.1656$, $p = 0.0051$) and 3D projector ($t = 4.4653$, $p = 0.002$). However, background luminance has a distinct impact on both devices (Fig. 2.10c). Subjects have a larger vertical disparity tolerance when background luminance on 3D projector screen is black. The situation is reversed for autostereoscopic TV. The disparity velocity effect on VFA is demonstrated in Fig. 2.10d. **Vertical fusion capability is enhanced with faster disparity velocity. The difference is statistically significant both on 3D projector ($f = 4.5959$, $p = 0.001$) and autostereoscopic TV ($f = 3.9659$, $p = 0.0036$).**

The trend of target complexity effect on VFA is consistent with previous studies. Kertesz reported that subjects tend to fuse larger vertical disparity when the target is more complex

[54], we got the same result both on 3D projector and autostereoscopic TV. Vertical disparity velocity is another significant factor influencing subject perception on both devices. **Our results indicate that VFA increases with velocity, which is inconsistent with previous conclusions, in Perlmutter and Kertesz's experiments, the maximum fusible vertical disparity for step and ramp disparities has slightly difference [56].** An explanation for the discrepancy of their results and the current study could be the velocity range, in our experiment, although VFA was measured with five velocities, the significant difference only existed when velocity increased from $0.1\Delta/s$ to $0.2\Delta/s$, and there was no significant difference among step disparity, $0.05\Delta/s$ and $0.1\Delta/s$ according to LSM student's t-test. However, the ramp velocity in previous studies was equivalent to $0.06\Delta/s$, which is between the investigated velocities of $0.05\Delta/s$ to $0.1\Delta/s$. Parts of the target properties that could affect VFA are consistent with previous studies. Kertesz reported that subjects tend to fuse larger vertical disparity when the target is more complex [54], it is confirmed in the current study.

Two new parameters were investigated in the current study, they are fundamental parameters corresponding to realistic viewing environments. Room lighting is a common element that might affect viewing experiences both for 3D projector and autostereoscopic TV. However, the statistical analysis does not indicate significant differences for its effect on VFA, even with the two extreme cases (light on/ light off). This result is a little bit surprising, because room lighting has always been an important parameter to be considered in many experiment configurations and measurement, and it is a common knowledge that visual performance is related with room lighting, such as visual acuity, stereo vision etc. one explanation for this insignificance of room lighting could be the high illuminance of the screen, both for 3D projector and autostereoscopic TV, the image displayed as visual stimulus was the Fig. 2.3a, it has large area of white background, providing a considerable amount of luminance. Besides, as observers were quite close to the screen (1.8m for autostereoscopic TV; 3m for 3D projector), the effect from the other light source is declined. In order to confirm this speculation, we measured VFA when the stimulus image was Fig. 2.3c on a small amount of [72]observers (12 subjects on autostereoscopic TV, 10 subjects on 3D projector). The results indicate that with dark background, VFA is significantly affected by room lighting (Fig. 2.11) on 3D projector ($t = 0.1722$, $p = 0.4322$), but not on autostereoscopic TV ($t = 2.9462$, $p = 0.01$).

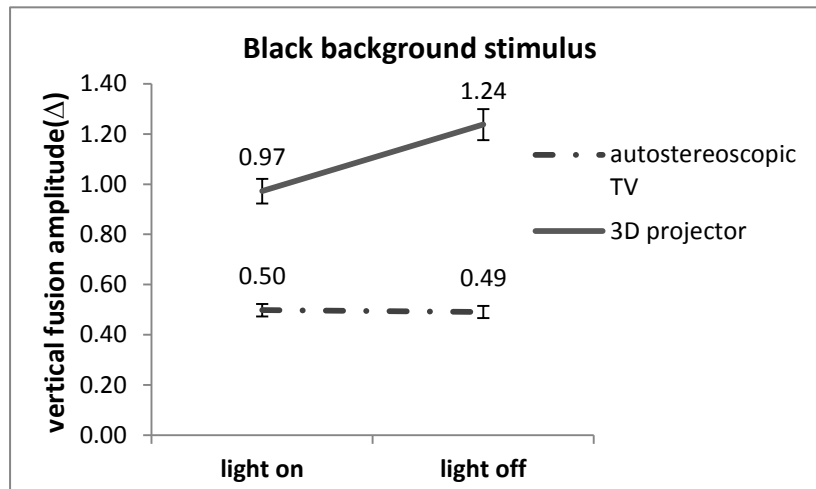

Figure 2.11 Averaged VFA on 3D projector and autostereoscopic TV when stimulus image is Fig. 2.3c

2.5. Discussion

Background luminance effect on VFA is first investigated here in this study. According to the previous exploration for luminance effect on visual performance, it is generally accepted that horizontal disparity threshold is increased because Panum area is enlarged with scotopic luminance [69]. However, for the current study, the trend for background luminance effect on VFA is reversed, this is possibly due to the crosstalk discrepancy, when different contents are displayed on autostereoscopic TV. There are several types of crosstalk on autostereoscopic display, the crosstalk between neighbor views or the interference between the left eye and right eye. In our experiment, we just consider the crosstalk between right/left images. When black luminance is depicted(Fig. 1c), the only light source is the white line on the screen, and this line is the fusion target stimulus at the same time, because the energy of the black background is nearly zero, the crosstalk results mainly from the white line. When white luminance is displayed, the main light source is white background, while the black line becomes the fusion target. Therefore, the crosstalk generated by the black line is relatively weak compared with the previous case. **Hence, the crosstalk effect is less significant for the white luminance than for a black luminance, thus resulting in different visual tolerance for the vertical disparity.**

The comparison of VFA on 3D projector and autostereoscopic TV in Fig. 2.9 indicates that subjects have generally better tolerance to vertical disparity on 3D projectors than on autostereoscopic TV. Although no specific studies have investigated the visual tolerance of vertical disparity on 3D projectors versus lenticular auto-stereoscopic TV, vertical disparity as a

key factor to affect the visual comfort has been mentioned in several studies[73]. Therefore, the investigation of the vertical disparity tolerance on the two current main display technologies will provide a practical reference for the standard formulation for 3D display devices in the future.

2.5.1. Crosstalk effect on VFA on autostereoscopic TV

One point should be noticed during the experiment is that all the subjects reported a presence of crosstalk during the experiment on autostereoscopic TV while this did not happen with 3D projector. This indicated that crosstalk ratio is larger on the autostereoscopic TV with the current stimulus images which is a possible impact on vertical fusion.

2.5.2. Recommendation for 3D content generation and display

Based on the data obtained in both experiments, we propose here a recommendation for 3D viewing environment configurations. As shown in Table 2.5, the parameters for viewing environment setup and content generation are listed with respect to 3D projector and autostereoscopic display. To limit the vertical misalignment of 3D contents which reduces the visual comfort, a recommended VFA threshold value is added in the table. This empirical value depends on the technology, environment parameters and set-up configuration.

Table 2.5 Recommended viewing environment configurations based on the experimental results

Preferred configuration for better vertical disparity tolerance		
Effect parameters	3D stereoscopic display	Autostereoscopic display
Background luminance	Dark	Bright
Viewing distance	Close to	Optimal distance
target complexity	complex	complex
Disparity velocity	fast	fast
Viewing angle(°)	Not important	Frontal viewing
Room lighting	Not important	Not important
Recommend VFA threshold (Δ)	1	0.7

2.5.3. General discussion

The experimental results show that VFA is generally larger on 3D projector than on lenticular autostereoscopic TV and that different target properties may lead to different visual performance on the two devices. Practical references and recommendations are provided when 3D contents are created and displayed, such as the 3D contents synthesis, visual comfort guidelines for 3D viewing environment configuration and the visual comfort assessment of the 3D media in the sense of disparity tolerance. However, exploration of VFA difference on 3D projector and autostereoscopic TV is an open question, it may relate to the choice of the test targets, the targets in the current study are commonly used in the literature for binocular vision tests. The targets are fully appropriate for 3D stereo projections, but maybe not for autostereoscopic display, because the current target generated relatively obvious crosstalk.

Other limitations of this study are the limited types of 3D display platform and stimulus target choice. There are plenty of stereoscopic display technologies that available on the display market, such as autostereoscopic TV with eye tracking, multi projector based autostereoscopic display and holographic stereoscopic display. On these displays, the observation position is well detected and corresponding display configurations are precisely controlled in real time. The interference between views are reduced or eliminated. So the visual performance should be significantly different with the ones that are tested in the current study. Due to the diversity of target properties, such as luminance, contrast, complexity etc, visual performance varies largely with different stimulus, so in the future study, it will be meaningful and fruitful to generalize the target properties effect on visual perception. By understanding the critical target parameters on corresponding display platform, 3D content creation and representation will be more targeted and efficient.

2.6. Conclusion

In this chapter, vertical fusion amplitude is measured and compared with respect to certain parameters that could affect visual comfort. This study aims at seeking to understand the nature of visual experience in terms of the current 3D display technologies. The experimental results confirmed some previous conclusions, such as the role of viewing distance, target complexity and velocity, also it introduced for the first time the role of parameters in physiological optics and 3D display technology, such as room lighting, background luminance, crosstalk and 3D display platforms.

Chapter 3

Environmental parameter impact on visual perception of 3D Stereo objects

Table of contents

3.1. Introduction

3.2. Methods

3.2.1. Subjects

3.2.2. Apparatus

3.2.2.1. Stimulus

3.2.2.2. 3D display platform

3.2.2.3. Prism

3.2.2.4. Lighting conditions

3.2.2.5. Eye movement recording and data analysis

3.2.2.6. Questionnaire

3.3. Procedures

3.3.1. Experiment 1: Interaction of peripheral and central fusion

3.3.2. Control test of Experiment 1

3.3.3. Experiment 2: Stimulus size effect on vertical disparity fusion.

3.4. Results and discussions

3.4.1. Peripheral induced vertical disparity effect on central VFA

3.4.2. Disparity direction effect on VFA

3.4.3. Stimulus size effect on VFA

3.4.4. Eye dominance

3.4.5. Questionnaire analysis

3.5. Conclusion

3.1. Introduction

Each 3D presentation takes place in a certain environment, no matter what is the perspective, clinical diagnose, laboratory research or daily applications, there are always basic components, such as display platform, observers and the environment approach the 3D projection. However, there are parameters that have critical effect on visual perception for 3D viewing and there are factors that influence visual experience slightly, or some factors which only affect our visual perception under certain conditions. Among these parameters, the interaction between central and peripheral viewing areas is a prerequisite and follows the whole viewing period.

There are several classifications about central and peripheral viewing areas. About the aspect of display, the screen or medium that displays the 3D object is the central viewing areas, the objects around the display area belong to peripheral. On the aspect of fixation, the central area is where the eyes focus on, it is a quite small part and the rest of the screen is considered as peripheral. However, if we take the eye structure into consideration, the retina could be divided into central fovea and para fovea, where the visual acuity and sensitivity is the maximum at central fovea while the para fovea works for motion detection. Both central and peripheral visions are important for scene recognition, the advantages of central vision (the fovea and parafovea) are its higher visual resolution and sensibility for object recognition, for the periphery, it is good at resolving lower spatial frequencies and in a large extent both are useful for recognition of the main part of a scene, and its large extent. It has been reported that if the whole scene is divided into central and peripheral region, showing the peripheral region while blocking the central region will not affect the perception of the entire scene, but showing the central region while blocking the peripheral region is difficult to recognize the whole information. This result indicates that periphery was more useful than central vision for maximal performance, some patients who have lost central vision can efficiently categorize natural scenes with the help of peripheral vision. However, central vision is more efficient than the periphery on precise feature recognition

When central and peripheral vision is assessed in stereoscopic viewing, disparity has been often involved, due to its essential role in stereoscopic perception. The fusion process of disparity has been investigated in a wide array of studies. The concept of peripheral fusion for disparity was first introduced by Burian, indicating that peripheral retina has the ability to fuse two identical objects imaged on each retina[74]. Winkelman demonstrated that central fusion could be interrupted by adding objects in the peripheral area [75]. Houtman reported that the influence of the stimulated retinal area decreases from the fovea to the periphery [76]. More recently, Howard et al. demonstrated that the central retina has more power to evoke horizontal or vertical vergence than the periphery [55]. In the current study, we chose vertical disparity as an indicator for visual performance of central and peripheral vision, there are two reasons, one is that vertical disparity is a key factor affecting human vision perception, little amount of vertical

disparity could cause serious eye strain, visual fatigue or worse stereo acuity [48, 77]. Another reason is the visual sensitivity for vertical disparity, small amount of vertical disparity will stimulate diplopia, compared with horizontal disparity. So it is easier to stimulate binocular system with vertical disparity to assess visual performance. Besides, due to the similar stimulation mechanism of vertical and horizontal disparities, we believe that there is a link between the perceptions of the two types of disparity, by evaluating visual response on vertical disparity, the results may also apply for horizontal disparity to some extent.

Previous studies mentioned that central fusion could be interrupted by peripheral disparity and the fusion capability decreased from fovea towards the periphery [74, 76], but the current understanding of interactive mechanism of central and peripheral fusion requires further exploration, in terms of direction and intensity effect of peripheral disparity on central fusion. **In the current study, we evaluated the interaction of central and peripheral fusion for vertical disparity.** By modifying the ratio of central and peripheral stimulus size, the fusional responses of vertical disparity were recorded, and the interaction of central and peripheral fusion as a function of stimulus ratio is analyzed objectively. In previous studies, the influence of peripheral fusion is only indicated subjectively, how and at which extent the interaction happens has rarely been investigated. We designed two experiments to complete this lack of quantitative representation. The first experiment tested the interaction between central and peripheral fusion by inserting a series of base-up prisms in peripheral vision. In the second experiment, VFA was measured at different viewing distances with constant induced peripheral disparity, which aimed at assessing the central and peripheral fusion interaction as a function of the stimulus size.

Furthermore, most of studies about vertical disparity fusion are carried out with specific devices under constrained conditions. Few measurements have been done under real viewing environment using consumer displays. This diversity could result in a discrepancy for the criteria of VFA measurement, when vertical disparity fusion threshold is given as a reference for vertical phoria in clinical treatment or 3D content displays. Stereoscopic 3D nowadays is a universal experience often merged in complex and uncontrolled projection environments, resulting in possible conflicts between perception for the central region sight of a 3D display and the real world around. This issue is mitigated in movie theatres by the large screen size and surrounding darkness. In contrast, it is more critical for 3D home TV or computer screens when peripheral objects are perceived in the close vicinity. **In this study, we carried out the experiments in a relatively practical environment with a commercial 3D projector, aiming at exploring the observers' performance in normal viewing environment. The hypotheses for these experiment is that subjects' performance will be significantly affected by different environment configuration or target manipulation, besides, the interaction of the central and**

peripheral could be evaluated quantitatively by changing the stimulus size on retina. By conducting a series of experiments, we are expected to identify the appropriate 3D viewing environment configuration in a real view condition.

3.2. Methods

3.2.1. Subjects

Fourteen subjects with an average age of 24.25 ± 3.63 years were recruited (three females and eleven males, all right-dominant eyes). All subjects were naïve to the experimental procedures and informed about the nature of the study. Approval for the publication of subject data was obtained from Brest University Hospital institutional review board, according to the tenets of the Declaration of Helsinki. The inclusion criteria are the same as explained in Chapter 2.

3.2.2. Apparatus

3.2.2.1. Stimulus

The test stimuli are shown in Fig. 3.1a-d, similar pictures were used by Kertesz [54]. The image resolution was 1280x800 pixels and each pixel was 1mm/ pixel on the screen. Corresponding prismatic value for each pixel could be easily calculated according to a given viewing distance. Each image on the screen subtended the visual angle of 44° (vertical) and 66° (horizontal) on the screen from 1 m distance.

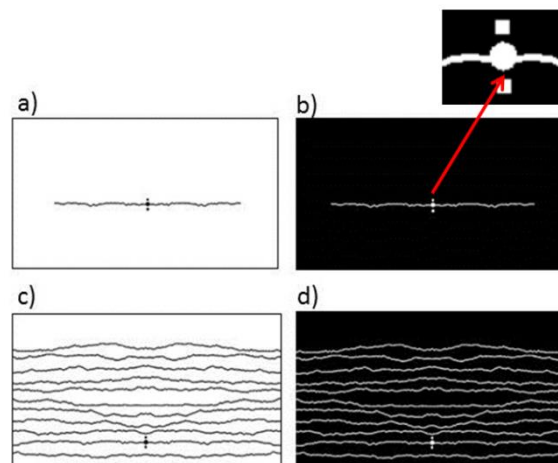

Figure 3.1 stimulus Images used in the experiments, by compare figure a-d, the parameters of target complexity, background luminance are represented.

3.2.2.2. 3D display platform

The 3D platform was made up of a 3D projector (NEC-U310W) and 3D active glasses. The custom-programmed software was written using VS2010 C++ and DirectX 11.0. an eye tracker was used to record the eye movement, the brand is TheEyeTribe.

The 3D projector worked in page flipping 3D mode. Page flipping is a display method, by synchronizing the 3D glasses images with the projector frequency, the stereo paired images are delivered to the corresponding eyes, each image keeps their original resolution, for example, the images on the current experiment is 1280x800. If the projector works in up-bottom 3D mode, the paired images are drawn in the same frame and split into two images to be delivered to the right and left eyes (two images, each 640x800), there will be an interpolation for each image, in order to reach the same resolution as the screen resolution (1280x800), so the images that transmitted by the 3D glasses are not the same as the original ones. The page flipping 3D mode insured the images that perceived by the eyes are the original stimulus images.

3.2.2.3. Prism

Prism is a transparent optical element with flat, polished surfaces that refract light. At least two of the flat surfaces must have an angle between them (Fig 3.2a). When light pass through a prism, it will be refracted and its direction is shifted to another direction (β), the direction and value of the shift angle depends on the prism material and the angles (α) between the surfaces of the prism. According to the characteristic of the prism, when a base-down prism is inserted in front of one eye, the view of that eye will be shifted upward (Fig. 3.2b).

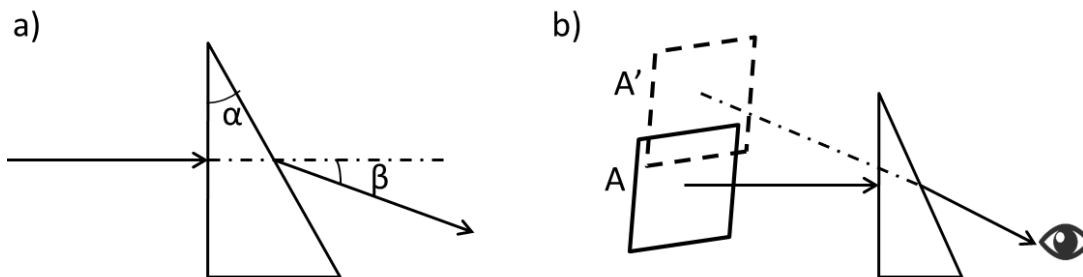

Figure 3.2 a) Light refraction when it passes through the prism, b) The view is shifted upward when the eye look through a base-down prism.

Prisms in optometry are often used to create disparity between the two eyes to stimulate diplopia, or to detect Positive and negative fusion problems [10]. In the current study, we used a series of prisms to induced different level of vertical disparity, as shown in Fig. 3.3.

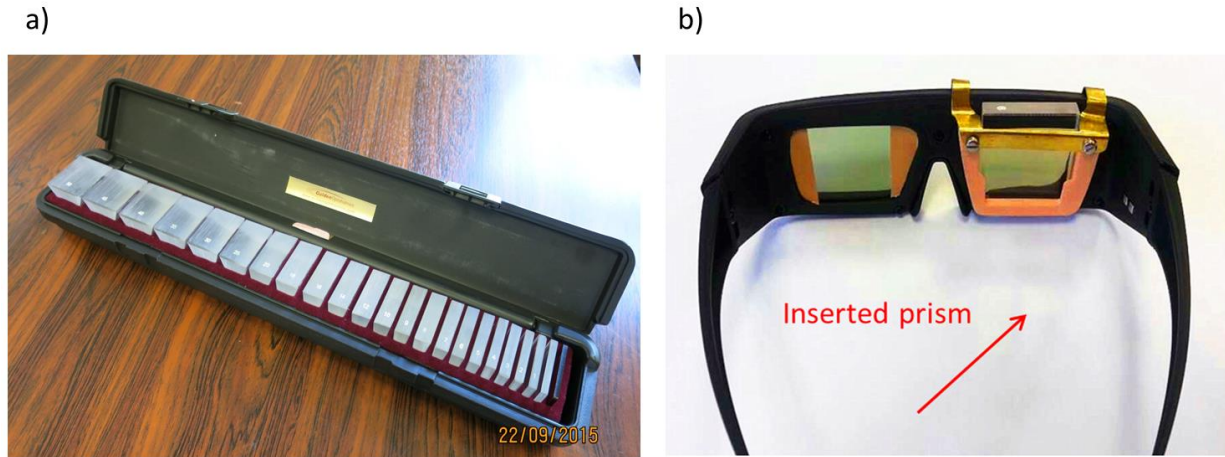

Figure 3.3 a) The prism that are used in the current study, b) The prism is inserted in the right view of 3D glasses, thanks to a dedicated prismholder.

3.2.2.4. Lighting conditions

The only light sources were the room light and the light from the projector on a white screen. Near the right side of the screen, a PC was visible during the test. The luminance during the experiment is shown in Table 3.1. The lighting condition was measured when observer was located at 1.5 and 3 m from the screen. To compare the different lighting conditions, we measured the illuminance to the different test conditions and the front luminance (the observation cone determined by the screen and the observer position). Values were measured using a photometer (ILM-1335 from ISO-TECH) and luminance meter (Konica Minolta, CS-100A). A significant difference in the room illuminance is observed, when displaying white and black backgrounds on the screen. The background acts as a secondary light source. Similarly, when the viewing angle is modified according to the observation distances a significant change of luminance is observed and should be considered in the final analysis due to the presence of lamps at different locations in the ceiling.

Table 3.1 Lighting conditions a) with room light, b) without room light.

a) Test type	Illuminance face to screen (lx) 1.5m	Illuminance face to screen (lx) 3m	Luminance 1.5m (cd/m ²)	Luminance 3m (cd/m ²)
Simple white background(Fig. 3.1a)	102	101	110	155
Simple black background(Fig. 3.1b)	49	78	75	42
Complex white background(Fig. 3.1ac)	100	100	115	150
Complex black background(Fig. 3.1d)	55	78	72	50
b) Test type	Illuminance face to screen, lx (1.5m)	Illuminance face to screen (3m)	Luminance 1,5m (cd/m ²)	Luminance 3m (cd/m ²)
Simple white background(Fig. 3.1a)	51	23	90	132
Simple black background(Fig. 3.1b)	1	0	55	18
Complex white background(Fig. 3.1ac)	48	21	90	122
Complex black background(Fig. 3.1d)	4	2	45	23

3.2.2.5. Eye fixation measurement and data analysis

Eye motion was monitored by a fixation measurement test (Nonius lines type) before and after the experiment, no vertical phoria was detected before the test, no vertical misalignment of eyes was reported after the test and during the test, except for a very short adaptation time. The disparity between the images for left and right eyes was recorded immediately when the subject reported a diplopia or suppression. Data was automatically converted by the software into prism diopter, according to the corresponding viewing distance. For multiple variables comparison, ANOVA was implemented for statistical analysis, for the comparison of two

stimulus effect, t-test was used. χ^2 test was also induced to compare observed data with theoretical data we would expect.

3.2.2.6. Questionnaire

In order to have a subjective evaluation about the experiment, we designed a questionnaire for subjects at the end of the experiment to collect their suggestions and to understand their experience. The questionnaire could be found in Appendix A.

3.3. Procedures

3.3.1. Experiment 1: Interaction between peripheral and central fusion

In this experiment, vertical fusion amplitude (VFA) in central vision was measured when vertical disparity was induced in peripheral vision. This study aimed at investigating the imbalance point of central and peripheral fusion strength. A series of prisms (0Δ , 2Δ , 4Δ , 6Δ) were inserted in front of subject's right eye to create disparity in peripheral retinal area.

The demonstration of experimental design is shown in Fig. 3.4. When a base-up prism was inserted in front of the right eye, the whole vision field of the right eye was shifted downward. A compensation disparity was induced on screen in order to achieve zero disparity in central vision. For instance, when the inserted prism is 2Δ and the viewing distance is 1.5m, there should be a 3cm upward shift for right eye image, because initially, the view of right eye was shifted 3cm below the original position by the prism.

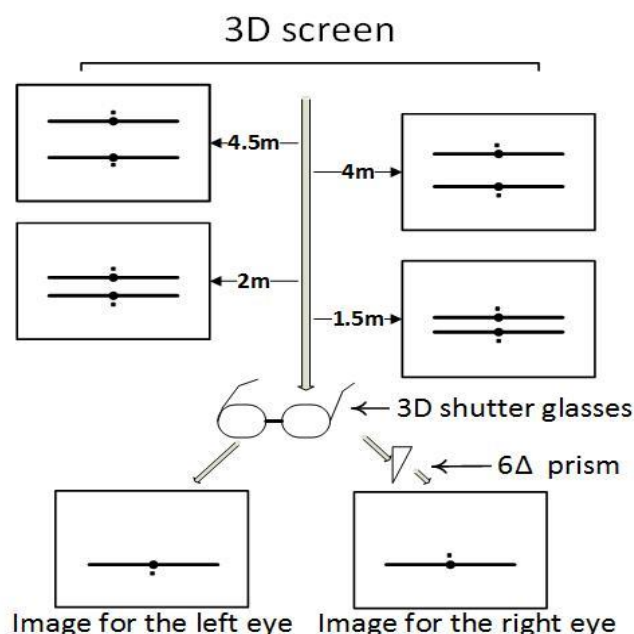

Figure 3.4 General experimental demonstrations.

We have defined the direction of image shift, as revealed in Fig. 3.5, if the image is shifted upward, it is represented by $+D$, D is the shifted distance, if the image moves downward, it is defined as $-D$.

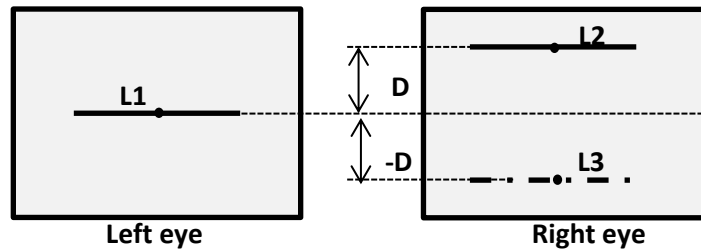

Figure 3.5 Image shift definition. When the right eye image is shifted upward, the direction is defined as positive, when it is shifted downward, the direction is given a negative sign. L1-L3 represent the lines on the image.

We chose Fig. 1a and Fig.1c as stimulus, other parameters are room lighting (light on / light off) and induced prisms values (0Δ , 2Δ , 4Δ , 6Δ). 0Δ here means there is no prism inserted in the 3D glasses, it is added here as a reference. A crossed parameter test was implemented, so the total trials were 16 ($2 \times 2 \times 4$), and the trial number was randomized. At the beginning of each trial, the right eye image was shifted upward by a certain distance, then, a corresponding base-up prism was inserted in the right eye of 3D glasses to make sure that subjects perceived zero disparity on the screen. Subjects were instructed to keep their eyes closed when the prism was inserted, when they opened their eyes, they would report if they perceived on the screen was a single image, if they perceived diplopia, the stimulus and inserted prism value would be noted in the experiment note. Subjects used a joystick to increase the vertical disparity of the stereo images until they perceived diplopia, the maximum vertical distance between the stereo images was recorded as VFA in central vision. The vertical disparity direction was right eye image over left eye image ($+D$). As it is proved in Bharadwaj work, the adaptation of the vertical vergence does not influence VFA significantly [57]. Here we do not consider the adaptation effect on vertical fusion.

3.3.2. Control test of Experiment 1

In experiment 1, there was an induced vertical disparity with a constant $-D$ direction in peripheral area. The vertical disparity direction in central area was $+D$ because the right eye image was shifted upward. Therefore, the vertical disparity direction in central region was opposite to the peripheral region. It is necessary to design a control test direction asymmetry effect of peripheral disparity on the central fusion.

In the control test, when subjects used the joystick to enlarge the vertical distance of the stereo images, right eye image was shifted downward after the disparity compensation in central screen, thus both central and peripheral disparities had the same direction (-D) (Fig. 3.6). The principle to record the VFA was the same as for Experiment 1. The test was carried out in a dark room and the stimulus image was the one of Fig. 3.1c.

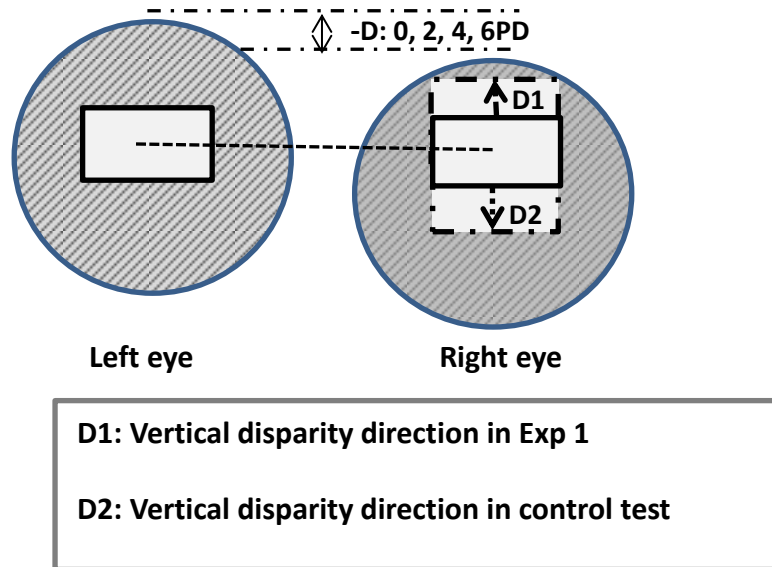

Figure 3.6 Demonstration of control test, in this test, the right eye image is downward shifted.

3.3.3. Experiment 2: Stimulus size effect on vertical disparity fusion.

This experiment dealt with the interaction of central and peripheral fusion as a function of stimulus size. The stimulus size here is defined as the vertical angle of up and bottom screen edge, corresponding to image size on the screen and the distance between subject and the screen.

A constant peripheral vertical disparity was induced by a base-up prism (6Δ) in front of the right eye, corresponding disparity compensation was made to assure zero disparity on central screen for subjects when they looked through the 3D glasses and inserted prism (Fig. 3.4). The viewing distance varied from 1.5m to 5m in a random order, with an interval of 0.5m between adjacent positions. The stimulus size on the retina corresponding to the each distance is shown in Table 3.3, the angle is calculated according to the object size on the images. Two stimuli were tested in this subsection (Fig. 1a, Fig. 1c). There were two sessions for this experiment, each session tested on stimulus image, the total trial number was 10 for the whole experiment. At the beginning of each trial, the right eye image was shifted upward for a certain distance, then subjects were moved to the corresponding viewing distance, where theoretical zero vertical

was achieved. For example, if the right eye image was shifted 18cm, because the prism inserted to the eyes is 6Δ , the viewing distance should be 3m. Subjects kept their eyes closed before they were ready on the right viewing position. When subject opened their eyes, they were instructed to tell if they perceived diplopia on the screen. A yes/no answers were recorded corresponding to the viewing distance. If subjects perceived diplopia, they should use a joystick to increase or decrease the vertical disparity on the screen until they could achieve single vision again. This value was recorded and defined as the peripheral fusion effort.

Table 3.2 Viewing angles at different distances

Viewing distance(m)	Single line picture (Fig. 1a)		Multiple lines picture(Fig. 1c)	
	Horizontal angle	Vertical angle	Horizontal angle	Vertical angle
1.5	27°	1.5°	46°	23°
2.0	20°	1.2°	36°	17°
2.5	16°	0.9°	29°	14°
3.0	14°	0.8°	24°	12°
3.5	12°	0.7°	21°	10°
4.0	10°	0.6°	18°	9°
4.5	9°	0.5°	16°	8°
5.0	8°	0.46°	15°	7°

3.4. Results and discussions

3.4.1. Peripheral induced vertical disparity effect on central VFA

Based on $2 \times 4 \times 2$ repeated ANOVA data (2 stimulus images, 4 inserted prism values and 2 lighting conditions), results show a **significant effects of target stimulus ($F(1, 15) = 17.856, P=0.0007$), induced prism values ($F(3,15)=5.376, P=0.003$). Lighting condition did not affect VFA significantly ($F(1, 15) = 1.083, P=0.3145$). The averaged VFA for each test condition is shown in Fig. 3.7. When the stimulus target of Fig. 3.1c has more complex contents than Fig. 3.1a, and VFA also increase with the complexity of target. When the prisms were inserted in front of one eye, the effect trend on MAE varies with stimulus images and room lighting.**

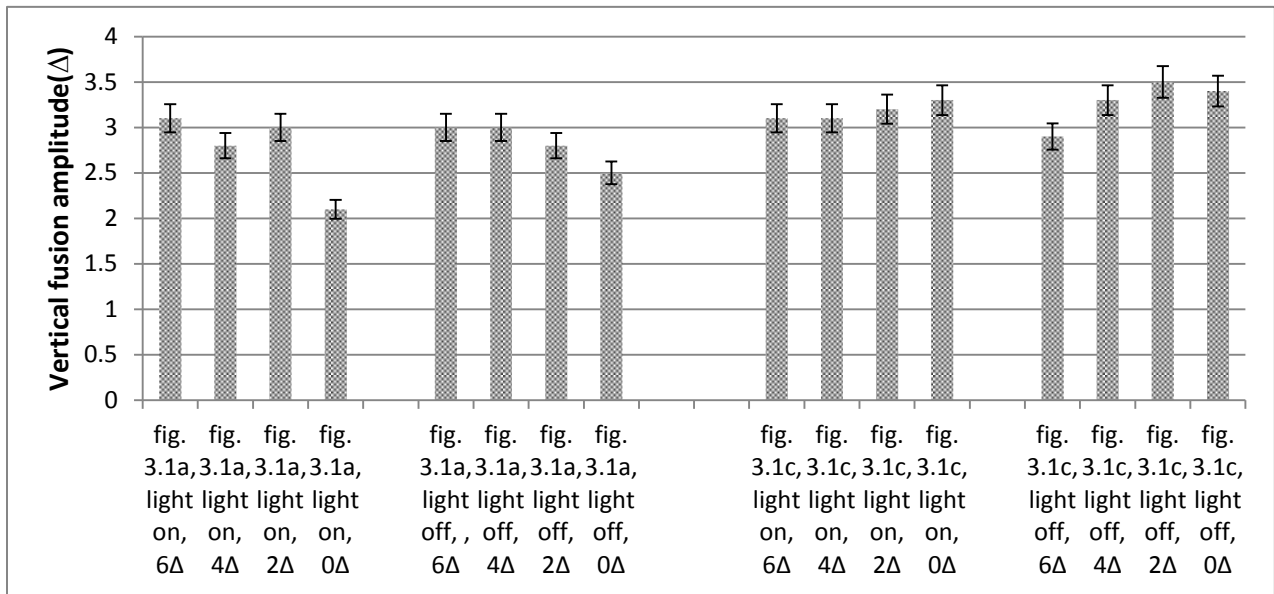

Figure 3.7 Averaged VFA for all subjects according to different parameters.

If we only consider the mean VFA under the condition of room lighting off, as is shown in Fig. 3.8, the solid line demonstrates the VFA variation trend when the stimulus image is a complex target, the dotted line reveals the trend when the stimulus is a simple target. Although the statistical analysis shows that the fusion capability is impacted by the prism value, particularly for 2 Δ, when we consider the difference between prisms (2Δ, 4Δ, and 6Δ) using Fisher PLSD test, the significance impact only exists between 2Δ and 0Δ, both for complex target and simple target. According to the literature, vertical fusion amplitude for induced prism is around 2-3 Δ [10]. When 4 Δ or larger disparities were induced in the periphery, our central fusion capability was impacted and vertical fusion amplitude started to decrease. Table 3.3 shows the measured vertical disparity amplitude in presence of reversed peripheral disparities, compared to what is expected, considering peripheral disparity does not affect the central fusion (called expected value in the table). Results show that reversed disparity in peripheral area improves our fusion capability in the central area, with an optimum around 2, and then decreases when the peripheral disparity increases, such as 4 Δ and 6 Δ. This effect of peripheral disparity on central fusion is not the same when the stimulus image has simple content, as shown by the dotted line, from 0Δ to 6Δ. Central VFA keeps increasing, however, this trend may be due to the limited range of peripheral disparity, if larger prism power was induced, VFA would decrease if we continue to increase prism value to more than 6Δ.

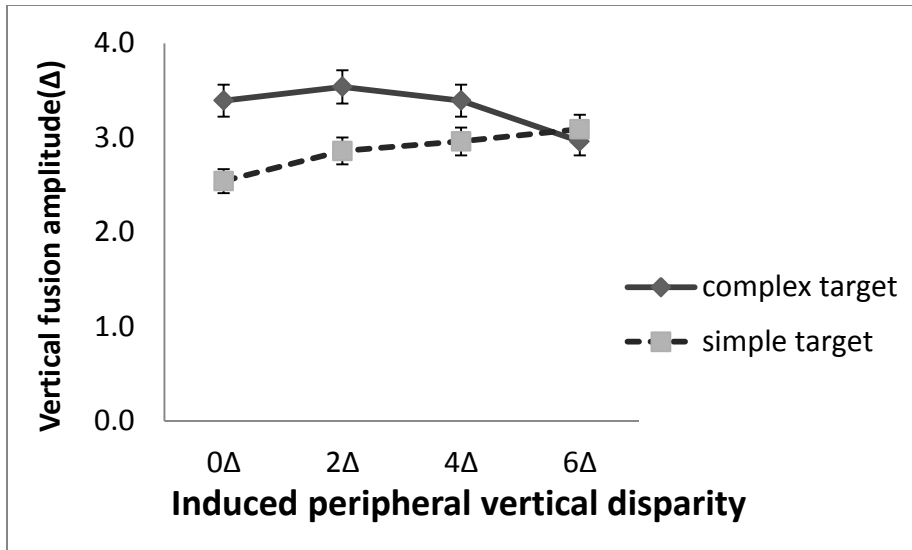

Figure 3.8 average VFA under different prism values when the room lighting is off.

Table 3.3 Comparison of vertical fusion amplitude with induced peripheral disparity.

reversed disparity	Measured value in central fusion (Δ)	Expected value without effect from peripheral disparity (Δ)	Increased ability due to reverse peripheral disparity (Δ)
0 Δ	2.82	2.82	0
2 Δ	5.13	4.82	0.31
4 Δ	7.03	6.82	0.21
6 Δ	9.01	8.82	0.19

3.4.2. Disparity direction effect on VFA

In the control test of experiment 1, VFA was measured when right eye image was shifted downward, the averaged results is indicated in Fig. 3.9, solid line. The averaged VFA in experiment 1 is also added in the figure for comparison. The stimulus condition is: Fig. 3.1c, light off. As it is revealed, when the vertical disparity in central and peripheral vision are downward, the effect from peripheral fusion has an opposite direction in the control test, compared with the case of experiment 1. From this results, first we can conclude that the binocular vision fusion was asymmetric, the VFA being significantly greater with L/R direction than with R/L direction, as shown in Fig. 3.9 at the point of 0 Δ . Kim reported the same trend in his study [51]. Second, when vertical disparity is induced in peripheral vision, central fusion will

be affected, and the impact has directional and there is a balance point, for complex target, the balance point is around 2-3 Δ .

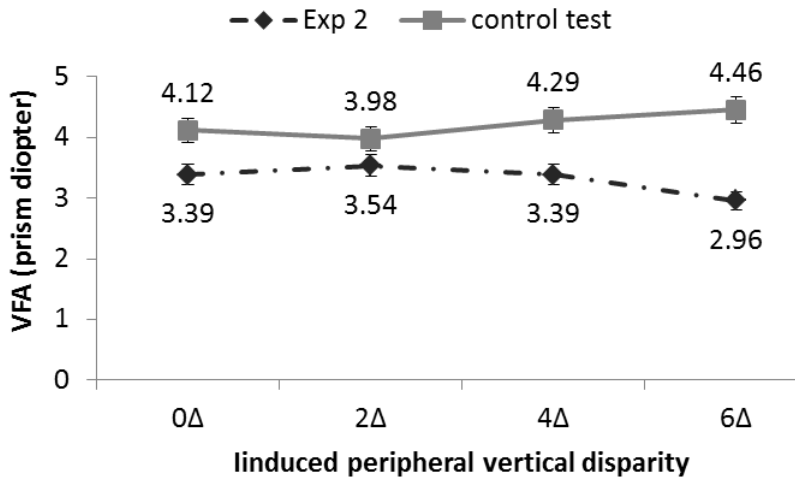

Figure 3.9 Averaged VFA when different prisms were induced.

In order to investigate peripheral induced vertical disparity effect on eye motion, we recorded the fusion process in Experiment 2 using an infrared eye tracker. One subject's record is shown in Fig. 3.10. The y-axis stands for the vertical pupil distance of right eye over left eye, the x-axis is the time since each trial started. When the induced peripheral disparity was 0 Δ , a continuous eye vergence occurred when vertical disparity increased. For 2 Δ induced peripheral disparity, the eye motion is similar as for the 0 Δ case. However, when a larger peripheral disparity is added, eye vergence is stimulated at the beginning of the test, the vertical distance between two pupil centres decreased from 0.02cm to -0.02cm for the case of 4 Δ induced prism and from 0.02 to -0.04cm for the case of 6 Δ induced prism. Meanwhile, the eye vergence becomes smaller during the whole fusion process, indicating that peripheral induced vertical disparity has a suppression effect on eye vergence.

In this experiment, VFA in central vision was measured with effect from induced peripheral disparity. Previous works just mentioned peripheral vertical disparity influence on the central fusion without identifying the effect of disparity direction [74]. Houtman indicated that the fusion ability decreases from fovea to periphery[76]. It has been a common knowledge that VFA increases with the enlargement of stimulus size, which further indicates the significant role of the peripheral fusion [54]. It is also mentioned in Howard work that eye vergence evoked by vertical disparity increases with larger eccentricity when the central stimulus is approximately

less than 20° [67]. Here, we induced the peripheral disparity by inserting prisms with quantitative values and specific directions instead of using large stimulus, which allowed an objective investigation on the interaction of central and peripheral fusion. It was surprising to explore that VFA had a slight increase when small peripheral disparity (2Δ) was induced. This may be due to the compensation of the peripheral disparity on central vertical disparity because the vertical disparity direction was opposite in central and peripheral regions. However, when larger peripheral vertical disparity was induced, it could be clearly observed in Fig. 3.10 that there is a drop of vertical distance between pupil centers at the beginning of the trial, which indicates an eye vergence was stimulated. However, the pupil vertical distance started to increase because larger central vertical disparity was created along with time of trial. In each figure of Fig. 3.10, there are slight fluctuations all along the eye movement measurements process, this is due to the eye-tracker we have used, it is a low-cost device and has limited precision.

Based on the previous eye motion analysis, we could come to the assumption that central vertical disparity could be compensated by small amount of peripheral disparity which results in larger VFA. But large peripheral vertical disparity will stimulate eye vergence, thus central fusion is affected. This assumption is confirmed in the control test, which indicates that when the peripheral disparity has the same direction with central disparity, the central fusion could not be compensated, and the VFA decreases under certain thresholds (2Δ). However, when peripheral disparity is large enough to invoke eye vergence, central fusion will benefit from this help from peripheral fusion to achieve a larger VFA.

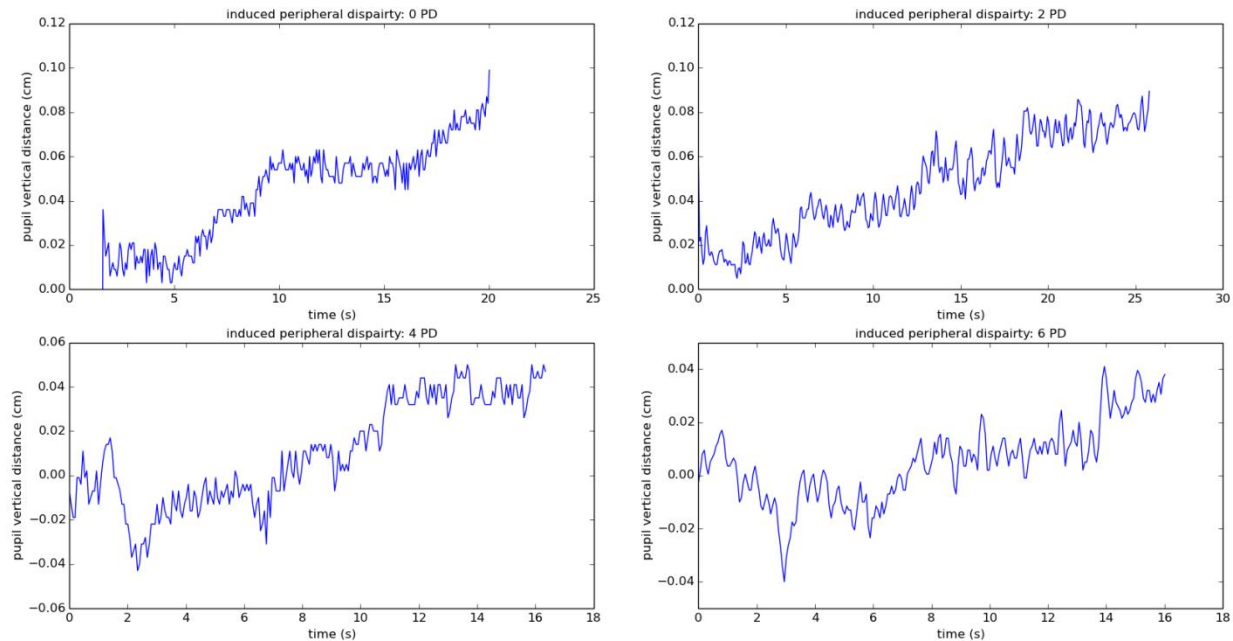

Figure 3.10 Vertical eye motion when 4 prisms were induced in peripheral retina: 0Δ , 2Δ , 4Δ , 6Δ . The x-axis is the vertical distance between pupil centers (cm), the y-axis is the time duration of the experiment from the beginning until diplopia is perceived.

Note for the choice of eye tracking: the reason to use eye-tracker is to verify the hypotheses and the results we have gotten. I only test 1 subject because I realized that it is necessary to use the eye movement data to verify the results when I was doing the data analysis, but this experiment lasts for a long time, most of the subjects are students in Telecom Bretagne, they left the school after the experiments. I only got one subjects still in my department. He is an professional subject for such experiment, so the data from him could be relatively stable. In order to address a large size of subjects, it is necessary to identify a protocol based on the preliminary results, to consolidate the hypothesis.

3.4.3. Stimulus size effect on VFA

First, we calculated the subject responses for the perception of central fusion on the screen when they were at different viewing distances, as demonstrated in Fig. 3.11. The y-axis stands for the percentage of subjects who perceived single vision for the stimulus on the screen. The x-axis represents different viewing distances.

All the subjects achieve stable fusion on central screen when the viewing distance is 1.5m, while the percentage decreases dramatically to less than 40% near the viewing distance of 3.5m. However, the percentage keeps relatively stable when subjects moved further from the screen.

The effect of viewing distance on central and peripheral fusion interaction was analyzed by χ^2 test. The results indicates that viewing distance affects central and peripheral fusion interaction significantly, both for simple target ($\chi^2=42.51$, $p<0.001$) and complex target ($\chi^2=32.97$, $p<0.001$). Moreover, the central fusion is related with target contents, as the central fusion proportion for complex target is almost always larger than for simple target, except at 2 m. However, this difference is not significantly according to t-test ($F(1,8) = 0.07$, $p = 0.1838$). Eye tracker measurement was also carried out in this experiment, but significant conclusion is not achieved.

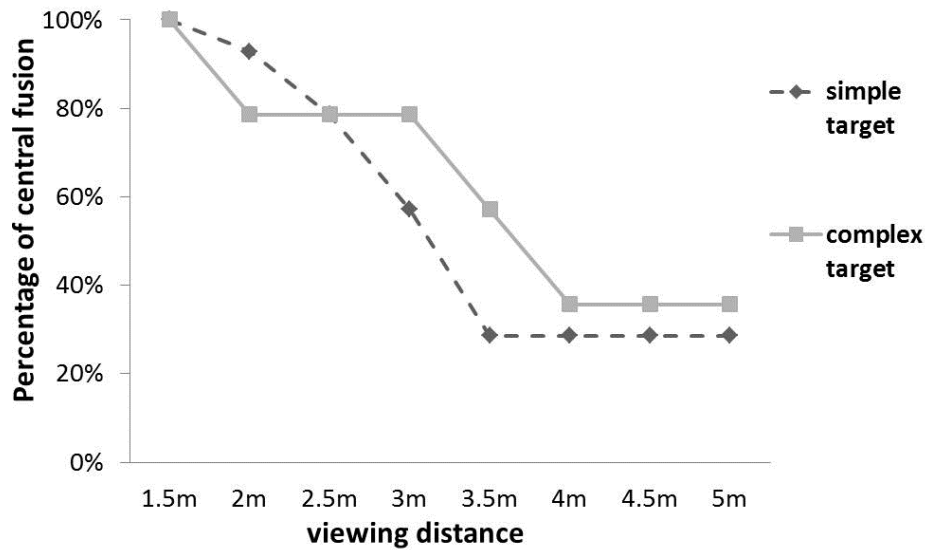

Figure 3.10 Averaged fusion ratios for all subjects as function of the viewing distance.

In order to demonstrate the trend of peripheral fusion effect in a more precise way, a modulation of the relationship between stimulus size and peripheral fusion effect was implemented. As mentioned before, the peripheral fusion effect is calculated by the shifted distance of the right eye image, when subjects perceived diplopia at certain viewing position.

Because of the obvious VFA individual, we made normalization before modulation. The calculation function is as following:

$$F_n = \frac{VFA_n}{VFA_{1.5}} \quad (1)$$

F_n stands for peripheral fusion effect at the distance of n ($n = 1.5, 2, 2.5, \dots$), VFA_n stands for the shifted prism diopter before subjects achieve single vision again at the distance of n , $VFA_{1.5}$

stands for Individual VFA on the central vision at 1.5 m with 6Δ prism induced in peripheral vision.

The curve of the modulation is shown in Fig. 3.12, the y-axis stands for the proportion of peripheral fusion effect and x-axis stands for stimulus size (°). For complex stimulus, since the central fusion is more efficient, a logistic function was implemented to fit the model:

$$F = \frac{b_0}{1 + e^{b_1 * s + b_2}} \quad (2)$$

F stands for the peripheral fusion effect, s is stimulus size, $\{b_0, b_1, b_2\} = \{0.57, 0.47, -8.94\}$. SSE = 1.28.

When the stimulus was simple content, we applied a linear regression to simulate the function of peripheral effort and stimulus size:

$$F = b_0 * s + b_1 \quad (3)$$

$\{b_0, b_1\} = \{0.0063, 0.25\}$. SSE = 2.43.

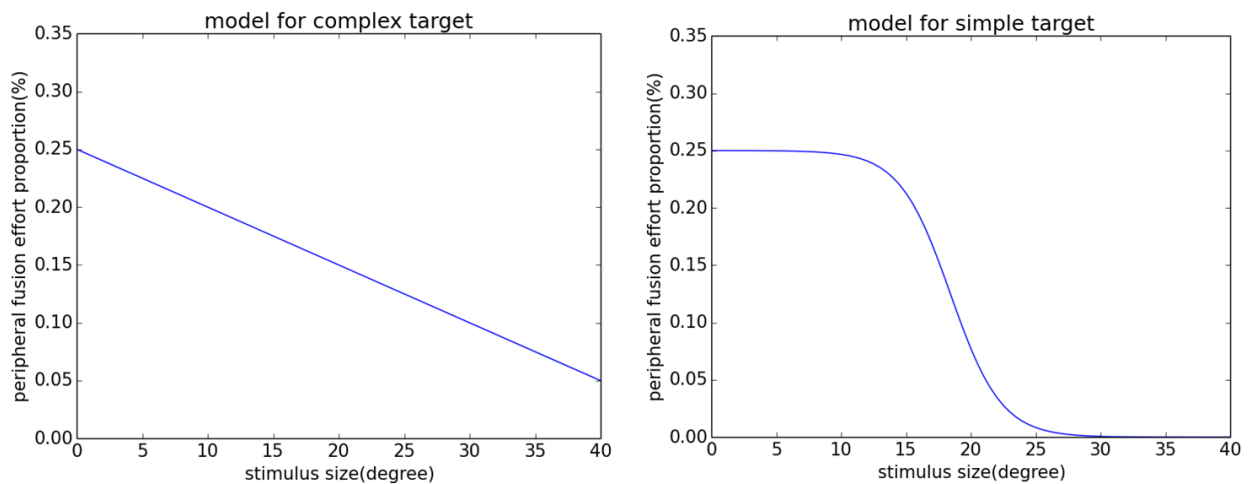

Figure 3.12 Fitted functions for peripheral fusion effect as a function of stimulus size.

The regression of peripheral fusion effect as a function of stimulus size gives a quantitative assessment of the interaction of central and peripheral fusion. Previous studies just give a general trend about how peripheral vision affect central vision, with the regressed curves, we can have a more precise understanding about how the trend varies with stimulus size. However, the interaction is also related with stimulus target. So when we analyze the interaction of central and peripheral vision, it is necessary to take stimulus size and target into consideration.

3.4.4. Individual difference for stimulus size effect on VFA

There is an obvious individual response difference for induced peripheral disparity. Among 14 subjects, nine subjects reported diplopia when viewing distance increased, the other five subjects perceived single vision at each location. For those who perceived diplopia, they shifted right eye image downward to achieve single vision again. To the best of our knowledge, no similar investigation has been done in previous studies, we assumed that vertical eye vergence was stimulated by increased effect from induced peripheral vertical disparity when subjects moved further from the screen. In our case, the peripheral real world was shifted downward by the prism, so the right eye was stimulated to vergence downward to achieve a single vision again, at this time, the retinal image of right eye which should be in the middle of retina is depicted on the bottom, if the eye vergence was too large, the retinal disparity of the right and left images resulted in diplopia in central vision. Therefore, subjects needed to shift the right image on the screen downward in order to reduce the retinal disparity. However, the interaction of central and peripheral vertical fusion was also related with target contents. In Fig.7a, when complex stimulus was depicted, central fusion was strongly evoked, the increase of peripheral fusion effort was relatively slow, since central fusion occupied a primary role in the fusion process. When the target was simple, less central retinal area was stimulated, the change of stimulus size resulted in a more intense peripheral fusion effort on the central fusion, thus generating a sharp curve from the stimulus size of 15° to 25°.

3.4.4. Eye dominance

In previous studies, it has been reported that eye dominance lead to asymmetry for vertical fusion amplitude. Matheron et al. have shown that the vergence combined with a prism of 2Δ is more appropriate on the dominant eye [78] In experiment 1, 14 subjects have right dominant eye while 2 subjects have left dominant eye. We calculated the VFA by the category of dominant eyes, as shown in Fig. 3.13, the stimulus condition is: image Fig. 3.1c and the room lighting off. Generally, the VFA for different side of dominant eyes are asymmetric, right eye dominated subjects tend to have larger VFA. Besides, the dominant eye is sensitive with prism induced disparities, if we compare the VFA difference between right and left eye dominant, the largest discrepancy exists in the case when 2Δ prism is inserted. However, a statistical conclusion is difficult to get due to the limited number of samples.

The vertical prism adaptation will not affect fusion amplitude as each trail was measured over a short period. Larger binocular vertical fusion amplitude was observed by Ogle and Prangen [79], for longer exposure to disparity. Our experiment controlled the disparity increased every

16.7ms and the measurement was taken immediately when subject felt diplopia, thus avoiding prism adaptation time.

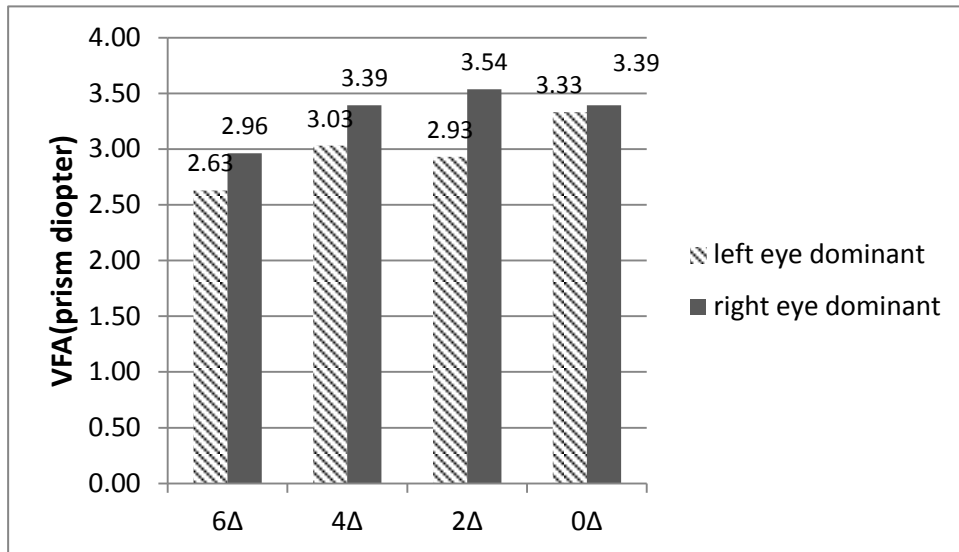

Figure 3.13 Mean value of vertical fusion capability for the dominant eye effect (with different value of induced prisms).

3.4.5. Questionnaire analysis

In addition to measurements, we have set up a questionnaire to analyze the subject feeling and acceptance. The questionnaire concerned experiment 1 only. The results is indicated in Table 3.4.

Table 3.4 statistical results of the questionnaire

Parameters (result)	Statistics at 3m viewing distance	Statistics at 1.5m viewing distance
Test difficulty (not difficult)	P<0.005, $\chi^2=9$	P<0.005, $\chi^2=16$
Lighting condition(prefer low lighting condition)	P<0.01, $\chi^2=7.143$	P<0.01, $\chi^2=7.14$
Stimulus background(prefer black background)	P<0. 1, $\chi^2=2.86$	P<0. 1, $\chi^2=2.57$
Stimulus complexity(prefer simple stimulus)	P<0. 1, $\chi^2=2.8$	P<0.005, $\chi^2=11.3$
Disparity velocity (not significant)		P=0.9, $\chi^2=3.849$

3.5. Conclusion

In this chapter, vertical fusion amplitude was measured on a 3D projector emulating an environment relatively closer to the reality. We observed a strong interaction between central and peripheral fusion during the experiment. The novelty of the study relies on the comprehensive exploration of the interaction between different retina regions in the vertical fusion process, which has been particularly highlighted by introducing a disparity offset on peripheral vision using a series of prisms. The experimental results confirm the dominant role of the central fusion. Thanks to more specific investigations on the interaction between central and peripheral fusion, **we observed that the impact of peripheral disparity on central fusion is direction dependent.** Moreover, the impact intensity is related to the value of induced peripheral disparity and stimulus size. By recording the eye movement by an eye tracker, we explored that large disparity over 4Δ in periphery can start to stimulate eye vergence. Consequently peripheral fusion influence on central fusion will be stronger when stimulus size is decreased. Distinct from previous studies, we made an objective assessment for the central and peripheral fusion, relatively precise value and trend was given in the results.

The conclusions should be taken into consideration when 3D viewing environment is set up in real life, because in a normal viewing condition, such as dining room or small cinema, there will be more interferences when we watch the TV, with objects hung closely to the screen, or other persons walking around, all these will affect the perception of peripheral vision. So it is necessary to know how and at which level the interaction between central and peripheral vision operations, in an environment that is relatively close to reality.

However, due to the limited types of stimulus (black and white lines), we did not explore enough details about image properties' effect on the interaction between central and peripheral fusion, such as image color, contrast and luminance. Besides, the dominant eye effect needs further confirmation after testing on larger sample size.

Chapter 4

Motion-in-depth perception

Table of contents

4.1. Introduction

- 4.1.1. Frame of Motion-in-depth perception
- 4.1.2. Research objective of the current study

4.2. Apparatus and subjects

- 4.2.1. 3D display platform
- 4.2.2. Haploscope
- 4.2.3. Eye tracker
- 4.2.4. Subjects

4.3. Investigation on sensory and oculomotor system interaction in motion-in-depth perception

4.3.1. Experiment protocols

- 4.3.1.1. Experiment 1
- 4.3.1.2. Experiment 2
- 4.3.1.3. Experiment 3

4.3.2. Data analysis

4.3.3. Results and discussions

- 4.3.3.1. A/V reflex in MID perception
- 4.3.3.2. Cortical stimulus in MID perception
- 4.3.3.3. The interaction of oculomotor system and sensory system in MID perception
- 4.3.3.4. The interaction between oculomotor system and sensory system in MID perception

4.4. Corrected experiments for sensory and oculomotor system interaction investigation in motion-in-depth perception

- 4.4.1. Experiment protocols
- 4.4.2. Results and discussions

4.5. Motion-in-depth perception training

- 4.5.1. Experiment stimulus and protocols
- 4.5.2. Experimental results
 - 4.5.2.1. Perceptual training effect on MID direction discrimination
 - 4.5.2.2. Perceptual training results retention
 - 4.5.2.3. Transitivity of perceptual training
- 4.5.3. Discussion

4.6. How to design motion-in-depth stimulus

- 4.6.1. Experiment stimulus
- 4.6.2. Experiment results

4.7. Conclusion

4.1. Introduction

4.1.1. Frame of Motion-in-depth perception

One of the restrictions of two-dimensional (2D) perception is the lack of depth information, including the information about object position in space, object moving direction and velocity etc. It is very important to have 3D perception, stereo vision deficiency will not only make the perception less vivid, it also rise some limitations for certain professions, such as a doctor doing a very precise surgery, or a driver driving a car in a very busy road, or even in our daily life, it will be difficult to put a thread through a needle without stereo vision, where a precise understanding of structural orientation is required. In spite of the limitations of the 2D perception, people have been trained or learnt to extract depth information from 2D images. Nevertheless, it is likely that an effective high definition of 3D display would improve depth perception, which is specifically important for some tasks that need high precision (e.g. surgery). Adding binocular vision through novel 3D imaging and display technology provides more cues which can better illuminate depth relationships, enhance the viewing experience and reduce mistakes for motion perception. However, in spite of these obvious advantages of stereoscopy, there are several drawbacks considering the current 3D display technology, such as the paucity of motion-in-depth (MID) perception and visual fatigue.

Generally, stereo vision is assessed by stereo acuity. Stereo acuity is one of the key attributes for completion of a fine detail static visual perception [80]. Good stereo acuity allows people to enjoy a more vivid observation in daily life. It is also widely used in clinical and laboratory experiments as a key parameter for binocular vision. Normally, stereo acuity is measured by several methods such as Randot and Contour stereo tests [81]. However, to our knowledge, these measurements are based on static stereopsis tests, which could not provide sufficient information on binocular vision capability. Normal static stereo acuity has been a general criterion for most physiological experiments without being considered whether it equals to good visual performance for dynamic stereopsis. Previous studies have been exploring the neural processing regions and mechanisms for dynamic and static stereopsis in human vision. In Regan's work, it is mentioned that static and dynamic disparities are processed by separated mechanisms. Subject who could answer normally to static disparity may have degraded performance with dynamic disparity or vice versa [82-84]. More recently, it is reported in Iwami's work that both dynamic and static stereopsis information are processed in dorsal parieto-occipital portion [85]. An assessment of MID perception of patients with strabismus was carried out by Watanabe to compare the dynamic stereopsis and static depth perception using a conventional stereo test, showing a low correlation in the threshold between stereo motion test and static stereo test [86]. Children with normal vision could perceive stereopsis in Handa's experiment for motion stimulation without changing binocular disparity, while patients

with strabismus showed different performance, indicating that target motion may have different effects on people with normal or abnormal vision [87]. Nevertheless, the relationship between stereo acuity and MID direction perception is not well determined, and the plasticity of MID perception remains to be investigated more deeply.

The depth perception could be improved by perceptual training. Perceptual training is a method to improve visual performance as a result of training or practice, there are many visual tasks that applied through perceptual learning: Vernier acuity, resolution acuity, orientation discrimination, motion direction discrimination, contrast discrimination, depth perception in random dot stereograms (RDS) etc. Liat et al has carried out an experiment to address the mechanisms that underlays the perceptual learning of depth discrimination in RDS, reporting that visual performance is significantly improved after a training process and the learning effects are retained over a period of six months. However, MID perception is a more complex process than the static depth perception, and it can be stimulated by various cues, it does not only require good visual acuity but also binocular cooperation and neural process and response, the perceptual training for motion-in-depth has not been fully explored.

The main purpose of stereoscopic technology is to stimulate the stereo vision by displaying all types of 3D media. In previous studies, the conditions that could stimulate motion-in-depth perception and the mechanisms that processes the information have been studied extensively [88-91]. Among all experimental stimuli, random-dot stereoscopic (RDS) and the dynamic random-dot stereoscopic (DRDS) have been widely implemented to study the visual perception of binocular disparity and motion-in-depth (MID) perception[33, 92-95]. All are efficient tools because extra sources of depth are elicited except stereograms disparity. However, stereo motion scotomas commonly occur during the perception process in many otherwise healthy observers, these impairments may be due to the characteristics of visual stimuli (target size, stimulus time, target density etc) [88, 96], the low sensitivity to motion-in-depth compared with the detection of static depth (Westheimer, 1990), the stereo motion blindness area [88] or sensory uncertainty[97]. Previous researches reported that motion-in-depth perceptual sensitivity was related to cues, stimulus contrast, motion speed, eye vergence and lateral motion [90, 98-100], most of the stimuli used are RDS covering the entire plane of motion in depth, DRDS where dots distributed at different positions in depth were rarely implemented. Czuba et al have used DRDS to assess the eccentricity and speed effect on motion-in-depth perception, but the observers were all experienced. How to achieve appropriate stimuli for naïve observers still needs specific investigations. Besides, observer eyes motion during the motion processing should be recorded to clarify where the fixation point is focused when observers perceive the DRDS motion.

In this chapter, we carried out a series of experiments to investigate different aspects about MID perception, including the MAE generated by MID stimulus, mitigating sensorial generated MAE by inducing oculomotor cue, the training of MID experiment for naïve subjects and how to create MID stimulus allowing better perception. We were expected to investigate the link between sensorial and oculomotor system for MID perception and achieve mitigation for accommodation/vergence conflict for conventional 3D technology based on the link. What's more, the sample size could be enlarged by training and implementing more appropriate MID stimulus, which will future consolidate similar MID experiments.

4.1.2. Research objective of the current study

There are two mechanisms to stimulate MID perception, one is sensorial system while the other one is the oculomotor system. The cues used in the two mechanisms are different, for sensorial system, disparity cues such as CD and IOVD are commonly used to generate MID perception. For oculomotor system, eye vergence and accommodation cues are used to perceive MID. In real life, both sensory and oculomotor systems are usually stimulated at the same time when we perceive MID information, the stimulation cues and neural process has been investigated by various studies. When watching 3D stereo, discrepancy will happen between both mechanisms, such as accommodation/vergence conflict. Therefore, our objective was to investigate the interaction between the two mechanisms, if a link exists when 3D stereo stimulate sensorial and oculomotor system, how does the one affect the other one.

However, we were curious to know if there is an interaction between the two mechanisms, if the link exists, how does one affect another one?

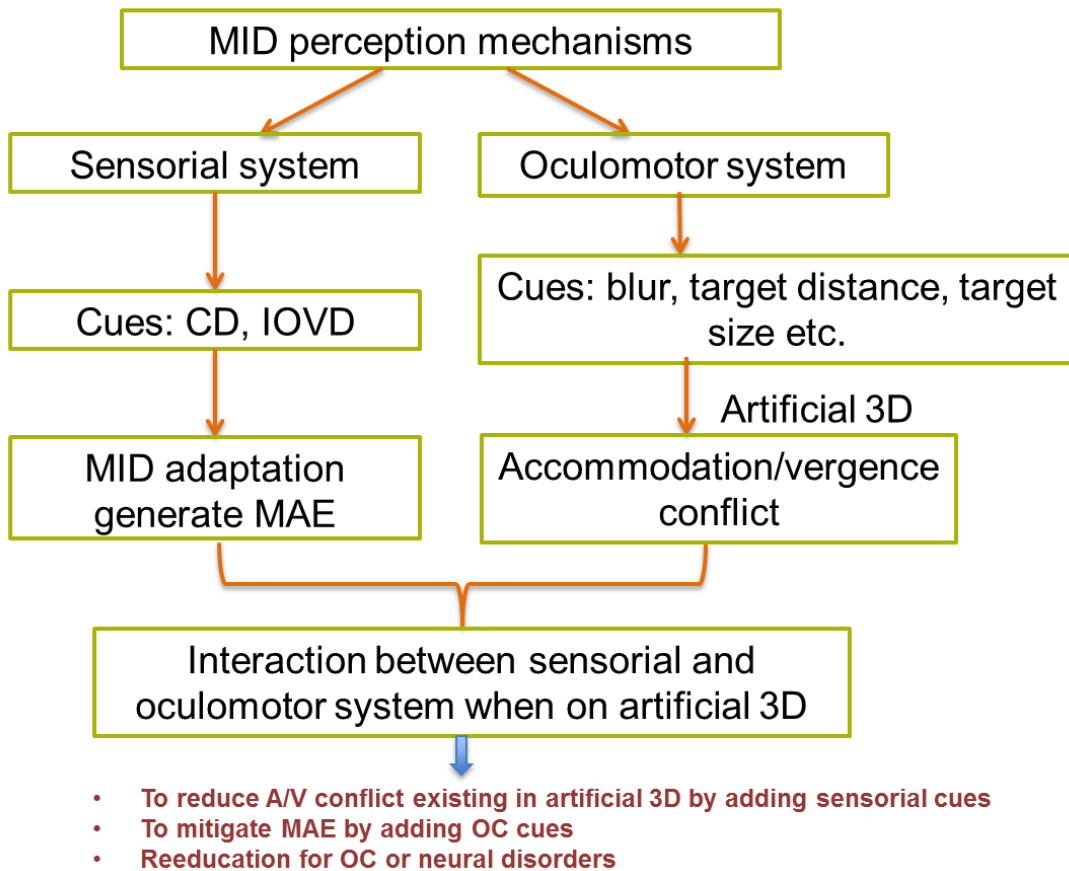

Figure 4.1 Research motivations for motion in depth perception.

By understanding the interaction between the two mechanisms, we were expected to reach the following aims:

- In real life, when both mechanisms are stimulated, the eyes and brain can cooperate well without inducing any conflict and visual fatigue, but in artificial 3D technology, a commonly known A/V conflict is a main issue for comfort viewing experience. In our study, we hypothesises that by adding some invisible RDS, the conflict could be mitigated.
- Motion aftereffect (MAE) is a vision adaptation to a consistent motion stimuli (e.g. waterfall illusion), because MAE has the opposite direction with the motion stimuli, it will reduce the experience of depth perception when we are viewing some 3D content. In our study, we supposed that by adding some oculomotor cues in the scene, this MAE could be mitigated.
- Since oculomotor response and sensorial information are processed by different part of the brain, we were expected to adapt our laboratory tests to some clinical diagnose measurement and visual disorder reeducations.

However, we have experienced and faced many difficulties when the experiments were carried out to investigate the research goals. At the very beginning of the thesis, we replicated the experiment of Czuba's study [38], in which he measured MAE using RDS stimulus, and he got significant MAE in the experiment. However, the protocol of Czuba's experiment is quite complex and there are many details that needed to be taken into consideration carefully. Due to limited experience of physiological experiment, we have experienced many difficulties to conduct the first experiment in order to get the same results as Czuba team. One of the difficulties is the unexperienced subjects, we neglected this point when we just started the experiments, all the subjects are naïve, when subjects have never participated such experiment, it is not an easy task for them to understand a complex protocol and give the correct answer. We were surprised to get a quite unobvious results compared with Czuba's paper, most of the answers given by the subjects were nearly random. They could not perceive motion-in-depth at all! After the unsuccessful experiment, we contacted with Czuba about the experiment details and this was quite helpful for the protocol understanding.

Although we have encountered many difficulties during the experiments, we were not discouraged and we thought the blocking points that existed during the experiments could also concern other scientists who want to make similar experiments, especially when they are not experienced enough. So we decided to simplify the experiment protocol and focus on the stimulus features determination. We believe that a simple and clever stimulus could progress the research smoothly with fruitful results, and we did explore some interesting phenomenon in later work.

After training the subjects, we repeated the experiments and finally got the similar results with Czuba's study. However, we have noticed many aspects that could have critical effect on MAE perception. One aspect is the subject selection and training, the individual difference for training effect was very large. Another aspect is the stimulus design, with the complex and difficult stimulus, only few subjects could perceive MID direction, but when we simplified the protocol and adapted the stimulus to normal subject (not professional), the performance was significantly improved. The third aspect is some additional stimulus features that could affect for MID perception, such as the design of reference object, the background texture etc.

In this chapter, I will describe the obstacles of the first experiments and the problem I have encountered during this period. Then, I will describe my investigations on the path of creating better MID stimulus, which will be helpful for new entrants in this physiological field and avoid them to face the same difficulties that I have to face.

4.2. Apparatus and subjects

4.2.1. 3D display platform

The 3D platform was made up of a 3D projector (NEC-U310W) and 3D active glasses. The custom-programmed software was written using VS2010 C# and OpenGL.

4.2.2. Haploscope

An haploscope is used to measure the convergence while stimulating accommodation and/or convergence. An additional optometer is required to measure the accommodation. The haploscope in our experiment is a loan from the IRBA [19], it allows the simultaneous measurement of the ratio AC/A and CA/C , which was not always the case with haploscopes used in the past[101](Fig. 4.2). Haploscope presents a target to each eye (binocular vision) by inserting the targets in the optical path of each arm. The image of the target is seen through the infrared transmission mirrors inclined at 45° . An accommodation arm contains a linear motorized axis to stimulate successively accommodation at different levels. The maximum speed of accommodative stimulation variation is 0.4 D/s for the accommodation arm. The resolution of the vergence arm measurement is less than 0.01° (0.003 or AM).

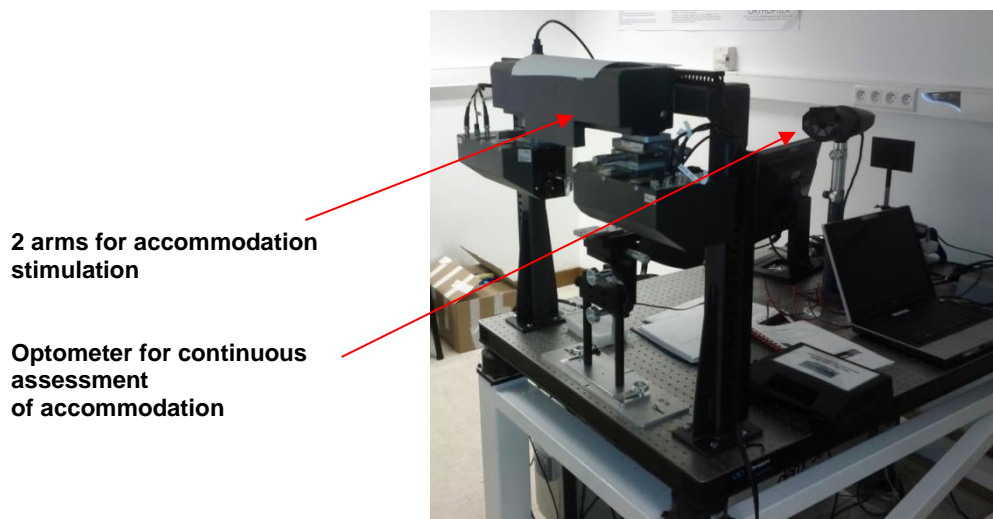

Figure 4.2 view of the haploscope from IRBA in our laboratory.

4.2.3. Eye tracker

We used an eye tracker to record eye movements. The Eye tracker works on the platform of FaceLAB, FaceLAB is a software package that uses a set of cameras as a passive measuring device. Images from the cameras are analyzed to work out characteristics of subjects' face, including the current position and orientation in 3D space, the gaze direction, binocular

vergence angle, visual fatigue and other measurements. The cameras are passive ones and they are the only measurement devices that FaceLAB uses, so subjects do not need to wear uncomfortable and restrictive glasses and other wires or sensing devices. Subjects can move around freely as long as their head is visible to both cameras. The observers eyes' are detected by an IR pod, between the two cameras (Fig. 4.3). The precision of the measurement is 0.1°.

The eye tracker has two tracking modes: precision mode and classic mode. In precision mode, the tracking is very accurate but depends on an IR source to cast a reflection in the subject's eyes. Because facelab tracks the position of the IR reflection to provide the accurate results, precision mode is effective when the light from the IR source is visible to the cameras and the reflection is seen within the correct region of the subject's eyes. This mode could be used in almost situations in practice. The classic mode works independently on IR illumination, it uses two pods placed low and wide with respect to the stereo-head. The control window of the eye tracker is shown in Fig. 4. The information about head position, eye direction and eye gaze are displayed in real time.

Since the eye tracking is based on the IR reflection, and there are angle requirements for the cameras and subjects eyes, we have faced a lot of problems when subjects are wearing 3D glasses: sometimes the iris is blocked by the spectacles frame; sometimes the 3D glasses have some synchronizing problems and one of the views is blocked; some subjects have very short inter pupil distance, and this lead to difficulties for the eye tracker software to estimate eye positions. In the experiments, all these conditions needed to be taken into account and reach a final agreement by some compromise. The eye tracker needed to be configured each time in the experiment according to the subjects own condition (height, siting position, inter-pupil distance etc.). The sample rate of the eye tracker is 60Hz.

a)



b)

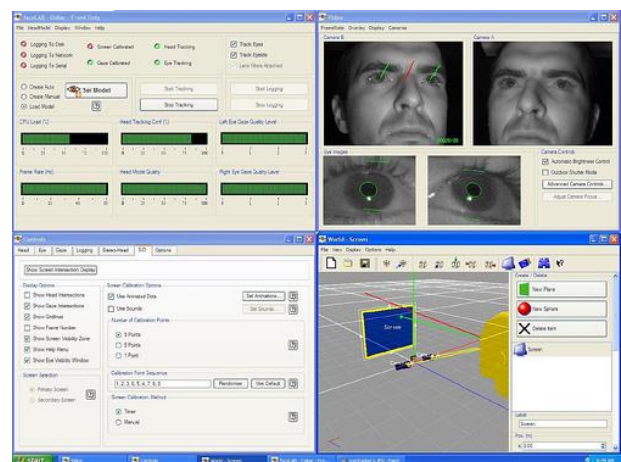

Figure 4.3 a) 3D display platform and eye-tracker. b) The control software of the eye-tracker, the tracking accuracy and head motion are displayed in real time.

4.2.4. Subjects

Fifteen subjects with an average age of 25.36 ± 4.62 years were recruited (six females and nine males, all right-dominant eyes). All subjects were naïve to the experimental procedures and informed about the nature of the study. Approval for the publication of subject data was obtained from Brest University Hospital institutional review board, according to the tenets of the Declaration of Helsinki. The inclusion criteria are the same as explained in Chapter 3.

4.3. Investigation on sensory and oculomotor system interaction in motion-in-depth perception

In this subsection, I am going to explain the original aims of the work concerning motion-in-depth perception investigation. Since MID perception could be both stimulated by sensory and oculomotor system information, and there exists A/V conflict in oculomotor system MID is stimulated by artificial 3D stereo. We aimed at investigate the interaction of sensory and oculomotor systems, by better understanding the link between the two MID perception mechanisms, we expected to mitigate A/V conflict by adding sensorial cues, or to mitigate MAE by adding oculomotor cues, as explained in Fig. 4.1.

There are three experiments in this part, the first experiment measured the accommodation/vergence changes after oculomotor stimulus. The second experiment replicated an experiment of Czuba to measure the MAE after IOVD stimulus cue. The third experiment aims at mitigate MAE by adding an oculomotor cue (dynamic cross).

4.3.1. Experiment protocols

There are three experiments in this part, the stimulus for each experiment is shown in Fig. 4.4. In the first two experiments, MID perception is measured separately according to the channel of accommodation and vergence reflex stimulus and cortical stimulus (disparity cue). In the last experiment, the two mechanisms stimulus was combined to investigate the interaction effect on MID perception. Motion aftereffect served as an indicator in this part to evaluate the MID perception strength. We have encountered a lot of difficulties in these experiments. There are also some duplicated problems in the protocol, I will explain them in detail along with the results and discussions.

A&V versus CD&IOVD

Investigation of different channels for 3D motion perception (MID).

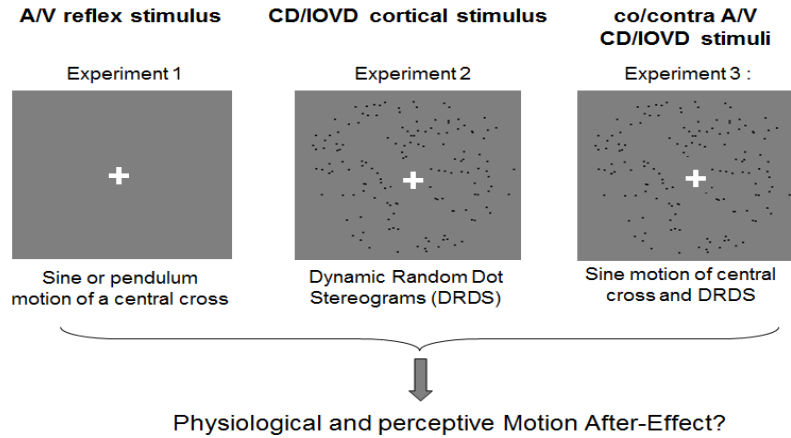

Figure 4.4 Demonstrations for Experiment 1-3.

4.3.1.1. Experiment 1

Stimulus: In this experiment, a cross is drawn on a gray background on each view for both eyes, and the 3D content was viewed through 3D active glasses, with a high contrast ratio (Srivastava, A.K. et al., 2010). 9 subjects were exposed to 23 min of a moving cross followed by 1 min of fixation on a stable cross. Subjects were instructed to discriminate the cross motion direction in depth during the 24 min of exposure. Viewing distance: 0.67m. Amplitude of cross motion in depth is 0.12 m (vergence demands ranged in virtual space between 4.23° to 7.84° (1.14 to 2.14 AM or ± 0.2 m). Oculomotor system tend are assessed by the haploscope. The questionnaire concerning occurrence, duration etc. of diplopia was proposed to all subjects at the end of the experiment (Appendix B). **This part experiment has been carried out by my colleague Yulia Fattakhova [102], I added this experiment here to make the whole content consistent.**

Cross motion: The cross was associated to an exposure based on the studies of Neveu et al. and Eadie et al.[103, 104]. The aim of this exposure was to create the absolute disparity changes and a considerable mismatch between accommodation and vergence, as it was the case which produces the largest oculomotor adaptation[19]. It is also well known that the cross as a visual target for the stereoscopic exposure is associated with dissociation of accommodation and convergence. The characteristics of the cross were chosen specifically to continuously stimulate accommodation and fusion. The binocular disparities varied according to the equation (4.1):

$$2\arctan\left(\frac{IOD*a*\sin(\omega t)}{0.7*(0.7+a*\sin(\omega t))}\right) \quad (4.1)$$

where «IOD» is the inter-ocular distance of the observer, a – amplitude of sine(0.12m) and ω the pulse of the sine function which is $2\pi F$, where « F » is frequency of sinusoidal oscillations (0.25Hz). These parameters were adjusted from the previous studies in order to facilitate achievement of the visual task.

Subjects were instructed to use a joystick to answer the cross motion they had perceived after a sound signal in each 5 seconds.

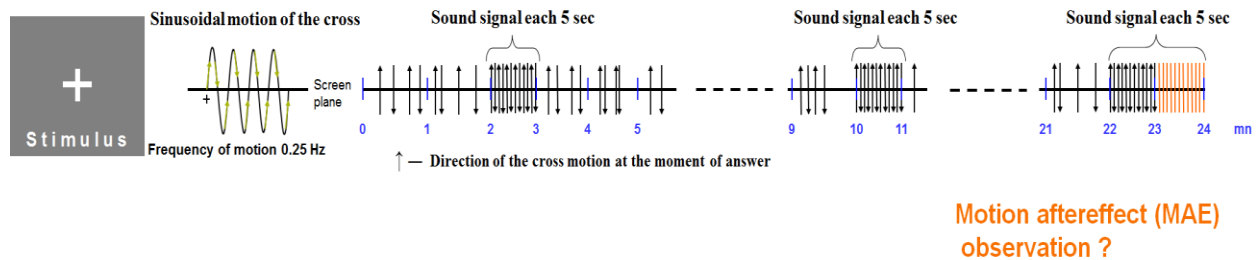

Figure 4.5 Demonstration of cross motion as a function of time.

4.3.1.2. Experiment 2

3 subjects were selected to do this experiment. They have been successfully trained during the experiments to insure high accuracy. The cross was stable during the experiment in this part, it served as a fixation object.

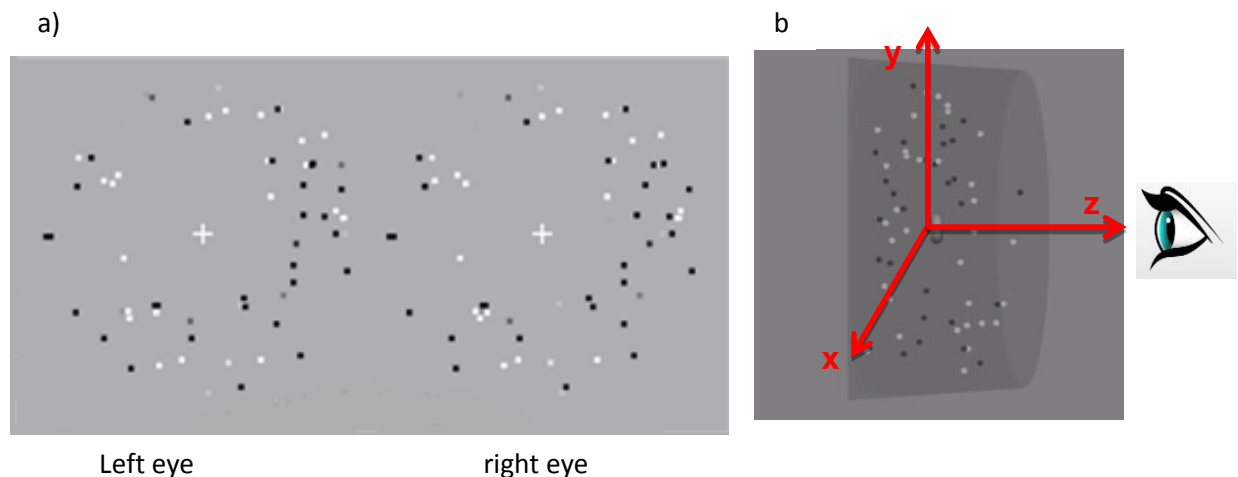

Figure 4.6 a) Stimulus for the binocular view; b) Side view of the stimulus when subject looks through the 3D glasses.

General stimulus: In each frame, 80 random-dot stereograms (RDS) were displayed on the screen. Each RDS with grey background (164 cd/m^2) contained 80 dots: half of the dots were white (392 cd/m^2) and the rest were dark (6.9 cd/m^2). Each dot had a 9 arcmin angular size. Anti-aliasing was done for achievement of pixel position accuracy. The dots were moving within the

$\pm 0.6^\circ$ disparity volume. Radiuses of the internal and external fields of RDS view were 3° and 7° , respectively. During the whole exposure time of the stimuli, observers were asked to fixate on the white cross in the middle of the RDS with a subtending angle of 24 arcmin and a thickness of 4.8 arcmin.

There were two kinds of dots composing the 80 dots: signal dots and noise dots. Each signal dot had the same monocular velocity of $0.6^\circ/\text{s}$, a randomly chosen motion direction during each trial: toward or away from observer. For the signal dots, they were assigned random positions in depth within stimulus volume ($\pm 0.6^\circ$) and dot lifetimes within range 0-250ms (Czuba et al., 2011). The two requirements for replacement of each signal dot to its new randomly chosen MID position were introduced: (1) as soon as lifetime is equal to or more than 250ms, (2) if the signal dot reaches one of the borders ($\pm 0.6^\circ$). After the relocation, the same direction of motion and speed were assigned, but the new initial lifetime was equal to 250ms. For the noise dots, they were assigned a random MID position and lifetime which ranges from 1 to 12 frames (16.7 to 200 ms) from a reversed-squared distribution (see details in Czuba et al., 2010). The conditions for relocation of noise dots were the same as for the signal dots. The noise dots' MID direction is randomly given (toward or away from observer). In addition, we implemented the linear changing of the contrast from 100% to 0% "visible" color of all dots (signal and noise) on the grey background. Within the volume all dots were 100% "visible" and on the border we artificially "increased" the stimulus volume up to $\pm 0.9^\circ$, i.e. we added $\pm 0.3^\circ$ to initial volume and within this part of stimulus volume we changed the contrast. This allows smoother motions and therefore facilitates performance of the direction discrimination task.

There are 3 sessions in experiment 2: un-adapted test, adaptation toward test (the RDS motion direction is toward the subject during adaptation stimulus), and adaptation away test (the RDS motion direction is away from the subject during adaptation stimulus).

Un-adapted test: in each trial, there is a sequence of 1.25 s of inter-stimulus interval (ISI) (gray screen without RDS), a 1s test stimulus (binocularly correlated RDS with 6 different coherence levels: $\pm 5, 30, 50\%$), and a 1.25 s ISI. Coherence level means the signal dots ratio among the whole RDS stimulus. The sign "+" corresponds to the motion-toward signal dots, while "-" corresponding to the motion-away signal dots. The observers had to give their answers during 1s of test stimulus or the 1.25 second ISI. Each coherence level was tested 15 times, so the total trial number was 90, the trial order was randomized.

The composition of 1 trial is shown in the following:

- 1 trial in un-adapted test
- Inter-stimulus interval 1.25 s (noise),
 - 1 s of test stimulus
 - Inter-stimulus interval 1.25s

The adaptation toward test and adaptation away test were similar to each other, except for the adaptation stimulus direction. In the adaptation sessions, for 1 trial, the sequence was: 4s IOVD adaptation (binocularly anti-correlated RDS, black dot pairs with white dot) (Fig. 4.7a top image), 1.25 s of ISI, 1 s of test stimulus (Fig. 4.7a bottom image), and 1.25 s of ISI. 100s of initial IOVD adaptation was displayed at the very beginning of the test. In each trial, observers had to the motion direction they have perceived during 1 s of test stimulus or 1.25 s of ISI (Fig. 4.7b). The 1.25 s ISI and 1 s test stimulus were the same with the un-adapted session, except that we increased the number of coherence levels up to ten ($\pm 5, 30, 50, 80, 95\%$). There are 15 trials for each coherence level, so the total trial number was 150. For simplification of the IOVD cue motion perception, the 4-quadrant planar technique was implemented for adaptation part (see Czuba et al., 2011).

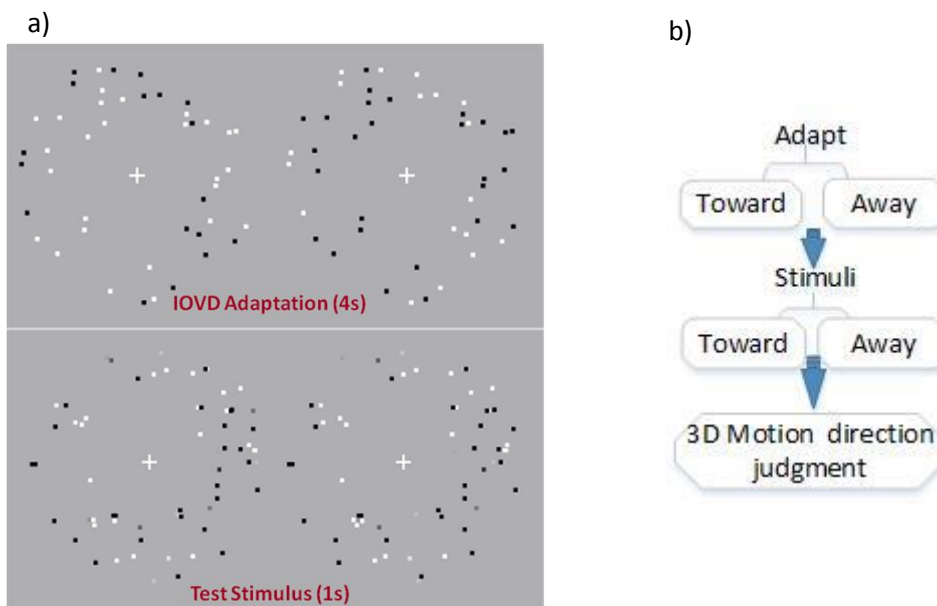

Figure 4.7 a) Example of 4s adaptation and 1s test stimulus during one trial. b) Adaptation session schedule in 1 trial.

4.3.1.3. Experiment 3

This experiment protocols were similar with experiment 2, three sessions were involved in the experiment (un-adapted test, adaptation toward test and adaptation away test). The only

difference was that the cross in the centre of the screen was given a cosine motion in depth during the three test, and manipulation of cross motion was the same as it is explained in experiment 1. Fig. 4.8 demonstrates the relative motion of the cross and RDS in depth during 4s adaptation in one trial.

In un-adapted test, there were 16 trials for each coherence level. We increased the number of trials per coherence level in order to coordinate with the dynamic cross motion. For the same coherence level, there were 8 trials for cross moving toward and 8 trials for cross moving away. The total trial number was 96. **In the adaptation tests**, there were also 16 trials for each coherence level, half of the trials for cross motion toward, half for motion away. The each adaptation test lasted 20 minutes. Fig. 4.8 reveals the motion of cross and RDS during the 4s adaptation.

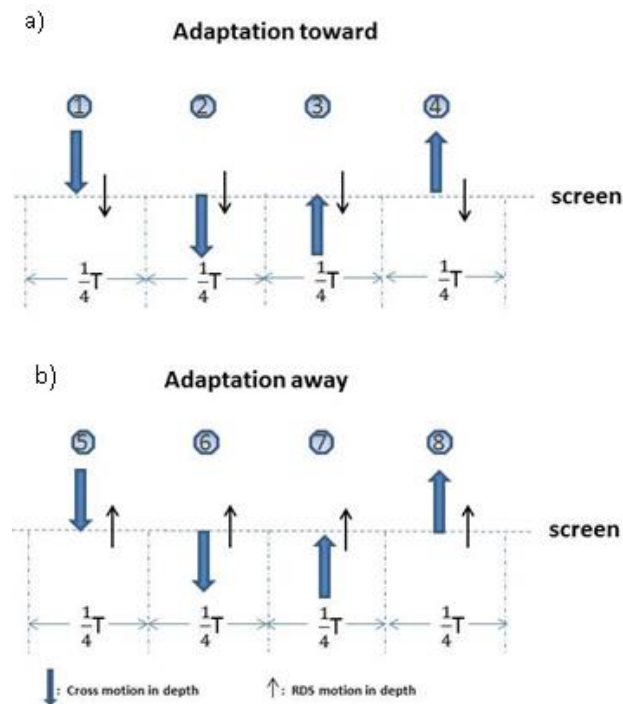

Figure 4.8 The relative disparity of cross and RDS during 4s adaptation. a) 4 relative positions in depth of the cross and RDS during 4s adaptation motion-toward. b) 4 relative positions in depth of the cross and RDS during 4s adaptation motion-away.

4.3.2. Data analysis

We use psychometric function to analysis the data, it is a conventional method applied in detection and discrimination tasks. To fit the psychometric function, we used Psignifit Toolbox 3.0 for Python 2.7[37]. Bootstrap was applied to fit the Psychometric Function (PF). The following logistic function was used:

$$F_L(x; \alpha, \beta) = \frac{1}{1 + \exp\left(-\frac{x - \alpha}{\beta}\right)} \quad (4.2)$$

Where $x \in (-\infty, +\infty)$, $\alpha \in (-\infty, +\infty)$, $\beta \in (-\infty, +\infty)$, α corresponds to the threshold: $F_L(x = \alpha; \alpha, \beta) = 0.5$, it determines the overall position of the curve along the abscissa. For the logistic function, corresponds to the contrast value at which the correct proportion is halfway between the lower and upper asymptote. Parameter β determines the slope of the PF. Output data of each observer for further analysis represented the correspondence of percentage of answers “toward” (ordinate axis) to each coherence level (abscissa axis).

Plotted psychometric functions correspond to the average fit parameters which were collected across three fitted functions for each subject. Goodness-of-fit assessment was applied to evaluate how well the fitting function performed in representing the raw data. Thus, 2000 repetitions of the experiment resampling were created based on the logistic parameters from the fitted function, bootstrapped confidence intervals were computed to describe the estimation of these logistic parameters. The MAE magnitude was defined by the shift from 0% coherence level to the equivalent “toward” answers proportion (threshold is equal 0.5), where corresponding coherence level on the abscissa axis represented the number of sufficient signal dots for compensation of generated MAE (Blake & Hiris, 1993). Then we combined the data across all observers for each test, computed the average proportion of answers “toward” and plotted the psychometric functions.

4.3.3. Results and discussions

4.3.3.1. A/V reflex in MID perception

In experiment 1, we have measured the A/V reflex by comparing the V/A changes before and after an oculomotor stimulus (dynamic cross).

Concerning the results for questionnaire in the experiment, a majority of subjects ($p = 0.0196$, $\chi^2 = 5.4444$) had diplopia during less than 30% time of experiment ($p = 0.0015$, $\chi^2 = 15.373$) especially in the case when the eye make divergence movement ($p = 0.0265$, $\chi^2 = 9.2222$). The period of the test (beginning/middle/end) had not influence on the diplopia occurrence ($p = 0.3679$, $\chi^2 = 2$) and test complexity is also insignificant ($p = 0.7389$, $\chi^2 = 0.1111$).

During the experiment, the correct answer for cross motion decrease with time (Fig. 4.9a), but no MAE could be observed after 23mins of stimulation. The experimental data shows that crosslink between accommodation and vergence was changed by prolonged oculomotor system stimulation displayed on stereoscopic displays (Fig. 4.9b-e). The changes of AC/A and CA/C ratio was similar to A.S. Eadie et al. [104]. Besides, similar tendency of oculomotor system and diplopia appearance can be found in work of P. Neveu [19]. However, the difference

between pre-stimulus and post-stimulus were not statistically significant, this may be due to relatively small amplitude of cross motion and short exposure time.

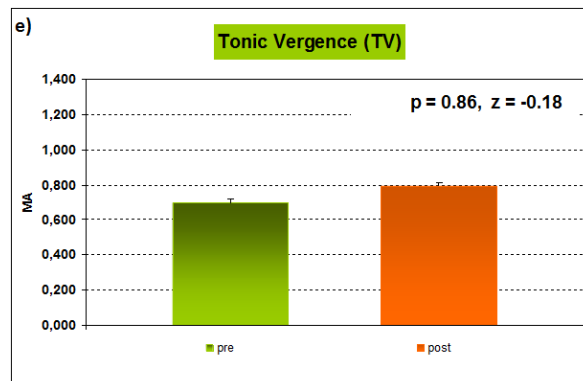
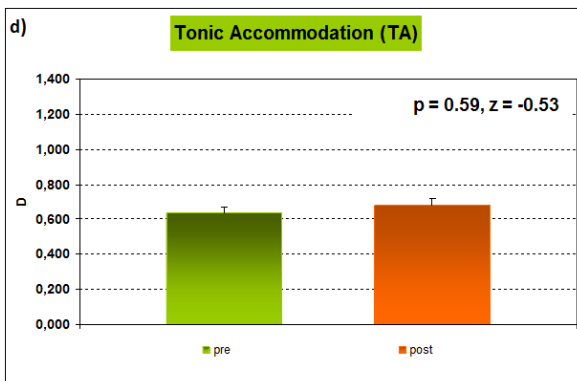
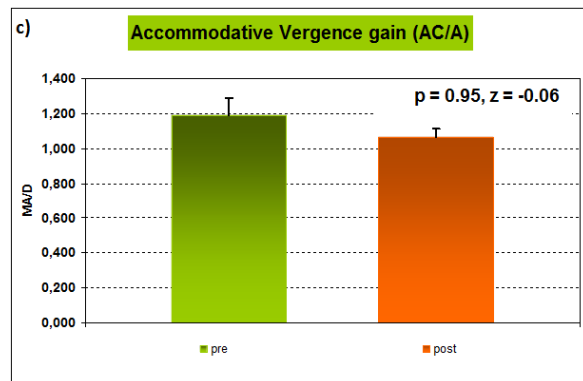
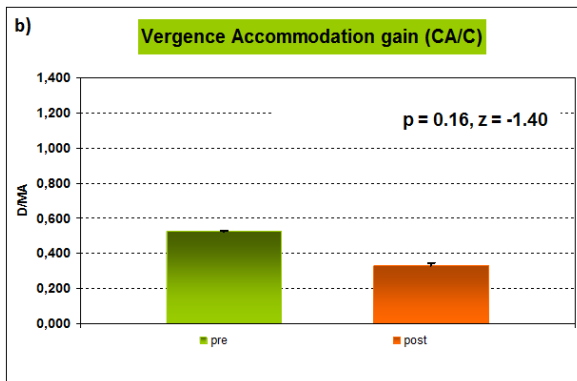
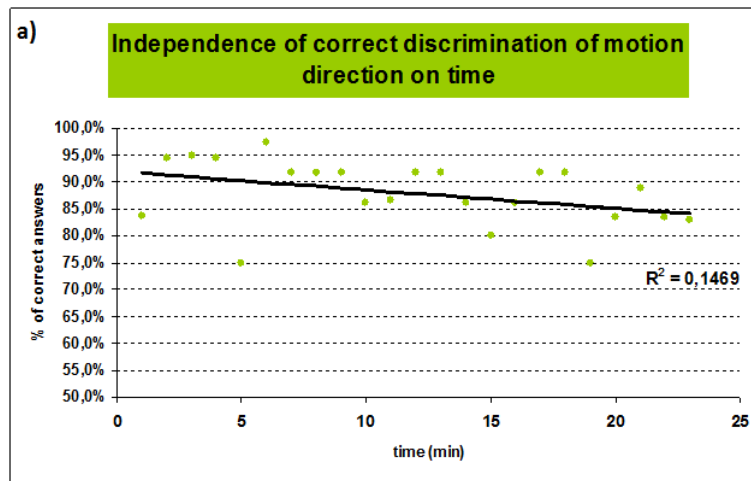

Figure 4.9 a) Cross motion direction discrimination during the experiment; b-e) oculomotor system change between pre-stimulus and post-stimulus.

4.3.3.2. Asymmetrical MID direction sensitivity for motion-toward and motion-away

In the un-adapted test of experiment 2, we observed an obvious sensitivity bias for the motion-

in-depth direction from the observers. Fig. 4.10 illustrates the correct motion discrimination as a function of coherence level. The red line with squares stands for the subjects' performance for motion-away detection, while the black line with points represents the direction discrimination of motion toward. We could find that motion-toward is easier to be perceived comparing to motion-away, and the statistical analysis indicated that the difference between subjects' sensitivity to motion-toward and motion-away was significant ($t = 1.866$, $p = 0.0026$).

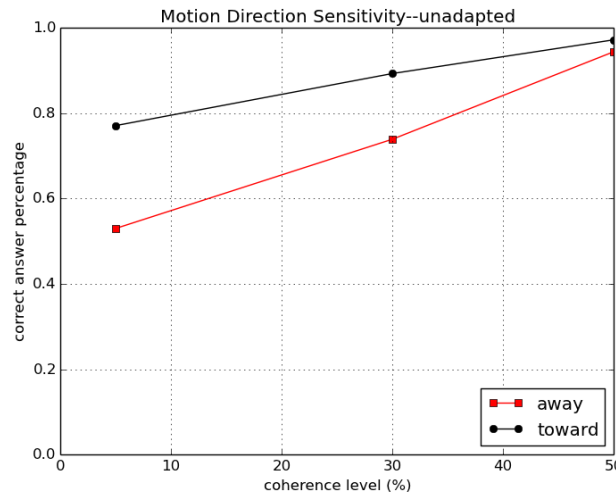

Figure 4.10 MID direction sensitivity for the motion-toward and motion-away.

One should notice that the sensitivity bias is related to the coherence level. The difference was no longer obvious when the coherence level was increased. The result is in accordance with the conclusions of prior explorations. Pardo Mustillo observed that the visual system is more sensitive to discriminate the targets with crossed disparity than targets with uncrossed disparity[105]. Other research also pointed out that the human visual system sensitivity is not asymmetrical for object which changes in two opposite aspects. In the research of Shirai, it is proved that expanding convex circles (which create the impression of approaching objects) is easier to be perceived than other changement of the object, which is related to luminance of the target [106].

4.3.3.3. Existence of MAE on real 3D display and its bias for adaptation directions

Compared with the previous result from Czuba [38], our results in experiment 2 confirmed that MAE can be generated by the adaptation to IOVD cue (Fig. 4.11). The values on the x-axis represent the coherence level, and the values on y-axis are the motion-toward answers percentage.

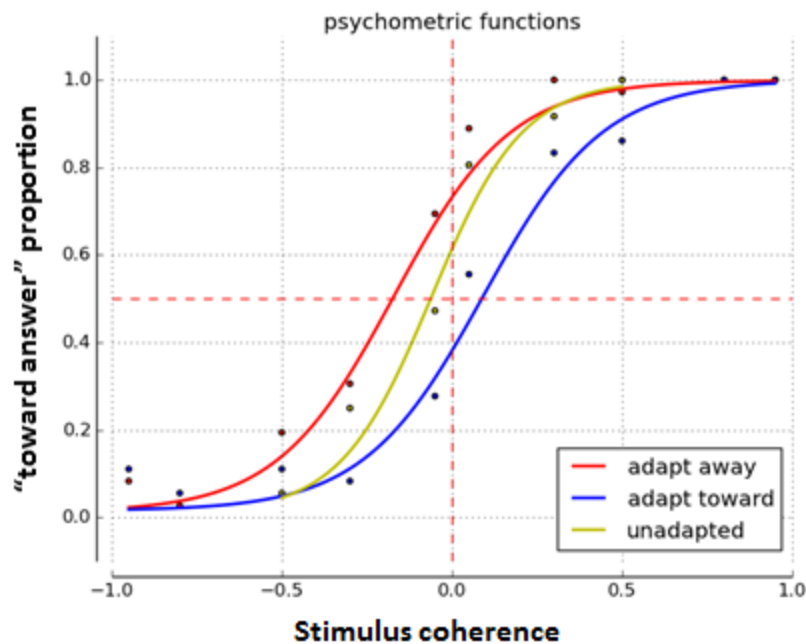

Figure 4.11 Fitted psychometric functions (logistic functions) as a function of coherence of the test stimulus (x axis) and the toward answer percentage (y axis). The “+” and “-“ on x-axis stands for the signal motion direction, “+” means signal dots moving toward observer while “-“ means signal dots moving away from the observer. Same applies for Fig. 4.12-4.14. Green curve corresponds to un-adapted test, blue for adaptation motion-toward, and red for motion-away. The point of subjective equality is fixed at a 0.5 threshold.

The green curve shows a logistic fit to the responses of subjects during the un-adapted test, i.e. pure motion direction discrimination. The sensitivity is $\beta^{-1} = 0.168$ CI95 = [0.095, 0.259]. This curve supposes having a point of subjective equality (PSE) at zero on abscissa axis, which corresponds 0.5 at y-axis. However, there is a shift to the left ($\alpha = -0.072$, CI95 = [-0.154, 0.135]), which due to the sensitivity for motion-in-depth direction, as explained before. Nevertheless, we considered the green curve as a reference curve.

For the motion-toward adaptation (Fig.4.11; blue curve; $\alpha = 0.105$, CI95 = [-0.016, 0.218]; $\beta^{-1} = 0.138$ (CI95 = [0.075, 0.199]), the psychometric function shift from the left to the right due to MAE generated by 4s IOVD adaptation is about 17% motion coherence. The red curve in Fig.4.11 represents the PF in case of adaptation “away” ($\alpha = -0.171$, CI95 = [-0.289, 0.108]; $\beta^{-1} = 0.177$ CI95 = [0.096, 0.249]). The leftward shift is about 10% motion coherence. Our results indicated that the shift of the psychometric functions was asymmetrical based on the adaptation direction. When the adaptation stimuli direction was “toward”, the generated MAE was larger (17%) than the case of stimuli “away” (10%). This meant that motion-toward

adaptation could generate stronger MAE. Our result was different to the Czuba conclusion (2011), which reported a larger shift and a symmetrical shift between two stimuli cases.

4.3.3.4. The interaction between oculomotor system and sensory system in MID perception

First of all we confirmed our hypothesis that the oculomotor cue did affect the MID perception. Here we compared the un-adapted tests in experiment 2 and experiment 3. The green curve is the fitted logistic functions in case of the stable cross (experiment 2), red curve stands for cross moving away (experiment 3) and cross moving toward (experiment 3). By comparing the green curve and blue curve, the motion toward answer percentage is decreased. This is because the motion of the toward-moving cross created an illusory effect that signal dots moved away, especially for low percentage of the signal dots. The same explanation can be applied for the left shift of red curve. In this situation the cross moving away generated an impression that signal dots surrounded it were moving toward, leading to the result of leftward shift. Besides, we noticed that the shift for cross motion toward and away from the static case was not asymmetrical, motion-toward cross had a larger effect on MID perception, this could be another prove that our oculomotor system was more sensitive for toward-motion.

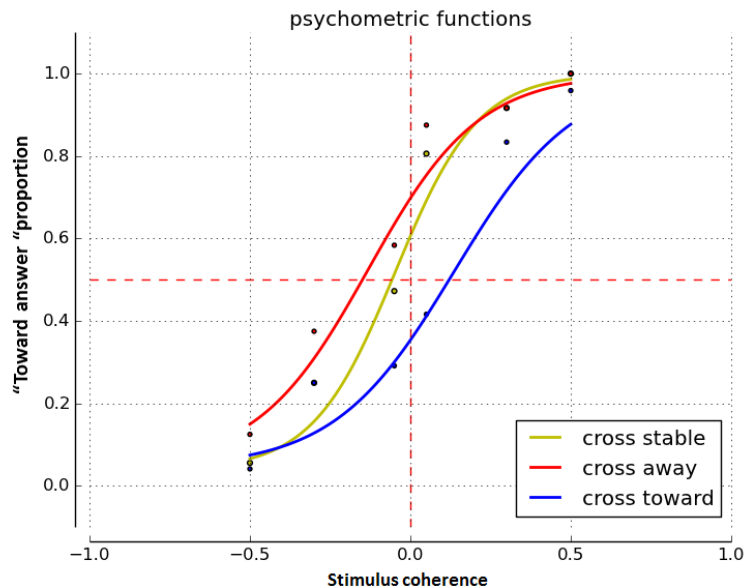

Figure 4.12 Fitted psychometric functions for the un-adapted tests in experiment 2 and 3. The green curve is the fitted logistic function for stable cross. The red curve corresponds to the fitted logistic function in case of cross motion away. The blue curve represents the fitted logistic function for cross moving toward.

For the results of experiment 3, in which a cosine motion was added to the cross, we can find that the MAE was significantly affected by A/V reflex (see Fig.4.13). We explored a strong MAE

in depth (approximately 23% motion coherence) generated by adaptation with motion-away while much smaller MAE for adaptation with motion-toward (approximately 7% motion coherence). Unfortunately, we have realized that there are some duplicate problems in the protocol when we were analyzing the data in experiment 3. The main issue is the pendulum motion of the cross during each trial. Normally, MAE is generated by consistent motion stimulation, when the stimulation time is too short or the motion direction changes from time to time, it becomes difficult to explore MAE. In the current experiment, the cross motion changed four times in 4s adaptation, which probability canceled the MAE, the shift that we have seen in Fig. 4.13 may just due to the relative disparity variation of cross and dots during 1.25s test stimulus.

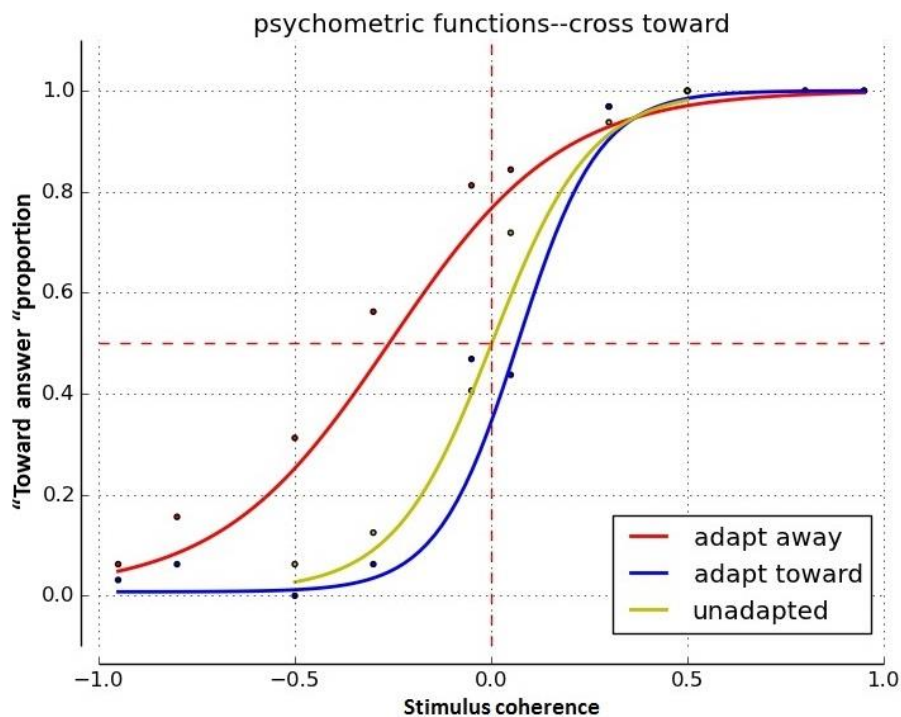

Figure 4.13 Fitted psychometric functions in experiment 3, the data is an average of the case of cross motion-toward and motion-away. Yellow curve stands for the case of un-adapted test ($\alpha = 0.03$, $CI_{95} = [-0.095, 0.112]$; $\beta - 1 = 0.126$ ($CI_{95} = [0.036, 0.204]$), red curve is the case adaptation motion-away ($\alpha = -0.225$, $CI_{95} = [-0.426, -0.093]$; $\beta - 1 = 0.217$ ($CI_{95} = [0.113, 0.318]$), blue curve is fitted in the case adaptation motion-toward ($\alpha = 0.069$, $CI_{95} = [-0.021, 0.169]$; $\beta - 1 = 0.103$ ($CI_{95} = [0.012, 0.159]$).

4.4. Corrected experiments for sensory and oculomotor system interaction investigation in MID perception

Learning from the lessons of the previous unsuccessful experiment, we have corrected the imperfection in the protocols in later experiments. With the three experienced subjects, we repeated Experiment 3 described in section 4.3 with specific changes on the cross motion.

4.4.1. Experiment protocols

In the new experiment, the cross was stable during the 4s adaptation, and it was given a constant motion direction in depth during 1s test stimulus (toward or away from subjects). The cross was disappeared 1.25s Inter-stimulus interval (ISI) and it appears at the beginning of 1s test, with zero disparity (the same depth as the screen). There are three sessions in this experiment, session one is the un-adapted test, the manipulation was the same with experiment 2 in subsection 4.3. in the other two sessions, a 4d adaptation stimulus (motion toward) was added in each trail as well as the cross motion in 1s test stimulus. The other parameters manipulation remained the same with experiment 3 in subsection 4.3.

4.4.2. Results and discussions

Since no cross motion was added during 4s adaptation, we can consider that MAE generation was successfully generated, as shown in Fig. 4.14, the green curve is the fitted psychometric functions for un-adapted test when the cross was stable during 1s test stimulus. The blue curve represents the case of 4s adaptation toward plus stable cross in 1s test stimulus. The red curve stands for the fitted function when the cross kept moving away from the observer during 1s test stimulus. Comparing the un-adapted test (green curve) and adaptation toward test (blue curve), there is a shift between the two cases (approximately 14%), which is due to the MAE generated by 4s adaptation. However, when an oculomotor cue was induced (dynamic cross during 1s test stimulus), the psychometric function shifted leftward (red curve), less MAE was observed, which indicated that the MAE generated by sensorial cue (RDS) was partially mitigated by oculomotor cue (dynamic cross). However, the curve's slope also decreased when the oculomotor cue was added, and there is also a large difference between the curves of un-adapted test and motion-toward adaptation plus dynamic cross test. The results confidence should be improved by increasing the sample size.

In this experiment, we only obtained the interaction of sensory and oculomotor system for one direction, which is mitigating sensory cue, generated MAE by applying oculomotor cue. More experiments should be carried out to search the interaction on the other direction in the future work, which is to use sensorial cue to mitigate MAE generated by oculomotor stimulus. by adding some non-cognitive RDS in the 3D scene, which belongs to sensorial cues, the A/V conflict which exists on stereo displays could be reduced by this mitigation method.

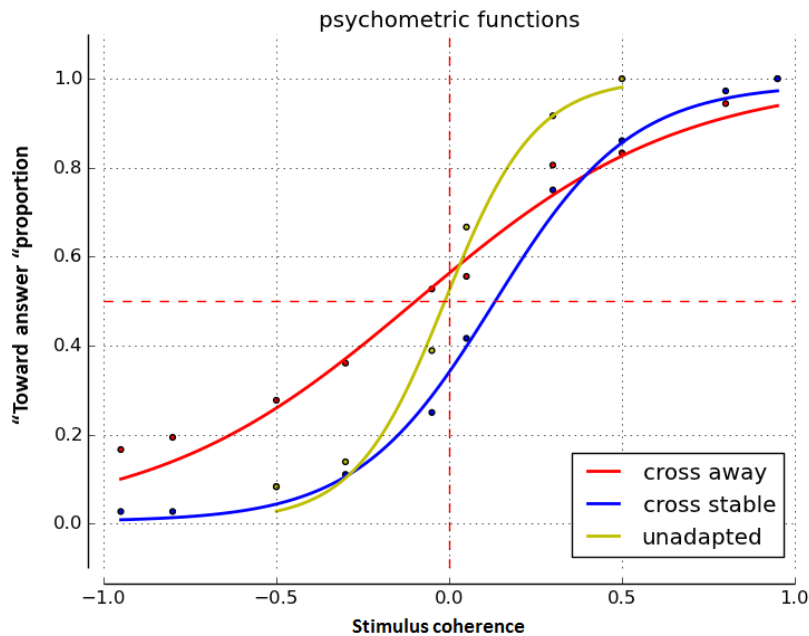

Figure 4.14 Fitted psychometric functions for the case of un-adapted test, adaptation toward test and adaptation toward test + cross moving away during 1s test stimulus. Green curve ($\alpha = -0.01$, $CI_{95} = [-0.09, 0.071]$; $\beta - 1 = 0.130$ ($CI_{95} = [0.059, 0.194]$). Blue curve ($\alpha = 0.13$, $CI_{95} = [-0.014, 0.247]$; $\beta - 1 = 0.199$ ($CI_{95} = [0.093, 0.277]$). Red curve ($\alpha = -0.093$, $CI_{95} = [-0.272, 0.069]$; $\beta - 1 = 0.382$ ($CI_{95} = [0.259, 0.547]$).

4.5. Motion-in-depth perception training

The aim of this experiment is to investigate the MID direction discrimination ability among naïve subjects and the effect of perceptual training for MID perception. Due to less experience of physiological experiment design, we selected a number of subjects to do a preliminary MID experiment. These subjects have good visual acuity, stereo acuity and better than normal convergence strength both at far and close distance. The stimulus was a video that displaying dynamic random stereogram dots in depth, there were signal dots and noise dots in each frame. However, we could hardly obtain correct visual performance for MID perception with the stimulus at that time. Subject reported a great difficulty to extract MID information during the experiment, although all of them have very good views. Then we realized that the inefficient results might be due to the naïve nature of subjects, so we carried out a training session to improve their performance. Fortunately, their performance was significantly enhanced after the training, but the individual difference existed in the results, only half of the subjects could

achieve the accuracy better than 80% for MID perception. Then we decided to clarify which features are critical for MID perception in observers with normal stereo vision.

4.5.1. Experiment stimulus and protocols

The stimulus in this experiment is the same as for the un-adapted test in experiment 2 in subsection 4.2.

There are three sessions for all the subjects, pre-training session, perceptual training session and post-training session.

In the pre-training session, subjects were instructed to focus on the cross in the center, and extract the MID direction of signal dots. There was coherence for all the dots, when the dots coherence is 0%, that means all the dots are given a motion direction in depth randomly, when the coherence is 50% that means half of the dots are signal dots and they have a certain motion direction in depth, either toward the subject or away from them. 100% coherence stands for all the dots are signal dots and they all have the same MID direction. In this experiment, there are three coherence with different MID direction: $\pm 5\%$, $\pm 30\%$, $\pm 50\%$, '+' stands for motion toward, '-' stands for motion away from observers. For every subject, each ratio was tested fifteen times during the whole experiment, the trial number for the whole test is 90. The order of signal ratio presentation was counterbalanced. The sequence for one trial includes two periods: test stimulus (TS) of 1s, inter-stimulus interval (ISI) of 1.25s. RDS with signal information was displayed during test stimulus period and during the ISI, there were no dots displayed on the screen except the cross and a grey background. Subjects used a joystick to give their answer for motion-toward or motion-away.

In the training session, only signal dots were displayed, the dot numbers were chosen from [± 4 , ± 24 , ± 40], all dots moved in one direction in one trial. The training session was stopped until subject could not make further improvement in MID direction discrimination. There are 500 trials with varying number of signal dots in one training session. However, because the learning ability varied individually, the total training trial number was different for subjects, ranging between 1100 and 3000 trials, with an average of 2000 trials. A post training session was carried out after the training with the same protocols like pre-training session.

In order to examine the transfer rate of perceptual learning for MID, we enlarged the dot size from 9 arcmin to 14 arcmin. The same signal ratio, monocular velocity and the procedures to record subjects' responses are the same with the pre-training session.

4.5.2. Experimental results

4.5.2.1. Perceptual training effect on MID direction discrimination

The experimental results indicate that MID perceptual training significantly improves visual perception for MID direction discrimination. A psychometric function calculation was performed based on the toward answer percentage according to coherence level. As shown in Fig. 4.15, the plotted psychometric functions in the figures correspond to the six subjects' MID discrimination performance in pre- and post- training sessions. The y-axis stands for the "toward answer" percentage among the total trial number across each coherence level (x-axis). The dot lines demonstrate the discrimination in pre-trained session. It is obvious that for all the subjects, it was difficult to discriminate the MID direction even with large coherence level, the toward answer proportion is nearly 50% when the signal ratio is 50%, which indicates that subjects could not extract signal motion and the answer is randomly given. The training session largely improved the MID perception, as shown with solid line in Fig. 4.15, for subject 3, the correct perception for RDS motion increased from 50% to 100% when the coherence level was 50%. The average performance improvement from pre-training to post-training is significant according to paired t-test ($P < 0.001$). However, two subjects did not achieve good performance after training (Fig. 4.15a, Fig. 4.15d), the toward answer percentage changed slightly with signal ratio, and the answer for MID perception in post-training is almost the same with the result in pre-training. Statistical analysis revealed an insignificant improvement after training session among the two subjects ($P = 0.068$).

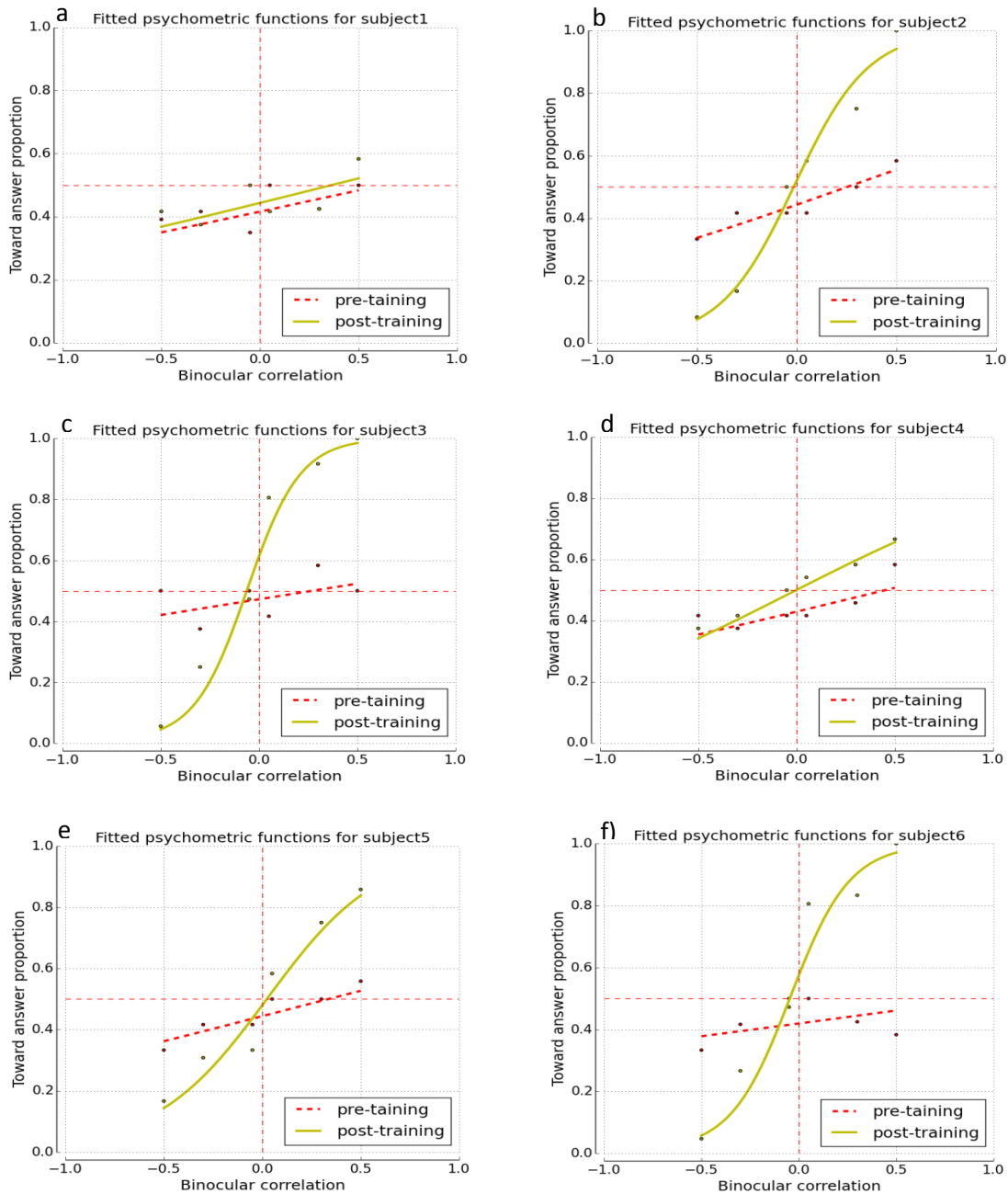

Figure 4.15 Psychometric functions for pre-and post-training session performance for all subjects. The abscissa stands for the coherence levels across all the stimuli, “+” means signal dots moving toward to observer during the trial, “-” means signal dots moving away from observer. The ordinate represents the toward answer proportion among the whole trial number corresponding to each coherence (15 trials for each signal ratio).

4.5.2.2. Perceptual training results retention

To explore the time retention of MID perceptual learning with RDS, two subjects who achieved good visual performance for MID perception (Subject 3, Subject 6) were retested using the same protocols two months and nine months after the first post-training session. The data is demonstrated in Fig. 4.16a-b. Both subjects remained precise direction discrimination over a long period. The visual performance among the three post training sessions did not change significantly ($P = 0.130$).

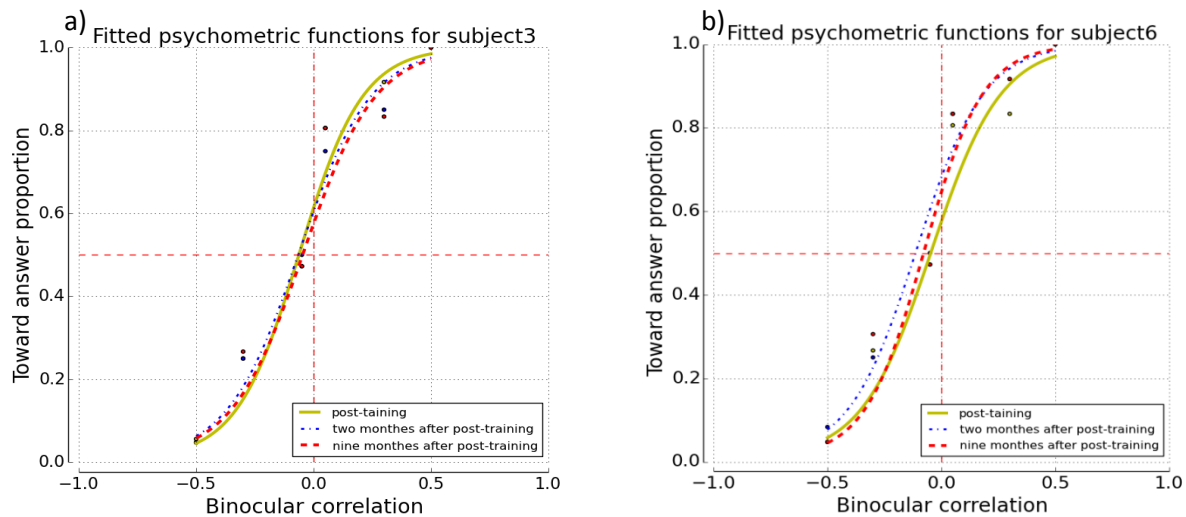

Figure 4.16 Psychometric functions for retesting on subject 3 and subject 6, two and nine months after post- training sessions.

4.5.2.3. Transitivity of perceptual training

To examine the transfer rate of perceptual training for MID direction discrimination, a control test was carried out on subjects whose MID discrimination has been improved after perceptual training. Before the training session, a similar stimulus was shown to subjects, all the test manipulation was the same with the original stimulus except the dot size was enlarged to 5 arcmin. Subjects' correct answer percentage of dots MID perception was recorded. After the training session, the same experiment was repeated to calculate the improvement of MID perception. The data of subject 3 and subject 6 is shown in Fig. 4.17a-d. It reveals that perceptual training for MID discrimination could be transferred to similar objects with relative high transfer rate.

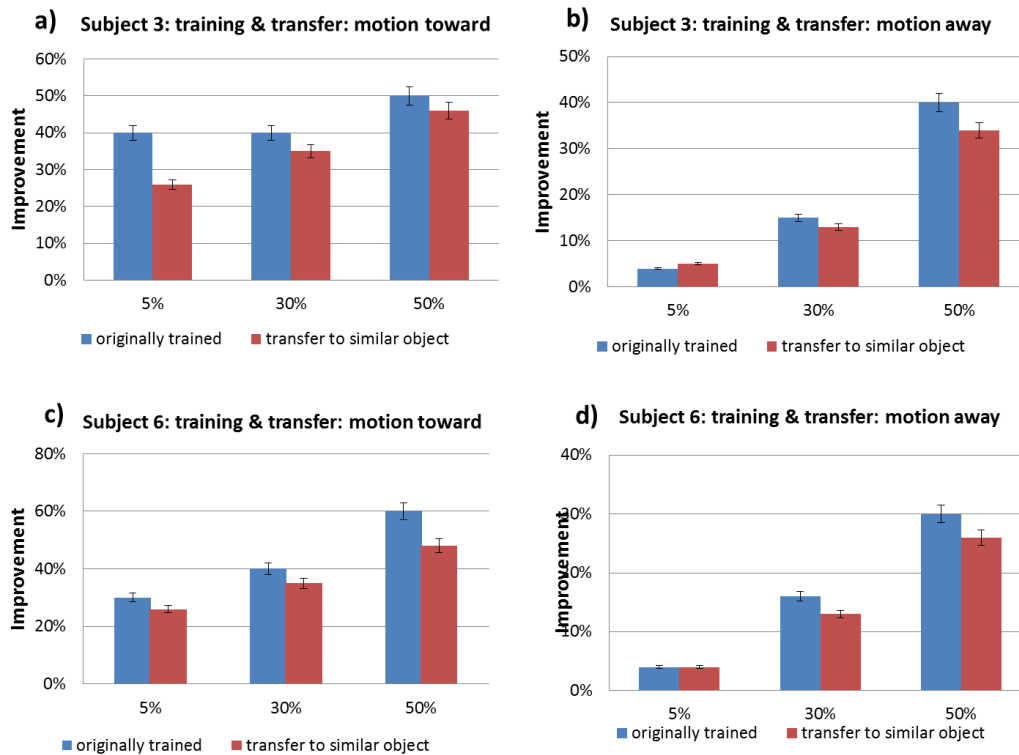

Figure 4.17 The improvement of MID perception accuracy of the original test and the control test. a) And b) present the data obtained from Subject 3, c) and d) present the result of subject 6.

4.5.3. Discussion

This experiment aims to assessing visual perception for MID among normal stereo acuity observers and to determine the effect of perceptual training on MID direction discrimination. The experimental results demonstrated a substantial improvement in MID perception with long time retention and high transfer rate, although the improvement was individually different.

All the observers in this study have good stereo acuity, since the normal stereo acuity for Titmus Stereo Test is less or equal to 100" [107]. Their poor discrimination ability for MID direction before training confirms the discrepancy of perception of static depth and dynamic MID. Watanabe proposed several tests to assess discrimination of dynamic motion, which could provide a comprehensive analysis for binocular vision by involving more cues in the tests[86]. In the current study, we use different stimuli focusing on MID perception, the choice of emmetropic observers eliminate the effect from strabismus for binocular perception. The

independence between static stereo vision and dynamic stereo motion should be evaluated separately.

The novelty of this study is the observation of low discrimination capability for MID perception in observers with normal stereo acuity and good plasticity of MID perception training within the same sample. It has been reported in various studies that stereo acuity could be trained effectively by repeating training trials, the stimuli could be objects or RDS [108, 109]. Most of the studies are based on static stereo acuity training which only improves the visual sensitivity for perception in depth, the training for stereo motion is rarely mentioned. In our study, we successfully trained observers to achieve high discrimination for stereo motion, and the training effect could maintain at least 9 month with high transfer rate. Nevertheless, the improvement differs between subjects, since the subjects all have good eye vergence function (far distance: more than 10 prism diopter, near distance: more than 30 prism diopter), the effect of vergence disability is eliminated. One of the reasons for the discrepancy for perceptual training result could be the focus effort on the central cross, because the sensation of motion toward or away is generated by the relative disparity between static cross and dynamic dots. If subjects cannot focus well on the central cross, the reduction of relative disparity will affect MID perception. On the other hand, the stimulus could play an important role during the perception process, since all normal subjects in Fujikado's experiment passed dynamic stereopsis tests, and the objects and temporal frequency is quite different from the current study [110]. Therefore, specifically designed fixation objects and stimulus characters need to be investigated in more detail in further studies.

4.6. How to design motion-in-depth stimulus

The goal of this experiment is to explore the criteria stimulus features that affect MID direction discriminations.

We simplified the experimental protocol, we removed the noise dots that will disturb MID perception, and we modified the signal features including dot lifetime, density, contrast, as well as some parameters surrounding the dynamic dots area, such as adding a background with texture, or to enhance the fixation area in the center of the stimulation. An eye-tracker is implemented in the experiment to record the eye gaze and vergence data. Finally, some critical features were identified and we believe that the experiences will be useful for the one that are not familiar with motion-in-depth experiment design.

4.6.1. Experiment stimulus

The 3D display platform is the same as for experiment 1, but the stimulus is different. One scene of the experiment is shown in Fig. 4.18 on the left. We removed all the noise dots on each frame, leaving only signal dots. All the signal dots had a white color and the background color was black. The dots lifetime increased to 1s, compared with previous experiment (250ms). The viewing distance was 70cm. 13 subjects participated in the experiment.

In each trial, a dot density was randomly chosen from ± 4 , ± 24 , ± 40 , “ \pm ” stands for the dots’ MID direction. For each dot density, there were 10 trials, so the total trial number was 60 for each session.

There were two parts in the experiment to explore the MID perception variation with stimulus design, the first part include the background texture (Fig. 4.18b), fixation object (Fig. 4.18c), signal contrast (Fig. 4.18d). When a background texture was added, the circle angle was 9°

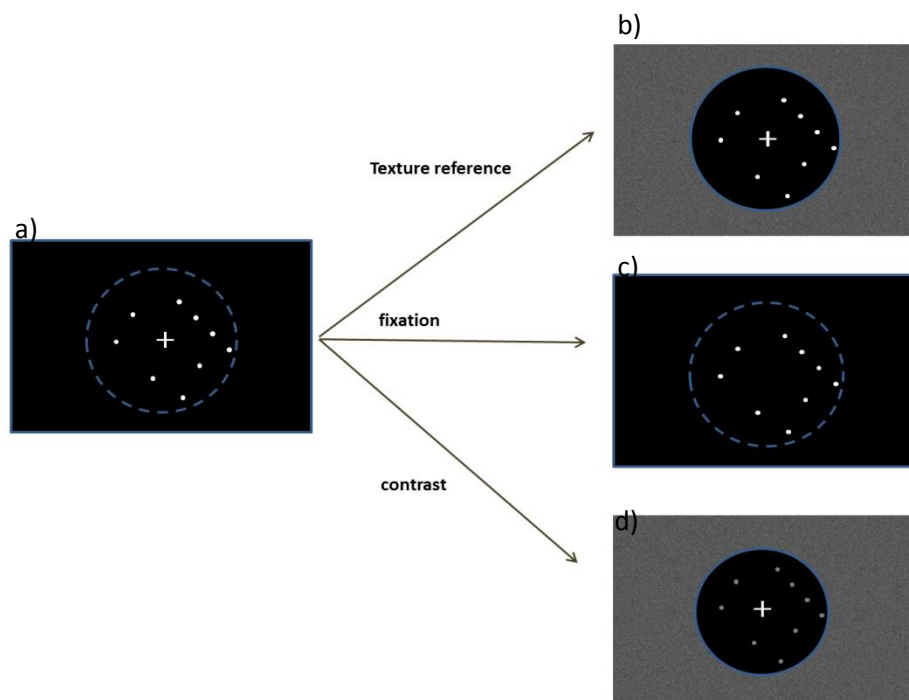

Figure 4.18 Stimulus images for the test parameters for background texture, fixation and contrast.

In order to understand the relation of constant eye vergence and MID perception in the second part of the experiment, we modified the fixation point in depth, as shown in Fig. 4.19, as a reference of the screen, the eye fixation will be on the screen, at the bottom and front of the volume in depth, the whole length of the volume in depth was 16 cm. There are three sessions

for this part, the test stimulus in this part is Fig. 4.18b, and the background texture is always at the same position as the fixation in depth. The principle to measure MID perception is the same as previously described.

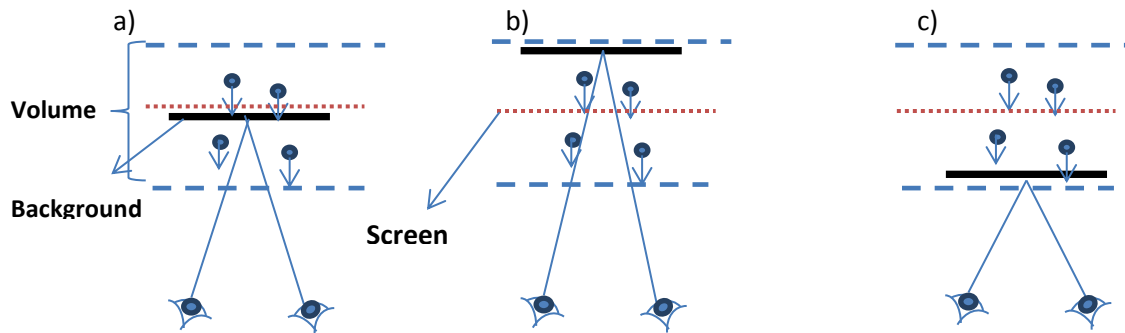

Figure 4.19 Plan view of the stimulus when eye vergence effect is tested, a) the fixation cross and background is in the same position with the screen in depth volume, b) the fixation cross and background is at the bottom of depth volume, c) the fixation cross and background is at the front of depth volume.

4.6.2. Experiment results

4.6.2.1. Background texture reference effect

As is revealed in Fig. 4.20, **subjects have generally better MID perception when background texture is added. And the difference is statistically significant (table 1).** However, larger standard deviation is observed in the experiment where there is no background texture. **Besides, the signal dots density has no significant effect for both cases (Fig. 4.18a: F- Ratio = 2.1595, Prob>|f| = 1.1735; Fig. 4.18b: F- Ratio = 1.3145, Prob>|f| = 0.2731).** This result is not consistent with previous studies, as in Czuba's experiment, dot density is a significant parameter that will affect MID perception.

Table 4.1 Statistical analysis of MID perception for the effect of background texture effect.

Dots density	t- Ratio	Prob> t
-40	2.7971	0.0094
-24	1.74715	0.1112
-4	2.2290	0.0250
4	3.2595	0.0043
24	3.1357	0.0106
40	2.9515	0.0145

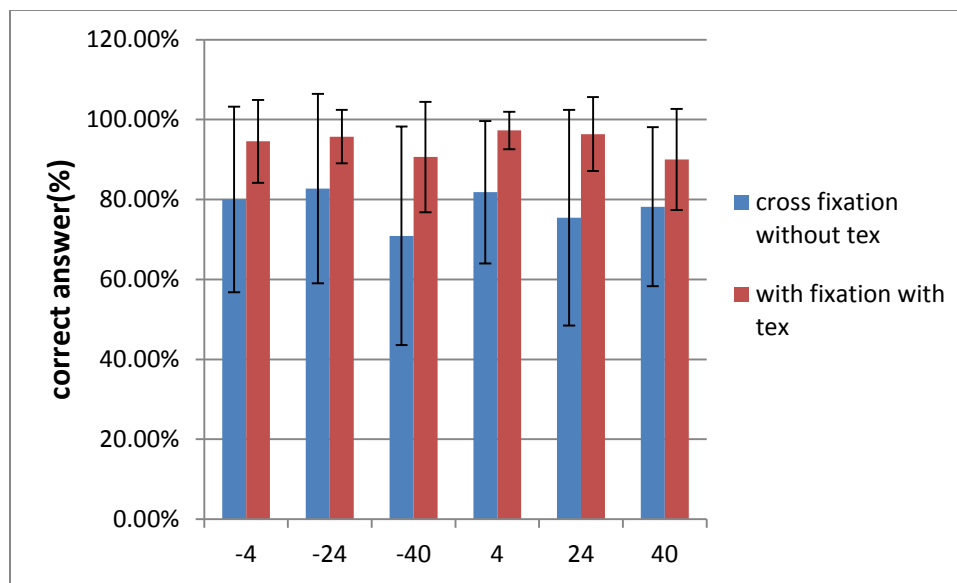

Figure 4.20 Background Texture effect on MID perception.

4.6.2.2. Fixation object effect

As is demonstrated in Fig. 4.21, when there is no fixation cross in the center of the stimulus, subjects' performances decrease. And there exists large individual differences for MID direction discrimination, because there exists relative large standard deviation. However, **the statistic show that the MID perception performance did not change significantly when the fixation cross was removed (Table 4.2). And the dot density is not a significant feature in this part (Fig. 4.18c: F- Ratio = 0.6915, Prob>|f| = 0.6322).**

Table 4.2 Statistical analysis of MID perception for the effect of background texture effect.

Dots density	t- Ratio	Prob> t
-40	0.1804	0.8604
-24	0.8868	0.3960
-4	0.4359	0.6722
4	2.0254	0.0703
24	0.39645	0.7001
40	3.1345	0.0106

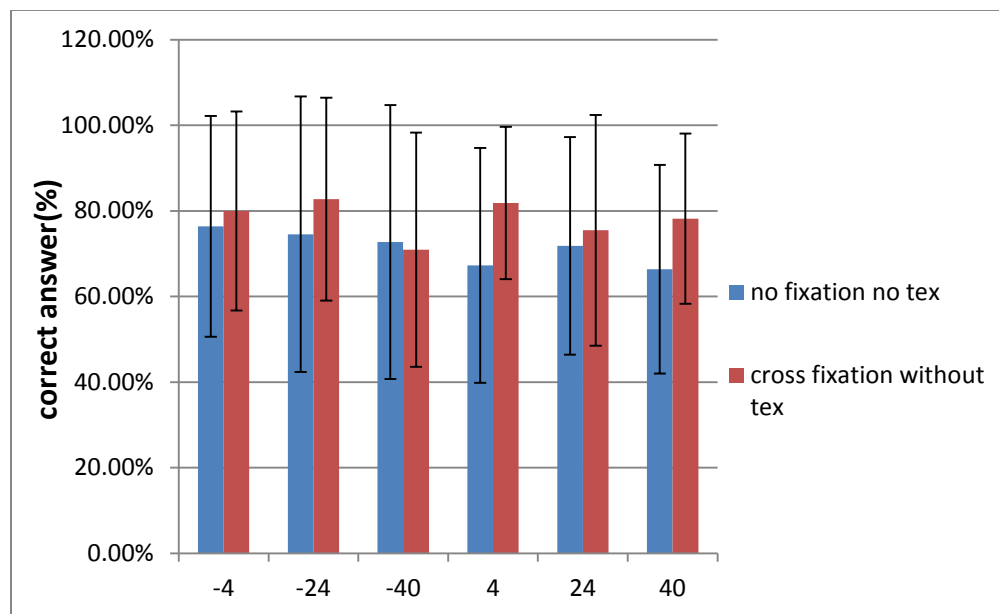

Figure 4.21 Fixation effect on MID perception.

4.6.2.3. Contrast effect

As demonstrated in Fig. 4.22, subjects' performance of MID perception is slightly affected by stimulus contrast. **According to ANOVA, the difference is not significant (Table 4.3). This result is inconsistent with previous works, indicating that contrast is an essential parameter to affect stereo acuity.**

Table 4.3 Statistical analysis of MID perception for the effect of background texture effect.

Affect parameters	f- Ratio	Prob> f
contrast	2.9531	0.0778
Signal dot density	2.1422	0.0776

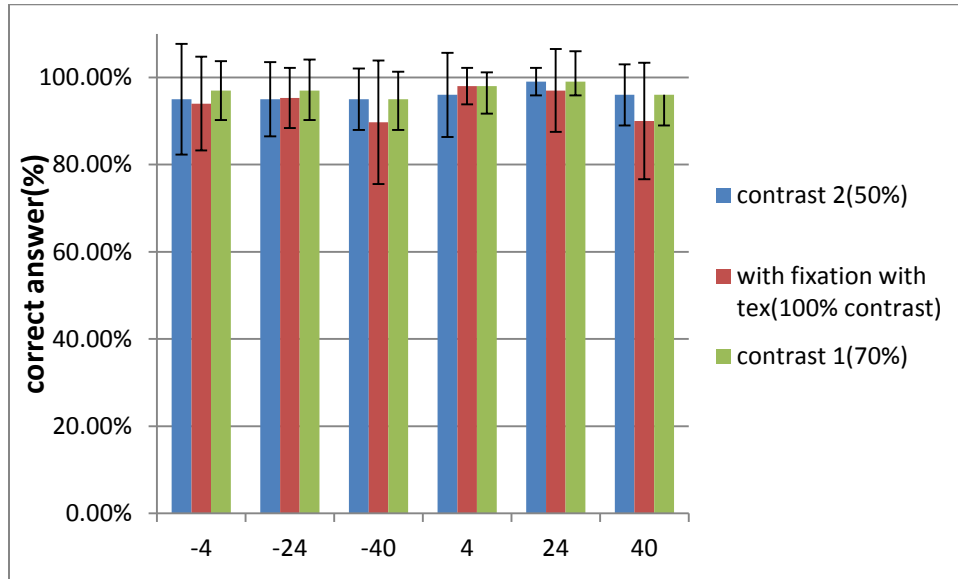

Figure 4.22 Stimulus contrast effect on MID perception.

4.6.2.4. Relative disparity effect

We have been surprised to observe that the position in depth of the fixation has no significant impact on MID perception (Table 4.4). As is shown in figure 4.19a-c, when the fixation cross is in the middle of the depth volume (Fig. 4.19a), the relative disparity of fixation and signal dots is the smaller than the case when the fixation cross is at the back of the depth volume (Fig. 4.19b) or at the front of the depth volume (Fig. 4.19c). However, this relative disparity did not affect the MID discrimination ability, which is not the same when stereo acuity is measured. In stereo acuity test, the main purpose is to evaluate the stereo vision resolution for relative disparity, such as fly stereo test.

Table 4.4 statistical analysis of MID perception for the effect of background texture effect.

Affect parameters	f- Ratio	Prob> f
Relative disparity	0.3324	0.7215
Signal dot density	2.3818	0.0533

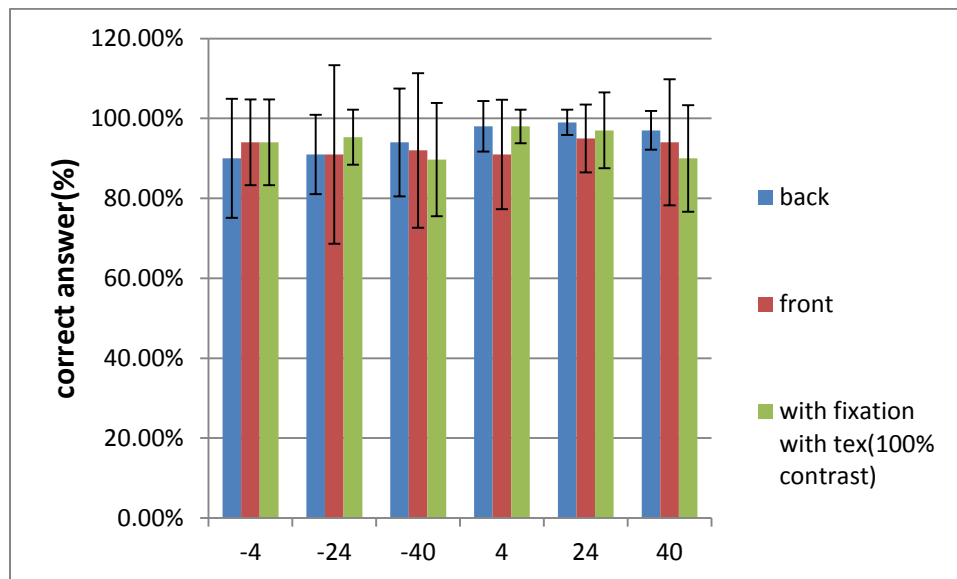

Figure 4.23 Relative disparity effects on MID perception.

4.6.3. Eye movement records

In order to understand the eye movement during each stimulus condition, we used an eye-tracker to record the gaze position during the experiment. We have collected five subjects' data using the eye-tracker.

4.6.3.1. Eye fixation is affected by dynamic RDS

Before analyzing the effect of dynamic dots effect on eye movement, it is necessary to record the eye reaction when static dots are displayed in depth. So at the beginning of the eye movement measurement, we asked subjects to look at a static stimulus on the screen, the image was the same as for Fig. 4.18b, the only difference is the dots are randomly distributed in depth and they never move in depth, subjects were instructed to focus on the screen for 30 seconds. The eye movements were recorded and the gaze heat map is shown in Fig 4.24a-d.

The warmer the color is on the gaze heat map, the longer the gaze stayed at that point. **These are the records of two subjects, for subject 2, it could be easily explored that eye fixation is affected by dynamic dots moving in depth, since the heat area is larger for the dynamic stimulus. But the fixation of subject 1 is not obviously affect by the dots motion.**

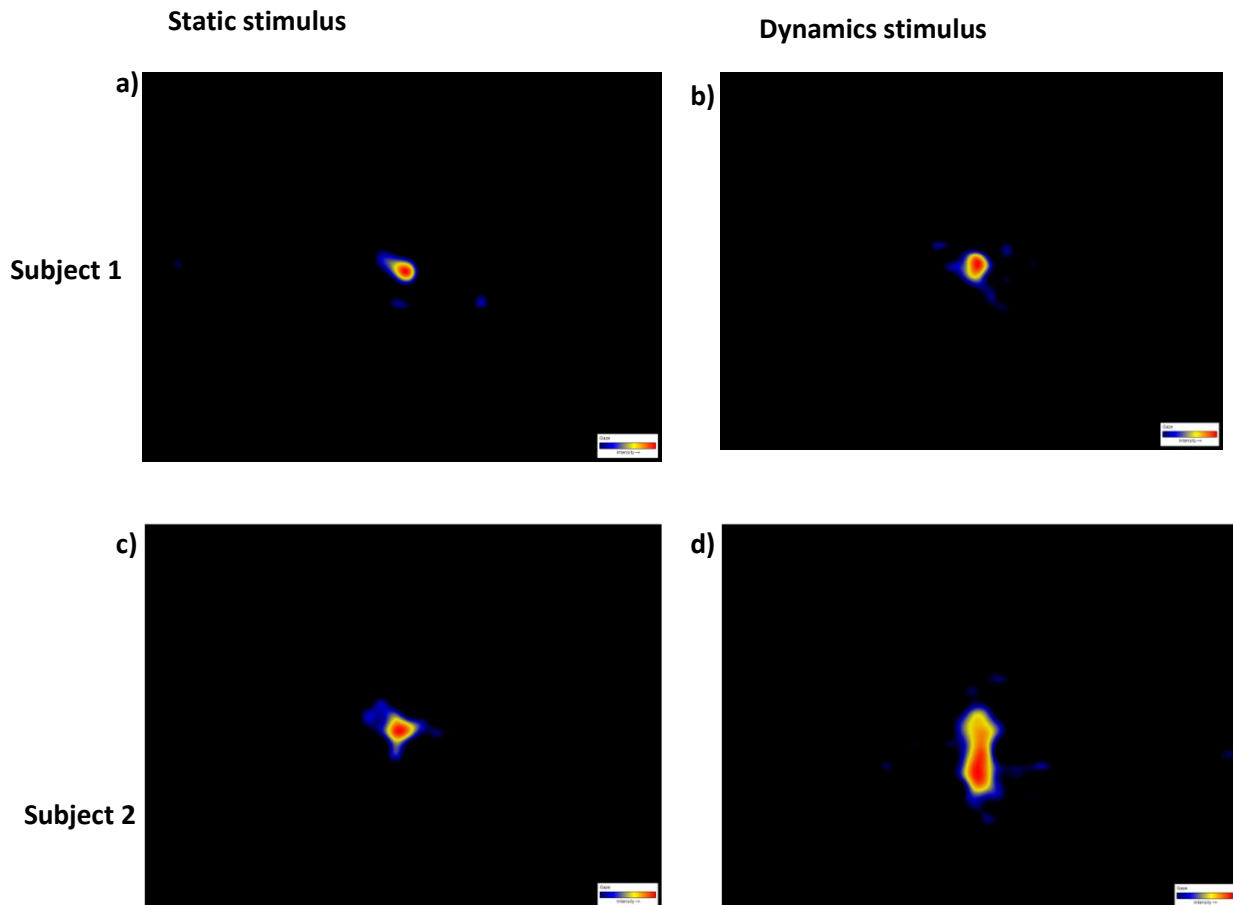

Figure 4.24 Gaze heat map comparison for static stimulus and dynamic stimulus. There are two subjects' data presented in this figure.

4.6.3.2. Background texture facilitate eye fixation

In order to investigate the eye movement when the background texture or fixation cross is presented in the stimulus, we recorded the eye motion during the experiment, the eye gaze heat map is shown in Fig. 4.25. There are two columns in the figure: each column presents the eye gaze under three stimulus conditions: fixations cross + background texture; only fixation cross; no fixation cross and no background texture. The eye gaze is obviously stable when both

fixation and background texture is used, this indicates that the reference in peripheral area of stimulus are helpful for subjects to make good fusion and fixation, and when the fixation is more stable, the MID perception accuracy is better. However, if we compare the gaze heat map between subjects, the gaze area is not the same under the same stimulus condition. But the two subjects have similar performance for MID perception, which indicates the individual difference of gaze fixation between subjects.

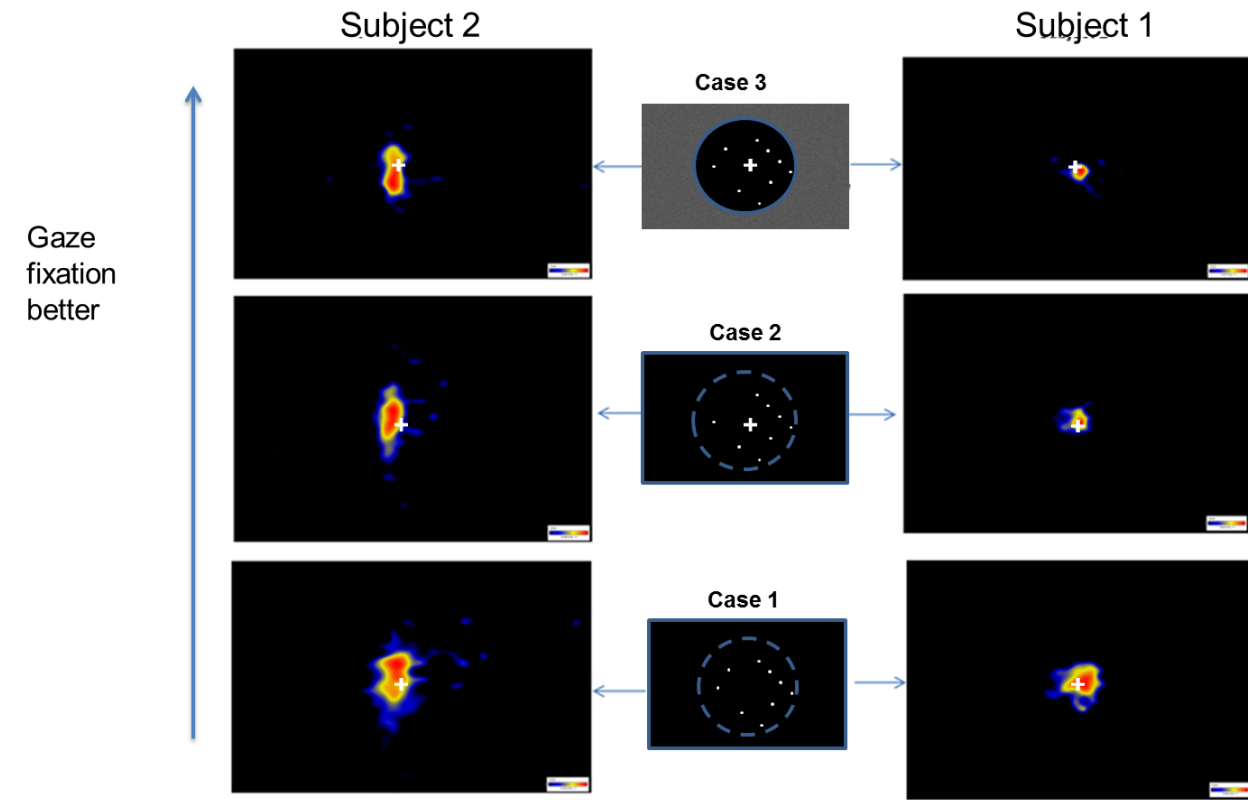

Figure 4.25 Eye gaze heat map when background texture and fixation are modified.

4.6.3.3. Good fixation is not the only parameter for high accuracy MID perception

However, we have encountered issues to make every subjects to achieve good MID performance, there are several subjects who experienced great difficulty for MID direction discrimination. Fig 4.26 reveals the eye gaze heat map of one subject who can barely perceive MID, despite he has been trained for many times and the vision parameters indicate that there should not be any defect from his eyes. according to his MID perception results, the answer he gave was almost randomly across all stimulus, even with the easiest stimulus (background texture + fixation cross), the correct answer is around 50% while other subjects could achieve more than 90%. When we look at Fig. 4.26, which indicate the eye gaze during the three

stimulus condition in figure 4.18a-c, we find that the gaze area does not change obviously, and the dispersion of the gaze area is not very significant comparing with other subjects who can well perceive MID stimulus.

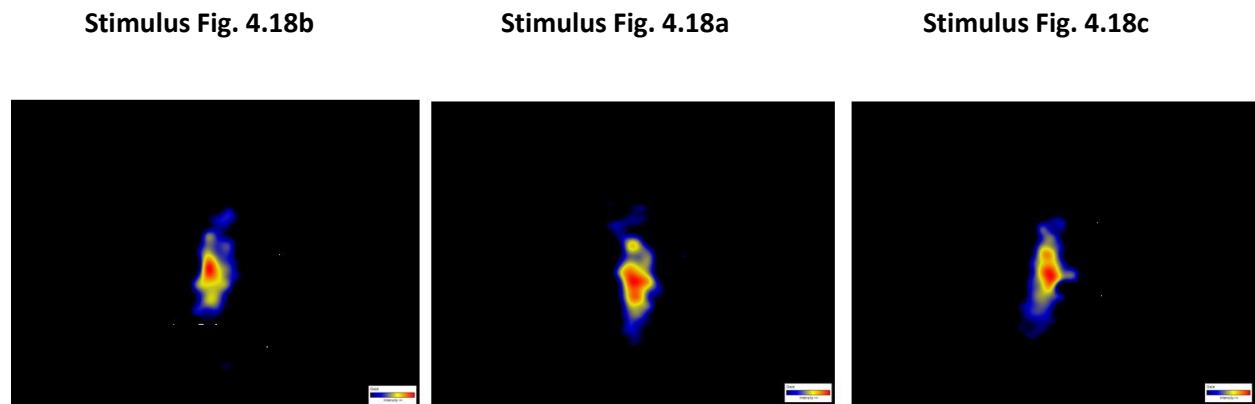

Figure 4.26 Eye gaze heat map of one subject, who have great difficulty to discriminate MID during the experiment.

4.6.3. Discussions

The aim of this chapter is to identify critical features for MID stimulus design, based on normal unexperienced subject's samples. The motion perception is a very fine reaction which needs the cooperation of oculomotor system and cortical analysis, and the configuration of objects' parameters may lead to apparent effect. Inappropriate design of MID stimulus is very likely to cause difficulty for satisfying and comfortable perception.

According to the experiment results, we have clarified several critical parameters for MID perception: large background reference is necessary for keeping good and stable fixation; fixation objects is fundamental for MID perception. However, stimulus contrast which is used to affect static stereo acuity is not a significant factor anymore in the current study. Further investigations are needed to clarify the effect of this factor. In our experiment, the minimum contrast is only 50%, maybe the MID perception will be affected if lower contrast is implemented. Besides, due to subjects' ceiling performance on the stimulus with background texture and cross fixation, the performance variation space for the effect of contrast is limited, more parameters should be analyzed, such as response time and the feeling of difficulty and comfort from the subjects themselves. Normally, large relative disparity makes it easier to discriminate the relative position of two objects, but this is confirmed only with static tests.

When the objects are moving in depth, relative disparity is no longer a critical parameter for the MID perception sensitivity.

The eye tracker data in the experiment provided apparent difference between different stimulus cases. **We confirmed our hypothesis that stable eye fixation is necessary for MID perception.** But there are many aspects to be considered to reach the final conclusion. First, individual difference should be considered, due to the variety of vision conditions for each subject, the ability to keep a stable fixation varies from people to people. Second, the effect of eye fixation on MID perception should be considered under different stimulus conditions with the same subject, one subject's gaze area is larger than the other one's does not mean his/her performance is worse. If there is large gaze area difference between different stimulus cases, it is very likely that the subject's performance will be distinctive. What's more, as the response time and learning abilities varies among subjects, some neuro parameters also lead to performance variation.

4.7. Conclusion

In this chapter, we measured motion-in-depth perception under different aspects. The first objective of the study was to investigate the link and interaction between oculomotor system and sensorial system. We have designed complex protocol combining the cues for MID perception from the two mechanisms. We induced a cross moving back and forth in depth to stimulate oculomotor system while inducing disparity to stimulate sensorial response. By using the haploscope, we measured the aftereffect of oculomotor stimulus on vergence and accommodation reflex, opening a new research field for the A/V reflex visual fatigue mitigation by adding potential cortical cues. However, in spite of collecting 20 subjects with strong eye vergence ability, standard visual acuity and stereo acuity, we have encountered many difficulties to make them able to perceive MID with the original stimulus design. Then we realized that all the subjects were unexperienced for such experiment and with such complex protocols. There may be some bias for their understanding. It is inappropriate to imply complex and difficult protocols on them, bringing a lot of pressure on them and the researchers may not probably get the accurate results that are expected. So it was necessary to figure out a simple and clear protocol that allows more subjects to participate. So we decided to train them with simpler stimuli. There are only four of the eight subjects who succeed in the training and their MID direction discrimination reached as high as 90% correct. Due to the difficulties that we faced during these preliminary experiments, we observed great individual differences for MID perception and we thought that it is necessary to clarify the features that will affect subjects' performance for MID direction discrimination and design a test that could be applied on most of the subjects who have normal view. Therefore, we carried out the forth experiment in this

chapter. In this part, we simplified the protocol and modified different features to achieve the best MID perception accuracy.

It is necessary to explain specifically about the sample selection for MID experiments, unlike normal stereo acuity test, these MID tests not only require subjects to have good vision parameters but also quick response and well-focused concentration. It is a test both for physical parameters but also neuro response cooperation. For the subjects we have included during the whole observation, they could be divided into two levels: the first level is the visual parameters, concerning the current evaluation standard for the vision parameters, all the subjects have good view; the second level is their ability to adapt the MID stimulus and learn to discriminate MID direction. Many subjects failed in this stage when the original tests were conducted, however, when we removed the noise information in the test and enlarged the response time, more subjects could give correct answers. **This investigation about within-sample difference should be considered in similar tests.**

In the future work, it will be meaningful to measure MID perception in the form of MAE based on the simplified protocols on larger samples. The current stereo vision test only concerns static objects and vision, the ability to detect motion-in-depth has not been measured under standard tests, it is necessary to define a test to evaluate the MID perception acuity.

The amelioration of MID protocols will enable us to consider non experienced population samples. Maybe enlarging the size of the sample and thus the reliability of the statistics made on these samples can drive a more relevant analysis. The second important point for the MID test is that there are dynamic RDS stimulating the oculomotor system, which could be applied on some reeducation practices. A good understanding of MID mechanism and the interaction between sensory and oculomotor system for MID perception could be useful both to early detect neuro or cortical disorders as well as to provide some reeducation tools.

Chapter 5

Conclusions and perspectives

5.1. Recall of research purposes

We had two main objectives in this thesis: a) To investigate the environment and display technical parameters impacting stereo visual comfort by measuring visual tolerance of vertical disparity (such as viewing distance, 3D contents, peripheral interference and 3D display technology); b) To evaluate the link between oculomotor system and sensory mechanisms in particular for motion-in-depth perception. This has been obtained by varying the stimulus parameters, with the objective to make a more comfortable and applicable MID perception tests.

The first objective concerned our visual response to stereoscopic stimulus in real world. In order to get a quick and sensitive reaction from the subjects, we have chosen visual tolerance of vertical disparity as an indicator to evaluate the oculomotor response to various stimulations. This is due to the fact that visual tolerance for vertical disparity is significantly smaller than horizontal disparity, and the link between the two stimulus cues allows a better understanding between vertical and horizontal cues. By measuring vertical disparity fusion amplitude, we evaluated stereo vision performance on two mostly used stereoscopic displays: 3D stereoscopic projector and autostereoscopic TV. We observed that subjects have significantly different responses on the two types of displays. Besides, since stereoscopic viewing is always in a certain environment, mostly in a normal viewing condition on commercial displays, we believed that it was necessary to assess the interaction of stereoscopic viewing and the environment, such as modifying viewing distance, adding some inference in peripheral area near the screen etc. By understanding how the visual system reacts to different stimulus environment and the different impact parameters of stereoscopic displays, we expected to make more appropriate viewing configurations and choose the correct medium on corresponding stereoscopic display technologies.

The second aspect focused on the study of motion-in-depth perception. The major superiority of stereo vision compared with 2 dimensions perception is the perception of depth information. There are several ways to evaluate the ability and experience of depth perception, such as stereo acuity test. However, the stereo acuity is only measured on static objects and cannot provide a serious assessment for the motion-in-depth perception. The most important for MID perception is to discriminate the direction, velocity and amplitude of objects moving in depth. In laboratory studies, motion aftereffect is considered as a conventional parameter to evaluate the strength of MID perception. In our study, we expected to explore the potential methods to mitigate the MAE by adding some RDS which carried the information only be processed in cortical stages. Because RDS added in a scene will not be recognized, it is only processed by the brain. If we could achieve the mitigation, the visual comfort could be improved. Besides, due to the complexity of 3D scenes, both sensory system and oculomotor system are stimulated when

observers are watching 3D medium. Since accommodation / vergence conflict is one of the fundamental issues faced by the current 3D technologies, it is necessary to explore the sensory response when both the two mechanisms are stimulated.

5.2. Results and Contributions

Three experiments concerning three aspects of stereo perception have been carried out, according to the results analysis and discussion, which can be summarized as follows:

- Evaluation of the impacts of environment parameters on stereo vision perception based on vertical disparity tolerance. We observed that the most critical parameter for stereo perception is the stimulus size on the retina. Viewing distance mentioned in many works is as an important parameter for perception, and it is confirmed in our experiment, with a constant screen size. However, we found that vertical disparity tolerance had slightly changes when we increase both screen size parallel and viewing distance in order to keep the same stimulus size on the retina. Besides, we also observed significant effect from background luminance and target complexity. The only parameter that is not significant is the room lighting. We also investigated a strong interaction between central and peripheral vision. By using a series of prisms with precise values inserted in front of one eye, we have been able to propose a quantitative analysis between the interaction of central and peripheral vision.
- Evaluation on the stereo vision performance on 3D projector and autostereoscopic TV. We observed different subject performances on the two display technologies. We observed that visual tolerance for vertical disparity was larger when the measurement is carried on a 3D projector than it is on an autostereoscopic TV. However, due to the technical characteristic of each display technology, the critical parameters that could affect visual perception are distinct between the displays. The viewing distance and background luminance have significant impact on subjects' performance for 3D projector, while for autostereoscopic TV, the main factor is the crosstalk and viewing angle. Based on preliminary analysis and results, some recommendations have been proposed to provide a good environment configuration and help for display technology choice.
- Measurement of motion aftereffect of motion-in-depth perception. By replicating the experiments proposed by the literature, we observed the same trend of MAE in depth generation, but slight direction bias of MAE was also noticed in the results (the amplitude of MAEs is different when the MID direction is toward or away). In order to adapt the protocol to mitigate MAE, we induced oculomotor cues, by adding a dynamic

cross moving in depth. The results indicated that MAE could be reduced by the oculomotor stimulation cue.

- Demonstration of a training method to improve naïve observers' performances of motion-in-depth perception. We observed that naïve subjects generally have difficulties to perceive MID direction with random dots stereograms. But their performance could be largely improved after specific MID perceptual training (such as removing the noise information in the stimulus and giving feedback when subjects give their answers for MID direction). The training effect could be maintained for a long time, and subjects have better MID performance on other different stimulus.
- Identify the critical features that will affect motion in depth perception. By modifying the parameters of MID stimulus, such as background texture, fixation object, stimulus contrast and relative disparity of signal and fixation objects, we observed an obvious effect of background texture for MID direction discrimination accuracy. The eye-tracker data also confirmed that stable fixation and fusion on the stimulus is essential for MID perception.

5.3. Perspectives

Based on the previous results and current knowledge about stereo vision perception, I propose here three directions for future research works.

First, due to the differences between 3D display technologies, there will be specific features that affect visual perception according to certain display technology. It means that with the same 3D content, subjects will have different viewing experience on different display platforms, such as 3D projector and autostereoscopic TV. Therefore, it will be meaningful to identify the critical features tests for different 3D display technologies. With specific mitigation applied to the contents according to the display, subjects' visual comfort could be improved. However, before prescribing recommendations for the creation of 3D content according to 3D display technologies, it is necessary to make more specific experiments for a better understanding of visual response to 3D stimulus.

Second, most of the current clinical measurement for stereo vision nowadays focuses on stereo acuity, some related tests are vergence strength measurements or phoria test, however, these parameters are not sufficient for a comprehensive understanding of one subject's stereo vision, because motion-in-depth perception is an essential function for the daily life. According to the preliminary results of the current study, sufficient stereo acuity and vergence strength cannot guarantee good MID perception performances. So it is necessary to develop a specific test to

evaluate MID perception, which will bring more information for stereo vision assessment and treatment, in such a way that laboratory tests could be transformed into clinical tests.

Third, since stereo perception is a result of sensory and oculomotor system combination, some response to stereo stimulus may relate with cortical process, so it could be promising to explore the stereo vision reactions on some patients who have neurodevelopment disorders. The investigation of stereo perception on specific samples can bring some reference for disease diagnoses and treatments.

According to our preliminary results, we have been in contact with the Faculty of Life Sciences in Manchester University, where I spent 6 weeks working with Dr Emma Gowen to identify if MID tests could be useful for the discrimination and early detect of autism patients. By adapting the MID test made for normal people to autistic people concerning their visual features, an experiment will be carried out on a small sample of autistic patient in Manchester. We are expecting to really identify a test based on stereo vision reaction that could be helpful for autism diagnose and treatment.

List of publications

- **Journals:**

1. D, Zhang.; X, Sang.; P, Wang.; D, Chen.; J-L, de Bougrenet de la Tocnaye, Comparative visual tolerance to vertical disparity on 3D stereo versus lenticular autostereoscopic displays. *Display Technology, Journal of* , vol.PP, no.99, pp.1-1
2. D, Zhang.; P, Neveu.; Y Fattakhova.; S, Ferragut.; M, Lamard.; J-L, de Bougrenet de la Tocnaye, Target properties effects on vertical fusion amplitude (VFA) based on applied 3D platform and quantitative assessment of central and peripheral vertical fusion interaction. *Current Eye Research*. In review.
3. D, Zhang.; J-L Jean-Louis de Bougrenet de la Tocnaye. How to improve the motion-in-depth perception of dynamic random-dot stereograms for normal vision observers? submitted to *Investigative Ophthalmology & Visual Science (IOVS)*.

- **Conferences**

1. Oral presentation on ARVO Asia 2015, Japan.

X, Sang.; D, Zhang.; P, Wang.; D, Chen.; J-L de Bougrenet de la Tocnaye. Human vertical disparity tolerance differences between 3D stereoscopic and autostereoscopic displays

2. Poster on ARVO Asia 2015, Japan.

D, Zhang.; Y Fattakhova.; J-L, Jean-Louis de Bougrenet de la Tocnay. Individual difference between static and dynamic motion in depth discrimination training tasks

Bibliography

1. Curcio, C.A., And Allen, K. A., *Topography of ganglion cells in human retina*. J. Comp. Neurol, 1990. **300**: p. 5-25.
2. Snowden, R.J., Peter Thompson, and Tom Troscianko, *Basic Vision: An Introduction to Visual Perception*. 2006: Oxford: Oxford University Press.
3. Goodale, M.A. and A.D. Milner, *Separate visual pathways for perception and action*. Trends in neurosciences, 1992. **15**(1): p. 20-25.
4. Neri, P., *A stereoscopic look at visual cortex*. Journal of Neurophysiology, 2005. **93**(4): p. 1823-1826.
5. Watanabe, S., R. Kakigi, and A. Puce, *Occipitotemporal activity elicited by viewing eye movements: a magnetoencephalographic study*. Neuroimage, 2001. **13**(2): p. 351-363.
6. Freeman, R.D., *Stereoscopic vision: Which parts of the brain are involved?* Current biology, 1999. **9**(16): p. R610-R613.
7. Anzai, A., X. Peng, and D.C. Van Essen, *Neurons in monkey visual area V2 encode combinations of orientations*. Nature neuroscience, 2007. **10**(10): p. 1313-1321.
8. Jones, R.K. and D.N. Lee, *Why two eyes are better than one: the two views of binocular vision*. Journal of Experimental Psychology: Human Perception and Performance, 1981. **7**(1): p. 30.
9. Howard, I.P. and B.J. Rogers, *Binocular vision and stereopsis*. 1995: Oxford University Press.
10. Benjamin, W.J., *Borish's clinical refraction*. Vol. 2. 2006: Butterworth-Heinemann St. Louis.
11. Neri, P., H. Bridge, and D.J. Heeger, *Stereoscopic processing of absolute and relative disparity in human visual cortex*. Journal of Neurophysiology, 2004. **92**(3): p. 1880-1891.
12. Ogle, K.N., *The optical space sense*. Visual optics and the optical space sense, 1962. **4**: p. 374-376.
13. Grove, P.M. and H. Ono, *Horizontal/vertical differences in range and upper/lower visual field differences in the midpoints of sensory fusion limits of oriented lines*. Perception, 2012. **41**(8): p. 939-949.
14. Howard, I.P., *Alhazen's neglected discoveries of visual phenomena*. PERCEPTION-LONDON-, 1996. **25**: p. 1203-1218.
15. Bhola, R., *Binocular vision*. Department of Ophthalmology and Visual Sciences, University of Iowa, 2006.
16. Schor, C., T. Heckmann, and C.W. Tyler, *Binocular fusion limits are independent of contrast, luminance gradient and component phases*. Vision research, 1989. **29**(7): p. 821-835.
17. Ciuffreda, K.J. and D. Rumpf, *Contrast and accommodation in amblyopia*. Vision research, 1985. **25**(10): p. 1445-1457.
18. Toates, F., *Accommodation function of the human eye*. Physiological Reviews, 1972. **52**(4): p. 828-863.
19. Neveu, P., *L'impact des dispositifs de visualisation en relief sur les composantes oculomotrices d'accommodation et de vergence*. 2012, Paris 8.
20. Hung, G.K. and J.L. Semmlow, *Static behavior of accommodation and vergence: computer simulation of an interactive dual-feedback system*. Biomedical Engineering, IEEE Transactions on, 1980(8): p. 439-447.
21. Hung, G.K., K.J. Ciuffreda, and M. Rosenfield, *Proximal contribution to a linear static model of accommodation and vergence*. Ophthalmic and Physiological Optics, 1996. **16**(1): p. 31-41.
22. Schor, C.M., *The relationship between fusional vergence eye movements and fixation disparity*. Vision Research, 1979. **19**(12): p. 1359-1367.
23. Schor, C.M., et al., *Negative feedback control model of proximal convergence and accommodation*. Ophthalmic and Physiological Optics, 1992. **12**(3): p. 307-318.

24. Chen, J.C., K.L. Schmid, and B. Brown, *The autonomic control of accommodation and implications for human myopia development: a review*. *Ophthalmic and Physiological Optics*, 2003. **23**(5): p. 401-422.
25. Ciuffreda, K.J., *The scientific basis for and efficacy of optometric vision therapy in nonstrabismic accommodative and vergence disorders*. *OPTOMETRY-ST LOUIS-*, 2002. **73**(12): p. 735-762.
26. Tychsen, L., et al., *The neural mechanism for latent (fusion maldevelopment) nystagmus*. *Journal of Neuro-Ophthalmology*, 2010. **30**(3): p. 276-283.
27. Parker, A.J., *Binocular depth perception and the cerebral cortex*. *Nature Reviews Neuroscience*, 2007. **8**(5): p. 379-391.
28. Regan, D. and K. Beverley, *Some dynamic features of depth perception*. *Vision research*, 1973. **13**(12): p. 2369-2379.
29. Banks, M.S., et al., *Consequences of incorrect focus cues in stereo displays*. *Journal of the Society for Information Display*, 2008. **24**(7): p. 7.
30. Sanada, T.M. and G.C. DeAngelis, *Neural representation of motion-in-depth in area MT*. *The Journal of Neuroscience*, 2014. **34**(47): p. 15508-15521.
31. Sakano, Y., R.S. Allison, and I.P. Howard, *Motion aftereffect in depth based on binocular information*. *Journal of Vision*, 2012. **12**(1): p. 11.
32. Regan, D., *Binocular correlates of the direction of motion in depth*. *Vision Research*, 1993. **33**(16): p. 2359-2360.
33. Czuba, T.B., et al., *Speed and eccentricity tuning reveal a central role for the velocity-based cue to 3D visual motion*. *Journal of Neurophysiology*, 2010. **104**(5): p. 2886-2899.
34. Harris, J.M. and S.K. Rushton, *Poor visibility of motion in depth is due to early motion averaging*. *Vision Research*, 2003. **43**(4): p. 385-392.
35. Sumnall, J.H. and J.M. Harris, *Binocular three-dimensional motion detection: contributions of lateral motion and stereomotion*. *JOSA A*, 2000. **17**(4): p. 687-696.
36. Barlow, H. and R. Hill, *Evidence for a physiological explanation of the waterfall phenomenon and figural after-effects*. 1963.
37. Fründ, I., N.V. Haenel, and F.A. Wichmann, *Inference for psychometric functions in the presence of nonstationary behavior*. *Journal of vision*, 2011. **11**(6): p. 16.
38. Czuba, T.B., et al., *Three-dimensional motion aftereffects reveal distinct direction-selective mechanisms for binocular processing of motion through depth*. *Journal of Vision*, 2011. **11**(10): p. 18-18.
39. Harris, J.M., H.T. Nefs, and C.E. Grafton, *Binocular vision and motion-in-depth*. *Spatial vision*, 2008. **21**(6): p. 531-547.
40. Nefs, H.T., L. O'hare, and J.M. Harris, *Two independent mechanisms for motion-in-depth perception: Evidence from individual differences*. *Frontiers in Psychology*, 2010. **1**: p. 155.
41. Sexton, I. and P. Surman, *Stereoscopic and autostereoscopic display systems*. *Signal Processing Magazine, IEEE*, 1999. **16**(3): p. 85-99.
42. Geng, J., *Three-dimensional display technologies*. *Advances in optics and photonics*, 2013. **5**(4): p. 456-535.
43. Lambooi, M., et al., *Visual discomfort and visual fatigue of stereoscopic displays: a review*. *Journal of Imaging Science and Technology*, 2009. **53**(3): p. 30201-1-30201-14.
44. Javidi, B. and F. Okano, *Three-dimensional television, video, and display technologies*. 2002: Springer Science & Business Media.
45. Barkowsky, M., et al. *55.3: Crosstalk Measurements of Shutter Glasses 3D Displays*. in *SID Symposium Digest of Technical Papers*. 2011. Wiley Online Library.
46. Blondé, L., et al. *55.1: Diversity and Coherence of 3D Crosstalk Measurements*. in *SID Symposium Digest of Technical Papers*. 2011. Wiley Online Library.

47. Roberts, D.E., *History of lenticular and related autostereoscopic methods*. Leap Technologies. Hillsboro, 2003: p. 16.
48. Kooi, F.L. and A. Toet, *Visual comfort of binocular and 3D displays*. Displays, 2004. **25**(2): p. 99-108.
49. ITU-R, *Subjective assessment of stereoscopic television pictures*, in *ITU-R Recommendation BT.1438*. 2000.
50. Thomas, S., et al., *Vertical deviation exacerbated by convergence and accommodation*. British journal of ophthalmology, 2005. **89**(10): p. 1371-1372.
51. Kim, J., et al., *Response pattern asymmetry of binocular vision vertical fusion amplitudes in a normal population*. Binocular vision & strabismus quarterly, 2007. **23**(1): p. 23-30.
52. Sharma, K. and A.S. Abdul-Rahim, *Vertical fusion amplitude in normal adults*. American journal of ophthalmology, 1992. **114**(5): p. 636.
53. Chern, K.C. and K.W. Wright, *Review Questions in Ophthalmology: A Question and Answer Book*. 2004: Lippincott Williams & Wilkins.
54. Kertesz, A.E., *Effect of stimulus size on fusion and vergence*. JOSA, 1981. **71**(3): p. 289-293.
55. Howard, I., R.S. Allison, and J.E. Zacher, *The dynamics of vertical vergence*. Experimental Brain Research, 1997. **116**(1): p. 153-159.
56. Perlmutter, A.L. and A.E. Kertesz, *Measurement of human vertical fusional response*. Vision research, 1978. **18**(2): p. 219-223.
57. Bharadwaj, S.R., et al., *Variation of binocular-vertical fusion amplitude with convergence*. Investigative ophthalmology & visual science, 2007. **48**(4): p. 1592.
58. Stevenson, S., L. Lott, and J. Yang, *The influence of subject instruction on horizontal and vertical vergence tracking*. Vision research, 1997. **37**(20): p. 2891-2898.
59. Ulyat, K., A. Firth, and H. Griffiths, *Quantifying the vertical fusion range at four distances of fixation in a normal population*. British and Irish Orthoptic Journal, 2004. **1**: p. 43-45.
60. Speranza, F. and L.M. Wilcox. *Viewing stereoscopic images comfortably: the effects of whole-field vertical disparity*. in *Electronic Imaging 2002*. 2002. International Society for Optics and Photonics.
61. Tam, W.J., et al., *Stereoscopic 3D-TV: visual comfort*. Broadcasting, IEEE Transactions on, 2011. **57**(2): p. 335-346.
62. Srivastava, A.K., J. de Bougrenet de La Tocnaye, and L. Dupont, *Liquid crystal active glasses for 3D cinema*. Journal of Display Technology, 2010. **6**(10): p. 522-530.
63. Yu, X., et al., *Autostereoscopic three-dimensional display with high dense views and the narrow structure pitch*. Chinese Optics Letters, 2014. **12**(6): p. 060008.
64. Howard, I. and B. Rogers, *Perceiving in Depth, Volume 2: Stereoscopic Vision, no. 29*. 2012, Oxford University Press.
65. Boher, P.M. and T. Leroux, *Optical characterization of 3D displays*.
66. Hara, N., et al., *Effect of horizontal vergence on the motor and sensory components of vertical fusion*. Investigative Ophthalmology and Visual Science, 1998. **39**: p. 2268-2276.
67. Howard, I.P., et al., *Effects of stimulus size and eccentricity on horizontal and vertical vergence*. Experimental Brain Research, 2000. **130**(2): p. 124-132.
68. Berry, R.N., L.A. Riggs, and C.P. Duncan, *The relation of vernier and depth discriminations to field brightness*. Journal of experimental psychology, 1950. **40**(3): p. 349.
69. Didyk, P., et al., *A luminance-contrast-aware disparity model and applications*. ACM Transactions on Graphics (TOG), 2012. **31**(6): p. 184.
70. Zhou, M., et al., *A Unified Method for Crosstalk Reduction in Multiview Displays*. Display Technology, Journal of, 2014. **10**(6): p. 500-507.

71. Li, X.-F., et al., *Image processing to eliminate crosstalk between neighboring view images in three-dimensional lenticular display*. Journal of Display Technology, 2011. **7**(8): p. 443-447.
72. Di Z, P.N., Yulia F, Stéphanie F, Mathieu L, J-L Jean-Louis de Bougrenet de la Tocnaye *Target properties effects on vertical fusion amplitude (VFA) based on applied 3D platform and quantitative assessment of central and peripheral vertical fusion interaction* Current Eye Research, 2015.
73. Thibaut, M., et al., *The contribution of central and peripheral vision in scene categorization: A study on people with central vision loss*. Vision research, 2014. **98**: p. 46-53.
74. BURIAN, H.M., *Fusional movements: role of peripheral retinal stimuli*. Archives of Ophthalmology, 1939. **21**(3): p. 486.
75. Winkelman, J., *Peripheral fusion*. AMA archives of ophthalmology, 1951. **45**(4): p. 425-430.
76. Houtman, W. and B. van der Pol, *Fusional movements by peripheral retinal stimulation ('peripheral motor fusion')*. Graefe's Archive for Clinical and Experimental Ophthalmology, 1982. **218**(4): p. 218-220.
77. Momeni-Moghaddam, H., et al., *Induced vertical disparity effects on local and global stereopsis*. Current eye research, 2013. **39**(4): p. 411-415.
78. Matheron, E., et al., *Effects of ocular dominance on the vertical vergence induced by a 2-diopter vertical prism during standing*. Neuroscience letters, 2008. **444**(2): p. 176-180.
79. Ogle, K.N., *Observations on vertical divergences and hyperphorias*. AMA archives of ophthalmology, 1953. **49**(3): p. 313-334.
80. O'Connor, A.R., et al., *The functional significance of stereopsis*. Investigative ophthalmology & visual science, 2010. **51**(4): p. 2019-2023.
81. Birch, E., et al., *Randot® Preschool Stereoacuity Test: Normative data and validity*. Journal of American Association for Pediatric Ophthalmology and Strabismus, 2008. **12**(1): p. 23-26.
82. Richards, W. and D. Regan, *A stereo field map with implications for disparity processing*. Investigative Ophthalmology & Visual Science, 1973. **12**(12): p. 904-909.
83. Regan, D., K. Beverley, and M. Cynader, *The visual perception of motion in depth*. Scientific American, 1979.
84. Regan, D., et al., *Stereoscopic Subsystems for Position in Depth and for Motion in Depth [and Discussion]*. Proceedings of the Royal Society of London B: Biological Sciences, 1979. **204**(1157): p. 485-501.
85. Iwami, T., et al., *Common neural processing regions for dynamic and static stereopsis in human parieto-occipital cortices*. Neuroscience letters, 2002. **327**(1): p. 29-32.
86. Watanabe, Y., et al., *A new method for assessing motion-in-depth perception in strabismic patients*. British Journal of Ophthalmology, 2008. **92**(1): p. 47-50.
87. Handa, T., et al., *Effect of motion stimulation without changing binocular disparity on stereopsis in strabismus patients*. American Orthoptic Journal, 2010. **60**(1): p. 87-94.
88. Regan, D., C. Erkelens, and H. Collewijn, *Necessary conditions for the perception of motion in depth*. Investigative Ophthalmology & Visual Science, 1986. **27**(4): p. 584-597.
89. Harris, J.M. and P.J. Dean, *Accuracy and precision of binocular 3-D motion perception*. Journal of Experimental Psychology: Human Perception and Performance, 2003. **29**(5): p. 869.
90. Howard, I.P., Y. Fujii, and R.S. Allison, *Interactions between cues to visual motion in depth*. Journal of vision, 2014. **14**(2): p. 14.
91. Barendregt, M., S.O. Dumoulin, and B. Rokers, *Stereomotion scotomas occur after binocular combination*. Vision research, 2014. **105**: p. 92-99.
92. Julesz, B., *Binocular depth perception without familiarity cues*. Science, 1964. **145**(3630): p. 356-362.

93. Stevenson, S.B., L.K. Cormack, and C.M. Schor, *The effect of stimulus contrast and interocular correlation on disparity vergence*. Vision Research, 1994. **34**(3): p. 383-396.
94. Brooks, K.R. and L.S. Stone, *ACCURACY OF STEREOMOTION SPEED PERCEPTION WITH PERSISTING AND DYNAMIC TEXTURES 1*. Perceptual and motor skills, 2010. **111**(3): p. 921-935.
95. Allison, R.S., et al., *Stereoscopic motion in depth*. Vision in 3D environments, 2011: p. 163-186.
96. Thompson, P., *Perceived rate of movement depends on contrast*. Vision research, 1982. **22**(3): p. 377-380.
97. Fulvio, J.M., M.L. Rosen, and B. Rokers, *Sensory uncertainty leads to systematic misperception of the direction of motion in depth*. Attention, Perception, & Psychophysics, 2015: p. 1-12.
98. Stone, L.S. and P. Thompson, *Human speed perception is contrast dependent*. Vision research, 1992. **32**(8): p. 1535-1549.
99. Harris, J.M., *The interaction of eye movements and retinal signals during the perception of 3-D motion direction*. Journal of Vision, 2006. **6**(8): p. 2.
100. Welchman, A.E., J.M. Harris, and E. Brenner, *Extra-retinal signals support the estimation of 3D motion*. Vision Research, 2009. **49**(7): p. 782-789.
101. Miles, F. and S. Judge, *Optically-induced changes in the neural coupling between vergence eye movements and accommodation in human subjects*. Functional basis of ocular motility disorders, 1982: p. 93-96.
102. Fattakhova, Y., et al., *Impact of absolute disparities on motion in depth perception in stereoscopic displays*. Perception ECVP abstract, 2013. **42**: p. 118-118.
103. Neveu, P., et al., *Vergence tracking: a tool to assess oculomotor performance in stereoscopic displays*. Journal of Eye Movement Research, 2012. **5**(2): p. 1-1.
104. Neveu, P., et al., *Short exposure to telestereoscope affects the oculomotor system*. Ophthalmic and Physiological Optics, 2010. **30**(6): p. 806-815.
105. Mustillo, P., et al., *Anisotropies in global stereoscopic orientation discrimination*. Vision Research, 1988. **28**(12): p. 1315-1321.
106. Shirai, N. and M.K. Yamaguchi, *Asymmetry in the perception of motion-in-depth*. Vision research, 2004. **44**(10): p. 1003-1011.
107. Ohlsson, J., et al., *Screening merits of the Lang II, Frisby, Randot, Titmus, and TNO stereo tests*. Journal of American association for pediatric ophthalmology and strabismus, 2001. **5**(5): p. 316-322.
108. Ding, J. and D.M. Levi, *Recovery of stereopsis through perceptual learning in human adults with abnormal binocular vision*. Proceedings of the National Academy of Sciences, 2011. **108**(37): p. E733-E741.
109. Chang, D.H., Z. Kourtzi, and A.E. Welchman, *Mechanisms for extracting a signal from noise as revealed through the specificity and generality of task training*. The Journal of Neuroscience, 2013. **33**(27): p. 10962-10971.
110. Fujikado, T., et al., *Use of dynamic and colored stereogram to measure stereopsis in strabismic patients*. Japanese journal of ophthalmology, 1998. **42**(2): p. 101-107.

Appendix A

Questionnaire for vertical disparity test

1. Is this stimulation difficult?

Yes	No
-----	----

If yes, which stimulus?

2. Which color of background is more comfortable

White	Black
-------	-------

3. Which stimulation is more comfortable

Single line	Multilines
-------------	------------

4. Which condition of the test is easier ?

Light on	Light off
----------	-----------

5. What is the colour of the scene (white background) ?

6. What is the colour of the lines (white lines) ?

7. Do you see the motion of the line like wave motion ?

Yes	No
-----	----

Appendix B

1. Have you seen double cross during stimulation session? (Yes No)
2. If so, do you see double cross when it moved forward, backward or at both direction?
(forward/ backward/ Both direction)
3. If so, during which period you see most of the double corss? At the beginning, middle, or end of the experiment? (Beginning, Middle, End)
4. Is this test difficult for you (telling the cross motion direction)? (difficult, easy, normal)

Appendix C. Statistics

The t-test

The version of t-test depends on whether the design is between or within-subjects.

Between-subjects t-test

There are two groups of subjects, one acts as the experimental group and receives treatment, the other is the control group which does not receive treatment. The difference between the two groups is compared using between-subjects t-test.

The equation for the between-subjects t-test is

$$t = \frac{\bar{x}_1 - \bar{x}_2}{\sqrt{\left(\frac{((n_1-1) \times s_1^2) + ((n_2-1) \times s_2^2)}{n_1 + n_2 - 2} \right) \times \left(\frac{1}{n_1} + \frac{1}{n_2} \right)}} \quad (C.1)$$

Where \bar{x}_1 and \bar{x}_2 are the means for the two groups

n_1 and n_2 are the sample size for the two groups

s_1^2 and s_2^2 are the variances for the two groups

$\frac{((n_1-1) \times s_1^2) + ((n_2-1) \times s_2^2)}{n_1 + n_2 - 2}$ is the pooled variance, that is the variance for the two groups combinations.

When the sample sizes are the same, the equation becomes simpler

$$t = \frac{\bar{x}_1 - \bar{x}_2}{\sqrt{\frac{s_1^2 + s_2^2}{n}}} \quad (C.2)$$

Within-subjects t-test

To test the performance difference between two conditions based on one group.

The equation for this version of the t-test is :

$$\text{Within-subject } t = \frac{\text{mean of the differences}}{\frac{\text{SD of the difference}}{\sqrt{\text{sample size}}}} \quad (C.3)$$

One-way within-subjects ANOVA

To test the performance variation under more than two conditions based on one sample. For example, the visual comfort for different images: each subjects give there visual comfort scores for three groups of images.

The sources of variation in scores are the total variation:

- 1) the variation due to the subjects—between subjects
- 2) the variation due to the combination of the subjects and the treatment—within subjects

so, the total sum of squared deviations can be split into:

$$\text{total S of S} = \boxed{\text{Subjects S of S}} + \boxed{\text{Subjects S of S + residual S of S}}$$

between subjects within subjects

The χ^2 goodness-of-fit test

The test is used to compare the frequencies found in a set of data with those which would occur under the NULL Hypothesis. It also could be used to compare the data distribution with what would be predicted if the data had a particular theoretical distribution, such as the normal distribution. A statistically significant result in such test indicates that the data did not conform the NULL Hypothesis or to the theoretical distribution.

An example for the use of the test could be the experiment given in Chapter 3: for the fusion of vertical disparity on the screen, there is a percentage of subjects who can fuse the vertical disparity at certain viewing distance, and the percentage value varies according to different viewing distance. A theoretical distribution should be: there are always 100% subjects that fuse the vertical disparity at each viewing distance.

The χ^2 test compares the observed frequencies (f_0) with the expected frequencies (f_e) to see if they differ statistically significantly. The following equation is used:

$$\chi^2 = \frac{\sum(f_0 - f_e)^2}{f_0} \quad (\text{C.4})$$

Sommaire :

La technologie 3D est un moyen important de présenter des informations. L'utilisation de la disparité binoculaire pour stimuler la perception de la troisième dimension a été inventée à la fin du 19^{ème} siècle. La perception de la profondeur qui est générée par la disparité binoculaire est plus convaincante et plus robuste que la perception de profondeur stimulée par des indices monoculaires. Un certain nombre d'applications de la technologie 3D ont été largement mis en œuvre dans la visualisation scientifique et de mesure, l'imagerie médicale, la télé, les jeux, ainsi que des films et des téléviseurs.

Le confort de visualisation a été un objectif permanent dans la recherche stéréoscopique en raison du développement des technologies 3D. Cependant, divers paramètres affectent la perception de la vision stéréo, et la classification des facteurs est divisée en plusieurs catégories. Sur l'aspect de la technologie d'affichage 3D, la perception visuelle n'est pas la même chose avec des écrans autostéréoscopiques, affichages volumétriques et des affichages holographiques. Si l'on considère l'effet du contenu 3D, les facteurs comprennent la distribution des disparités, asymétries binoculaires, diaphonie intraoculaire, incohérences de profondeur, etc. qui plus est, les paramètres de la vision humaine conduiront à la perception différente de la stéréoscopie, comme Incohérences perceptives et cognitives, le conflit de la convergence et de l'hébergement, la différence intraoculaire en luminance et le contraste, l'acuité visuelle, l'acuité stéréo, âges, etc. Même la méthode pour évaluer l'expérience de la perception visuelle pourrait être objective ou subjective, la mesure pourrait être la fatigue visuelle ou l'inconfort. Quand la fatigue visuelle est évaluée, il est généralement fait référence à une diminution des performances du système visuel présenté par une modification physiologique. Par conséquent, la fatigue visuelle peut être mesurée avec une réponse physiologique, telle que les changements dans la réponse de l'hébergement, le diamètre pupillaire, et les caractéristiques des mouvements oculaires. L'inconfort visuel d'autre part, se réfère à la sensation subjective d'un inconfort qui accompagne le changement physiologique. Ainsi, le confort visuel peut être mesuré grâce aux réponses des sujets pour le niveau de confort visuel

perçu. La disparité est un repère fondamental pour la génération de perception stéréoscopique, il dispose de deux types : disparité horizontale et disparité verticale. La disparité horizontale est le composant principal pour stimuler la stéréovision, la perception visuelle différente pourrait être atteinte en modifiant les caractères de disparité horizontale. Diverses tentatives ont été faites pour explorer les facteurs qui auront une incidence sur la perception 3D visuelle, qui pourraient être regroupées en quatre aspects : la technologie d'affichage 3D, l'environnement de visualisation 3D, le contenu 3D et des personnages binoculaires du système visuel.

Dans la thèse actuelle, nous avons mesuré la réponse physiologique d'observateur à une certaine stimulation pour évaluer la perception visuelle. Nous avons choisi les aspects qui sont le plus en rapport avec le processus de perception dans la pratique lorsque la technologie 3D est appliquée. Tout d'abord, la plate-forme 3D d'affichage est obligatoire lorsque nous avons besoin de présenter les médias 3D et la technologie d'affichage différent, apporter une expérience de visualisation différente. Deuxièmement, quand nous regardons de la 3D, nous sommes dans un certain environnement de visualisation, la configuration de l'environnement sera affecté de façon significative la perception visuelle, comme la façon de décider de la taille de l'écran, quelle est la meilleure distance de visionnement, comment contrôler la luminance la salle de spectacle, etc. Enfin, l'introduction d'un contenu 3D approprié pour les observateurs est fondamental pour une perception réussie et confortable. Lorsque nous créons un stimulus 3D, il y a beaucoup de facteurs à prendre en considération pour le contenu 3D, par exemple, la gamme de profondeur, la vitesse de déplacement de mouvement en profondeur, et les critères des paramètres de la vision humaine doivent être également examinés parce que les paramètres visuels des observateurs varient considérablement.

Il y a trois aspects suivants pour la thèse:

- Effet de la technologie d'affichage 3D sur la perception visuelle

Les technologies 3D ont apporté une grande possibilité d'équipements pour le divertissement, l'éducation, le médical et les applications militaires. Cependant, les questions de confort visuel se posent avec la diffusion des technologies d'affichage 3D en raison de nombreux concepts, et de la technologie d'affichage 3D est l'une des questions cruciales. Parmi les technologies d'affichage 3D actuelles, l'affichage stéréoscopique et autostéréoscopique sont le plus largement utilisés, en raison de leurs applications faciles et économiques dans la vie réelle. Par conséquent, nous pensons qu'il est intéressant et significatif de faire une comparaison de l'expérience visuelle entre les deux technologies. Cette étude peut fournir des références et des recommandations pour le choix de la cible d'affichage, la technologie d'affichage et configurations d'environnement de visualisation.

Il existe plusieurs variétés d'indicateurs pour évaluer le confort visuel, comme la méthode d'évaluation subjective avec laquelle les observateurs donnent leur score de confort. Il y a aussi quelques paramètres visuels couramment utilisés dans l'affichage de l'évaluation du confort, comme la taille de la pupille, la précision de la réponse ou le temps de réponse, etc. Dans la présente étude, nous avons choisi l'amplitude de fusion de disparité verticale comme indicateur de l'expérience visuelle.

Parce que les yeux sont situés horizontalement sur la tête, il doit y avoir une légère différence entre les points de vue de l'œil droit et l'œil gauche. Mais la perception d'un écart horizontal est un mécanisme naturel pour l'homme, et l'information de profondeur pourrait être calculée par l'écart horizontal entre les yeux. Cependant, ce n'est pas le même cas pour la disparité verticale, notre système visuel a moins de tolérance substantielle pour la disparité verticale Comparer avec la disparité horizontale. La disparité verticale est le déplacement vertical des vues entre l'œil droit et l'œil gauche, normalement, légère valeur de disparité verticale pourrait être fusionné par le cerveau et les observateurs pouvait encore percevoir la vision unique. Néanmoins, lorsqu'une grande valeur de disparité verticale est induite, la fusion verticale est interrompue et l'observateur percevra diplopie ou de rivalité. La disparité verticale maximale qui

peut être fusionnée est appelée amplitude de fusion verticale (vertical fusion amplitude : VFA).

Comme un indicateur de la tolérance de la vision de désalignement vertical binoculaire, la VFA est mesurée dans de nombreuses études, tant dans des conditions cliniques et pratiques. Pour VFA de l'application clinique, le seuil moyen est compris entre $3-5\Delta$, en général, cette valeur est mesurée à l'aide de prismes. Pour la norme VFA dans la pratique, il a plus de paramètres en raison de la complexité de la condition de visualisation réelle. Tels que la distance de visualisation, cibler la complexité, la vitesse de la disparité et la convergence des yeux, même l'instruction donnée au sujet et à l'œil dominant aura une influence sur elle. Dans certaines études, VFA est mesurée en utilisant un haploscope ou un affichage stéréoscopique, dont la vocation est de représenter les images verticalement désalignement séparément pour les yeux droit et gauche, et ces différentes mesures pourrait également conduire à VFA écart.

Pour la technologie d'affichage 3D actuel, un mauvais alignement des images stéréo est l'un des problèmes cruciaux pour l'expérience visuelle. Mais le standard de la disparité verticale qui mène à la fatigue visuelle ne fait pas encore l'objet d'un accord. Plusieurs études ont observé comment réduire l'inconfort lors de la disparité verticale est induite, tandis que d'autres ont suggéré que le système de vision avait une tolérance relativement élevée pour la disparité verticale. La raison de ces conclusions opposées est que l'effet de disparité verticale sur le confort visuel a été évalué sans tenir compte des conditions d'essai et les technologies d'affichage. Avec le développement de la technologie d'affichage 3D, différents types d'affichage ont été appliqués dans la vie normale, mais les enquêtes spécifiques de tolérance de disparité verticale sur les principales technologies d'affichage restent à être complétées.

Dans la thèse, nous proposons des mesures complètes psychophysiques de tolérance visuelle pour la disparité verticale à l'aide de cibles de test classiques sur les principales technologies 3D actuelles : projecteurs 3D et TV autostéréoscopique lenticulaire. Considérant certains paramètres, une

comparaison VFA sur la technologie de deux affichages contemporains est réalisée. L'hypothèse est que les sujets donneront des performances différentes sur les deux plates-formes en raison des caractéristiques spécifiques des technologies 3D. Sur la base des résultats expérimentaux, des recommandations pour l'installation de l'environnement d'affichage 3D et la configuration est identifié.

- l'impact des paramètres de l'environnement sur la perception visuelle des objets 3D stéréo

Chaque présentation 3D a lieu dans un certain environnement, peu importe quelle est la perspective : diagnostic clinique, la recherche en laboratoire ou des applications quotidiennes, il y a toujours des éléments de base, comme la plate-forme d'affichage, les observateurs et l'environnement de la projection 3D. Cependant, il y a des paramètres qui ont un effet critique sur la perception visuelle pour la visualisation 3D et il y a des facteurs qui influent sur l'expérience visuelle légèrement, ou certains facteurs qui n'affectent notre perception visuelle sous certaines conditions. Parmi ces paramètres, l'interaction entre les zones de vision centrale et périphérique est une condition préalable et suit toute la période d'observation.

Il existe plusieurs classifications sur les zones de vision centrale et périphérique. A propos de l'aspect de l'affichage, l'écran ou moyenne qui affiche l'objet 3D est les zones d'observation centrale, les objets autour de la zone d'affichage appartiennent à périphérique. Sur l'aspect de la fixation, la zone centrale est l'endroit où les yeux se concentrent, et qui correspond à une petite partie, et le reste de l'écran est considéré comme périphérique. Cependant, si nous prenons la structure de l'œil en considération, la rétine pourrait être divisée en fovéa et para fovéa centrale, où l'acuité visuelle et la sensibilité est le maximum à fovéa centrale tandis que la fovéa para est responsable de la détection de mouvement. Les deux visions centrales et périphériques sont importantes pour la

reconnaissance de contenus. Les avantages de la vision centrale (la fovéa et parafovéa) sont la résolution et la sensibilité plus visuelle pour la reconnaissance d'objets. La vision périphérique sert à résoudre le problème des basses fréquences spatiales et d'en extraire la partie principale d'une scène. Il a été rapporté que si la scène est divisée en une zone centrale et une zone périphérique, alors montrer la région périphérique, tout en bloquant la région centrale n'affectera pas la perception de la scène entière, mais si l'on montre la zone centrale tout en bloquant la région périphérique, alors l'observateur aura des difficultés à reconnaître l'ensemble des informations. Ce résultat indique que la périphérie est plus utile que la vision centrale pour une performance maximale, certains patients qui ont perdu la vision centrale peuvent efficacement catégoriser des scènes naturelles avec l'aide de la vision périphérique. Cependant, la vision centrale est plus efficace que la périphérique quant à la reconnaissance des caractéristiques précises.

Lorsque la vision centrale et périphérique est évaluée en visualisation stéréoscopique, la disparité a souvent été impliquée, en raison de son rôle essentiel dans la perception stéréoscopique. Le processus de fusion de la disparité a été étudié dans un large éventail d'études.

Des études antérieures ont indiqué que la fusion centrale pourrait être interrompue par la disparité périphérique et la capacité de fusion est passée de la fovéa vers la périphérie. Pour la compréhension actuelle du mécanisme interactif de fusion centrale et périphérique, d'autres explorations sont nécessaires, en termes de direction et l'effet l'intensité de la disparité périphérique sur la fusion centrale.

En outre, la plupart des études sur la fusion verticale de disparité sont réalisées avec des appareils spécifiques dans des conditions limitées. Peu de mesures ont été effectuées dans un environnement de visualisation réel en utilisant les écrans grand public. Cette diversité pourrait se traduire par un écart pour les critères de mesure VFA, en position verticale, le seuil de disparité de fusion est donné comme référence pour phoria verticales dans le traitement clinique ou de contenu 3D affiche. Stereoscopic 3D est aujourd'hui une expérience universelle

souvent présentée dans des environnements de projection complexes et non contrôlés, ce qui entraîne des conflits possibles entre la perception de la région centrale de la vue d'un affichage 3D et le monde réel autour. Ce problème est atténué dans les salles de cinéma par la grande taille de l'écran et l'obscurité environnante. En revanche, il est plus important pour la 3D à la maison TV ou un écran d'ordinateur lorsque des objets périphériques sont perçus dans le voisinage immédiat. Dans cette étude, nous avons réalisé les expériences dans un environnement relativement pratique avec un projecteur 3D commercial, visant à explorer la performance des observateurs dans un environnement de visualisation normal. Les hypothèses pour ces expériences est que la performance de sujets sera significativement affectée par la configuration de l'environnement différent ou manipulation cible, en outre, l'interaction entre le central et périphérique pourrait être évaluée quantitativement en changeant la taille du stimulus sur la rétine. En procédant à une série d'expériences, nous sommes appelés à identifier la configuration de l'environnement de visualisation 3D approprié dans un état réel de la vue.

Dans cette thèse, nous avons évalué l'interaction de fusion centrale et périphérique en introduisant la disparité verticale. En modifiant le rapport de la taille centrale et périphérique de stimulation, les réponses fusionnelles de disparité verticale ont été enregistrées, et l'interaction de fusion centrale et périphérique en fonction du taux de stimulation est analysée de manière objective. Dans des études précédentes, l'influence de la fusion périphérique est seulement indiquée subjectivement, comment et à quel point l'interaction se produit a rarement été étudié. Nous avons conçu une série d'expériences pour compléter ce manque de représentation quantitative. La première expérience a testé l'interaction entre fusion central et périphérique en insérant une série de prismes de base dans la vision périphérique. Ensuite, VFA a été mesurée à différentes distances d'observation avec la disparité périphérique induite constante, qui vise à évaluer l'interaction centrale et périphérique fusion en fonction de la taille du stimulus.

- Perception de motion en profondeur

L'un des désavantages de la perception en deux dimensions (2D) est le manque d'informations sur la profondeur, y compris les informations sur la position de l'objet dans l'espace, sa direction de déplacement et sa vitesse. Il est très important d'avoir la perception 3D, car le déficit de vision stéréoscopique n'aura pas pour seules conséquences de rendre la perception moins vive, mais génèrera aussi des limites pour certaines professions, comme un médecin faisant une chirurgie très précise, ou un pilote au volant d'une voiture sur une route très chargée, ou même dans notre vie quotidienne, il sera difficile de mettre un fil dans une aiguille sans vision stéréo, où une compréhension précise de l'orientation structurelle est nécessaire. En dépit des limites de la perception 2D, les gens ont été formés ou ont appris à extraire des informations de profondeur à partir d'images 2D. Néanmoins, il est probable qu'une haute définition efficace de l'affichage 3D permettrait d'améliorer la perception de profondeur, ce qui est particulièrement important pour certaines tâches qui nécessitent une grande précision (par exemple le médecin en train de faire une chirurgie). L'ajout d'une vision binoculaire grâce à la technologie d'imagerie 3D et l'affichage d'une texture fournit plus de repères qui permet de mieux éclairer les relations de profondeur, d'améliorer l'expérience de visionnement et de réduire les erreurs de perception du mouvement. Cependant, en dépit des avantages évidents de la stéréoscopie, il y a plusieurs inconvénients compte tenu de la technologie d'affichage 3D en cours, tels que le manque de mouvement en profondeur (motion-in-depth: MID) la perception et la fatigue visuelle.

En général, la vision stéréo est évaluée par l'acuité stéréo. L'acuité stéréo est l'un des attributs clés pour la perception visuelle statique en détail. Une bonne acuité stéréo permet aux gens de profiter d'une observation plus vive dans la vie quotidienne. Il est aussi beaucoup utilisé dans des expériences cliniques et de laboratoire comme un paramètre essentiel pour la vision binoculaire. Normalement, l'acuité stéréo est mesurée par plusieurs méthodes telles que les tests stéréo Randot et Contour. Cependant, à notre connaissance, ces mesures

sont basées sur des tests de vision stéréoscopique statiques, qui ne pouvaient pas fournir suffisamment d'informations sur la capacité de vision binoculaire. Une acuité stéréo normale statique a été un critère général pour la plupart des expériences physiologiques sans considérer si elle est égale à la bonne performance visuelle pour stéréos dynamique. Des études antérieures ont exploré les régions et les mécanismes de traitement neural pour stéréos dynamique et statique dans la vision humaine. Il est rapporté que les écarts statiques et dynamiques sont traités par des mécanismes séparés. Sous réserve qui pourrait répondre normalement à la disparité statique peut avoir des performances dégradées avec la disparité dynamique ou vice versa. Plus récemment, grâce à la technologie d'électroencéphalographie on observe que les deux informations dynamiques et statiques stéréo sont traitées dans la partie pariéto-occipital dorsale. Une évaluation de perception MID par des patients atteints de strabisme a été réalisée pour comparer la perception de la stéréo dynamique et statique, la perception de la profondeur était une clé pour l'évaluation de la stéréo dynamique et statique. La corrélation faible du seuil entre le test de mouvement stéréo et un test stéréo statique n'est pas trouvé. Néanmoins, la relation entre l'acuité stéréo et la perception MID est pas bien déterminée, et la plasticité du MID perception reste à étudier plus en profondeur.

La perception de la profondeur pourrait être améliorée par la formation perceptive. La formation perceptive est une méthode pour améliorer la performance visuelle. A la suite de la formation ou de la pratique, il y a beaucoup de tâches visuelles appliquées à travers l'apprentissage perceptif: acuité visuelle, la résolution de l'acuité, la discrimination fondée sur l'orientation, la perception de la direction du mouvement, perception du contraste, perception de la profondeur dans stéréogrammes de points aléatoires (RDS), etc. Cependant, MID perception est un processus plus complexe que la perception de la profondeur statique, et il peut être stimulé par divers stimuli, il ne nécessite pas seulement une bonne acuité visuelle, mais aussi la coopération binoculaire et une bonne réponse du processus neural. Mais la formation perceptive pour le mouvement de la profondeur n'a pas été pleinement explorée.

Le but principal de la technologie stéréoscopique est de stimuler la vision stéréo en affichant tous les types de médias 3D. Dans des études précédentes, les conditions qui pourraient stimuler la perception de mouvement en profondeur et les mécanismes qui traitent les informations ont été largement étudiées. Parmi tous les stimuli expérimentaux, stéréoscopie points aléatoires (RDS) et la stéréoscopie aléatoire dot dynamique (DIRD) ont été largement mis en œuvre pour étudier la perception visuelle de la disparité binoculaire et le mouvement en profondeur (MID) perception.

Dans la thèse, nous avons réalisé une série d'expériences pour étudier les différents aspects au sujet de MID perception, y compris le mouvement suivant généré par MID stimulus, la formation de l'expérience MID pour les sujets naïfs et comment créer un stimulus MID permettant une meilleure perception. Nous nous attendions à étudier le lien entre le système sensoriel et oculomoteur pour la perception MID, et de parvenir à l'atténuation des conflits d'accommodation/vergence pour la technologie 3D conventionnelle basée sur le lien. En outre, la taille de l'échantillon pourrait être élargie par la formation et la mise en œuvre d'un stimulus MID le plus approprié, qui viendra consolider les expériences MID similaires.

Cette thèse a fait une exploration complète de la perception binoculaire humaine, basée sur les outils d'optométrie commerciaux. Les résultats de la recherche conduiront à des implications plus larges, y compris la formation de la vision, la recherche cognitive, l'amélioration de la technologie 3D et de diagnostic de troubles neuronaux.

Résumé

Le confort de visualisation a été un objectif permanent dans la recherche stéréoscopique en raison du développement des technologies 3D. Cependant, divers paramètres affectent la perception de la vision stéréo. Dans cette thèse, une série d'expériences physiologiques ont été menées visant à évaluer la perception visuelle 3D par rapport à 3 des facteurs les plus importants: la technologie d'affichage 3D, les environnements de visualisation et de mouvement en profondeur (MID). Nous avons d'abord mesuré l'amplitude de fusion verticale (VFA) sur les projecteurs 3D et une télévision autostéréoscopique. Le VFA a été choisi comme un indicateur pour le confort visuel en raison de notre forte sensibilité à la disparité verticale. Plusieurs facteurs ont été testés (e.g. distance d'observation, la luminance du fond, la diaphonie, l'angle de vue, etc.). Nous avons comparé les performances d'observateur sur les deux écrans 3D et conclu que la tolérance pour la disparité verticale était meilleure sur le projecteur 3D que sur la télévision autostéréoscopique. Pour l'impact de l'environnement sur la perception stéréo, nous avons mesuré le VFA sur un projecteur 3D en fonction de l'éclairage de la pièce, de la complexité du contenu 3D, de la vitesse de disparité. Nous avons évalué l'interaction entre la fusion centrale et périphérique, en introduisant une série de prismes en face d'un œil. Nous avons observé que l'équilibre de la fusion entre vision centrale et périphérique était rompu quand de grandes disparités périphériques (> 4 dioptries prismatiques) ou tailles de stimuli (angle central du stimulus $< 15^\circ$) étaient induites sur la vision périphérique. Enfin, nous avons étudié l'interaction entre le système sensoriel et oculomoteur en stimulation MID. Les premiers résultats indiquent que les post-effets générés par stimulation sensorielle pouvaient être partiellement atténués par des stimulations oculomotrices. Nous avons en outre identifié certains facteurs critiques pour la génération de contenu 3D pour améliorer la perception MID, comme la texture de fond, le temps de fixation objet et la durée de vie des random dots.

Mots-clés : Vision stéréoscopique, Disparité, Perception, Technologie 3D, Confort visuel

Abstract

Comfort viewing experience has been a permanent goal in stereoscopic research due to the development of 3D technologies. However, various parameters affect stereo vision perception. In this thesis, a series of physiological experiments have been carried out aiming at evaluating the 3D visual perception with respect to 3 of the most important factors: 3D display technology, viewing environments and motion-in-depth (MID) perception. First we measured vertical fusion amplitude (VFA) on 3D projectors and an autostereoscopic TV. VFA was chosen as an indicator for visual comfort due to our strong sensitivity to vertical disparity. Several factors have been tested (e.g. viewing distance, background luminance, crosstalk, viewing angle etc.). We compared observer performance on both 3D displays and concluded the tolerance for vertical disparity was better on 3D projector than on autostereoscopic TV. For the environment effect, we measured VFA on a 3D projector by varying the room lighting, 3D content complexity, disparity velocity. We assessed the interaction between central and peripheral fusion, by introducing a series of base-up prisms in front of one eye. We observed that the fusion balance of central and peripheral vision was broken when large peripheral disparities (>4 prism diopter) or stimulus sizes (central stimulus angle $< 15^\circ$) were induced on the peripheral vision. Finally, we investigated the interaction between sensorial and oculomotor system for MID stimulation. Preliminary results indicated that the motion aftereffect generated by sensorial cue stimulus could be partially mitigated by oculomotor cue and that MID perception performance could be improved by specific trainings. We identified some critical factors for 3D content generation to enhance the MID perception, such as background texture, fixation object dot life time.

Keywords : Stereo vision, Disparity, Perception, 3D technology, Visual comfort



n° d'ordre : 2016telb0389

Télécom Bretagne

Technopôle Brest-Iroise - CS 83818 - 29238 Brest Cedex 3

Tél : + 33(0) 29 00 11 11 - Fax : + 33(0) 29 00 10 00