



**HAL**  
open science

# TCP Protocol Optimization for HTTP Adaptive Streaming

Chiheb Ben Ameer

► **To cite this version:**

Chiheb Ben Ameer. TCP Protocol Optimization for HTTP Adaptive Streaming. Modeling and Simulation. Rennes 1, 2015. English. NNT: . tel-01249840

**HAL Id: tel-01249840**

**<https://hal.science/tel-01249840v1>**

Submitted on 4 Jan 2016

**HAL** is a multi-disciplinary open access archive for the deposit and dissemination of scientific research documents, whether they are published or not. The documents may come from teaching and research institutions in France or abroad, or from public or private research centers.

L'archive ouverte pluridisciplinaire **HAL**, est destinée au dépôt et à la diffusion de documents scientifiques de niveau recherche, publiés ou non, émanant des établissements d'enseignement et de recherche français ou étrangers, des laboratoires publics ou privés.



THÈSE / UNIVERSITÉ DE RENNES 1  
*sous le sceau de l'Université Européenne de Bretagne*

pour le grade de

DOCTEUR DE L'UNIVERSITÉ DE RENNES 1

*Mention : Informatique*

Ecole doctorale MATISSE

présentée par

**Chiheb Ben Ameer**

préparée à l'unité de recherche UMR 6074 IRISA

Equipes d'accueil :

Orange Labs OLPS/DTV/TV/PTC - IRISA/ADOPNET  
Contrat CIFRE N° 2012/1577

---

**TCP Protocol  
Optimization for  
HTTP Adaptive  
Streaming**

**Thèse soutenue à Rennes  
le 17 décembre 2015**

devant le jury composé de :

**Toufik AHMED**

Professeur à ENSEIRB-MATMECA / rapporteur

**Abdelhamid MELLOUK**

Professeur à l'Université de Paris-Est Créteil /  
rapporteur

**Julien BOURGEOIS**

Professeur à l'Université de Franche-Comté / exami-  
nateur

**Dominique GAITI**

Professeur à l'Université de technologie de Troyes /  
examinateur

**Bernard COUSIN**

Professeur à l'Université de Rennes 1 / directeur de  
Thèse

**Emmanuel MORY**

Docteur et Ingénieur de recherches à Orange Labs  
de Rennes / examinateur

***To my beloved parents Radhia & Moncef  
for making me who I am today.***



---

# Abstract

HTTP adaptive streaming (HAS) is a streaming video technique widely used over the Internet for Video on Demand (VoD) and Live streaming services. It employs Transmission Control Protocol (TCP) as transport protocol and it splits the original video inside the server into segments of same duration, called "chunks", that are transcoded into multiple quality levels. The HAS player, on the client side, requests for one chunk each chunk duration and it commonly selects the quality level based on the estimated bandwidth of the previous chunk(s). Given that the HAS clients are located inside access networks, our investigation involves several HAS clients sharing the same bottleneck link and competing for bandwidth inside the same home network. Here, a degradation of both Quality of Experience (QoE) of HAS users and Quality of Service (QoS) of the access network are often recorded. The objective of this thesis is to optimize the TCP protocol in order to solve both QoE and QoS degradations.

Our first contribution consists of proposing a gateway-based shaping method, that we called Receive Window Tuning Method (RWTM); it employs the TCP flow control and passive round trip time estimation on the gateway side. We compared the performances of RWTM with another gateway-based shaping method that is based on queuing discipline, called Hierarchical Token Bucket shaping Method (HTBM). The results of evaluation indicate that RWTM outperforms HTBM not only in terms of QoE of HAS but also in terms of QoS of access network by reducing the queuing delay and significantly reducing packet drop rate at the bottleneck.

Our second contribution consists of a comparative evaluation between eight combinations that result from combining two shaping methods, RWTM and HTBM, and four very common TCP variants, NewReno, Vegas, Illinois and Cubic. The results show that there is a significant discordance in performance between combinations. Furthermore, the best combination that improves performances in the majority of scenarios is when combining Illinois variant with RWTM. In addition, the results reveal the importance of an efficient updating of the slow start threshold value, *ssthresh*, to accelerate the convergence toward the best feasible quality level.

Our third contribution consists of proposing a novel HAS-based TCP variant, that we called

TcpHas; it is a TCP congestion control algorithm that takes into consideration the specifications of HAS flow. Besides, it estimates the optimal quality level of its corresponding HAS flow based on end-to-end bandwidth estimation. Then, it permanently performs HAS traffic shaping based on the encoding rate of the estimated level. It also updates *ssthresh* to accelerate convergence speed. A comparative performance evaluation of TcpHas with a recent and well-known TCP variant that employs adaptive decrease mechanism, called Westwood+, was performed. Results indicated that TcpHas largely outperforms Westwood+; it offers better quality level stability on the optimal quality level, it dramatically reduces the packet drop rate and it generates lower queuing delay.

**Keywords:** HTTP Adaptive Streaming, TCP protocol, TCP congestion control, TCP flow control, bandwidth management, traffic shaping, Quality of Experience, Quality of Service, access network, bottleneck issue, cross-layer optimization.

---

# Résumé

Le streaming vidéo adaptatif sur HTTP, couramment désigné par HTTP Adaptive Streaming (HAS), est une technique de streaming vidéo largement déployée sur le réseau Internet pour les services de vidéo en direct (Live) et la vidéo à la demande (VoD). Cette technique utilise le protocole TCP comme protocole de transport. Elle consiste à segmenter la vidéo originale, stockée sur un serveur HTTP (serveur HAS), en petits segments (généralement de même durée de lecture) désignés par "chunks". Chaque segment de vidéo est transcodé à plusieurs niveaux de qualité, chaque niveau de qualité étant disponible sur un chunk indépendant. Le player, du côté du client HAS, demande périodiquement un nouveau chunk une fois par durée de lecture du chunk. Dans les cas communs, le player sélectionne le niveau de qualité en se basant sur l'estimation de la bande passante du/des chunk(s) précédent(s). Étant donné que chaque client HAS est situé au sein d'un réseau d'accès, notre étude se concentre sur un cas particulier assez fréquent dans l'usage quotidien : lorsque plusieurs clients partagent le même lien présentant un goulet d'étranglement (bottleneck) et se trouvant en état de compétition sur la bande passante. Dans ce cas, on signale fréquemment une dégradation de la qualité d'expérience (QoE) des utilisateurs de HAS et de la qualité de service (QoS) du réseau d'accès. Ainsi, l'objectif de cette présente thèse est d'optimiser le protocole TCP pour résoudre ces dégradations de QoE et QoS.

Notre première contribution consiste à proposer une méthode de bridage du débit HAS au niveau de la passerelle. Cette méthode est désignée par "Receive Window Tuning Method" (RWTM) et elle consiste dans l'utilisation du principe de contrôle de flux de TCP et l'estimation passive du temps d'aller retour au niveau de la passerelle. Nous avons comparé les performances de cette méthode avec une autre méthode récente implémentée à la passerelle et utilisant une discipline particulière de gestion de la file d'attente, qui est désignée par "Hierarchical Token Bucket shaping Method" (HTBM). Les résultats d'évaluations ont révélé que RWTM a non seulement une meilleure QoE, mais aussi une meilleure QoS de réseau d'accès que pour l'utilisation de HTBM ; plus précisément une réduction du délai de mise en file d'attente et une forte réduction du taux de paquets rejetés au niveau du goulet d'étranglement.

Notre deuxième contribution consiste à mener une étude comparative combinant huit combinaisons résultant de la combinaison de deux méthodes de bridages, RWTM et HTBM, avec quatre variantes TCP largement déployées, NewReno, Vegas, Illinois et Cubic. Les résultats de l'évaluation montrent une discordance importante entre les performances des différentes combinaisons. De plus, la combinaison qui améliore les performances dans la majorité des scénarios étudiés est celle de RWTM avec Illinois. En outre, nous avons révélé qu'une mise à jour efficace de la valeur du paramètre "Slow Start Threshold", *ssthresh*, peut accélérer la vitesse de convergence du client vidéo vers la qualité de vidéo optimale.

Notre troisième contribution consiste à proposer une nouvelle variante de TCP adaptée aux flux HAS, qu'on désigne par TcpHas ; c'est un algorithme de contrôle de congestion de TCP qui prend en considération les spécifications de HAS. TcpHas estime le niveau de la qualité optimale du flux HAS en se basant sur l'estimation de la bande passante de bout en bout. Ensuite, TcpHas applique, d'une façon permanente, un bridage au trafic HAS en se basant sur le débit d'encodage du niveau de qualité estimé. En plus, TcpHas met à jour *ssthresh* pour accélérer la vitesse de convergence. Une étude comparative a été réalisée avec une variante de TCP, connue sous le nom Westwood+, qui utilise le mécanisme de la diminution adaptative. Les résultats de l'évaluation ont indiqué que TcpHas est largement plus performant que Westwood+ ; il offre une meilleure stabilité autour de la qualité optimale, il réduit considérablement le taux de paquets rejetés au niveau du goulet d'étranglement, et diminue le délai de la file d'attente.

**Mots-clés** : HTTP Adaptive Streaming, protocole de transport TCP, le contrôle de congestion TCP, le contrôle de flux TCP, la gestion de la bande passante, bridage du trafic, Qualité d'Expérience, Qualité de Service, réseau d'accès, goulet d'étranglement, optimisation inter-couche.



---

# Acknowledgments

I am most grateful to my advisors, Dr. Emmanuel MORY and Pr. Bernard COUSIN. Their guidance and insights over the years have been invaluable to me. I feel especially fortunate for the patience that they have shown with me when I firstly stepped into the field of HTTP Adaptive Streaming and TCP congestion control. I am indebted to them for teaching me both research and writing skills. Without their endless efforts, knowledge and patience, it would have been extremely challenging to finish all my dissertation research and Ph.D study in three years. It has been a great honor and pleasure for me to do research under their supervision. I would like to thank Pr. Toufik AHMED, Pr. Abdelhamid MELLOUK, Pr. Julien BOURGEOIS and Pr. Dominique GAITI for serving as my Ph.D committee members and reviewing my dissertation.

I would like to thank my Orange Labs colleagues: UTA team members, especially Mr. Frédéric HUGO, Mr. Fabien GUEROUT, Mr. Johnny SHEMASTI and Mr. Franck GESLIN; PTC team leader François DAUDE; CDI project leader Ms. Claudia BECKER; doctors and PhD students, especially Dr. Haykel BOUKADIDA, Dr. Moez BACCOUCHE, Ms. Sonia YOUSFI, Dr. Khaoula BACCOUCHE, Dr. Imad JAMIL and Dr. Youssef MEGUEBLI. I would like to extend my thanks to the members of ADOPNET team that I have had the pleasure to work with. Thanks to all my colleagues with who I have enjoyed working with: Dr. Samer LAHOUD, Dr. Cedric GUEGUEN, Dr. Mohamed YASSIN, Mehdi EZZAOUIA, Dr. Farah MOETY, Dr. Siwar BEN HADJ SAID and Dr. Melhem ELHELOU.

I am thankful to all my friends for their continued help and support: the new ones, for the life experiences we have shared in France, and the old ones, for staying present despite the distance. Especially Mohamed ELAOU, Amine CHAABOUNI, Bassem KHALFI, Abdlehamid ESSAIED and Ayoub ABID. Last, but by no means least, I must thank my family in Tunisia, who supported me a lot. Without their endless love and encouragement I would have never completed this dissertation. I would like to give the biggest thanks to my parents Radhia & Moncef, to my brother Hazem, my sisters Ines and Randa, their spouses and their children.



---

# Résumé français

## Introduction

En 2019, le trafic des contenus vidéo sur Internet présentera environ 80% du trafic Internet, soit 64% de plus qu'en 2014, selon un rapport récent de Cisco [37]. Par conséquent, une adaptation des fournisseurs de contenus vidéo (comme en l'occurrence YouTube, Netflix et Dailymotion) ainsi que les fournisseurs d'accès à Internet (FAI) à cette utilisation croissante du streaming vidéo sur Internet s'avère indispensable. Par exemple, YouTube, qui est l'un des plus grands fournisseurs de contenus avec plus qu'un milliard d'utilisateurs, compte des centaines de millions d'heures de vues chaque jour. De ce fait, améliorer les techniques utilisées pour le streaming vidéo (comme le type du codec vidéo, le type du protocole de transport, la configuration du player) est actuellement une piste prometteuse pour améliorer les services et les bénéfices des fournisseurs de contenus. En plus, les débits d'encodages des contenus vidéo varient entre des faibles débits de l'ordre de quelques dizaines de kilo-octets par seconde, typiquement pour servir les écrans de petites tailles et de faibles capacités d'affichage, jusqu'à arriver aux débits de quelques dizaines de méga-octets par seconde pour les écrans qui supportent les ultra hautes définitions, typiquement 4K et 8K. Par conséquent, les FAI se concurrencent pour offrir le haut débit à leurs abonnés pour satisfaire leurs besoins de regarder des vidéos en haute définition. De plus, un troisième acteur s'est présenté depuis les années 2000 pour accélérer la distribution des contenus sur les cœurs des réseaux des FAI. Cet acteur est dénommé fournisseur du réseau de livraison des contenus, ou fournisseur de Content Delivery network (CDN). Ce dernier place des caches, appelés aussi des proxies de contenus, distribués dans les réseaux jusqu'au niveau cœur du réseau FAI afin de pouvoir y stocker des contenus populaires et ainsi réduire la charge du trafic réseau sur les serveurs. Plusieurs fournisseurs de CDN, comme Akamai, ont adapté leurs services de mise en cache aux contenus vidéo transmis sur Internet. Globalement, 72% du trafic vidéo sur Internet sera géré par les réseaux CDN en 2019, soit 57% de plus qu'en 2014 [37]. En conséquence, la collaboration entre ces trois acteurs (c.-à-d. les fournisseurs de contenus vidéos, les FAI et les fournisseurs de

CDN) demeure nécessaire pour offrir une meilleure qualité d'expérience (QoE) aux utilisateurs du streaming vidéo et garantir une bonne qualité de service (QoS) [36].

L'objectif de cette thèse est d'améliorer la QoE et la QoS lorsqu'on utilise une technique de streaming vidéo particulière et largement déployée, désignée par HTTP Adaptive Streaming (HAS).

De ce fait, la Section 0.1 présente la problématique posée autour d'un cas d'usage répandu de HAS. Puis, nos trois contributions majeures qui tentent à résoudre cette problématique sont présentés aux sections 0.2, 0.3 et 0.4.

## 0.1 Problématique

Le streaming vidéo adaptatif sur HTTP, couramment désigné par HTTP Adaptive Streaming (HAS), est une technique de streaming vidéo largement déployée sur le réseau Internet pour les services de vidéo en directe (Live) et de vidéo à la demande (VoD). Cette technique consiste à segmenter la vidéo originale, stockée sur un serveur HTTP (serveur HAS), en petits segments (généralement de même durée de lecture) désignés par "chunks". Chaque segment de vidéo est transcodé à plusieurs niveaux de qualité, chaque niveau de qualité étant disponible dans un chunk indépendant. Le player, du côté du client HAS, demande les chunks du serveur HAS selon deux phases différentes : la phase de la mise en mémoire tampon, "*buffering phase state*" et la phase de régime stationnaire, "*steady state phase*". Pendant le buffering phase state, les chunks sont demandés successivement les uns à la suite des autres jusqu'à remplir la file d'attente du player, désignée par "playback buffer". Une fois que le playback buffer est suffisamment rempli, le player bascule vers la deuxième phase, steady state phase, durant laquelle le player est en train de demander périodiquement, un nouveau chunk une fois par durée de lecture du chunk, afin de préserver le même niveau de remplissage du playback buffer. En conséquence, cette périodicité crée des périodes d'activité, désignées par périodes ON, durant lesquelles le chunk est en cours de téléchargement, suivis par des périodes d'inactivité, désignées par périodes OFF, durant lesquelles le player attend pour lancer la nouvelle requête du prochain chunk. La périodicité des périodes ON-OFF n'influence pas la continuité du décodage et la lecture de la vidéo demandée.

Le player HAS est doté d'une intelligence qui s'appelle le contrôleur de débit, désigné par "bitrate controller". Son rôle est de choisir le niveau de qualité et l'instant de la demande du prochain chunk. Dans les cas communs, ce contrôleur prend comme paramètres l'estimation de la bande passante du/des chunk(s) précédent(s) et/ou le niveau de remplissage du playback buffer. Néanmoins, le player HAS est dans l'incapacité d'estimer la bande passante durant la période

OFF car pendant cette durée il ne reçoit pas de données. Ainsi, le player n'a aucune information sur l'état du réseau durant les périodes OFF. Ce problème s'appelle "la contrainte de la période OFF".

Notre investigation se concentre sur un cas particulier assez fréquent dans l'usage quotidien, précisément lorsque plusieurs clients partagent le même lien présentant un goulot d'étranglement (bottleneck) et se trouvant en état de compétition sur la bande passante. Un exemple plus concret de ce cas est lorsque les clients HAS se trouvent dans un réseau domestique à l'issue d'un réseau fixe d'accès à haut débit. Dans ce cas, la contrainte de la période OFF sera amplifiée. En effet, si la période ON du premier client coïncide avec la période OFF d'un deuxième client, une surestimation de la bande passante sera enregistrée pour le premier client car il ignore l'existence du flux HAS du deuxième client. Ce cas de figure peut engendrer plusieurs problèmes à savoir des congestions au niveau du bottleneck, une instabilité des niveaux de qualité sélectionnés, un partage inéquitable de la bande passante entre les flux HAS et même une déplétion du playback buffer pouvant provoquer une interruption de la lecture de la vidéo dans le pire des cas. Ainsi, on peut subir une dégradation de la qualité d'expérience (QoE) des utilisateurs de HAS et de la qualité de service (QoS) du réseau d'accès.

Une des solutions les plus pratiques pour améliorer les performances du HAS et réduire l'effet indésirable de la contrainte de la période OFF est de dilater les périodes ON et ainsi de réduire les périodes OFF. Dans ce cas, on maximise la connaissance des conditions réseaux pour le player HAS, car il ne se retrouve quasiment qu'en périodes ON. Cette solution se manifeste par un bridage du débit des flux HAS et est désignée par "traffic shaping".

Étant donné que HAS est basé sur le protocole de transport TCP, l'objectif de cette thèse est de résoudre les problèmes cités ci-dessus en utilisant judicieusement certains des paramètres de la couche TCP. En effet, certaines améliorations (qui sont en relation avec la gestion de la bande passante et le bridage du trafic) sont plus efficaces à concrétiser au niveau de la couche TCP qu'à celui de la couche applicative.

Pour l'ensemble des contributions, nous avons développé un émulateur de player HAS qui prend en considération les caractéristiques communes entre les players commerciaux de HAS. Nous avons également développé des tests sur une maquette pour valider les solutions proposées pour trois scénarios simples avec seulement deux clients HAS en compétition. Ensuite, nous avons étendu l'étude sur le simulateur de réseau ns-3 pour couvrir d'autres scénarios tels que l'augmentation du nombre des clients en compétition, changer les paramètres du player HAS, changer les conditions du réseau cœur du FAI, changer la taille de la file d'attente et l'algorithme de la gestion de la file d'attente du lien du goulot d'étranglement.

## 0.2 Méthode de bridage du trafic HAS au niveau de la passerelle

Notre première contribution consiste à proposer une méthode de bridage de débit des flux HAS au niveau de la passerelle. Cette méthode est désignée par "Receive Window Tuning Method" (RWTM). Elle consiste dans l'utilisation du principe de contrôle de flux de TCP et l'estimation passive du temps d'aller retour (RTT) au niveau de la passerelle. Le choix de l'implémentation au niveau de la passerelle est justifié par le fait que cette passerelle a une visibilité totale sur toutes les machines connectées sur même réseau domestique. RWTM utilise également un gestionnaire de la bande passante au niveau de cette passerelle afin de pouvoir estimer la bande passante totale qui peut être réservées aux flux HAS en identifiant les flux HAS qui la traverse. Ainsi, ce gestionnaire de débit définit le débit de bridage pour chaque flux HAS en utilisant comme paramètre les débits d'encodages disponibles pour chaque flux HAS. Donc, RWTM prend comme paramètre le débit de bridage choisi par le gestionnaire de la bande passante multiplié par le temps d'aller-retour (RTT) estimé. Ensuite, RWTM utilise le principe de contrôle de flux en changeant la taille de la fenêtre de réception, *rwnd*, indiquée dans chaque paquet envoyé du client HAS au serveur HAS.

Nous avons comparé les performances de cette méthode avec une autre récente implémentée à la passerelle qui utilise une discipline particulière de gestion de la file d'attente. Cette méthode est désignée par "Hierarchical Token Bucket shaping Method" (HTBM). Les résultats d'évaluations sur différents scénarios ont révélé que RWTM présente une meilleure QoE de HAS que HTBM. En plus, RWTM améliore la QoS du réseau d'accès contrairement à HTBM ; en effet, RWTM réduit le délai de mise en file d'attente et élimine presque totalement le taux de paquets rejetés au niveau du goulot d'étranglement. Néanmoins, RWTM reste moins efficace que HTBM sur la réduction de la fréquence des périodes OFF de durée supérieure au délai de retransmission TCP. La raison est la mise à jour relativement longue du RTT employée par RWTM ; RWTM estime le RTT une seule fois par chunk, au début de son téléchargement. Par conséquent, RWTM ne prend pas en compte les variations de RTT au cours du téléchargement du chunk pour mettre *rwnd* à jour.

Les publications directement liées à cette contribution sont :

- Chiheb Ben Ameer, Emmanuel Mory, and Bernard Cousin. Shaping http adaptive streams using receive window tuning method in home gateway. In Performance Computing and Communications Conference (IPCCC), 2014 IEEE International, pages 1-2, 2014
- Chiheb Ben Ameer, Emmanuel Mory, and Bernard Cousin. Evaluation of gateway-based shaping methods for http adaptive streaming. In Quality of Experience-based Management for Future Internet Applications and Services (QoE-FI) workshop, International Conference on Communications (ICC), ICC workshops'04, 2015 IEEE International, pages 1-6, 2015.

### 0.3 Evaluation de l'effet du protocole de control de congestion TCP sur HAS

Notre deuxième contribution consiste à mener une étude comparative combinant deux méthodes de bridage, RWTM et HTBM, avec quatre variantes TCP largement déployées, NewReno, Vegas, Illinois et Cubic. Les deux objectifs principaux de cette comparaison sont 1) d'étudier si l'une ou l'autre des deux méthodes de bridage est(sont) sensible(s) à la modification de la variante de TCP, et 2) d'identifier la meilleure combinaison en termes de performances de QoE et de QoS. Les résultats de l'évaluation montrent une discordance importante entre les performances des différentes combinaisons. De plus, la combinaison qui améliore les performances dans la majorité des scénarios étudiés est celle de RWTM avec Illinois. En outre, nous avons révélé qu'une mise à jour efficace de la valeur du paramètre "Slow Start Threshold", *ssthresh*, peut accélérer la vitesse de convergence du client vidéo vers la qualité de vidéo optimale.

La publication soumise directement liée à cette contribution est :

- Chiheb Ben Ameer, Emmanuel Mory, and Bernard Cousin. Combining Traffic Shaping Methods with Congestion Control Variants for HTTP Adaptive Streaming, submitted to Multimedia Systems, Springer (minor revision)

### 0.4 TCPHas : une variante TCP adaptée au service HAS

Notre troisième contribution, qui est basée sur le résultat de la deuxième contribution, consiste à proposer une nouvelle variante de TCP adaptée aux flux HAS, désignée par TcpHas ; c'est un algorithme de contrôle de congestion de TCP qui prend en considération les spécificités du HAS. TcpHas estime le niveau de qualité optimale du flux HAS en se basant sur l'estimation de la bande passante de bout-en-bout. Ensuite, TcpHas applique d'une façon permanente un bridage au trafic HAS en se basant sur le débit d'encodage du niveau de qualité estimé. En plus, TcpHas met à jour *ssthresh* pour accélérer la vitesse de convergence. On note ici que TcpHas est considéré à la fois comme une variante TCP et un algorithme de bridage de HAS du côté du serveur totalement intégrée à la couche de transport TCP.

Plus précisément, TcpHas utilise un mécanisme de contrôle de congestion avec une diminution adaptative, *adaptive decrease*, utilisé par Westwood et Westwood+ ; il consiste à mettre *ssthresh* à jour après chaque détection de congestion en se basant sur l'estimation de la bande passante de bout-en-bout. TcpHas utilise également une méthode d'estimation de la bande passante qui évite les problèmes des fausses estimations liées à la compression et le clustering des paquets. TcpHas

utilise aussi les débits d'encodages disponibles pour le flux HAS pour calculer le débit de bridage et appliquer le bridage sur le flux HAS. Le bridage employé consiste à modifier la fenêtre de congestion de TCP, *cwnd*, pour correspondre au produit entre le RTT estimé et lissé, et le débit de bridage calculé. TcpHas élimine la réduction de *cwnd* après chaque période de repos *idle* (c.-à-d. lorsque sa durée est supérieure au délai de retransmission de TCP) afin d'éviter la déstabilisation du débit de bridage. En outre, il met à jour *ssthresh* après chaque période *idle* pour améliorer l'adaptabilité au changement des conditions du réseau sans causer des congestions.

Une étude comparative a été réalisée avec la variante Westwood+ de TCP qui utilise le mécanisme de la diminution adaptative. Les résultats de l'évaluation ont indiqué que TcpHas est largement plus performant que Westwood+ ; il offre une meilleure stabilité autour de la qualité optimale, réduit considérablement le taux de paquets rejetés au niveau du goulot d'étranglement, diminue le délai de la file d'attente, et tend à maximiser l'occupation de la bande passante disponible. Néanmoins, TcpHas reste sensible aux surcharges des réseaux cœurs de FAI. Mais ce problème doit être évité avec le déploiement du réseau CDN.

## Conclusion

Nous avons étudié durant cette thèse la technique du streaming HAS, qui est largement déployée par les fournisseurs de contenus vidéo. Nous avons précisé que, malgré l'utilisation des caches de CDN au niveau des réseaux cœur de FAI, un cas d'usage particulier et fréquent reste encore problématique pour la qualité d'expérience des utilisateurs de HAS et à la qualité de service du réseau d'accès de HAS : lorsque plusieurs clients HAS partagent le même lien présentant un goulot d'étranglement (bottleneck) et se trouvent en état de compétition sur la bande passante.

Nous avons proposé deux méthodes de bridage différentes qui utilisent des mécanismes de contrôle de la couche TCP : RWTM qui exploite le contrôle de flux de TCP au niveau de la passerelle, et TcpHas qui propose une nouvelle variante de contrôle de congestion de TCP au niveau du serveur HAS. Nous avons aussi présenté une étude comparative entre deux méthodes de bridage implémentées à la passerelle : RWTM et HTBM avec quatre variantes de TCP (NewReno, Vegas, Illinois et Cubic). Nous avons utilisé des critères objectifs pour l'évaluation de la QoE et des critères spécifiques de la QoS du réseau d'accès de FAI.

Les résultats de l'évaluations des performances sont satisfaisants pour l'ensemble des scénarios utilisés. D'autres pistes de travaux futures seront intéressants, comme l'implémentation réelle de la solution RWTM sur la passerelle du réseau d'Orange, la "Livebox" ou l'implémentation de TcpHas sur quelques serveurs déployés par un fournisseur des contenus vidéos, comme Dailymo-



tion. En plus, le placement des caches au niveau du réseau d'accès du FAI, proche de la passerelle, est une piste de recherche intéressante qui permettra de réduire la charge du réseau sur le goulot d'étranglement et d'améliorer la QoE des utilisateurs de HAS. En outre, nous avons remarqué qu'une nouvelle stratégie est en train de se développer très récemment : elle consiste à réadapter les techniques de streaming vidéo sur UDP en jonction avec des algorithmes de contrôle du débit compatibles avec TCP, désigné par *TCP-Friendly Rate Control* (TFRC), comme en l'occurrence la technique QUIC [53] développé par Google. Par conséquent, un travail futur consistera à adopter les spécificités de notre variante TcpHas à TFRC.



---

# Contents

<b>Abstract</b>	<b>v</b>
<b>Résumé</b>	<b>vii</b>
0.1 Problématique . . . . .	x
0.2 Méthode de bridage du trafic HAS au niveau de la passerelle . . . . .	xii
0.3 Evaluation de l'effet du protocole de control de congestion TCP sur HAS . . . . .	xiii
0.4 TCPHas: une variante TCP adaptée au service HAS . . . . .	xiii
<b>Acknowledgments</b>	<b>viii</b>
<b>Résumé Français</b>	<b>xvi</b>
<b>Contents</b>	<b>xxii</b>
<b>List of Figures</b>	<b>xxv</b>
<b>List of Tables</b>	<b>xxv</b>
<b>1 Introduction</b>	<b>1</b>
1.1 General Context . . . . .	2
1.1.1 HTTP Adaptive Streaming . . . . .	2
1.1.2 ISP Access Network . . . . .	3
1.1.3 TCP protocol . . . . .	3
1.1.4 What can we do ? . . . . .	4

1.2	Contributions . . . . .	4
1.3	Thesis Organization . . . . .	6
<b>2</b>	<b>State of the art</b>	<b>7</b>
2.1	Introduction . . . . .	7
2.2	Video Streaming Over Internet . . . . .	7
2.2.1	Classification of Video Streaming Technologies . . . . .	8
2.2.1.1	UDP-based Video Streaming . . . . .	8
2.2.1.2	TCP-based Video Streaming . . . . .	9
2.2.2	HTTP Adaptive Streaming (HAS) . . . . .	10
2.2.2.1	HAS General Description . . . . .	11
2.2.2.2	HAS Commercial Products . . . . .	12
2.2.2.3	HAS Player Parameters . . . . .	16
2.3	Architecture Description and Use Cases . . . . .	19
2.3.1	Network Architecture . . . . .	19
2.3.1.1	HAS Client Inside Fixed Broadband Access Network . . . . .	20
2.3.1.2	HAS Client Inside Mobile Broadband Access Network . . . . .	21
2.3.1.3	The Importance of Content Delivery Network . . . . .	22
2.3.2	Use Cases . . . . .	24
2.3.2.1	Bottleneck Issue . . . . .	24
2.3.2.2	Competition between HAS Flows . . . . .	25
2.4	QoE Characterization and Improvement . . . . .	27
2.4.1	QoE Metrics . . . . .	27
2.4.1.1	Subjective QoE Metrics . . . . .	27
2.4.1.2	Objective QoE Metrics . . . . .	28
2.4.2	Technical Influence factors of QoE and Cross-layer Optimization . . . . .	30
2.4.2.1	Technical Influence Factors . . . . .	30
2.4.2.2	Cross-layer Optimizations . . . . .	33

2.5	Conclusion . . . . .	34
<b>3</b>	<b>General Framework for Emulations, Testbeds, Simulations and Evaluations</b>	<b>35</b>
3.1	Introduction . . . . .	35
3.2	Emulation of HAS Player . . . . .	36
3.3	Testbed Description . . . . .	37
3.4	Simulating HAS Traffic over ns-3 . . . . .	40
3.4.1	HAS Module Implementation in ns-3 . . . . .	41
3.4.2	Network Architecture Implemented in ns-3 . . . . .	43
3.5	Performance Metrics . . . . .	46
3.5.1	QoE Metrics . . . . .	46
3.5.1.1	Instability of Video Quality Level . . . . .	47
3.5.1.2	Infidelity of Video Quality Level . . . . .	47
3.5.1.3	Convergence Speed . . . . .	48
3.5.1.4	Initial Delay . . . . .	48
3.5.1.5	Stalling Event Rate . . . . .	49
3.5.1.6	QoE Unfairness . . . . .	49
3.5.2	QoS Metrics . . . . .	49
3.5.2.1	Frequency of $\widehat{OFF}$ periods per chunk . . . . .	50
3.5.2.2	Average Queuing Delay . . . . .	50
3.5.2.3	Congestion Rate . . . . .	51
3.5.2.4	Average Packet Drop Rate . . . . .	51
3.6	Conclusion . . . . .	51
<b>4</b>	<b>Gateway-based Shaping Methods</b>	<b>53</b>
4.1	Introduction . . . . .	53
4.2	State of The Art . . . . .	54
4.2.1	The Efficiency of Traffic Shaping in The Context of HAS . . . . .	54

4.2.2	Classification of HAS Traffic Shaping . . . . .	55
4.3	RWTM: Receive Window Tuning Method . . . . .	56
4.3.1	Constant RTT . . . . .	57
4.3.2	General Case: Variable RTT . . . . .	58
4.3.3	RWTM Implementation . . . . .	59
4.4	Evaluation of Gateway-based Shaping Methods . . . . .	60
4.4.1	Proposed Bandwidth Manager Algorithm . . . . .	60
4.4.2	Scenarios . . . . .	61
4.4.3	Analysis of The Results . . . . .	62
4.4.3.1	QoE Evaluation . . . . .	62
4.4.3.2	Congestion Window Variation . . . . .	65
4.5	Extended Evaluation of RWTM . . . . .	68
4.5.1	Effect of Increasing the Number of HAS Flows . . . . .	69
4.5.2	Effect of Variation of Player Parameters . . . . .	72
4.5.2.1	Playback Buffer Size effect . . . . .	72
4.5.2.2	Chunk Duration Effect . . . . .	75
4.5.3	Effect of Variation of Network Parameters . . . . .	77
4.5.3.1	Initial round-trip propagation delay Effect . . . . .	77
4.5.3.2	IP Traffic Effect . . . . .	82
4.5.3.3	Bottleneck Queue Effect . . . . .	84
4.6	Conclusion . . . . .	86
<b>5</b>	<b>TCP Congestion Control Variant Effect</b>	<b>89</b>
5.1	Introduction . . . . .	89
5.2	State of the Art . . . . .	90
5.3	Evaluation of the Combinations Between TCP Variants and Gateway-based Shaping Methods . . . . .	93
5.3.1	Scenarios . . . . .	94

---

5.3.2	Scenario 1 . . . . .	94
5.3.2.1	Measurements of Performance Metrics . . . . .	95
5.3.2.2	Analysis of <i>cwnd</i> Variation . . . . .	98
5.3.3	Scenarios 2 and 3 . . . . .	105
5.3.4	Scenario 4 . . . . .	107
5.3.5	Scenario 5 . . . . .	109
5.4	Discussion . . . . .	111
5.5	Conclusion . . . . .	112
<b>6</b>	<b>TcpHas: HAS-based TCP Congestion Control Variant</b>	<b>113</b>
6.1	Introduction . . . . .	113
6.2	State of The Art . . . . .	114
6.2.1	Optimal Quality Level Estimation . . . . .	114
6.2.2	Shaping Methods . . . . .	115
6.2.3	How Can We Optimize Solutions ? . . . . .	116
6.2.3.1	Adaptive Decrease Mechanism . . . . .	117
6.2.3.2	Bandwidth Estimation Schemes . . . . .	118
6.3	TcpHas Description . . . . .	122
6.3.1	Bandwidth Estimator of TcpHas . . . . .	123
6.3.2	Optimal Quality Level Estimator of TcpHas . . . . .	124
6.3.3	Ssthresh Modification of TcpHas . . . . .	125
6.3.3.1	Congestion Events . . . . .	125
6.3.3.2	Idle Periods . . . . .	125
6.3.3.3	Initialization . . . . .	126
6.3.4	Cwnd Modification of TcpHas for Traffic Shaping . . . . .	127
6.4	TcpHas Evaluation . . . . .	129
6.4.1	TcpHas Parameter Settings . . . . .	129
6.4.2	Effect of Increasing the Number of HAS Flows . . . . .	130

6.4.3	Effect of Variation of Player Parameters . . . . .	133
6.4.3.1	Playback Buffer Size effect . . . . .	133
6.4.3.2	Chunk Duration Effect . . . . .	134
6.4.4	Effect of Variation of Network Parameters . . . . .	138
6.4.4.1	Initial Round-trip Propagation Delay Effect . . . . .	138
6.4.4.2	IP Traffic Effect . . . . .	141
6.4.4.3	Bottleneck Queue Effect . . . . .	143
6.5	Conclusion . . . . .	145
<b>7</b>	<b>Conclusion and Perspectives</b>	<b>147</b>
7.1	Achievements . . . . .	149
7.2	Future Works . . . . .	151
7.2.1	Testing the Proposed Solutions in Real Conditions . . . . .	151
7.2.2	video Content Caching Inside Access Network . . . . .	151
7.2.3	Optimizing UDP-based Video Streaming . . . . .	152
<b>A</b>	<b>List of Publications</b>	<b>155</b>
A.1	International conferences with peer review . . . . .	155
A.2	International Journals with peer review . . . . .	155
	<b>Publications</b>	<b>156</b>
	<b>Bibliography</b>	<b>170</b>
	<b>Autorisation de publication</b>	<b>171</b>



---

# List of Figures

2.1	General description of HTTP Adaptive Streaming . . . . .	11
2.2	(f)MP4 file format [162] . . . . .	13
2.3	Apple HLS description [16] . . . . .	15
2.4	Abstract model of common HAS player [157] . . . . .	17
2.5	Fixed broadband access network architecture with triple play service [34] . . . . .	20
2.6	A typical Cellular Network [27] . . . . .	22
2.7	CDN description [93] . . . . .	23
2.8	The OFF period issue when two HAS clients compete for bandwidth . . . . .	26
3.1	Architecture used in test bed . . . . .	38
3.2	Network architecture used in ns-3 . . . . .	43
4.1	HAS traffic shaping when two HAS clients are competing for bandwidth . . . . .	54
4.2	$RTT_{C-S}$ estimation in the home gateway . . . . .	59
4.3	$Cwnd$ and $ssthresh$ variation when using HTBM (IS=1.98% , IF=19.03% , V=33 s) . . . . .	66
4.4	$Cwnd$ and $ssthresh$ variation when using RWTM (IS=1.78% , IF=5.5% , V=8 s) . . . . .	66
4.5	$RTT_{1-S}$ variation . . . . .	67
4.6	Performance measurements when increasing the number of HAS competing clients . . . . .	71
4.7	Performance measurements when increasing the playback buffer size . . . . .	74
4.8	Performance measurements when increasing the chunk duration . . . . .	76
4.9	Performance measurements when changing $RTT_{C-S}^0$ value . . . . .	78

4.10	Performance measurements when increasing $RTT_{C-S}^0$ unfairness . . . . .	81
4.11	Performance measurements when increasing PPBP burst arrival rate $\lambda_p$ . . . . .	83
4.12	RWTM performance under different queuing disciplines and queue lengths . . . . .	85
5.1	$Cwnd$ variation of {NewReno HTBM} ( $IS = 5.48\%$ , $IF = 35.68\%$ , $V = 180s$ , $fr_{\widehat{OFF}} = 0.2$ , $CNG = 43.33$ ) . . . . .	99
5.2	$Cwnd$ variation of {NewReno RWTM} . . . . .	99
5.3	$Cwnd$ variation of {Vegas HTBM} ( $IS = 1.31\%$ , $IF = 46.74\%$ , $V = 87s$ , $fr_{\widehat{OFF}} = 0.4$ , $CNG = 46.11$ ) . . . . .	101
5.4	$Cwnd$ variation of {Vegas RWTM} ( $IS = 5.32\%$ , $IF = 31.15\%$ , $V = 180s$ , $fr_{\widehat{OFF}} = 0.29$ , $CNG = 6.11$ ) . . . . .	101
5.5	$Cwnd$ variation of {Illinois HTBM} ( $IS = 2\%$ , $IF = 7.66\%$ , $V = 5s$ , $fr_{\widehat{OFF}} =$ $0.03$ , $CNG = 51.11$ ) . . . . .	102
5.6	$Cwnd$ variation of {Illinois RWTM} ( $IS = 2.4\%$ , $IF = 5.47\%$ , $V = 27s$ , $fr_{\widehat{OFF}} = 0.22$ , $CNG = 0.55$ ) . . . . .	103
5.7	$Cwnd$ variation of {Cubic HTBM} ( $IS = 1.98\%$ , $IF = 19.03\%$ , $V = 33s$ , $fr_{\widehat{OFF}} = 0.16$ , $CNG = 186.11$ ) . . . . .	104
5.8	$Cwnd$ variation of {Cubic RWTM} ( $IS = 1.78\%$ , $IF = 5.5\%$ , $V = 8s$ , $fr_{\widehat{OFF}} = 0.22$ , $CNG = 1.66$ ) . . . . .	105
5.9	Performance measurements when increasing $RTT_{C-S}$ standard deviation . . . . .	110
6.1	Pattern of packet transmission [25] . . . . .	120
6.2	Basic idea of TcpHas . . . . .	122
6.3	Performance measurements when increasing the number of HAS competing clients . . . . .	132
6.4	Performance measurements when increasing the playback buffer size . . . . .	135
6.5	Performance measurements when increasing the chunk duration . . . . .	137
6.6	Performance measurements when changing $RTT_{C-S}^0$ value . . . . .	140
6.7	Performance measurements when increasing PPBP burst arrival rate $\lambda_p$ . . . . .	142
6.8	TcpHas performance under different queuing disciplines and queue lengths . . . . .	144
7.1	Proposed implementation of proxy inside fixed broadband access network . . . . .	152

---

## List of Tables

3.1	Video encoding bitrates . . . . .	38
3.2	Parameter description . . . . .	47
4.1	Parameters description . . . . .	58
4.2	Performance metric measurements . . . . .	63
4.3	The relative differences of QoE mean values related to W/o . . . . .	69
4.4	The relative differences of QoE mean values related to RWTM . . . . .	69
4.5	ISP network occupancy when varying $\lambda_p$ . . . . .	82
5.1	QoE measurements for client 1 in scenario 1 . . . . .	95
5.2	QoE measurements for client 2 in scenario 1 . . . . .	95
5.3	Congestion detection rate and frequency of $\widehat{OFF}$ period for client 1 in scenario 1 . . . . .	97
5.4	QoE measurements for client 1 in scenarios 1, 2 and 3 . . . . .	106
5.5	ongestion detection rate and frequency of $\widehat{OFF}$ period for client 1 in scenarios 1, 2 and 3 . . . . .	106
5.6	QoE measurements for client 1 in scenarios 4 . . . . .	107
5.7	ongestion detection rate and frequency of $\widehat{OFF}$ period for client 1 in scenarios 4 . . . . .	107
5.8	The final score for each combination . . . . .	111



# CHAPTER 1 Introduction

---

On n'est jamais servi si bien que par  
soi-même

---

Charles-Guillaume Étienne

Globally, consumer Internet video traffic will present 80% of all consumer Internet traffic in 2019, up from 64% in 2014 according to a recent Cisco report [37]. Consequently, an adaptation of the video content providers (such as YouTube, Netflix and Dailymotion) and Internet Service Providers (ISP) to this growth of video streaming over Internet becomes needful. Youtube company, which is one of the biggest video content providers, has over a billion users and every day people watch hundreds of millions of hours on YouTube and generate billions of views [160]. Hence, improving the technology of streaming (such as the video codec, the transport protocol and the player configuration) becomes mandatory to increase profitability. In addition, today, the encoding bitrates of video contents range from low bitrates, typically to fit small screen sizes such as small handled devices, to Ultra High Definition, typically 4K and 8K. Consequently, ISPs are competing to provide high-speed data services to their consumers in order to enable the access to high quality videos and to satisfy the high demand of video contents. Moreover, in order to reduce the delay of video content delivery between the servers of content providers and the clients located in the access network of the ISPs, the Content Delivery Network (CDN) providers, such as Akamai, have placed caches (i.e. content proxies) inside ISP core networks and have adapted the caching and pre-fetching strategies to the video content. Globally, 72% of all Internet video traffic will cross content delivery networks by 2019, up from 57% in 2014 [37]. Accordingly, the collaboration between the video content providers, ISPs and CDN providers is necessary to deliver a superior user's Quality of Experience (QoE), a good quality of Service (QoS), and hence to increase their revenues [36].

In this thesis, we aim to further improve the QoE and the QoS when employing a particular and widely used video streaming technology, called HTTP Adaptive Streaming (HAS). Therefore, we

present in Section 1.1 the general context of this thesis with additional details about one common use case. Then, we explain the different contributions that we have performed during the last three years in Section 1.2. Finally, we give the outlines of the thesis report in Section 1.3.

## 1.1 General Context

HAS is a streaming video technology that uses Transmission Control Protocol (TCP) as transport protocol. It is increasingly employed over fixed and mobile access networks. Additionally, one particular use case is being more and more frequent: it consists of having many HAS clients connected to the same access network and are competing for bandwidth. Practically, this use case is assimilated to many HAS users connected to the same home network inside fixed access network. Similarly, it is also assimilated to many mobile devices requesting HAS content and are connected to the same base station inside the mobile access network.

The general context of this thesis focuses on studying the described use case, and hence covers three main areas of interest: the HTTP Adaptive Streaming technology, the access network characteristics and TCP protocol properties. They are briefly described in the remaining of this section in Subsections 1.1.1, 1.1.2 and 1.1.3, respectively.

### 1.1.1 HTTP Adaptive Streaming

Nowadays, video streaming with its both Live and Video on Demand (VoD) services are increasingly employing the HTTP Adaptive Streaming (HAS) technology. HAS employs HTTP as application layer protocol and Transmission Control Protocol (TCP) as transport protocol. It consists of storing video contents on a web server, called HTTP server, and splitting the original file into independent segments of the same duration, called "chunks". Each chunk is transcoded into different lower encoding rates. The HAS player, on the client side, requests for chunks, decodes and displays them successively on the client screen. The specificity of HAS technology is that it offers adaptability to the network conditions; in fact, it enables the HAS client to switch from one quality level to another within the same HAS stream. In common HAS implementations, the selection of the quality level of each requested chunk depends mainly on the estimation of the available bandwidth on the client side. Many commercial products of HAS have been proposed, such as Microsoft Smooth Steaming (MSS), Apple HTTP Live Streaming (HLS) and Adobe HTTP Dynamic Streaming. MPEG-DASH has been proposed in 2012 in order to converge different products into one commercial standard. However, there is still dissimilarities not only between commercial products, but also inside the same product, even inside MPEG-DASH: for example the chunk du-

ration, the playback buffer length and the configuration of the bitrate controller that selects the quality level of the next chunk and the time of its request. Accordingly, further investigations should be paid to these dissimilarities and their effect on HAS user's QoE.

### 1.1.2 ISP Access Network

Many investigations have shown that the use case of many HAS clients connected to the same ISP access network and competing for the same bandwidth presents a degradation of QoE of HAS users. In fact, this competition results in an instability of video quality level selection for each competing HAS player; each player switches frequently from one quality level to another without being able to stabilize around the best feasible quality level. Besides, a high queuing delay as well as a high congestion rate and high packet drop rate are generated because of this competition. Hence, a degradation of the QoS of the access network is also observed. Unfortunately, the deployment of CDN caches inside ISP core networks does not resolve these degradations of the investigated use case, because it is located inside the access network. Hence, a further investigation should be developed to improve both the QoE of all competing HAS users and the QoS of ISP access network. Accordingly, we should take into consideration the characteristics of the access network architecture, in addition to that of HAS, to accurately define the cause of performance deterioration and find solutions of improvements.

### 1.1.3 TCP protocol

TCP protocol used by HAS was designed for general purpose and not for video streaming in particular. In fact, TCP congestion control protocol aims to occupy the whole end-to-end available bandwidth and its behavior may have many discordances with HAS behavior. Moreover, many TCP congestion control variants have been proposed in the literature (such as NewReno, Vegas, Illinois, Cubic and Westwood+) for general use and independently of the service and the application layer of each corresponding TCP flow. However, these variants have different behaviors that may induce divergent impacts on the QoE of HAS and the QoS of the access network. In addition, the competition between HAS clients for bandwidth is a particular case of competition between TCP flows; the only difference is the download of many chunks, instead of a unique file, within the same TCP session.

Accordingly, an additional attention should be paid for this transport protocol and its congestion control algorithms to understand its implication on the performances of HAS and access network.

### 1.1.4 What can we do ?

As discussed above, in presented use case, three major areas of interest are mandatory to understand the different issues related to the degradation of the HAS user's QoE and the QoS of access network. Further investigations should be done in the three areas. Accordingly, the major steps that we have followed in order to achieve our proposed contributions are as the following:

- identify the QoE and QoS criteria that are sensitive to the presented use case, in order to be used for our evaluations
- overview the different HAS commercial products . Then propose a common HAS player with accurate defined and justified parameters, based on different HAS implementations.
- identify the different characteristics of access network in order to be used for testbed and simulations
- overview the TCP protocol, its congestion control algorithms and its behavior for different proposed TCP variants
- overview recent proposed solutions in the same context

Once we get information and sufficient background from different items cited above, we would be able to propose solutions and evaluate their performances.

## 1.2 Contributions

This thesis aims to give new solutions to resolve the issues cited above in the presented use case. In the following, we summarize our main contributions:

- Our first contribution consists of proposing a novel technique of traffic shaping based on TCP flow control and passive *RTT* estimation, that we called *Receive Window Tuning Method* (RWTM). The traffic shaping consists of limiting the throughput of a given flow to a desired value. In the context of HAS, it consists of limiting the throughput of each HAS flow to the desired value that enables each HAS player to select its best feasible quality level at each moment during the whole HAS session. The TCP flow control consists of limiting the sending rate of the sender in the receiver. Its objective is to prevent the sender to exceed the processing capacity of the receiver. The proposed method is implemented in the gateway, which is the nearest device of the access network to the HAS clients and which has visibility toward all connected devices inside the same local network. In the gateway, we implemented a bandwidth manager; it detects the HAS flows, identify the encoding rates of each HAS flow, estimates the available bandwidth inside the local



network and gives as output the shaping rates for each HAS flow. RWTM shapes the HAS traffics according to the computed shaping rates of the bandwidth manager. The novelty of this approach is that not only it improves the QoE of HAS users, but it also improves the access network QoS by reducing considerably the queuing delay and the congestion rate. In order to validate this contribution, we compare the performances of RWTM with a well-known gateway-based shaping method that it is based on queuing management, called Hierarchical Token Bucket shaping Method (HTBM).

- Our second contribution is a comparative evaluation between the combinations of two gateway-based shaping methods, RWTM and HTBM, and four different TCP congestion control variants, NewReno, Vegas, Illinois and Cubic. The objectives of this contribution are 1) to study whether one or both of the shaping methods are affected by the modification of the congestion control variant or not, and 2) what is the best combination that offers better performances. In this study, we present accurately not only the results of QoE and QoS metric measurements, but also the variation of TCP congestion control parameters over time for each combination. Results indicated that not only shaping methods or TCP congestion control variants have an effect on QoE of HAS and access network QoS, but also their combinations. Besides, the best combination that satisfies a maximum number of our use cases is when using RWTM shaping method with Illinois TCP variant. Moreover, our study reveals that the Slow Start Threshold (*ssthresh*) parameter has a great impact on accelerating the convergence speed of HAS client to reach the best feasible quality level.
- Based on the results of the second contribution, our third contribution consists of proposing a server-based shaping method: an HAS-based TCP congestion control variant. It consists of using "adaptive decrease mechanism" when encountering a congestion detection, accurately estimating the available bandwidth, and using the encoding bitrates of available video quality levels in order to set the slow start threshold (*ssthresh*) parameter to match to the best feasible video quality level. It also shapes the sending bitrate to match to the encoding bitrate of the best feasible quality level by handling the congestion window, *cwnd* during the congestion avoidance phase. Results indicated a remarkable improvement of HAS QoE and network QoS compared with a well-known adaptive decrease TCP variant "Westwood+".

### 1.3 Thesis Organization

The thesis dissertation is organized as the following:

First, we present in Chapter 2 the state of the art. It includes all details discussed in Subsection 1.1 about the general context.

Second, we present in Chapter 3 the general framework that we used and developed for emulations, testbeds, simulations and evaluations.

Third, we explain and show our first contribution, RWTM, in Chapter 4 and we evaluate its performances by a comparative evaluation with a recent gateway-based shaping method, HTBM.

Fourth, we evaluate in Chapter 5 the effect of TCP congestion control variant on HAS performances and we give a comparative evaluation when combining shaping methods with TCP congestion control variants.

Fifth, we present and evaluate TcpHas in Chapter 6; our HAS-based TCP congestion control variant which is a server-based solution totally implemented on the TCP layer.

Finally, we conclude this dissertation in Chapter 7 by summarizing our contributions and our main evaluation results and discuss possible future works.

# CHAPTER 2

---

## State of the art

### 2.1 Introduction

Internet video streaming, also called video streaming over Internet, has been widely deployed and studied for decades. According to a recent report of Cisco [37], it would take an individual over 5 million years to watch the amount of video that will cross global IP networks each month in 2019. Every second, nearly a million minutes of video content will cross the network by 2019. Globally, consumer video traffic will present 80% of all consumer Internet traffic in 2019, up from 64% in 2014 [37]. This growth could generate drawbacks on quality of service of Internet network such as networks overload and congestions. In addition, the video streaming users could have some difficulties to satisfy the user's quality of experience. Therefore, adapting the growth of video streaming use to the different network conditions is nowadays a challenging issue for both industry and academia. It is our overall objective in this thesis.

The purpose of this chapter is to give a state of the art of the research topics that are highlighted in this thesis. Section 2.2 presents a survey of the different video streaming technologies that have been used over Internet and specifically describes HTTP Adaptive Streaming (HAS). Section 2.3 overviews the different network architectures employed in conjunction with HTTP Adaptive Streaming and some critical use cases. Section 2.4 surveys the Quality of Experience (QoE) of HAS and its correlation with the Quality of Service (QoS).

### 2.2 Video Streaming Over Internet

Video streaming is a specific kind of downloading where a client video player can begin playing the video before it has been entirely transmitted. Accordingly, the media is sent in a continuous stream of data and is played as it arrives. Since the growth of Internet use, the improvement of the quality of service of Internet Service Providers (ISP), the optimization of video compression and encoding standards and the diversity of transport protocols, video streaming over Internet

has experienced large improvements. In this section, we present a classification of video streaming technologies that have been used over Internet according to the employed transport protocol. Then, we overview the HTTP Adaptive Streaming technology, explain the cause of their wide use and present its different commercial implementations.

### 2.2.1 Classification of Video Streaming Technologies

Video streaming technologies used over best effort network can be classified depending on their transport protocol. We can distinguish two major categories: video streaming based on User Datagram Protocol (UDP) [121], called UDP-based video streaming, or based on Transmission Control Protocol (TCP) [9], called TCP-based video streaming. The two categories are described in Subsections 2.2.1.1 and 2.2.1.2, respectively.

#### 2.2.1.1 UDP-based Video Streaming

A large number of video streaming services have employed UDP as a transport protocol. In fact, UDP is a simple connectionless transmission protocol without handshaking dialog and does not offer the guarantee of delivery, ordering, or retransmission [121]. These characteristics simplify data transmission and reduce the end-to-end delay. Therefore, UDP is suitable for real-time applications, such as Live video streaming, that are sensitive to delay.

Consequently, to transfer real-time data streams, UDP was widely employed as a transport protocol in conjunction with specific application layer protocols, called Real-time Transport Protocol (RTP) [130]. RTP provides end-to-end network transport functions suitable for applications transmitting real-time data over multicast or unicast network services [84]. It does not address resource reservation and does not guarantee quality-of-service for real-time services. Moreover, another application layer protocol, called Real Time Streaming Protocol (RTSP) [84], has been usually used with RTP. RTSP provides an extensible framework specific to media content to be used upon RTP; it establishes and controls either a single or several time-synchronized streams of continuous media such as audio and video stream. In addition to unicast/multicast network services, RTSP provides operations, such as playback, pause, and record, for audio or video streaming clients [61] and acts like a "network remote control" for multimedia servers, hence the reason of RTSP employment for IPTV service. Besides, both RTP and RTSP [84] are supported by commercial players such as Windows Media Player [101] and Real Player [124] which provide easy video streaming access for Internet users.

Moreover, the data transport is augmented by a control protocol (RTCP) [48] which provides min-

imal control and stream identification functionality to allow the management of media delivery for multicast networks. Note that RTP and RTCP are designed to be independent of the underlying transport and network layers.

But even in the case of adopting RTP/RTCP, the effectiveness of video streaming will degrade when RTP packets are lost or when delay time increases unexpectedly by any reason. In fact, in [158] authors indicated that degradation of video quality by packet loss begins at the packet loss ratio of about 2.5% regardless of video transmit rate. They also found that video quality degrades when the standard deviation of round trip time (RTT) exceeds 30 ms. Many contributions have been proposed in order to reduce the packet loss events. However, these contributions are still either unreliable or complex to implement in real large-scale network architectures: For example, in [119], authors proposed the use of Datagram Congestion Control Protocol (DCCP) [45], a specified transport protocol which gives a general congestion control mechanism for UDP-based applications. However, authors revealed many issues of running RTP/RTCP over DCCP; they are mainly related to the complexity of managing multicast transmissions and the incompatibilities between the behavior of DCCP and RTCP.

Moreover, MJ Prins et al. [120] added a fast retransmission mechanism inside RTP streams. Although the proposed solution reduces packet loss, it adds some complexity in the clients and the nodes containing the retransmission cache. Moreover, RTP/RTCP protocol (UDP-based communications in general) may have network access issues because its packets are often intercepted by firewalls and/or Network Address Translations (NATs), which creates environments where video streaming services cannot be offered [61].

Because of all reasons cited above, RTP/RTCP has been reserved for IPTV services inside a managed network [92]. We note that the managed network is a built and secured network which is entirely monitored, maintained and operated by the service provider (ISP) [148]. Actually, the Quality of Service (QoS) of Orange managed network provides the guarantee of well employing the IPTV service with RTP/RTCP protocols for Orange subscribers. However, offering a good quality of streaming when users access to Internet, e.g. outside the managed network, is still difficult to achieve with RTP/RTCP protocols. Because of that, many researches have been developed to use another transport protocol for video streaming over Internet such as TCP.

### 2.2.1.2 TCP-based Video Streaming

TCP is connection-oriented, end-to-end reliable protocol that provides ordered, and error-checked delivery of a byte stream [9]. Nowadays, video streaming over Internet is usually based on TCP owing to its reliability. Although TCP is currently the most widely used transport protocol

in the Internet, it is commonly considered to be unsuitable for multimedia streaming. The main reasons lies in 1) the TCP acknowledgment mechanism which does not scale well when the number of destinations increases for the same server, and 2) the retransmission mechanism which may result in undesirable transmission delays and it may violate strict time requirements for streamed live video [18, 46, 61]. In order to facilitate the traversal of NATs and firewalls, Hypertext Transfer Protocol (HTTP) has been usually employed upon TCP [18]. As a consequence, the video player is incorporated in a web browser.

For HTTP/TCP-based video streaming, there are essentially two categories: Progressive HTTP Download and HTTP Adaptive Streaming (HAS):

Progressive HTTP download was initially adopted for Video on Demand (VoD) service by popular video streaming services [2, 58], such as YouTube [159]. The video content on the server side could be present with many different quality levels, and thus different encoding bitrates. The client can select one of the offered quality levels based on its processing capability, its display resolution and its available bandwidth [118]. However, it is still a static selection for the whole video. In fact, this selection is made before transmission starts and the same video file with the same quality level is used till the end [118]. The player employs a playback buffer that allows the video file to be stored in advance in order to mitigate network jitter, and thus video interruptions [38]. However, knowing that network conditions may vary during the streaming session, such as the available bandwidth or end-to-end delay, the static selection of video quality level may be unsuitable for real network conditions. Accordingly, dynamic adaptation to network conditions would be an interesting way whereby we could switch from one video quality level to another into the same streaming session [118].

In order to cope with this problem, a concept of dynamic adaptation was introduced by the HTTP Adaptive Streaming (HAS) technology; it does not perform a progressive download of the complete video file, but rather of each segment of it. HAS will be described with details in the next Subsection (2.2.2).

### **2.2.2 HTTP Adaptive Streaming (HAS)**

Over the past few years, HTTP Adaptive Streaming (HAS) has become a popular method for streaming video over Internet. With HAS, the video content is adapted on-the-fly to the network available bandwidth. This behavior represents a key advancement compared to classic progressive HTTP download streaming for the following reasons [38]: 1) live video content can be delivered in real-time, while progressive HTTP download is only limited to VoD service; 2) the video quality can be continuously adapted to the network available bandwidth during the same streaming session

so that each user can watch its requested video at the maximum bitrate that is allowed by its time-varying available bandwidth.

In this section, we describe the common characteristics of HAS in Subsection 2.2.2.1. Then, we overview the actual HAS methods that are commercially employed for streaming service in Subsection 2.2.2.2. Finally, we survey the parameters of HAS player and HAS streaming protocol in Subsection 2.2.2.3.

### 2.2.2.1 HAS General Description

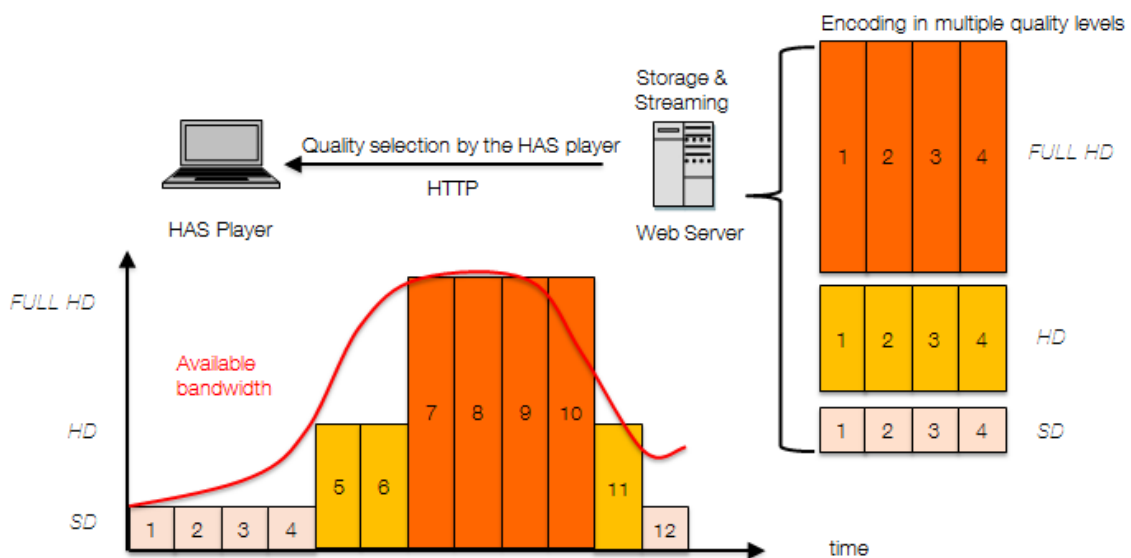

Figure 2.1 – General description of HTTP Adaptive Streaming

HAS is based on downloading video segments of short playback duration, called chunks, from a HAS server to a HAS client. The playback duration of each chunk is one or a few Group of Pictures (GOPs). At the video codec level, this typically means that each chunk is cut along video GOP boundaries (each chunk starts with a key frame) and has no dependencies on past or future chunks/GOPs. This allows each chunk to later be decoded independently of other chunks [162]. Each chunk is encoded at multiple encoding bitrates, video frame rates and video resolutions corresponding to multiple video quality levels as shown in Figure 2.1. Chunks with different quality levels are stored (or at least can be produced in real-time) in the HAS server. In a typical HAS streaming session, at first, the client makes an HTTP request to the server in order to obtain meta-data of the different audio and video representations available, which is contained in a specific file, so-called the *index file* [131]. The purpose of this index file is to provide a list of representations available to the client (e.g. characteristics of each video quality level) and a means to formulate HTTP requests for a chosen representation [131, 144].

The adaptation engine in the client (also called bitrate controller), which distinguishes HAS from classic progressive HTTP download, decides which chunks should be downloaded based on their availability (indicated by the index file), the actual network conditions (measured or estimated available bandwidth), as shown in Figure 2.1, and media playout conditions (playback buffer occupancy) [131, 157]. Typically one HTTP GET request is sent from the player to the HAS server for each chunk [144]. In addition, HAS employs HTTP/1.1 with enabled persistent connection option in order to maintain the same TCP session throughout the entire video stream. Then, the chunk is stored in the playback buffer of the player to be decoded and displayed.

As the chunks are downloaded at the client, and more precisely in the playback buffer of the player, the player plays back the sequence of chunks in sequence order. Because the chunks are carefully encoded without any gaps or overlaps between them, the chunks play back as a seamless video [162]. In order to avoid the famine of playback buffer, the player operates in one of two states: Buffering State and Steady State. During the Buffering-State, the player requests a set of chunks consecutively until the playback buffer has been filled. Generally, the player selects the lowest video quality level to accelerate buffering process. During this phase, the player does not begin decoding and displaying video. This phase is called *initial loading* or *initial buffering* when it is in the beginning of the HAS session and *stalling* or *rebuffering* when it happens later on in time [50]. In general cases, the player shows a message to users indicating that the buffering is processing. Once the playback buffer is filled, the player switches to Steady State by requesting the chunks periodically to maintain a constant playback buffer size. Accordingly, this periodicity creates periods of activity, so-called ON periods [6, 147], when the chunk is being downloaded, followed by periods of inactivity, so-called OFF periods [6, 147], when the player is waiting for the request message of the next chunk, without impacting the continuity of the video playing.

We also notice that unlike progressive HTTP download, HAS supports not only VoD streaming, but also Live streaming [166] thanks to its adaptability to network changes. Accordingly, employing HAS for both VoD and Live services by just adjusting some parameters (such as playback buffer length on the player side or chunk generating method on the server side) is more practical for video service providers.

#### **2.2.2.2 HAS Commercial Products**

After the first launch of an HTTP adaptive streaming solution by Move Networks in 2006 [113, 161], HTTP adaptive streaming was commercially rolled out by three dominant companies in parallel [131]:



### 1. Microsoft Smooth Streaming (MSS) [162] by Microsoft Corporation (2008):

Its official name is *IIS Smooth Streaming*. It uses the MPEG-4 part 14 (ISO/IEC 14496-12) file format, so-called MP4, as its storage and transport format. MP4 supports the H.264/AVC codec. However, each video is no longer split up into many files of chunks, but it is "virtually" split into fragments of one GOP and stored inside one MP4 file as shown in Figure 2.2, to the point where MP4 file is designed as *Fragmented MP4 file* (fMP4). The (f)MP4 file contains metadata related to the whole media file and to each fragments. As a consequence, the client has more flexibility to choose the chunk duration by just defining the time-code in each HTTP GET request. In addition, the server has additional intelligence to set the requested chunk from fMP4 file. We notice that the chunk contains obviously at least one fragment.

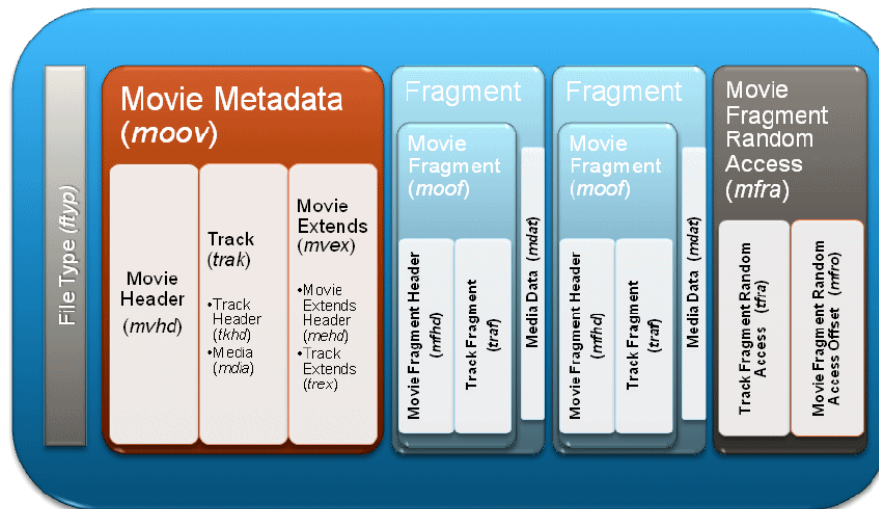

Figure 2.2 – (f)MP4 file format [162]

The server translates this request into byte ranges in the (f)MP4 file and sends back the corresponding fragment. In addition, MSS uses specific index file so-called *Manifest File*. The manifest files are XML-formatted files. More specifically, the client and the server holds two different manifest files ".ismc" and ".ism". The former is requested by the client from MSS server to learn about the available resolutions, codecs, encoding rates, and list of available chunks (with their time-code) while the latter is held by the server and describes the relationship between media contents, bitrates and (f)MP4 files. It also maps the request of clients to the corresponding ".ismv" and/or ".isma" files contained in the (f)MP4 files. These files contain the video (ismv) and the audio (isma) content of the chunk to be served to the client.

Typically, MSS employs a chunk duration of 2 seconds [58, 8]. In the default configuration,

MSS encodes the video stream in seven layers that range from 300 kbps to 2.4 Mbps [38]. The player of MSS is developed using Silverlight framework and called *Smooth Streaming Silverlight client*. However, the most challenging part of this client is the heuristics module of the adaptation engine (e.g bitrate controller) that determines when and how to switch between bitrates. It is also customizable for developers. In addition, Microsoft proposed an open video player (OVP) that provides a video player platform that it was used by Akamai on SmoothHD.com [162]. Netflix had also used MSS with its Silverlight framework to stream videos [123]. However, as authors of [8] said, each Netflix player maintains two TCP connections with the server. They also indicated that each of these two connections is managed in a similar way by the MSS player.

## 2. HTTP Live Streaming (HLS) [16] by Apple Inc. (2009):

As shown in Figure 2.3, inside the server, HLS begins by converting each new MPEG video file into multiple MPEG-2 transport streams (MPEG-2 TS) also denoted by M2TS. Unlike MSS, HLS server split each video stream into chunks, called media segment files, of configurable duration and video quality using a software stream segmenter. These chunks are stored on a web server as files with `*.ts` extension. Besides, the stream segmenter creates and maintains an index file which indicates the list of chunks related to the same video stream and their characteristics (chunk number and encoding bitrates). The index file is so-called a playlist. It has `*.m3u8` as file extension and includes the URL which identifies each chunk. This URL does not necessarily include informations about the characteristics of chunks, because they are well described in the playlist [16, 144]. Typically, the duration of each chunk is 10 seconds. Less than 10 seconds will result in extra network overhead because it causes more frequent refreshes of the index file [131]

We note here that M2TS is not as flexible as in the case of (f)MP4 [131, 162]; In fact, with M2TS the duration of chunks is selected by the stream segmenter at the beginning and it is unchangeable, while with (f)MP4 the player has always the possibility to select what ever chunk duration it desires by choosing the number of media fragments per chunk.

We also note that HLS supports Live as well as VOD streaming services. For a Live streaming, the chunks (`*.ts`) are created continuously and the playlists are regularly refreshed.

HLS employs H.264 codec and it is available on any device running iPhone OS 3.0 or later (including iPad), or any computer with QuickTime X or later installed [38]. Apple TV 2 and later includes an HTTP Live Streaming client [16].

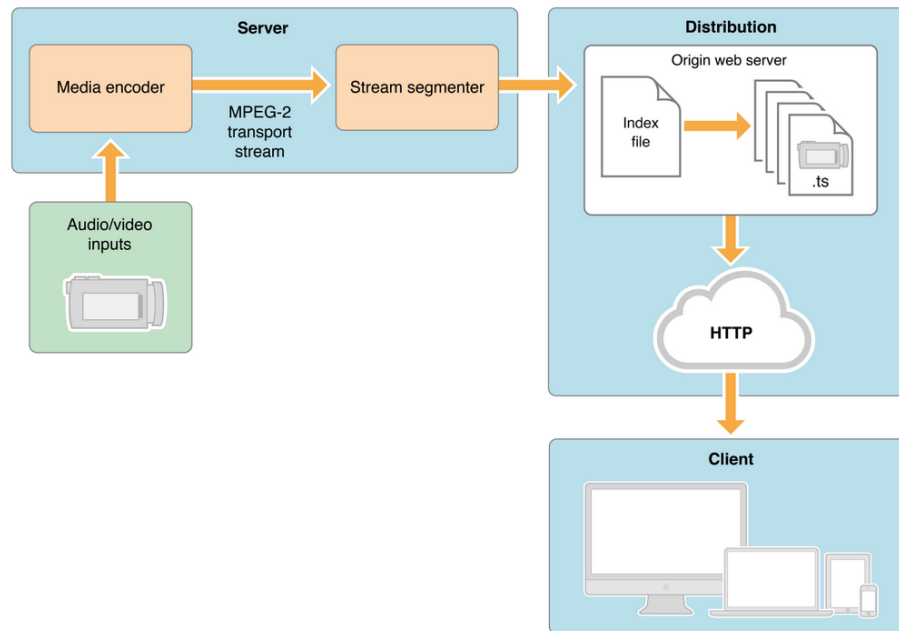

Figure 2.3 – Apple HLS description [16]

### 3. Adobe HTTP Dynamic Streaming (HDS) [3, 4] by Adobe Systems Inc. (2010):

HDS uses a similar file format as MSS, MPEG-4 part 14 (f)MP4 and it supports both H.264 and VP6 codecs. It uses a specific tool, called packager, to package media into fragments. It supports both Live and VOD streams [166]. This packager generates the index file, called manifest, which is an XML-based index file with extension *"\*.f4m"*, and (f)MP4 files with well-defined fragments. All fragments are stored in an HTTP server. The chunk, so-called segment, generated by the packager have *"\*.f4f"* as file extension and could have one or more fragments, to be delivered to the client. The recommended chunk duration is 2-3 seconds for video up to 30 second length [85].

HDS uses specific player developed with Adobe Flash, Flash Player 10.1, which is easy to integrate in desktop and mobile platforms. It also offers an open source and customizable media player framework, called OSMF (Open Source Media Framework), which is widely used by researchers and developers [3].

Despite their wide adoption and commercial success, these solutions are mutually incompatible, although they share a similar technological background [131] as described in 2.2.2.1. Therefore, the need to a standard for a general use of HAS becomes unavoidable. The first approach of a HAS standard was proposed by 3GPP and published in TS 26.234 Release 9 in 2009. The collaboration between 3GPP and MPEG had resulted in publishing a new standard, ISO/IEC 23009-1 [140], called Dynamic Adaptive Streaming over HTTP (**MPEG-DASH**) in 2012, defining the structure and semantics of an index file and additional restrictions and extensions for container

formats.

The MPEG-DASH standard uses an XML-based index file called Media Presentation Description (MDP). It supports any type of codec, even recently the H.265 HEVC codec. The file format could be either (f)MP4 or M2TS. The segment length is not specified and is left to individual implementations.

Many DASH-compatible players have been proposed: VLC Media Player [110], libdash open source player [20], DASH-JS [116] by University of Klagenfurt, bitdash player [19] provided by bitmovin for HTML5 and Flash, Viblast player [146] for HTML5, iOS and Android, and OSO4 [69] by Telecom ParisTech.

Nowaday, many video content providers have recently adopted MPEG-DASH standard, like YouTube and Netflix [96]. MPEG-DASH has also developed special specifications for the Hybrid Broadcast Broadband TV (HbbTV) standard [129] which offers the service of getting digital television content from various sources such as Internet, traditional broadcast TV and connected devices in the home.

However, the diversity of HAS commercial products (MSS, HLS, HDS and the standard MPEG-DASH) leads to having different behavior of the streaming among HAS methods and even with the same method but using different configuration of the player (such as bandwidth estimation method and playback buffer length). Studying this behavior is been investigated by some researchers and will be further described in the next Subsection 2.2.2.3.

### **2.2.2.3 HAS Player Parameters**

The HAS commercial products have common characteristics that have been integrated in the MPEG-DASH standard. However, until now, there is still no convention for the values of player parameters and they are still fully customizable. Figure 2.4 gives a presentation of the common HAS player; it mainly depends on two parameters for its adaptation engine (i.e bitrate controller): the bandwidth prediction and the actual buffer occupancy. Using these two parameters, the player makes decision for the next chunk; its bitrate (i.e quality level) and its request time [157]. Accordingly, the difference between players is mainly around three questions: How is configured the bitrate controller ? How is estimated the bandwidth ? And what is the length of playback buffer ?

In this paragraph we try to give answers for these three questions by overviewing very common and proposed players:

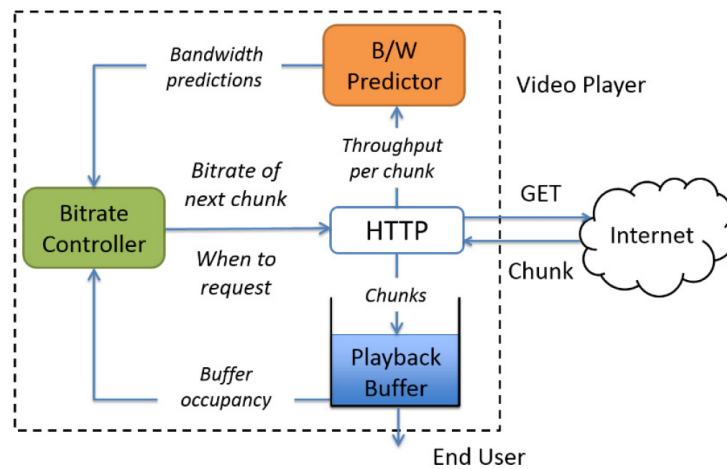

Figure 2.4 – Abstract model of common HAS player [157]

#### — How is configured the bitrate controller ?

In [157], the authors classify bitrate controller into three main categories: *rate-based* (RB), *rate and buffer based* (RBB) and *buffer-based* (BB) bitrate controller. Although majority of players uses RB bitrate controller by only using a bandwidth estimator, the use of buffer occupancy information is increasingly proposed by researchers in order to avoid stalling (e.g buffer famine) in the case of bad network conditions. Using the playback buffer occupancy in conjunction with bandwidth estimator (RBB) was proposed since 2012 by [103] and [109]. Moreover, a new BB player has recently been proposed [68] in 2014; it uses only the buffer occupancy level in steady-state phase to select the quality level and presents better performances than the DASH player of Netflix.

The request time defined by bitrate controller could also be different among players. In fact, traditional players request chunks successively during Steady-State phase. However, some implementations are quite different. One of the most controversial modification of this request time is the use of "multiple TCP connections with parallel HTTP requests" within the same video streaming. Authors of [82, 81, 109] cited the benefits of this technique to maintain satisfactory performance. However, it is more greedy than other classic players with unique TCP connections, and thus it presents an unfairness issue [82]. For example, Netflix employs this technique within its player as indicated in [96], published in 2013. Moreover, another approach was proposed in [109] over DASH player; it is a non-standardized approach called pipeline DASH. It consists of using the HTTP pipelining technique of HTTP/1.1 by sending multiple HTTP requests on a single TCP connection without waiting for their corresponding responses. However, it is somehow complicate to implement in daily use because pipelining requires appropriate sending buffer control which would increase server complexity [131].

Accordingly, the RBB bitrate controller with a unique TCP persistent connection, with unique HTTP request per chunk and without HTTP pipelining represents the most common use.

— **How is estimated the bandwidth ?**

The estimation of bandwidth is based on dividing the chunk size by its downloading duration. We notice that this estimation is obviously possible only in ON periods. Moreover, it is possible to apply an exponential moving average function on actual and previous estimations [88] to give a smoothed estimation and thus could produce a more stable player. A similar smoothed estimation technique is used by MSS [8].

In addition, an overall aggressiveness of players toward available end-to-end bandwidth offered to the client is studied by Saamer Akhshabi et al. [8]; their investigations indicate that Netflix player is more aggressive than MSS. The former tries to reach higher quality level even at the expense of quality level changes and sometimes switches to a higher bitrate than the available bandwidth.

Accordingly, the estimation of the bandwidth is commonly based on the estimation of the throughput of the previous chunk. However, it may result on an instable player. The aggressiveness is an important parameter for player design. But, this aggressiveness should take the length of the playback buffer into consideration in order to avoid stalling events.

— **What is the length of playback buffer ?**

The length of playback buffer is different between players and even between devices and type of connection. For example, Netflix, which uses DASH standard, employs different playback buffer sizes: they range from 30 seconds (on an Android WiFi device) to 4 minutes (on a Windows Wired device) [96]. OSMF player has a playback buffer size around 10 seconds [8]. Furthermore, Saamer Akhshabi et al. [8] said that the playback size for Live streaming is significantly lower than the typical playback buffer sizes of VoD streaming; for example, in MSS player, the typical size of playback buffer is only 8 seconds for Live streaming while it is 30 seconds for VoD streaming. Obviously, the objective of this dissimilarity is to reduce the playback delay to be near to Live streaming. Nevertheless, tolerating few seconds of playback delay (e.g, 8 seconds in the case of MSS) in Live streaming is unavoidable because shorter buffer size may increase stalling events. Accordingly, the most common length of playback buffer is around 30 seconds for VoD service and around 8 seconds for Live service.

A huge number of combinations is possible between different bitrate controllers, different bandwidth estimators and different playback buffer lengths. For example, In [109], the authors compared MSS, HLS, HDS, and DASH under real world mobile network conditions using bandwidth traces that have been captured under vehicular mobility. They found that the best performance was achieved by MSS, represented by the highest average achieved video bitrate and a low number of switches among quality levels. As Saamer Akhshabi et al. [8] indicates, the behavior of different players to persistent or short-term bandwidth changes and to the speed of convergence to the maximum sustainable quality level is quite different. Further investigations are surveyed in the Subsection 2.4.2.1 in order to give informations about the effect of each parameter inside the player on the user's quality of experience (QoE). We also describe how some previous works aim to design QoE-driven player in Subsection 2.4.2.2.

## **2.3 Architecture Description and Use Cases**

HAS is nowadays used under various network architectures that connect the HAS client inside an access network to the HAS server located far away in the best effort network. Besides, under the diversity of these architectures, we can find common use cases that presents similar constraints and limits the performances of HAS. In this section, we present the typical architectures used for access and delivery of HAS content in Subsection 2.3.1. Then, we present the common use cases in Subsection 2.3.2 and give investigations about the effect of their constraints on HAS behavior.

### **2.3.1 Network Architecture**

The HAS stream is been deployed over many network architectures thanks to its HTTP/TCP protocols that can be smoothly routed over IP network. Accordingly, the HAS client could be located in different access networks. Depending on the type of access network, whether it is fixed or mobile, we give an overview of the two types in Subsection 2.3.1.1 and Subsection 2.3.1.2, respectively. Recently, a new architecture used for content delivery has been employed, called Content Delivery Network (CDN). We overview CDN architecture and its effectiveness for HAS in Subsection 2.3.1.3.

### 2.3.1.1 HAS Client Inside Fixed Broadband Access Network

According to recent Cisco report [37], in 2014, 95% of global IP traffic was served by fixed broadband access network users. More precisely, 29% of global IP traffic was used through managed network which is reserved for IPTV service, and the remaining amount of 66% was employed by unmanaged network (e.g, outside managed network). Moreover, the IP traffic over unmanaged network will grow up by 23% from 2014 to 2019. By 2019, broadband speed will reach 43 Mbps, up from 20 Mbps in 2014 [37].

Figure 2.5 describes the common architecture of fixed broadband access network provided by an Internet Service Provider (ISP). Inside the same home network, we can have three types of devices: Phones, served by Voice over Ip (VoIP), Set Top Boxes (STB) for IPTV service and computers for diverse services over IP. This multiplicity of services provided by ISP is commercially designed by *Triple Play Service*.

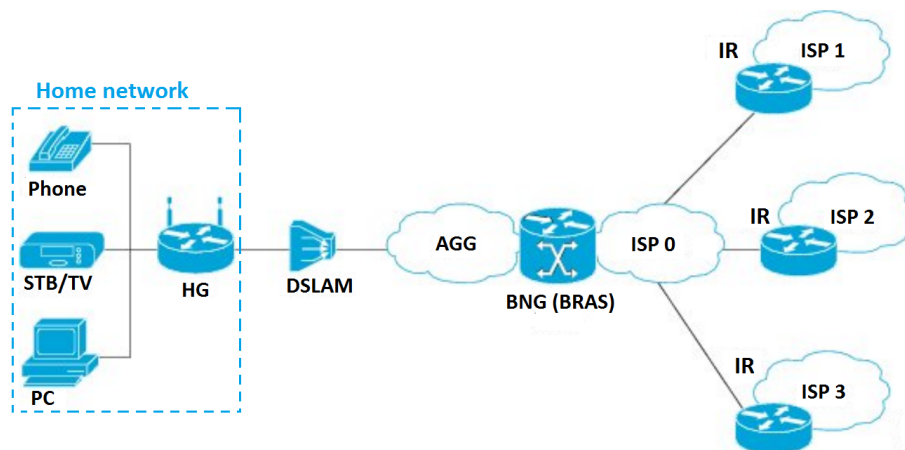

Figure 2.5 – Fixed broadband access network architecture with triple play service [34]

The devices of the same home network are connected to an unique home gateway (HG) and are sharing the same broadband connection offered by the ISP. Each subscriber inside the home network connects to the IP network over a Digital Subscriber Line (DSL) connection. Therefore, each HG is connected to the Digital Subscriber Line Access Multiplexer (DSLAM). DSLAM connects multiple HG interfaces to a high-speed digital communications channel using multiplexing techniques. Broadband Network Gateway (BNG), also called broadband remote access server (BRAS, B-RAS or BBRAS), is the access point for subscribers, through which they connect to the broadband network [34]. BNG is located at the core of an ISP's network, which is the managed network and is denoted by *ISP 0* in Figure 2.5. BNG aggregates user sessions from the access network. When a connection is established between BNG and a device in the home network, the subscriber access the broadband services provided by one of the ISPs. The managed network,



denoted by *ISP 0*, offers the services of VoIP and STB. It is also connected to the Internet (i.e. other ISP networks, denoted by *ISP 1*, *ISP 2*, etc. in Figure 2.5) via Internet Router (IR). Here we denote by *unmanaged network* the network that it is located outside the *ISP 0* network. Obviously, the unmanaged network is not controlled by *ISP 0*.

We notice that the home network is a Local Area Network. Generally, STB and Phone are connected with wired connection to HG. Other devices could use either wired or wireless connection [15]. The wireless home network provided by HG -which behaves as an access point- is based on 802.11 families and called WiFi.

### 2.3.1.2 HAS Client Inside Mobile Broadband Access Network

The mobile broadband designates wireless Internet access delivered to mobile phone through cellular network. Since the deployment of new generation of cellular network of 3G and beyond, the delivery of diverse web contents from Internet has become possible. In addition, the mobile phones has experienced a large improvement of their processing capacity and their display quality, namely with smart-phones, that made high quality streaming video over cellular network possible.

According to recent Cisco report [37], actually, only less than 5% of global IP traffic was served to mobile broadband access network users. Nevertheless, it will grow at a compound annual growth rate (CAGR) of 57% between 2014 and 2019, reaching 24.2 exabytes per month by 2019.

Jiali Chen et al. [27] give the general architecture of typical cellular network as shown in Figure 2.6. It consists of two parts; the Radio Access Network (RAN) and the Mobile IP Core network. RAN is a network of base stations connected to a same Gateway called *serving gateway*. This gateway handles and routes incoming and outgoing traffic to and from hundred of base stations. Each base station provides wireless resource allocation across multiple flows of mobile stations and performs radio resource management, handover initiation and interference reducing. The Mobile IP core network includes principally the serving gateways and PDN (Packet Data Network) gateways and principally provides the functionalities of IP connectivity. The PDN gateway enables access to the Internet as well as to the managed network of the ISP (e.g mobile network operator). Accordingly, HAS streaming is performed over the cellular network when the HAS player inside the mobile station, which is connected to one base station, connects to a HAS server located in the Internet and asks for video content.

Compared with fixed broadband access network, when HAS clients are located inside the mobile broadband network, additional constraints are presents; 1) the variability of available bandwidth due to the change of connected mobiles to the same base station; 2) the high variability of

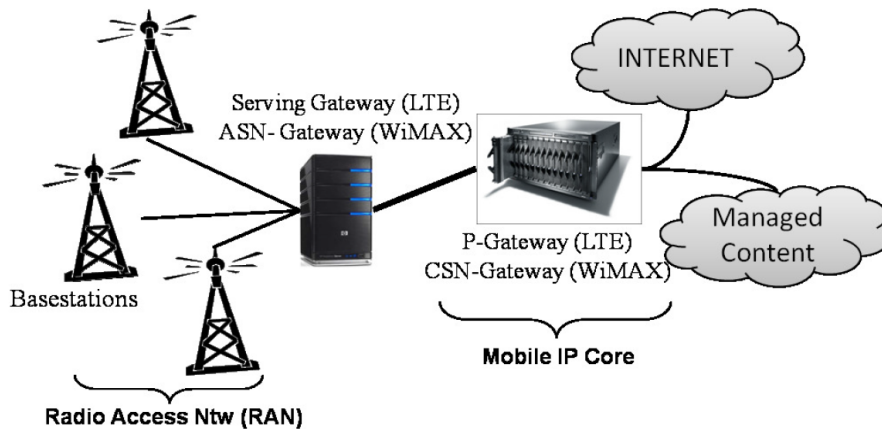

Figure 2.6 – A typical Cellular Network [27]

delay due to mobility and handover events when the mobile station changes its access from one base station to another; and 3) a higher error rate (interference, shadowing, multipath fading, route changes, connection loss) [87].

Nevertheless, many other similitudes are present between the two types of architectures (fixed or mobile broadband access networks). For example, the serving gateway (respectively, the PNR gateway) in cellular network is similar to DSLAM (respectively, the Internet Router (IR)) in fixed broadband network.

Besides, for both architectures, the video content served by unmanaged network is called Over The Top content (OTT). This content arrives from a third party of content provider such as YouTube, Netflix, Hulu and Dailymotion. In this case, ISP has only the role of transporting IP packets between the end-user and this third party provider. Consequently, many constraints related to the unmanaged network, such as high delay, packet loss and low end-to-end-bandwidth could be harmful for OTT user's experience (QoE). In this context, the Content Delivery Network (CDN) is employed in order to reduce these drawbacks.

### 2.3.1.3 The Importance of Content Delivery Network

Content Delivery Network (CDN) is a specific architecture for content delivery that has been widely employed over Internet since the early 2000s. Moreover, according to recent Cisco report [37], CDN will carry over half of Internet traffic by 2019. Globally, 62% of all Internet traffic will cross content delivery networks by 2019 globally, up from 39% in 2014.

Figure 2.5 shows a simplified description of CDN. It consists of deploying caches (e.g, proxies) inside IP network that store replicated contents from servers located far away inside data

centers. The client selects the closest cache that owns its requested content instead of asking the original server. In fact, the caches provided by CDN have been principally designed to accomplish two major challenges; avoiding the core network congestions by minimizing the need for its traversal, and reducing the load on servers. Akamai was the first pioneered the concept of Content Delivery Networks (CDNs) [115]. It began deploying its CDN by using more than 12,000 servers in over 1,000 networks. Thanks to this first implementation, Akamai proved that CDN was able to reduce service bottlenecks and shutdowns by delivering content from the Internet's edge [41].

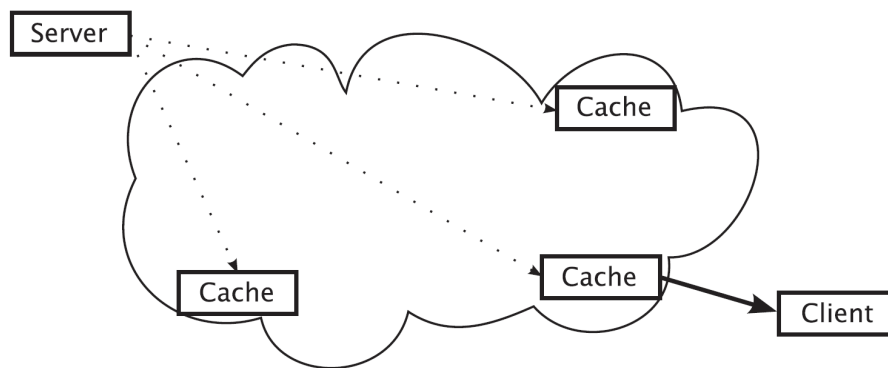

Figure 2.7 – CDN description [93]

Furthermore, caching replacement policy consists of deciding which content should be stored inside caches. It is a controversial issue because of the dilemma between minimizing the cost (in terms of number of caches and their storage space) and maximizing the efficiency of caching. Caching replacement policy is well investigated by CDN service providers and researchers. Due to the growth of HAS use over Internet, caching replacement has been customized for HAS contents for both Live and VoD services [93]. It takes into consideration the segmentation of video content into chunks with different quality levels and adopts a chunk-based caching, such as the proposed approaches of Huang et al. [64]. In addition, it focus on the popularity of video content per chunk to store the most popular chunks inside caches, such as the proposed works of Shen et al. [132] and Tu et al. [142]. It also implements a prefetching technique which consists of predicting the next chunks that would be asked and stores them in advance as the proposed contributions of Chen et al. [28, 29, 30]. Prefetching has been largely employed and presents the advantage of reducing latency. Many HAS-compatible caching and prefetching policies have been adopted by CDN providers, like Akamai Media Delivery Solutions which aim to deliver content at the highest quality wherever and whenever users want [5]. Globally, 72% of all Internet video traffic will cross content delivery networks by 2019, up from 57% in 2014 [37].

In this subsection, we have presented the different types of broadband access networks (fixed

and mobiles access networks) inside which the HAS clients are connected and are using the HAS services. We have also presented the CDN networks that are implemented inside ISP networks in order to improve the QoS of access networks, especially in the context of HAS. By taking into consideration the similarities between the two access networks and the advantages of CDN, we present the common use cases in the context of HAS that still present side effects.

### 2.3.2 Use Cases

Thanks to CDN, the constraints related to the quality of service of core network has been reduced. Nevertheless, we still have some use cases where the HAS streams suffer from some issues in the access network. In this section, we present two major issues that harm the quality of HAS streaming: the bottleneck issue in Subsection 2.3.2.1 and the competition between HAS flows in Subsection 2.3.2.2.

#### 2.3.2.1 Bottleneck Issue

The bottleneck in a network is a node or a link in which the bandwidth is reduced and the transmission is slowed down due to limited resources or components. The severity of the bottleneck relates to the degree of mismatching between traffic demand and available capacity. In fact, a bottleneck at an early stage may impact the network performance only slightly but it will lead to increasing performance degradation with time [128]. More precisely, the bottleneck node, as each network device, has one or many queues (also called buffers) which are outfitted with specific algorithm to schedule incoming and out-coming packets. This algorithm is called *queuing discipline*; depending on the queue length, it decides whether to buffer, route or drop the incoming packet. Consequently, when the incoming packet rate is higher than the out-coming rate, the bottleneck node becomes more likely delay than to drop packets, hence the degradation of network performance.

As described in Subsection 2.3.1.3 the CDN has improved the network capacity inside Internet and has reduced considerably the bottleneck occurrence. Therefore, reducing bottleneck side effects is more required over access networks.

In the fixed broadband access network, Jairo Esteban et al. [43] found in their investigations that DSLAM is more likely to be the bottleneck. In fact, they report that DSLAM buffers are smaller in comparison to those found in network device routers. Some authors like Xiaoqi Yin [157] use the term of *bottleneck link* which refers to the link between HG and DSLAM. This designation is equivalent to the DSLAM buffers because the bandwidth is dramatically reduced

from aggregate link to HG-DSLAM link (see Figure 2.5). Moreover, inside cellular networks, Fabio Ricciato et al. [126] and Jason J. Quinlan et al. [122] argue that bottleneck is more often to be located in the RAN. In fact, inside RAN we can locate a geographical area that is frequently overloaded because the provisioned radio capacity does not match the peak-hour traffic demand. Grigorik et al. [54] indicated that depending on the location of radio resource controller, whether it is in the base station (e.g, LTE) or in the serving gateway (e.g, 3G), the bottleneck could be located inside RAN or in the serving gateway (SG). Accordingly, we can make the assumption that for mobile broadband access network, the bottleneck link could be considered as located between the serving Gateway and the base station. We denote it by SG-BS link.

Given that HAS is based on TCP protocol, it produces bursty traffic inside the access network. Overloading bottleneck nodes and overflowing their buffers could happen more frequently with the increase of the number of HAS flows. As a consequence, the bottleneck issues in HG-DSLAM and SG-BS links could be accentuated. Nevertheless, some researches like [90] and [79] make the assumption that the bottleneck between the HAS client and HAS server is more likely to be located near the server. However, this assumption is no longer valid with the distributed caches of CDN that reduce the load on servers. Besides, the data centers where HAS servers are located are supposed to be well designed to support high traffic bitrate by insuring low delay and negligible loss rate.

Furthermore, the testbed used in the context of HAS to emulate the bottleneck of cellular access network in [122] was similar to what it was used for DSL network in [94]. This similitude in the architecture leads us to consider both mobile and fixed broadband access networks as the same use case for emulations over testbeds and for simulations in this thesis. We just should consider one shared bottleneck link (e.g, presenting SG-BS or HG-DSLAM link) near the HAS clients and we also should take into consideration the difference of characteristics between wired and wireless connection offered to clients.

### 2.3.2.2 Competition between HAS Flows

With an increasing demand for HAS video content over the Internet, the use case of two or more HAS players sharing the same network bottleneck and competing for available bandwidth is increasingly becoming more often. In addition, offering high video quality level content for competing HAS players is becoming possible, although it increases the bottleneck overloading. The investigation of Saamer Akshabi et al. [6] indicated the effect of this competition on the behavior of MSS players; it leads to the instability of video quality level selection, unfairness between players and bandwidth underutilization. The main cause of this degradation is the typical

behavior of HAS player during the Steady State phase. In fact, as indicated in Subsection 2.2.2.3 the player cannot estimate its available bandwidth during OFF period because it does not receive any data then.

In order to make things clear, we give an example of two players competing for available bandwidth during Steady State phase in Figure 2.8. Optimally, each player should have an estimation of available bandwidth around the half of the total bandwidth. However, when we treat a particular event when having the ON period of one player coincides with the OFF period of the second player, we will have a great issue. In fact, each player will typically use the throughput measurement of the downloaded chunk during its ON period as an estimation of its available bandwidth, hence an overestimation of available bandwidth. Consequently, the bitrate controller of the player (see Subsection 2.2.2.3) may use this estimation to switch to a higher quality level, for example from HD to FULL HD level as shown in Figure 2.8.

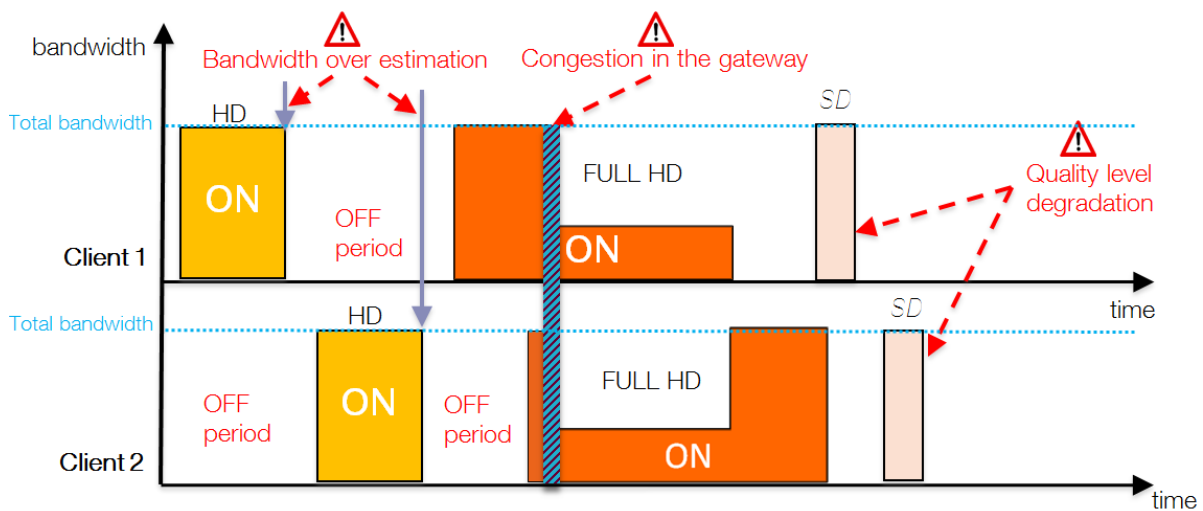

Figure 2.8 – The OFF period issue when two HAS clients compete for bandwidth

However, if the sum of the encoding bitrate of the two selected chunks is higher than the available bandwidth, an overloading will be caused in the bottleneck link that will result in packet drop, which is called a congestion event. Knowing that TCP employs congestion control algorithm, the sending bitrate will be reduced on the HAS server side. Consequently, the download of two chunks will take longer duration, hence a new estimation of available bandwidth on the player side could lead to a lower quality level selection for the next chunk of one or both of players.

This example illustrates why and how the competition between HAS players is harmful for both access network QoS (packet drop and congestion events at the bottleneck) and user experience (video quality level fluctuation and/or stalling events).

Many works have been developed in order to reduce the side effect of this use case for both fixed and mobile broadband access network when bottleneck location is as described in Subsection 2.3.2.1. In addition, as the observation made by Saamer Akshabi et al. in [8] indicates when using just two HAS players, the adaptation logic of the player's bitrate controller "is not able to avoid oscillations and it does not aim to reduce unfairness in bandwidth sharing competition". Accordingly, this observation leads us to look for other investigations other than in the application layer inside the player to resolve "radically" the source of this issue.

The competition between HAS clients in the same network is one of the most critical scenario. This thesis focuses mainly on this use case in order to improve the overall QoE of competing players (QoE fairness) and reducing the bottleneck side effect. But, to be able to improve this QoE, we first should characterize it and understand its interaction with user perception and technical parameters, which will be described in the next Section 2.4.

## 2.4 QoE Characterization and Improvement

According to a recent Cisco report, [37], consumer VoD traffic will double by 2019; HD will be 70% of IP VOD traffic in 2019, up from 59% in 2014. This forecast is challenging for ISP, video content and CDN providers to enable users to enjoy watching high quality level with highest experience (QoE). In this section, we describe and explain how QoE has been measured with specific metrics in Subsection 2.4.1. Then, we overview a detailed investigation of different factors that could affect this QoE in Subsection 2.4.2.

### 2.4.1 QoE Metrics

QoE (Quality of Experience) is an increasingly important overall quality attracting both industry and academia in the field of Information and Communication Technology (ICT) [136]. It includes human subjective quality in addition to objective quality [22]. Therefore, the assessment of QoE by using well-designed metrics would be an essential ingredient of successful deployment of HAS. In this section, we present the two categories of QoE metrics; subjective (in Subsection 2.4.1.1) and objective metrics (in Subsection 2.4.1.2).

#### 2.4.1.1 Subjective QoE Metrics

The most widely used metric of subjective quality measurement is MOS (Mean Opinion Score) [125], which is an arithmetic average of scores (say, 1 through 5) given by many subjects to an ob-

ject to be assessed. Historically, MOS has been adopted in Recommendations by ITU (e.g., [70]) for conventional ICT services typified by telephony and TV broadcast [136]. Many researches has adopted MOS in order to collect an overall experience of HAS users, such as [26, 127]. Nevertheless, some limitations of MOS have been pointed out by many researchers [72, 63, 108, 137].

In fact, MOS value does not necessarily represent exact difference between the observer's sensory magnitude. Therefore, Shuji Tasaka et al. [137, 138] employed another metric called *psychological scale*; it uses an interval scale instead of the MOS ordinal scale. Authors demonstrate that this scale represents human subjectivity more accurately than MOS.

Moreover, the MOS measurements may vary between type of users (e.g, gender, country, culture); the process of averaging subjective ratings employed by MOS (and even by psychological scale) eliminates the diversity of user assessments. Therefore, Tobias Hossfeld et al. [63] proposed an additional subjective metric, SOS (Standard deviation of Opinion Scores), that gives the standard deviation between opinion score measurements in order to get more accurate assessments about opinion diversity.

However, the subjective criteria cited above do not give sufficient information about the disturbing factors for users and/or their impact on user's experience; they are still overall measurements. Therefore, some authors have used *acceptability threshold* metric; it was defined by S. Jumisko-Pyykkö et al. [76] in the context of video QoE as "binary measure to locate the threshold of minimum acceptable quality that fulfills subject quality expectations and needs for a certain application or system". In other words, acceptability metric is the user's tolerance for videos containing impairment and failure events. Petros Spacho et al. [135] have shown that technical factors as well as the overall user's experience have the major impact on acceptability.

The subjective metric involves collecting users' opinions which is a heavy task in research and industry. In [40] and [134], authors present QoE models that predict the MOS based on characteristics of the received video. This kind of models lead us to further investigate arithmetic metrics that represent objectively the user's experience.

#### **2.4.1.2 Objective QoE Metrics**

Ideally, the HAS end-user likes to watch video without any annoying events. He/she generally does not care about technical factors related to streaming video, but he/she rather focuses on perceptual factors like absence of artifact, high resolution, high video quality, small initial delay and absence of stalling [131]. Many researches have been developed in order to map between these perceptual factors and the QoE, and consequently propose objective analytic metric for each



factor.

T. Zinner et al. [165] used an objective metric, Structural Similarity Metric (SSIM) [150], that compares between the sent and the received video. They found that the worst QoE perceptual factor is when having artifacts due to packet loss or error; it is much more severe than the reduction of video quality. Knowing that HAS is using a reliable protocol (TCP), the risk of artifacts is very negligible, hence the absence of this factor in the context of HAS in the literature. For this reason, SSIM metric is no longer used in the context of HAS.

Moreover, video spatial resolution is a perceptual factor that is highly dependent on the end-user device (e.g. its computational and display capacity). For example displaying a low video resolution on a large screen would result in low user's QoE. Besides, the HAS player is supposed to select the adequate resolution which is suitable with the device capacity. For this reason, video spatial resolution is almost not employed as objective QoE metric in the context of HAS. It is also the same case for other similar perceptual factors that are intrinsic to computer vision field rather than adaptive video streaming such as frame rate or type of video codec.

Nevertheless, many researches have used objective metrics related to video quality. For example, [157, 78, 154] use the average video encoding rate as objective metric. The logic behind this is that users generally prefer to watch high video quality during time. However, Jinyao Yan et al. [153] find an important correlation between standard deviation of quality level and QoE. In addition, Ricky K. P. Mok et al. [107] show that users prefer a gradual quality change between the best and the worst quality levels, instead of an abrupt switching. Therefore, many authors have adopted metrics based on this criterion, such as average quality variation in [157] and quality level instability [133]. Moreover, M. Zink et al. [164] indicate that higher quality level in the end leads to a higher QoE. Therefore, J. Jiang [74] uses an instability metric with a weight function that adds penalty to a more recent switching of quality level.

Furthermore, the initial delay has been adopted by many authors [78, 133]. In fact, the user dislikes waiting long duration before the beginning of video display. However, the impact of initial delay on QoE is not severe [39]. As T. Hoßfeld et al. [65] indicate, an initial delay up to 16 seconds reduce the user's QoE only marginally. However, they indicate that stalling is much more harmful. We remember that stalling consists of video playback interruption due to playback buffer depletion. During this interruption, the player is asking for chunks consecutively in order to fill its buffer and to continue video displaying. Some authors have used the stalling time as a metric such as [102] and others have employed analytic function that depends both on number and duration of stalling events [133].

In the literature, authors select their own objective metrics depending on the perceptual factors

they want to improve. Some authors employed more than one metric for evaluation, and consider them like "independent" metrics such as [78, 133], while others inject their metrics inside one analytic formula; for example, in [157] authors employ three metrics (average video quality, average quality variation, total stalling time) inside one linear formula by using weight coefficients that reflect the sensibility of users toward each metric. However, the big issue in this case is the choice of the weight coefficients because they could vary between users.

Moreover, some authors have introduced other metrics suitable for each specific use case (such as competition between HAS flows). In fact, each use case has its own major side effects that should be considered to reduce their harmful consequences on user's QoE. These metrics will be more investigated in Chapter 3 (Section 3.5.1).

The subjective and objective metrics are still used nowadays in the context of HAS to make a more accurate evaluation. For example, in [127], authors make both subjective and objective metrics for their evaluations. Nevertheless, the measurements of QoE are still insufficient when we consider only the perceptual factors. In fact, such technical factors could have an important influence on the perceived QoE. This influence is further discussed in the next Subsection 2.4.2.

## 2.4.2 Technical Influence factors of QoE and Cross-layer Optimization

Factors affecting QoE are not only human being as the truly end-user but also traditional QoS (Quality of Service) and all surrounding environments with which the end-user interacts [83, 18, 106] that are designated as *technical influence factors*. For this reason, studying the impact of these factors on QoE could be helpful for improving user's experience. This section is organized as the following; we give an overview of technical influence factors, classified according to OSI model in Subsection 2.4.2.1. Then we overview the proposed improvements of QoE by involving different OSI layers, so-called *cross-layer optimizations*, in Subsection 2.4.2.2.

### 2.4.2.1 Technical Influence Factors

#### — Application layer factors:

Jun Yao et al. [156] indicated the effect of playback buffer size and chunk duration on QoE; there is a tradeoff between short and large values. In fact, small playback buffer size results in short initial delay and short but frequent stalling events. However, a large buffer reduces stalling events but it increases the initial delay. Furthermore, small chunk duration results in a shorter delay to adapt the quality level to the estimated bandwidth, but it may result in more quality level changes in the case of instable network conditions. However,

a large chunk gives better stability and higher quality level selection, but it may cause more stalling events because it may be incapable to adapt to rapid bandwidth fluctuations. Additionally, R. Kuschnig et al. [80] and [79] reveal the harmful impact of long chunk duration on fair concurrence between HAS players, although it offers higher bandwidth utilization. Thorsten Lohmar et al. [91] have also revealed that longer chunks would cause higher end-to-end delay which is harmful for OoE of HAS Live streaming.

Moreover, some new contributions include other application-level parameters in the bitrate controller in order to improve the QoE. For example, in [75] authors proved that taking the size of the chunk into consideration in the bitrate controller improves the QoE in terms of video quality level and bitrate switching events. In [111] authors include the frame rate parameter in their bitrate controller and proved that it optimizes the user's QoE by avoiding stalling, and pausing during video playback. In [68] authors proposed a *buffer-based* (BB) bitrate controller by only using the buffer occupancy level information for quality level selection. Their approach has reduced the stalling rate by 10-20% compared to Netflix player, while improving the average steady-state video rate.

— **Transport layer factors:**

As described in Subsection 2.2.1.2, the TCP transport protocol was not designed specifically for video streaming. Consequently, some factors of TCP could be harmful for QoE: the reaction toward congestions, packet loss and the congestion detection.

First, the congestion control algorithm used by TCP on the sender side has a significant impact on throughput variation. In fact, when the sender detects a congestion event, it reduces its congestion window, *cwnd*, by a multiplicative decrease factor (generally 0.5 in standard implementation) [9]. This reduction means that the throughput will be reduced by the same factor. The presence of bottleneck which increases the frequency of congestion events would increase the throughput fluctuation. Consequently, the player could be instable in its quality level selection. Hence there is a degradation in the QoE.

Second, the packet loss caused by network congestions results in TCP packet retransmissions. However, retransmissions in HAS stream are harmful to QoE because it adds undesirable long transmission delays [18, 46, 61]. One mechanism was proposed to reduce packet loss in routers and called Explicit Congestion Notification (ECN); Routers can set a specific codepoint in the IP header of packets instead of dropping them, and TCP protocol considers this codepoint as a congestion event. Hence, packet loss and retransmissions are reduced considerably. Unfortunately, ECN has not been widely deployed due to the need of a specific configuration requirement inside routers. Moreover ECN bit positioning and

analyzing are accused to add delay to packet forwarding in routers.

Third, there are many TCP congestion control variants with different methods of managing *cwnd* and detecting congestion events. As H. Jamal et al. [71] indicate, these variants give different performances according to some criteria, like average throughput, packet loss, flow fairness and aggressiveness. Accordingly, the choice of TCP variant could impact the HAS traffic behavior and could influence the QoE.

— **Network layer factors:**

The network layer factors that influence the QoE of HAS users could be reduced to two elements: the length of router queues and the queuing disciplines.

In one hand, reducing the size of queues of routers would obviously increase the packet drop rate, as described in Subsection 2.3.2.1. Nevertheless, large queues would cause *buffer bloat effect* phenomenon; in which the excess buffering of packets causes high latency and packet delay variation, as described in [51]. In this case, traffic can experience very high queuing delays that can reach several hundreds of milliseconds and sometimes even more than a second [155], which is very harmful to HAS QoE.

In another hand, the queuing discipline is a queuing management algorithm inside routers (e.g, network devices in general) that decides whether to drop, route or buffer packets. Many optimizations have been employed that could be classified into two major classes: *Drop Tail* [117] and *Random Early Detection (RED)* [47]. With Drop Tail, when the queue reaches its maximum capacity, the newly arriving packets are dropped until the queue has enough space to accept incoming traffic. While with RED, the average queue size and drops of packets are based on statistical probabilities; as the queue grows, the probability for dropping an incoming packet grows too. Similarly, when the queue becomes full, this probability reaches 1 and all incoming packets are dropped [47]. The dissimilarity between the two categories would impact the packet drop rate and end-to-end delay as well as the QoE of HAS.

— **Link and physical layer factors:**

Many factors related to physical and link layer (generally MAC layer) have a direct effect QoE; such as the channel modulation and estimation, mobility and resource allocations [152, 87], as well as collision detection or avoidance [145]. The cause of this influence is that these factors could modify the network resource utilization and the bandwidth allocation for each HAS player [1].

In this subsection, we have presented the different technical factors that influence the QoE of HAS users classified according to the OSI model. These factors have been exploited in many contributions in order to improve this QoE as explained in the next Subsection 2.4.2.2.

#### 2.4.2.2 Cross-layer Optimizations

Due to the multiplicity of technical factors which, as explain above, come from the different OSI model layers, the maximization of QoE would become complex. Hence, the cross-layer optimization has been employed by many researchers in the context of HAS [95]. It enables one layer to exchange information with another layer and enable interactions [87]. In the literature, we can find many cross-layer optimization methods using different parameters:

In [33] authors proposed effective adaptive cross-layer schemes for multimedia delivery over the time varying link characteristics, including the channel coding (Forward Error correction), MAC layer retransmission limit, the application layer, and packet size. In [151], authors propose a novel approach for bitrate controller based on the estimated probability of stalling events. This probability is calculated using an analytical model of playout buffer and TCP layer measurements such as RTT. T. Kim et al. [77] proposed an optimal buffer length that depends on the video bitrate, network characteristics from IP and TCP layers (packet loss rate, round-trip time, and retransmission timeout) and desired video quality in order to offer best QoE. In [133], authors present Open-Loop rAte Control (OLAC), an adaptive streaming architecture designed to support low-latency streaming applications. The key components of their architecture are a server-side simulation of the streaming client's buffer, which provides a low-delay feedback for the video rate selection, and a hybrid adaptation logic based on throughput and buffer information, which stabilizes the adaptive response to dynamics of transport and application layers.

Moreover, some other cross-layer optimizations are more specific to mobile networks. For example, in [112], authors propose to combine mobility management and application layer filtering in order to optimize and maintain video quality. In [141], integration of the handover initiation into a cross-layer mechanism is proposed aiming to improve the overall system performance. In [152] authors present a module that allows the player to efficiently monitor the LTE base station physical layer resource allocation, and then map such information to an estimation of available bandwidth.

In this subsection, we have overviewed the different technical factors that influence the QoE of HAS users and the different proposed cross-layer optimizations. However, we remark that the proposed cross-layer methods in the literature are implemented in the HAS server or/and the HAS player and are controlled by the application layer. However, the concept of cross-layer optimization can also be extended to the implementation inside other intermediate nodes between

the HAS client and the HAS server and can also be controlled by another lower OSI layer than the application layer.

## 2.5 Conclusion

In this chapter, we gave an overview of existing video streaming techniques used over Internet. We found that HAS is the best efficient technique among all other techniques whether based on UDP or TCP in terms of reliability and adaptability to network conditions. The diversity of HAS implementations has led to a new standard called MPEG-DASH. However, previous implementations still exist and even the standard MPEG-DASH still contains parameter values inside the player which are not conventional. This would cause a diversity of HAS behaviors among different values of parameters. We also showed the architectures in which the HAS service is employed. We gave an overview of fixed and mobile broadband access network where the HAS client could be located. We gave the similarity and the dissimilarity between the two access architectures. We also highlighted the benefits of using CDN networks in reducing latency and improving the quality of streaming. We also described an increasingly frequent use case when HAS clients are competing for bottleneck link and we presented its drawbacks on QoS and QoE. Then we overviewed the characterization of QoE of HAS by using objective and subjective criteria. We also gave a classification of technical factors that influence the QoE in accordance with OSI model layers. We also gave examples of cross-layer optimization that aims to improve the QoE by using several parameters from different OSI layers. Additionally, the background given by this state of the art will be mandatory both for further assumptions that we could take throughout and for the frameworks that we would employ for emulations, testbeds, simulations and evaluations. These frameworks are described with details in Chapter 3.

The objective of this thesis is to add optimizations to the transport protocol TCP, which is not well investigated in the literature in the context of HAS, in order to limit the drawbacks of the cited scenario of HAS clients sharing the same bottleneck link and are competing for bandwidth. These optimizations could be considered as cross-layer solutions. In the following sections, we will give additional details of specific state of the art relative to each kind of proposed optimization (see Sections 4.2, 5.2 and 6.2).

---

# General Framework for Emulations, Testbeds, Simulations and Evaluations

## 3.1 Introduction

This chapter gives all the details about tools and parameters that we have used and implemented during this thesis. The use case that we focus on is when HAS players share the same bottleneck link and compete for bandwidth. In fact, during the thesis we have implemented a testbed that it has been used for validation and evaluation of our proposed solutions by using real machines. For extended evaluations, we have used *network simulator ns-3* with precise specifications that mimics real conditions. Besides, we have developed and used the same emulated HAS player for both implementations (testbed and simulator). Moreover, we have used for our evaluations specific performance metrics for both QoE and QoS criteria.

The objective of this chapter is to give the researchers the ability to re-implement our work, verify results and understand the explanation of each choice we made for configuration, implementation and metrics of evaluation. To be more accurate, we refer to some recent references to justify our choice among many alternatives.

This chapter is organized as the following: In Section 3.2 we describe the characteristics of our emulated HAS player. In Section 3.3 we give details about the architecture used in our testbed and the configurations made in each machine. In Section 3.4 we demonstrate the implementation of HAS traffic in ns-3 simulator and the extensible architecture used for simulations. In Section 3.5 we present the performance metrics that are analytically defined for evaluating the QoE and the

QoS based on related works and observations.

## 3.2 Emulation of HAS Player

Knowing that each parameter of the HAS player could affect the QoE as described in Chapter 2 (Subsections 2.2.2.3 and 2.4.2), we should pay attention to each parameter inside the player in order to achieve two main goals: being close to common players and avoiding side effects of some proposed players.

Maybe the reader would ask the question: "Why have we employed an emulated player instead of a commercial player?". The explanation of this choice has four major arguments:

- First, the commercial players have complicated implementation with many parameters. Besides, the bitrate controller has dissimilarities among commercial players and even between different versions of the same player as discussed in Subsection 2.2.2.2. Accordingly, using our own well-controlled player would be better for evaluations than a "black box" commercial player that could give incomprehensible behaviors.
- Second, as we mentioned in Subsection 2.4.1, some perceptual factors related to computer vision field (e.g video spatial resolution, frame rate or type of video codec) are not interesting for HAS evaluation. Therefore, using an emulated player that mimics the behavior of HAS player without decoding and displaying video content would conduct us to the same evaluation purpose as with a real player.
- Third, the objective metrics are increasingly employed for HAS evaluation (see Subsection 2.4.1.2). Hence, with a fully controlled emulated player we can easily get the variation of its parameters during time and employ them for objective QoE metric computation.
- Fourth, for testbeds and simulations, we need to automatize events such as triggering the beginning and the end of HAS flow at precise moments. Using an emulated player offers easier manipulation than real player, especially in the case of many players to be launched at the same moment.

Our emulated HAS player is a *Rate and Buffer Based* (RBB) player (see Subsection 2.2.2.3). This choice is justified by the fact that using buffer occupancy information is increasingly proposed and used due to its advantages for reducing stalling events. In addition, the bandwidth estimator we used consists of dividing the size of received chunk by its download duration. The buffer occupancy information is used only to define an aggressiveness level of the player. In fact, this aggressiveness enables the player to add additional amount to the estimated bandwidth to promote higher quality level selection. As explained in [67], the bandwidth estimator does not take into



consideration the increase of TCP congestion window from low value at the beginning of some ON periods. As a consequence, an underestimation of available bandwidth becomes frequent and leads to "downward spiral effect" phenomenon: a feedback loop that leads to undesirably variable and low-quality video. For this purpose, we used a bitrate controller algorithm based on bandwidth estimation in which we define an aggressiveness  $\rho_C(t)$  at time  $t$  that depends on playback buffer occupancy as follows:

$$\rho_C(t) = \sigma \times \frac{R_C(t)}{B_C} \quad (3.1)$$

Where  $R_C(t)$  is the filling level of the playback buffer at time  $t$ ,  $B_C$  is the size of the playback buffer of client  $C$ , and  $\sigma$  is the aggressiveness constant. The fuller the playback buffer is, the closer to  $\sigma$  the aggressiveness is. Accordingly, the player could be more aggressive only when it has less risk of playback buffer underflow (e.g, stalling event).

The player employs a single TCP connection with a single HTTP request per chunk without any overlap of HTTP requests among the same HAS flow because it is the most common type of players. During buffering state, the player selects the lowest quality level while during steady state phase, the chunks are asked successively every chunk duration. When a chunk takes more than chunk duration to be downloaded, the next chunk will be asked immediately after the previous chunk is entirely received.

As a default configuration to be used for testbeds and simulations, the chunk duration is equal to 2 seconds, the buffer size is equal to 30 seconds of playback, i.e 15 chunks, like what it has been used in [66]. This configuration includes the common parameters for VoD service as indicated in Subsection 2.2.2.3. Besides, the aggressiveness constant  $\sigma$  is chosen to be equal to 0.2. The justification of this value is to try to deliver the highest possible encoding rate even when the latter is higher than the available bandwidth, as long as the playback occupancy is sufficiently large. Besides, the selected aggressiveness gives a similar behavior of Netflix player, which was experimentally evaluated in [8]: In fact, the player reacts rapidly to a rapid increase of available bandwidth. In addition, it tries to preserves its selected quality level when the available bandwidth suddenly decreases for short duration.

### 3.3 Testbed Description

We propose a testbed architecture, presented in Figure 3.1, that emulates our use case. The choice of only two clients is sufficient to show the preliminary behavior of concurrence between HAS flows in the same home network. This testbed has an objective of validating proposed meth-

ods and analyzing some results before extending the evaluation to large-scale architectures. We use the designations of fixed broadband access network (see Subsection 2.3.1.1) to describe each component of the testbed as presented in Figure 3.1:

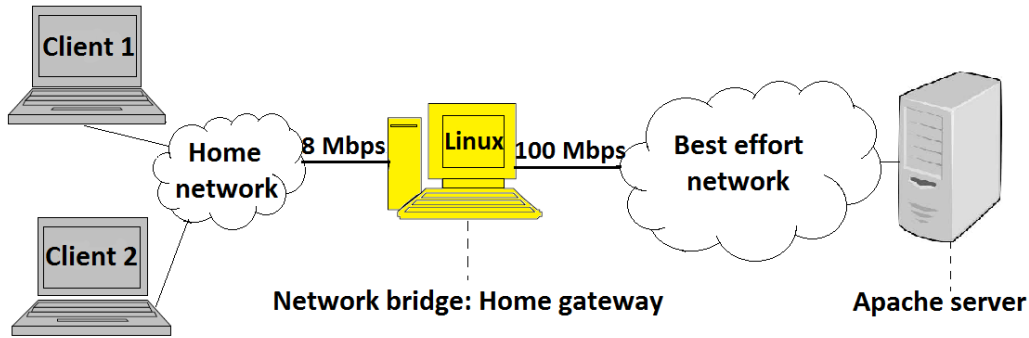

Figure 3.1 – Architecture used in test bed

#### — HAS server

The HAS server is modeled by an HTTP Apache Server installed on a Linux machine operating on Debian version 3.2. We can change the congestion control variant of the server by varying the parameter `net.ipv4.tcp_congestion_control`. HTTP version 1.1 (HTTP/1.1) is used to enable a persistent connection. All tests use five video quality levels with constant encoding rates as presented in Table 3.1, they correspond to the quality levels employed by Orange.

Table 3.1 – Video encoding bitrates

video quality level	0	1	2	3	4
Encoding bitrate (kbps)	248	456	928	1632	4256

The number of five video quality levels is the same as employed by Netflix player. Typically, the encoding rates range between 235 kbps, as low definition, to 5 Mbps, as high definition, as indicated in a recent publication [68]. Its authors also indicate that using the lowest quality level with an encoding rate of around 235 kbps is tolerated, although the second lowest quality level, with an encoding rate around 500 kbps (standard definition), is actually more adequate for European customers owing to the high offered bandwidth. Hence, our choice of the number and the encoding rates of quality levels is in conformity to the above considerations.

— **Best effort network**

The best effort network is characterized by the presence of bursts and the presence of packet loss which induces a variability to the delays of delivered packets. Therefore, in order to offer a more realistic test bed, we employ the modeling formula of the round trip time  $RTT_{C-S}(t)$  in a best effort network as expressed in [104]:

$$RTT_{C-S}(t) = a_{C-S} + \frac{q(t)}{\zeta} \quad (3.2)$$

Where  $a_{C-S}$  is a fixed propagation delay between client  $C$  and server  $S$ ,  $q(t)$  is the instantaneous occupancy level of the queue of a single congested router (e.g, the DSLAM, in fixed broadband access network), and  $\zeta$  is the transmission capacity of the router.  $\frac{q(t)}{\zeta}$  models the queuing processing delay. To comply with equation 3.2, we emulate  $RTT_{C-S}(t)$  of each HAS flow between server  $S$  and client  $C$  by a normal distribution with a mean value  $a_{C-S}$  and a standard deviation equal to  $0.07 \times a_{C-S}$ . Here, the standard deviation emulates the queuing processing delay  $\frac{q(t)}{\zeta}$ . The choice of only 7% of  $a_{C-S}$  is sufficient for our evaluation because it induces a similar RTT variation as a real conditions. Besides, this standard deviation would also increased when the HAS flows of competing clients cross the bottleneck link. The cause is that the queuing process delay  $\frac{q(t)}{\zeta}$  will be more instable due to the high occupancy of the queue, the presence of congestions, and the instability of HAS throughput as explained in Subsection 2.3.2. In addition, using a higher standard deviation than 7% of  $a_{C-S}$  would be reserved for a more instable network, especially in the case of wireless access networks, such as WiFi in the home network. This case of instable network is also tested in our evaluations. This emulation is accomplished by using the "netem delay" parameter of the *traffic controller* tool in the gateway machine interfaces.

We note that the emulated best effort network designates the ISP networks that contains the managed network, controlled by *ISP 0* (see Figure 2.5 in Subsection 2.3.1.1), and the unmanaged networks that are crossed by the HAS flow to reach the HAS server.

— **Home gateway**

The emulated home gateway consists of a Linux machine configured as a network bridge to forward packets between the home network and the best-effort network. Here we merge DSLAM into HG (Home gateway) to make the testbed easier to manage without changing the bottleneck behavior. We emulate the queuing discipline of DSLAM by using Stochastic Fairness Queuing discipline (SFQ) [143]. SFQ is a classless queuing discipline that we configured using the Traffic Controller tool (*tc*). SFQ schedules the transmission of packets based on flow identification (the source and destination IP addresses and the

source port) and injects them into hash buckets during the enqueueing process. Each of these buckets should represent a unique flow. Besides, SFQ employs Round Robin fashion for dequeuing packets by taking into consideration the bucket classification. The goal of using buckets for enqueueing and Round Robin for dequeuing is to ensure fairness between flows so that the queue is able to forward data in turn and prevents any single flow from drowning out the rest. We also configured SFQ in order to support the *Drop Tail* algorithm when the queue becomes full. Hence, this configuration of queuing discipline is classified as a *Drop Tail* class (see Subsection 2.4.2.1). The queue length of SFQ, which is indicated by parameter *limit* within *tc* tool, is set to the bandwidth-delay product.

#### — Home network

In the modeled home network, the clients are connected directly to the gateway. The total download bitrate, or home available bandwidth, is limited to 8 Mbps. We choose this value because it is lower than twice the video encoding bitrate of the highest quality level. Accordingly, two clients in the home network cannot select the highest quality level at the same time, unless they cause congestion and QoE degradation. In this case, one client should select quality level  $n^\circ 4$  and the other should select the quality level  $n^\circ 3$  as optimal qualities. We do not test a use case in which two clients have the same optimal quality level, because this is a very specific case, and dissimilarity between optimal quality levels is more general.

#### — HAS clients

We used two Linux machines as HAS clients. The emulated player described in Section 3.2 was integrated in each machine using Python language.

### 3.4 Simulating HAS Traffic over ns-3

The network simulator version 3 (ns-3) [114] is a discrete-event network simulator for Internet systems, targeted primarily for research and educational use. It is a free software, licensed under the GNU GPLv2 license, and is publicly available for research, development, and use since 2008 [60]. The core is written in C++ but with an optional Python scripting interface. In ns-3, each machine is modeled as a "node". Each node is designed to be faithful to real computer, including its support for key interfaces such as network devices and sockets, multiple interfaces per nodes and the use of IP addresses. In addition, we can design our network architecture by interconnecting

nodes. Algorithms related to routing daemons, kernel protocol stacks, and packet trace analyzers are well integrated in ns-3. Moreover, tracing and statistics gathering are enabled by using a callback-based design.

In this section, we give a detailed description of our implemented work in the ns-3 simulator. Therefore, we present, in Subsection 3.4.1, our HAS module and how it has been implemented in ns-3. Then, we describe, in Subsection 3.4.2, the architecture and the configuration of its nodes and links.

### 3.4.1 HAS Module Implementation in ns-3

Given that ns-3 is not outfitted with HTTP layer, simulating HAS flows could become an issue. Fortunately, Yufei Cheng et al. proposed an HTTP traffic generator module [32, 31] in 2011. It ensures the communication between two nodes using HTTP protocol; it includes all features that generate and control HTTP Get Request and HTTP response messages. It uses two application containers; *HttpClientHelper* and *HttpServerHelper* that should be installed on the client and the server nodes, respectively. This module contains principally three main classes: *http-client*, *http-server* and *http-controller*. The latter class enables the programmer to control parameters and events of HTTP messages by using a *user defined* mode. In this mode, we can define the number of web pages to be asked during the session between client and server, *UserNumPages*; it is helpful to define the number of chunks to be displayed. It also defines the server response size, *UserResponseSize*, which can be considered as the chunk size for HAS flow. The time gap between two consecutive page request messages is defined as *UserPageRequestGap* parameter; it is useful to define the request time of each chunk and the chunk duration parameter. Besides, it supports HTTP/1.1 with persistent connection.

Accordingly, many features of the proposed module provide a good background for implementing HAS player on the client side. However, the defined parameters are exploited by the *http-controller* class as "a priori" inputs to be executed without any modification during simulation process. This configuration is not suitable for the bitrate controller of HAS player: we should implement an intelligence inside *http-client* and *http-controller* classes in order to follow the instructions of the bitrate controller. In other words, the modified algorithm should adapt the size of the chunk (*UserResponseSize* parameter) and the chunk request time to the bandwidth estimation and the buffer occupancy level. For that, based on HTTP module, we adapt classes, their attributes and their functions to the HAS context in order to build our own HAS module. We notice that all instructions of Section 3.2 related to our custom HAS player were respected in our implementation described as the following:

- We defined a table that contains all encoding bitrates corresponding to quality levels, *m\_layers[]*. It is compliant with Table 3.1. The size of chunk, *UserResponseSize*, is equal to the encoding bitrate of the corresponding quality level multiplied by the chunk duration *UserPageRequestGap*.
- We defined a playback buffer, *m\_actualFilledPlaybackBufferSize*, that provides the buffer occupancy level during time. The length of this buffer is defined as *m\_userBufferLength* parameter to be tuned by the programmer.
- We added a scheduler of chunk request time compatible with buffering and steady state phases. This scheduler depends on the value of *m\_actualFilledPlaybackBufferSize*; if it becomes null (e.g. stalling event), the *http-client* asks for chunks of lowest quality level consecutively until *m\_actualFilledPlaybackBufferSize* reaches *m\_userBufferLength* value. Then, *http-client* asks for one chunk every *UserPageRequestGap* duration. If the chunk takes longer delay to be downloaded than *UserPageRequestGap*, *http-client* asks for the next chunk when the previous one is completely received.
- We added a bandwidth estimator function, *getBitRate()*, in the *http-client* class to estimate the available bandwidth in the end of each ON period.
- We integrated the bitrate controller in the *http-client* with additional ability to modify *http-controller* parameters during simulation process. It modifies the size (e.g. that corresponds to one quality level) and the request time of chunk based on bandwidth estimation, *getBitRate()*, buffer occupancy level, *m\_actualFilledPlaybackBufferSize*, and aggressiveness value in accordance with equation 3.1.
- We added callbacks that monitor all player parameters over time (e.g. selected quality level, buffer occupancy level, bandwidth estimation, OFF period duration) and at the moment the *http-client* sends HTTP request message. These values are used for QoE and QoS metric measurements.

### 3.4.2 Network Architecture Implemented in ns-3

In this subsection we give a detailed description of our proposed network architecture that we implemented in ns-3.17 simulator. It is compliant to the fixed broadband access network architecture described in Subsection 2.3.1.1:

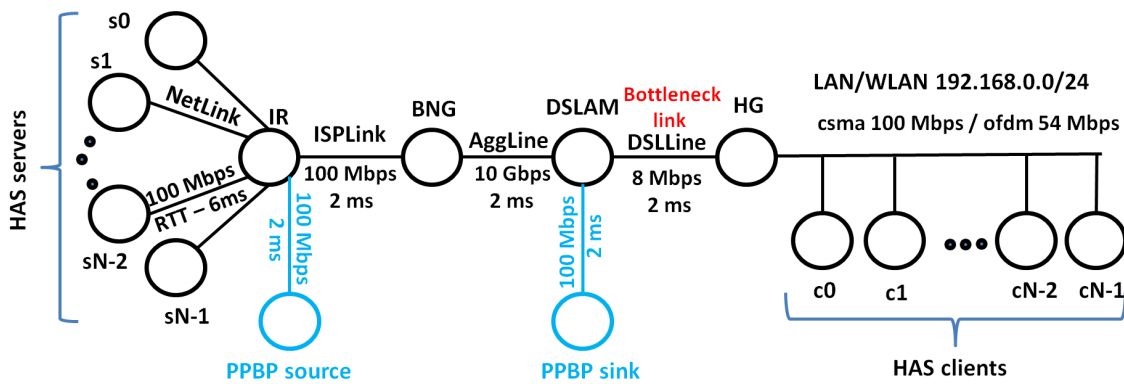

Figure 3.2 – Network architecture used in ns-3

#### — HAS flows

Given that the emulated HAS player employs a unique TCP session for each HAS flow, identifying one HAS flow is equivalent to identifying the quadruplet of TCP session (e.g., IP source address, IP destination address, source port, destination port). However, in our assumption we design only one client and one server to process a unique HAS flow. Accordingly, using IP addresses is sufficient to identify each flow. Moreover, we denote by  $f$  the flow identification that it is identified by a pair of IP addresses of client and server. Where  $0 \leq f \leq N - 1$  and  $N$  is the number of competing HAS flows, to be tuned by the network designer.

We created a node container, called *servers*, that gathers all HAS server nodes. Each node is automatically connected to the Internet Router (IR) node and has an IP address 10.f.0.1. Similarly, we created a node container, called *clients*, that gathers all HAS client nodes. Each node is connected to the same home network and has 192.168.f.1 as IP address.

Our proposed HAS module installs its HAS application container on the client and on the server of the same HAS flow. The events of the beginning and the end of each HAS flow  $f$  between HAS client  $C_f$  to server  $S_f$  are monitored by the network designer.

We employed Westwood+ [49] as the default TCP congestion control variant in HAS servers. Besides, The log traces related to the TCP congestion control parameters of the HAS server (i.e.,  $cwnd$ ,  $ssthresh$ ,  $rwnd$ ,  $RTT$  and  $RTO$ ) and to HAS client parameters are stored and classified by HAS flow id. All generated log files are processed automatically

just after simulation by our Shell scripts to generate performance metrics and to plot curves.

— **NetLink configuration**

In our design, the NetLink emulates the Internet network branch where the server is located. For this purpose, we generate one NetLink link to connect one HAS server to the IR node. The bandwidth inside this link is equal to 100 Mbps to emulate Internet network with high capacity. In addition, using NetLink, we configure the round-trip delay of each HAS flow.

We denote by  $RTT_{C-S}^0$  the initial round-trip propagation delay between the HAS client  $C$  and the server  $S$ . Knowing that the configured round-trip propagation delay between IR and HG is equal to  $6\text{ ms}$  ( $3 \times 2\text{ ms}$ ), the round-trip propagation between the IR and a HAS server node is configured to be equal to  $RTT_{C-S}^0 - 6\text{ ms}$ . Here, the designer has just to define the value of  $RTT_{C-S}^0$  parameter for his custom simulation. The default value is set to  $100\text{ ms}$  because it is often measured for streaming video applications [17].

— **ISPLink configuration**

The ISPLink emulates the ISP network. Given that the emulated network corresponds to the managed network of ISP provider as described in Subsection 2.2.1.1, it is supposed to offer a high QoS such as low delay and high bandwidth. For this reason, we configure ISPLink with low round-trip propagation delay of  $2\text{ ms}$  and a high bandwidth of  $100\text{ Mbps}$ .

— **AggLine configuration**

The bandwidth in the aggregate link, AggLine, is set to 10 Gbps, which is in conformity with the literature [139]. We also select round-trip propagation delay of  $2\text{ ms}$  because the delay between the two nodes DSLAM and BNG is designed to be very short. (see Subsection 2.3.1.1).

— **Internet traffic emulation (PPBP traffic)**

We chose to generate Internet traffic that crosses ISPLink and AggLine. We selected this location because the two emulated links are supposed to support a heavy traffic from ISP networks. For this purpose, we employed the *Poisson Pareto Burst Process* (PPBP) model, proposed by M. Zukerman [167], that emulates Internet Traffic. This model has been considered as a simple and accurate traffic model that matches statistical properties of real-life IP networks (such as their bursty behavior). The PPBP is a process based on the overlapping of multiple bursts with heavy-tailed distributed lengths. Events in this process



represent points of time at which one of an infinite population of users begins or stops transmitting a traffic burst. The PPBP is closely related to the  $M/G/\infty$  queue model [167].

Fortunately, Doreid Ammar et al. [14] provide a tool for PPBP implementation in ns-3 [13]. This implementation suggests using four parameters to configure the PPBP traffic:

- Burst arrival rate  $\lambda_p$ , which is in accordance with Poisson process.
- Hurst parameter  $H$ , which is the length of burst that follows Pareto distribution. Its recommended value is 0.7.
- The mean length of burst,  $T_{on}$ .
- The bitrate of the burst,  $r$ : in PPBP each burst is modeled by a flow with constant bitrate  $r$ .

For our simulations, the default configuration of PPBP is as the following:

- $\lambda_p = 20$ ; as used in [14]
- $H = 0.7$ ; as recommended in [42]
- $T_{on} = 200\text{ ms}$ ; as used in [14]
- $r = 10\text{ Mbps}$ ; we used a higher bitrate burst than that of [14] in order to be adequate with the high capacity of ISP networks -that we have modeled by 100 Mbps in ISPLink in our configuration-. Our justification is based on the observations of Cisco which indicate that the large-capacity systems tend to observe large burst patterns [35].

Here we notice that the overall rate of the PPBP traffic,  $\lambda$ , is equal to  $\lambda = \lambda_p \times T_{on} \times r$ . In our configuration, the overall rate of PPBP traffic is equal to 40 Mbps which is equivalent to an occupancy of 40% of ISPLink capacity.

As shown in Figure 3.2, we used two nodes for traffic generation: PPBP source and PPBP sink. They are connected to IR and DSLAM respectively.

#### — Bottleneck link configuration (DSLLine)

The bottleneck link is designed by DSLLine. Its bandwidth is set to 8 Mbps like the configuration of the testbed. The round trip delay between the two extremities is set to 2 ms because, in real architecture, the delay between the two devices is designed to be very low.

The net device of DSLAM node that is connected to DSLLine link has a small queue length. It is fixed to 68 packets, which corresponds to the bandwidth delay product, when bottleneck bandwidth is 8 Mbps,  $RTT_{C-S}^0$  is 100 ms and packet size is 1500 bytes.

— **Queuing discipline configuration**

The drop tail queuing discipline is been configured for all net devices of nodes. The justification of employing drop tail discipline is its wide range use and its simplicity. Excepting the net device of DSLAM node connected to DSLLine link, the length of each queue is set large enough (1000 packets) to support large bandwidth of 100 Mbps without causing packet losses.

— **Home network**

In practice, the home network is a local area network (LAN). Therefore, we define a node container *lan* that connects the HG to the *clients* node container with network IP address of 192.168.0.0/24. For wired LAN, we employed *csma* module with bandwidth of 100 Mbps. For wireless LAN, we used the *wifi* module with ofdm modulation and bandwidth of 54 Mbps and a simple mobility model. In our simulations we are using wired LAN as a default configuration. We notice that the home network could be configured as a wireless LAN (WLAN) using WiFi protocol. In this case, a mobility model should be added to the client nodes connected to WLAN.

## 3.5 Performance Metrics

To evaluate the use case of HAS players sharing the same bottleneck and competing for bandwidth, we should define performance metrics for evaluations. Some metrics were inspired from the literature and some others from our own observations during initial tests or simulations. We classify our metrics into two categories: QoE and QoS metrics.

### 3.5.1 QoE Metrics

In this subsection, we define analytically the objective QoE metrics that we used for evaluations and justify our selection. For this purpose, we define in Table 3.2 the parameters to be used in this subsection.

Our QoE metrics that are sensitive to our use case are the Instability of video quality level, described in Subsection 3.5.1.1, the Infidelity of video quality level, described in Subsection 3.5.1.2 and convergence speed, described in Subsection 3.5.1.3. In addition, we select two other QoE metrics from Subsection 2.4.1.2 that are used for general QoE evaluation purpose; initial delay and stalling event rate, described in Subsection 3.5.1.4 and Subsection 3.5.1.5, respectively. We also use the QoE fairness between competing HAS players, described in Subsection 3.5.1.6 as metric

Table 3.2 – Parameter description

Parameter	Description
$i$	Discrete time index
$L_C(i)$	Video quality level index of client $C$ at time $i$ , $L_C(i) \in \{0,1,2,3,4\}$
$L_{C,opt}(i)$	Theoretical optimal value of $L_C(i)$
$Q_C(i)$	Video encoding bitrate of client $C$ at time $i$

to be applied on all QoE metrics cited above.

### 3.5.1.1 Instability of Video Quality Level

We use the instability metric  $IS_C(K)$ , which measures the instability for client  $C$  for a  $K$ -second test duration as described in [74]:

$$IS_C(K) = \frac{\sum_{i=0}^{K-1} |Q_C(K-i) - Q_C(K-i-1)| \times w(i)}{\sum_{i=1}^K Q_C(K-i) \times w(i)} \quad (3.3)$$

where  $w(i) = K - i$  is a weight function that adds a linear penalty to a more recent change in quality level. The lower  $IS_C(K)$  value is, the higher the stability of video quality level is.

### 3.5.1.2 Infidelity of Video Quality Level

J. Jiang et al. [74] define two additional goals to achieve for our use case: 1) fairness between players: players should be able to converge to an equitable allocation of network resources; 2) efficiency among players: players should choose the highest feasible quality levels to maximize the user's experience. Besides, Saamer Akhshabi et al. [6] addressed the bandwidth underutilization issue which may prevent possible improvement of QoE. So, maximizing the use of bandwidth can be considered as QoE criteria. In order to give a formula that satisfy these three criteria, we define our metric called *infidelity to optimal quality level*.

The infidelity metric,  $IF_C(K)$ , of client  $C$  for a  $K$ -second test duration, measures the duration of time over which the HAS client  $C$  requests optimal quality:

$$IF_C(K) = \left\{ \frac{\sum_{i=1}^K \theta_C(i)}{K} \mid \theta_C(i) = \begin{cases} 1 & \text{if } L_C(i) \neq L_{C,opt}(i) \\ 0 & \text{otherwise} \end{cases} \right\} \quad (3.4)$$

The lower  $IF_C(K)$  value is, the higher the fidelity to optimal quality is.

Here we note that the theoretical optimal quality level  $L_C(i)$  aims to resolve the dilemma between the two criteria of maximum use and fair share of bandwidth between HAS players. In fact, considering only the fair share of bandwidth may cause bandwidth underutilization; in some cases it may leave some residual bandwidth allocated to nobody. Hence, based on the optimal quality level, the value of the infidelity metric is representative of user expectation.

### 3.5.1.3 Convergence Speed

The convergence speed metric was previously defined by R. Houdaille et al. [66]. We provide an analytical definition as follows:

$$V_{C,T}(K) = \left\{ \min_{1 \leq d \leq K} (d) \mid L_C(i) = L_{C,opt}(i), \forall i \in [d, d + T] \right\} \quad (3.5)$$

This metric is the time that the player of HAS client  $C$  takes to reach and remain at optimal quality level for at least  $T$  seconds during a  $K$ -second test duration. In fact, observations show that when HAS players compete for bandwidth, the convergence to optimal quality level may take several seconds or may be very hard to be achieved. Accordingly, the speed of this convergence is a valuable QoE criteria for our evaluations. The lower  $V_{C,T}(K)$  value is, the faster the convergence to the optimal quality level is.

Here we note that when the player is not able to converge to the optimal quality level during  $K$ -second test duration, the convergence speed value will take the following value:

$$V_{C,T}(K) = K \quad (3.6)$$

Although the value of equation 3.6 is not significant enough, because it could be an infinite value, it enables us to compute the mean value among many runs.

### 3.5.1.4 Initial Delay

The initial delay, as explained in Subsection 2.4.1.2, is the time that the player takes to fill its playback buffer. Given that the video displaying begins just when the playback buffer is filled, the initial delay metric is important for QoE evaluation; in fact, the user prefers to get the video displayed on his/her screen within a short delay after requesting the video.

### 3.5.1.5 Stalling Event Rate

As explained in Subsection 2.4.1.2, the stalling event consists of video display interruption on the client side caused by a famine of the playback buffer. The stalling event is a hard penalizing factor toward the QoE because the user is highly disturbed when the video display is interrupted when he/she is concentrated on watching. Therefore, we define the stalling event rate metric,  $StallingRate(K)$ , as the number of stalling events during  $K$ -second test duration, divided by  $K$  and multiplied by 100, as expressed in equation 3.7:

$$StallingRate(K) = \frac{\text{number of stalling events during } K \text{ seconds}}{K} \times 100 \quad (3.7)$$

The lower  $StallingRate(K)$  value is, the better satisfaction of the user is. A zero stalling event rate should be guaranteed.

### 3.5.1.6 QoE Unfairness

Z. Yan et al. [154] addressed the issue of QoE unfairness between competing HAS players. This unfairness is a very valuable point. In fact we could have a mean measurement of QoE among players that it is satisfying, while one of more players have a poor measurement. Accordingly, computing the standard deviation between measured QoE metrics give us the idea about QoE unfairness. For a given QoE metric (e.g, instability, infidelity, convergence speed, initial delay or number of stalling events), that we denote by  $M$ , the QoE unfairness between  $N$  HAS clients, denoted by  $UNF_N(M)$  is described as the following:

$$UNF_N(M) = \sqrt{\frac{\sum_{n=0}^{N-1} (M_n - mean_N(M))^2}{N}} \quad (3.8)$$

where  $M_i$  is the measurement of metric  $M$  of HAS client  $n$  and  $mean_N(M)$  is the mean measurement of metric  $M$  among  $N$  HAS clients, expressed as the following:

$$mean_N(M) = \frac{\sum_{n=0}^{N-1} (M_n)}{N} \quad (3.9)$$

The lower the  $mean_N(M)$  is, the better fairness of QoE between HAS players is.

## 3.5.2 QoS Metrics

Although the QoE objective metrics are interesting to measure the user's experience, they are not sufficient to analyse the results. Hence, QoS metrics are mandatory to understand the effect

of each method that we propose on the QoS of access network. The remaining of this subsection is organized to present four QoS metrics that we used for our evaluation, as the following: First, we define the Frequency of  $\widehat{OFF}$  periods per chunk metric in Subsection 3.5.2.1. Second, we present the average queuing delay metric in Subsection 3.5.2.2. Third, we explain the congestion rate metric in Subsection 3.5.2.3. Fourth, we present the average packet drop rate metric in Subsection 3.5.2.4.

### 3.5.2.1 Frequency of $\widehat{OFF}$ periods per chunk

During HAS flow, an OFF period whose duration exceeds TCP retransmission timeout duration ( $RTO$ ) is denoted by  $\widehat{OFF}$ ; it is important for our evaluations because, as we revealed in Subsection 4.4.3.2, when OFF period becomes larger than  $RTO$  a reduction of bitrate and a degradation of performances would happen.

Our defined metric computes the frequency of  $\widehat{OFF}$  periods by chunk rather than by second. In fact, the frequency by chunk is more significant due to its independence to the chunk duration.

This metric is denoted by  $fr_{\widehat{OFF}}$ . It is equal to the total number of  $\widehat{OFF}$  periods divided by the total number of downloaded chunks of one HAS flow.

### 3.5.2.2 Average Queuing Delay

We found in our investigations that the round-trip time  $RTT_{C-S}$  in a HAS flow between client  $C$  and server  $S$  could increase significantly. This additional increase is called queuing delay. As described in Subsection 2.4.2.1, a high queuing delay is harmful to HAS and for real-time applications.

By using specific tools on the server side (*tcp\_probe* in Linux machine of the testbed, and callbacks in ns-3 node), we can compute exhaustively the  $RTT_{C-S}$  values during HAS session at each reception of ACK packet. We compute the average value of  $RTT_{C-S}$ , denoted by  $MeanRTT_{C-S}(K)$  among all  $RTT_{C-S}$  samples of the whole HAS session for  $K$ -second test duration. Then, we compute the average queuing delay,  $Delay_{C-S}(K)$ , by subtracting from  $MeanRTT_{C-S}(K)$  the initial round-trip propagation delay between the client  $C$  and the server  $S$ , denoted by  $RTT_{C-S}^0$  as described in equation 3.10:

$$Delay_{C-S}(K) = MeanRTT_{C-S}(K) - RTT_{C-S}^0 \quad (3.10)$$

### 3.5.2.3 Congestion Rate

The congestion detection events are extremely influencing both QoS and QoE of HAS because the server decreases its sending rate at each congestion detection. Hence, by analyzing the code description of four TCP congestion control algorithms (NewReno, Vegas, Illinois and Cubic), we found that the congestion event appears when the value of parameter *slow start threshold* (*ssthresh*) decreases. Hence, we define a metric called *congestion rate*, denoted by  $CNG_{C-S}(K)$  that computes the rate of congestion events, that are detected on the server side, corresponding to the HAS flow between client  $C$  and server  $S$  during a  $K$ -second test duration as shown in equation 3.11:

$$CNG_{C-S}(K) = \frac{D_{C-S}^{ssthresh}(K)}{K} \times 100 \quad (3.11)$$

Where  $D_{C-S}^{ssthresh}(K)$  is the number of times the *ssthresh* has been decreased for the  $C$ - $S$  HAS session during  $K$ -second test duration.

### 3.5.2.4 Average Packet Drop Rate

The number of dropped packets at the bottleneck gives an idea about the congestion severity of the bottleneck link. This metric is different from congestion rate of subsection 3.5.2.3. In fact, the server could detect a congestion event whereas there is no packet loss. Indeed, the detection of a congestion event depends on the TCP congestion control algorithm.

Our metric is denoted by  $DropPkt(K)$  and gives the average packet drop rate at the bottleneck during  $K$ -second test duration as shown in equation 3.12:

$$DropPkt(K) = \frac{\text{number of dropped packets during } K \text{ seconds}}{K} \times 100 \quad (3.12)$$

## 3.6 Conclusion

In this chapter, we have presented our emulated HAS player which imitates the behavior of common HAS players without decoding and displaying video content. We justified the use of different player parameters, its RBB bitrate controller with an aggressiveness that depends on the playback occupancy level, its buffer length and its chunk duration. We have also presented our testbed that we have implemented and used for the first part of our evaluation.

We have described the configuration of each connected Linux machine and explained how it

matched with the real architecture. This testbed have been developed in order to give a realistic evaluation when two HAS clients are sharing the same bottleneck link and are competing for the same bandwidth. It has been used for evaluations in Chapter 4 and Chapter 5.

In addition, we have developed a more extensible architecture using the network simulator ns-3 in order to give extended evaluations of our proposed solutions under various conditions; when changing the number of competing HAS clients inside the home network, when changing the player parameters and when changing the ISP network conditions. We have explained the integrated and implemented modules and justified the different configurations of nodes and emulated links in order to be compliant to the fixed broadband access network. This implemented architecture has been used in our simulations. The evaluation results of our proposed methods are presented in Chapter 4 and Chapter 6.

Besides, we have presented in this chapter the different metrics that we have used for evaluating the QoE of HAS users and the QoS of access network: We have selected two important general QoE metric (Stalling event rate and initial delay) and the most compliant QoE criteria that match with our use case (instability of video quality level, infidelity of video quality level, convergence speed and QoE unfairness). We have also selected four relevant QoS metrics (frequency of  $\widehat{OFF}$  periods per chunk, average queuing delay, congestion rate and average packet drop rate). These metrics are employed throughout the remainder of this thesis for evaluating our proposed solutions.



---

# Gateway-based Shaping Methods

## 4.1 Introduction

Improving the QoE of HAS is being actually a challenging purpose. Moreover, as described in Chapter 2 (section 2.3.2), when HAS players are sharing the same bottleneck link and are competing for bandwidth, the QoE degrades dramatically. The most disturbing user's experience in this case is the instability of video quality level, low fidelity to optimal quality level and slow convergence speed to optimal quality level.

This use case is becoming more frequent in daily use not only in mobile broadband access network but also in fixed broadband access network. Accordingly proposing a solution that limits the drawback effects of this use case on QoE is becoming highly demanded. One of the most convenient solutions is to apply traffic shaping on HAS streams. One of convenient ways of implementation is to carry out this shaping on the gateway side. Here we denote by gateway the home gateway in the case of fixed broadband access network and base station in the case of mobile broadband access network.

The objective of this chapter is to propose a new solution of HAS traffic shaping in the gateway to improve the QoE among competing players. For this purpose, we first study the state of the art about traffic shaping methods in the context of HAS in Section 4.2. Second, we describe in Section 4.3 our proposed method, called *Receive Window Tuning Method* (RWTM) which is a shaping method implemented in the gateway. Third, we give in Section 4.4 a comparative evaluation between our proposed method and a well-known gateway-based shaping method, called *Hierarchical Token Bucket Method* (HTBM). Finally, we extend the performance evaluation of RWTM, in Section 4.5, by increasing the number of HAS flows, employing different values of player parameters and exploring different network conditions.

## 4.2 State of The Art

In the literature, we found that many studies aim to improve the QoE of HAS, when many HAS clients compete for bandwidth, by employing different traffic shaping methods. In this section, we give the state of the art of the main proposed methods. We first describe the concept of traffic shaping and its effect on HAS in Subsection 4.2.1. Then, we describe, classify and criticize the proposed HAS traffic shaping methods in Subsection 4.2.2.

### 4.2.1 The Efficiency of Traffic Shaping in The Context of HAS

The main objective among many research studies, when HAS clients compete for bottleneck bandwidth, is to allocate virtually a bandwidth - called a *shaping rate* - to each HAS stream that enables the HAS player to select the desirable quality level and stabilize on it. Given that HAS stream is characterized by ON-OFF periods during steady state phase, a good shaping rate would result in an expansion of ON periods and a shrink of OFF periods as indicated in Figure 4.1. In this

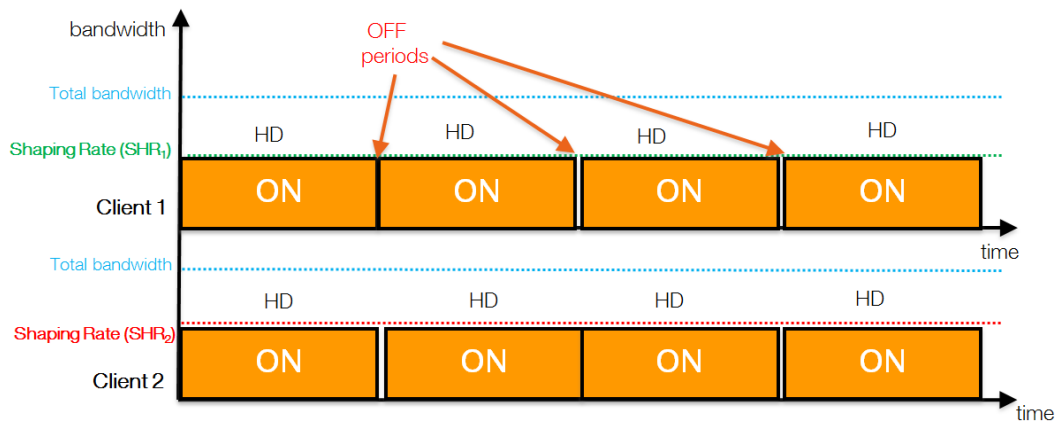

Figure 4.1 – HAS traffic shaping when two HAS clients are competing for bandwidth

case, the competing players would have a good awareness about the network conditions because they are in ON period during the majority of time. Consequently, the estimation of bandwidth of the bitrate controller will be accurate and close to the available bandwidth. Hence, when we compare this figure to Figure 2.8 of Chapter 2 (Subsection 2.3.2.2) a better QoE would be offered to users with more stable quality level, better fidelity to optimal quality level and faster convergence to the optimal quality level. Accordingly, the HAS traffic shaping is beneficial in this use case. Nevertheless, in practice, applying the traffic shaping should take into consideration not only the HAS characteristics, such as the optimal quality level (the highest feasible quality level) for each competing HAS flow, but also the characteristics of access network architecture. Hence, a further study of the state of the art of the different proposed HAS traffic shaping is mandatory.

### 4.2.2 Classification of HAS Traffic Shaping

Many research studies have conducted to improve the QoE when several HAS clients are located in the same home network. The methodology most often employed involved avoiding incorrect estimations of the available bandwidth during ON periods in order to more effectively select the video quality level. Three types of solutions have been proposed to improve HAS user's QoE: client-based, server-based and gateway-based solutions. They differ with respect to the device in which the shaping solution is implemented. Below, we cite relevant methods for each type of solution:

— **Client-based solution**

The client-based solutions involve only the HAS client in order to reduce its OFF period durations. One of the recent client-based solutions is proposed in the FESTIVE method [74]. It randomizes the events of chunk requests inside the player in order to reduce the periodicity of ON periods. Consequently, most of the incorrect estimations of bandwidth could be avoided when several HAS clients competed for bandwidth. However, this method is not efficient enough to prevent all incorrect estimations. Moreover, the client-based solutions do not provide coordination between HAS clients, which is required to further improve bandwidth estimations and QoE.

— **Server-based solution:**

The server-based solutions consist of implicating only the HAS server. They proceed according to two steps: First, finding the optimal quality level for each provided HAS flow, and second, shaping the sending rate of the HAS server according to the encoding rate of this level. S. Akhshabi et al. [7] propose a server-based method: it consists of detecting the oscillation between quality levels on the server side and deciding which optimal quality level must be selected. Although this method improves the QoE, it cannot conveniently respond to the typical use cases of many HAS servers. Moreover, it requires an additional processing task, which becomes burdensome and costly when many HAS clients are demanding video contents from the same HAS server. In addition, the server-based shaping methods are unable to have information about the other competing flows with its corresponding HAS client(s). Hence, the selection of the optimal quality level in the server is still just an estimation. This estimation is less accurate than a selection based on a good knowledge about the access network of the corresponding HAS client(s).

#### — Gateway-based solution

The gateway-based solution consists of employing a bandwidth manager in the gateway that divides the available bandwidth between the HAS clients. The bandwidth manager defines a shaping rate for each HAS client based on the index files that define the available quality levels for each HAS session. Then, this manager shapes the sending bitrate for each client. This solution is more convenient than client-based and server-based solutions because the gateway can acquire information about the HAS traffic of all clients of the same home network, which is not possible either for the server or for the client. Additionally, the gateway-based solution does not require changes in the implementations of the player or the server.

One of the recent gateway-based solutions is the HTB shaping Method (HTBM) [66]. It is based on well-adapted queuing discipline in the gateway. It employs the bandwidth manager with a specific shaping method, the *Hierarchical Token Bucket* (HTB) queuing discipline; it uses one link, designated as the parent class, to emulate several slower links, designated as the children classes, and to send different kinds of traffic on different emulated links. HTB also employs the "token bucket" concept together with the class-based system, to achieve better control over traffic and for shaping in particular [23]. A fundamental part of the HTB queuing discipline is the *borrowing mechanism*: children classes borrow tokens from their parent once they have exceeded the shaping rate. A child class will continue to try to borrow until it reaches a defined threshold of shaping, at which point it will begin to queue packets that will be transmitted when more tokens become available. HTBM considers each HAS stream as a child class. Accordingly, it enables shaping by delaying packets received from a HAS server. R. Houdaille et al. [66] indicate that HTBM improves the user's QoE; features that are enhanced include stability of video quality level, fidelity to optimal quality level, and convergence speed. However, delaying packets in the bottleneck queue in order to reduce the sending rate of HAS flows to the selected shaping rate may add additional delay that it is harmful for the QoS of access network. In fact, some applications are very sensitive to the increase of delay, mainly the real-time applications such as VoIP.

### 4.3 RWTM: Receive Window Tuning Method

Our proposed method, *Receive Window Tuning Method* (RWTM) [11], was also integrated in the gateway due to the convenience of gateway-based solutions, cited above. It is based on TCP flow control to define the shaping rate for each HAS client in accordance with the bandwidth

manager policy.

RWTM is based on TCP flow control. In fact, TCP uses this flow control mechanism in order to prevent a sender from sending more packets than the receiver capacity. In each TCP acknowledgment (ACK) the receiver specifies the maximum amount of data that can be buffered. The value of this amount is sent to the sender in the receiver's advertised window field,  $rwnd$ , of each TCP ACK. The sender cannot exceed the amount  $\min(rwnd, cwnd)$  of bytes during one round-trip time between the sender and the receiver ( $RTT$ ). Where  $cwnd$  is the congestion window size of the sender. In other words, the sending bitrate of a given TCP session is bounded by the amount  $\frac{\min(rwnd, cwnd)}{RTT}$ . As a consequence, if  $rwnd$  becomes constant and  $cwnd$  exceeds it, the send window will still be constant and equal to  $rwnd$ . Therefore, the theoretical sending rate will be always limited by the maximum bitrate  $\frac{rwnd}{RTT}$ , which can be considered as the shaping rate.

The idea of RWTM is to modify the value of  $rwnd$  to have a sending rate limited by  $\frac{rwnd}{RTT}$ . For instance, in Linux, it is possible to set the parameter `net.ipv4.tcp_rmem` on the client side. However, this sets the maximum socket buffer size for all TCP connections on the client [94], without regard to the specific needs or constraints of each connection. Instead, it is possible to modify the header of each TCP Acknowledgment packet (ACK) sent from a HAS client to a HAS server at the gateway.

Accordingly, the methodology of RWTM involves acquiring the shaping rate value,  $SHR$ , from the bandwidth manager, to estimate the  $RTT$  value and to modify the  $rwnd$  of each HAS client in the gateway to be equal to  $SHR \times RTT$ . The modification of  $rwnd$  is ensured in the gateway by modifying the  $rwnd$  field of each TCP acknowledgment (ACK) packet sent from the HAS client to the HAS server. The modification of  $rwnd$  and the estimation of  $RTT$  will be described in detail in Subsection 4.3.1 and Subsection 4.3.2, respectively.

### 4.3.1 Constant RTT

When  $RTT_{C-S}$  is stationary, the definition of  $rwnd_{C-S}$  will depend only on  $SHR_{C-S}$  after the first estimation of  $RTT_{C-S}$ . Accordingly, computing  $RTT_{C-S}$  in the three-way handshake phase of the TCP connection before data transfer, as proposed in [149], will be sufficient for RWTM processing. However, the authors of SABRE [94] reveal that during the ON period of a HAS stream, the  $RTT_{C-S}$  value increases. It is caused by the queuing delay in the gateway. In fact, the reception of several bursts of video packets fills the queue at the gateway, which causes new packets to experience long delays until the queue is drained. Thus, in order to improve the

Table 4.1 – Parameters description

Parameter	Description
$avail\_bw$	Available bandwidth in home network for HAS streams
$N$	Total number of active HAS clients connected to the home network
$C$	HAS client index, $C \in \{1, \dots, N\}$
$l$	Video quality level index, or profile index
$R_l$	Shaping rate of the $l^{th}$ quality level; 10% higher than the profile encoding rate [66]
$SHR_{C-S}$	The shaping rate for the HAS stream requested by the client $C$ from the server $S$
$RTT_{C-S}$	Round-trip time between client $C$ and server $S$
$rwnd_{C-S}$	The $rwnd$ value defined by RWTM in the TCP ACK packet sent from the client $C$ to the server $S$

estimation of  $RTT_{C-S}$  during the ON period, we multiply it by a weight empirical constant  $\mu$  ( $\mu > 1$ ) as shown in equation 4.1

$$\widehat{RTT}_{C-S} = \mu \times RTT_{C-S} \quad (4.1)$$

Hence, an improved definition of  $rwnd_{C-S}$  is proposed in equation 4.2

$$rwnd_{C-S} = SHR_{C-S} \times \widehat{RTT}_{C-S} \quad (4.2)$$

The value of  $\mu$  is set empirically in order to adapt  $rwnd$  to the increase of  $RTT$  during the ON period. We should pay attention that a very high value of  $\mu$  have a contradictory effect; In fact, the resulting shaping rate will be higher than the desired shaping rate  $SHR_{C-S}$ . In this case, the OFF period issue would not be efficiently resolved. Hence, the QoE improvement would be lower than our expectations.

### 4.3.2 General Case: Variable RTT

When  $RTT_{C-S}$  becomes variable over time, RWTM should update the  $rwnd_{C-S}$  value to maintain the same shaping rate as described in equation 4.3

$$rwnd_{C-S}(t) = SHR_{C-S} \times \widehat{RTT}_{C-S}(t) \quad (4.3)$$

The gateway may have to compute the  $RTT_{C-S}$  value exhaustively. Since this may be a heavy processing task, our idea consists of only estimating  $RTT_{C-S}$  from packets sent by the HAS client: this is called passive estimation of RTT [73]. As a result, we define two variables,

$RTT_{G-S}$  and  $RTT_{C-G}$ , which are the round trip time between the home gateway and the HAS server, and the round trip time between the HAS client and the gateway, respectively. Since all packets circulating between the HAS client and HAS server pass through the home gateway, we can provide the following equation:

$$RTT_{C-S}(m, m') \approx RTT_{C-G}(m, m') + RTT_{G-S}(m', m + 1) \quad (4.4)$$

where;

- $m$  designates the packet sent from the client C to the server S
- $m'$  designates the packet that acknowledges the packet  $m$  sent from server S to client C
- $m + 1$  designates the next packet sent from client C to server S after the packet  $m$

$RTT_{C-S}$  estimation is only possible when the HAS client sends a HTTP GET request message, as illustrated in Figure 4.2. In fact, the HAS client will receive the HTTP response message after one  $RTT_{C-S}$  and will immediately send an ACK packet. The time difference between the HTTP GET request message and the first ACK message at the home gateway is close to the  $RTT_{C-S}$  value measured on the client side because it satisfies equation 4.4.

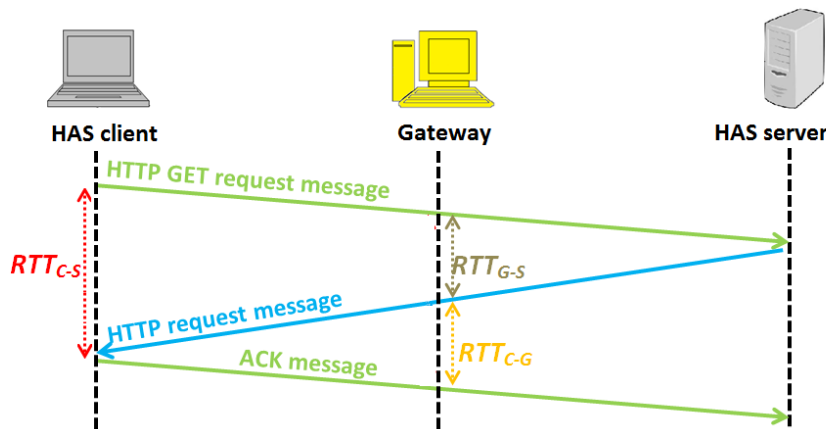

Figure 4.2 –  $RTT_{C-S}$  estimation in the home gateway

Accordingly, the home gateway will be able to estimate  $RTT_{C-S}$  at the beginning of each chunk request. Then, it applies Equations 4.1 and 4.3 to update the  $rwnd_{C-S}$  value.

### 4.3.3 RWTM Implementation

The implementation of RWTM has been done in the home gateway for both our testbed and our ns-3 simulator. For the testbed, we used Python language to intercept and modify ACK packets. Similarly, for ns-3, we exploited the *ip-interceptor* C++ class proposed by Antonio Grilo [55] that

enables the interception of packets that pass through one simulation node. Then, we modified the *ip-interceptor* class to enable the modification of *rwnd* of each intercepted ACK packet sent from each HAS client to its corresponding HAS server.

Concerning the classification of HAS flows, that is mandatory for bandwidth manager, we used the two known IP source addresses of the two competing HAS clients in the testbed, while we used the HAS flow id,  $f$ , in our ns-3 implementation, as described in Subsection 3.4.2. The bandwidth manager defines the shaping rate  $SHR_{C-S}$  that should be assigned for each HAS flow.

Concerning the RTT estimation, we used the passive estimation for both implementations as described in Subsection 4.3.2.

## 4.4 Evaluation of Gateway-based Shaping Methods

The objective of this section is to compare between the two gateway-based shaping methods, HTBM and RWTM, by using a same well-chosen bandwidth manager that is supposed to define the optimal quality level for each HAS client [12]. For this purpose, we define our proposed bandwidth manager algorithm in Subsection 4.4.1. Then we define three different scenarios of HAS client competition in Subsection 4.4.2. Finally, we give our analysis of the results in Subsection 4.4.3. We notice that in this section we use the developed testbed in conformity with its description in Section 3.3 and we employ the emulated HAS player as described in Section 3.2

### 4.4.1 Proposed Bandwidth Manager Algorithm

The bandwidth manager is the fundamental component of the gateway-based solution. It uses as inputs three parameters: the home available bandwidth  $avail\_bw$ , the number of competing HAS clients  $N$ , and the index file of each HAS stream that defines the encoding rates of each quality level for each stream. Then, it computes the shaping rate for each HAS client as indicated in Equation 4.5:

$$SHR_{C-S} = \left\{ \max(R_l) \mid R_l \leq \frac{C}{N} \times avail\_bw - \sum_{j=1}^{C-1} SHR_{j-S} \right\} \quad (4.5)$$

$SHR_{C-S}$  is chosen in a manner that enables the players to select optimal quality levels by ensuring both the fairest share of  $avail\_bw$  between HAS clients and the maximum use of  $avail\_bw$ . This choice necessitates that if the fair share of  $avail\_bw$  according to  $\left\{ \max(R_l) \mid R_l \leq \frac{avail\_bw}{N} \right\}$  involves  $avail\_bw$  underutilization, and if the unused portion of



*avail\_bw* enables one or more HAS clients to switch to a higher quality level, the bandwidth manager will allow it. In other words, the shaping rate is chosen in a manner that it ensures the fairest share of the available home bandwidth between clients with prioritization to achieve the maximum use of the available home bandwidth. This entails that some clients could have a higher quality level than others when their fair share of available home bandwidth is not sufficient to maximize the use of the available home bandwidth.

The bandwidth manager is sufficiently sophisticated to be able to update the number of active connected HAS clients to the home gateway,  $N$ , by sniffing the *SYN* and *FIN* flags in the header of TCP packets. We also assume that it is capable of estimating the *avail\_bw* and updating its value over time. Accordingly, the manager updates the shaping rate when any change occurs. In order to facilitate our implementation, the *avail\_bw* of the configuration (of both testbed and ns-3) is directly used as input by the bandwidth manager.

#### 4.4.2 Scenarios

We define three scenarios that are typical to concurrence between HAS clients in a same home network. We have chosen the duration of each test  $Z = 180$  seconds. This duration resolves the tradeoff between having sufficient long duration to have a significant number of measurements (about 100 chunks are exchanged) and a not too long duration (to reduce the duration of the simulation runs and the experimental executions):

1. Both clients start to play simultaneously and continue for  $Z$  seconds. This scenario illustrates how HAS clients compete.
2. Client 1 starts to play, the second client starts after 30 seconds, and both continue together for  $Z - 30$  seconds. This scenario shows how transition from one client to two clients occurs.
3. Both clients start to play simultaneously, client 2 stops after 30 seconds, and client 1 continues alone for  $Z - 30$  seconds. This scenario shows how a transition from two clients to one takes place.

We note that we have chosen 30 seconds as the transitory duration before the change of the number of competing HAS clients for scenarios 2 and 3. Our justification of this value is that the clients reach a more stable state within around 30 seconds when employing a gateway-based shaping method, HTBM or RWTM, as it will be described below in Subsection 4.4.3.1.

### 4.4.3 Analysis of The Results

In this section, we discuss the QoE measurements of the two shaping methods RWTM and HTBM during the three scenarios, and we provide accurate explanations of the observed results by showing the congestion window variation. The two compared methods shape bandwidth in the gateway in accordance with the bandwidth manager's decisions, as described in Subsection 4.4.1. The shaping rate for each client is chosen as indicated in [66], Table 4.1 and Subsection 4.4.1; it is 10% higher than the encoding rate of the optimal quality level for each client. The weight constant  $\mu$  of equation 4.1 employed by RWTM is chosen empirically and is equal to  $\mu = 1.275$ . We justify this value by several experimental tests that measure the increase of RTT during the ON period: we found that multiplying the first measured RTT of ON period by 1.275 is approximately equal to the mean value of RTT during the whole ON period.

#### 4.4.3.1 QoE Evaluation

For each scenario, we repeat each test 60 times, and we employ the average value of QoE metrics in our evaluation. The number of 60 runs is justified by the fact that the difference of the average results obtained after 40 runs and 60 runs is lower than 6%. This observation is verified for all scenarios. Accordingly, using 60 tests is sufficient to yield statistically significant results. The average values of metrics are listed in Table 4.2. We note that convergence speed metric is computed for scenarios 2 and 3 from 30 seconds instead of the beginning of the test. We justify this choice by our objective of measuring the convergence speed just after the change of the number of competing HAS clients, i.e. from the second 30. We also notice that for scenario 2 and 3 we present the performance measurements only for client 1. In fact, the client 2 is just designed for studying the effect of its presence and absence on the performances of client 1. In this table, we denote by *W/o* the case that we does not use traffic shaping.

The overall evaluation indicates that the two gateway-based shaping methods improve QoE (instability, infidelity and convergence speed) compared with *W/o*. This overall result confirms the importance of employing a gateway-based shaping method for improving the QoE of the competing HAS clients. In the following, we give our observations taken from Table 4.2 classified by scenarios:

- For the first scenario, the simultaneous playing of two HAS clients involves better QoE measurements for client 2 than for client 1. This behavior is expected because the bandwidth manager assigns lower optimal quality level ( $n^\circ 3$ ) for client 2 than for client 1 ( $n^\circ 4$ ). Obviously, the quality level  $n^\circ 3$  is easier to achieve than that of  $n^\circ 4$ .

Table 4.2 – Performance metric measurements

Scenario		1		2	3	Average
Client		1	2	1	1	1
Instability (%) $IS_C(K)$	W/o	7.47	5.82	3.87	2.18	4.5
	HTBM	1.86	1.15	3.44	2.19	2.49
	RWTM	1.63	1.13	1.43	1.63	1.56
Infidelity (%) $IF_C(K)$	W/o	50.46	36.93	67.36	13.94	43.92
	HTBM	20.45	4.47	32.09	18.49	23.95
	RWTM	5.02	2.61	3.42	4.81	4.42
Convergence speed (s) $V_{C,60}(K)$	W/o	180	92.81	180	20.1	126.7
	HTBM	52.06	13.26	64.13	34.65	50.28
	RWTM	19.55	8.95	10.98	14.36	14.96

Moreover, we observe that the improvement of QoE of RWTM, computed on the bases of W/o measurements, is reduced with a lower rate than HTBM when we compare the QoE measurements of client 2 to that of client 1. For example, for client 2, the infidelity rate of RWTM is 14 times lower than that of W/o ( $IF = 2.61\%$  vs.  $36.93\%$ ) and it is reduced to 10 times for client 1 ( $IF = 5.02\%$  vs.  $50.46\%$ ). In contrast, for client 2, the infidelity rate of HTBM is 8 times lower than that of W/o ( $IF = 4.47\%$  vs.  $36.93\%$ ) and it is dropped to 2.4 times for client 1 ( $IF = 20.45\%$  vs.  $50.46\%$ ). Hence, HTBM is more sensitive to the increase of video encoding bitrate than RWTM. Moreover, when considering client 1, RWTM is 12% more stable than HTBM ( $IS = 1.63\%$  vs.  $1.86\%$ ) 4 times more faithful to optimal quality level ( $IF = 5.02\%$  vs.  $20.45\%$ ) and converges 2.6 times faster ( $V = 19.55$  s vs.  $52.06$  s) than HTBM. Accordingly, RWTM has a better capacity than HTBM to improve the QoE when two HAS clients are competing simultaneously for bandwidth.

- For the second scenario, when the client 2 starts 30 seconds after client 1, we begin by giving our observations by comparing the QoE measurements of client 1 with that of scenario 1: We find that scenario 2 lets RWTM improve its performances; RWTM have a lower instability rate ( $IS = 1.43\%$  vs.  $1.63\%$ ), a lower infidelity rate ( $IF = 3.42\%$  vs.  $5.02\%$ ) and a faster convergence speed ( $V = 10.98$ s vs.  $19.55$ s). In contrast, scenario 2 is harmful for HTBM because we observe a degradation of QoE measurements compared to scenario 1; HTBM have higher instability rate ( $IS = 3.44\%$  vs.  $1.86\%$ ), a higher infidelity rate ( $IF = 32.09\%$  vs.  $20.45\%$ ) and a slower convergence speed ( $V = 64.13$ s

vs. 52.06s). Hence, unlike RWTM, HTBM is disturbed by the increase of competing HAS clients from one to two clients. The comparison between the QoE measurements of RWTM and HTBM indicates the following: RWTM is 2.4 times more stable than HTBM ( $IS = 1.43\%$  vs.  $3.44\%$ ), 9.4 times more faithful to the optimal quality level ( $IF = 3.42\%$  vs.  $32.09\%$ ) and converges 5.8 times faster to the optimal quality level than HTBM ( $V = 10.98s$  vs.  $64.13$ ). Accordingly, the adaptability of RWTM to the increase of competing HAS clients from one to two clients is much better than that of HTBM.

- For the third scenario, when the client 2 stops its HAS stream 30 seconds before client 1, we begin by giving our observations by comparing the QoE measurements of client 1 with that of scenario 1: We find that the overall QoE measurements are improved for W/o, HTBM and RWTM. Even with W/o the HAS client is able to converge within only 20.1 seconds. This result is expected because the client operates alone for 150 seconds, and therefore is easier to stabilize on the optimal quality level. The comparison between the QoE measurements of the third scenario between W/o, HTBM and RWTM indicates the following: RWTM offers better QoE measurements than W/o while HTBM offers worse QoE measurements than W/o. Hence, reducing the number of competing HAS clients from 2 to one client has a negative effect on QoE when employing HTBM.

Accordingly, we can notice that RWTM always improves the QoE for the three scenarios compared to W/o and HTBM. In order to give a more accurate observation, we indicate in the last column of Table 4.2 the average performance values of three scenarios related to client 1. We observe that RWTM is 37.3% more stable ( $IS = 1.56\%$  vs.  $2.49\%$ ), 5.41 times more faithful to optimal quality level ( $IF = 4.42\%$  vs.  $23.95\%$ ), and converges 3.4 times faster ( $V = 14.96$  s vs.  $50.28$  s) than HTBM.

We can conclude that the recommended gateway-based method to be used for improving user's experience is RWTM. In fact, RWTM presents a better robustness against the increase of the video encoding rate than HTBM when two HAS clients compete for bandwidth. Besides, unlike HTBM, RWTM is not disturbed with the change of the number of competing HAS clients between one and two clients (scenarios 2 and 3), but instead, it presents better QoE rate.

In order to understand the cause of the dissimilarity of QoE measurements between the two gateway-based shaping methods, we provide an explanation of these results in the next subsection 4.4.3.2 by examination the variation of the congestion window during time in the HAS server.

#### 4.4.3.2 Congestion Window Variation

In order to explain the cause of these results, we used the *tcp\_probe* module in the HAS server. This module shows the evolution of the congestion window, *cwnd*, and slow start threshold, *ssthresh*, during each test. We select two tests that have the nearest QoE measurements of the first column of Table 4.2 related to HTBM and RWTM, respectively. We present the *cwnd* and *ssthresh* variation of the two tests in Figure 4.3 and 4.4. In the two figures, we indicate by a vertical bold dotted line the moment of convergence. We observe that this moment coincides with a considerably higher stability of *ssthresh* and higher stability of *cwnd* in the congestion avoidance phase.

In order to be accurate in our analysis, based on the Cubic [57] congestion control algorithm used in the server and its source code *tcp\_cubic.c*, we present some important value updates of *cwnd* and *ssthresh* for different events:

- **Congestion event** - we have two cases:
  - When three duplicated ACKs are received, the Fast Recovery / Fast Retransmit (FR/FR) phase reduces *ssthresh* by a multiplicative decrease factor and sets *cwnd* to  $ssthresh+3$ . Hence, *cwnd* remains in congestion avoidance phase.
  - When the retransmission timeout expires before receiving ACK of the supposed lost packet, *ssthresh* is reduced by a multiplicative decrease factor, and *cwnd* is set to a small value and restarts from slow start phase.
- **Idle period**: When the server sends a packet after an idle period that exceeds retransmission timeout (*RTO*), *ssthresh* is set to  $\max(ssthresh, \frac{3}{4}cwnd)$ , and the *cwnd* value is computed as in Algorithm 1:

---

**Algorithm 1** *cwnd* update after an idle period

---

```

1: for  $i = 1$  to  $\text{int}(\frac{\text{idle}}{RTO})$  do
2:    $cwnd = \max(\frac{\min(cwnd, rwnd)}{2}, 1MSS)$ 

```

▷ Where *MSS* is the maximum TCP segment size.

---

In the context of HAS, an idle period coincides with an OFF period between two consecutive chunks. We denote by  $\widehat{OFF}$  the OFF period whose duration exceeds *RTO*.

After convergence, with HTBM we have a high congestion rate: as presented in Figure 4.3, the majority of congestions is caused by retransmission timeout. In contrast, with RWTM, congestion events are negligible: only two visible congestions occur in Figure 4.4. As a consequence, *ssthresh* becomes lower when using HTBM than when using RWTM: *75 MSS* in Figure 4.3 vs. *110 MSS*

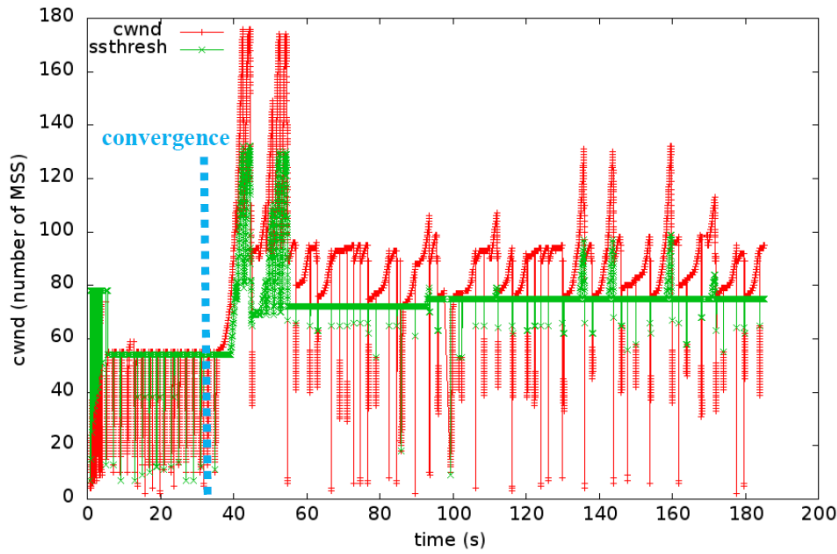

Figure 4.3 –  $Cwnd$  and  $ssthresh$  variation when using HTBM (IS=1.98% , IF=19.03% , V=33 s)

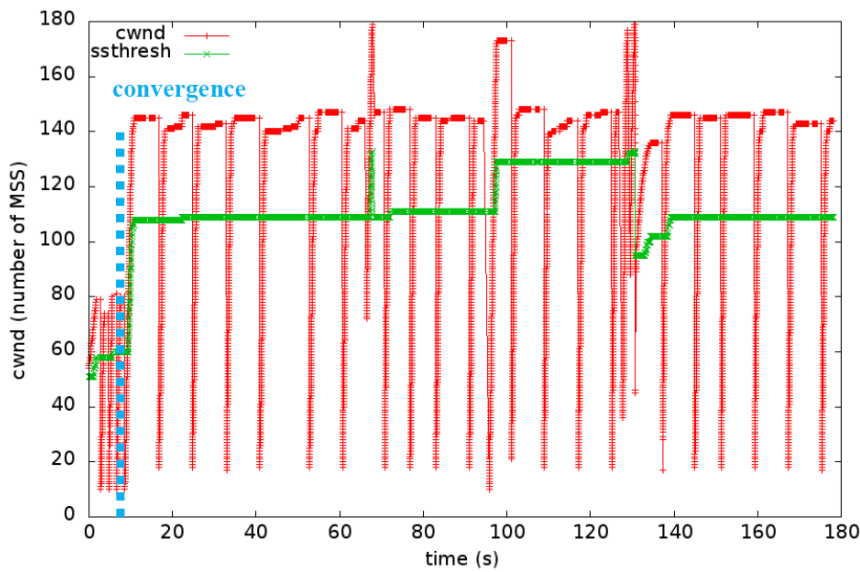
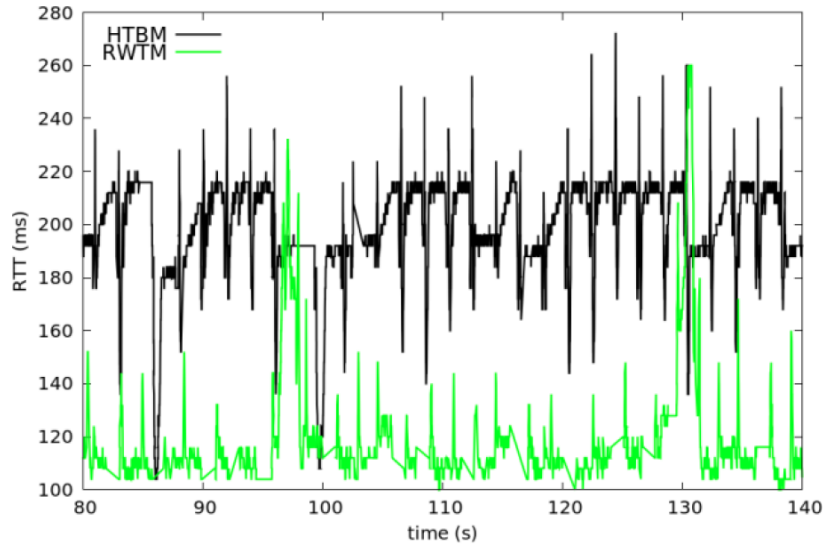

Figure 4.4 –  $Cwnd$  and  $ssthresh$  variation when using RWTM (IS=1.78% , IF=5.5% , V=8 s)

in Figure 4.4. On the other hand, RWTM has frequent  $\widehat{OFF}$  periods, with one  $\widehat{OFF}$  period every 4.14 chunks, on average, unlike HTBM, which shows practically no idle periods in Figure 4.3. In Figure 4.4,  $cwnd$  is divided by 8 after each  $\widehat{OFF}$  period. Based on Algorithm 1, the  $\widehat{OFF}$  period's duration is included in the interval  $[3 RTO, 4 RTO]$ . This observation leads us to compute the RTT variation between client 1 and server,  $RTT_{1-S}$ , for each test.  $RTT_{1-S}$  jumps from 100 ms to around 200 ms when using HTBM, as presented in black in Figure 4.5. In contrast, when using RWTM,  $RTT_{1-S}$  increases slightly and reaches approximately 120 ms, as presented in green in Figure 4.5.

Figure 4.5 –  $RTT_{1-S}$  variation

Consequently, approximately  $100\text{ ms}$  of queuing delay is generated by HTBM, in contrast to about  $20\text{ ms}$  generated by RWTM. As result, on one hand, a large number of packets is buffered in the gateway queue when using HTBM, and that increases the congestion rate. On the other hand, the high queuing delay generated by HTBM has the advantage of reducing the frequency of  $\widehat{OFF}$  periods by increasing  $RTO$  duration: the ratio  $\frac{\widehat{OFF}}{RTO}$  is reduced. Even if an  $\widehat{OFF}$  period occurs, based on Algorithm 1, the  $cwnd$  value will be divided, but will still be twice higher than when using RWTM. So, on one hand, HTBM delays packets considerably, which causes a high congestion rate and, by consequence, lower convergence speed, but it practically eliminates  $\widehat{OFF}$  periods. On the other hand, RWTM does not generate congestions, but concerning  $\widehat{OFF}$  periods, RWTM reduces their frequency but does not eliminate them. The cause is the non-exhaustive estimation of  $RTT_{C-S}$ , i.e. limited to only one estimation per chunk, which may induce a low conformity of the shaping rate computation to the  $SHR_{C-S}$  value defined by the bandwidth manager.

In this evaluation, we have conducted a comparative evaluation between two gateway-based shaping methods, HTBM and RWTM, employed to improve the HAS user's experience (QoE). The use case is defined as HAS clients being located in the same home network and competing for bandwidth. We define the same bandwidth manager in the gateway, and we present the testbed and its parameters to permit an accurate comparison. By defining objective QoE criteria, the comparative evaluation shows that, for our scenarios and their parameter values, RWTM is more beneficial; it is 37.3% more stable, 5.41 times more faithful to optimal quality level, and converges 3.4 times faster to the optimal quality level than HTBM. The main explanation of this result is directly related to the additional queuing delay induced by HTBM to shape HAS traffic, while RWTM just

reduces the advertised window of HAS clients and thus does not add significant queuing delay.

## 4.5 Extended Evaluation of RWTM

In this section we evaluate RWTM under more different conditions using the ns-3 simulator. To perform this evaluation, we use our implementation in ns-3 as described in Section 3.4 and RWTM implementation as shown in Subsection 4.3.3. We also employ several QoE and QoS metrics in conformity to their definition in Section 3.5. The competing players are playing simultaneously during 180 seconds. All results are compared to the case without shaping, denoted by W/o.

Nevertheless, in order to be more accurate in our evaluation, we should test many runs for the same scenario and compute the average value of performance metric measurements. However, we should select a credible run number in order to resolve the following dilemma; giving an expressive evaluation that presents a more general case with the minimum possible number of runs. In order to define the number of runs that should be used for our evaluation, we use the method of the relative difference between the mean values of criteria measurements. Let  $n1$  and  $n2$  two different numbers of runs ( $n1 < n2$ ),  $M_{n1}$  and  $M_{n2}$  the mean values, related to one criterion measurement, among  $n1$  and  $n2$  runs, respectively. The relative difference between these two mean values, denoted by  $Relative\_Diff(n1, n2)$ , is obtained as shown in Equation 4.6:

$$Relative\_Diff(n1, n2) = \frac{|M_{n1} - M_{n2}|}{M_{n1}} \quad (4.6)$$

Concretely, we selected four run numbers which are power of 4: i.e 4, 16, 64 and 256. Then, we compute  $Relative\_Diff(n1, n2)$  of each two consecutive run numbers for three different QoE criteria: instability  $IS$ , infidelity  $IF$  and convergence speed  $V$ . We note that we select only these criteria because they are the most determinative QoE criteria for our evaluation. Then, we select the number of run  $n1$  when  $Relative\_Diff(n1, n2)$  is lower than a threshold of 4%.

For example, when considering the scenario of two HAS clients competing for bandwidth, the computation of  $Relative\_Diff(n1, n2)$  related to W/o and RWTM are shown in Tables 4.3 and 4.4, respectively.

The two tables indicate that when increasing the number of runs from 16 to 64 runs, the relative difference related to three QoE criteria among 16 and 64 runs is less than 4% for both W/o and RWTM. Accordingly, it is not necessary to increase the number of runs above 16 runs. Hence, employing 16 runs is sufficient to have a meaningful evaluation of the performances.

The remaining of this section is organized as the following: First, we evaluate the effect of in-



Table 4.3 – The relative differences of QoE mean values related to W/o

	QoE criterion	<i>n1-n2</i>		
		4-16	16-64	64-256
<i>Relative_Diff(n1,n2) (%)</i>	<i>IS</i>	3.64	3.84	0.63
	<i>IF</i>	7.25	0.46	0.01
	<i>V</i>	8.39	3.29	0.53

Table 4.4 – The relative differences of QoE mean values related to RWTM

	QoE criterion	<i>n1-n2</i>		
		4-16	16-64	64-256
<i>Relative_Diff(n1,n2)(%)</i>	<i>IS</i>	0.01	0.01	0
	<i>IF</i>	0.22	0.07	0
	<i>V</i>	0.26	0.39	2.56

creasing the number of HAS flows on the performances of RWTM in Subsection 4.5.1. Second, we evaluate the RWTM performances when changing the HAS player parameters in Subsection 4.5.2. Third, we study the effect of changing network conditions on RWTM performances in Subsection 4.5.3.

#### 4.5.1 Effect of Increasing the Number of HAS Flows

In the literature, many authors reveal that increasing the number of HAS flows degrades the QoE. For example, [131, 80] indicate that with a rising number of competing clients the unfairness increases.

In this subsection we evaluate the robustness of RWTM against the increase of competing HAS clients in the same home network. We vary the number of competing players from one to 9 clients. We select 9 as the maximum number of competing HAS clients, because, in practice, the number of users inside the home network does not exceed 9 users. The mean performance measurements between competing players are presented in Figure 4.6. In this figure the performance unfairness measurements between HAS clients are indicated with vertical error bars.

Concerning the QoE measurements, we observe that RWTM provides a good QoE rate and keeps practically the same measurements independently with the number of competing HAS clients. In fact, we observe in Figure 4.6a that the instability of RWTM is kept lower than 3% with a negligible instability fairness between clients, while the instability of W/o is comprised be-

tween 5% and 13% and seems to increase when increasing the number of competing clients. The infidelity rate of RWTM is maintained around 14% with a negligible infidelity unfairness rate as presented in Figure 4.6b, while W/o presents a higher infidelity rate that exceeds 60% when the number of competing HAS clients is higher than 6. In addition, Figure 4.6c shows that all HAS clients rapidly converge to the optimal quality level within only 10~15 seconds, in contrast to W/o where the clients become unable to converge when the number of competing clients exceeds 5.

In addition, the initial delay of both RWTM and W/o is increased when the number of competing HAS clients increases as shown in Figure 4.6d. This result is predictable. In fact, during the buffering phase the HAS player asks for chunks successively. Consequently, when the number of competing HAS clients increases, the bandwidth would be shared between instable HAS flows, hence an additional delay is generated. We also remark that RWTM presents a slight lower initial delay than W/o when the number of competing HAS clients exceeds 4 clients. The main cause is that, during buffering state, when many unshaped HAS flows are competing for bandwidth they are more aggressive than RWTM and cause many congestion events; as shown in Figure 4.6g, the congestion rate is increasing from 4 competing HAS clients. Consequently, the HAS sending rate would be obviously reduced because of these congestions. Hence, the initial delay of W/o is slightly lower than that of RWTM. We note that the initial delay with 9 HAS competing clients is around 9 seconds, which is lower than 16 seconds and does not disturb the QoE of users, as described in Subsection 2.4.1.2. Moreover, RWTM generates no stalling event, as shown in Figure 4.6i, while W/o begins to cause stalling events with ascending rate from 7 competing clients. This result is a direct consequence of the high stability rate, generated by the bandwidth manager and the traffic shaping method of RWTM, that is well preserved even with a high number of competing HAS clients.

Concerning QoS measurements, we observe a decrease of  $\widehat{OFF}$  period frequency,  $fr_{\widehat{OFF}}$ , for both W/o and RWTM in Figure 4.6e. Although  $fr_{\widehat{OFF}}$  of RWTM is higher than that of W/o, when increasing the number of competing clients, the  $fr_{\widehat{OFF}}$  decreases and becomes close to W/o (around 0.05 when the number of HAS clients is equal to 9). This decrease is beneficial to RWTM because one of the objectives of shaping is to reduce the duration of OFF periods, and it results in saving good QoE measurements as described above. In addition, we observe in Figure 4.6f that the queuing delay increases proportionally with the number of HAS clients. Besides, the average queuing delay is at least twice lower with RWTM than with W/o: for example when 6 HAS clients are competing for bandwidth, the queuing delay of RWTM is equal to 30 ms while that of W/o is equal to 62 ms. The obvious explanation is the efficiency of RWTM, in terms of bandwidth management and traffic shaping, that avoids the aggressive competition between HAS flows and

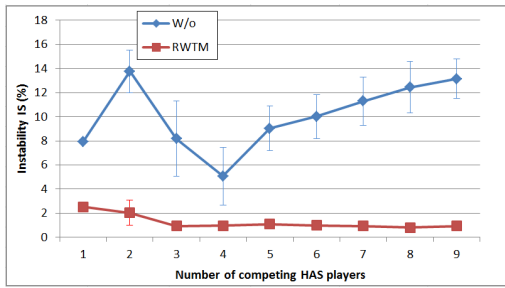

(a) Instability vs. number of HAS player

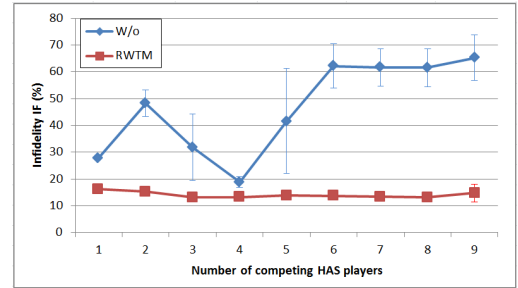

(b) Infidelity vs. number of HAS player

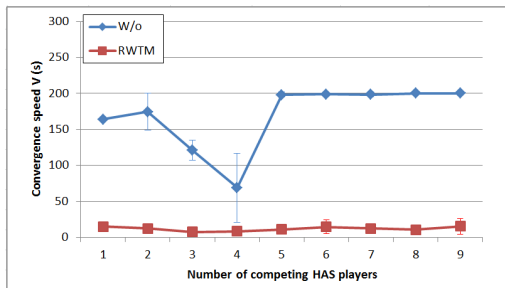

(c) Convergence speed vs. number of HAS player

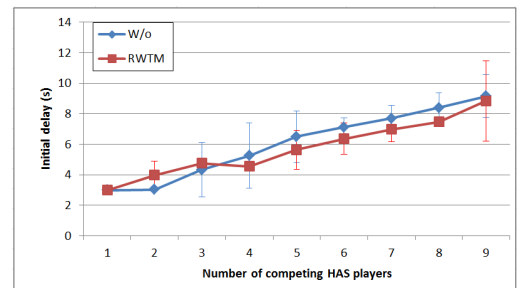

(d) Initial delay vs. number of HAS player

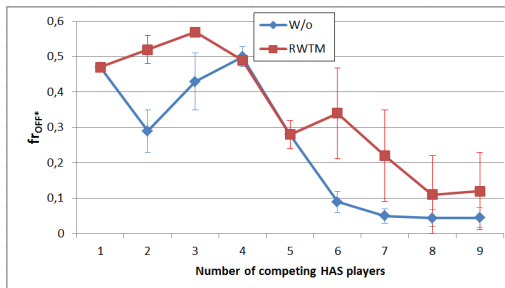

(e)  $f_{OFF}$  vs. number of HAS player

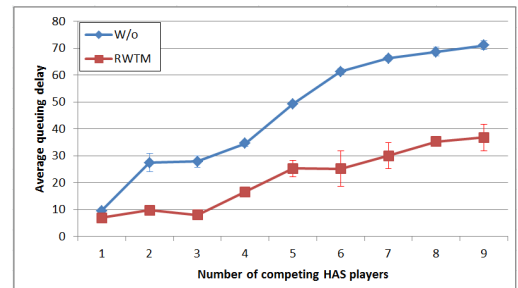

(f) Queuing delay vs. number of HAS player

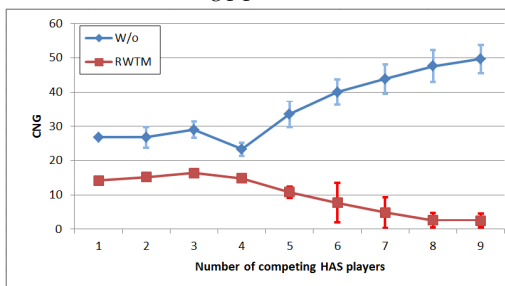

(g) Congestion rate vs. number of HAS player

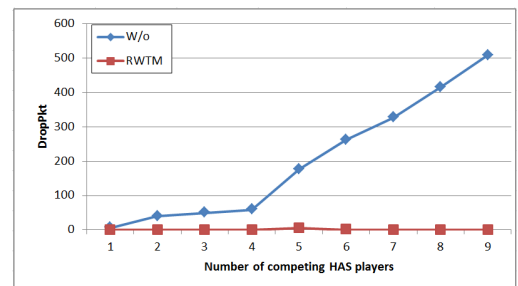

(h) packet drop rate vs. number of HAS player

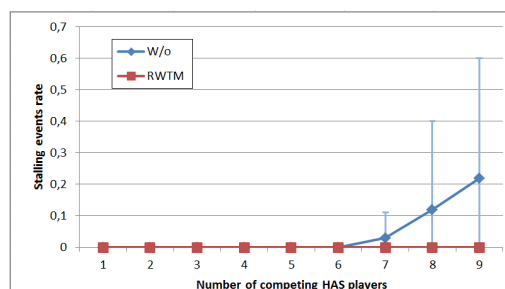

(i) Stalling event rate vs. number of HAS player

Figure 4.6 – Performance measurements when increasing the number of HAS competing clients

reduces the over-estimations of bandwidth which are responsible of the saturation of the bottleneck queue. For the same reason, the congestion detection rate of RWTM on the server side is reduced as indicated in Figure 4.6g and the packet drop rate at the bottleneck is still null as shown in Figure 4.6h. In contrast, W/o highly increases the congestion detection rate and the packet drop rate at the bottleneck.

To summarize, RWTM is not disturbed by the increase of the competing HAS clients in the same home network in terms of access network QoS and HAS QoE. For QoE measurements, unlike W/o, RWTM preserves a high instability, high fidelity and a rapid convergence speed, reduces slightly the initial delay and does not generate stalling events. For QoS measurements, RWTM reduces the queuing delay to less than the half, reduces the congestion detection rate and practically does not cause packet drop at the bottleneck. However, the frequency of  $\widehat{OFF}$  periods is higher than that of W/o. The cause of this high value is the low frequency of RTT estimations of RWTM, which are done only one time per chunk.

## 4.5.2 Effect of Variation of Player Parameters

In this subsection, we study the effect of player parameters on RWTM shaping method performances. For this purpose, we select two main important parameters: the player buffer size and the chunk duration. The chosen scenario is when two HAS players are competing for bandwidth simultaneously during 180 seconds.

### 4.5.2.1 Playback Buffer Size effect

Knowing that Live and VoD streaming services differ by the length of playback buffer as explained in Subsection 2.2.2.3, studying of the effect of playback buffer length on RWTM performances is equivalent to study the behavior of RWTM in Live and VoD video streaming.

In Figure 4.7 we show performance metric measurements of RWTM and W/o for different lengths of playback buffer ranging from 6 to 30 seconds. We remember that the common value of buffer length for Live streaming service is around 8 seconds and that for VOD around is 30 seconds as indicated in Subsection 2.2.2.3.

Considering the QoE measurements, RWTM outperforms W/o in three QoE criteria, instability, infidelity and convergence speed, for all playback buffer lengths: For instability rate, it decreases with RWTM from 4% to 2% when increasing the playback buffer length from 6 to 30 seconds as presented in Figure 4.7a, while it is around 14% with W/o. Here we can say that RWTM offers a more stable quality level with a longer playback buffer. In addition, when the playback

buffer is higher than 10 seconds, we observe the following: the infidelity rate of RWTM is maintained at a low value less than 14% while it is higher than 50% with W/o and the convergence speed of RWTM is maintained at around 13 seconds while it is higher than 160 seconds with W/o, as presented in Figures 4.7b and 4.7c, respectively. However, for a 6-second length buffer, we observe a degradation in infidelity and convergence speed and a high unfairness between clients for these criteria with RWTM. The cause of that is also related to the bitrate controller and the aggressiveness employed in the formula 3.1: when the playback buffer is shorter, the loss of player aggressiveness becomes faster. For example, one missing chunk (whose duration is 2 seconds) in the 6-second length buffer results in decreasing the player aggressiveness by 1/3 which is five times higher than with a 30-second length buffer. When a such player has its own bandwidth shaped by RWTM that corresponds to a highest quality level which is difficult to achieve with a low aggressiveness, the "downward spiral effect" described in Section 3.2 would take place. Moreover, we observe in Figure 4.7d that the initial delay is increased for both W/o and RWTM, which is expected because the HAS players have to request for more chunks in the buffering state. In addition, the initial delay of RWTM is slightly higher but it keeps the same ratio with W/o. This slightly higher initial delay is not disturbing for users' QoE as indicated in [65] because it is still far lower than 16 seconds. Moreover, unlike W/o which generates high stalling event rate when the playback buffer length is lower than 10 seconds, RWTM generates no stalling event for all playback buffer sizes ranged between 6 and 30 seconds as indicated in Figure 4.7i.

Considering the QoS measurements, we observe in Figure 4.7e that the frequency of  $\widehat{OFF}$  periods is reduced for both RWTM and W/o when increasing the playback buffer length. This result is predictable because a longer playback buffer results in requesting more chunks successively, i.e. without any delay between them, during the buffering state phase. Besides, the frequency of  $\widehat{OFF}$  of RWTM is still higher than W/o, which is caused by the non-exhaustive computation of RTT as explained above in Subsection 4.4.3.2. Moreover, the queuing delay generated by RWTM is maintained at the same low value, around 9 ms, for different playback buffer lengths while it is comprised between two high values, 15 ms and 30 ms, with W/o, as shown in Figure 4.7f. In addition, the congestion detection rate of RWTM is also maintained at a low value as presented in Figure 4.7g and generates practically no packet drop at the bottleneck as shown in Figure 4.7h. In contrast, W/o is still aggressive and generates high congestion detection rate and high packet drop rate.

To summarize, RWTM improves both QoE and QoS for different playback buffer lengths ranged between 6 and 30 seconds. Hence, we can say that RWTM improves performances for both Live and VoD streaming services.

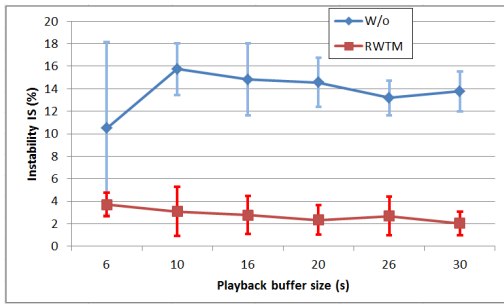

(a) Instability vs. playback buffer size

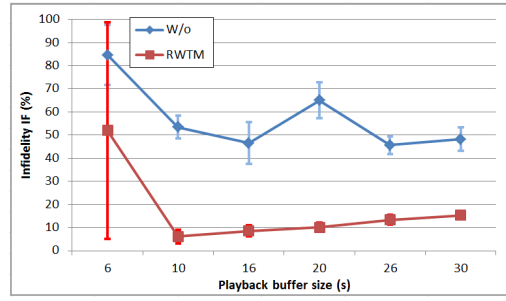

(b) Infidelity vs. playback buffer size

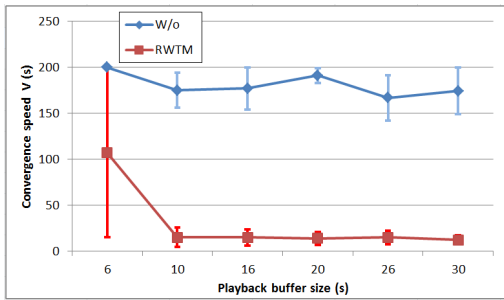

(c) Convergence speed vs. playback buffer size

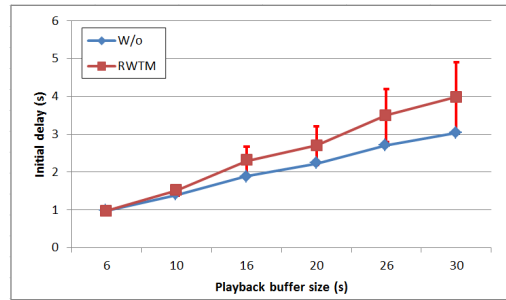

(d) Initial delay vs. playback buffer size

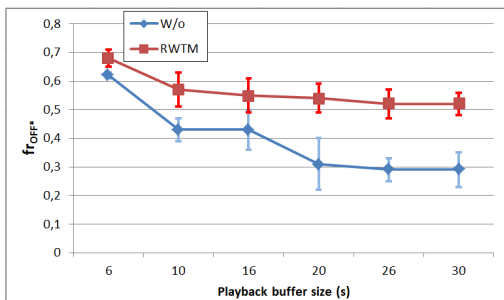

(e)  $f_{OFF}$  vs. playback buffer size

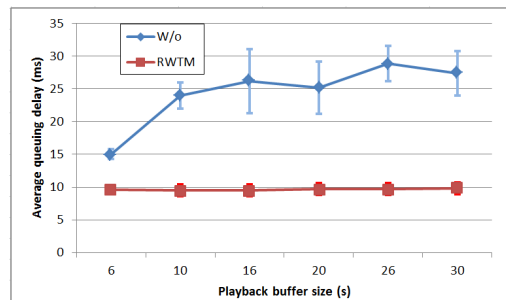

(f) Queuing delay vs. playback buffer size

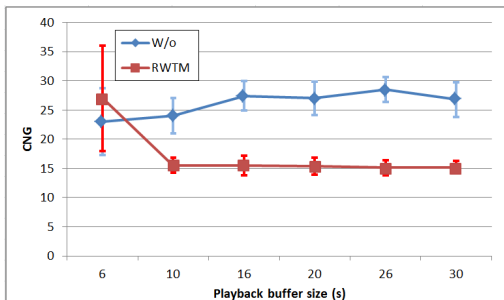

(g) Congestion rate vs. playback buffer size

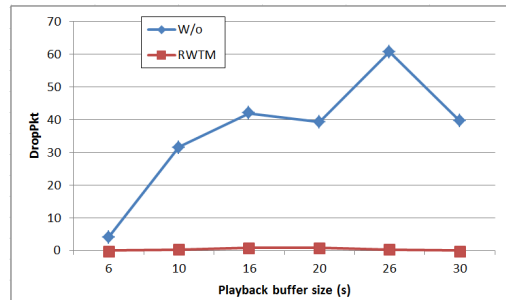

(h) Packet drop rate vs. playback buffer size

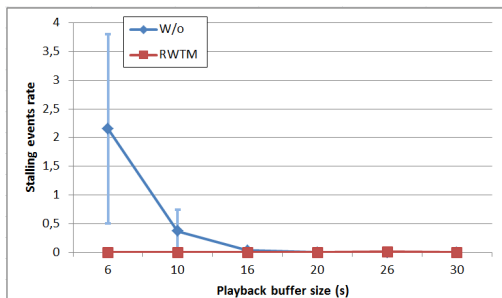

(i) Stalling event rate vs. playback buffer size

Figure 4.7 – Performance measurements when increasing the playback buffer size

#### 4.5.2.2 Chunk Duration Effect

As indicated in Subsection 2.2.2.2, majority of HAS players employs a chunk duration of 2 seconds. However, some others employs higher duration; such as Adobe HDS, which ranges between 2 and 5 seconds [85], and Apple HLS, which uses the highest value of 10 seconds just because of problems related to the refresh process of the index file. In order to study the effect of chunk duration on RWTM performances, we make simulations with different chunk duration ranging from 2 to 7 seconds. The results are shown in Figure 4.8.

Concerning the QoE measurements, we observe in Figure 4.8a that the instability rate of RWTM slightly decreases from 2% to around 1% when the chunk duration increases from 2 seconds to 7 seconds. Similarly, in the case without shaping (W/o), the instability decreases from 14% to 5%. A similar observation is valid for infidelity and convergence speed presented in Figures 4.8b and 4.8c: the infidelity of RWTM is decreased from 15% to less than 9% and convergence speed is slightly improved from 12 seconds to 9 seconds. This improvement of the three criteria of QoE cited above is expected because as indicated in Subsection 2.4.2 a larger chunk duration offers a higher quality selection, which decreases the infidelity rate, and gives better stability. Moreover, the initial delay generated by RWTM is slightly higher than W/o, as indicated in Figure 4.8d, but it is still acceptable for user's QoE (lower than 4 seconds) because it is lower than the threshold of 16 seconds defined in [65] (see Subsection 2.4.1.2).

Concerning the QoS measurements, we observe that the  $\widehat{OFF}$  frequency is increased with RWTM, as shown in Figure 4.8e, and becomes stable around  $0.85 \widehat{OFF}$  period per chunk. This result is expected because the larger the chunk duration is, the larger ON period is required for the shaping process, and hence, the higher risk to generate OFF periods that exceeds the retransmission timeout is. This high frequency of  $\widehat{OFF}$  period in the case of large chunk duration has no effect on QoE; in fact, even if the congestion window,  $wnd$ , of the HAS server restarts from a low value the slow start phase after each  $\widehat{OFF}$  period, it has sufficient large ON period to be increased, which enables the HAS server to reach the desired shaping rate and the HAS player to have a good estimation of the bandwidth. The queuing delay is increased when increasing the chunk duration as shown in the case of W/o in Figure 4.8f. This delay has an effect on increasing the congestion detection rate and packet drop rate at the bottleneck as shown in Figures 4.8g and 4.8h. However, with RWTM, the queuing delay not only has a low value but it is also slightly decreased to be lower than 9 ms as shown in Figure 4.8f. Besides congestion detection rate is still low and the packet drop rate at the bottleneck is still null.

To summarize, we can say that employing a larger chunk duration is possible with RWTM and even beneficial for HAS user's QoE and access network QoS. In fact, the QoE is improved and the

side effects of long chunk duration such as large queuing delay and high packet drop rate at the bottleneck are resolved.

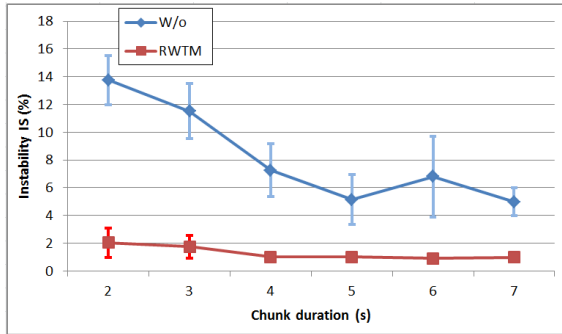

(a) Instability vs. chunk duration

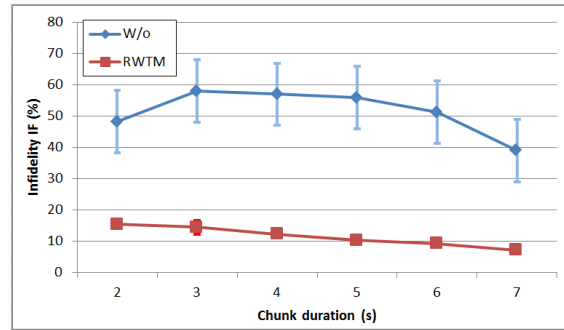

(b) Infidelity vs. chunk duration

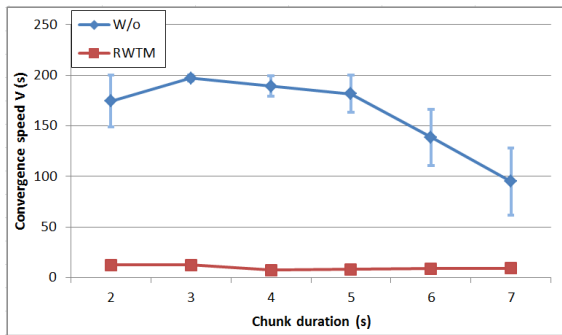

(c) Convergence speed vs. chunk duration

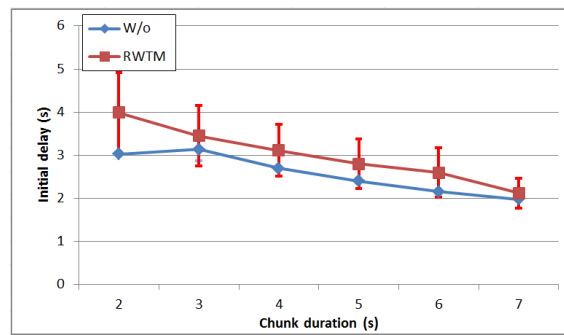

(d) Initial delay vs. chunk duration

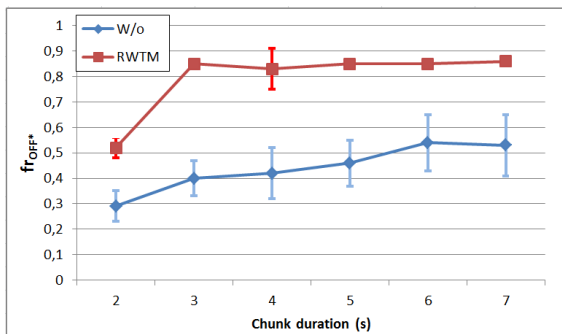

(e)  $f_{OFF}^r$  vs. chunk duration

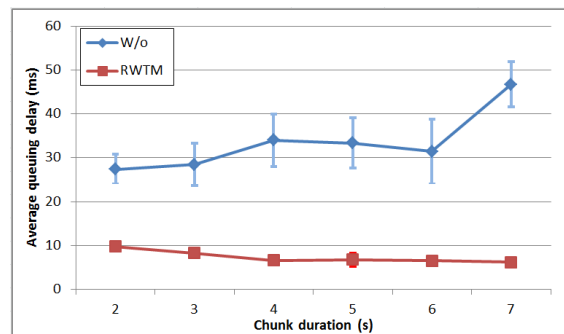

(f) Queuing delay vs. chunk duration

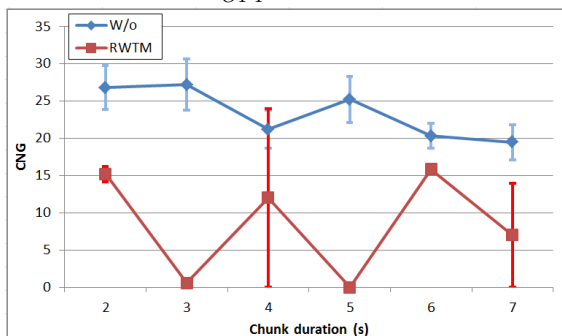

(g) Congestion rate vs. chunk duration

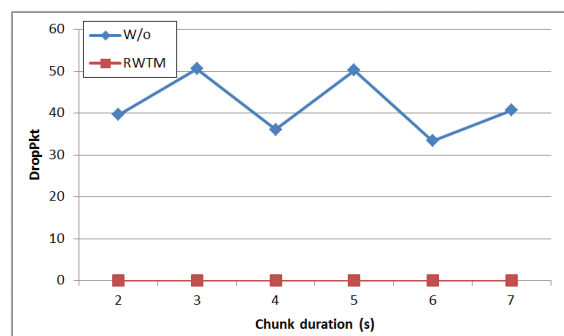

(h) Packet drop rate vs. chunk duration

Figure 4.8 – Performance measurements when increasing the chunk duration



### 4.5.3 Effect of Variation of Network Parameters

Network conditions have a direct implication on the HAS performances because they are responsible on changing the behavior of HAS players as overviewed in Subsection 2.4.2. For that, we study the effect of varying the round-trip propagation delay and the arrival rate of IP traffic on RWTM performances in Subsections 4.5.3.1 and 4.5.3.2, respectively.

#### 4.5.3.1 Initial round-trip propagation delay Effect

In this subsection we study the effect of the initial round-trip propagation delay  $RTT_{C-S}^0$  on HAS performances when using RWTM shaping method. For this purpose, we show two use cases: when two HAS flows have the same  $RTT_{C-S}^0$  and when two HAS flows have different  $RTT_{C-S}^0$ . Here we notice that the queue length of the bottleneck (DSLLine in Figure 3.2) is set to the bandwidth delay product value when changing  $RTT_{C-S}^0$  for each simulation.

##### 1. Same $RTT_{C-S}^0$ for HAS flows

We vary the initial round-trip propagation delay for both HAS clients from 25 ms to 200 ms. The performance measurements are shown in Figure 4.9.

Concerning the QoE measurements, we observe that RWTM presents better QoE than W/o only when  $RTT_{C-S}^0$  is lower than 150 ms; as presented in Figure 4.9a, the instability rate of RWTM is lower than that of W/o but it increases from 1% to 10% when the  $RTT_{C-S}^0$  increases from 25 ms to 125 ms. We also remark that the instability rate of W/o is very important for low  $RTT_{C-S}^0$  values (e.g. IS=16% when  $RTT_{C-S}^0 = 25ms$ ). When exceeding 150 ms, both W/o and RWTM offer similar instability rates. Moreover, as presented in Figure 4.9b, the infidelity rate of RWTM is around 15% when  $RTT_{C-S}^0$  is lower than 100 ms. But this rate increases and becomes close to that of W/o when  $RTT_{C-S}^0$  is higher than 150 ms. Similarly, as presented in Figure 4.9c, RWTM converges rapidly to the optimal quality level within around 5 seconds when  $RTT_{C-S}^0$  is equal to 25 ms and increases slowly to around 12 seconds for an  $RTT_{C-S}^0$  of 100 ms. However, it increases suddenly from  $RTT_{C-S}^0$  of 125 ms and is set practically on the same range of values of that of W/o when exceeding 150 ms. In addition, we observe in Figure 4.9d that the initial delay of RWTM is slightly lower than that of W/o for low  $RTT_{C-S}^0$  values, lower than 100 ms, but becomes higher for high  $RTT_{C-S}^0$  values. We also remark that the initial delay increases when increasing  $RTT_{C-S}^0$ , which is obvious because higher round trip delay slows down the delivery of chunks during the buffering state phase. The explanation of the above results is given when examining the QoS measurements.

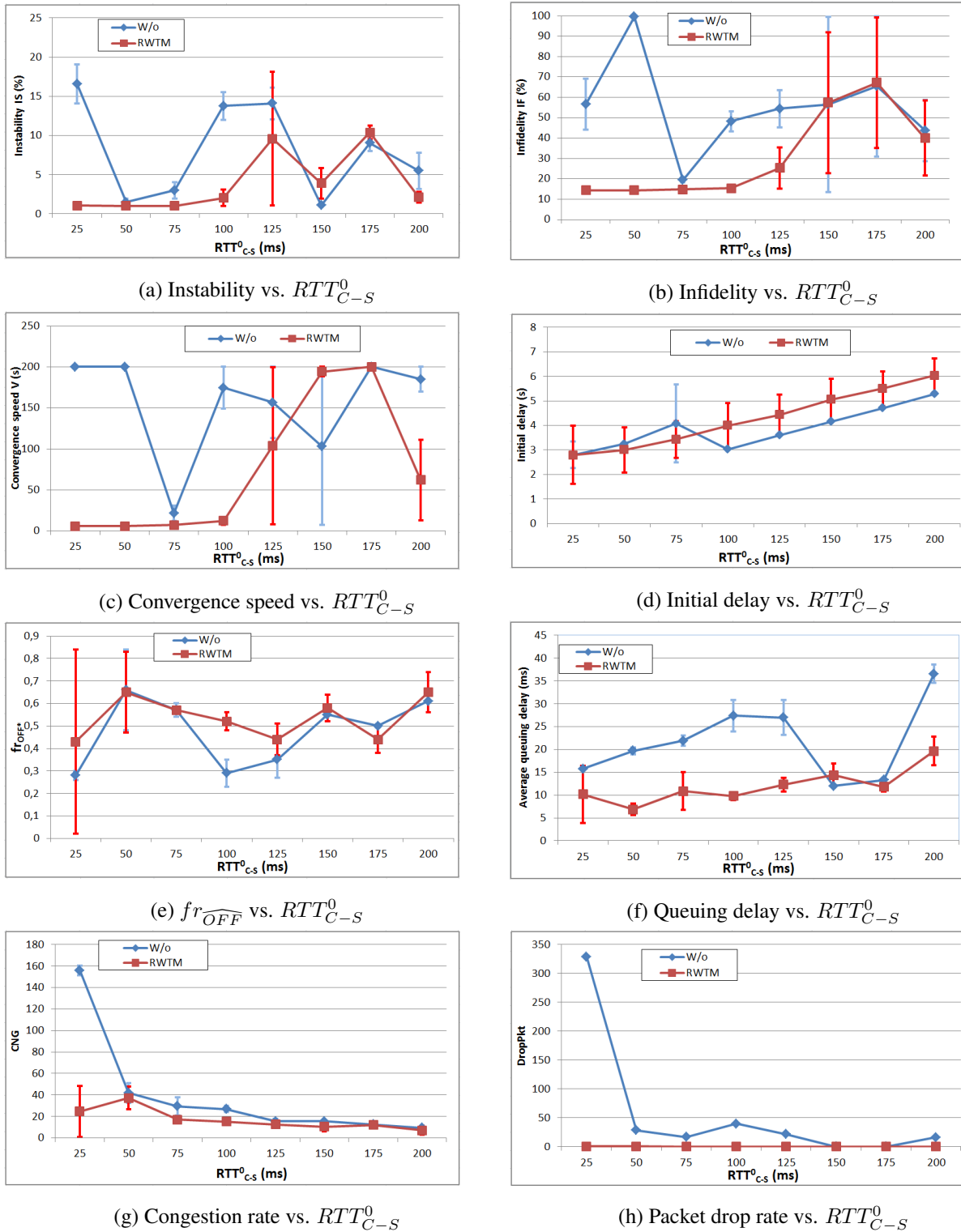

Figure 4.9 – Performance measurements when changing  $RTT_{C-S}^0$  value

Concerning the QoS measurements, on the one hand, we observe in Figure 4.9f that W/o causes high queuing delay when  $RTT_{C-S}^0$  is lower than 150 ms; for example, it generates a queuing delay of 60% of  $RTT_{C-S}^0$  when  $RTT_{C-S}^0$  is equal to 25 ms. In

addition, W/o generates high congestion detection rate and high packet drop rate for low  $RTT_{C-S}^0$  values, as shown in Figures 4.9g and 4.9h, respectively. The main cause is that for low  $RTT_{C-S}^0$  values, the server becomes more aggressive because its TCP congestion window,  $cwnd$ , increases rapidly. Hence, the HAS sending rates offered by HAS servers exceed the capacity of the home network and the length of the bottleneck queue. Hence a high queuing delay, high congestion detection and high packet drop rate are detected. In contrast, when employing RWTM, its traffic shaping that limits the server sending rate by modifying the receive window,  $rwnd$ , prevents the server to be aggressive and helps the HAS clients to stabilize on the optimal quality levels; hence the cause of the improvement recorded for RWTM in terms of QoE. On the other hand, when the  $RTT_{C-S}^0$  exceeds 150 ms, we observe that both W/o and RWTM generates low queuing delay, low congestion detection rate and practically no packet drop rate. The cause of this observation is related to the slow increase of the congestion window,  $cwnd$ , on the HAS server side, which is caused by high  $RTT_{C-S}^0$  value. Consequently, the HAS server becomes conservative and its sending rate is reduced. Even employing RWTM does not changes results because  $cwnd$  is mostly below the modified receive window,  $rwnd$ . Hence, we explain the similarity of QoE measurements between W/o and RWTM for high  $RTT_{C-S}^0$  values.

To summarize, the results indicate that RWTM gives satisfactory performances for low and medium  $RTT_{C-S}^0$  values. However, it generates low QoE measurements, similar to W/o, when  $RTT_{C-S}^0$  is higher than 150 ms. This result is important for RWTM enhancement, because in the bandwidth manager algorithm we can attribute the highest optimal quality to the HAS stream with the lowest RTT value. In fact, the HAS stream with the lowest RTT value has the best potential to select higher quality level among the competing HAS flows. This ascertainment leads us to test the effect of  $RTT_{C-S}^0$  unfairness between competing players on RWTM performance.

## 2. $RTT_{C-S}^0$ unfairness between HAS flows

To study the effect of  $RTT_{C-S}^0$  unfairness between HAS flows, we employ the following scenario: two competing HAS flows where  $RTT_{C-S}^0$  of flow 0 is fixed to 25 ms and that of the second flow 1 is a defined value; it ranges between 25 ms and 200 ms for each simulation. In our configuration, the optimal quality level for flow 0 is higher than that of flow 1.

Concerning the QoE measurements, we observe that RWTM presents better QoE than

W/o in terms of instability, infidelity, convergence speed and initial delay as shown in Figures 4.10a, 4.10b, 4.10c and 4.10d. For W/o, we observe that when increasing the unfairness of  $RTT_{C-S}^0$ , the QoE is improved. This result is predicted because the two optimal quality levels of the competing HAS flows are different. Hence, the HAS flow with lower  $RTT_{C-S}^0$  value is more aggressive and is more likely to achieve a higher optimal quality level than the other HAS flow. For RWTM, the unfairness of  $RTT_{C-S}^0$  does not affect its QoE measurements when the difference of  $RTT_{C-S}^0$  between the two HAS flows is lower than 125 ms: in this case, RWTM preserves an instability rate around 1.3%, an infidelity rate around 15%, convergence speed lower than 25 seconds and an initial delay lower than W/o. However, when this difference exceeds 125 ms, the QoE rate of RWTM degrades a little: an instability rate around 5%, an infidelity rate around 20%, a convergence speed around 100 ms and a higher initial delay than W/o. The cause of this degradation is not due to the unfairness of  $RTT_{C-S}^0$ , but rather from the high  $RTT_{C-S}^0$  of the second HAS flow. In fact, as explained in the previous paragraph related to Figure 4.9, a high  $RTT_{C-S}^0$  makes the HAS server less aggressive and results in a slow increase of *cwnd* which is sometimes lower than the *rwnd* of RWTM. Hence, the HAS player whose HAS flow has a high  $RTT_{C-S}^0$  value encounters difficulties to reach the optimal quality level.

Concerning QoS measurements, we observe that the average queuing delay of RWTM is practically 25% lower than that of W/o as shown in Figure 4.10f. Besides, the unfairness of the queuing delay between the two HAS flows, indicated by vertical error bars, is very important for both RWTM and W/o. This observation means that the unfairness between HAS flows does not affect the queuing delay of each HAS flow. Moreover, we observe in Figure 4.10g that the congestion detection rate decreases, for both RWTM and W/o, when the difference of  $RTT_{C-S}^0$  between HAS flows increases. This result is predictable because the increase of  $RTT_{C-S}^0$  for one HAS flows results in a less aggressive sending rate. The congestion detection rate of RWTM is clearly lower than that of W/o. In addition, the packet drop rate at the bottleneck of RWTM is practically null in contrast with W/o as shown in Figure 4.10h. Accordingly, the additional stability around the optimal quality level offered by RWTM has a positive impact on the QoS even in the case of unfair  $RTT_{C-S}^0$  between HAS flows.

To summarize, we can say that, in the case of  $RTT_{C-S}^0$  unfairness among HAS flows, the bandwidth manager should attribute the highest optimal quality level to the HAS flow that has the lowest  $RTT_{C-S}^0$  value. In this case, RWTM outperforms W/o in terms of QoE and QoS when  $RTT_{C-S}^0$ .

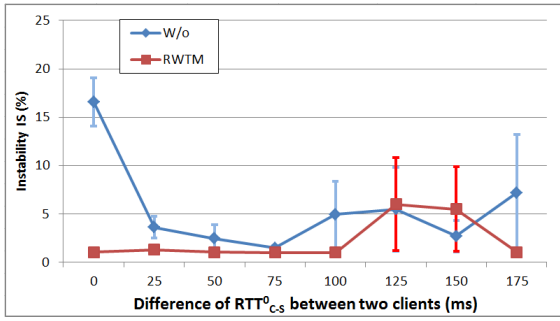

(a) Instability vs.  $RTT_{C-S}^0$  unfairness

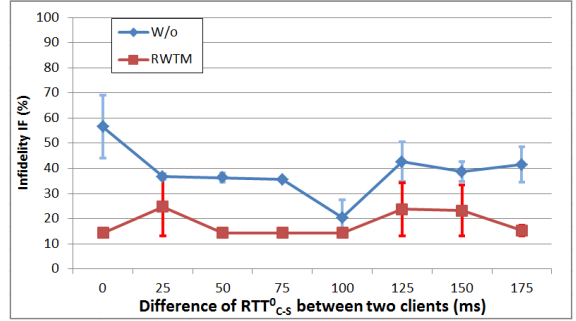

(b) Infidelity vs.  $RTT_{C-S}^0$  unfairness

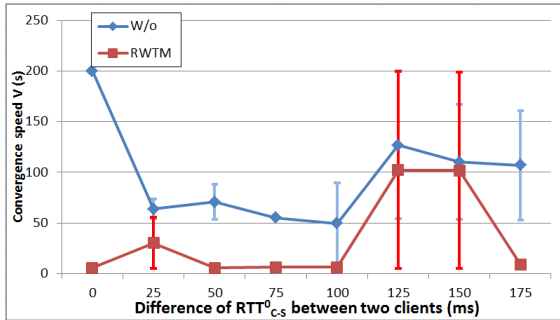

(c) Convergence speed vs.  $RTT_{C-S}^0$  unfairness

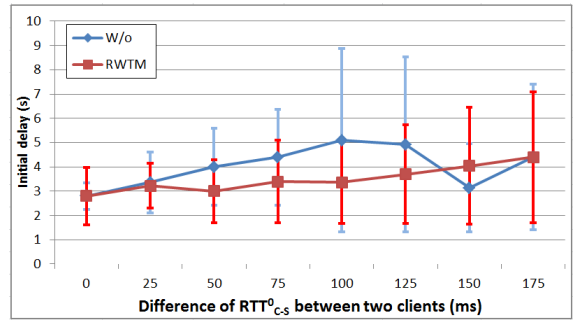

(d) Initial delay vs.  $RTT_{C-S}^0$  unfairness

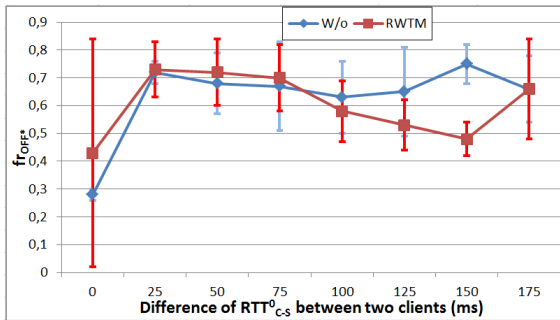

(e)  $f_{r_{OEF}}$  vs.  $RTT_{C-S}^0$  unfairness

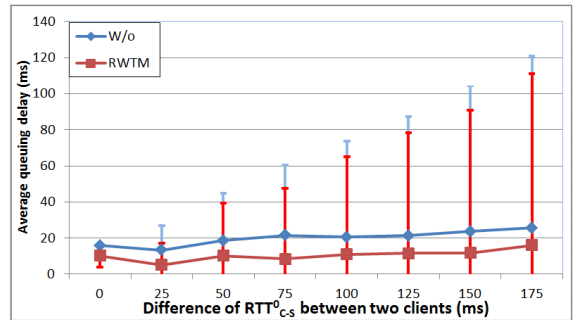

(f) Queuing delay vs.  $RTT_{C-S}^0$  unfairness

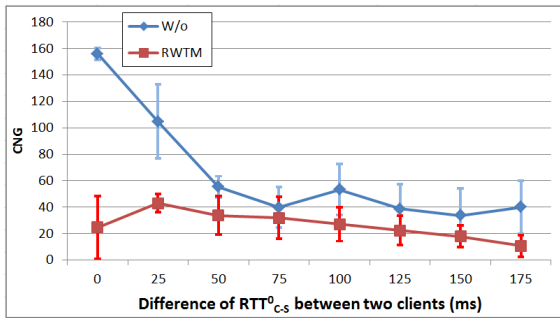

(g) Congestion rate vs.  $RTT_{C-S}^0$  unfairness

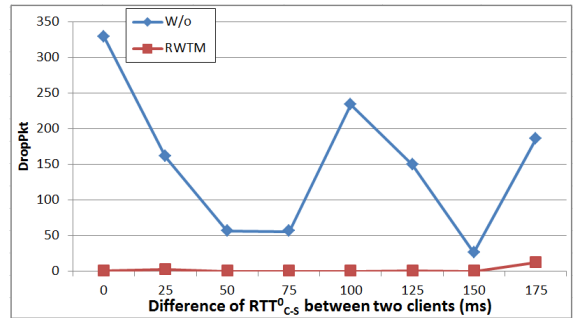

(h) Packet drop rate vs.  $RTT_{C-S}^0$  unfairness

Figure 4.10 – Performance measurements when increasing  $RTT_{C-S}^0$  unfairness

### 4.5.3.2 IP Traffic Effect

In order to study the effect of IP traffic on the performance of RWTM, we vary the burst arrival rate  $\lambda_p$  of the PPBP traffic that crosses Internet Router (IR) and the DSLAM (see Subsection 3.4.2). Knowing that in our configuration the ISP network (ISPLink in our ns-3 implementation) capacity is *100 Mbps*, we give in Table 4.5 the percentage of ISP network occupancy for each selected  $\lambda_p$  value (without counting HAS traffic).

Table 4.5 – ISP network occupancy when varying  $\lambda_p$

$\lambda_p$	10	15	20	25	30	35	40	45	50
<b>ISP network occupancy (%)</b>	20	30	40	50	60	70	80	90	100

Concerning the QoE measurements, we observe that the QoE of both W/o and RWTM degrade when increasing the ISP network occupancy. For instability, infidelity and convergence speed, RWTM outperforms W/o as presented in Figures 4.11a, 4.11b and 4.11c. Besides, the three figures indicate that the degradation of the measurements of three QoE criteria follows exponential curves when using RWTM. In fact, for low IP traffic, with  $\lambda_p \leq 25$ , RWTM preserves a high QoE rate (low instability rate around 2%, low infidelity rate around 17% and a rapid convergence within less than 20 seconds), but it loses rapidly this rate for higher  $\lambda_p$  until reaching the rate of W/o when the ISP network occupancy is near to 100%. This observation is positive because RWTM is able to improve the three QoE criteria even in bad network conditions where the ISP network is highly loaded. Besides, we observe in Figure 4.11d that the initial delay for both W/o and RWTM is practically maintained constant with a slight higher delay for RWTM. This result is not disturbing for the user's experience because the maximum initial delay that is recorded is around 6 ms which is tolerated for user's QoE because it is lower than the threshold of 16 seconds defined in [65] (see Subsection 2.4.1.2). Moreover, we remark that stalling events are recorded for both W/o and RWTM with close rates when  $\lambda_p$  exceeds 40, as presented in Figure 4.11i. This result is expected because, when increasing  $\lambda_p$ , the ISP network becomes instable. Consequently, the delivery of the requested chunk could be done in a longer duration as expected, hence a possible famine of playback buffer.

Concerning the QoS measurements, we observe in Figure 4.11e that increasing the occupancy of ISP network causes a reduction of the frequency of  $\widehat{OFF}$  period for both W/o and RWTM. Their frequency converges to the same low value around 0.05. This decrease is beneficial to RWTM because one of the objectives of shaping is to reduce the duration of OFF periods, and it resulted in saving good QoE measurements for high ISP network occupancy. Moreover, we

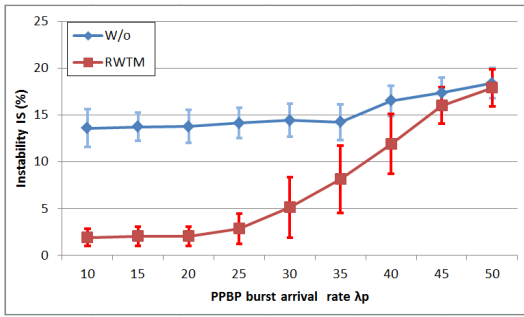

(a) Instability vs.  $\lambda_p$

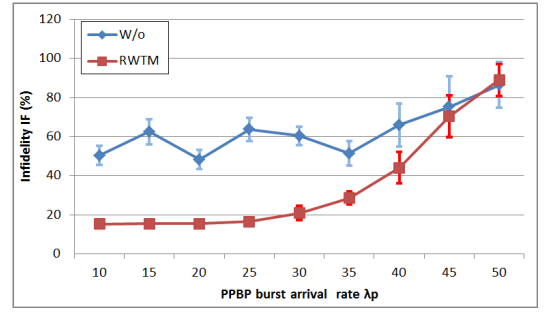

(b) Infidelity vs.  $\lambda_p$

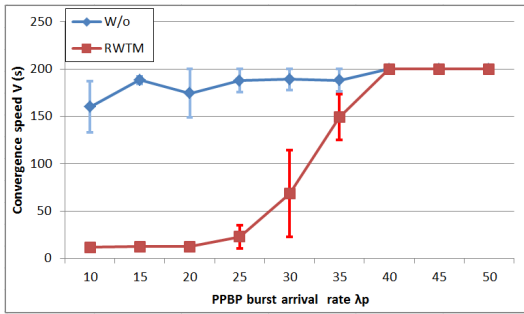

(c) Convergence speed vs.  $\lambda_p$

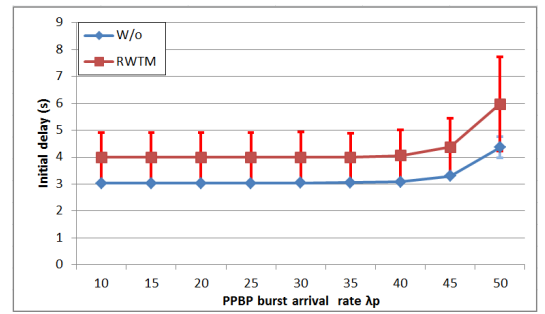

(d) Initial delay vs.  $\lambda_p$

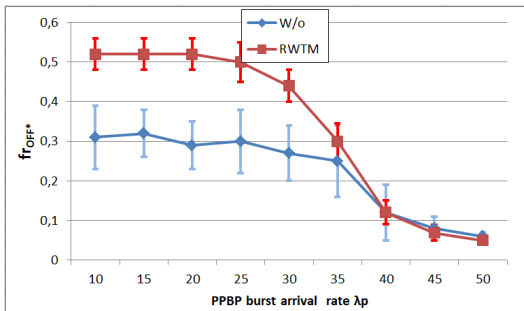

(e)  $fr_{OFF}$  vs.  $\lambda_p$

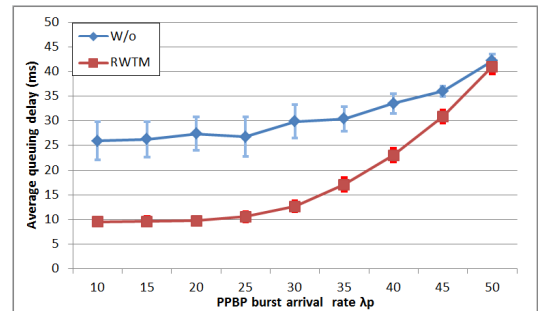

(f) Queuing delay vs.  $\lambda_p$

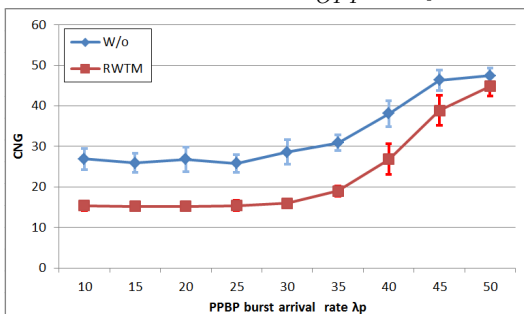

(g) Congestion rate vs.  $\lambda_p$

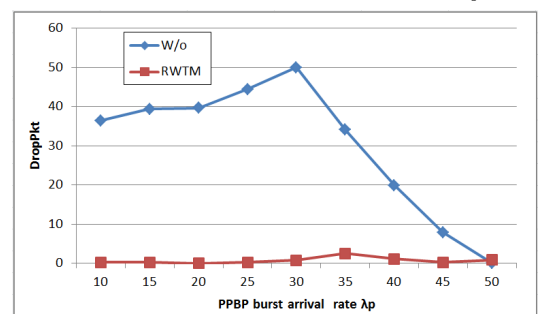

(h) Packet drop rate vs.  $\lambda_p$

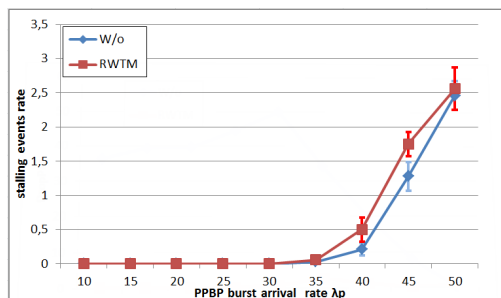

(i) Stalling event rate vs.  $\lambda_p$

Figure 4.11 – Performance measurements when increasing PPBP burst arrival rate  $\lambda_p$

observe that the queuing delay is affected by the increase of ISP network occupancy. In fact, as shown in Figure 4.11f the average queuing delay is increased for both W/o and RWTM and reaches the same value around 40 ms when the ISP network is overloaded ( $\lambda_p = 50$ ). However, RWTM preserves lower queuing delay values due to its traffic shaping method that reduces the bottleneck queue occupancy. In addition, we remark that, for W/o, the congestion detection rate is increased while the packet drop rate at the bottleneck is reduced from  $\lambda_p = 35$  and reaches 0 when the ISP network is overloaded, as indicated in Figures 4.11g and 4.11h, respectively. Hence, when  $\lambda_p$  is higher than 35, the real bottleneck link is being moved from the link between DSLAM and HG to the ISP network. Given that the congestion detection rate of RWTM is maintained lower than that of W/o and the packet drop rate is practically kept null for different  $\lambda_p$  values, RWTM maintains better QoS than W/o.

To summarize, we can say that RWTM is sensitive to the increase of occupancy of ISP networks, through which the HAS flows are transmitted. However, RWTM is able to improve the QoE for HAS users and to offer better QoS for access network even if the ISP networks is highly loaded by IP traffic.

#### 4.5.3.3 Bottleneck Queue Effect

As we indicated in Subsection 2.4.2.1, the length of a router queue and the type of its queuing discipline, such as Drop Tail and RED, have an effect on HAS performances because they have a direct impact on packet drop rate and end-to-end delay.

In this subsection, we employ in the bottleneck link one of two types of queuing disciplines, Drop Tail or RED, with one of three lengths of queue: half, twice or equal to the bandwidth delay product. RED is configured by setting the minimum threshold (*minTh*) to one third the queue length and the maximum threshold (*maxTh*) to the queue length. Here we notice that *minTh* is the number of buffered packets where RED begins to drop incoming packets with a low probability. This probability increases to reach 1 when the buffered packets attains *maxTh* threshold. The results of simulations are presented in Figure 4.12.

In the case without shaping, W/o, the size of the bottleneck queue has a great effect on QoE of HAS and QoS. On the one hand, when employing small queue, we observe low instability, high infidelity and difficulties to converge to optimal quality level, as shown in Figures 4.12a, 4.12b and 4.12c, respectively. We also remark a low queuing delay and low dropped packets, as presented in Figures 4.12f and 4.12h, respectively. This observation means that there is a stability around a lower quality level below optimal quality level and an underutilization of bottleneck bandwidth. In fact, due to the small queue size, the competing HAS players become unable to select the optimal



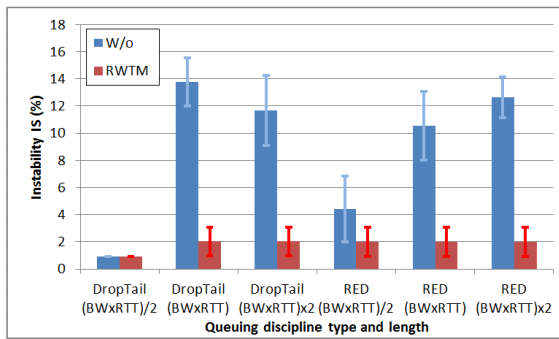

(a) Instability vs. queuing discipline

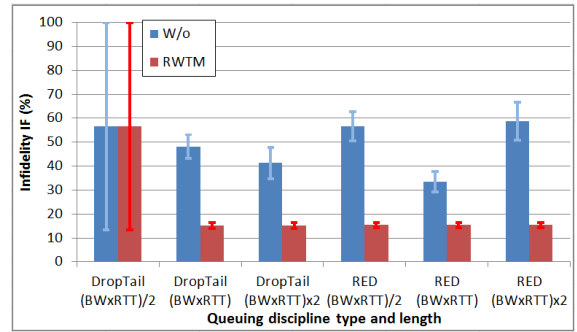

(b) Infidelity vs. queuing discipline

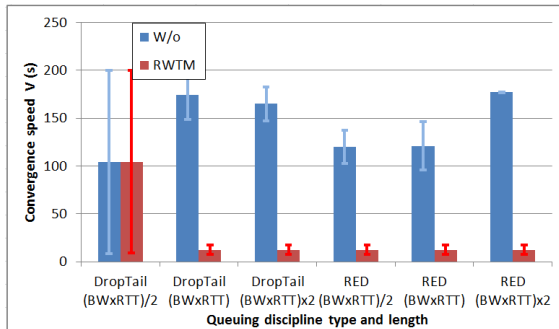

(c) Convergence speed vs. queuing discipline

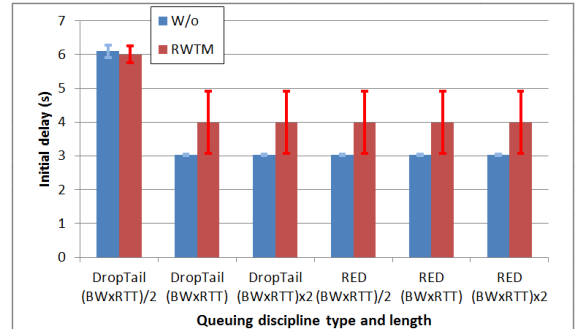

(d) Initial delay vs. queuing discipline

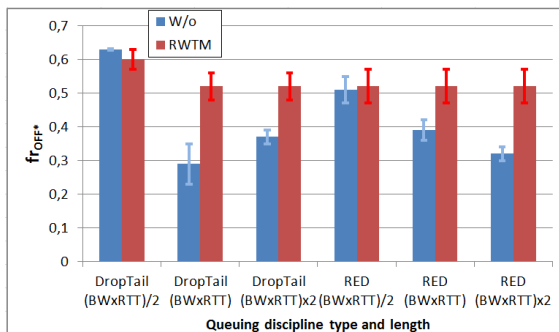

(e)  $fr_{OFF}$  vs. queuing discipline

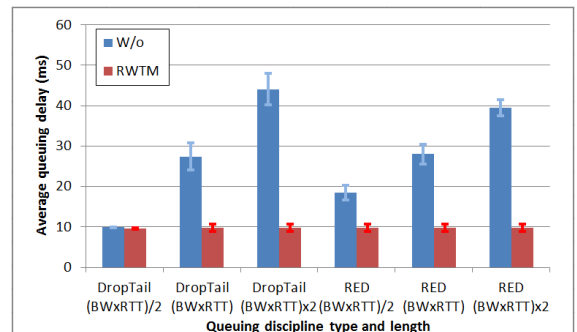

(f) Queuing delay vs. queuing discipline

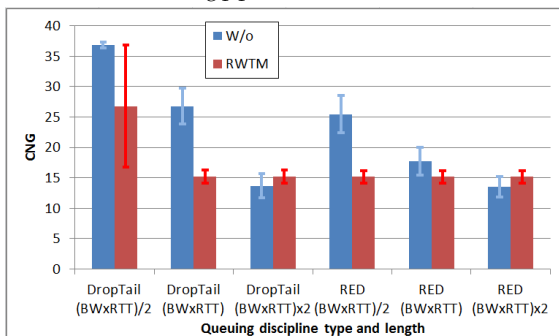

(g) Congestion rate vs. queuing discipline

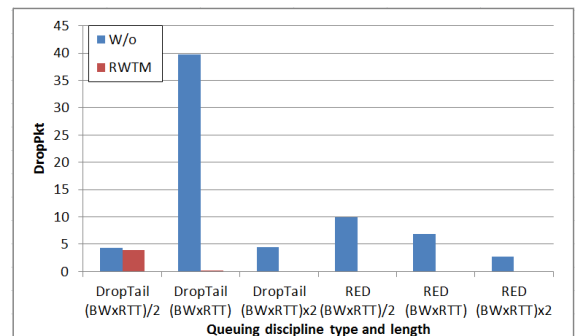

(h) Packet drop rate vs. queuing discipline

Figure 4.12 – RWTM performance under different queuing disciplines and queue lengths

quality level. In fact, when they do, the queuing discipline drops packets and provokes a congestion detection in the servers. On the other hand, when employing a large queue corresponding to twice the bandwidth delay product, we observe a negligible packet drop rate and a clear reduction of congestion detection rate on the server side. However, this result, beneficial to QoS, have no impact on QoE: we still observe a high instability rate (higher than 10%), a high infidelity rate of 60% and inability to converge. The main cause is the very large queuing delay that exceeds *40 ms* as shown in Figure 4.12f. In this case, the RTT of each HAS streams is increased to around *140 ms* which impacts negatively the QoE as observed in Subsection 4.5.3.1.

When focusing on RWTM results, we observe that it preserves practically the same performances (instability around 2% infidelity around 15%, convergence speed around 12 seconds, initial delay around 4 seconds, average queuing delay less than *10 ms* and a null packet drop rate) for Drop Tail and RED queuing disciplines with different queue lengths, excepting Drop Tail with a queue length equals to the half of bandwidth delay product. In the latter case, RWTM performs like W/o.

Accordingly, we can say that RWTM is not affected, in terms of QoE and QoS, by the queuing discipline of the bottleneck when the queue length is equal or higher than the bandwidth delay product. Besides, when the queue length is equal to the half of the bandwidth delay product, RWTM preserves its performances when employing RED queuing discipline.

## 4.6 Conclusion

In this chapter we have described our proposed gateway-based shaping method RWTM that it is based on TCP flow control and employs RTT passive estimation. We have compared the performances of RWTM with another recent gateway-based shaping method HTBM. Results indicated that RWTM outperforms HTBM not only in QoE of HAS, but also in the QoS of the access network by reducing the queuing delay at the bottleneck. However, the non-exhaustive estimation of RTT employed by RWTM is the cause of longer OFF periods than HTBM. Moreover, we have extensively evaluate RWTM performances in extended evaluation. RWTM preserves its high QoE rate, its low queuing delay and its near null packet drop rate at the bottleneck link even when the number of competing HAS clients is increased. Moreover, RWTM is able to improve the QoE of Live HAS streaming where player is configured with a small playback buffer size. Besides, it presents better performances when the chunk duration is increased to 7 seconds. In addition, RWTM performs well when competing HAS flows have high initial round-trip delay below *150 ms* without causing bandwidth underutilization. Unfair initial round-trip delay between compet-

---

ing HAS players lower than *125 ms* does not disturb HAS performances. Nevertheless, RWTM is sensitive to the increase of IP traffic in best effort network but it improves the QoE of HAS unless the ISP network is overloaded. Furthermore, RWTM is not affected by the type of queuing discipline employed in the bottleneck unless the queue length is small compared to the bandwidth delay product. In the latter case, RED discipline is advisable to get improvement in QoE.



---

# TCP Congestion Control

## Variant Effect

### 5.1 Introduction

Typically, the TCP congestion control algorithm on the sender side updates the congestion window value,  $cwnd$ , at each reception of acknowledgment (ACK) from the receiver. Consequently, the sender's sending rate depends on TCP congestion control algorithm. Given that many TCP congestion control variants were proposed and have been employed, the performance of HAS may be affected from one variant to another.

Moreover, traffic shaping methods have a beneficial effect on the QoE of HAS and on the QoS of the access network. As presented in Chapter 4, we have compared two gateway-based shaping methods, RWTM and HTBM, when the server is employing Cubic variant. Results indicated that RWTM outperforms HTBM in terms of QoE and largely reduces the queuing delay. However, HTBM reduces the frequency of  $\widehat{OFF}$  period more than RWTM. Nevertheless, given that this result is valid for Cubic variant, we aim to study the effect of other well-known TCP congestion control variants (NewReno, Vegas and Illinois) on the two shaping methods; in other words, whether RWTM or HTBM are affected by the TCP variants or not.

Accordingly, in this chapter our objective is to study the effect of TCP congestion control variants on HTTP adaptive streaming performance when employing a gateway-based shaping method. Therefore, we classify and study theoretically each variant of TCP congestion control in Section 5.2. Then, we evaluate the combination between the two gateway-based shaping methods, RWTM and HTBM, and four well-known TCP congestion control variants in Section 5.3. Finally, we summarize results and give a detailed discussion in Section 5.4.

## 5.2 State of the Art

All TCP congestion control variants have two common phases: a slow start phase and a congestion avoidance phase. The slow start phase consists of increasing *cwnd* rapidly by one maximum segment size (*MSS*) for each received acknowledgment (*ACK*), i.e. the *cwnd* value is doubled for each round trip time (*RTT*). This rapid increase of *cwnd* has an objective of reaching a high bitrate within a short duration. When the *cwnd* size exceeds a threshold, called *Slow Start Threshold* (*ssthresh*), the TCP congestion control algorithm switches to the second phase: the congestion avoidance phase. During this phase, *cwnd* is generally increased slowly. The justification of this slow increase is to push carefully TCP to fill the maximum end-to-end available bandwidth with lower risk of producing congestion.

TCP congestion control variants are classified according to two main criteria [59]:

1. The first criterion is the way *cwnd* is increasing during the congestion avoidance phase and the way *cwnd* is decreased immediately following congestion detection. Generally, the increase is additive, and the *cwnd* size increases by one *MSS* for each *RTT*. For decreasing *cwnd*, the standard variants employ multiplicative decreasing, i.e. the *cwnd* size is weighted by a multiplicative decrease factor  $(1 - \beta)$ , where  $0 < \beta < 1$ . This is the Additive Increase Multiplicative Decrease (AIMD) approach. Other variants using different techniques are classified as non-AIMD approaches.
2. The second criterion is the method by which the algorithm detects congestion. We distinguish three modes: loss-based, delay-based, and loss-delay-based modes. The loss-based mode considers any detection of packet loss as a congestion event. A majority of TCP congestion control variants that use the loss-based mode consider receiving three duplicated *ACKs* from the receiver as an indication of a packet loss and, as a consequence, as an indication of a congestion event. However, the delay-based mode considers a significant increase in the *RTT* value as the only indication of a congestion event. The third mode, the hybrid mode, combines the delay-based and loss-based modes to improve congestion detection.

In order to facilitate our study, we chose four well-known congestion control variants and we classify them according to the two criteria cited above:

— **NewReno** [44]:

This variant is designed as the standard TCP congestion control approach. It uses the AIMD approach with the loss-based mode. Two mechanisms are employed immediately following congestion detection: fast retransmit and fast recovery [62]. Fast retransmit consist of performing a retransmission of what appears to be the missing packet (i.e. when

receiving 3 duplicate ACKs), without waiting for the retransmission timer to expire. After the fast retransmit algorithm sends this packet, the fast recovery algorithm governs the transmission of new data until a non-duplicate ACK arrives. The reason for using fast recovery is to allow the continual sending of packets when the receiver is still receiving packets, even if some packets are lost.

— **Vegas** [21]:

This non-AIMD variant is an Additive Increase Additive Decrease (AIAD) variant. It is a delay-based variant that accurately estimates  $RTT$  for every sent packet and adjusts  $cwnd$  size based on actual throughput and expected throughput. If  $RTT$  increases,  $cwnd$  decreases by one  $MSS$ , and vice versa. Vegas is the smoothest TCP congestion control variant [71]; it is able to allocate a fair share of bandwidth with minimal packet loss events.

— **Illinois** [89]:

This is a TCP loss-delay-based congestion variant that employs a particular classification of the AIMD approach, C-AIMD, which involves a concave window size curve. Packet loss is used for primary congestion inference to determine the direction (increase or decrease) of  $cwnd$ , with a delay for secondary congestion inference to adjust the value of the window size change. More precisely, when the average queuing delay is small (small increase of  $RTT$ ), the sender supposes that the congestion is not imminent and sets a large additive increase  $\alpha$  and small multiplicative decrease  $\beta$ . In the opposite case, when the average queuing delay is large (large increase of  $RTT$ ), the sender supposes that the congestion is imminent and sets a small  $\alpha$  and large  $\beta$ . Illinois measures  $RTT$  for each received ACK to update  $\alpha$  and  $\beta$ . Moreover, it retains the same fast recovery and fast retransmit phases as NewReno. Illinois was designed for high-speed and high-latency networks, where the bandwidth-delay product is relatively high. Consequently, it enables higher throughput than NewReno for high-speed and high-latency networks.

— **Cubic** [57]: This variant is loss-based, but it uses a non-AIMD approach. A cubic function is used to increase the  $cwnd$  in the congestion avoidance phase immediately after the fast recovery phase, and a multiplicative decrease approach is used to update the  $cwnd$  after congestion event detection. The cubic function has a concave region followed by a convex region. The plateau between the two regions, or the inflexion point (denoted by  $W_{max}$ ), corresponds to the window size just before the last congestion event. The cubic function enables a slow growth around  $W_{max}$  to enhance the stability of the bandwidth, and enables a fast growth away from  $W_{max}$  to improve scalability of the protocol. Upon receiving an ACK during the congestion avoidance phase at time  $t$ , Cubic computes the new value of  $cwnd$  corresponding to the cubic function at time  $t$ . As a consequence, Cubic uses the time

instead of the  $RTT$  to increase the  $cwnd$ . Cubic employs a new slow-start algorithm, called HyStart [56] (hybrid slow start). It finds a safe exit point to the slow start, the  $ssthresh$  value, at which the slow start can finish and safely move to congestion avoidance before  $cwnd$  overshoot occurs. HyStart uses the  $RTT$  delay increase and the inter-arrival time between consecutive ACKs to identify the safe exit point, and to modify the  $ssthresh$  value [56]. This variant does not make any change to the Fast Retransmit and the Fast Recovery of standard NewReno. Cubic is the smoothest loss-based congestion control variant [71]: it is characterized by a congestion window that falls less abruptly and that remains constant over a wide range of elapsed time. It is also designed for high-speed and high-latency networks.

For precise analysis, based on the descriptions of congestion control algorithm variants and their source code, we describe below the update of the congestion window size,  $cwnd$ , and the slow start threshold value,  $ssthresh$ , for different events:

— **Congestion events:** there are two cases

- When a congestion event is detected, the Fast Retransmit / Fast Recovery (FR/FR) phase reduces the  $ssthresh$  value and sets the  $cwnd$  value to  $ssthresh + 3$ , for the purpose of remaining in the congestion avoidance phase. The  $ssthresh$  value after a congestion event is updated as follows in Algorithm 2:

---

**Algorithm 2**  $ssthresh$  update after a congestion event

---

- 1: **NewReno:**  $ssthresh = \max(\frac{cwnd}{2}, 2 \times MSS)$
- 2: **Vegas:**  $ssthresh = \min(ssthresh, cwnd - 1)$
- 3: **Illinois:**  $ssthresh = \max(cwnd \times (1 - \beta), 2 \times MSS)$
- 4: **Cubic:**  $ssthresh = \max(cwnd \times (1 - \beta), 2 \times MSS)$

▷ Where  $MSS$  is the maximum segment size, and  $\beta$  is the multiplicative decrease factor.

---

- When the retransmission timeout expires before receiving any ACK of the retransmitted packet,  $ssthresh$  is reduced as indicated in Algorithm 2, but  $cwnd$  is set to a the initial value (generally  $2 \times MSS$ ), and restarts from the slow start phase.

— **Idle period:**

When the server sends a packet after an idle period that exceeds the retransmission timeout (RTO),  $cwnd$  and  $ssthresh$  are computed for the four congestion control variants as in Algorithm 3: In the HAS context, an idle period coincides with an OFF period between two consecutive chunks. An OFF period whose duration exceeds RTO is denoted by  $\widehat{OFF}$ .



---

**Algorithm 3**  $cwnd$  and  $ssthresh$  update after an idle period

---

```

1:  $ssthresh = \max(ssthresh, \frac{3}{4} \times cwnd)$ 
2: for  $i = 1$  to  $\text{int}(\frac{\text{idle}}{RTO})$  do
3:    $cwnd = \max(\frac{\min(cwnd, rwnd)}{2}, 1 \text{ MSS})$ 
end for

```

---

### 5.3 Evaluation of the Combinations Between TCP Variants and Gateway-based Shaping Methods

The objective of our study is to combine two solution categories: TCP congestion control variants to reduce the negative effects of congestion events, and traffic shaping methods to restrict the drawbacks of the concurrence between HAS streams in the home gateway. The optimal combination will have the highest grade of QoE, i.e. the best possible video quality level stability, best fidelity to optimal quality level selection, and best convergence speed.

In this section, we compare the different combinations of TCP congestion control variants in the server and shaping methods in the gateway. Altogether, we evaluate eight combinations: four TCP congestion control variants combined with two shaping methods. We evaluate these combinations under five different scenarios. We give a the designation and the description of these scenarios in Subsection 5.3.1. For result evaluation, we employ three QoE metrics (insatibility  $IS$ , infidelity  $IF$ , and convergence speed  $V$ ) as described in Subsection 3.5.1, and two QoS metrics (frequency of  $\widehat{OFF}$  periods,  $fr_{\widehat{OFF}}$ , and congestion detection rate  $CNG$ ) as defined in Subsection 3.5.2. Concerning the two gateway-based shaping methods, RWTM and HTBM, their bandwidth manager is configured in conformity with Subsection 4.4.1 of Chapter 4. We notice that we use the developed testbed in conformity with its description in Section 3.3 and we employ the emulated HAS player as described in Section 3.2. For each scenario, we repeated each test 60 times and we computed an average value of each metric. The number of 60 runs is justified by the fact that the difference of the average results obtained after 40 runs and 60 runs are lower than 6%. This observation is verified for all scenarios. Accordingly, 60 runs are sufficient to achieve statistically significant results.

This section is organized as follows. First, we describe the five proposed scenarios in Subsection 5.3.1. Second, we evaluate the performance of scenario 1 in Subsection 5.3.2 and we analyze the variation of  $cwnd$  for each combination. Third, we evaluate the performance of scenarios 2 and 3 in Subsection 5.3.3 to study the effect of transition from one to two clients (and vice versa) on performances of each studied combination. Fourth, we present the performance of scenario 4

in Subsection 5.3.4 to measure the robustness of the combinations against induced congestions. Fifth, we study scenario 5 in Subsection 5.3.5 to measure the robustness against the instability of  $RTT_{C-S}$  for each combination. Finally, we discuss all results by presenting a summary of observations and defining the combination that is suitable for each particular case.

### 5.3.1 Scenarios

We define five scenarios that are typical to concurrence between HAS clients in a same home network (scenario 1, 2 and 3), and how the HAS client reacts when some changes occur (scenario 4 and 5):

1. Both clients start to play simultaneously and continue for 3 minutes. This scenario illustrates how clients compete.
2. Client 1 starts to play, the second client starts after 30 seconds, and both continue together for 150 seconds. This scenario shows how transition from one client to two clients occurs.
3. Both clients start to play simultaneously, client 2 stops after 30 seconds, and client 1 continues alone for 150 seconds. This scenario shows how a transition from two clients to one takes place.
4. Only one client starts to play and continues for 3 minutes. At 30 seconds, we simulate a heavy congestion event with a provoked packet loss of 50% of the received packets at the server over a 1-second period. This scenario shows the robustness of each combination against the congestions that are induced by external factors, such as by other concurrent flows in the home network.
5. Only one client is playing alone for 3 minutes. We vary the standard deviation value of  $RTT_{C-S}$  (round trip time between the client and the server) for each set of tests. This scenario investigates the robustness against  $RTT_{C-S}$  instability.

The test duration was selected to be 3 minutes to offer sufficient delay for players to stabilize.

### 5.3.2 Scenario 1

In this scenario, two clients are competing for bottleneck bandwidth and are playing simultaneously. Let us recall that in our configuration the home bandwidth permits only one client has the highest quality level,  $n^\circ 4$ . We make the assumption that the client who gets the highest quality level  $n^\circ 4$  is identified as client 1. Optimally, the first player in our use case should obtain quality level  $n^\circ 4$  with an encoding rate of 4,256 kbps, and the second player should have quality level  $n^\circ 3$  with an encoding rate of 1,632 kbps. In this section, we will present our results and discuss

them. Then, we analyze the *cwnd* variation for each combination to understand the reason for the observed results.

### 5.3.2.1 Measurements of Performance Metrics

The average values of QoE metrics for client 1 and client 2 are listed in Table 5.1 and 5.2, respectively. The large difference between QoE metric measurements from the different combinations confirms the importance of our work.

Table 5.1 – QoE measurements for client 1 in scenario 1

Performance metric	Shaping method	TCP congestion control variant			
		NewReno	Vegas	Illinois	Cubic
Instability (%) $IS_1$	W/o	4.95	2.15	8.35	7.47
	HTBM	1.89	1.08	1.56	1.86
	RWTM	1.69	4.10	1.88	1.63
Infidelity (%) $IF_1$	W/o	41.33	52.31	74.14	50.46
	HTBM	49.57	47.81	7.75	20.45
	RWTM	45.87	32.24	6.17	5.02
Convergence speed (s) $V_1$	W/o	100.93	102.11	174.13	145.03
	HTBM	101.83	87.11	21.10	52.06
	RWTM	94.51	104.00	24.22	19.55

Table 5.2 – QoE measurements for client 2 in scenario 1

Performance metric	Shaping method	TCP congestion control variant			
		NewReno	Vegas	Illinois	Cubic
Instability (%) $IS_2$	W/o	5.82	3.06	7.82	5.82
	HTBM	1.17	0.95	1.05	1.115
	RWTM	1.09	0.95	1.03	1.13
Infidelity (%) $IF_2$	W/o	26.64	70.77	39.27	36.33
	HTBM	4.72	3.62	4.21	4.47
	RWTM	2.49	2.30	2.47	2.61
Convergence speed (s) $V_2$	W/o	96.25	137.01	126.33	92.81
	HTBM	12.41	6.95	9.73	13.26
	RWTM	6.73	5.03	6.54	8.95

The results show that traffic shaping considerably improves the QoE metric measurements for a majority of cases, especially for instability, which is largely reduced (e.g. a reduction of instability rate by a factor of 2.6 from 4.95% to 1.89% when employing HTBM with NewReno, and a reduction by a factor of 4.5 from 7.47% to 1.63% when employing RWTM with Cubic, as shown in Table 5.1). Furthermore, RWTM shows better performance than HTBM in the majority of cases. Moreover, client 2 has always better performances than client 1 with both shaping methods: the reason is that the optimal quality level of client 2 (i.e. quality level  $n^{\circ} 3$ ) is lower than that of client 1 (i.e. quality level  $n^{\circ} 4$ ): obviously the quality level  $n^{\circ} 3$  is easier to achieve. In addition, the gap between the QoE metric measurements of the two shaping methods is higher for client 1 than client 2: For example, when considering the Cubic variant, the gap of infidelity rate between RWTM and HTBM of client 1 is 15.43% (5.02% vs. 20.45%) is higher than that of client 2 which is equal to 1.86% (2.61% vs. 4.47%). Consequently, the dissimilarity of performances between different combinations is more visible for client 1. For this reason, we limit our observation to the client 1 in the remaining of this subsection.

Concerning the QoE measurements, we present the most important observations, based on Table 5.1, related to client 1:

- Combining NewReno or Vegas variants with HTBM or RWTM does not improve the QoE. Additionally, these four combinations have high infidelity value (near 50%) and very high convergence speed value (around 90~100 ms), but a low value of instability. These values indicate that the player was stable at a low quality level during the first half of the test duration and has difficulties converging to its optimal quality level.
- HTBM has better QoE with Illinois than with Cubic: it is slightly more stable, 16% more faithful to optimal quality, and converges 2.4 times faster.
- RWTM has better QoE with Cubic than with Illinois: it is slightly more stable, slightly more faithful to optimal quality level, and converges 1.24 times faster.

In order to be more accurate in our analysis, we use the two additional metrics, as defined in Subsection 3.5.2: the frequency of  $\widehat{OFF}$  periods per chunk,  $fr_{\widehat{OFF}}$  (see Subsection 3.5.2.1), and the congestion rate,  $CNG$  (see Subsection 3.5.2.3). In Table 5.3, we present the average value over 60 runs for each metric and for each combination, related to client 1 and scenario 1.

RWTM presents a negligible congestion rate, while HTBM has a very high rate of congestion, especially when the Cubic variant is used. Moreover, HTBM reduces the frequency of  $\widehat{OFF}$

Table 5.3 – Congestion detection rate and frequency of  $\widehat{OFF}$  period for client 1 in scenario 1

Metric	Shaping method	TCP congestion control variant			
		NewReno	Vegas	Illinois	Cubic
CNG	W/o	46.13	43.00	66.11	85.65
	HTBM	44.06	40.50	58.68	191.72
	RWTM	0.10	8.26	0.76	1.11
$fr_{\widehat{OFF}}$	W/o	0.42	0.35	0.27	0.40
	HTBM	0.31	0.32	0.06	0.16
	RWTM	0.32	0.41	0.24	0.24

period better than RWTM, mainly with Illinois and Cubic. These results have a direct relationship to the shaping methods described in Chapter 4 (Subsection 4.4.3):

- HTBM was designed to delay incoming packets, which causes an additional queuing delay. In all of the tests, we verified that HTBM induces a queuing delay of around 100 ms in scenario 1 for client 1. On one hand, this delay causes an increase of congestion rate because it increases the risks of queue overflow in the gateway, even when the QoE is good, such as with Cubic or Illinois variants. The dissimilarity of congestion rate between congestion control variants are investigated in the next Subsection 5.3.2.2. On the other hand, the  $RTT_{C-S}$  value also jumps from 100 ms to 200 ms, which increases the retransmission timeout value, RTO, to about 400 ms, hence reducing  $\widehat{OFF}$  periods. The  $fr_{\widehat{OFF}}$  of HTBM is noticeably lower than RWTM and the case without shaping (W/o). In addition, the assertion "the higher the QoE metric measurement, the lower the  $fr_{\widehat{OFF}}$  value" seems to be valid; for example, HTBM presents better QoE with Illinois than with Cubic, and  $fr_{\widehat{OFF}}$  is lower with Illinois than with Cubic.
- Nevertheless, RWTM was designed to limit the value of the receiver's advertised window,  $rwnd$ , of each client. Therefore, no additional queuing delay is induced by RWTM. Hence, the congestion rate is very low. Besides, the  $RTT_{C-S}$  estimation is performed only once per chunk. So, the  $rwnd$  value is constant during the ON period, even if  $RTT_{C-S}$  varies. In our configuration, the standard deviation of  $RTT_{C-S}$  is equal to 7 ms, i.e.  $0.07 \times a_{C-S}$ , as described in Chapter 3 (Section 3.3). Consequently, eliminating  $\widehat{OFF}$  periods will not be possible. Instead, the  $fr_{\widehat{OFF}}$  value will be bounded to a minimum value that characterizes RWTM when the QoE measurements are the most favorable. When testing with the four congestion control variants, this  $fr_{\widehat{OFF}}$  value is equal to  $0.24 \widehat{OFF}$  period per chunk for

the selected standard deviation. This means that RWTM can guarantee, in the best case, one  $\widehat{OFF}$  period every 4.17 chunks. This frequency is useful, and will be discussed in the next Subsection 5.3.2.2 and in further detail in scenario 5 (Subsection 5.3.5).

### 5.3.2.2 Analysis of *cwnd* Variation

To explain the results of scenario 1, we used the *tcp\_probe* module in the HAS server. This module shows the evolution of the congestion window, *cwnd*, and the slow start threshold, *ssthresh*, during each run. For each combination, we selected a run whose performance values are the nearest to its average values of Tables 2 and 4, i.e. instability *IS*, infidelity *IF*, convergence speed *V*, frequency of  $\widehat{OFF}$  periods per chunk  $fr_{\widehat{OFF}}$ , and congestion rate *CNG*. Then, we present their *cwnd* and *ssthresh* evolution in Figures 5.1 through 5.8. We also indicate the moment of convergence by a vertical bold dotted line. We observed that this moment corresponds to the second from which the TCP congestion control is often processing under the congestion avoidance phase; i.e. when  $cwnd > ssthresh$ . Hence, we observe that *ssthresh* is practically around a constant value.

Figure 5.1 shows that the combination NewReno with HTBM cannot guarantee convergence to the optimal quality level. The congestion rate is around 43 congestion event per 100 seconds, which is lower than Illinois and Cubic. After 50 seconds, *cwnd* was able to reach the congestion avoidance phase for short durations, but the continuous increase of *cwnd* with the additive increase approach caused congestion detections. Moreover, the multiplicative decrease approach after congestions employed by NewReno was very aggressive; in effect, as described in Subsection 5.2, the new *cwnd* value will be reduced by half (more precisely, to  $\frac{cwnd}{2} + 3 \times MSS$  following the FR/FR phase) and *ssthresh* will also be reduced to  $\frac{cwnd}{2}$ . This aggressive decrease prevents the server from rapidly reaching a desirable *cwnd* value and, as a consequence, prevents the player from correctly estimating the available bandwidth and causes a lower quality level selection. Furthermore, the  $fr_{\widehat{OFF}}$  value was relatively high (around 30  $\widehat{OFF}$  period) which is more than twice of that of Illinois and Cubic variants. This value is also caused by the multiplicative decrease approach that generates a lower quality level selection. Due to the shaping rate that adapts the download bitrate of the client to its optimal quality level, chunks with a lower quality level will be downloaded more rapidly, which results in causing more frequent  $\widehat{OFF}$  periods. For this reason, the player is not able to stabilize on the optimal quality level, resulting in a poor QoE.

When combining NewReno with RWTM, we observed that evaluation results diverged and could be classified into two categories: those with infidelity value of 100% and that do not converge (Figure 5.2a), and those with a low value of infidelity and that converge rapidly (Figure 5.2b). In

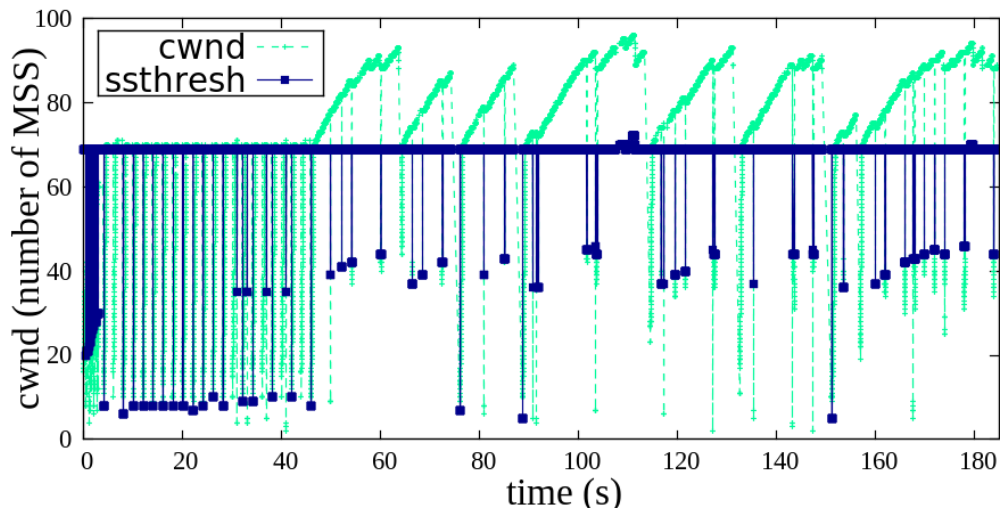
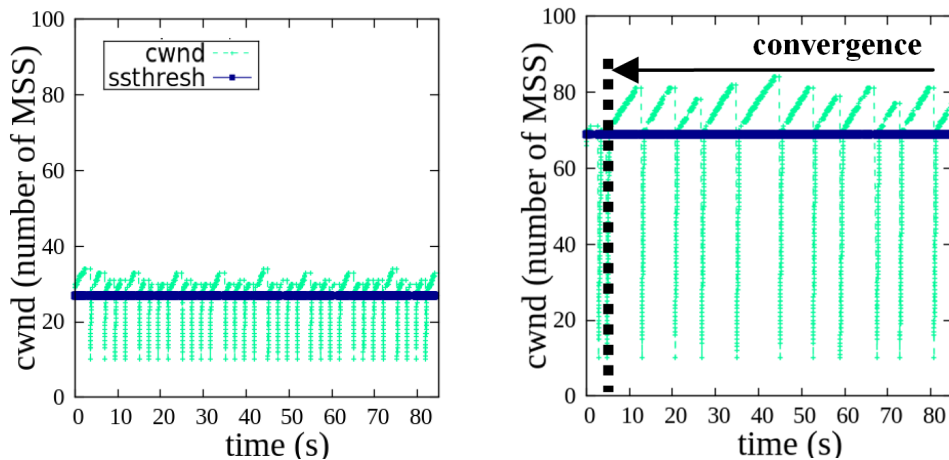

Figure 5.1 – *Cwnd* variation of {NewReno HTBM} ( $IS = 5.48\%$ ,  $IF = 35.68\%$ ,  $V = 180s$ ,  $fr_{\widehat{OFF}} = 0.2$ ,  $CNG = 43.33$ )



(a)  $IS = 0.95\%$ ,  $IF = 100\%$ ,  $V = 180s$ ,  
 $fr_{\widehat{OFF}} = 0.68$ ,  $CNG = 0$

(b)  $IS = 2.62\%$ ,  $IF = 4.92\%$ ,  $V = 4s$ ,  
 $fr_{\widehat{OFF}} = 0.23$ ,  $CNG = 0$

Figure 5.2 – *Cwnd* variation of {NewReno RWTM}

both figures, *ssthresh* is always invariable. Both figures have no congestion event, which is due to the use of RWTM. The  $\widehat{OFF}$  periods are more frequent in Figure 5.2a ( $fr_{\widehat{OFF}} = 0.68$ ) than in Figure 5.2b ( $fr_{\widehat{OFF}} = 0.23$ ). Although both figures present a constant value of *ssthresh*, we observe that the only difference between them is the initial value of *ssthresh*. Figure 5.2a has a lower value of *ssthresh* than Figure 5.2b: 27 MSS vs. 69 MSS. The additive increase approach of NewReno during the congestion avoidance phase prevents the server from rapidly increasing the *cwnd* value during ON periods. Therefore, the player was not able to reach the optimal quality level  $n^\circ 4$  at any time. The cause of the dissimilarity between the initial value of *ssthresh* in the

two figures is explained in [10] some implementations of NewReno use the size of the receiver's advertised window,  $rwnd$ , to define the initial value of  $ssthresh$ , but in fact, this value may be arbitrarily chosen. Accordingly, the combination of NewReno with RWTM could have high QoE rate if the initial value of  $ssthresh$  is well-chosen.

When combining Vegas with HTBM, we obtain  $cwnd$  variation, as shown in Figure 5.3. The convergence moment (at 87 s in Figure 5.3) occurs when  $cwnd$  becomes often set higher than  $ssthresh$  (i.e. TCP congestion control is often processing under congestion avoidance phase) and  $ssthresh$  is often set at the same value. We can observe the additive increase and additive decrease aspect of  $cwnd$  in the congestion avoidance phase after convergence. The additive decrease of  $cwnd$  involved in Vegas is caused by the queuing delay increases resulting from HTBM. This additive decrease has the advantage of maintaining a high throughput and reducing the dropping of packets in the gateway. Therefore, the congestion rate,  $CNG$ , is relatively low; because it is reduced in Figure 5.3 from around 75 congestion event per 100 seconds to only 15. The additive decrease also has the advantage of promoting convergence to the optimal quality level, unlike multiplicative decrease. As a result, the delay-based aspect with the additive decrease approach improves the stability of the HAS player after convergence. In contrast, Vegas uses a slightly low value of  $ssthresh$  (60  $MSS$ ) and employs the additive increase approach for  $cwnd$  updates during the congestion avoidance phase. As a consequence, the server cannot rapidly increase the  $cwnd$  value during the ON period, which results in slow convergence. Therefore, the player was not able to reach the optimal quality level  $n^\circ 4$  at any time before the moment of convergence. Consequently, the frequency of the  $\widehat{OFF}$  period increases before the convergence moment; hence, the high value of  $fr_{\widehat{OFF}}$ .

The performance worsens when Vegas is combined with RWTM. As presented in Figure 5.4, the player was not able to converge. Instead, we observed many timeout retransmissions (such as at seconds 90 and 159) characterized by  $ssthresh$  reduction and  $cwnd$  restarting from slow start. The timeout retransmissions are generated by Vegas when only a duplicate ACK is received and the timeout period of the oldest unacknowledged packet has expired [21]. Because of this, Vegas generates more timeout retransmissions than NewReno. Hence, the  $CNG$  value is worse than in the other combinations of RWTM. Moreover,  $\widehat{OFF}$  periods, characterized by a drop of  $cwnd$  value while  $ssthresh$  is kept constant, are frequent during the first 45 seconds, because the player requests quality level  $n^\circ 3$  instead of  $n^\circ 4$ . In this phase,  $fr_{\widehat{OFF}}$  reaches practically the highest value of one  $\widehat{OFF}$  per chunk. Subsequently,  $\widehat{OFF}$  periods become far less frequent (just at seconds 79, 125, 138, 150, 165 and 175) because the player was able to switch to a optimal quality level ( $n^\circ 4$ ). Hence,  $fr_{\widehat{OFF}}$  of the whole test duration is equal to an acceptable value (0.29  $\widehat{OFF}$  period per chunk). The player becomes able to



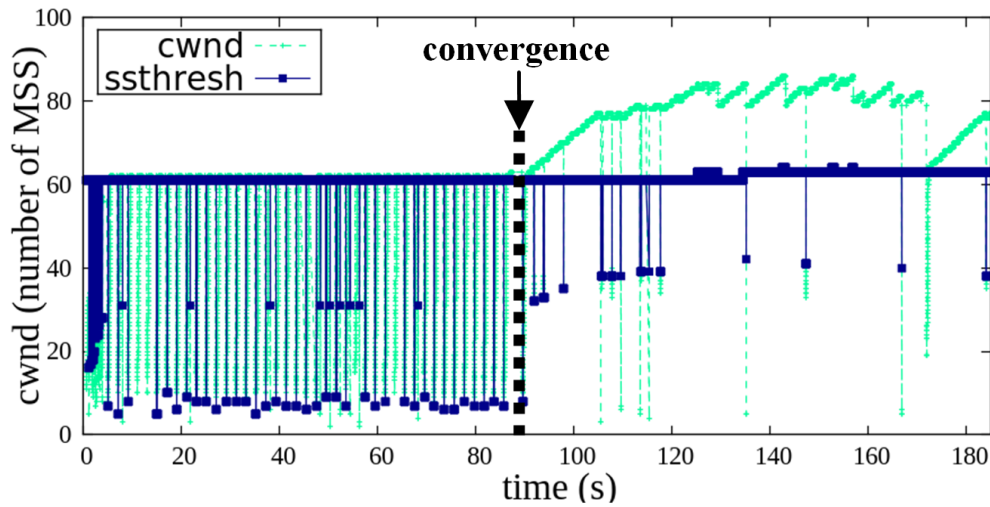

Figure 5.3 – *Cwnd* variation of {Vegas HTBM} ( $IS = 1.31\%$ ,  $IF = 46.74\%$ ,  $V = 87s$ ,  $fr_{\widehat{OFF}} = 0.4$ ,  $CNG = 46.11$ )

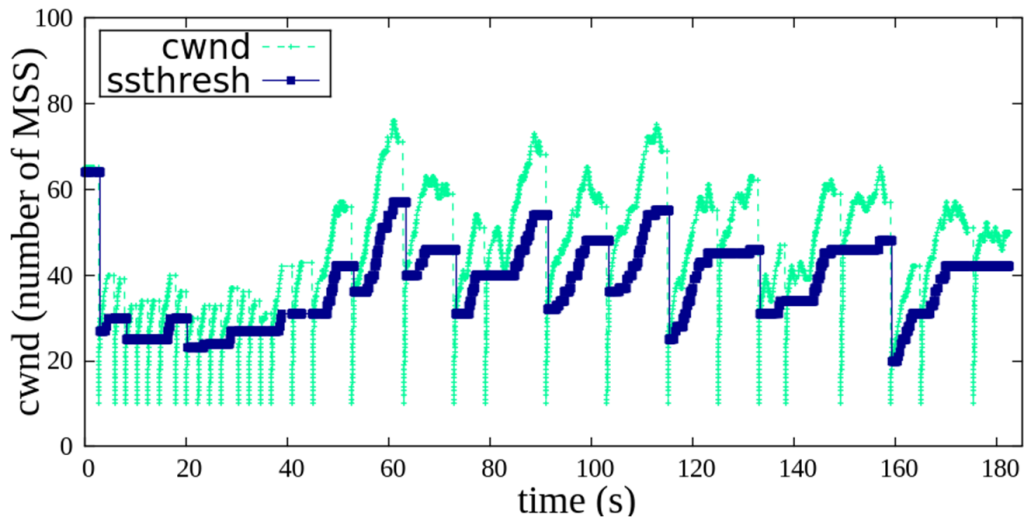

Figure 5.4 – *Cwnd* variation of {Vegas RWTM} ( $IS = 5.32\%$ ,  $IF = 31.15\%$ ,  $V = 180s$ ,  $fr_{\widehat{OFF}} = 0.29$ ,  $CNG = 6.11$ )

request the optimal quality level  $n^\circ 4$  predominantly in the second period (after 45 seconds), but it is incapable of being stable for more than 60 seconds because of the retransmission timeout events.

When we use the loss-delay-based variant Illinois, significant improvement of performances is observed with the two shaping methods:

In Figure 5.5, despite the rapid convergence, a high rate of congestions (that reduces the *ssthresh* and *cwnd* values but maintains the *cwnd* higher than *ssthresh*, as described in Algorithm 2) and timeout retransmissions (that reduces *ssthresh*, drops *cwnd* and begins from the slow

start phase) was recorded. Consequently, the frequent reduction of  $ssthresh$  was the cause of the high rate of  $CNG$ : in this example,  $CNG$  is equal to 51.11 congestion event per 100 seconds.  $CNG$  is higher than that recorded for NewReno. The cause is the high value of  $ssthresh$  (of about 115  $MSS$ ).  $Ssthresh$  was able to rapidly return to a fixed value after retransmissions, due to the update of  $\alpha$  and  $\beta$  using accurate  $RTT_{C-S}$  estimation (see Subsection 5.2). As a consequence,  $cwnd$  restarts from the slow start phase after timeout detection and reaches rapidly the high value of  $ssthresh$ . Hence, the HAS player converges despite high congestion. In addition,  $\widehat{OFF}$  periods were negligible, we recorded only two  $\widehat{OFF}$  periods after convergence. This is why  $fr_{\widehat{OFF}}$  was very low (0.03). In the congestion avoidance phase,  $cwnd$  was able to increase and reach high values, even during short timeslots. This was due to the concave curve of  $cwnd$  generated by Illinois, which is more aggressive than NewReno. As a consequence, the player could be stabilized at the optimal quality level  $n^\circ 4$ .

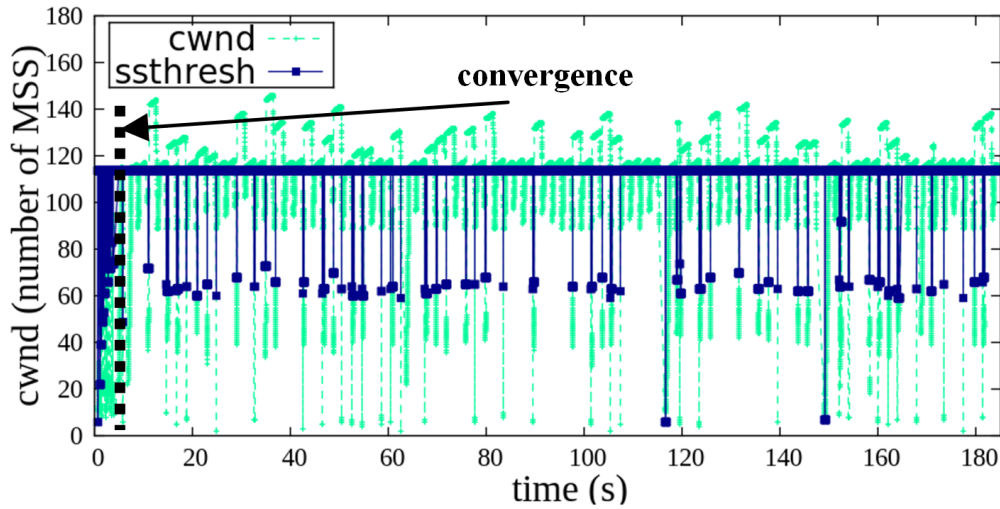

Figure 5.5 –  $Cwnd$  variation of {Illinois HTBM} ( $IS = 2\%$ ,  $IF = 7.66\%$ ,  $V = 5s$ ,  $fr_{\widehat{OFF}} = 0.03$ ,  $CNG = 51.11$ )

When using RWTM with Illinois, the player converges, as presented in Figure 5.6. The congestion rate is very low ( $CNG = 0.55$  congestion event detection per 100 seconds), but congestions are caused by the aggressiveness of Illinois (the concave curve of  $cwnd$  in the C-AIMD approach) and its high  $ssthresh$  value (120  $MSS$ ). Congestions slow down the convergence speed and slightly reduce the QoE due to the multiplicative decrease approach of Illinois. As shown in Figure 5.6, one congestion event delayed the convergence time to 27 seconds. In addition, Illinois has the ability to select the suitable  $ssthresh$  value (110  $MSS$  in Figure 5.6) that minimizes congestion events in the future, in spite of the sensitivity of RWTM to congestions.  $\widehat{OFF}$  periods still exist, with low frequency ( $fr_{\widehat{OFF}} = 0.22$ ).

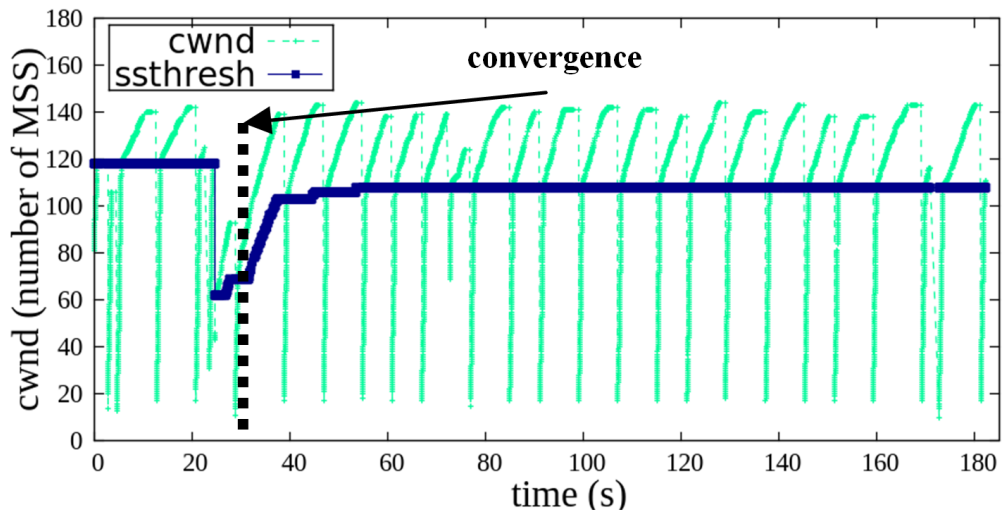

Figure 5.6 – *Cwnd* variation of {Illinois RWTM} ( $IS = 2.4\%$ ,  $IF = 5.47\%$ ,  $V = 27s$ ,  $fr_{\widehat{OFF}} = 0.22$ ,  $CNG = 0.55$ )

The Cubic variant yielded good performances with both shaping methods. The variations of *cwnd* when Cubic is combined with HTBM and RWTM are presented in Figure 5.7 and 5.8, respectively.

In Figure 5.7, the player converges tardily after a delay of 33 seconds. The cause is mainly the low value of *ssthresh* that is selected by the Cubic algorithm. As explained in Subsection 5.2, the HyStart algorithm, implemented in Cubic, defines this *ssthresh* in order to have a less aggressive increase of *cwnd*. The *ssthresh* becomes lower when the  $RTT_{C-S}$  increases. Knowing that HTBM increases  $RTT_{C-S}$  by adding an additional queuing delay, HyStart decreases *ssthresh* to be approximately 57 MSS. This is why the player cannot upgrade to its optimal quality level  $n^{\circ} 4$  before convergence. The second cause is the multiplicative decrease approach of Cubic and the high rate of congestions caused by HTBM. This second cause makes the convergence to optimal quality level more difficult because the server is not able to increase its reduced congestion window *cwnd* during the ON period, as it should be increased.

After convergence, many congestions were recorded, and  $\widehat{OFF}$  periods were negligible. The *ssthresh* becomes more stable around 75 MSS: this is well-set by the HyStart algorithm. This enhances stability in the congestion avoidance phase with a more uniform increase of *cwnd*, as shown between 60 and 80 seconds in Figure 5.7. Furthermore, there is a set of large cubic curves with inflection points close to the *ssthresh* value. *Cwnd* is more present in the convex region, which makes the increase of *cwnd* more aggressive when moving away from the inflection point.

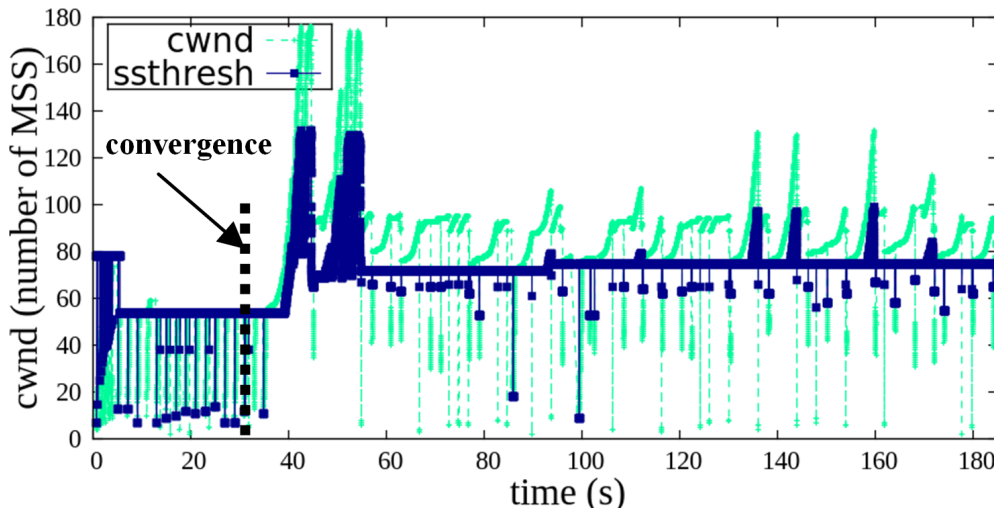

Figure 5.7 – *Cwnd* variation of {Cubic HTBM} ( $IS = 1.98\%$ ,  $IF = 19.03\%$ ,  $V = 33s$ ,  $fr_{\widehat{OFF}} = 0.16$ ,  $CNG = 186.11$ )

In Figure 5.8, the player converges rapidly in only 8 seconds. The *ssthresh* begins with a low value (60 MSS) for few seconds during the buffering state, and then the HyStart algorithm implemented in Cubic rapidly adjusts the *ssthresh* value and enables the server to be more aggressive. Comparing with Figure 5.6, selecting a lower initial value of *ssthresh* is better for accelerating convergence, because otherwise there are more risks of congestion that slow down the convergence speed. Congestions are infrequent: only two congestion events are visible in Figure 5.8 at seconds 70 and 130, and they are resolved by fast retransmission in accordance with Algorithm 2 and by using Hystart. As a consequence, separated congestion events do not dramatically affect the performance, as when Illinois is used with RWTM (Figure 5.8). The Cubic algorithm chooses the inflection point to be around 140 MSS, which is much higher than the *ssthresh* value, so that the concave region becomes more aggressive than the convex region. The  $\widehat{OFF}$  periods persist, even with Cubic, but with a low frequency:  $fr_{\widehat{OFF}} = 0.22$ .

Accordingly, the Cubic variant is able to adjust its congestion window curve in different situations. When many congestions occur, the cubic curve becomes rather convex to carefully increase *cwnd*. When many  $\widehat{OFF}$  periods occur, the cubic curve becomes rather concave, and is thus more aggressive than the concave curve of Illinois in order to rapidly achieve the desired sending bitrate and compensate for the fall of the *cwnd* value. However, Cubic begins by estimating a low value of *ssthresh* that is adjusted over time by the HyStart algorithm, which is beneficial only when using RWTM as a shaping method. Using HTBM slows down convergence considerably and affects the infidelity metric.

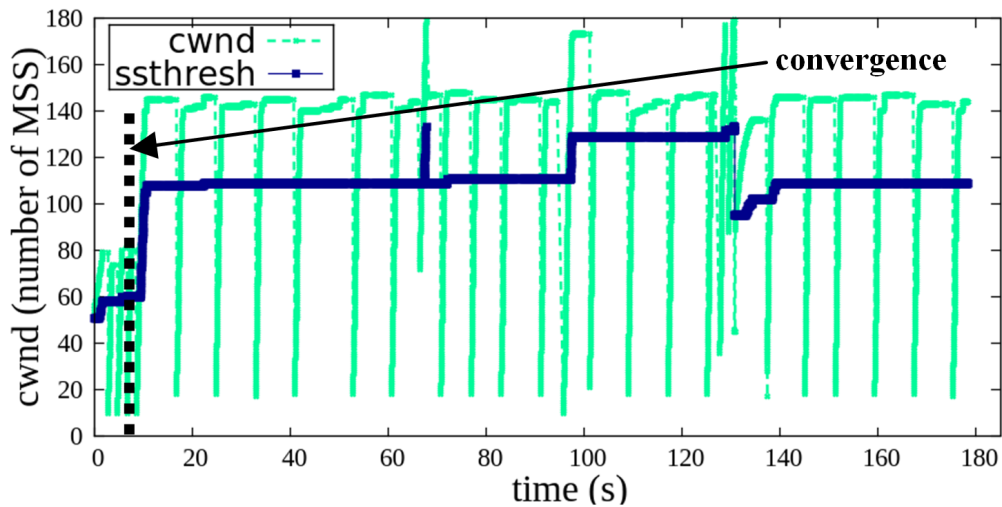

Figure 5.8 –  $Cwnd$  variation of {Cubic RWTM} ( $IS = 1.78\%$ ,  $IF = 5.5\%$ ,  $V = 8s$ ,  $fr_{OFF} = 0.22$ ,  $CNG = 1.66$ )

### 5.3.3 Scenarios 2 and 3

In this section, we present the five performance measurements of client 1 for the first three scenarios described in Subsection 5.3.1. We make the assumption that the optimal quality level of client 1 is  $n^\circ 4$ . We do not present NewReno and Vegas variants because they demonstrated low performance. The average values of QoE metrics for client 1 in the first three scenarios are listed in Table 5.4, and the average values of  $CNG$  and  $fr_{OFF}$  in the first three scenarios are listed in Table 5.5. Both tables show the total mean values (denoted by MV) over the three scenarios. MV indicate the global performance measurement for a given metric over the three scenarios in order to be used to compare between combinations. Both tables indicate two valuable points, one on RWTM and the other on HTBM:

- On the one hand, RWTM has better QoE metric measurements than HTBM with both Cubic and Illinois variants. Moreover, RWTM not only has a lower congestion rate,  $CNG$ , than HTBM, but it also has a negligible  $CNG$  with the two TCP variants for all three scenarios. RWTM also preserves a constant value of  $fr_{OFF}$ . Consequently, even the transition from one to two clients and vice versa (i.e., scenarios 2 and 3, respectively) does not disturb RWTM, which preserves its inherit characteristics of negligible congestion rate and its  $fr_{OFF}$  rate around 0.25. This preservation has positive consequences for the user's QoE. Although the gap between the QoE metrics measurements of {Cubic RWTM} and {Illinois RWTM} is not very significant, {Cubic RWTM} yields better values. Accordingly, we can say that the use of Cubic or even Illinois is beneficial for improving the user's experience, with a slight preference for Illinois.

Table 5.4 – QoE measurements for client 1 in scenarios 1, 2 and 3

TCP variant	Scenario	Performance metric					
		IS (%)		IF (%)		V (s)	
		HTBM	RWTM	HTBM	RWTM	HTBM	RWTM
Cubic	1	1.86	1.63	20.45	5.02	52.06	19.55
	2	3.44	1.43	32.90	3.42	64.13	10.98
	3	2.19	1.63	18.49	4.81	34.65	14.34
	MV	<b>2.49</b>	<b>1.56</b>	<b>23.95</b>	<b>4.42</b>	<b>50.28</b>	<b>14.96</b>
Illinois	1	1.56	1.88	7.75	6.17	21.10	24.22
	2	3.20	1.56	29.75	4.42	59.58	13.28
	3	1.85	1.76	7.92	5.66	21.03	18.80
	MV	<b>2.20</b>	<b>1.73</b>	<b>15.14</b>	<b>5.42</b>	<b>33.90</b>	<b>18.56</b>

Table 5.5 – ongestion detection rate and frequency of  $\widehat{OFF}$  period for client 1 in scenarios 1, 2 and 3

Metric	Scenario	Cubic		Illinois	
		HTBM	RWTM	HTBM	RWTM
CNG	1	191.72	1.11	58.68	0.76
	2	375.62	0.82	33.11	0.68
	3	173.48	0.66	56.27	0.76
	MV	<b>246.92</b>	<b>0.86</b>	<b>49.35</b>	<b>0.73</b>
$fr_{\widehat{OFF}}$	1	0.16	0.24	0.06	0.24
	2	0.23	0.24	0.21	0.24
	3	0.13	0.26	0.05	0.26
	MV	<b>0.17</b>	<b>0.25</b>	<b>0.10</b>	<b>0.25</b>

- On the other hand, HTBM presents better QoE with Illinois than with the Cubic variant. In conjunction, it has a fivefold lower congestion rate (49.35 vs. 246.92) and lower  $\widehat{OFF}$  period frequency  $fr_{\widehat{OFF}}$ . This observation is valid not only for total mean values, MV, but also with every scenario (1, 2 and 3). Therefore, Illinois is distinctly better than Cubic for the HTBM shaping method, even when the number of active HAS clients in the home gateway changes between one and two clients. Accordingly, the loss-delay-based variant with the C-AIMD approach used by Illinois has more favorable impacts on QoE, CNG and

$fr_{\widehat{OFF}}$  than the loss-based variant with the AIAD approach using the HyStart algorithm employed by Cubic.

#### 5.3.4 Scenario 4

The objective of this section is to evaluate the robustness of each combination against the congestions that may be induced by other flows. Therefore, we employed scenario 4, as described in Subsection 5.3.1, in which a heavy congestion is induced. To be able to compare performances correctly, a reference scenario, denoted by WL (Without Loss), consisting of a HAS client working alone in the home network, is used. No loss is observed in the reference scenario. We do not present the NewReno and Vegas variants because they showed poor performance. Altogether, we have four combinations to evaluate: Cubic and Illinois combined with two shaping methods, HTBM and RWTM. The average values of the QoE metrics of the client in scenario 4 are provided in Table 5.6, and the average values of  $CNG$  and  $fr_{\widehat{OFF}}$  are listed in Table 5.7.

Table 5.6 – QoE measurements for client 1 in scenarios 4

TCP variant	Scenario	Performance metric					
		IS (%)		IF (%)		V (s)	
		HTBM	RWTM	HTBM	RWTM	HTBM	RWTM
Cubic	WL	1.08	1.07	3.71	1.79	7.61	4.10
	4	4.86	6.40	48.20	46.14	120.3	129.3
Illinois	WL	1.08	1.07	2.23	1.66	5.37	4.01
	4	2.7	2.92	15.6	17.81	35.48	42.75

Table 5.7 – ongestion detection rate and frequency of  $\widehat{OFF}$  period for client 1 in scenarios 4

Metric	Scenario	Cubic		Illinois	
		HTBM	RWTM	HTBM	RWTM
CNG	WL	34.2	0.98	38.51	0.79
	4	216.19	120.36	146.68	143.54
$fr_{\widehat{OFF}}$	WL	0.03	0.36	0.03	0.43
	4	0.40	0.41	0.09	0.31

The measurements in the two tables indicate three major observations:

- The lowest QoE metric measurements are recorded for the Cubic variant for both shaping methods: their instability is around 5~6%, their infidelity is near 50%, and their convergence speed is around 120~130 ms. We also notice that the congestion rate,  $CNG$ , is very high, between 120 and 220, and the frequency  $fr_{\widehat{OFF}}$  is important around 0.4 (i.e., one  $\widehat{OFF}$  period occurs for every 2.5 chunks, on average). We observe not only lower measurements, but also a higher degradation rate in performance: the gap of QoE metric measurements,  $CNG$  and  $fr_{\widehat{OFF}}$ , are clearly large between scenario WL and scenario 4. Accordingly, Cubic is not suitable as a TCP congestion control variant of the HAS server for both shaping methods when heavy congestion occurs. This result can be verified by examining Figure 5.7 and 5.8 in Subsection 5.3.2.2, where Cubic has difficulties with rapidly defining the suitable  $ssthresh$  value before convergence and after congestion, respectively.
- The RWTM shaping method presents higher degradation in QoE metric measurements than HTBM when we compare scenario WL to scenario 4 for both TCP congestion variants, Cubic and Illinois. The cause is mainly related to the fact that HTBM is used to generate congestion events and maintain high QoE under normal circumstances, which is not the case with RWTM. Accordingly, we can say that RWTM is more sensitive to induced congestions than HTBM. This result can be verified when examining Figures 5.6 and 5.8 in Subsection 5.3.2.2, in which a single congestion event instantaneously degrades performances.

Under the first and the second observations, we can deduce that the best combination that maintains optimal QoE metric measurements with low degradation and has the lowest frequency of  $\widehat{OFF}$  periods,  $fr_{\widehat{OFF}}$ , is ensured by the combination {Illinois HTBM}.

- The second-best combination is {Illinois RWTM}. Here, the QoE metric measurements are acceptable, but the degradation rate is higher than the best combination {Illinois HTBM}. This degradation indicates that {Illinois RWTM} cannot adequately resist against induced congestions, especially when we have a highly congested link between client and server. However, this combination could successfully be used with a link under less frequent congestions.



### 5.3.5 Scenario 5

In this section, we present the performance metric measurements when the standard variation of  $RTT_{C-S}$  varies. The behavior of the resulting curves will indicate how performance degrades when the standard deviation of  $RTT_{C-S}$  increases. More particularly, this scenario indicates the efficiency of each combination in wired and wireless networks. In fact, as BaekYoung Choi et al. indicated [33], the variability of  $RTT$  can be effectively used for distinction between wired and wireless networks. Their experimental results showed that the variable portion of  $RTTs$  on a wireless network has a significantly larger standard deviation than wired network. The standard deviation of wireless network can reach 50% of the mean measured  $RTT$ .

We remind that the round trip propagation delay,  $a_{C-S}$ , of Equation 3.2 (See subsection 3.3) is equal to 100 ms. We vary the standard deviation of  $RTT_{C-S}$  from 7 to 56 ms. We present the measurements of three QoE metrics (instability  $IS$ , infidelity  $IF$  and convergence speed  $V$ ) and of two QoS metrics (congestion detection rate,  $CNG$ , and frequency of  $\widehat{OFF}$  period,  $fr_{\widehat{OFF}}$ ) in Figure 5.9 for the four combinations. We have two major observations: one on RWTM and the other on HTBM:

On the one hand, the {Illinois RWTM} (purple cross) and the {Cubic RWTM} (red square) curves are convex and close to each other and are predominantly below the other curves. The three QoE metric values are good until an  $RTT_{C-S}$  standard deviation of around 40 ms, where performance degradation begins to be visible, as shown in Figures 5.9a, 5.9b and 5.9c. Moreover, the combination {Illinois RWTM} preserves its performance better and has a less aggressive degradation rate for higher  $RTT_{C-S}$  standard deviation, especially from 35 ms. Accordingly, we can say that using RWTM with Illinois is safer when  $RTT_{C-S}$  is very unstable. Otherwise, RWTM Cubic can also be used, most usefully when the standard deviation of  $RTT_{C-S}$  is lower than 35 ms. We also observe in Figures 5.9e and 5.9d that both combinations have a similarly low congestion rate,  $CNG$ , and similar frequency of  $\widehat{OFF}$  periods,  $fr_{\widehat{OFF}}$ . Based on this observation, we can deduce that RWTM preserves its inherent characteristics with Cubic and Illinois variants, and that the degradation of QoE metric measurements for highly unstable  $RTT_{C-S}$  is mainly caused by the congestion control algorithms used by Cubic and Illinois variants. Since RWTM seems to be more adequate with Illinois, we can say that the loss-delay-based and C-AIMD approach of Illinois helps more than the loss-based and cubic RTT-independent approach of Cubic to preserve good performance for highly unstable  $RTT_{C-S}$  values.

On the other hand, HTBM is less robust against  $RTT_{C-S}$  instability. As presented in Figures 5.9a, 5.9b and 5.9c, the green and the blue curves that present the combination of HTBM with Illinois and Cubic, respectively, show a significant degradation of QoE metric measurements

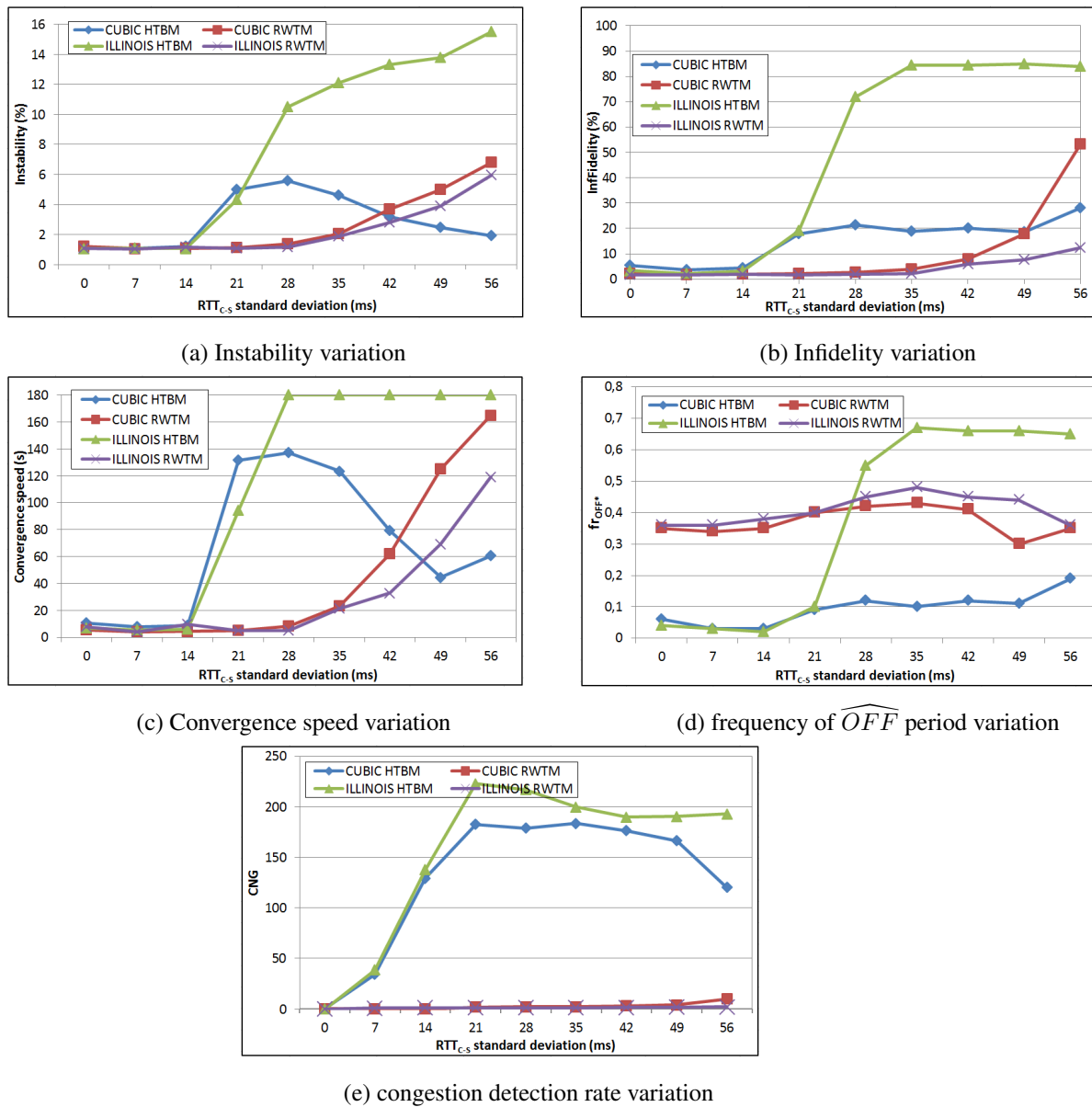

Figure 5.9 – Performance measurements when increasing  $RTT_{C-S}$  standard deviation

when the standard deviation of  $RTT_{C-S}$  is above 14 ms. However, HTBM Illinois is more sensitive to  $RTT_{C-S}$  instability than HTBM Cubic. This means that combining the loss-delay-based congestion control variant Illinois, with the HTBM shaping method that increases the queuing delay, entails harmful drawbacks for QoE when the  $RTT_{C-S}$  is unstable. We can also validate this observation in Figures 5.9e and 5.9d: the congestion rate  $CNG$  of HTBM Illinois and HTBM Cubic are predominantly close to each other, but the frequency of  $\widehat{OFF}$  periods explodes with HTBM Illinois for  $RTT_{C-S}$  standard deviation higher than 20 ms. This implies that the additional delay caused by HTBM is practically the same for both congestion control variants Cubic and Illinois, but the effects on  $fr_{\widehat{OFF}}$  and QoE are quite different and involve more drawbacks for

the Illinois variant. In contrast, HTBM with Cubic has fewer drawbacks and presents QoE metrics measurements that are relatively constant for instability and infidelity from  $RTT_{C-S}$  standard deviations around 20 ms. This results can be explained by the fact that the Cubic variant does not use  $RTT_{C-S}$  to compute its congestion window  $cwnd$  during the congestion avoidance phase, as explained in Subsection 5.2.

## 5.4 Discussion

After comparing the results of five scenarios, we have made numerous observations, but in this subsection, we want to summarize the most important observations. First, NewReno and Vegas variants do not provide good performance in the HAS context, excepting the combination {NewReno RWTM} that could perform well if the initial value of  $ssthresh$  is well-chosen. Second, we summarize the observations of the five scenarios for the four combinations in Table 5.8. Thus, we give a score for each combination that ranges between "-" and "++": - (bad), - (insufficient), +/- (average), + (good) and ++ (excellent). This score is based on the analysis of results for each scenario.

Table 5.8 – The final score for each combination

Scenario	Combination			
	RWTM		HTBM	
	Cubic	Illinois	Cubic	Illinois
{1,2,3}	++	++	+/-	+
4	-	+	-	++
5	+	++	+/-	-

The best combination is {Illinois RWTM}: it offers good performance when two clients compete for bandwidth, and is robust against high  $RTT_{C-S}$  variation, but it is somewhat vulnerable to heavy congestions that could be caused by external factors. In the second position, we have two combinations:

- {Cubic RWTM}: Unfortunately, it is very vulnerable to congestions and slightly sensitive to high  $RTT_{C-S}$  variation.
- {Illinois HTBM}: It has the advantage of being robust against heavy congestions. However, it is very sensitive to  $RTT_{C-S}$  variation. Furthermore, it causes a high rate of congestion in the gateway that could disturb other sessions in concurrence with HAS sessions.

## 5.5 Conclusion

A comparative evaluation has been developed in order to study the effect of combining two well-known traffic shaping methods (HTBM and our own method RWTM) in the gateway with four very common TCP congestion algorithms (NewReno, Vegas, Illinois, and Cubic) in the server in the context of HTTP adaptive streaming technique. We examined the user's QoE by applying objective metrics. Furthermore, we observed the evolution of the congestion window on the server side in order to explain the behavior of each combination and its relationship with QoE metrics. We also used the congestion rate and the frequency of OFF periods that exceeds retransmission timeout as indicators. We have addressed many scenarios: two HAS clients competing for the home bandwidth simultaneously, adding or removing a HAS client, inducing a heavy congestion in the gateway, and increasing the instability of the round trip time, *RTT*, between the HAS server and the HAS client. The results show that there is a significant discordance in performance between combinations. The best combination that improves the QoE, reduces the congestion rate, and reduces the OFF periods in the majority of scenarios is when combining the loss-delay-based congestion control variant, Illinois, which uses the C-AIMD approach, with the TCP flow control based method, RWTM. The characteristics of the combination of Illinois and RWTM seem to be similarly robust against high *RTT* instability. Hence, it would offer good performances in wireless network, i.e. when the HAS clients are located in wireless home network. Moreover, this combination does not disturb other real-time streams in the home network because it does not induce additional queuing delay and it considerably reduces the congestion rate. However, it is slightly vulnerable to heavy congestions that could be caused by external factors such as other concurrent streams.

Having extended our knowledge about the combination of TCP congestion control variants with shaping methods in this work, we intend in the next chapter to design a new TCP congestion control variant that is compatible with all specifications of HAS and shaping methods.

---

# TcpHas: HAS-based TCP Congestion Control Variant

## 6.1 Introduction

The HTTP Adaptive Streaming technology is based on TCP protocol, which is not designed for video streaming. Many TCP variants have been proposed to resolve the problems of high bandwidth-delay product (such as Cubic, Illinois, and WestWood+) in order to be more reactive to achieve high bandwidth in short delay. The high bandwidth-delay product TCP variants seem to give better performances for HAS service as described in Chapter 5 (see Subsection 5.3.2) than the previous TCP variants such as NewReno and Vegas. However, until today, there is no proposition of TCP variant specifically designed for HAS application. Given that HAS differs from other types of applications by its highly periodical ON-OFF activity pattern, proposing an HAS-based TCP congestion control variant could improve HAS application performances: Implementing this TCP variant inside HAS servers could mitigate the OFF period issues, offer better bandwidth share for each HAS stream, reduce congestion events and improve the QoE of HAS users. Moreover, server-based shaping methods have been proposed for the same purpose, but they are implemented in the application layer. Nevertheless, these methods fall within the context of cross-layer optimization because they are interacting with the TCP layer and its parameters such as the congestion window, *cwnd*, and the round-trip time, *RTT*. Hence, integrating the HAS traffic shaping directly into the TCP congestion control algorithm would be more practical and easier to manage.

In this chapter, we propose a new HAS-based TCP congestion control variant that we called "TcpHas" which can be classified as a server-based shaping method totally implemented in the TCP layer. The remainder of this chapter is organized as the following: First, we give a state of the art of server-based shaping methods and describe possible optimizations that could be integrated

into TCP congestion control algorithm in Section 6.2. Second, we describe TcpHas algorithm in Section 6.3. Finally, we give the performance evaluation of TcpHas under various scenarios in Section 6.4.

## 6.2 State of The Art

In the literature, many server-based shaping methods have been proposed in order to improve the QoE of HAS. Their main common steps can be grouped into two major functions:

1. The estimation of the best feasible quality level, i.e the optimal quality level: this function is equivalent to the bandwidth manager in the context of gateway-based shaping methods (Chapter 4)
2. The shaping function of the sending rate which should be suitable to the encoding rate of the estimated optimal quality level.

The dissimilarity between the server-based shaping methods is located in both functions cited above. The rest of this chapter will focus on the two functions separately, in Subsection 6.2.1 and 6.2.2, by describing their constraints and their proposed solutions. Then, we overview, in Subsection 6.2.3, some possible ways to optimize and improve the two functions that provide the background for TcpHas conception.

### 6.2.1 Optimal Quality Level Estimation

The major constraint of optimal quality level estimation is that the server has no visibility on the set of flows which are competing with its corresponding HAS client inside the same home network.

Akhshabi et al. [7] propose a server-based shaping method that aims to stabilize the quality level sent by the server by detecting the oscillation events. The shaping function is only activated when oscillations are detected. An algorithm was proposed to suggest an optimal quality level based on the history of quality level oscillations. Then, the server shapes its sending rate based on the encoding bitrate of the estimated optimal quality level. However, when the end-to-end available bandwidth increases, the HAS player could not increase its quality level when the shaper is activated. In fact, the sending bitrate is limited on the server side and when the end-to-end available bandwidth increases, the player is still stable on the same quality level that matches with the shaping rate. For that, authors deactivate the shaping function for some chunks and use two TCP parameters,  $RTT$  and  $cwnd$ , to compute the connection throughput that corresponds to the

end-to-end available bandwidth ( $\frac{cwnd}{RTT}$ ). If the estimated bandwidth is higher than the shaping rate, the optimal quality level is increased to the next higher quality level, and the shaping rate is increased to follow its encoding rate. This method is implemented in the application layer. It takes as inputs the encoding rates of delivered chunks and two TCP parameters ( $RTT$  and  $cwnd$ ). The authors indicated that their method stabilizes the competing players inside the same home network without significant bandwidth utilization loss.

Accordingly, the optimal quality estimation process is based on two different techniques: the quality level oscillation detection and the bandwidth estimation using the throughput measurement. The former is based on the application layer information (i.e the encoding rate of the actual and previous sent chunks) and is sufficient to activate the shaping function (i.e the shaper). However, to verify whether the optimal quality level has been increased or not, the server is obliged to deactivate the shaper in order to let TCP congestion control algorithm occupy the remaining capacity available for HAS stream.

Although this proposed method offers performance improvements on both QoE and QoS, the concept of activating and deactivating the shaper is not sufficiently solid especially against instable network condition and could raise a number of questions about the duration of deactivation of the traffic shaping and their impact on increasing the OFF period duration. Besides, this method is not proactive and the shaper is activated only in the case of quality level oscillation.

What it is missing in this proposed method is a good estimation of the available bandwidth for the corresponding HAS flow. This method is relying on the throughput measurement during non-shaped phases. If we could give a bandwidth estimation that is less dependent to the congestion window value,  $cwnd$ , we could keep the shaper activated during the whole HAS stream and adapt the estimation of optimal quality level to the estimation of available bandwidth.

### 6.2.2 Shaping Methods

Ghobadi Monia et al. proposed a shaping method called "Trickle" [52] on the server side. This method was proposed for YouTube since 2011 when it adopted progressive download technology. The key idea of Trickle is to place a dynamic upper bound on the congestion window ( $cwnd$ ) such that TCP itself limits the overall data rate. The server application periodically computes the  $cwnd$  bound from the product between the round-trip time ( $RTT$ ) and the target streaming bitrate. Then it uses a socket option to apply it to the TCP socket. Their results show that Trickle reduces the average  $RTT$  by up to 28% and the average TCP loss rate by up to 43%. However, HAS differs from progressive download by the change of encoding rate during streaming. Nevertheless,

Trickle method can also be suitable for HAS by adapting the *cwnd* bound to the encoding rate of each chunk.

We note that the selection of the shaping rate by the server-based shaping methods does not mean that the player will automatically start requesting that next higher quality level [7]. One transition to another shaping rate may take place several chunks later, depending on the player's bitrate controller and the server-based shaping method efficiency.

Furthermore, we reported in Chapter 5 that the *ssthresh* has a predominant effect on convergence speed of the HAS client to select the desired optimal quality level. In fact, when *ssthresh* is set higher than the product of shaping rate and the round trip time, the server becomes aggressive and would cause congestions and a reduction of quality level selection on the player side. In contrast, when *ssthresh* is set lower than the product of the shaping rate and round trip time, the congestion window *cwnd* would take several round trip times to reach the value of this product, because in the congestion avoidance phase the increase of *cwnd* is relatively slow (one *MSS* each round trip time). Consequently, the server becomes conservative and takes long duration to occupy its selected shaping rate. Hence, the player would have difficulties to reach its optimal quality level.

Accordingly, shaping the sending rate by limiting the congestion window, *cwnd*, as described in Trickle, has a good effect for improving the QoE of HAS. However, it is still insufficient to increase the reactivity of the HAS player and consequently to accelerate the convergence speed. Hence, to improve the performance of the shaper, a modification of *ssthresh* is necessary. The value of *ssthresh* should be set at the right value that enables the server to rapidly reach the desired shaping rate.

### 6.2.3 How Can We Optimize Solutions ?

What we note from the different proposed methods for estimating the optimal quality level is that we can improve their performances if we would be able to find an efficient end-to-end estimator of available bandwidth, as shown in Subsection 6.2.1. In addition, the only parameter from application layer that we need for shaping the HAS traffic is the encoding rate of each available quality level of the corresponding HAS stream. As explained in Subsection 6.2.2, the remaining parameters are located into the TCP layer: the congestion window *cwnd*, the slow start threshold *ssthresh*, and the round-trip time *RTT*. Adjusting *ssthresh* value to accelerate the convergence speed is also our primordial objective.

Accordingly, we said that the best manner to take into consideration the whole optimization



ways that we cited above is to propose a TCP congestion control variant. In fact, adjusting the TCP behavior to the context of server-based HAS traffic shaping seems to be more efficient than a cross-layer solution controlled by the application layer. Nevertheless, what it is missing here is to find an efficient TCP-based method for end-to-end bandwidth estimation.

For the purposes cited above, we sought mechanism that adjusts *ssthresh* by employing the output of bandwidth estimator scheme. We found a mechanism, called *adaptive decrease mechanism*, which has been already used by some TCP congestion control variants. This mechanism is presented in Subsection 6.2.3.1. Moreover, we overview the bandwidth estimator schemes used by different TCP variants and we evaluate theoretically their estimation efficiency in Subsection 6.2.3.2.

### 6.2.3.1 Adaptive Decrease Mechanism

In the literature, we found a specific category of TCP congestion control variants that employs bandwidth estimation for positioning the *ssthresh* value. This category performs a bandwidth estimation scheme, which is updated over time. However, this estimation is taken into consideration by TCP only when a congestion event is detected. This mechanism of changing the *ssthresh* after congestion detection by using bandwidth estimation is classified as *adaptive decrease mechanism*. What is beneficial in this mechanism is described in [100] as the following: *the adaptive window setting provides a congestion window which is decreased more in the presence of heavy congestion and less in the presence of light congestion or losses that are not due to congestion, such as in the case of losses due to unreliable links*. Moreover, the updating process of *ssthresh* is chosen only after congestion detection. This low frequency of *ssthresh* updating is justified by Antonio Capone [24] by the fact that, in the contrary, a frequent updating of *ssthresh* tends to force the TCP source into congestion avoidance phase, preventing it from following the variations in the available bandwidth.

Hence, the unique difference of this category with classical TCP congestion variant is only the adaptive decrease mechanism when detecting a congestion; i.e when receiving 3 duplicated ACKs or when the retransmission timeout expires before receiving ACK. This mechanism is described in Algorithm 4:

We remark that the algorithm employs the estimated bandwidth,  $\widehat{Bwe}$ , multiplied by  $RTT_{min}$  to update the *ssthresh* value. The use of  $RTT_{min}$  instead of actual *RTT* is justified by the fact that  $RTT_{min}$  can be considered as an estimation of *RTT* of the connection when the network is not congested.

**Algorithm 4** TCP adaptive decrease mechanism

---

```

1: if (3 duplicate ACKs are received) then
2:    $ssthresh = \widehat{Bwe} \times RTT_{min}$ 
3:   if ( $cwnd > ssthresh$ ) then
4:      $cwnd = ssthresh$ 
5:   end if
6: end if
7: if (retransmission timeout expires) then
8:    $ssthresh = \widehat{Bwe} \times RTT_{min}$ 
9:    $cwnd = initial\_cwnd$  ▷ i.e  $2 \times MSS$ 
10: end if

```

---

▷ Where  $\widehat{Bwe}$  is the estimated bandwidth and  $RTT_{min}$  is the lowest  $RTT$  measurement

---

**6.2.3.2 Bandwidth Estimation Schemes**

The most common TCP variant that employs the bandwidth estimation for  $ssthresh$  update is Westwood. Other newer variants have been proposed, such as Westwood+ and TIBET. The only difference between them is the employed bandwidth estimation scheme. In the following, we overview the different schemes and describe their performances:

— **Westwood estimation scheme** [97]:

The key idea of Westwood is that the source performs an end-to-end estimation of the bandwidth available along a TCP connection by measuring the rate of returning acknowledgments [97]. It consists of estimating this bandwidth by properly filtering the flow of returning ACKs. A sample of available bandwidth  $Bwe_k$  is computed each time  $t_k$  the sender receives an ACK as shown in Equation 6.1:

$$Bwe_k = \frac{d_k}{(t_k - t_{k-1})} \quad (6.1)$$

Where  $d_k$  is the amount of data acknowledged by the ACK that is received at time  $t_k$ . We notice that  $d_k$  is determined by an accurate counting procedure by taking into considerations delayed ACKs, duplicate ACKs and selective ACKs. Then, the bandwidth samples  $Bwe_k$  are low-pass filtered by using a discrete-time low-pass filter to obtain the bandwidth estimation  $\widehat{Bwe}_k$ . The low-pass filter employed is generally the exponentially-weighted moving average function as defined in Equation 6.2:

$$\widehat{Bwe}_k = \gamma \times \widehat{Bwe}_k + (1 - \gamma) \times Bwe_k \quad (6.2)$$

where  $0 \leq \gamma \leq 1$ . Low-pass filtering is necessary since congestion is due to low frequency components of the available bandwidth, and because delayed ACK option [86, 98].

However, this estimation scheme is affected by the *ACK compression* phenomenon. This phenomenon occurs when the time spacing between the received ACKs is altered by the congestion of the routers on the return path [163]. In fact, when ACKs pass through one congested router, which generates additional queuing delay, they lose their original time spacing because during forwarding they are spaced by the short ACK transmission time [24]. The result is ACK compression that can lead to bandwidth overestimation when computing the bandwidth sample  $Bwe_k$ . Moreover, the low-pass filtering process is also affected by ACK compression because it cannot filter bandwidth samples that contain high frequency component [98]. Accordingly, the ACK compression causes a systematic bandwidth overestimation when using Westwood bandwidth estimation scheme. The ACK compression is commonly observed in real network operation [105] and thus should not be neglected in the estimation scheme.

Another phenomenon that distorts the estimation scheme of Westwood is *clustering*: As explained in [24, 163] the packets belonging to different TCP connections that share the same link do not intermingle. As a consequence, many consecutive packets of the same connection can be observed on a single channel. This means that each connection uses the full bandwidth of the link for the time needed to transmit its cluster of packets. Hence, a problem of fairness between TCP connections is experienced when the estimation scheme does not take the clustering phenomenon into consideration and continues to estimate the bandwidth of the whole shared bottleneck link instead of their available bandwidth.

— **Westwood+ estimation scheme** [99]

In order to correctly estimate the bandwidth and alleviate the effect of ACK compression and clustering, a TCP source should observe its own link utilization for a time longer than the time needed for entire cluster transmission. For this purpose, Westwood+ modifies the bandwidth estimation mechanism to perform the sampling every  $RTT$  instead of every ACK reception as described in Equation 6.3:

$$Bwe = \frac{d_{RTT}}{RTT} \quad (6.3)$$

Where  $d_{RTT}$  is the amount of data acknowledged during one  $RTT$ . As indicated in [99], the result is a more accurate bandwidth measurement that ensures better performance when comparing with NewReno and it is still fair when sharing the network with other TCP connections.  $Bwe$  is updated once every one  $RTT$ . The bandwidth estimation samples are low-pass filtered to give better smoothed estimation  $\widehat{Bwe}$ .

However, the amount of acknowledged data during one  $RTT$  ( $d_{RTT}$ ) is bounded by the sender's window size,  $\min(cwnd, rwnd)$ , that is defined by the congestion control algorithm (i.e,  $d_{RTT} \leq \min(cwnd, rwnd)$ ). In fact,  $\min(cwnd, rwnd)$  defines the maximum amount of data to be transmitted during one  $RTT$ . Consequently, the bandwidth estimation of Westwood+, given by each sample  $Bwe$ , is still always lower than the sender sending rate ( $Bwe \leq \frac{\min(cwnd, rwnd)}{RTT}$ ).

Hence, although the estimation scheme of bandwidth of Westwood+ reduces the side effects of ACK compression and clustering, it is still dependent to the sender sending rate rather than the available bandwidth of the corresponding TCP connection.

— **TIBET estimation scheme** [25, 24]:

TIBET (Time Interval based Bandwidth Estimation Technique) is another technique that gives a good estimation of bandwidth even in the presence of packet clustering and ACK compression.

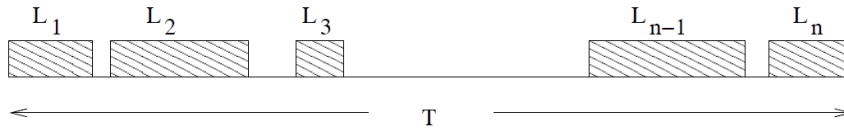

Figure 6.1 – Pattern of packet transmission [25]

To explain the rationale of TIBET, authors refer to the example in Figure 6.1 where transmissions occurring in a period  $T$  are considered. Let  $n$  be the number of packets belonging to a connection and  $L_1, L_2 \dots L_n$  the lengths, in bits, of these packets. The average bandwidth used by the connection is simply given by  $\frac{1}{T} \sum_{i=1}^n L_i$ . If we define  $\bar{L} = \sum_{i=1}^n L_i$ , the authors express the bandwidth ( $Bwe$ ) occupied by the connection as Equation 6.4:

$$Bwe = \frac{n\bar{L}}{T} = \frac{\bar{L}}{\frac{T}{n}} \quad (6.4)$$

The basic idea of TIBET is to perform a run-time sender-side estimate of the average packet length,  $L$ , and the average inter-arrival,  $\frac{T}{n}$ , separately. Following the TCP Westwood approach this can be done by measuring and low-pass filtering the length of acked packets and the intervals between ACKs' arrivals. However, since the authors want to estimate the used bandwidth they can also low-pass filter directly the packets' lengths and the intervals between sending times.

The bandwidth estimation scheme can be applied to the stream of the received ACKs and its pseudocode is described, as indicated in [24], in Algorithm 5:

**Algorithm 5** Bandwidth estimation scheme

---

```

1: if (ACK is received) then
2:   sample_length = (acked × packet_size × 8)
3:   sample_interval = now − last_ack_time
4:   Average_packet_length = alpha × Average_packet_length + (1 − alpha) ×
     sample_length
5:   Average_interval = alpha × Average_interval + (1 − alpha) × sample_interval
6:    $Bwe = \frac{Average\_packet\_length}{Average\_interval}$ 
7: end if

```

---

Where *acked* is the number of segments acknowledged by the last ACK and *packet\_size* is the average segment size in bytes, *now* is the current time and *last\_ack\_time* is the time of the previous ACK reception. *Average\_packet\_length* and *Average\_interval* are the low-pass filtered measures of the packet length and the interval between sending times.

*Alpha* ( $0 \leq \alpha \leq 1$ ) is the pole of the two low-pass filters. The value of *alpha* has a critical impact on TIBET performance: If *alpha* is set to a low value, TIBET is highly responsive to changes in the available bandwidth, but the oscillations of *Bwe* are quite large. On the contrary, if *alpha* approaches 1, TIBET produces more stable estimates, and is less responsive to network changes. Here we note that if *alpha* is set to zero we are in the case of Westwood bandwidth estimation scheme, where the sample *Bwe* varies between 0 and the bottleneck bandwidth.

TIBET employed a second low-pass filtering, with parameter  $\gamma$ , on the estimated available bandwidth *Bwe* in order to give better smoothed estimation  $\widehat{Bwe}$  as described in Equation 6.2. However, authors use a variable parameter  $\gamma$  equal to  $e^{-T_k}$  where  $T_k = t_k - t_{k-1}$  is the time interval between the two last received ACKs. This means that they give more importance to the bandwidth estimation samples *Bwe* with high  $T_k$  value than those of low  $T_k$  values.

The results of simulations made in [24] indicate that TIBET gives bandwidth estimations very close to the correct values, even in the presence of other UDP traffics with variable rates or other TCP flows in concurrence.

To summarize, the background we need to implement our HAS-based TCP congestion control algorithm is as the following:

- adopting the adaptive decrease algorithm for updating *ssthresh*.
- using an efficient end-to-end bandwidth estimator, such as TIBET.

- shaping the sending rate using  $cwnd$ ,  $RTT$  and  $ssthresh$  parameters.
- having informations about the number of quality levels and their encoding rates for the corresponding HAS video.

### 6.3 TcpHas Description

Our conception of HAS-based TCP congestion control algorithm, TcpHas, is mainly based on the two functions; optimal quality level estimation and sending traffic shaping. By taking into consideration the previous explanation about bandwidth estimation,  $ssthresh$  and  $cwnd$  modifications, the basic idea of TcpHas is presented as a flowchart in Figure 6.2:

In fact, TcpHas employs a bandwidth estimator inspired from TIBET scheme and adapted to the

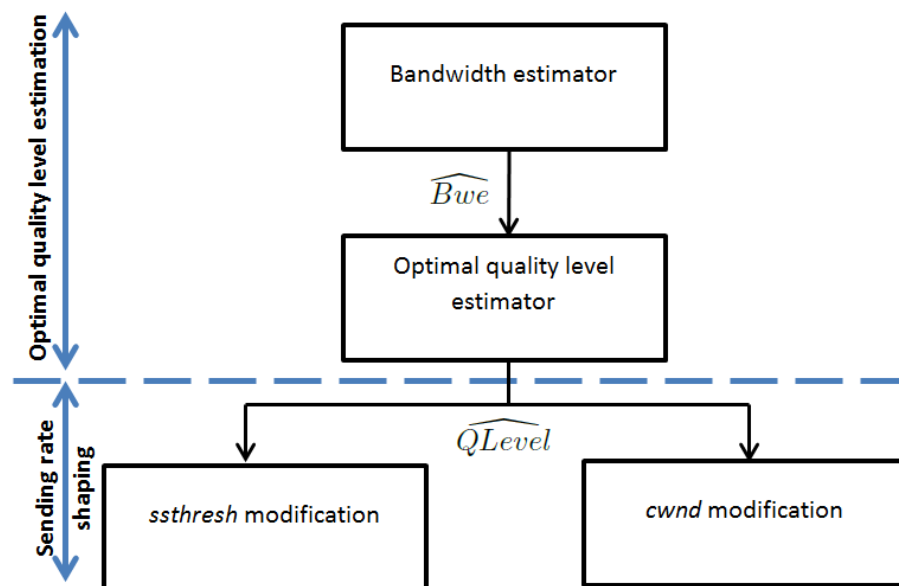

Figure 6.2 – Basic idea of TcpHas

HAS context. Then, the estimated bandwidth,  $\widehat{Bwe}$ , is used by the optimal quality level estimator module to define the quality level,  $\widehat{QLevel}$ . Then,  $\widehat{QLevel}$  is employed during the sending rate shaping process by modifying  $ssthresh$  and  $cwnd$ .

Nevertheless, many questions about details related to this flowchart should find answers:

1. How is configured the bandwidth estimator and how TIBET estimation scheme can be adapted to HAS context ?
2. When should the estimator update its estimated optimal quality level  $\widehat{QLevel}$  (at each ACK reception, periodically, at congestion events or after idle periods ?)
3. Which value should be attributed to  $ssthresh$  to accelerate the convergence speed to

$\widehat{QLevel}$  quality level ?

4. How should  $cwnd$  be limited to match with the sending rate (i.e the encoding rate of  $\widehat{QLevel}$ ) ?

In order to answer these four principal questions in a manner that we progressively present TcpHas algorithm, the remaining of this section is organized as the following: First, we describe TcpHas' bandwidth estimator in Subsection 6.3.1. Second, we present TcpHas' optimal quality level estimator and the in Subsection 6.3.2. Third, we present the updating process of TcpHas'  $ssthresh$  in Subsection 6.3.3. Finally, we describe how TcpHas adapts the  $cwnd$  value to the shaping rate in Subsection 6.3.4.

### 6.3.1 Bandwidth Estimator of TcpHas

As described in Section 6.2, TIBET performs better than previous proposed schemes. It reduces the effect of ACK compression and packet clustering and is less dependent to the congestion window,  $cwnd$ , than Westwood+.

However, the parameter  $\gamma$  employed by TIBET to smooth the  $Bwe$  estimations (see Equation 6.2) is variable and equal to  $e^{-T_k}$ , where  $T_k$  is the time interval between the two last received ACKs [25]. However, this variable parameter is not suitable to the context of HAS. In fact, when HAS stream has a large OFF period, the HTTP Get request packet sent from client to the server to ask for a new chunk is considered on the server side as a new ACK. As a consequence, the new bandwidth estimation sample,  $Bwe$ , has an underestimated value and  $\gamma$  is reduced. Hence, this filter gives higher importance to an underestimated value in the detriment of the previous better estimations. For example, if OFF period is equal to 1 second,  $\gamma$  is equal to 0.36, which means that we give a factor of 0.64 to the new underestimated value in the filtering process. Consequently, the smoothed bandwidth estimation,  $\widehat{Bwe}$ , will be reduced at each high OFF period. However, our objective is rather to maintain a good estimation of available bandwidth, even during idle periods. For this purpose, we proposed that the parameter  $\gamma$  should be constant in order to avoid the risk of available bandwidth underestimation during OFF periods.

Hence, the bandwidth estimator of TcpHas is the same as TIBET bandwidth estimation scheme, except for the low-pass filtering process: we employ a constant value of  $\gamma$  instead of  $e^{-T_k}$  defined by TIBET.

### 6.3.2 Optimal Quality Level Estimator of TcpHas

TcpHas's optimal quality level estimator is based on the estimated bandwidth,  $\widehat{Bwe}$ , as described in Subsection 6.3.1. This estimator is a function that adapts HAS features to TCP congestion control and replaces the  $\widehat{Bwe}$  value by the encoding rate of the estimated optimal quality level  $\widehat{QLevel}$ . To perform this estimator, we need one information from the application layer: the encoding rates available in the server for the corresponding HAS stream. These encoding rates are those indicated in the index file of HAS stream. They are injected into the vector *EncodingRate* in TcpHas algorithm. This vector contains the available encoding rates in ascending order. Our estimator is defined by the function *QLevelEstimator* and is described as the following in Algorithm 6:

---

#### Algorithm 6 QLevelEstimator function description

---

```

1: for reverse  $i = \text{length}(\text{EncodingRate})$  to  $i = 0, i - -$  do
2:   if ( $\widehat{Bwe} \geq \text{EncodingRate}[\widehat{QLevel}]$ ) then
3:     Break
4:   end if
5: end for
6:  $\widehat{QLevel} = i$ 

```

---

*QLevelEstimator* selects the highest quality level that its encoding rate is lower than the estimated bandwidth,  $\widehat{Bwe}$ . We do not tolerate selecting a quality level whose encoding rate is slightly higher than  $\widehat{Bwe}$ . Our justification is that we do not prefer to push the server to take the risk of sending chunks at a high bitrate that may cause congestions.

We also note that  $\widehat{QLevel}$  is an attribute of TcpHas which is only updated by *QLevelEstimator* function and is used over time by TcpHas algorithm. However, the time and the frequency of updating  $\widehat{QLevel}$  is a delicate issue that we should pay attention:

- We still consider the adaptive decrease mechanism (see Algorithm 4), because when a congestion occurs, we should update  $\widehat{QLevel}$  to the new network conditions. Hence, *QLevelEstimator* is launched after each congestion detection to update  $\widehat{QLevel}$ .
- Moreover, given that TcpHas performs a shaping rate that reduces  $\widehat{OFF}$  occupancy, when TcpHas detects an  $\widehat{OFF}$  period, it may mean that some network conditions have been changed (e.g an incorrect increase of the shaping rate for example). Accordingly, to offer a better estimation of optimal quality level, *QLevelEstimator* is also activated after each  $\widehat{OFF}$  period to update  $\widehat{QLevel}$ .



### 6.3.3 Ssthresh Modification of TcpHas

The TCP variants, that adopt the TCP decrease mechanism, employ  $RTT_{min}$  multiplied by the estimated bandwidth,  $\widehat{Bwe}$ , to update  $ssthresh$ . In addition, given that the value of  $ssthresh$  affects the acceleration of convergence speed, it should correspond to the desired shaping rate instead of  $\widehat{Bwe}$ . Moreover, the shaping rate is defined by the authors of Trickle [52] to be 20% higher than the encoding rate. Although a lower amount could give similar results, the authors consider 20% value as a headroom that better allows the server to deal with transient network congestion.

Hence, by taking into consideration the above headroom, TcpHas replaces  $\widehat{Bwe}$  by  $EncodingRate[\widehat{QLevel}] \times 1.2$ , which represents its shaping rate, as the following equation:

$$ssthresh = EncodingRate[\widehat{QLevel}] \times RTT_{min} \times 1.2 \quad (6.5)$$

The timing of  $ssthresh$  updating is the same as that of  $\widehat{QLevel}$ : when detecting a congestion event and just after an  $\widehat{OFF}$  period; a more detailed description is given in Subsections 6.3.3.1 and 6.3.3.2, respectively. Moreover, the initial value of  $ssthresh$  should be modified to correspond to the context of HAS. A detailed explanation of this initialization is presented in Subsection 6.3.3.3.

#### 6.3.3.1 Congestion Events

Inspired from Algorithm 4, the TcpHas algorithm when detecting a congestion event is described in Algorithm 7. This algorithm includes the two cases of congestion events, when receiving 3 duplicated ACKs, and when the retransmission timeout expires. For both cases, TcpHas updates  $\widehat{Qlevel}$  from  $\widehat{Bwe}$  using  $QLevelEstimator$  function. Then, it updates  $ssthresh$  according to Equation 6.5. The update of  $cwnd$  is kept the same as Algorithm 4.

#### 6.3.3.2 Idle Periods

As explained in Section 5.2 (Algorithm 3), the congestion window,  $cwnd$ , is reduced when the idle period exceeds the retransmission timeout  $RTO$  where  $ssthresh$  is updated to  $\max(ssthresh, \frac{3}{4} \times cwnd)$ . Let us recall that the idle period coincides with the OFF period in the context of HAS. Besides, we denote by  $\widehat{OFF}$  the OFF period whose duration exceeds  $RTO$ . Accordingly, reducing  $cwnd$  value after an  $\widehat{OFF}$  period will oblige the  $cwnd$  to switch to the slow start phase although the server is asked to deliver the video content with the optimal shaping rate.

For this purpose, we propose to eliminate the  $cwnd$  reduction after  $\widehat{OFF}$  period. Instead, as explained in Algorithm 8, TcpHas updates  $\widehat{Qlevel}$  and  $ssthresh$ . Then, we set  $cwnd$  to the same

**Algorithm 7** TcpHas algorithm when congestion occurs

---

```

1: if (3 duplicate ACKs are received) then
2:    $\widehat{QL}_{Level} = \mathbf{QLevelEstimator}(\widehat{Bwe})$ 
3:    $ssthresh = \text{EncodingRate}[\widehat{QL}_{Level}] \times RTT_{min} \times 1.2$ 
4:   if ( $cwnd > ssthresh$ ) then
5:      $cwnd = ssthresh$ 
6:   end if
7: end if
8: if (retransmission timeout expires) then
9:    $\widehat{QL}_{Level} = \mathbf{QLevelEstimator}(\widehat{Bwe})$ 
10:   $ssthresh = \text{EncodingRate}[\widehat{QL}_{Level}] \times RTT_{min} \times 1.2$ 
11:   $cwnd = initial\_cwnd$  ▷ i.e  $2 \times MSS$ 
12: end if

```

---

value of  $ssthresh$ . This modification is very useful in the context of HAS. On the one hand, we eliminate the sending rate reduction after each  $\widehat{OFF}$  period which adds additional delay to deliver the next chunk and may cause a reduction of quality level selection on the player side. On the other hand, the update of  $ssthresh$  each  $\widehat{OFF}$  period enables the server to adjust its sending rate more correctly, especially when the client generates high  $\widehat{OFF}$  period between two consecutive chunks.

**Algorithm 8** TcpHas algorithm after an  $\widehat{OFF}$  period

---

```

1: if ( $idle > RTO$ ) then ▷ When  $\widehat{OFF}$  period is detected
2:    $\widehat{QL}_{Level} = \mathbf{QLevelEstimator}(\widehat{Bwe})$ 
3:    $ssthresh = \text{EncodingRate}[\widehat{QL}_{Level}] \times RTT_{min} \times 1.2$ 
4:    $cwnd = ssthresh$ 
5: end if

```

---

**6.3.3.3 Initialization**

The default configuration of TCP congestion control consists of using an initial value of  $ssthresh$ , denoted by  $initial\_ssthresh$ , which is equal to 65535 bytes. The justification of this default value selection comes back to the TCP conception that aims to occupy the whole available end-to-end bandwidth. Accordingly, when setting a high  $initial\_ssthresh$ , the  $cwnd$  will increase exponentially from its initial value,  $initial\_cwnd$ , which is generally equal to 2 MSS, to reach  $ssthresh$ .

However, in the context of HAS, TcpHas should adapt the initial value of *ssthresh* to the encoding rates. At the same time, we prefer setting *initial\_ssthresh* to correspond to the highest quality level at the beginning of the HAS stream. Our methodology is to satisfy two conditions: 1) giving a similar aggressiveness of default TCP configuration at the beginning of TCP session, and 2) avoiding to go far away from the encoding rate of the highest quality level in order to save the HAS traffic shaping concept. Accordingly, we decide to set the *initial\_ssthresh* to correspond to the highest quality level.

Given that setting *initial\_ssthresh* according to the highest quality level should be done in conformity with Equation 6.5, the computation of *RTT* is needful. Consequently, TcpHas just update the *ssthresh* when the first *RTT* is computed. In this case, our updated *ssthresh* serves the same purpose as *initial\_ssthresh*. The TcpHas initialization algorithm is presented in Algorithm 9:

---

**Algorithm 9** TcpHas initialization

---

```

1:  $\widehat{QLevel} = length(EncodingRate)$  ▷ the highest quality level
2:  $cwnd = initial\_cwnd$  ▷ i.e  $2 \times MSS$ 
3:  $ssthresh = initial\_ssthresh$  ▷ i.e 65535 Bytes
4:  $RTT = 0$ 
5: if ((New ACK is received)) then
6:   if ( $RTT \neq 0$ ) then ▷ i.e When the first RTT is computed
7:      $ssthresh = EncodingRate[\widehat{QLevel}] \times RTT \times 1.2$ 
8:   end if
9: end if

```

---

### 6.3.4 Cwnd Modification of TcpHas for Traffic Shaping

We showed in Subsection 6.2.2 the Trickle method for HAS traffic shaping on the server-side that sets a maximum bound of *cwnd*. This maximum bound is equal to the shaping rate multiplied by the actual *RTT*. However, during congestion avoidance phase (i.e, when  $cwnd > ssthresh$ ), *cwnd* is increased very slowly by one MSS every one *RTT*. As a consequence, when *cwnd* is lower than this bound, it would take several *RTTs* to reach it. As a consequence, a slow convergence speed could be caused.

Instead, we try to change the congestion avoidance algorithm of TCP by directly tuning *cwnd* to match with the shaping rate. Given that TcpHas does not change its shaping rate ( $EncodingRate[\widehat{QLevel}] \times 1.2$ ) during the congestion avoidance phase (see Subsection 6.3.2), *cwnd* is updated according to *RTT* variation. However, in this case, we confronted a problem

related to  $RTT$  variation. This problem is presented as the following dilemma:

- On the one hand, the increase of  $RTT$  means that additional queuing delay is being emphasized and could cause congestions when the congestion window,  $cwnd$ , is still increasing. Even worse, if the standard deviation of  $RTT$  is important (e.g, in the case of wireless home network, or instable network conditions), an important jitter of  $RTT$  would oblige  $cwnd$  to increase suddenly and would cause a heavy congestion.
- On the other hand, the increase of  $RTT$  over time should be taken into consideration by the server in its  $cwnd$  updating process. In fact, as the authors of SABRE [94] reveal, during the ON period of a HAS stream, the  $RTT$  value is increasing. Consequently, using a constant value of  $RTT$  (such as  $RTT_{min}$ ) does not take into consideration this increase of  $RTT$  and may result into a lower shaping rate than the desirable one. Accordingly, following the change of  $RTT$  measurements over time is necessary for an accurate shaping purpose.

One way to mitigate  $RTT$  fluctuation and taking into consideration the increase of  $RTT$  during ON period, is using smoothed  $RTT$  computations. We propose employing a low-pass filter for this purpose. We denote by  $\widehat{RTT}$  the smoothed  $RTT$  that it is updated at each ACK reception as described in Equation 6.6:

$$\widehat{RTT} = \psi \times \widehat{RTT} + (1 - \psi) \times RTT \quad (6.6)$$

Where  $0 \leq \psi \leq 1$ . Given that the shaping rate is defined in TcpHas as  $EncodingRate[\widehat{QLevel}] \times 1.2$ , the TcpHas algorithm during the congestion avoidance phase is as described in Algorithm 10:

---

**Algorithm 10** TcpHas algorithm in congestion avoidance phase

---

- 1: **if** ((*New ACK is received*) **and** ( $cwnd \geq ssthresh$ )) **then**
  - 2:      $cwnd = EncodingRate[\widehat{QLevel}] \times \widehat{RTT} \times 1.2$
  - 3: **end if**
- 

In this section, we have presented the TcpHas algorithm that it is both a HAS-based TCP congestion control algorithm and a server-based shaping method. We have given justifications for each choice we made during the proposition of this variant. In the next section, we present the performance evaluation of TcpHas under various conditions.

## 6.4 TcpHas Evaluation

In this section, we evaluate the performance of HAS when employing our proposed TCP congestion control variant, TcpHas. The use case is when HAS players are sharing the same bottleneck link and are competing for bandwidth inside the home network. For this evaluations, we used our implementation of ns-3 as described in Section 3.4 and we employ QoE and QoS metrics in conformity to their definitions in Section 3.5. We used the same HAS player as described in Section 3.2. For all evaluations we used competing players which are playing simultaneously during 180 seconds. Then, we compare performances between TcpHas and Westwood+. We selected Westwood+ as reference for our evaluation because it is a well-known TCP variant widely used and it presents better performances than Westwood in the case of ACK compression and clustering. In addition, the Westwood+ has been used in Chapter 4 in our evaluation. Hence, we tend to conserve the same reference to offer a better consistency between chapters.

We also notice that the optimal quality level  $L_{C-S,opt}$  used in this evaluation is obtained by selecting the highest encoding rate among quality levels (there are five quality levels with index  $0 \leq L_{C-S} \leq 4$  in our implementation) that is lower than the result of dividing the bottleneck bandwidth by the number of competing HAS players  $N$ , as described in Equation 6.7:

$$L_{C-S,opt} = \left\{ \max_{0 \leq L_{C-S} \leq 4} (L_{C-S}) \mid (EncodingRate(L_{C-S}) \times 1.2) \leq \frac{avail\_bw}{N} \right\} \quad (6.7)$$

In the case of same encoding rates among competing HAS players, our assumption means that all competing HAS flows should have the same optimal quality level (i.e, same shaping rate). Here we focus on fairness of quality level among HAS flows rather than the maximum occupancy of the bottleneck bandwidth.

For this purpose, we describe the parameter settings that we used during our simulations for both evaluation and configuration of TcpHas in Subsection 6.4.1. Then we give and comment results of evaluation in different scenarios: when increasing the number of competing HAS flows in the home network in Subsection 6.4.2, when varying the HAS player parameters in Subsection 6.4.3 and when changing network conditions in Subsection 6.4.4.

### 6.4.1 TcpHas Parameter Settings

The parameter  $\gamma$  of  $\widehat{Bwe}$  low-pass filter is configured as a constant value in conformity with Subsection 6.3.1. We set  $\gamma = 0.99$  in order to reduce the oscillation of bandwidth estimations,  $\widehat{Bwe}$ , over time.

Moreover, the initial bandwidth estimation value of  $\widehat{Bwe}$  is set to the highest encoding rate.

This initial value is very important for the low-pass filtering process of  $\widehat{Bwe}$ . In fact, if the first value is set to zero or to the first estimation sample, which both do not reflect the right estimation, the low-pass filtering process with parameter  $\gamma = 0.99$  will be too slow to reach the correct estimation. In addition, our methodology is to be aggressive at the beginning of the HAS stream and to try to reach the highest quality level, as explained in Subsection 6.3.3.3. Hence the justification of adopting the highest encoding rate as initial value of  $\widehat{Bwe}$  for TcpHas.

The parameter *alpha* of TIBET estimation scheme (see Algorithm 5) is chosen empirically in our simulations and is set to 0.8. In fact, on the one hand, using higher value such as 0.99 produces more stable estimations but less responsive to network changes: our simulations indicated that TcpHas becomes too much conservative and is more likely to select lower quality level than the optimal quality level, even when the HAS client is located alone inside the home network. On the other hand, when *alpha* is set at a lower value, such as 0.6, TcpHas becomes more aggressive and have tendency to select the quality level that corresponds to the whole bandwidth of the home network: our simulations indicated that TcpHas engenders unfairness of quality level selection between competing HAS players. The cause comes back to the bandwidth estimation at the beginning where one of the competing players selects the highest quality level, and the rest of competing players would share the rest of the available bandwidth. Here, we are more likely to face the problems of ACK compression and packet clustering. For instance, the value of 0.8 seems to be adequate in the majority of use cases in our simulations.

The parameter  $\psi$  used for low-pass filtering the *RTT* measurements in Subsection 6.3.4 is set to 0.99. Our justification of this value is that it reduces better the *RTT* fluctuations, and consequently reduces *cwnd* fluctuation during congestion avoidance phase. Our simulations indicated that with  $\psi = 0.99$  TcpHas gives better performances especially when the network conditions degrade.

#### 6.4.2 Effect of Increasing the Number of HAS Flows

In this subsection we show the robustness of TcpHas against the increase of competing HAS clients in the same home network. Here, we vary the number of competing players from 1 to 9 clients. We select 9 as the maximum number of competing HAS clients, because, in practice, the number of users inside the home network does not exceed 9 users. The mean performance measurements between competing players are presented in Figure 6.3. We indicate the performance unfairness measurements between HAS clients with vertical error bars.

Concerning the QoE measurements, the first observation is taken from the Figure 6.3a where the instability rate of TcpHas is kept much lower than Westwood+ (less than 4%) with a negligible

instability unfairness between players, while the instability of Westwood+ increases when increasing the number of competing players. The infidelity and convergence speed of TcpHas gives good measurements as presented in Figures 6.3b and 6.3c: infidelity rate is lower than 30% and convergence speed lower than 50 seconds. This assumption is valid excepting two cases: when the number of competing HAS clients is equal to 5 or 9. In fact, in these two cases, TcpHas selects higher quality level than the optimal quality level that we define for our evaluation; TcpHas was able to select higher quality level, to converge to it and be stable on it for all the time of simulation. This result is rather beneficial, because TcpHas was able to maximize the occupancy of the home bandwidth to near 100% in these two particular cases. Moreover, the initial delay of both TcpHas and Westwood+ is increased when the number of competing HAS clients increases as presented in Figure 6.3d: This result is predictable. In fact, during the buffering phase the HAS player asks for chunks successively. Consequently, when the number of competing HAS clients increases, the bandwidth would be shared between HAS flows and generates additional delay. We also remark that TcpHas presents a slight lower initial delay than Westwood+. The main cause is that Westwood+ is more dependent to  $cwnd$  than TcpHas. In fact, both variants select initial  $ssthresh$  at a higher values (at 65535 for Westwood+ and at a value that corresponds to the highest quality level for TcpHas). Hence, when increasing the number of competing HAS flows, the aggressiveness of HAS flows is increased. Consequently, a more imminent congestion event is generated. Knowing that Westwood+ bandwidth estimation scheme is highly dependent to the congestion window value,  $cwnd$  and given that  $cwnd$  cannot be sufficiently increased in the case of imminent congestion, the new selected  $ssthresh$  is set to a low value. In contrast, TcpHas sets  $ssthresh$  at a higher value because it is less dependent to  $cwnd$  in its bandwidth estimation scheme. Hence, TcpHas offers better throughput to HAS clients which slightly accelerates the buffering phase. In addition, we observe in Figure 6.3i that TcpHas generates no stalling events, unlike Westwood+. In contrast, Westwood+ causes more stalling events when the number of competing HAS clients exceeds 7 clients. This observation is a direct result of the high stability rate that TcpHas is able to preserve even with high number of competing HAS clients.

Concerning QoS measurements, we remark that the  $\widehat{OFF}$  period frequency of TcpHas is kept near to zero and far lower than Westwood+, excepting the case of only one HAS client presents in the home network. As shown in Figure 6.3e, in the latter case, the optimal quality level is  $n^{\circ}4$  whose encoding rate is 4.256 Mbps. Hence, the chunk size is equal to 8.512 Mbits. Consequently, when TcpHas shapes the sending rate according to this encoding rate while delivering chunks with large sizes, it would be difficult to reduce  $OFF$  periods below the retransmission timeout duration,  $RTO$ . Fortunately, we have taken this case into consideration when proposing TcpHas by eliminating the reduction of  $cwnd$  after idle periods in order to preserve high QoE. Moreover,

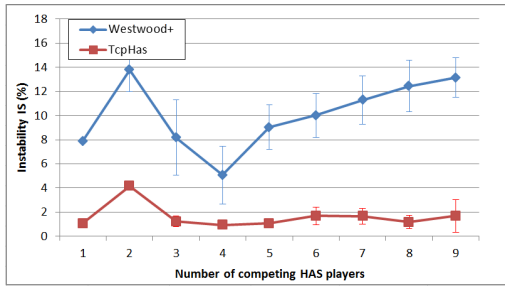

(a) Instability vs. number of HAS player

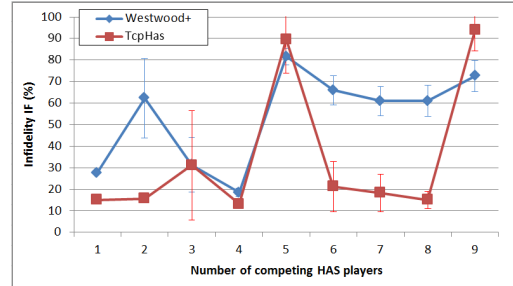

(b) Infidelity vs. number of HAS player

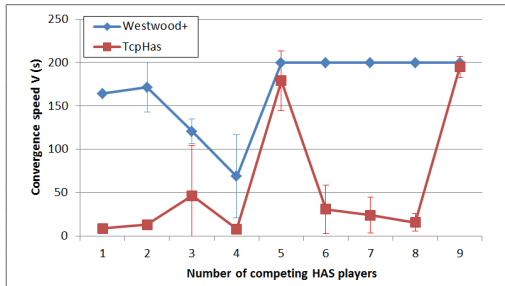

(c) Convergence speed vs. number of HAS player

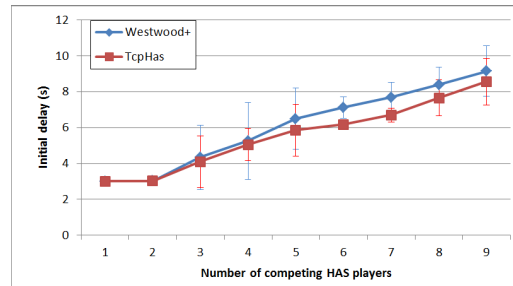

(d) Initial delay vs. number of HAS player

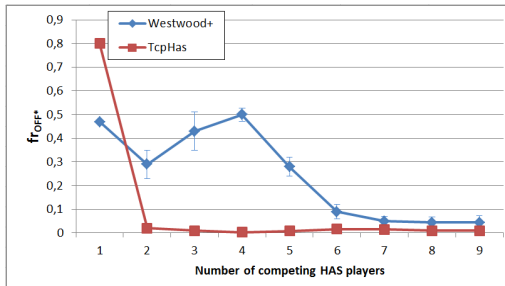

(e)  $f_{OFF}$  vs. number of HAS player

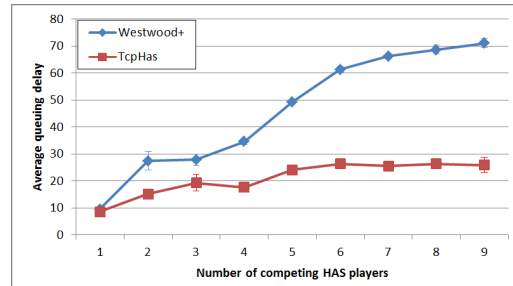

(f) Queuing delay vs. number of HAS player

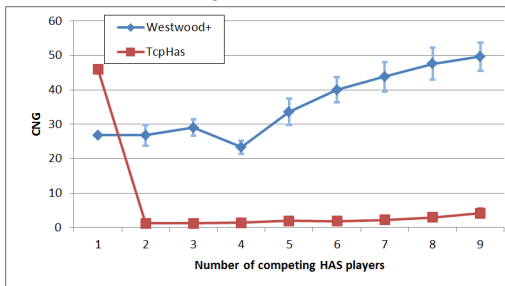

(g) Congestion rate vs. number of HAS player

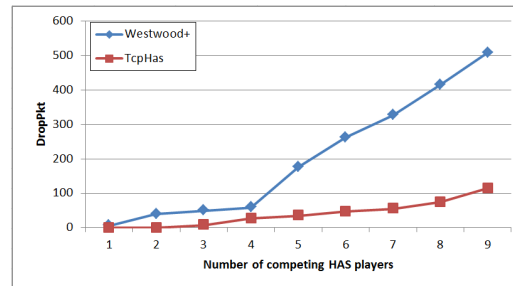

(h) packet drop rate vs. number of HAS player

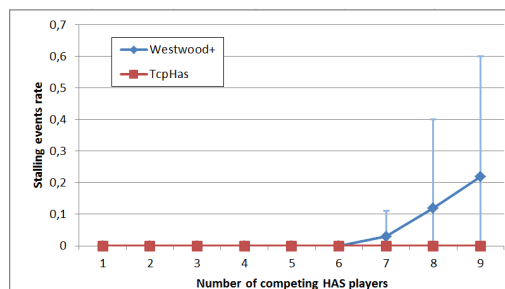

(i) Stalling event rate vs. number of HAS player

Figure 6.3 – Performance measurements when increasing the number of HAS competing clients



as presented in Figure 6.3f, although the queuing delay of both TcpHas and Westwood+ is increased when increasing the number of competing HAS clients, TcpHas generates practically the half queuing delay of Westwood+. This result is mainly due to the high stability of HAS quality level generated by TcpHas which offers better fluidity of HAS flows inside the bottleneck. Furthermore, this stability of TcpHas dramatically reduces the congestion detection rate and the packet drop rate at the bottleneck as shown in Figures 6.3g and 6.3h.

To summarize, TcpHas is not disturbed by the increase of the competing HAS clients in the same home network in both considerations; QoE and QoS. For QoE measurements, it preserves high stability and high fidelity to optimal quality level, and has tendency to increase the occupancy of the home bandwidth. While for QoS, it keeps low  $\widehat{OFF}$  period duration, low queuing delay and low packet drop rate.

### 6.4.3 Effect of Variation of Player Parameters

In this subsection, we study the effect of player parameters on TcpHas performances. For this purpose, we select two main important parameters: the player buffer size and the chunk duration. The scenario is when two HAS players are competing for bandwidth simultaneously during 3 minutes.

#### 6.4.3.1 Playback Buffer Size effect

Given that Live and VoD streaming services differ by the size of playback buffer as explained in Subsection 2.2.2.3, studying the effect of playback buffer size on TcpHas performances comes back to studying the behavior of TcpHas in Live and VoD HAS video streaming. In Figure 6.4 we present the performance metric measurements of TcpHas and Westwood+ for different lengths of playback buffer ranging from 6 to 30 seconds. We remember that the common value of buffer length for Live streaming service is around 8 seconds and that for VOD around is 30 seconds as indicated in Subsection 2.2.2.3.

Concerning the QoE measurements, we observe that TcpHas outperforms Westwood+. In fact, as presented in Figure 6.4a, TcpHas has an instability rate around 4% even with the lowest playback buffer size of 6 seconds, while Westwood+ has a rate around 14%. The infidelity rate of TcpHas is increased linearly and slowly when increasing the playback buffer size and is still far lower than Westwood+ as indicated in Figure 6.4b: it is between 5 and 7 times lower than infidelity rate of Westwood+. We notice that the increase of infidelity rate when increasing the playback buffer size is obviously justified by the selection of the lowest quality level during the buffering

state. Consequently, when the playback buffer size is increased, the number of selected chunks with the lowest quality level is increased, hence the increase of infidelity rate. In addition, TcpHas has a higher convergence speed than Westwood+, as presented in Figure 6.4c: the convergence speed rate is around 12 seconds while it varies between 100 and 200 seconds with Westwood+. Moreover, TcpHas presents the same initial delay with Westwood+ as shown in Figure 6.4d: it ranges between one to three seconds. The linear increase of initial delay when increasing the playback buffer size is obvious. A larger playback buffer necessitates a larger delay to be filled by chunks before displaying video content. Besides, we remark that playback buffer size lower than 16 seconds generates a high risk of stalling event. As presented in Figure 6.4i, both TcpHas and Westwood+ cause stalling events for the two playback buffer sizes 6 s and 10 s. However, TcpHas presents a lower stalling event rate than Westwood+ (0.5 vs. 2 for playback buffer size of 6 seconds). We also notice that the unfairness of QoE between the two competing HAS clients, which is presented by vertical error bars, is very negligible in contrast with Westwood+; this result is verified for the four QoE measurements of this paragraph.

Concerning the QoS measurements, we observe that TcpHas saves the same low  $\widehat{OFF}$  frequency independently to the playback buffer size as shown in Figure 6.4e. Besides, it keeps practically the same low value of average queuing delay (15 seconds) which is 67% lower than that of Westwood+ as presented in Figure 6.4f. In addition, the congestion detection rate of TcpHas is also maintained at the same low value independently to the playback buffer size as presented in Figure 6.4g while the congestion detection rate of Westwood+ is kept extremely high. This result is explained by Figure 6.4h which indicates that the bottleneck does not practically drop packets when employing TcpHas. In contrast, Westwood+ is much aggressive and causes a higher congestion rate when increasing the playback buffer size.

To summarize, in this use case TcpHas largely outperforms Westwood+ in both QoE and QoS measurements. In addition, TcpHas is slightly affected by the playback buffer size.

### 6.4.3.2 Chunk Duration Effect

As indicated in Subsection 2.2.2.2, majority of HAS players employs a chunk duration of 2 seconds. However, some others employs higher duration; such as Adobe HDS, which ranges between 2 and 5 seconds [85], and Apple HLS, which uses the highest value of 10 seconds just because of problems related to the refresh process of the index file. In order to study the effect of chunk duration on TcpHas performances, we launched simulations with different chunk duration ranging from 2 to 7 seconds. The use case is when two HAS clients are competing inside the same home network. The results are shown in Figure 6.5.

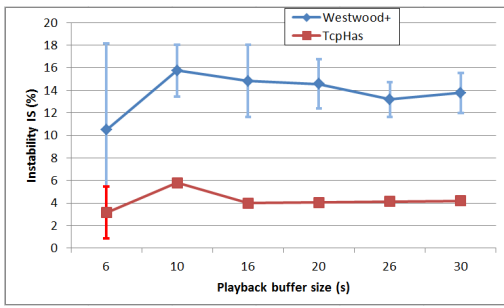

(a) Instability vs. playback buffer size

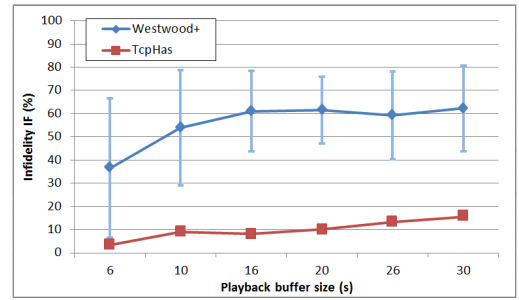

(b) Infidelity vs. playback buffer size

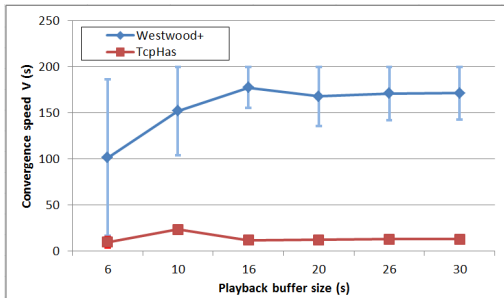

(c) Convergence speed vs. playback buffer size

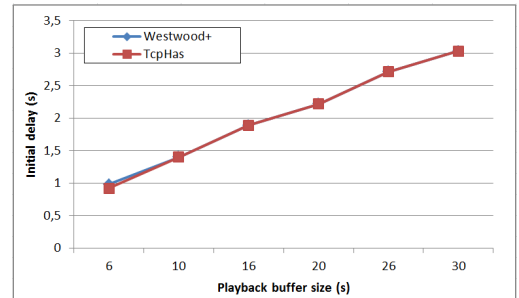

(d) Initial delay vs. playback buffer size

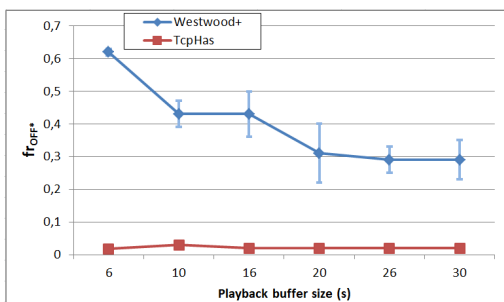

(e)  $f_{OFF}$  vs. playback buffer size

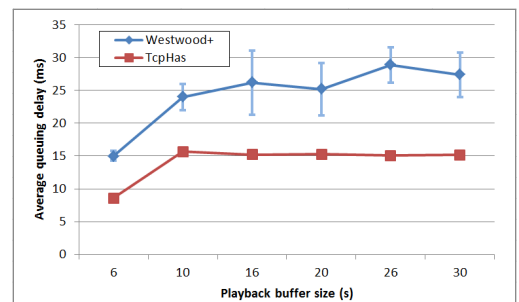

(f) Queuing delay vs. playback buffer size

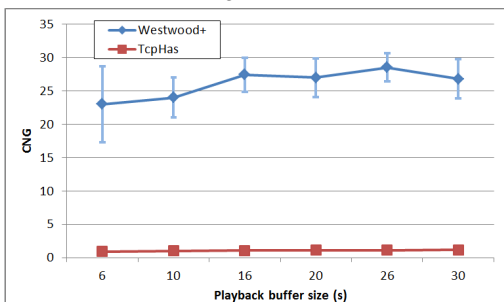

(g) Congestion rate vs. playback buffer size

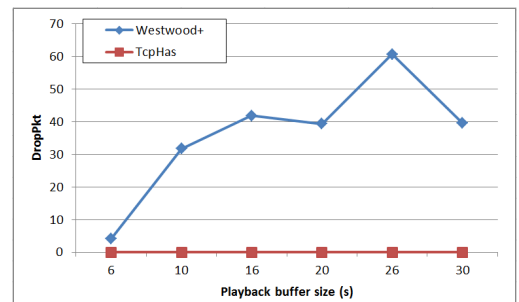

(h) Packet drop rate vs. playback buffer size

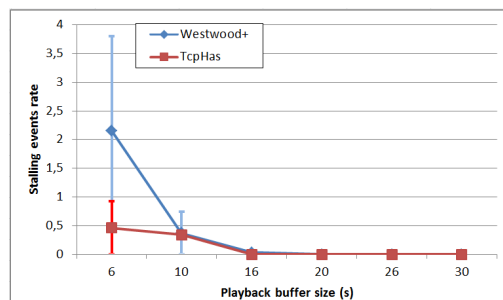

(i) Stalling event rate vs. playback buffer size

Figure 6.4 – Performance measurements when increasing the playback buffer size

Concerning the QoE measurements, we observe in Figure 6.5a that the instability rate of TcpHas decreases from 4% to less than 2% when the chunk duration increases from 2 seconds to 7 seconds. Similarly, Westwood+ decreases from 14% to 5%. Here, we notice that TcpHas is much more stable than Westwood+ while they both improve their stability when increasing the chunk duration. Moreover, the infidelity rate of TcpHas is maintained lower than Westwood+ (for example 15% vs. 57% when using a 4-second-duration chunk) as shown in Figure 6.5b. This rate is decreased for Westwood+ when increasing the chunk duration. However, we observe that the infidelity suddenly increases with a high unfairness value (indicated by the red vertical error bars) with TcpHas when the chunk duration is higher than 5 seconds. When examining the quality level selection of both clients, we found that one of the players selects a higher quality level than the defined optimal quality level,  $L_{C-S,opt}$ . Given that the sum of the encoding rates of the two selected quality levels does not exceed the home bandwidth but, instead, it maximizes its occupancy, we can say that this result is rather positive. The cause of this behavior change of TcpHas is explained in Subsection 2.4.2: a larger chunk duration offers higher quality selection and gives better stability. Hence, when TcpHas estimates the bandwidth with a large chunk duration, the estimation is much stable and much close to the real available bandwidth. Consequently, TcpHas tolerates to set  $\widehat{QLevel}$  higher than  $L_{C-S,opt}$  and adapts the shaping rate to its corresponding encoding rate for one of the two HAS flows. The same remark is given for the convergence speed measurement as indicated in Figure 6.5c. We observe that TcpHas offers and maintains a much higher convergence speed than Westwood+ (lower than 13 seconds vs. higher than 100 seconds). When the chunk duration is higher than 5 seconds, TcpHas rapidly converges to the selected quality levels that maximize the bandwidth occupancy. Accordingly, we can conclude that increasing the chunk duration improves the three QoE measurements (instability, infidelity and convergence speed) of TcpHas; even a duration of chunk higher than 5 seconds would further improve the bandwidth occupancy. Moreover, we observe in Figure 6.5d that the initial delay of both TcpHas and Westwood+ slightly decreases when increasing the chunk duration. Although TcpHas records slightly higher initial delay, it does not disturb the user's QoE because it is still low (lower than 3 seconds) and lower than the threshold of 16 seconds defined in [65] (see Subsection 2.4.1.2). We also note that no stalling event has been recorded for both TCP variants.

Concerning the QoS measurements, we remark that the  $\widehat{OFF}$  frequency is suddenly increased from a chunk duration of 2 seconds to 4 seconds as shown in Figure 6.5e and becomes stable around  $0.85 \widehat{OFF}$  period per chunk. This result is expected, because reducing the OFF periods of large chunk durations below the retransmission timeout duration,  $RTO$ , during the shaping process becomes more difficult. The QoE has not been affected by this parameter modification because we eliminated in TcpHas the reduction of  $cwnd$  after each idle period. This modification was able

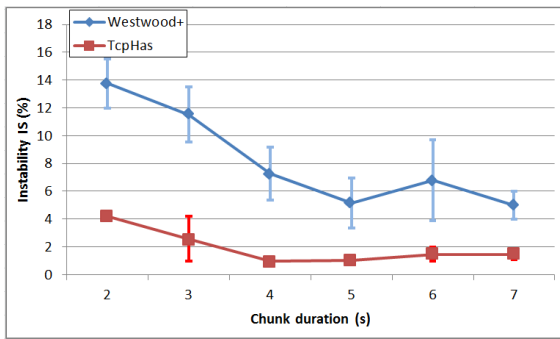

(a) Instability vs. chunk duration

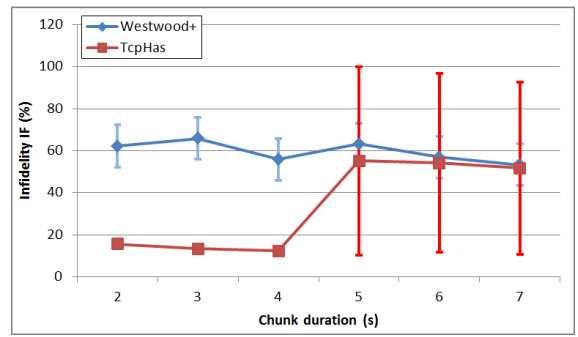

(b) Infidelity vs. chunk duration

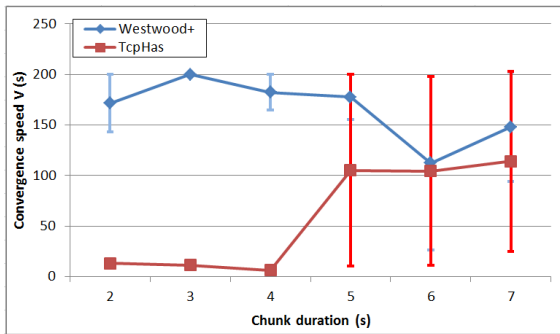

(c) Convergence speed vs. chunk duration

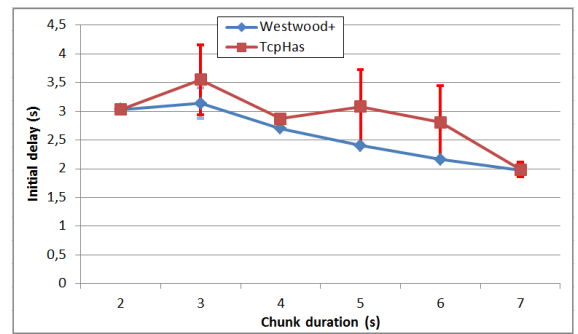

(d) Initial delay vs. chunk duration

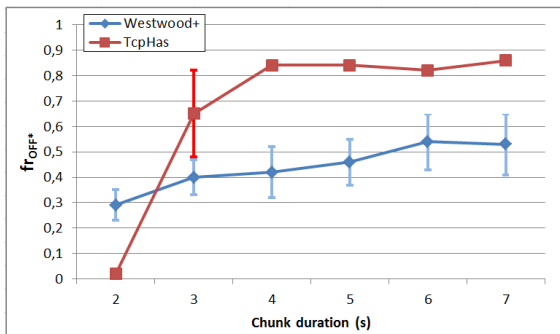

(e)  $fr_{OFF}^*$  vs. chunk duration

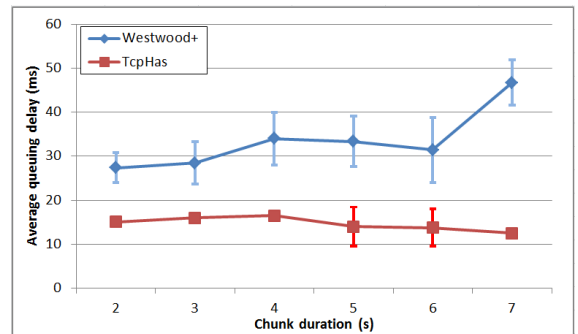

(f) Queuing delay vs. chunk duration

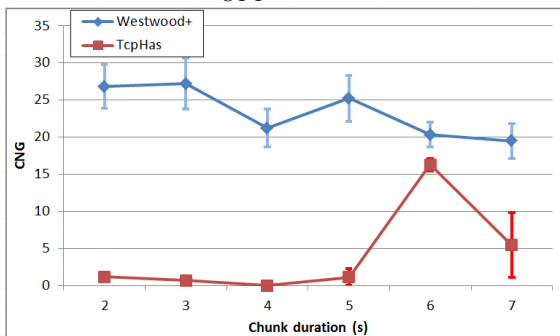

(g) Congestion rate vs. chunk duration

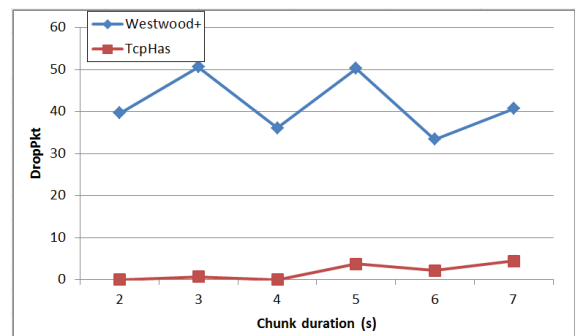

(h) Packet drop rate vs. chunk duration

Figure 6.5 – Performance measurements when increasing the chunk duration

to avoid destabilizing the shaping rate as explained in Subsection 6.3.3.2. Moreover, according to Figure 6.5f, we observe that the average queuing delay is maintained stable with TcpHas (around 12~15 ms). In contrast, it increases with Westwood+ from 28 ms to 45 ms when increasing the chunk duration from 2 to 7 seconds. Besides, we observe a low congestion detection rate with TcpHas in Figure 6.5g. In contrast, Westwood+ records a much higher rate but it decreases when increasing the duration of chunk. We also remark that TcpHas always generates a negligible packet drop rate at the bottleneck with a slight increase when increasing the chunk duration, as presented in Figure 6.5h. Accordingly, these observations reflect that TcpHas maintains a good QoS for different values of chunk duration.

To summarise, we can say that the increase of chunk duration is slightly beneficial for QoE with TcpHas and it stimulates it to improve the bandwidth occupancy. However, the chunk duration has practically no effect on the QoS measurements of TcpHas, excepting the frequency of  $\widehat{OFF}$  which is increased.

#### 6.4.4 Effect of Variation of Network Parameters

Network conditions have a direct implication on the HAS performances because they highly affect the behavior of HAS players as overviewed in Subsection 2.4.2. In order to study the effect of the network conditions on TcpHas, we select two use cases: when changing the initial round trip time of the competing HAS flows, and when increasing the arrival rate of IP traffic. These two use cases have been simulated and results are presented in Subsections 6.4.4.1 and 6.4.4.2, respectively.

##### 6.4.4.1 Initial Round-trip Propagation Delay Effect

In this subsection we study the effect of the initial round-trip propagation delay  $RTT_{C-S}^0$  between client C and server S on HAS performances when using TcpHas. For this purpose, we employ the following use case: when two HAS flows have the same  $RTT_{C-S}^0$  while their corresponding HAS clients are competing inside the same home network. We vary the initial round-trip propagation delay for both HAS clients from 25 ms to 200 ms.

Here we notice that the queue length of the bottleneck (DSLLine in Figure 3.2) is set to the bandwidth delay product value when changing  $RTT_{C-S}^0$  for each simulation. The QoE and QoS measurements are presented in Figure 6.6.

Concerning the QoE measurements, we observe in Figure 6.6a that TcpHas has an overall instability rate around 5% for different  $RTT_{C-S}^0$  values. In contrast, this rate varies between 1%

and 15%. TcpHas gives more guarantee of a good rate of instability. Moreover, we observe in Figure 6.6b that TcpHas have a low instability metric when  $RTT_{C-S}^0$  is ranging between 25 ms and 100 ms. However, when increasing  $RTT_{C-S}^0$  above 125 ms, the infidelity rate decreases to reach 60% with a high infidelity unfairness value between the two competing clients (indicated by red vertical error bars). When verifying the results of simulations, we found that one of the competing clients select quality level 4 instead of quality level 3. Here we note that the optimal quality level used for our evaluation,  $L_{C-S,opt}$ , is equal to 3. In addition, we found that the estimated optimal quality level of TcpHas,  $\widehat{QLevel}$ , is set to 4 instead of 3 for only one TCP session. Hence, TcpHas offers a higher quality level for one HAS flows. Given that the sum of the encoding rates of the two selected quality levels (3 and 4) does not exceed the total home bandwidth but, instead, it maximizes its occupation, we can say that this result is rather positive. The cause of this behavior of TcpHas for high  $RTT_{C-S}^0$  is the length of the bottleneck queue length. In fact, as we indicated above, this queue length is equal to the bandwidth-delay product. The bandwidth used for this computation is the total home bandwidth. Accordingly, the remaining amount of subtraction between the available bandwidth and two times the encoding rate of the optimal quality level in our case is relatively important (it is equal to 4.1 Mbps in our simulations). Multiplying this value with a higher  $RTT_{C-S}^0$  generates a high supplementary available space in the bottleneck queue. In addition to that, with a high  $RTT_{C-S}^0$  value, the HAS flow fills slowly the bottleneck queue. Consequently, TcpHas finds that it could select a higher quality level easily. We also remark that the convergence speed to the estimated optimal quality level is very low as for lower  $RTT_{C-S}^0$  values as shown in Figure 6.6c. However, when increasing  $RTT_{C-S}^0$  above 125 ms, the convergence speed increases suddenly. We verify that the players converge rapidly to the selected quality levels (3 and 4) instead of the quality level 3, which is rather beneficial. Moreover, TcpHas offers practically the same initial delay as Westwood+ as shown in Figure 6.6d. They both have their initial delay increased when using higher  $RTT_{C-S}^0$  values. This result is obvious because increasing  $RTT_{C-S}^0$  increases the transmission delay and, consequently, increases the buffering delay. Besides, the initial delay is kept relatively low, 5.3 seconds even with  $RTT_{C-S}^0$  equals to 200 ms. We also note that no stalling events have been recorded for the simulations of this subsection.

Concerning the QoS measurements, we remark that TcpHas keeps a low frequency of  $\widehat{OFF}$  periods for high  $RTT_{C-S}^0$  values as presented in Figure 6.6e. Moreover, the mean queuing delay of TcpHas is increased from 5 ms to 40 ms as shown in Figure 6.6f. However, in terms of percentage and the quality level selection, the queuing delay of TcpHas is much lower than Westwood+. In addition, we observe in Figure 6.6g and Figure 6.6h that the congestion detection rate and the packet drop rate at the bottleneck of TcpHas is very negligible when  $RTT_{C-S}^0$  is lower than 125

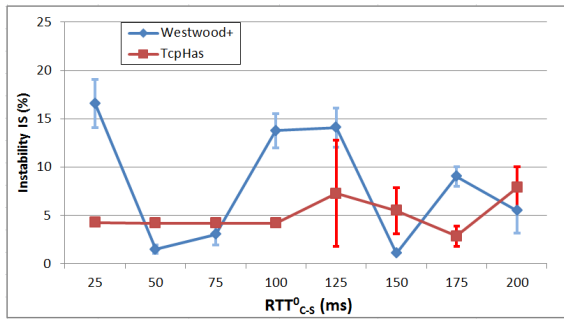

(a) Instability vs.  $RTT^0_{C-S}$

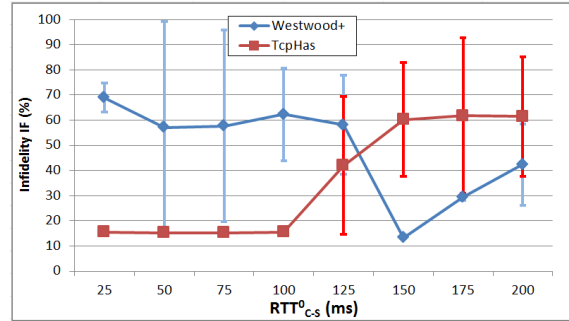

(b) Infidelity vs.  $RTT^0_{C-S}$

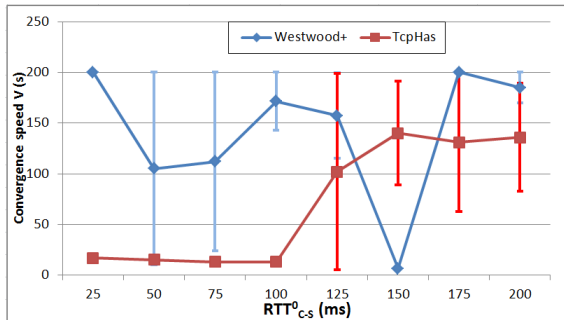

(c) Convergence speed vs.  $RTT^0_{C-S}$

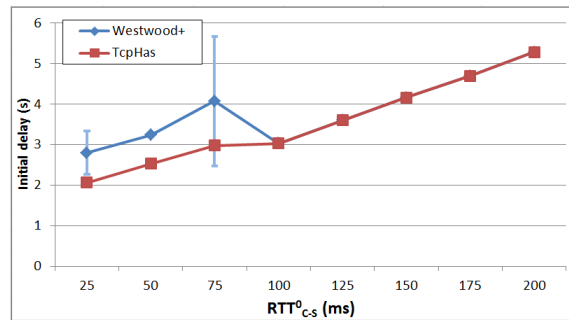

(d) Initial delay vs.  $RTT^0_{C-S}$

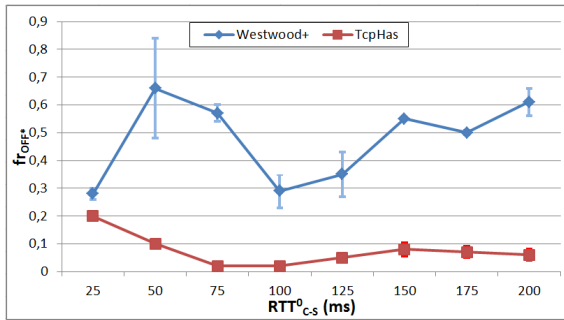

(e)  $f_{r_{OFF}}$  vs.  $RTT^0_{C-S}$

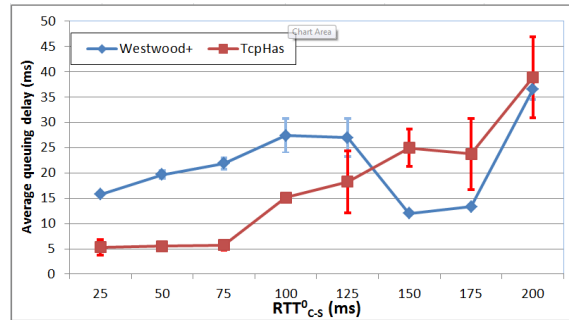

(f) Queuing delay vs.  $RTT^0_{C-S}$

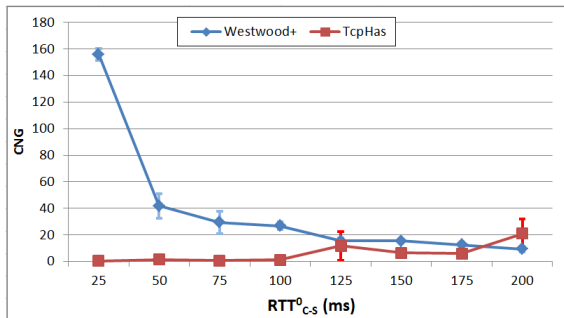

(g) Congestion rate vs.  $RTT^0_{C-S}$

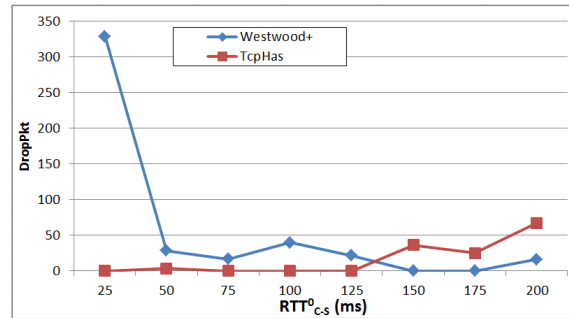

(h) Packet drop rate vs.  $RTT^0_{C-S}$

Figure 6.6 – Performance measurements when changing  $RTT^0_{C-S}$  value



ms. This rate is slightly increased when  $RTT_{C-S}^0$  is above 125 ms: the reason is the competition between the two clients to select a higher quality level; it causes a small congestion at the bottleneck before this quality level is attributed to one of them. In contrast, Westwood+ decreases its congestion detection rate and the packet drop rate at the bottleneck. In fact, it becomes unable to select high quality levels because of the additional transmission delay caused by high  $RTT_{C-S}^0$ .

To summarize, TcpHas performs well for different  $RTT_{C-S}^0$ . In terms of QoE, it offers good measurements for low  $RTT_{C-S}^0$  values, while it rather tends to further maximize the occupancy of bandwidth for high  $RTT_{C-S}^0$  values. In terms of QoS, it offers acceptable measurements for all  $RTT_{C-S}^0$  values.

#### 6.4.4.2 IP Traffic Effect

In order to study the effect of IP traffic on the performance of TcpHas, we vary the burst arrival rate  $\lambda_p$  of the Poisson Pareto Burst Process (PPBP) that simulates the traffic that cross Internet Router (IR) and DSLAM (see Subsection 3.4.2). Knowing that in our configuration the ISP network (ISPLink in our ns-3 implementation) capacity is *100 Mbps*, we cited in Table 4.5 (Subsection 4.5.3.2) the percentage of ISP network occupancy for each selected  $\lambda_p$  value (without counting HAS traffic). In our simulations, we used two competing HAS clients inside the same home network. The results of simulations are listed in Figure 6.7.

Concerning the QoE measurements, we found that the instability, infidelity, convergence speed and stalling events rate curves of TcpHas present two different regimes as presented in Figures 6.7a, 6.7b, 6.7c and 6.7i: When ( $\lambda_p < 35$ ) TcpHas keeps practically the same satisfying measurements far better than Westwood+. However, when  $\lambda_p$  exceeds 35, the four measurements degrade suddenly and stabilize around same high values; Even for infidelity and stalling rate, TcpHas presents worse measurements than Westwood+. Hence, TcpHas is sensitive to additional load of ISP network that could be more harmful than Westwood+. However, we observe in Figure 6.7d that TcpHas presents the same initial delay as Westwood+, which is around 3 seconds and does not exceed 5 seconds and does not disturb the user's QoE.

Concerning QoS measurements, despite the high frequency of  $\widehat{OFF}$  periods generated by Westwood+ which decreases when increasing the ISP network occupancy, TcpHas presents the same low  $\widehat{OFF}$  frequency, as shown in Figure 6.7e. In addition, the average queuing delay generated by TcpHas is lower than that of Westwood+, excepting the case where  $\lambda_p$  exceeds 40. The reason of that is explained in Figures 6.7g and 6.7h: we remark that the congestion detection rate is increased when increasing  $\lambda_p$  (especially above 40) while the packet drop rate at the bottleneck is still null for TcpHas. Hence, we understand that the bottleneck is no more located in the link

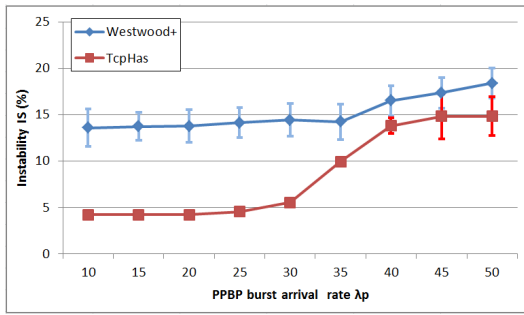

(a) Instability vs.  $\lambda_p$

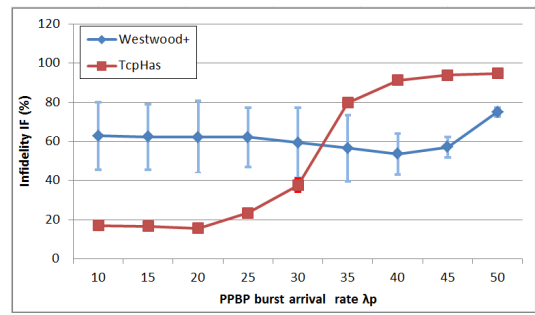

(b) Infidelity vs.  $\lambda_p$

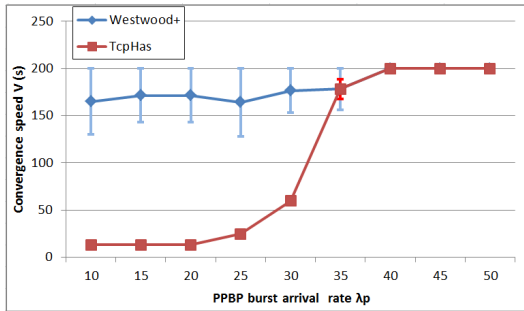

(c) Convergence speed vs.  $\lambda_p$

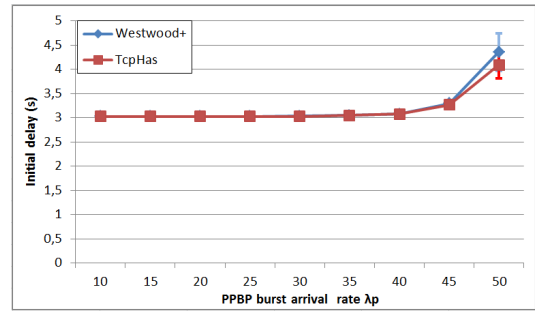

(d) Initial delay vs.  $\lambda_p$

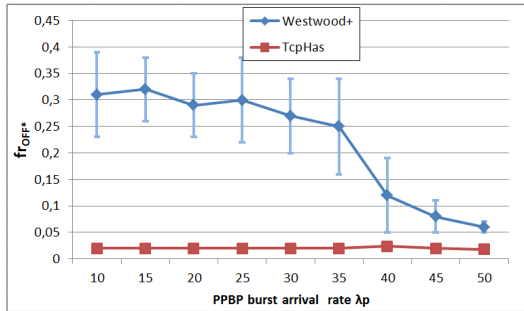

(e)  $fr_{OFF}$  vs.  $\lambda_p$

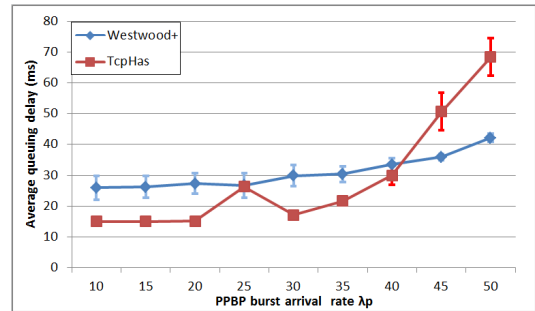

(f) Queuing delay vs.  $\lambda_p$

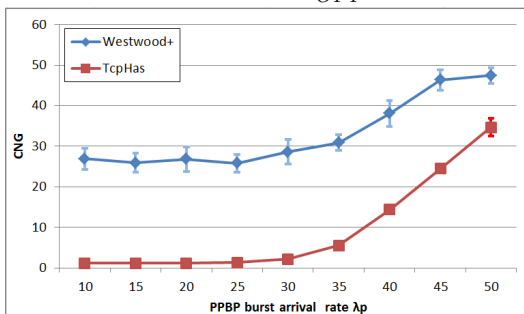

(g) Congestion rate vs.  $\lambda_p$

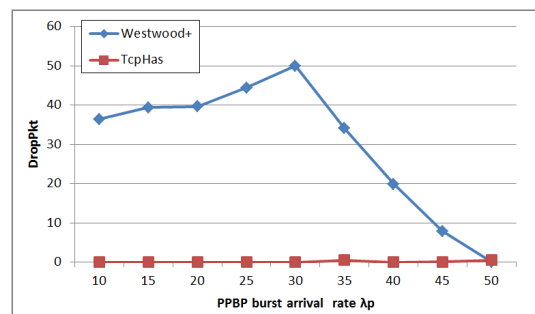

(h) Packet drop rate vs.  $\lambda_p$

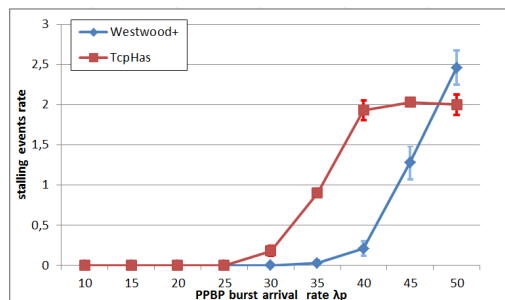

(i) Stalling event rate vs.  $\lambda_p$

Figure 6.7 – Performance measurements when increasing PPBP burst arrival rate  $\lambda_p$

between DSLAM and IR but it is rather transposed inside the loaded ISP link.

To summarize, we can say that TcpHas presents satisfying QoE and QoS measurements when the ISP link is well managed. However, the performances degrade when the ISP link load exceeds 70% of its whole capacity. The justification is that in the latter case the congestion rate increases, which degrades the QoS, and obliges TcpHas to frequently update its estimated optimal quality level which degrades the QoE.

#### 6.4.4.3 Bottleneck Queue Effect

As we indicated in Subsection 2.4.2.1, the length of a router queue and the type of its queuing discipline, such as Drop Tail and RED, have an effect on HAS performances because they have a direct impact on packet drop rate and end-to-end delay.

In this subsection, we employ in the bottleneck link one of two types of queuing disciplines, Drop Tail or RED, with one of three lengths of queue: half, twice or equal to the bandwidth delay product. RED is configured by setting the minimum threshold ( $minTh$ ) to one third the queue length and the maximum threshold ( $maxTh$ ) to the queue length. Here we notice that  $minTh$  is the number of buffered packets where RED begins to drop incoming packets with a low probability. This probability increases to reach 1 when the buffered packets attains  $maxTh$  threshold. The results of simulations are presented in Figure 6.8.

Results indicated that TcpHas preserves practically the same QoE and QoS rates that are much better than that of Weswood+. As presented in Figure 6.8a, the instability rate of TcpHas is around 4% while that of Westwood+ can exceed 10%. The infidelity rate of TcpHas is around 15% which is always lower than that of Westwood+ that can exceed 50%, as shown in Figure 6.8b. The convergence speed of TcpHas is maintained around 13 seconds much lower than that of Weswood+ that have difficulties to converge within less than 100 seconds, as presented in Figure 6.8c. The initial delay of TcpHas is around 3 seconds and it is practically equal to that of Westwood+, as indicated in Figure 6.8d. The frequency of  $\widehat{OFF}$  period of TcpHas is negligible compared to that of Westwood+ as presented in Figure 6.8e. The average queuing delay of TcpHas is often lower than that of Westwood+ as shown in Figure 6.8f. The congestion detection rate and the packet drop rate are negligible for TcpHas as presented in Figures 6.8g and 6.8h.

However, the above observations have an exception in the case of Drop Tail queuing discipline with a queue size equals to the half of bandwidth-delay product. In this case, we remark that TcpHas generates higher initial delay and a slightly higher packet drop rate as indicated in Figures 6.8d and 6.8h, respectively.

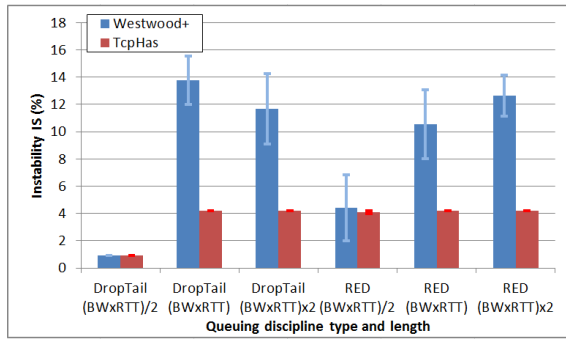

(a) Instability vs. queuing discipline

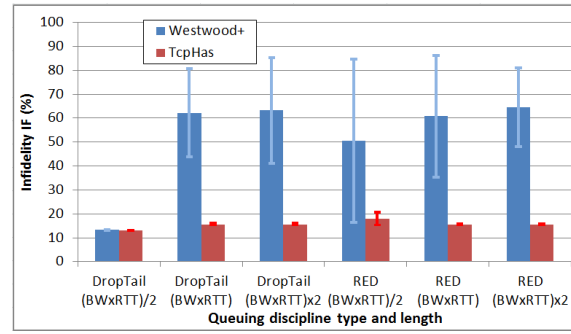

(b) Infidelity vs. queuing discipline

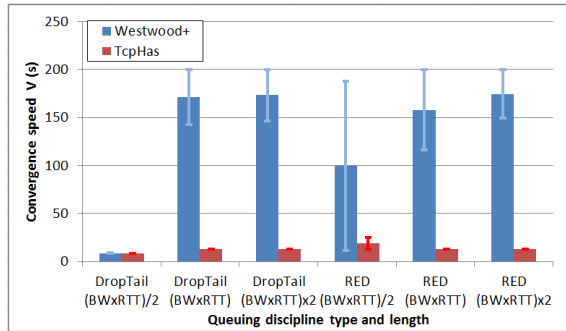

(c) Convergence speed vs. queuing discipline

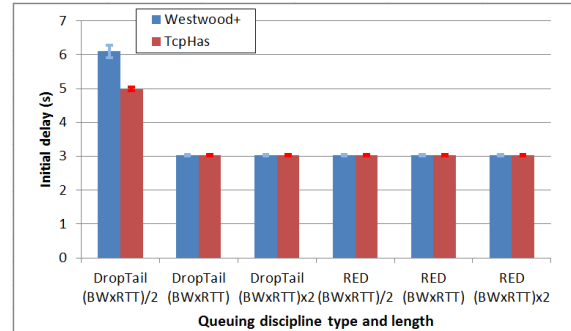

(d) Initial delay vs. queuing discipline

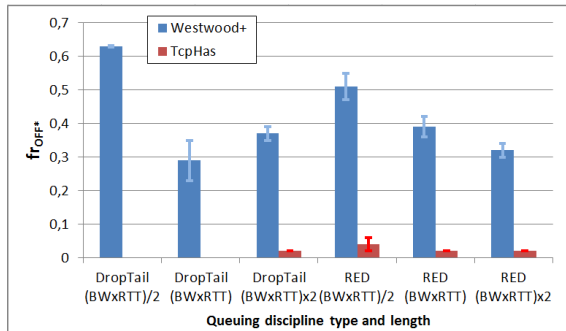

(e)  $f_{OFF}$  vs. queuing discipline

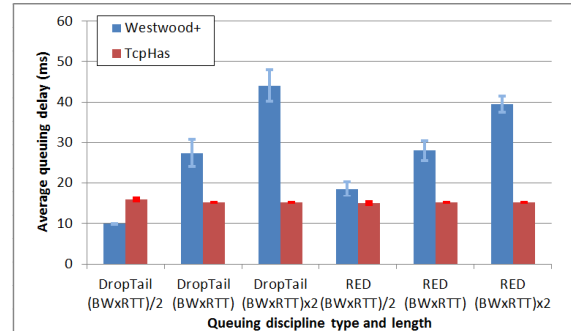

(f) Queuing delay vs. queuing discipline

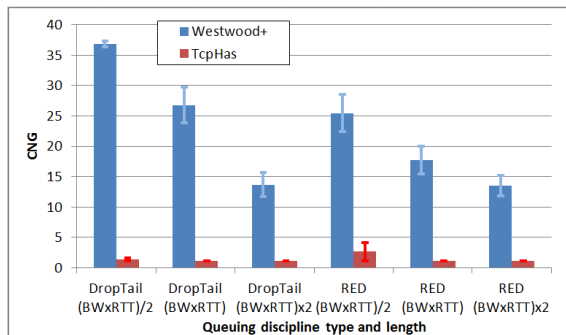

(g) Congestion rate vs. queuing discipline

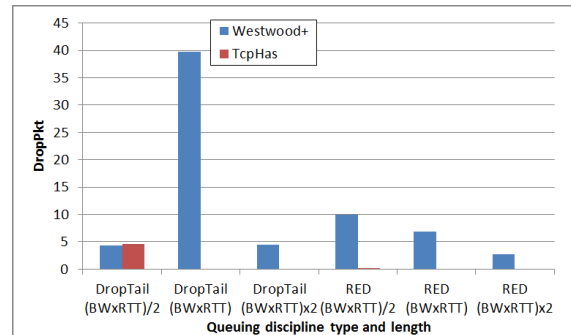

(h) Packet drop rate vs. queuing discipline

Figure 6.8 – TcpHas performance under different queuing disciplines and queue lengths

Accordingly, we can say that TcpHas maintains its good QoE and QoS measurements for the two types of queuing disciplines, Drop Tail and RED, with different queue lengths. We may add that using RED queuing discipline is more safe.

## 6.5 Conclusion

In this chapter, we have presented server-based shaping methods that aim to stabilize the video quality level and improve the QoE of HAS users. We have shown that they employ two functions; 1) the optimal quality level estimation of HAS flow, and 2) shaping the sending rate according to the encoding rate of this level. We have shown that the first function depends on the end-to-end bandwidth estimation, which can be computed using the arrival times of ACKs. We have proved that the estimation scheme of TIBET offers more accurate estimations with less dependency to actual throughput value and reduces the drawbacks of ACK compression and clustering. We have indicated that the second function is dependent to the TCP layer parameters; it is highly dependent to the congestion window,  $cwnd$ , and it can further improve performances by dynamically adjusting the slow start threshold,  $ssthresh$ , on the product between the round-trip time,  $RTT$ , and the encoding bitrate of the estimated optimal quality level.

Based on this detailed analysis, we have proposed and described TcpHas, an HAS-based TCP congestion control variant that serves the same role of a server-based HAS traffic shaping method. Our proposed algorithm is totally implemented in the TCP layer and obtains the encoding rate of the available quality levels of the corresponding HAS flow from the application layer (the index file). It is inspired from TCP adaptive decrease mechanism and employs the end-to-end bandwidth estimation of TIBET in order to estimate the optimal quality level. Then, it shapes the sending rate to correspond to the encoding rate of the estimated optimal quality level. The traffic shaping process is based on updating  $ssthresh$  when detecting a congestion event and after an idle period. It is also based on modifying  $cwnd$  during congestion avoidance phase. It also initializes the shaping rate to correspond to the encoding rate of the highest quality level.

We evaluated TcpHas in the case of HAS clients that are sharing the same bottleneck link and are competing for the same home network under various conditions. We have used ns-3 simulator for our evaluation and our defined QoE and QoS metrics. Results indicated that, under the considered scenarios, TcpHas improves considerably both HAS QoS and network QoS. Concerning QoE it offers a high stability, high fidelity to optimal quality level, a rapid convergence speed and an acceptable initial delay. Concerning QoS, it reduces  $\widehat{OFF}$  period frequency, reduces queuing delay and dramatically reduces the packet drop rate in the shared bottleneck queue. TcpHas performs

well even when increasing the number of competing HAS clients without causing stalling events. In addition, it practically maintains the same performances for various chunk durations, for various initial end-to-end delays and for various lengths and types of queuing disciplines in the bottleneck. However, TcpHas could cause stalling events in the case of Live streaming service where the buffer length is set to a lower value (lower than 10 seconds). In addition, its performances degrade when the ISP network is highly loaded with Internet traffic.

---

## Conclusion and Perspectives

This thesis has studied the video streaming technologies. We have presented UDP-based and TCP-based video streamings, their usages, their advantages and their drawbacks. We have shown that TCP-based video streaming technologies benefit from the congestion control algorithm of TCP when video-content is uploaded from a server located inside unmanaged network. Besides, we have shown that HTTP Adaptive Streaming (HAS) presents tremendous advantages, especially its adaptability to network conditions and its capability to switch from one quality level to another. Moreover, we have presented the similarity between the fixed and mobile access networks; both networks offer one shared bottleneck that presents a high risk of congestions and could degrades both QoE of HAS and QoS of the access network. Furthermore, we have studied the use case where many HAS clients are sharing the same bottleneck link and are competing for the same home network. In this case, we have shown that the ON-OFF pattern of HAS during steady state phase is also responsible of further performance degradation: In fact, during the Steady State phase, the HAS client is asking for one chunk, each chunk duration, in order to preserve the same playback buffer occupancy. Hence, the HAS client has no information about the network bandwidth availability during OFF periods and it is only based on the previous bandwidth estimation of the previous ON periods to select the quality level of the next chunk. However, when many clients are competing for the same bandwidth, the discordance in time of ON-OFF patterns of the concurrent players would cause bandwidth overestimation in the players which may produce congestions and QoE degradation.

We found that one of the most efficient solutions is to reduce OFF period durations. In this case, the HAS player would be able to be aware about the network conditions, and hence, to get a correct bandwidth estimation and quality level selection. This type of solution is designed as "traffic shaping method". Applying this shaping on HAS traffic has given an improvement of QoE. Some works have been proposed in this context, but they present dissimilarities. The first

dissimilarity is the network component on which we should apply the traffic shaping. Here we have principally two classifications; Server-based and Gateway-based shaping methods. For the latter methods, a bandwidth manager should be implemented in the gateway to decide to manage the bandwidth among competing HAS flows and allocate bandwidth for each HAS flow. This bandwidth manager should take into consideration the total bandwidth measurement, the number of concurrent players and the encoding bitrates of each HAS flow. The second dissimilarity is the method of traffic shaping. Here, we have principally found two categories; Queue-based shaping method and TCP-based shaping method. The former employs the queuing discipline algorithms while the latter applies TCP modifications in order to achieve the same purpose of traffic shaping. Our contributions are based on these two classifications and we have made comparative evaluations between our proposed shaping methods with a gateway-based and queue-based shaping method called Hierarchical Token Bucket shaping Method (HTBM).

In order to better evaluate performances and more accurately discuss results, we have built our own objective QoE and QoS criteria. Concerning the QoE criteria, we have used Instability metric, *IS*, which computes the quality level selection instability of each player. Besides, we have employed Infidelity metric, *IF*, which computes, for each player, the infidelity of the selected quality levels to the optimal quality level that satisfy fair share and higher bandwidth occupancy. Moreover, we have used Convergence speed to the optimal quality level, *CS*, which compute from which second the player was able to select the optimal quality level and be stable on it for at least 60 seconds. We have also used the initial delay, the stalling event rate and QoE fairness between the concurrent players. The latter have been used in order to be sure that we offer similar QoE satisfaction for the users of concurrent players.

For QoS criteria, we have used the frequency of OFF periods whose duration exceeds the TCP retransmission timeout duration, because we have found that the higher this frequency is, the lower the QoE is. We have also employed the average queuing delay metric that computes the average generated queuing delay for each HAS flow. Besides, we have exploited the congestion detection rate, which is based on the slow start threshold (*ssthresh*) reduction during the TCP congestion control processing in the HAS server, related to each HAS flow. Moreover, we have employed the average packet drop rate at the bottleneck.

Furthermore, we have presented our emulated HAS player that takes into consideration the main functions of HAS players and adopts the most used parameters among different proposed commercial players, mainly those of the MPEG-DASH standard. We have justified the use of parameters and the algorithm of the bitrate controller. In addition, we have built a prototype to validate our proposed works and we have developed the architecture of fixed-broadband access



network in the ns-3 simulator. For the latter, we have also added the HTTP layer and integrated our emulated player. The QoE and QoS criteria are implemented for both works and their measurements are generated automatically for each test.

The description of our proposed shaping methods of this thesis are presented in Section 7.1. While our proposed future works are listed in Section 7.2:

## 7.1 Achievements

During this thesis, we have proposed three main contributions:

- The first contribution, Receive Window Tuning Method (RWTM), consists of proposing a gateway-based and TCP-based shaping method for HAS services. The choice of gateway as a network component on which we apply the shaping process is justified by the fact that it is the unique component that have the best visibility toward all concurrent players inside the home network. Whereas the choice of TCP comes back to the flow control mechanism of TCP congestion control. In fact, the TCP receiver can inform the sender of the maximum amount, of bytes, in the receiver's sending window. This amount is transmitted inside each TCP acknowledgment segment (ACK) sent from the receiver to the sender. It is indicated by the receive window field, *rwnd*. Our method consists of using a bandwidth manager in the gateway and shaping the bandwidth for each HAS flow according to the bandwidth manager instructions by just modifying *rwnd* of each ACK sent from the HAS client to the HAS server. Our scenarios have indicated that RWTM improves QoE of HAS better than HTBM. Besides, it improves the QoS, mainly by reducing the queuing delay, the rate of dropped packets at the bottleneck and the congestion rate. However, its OFF period reduction is not large compared to HTBM. The cause is mainly due to the constant RTT for each ON period; RWTM estimates RWTM only one time at the beginning of each ON period and does not take into consideration the RTT variation for *rwnd* update.
- The second contribution was an extended comparative evaluation between the two gateway-based shaping methods, RWTM and HTBM, and four different congestion control variants, NewReno, Vegas, Illinois and Cubic. In our investigations, we have found that the congestion control algorithm has an important effect on both QoE of HAS and QoS of access network. The results of this contribution have indicated that an additional consideration should be offered to the update of the slow start threshold (*ssthresh*) value; if *ssthresh* is set near the product of the round trip time and the encoding

rate of the optimal quality level, the HAS player accelerates its convergence to the optimal quality level when the HAS traffic shaping is applied.

- The third contribution is the result of the second contribution which have led us to design a TCP congestion control algorithm compatible with HAS flows. However, we must also maintain an HAS traffic shaping process in the server side within this algorithm. Hence, this contribution is classified as a server-based shaping method. We have denoted it by TcpHas; a HAS-based TCP congestion control variant. Our method has not been proposed before in the literature. In fact all previous contributions are considered as application layer solutions with a cross-layer optimization to access to the TCP layer for traffic shaping purpose. TcpHas is inspired from TCP adaptive decrease mechanism, where the *ssthresh* is set after congestion detection event based on the end-to-end bandwidth estimation. Moreover, it adopts a sophisticated bandwidth estimator, called TIBET, that avoids the problems of ACK compression and packet clustering. It uses the estimated bandwidth in conjunction with the encoding bitrates of the available quality levels of the corresponding HAS flows to estimate the optimal quality level of the shaping rate. Then, it updates the *ssthresh* and the congestion window, *cwnd*, according to the encoding rate of the estimated quality level. TcpHas eliminates the *cwnd* reduction after each long idle period (i.e, that exceeds the retransmission timeout) in order to avoid destabilizing the shaped sending rate and updates *ssthresh* after each idle period to add more dynamicity to the shaping rate when network conditions changes without causing congestions. We have shown a comparative performance evaluation of TcpHas with another well-known TCP variant that employed adaptive decrease mechanism, called Westwood+. Results indicated that TcpHas largely outperforms Westwood+. In terms of QoE, TcpHas preserves a high stability under various networks conditions. Besides, it offers a good fidelity to optimal quality level and a fast convergence speed. In addition, it tends to improve the occupancy of bandwidth. Concerning QoS, it offers a negligible packet drop rate at the bottleneck and a lower queuing delay than Westwood+. However, TcpHas is still sensitive to a high traffic occupancy inside ISP network and Internet. This case should be avoided when optimizing the managed network and employing the content caching of Content Delivery Network (CDN) providers. Moreover, TcpHas still presents stalling events when using a small buffer size, i.e. in the case of Live streaming service.

## 7.2 Future Works

Our research activities during the past three years have enlarged our knowledge about three main major areas of interest; the HAS technology features, the access network characteristics and the TCP protocol proprieties. This knowledge was necessary to build our testbed and simulation environments and evaluating our proposed solutions. Hence, testing our proposed solutions on real conditions is an important future work for their deployment, as it will be described in Subsection 7.2.1. Besides, we have explored other related areas, such as the Content Delivery Network (CDN) and the importance of its caching and prefetching policies on the QoE of HAS users and the QoS of ISP core network. Hence, we could propose similar caching properties inside the access network in conjunction with our proposed solutions as a future work, as it will be described in Subsection 7.2.2. Moreover, we have overviewed the characteristics of UDP-based streaming video. Therefore, we could adapt our proposed solutions to them, as it will be explained in Subsection 7.2.3.

### 7.2.1 Testing the Proposed Solutions in Real Conditions

Given that we have tested and validated our two proposed solutions, RWTM and TcpHas, under ns-3 simulator and with conditions similar to a real daily use, it would be also important to test them under real conditions and under different configurations. For this purpose, many steps are important for the deployment of our solutions, which are indicated as the following:

- Employing the real fixed access network of Orange. In this case, the RWTM solutions should be implemented in the "Livebox" device.
- Testing our proposed solutions with real HAS flows provided from video content providers, such as YouTube, Netflix and Dailymotion.
- Testing TcpHas with many real HAS servers that are offering HAS contents for many HAS clients located in different access networks.
- Testing the two proposed solutions when HAS flows coexist, in the home network, with other different types of TCP and UDP flows.

### 7.2.2 video Content Caching Inside Access Network

A possible way to further optimize solutions is to take into consideration the content caching jointly with the traffic shaping. One future work consists of installing proxies (caches) inside the access network near the gateway, as indicated in Figure 7.1 for fixed broadband access network. In

this case, the proxy could be optimized in order to cache previous chunks and to prefetch chunks that are predictable to be requested in near future. Hence, the round trip time would be reduced, which is beneficial to the QoE of HAS users and the QoS of access network. In addition to that, the proximity of the proxy to the gateway has a great advantage of reducing the overload of bottleneck; in fact, the proxy would cache many chunks that are previously asked from one HAS client. Consequently, when the same content is requested by another HAS client, simultaneously or later, a number of chunks could already exist in the proxy. Hence, the proxy will just upload the existing chunks without the need to request them from outside the access network.

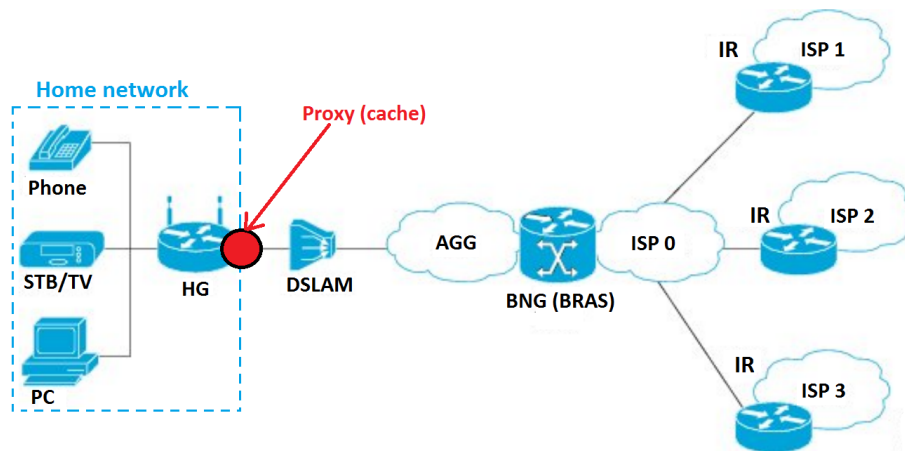

Figure 7.1 – Proposed implementation of proxy inside fixed broadband access network

Besides, in this case, a traffic shaping could be applied in order not to exceed the home network capacity when several HAS clients are competing for bandwidth. Here, we could adopt our proposed solutions, TcpHas in the proxy and/or RWTM in the gateway, in order to improve the quality level stability and to maximize the occupancy of the home bandwidth.

### 7.2.3 Optimizing UDP-based Video Streaming

Given that IPTV still employs the UDP protocol in conjunction with RTP/RTCP application layer protocols, it would be beneficial to take the IPTV flows in consideration in our RWTM solution; in fact, IPTV flow should be prioritized against HAS flows inside the home network, because it is usually displayed over large TV screen which demands a high bandwidth. Hence, a further optimization should be done in the bandwidth manager of RWTM to take this issue into consideration.

In addition, new UDP-based video streaming technologies are being increasingly proposed during the previous months, such as QUIC [53], provided by Google. A congestion control is implemented on the server side in order to give a similar behavior with TCP flows, which is called

TCP-Friendly Rate Control (TFRC). Hence, a possible contribution is to implement a new TFRC variant that takes into consideration the specifications of our HAS-based TCP congestion control protocol, TcpHas.



# A

---

## List of Publications

### A.1 International conferences with peer review

1. Chiheb Ben Ameer, Emmanuel Mory, and Bernard Cousin. Shaping http adaptive streams using receive window tuning method in home gateway. In Performance Computing and Communications Conference (IPCCC), 2014 IEEE International, pages 1-2, 2014
2. Chiheb Ben Ameer, Emmanuel Mory, and Bernard Cousin. Evaluation of gateway-based shaping methods for http adaptive streaming. In Quality of Experience-based Management for Future Internet Applications and Services (QoE-FI) workshop, International Conference on Communications (ICC), ICC workshops'04, 2015 IEEE International, pages 1-6, 2015.

### A.2 International Journals with peer review

- Chiheb Ben Ameer, Emmanuel Mory, and Bernard Cousin. Combining Traffic Shaping Methods with Congestion Control Variants for HTTP Adaptive Streaming, submitted to Multimedia Systems, Springer (minor revision)





---

# Bibliography

- [1] ABDALLAH, A., MEDDOUR, D. E., AHMED, T., AND BOUTABA, R. Cross layer optimization architecture for video streaming in wimax networks. In *Computers and Communications (ISCC), 2010 IEEE Symposium on* (2010), IEEE, pp. 8–13.
- [2] ADHIKARI, V. K., JAIN, S., CHEN, Y., AND ZHANG, Z.-L. Vivisecting youtube: An active measurement study. In *INFOCOM, 2012 Proceedings IEEE* (2012), IEEE, pp. 2521–2525.
- [3] ADOBE. Http dynamic streaming 2013, available at <http://www.adobe.com/products/hds-dynamic-streaming.html>.
- [4] ADOBE. Http dynamic streaming on the adobe flash platform 2010, available at <https://bugbase.adobe.com/index>.
- [5] AKAMAI. Akamai media delivery solutions, available at <https://www.akamai.com/us/en/solutions/products/media-delivery/index.jsp>.
- [6] AKHSHABI, S., ANANTAKRISHNAN, L., BEGEN, A. C., AND DOVROLIS, C. What happens when http adaptive streaming players compete for bandwidth? In *Proceedings of the 22nd international workshop on Network and Operating System Support for Digital Audio and Video* (2012), ACM, pp. 9–14.
- [7] AKHSHABI, S., ANANTAKRISHNAN, L., DOVROLIS, C., AND BEGEN, A. C. Server-based traffic shaping for stabilizing oscillating adaptive streaming players. In *Proceeding of the 23rd ACM Workshop on Network and Operating Systems Support for Digital Audio and Video* (2013), ACM, pp. 19–24.
- [8] AKHSHABI, S., BEGEN, A. C., AND DOVROLIS, C. An experimental evaluation of rate-adaptation algorithms in adaptive streaming over http. In *Proceedings of the second annual ACM conference on Multimedia systems* (2011), ACM, pp. 157–168.
- [9] ALLMAN, M., PAXSON, V., AND BLANTON, E. Tcp congestion control. Tech. rep., 2009.
- [10] ALLMAN, M., PAXSON, V., AND STEVENS, W. Rfc 2581: Tcp congestion control, 1999.

- [11] AMEUR, C. B., MORY, E., AND COUSIN, B. Shaping http adaptive streams using receive window tuning method in home gateway. In *Performance Computing and Communications Conference (IPCCC), 2014 IEEE International* (2014), pp. 1–2.
- [12] AMEUR, C. B., MORY, E., AND COUSIN, B. Evaluation of gateway-based shaping methods for http adaptive streaming. In *Quality of Experience-based Management for Future Internet Applications and Services (QoE-FI) workshop, International Conference on Communications (ICC), ICC workshops'04, 2015 IEEE International* (2015), pp. 1–6.
- [13] AMMAR, D. Ppbp implementation in ns-3, available at: <https://codereview.appspot.com/4997043/>.
- [14] AMMAR, D., BEGIN, T., AND GUERIN-LASSOUS, I. A new tool for generating realistic internet traffic in ns-3. In *Proceedings of the 4th International ICST Conference on Simulation Tools and Techniques* (2011), ICST (Institute for Computer Sciences, Social-Informatics and Telecommunications Engineering), pp. 81–83.
- [15] ANDERSON, H. R. *Fixed broadband wireless system design*. John Wiley & Sons, 2003.
- [16] APPLE. Http live streaming overview 2013, available at <http://developer.apple.com/library/ios/documentation/networkinginternet/conceptual/streamingmediaguide/introduction/introduction.html>.
- [17] ARMITAGE, G., JAVIER, C., ZANDER, S., ET AL. Client rtt and hop count distributions viewed from an australian "enemy territory" server. Tech. rep., CAIA Technical Report, 2006.
- [18] BIERNACKI, A., AND TUTSCHKU, K. Performance of http video streaming under different network conditions. *Multimedia Tools and Applications* 72, 2 (2014), 1143–1166.
- [19] BITMOVIN. bitdash mpeg-dash player feature details, available at <http://www.dash-player.com/feature-details/>.
- [20] BITMOVIN. bitmovin, open-source dash client library, available at <http://www.bitmovin.net/>.
- [21] BRAKMO, L. S., O'MALLEY, S. W., AND PETERSON, L. L. *TCP Vegas: New techniques for congestion detection and avoidance*, vol. 24. ACM, 1994.
- [22] BROOKS, P., AND HESTNES, B. User measures of quality of experience: why being objective and quantitative is important. *Network, IEEE* 24, 2 (2010), 8–13.
- [23] BROWN, M. A. Traffic control howto. *Guide to IP Layer Network* (2006).
- [24] CAPONE, A., FRATTA, L., AND MARTIGNON, F. Bandwidth estimation schemes for tcp over wireless networks. *Mobile Computing, IEEE Transactions on* 3, 2 (2004), 129–143.

- [25] CAPONE, A., MARTIGNON, F., AND PALAZZO, S. Bandwidth estimates in the tcp congestion control scheme. In *IWDC (2001)*, Springer, pp. 614–626.
- [26] CASAS, P., SACKL, A., SCHATZ, R., JANOWSKI, L., TURK, J., AND IRMER, R. On the quest for new kpis in mobile networks: The impact of throughput fluctuations on qoe. In *Communication Workshop (ICCW), 2015 IEEE International Conference on (2015)*, IEEE, pp. 1705–1710.
- [27] CHEN, J., MAHINDRA, R., KHOJASTEPOUR, M. A., RANGARAJAN, S., AND CHIANG, M. A scheduling framework for adaptive video delivery over cellular networks. In *Proceedings of the 19th annual international conference on Mobile computing & networking (2013)*, ACM, pp. 389–400.
- [28] CHEN, S., SHEN, B., WEE, S., AND ZHANG, X. Designs of high quality streaming proxy systems. In *INFOCOM 2004. Twenty-third Annual Joint Conference of the IEEE Computer and Communications Societies (2004)*, vol. 3, IEEE, pp. 1512–1521.
- [29] CHEN, S., SHEN, B., WEE, S., AND ZHANG, X. Segment-based streaming media proxy: modeling and optimization. *Multimedia, IEEE Transactions on* 8, 2 (2006), 243–256.
- [30] CHEN, S., SHEN, B., WEE, S., AND ZHANG, X. Sproxy: A caching infrastructure to support internet streaming. *Multimedia, IEEE Transactions on* 9, 5 (2007), 1062–1072.
- [31] CHENG, Y. Http traffic generator, available at: <https://codereview.appspot.com/4940041>.
- [32] CHENG, Y., ÇETINKAYA, E. K., AND STERBENZ, J. P. Transactional traffic generator implementation in ns-3. In *Proceedings of the 6th International ICST Conference on Simulation Tools and Techniques (2013)*, ICST (Institute for Computer Sciences, Social-Informatics and Telecommunications Engineering), pp. 182–189.
- [33] CHOI, B.-Y., SONG, S., WANG, Y., AND PARK, E. K. Using rtt variability for adaptive cross-layer approach to multimedia delivery in heterogeneous networks. *Multimedia, IEEE Transactions on* 11, 6 (2009), 1194–1203.
- [34] CISCO. Broadband network gateway overview, available at: [http://www.cisco.com/c/en/us/td/docs/routers/asr9000/software/asr9k\\_r4-3/bng/configuration/guide/b\\_bng\\_cg43xasr9k/b\\_bng\\_cg43asr9k\\_chapter\\_01.html](http://www.cisco.com/c/en/us/td/docs/routers/asr9000/software/asr9k_r4-3/bng/configuration/guide/b_bng_cg43xasr9k/b_bng_cg43asr9k_chapter_01.html).
- [35] CISCO. Measuring ip network performance, available at: [http://www.cisco.com/web/about/ac123/ac147/archived\\_issues/ipj\\_61/measuring\\_ip.html](http://www.cisco.com/web/about/ac123/ac147/archived_issues/ipj_61/measuring_ip.html).
- [36] CISCO. Wholesale content delivery networks: Unlocking new revenue streams and content relationships, available at: [http://www.cisco.com/c/en/us/products/collateral/video/content-deliveryengineseries/white\\_paper\\_c11710667.html](http://www.cisco.com/c/en/us/products/collateral/video/content-deliveryengineseries/white_paper_c11710667.html).

- [37] CISCO, I. Cisco visual networking index: Forecast and methodology, 2014–2019. *CISCO White paper* (2015), 1–14.
- [38] DE CICCIO, L., AND MASCOLO, S. *An experimental investigation of the Akamai adaptive video streaming*. Springer, 2010.
- [39] DE PESSEMIER, T., DE MOOR, K., JOSEPH, W., DE MAREZ, L., AND MARTENS, L. Quantifying the influence of rebuffering interruptions on the user’s quality of experience during mobile video watching. *Broadcasting, IEEE Transactions on* 59, 1 (2013), 47–61.
- [40] DE VRIENDT, J., DE VLEESCHAUWER, D., AND ROBINSON, D. Model for estimating qoe of video delivered using http adaptive streaming. In *Integrated Network Management (IM 2013), 2013 IFIP/IEEE International Symposium on* (2013), IEEE, pp. 1288–1293.
- [41] DILLEY, J., MAGGS, B., PARIKH, J., PROKOP, H., SITARAMAN, R., AND WEIHL, B. Globally distributed content delivery. *Internet Computing, IEEE* 6, 5 (2002), 50–58.
- [42] DONALD GROSS, JOHN F. SHORTLE, M. J. F. D. M. B. M. Simulation input analysis: difficulties in simulating queues with pareto service. In *WSC '02 Proceedings of the 34th conference on Winter simulation: exploring new frontiers* (2002), vol. 1, ACM, pp. 407–415.
- [43] ESTEBAN, J., BENNO, S. A., BECK, A., GUO, Y., HILT, V., AND RIMAC, I. Interactions between http adaptive streaming and tcp. In *Proceedings of the 22nd international workshop on Network and Operating System Support for Digital Audio and Video* (2012), ACM, pp. 21–26.
- [44] FLOYD, S., AND GURTOV, A. The newreno modification to tcp’s fast recovery algorithm", rfc 3782.
- [45] FLOYD, S., HANDLEY, M., AND KOHLER, E. Datagram congestion control protocol (dccc).
- [46] FLOYD, S., HANDLEY, M., PADHYE, J., AND WIDMER, J. *Equation-based congestion control for unicast applications*, vol. 30. ACM, 2000.
- [47] FLOYD, S., AND JACOBSON, V. Random early detection gateways for congestion avoidance. *Networking, IEEE/ACM Transactions on* 1, 4 (1993), 397–413.
- [48] FRIEDMAN, T., CACERES, R., AND CLARK, A. Rtp control protocol extended reports (rtcp xr). Tech. rep., 2003.
- [49] GANGADHAR, S., NGUYEN, T. A. N., UMAPATHI, G., AND STERBENZ, J. P. Tcp westwood (+) protocol implementation in ns-3. In *Proceedings of the 6th International ICST Conference on Simulation Tools and Techniques* (2013), ICST (Institute for Computer Sciences, Social-Informatics and Telecommunications Engineering), pp. 167–175.

- [50] GARCIA, M., DYTOKO, D., AND RAAKE, A. Quality impact due to initial loading, stalling, and video bitrate in progressive download video services. In *Quality of Multimedia Experience (QoMEX), 2014 Sixth International Workshop on* (2014), IEEE, pp. 129–134.
- [51] GETTYS, J., AND NICHOLS, K. Bufferbloat: Dark buffers in the internet. *Queue* 9, 11 (2011), 40.
- [52] GHOBADI, M., CHENG, Y., JAIN, A., AND MATHIS, M. Trickle: Rate limiting youtube video streaming. In *Usenix Annual Technical Conference* (2012), pp. 191–196.
- [53] GOOGLE. Quic, a multiplexed stream transport over udp, available at: <https://www.chromium.org/quic>.
- [54] GRIGORIK, I. *High Performance Browser Networking: What every web developer should know about networking and web performance*. " O'Reilly Media, Inc.", 2013.
- [55] GRILO, A. How to "intercept" a packet in ns-3 , available at: <https://groups.google.com/forum/#!topic/ns-3-users/ba5qrduivvq>.
- [56] HA, S., AND RHEE, I. Taming the elephants: New tcp slow start. *Computer Networks* 55, 9 (2011), 2092–2110.
- [57] HA, S., RHEE, I., AND XU, L. Cubic: a new tcp-friendly high-speed tcp variant. *ACM SIGOPS Operating Systems Review* 42, 5 (2008), 64–74.
- [58] HADDAD, M., ALTMAN, E., EL-AZOUZI, R., JIMÉNEZ, T., ELAYOUBI, S. E., JAMAA, S. B., LEGOUT, A., AND RAO, A. A survey on youtube streaming service. In *Proceedings of the 5th International ICST Conference on Performance Evaluation Methodologies and Tools* (2011), ICST (Institute for Computer Sciences, Social-Informatics and Telecommunications Engineering), pp. 300–305.
- [59] HAYES, D., ARMITAGE, G., ET AL. Improved coexistence and loss tolerance for delay based tcp congestion control. In *Local Computer Networks (LCN), 2010 IEEE 35th Conference on* (2010), IEEE, pp. 24–31.
- [60] HENDERSON, T. R., LACAGE, M., RILEY, G. F., DOWELL, C., AND KOPENA, J. Network simulations with the ns-3 simulator. *SIGCOMM demonstration 14* (2008).
- [61] HISAMATSU, H., HASEGAWA, G., AND MURATA, M. Network friendly transmission control for progressive download over tcp. *Journal of Communications* 7, 3 (2012), 213–221.
- [62] HO, C.-Y., CHEN, Y.-C., CHAN, Y.-C., AND HO, C.-Y. Fast retransmit and fast recovery schemes of transport protocols: A survey and taxonomy. *Computer Networks* 52, 6 (2008), 1308–1327.

- [63] HOBFELD, T., SCHATZ, R., AND EGGER, S. Sos: The mos is not enough! In *Quality of Multimedia Experience (QoMEX), 2011 Third International Workshop on* (2011), IEEE, pp. 131–136.
- [64] HONG, D., DE VLEESCHAUWER, D., AND BACCELLI, F. A chunk-based caching algorithm for streaming video. In *NET-COOP 2010-4th Workshop on Network Control and Optimization* (2010).
- [65] HOSSFELD, T., EGGER, S., SCHATZ, R., FIEDLER, M., MASUCH, K., AND LORENTZEN, C. Initial delay vs. interruptions: between the devil and the deep blue sea. In *Quality of Multimedia Experience (QoMEX), 2012 Fourth International Workshop on* (2012), IEEE, pp. 1–6.
- [66] HOUDAILLE, R., AND GOUACHE, S. Shaping http adaptive streams for a better user experience. In *Proceedings of the 3rd Multimedia Systems Conference* (2012), ACM, pp. 1–9.
- [67] HUANG, T.-Y., HANDIGOL, N., HELLER, B., MCKEOWN, N., AND JOHARI, R. Confused, timid, and unstable: picking a video streaming rate is hard. In *Proceedings of the 2012 ACM conference on Internet measurement conference* (2012), ACM, pp. 225–238.
- [68] HUANG, T.-Y., JOHARI, R., MCKEOWN, N., TRUNNELL, M., AND WATSON, M. A buffer-based approach to rate adaptation: Evidence from a large video streaming service. In *Proceedings of the 2014 ACM conference on SIGCOMM* (2014), ACM, pp. 187–198.
- [69] INSTITUTE, M.-T. Osmo4 player of gpac, available at <https://gpac.wp.mines-telecom.fr/player/>.
- [70] ITU-T RECOMMENDATION, P. Subjective audiovisual quality assessment methods for multimedia applications.
- [71] JAMAL, H., AND SULTAN, K. Performance analysis of tcp congestion control algorithms. *International journal of computers and communications* 2, 1 (2008), 18–24.
- [72] JANOWSKI, L., AND PAPIR, Z. Modeling subjective tests of quality of experience with a generalized linear model. In *Quality of Multimedia Experience, 2009. QoMEX 2009. International Workshop on* (2009), IEEE, pp. 35–40.
- [73] JIANG, H., AND DOVROLIS, C. Passive estimation of tcp round-trip times. *ACM SIGCOMM Computer Communication Review* 32, 3 (2002), 75–88.
- [74] JIANG, J., SEKAR, V., AND ZHANG, H. Improving fairness, efficiency, and stability in http-based adaptive video streaming with festive. In *Proceedings of the 8th international conference on Emerging networking experiments and technologies* (2012), ACM, pp. 97–108.

- [75] JULURI, P., TAMARAPALLI, V., AND MEDHI, D. Sara: Segment aware rate adaptation algorithm for dynamic adaptive streaming over http.
- [76] JUMISKO-PYYKKÖ, S., MALAMAL VADAKITAL, V., AND HANNUKSELA, M. M. Acceptance threshold: A bidimensional research method for user-oriented quality evaluation studies. *International Journal of Digital Multimedia Broadcasting 2008* (2008).
- [77] KIM, T., AVADHANAM, N., AND SUBRAMANIAN, S. Dimensioning receiver buffer requirement for unidirectional vbr video streaming over tcp. In *Image Processing, 2006 IEEE International Conference on* (2006), IEEE, pp. 3061–3064.
- [78] KROGFOSS, B., AGRAWAL, A., AND SOFMAN, L. Analytical method for objective scoring of http adaptive streaming (has). In *Broadband Multimedia Systems and Broadcasting (BMSB), 2012 IEEE International Symposium on* (2012), IEEE, pp. 1–6.
- [79] KUPKA, T., HALVORSEN, P., AND GRIWODZ, C. Performance of on-off traffic stemming from live adaptive segmented http video streaming. In *Local Computer Networks (LCN), 2012 IEEE 37th Conference on* (2012), IEEE, pp. 401–409.
- [80] KUSCHNIG, R., KOFLER, I., AND HELLWAGNER, H. An evaluation of tcp-based rate-control algorithms for adaptive internet streaming of h. 264/svc. In *Proceedings of the first annual ACM SIGMM conference on Multimedia systems* (2010), ACM, pp. 157–168.
- [81] KUSCHNIG, R., KOFLER, I., AND HELLWAGNER, H. Improving internet video streaming performance by parallel tcp-based request-response streams. In *Consumer Communications and Networking Conference (CCNC), 2010 7th IEEE* (2010), IEEE, pp. 1–5.
- [82] KUSCHNIG, R., KOFLER, I., AND HELLWAGNER, H. Evaluation of http-based request-response streams for internet video streaming. In *Proceedings of the second annual ACM conference on Multimedia systems* (2011), ACM, pp. 245–256.
- [83] LAGHARI, K. U. R., AND CONNELLY, K. Toward total quality of experience: A qoe model in a communication ecosystem. *Communications Magazine, IEEE* 50, 4 (2012), 58–65.
- [84] LANPHIER, R. Real time streaming protocol (rtsp). Tech. rep., 1998.
- [85] LEVKOV, M. Video encoding and transcoding recommendations for http dynamic streaming on the adobe® flash® platform. *White Paper, Adobe Systems Inc* (2010).
- [86] LI, S.-Q., CHONG, S., AND HWANG, C.-L. Link capacity allocation and network control by filtered input rate in high-speed networks. *IEEE/ACM Transactions on Networking (TON)* 3, 1 (1995), 10–25.
- [87] LINDBERG, M., KRISTIENSEN, S., PLAGEMANN, T., AND GOEBEL, V. Challenges and techniques for video streaming over mobile ad hoc networks. *Multimedia Systems* 17, 1 (2011), 51–82.

- [88] LIU, C., BOUAZIZI, I., AND GABBOUJ, M. Rate adaptation for adaptive http streaming. In *Proceedings of the second annual ACM conference on Multimedia systems* (2011), ACM, pp. 169–174.
- [89] LIU, S., BAŞAR, T., AND SRIKANT, R. Tcp-illinois: A loss-and delay-based congestion control algorithm for high-speed networks. *Performance Evaluation* 65, 6 (2008), 417–440.
- [90] LIU, X., AND MEN, A. Qoe-aware traffic shaping for http adaptive streaming. *Int. J. Multimedia Ubiquitous Eng* 9, 2 (2014), 33–44.
- [91] LOHMAR, T., EINARSSON, T., FRÖJDH, P., GABIN, F., AND KAMPMANN, M. Dynamic adaptive http streaming of live content. In *World of Wireless, Mobile and Multimedia Networks (WoWMoM), 2011 IEEE International Symposium on a* (2011), IEEE, pp. 1–8.
- [92] LUEBBEN, R., LI, G., WANG, D., DOVERSPIKE, R., AND FU, X. Fast rerouting for ip multicast in managed iptv networks. In *Quality of Service, 2009. IWQoS. 17th International Workshop on* (2009), IEEE, pp. 1–5.
- [93] MA, K. J., BARTOŠ, R., AND BHATIA, S. A survey of schemes for internet-based video delivery. *Journal of Network and Computer Applications* 34, 5 (2011), 1572–1586.
- [94] MANSY, A., VER STEEG, B., AND AMMAR, M. Sabre: A client based technique for mitigating the buffer bloat effect of adaptive video flows. In *Proceedings of the 4th ACM Multimedia Systems Conference* (2013), ACM, pp. 214–225.
- [95] MANTZOURATOS, S., GARDIKIS, G., KOUMARAS, H., AND KOURTIS, A. Survey of cross-layer proposals for video streaming over mobile ad hoc networks (manets). In *Telecommunications and Multimedia (TEMU), 2012 International Conference on* (2012), IEEE, pp. 101–106.
- [96] MARTIN, J., FU, Y., WOURMS, N., AND SHAW, T. Characterizing netflix bandwidth consumption. In *Consumer Communications and Networking Conference (CCNC), 2013 IEEE* (2013), IEEE, pp. 230–235.
- [97] MASCOLO, S., CASETTI, C., GERLA, M., SANADIDI, M. Y., AND WANG, R. Tcp west-wood: Bandwidth estimation for enhanced transport over wireless links. In *Proceedings of the 7th annual international conference on Mobile computing and networking* (2001), ACM, pp. 287–297.
- [98] MASCOLO, S., AND GRIECO, L. Additive increase early adaptive decrease mechanism for tcp congestion control. In *Telecommunications, 2003. ICT 2003. 10th International Conference on* (2003), vol. 1, IEEE, pp. 818–825.



- [99] MASCOLO, S., GRIECO, L. A., FERORELLI, R., CAMARDA, P., AND PISCITELLI, G. Performance evaluation of westwood+ tcp congestion control. *Performance Evaluation* 55, 1 (2004), 93–111.
- [100] MASCOLO, S., AND RACANELLI, G. Testing tcp westwood+ over transatlantic links at 10 gigabit/second rate. In *Protocols for Fast Long-distance Networks (PFLDnet) Workshop* (2005).
- [101] MICROSOFT. Microsoft media player available at <http://windows.microsoft.com/en-us/windows/windows-media>.
- [102] MILLER, K., CORDA, N., ARGYROPOULOS, S., RAAKE, A., AND WOLISZ, A. Optimal adaptation trajectories for block-request adaptive video streaming. In *Packet Video Workshop (PV), 2013 20th International* (2013), IEEE, pp. 1–8.
- [103] MILLER, K., QUACCHIO, E., GENNARI, G., AND WOLISZ, A. Adaptation algorithm for adaptive streaming over http. In *Packet Video Workshop (PV), 2012 19th International* (2012), IEEE, pp. 173–178.
- [104] MISRA, V., GONG, W.-B., AND TOWSLEY, D. Fluid-based analysis of a network of aqm routers supporting tcp flows with an application to red. In *ACM SIGCOMM Computer Communication Review* (2000), vol. 30, ACM, pp. 151–160.
- [105] MOGUL, J. C. *Observing TCP dynamics in real networks*, vol. 22. ACM, 1992.
- [106] MOK, R. K., CHAN, E. W., AND CHANG, R. K. Measuring the quality of experience of http video streaming. In *Integrated Network Management (IM), 2011 IFIP/IEEE International Symposium on* (2011), IEEE, pp. 485–492.
- [107] MOK, R. K., LUO, X., CHAN, E. W., AND CHANG, R. K. Qdash: a qoe-aware dash system. In *Proceedings of the 3rd Multimedia Systems Conference* (2012), ACM, pp. 11–22.
- [108] MU, M., MAUTHE, A., TYSON, G., AND CERQUEIRA, E. Statistical analysis of ordinal user opinion scores. In *Consumer Communications and Networking Conference (CCNC), 2012 IEEE* (2012), IEEE, pp. 331–336.
- [109] MÜLLER, C., LEDERER, S., AND TIMMERER, C. An evaluation of dynamic adaptive streaming over http in vehicular environments. In *Proceedings of the 4th Workshop on Mobile Video* (2012), ACM, pp. 37–42.
- [110] MÜLLER, C., AND TIMMERER, C. A vlc media player plugin enabling dynamic adaptive streaming over http. In *Proceedings of the 19th ACM international conference on Multimedia* (2011), ACM, pp. 723–726.

- [111] MUSHTAQ, M. S., AUGUSTIN, B., AND MELLOUK, A. Regulating qoe for adaptive video streaming using bbk method. In *Communications (ICC), 2015 IEEE International Conference on* (2015), IEEE, pp. 6855–6860.
- [112] MYSIRLIDIS, C., LYKOYRGIOTIS, A., DAGIUKLAS, T., POLITIS, I., AND KOTSOPOULOS, S. Media-aware proxy: Application layer filtering and l3 mobility for media streaming optimization. In *Communications (ICC), 2015 IEEE International Conference on* (2015), IEEE, pp. 6912–6917.
- [113] NETWORKS, M. Move networks 2010. available at <http://www.movenetworkshd.com>.
- [114] NS 3 DEVELOPERS. ns-3 simulator, available at: <https://www.nsnam.org/>.
- [115] NYGREN, E., SITARAMAN, R. K., AND SUN, J. The akamai network: a platform for high-performance internet applications. *ACM SIGOPS Operating Systems Review* 44, 3 (2010), 2–19.
- [116] OF INFORMATION TECHNOLOGY, I. Dash-js, available at <http://www-itec.uni-klu.ac.at/dash/>.
- [117] PATEL, S., GUPTA, P., AND SINGH, G. Performance measure of drop tail and red algorithm. In *Electronic Computer Technology (ICECT), 2010 International Conference on* (2010), IEEE, pp. 35–38.
- [118] PEREIRA, R., AND PEREIRA, E. Dynamic adaptive streaming over http and progressive download: Comparative considerations. In *Advanced Information Networking and Applications Workshops (WAINA), 2014 28th International Conference on* (2014), IEEE, pp. 905–909.
- [119] PERKINS, C., AND GHARAI, L. Rtp and the datagram congestion control protocol. In *Multimedia and Expo, 2006 IEEE International Conference on* (2006), IEEE, pp. 1521–1524.
- [120] PRINS, M., BRUNNER, M., KARAGIANNIS, G., LUNDQVIST, H., AND NUNZI, G. Fast rtp retransmission for iptv-implementation and evaluation. In *Global Telecommunications Conference, 2008. IEEE GLOBECOM 2008. IEEE* (2008), IEEE, pp. 1–6.
- [121] PROTOCOL, U. D. Rfc 768 j. postel isi 28 august 1980. *Isi* (1980).
- [122] QUINLAN, J. J., ZAHRAN, A. H., RAMAKRISHNAN, K., AND SREENAN, C. J. Delivery of adaptive bit rate video: balancing fairness, efficiency and quality. In *Local and Metropolitan Area Networks (LANMAN), 2015 IEEE International Workshop on* (2015), IEEE, pp. 1–6.

- [123] RAO, A., LEGOUT, A., LIM, Y.-S., TOWSLEY, D., BARAKAT, C., AND DABBOUS, W. Network characteristics of video streaming traffic. In *Proceedings of the Seventh Conference on emerging Networking EXperiments and Technologies* (2011), ACM, p. 25.
- [124] REAL. Real player available at <http://www.real.com>.
- [125] REC, I. P. 800: Methods for subjective determination of transmission quality. *International Telecommunication Union, Geneva* (1996).
- [126] RICCIATO, F., VACIRCA, F., AND SVOBODA, P. Diagnosis of capacity bottlenecks via passive monitoring in 3g networks: an empirical analysis. *Computer Networks* 51, 4 (2007), 1205–1231.
- [127] SALVADOR, A., NOGUEIRA, J., AND SARGENTO, S. Qoe assessment of http adaptive video streaming. In *Wireless Internet*. Springer, 2015, pp. 235–242.
- [128] SCHIAVONE, M., ROMIRER-MAIERHOFER, P., RICCIATO, F., AND BAIOCCHI, A. Towards bottleneck identification in cellular networks via passive tcp monitoring. In *Ad-hoc, Mobile, and Wireless Networks*. Springer, 2014, pp. 72–85.
- [129] SCHIERBAUM, T., AND LAWRENCE, B. Version 1.5 of hbbtv specification released. *Four new members added to Steering Group, HbbTV, München* (2012).
- [130] SCHULZRINNE, H., CASNER, S., FREDERICK, R., AND JACOBSON, V. Rtp: A transport protocol for real-time applications", rfc 1889.
- [131] SEUFERT, M., EGGER, S., SLANINA, M., ZINNER, T., HOBFELD, T., AND TRAN-GIA, P. A survey on quality of experience of http adaptive streaming. *Communications Surveys & Tutorials, IEEE* 17, 1 (2014), 469–492.
- [132] SHEN, L., TU, W., AND STEINBACH, E. A flexible starting point based partial caching algorithm for video on demand. In *Multimedia and Expo, 2007 IEEE International Conference on* (2007), IEEE, pp. 76–79.
- [133] SHUAI, Y., PETROVIC, G., AND HERFET, T. Olac: An open-loop controller for low-latency adaptive video streaming. In *Communications (ICC), 2015 IEEE International Conference on* (2015), IEEE, pp. 6874–6879.
- [134] SINGH, K. D., HADJADJ-AOUL, Y., AND RUBINO, G. Quality of experience estimation for adaptive http/tcp video streaming using h. 264/avc. In *Consumer Communications and Networking Conference (CCNC), 2012 IEEE* (2012), IEEE, pp. 127–131.
- [135] SPACHOS, P., LI, W., CHIGNELL, M., LEON-GARCIA, A., ZUCHERMAN, L., AND JIANG, J. Acceptability and quality of experience in over the top video. In *Communication Workshop (ICCW), 2015 IEEE International Conference on* (2015), IEEE, pp. 1693–1698.

- [136] TASAKA, S. A bayesian hierarchical model of qoe in interactive audiovisual communications. In *Communications (ICC), 2015 IEEE International Conference on* (2015), IEEE, pp. 6983–6989.
- [137] TASAKA, S., AND ITO, Y. Psychometric analysis of the mutually compensatory property of multimedia qos. In *Communications, 2003. ICC'03. IEEE International Conference on* (2003), vol. 3, IEEE, pp. 1880–1886.
- [138] TASAKA, S., AND NUNOME, T. Qoe enhancement of multimedia communications by user-assistance. In *WTC 2014; World Telecommunications Congress 2014; Proceedings of* (2014), VDE, pp. 1–6.
- [139] TECHNOLOGIES, A. Understanding dslam and bras access devices. *White paper* (2006), 1–16.
- [140] TECHNOLOGY, I. Dynamic adaptive streaming over http (dash)-part 1: Media presentation description and segment formats. In *ISO/IEC 23009-1:2012* (2012).
- [141] TRIANTAFYLLOPOULOU, D., PASSAS, N., KALOXYLOS, A., AND MERAKOS, L. Co-ordinated handover initiation and cross-layer adaptation for mobile multimedia systems. *Multimedia, IEEE Transactions on* 11, 6 (2009), 1131–1139.
- [142] TU, W., STEINBACH, E., MUHAMMAD, M., AND LI, X. Proxy caching for video-on-demand using flexible starting point selection. *Multimedia, IEEE Transactions on* 11, 4 (2009), 716–729.
- [143] UBUNTU. Stochastic fairness queuing discipline, linux man page, available at: <http://manpages.ubuntu.com/manpages/trusty/man8/tc-sfq.8.html>.
- [144] VAN LANCKER, W., VAN DEURSEN, D., MANNENS, E., AND VAN DE WALLE, R. Http adaptive streaming with media fragment uris. In *Multimedia and Expo (ICME), 2011 IEEE International Conference on* (2011), IEEE, pp. 1–6.
- [145] VESCO, A., SCOPIGNO, R. M., AND MASALA, E. Tducsma: Efficient support for triple-play services in wireless home networks. In *Communications (ICC), 2015 IEEE International Conference on* (2015), IEEE, pp. 6941–6947.
- [146] VIBLAST. Viblast player features, available at <http://viblast.com/player/#features>.
- [147] VILLA, B. J., AND HEEGAARD, P. E. Group based traffic shaping for adaptive http video streaming by segment duration control. In *Advanced Information Networking and Applications (AINA), 2013 IEEE 27th International Conference on* (2013), IEEE, pp. 830–837.
- [148] WALKER, J., MORRIS, O., AND MARUSIC, B. Share it!-the architecture of a rights-managed network of peer-to-peer set-top-boxes. In *EUROCON 2003. Computer as a Tool. The IEEE Region 8* (2003), vol. 1, IEEE, pp. 251–255.

- [149] WAN, S., AND HAO, Y. Research on tcp optimization strategy of application delivery network. In *Intelligent Computation and Bio-Medical Instrumentation (ICBMI), 2011 International Conference on* (2011), IEEE, pp. 241–244.
- [150] WANG, Z., LU, L., AND BOVIK, A. C. Video quality assessment based on structural distortion measurement. *Signal processing: Image communication* 19, 2 (2004), 121–132.
- [151] WISNIEWSKI, P., BEBEN, A., BATALLA, J. M., AND KRAWIEC, P. On delimiting video rebuffering for stream-switching adaptive applications. In *Communications (ICC), 2015 IEEE International Conference on* (2015), IEEE, pp. 6867–6873.
- [152] XIE, X., ZHANG, X., KUMAR, S., AND LI, L. E. pstream: Physical layer informed adaptive video streaming over lte.
- [153] YAN, J., MÜHLBAUER, W., AND PLATTNER, B. Analytical framework for improving the quality of streaming over tcp. *Multimedia, IEEE Transactions on* 14, 6 (2012), 1579–1590.
- [154] YAN, Z., XUE, J., AND CHEN, C. W. Qoe continuum driven http adaptive streaming over multi-client wireless networks. In *Multimedia and Expo (ICME), 2014 IEEE International Conference on* (2014), IEEE, pp. 1–6.
- [155] YANG, H., CHEN, X., YANG, Z., ZHU, X., AND CHEN, Y. Opportunities and challenges of http adaptive streaming. *International Journal of Future Generation Communication and Networking* 7, 6 (2014), 165–180.
- [156] YAO, J., KANHERE, S. S., HOSSAIN, I., AND HASSAN, M. Empirical evaluation of http adaptive streaming under vehicular mobility. In *NETWORKING 2011*. Springer, 2011, pp. 92–105.
- [157] YIN, X., SEKAR, V., AND SINOPOLI, B. Toward a principled framework to design dynamic adaptive streaming algorithms over http. In *Proceedings of the 13th ACM Workshop on Hot Topics in Networks* (2014), ACM, p. 9.
- [158] YOKOTA, M. Y. S., AND NAKAJIMA, T. A quality evaluation of high-speed video streaming on congested ip networks. In *Information and Telecommunication Technologies, 2005. APSITT 2005 Proceedings. 6th Asia-Pacific Symposium on* (2005), IEEE, pp. 53–58.
- [159] YOUTUBE. Youtube <http://www.youtube.com>.
- [160] YOUTUBE. Youtube statistics, available at: <https://www.youtube.com/yt/press/statistics.html>.
- [161] ZAMBELLI, A. A history of media streaming and the future of connected tv. available at <http://www.theguardian.com/media-network/media-network-blog/2013/mar/01/historystreaming-future-connected-tv>.

- [162] ZAMBELLI, A. Smooth streaming technical overview, microsoft corp., redmond, wa, usa, tech. rep, available at <http://www.iis.net/learn/media/on-demand-smooth-streaming/smooth-streamingtechnical-overview>.
- [163] ZHANG, L., SHENKER, S., AND CLARK, D. D. Observations on the dynamics of a congestion control algorithm: The effects of two-way traffic. *ACM SIGCOMM Computer Communication Review* 21, 4 (1991), 133–147.
- [164] ZINK, M., SCHMITT, J., AND STEINMETZ, R. Layer-encoded video in scalable adaptive streaming. *Multimedia, IEEE Transactions on* 7, 1 (2005), 75–84.
- [165] ZINNER, T., HOSSFELD, T., MINASH, T. N., AND FIEDLER, M. Controlled vs. uncontrolled degradations of qoe—the provisioning-delivery hysteresis in case of video. *New Dimensions in the Assessment and Support of Quality of Experience (QoE) for Multimedia Applications* (2010).
- [166] ZONG, N. Survey and gap analysis for http streaming standards and implementations.
- [167] ZUKERMAN, M., NEAME, T. D., AND ADDIE, R. G. Internet traffic modeling and future technology implications. In *INFOCOM 2003. Twenty-Second Annual Joint Conference of the IEEE Computer and Communications. IEEE Societies* (2003), vol. 1, IEEE, pp. 587–596.

VU :

VU :

Le Directeur de Thèse

Le Responsable de l'École Doctorale

VU pour autorisation de soutenance

Rennes, le

Le Président de l'Université de Rennes 1

VU après soutenance pour autorisation de publication :

Le Président de Jury,