



HAL
open science

Reaction wood formation in Poplar (populus Spp.) at cell wall level

Raoufeh Abedini

► **To cite this version:**

Raoufeh Abedini. Reaction wood formation in Poplar (populus Spp.) at cell wall level. Mechanics [physics.med-ph]. Université Montpellier II - Sciences et Techniques du Languedoc; University of Teheran, 2014. English. NNT : 2014MON20142 . tel-01241445v2

HAL Id: tel-01241445

<https://hal.science/tel-01241445v2>

Submitted on 17 Jan 2018

HAL is a multi-disciplinary open access archive for the deposit and dissemination of scientific research documents, whether they are published or not. The documents may come from teaching and research institutions in France or abroad, or from public or private research centers.

L'archive ouverte pluridisciplinaire **HAL**, est destinée au dépôt et à la diffusion de documents scientifiques de niveau recherche, publiés ou non, émanant des établissements d'enseignement et de recherche français ou étrangers, des laboratoires publics ou privés.

THÈSE

Pour obtenir le grade de
Docteur

Délivré par **UNIVERSITE MONTPELLIER 2**

Préparée au sein de l'école doctorale Information,
Structures et Systèmes
Et de l'unité de recherche Laboratoire de Mécanique et
Génie Civil

Spécialité : **Mécanique et Génie Civil**

Présentée par **Raoufeh ABEDINI**

**Reaction wood formation in Poplar (populus
Spp.) at cell wall level**

**Formation du bois de tension de peuplier
(populus Spp.) à l'échelle pariétale**

Soutenue le 17/12/2014 devant le jury composé de

M Alinaghi KARIMI, Professor, Université Téhéran	Examineur
M Olivier ARNOULD, MdC Université Montpellier, LMGC Montpellier	Examineur
M Asghar TARMIAN, Associate Professor, Université Téhéran	Examineur
M Bruno CLAIR, CR CNRS, EcoFoG Kourou	Directeur de thèse
Mme Meriem FOURNIER, Professeur, AgroParisTech Nancy	Rapporteur
M Ghanbar EBRAHIMI, Professor, Université Téhéran	Rapporteur
M Joseph GRIL, DR CNRS, LMGC Montpellier	Examineur
M Kambiz POURTAHMASI, Associate Professor, Université Téhéran	Co-directeur de thèse

ACKNOWLEDGEMENT

I would never have been able to accomplish this dissertation without the guidance of the guidance committee members and very nice people that I have met during this project.

I would like to appreciate my first supervisor Dr. Bruno Clair, for his attempt to teach me to feel the subject and aims of the study and cell wall thickening process by different ways, long discussions and especially by interesting drawing method. His guidance was really valuable. It was great pleasure for me to be his student and it was very nice career of my life.

My second supervisor Dr. Kambiz Pourtahmasi, was important person in my life over years, which opened new views to life for me. I feel his support all over this project. It was interesting to work with him.

I would like to express my deepest gratitude to Dr. Joseph Gril, responsible of wood group in laboratory of mechanic and civil engineering for his guidance and helps during this study.

I would like to thank my advisors Dr. Olivier Arnould and Dr. Aghar Tarmian, for their technical helps and guiding me during writing. I would also like to thank Prof. Fournier, Prof. Ebrahimi, Dr. Gril and Prof. Karimi as committee members.

Thanks to Prof. Fournier and Dr. Ruelle who let me experience visiting and working in LERFoB laboratory in Nancy.

I would like to thank very kind staff of laboratory of wood mechanic in Montpellier and laboratory of wood anatomy in Karaj.

Special thanks to my friends who never leave me alone from sampling to defending of this dissertation. I would also like to thank to my friends in LMGC. I never forget lunch table in Montpellier, although sometimes it was difficult for me to understand stories but I always enjoyed friendly relationship of all around this table.

This study received the support of the SCAC (Service de coopération d'Action Culturelle) of French embassy in Tehran and the Iranian center of Excellency on applied management of fast growing wooden species. Part of this work was performed in the framework of the project "StressInTrees" funded by the French National Research Agency (ANR-12-BS09-0004).

Finally, I would like to thank my family and my husband for praying for me, supporting and encouraging me.

Thank you

Abbreviations and symbols

Ca	Cambial zone
EL	Early wood
G, GL, G-layer	Gelatinous layer
LW	Late wood
lg	Lignifying
MFA	Microfibril angle
ML	Middle lamella
OW	Opposite wood
Pc	Post cambial zone
P, PCW	Primary cell wall
PCD	Programmed cell death
S, SL	Secondary cell wall
S1	Secondary cell wall layer, first layer
S2	Secondary cell wall layer, middle layer
S3	Secondary cell wall layer, third layer
TW	Tension wood
TZ	Transition zone

Summary:

Trees can control their shape and resist gravity thanks to their ability to produce wood under tensile stress at their periphery. This prestress is known to be produced during the maturation of wood fibres but its generation mechanism remains unclear. This study focuses on the wood formation process at two levels: i) at the tissue level, the process and timing of tension wood (TW), opposite wood (OW) and normal wood (NW) formation which were investigated on field grown poplar trees and ii) at the cell wall level, the formation of the secondary wall in tension wood was studied in artificially tilted poplar saplings. Results have shown that there were no drastic differences between cambium activity duration for TW, NW and OW. However, the final number of cells produced by the cambium in TW was more than OW and NW. The total number of OW cells produced obviously decreased as a result of a lower cambial activity on this side. Consequently, one can observe pith eccentricity in the bent trees. The lignification phase starts later in OW than in TW and NW, however no observable differences exist between tension and normal wood. The so-called gelatinous layer (G-layer) is formed soon after the start of the lignification in tension wood. Although the total number of cells produced on the side of tension wood was more important than the averaged one produced in upright trees, the total number of cells produced in a complete growth ring of bent trees was similar to that of produced in upright trees. This was the result of a huge reduction in the number of cells produced on the side of OW in bent trees. TW needs a longer time to develop the majority of the xylem growth ring than NW and OW. This indicates that TW growth ring develops longer than NW and OW. Tilting also had an observable effect on the wall thickening of young poplar. The thickness of the secondary wall layer and G-layer were also measured, from cambium to mature wood, in several sampled trees at different time intervals after tilting. Measurements on wood fibres produced before tilting have shown a usual increment of secondary wall thickness during the growing season. After tilting, the secondary layer thickness decreased markedly from normal wood to tension wood while the total thickness with development of thick G-layer increased, as compared to normal wood. However, even after the G-layer formation, the secondary layer thickness continues to increment during the growing season. G-layer thickening has been observed to be faster than secondary layer thickening. The development of un-lignified GL is proposed to be a low cost and efficient strategy for a fast generation of high tensile stress in hardwood trees.

KEYWORDS: Wood formation, Tension wood, Cell differentiation, Cambium activity, Cell wall maturation, Gelatinous layer, secondary cell wall layer, Poplar

Résumé:

Les arbres sont capables de contrôler leur forme et de résister à la gravité grâce à leur aptitude à produire du bois sous tension en périphérie. Il est connu que cette précontrainte se développe durant la phase de maturation des fibres de bois mais le mécanisme sous jacent de génération de cette contrainte n'est pas encore clairement identifié et compris. Cette étude se focalise sur la formation du bois à deux échelles : i) à l'échelle du tissu, le processus et la chronologie de la formation du bois de tension, du bois opposé et du bois normal ont été étudiés sur des peupliers élevés en pleine terre et ii) à l'échelle de la paroi, la formation de la paroi secondaire dans le bois de tension a été étudiée sur de jeunes peupliers inclinés artificiellement. Les résultats montrent que, du côté du bois de tension, le nombre de cellules cambiales au début de la saison de croissance, et ainsi le nombre total de cellules produites au final, augmente comparé au bois opposé et normal. Le nombre de cellules produites du côté du bois opposé est clairement réduit suite à une baisse de l'activité cambiale de ce côté. En conséquence, les arbres fléchis présentent une croissance excentrique. La phase de lignification commence plus tard dans le bois opposé comparé au bois normal et de tension, mais aucune différence significative n'est constatée entre le bois normal et le bois de tension. Le développement de la couche dite G dans le bois de tension commence peu de temps après le début de la lignification. Bien que le nombre total de cellules produites du côté du bois de tension des arbres fléchis est en moyenne plus important que pour les arbres droits, le nombre total de cellules produites globalement dans un cerne de croissance des arbres fléchis est comparable à celui des arbres droits. Ceci est une conséquence directe de la forte réduction du nombre total de cellules produites du côté du bois opposé pour les arbres fléchis. L'inclinaison a aussi un effet évident sur l'épaississement de la paroi cellulaire des jeunes peupliers. L'évolution de l'épaisseur de la paroi secondaire et de la couche G a été mesurée, du cambium au bois mature, dans des échantillons, prélevés à différentes dates après inclinaison, issus de plusieurs arbres. Les mesures sur des fibres de bois produites avant inclinaison montrent l'épaississement progressif habituellement observé de la paroi secondaire au cours de la saison de croissance. Après la date d'inclinaison, l'épaisseur de la paroi secondaire diminue de façon marquée du bois normal vers le bois de tension alors que l'épaisseur totale de la paroi augmente, comparé au bois normal, avec le développement d'une couche G épaisse. Néanmoins, même après la formation de la couche G, l'épaisseur de la paroi secondaire continue d'augmenter au cours de la saison de croissance. L'observation montre que l'épaississement de la couche G est plus rapide que celui de la paroi secondaire. Le développement de la couche G non lignifiée pourrait être une stratégie économe, et efficace, pour la production rapide de contrainte de croissance importante chez les feuillus.

MOTS CLÉÉS: Formation du bois, bois de tension, différenciation cellulaire, activité cambial, maturation de la paroi cellulaire, couche gélatineuse, paroi secondaire, Peuplier

Table of contents

Introduction.....	1
1. State of the art	4
1.1. Poplar as a model tree.....	4
1.2. Wood formation	4
1.2.1 Timing of wood formation	5
1.2.2 The vascular cambium	5
1.2.3 Differentiation or maturation of xylem cells.....	8
1.2.3.1 Cell enlargement.....	8
1.2.3.2 Secondary cell wall formation.....	9
1.2.3.3 Lignification	9
1.2.3.4 Maturation and cell death (PCD).....	10
1.3. The ultrastructure of the wood cell walls	10
1.4 Tension wood.....	12
1.4.1 Macroscopic level.....	12
1.4.2 Microscopic level	13
1.4.3 Cell wall level.....	13
1.4.3.1 Gelatinous layer (GL)	13
1.4.4 Molecular level.....	15
1.5. Maturation stress in trees.....	16
1.5.1 The origin of maturation stress.....	16
1.5.2 Growth stress in tension wood	17
Part 1	
2. Timing of the wood formation in NW, TW and OW	19
2.1 Material and Methods.....	19
2.1.1. Sampling technique for wood formation studies	19
2.1.1.1. Trees selection	19
2.1.1.2. Microcore sampling.....	20
2.1.2. Microcore sample preparation	23
2.1.2.1. Impregnation of samples with paraffin	23
2.1.2.2. Embedding samples in paraffin	24
2.1.2.3. Trimming paraffin blocks	25
2.1.2.4. Sectioning of paraffin embedded microcores	25
2.1.2.5. Staining of sections	26
2.1.3. Examining of anatomical sections	26
2.1.4. Surveying number of cells.....	27
2.1.5. Modeling the growth by using Gompertz function.....	27
2.2. Results.....	30
2.2.1. Timing of wood formation in NW, TW and OW	30
2.2.2. Eccentricity of pith in bent trees	30
2.2.3. Dynamics of cambial activity	31
2.2.4. Phenology of trees.....	34
2.2.5. Cell differentiations.....	37
2.2.5.1. Phenology of enlarging cells.....	37

2.2.5.2. Secondary cell wall formation	39
2.2.5.3. Lignification phase	41
2.2.5.4. Gelatinous layer (GL) formation.....	41
2.2.6. Mature cells	43
2.2.7. Comparison of wood formation in bent trees and upright trees	44
2.2.8. Anatomical characteristic of TW, OW and NW	46
2.2.9. Growth phenology according to Gompertz equation	46
2.3. Discussions	50
2.3.1. Wood formation and maturation.....	50
2.3.2. Dynamic of TW, NW and OW formation	50
2.3.2.1. Comparing total amount of wood in TW, OW and NW	50
2.3.2.2. Stem eccentricity in TW	51
2.3.3. Cambium activity.....	51
2.3.3.1. Relationship of tree phenology and cambium activity	52
2.3.4. Cell enlargement (or postcambial) phase	53
2.3.5. Secondary cell wall thickening and lignification.....	54
2.3.6. Cell death (Mature cells)	55
2.3.7. Gelatinous layer formation	56
2.3.8. Comparing TW with OW and NW	57
2.3.9. Growth duration and growth rate according to Gompertz function.....	57
2.3.10. Conclusion	58
Part 2	
3. Cell wall thickening in poplar tension wood.....	59
3.1. Material and methods	59
3.1.1. Preliminary measurement of cell wall thickness	59
3.1.2. Sampling for cell wall thickening studies	60
3.1.3. Sample preparation.....	60
3.1.3.1. Embedding samples in resin	60
3.1.3.2. Trimming of the samples	61
3.1.3.3. Sectioning	62
3.1.4. Measurement of cell wall thickness	62
3.1.5. Data analysis	65
3.2. Results.....	66
3.2.1. Preliminary studies.....	66
3.2.2. Cell wall thickening in developing tension wood.....	69
3.2.3. Stimulus duration before GL formation	69
3.2.4. Cell diameter variation during tension wood formation	70
3.2.5. Identifying the tilting date in sections	71
3.2.6. Growth rate	71
3.2.7. SL thickness before tilting	72
3.2.8. Change in SL thickness after tilting	74
3.2.9. Kinetics of GL deposition vs. SL thickening.....	74
3.2.10. GL and SL growth rates	77
3.2.11. Cell wall thickening in opposite wood during tension wood formation.....	77
3.2.12. Cell wall thickening at the end of growing season	78
3.2.13. Cell death.....	79

3.3. Discussion	80
3.3.1. Cell wall developing in TW	80
3.3.2. Transition zone at the tilting time.....	81
3.3.3. Timing of GL versus SL deposition	82
3.3.4. GL thickening period	82
Conclusions and future prospects.....	84
References.....	86

Introduction

Wood as a raw material for major global industry and fifth most important product of world trade (Plomion et al. 2001) is the result of a biological process. It grows under a wide range of genetic and environmental influences and has similarly wide range of properties and characteristics (Punches 2004). The ability of trees to regulate their shape and maintain their trunk vertically is performed thanks to an asymmetrical distribution of mechanical stresses around the tree circumference (Archer 1986). When the axes of hardwood species need a strong reorientation or reaction to weight, a high tensile stress can be produced on the upper side of the leaning stem by the so-called tension wood (Fournier et al. 2014). This wood, generally considered as abnormal tissue, is produced by the cambium in reaction to a gravitational stimulus (Jourez 2001). Wood formation process (Mellerowicz & Sundberg 2008) and cell wall structure of tension wood can exhibit important changes compared with normal wood (Onaka 1949; Ruelle 2014). Wood formation and cell differentiation in normal wood has four major steps (enlarging, secondary cell wall deposition, lignifications and maturation). The most important mechanism, by which reaction wood allows a tree to return to the vertical, occurs during the cell maturation process (Plomion et al. 2001). At the cell wall level, normal wood cells are composed of a middle lamella, a thin primary wall and a large secondary wall layer (SL) divided into three sub-layers, called S1, S2 and S3 that are fabricated at different period during cell differentiation. Stimulation of cambial growth causes reprogramming of wood biosynthesis and consequences cell differentiation (Mellerowicz & Sundberg 2008). In numerous species, such as poplar, tension wood is characterized by fibres with a specific morphology and chemical composition due to the development of a so-called gelatinous layer (GL), replacing the S3 and a part of or the whole S2 layer (Saiki and Ono 1971; Andersson-Gunneräs et al. 2006). The GL is known to have a high cellulose content (Norberg and Meier 1966; Côté et al. 1969) with microfibrils oriented nearly parallel to the cell axis (Fujita et al. 1974; Prohdan et al. 1995), no lignin (Pilate et al. 2004), and a high mesoporosity (Mikshina et al. 2013; Chang et al. 2009). At the tissue level, poplar tension wood is also characterized by a reduced number and a lower diameter of vessel elements (Jourez et al. 2001).

Although the GL is the most important structural changes of tension wood in most temperate eudicots, numerous tropical species do not produce a GL (Okuyama et al. 1994; Yoshida et al. 2000; Clair et al. 2006; Sultana et al. 2010). In tension wood with G-fibres, the GL is recognized as the driving force of tensile stress as its amount is directly related to the mechanical stress level (Clair et al. 2003; Washusen et al. 2003; Fang et al. 2008) and tensile stress in cellulose microfibrils has been identified to occur synchronously with their deposition in the GL during cell maturation (Clair et al. 2011). It seems that in maturation process, this layer shrinks strongly in the longitudinal direction, thereby creating a very strong state of tensile stress in the cell. However, the clear mechanism of tensile stress generation remains unclear, and it is therefore interesting to focus research on the mechanism of GL development in tension wood.

Despite of important role of wood in human's life, our undrestanding of how wood develops is far from complete. Monitoring cambial phenology and intra-annual growth dynamics is a useful approach for characterizing the tree growth response to environmental factors (Michelot et al. 2012).

During one growing season, the timing, duration and rate of radial growth could differ among species under same climatic conditions (Rossi et al. 2006b; Rathgeber et al. 2011a). Besides climate condition, other environmental factors that induce mechanical stress in trees could change timing and duration of cambial activity and wood formation in trees. The number and size of cells is dependent on the environmental factors that can modify the structure of annual rings (Horacek et al. 2003).

Tension wood is often formed at a higher rate compared with normal wood (Andersson-Gunneräs 2006). Growth speed and developmental decisions regarding the cell type formed are determined in the meristematic cambial zone, whereas the formation of the GL takes place later during xylem differentiation (Timell 1986). The perception of the need of reaction is very fast; Jourez and Avella-Shaw (2003) observed that reaction is visible several hours after tree inclination but the GL is only visible after 1 to 2 days, depending on the trees. However, the development at a finer scale, and especially the balance between SL and GL production, has never been studied and could be of special interest for the understanding of maturation stress generation. Indeed, several observations have been done on the decrease of the SL thickness when the GL thickness increases (visible but not discussed in Clair et al. 2011; Yoshinaga et al. 2012; Chang et al. 2014). The starting point of this study was therefore to identify whether GL formation could be partially due to a modification of SL during maturation.

Repeated stem microcore sampling using specially designed tools has been used successfully to determine intra-annual cambial dynamics (Forster et al. 2000; Rossi et al. 2006a; Michelot et al. 2012). Using microcoring method, one can measure the growth of wood separately from other tissues in one radial direction (Michelot et al. 2012). Recently the number of intra-annual studies of wood formation using microcoring has increased (Deslauriers et al. 2008; Oladi et al. 2010; Michelot et al. 2012; Li et al. 2013), but study of growth dynamics of tension wood remains scarce.

This study is divided in 2 parts:

First, we compare cambial activity and intra-annual wood formation between tension and opposite wood of some artificially bent white poplar trees (*Populus alba*) and normal wood of upright trees. The main objective of this study was to understand how the timing, duration and rate of radial growth differ among these three kinds of wood and when the gelatinous fiber of tension wood forms. The general hypothesis is that timing, duration and rate of wood formation differ in tension wood, opposite and normal wood. We try to find the origin of eccentricity in

bent trees which is reported in several studies. The following questions were targeted to be answered in this study:

- Does higher growth in TW is because of higher growth speed?
- Or because of longer growth period in TW side?
- Does formation of cells with bigger diameter cause eccentricity in TW?
- Does need of recovery induce higher carbon cost in trees because of a higher wood production?

Secondly, the growth of cell wall layers of tension wood is investigated in poplar grown under artificial conditions. The study focuses on GL formation during the secondary wall formation stage (i.e., excluding the cambial zone and early stages of xylem cell expansion). This study aims to answer the following questions:

- How GL and SL thickness are changing during the reaction process?
- What is the relationship between GL and SL thickening?
- Does GL formation reduce SL thickness in the tension wood cell wall?

1. State of the art

1.1. Poplar as a model tree

Poplars as an important fast growing species has covered wide surface of plantations. This species is very sensitive to tension wood formation stimulants. *Populus* spp. and *Eucalyptus* spp. are evident candidates for wood formation studies among the hardwood species, because of their ease of vegetative propagation, their suitability for genetic transformation, their small genome size (5 _ 108 and 6 _ 108 bp respectively, i.e. only a little larger than that of Arabidopsis) and the availability of genetic maps (Plomion et al. 2001). In order to establish a platform for functional genomics in a tree species, poplar has been subjected to extensive expressed sequence tag (EST) sequencing projects. Tension wood has many advantages for functional genomics studies that will help decipher the molecular mechanisms responsible for the formation and properties of wood (Pilate et al. 2004).

White Poplar (*Populus alba*), is a fast-growing, deciduous tree of polar species and Willow family (Salicaceae). It is native in Spain and Morocco through central Europe (north to Germany and Poland) to central Asia. Trees of this species reach 18 to 30 m in height with a 12 to 15-m spread and makes a nice shade tree. The wood of White Poplar is fairly brittle and subject to breakage in storms and the soft bark is subject to injury from vandals. White Poplar should be grown in full sun and tolerates almost any soil, wet or dry (Gilman and Watson 1994).

In normal poplar wood, fibers are libriform type ones with thin walls and very fine pits with slit-like openings (Jacquot et al. 1973 in Jourez 2001). Concerning vessels, poplar presents a homogeneous wood with diffuse porosity, very numerous pores, solitary or radially joined in groups of two, three, or even more. The vessels have simple perforations and thin walls (Jacquot et al. 1973 in Jourez 2001). In poplar, as in most temperate tree species, tension wood fibers are characterized by the presence of a specific layer, called the G-layer (Clair et al., 2010).

1.2. Wood formation

Wood formation or Xylogenesis is a dynamic process which is derived from plant secondary (radial) growth represents an example of cell differentiation in an exceptionally complex form. This process is controlled by a wide variety of factors both exogenous (photoperiod and temperature) and endogenous (phytohormones) and by interaction between them. It is driven by the coordinated expression of numerous structural genes (some of the known function) involved in cell origination and maturation process (Plomion et al. 2001; Zhang et al. 2014). Plomion et al. (2001) described wood (secondary xylem) formation by a succession of five major steps, including cell division, cell expansion (elongation and radial enlargement), cell wall thickening (involving cellulose, hemicellulose, cell wall proteins, and lignin biosynthesis and deposition), programmed cell death, and heart wood (HW) formation. All of these steps influence the timing of wood formation.

1.2.1. Timing of wood formation

Wood formation varies during the growing season. The vascular cambium of tree stems undergoes seasonal cycles of activity and dormancy. Cambial activity is regulated by both internal signals and environmental factors. In temperate-zone species, cambial activity exhibits periodicity and usually occurs from early spring to early autumn. Environmental conditions specially temperature and photoperiod affect rate and timing of wood formation (Plomion et al. 2001; Begum et al. 2008).

In temperate region, EW is formed early in the growing season when temperature and photoperiod are favorable for active growth. EW has shorter cells and a lower density resulting from thinwalled tracheids or fibers of large radial diameter. LW is formed in the late summer or autumn when cambial cell division and expansion declines. LW has high density resulting from the small tracheid/ fiber radial diameter and large tangential wall thickness (Plomion et al. 2001). During the growing season, cells located in the same radial file can be at different stages of maturation and thus the different biochemical processes involved in xylem formation are in different stages. The timings of differentiation phases determine specific anatomical characteristics of the xylem. The characteristic pattern of xylem cell production and differentiation organizes the vascular elements in radial files. The radial sequence of cells corresponds to the temporal sequence of appearance in the trees, allowing wood formation to be assessed over different intra-annual time scales depending on the resolution required by the analysis, from a few hours to one week, to several weeks. A precise description of the period of wood formation allows the days spent in differentiation by each cell to be estimated (Rossi et al. 2006a). The length of the growing season is one of the main determinants of tree production in all forest ecosystems of the world. Delays in the start of the growing season reduce the period available for growth, so significantly affecting tree ring width and, consequently, radial growth. Temperature has important effect in both cambial reactivation and cell production (Begum et al. 2007, 2010). Different physiological processes may act at the beginning and ending of growth (Thibeault-Martel et al. 2008). Some studies have proposed that external factors, like photoperiod or water availability, or internal factors, like hormonal signals and vigour, may be more important than temperature for growth cessation (Schmitt et al. 2003; Schmitt, Jalkanen & Eckstein 2004; Gričar & Čufar 2008). It is reported that age, vigorous and growth ring width of the trees also affect timing of onset and cessation of cambial activity and lignification (Rossi et al. 2008a; Schmitt et al. 2003; Gričar et al. 2005).

1.2.2. The vascular cambium

Mature vascular tissues consist of highly specialized cell types that generally arise from discrete populations of undifferentiated progenitor cells located in meristem (stem cell) niches. Root and shoot apical meristems are established during embryo development, whereas lateral meristems (procambium and vascular cambium) appear at later stages of development and result from hormone-driven cellular recruitment and re-differentiation process. Procambial cells can undergo periclinal divisions (parallel to the plane of cell elongation), ultimately giving rise to the procambium tissue, from which specialized xylem and phloem cells are subsequently formed

(Fig. 1.1). However, a subset of cells within procambium remains in an undifferentiated state, positioned between differentiated xylem and phloem tissues. These cells function as vascular stem cells and enable the prolonged formation of vascular tissues in rapidly elongating or expanding organs such as young stem and leaves during plant growth (Schuetz et al. 2012).

The vascular cambium forms a continuous cylinder of meristematic cells in the stem, producing secondary phloem tissue on the outside and secondary xylem or wood on the inside. The term cambium *sensu stricto* refers to one or several layers of initials, analogous to the stem cells proposed for other meristems. Periclinal (tangential) divisions of these initials then produce phloem or xylem mother cells, which in turn can undergo several rounds of cell division before differentiating cambial initials and mother cells are collectively referred to as the cambial zone (Schrader et al 2004). Many factors which influence timing of wood formation (which mentioned in previous part) function with affecting cambium activity. It has been also reported that the cambial activity lasts longer on the upper face of inclined stems in some *Eucalyptus* (Dadswell & Wardrop 1956 in Jourez et al. 2001).

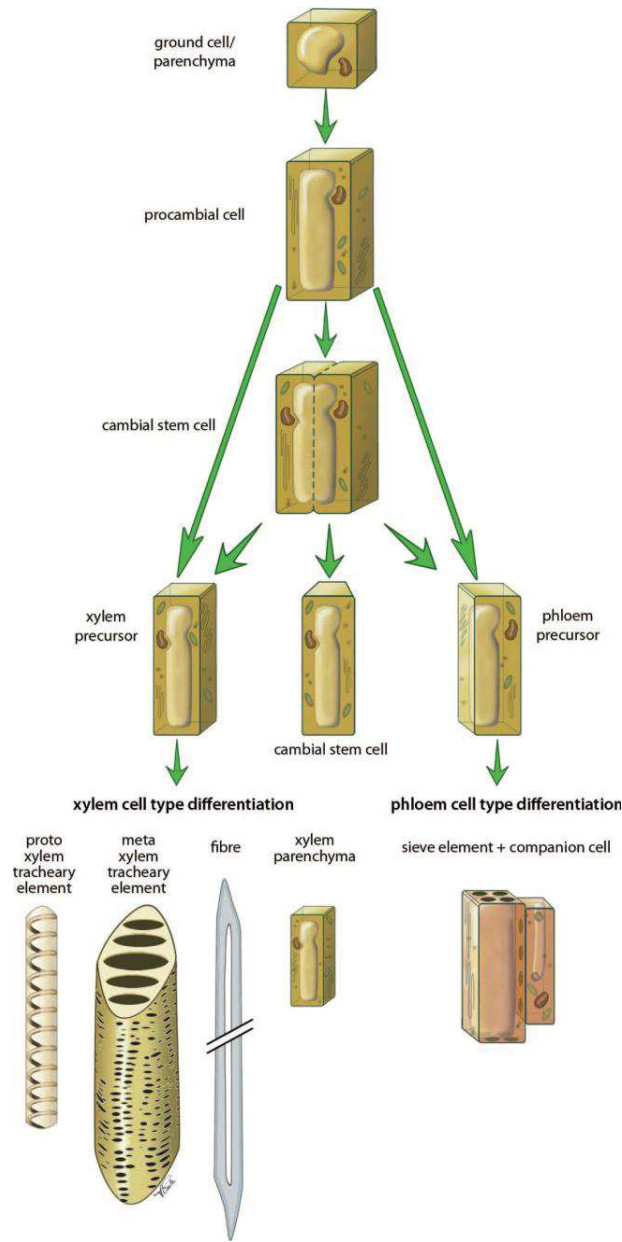

Figure 1.1 Overview of procambial/cambial cell specification and xylem/phloem cell differentiation. Procambial cells can form by the *de novo* (anew) differentiation of parenchyma cells, or by division of existing procambial cells during primary growth, thereby forming the procambium. The vascular cambium and associated cambial cells are derived from the procambium during the transition to secondary growth, at which point the nomenclature of procambial' cells no longer applies and 'cambial' cells is used instead. In woody plants, the cambial cells are further categorized as ray initials or fusiform initials (not shown here). cambial/procambial cells differentiate into either xylem or phloem cell types, as shown. Note: different cell types are not to drawn to scale (Schuetz et al. 2012).

1.2.3. Differentiation or maturation of xylem cells

The production of secondary xylem (wood) requires both mitosis in the vascular cambium and xylogenesis. Xylogenesis can be defined as the series of common developmental steps found in differentiation of both primary xylem (produced via procambium by apical meristems) and secondary xylem (produced by the vascular cambium) (Fig. 1.2) (Samuels et al. 2006).

The daughter cells, produced by the cambial initials, give rise to a wide variety of wood cells, whose unique characteristics and three-dimensional associations define the intrinsic structure of wood. The differentiation of these cells involves four major steps: cell expansion, followed by the ordered deposition of a thick multilayered secondary cell wall, lignification, and cell death (Plomion et al. 2001). Wood characteristics are due to cambium division, cell expansion, and secondary wall production (Giovannelli 2007).

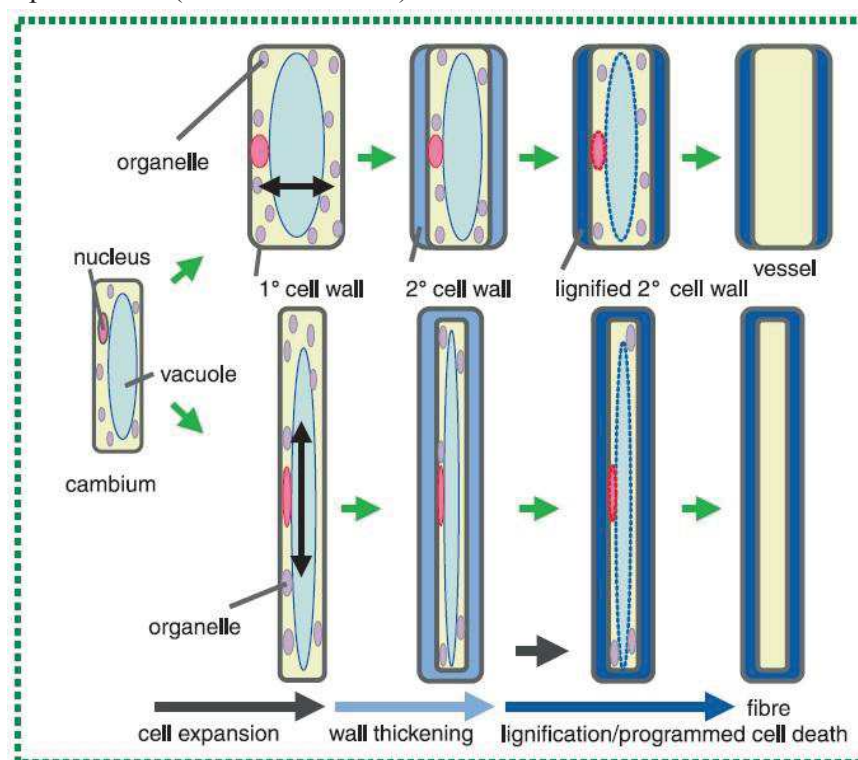

Figure 1.2 Secondary xylem development in angiosperms. Common elements of xylogenesis in secondary xylem. The steps of differentiation are: (1) expansion (2) secondary cell wall polysaccharide deposition (3) followed by lignifications and programmed cell death (PCD). For vessel of angiosperms, expansion is strongly in the radial direction, followed by secondary cell wall production, lignifications, and protoplast lysis. For angiosperm fibres, expansion is axial as the cells elongate by intrusive growth (Samuels et al. 2006).

1.2.3.1 Cell enlargement

Following cell division, cambial cell derivatives undergo a period of cellular expansion to reach their final size during the formation of the primary wall. Xyloglucan endotransglycosylases, endoglucanases, expansions, pectin methyl esterases, and pectinases are among the primary determinants of this process. (Plomion et al. 2001; Mellerowicz and Sundberg 2008). Variation

in differentiated xylem cells begins immediately at this early stage of development. Angiosperm vessels and gymnosperm tracheids, the cells that will conduct water, undergo radial expansion, while supportive fibers of angiosperms undergo intrusive elongation (reviewed by Mellerowicz et al. 2001). Completion of mitosis and cell expansions are closely linked. The first physical manifestation of a cambial cells commitment to differentiation is remodeling of the cortical microtubules, which have been observed with indirect immunofluorescence on dissected, sectioned cambium and developing xylem. At the transition between primary cell wall and secondary cell wall production, the cells biosynthesis machinery most undergo a dramatic shift in secretion from supportive active expansion of the pectin-rich primary cell wall to supporting assembly of a secondary cell wall consisting predominantly of the ordered cellulose and hemicellulose layers that will eventually be lignified (reviewed by Samuels et al. 2006).

1.2.3.2. Secondary cell wall formation

Once expansion is completed, the formation of the secondary cell wall begins, driven by the coordinated expression of numerous genes specifically involved in the biosynthesis and assembly of four major compounds: polysaccharides (cellulose, hemicelluloses), lignins, cell wall proteins and other minor soluble (stilbenes, flavonoids, tannins, and terpenoids), and insoluble (pectins and cell wall proteins) compounds in a neutral solvent (Plomion et al. 2001). Protoplast begins to produce the thickened secondary cell wall, a three layered structure (S1, S2, S3) made of cellulose microfibrils. The microfibril orientation of secondary cell wall layers change during development. The hemicelluloses of the secondary cell wall are produced and secreted by the Golgi. Golgi structure change dramatically during the transition from primary to secondary cell wall. In developing secondary xylem of poplar, both vessels and fibers have intact organelles. The cellulose synthases enzymes for secondary cell wall formation are different from cellulose synthases used in primary cell wall formation. At the later stages of polysaccharide biosynthesis proceed, lignifications of cell corners and the middle lamella of tracheary elements and fiber begins (Samuels et al. 2006). The chemical and mechanical properties of wood depend on the properties of the secondary walls (Mellerowicz and Sundberg 2008).

1.2.3.3 Lignification

Lignification is one of the final stages of xylem cell differentiation, where lignin is deposited within the carbohydrate matrix of the cell wall by infilling of interlamellar voids, and at the same time, formation of chemical bonds with the non-cellulosic carbohydrates. Lignin can be described as a highly complex polymer consisting of phenylpropane units linked together by a variety of carbon-oxygen and carbon-carbon bonds (Koch 2004). Lignification begins at the cell corners in the middle lamella and S1 regions, eventually spreading across the secondary wall towards the lumen. Lignification of the middle lamella and primary wall typically begins after the start of secondary wall formation, while lignification of the secondary wall usually begins when secondary wall formation is complete (Donaldson 2001).

The cell wall can be assimilated to a composite made of a matrix of lignins and hemicelluloses, reinforced by long bundles of cellulose microfibrils (Pilate et al. 2004).

The regulation of monolignol (lignin monomers) biosynthesis and subsequent lignin polymer formation is a complex process that is influenced by a variety of developmental, physiological, and environmental cues. Donaldson (2001) in a review of ultrastructural aspect of lignification expressed that lignin monomers are synthesized in the cytoplasm, and are released into the cell wall from vesicles as monolignols or monolignol glucosides. In order for monolignols to participate in polymerization to form the final lignin structure, they must move from their site of synthesis, across the plasma membrane to the cell wall. How this export is accomplished remains unclear. Lignification of the largely cellulosic secondary cell wall makes a major contribution to the functionality of mature tracheary elements and fibres. This phenolic polymer imparts both increased structural stability and water impermeability to the cell wall (Schuetz et al. 2012).

1.2.3.4. Maturation and programmed cell death (PCD)

Xylem cell death is an inseparable part of the xylem maturation programme. When lignification is completed, conducting xylem elements undergo programmed cell death (PCD), involving cell-autonomous, active, and ordered suicide, in which specific hydrolases are recruited. Several factors (auxins, cytokinins, and Suc) prepare the cell to die by determining the profile of hydrolases synthesized by the cell. These hydrolases are inactive in the vacuole. By a signal that remains unknown, a calcium flux provokes the vacuoles to collapse with the release of hydrolases that degrade all of the cellular content but not the secondary cell wall (Plomion 2001). The necessary components for xylem cell death are produced early during xylem differentiation, and cell death is prevented through the action of inhibitors and storage of hydrolytic enzymes in inactive forms in compartments such as the vacuole. Bursting of the central vacuole triggers autolytic hydrolysis of the cell contents, which ultimately leads to cell death. The expression of several genes functionally associated with PCD is correlated with xylem development, particularly with tracheary element differentiation (Schuetz *et al.* 2012). The death and complete clearing of xylem vessel elements and tracheids, commonly known as tracheary elements (TEs), is a prerequisite for the transport of water (Bollhöner et al. 2012).

1.3. The ultrastructure of the wood cell walls

The cell wall is composed of several layers that are fabricated at different periods during cell differentiation (Fig. 1.3).

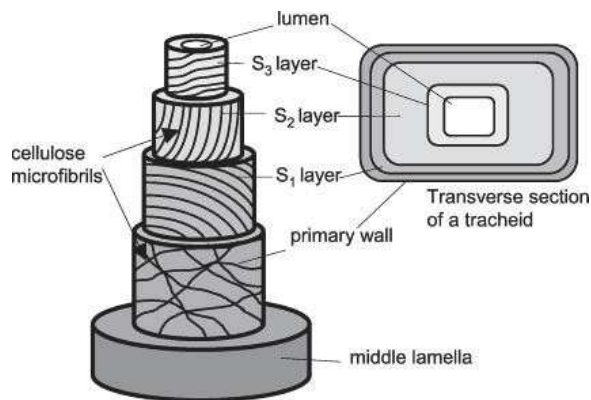

Figure 1.3 Three-dimensional structure of the secondary cell wall of a tracheid (xylem cell). The cell wall is divided into different layers, each layer having its own particular arrangement of cellulose MFs, which determine the mechanical and physical properties of the wood in that cell. These MFs may be aligned irregularly (as in the primary cell wall), or at a particular angle to the cell axis (as in layer S₁, S₂, and S₃). The middle lamella ensures the adhesion between cells (**Plomion et al. 2001**).

The middle lamella is the first layer which developed after cell division. It constructs between the wood cells, and ensures the adhesion of a cell with its neighbors. The middle lamella is only 0.5 to 1.5 μm thick and is made up of pectic substances to which lignin may be added during the differentiation period. The primary cell wall forms at the beginning of cell differentiation. Primary wall is highly elastic layer, which is attached to the middle lamella and is approximately 0.1 μm thick. The primary cell wall is made up of several layers of MFs (micro-fibrils), which are arranged randomly within this wall. Pectic substances, lignin, and hemicelluloses can be found between these cellulosic MFs. As the developing cell reaches its definitive size, secondary cell wall which is the most important layer for the cell and provide mechanical strength, is formed inside the primary cell wall. This new cell wall is divided into three different layers, S₁, S₂, and S₃ (Timell, 1986). Each of these layers is composed of cellulose MFs, aligned in an ordered, parallel arrangement, which differs from one layer to the other layer. Hemicelluloses and lignin are also present in each of these layers. These three S layers can be modified during cell maturation, which lasts for several days after the birth of the wood cell, e.g. the amount of lignin and cellulose laid down in the secondary cell wall may be influenced by abiotic factors such as mechanical stress, i.e. wind and stem lean. The S₁ layer is the thinnest of the S layers, being only 0.1 to 0.35 μm thick, and representing just 5% to 10% of the total thickness of the cell wall. This layer is considered as an intermediate between the primary cell wall and the S₂ and S₃ layers. The MF angle with regard to the cell axis is 60° to 80°. The S₂ layer is the thickest layer in the secondary cell wall, and is the most important, with regard to mechanical support. The thickness of the S₂ layer varies between 1 and 10 μm , and accounts for 75% to 85% of the total thickness of the cell wall. The MF angle in this layer is 5° to 30° to the cell axis, and can be even higher, depending on external mechanical stress. The angle of the cellulose MFs in the S₂ layer can influence greatly the physical and mechanical properties of the cell and even stem wood as a whole. As the MF angle increases, with regard to the cell axis, wood becomes less rigid, and the

longitudinal modulus of elasticity decreases, as in the case of juvenile and compression wood (CW). The innermost layer of the secondary cell wall, the S3 layer, is relatively thin, being only 0.5 to 1.10 μm thick. The MFs are ordered in a parallel arrangement, but less strictly than in the S2 layer, and the MF angle is 60° to 90° with regard to the cell axis (Plomion et al. 2001). Although chemical component of cell walls varies based on plant species and cell types, the secondary cell walls of flowering plants are predominantly composed of cellulose (~40–50%), lesser amounts of hemicelluloses (~20–30%) and lignin (~25–30%), with only small amounts of pectin and proteins (Mellerowicz and Sundberg, 2008; Dejardin *et al.*, 2010, Schuetz *et al.* 2012).

1.4. Tension wood

Trees control the shape of their stems through the generation of growth stresses during the process of wood formation. In situations demanding high orientation control, trees produce the so-called reaction wood (RW), defined by the International Association of Wood Anatomists (IAWA) as “wood with distinctive anatomical and physical characteristics, formed typically in parts of leaning or crooked stems and in branches, that tends to restore the original position of the branch or stem when it has been disturbed; also known as tension wood (in deciduous trees) and compression wood (in conifers)”. This restoration controls by a very active mechanical action driven by variations of cambial activity. Those variations of cambial activity will lead to variations in anatomy and ultrastructure of the xylem to achieve this biomechanical function (Ruelle 2014). Tension wood of arborescent angiosperm dicotyledons generally appears on the tightened upper face of inclined stems and branches (Jourez 2001). The wood produced on the side of a stem or branch opposite to the reaction wood (opposite wood) may also be of a special nature and can be viewed as having many properties intermediate between NW and reaction wood (plomion et al. 2001).

1.4.1 Macroscopic level

Although stem eccentricity of TW in angiosperm is not always as conspicuous as compression wood but can be considered as macroscopic appearance of TW. It is normally associated with eccentricity of the stem or branch with the wider rings normally being on the upper side of the stem or branches (Ruelle 2014).

The presence of tension wood in timber is a detrimental feature in terms of the texture and properties of the timber for its application in the field of furniture and building construction. The growth stress and G-layer (GL) of tension wood may cause log splitting and lumber distortion and other growth stress related problems during the cutting and drying processes, respectively (Tsai, et al. 2006). Shrinkage characteristics of tension wood tissue are different from those of adjacent normal wood. Since tension wood is typically localized on one side (upper side) of the trunk, is often found only in the proportion of the total number of annual rings and it causes differential shrinkage effects during drying, which leads to warping, twisting, bending, and cracking of logs, planks, machined parts, and veneers. Collapse is another problem in wood

industries associated with the seasoning of tension wood from the green condition. Green-sawn boards of tension wood have a woolly surface (Sultana 2013).

1.4.2 Microscopic level

Jourez et al. (2001) described the characteristics of tension wood of poplar widely. Fibers are longer in tension wood tissue than in opposite wood. The radial fiber diameter is lower in tension wood. Vessel elements are longer in tension wood. The external vessel diameter is lower in opposite wood and decreases from pith to bark. In the cross section, the vessel frequency like the area of vessel lumina is lower in tension wood and, consequently, the proportion of vessel lumina is lower in tension wood. The number of rays is higher in tension wood. Tension wood has a low proportion of vessel lumina, a low proportion of wall (– G layer) and a high proportion of fibre lumina (+ G layer). Jourez et al.(2001) has shown that the gravitational stimulus affects both phases of wood development: differentiation and maturation. During differentiation, the stimulus affects the numbers of cells, such as vessel elements, fibres, or rays. During maturation, the stimulus affects dimensions of cells, their lumina and their length. The patterns observed in their study were for very young stems of poplar. The increase of fibre proportions observed in tension wood structure can be occurred to provide supporting elements during the synthesis of tension wood (Ruelle 2014).

More-abundant axial parenchymatous cells and starch grains were observed in the opposite wood of Honduras mahogany (*Swietenia macrophylla* King) than in the reaction wood. They suggest such anatomical characteristics indicate that there are distinct patterns of regulation between the cambium zones of the reaction wood and opposite wood (Tsai et al. 2006).

In many tree species including *Populus* and *Eucalyptus*, TW fibers form a distinctive gelatinous inner wall GL. this layer is known to have a high cellulose content (Côté et al. 1969; Mellerowicz and Sundberg 2008) with microfibrils oriented nearly parallel to the cell axis (Prohdan et al. 1995), no lignin (Pilate et al. 2004), and a high mesoporosity (Chang et al. 2009). There is debate on presence of lignin in GL. Observations made using UV microscopy and TEM showed that there is almost no lignin in G-layers. This result is not consistent with the observations of Joseleau et al. (2004); however, it is known that small amounts of syringyl-rich lignin are difficult to observe by UV microscopy due to its very low absorptivity (Yushinaga 2012).

1.4.3 Cell wall level

1.4.3.1 Gelatinous layer (GL)

In some species of angiosperms, an extra layer exists between the lumen and the S3 layer, called the gelatinous, or G layer. The G layer is almost entirely made out of cellulose, with an almost vertical MF angle. During maturation, this layer shrinks strongly in the longitudinal direction, thereby creating a very strong state of tensile stress in the cell (Plomion et al. 2001). When the seedlings receive the gravitational signal, the xylem mother cells follow different pathways of differentiation. That is, more xylem mother cells develop into gelatinous fibers in the reaction cambium, but into axial parenchymatous cells in the opposite cambium. The process of cell

differentiation during wood formation is a complicated research topic involving many biochemical pathways and genetic regulators (Tsai et al. 2006).

Normal structure of cell wall changes during tension wood (TW) formation (Fig 1.4). A large variations show within secondary cell wall structure of tension wood fibers, which will be a tool for establishment of evolutionary development of secondary wall structure in tension wood fiber for dicotyledons, and also be a source for studding origin and evolution of species (Sultana 2013).

Gelatinous fibres can show various patterns, i.e. S1+G, S1+S2+G, S1+S2+S3+G. Onaka (1949) referred to three types of gelatinous layer which may correspond to the ones cited above. However, he has indicated that each type is to be found in certain genera or families, whereas some observations have demonstrated the occurrence of more than one type in the same tree or particular specimen (Ruelle 2014).

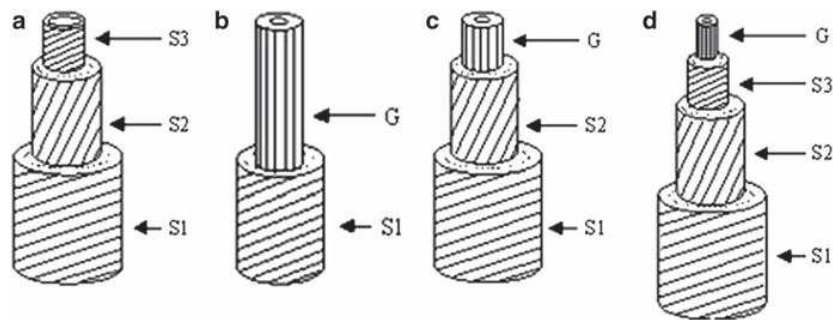

Figure 1.4 Schematic models for the cell wall structures of fibres in normal wood (a) and tension wood (b–d), redrawn from Wardrop and Dadswell (1955). Solid lines indicate cellulose microfibril orientation. (a) Normal fibres do not develop a G-layer. (b) G-layer where S2 and S3 layers develop normally. (c) S3 layer replaced with G-layer. (d) G-layer forms as the innermost layer next to the S3 layer (Kwon 2008 in Ruelle 2014).

Based on extensive studies on GL structure in different studies various cell wall structures can occur in tension wood: (a) Tension wood fibres with a G-layer, (b) Tension wood fibres with polylaminate secondary wall structure, and (c) Tension wood fibres not differing from non-reaction wood fibres (Fig. 1.5). Thickness of the GL also can vary from thin layer to thick layer or even fill the lumen (Coutand et al. 2004; Chang et al. 2009b).

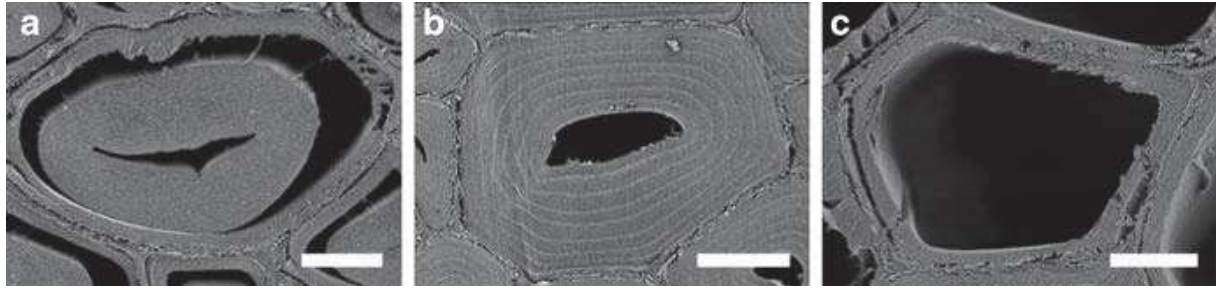

Figure 1.5 Cross sections of tension wood (a) *Eperua falcata* showing a well-developed G-layer (b) *Laetia procera* showing a poly laminate organisation, and (c) *Simarouba amara* showing no difference with non-reaction wood fibres. Bars, 5 μm (Ruelle et al. 2007a presented in Ruelle 2014).

Most standard methods for sectioning wood samples and preventing border effect lead to the conclusion that the G-layer is always adhered to the S2 layer in tension wood (Clair et al. 2005b). G-layer is described as almost entirely composed of cellulose, with highly crystalline microfibrils oriented nearly parallel to the longitudinal axis. Histological staining reactions, such as safranin-light green or chloroglucinol–HCl, seem to indicate that the G-layer is usually non-lignified or lignified to a very limited degree, whereas the wall layers external to the G-layer are strongly lignified (Pilate et al. 2004).

1.4.4 Molecular level

Plant hormones are key regulators in development and pattern formation, and environmental stimuli often act on plant growth by modulating the hormonal balance. When applied exogenously, plant hormones have been observed to affect most aspects of cambial growth, such as cell division, cell expansion, final cell morphology, the induction of differentiation into different cell types, and cell wall chemistry (Mellerowicz et al. 2001) It is reported that vascular cambium and adjacent radial expansion zone are the site of highest expression of genes encoding wall modifying enzymes (Mellerowicz and Sundberg 2008).

Differential gradients of several plant hormones (auxin, cytokinin, gibberellin and ethylen) across the cambium are hypothesized to play a role in both cambium cell proliferation and phloem/xylem cell fate determination (Schuetz et al. 2012).

Auxin is a key signal in xylogenesis. It is the only plant hormone that on its own is sufficient to induce differentiation of vascular elements when applied to plant tissues. Auxin can induce tracheary element (TE) differentiation, i.e cambial cell division and enhance lignification in primary phloem fibres and in secondary xylem (Mellerowicz et al. 2001). Perturbing auxin signaling by over expressing a mutated *Populus IAA3* gene resulted in reduced cell proliferation in the cambium and thus less wood formation. Other hormones often act in synergy with auxin. In particular, gibberellins (GAs) will stimulate meristematic activity and xylem fibre elongation when applied together with auxin. Unlike auxin, which is found in the cambium, gibberellic acid (GA) is observed in the differentiating xylem cells of tree stems. The role of cytokinin as an

essential regulator of cambium activity has been demonstrated in both *Arabidopsis* and *Populus*. Reduced cytokinin levels lead to impaired cambial activity in tree stems. Consistent with this, secondary growth is enhanced when cytokinin signaling is increased.

Ethylene acts as a positive regulator of wood formation. In *Populus*, ethylene treatment promotes cambial cell proliferation (Zhang et al. 2014).

Little is known about the molecular mechanisms that determine the formation of different types of wood, and about the role of hormones in this process. The formation of tension wood is an interesting case of a developmental switch that results in an increased formation of xylem having gelatinous fibres with an altered secondary wall composition and structure (Mellerowicz et al. 2001). The importance of auxin in wood formation was demonstrated a long time ago. Tension wood formation was not linked to any alteration in the balance of endogenous auxin (Hellgren *et al.*, 2004). Ethylene production is stimulated during tension wood formation and has been suggested to play a role in this process (Little and Savidge 1987). In support of this observation, the expression of ACC oxidase is strongly induced in hybrid aspen during tension wood formation. Taken together, both ethylene and IAA may be involved in growth stimulation accompanying tension wood formation rather than in the induction of gelatinous fibres (Mellerowicz et al. 2001). Acting in synergy with auxin, gibberellins are known to stimulate meristematic activity and fibre elongation (Eriksson et al. 2000). Funada and coworkers (2008) induced formation of tension wood in angiosperm trees by gibberellin. Results indicate that the application of gibberellin can induce the formation of tension wood on vertical stems of angiosperm trees in the absence of gravitational stimulus. Gibberellin plays an important role especially at the initial stages of formation of tension wood (Nugroho et al. 2012). Ethylene is likely to be involved, as its production is greatly increased in *Eucalyptus* on induction of tension wood (Pilate et al. 2004).

Auxin and ethylene have been proposed as important mediators of TW formation (e.g. Little and Savidge 1987; Du and Yamamoto 2003). The most abundant hormone related genes that were differentially regulated in TW represented the biosynthesis and/or signaling pathways of these two hormones.

The finding that the major change of auxin levels in stems induced to form TW is actually a decrease on the opposite side (Hellgren et al. 2004) contradicts previous theories that TW is formed in response to auxin deficiency (Andersson Gunnerås 2006).

1.5. Maturation stress in trees

1.5.1. The origin of maturation stress

Wood cells are produced in the cambium at the periphery of the stem. The formation of the secondary wall occurs at the end of cell elongation by the deposition of successive layers made of cellulose microfibrils bounded by an amorphous polymeric matrix (clair et al. 2011). During maturation process two mechanisms take place in cell wall: (a) the amorphous cellulose matrix swells transversely after lignin deposition, and (b) when cellulose crystallization occurs, MFs shrink longitudinally. The combined effect of these two mechanisms results in a longitudinal

shrinking of the cell. However, as the maturing wood cells are attached to older, already lignified cells, they cannot shrink completely. Hence, these maturing cells are held in a state of tensile stress which is named “maturation stresses”, and can be released in the form of residual strains along the longitudinal axis, only on cutting the wood (Archer, 1986 in Plomion et al. 2001). The wood cells at the surface of a tree are therefore stretched longitudinally and compressed tangentially and can be said to be held in tension. However, with aging the tree, as more and more wood is added to the tree surface, the wood cells inside the trunk are slowly compressed, until they are completely held in compression, toward the center of the trunk. This gradient of mechanical stress in a trunk, whereby the outside is held in tension, and the center in compression, is called “growth stress”. Support stress, which is, an elastic response to the increasing load of wood and shoots, is in superposition with internal growth stress. Maturation stress allows the tree to adapt to various mechanical constraints (Clair et al. 2006). Although growth stress can be highly detrimental to wood quality, resulting in warping and twisting of boards and planks but fulfills essential biomechanical functions for the tree. It compensates for the comparatively low compressive strength of wood and thus improves the stem resistance against bending loads. It also provides the tree with a motor system, necessary to maintain the stem at a constant angle during growth (Alméras and Fournier 2009) or to achieve adaptive reorientations (Calir et al. 2011).

1.5.2. Growth stress in tension wood

Both tension wood and normal wood shrink longitudinally and generates longitudinal tensile stresses during maturation of the xylem elements. But stresses generated by tension wood are much higher than in normal wood (Matsuzaki et al. 2007).

Presence of tension wood contains fibres with a special morphology and chemical composition due to the development of the so-called gelatinous layer in many hardwood species is attributed with generation of tensile stress in such trees. The G-layer is known to have a high cellulose content with a high degree of crystallinity and to contain microfibrils oriented along the axis of the cell (Fang et al. 2008). The specific organization of the G layer suggests a tensile force induced in the microfibrils during the maturation process. Investigations have shown that more G-fibres per unit of tissue area and thicker GL accompany higher longitudinal growth stress (proportional to GS) in tension wood with G-fibres and suggests that these factors contribute to growth stress generation and therefore the GL plays the most important role in high growth stress generation (Fang et al. 2008). However, there are some species which form TW without GL (Clair et al. 2006b). In these species, trees are able to keep efficiency to produce tensile stress even without GL formation. In tension wood of these trees, S2 layer of fibres exhibits some similar features as the G-layers, such as a lower microfibril angle, an increased cellulose to lignin ratio, or a higher crystal size (Yoshida et al. 2002b; Ruelle et al. 2006, 2007). As mentioned before, various cell wall structures can occur in tension wood, some of them contains GL and some without present of GL or with poly laminate secondary wall.

A first general observation based on combined anatomical observations and mechanical measurements (Clair et al. 2006; Ruelle et al. 2007a) is that the presence of an unusual structure,

such as a G-layer or polylaminate organization is not a key factor or prerequisite for the production of high tensile stressed wood; so the question still remains as to whether there are ultrastructural features that are characteristic of tension wood independent of the occurrence of the G-layer (Ruelle 2014). Clair et al. (2011) studied the mechanism generating maturation stress in woody plants. They investigated structural changes in cellulose microfibrils along sequences of xylem cell differentiation in tension and normal wood of poplar (*Populus deltoides* x *P. trichocarpa* cv. I45-51). Their results suggest that the inner part of the S2 layer significantly contributes to the generation of maturation stress in poplar tension wood, and that this occurs before the appearance of the G-layer.

The mechanism at the origin of tensile maturation stress has been the subject of a lot of controversy (Boyd 1972; Bamber 1978; Okuyama 1993; Yamamoto 1998; Clair et al. 2011) and is still not fully understood and is still subject to discussion.

In this study we are trying to earn better understanding of how TW grow during bending process and how its formation affect cell wall layers formation. Does its formation change normal sequences of wood formation? According to important role of GL in generation of tensile stress investigation of GL formation during the secondary wall formation stage can help us to understand how GL and SL thickness changing during the reaction process and how GL formation affect SL thickening. This study can raise a question that presence of GL is the origin of high tensile stress or change in SL thickness!

2. Timing of wood formation in NW, TW and OW

2.1. Material and Methods

In this study, wood formation is investigated at two different scales: tissue and cell wall scale. To study cell wall thickening, successive samplings have been done on young poplar saplings (*Populus tremula* x *P. alba*) grown in green-house in France and sampling for tension wood formation have been done in Iran on white poplar (*Populus alba*) grown in plantation.

2.1.1. Sampling technique for wood formation study

2.1.1.1. Trees selection

10 healthy six years old field-grown poplar (*Populus alba*) trees with diameter of 7-8 cm were selected from plantations at Iran Research Institute of Forest and Rangelands in Karaj, Iran (Fig. 2.1a).

Reaction wood was induced in 5 of them by bending the main stem at about 35-40° from their upright position before starting the growing season. 5 trees were left to grow upright as control trees for comparison of normal wood formation. All the sampled trees were in the same plantation so that grown under one growing condition. Control trees were selected among upright ones with symmetrical crowns and upright trunk.

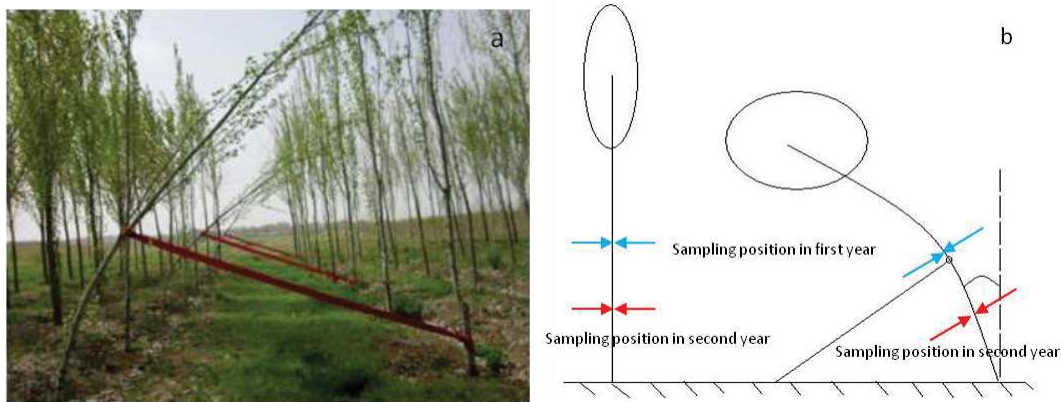

Figure 2.1 (a) Bent and straight trees in sampling field. **(b)** Schematic drawing of sampling position during two years of sampling

The average monthly precipitation and temperature of Karaj is shown in Fig. 2.2. Before beginning of growing season (in March) temperature start to increase and reached to maximum temperature in June, July and August. The study region passed dry summer especially in August and September. However, this plantation were irrigated weekly.

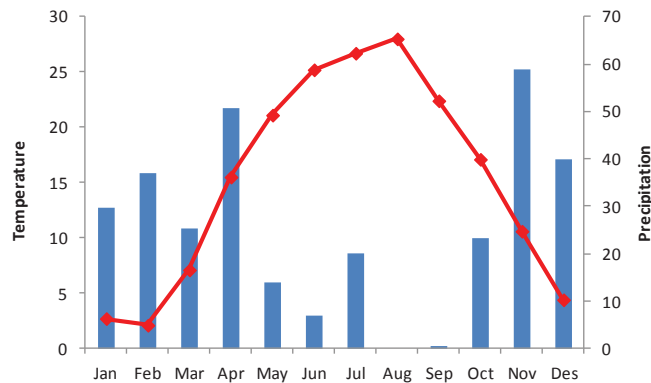

Figure 2.2 Average monthly temperature (red line) and precipitation (blue column) in sampling city (Karaj) in 2012.

2.1.1.2. Microcore sampling

Samplings have been done during 2 years period with a Trepbor instrument (Fig. 2.3a,b) from the end of March to the end of October each sampling year. Trepbor is a special instrument for taking micro-core samples (2 mm in diameter and 15 mm in length (Fig. 2.3e)) from living trees. It was designed and produced at the Centro Studi per l’Ambiente Alpino in San Vito di Cadore of Italy. Trepbor is designed specifically for long-term microcore sampling in forests. This tool allows for the sampling of microcores, containing bark, cambium and xylem. As cutting tube is only 1.5 cm long, thick barks were removed in order to sample the living tissues (Rossi et al. 2006). The advantage of white poplar was its thin bark that made sampling easier without removing bark thus minimizing damage to the stem. Sampling with Trepbor prevents the unligified tissue from compression that can increase cell deformation in the meristems or collapse of enlarging cells (Rossi et al., 2006). In the first year of sampling the microcore samples were collected weekly from the upper sides of the bending point of the stems and at the same height of the not bended trees (2 m height) (Fig. 2.1b). Sampling positions were arranged along the stem in an ascending helical pattern. The lowest sampling position was located just above the rope (Fig. 2.3c).

According to preliminary results of the first year sampling and probability of wound reaction, sampling interval and position were modified for the second year. In the second year, samples were collected each 3 weeks with a spacing 5 cm between each sampling and the number of control tree reduced to 3 trees. Details of sampling interval are reported in table 2.1. The lowest sample was located beneath the rope (Fig. 2.3d), 1 m above the ground (Fig. 2.1b). At the end of this second growing season, a total of 192 microcores were sampled.



Figure 2.3 (a & b) Trephor instrument; **(c)** Sampling position of first year; **(d)** Sampling position of second year **(e)** microcore.

Samples were placed in FAA: Formaldehyde 10%, Acetic acid 5% and Ethanol 50% (Schmitz, 2010) to avoid deterioration of sensitive part of samples especially cambial zone.

Table 2.1. Details of sampling intervals in 2012

	Tree No.	Sample's code	Sampling Interval	Sampling time	Sampling side	Number of sample
Bent trees	Tree 1	1-T-1...11	Three weeks	11	TW-OW	22
		1-O-1...11				
	Tree 2	2-T-1...11	Seven weeks	4	TW-OW	8
		2-O-1...11				
	Tree 3	3-T-1...11	Seven weeks	4	TW-OW	8
3-O-1...11						
Tree 4	4-T-1...11	Three weeks	11	TW-OW	22	
	4-O-1...11					
Tree 5	5-T-1...11	Three weeks	11	TW-OW	22	
	5-O-1...11					
Upright trees	Tree 6	6-N-E-1...11	Three weeks	11	E-W	22
		6-N-W-1...11				
	Tree 7	7-N-E-1...11	Three weeks	11	E-W	22
		7-N-W-1...11				
	Tree 8	8-N-E-1...11	Three weeks	11	E-W	22
8-N-W-1...11						
Tree 9	9-N-E-1...11	Three weeks	11	E-W	22	
	9-N-W-1...11					
Tree 10	10-N-E-1...11	Three weeks	11	E-W	22	
	10-N-W-1...11					
Total						192

2.1.2. Microcore sample preparation

Microcores were composed of two different parts: one stiff and resistant wooden part and one soft and fragile part that were composed of phloem and cambium. These heterogeneous tissues make the sample very sensitive and delicate to handle. This heterogeneous tissue may break in the cambium part and make the observation impossible. However, the use of an automatic rotary microtome for cutting samples, after impregnation and embedding in paraffin for microcores, gives good results. For this reason we have chosen Rossi et al. (2006b) method to embed samples in paraffin.

At first, each sample was oriented under a stereomicroscope at x10-20 magnification, and the transverse side was marked with a pencil. Microcores were oriented so that the wood fibers were parallel to a vertical axis to produce sections as transverse as possible by microtome. Each microcore was enclosed in a cassette on which the sample reference was written. To avoid microcores drying out, cassettes were put in a container of 50% ethanol.

2.1.2.1. Impregnation of samples with paraffin

Impregnation of microcores with paraffin was performed in Nancy (Lerfob) under the supervision of Dr Julien Ruelle. It was done by successive dipping of cassettes in 8 treating baths using automatic impregnation machine (STP120, Microm, MM France, Francheville, France) (Fig. 2.4) according to Rossi et al. (2006b) for the treatment of microcores (table 2.2).



Figure 2.4 Impregnation machine (STP120, Microm)

Table 2.2. Impregnation protocol (Rossi et al. (2006b))

Solvent	Time (h)
Ethanol 50%	4h
Ethanol 70% 3h	4h
Ethanol 90%	3h
Ethanol 95-96%	1h30
Ethanol 100%	3h
Histo-Clear	4h30
Paraffin (60°C)	1h30
Paraffin (62°C)	1h30

The microcores were dehydrated by immersing in five ethanol baths, with increasing concentration from 50% to 100%, before being cleaned with a bath of histoclear (paraffin solvent). This product is a natural paraffin solvent with low toxicity which replaced xylene. Finally, microcores were immersed in two hot baths (65°C) of liquid paraffin in order to make it penetrate in the lumen of all cells of microcores. The entire procedure takes about 20 hours (Table 2.2). When impregnation was complete, microcores were stored in liquid paraffin until completing embedding process.

2.1.2.2. Embedding samples in paraffin

Embedding station 350-2 EC (Microm, France MM Francheville, France) was used to embed samples in paraffin (Fig. 2.5). This consists of a tank of hot paraffin, two heating tanks, two hot zones, a cold zone and a chilled plate at -15°C, that is called cryosole. Cassettes containing the saturated microcores were stored in one of the heating tanks to be opened on the hot zone to prevent the cooling of the paraffin. The covers of the cassettes were thrown away but the basis of the cassettes was reused for embedding samples in mold.



Figure 2.5 Embedding station *EC 350-2 (Microm)*

Each microcore settled to the bottom of a preheated aluminum mold in which was a first layer of paraffin. The microcores were oriented according to the direction of the fibers (identified by the visible line of pencil on microcores) and held in this position by means of tweezers while the

mold deposited on the cold zone. Paraffin solidifies quickly in the bottom of the mold by trapping microcores while in the surface of the mold, paraffin remained fluid. The base of the cassette was then deposited over the aluminum mold and a second layer of paraffin was poured into the mold through the cassette. The assembly was then cooled on the cryosole and a paraffin block solidified. After about ten minutes paraffin blocks were ready to be stripped (Fig. 2.6).



Figure 2.6 (a) Fixing the microcore at the bottom of mold, **(b)** formation of the paraffin block **(c)** stripping the paraffin block off (Image: Harroué et al. 2011).

2.1.2.3. Trimming paraffin blocks

Before trimming with microtome, extra parts of paraffin blocks were removed in order to reduce contact surface between knife and sample. Then trimming is done by adjusting the surface of the paraffin block parallel to the cutting plane of the rotary microtome (Leica RM2265, Figure 2.7) and the outer excess layer of paraffin is removed until a smooth surface of the wood sample was obtained. Paraffin blocks are then immersed in water at room temperature for 1 day. This is essential because it softens the wood and makes the cut easier (Harroué et al. 2011).



Figure 2.7 Rotary microtome (Leica RM2265)

2.1.2.4. Sectioning of paraffin embedded microcores

Sections with thickness of 8 μm were prepared in Laboratoire de Mécanique et Génie Civil at the University of Montpellier 2. The rotary microtome produces a continuous strip of paraffin containing thin anatomical sections. Paraffin band were plunged in water at 40°C in order to stretch the sections and to place the films on microscope slides. Sections are dried at 40°C on a hotplate to increase sections adhesion to glass slide (Fig. 2.8).

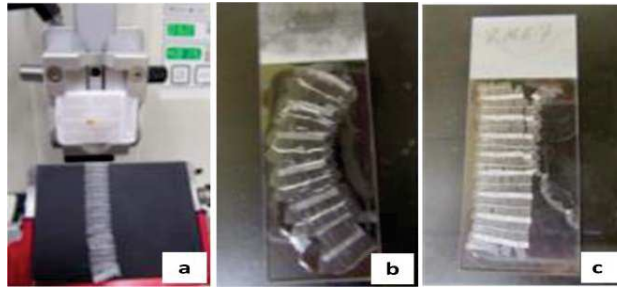

Figure 2.8 (a) Continuous strip of paraffin containing sections (b) stretching paraffin band on water at 40°C (c) dried sections on glass slide.

2.1.2.5. Staining of sections

After this step, the sections were transferred to the Laboratory of Wood Anatomy of Faculty of Natural Resources of the University of Tehran and stained with mixture of Safranin Astra blue (Schweingruber, 2007). Before staining, residual paraffin was cleaned by immersing sections in D-limonen and ethanol (10 minutes for each of them). After complete elimination of paraffin, in order to prevent intensive reaction between ethanol and distilled water, sections were placed in decreasing concentration of ethanol (75%, 50% and 25%). After this step, the sections are ready for staining. Astra blue (2 g in 100 ml distilled water) and safranin (with proportion of 1% or by weight 1 g in 100 ml water) were prepared by dissolving their powder in distilled water. Astra blue is mixed with safranin in a ratio of 1:1 and a drop of the solution is placed on the section for 2–3 min. After this, the sample is first washed with increasing concentration of ethanol (50%, 75% and 95%) until it runs clear, followed by rinsing with absolute alcohol to dehydrate the section. Then, sections were fixed on glass slide using cover quick medium. Staining makes unligified cells to be appeared blue, whereas lignified cells turn to red. Gelatinous fibers in tension wood also appear blue because lignification is minimum (Schweingruber, 2007).

2.1.3. Examining of anatomical sections

Anatomical sections were studied using an optical microscope (Olympus-BHSP), with magnifications of 10x and 40x with visible and polarized light. Number of cells in different phase of wood formation (cambial zone, enlarging cells, secondary cell wall formation and lignification phase) was counted. Theoretically, the term of cambial cells refers to the monolayer of cells (Timell 1980; Tsoumis 1991 mentioned in Rossi et al. 2006). Nevertheless, distinguishing the initial cambial cells from the cambium derivatives, which are still undifferentiated, is impossible. Because of this, the term “cambium zone” is used for multilayer cells composed of initial cambium and derivatives (Mahmood 1971 in Rossi et al. 2006). Identification of secondary cell wall formation is possible under polarized light thanks to the special orientation of cellulose microfibrils that shine under polarized light (figure 2.9b). Cellulose among the wall constituents has crystalline structure and shows birefringence (Srivastava 2002).

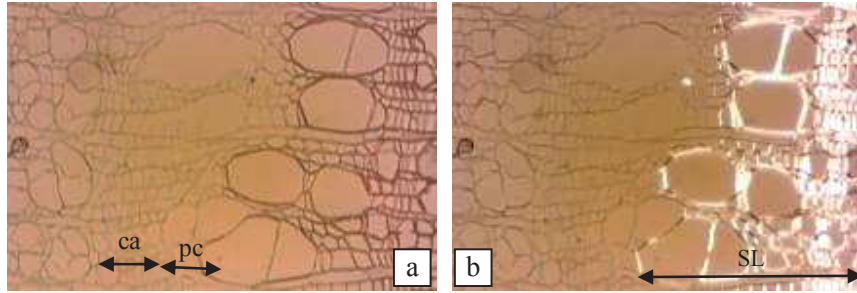

Figure 2.9 (a) Cambial zone (ca) and enlarging phase or post cambial zone (pc) or (b) brightness of secondary cell wall (SL) formation phase under polarized light

After starting the lignification phase, lignified cells turn to red. Chromatic light red to dark red indicates lignifying cells to lignified mature cells (figure 2.10).

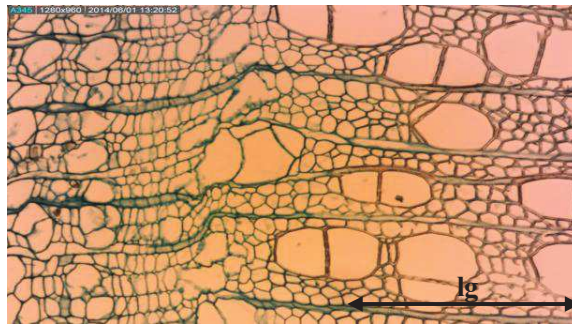

Figure 2.10 Cells that have started to lignify (lg)

2.1.4. Surveying of the number of cells

For each sample, the radial number of cells in the cambium zone, enlargement phase, secondary cell wall formation, G-fibres and maturing cells were counted along 3 radial lines (Rossi et al. 2006). Cell number in 3 files was averaged for each tree. In spring, when at least one cell was observed in the enlarging phase, xylem formation was considered to have begun. In summer, when no other cell was observed in the wall thickening phase, xylem formation was considered complete.

2.1.5. Modeling of growth pattern using Gompertz function

Gompertz equation was used to model growth of trees. Gompertz function is a logarithmic equation that is used in biology to draw and describe partial growth (Zeide 1993 in Oladi et al. 2010). Gompertz curve is a special case of the so-called hyper-Gompertz curve, which is also known as a generalized ecological curve, or simply, a generalized Gompertz curve (Juki.c et al. 2004). An example of Gompertz curve is shown in Fig. 2.11.

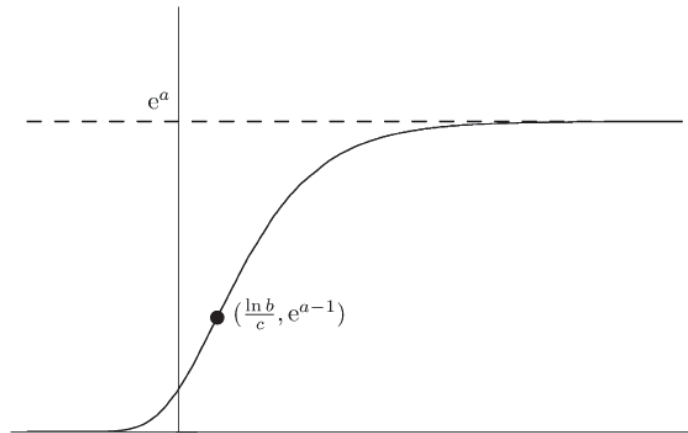

Figure 2.11 Gompertz curve (Juki.c et al. 2004)

For each tree and also for average of TW, OW, and NW, the cumulative number of cells in ring width was fitted using non-linear function of Gompertz, according to the following formula with OriginPro 9 software¹:

$$y = A \exp [-e^{(\beta-kt)}], \quad (1)$$

where y is the weekly cumulative sum of cells, t time according to Julian days, A the asymptotic maximum growth expressed as cell number, β the placement parameter on x -axis which positions the origin of the transformed line onto vertical axis at time $t = 0$ and k the rate of change of the shape which is calculated by these method (Berger 1980):

$$\beta = -\ln(y(t=0)/A), \quad (2)$$

and

The transformation equation is:

$$Y = -\ln(-\ln(y)); \quad (3)$$

and

$$k = ((y_2 - y_1) / (t_2 - t_1)). \quad (4)$$

Y_0 is initial growth at t_0 . K , the rate parameter can also be obtained by the slope value of the simple linear regression of the transformed growth over time.

¹ __ OriginLab Corporation, Northampton, MA, USA

Examination of the R-square, the asymptotic t-statistic for the parameters, and plots of the residual showed that the Gompertz function was appropriate for describing growth and time relationships (Rossi et al. 2006b).

2.2. Results

2.2.1. Timing of wood formation in NW, TW and OW

Timing of wood formation allows for the estimation of each period of wood formation in three kinds of studied woods (NW, TW and OW). As mentioned in the material part, in the first year of sampling, trees were sampled weekly, providing high time resolution to assess wood formation. But preliminary results showed that weekly sampling affected wood formation because selected trees were 6 years old and were not very big enough. This made us to limit sampling and increase sampling intervals to 3 weeks in second year together with a higher distance between samplings.

Results are presented as an average number of cells in 3 bent trees and 3 straight trees. Among 5 bent trees, 2 trees showed very low growth rate and it was decided to remove them for averaging. One of these two trees was sick and low growth rate was predictable in it, but the other one was healthy tree. It is necessary to mention that these two trees were bent from west to east, in the inverse direction compared to the three other trees. Growth trend of all trees is however presented in figures 2.14, 2.21, 2.23, 2.28, and 2.30.

2.2.2. Eccentricity of pith in bent trees

Very often tension wood formation is accompanied with eccentric growth of stem in upper side of bent trees. This phenomenon was observable in cross section of bent trees after 2 years of inclination (Fig. 2.11).

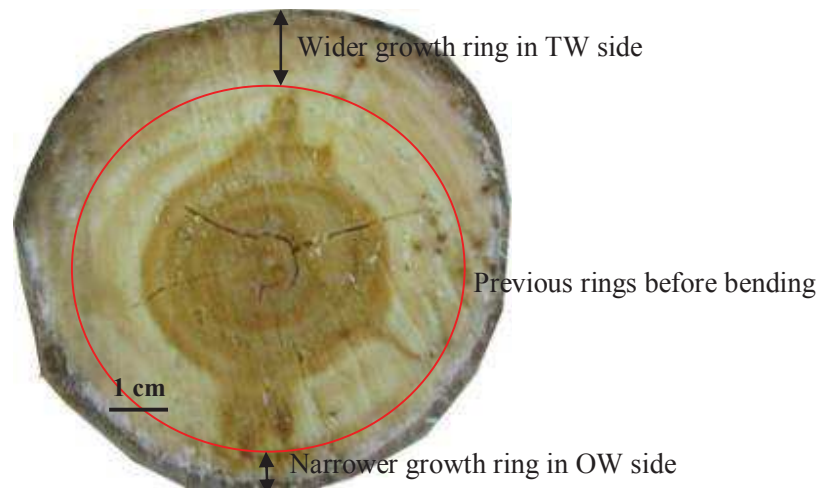

Figure 2.11 Eccentric growth of trees after inclination

In the 6 early growth rings around the pith, no eccentricity is observed. But after bending the tree its irregular growth is being visible.

2.2.3. Dynamics of cambial activity

Cells in the cambial zone were characterized by thin cell walls and small radial diameters (Rossi et al. 2006; Michelot et al. 2012). As these cells were not yet lignified, they presented a thin blue or green wall and were not shining under polarized light because there is no cellulose content in their cell wall. Cambial activity is different during growing season and therefore the number of cambial cells changes during growing season (Fig. 2.12). More cambial cells indicate more cambial activity and higher growth rate.

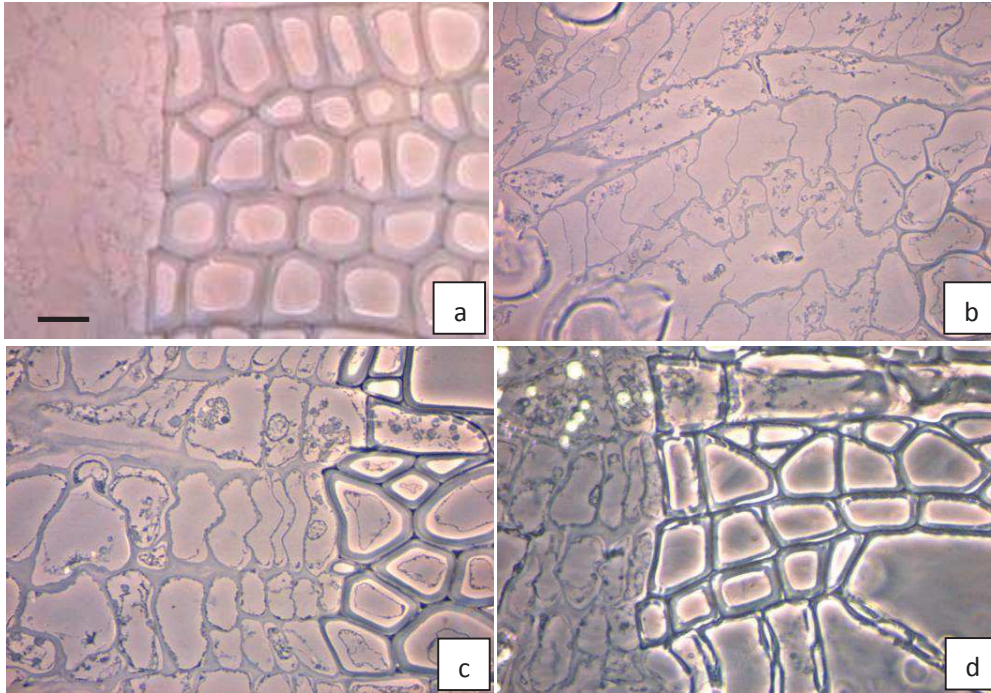

Figure 2.12 Light microscopy image in phase contrast mode **(a)** Cambial zone cells before onset of growth (date of sampling: 28/Mar/2011), **(b)** active cambial cells and new xylem cells (date of sampling: 18/Apr/2011), **(c)** cambial zone cells near the end of growing season (date of sampling: 28/Aug/2011), **(d)** inactive cambial cells at the end of growing season (date of sampling 12/Oct/2011). Scale bar: 10 μm

In autumn and winter, cell production ceased and cambium is inactive (or dormant). Dormant cambium is consisted by a minimum number and close together group of cells (Rossi et al. 2006). In all kinds of studied wood (TW, OW and NW), dormant cells were around 3-4 cells (Fig. 2.13 a). The beginning of cambial activity was defined by an increased number of cambial cells in spring and cessation by a decreased and constant number of them in autumn. At that time, there were no xylem cells in post cambial growth adjacent to the cambium. We determined the onset of wood formation as the point at which the number of cambial cells increased and cessation when the latest formed xylem cells were fully developed (Marion et al. 2007).

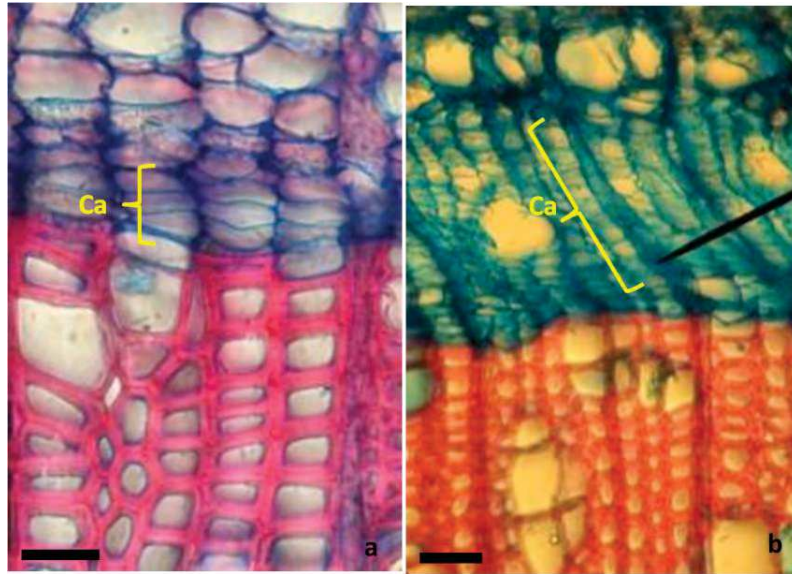

Figure 2.13 Light microscopy of poplar cambium cells stained with safranin-astra blue (a) dormant cambium in 28 March (b) active cambium in 13 April. ca: Cambium cells

Observation of pre-test samples, which were taken in the first year of sampling, showed that cambial activity starts in the first week of April in TW. In NW cambium division started in second week of April while at sampling date it had 1 or 2 cells in enlarging phase (visual observation). Cambium cells of OW side just start division. In the second year, in second week of April (11/Apr/2012) cambial activity started in all kind of studied wood and a few cells were in enlargement phase at sampling time. The number of cambial cell in OW was around 5 cell (SD: 0.9) that was less than TW (7.7 cells, SD: 0.5) and NW (7.8 cells, SD:0.3) (Fig. 2.17). Figure 2.14 shows variations of cambial cells of each tree in TW, OW, East and West side of straight trees during growing season.

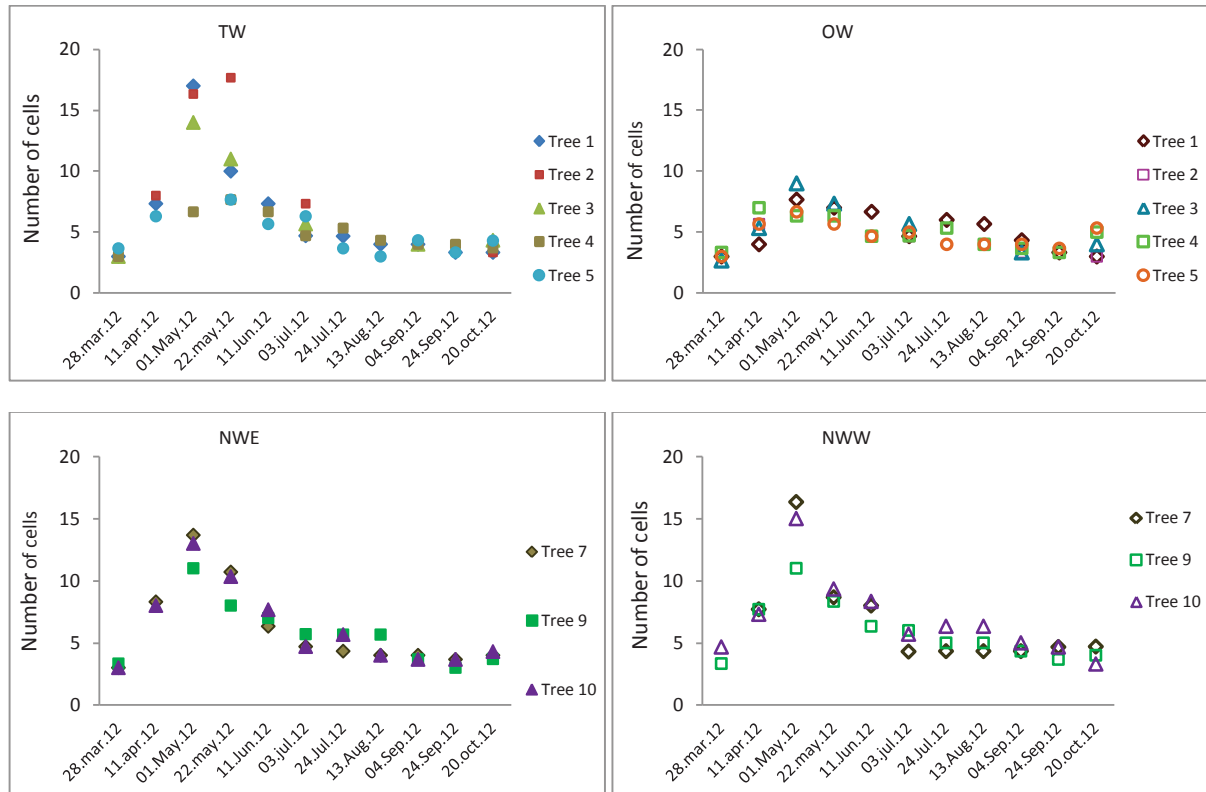

Figure 2.14 Variations of cambial cells of each tree in TW, OW, East and West side of upright trees during growing season (Close shape: TW and NWE, Open shape: OW and NWW).

In the sampling of the first year, at the beginning of the growing season, the number of new cells in TW was more than in NW and OW at the same date (Fig. 2.15).

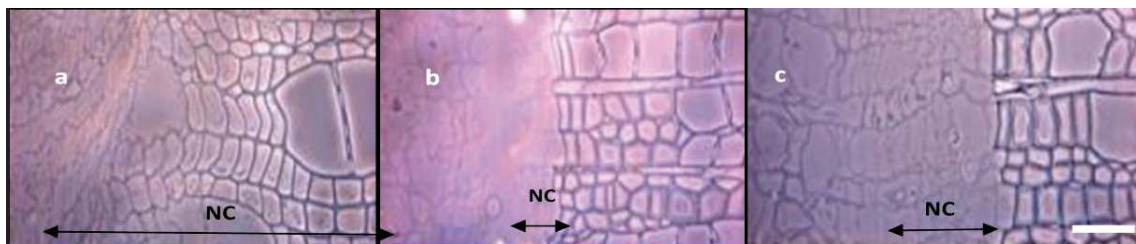

Figure 2.15 Phase contrast microscopy. Wood formation at the beginning of first year of bending (a) new cells (NC) of tension wood, (b) opposite wood, (c) normal wood, date of sampling: 18/Apr/2011. Scale bar: 40 μm

In the second year of sampling, there was no clear difference between times of onset of cambium activity. The maximum number of cell in TW (16 cells, SD: 1.6), OW (8 cells, SD: 0.9) and NW (14 cells, SD: 2.8) observed during last week of April (sampling of 1/May/12) (Fig. 2.16, 2.17 and 2.14). After that, the number of cambial cells reduced gradually until 13 August. Once annual activity has ended, the cambium stop dividing and the number of cells in cambial zone

decreased to minimum value equal to the number of dormant cambium. There was no clear difference in cessation time of cambium activity in 3 kind of studied wood.

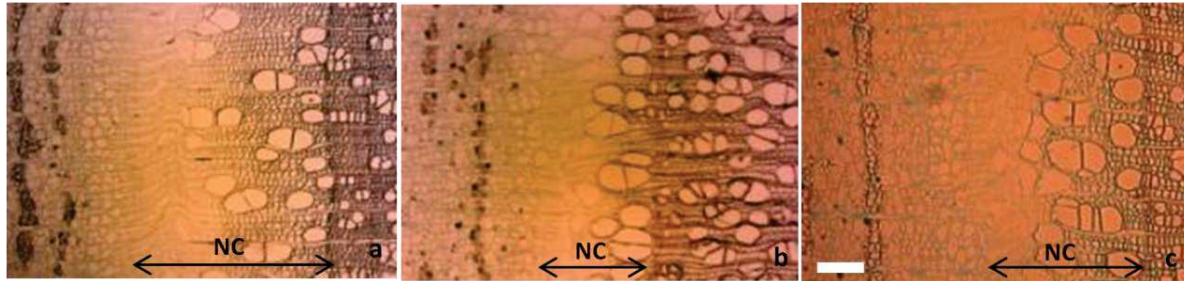

Figure 2.16 Light microscopy. New cells at the beginning of second year (a) tension wood, (b) opposite wood, (c) normal wood, date of sampling: 01/May/2012. Scale bar: 100 μ m

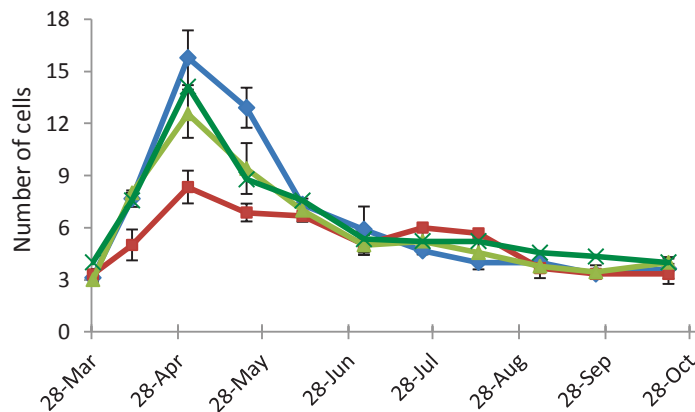

Figure 2.17 Mean number of cells observed in the cambial zone: TW (blue line), OW (red line), NEW (light green line), NWW (dark green line).

2.2.4. Phenology of trees

Phenological observations of buds, leaves and cambium have shown that, before budburst, cambium is inactive (Fig.2.19 a). Poplar growth has begun after budburst (Fig. 2.19b). Cambium cessation is also accompanied with changing the color of leaves to yellowish green (Fig. 2.19d). Maximal growth rate (maximum number of cambial cells and enlarging cells) was between end of April and first of May, when the leaves were completely burst and reached their maximum size (Fig 2.18).

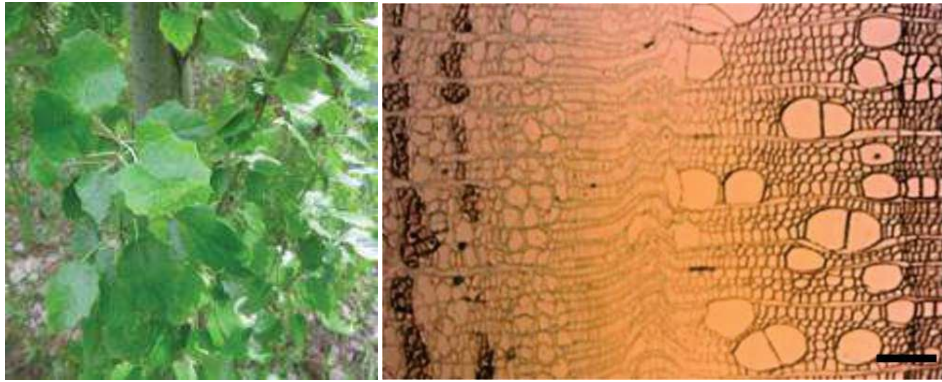

Figure 2.18 Mature leaves and maximum growth at first of May. Scale bar: 100 μ m



Figure 2.19 Bud phenology and cell situation at tissue and cell wall level at the same time (a) 28/Mar/2011, (b) 6/Apr/2011, (c) 18/Apr/2011 (d) 28/Aug/2011.

2.2.5. Cell differentiations

The daughter cells, produced by cambial initials undergo different wood cells like tracheids in gymnosperms and vessels and fibers in angiosperms. The differentiation of these cells involves four major steps: Cell expansion is the first step of differentiation which happens following cell division in cambial zone, Ordered deposition of thick multilayered secondary cell wall, lignifications and cell death (Plomion et al 2001).

2.2.5.1. Phenology of enlarging cells

The dimensions of the wood cells are determined before secondary wall deposition (Mellerowicz and Sundberg, 2008). Cambial cells derivatives undergo a period of cellular expansion. In cell enlargement phase, derivative cells expand longitudinally and radially to reach their final size during the formation of primary wall (Plomion et al. 2001). Differentiations of xylem cells begin immediately at this early stage. Vessels undergo radial expansion and fibers undergo intrusive elongations (Samuels 2006). Vessels were one of the first cells that observed very soon in enlarging phase and were distinguished because of their radial expansion (Fig. 2.20).

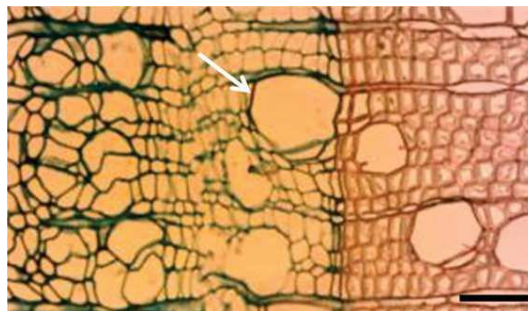

Figure 2.20 Light microscopy. First presence of vessels at the beginning of growing season (Sampling date: 1/May/12). Scale bar: 50 μm

Microscopic observations indicate that, in the first year of bending, vessels start to be formed in the second week of April when cells were in enlarging phase. In second year, observation of samples taken in 11th April showed that enlargement phase has been started. Just 1 or 2 cells were in enlarging phase that reached to maximum number at first of May in TW, OW and NW. Maximum average number of enlarging cell was observed in NW : 16 cells (SD: 5.7). Enlarging cell variation of each tree is shown in figure 2.21 and average number of enlarging cells of TW, OW and normal wood presented in figure 2.22. In the second week of August, there was no cells in enlarging phase just in opposite wood side of one tree a few enlarging cells were observable.

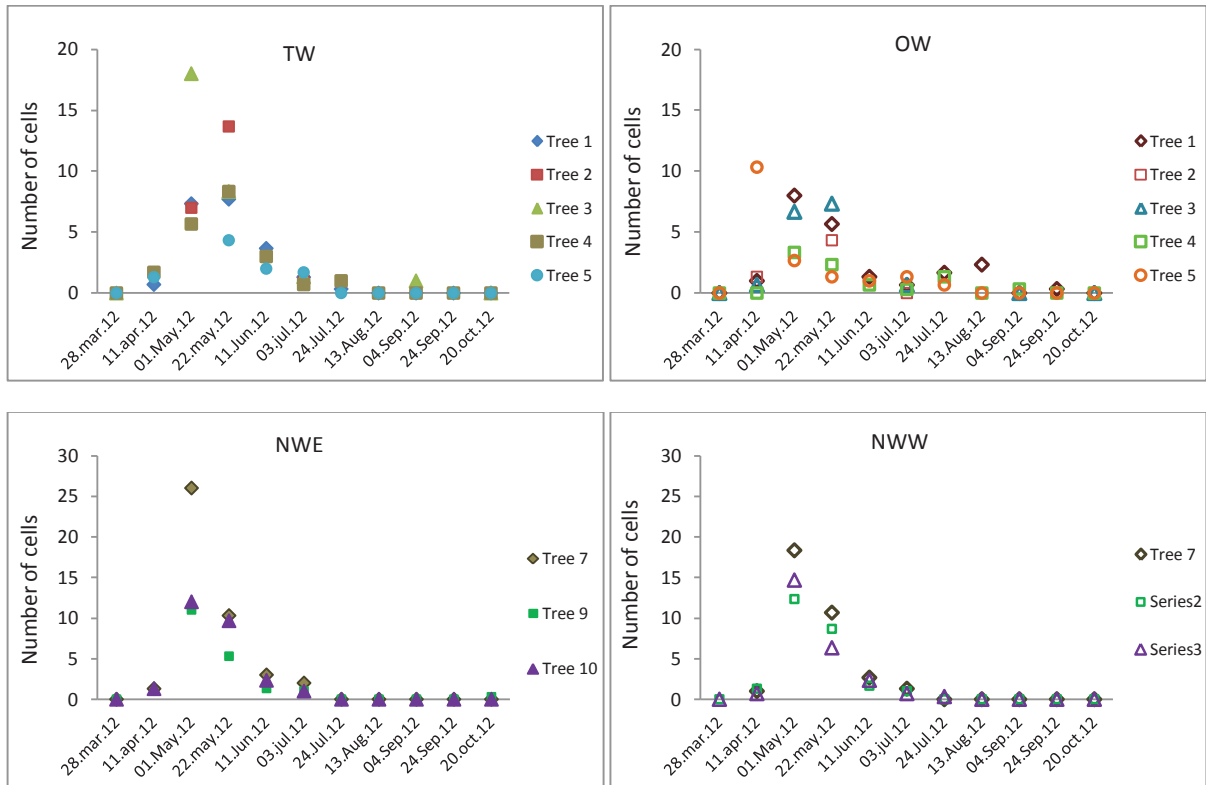

Figure 2.21 Variations of Enlarging cells of each tree in TW, OW, East and West side of upright trees during growing season (Close shape: TW and NWE, Open shape: OW and NWW).

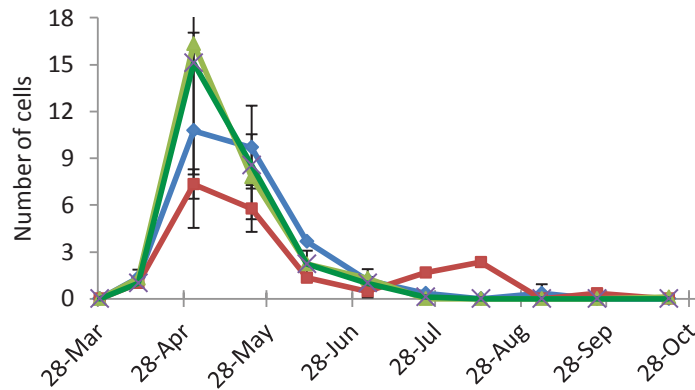

Figure 2.22 Mean number of cells observed in the enlargement phase (TW (Blue line), OW (Red line), NWE (light green line), NWW (dark green line)).

Time interval between onset of cambial activity and cell differentiation were estimated less than 2 weeks.

2.2.5.2. Secondary cell wall formation

Once expansion is completed, the formation of secondary cell wall begins (Plomion et al. 2001). Chemical and mechanical properties of wood depend on the properties of the secondary wall (Mellerowicz and Sundberg 2008). Cell wall thickening starts in the 2 last week of April, between 11/April and first of May. During these 2 weeks, the number of thickening cells reached an average of 19 cells (SD: 4.3) in TW, 18 cells (SD: 8) in NW and 5 (SD: 4) cells in OW (Fig. 2.24). Observation of the samples of first year of bending has also shown that wall thickening starts in third week of April (between 13 to 18 April). Secondary cell wall formation takes less than 2 weeks because, at sampling time, some cells already started lignification (next developing phase). Observation of samples of the first year showed that secondary cell wall formation and lignification occur during just one week in TW and NW.

In the last week of April and last week of May maximum number of cells undergo cell wall thickening phase in all three type of wood. In the first week of July number of cells in secondary cell wall decreased extensively and finished in middle of August. Just in opposite wood one or 2 cells remain in secondary cell wall formation until last week of September.

Secondary cell wall formation occurs simultaneously in fiber and vessels at the same radial line. In TW, no GL observed in secondary cell wall formation phase. Detailed number of cells in secondary cell wall phase is presented in Fig. 2.23 for each tree.

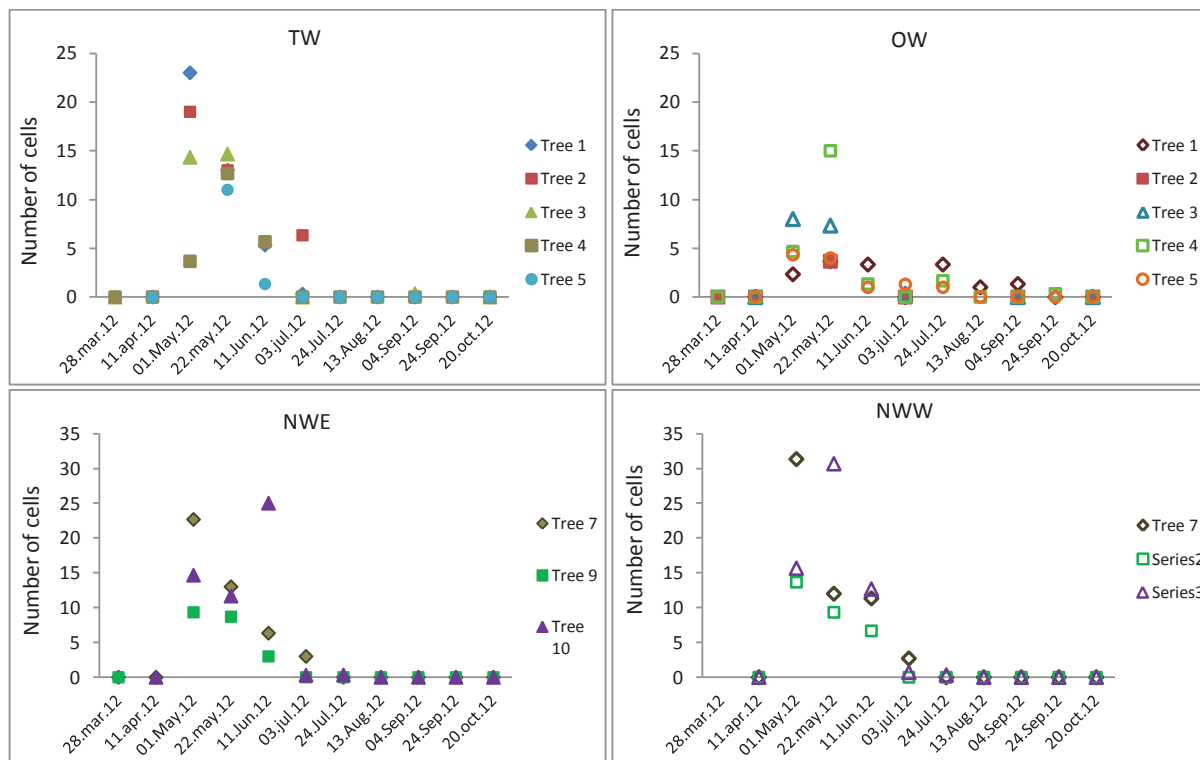

Figure 2.23 Variations of number of cells in wall thickening phase of each tree in TW, OW, East and West side of upright trees during growing season. (closed shape TW and NWE, Open shape OW and NWW)

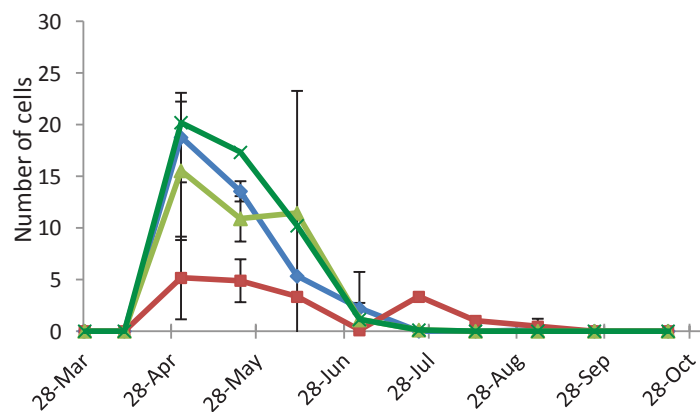

Figure 2.24 Second year sampling. Number of cells observed in wall thickening phase in TW (blue curve), OW (red curve), NW-E (light green curve) and NW-W (dark green curve).

2.2.5.3. Lignification phase

Lignification starts between 11th April and 1st of May in TW and NW. Number of lignified cells was not the same in different trees. Observation of the samples taken on 1st May show that lignification has already started. Two upright trees had high amount of lignified cell in their east side (around 36 cells), while the average of lignified cell in west side of three straight trees was 5 cells (SD: 2.4). While average number of lignified cells in TW side was 11 cells (SD: 0.2), lignification in opposite wood side was not start yet. Maximum rate of lignification occurs between 22nd May to 11th Jun. In NW, all cells are completely lignified until middle of August. But in TW it last until first week of September and in OW until last week of September.

Lignification occurs firstly at the cell corner and middle lamella, then extends to the secondary wall toward cell lumen. Dark red color in middle lamella indicates extensive lignifications in middle lamella (Fig. 2.25 a). Vessels were the first cells that start lignification, when fibers still were in wall thickening phase (Fig. 2.25 b).

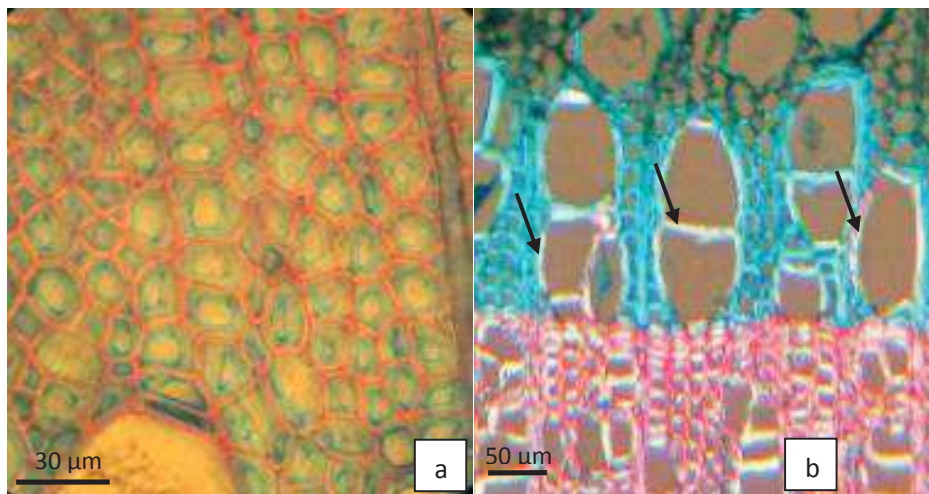

Figure 2.25 Optical microscopy. Lignification start in cell corners and middle lamella and undergo toward cell lumen. (a) Lignification in G-fibres (b) Vessels were the first cells that start lignification, when fibers still were in wall thickening phase. Light red color implies starting lignifications in vessels (arrows).

2.2.5.4. Gelatinous layer (GL) formation

First gelatinous layers formed in early stage of lignification around first of May in 3 bent trees that had normal growth rate (Fig. 2.28). Comparing number of cells in lignified cells and cells with GL (Fig. 2.29) indicates that GL formation occurs simultaneous with lignification or at least very soon after starting lignifications. Sampling with one week interval showed that during one week after beginning of lignifications, GL formation also starts (Fig 2.26).

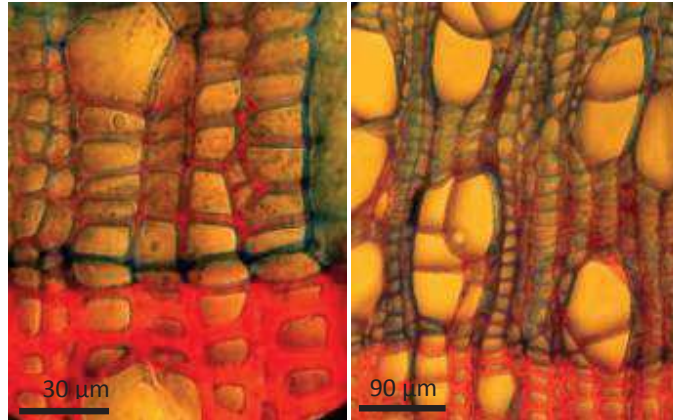

Figure 2.26 Light microscopy. First presence of GL. (a) cells in early stage of lignification (18/Apr). (b) GL formed during one week, when cells were in lignification phase (27/Apr).

GL is formed continuously in all cells in TW, side nevertheless in a few cells near cambial zone, GL is never formed at the end of growing season or if forms it has thin GL and thick secondary wall (Fig. 2.27).

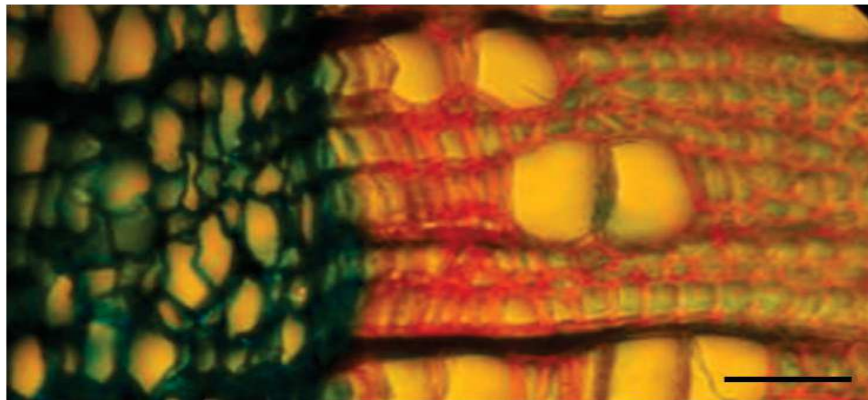

Figure 2.27 At the end of growing season, GL does not form in some last cells near cambium or if it forms, it has a thin GL. Scale bar: 50μm

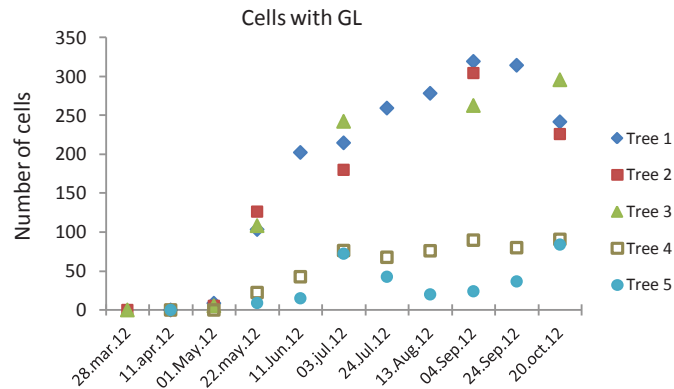

Figure 2.28 Number of cells that contains GL in different date during growing season (different shape show different trees).

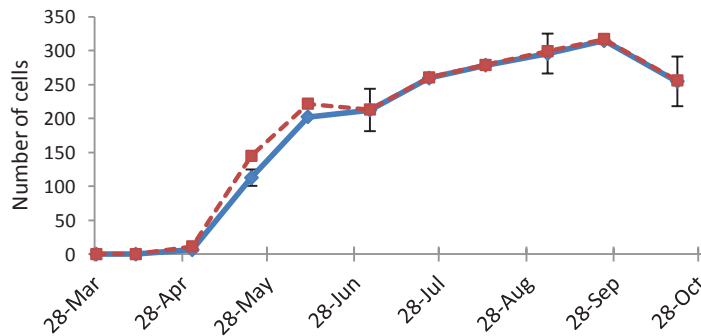

Figure 2.29 Number of G-fiber and lignified cells during growing season. (G-fibers (Blue curve), lignified cells (red dashed curve)).

2.2.6. Mature cells

With double staining of cells with safranin and astra blue completely lignified cells turn dark red. But this staining method is not sufficient to distinguish the end of lignifications and the start of mature cell zone. Because of this, mature cells are considered as a part of lignified cells. First rows of mature cells observed after 22nd May to 11th Jun. It means the cell differentiation and maturation process occurs during the period from 11th April to end of May. After cessation of cambium activity in last week of July, all cells matured during last week of July and middle of August. Just in some samples, one raw of cells remains in lignifications phase. TW and OW cells were the last cells reaching maturation, completely. In OW, despite lignifying of almost all cells, one or two cells remain in secondary cell wall and lignifying phase.

Total number of cells during growing season for each tree and for average of three bent trees and upright trees is shown in fig 2.30 and 2.31 As it is observable total number of OW cells is obviously lower than TW cells and NW cells in both sides.

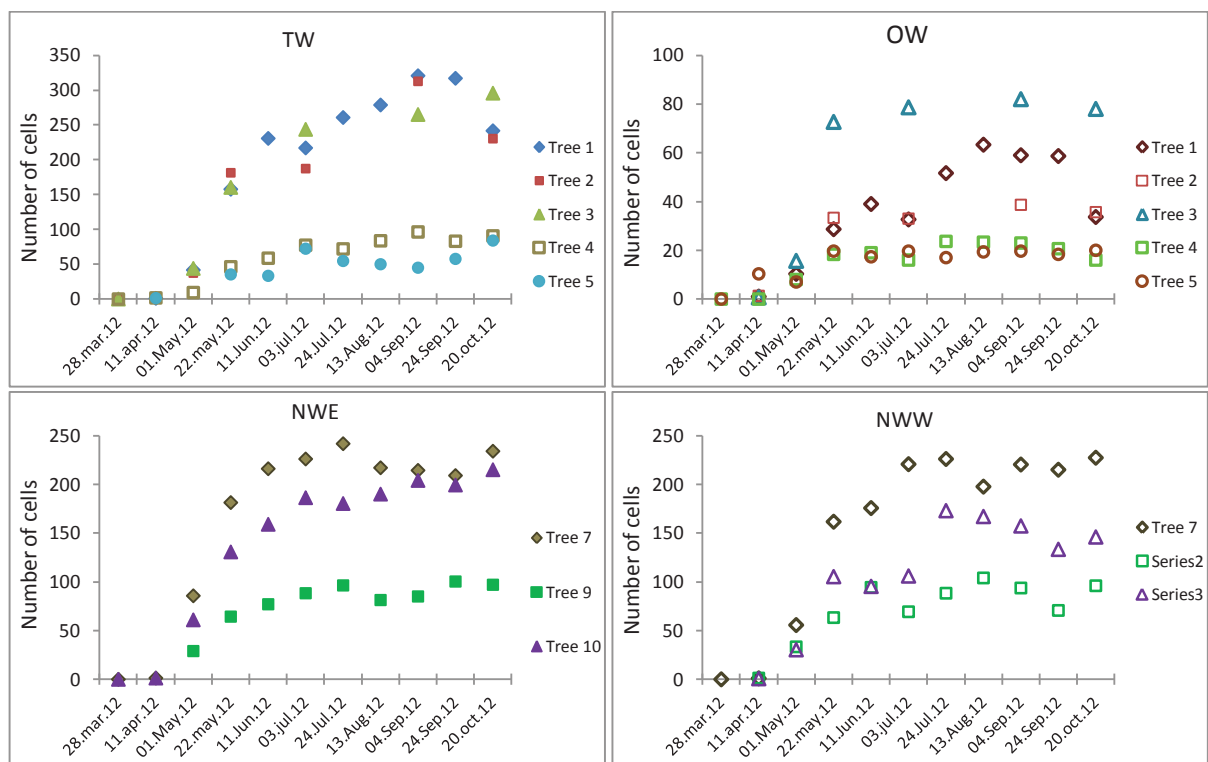

Figure 2.30 Variation of total number of cells in different date during growing season in two side of upright trees (NWE & NWW) and bent trees (TW & OW).(different shape show different trees).

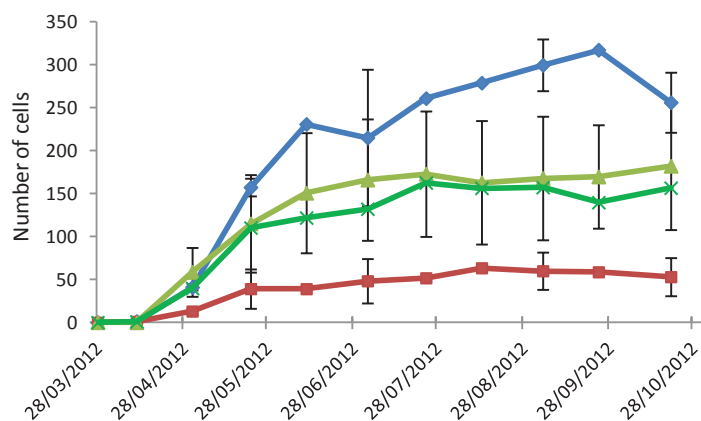

Figure 2.31 Comparison of average total number of cells during growing season. Each point is the average of three bent and three upright trees. TW (blue curve), OW (red curve), NWE (light green curve) and NWW (dark green curve).

2.2.7. Comparison of wood formation in bent trees and upright trees

TW and NW showed the same trend of xylem formation. In the period of April to May, the number of cells in cambial zone and enlarging phase increased, and decreased during Jun and July. Average of total cell number of TW (after removing 2 trees with low growth rate) was

twice times more than total number of NW cells and 5 times more than cell number in OW side (Fig. 2.31). TW is characterized by cells with GL were which are not observed in NW. In OW sometimes a few cells with thin GL formed separately. Comparison of growth rate in bent and upright trees performed with averaging number of produced cell in West and East side and TW and OW side of trees. Result showed that total number of cells in one growth ring in upright tree is equal to bent trees (Fig. 2.32) (After removing tree N.4 and 5 with low growth rate). At the end of growing season, number of cells in tension wood side was more than east or west side of upright trees (Fig. 2.31). It shows that although cell production in OW side is inhibited strongly, increase in number of TW cells can compensate it and total number of cells in one ring of bent trees is similar to upright trees.

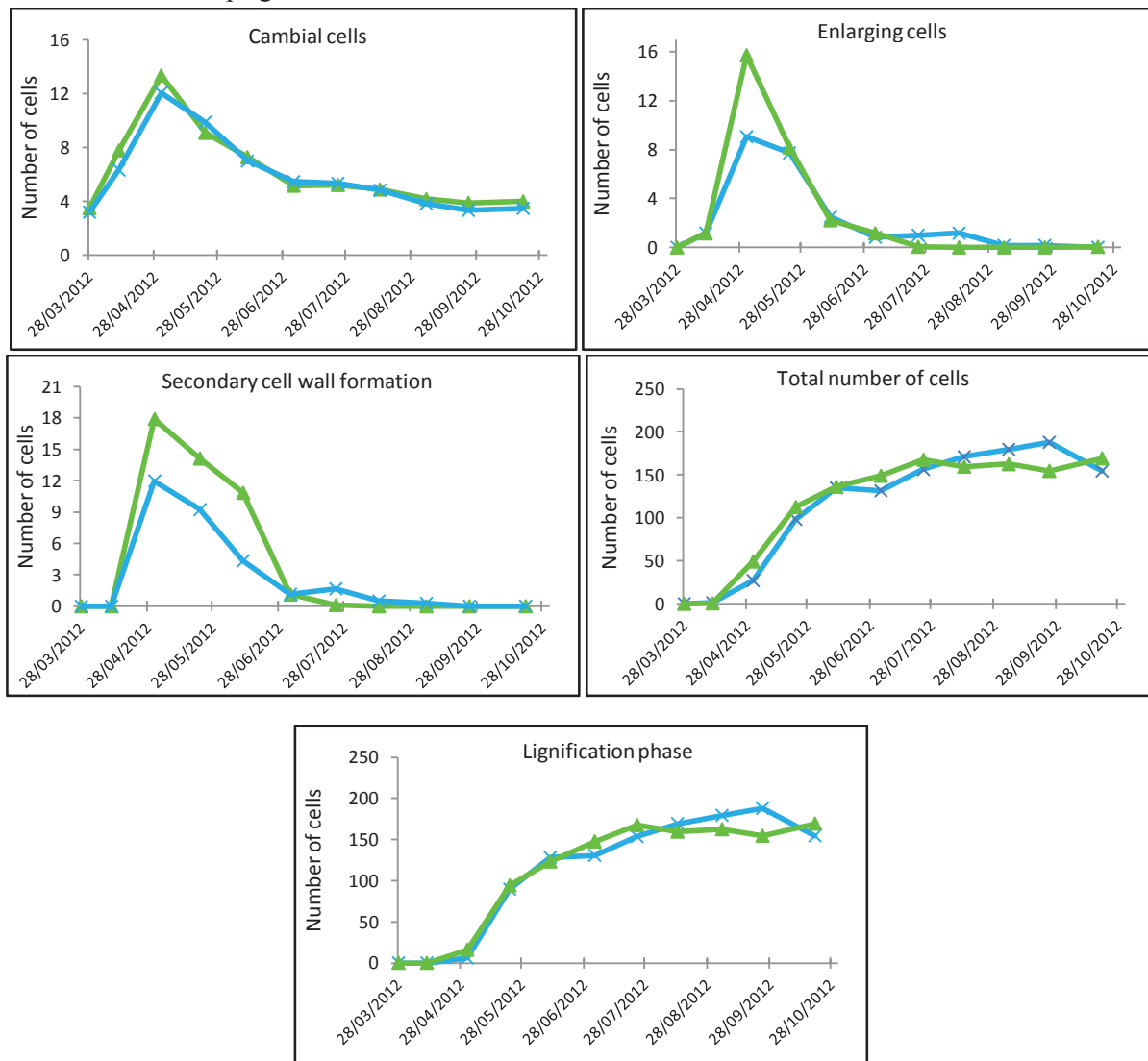

Figure 2.32 Average number of cells observed in different phase of wood formation in bent and upright trees. Bent trees (average of TW and OW, blue curve), upright trees (average of NEW and NWW, green curve).

2.2.8. Anatomical characteristic of TW, OW and NW

Anatomical feature of these three types of wood were completely different. The most important characteristic of TW microscopic tissue was the presence of cells with GL that make its appearance blue after double staining with safranin and astra blue. Low proportion of vessels was the other notable feature of TW. In OW, low proportion of fibres and in contrast outstanding increase in vessel proportion, small ring width are observable characteristic of OW. Figure 2.33 shows TW, OW and NW microscopic tissues. In ring boundary, marginal parenchyma cells were observable.

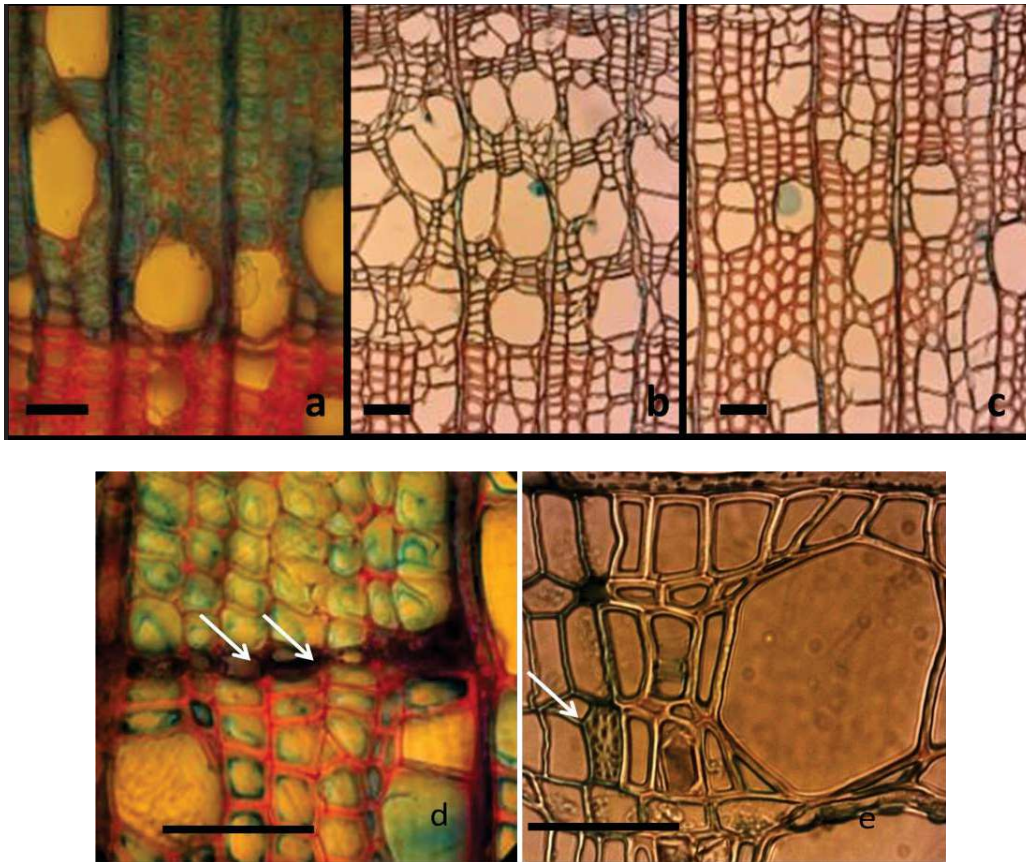

Figure 2.33 (a) TW tissue, (b) OW tissue, (c) NW tissue, (d) marginal parenchyma cells (arrows), (e) axial parenchyma cells. Scale bar: 50 μm

2.2.9. Growth phenology according to Gompertz equation

It is not possible to take sample daily or even weekly from thin trees, while growth rate change is not only daily but also hourly. Gompertz equation allows one to predict growth with high resolution according to real data collected weekly or with several weeks intervals. Gompertz equation is drawn for average of TW, NW and OW and also for each trees and then was fitted on actual data (Fig 2.34) and the quality of the adjustment was evaluated using statistical data

presented in Table 2.3. Daily increment calculated based on cumulative number of cells indicated that most intensive daily increment in TW occurred in 12th May (day of 133 Julian day), NW in 4th May (125 Julian day) and in OW in 8th May (129 Julian day) (Fig 2.34). Comparing growth rate according to Gompertz graph has shown that during first 25 days TW and normal wood growth rate was similar, while OW had lower growth rate. Seven days latter NW growth rate low down however, TW continue to increase with higher growth rate. Then NW decreased and TW increased and then low down. Finally 43 days after starting growth TW daily increment start to decrease.

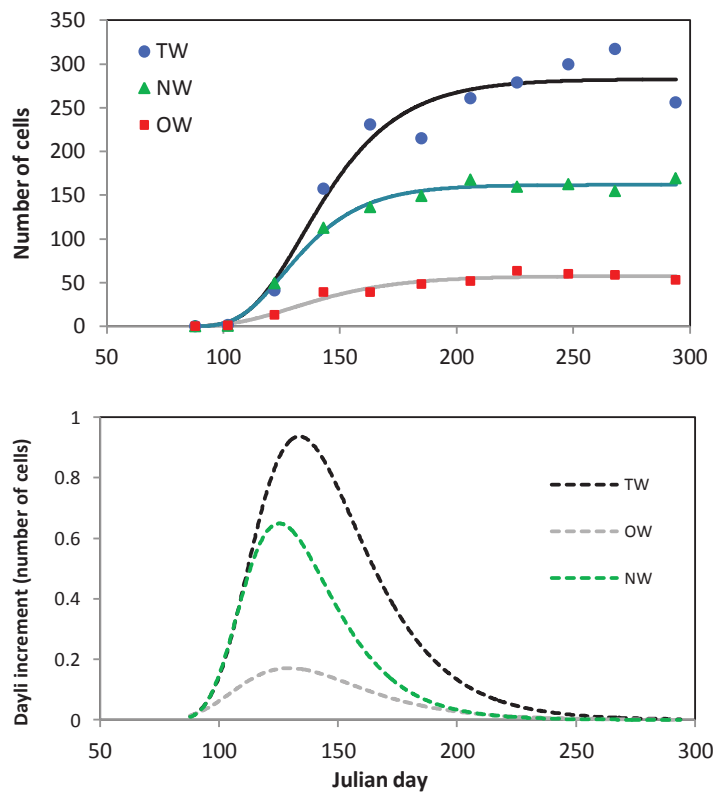

Figure 2.34 Increase cumulative growth rate calculated with Gompertz equation in 2012. Average number of cells is based on total number of cells of three bent and upright trees. (TW Gompertz (black line), NW Gompertz (green line) and OW Gompertz (gray line) and actual data (TW (blue circle), OW (red square), NW (green triangle)). Daily increment of TW (black dashed line), daily increment of NW (green dashed line), daily increment of OW (gray dashed line) day 88= 28 March, day 294=20 October.

Higher slope of NW cumulative growth graph (average of cell number of three upright trees), which were calculated in excel, indicates that NW reached to maximum number of cells sooner than TW and OW (Fig. 2.34). To see the behavior of each tree and compare growth per trees, Gompertz function fit also to actual data of each trees which is shown in Fig. 2.35. Growth trend is different from tree to tree. Considering duration of wood formation in each tree, except one OW tree, wood formation period was shorter in OW than NW and TW. Longer growth duration

of TW compared to OW and NW in average and per tree is obvious. Daily increment for TW and OW of each tree and for average of NWE and NWW is shown in Fig. 2.35c,d &g. Maximum daily increment of TW was more than NW and OW. In OW except one tree, all the trees had remarkably low daily increment. Low growth of two bent trees which mentioned before is observable (Fig. 2.35a&b).

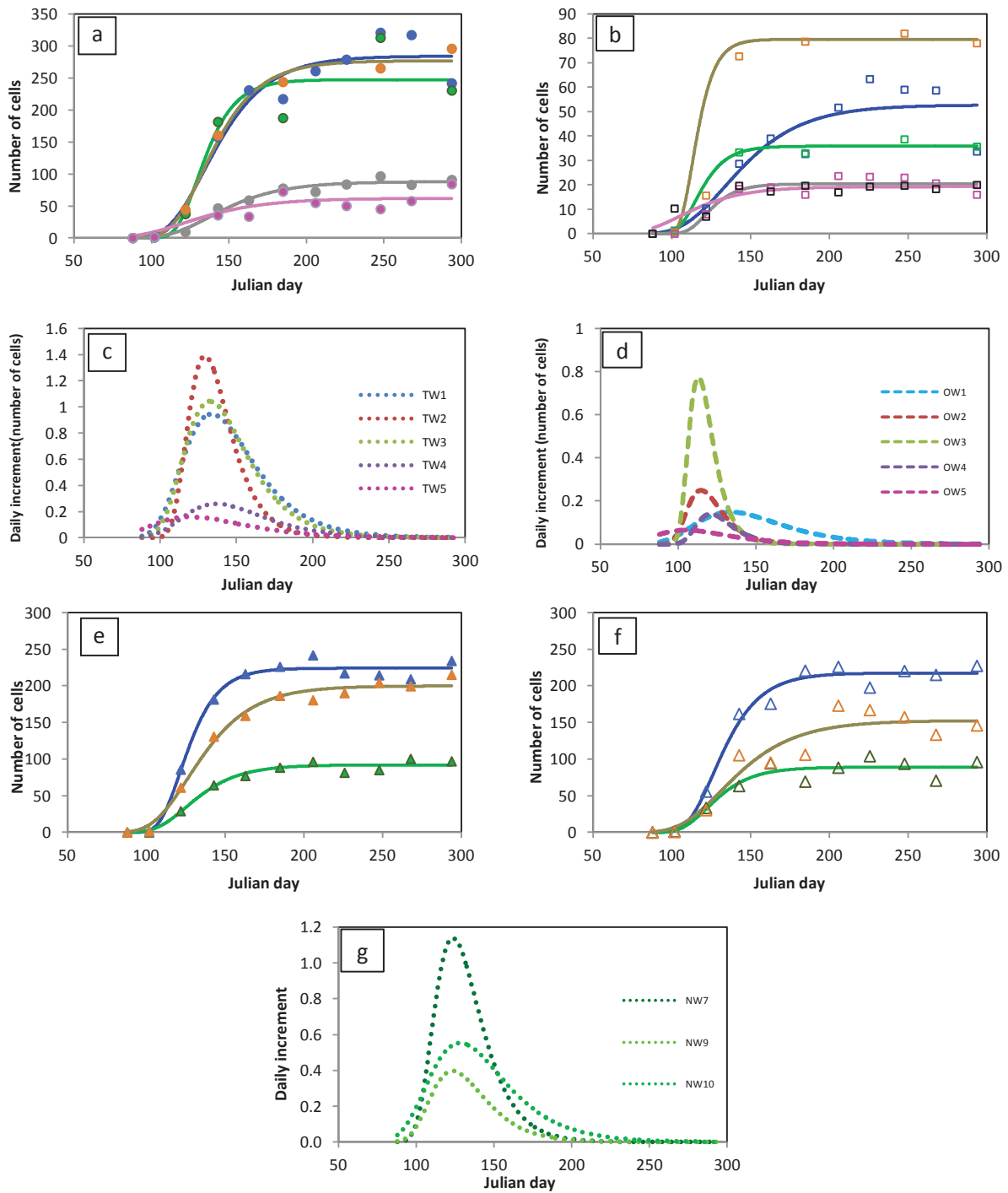

Figure 2.35 Gompertz function per trees. (a) TW of five bent trees, actual number of cells in TW (closed circles), (b) OW of five bent trees, actual number of OW cells (open squares), (c) Daily increment of Tw side; (d) daily increment of OW side; (e) NW of upright trees in east side, actual number of cells in upright trees, NWE (closed triangle), (f) actual number of cells in west side of upright trees, NWW (open triangle); (g) daily increment of upright trees; cumulative growth according to Gompertz (lines).

K factor of Gompertz equation, which determines rate of change of the growth curve shape, is one of the important output data of Origin Pro software that makes comparing of growth rate easier. K factor for average of TW, OW and NW and for each tree is shown in table 3.2. According to Gompertz growth graph, increasing growth period in TW was from 14th April to 28th of Jun (according to Julian day: 105 to 180), in OW from 9th April to 23th Jun (Julian day: 100 to 175) and in NW 9th April to 8th Jun (Julian day 100 to 160). Growth period for each tree and for average of trees is presented in table 3.2.

Table 3.2. k factor and statistical data of the adjustment of Gompertz equation with real data and wood formation duration according to Gompertz equation. Green cells shows the result for two bent trees with low growth which removed from averaging of bent trees.

	K	Reduced Chi-Sqr	Residual sum of squares	Adj. R-Square	Duration of wood formation
TW mean of 3 trees	0.044	565.4	4522.9	0.96	75
OW mean of 3 trees	0.039	23.0	184.2	0.96	75
NW mean E&W	0.053	33.54	268.3	0.99	60
TW1	0.04	818.7	6549.6	0.94	76
TW2	0.07	1959.1	7836.3	0.87	56
TW3	0.05	255.4	766.1	0.98	61
TW4	0.04	38.1	304.76	0.97	54
TW5	0.04	229.2	1375.0	0.6	45
OW1	0.04	97.26	778.0	0.82	73
OW2	0.09	5.26	15.78	0.98	36
OW3	0.14	3.2	9.6	0.99	34
OW4	0.09	8.2	65.57	0.89	32
OW5	0.04	8.6	68.5	0.81	42
NWE7	0.08	102.16	817.3	0.99	54
NWE9	0.05	37.93	303.46	0.97	48
NWE10	0.04	83	663.97	0.99	60
NWW7	0.06	147.84	1182.76	0.98	58
NWW9	0.06	140.64	1125.1	0.90	48
NWW10	0.04	426.93	3415.4	0.90	58

2.3. Discussions

2.3.1. Wood formation and maturation

Wood (secondary xylem) is manufactured and matured by a succession of five major steps, including cell division, cell expansion (elongation and radial enlargement), cell wall thickening (involving cellulose, hemicelluloses, cell wall proteins, and lignin biosynthesis and deposition), programmed cell death, and heartwood formation (Plomion et al. 2001). Some of these steps start after the other one and some occur simultaneously. During this process, each wood cell type undergoes specific anatomical changes that affect its shape and size, thickness, composition and structure of xylem cell walls. Each step will be influenced by a wide variety of external and internal factors that may change during the growing season and affect timing of each process.

TW is an example of spectacular reprogramming of wood formation, induced by external factors that will cause changes in internal wood biosynthesis factors. Combination of these factors expressed in cell wall, tissue and macroscopic structure of tension wood. In this part, we will discuss TW, OW and NW formation at the tissue level.

2.3.2. Dynamic of TW, NW and OW formation

Total number of cells in TW side was more than NW and OW. In contrast OW had lower amount of wood cells. This difference could derive from higher cambial cell division of TW compare to NW and TW, which has major effect on tree growth with affecting total amount of wood in annual growth ring and stem eccentricity.

2.3.2.1. Comparing total amount of wood in TW, OW and NW

Although the investigated upright trees were all healthy, same age and under same irrigation regime, number of cells in different phase of wood formation and total number of cells had some variations. In spite of the same age, one of the trees (tree N.7) had a little bit bigger diameter and finally had a higher total number of cells. However, the two other trees with the same diameter also produced different number of cells (Fig. 3.22, tree N.9 and N.10). Such variations between trees at the same site were reported also by Čufar and co-workers (2008) and Oladi and co-workers (2010).

Among five bent trees, two trees formed growth ring with extremely low number of cells (Fig. 2.30, trees N.4 and N.5) compare to the other ones. Although these trees were at the same site, they were bent from west toward east direction that was in opposite direction compared to the other three trees. One of these trees (tree N.5) was also defected strongly during experiment. These two trees were thus not taking into account in comparison with normal trees. Probably change in amount of available light could be an important factor in decrease of growth rate of these two trees. As the crown of these two groups of trees were in different direction.

The higher growth rate of TW that was observed in this study is reported in several investigations (Coutand et al. 2007; Jourez et al. 2001). This increase in growth was more important than in the opposite side of the bent tree and than the averaged cell production of upright trees. In spite of higher cell production in tension wood side, average growth of bent and upright trees were similar which result from a lower cell production in the opposite wood side. It shows that, although cell production in OW side is inhibited, the strong increase in number of TW cells can compensate it and the total number of cells in one growth ring of bent tree is equal to upright trees.

2.3.2.2. Stem eccentricity in TW

At the end of our experiments, 8 years old trees that have been bent for the last two years, eccentricity was observable after 6 growth rings (Fig 3.1). Stem eccentricity is an important macroscopic appearance of reaction wood in bent trees. Tension wood contracts longitudinally and pulls the stem back to the vertical position. It is characterized by a high rate of cell production on the tension wood side, which may lead to stem eccentricity. At the same time, wood formation on the opposite side of the stem is reduced (Mellerowicz et al. 2001). Eccentricity associated with wider ring normally being on the upper side of the stem or branches (Jourez et al. 2001, Ruelle 2014) and narrower ring in opposite side. This phenomenon is a mechanical reaction of tree to reorient their stem axis that is driven by variations of cambial region activity (Ruelle 2014). Our investigation also indicates an increase of cambial activity in TW side along with the production of a higher number of cambial cells at the beginning of growing season and a lower cambial activity (lower number of cambial cells). This leads to a narrower growth ring in OW side and thus eccentric pith position. Although change in fiber diameter or cell wall thickness during tension wood formation is reported in different studies, they cannot be the responsible of stem eccentricity. Ruelle (2014) based on an extensive study on numerous tropical species that did not reveal any general trend in fiber diameter and thickness variation between TW and non-TW, suggests that the stem eccentricity often observes with the formation of tension wood results from a larger number of cell divisions and not from a larger diameter of fibers. It appears to demonstrate that the cell division rate, i.e., cambial activity, is higher in tension wood tissue (Ruelle 2014).

2.3.3. Cambium activity

All types of xylem cells are derived from vascular cambium, the lateral secondary meristem. In all studied trees, including bend and upright trees, the number of dormant cambium cells was 3-4 cells and sometimes reached 5 cells. So bending the trees had no measurable effect on the number of dormant cambium cells in the second year of the bending. There was no difference between onset of cambium activity for TW, NW and OW. However, the increased sampling

interval, to avoid wound reaction, restricts the observation of time dependent variation of cambial activity.

Cambium activity, which was started in second week of April reached to maximum number of cambial cells during last week of April to last week of May. Peak of this activity was observed in first of May. It was the same for all types of studied wood (TW, NW, and OW). Nevertheless, the number of cambium derivatives in TW was more than NW and much more than opposite wood. There is no document available about cambium activity of poplar in the studied region. Cambium activity of beech (*Fagus orientalis*) in northern mountains of Iran (in 650 m a.s.l) was investigated, which starts between 17 to 27 March (Oladi 2010). About European beech, xylem formation started on April 18 (Cufar et al 2008). In Japanese poplar hybrid (*Populus sieboldii* × *P. grandidentata*) cambial reactivation was first observed on March 29 which happened after increasing maximum daily temperature from March 20 (Begum et al. 2008).

There were no differences between cambium activity duration for TW, NW and OW. All of them reached their minimum activity in the first week of July. Little and Savidage (1987) reported that auxin concentration control intensity and amount of mitosis division in cambial zone but it has no effect on cambial activity duration. Oladi et al (2010) reported that cessation time of cambial activity is more variable than onset of cambial activity in different sites of beech in Iran. Climate, type of species, crown extension, temperature, environmental stresses like drought and concentration of growth hormones, specially auxin, are controlling factors of cambium activity (Mellerowicz et al. 2001; Giovannelli et al. 2007; Begum et al. 2008; Oladi et al. 2010). In our investigation cambium cessation was not different between the three types of wood formation that were in the same site. We can consider 13th of August, in the second year of bending, as the time of cessation of cambium activity in TW and NW, as there were no cells in enlarging phase at this time.

Duration and rate of cambial activity has a major role in amount of wood production during a growing season. As the duration of cambium activity was not different we can say that rate of cambium activity was important factor in controlling wood production in our samples.

2.3.3.1. Relationship between tree phenology and cambium activity

In all bent and upright trees, cambium activity starts simultaneously or after bud break, around 6th of April. This synchronicity is also reported about hybrid poplar in UK and Japan (Barlow and Powers 2005; Begum et al. 2007), Iranian (Oladi et al. 2010) and European beech (Cufar et al. 2008a; Michelot et al. 2012). Hence, bud flushing can be considered as a sign of onset of cambium activity in broad leaves species. But it should be considered that in some species, like oak cambium activity start before bud break and in needle leaves pine before unfolding (Michelot et al. 2012). Oladi and co-workers (2010) explained this phenomenon clearly and assigned it to the role of auxin in stimulating the cambium activity and cambium sensitivity of species to this hormone.

In all types of trees, the maximum number of cambial cells and enlarging cells were formed in first of May when leaves was broad completely. This observation is similar to what Michelot and co-workers (2012) reported about the maximum growth rate of beech that occurred concurrently with leaves maturation. They attributed this phenomenon to leaf photosynthesis. Although onset of cambial activity happened after or simultaneous with bud burst and maximum rate of growth happened simultaneously with leave expansion, there was no clear relationship between changes in color of leaves and cessation of cambial activity. When leaves color turned yellow at the end of August cambium activity was already stopped.

It seems that bending doesn't have obvious effect on leaves and buds phenology. Study of buds and leaves phenology was not our major issue for this study but it can be investigated more precisely in the future.

2.3.4. Cell enlargement (or postcambial) phase

The dimensions of the wood cells are determined before secondary wall deposition in enlarging phase. Cells primary wall forms at this stage. During primary wall formation wood cells grow to their final shape by a unique combination of symplastic growth (when the neighboring cells grow together) and intrusive growth (when they move one past another, e.g., fiber elongation). Thus, the wall plasticity and variation in cell adhesion are related to the mechanism involved in wood cell growth (Mellerowicz and Björn 2008). Currently formed xylem cells in postcambial phase were defined by larger dimensions and thin, non-lignified, blue stained cell walls (Čufar and Prislan 2008). Initial enlarging cells just contain primary wall and expand longitudinally and radially to their maximum size.

Cambial derivatives undergo cell enlargement very soon after division. When cambium cells reached 7-8 cells, one or two cells undergo cell postcambial phase. In poplar, xylem cells consist of fibers, vessels, axial parenchyma and ray parenchyma cells. Vessels are one of the first xylem cells that forms simultaneously or soon after first fiber cells (Oladi 2010; Čufar et al. 2008). In investigated samples, the first developing vessels in post-cambial growth were observed between 11th of April and 1st of May 2012. In first of May, totally 46 fibers and vessel cells were already formed, which indicates that fiber and vessel differentiation has been started for a long time. Poplars which were grown in Japan had begun expansion of secondary xylem by April 15 (Begum et al. 2008). In European beech, the first developing vessels and fibers in post-cambial growth were observed between 18th and 24th April 2006 (Čufar et al. 2008). Number of enlarging cells in NW was more than TW and OW. Maximum number of enlarging cells in all types of wood was produced in 1st of May when the cambium cells was maximum too. Number of enlarging cells in Iranian beech does not showed a significant change during the growing season (Oladi et al. 2010) while the maximum number of enlarging cells in *Pinus halepensis* was observed in the third week of May (De Luis et al. 2007). Number of enlarging cells intensively

decreased in 11th of June and cell enlarging finished completely in 13th of August in TW and NW, while a few cells were still in enlarging phase in OW.

Cell enlargement duration estimated less than two weeks for one developing cell which was not different between TW, NW and opposite wood. Duration of each phase has important role in characteristic of growth ring. In conifers, it is demonstrated that change in cell size along a ring is closely related to the change in duration of enlargement through the growing season (Cuny et al. 2013). To precise estimation of duration of each phase more sampling with shorter interval is needed.

2.3.5. Secondary cell wall thickening and lignification

Secondary cell wall formation and subsequent PCD (Programmed cell death) are two critical steps in the maturation of xylem tracheary elements and fiber cells (Schuetz et al. 2012). During wall thickening phase, the originally thin cell walls started to thicken and the cell walls showed birefringence behavior under polarized light, which implies deposition and orientations of cellulose microfibrils in the secondary layer. In some cells, synthesis of multi-layered secondary cell wall started in third week of April and around two weeks later lignification starts in those cells. Duration of cell wall thickening phase can affect cell wall thickness of cells in growth ring of softwood (Cuny et al. 2013). In Japanese poplar, secondary wall thickening starts in 18th April (Begum et al. 2008). In beech synthesis of the secondary cell wall started between 24th of April and 3^d of May (2006) in the fibers that surround vessels (Čufar et al. 2008). First wall thickening cells in Iranian beech was observed in 6th of April. For trees at higher altitude this occurred 10 days later and it takes around 2 weeks long to observe first lignified cells (Oladi et al. 2010). Number of cells in secondary wall formation phase decreased in the first week of July. Vessels were the first cells that appear bright under polarized light. Then wall thickening spread in other fiber cells. Oladi and co-workers (2010) have not observed any difference in the start of the secondary wall deposition in fibers and vessels while Čufar and co-workers (2008) reported that wall thickening starts in the fibers that surround vessels.

Lignification of the secondary cell wall generally occurs after the initial deposition of the cellulosic components and it is initiated in a spatially specific pattern, beginning with the lignification of the middle lamella (Schuetz et al. 2012). Vessels were the first cells that started wall thickening and lignification processes. Then lignification starts in adjacent fibers and spread gradually to the remaining tissue. This pattern of lignification was observed in beech and maple, as well (Marion et al. 2007, Čufar et al. 2008 & Oladi et al. 2010). Although we haven't observed any difference in intensity of lignification between vessel and fiber cell walls, it has been reported in some investigations and demonstrated with UV microscopy method (Dünisch and Rühmann 2006; Eriksson et al. 1988). Vessels sustain the high pressure of water conduction in plants and the intensity of lignification increases their resistance and reduces the risk of the collapse (Yoshinaga et al. 1992; Abdul Khalil et al. 2010) by strengthen the cell wall and increase its hydrophobicity to reduce permeability of water. Lignification in OW side starts later

than that in TW and NW ones. Maximum number of cells in the lignification phase occurred from 22nd of May to 11th of June concurrently with the warmest days of summer. Temperature, growth rate and internal factors have been expressed as the most important factors that affect timing of lignification (Donaldson et al. 2001; Grünwald et al. 2002; Dyckmans et al. 2002; Schmitt et al. 2004; Rossi et al. 2007). Gindl and co-workers (2000) stated that there is a positive correlation between cell lignification and temperature especially at the end of the growing season.

There was no difference between beginnings of lignification between TW and NW while in OW lignification start one week later. Secondary wall formation and consequence lignification process does not change between TW, NW and OW. The only difference was synthesis of extra GL in inner side of TW cells which was observed after starting of lignification.

2.3.6. Cell death (Mature cells)

Although distinguishing the completely lignified cells from the other cells at final stage of lignification was not easy, completely red stained cells with empty lumina that were observed in the first week of June were considered as mature cells. Therefore, maturation process for first derivatives of cambium cells lasts around up to 2 months. These results were in agreement with cell differentiation duration of beech where the first fully differentiated fibers were observed between 13th and 20th of June, i.e., five weeks after their formation (Cufar et al. 2008). It is difficult to say when all the cells are fully developed and matured. It seems that in NW all cells completely developed until middle of August while in TW the development of the latest formed cells continued until first week of September and in OW until last week of September.

As axial and ray parenchyma cells contained cytoplasm and had relatively thin walls, their development process during differentiation is less apparent. Newly formed vessel elements and fibers died at the final stage of differentiation, whereas parenchyma cells can remain alive as long as they are a part of the sapwood (Panshin and de Zeeuw 1980 in Čufar et al. 2008). Total lignification of the massive secondary cell walls must be closely coordinated with the loss of metabolic capacity in these cells as they undergo PCD (Schuetz et al. 2012). With the current method of staining (double staining with safranin-astra blue), observation of living cells and the following of their content variation are not possible because paraffin removing, staining and washing of the sections remove cytoplasm of live cells. As sample embedding in resin was used for the cell wall thickening part of study, it allows us to follow the cell developing process according to presence of cytoplasm. We considered dead cells as the ones that have a completely clear lumen. Number and distance of dead cell from cambium zone were counted. It seems that fiber cells with GL kept their cytoplasm longer than adjacent fiber cells without GL. According to this observation, we conclude that life duration of the cells with GL is higher than that of cells without GL at the same distance from cambium. But as it is reported that cellular debris is often retained for a long time in the cell lumen even after cell death, we cannot be sure that cells with

shrunk cytoplasm were alive. Currently, little is known about the factors controlling timing of the vacuolar rupture and cell death. In xylem fibers, the time of vacuolar rupture varies significantly depending on the activity of the cambium and several external factors, and the lifetime of fibers is dramatically increased, for instance, during tension wood formation. In some species, xylem fibers retain their protoplast indefinitely (Bollhöner et al. 2012).

2.3.7. Gelatinous layer formation

At the end of the cell expansion phase, the protoplast begins to produce the thickened secondary cell wall, which consist of three layered structure (S_1 , S_2 , S_3) made of cellulose microfibrils (Samuels et al. 2006). This structure differs in tension wood because of reprogramming of wood cell wall biosynthesis that shifts from the S_2 -layer to the G-layer (Mellerowicz and Sundberg 2008). First gelatinous layers formed in the early lignification stage of the secondary cell wall around first of May. It has been demonstrated by Yoshinaga and co-workers (2012) that lignification of the CML does not end before the start of the G-layer formation and continues during G-layer deposition. Observation of GL in early stage of formation needs precise and efficient embedding and staining methods. As very thin GL could be detached easily and removed during paraffin removing process and bleaching the stained sections. Considering this problem, the first observed GL was in early stage of lignification. It is believed that GL forms after the complete deposition of the secondary cell wall but according to what we observed at the cell wall level in some samples, GL could appear to be formed before SL reached its final thickness.

TW that formed during bending treatment was distributed continuously along the upper side of the stem. All the fiber cells newly formed after differentiation contained GL distributed continuously in the growth ring. It is the effect of a continuous gravitropic stress induced by bending. Poplar trees are sensitive to form TW and formation of cells with GL is likely even in upright trees (Yoshinaga 2012). But the pattern of G-fiber distribution is different with bending trees. Upright growing stems usually form scattered bands or even isolated tension wood fibers, probably because of bending by wind or growth adjustment (Kaeiser, 1955 in Mellerowicz et al. 2001). In species where tension wood exhibits a G-layer, its occurrence is always correlated with tensile growth stresses, i.e., the proportion of G fibers is directly correlated with the magnitude of the growth stresses (Clair et al. 2003; Fang et al. 2008). In TW, lignification was observable just in middle lamella and secondary cell wall and GL stained blue, which indicates unligified structure of GL. TW generally described as containing a high proportion of cellulose and being less lignified than normal wood (Wada et al. 1995). However histological staining such as safranin-light green, phloroglucinol-HCL, indicate that the GL is usually non-lignified or lignified to a limited degree, whereas external wall layers of G-fibers are strongly lignified (Pilate et al. 2004). Our observations resulting from staining with safranin-astra blue are in agreement with this pattern of lignification of G-fiber. Timell concluded that a lack of

lignification should not be regarded as a characteristic of TW as a whole but only of the G-layer (in Pilate et al. 2004).

GL was formed continuously in all cells in TW side. Nevertheless, in few cells near the cambial zone, GL never formed at the end of growing season or when it was formed, it had thin GL and thick secondary wall. This phenomenon has been observed also by Jourez and Avella-Shaw (2003) and in wall thickening part of this investigation. It could be due to a higher sensitivity of earlywood to form G-fibers. In a review by Mellerowicz et al. (2001), it is mentioned that in upright aspen that forms TW, fibers with TW characteristics were more often seen in earlywood than in the latewood and in upper parts of the trunk than in the lower parts.

2.3.8. Comparing anatomy of TW with OW and NW

Although we haven't done numerical analysis on fibers and vessels proportion, it seems that the proportion of fiber cells decreased clearly and thus proportion of vessels increased in OW. Reversely, an increase in fibers proportion has been seen in TW side. Jourez et al. (2001) did an extensive work on poplar tension wood and found that not only vessel frequency but also the area of vessel lumen is lower in tension wood and consequently the proportion of vessel lumen is lower in tension wood. As mentioned in at the beginning of this chapter growth ring width was also higher in TW side compare to NW and OW, which derived from different cambial activity.

2.3.9. Growth duration and growth rate according to Gompertz function

Statistical approaches such as Gompertz function can help to extract a meaningful biological signal from naturally noisy data set (five bent trees and 3 upright trees). Based on precise study with three different statistical methods which was performed by Cuny and co-workers (2013) to describe seasonal changes in cell numbers in each of the xylem differentiation phases in conifers it was found that Gompertz function accurately represent the general changes in the number of cells in the enlargement and mature zones, but were inaccurate concerning the cambial and thickening zone. Gompertz function can be used to extract biological patterns such as the final number of produced cells and the value and occurrence of the maximal rate of cell production. By the use of Gompertz function, wood formation dynamics described three delayed bell-shaped curves for the number of cells in the cambial, enlargement and thickening zone. Nevertheless, in mature zone it is S-shaped curve (Cuny et al. 2013). In this study total number of produced cells fitted on Gompertz function which result S-shape curve. Although number of cells in differentiation phase (cambial, enlargement and thickening zone) was not fitted on Gompertz function but produced curves according to actual data fallowed bell-shaped curves. According to Gompertz growth curve (Fig. 2.34) in TW more intense cell production occurred from the 24th of April to the 29th of May and in May 12 it reached to maximum daily increment. Maximum daily growth of NW occurred in 4 May, while OW four days later reached to most intense daily growth. According to cumulative growth rate and daily increment, TW growth ring develops

later than NW and OW. In average of three upright trees, NW reaches to maximum growth rate sooner than OW and TW.

Gomperts model have shown that TW had higher growth rate and longer growth period. However, calculating growth rate for each tree showed that this trend is different in individual trees. According to growth duration (table 2.3) except one OW side, wood formation in other OW sides were extremely low and majority of OW cells produced in shorter time compare to TW and NW. Most intense growth rate of NW (Fig. 2.34) occurred during 14 April until the 24th of May. In average, according to Gompertz model, TW needs a longer time to develop the majority of the xylem growth ring (112 days) than OW (104 days) and NW (88 days).

2.3.10. Conclusion

In conclusion, we can say although according to the actual data wood formation process and duration does not change obviously between TW, NW and OW, some changes seem interesting. In TW, formation of GL, which was accompanied by lignifications, occurred after secondary wall thickening. In OW number of cambial cells and final number of cells was lower than TW and NW and lignification start latter than TW and NW.

Wood formation increased in TW side of bent trees but the amount of wood formation does not changed in one annual ring of bent trees compare to upright trees. However, number of cambial cells in TW side was more than NW and OW. Although actual data indicate that there is not distinct difference between cambial activity duration of three types of studied wood, modeling of growth pattern with Gomperts function have shown that TW had higher growth rate and longer growth period. Finally, we can conclude that higher cell production and consequence stem eccentricity in TW side comes from higher cambial activity result in higher cell division and longer growth period in TW side nor from higher cell diameter.

3. Cell wall thickening in poplar tension wood

3.1. Material and methods

3.1.1. Preliminary measurement of cell wall thickness

Second part of this study is devoted to investigation of wood formation in TW at cell wall level. For this purpose, cell wall thickness change during TW formation traced in different phase of wood formation. In the first year of investigation, sampling have been done weekly on field-grown white poplar (*Populus alba*) at Iran Research Institute of Forest and Rangelands in Karaj, Iran. The same trees which were sampled for wood formation study. Samples were embedded and sectioned according to the procedure described in the following paragraph. Cell wall thickness of compound middle lamella (CML), secondary cell wall (S2) and gelatinous layer (GL) were measured in radial direction from three points of each cell wall, as shown in Fig. 3.1, in three files of each section and then averaged. Cell wall thickness was calculated as follow: $CML = C$; $S2 = (B-C)/2$; $GL = (A-B)/2$.

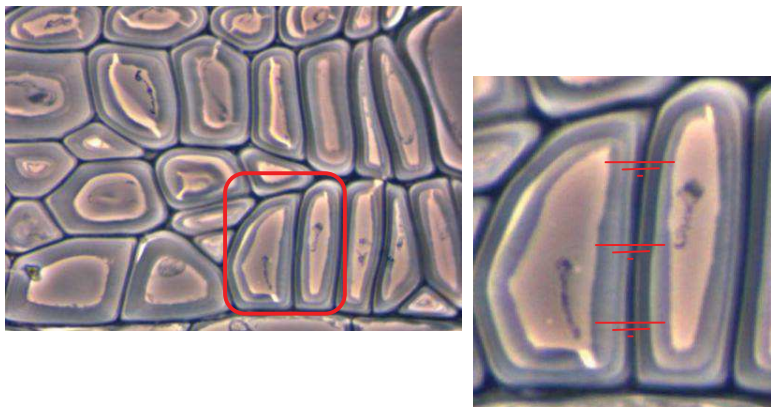

Figure 3.1 Cell wall thickness measurement with Image J in pretest samples

Preliminary result of cell wall thickness measurement in first year of sampling showed rhythmic fluctuation in thickness of cells. Because of these results, we suspect that consecutive microcoring may affect wood formation especially at cell wall level; we preferred to use samples grown in greenhouse in completely preserved conditions instead of field grown trees to study cell wall formation of tension and normal wood.

Although previous studies (Deslauriers et al. 2003a; Rossi et al. 2006a; Michelot et al. 2012) mentioned that 2 cm spacing between each sampling is enough to avoid wound reaction, it seems

that spacing between sampling is highly depend on diameter of the trees and in thin trees it should be increase.

3.1.2. Sampling for cell wall thickening study¹

Poplar saplings (hybrid *Populus tremula* x *P. alba* (clone INRA 717-1B4)) were grown in a greenhouse at the INRA centre in Orléans, France. Trees were tilted and attached to a tilted pole (Fig. 3.2) in the middle of the growing season on 25th June, 2012. Then, trees were sampled after one day (T1), three (T3), seven (T7), fourteen (T14) and 25 days (T25) after tilting. Sampling was performed on three trees at each sampling date. Trees were 1.3 m high and had a basal diameter of around 10 to 12 mm at the beginning of the experiment. Basal parts of tilted stems (3 cm) were cut and tension wood side marked with resistant pencil. The stems are then placed in tube with ethanol 80% and stored in refrigerator.

As this sampling performed in the middle of growing season just to study tension wood cell wall formation and to better understanding of tension wood cell wall thickness change during growing season, complementary sampling also performed with sampling of two tilted stem from the same clone (clone INRA 717-1B4). Saplings were tilted in January, before growing season and cut at the end of growing season in November. Then they were stored at -20°C. These samples contain both early and late wood cells.

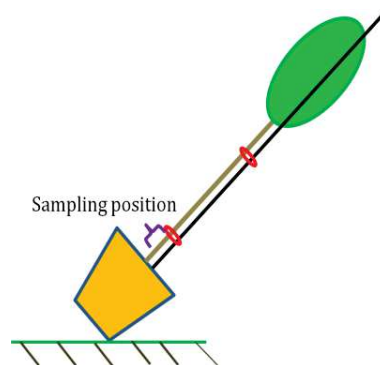

Figure 3.2 Schematic figure of sampling position on poplar saplings for cell wall thickening study

3.1.3. Sample preparation

3.1.3.1. Embedding samples in resin

Sample preparations have been done in Laboratory of mechanic and civil engineering of university of Montpellier II. Small blocks were cut from tension wood sides (upper side) and opposite wood side (lower side) of the basal part of the tilted stems by means of small band saw in laboratory. Final size of small blocks was around 5×3×3 mm before embedding in resin. The transverse side of each sample was marked with a pencil. All samples were dehydrated through

¹ poplar culture and tilting protocol were managed by colleagues from AGPF unit, INRA Orléans.

ethanol series and embedded in LR white resin (London Resin) according to standard methodology (two exchanges of resin/ethanol mixture for one hour, followed by two exchanges in pure resin for one hour, kept one day at room temperature, then kept overnight in a capsule mould at 65°C) (table 3.1).

Table 3.1. Embedding samples in resin protocol

Material	Time
Ethanol alcohol 75%	30 minutes
Ethanol alcohol 100%	1 hour
Ethanol alcohol 100%	1 hour
Ethanol alcohol 100%	6 hours
Ethanol alcohol 100% & L.R. White Resin (50% &50%)	3 hours
L.R. White Resin	3 hours
L.R. White Resin	a night
L.R. White Resin	a night in oven 60°C

3.1.3.2. Trimming of the samples

Then, capsule removed from resin blocks and excess part of resin at pick of the capsule is removed by using sand paper machine or trimmed with hand. The samples, blocked on the microtome clamp, oscillate vertically and meet the knife. Before final cut with diamond knife resin blocks trimmed with glass knife to reduce depreciation of diamond knife. At trimming and cutting time, the surface of the knife should be parallel to the surface of sample, but if it was not completely parallel the degree of knife or sample holder orientation should be adjusted to make the surface of the knife parallel to surface of the sample.



Figure 3.3 (a) resin block before trimming (b) resin block after trimming

3.1.3.3. Sectioning

Thin transverse sections ($0.5\ \mu\text{m}$ in thickness) were obtained using a rotary microtome (Leica RM2265) with diamond knife (Diatome Histo) (Fig 3.4). The use of dehydrated and embedded samples may affect the quantitative determination of the cell wall thickness compared to the native state. This sample preparation is expected to produce a slight shrinkage or swelling of the wall. For example, Chang et al. (2012) showed that ethanol dehydration produces a macroscopic swelling of 0.2%. However, this preparation is necessary to avoid the observation of the GL in a swollen state due to the border artefact described in Clair et al. (2005). This artefact has been shown to swell the GL by around 60% (Clair et al. 2005, Fang et al. 2008). In order to avoid observation of GL in a swollen state, sections were taken at least at $50\ \mu\text{m}$ below the trimming surface of the embedded samples. After cutting sections floated on distillate water bath behind the diamond knife and removed from surface of the water by a delicate hook made by hair and place in a drop of water on glass slide. Samples were dried on hot plate at $50\ ^\circ\text{C}$ for at least 1 hour. Sections were mounted in cover quick medium on glass slides without staining.

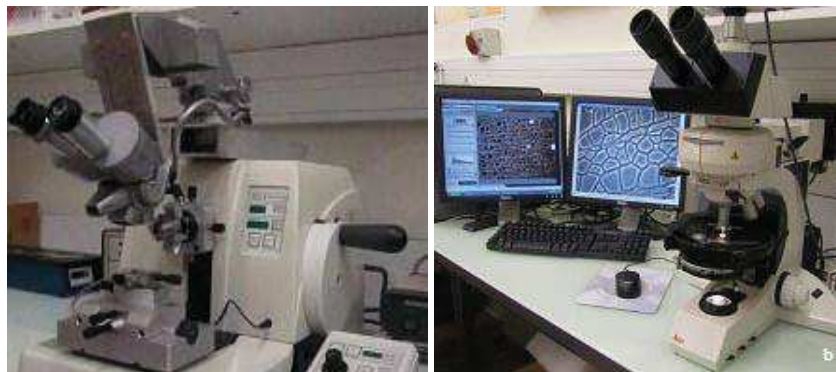

Figure 3.4 LEICA RM2265 microtome, (b) LEICA DMLP microscope

3.1.4. Measurement of cell wall thickness

Cell wall layer thickness of wood fibres was measured using the phase contrast mode with a Leica DMLP microscope (fig. 3.4) with immersion oil lenses. Phase contrast is preferable to bright field microscopy when high magnifications (400x, 1000x) are needed especially as the specimen is colourless or the details are so fine that colour does not show up well. Light

microscopy allows for the measurement of all the cells along a radial line and an average measurement on each whole cell, which is not possible using TEM technique that requires the deposition of the sections on a grid thus hiding part of the sample. As it is not possible to follow the thickening of a single cell, several cells in a single radial line from cambium to mature wood are considered as a good proxy of the maturing cell all along this study. Several images were captured using a digital camera (Leica DFC320) from cambium cells to ring boundary with a sufficient overlap to allow the repositioning of each image with the previous one in order to accurately measure the distance of each cell to the cambium (Fig. 3.5).

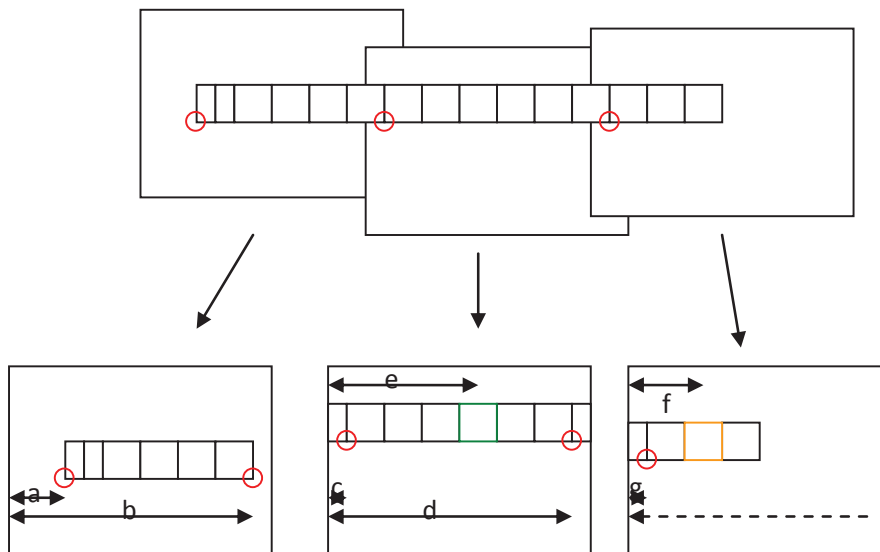

Figure 3.5 Calculation of the exact distance of each cell from cambium. Distance of the green cell to cambium = $e - c + b - a$, Distance of the orange cell to cambium = $f - g + d - c + b - a$.

Preliminary testing on first year sampling on white poplar indicated that the thickness of the compound middle lamella (CML) is constant all along the maturation sequence and does not show significant variation with SL and GL thickness changes (Fig.3.8). Therefore, CML thickness was not measured in this study. Thickness of GL and SL were measured in three radial lines of cells per sample using image analysis software ImageJ (National Institutes of Health, Bethesda, MD, USA). In order to handle the variability of cell wall layer thickness around the cell, and to increase the precision of the measurement, a mean cell wall thickness was calculated according to the method proposed by Yoshinaga et al (2012) (Fig. 3.6). External contours of the GL, SL and lumen were plotted manually from images (Fig. 3.7) and the average thickness was calculated according to following formula:

$$\text{GL mean thickness} = 2 \times A_{\text{GL}} / (P_{\text{GL}} + P_{\text{Lumen}}),$$

and

$$\text{SL mean thickness} = 2 \times A_{\text{SL}} / (P_{\text{SL}} + P_{\text{GL}}),$$

where A_{GL} is the area of GL, A_{SL} the area of SL, P_{GL} the external perimeter of GL, P_{SL} the external perimeter of SL and P_{Lumen} the lumen perimeter. Finally, the mean cell diameter was evaluated as $D = P_{SL}/\pi$. This method integrates the whole fibre and thus allows for a better precision in the thickness measurement than when performed only in some points. A reproducibility test, made by measuring 30 times the same wall thickness, yielded a confidence interval at 95% of $0.015 \mu\text{m}$.

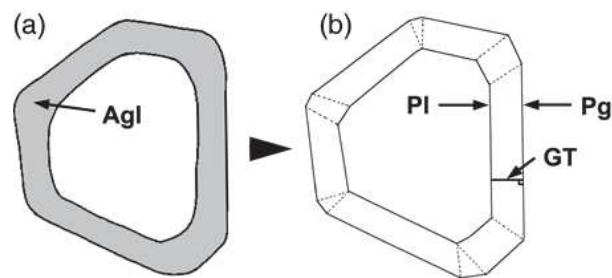

Figure 3.6 Schematic drawings of measurement of the G-layer thickness. The G-layer area A_{gl} (a) and the perimeters of the G-layer (P_g) and lumina (P_l) were determined using image analysis. The A_{gl} was regarded as a group of trapezoids, with the average G-layer thickness (GT) being the height of each trapezoid (b). Therefore, $GT = A_{gl}/0.5 (P_g + P_l)$ (Yoshinaga et al. 2012).

Each measured cell was later recognized by its distance to the cambium both in μm and in number of the cells (when a vessel interrupted the radial line, the number of cells was counted on the adjacent radial line), its cell dimensions (equivalent mean diameter) and its mean cell wall thicknesses (SL and GL). As mentioned in Fang et al. (2008), GL thickness is positively related to the cell diameter (the higher the fibre diameter, the thicker the GL) due to the reduced wall thickness near the end of the fibres, as shown by Okumura et al. (1977). Therefore, in order to make the progressive changes in the wall thickness comparable from fibre to fibre, thicknesses are presented as relative thicknesses by dividing them by the mean cell diameter.

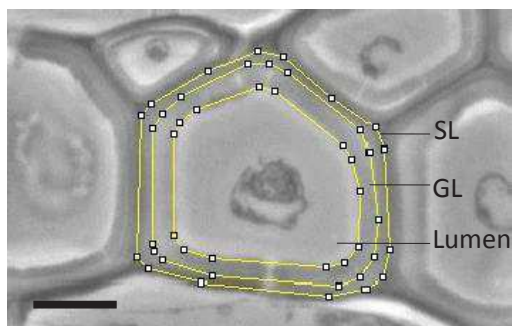

Figure 3.7 Detail of an optical image used for the measurement of cell walls parameters with ImageJ software. Scale bare = $5 \mu\text{m}$

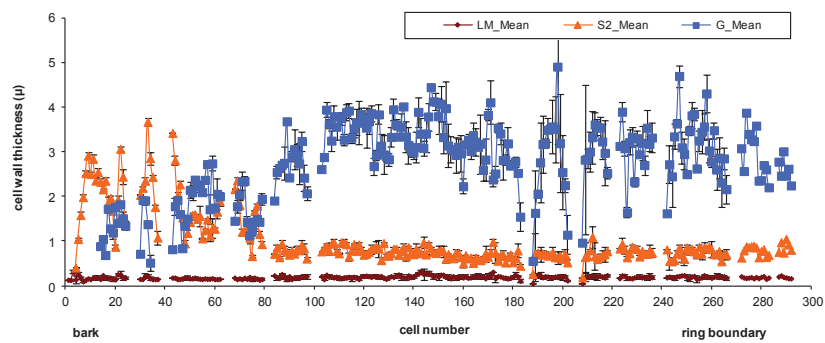

Figure 3.8. Constant middle lamella during growing season

3.1.5.Data analysis

Data were analyzed using EXCEL and SPSS soft ware.

3.2. Results

3.2.1. Preliminary study

Preliminary measurement of cell wall thickness performed on samples that were taken from six years old trees that were bent in 2011 in Iran. As mentioned before these trees were sampled weekly. Cell wall thickness measurement of these samples performed in 3 point (above, middle, bottom) of two adjacent cell walls. This measurement protocol allowed for the measurement of the thicknesses of middle lamella (ML), secondary wall (SL) and gelatinous layer (GL). Each thickness was calculated in 3 points and then averaged.

Preliminary results indicated that weekly sampling affected cell wall thickness change during growing season. Because of this sensitivity of the cell wall thickness, a new protocol was designed for cell wall thickness measurements. We took advantage of another experiment performed at INRA Orléans (described latter) using poplar sampled in greenhouse.

Despite difficulties encountered with this sampling, measurement of ML was one of the advantages of this method. Result showed that thickness of middle lamella does not change significantly during growing season.

Cell wall thickness change of TW, OW and NW cells during growing season is shown in Fig. 3.9.

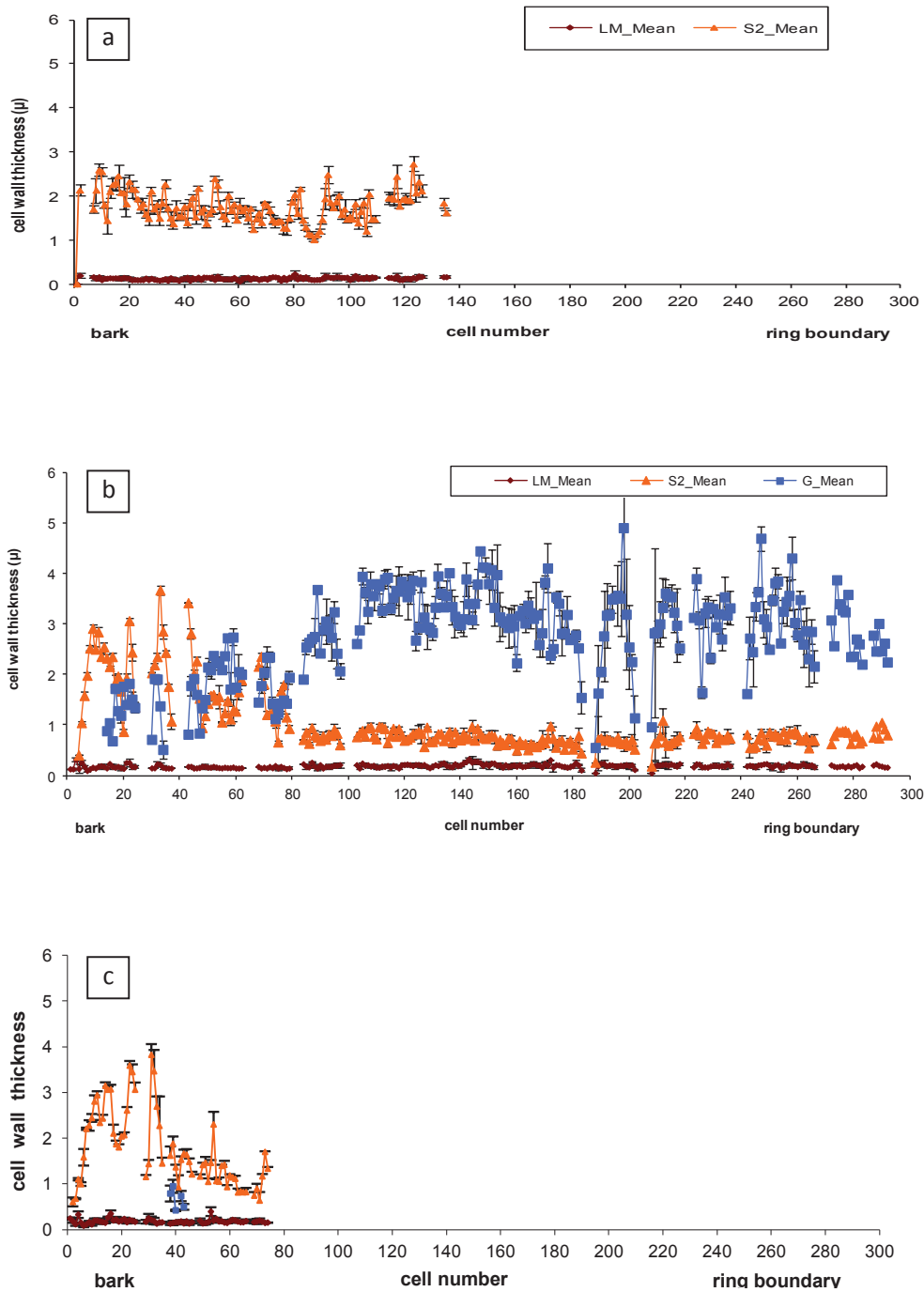

Figure 3.9 Cell walls thickness changes in (a) NW, (b) TW, (c) OW of white poplar during growing season. Sampling date: 28/Aug/2011. GL (blue square), SL (Orange triangle), ML (brown diamond).

Correlation between GL thickness and cell diameter indicate that there is a positive correlation between GL thickness and cell diameter. Therefore, relative cell wall thicknesses were calculated and its variation compared with real cell wall thickness (Fig. 3.10).

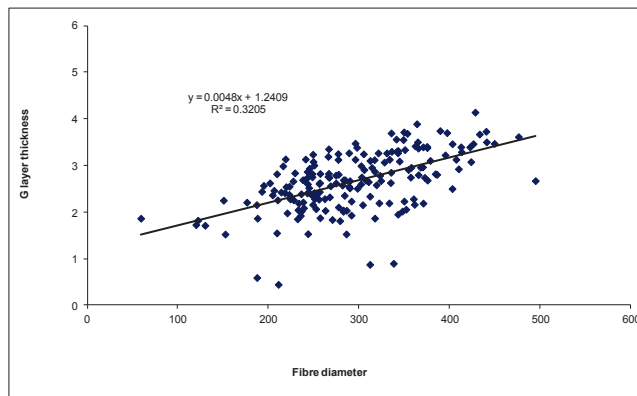

Figure 3.10 positive correlation between GL thickness and fibre diameter in pre-test sampling, GL (blue squares).

Careful observation of real cell wall thickness and relative cell wall thickness shows that there is some periodic reduction in G-layer thickness (Fig. 3.11) that could be the effect of micro coring in tree and because of this we decided to change the sampling. A new measurement protocol was also designed to increase the accuracy of the measurement.

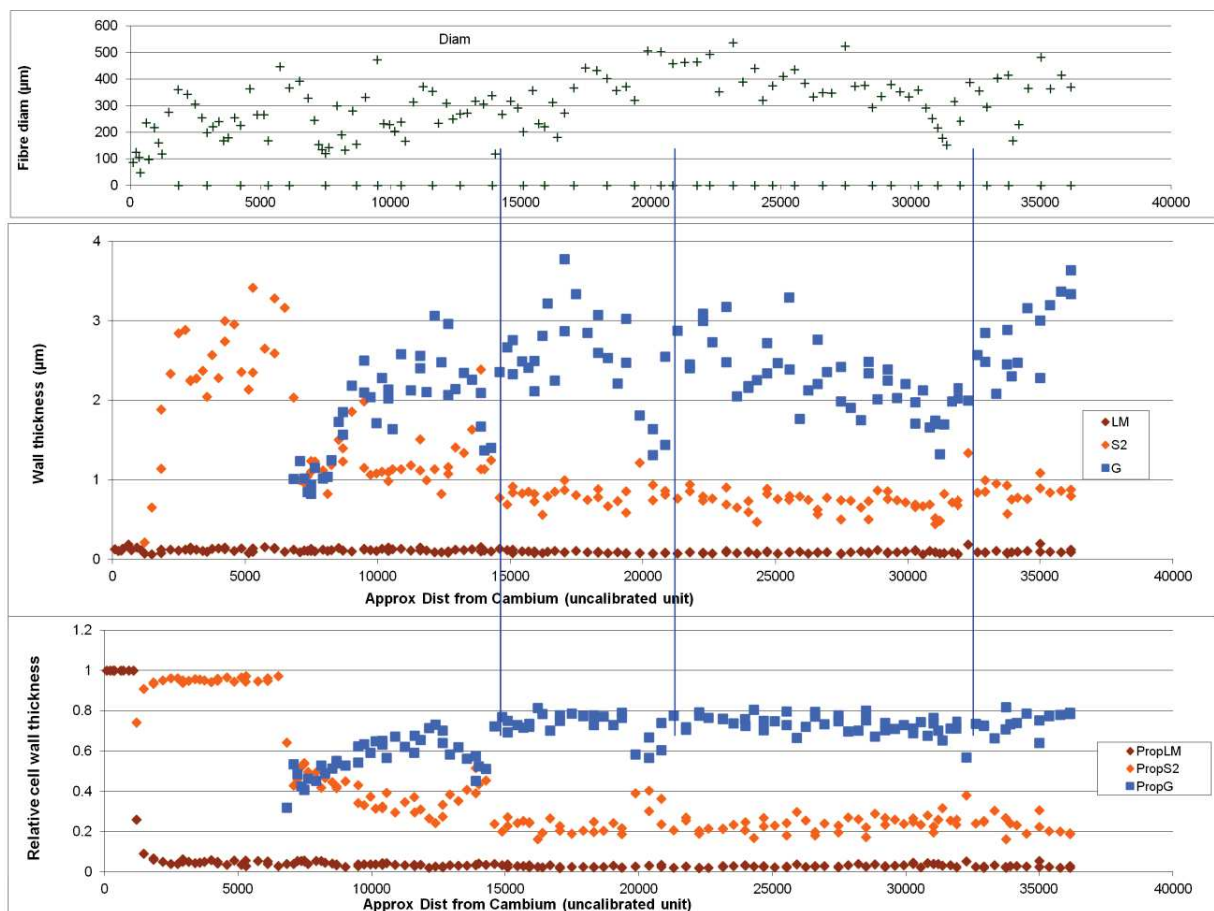

Figure 3.11 (a) changes of cell diameter with distance from cambium, (b) change cell wall thickness and distance from cambium, (c) relative cell wall thickness and distance from cambium. Fiber diameter (plus), GL (blue square), SL (Orange diamond), ML (brown diamond).

3.2.2. Cell wall thickening in developing tension wood²

Results of sampling of 2 years old polar sapling are presented in this part. On each sample, the three radial lines measured were very similar to each other, only disturbed by the presence of vessels. Therefore, for the sake of clarity, only one radial line is presented in our graphs, for a given sample.

3.2.3. Stimulus duration before GL formation

After tilting, trees immediately receive signal of mechanical stress. But it takes time to reaction features become observable. The presence of fibres with a GL (G-fibre) was not detectable one day after tilting. 3 days after tilting, GL was observable only in 1 tree among the 3 sampled trees. One week after tilting, all trees exhibit a GL in almost all of the tension wood fibres. Figure 3.12 shows the thickening of GL and SL in three samples sampled at 7, 14 and 25 days after tilting. With increase of tilting duration, fibre wall thickness, increase by large increase of GL more than compensating the decrease in SL.

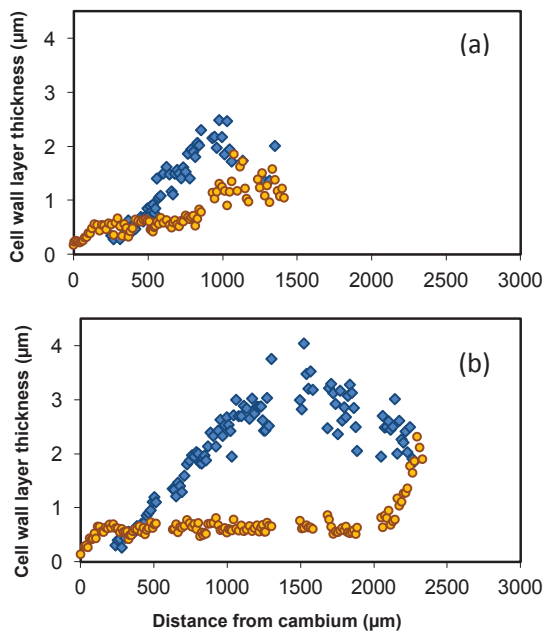

² a paper presenting part of these results has been accepted for publication in IAWA Journal: Abedini, Clair, Pourtamassi, Laurans, Arnould (in press 2015) Cell wall thickening in developing tension wood of artificially bent poplar trees.

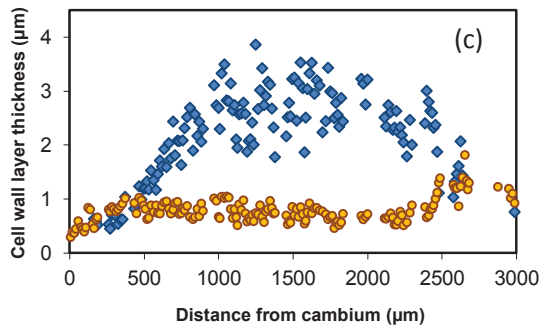

Figure 3.12 Developmental trend of GL and SL thickness during (a) 7, (b) 14 and (c) 25 days after tilting. GL (blue square), SL (yellow circle).

3.2.4. Cell diameter variation during tension wood formation

There was not clear correlation between cell diameter and distance from cambium. Statistical results showed that most of significant correlations were positive. This positive correlation indicates that fibre diameter increases with increase distance from cambial zone to ring boundary. Thus, median of fiber diameter showed slight decrease with increasing tilting duration (Fig.3.13). This is also associated to the increase number of G-fibers.

Statistical analysis of relationship between GL thickness and cell diameter confirmed that GL thickness depends on diameter ($r: 0.28 P<0.005$ to $r:0.8 P<0.001$), because of this result we used relative thickness instead of thickness. Correlation between SL thickness and diameter was also positive ($r: 0.32$ to $r: 0.72 P<0.001$).

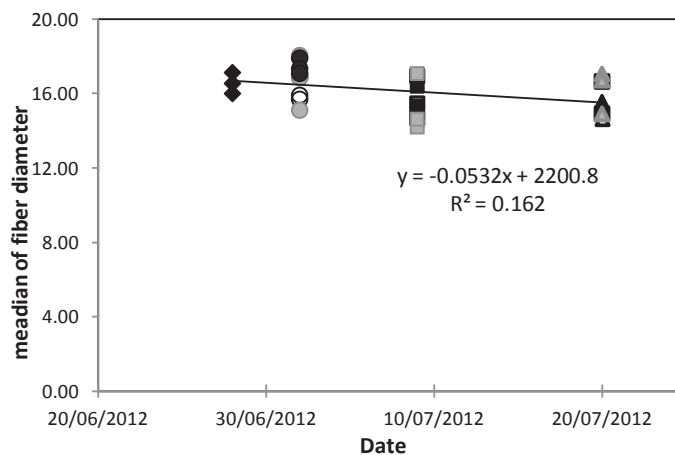

Figure 3.13 Change of median of fiber diameter during time. (Different shapes represent different date and different shades represent different trees).

3.2.5. Identifying the tilting date in sections

To better understand the cell wall thickness changes in response to the gravitropic stimulus, it is necessary to identify which cells were produced before and after tilting. This date is clearly identifiable thanks to the appearance of the GL at the tilting date followed by a strong decrease in SL thickness. In the transition zone, SL is first as thick as before tilting but with a thin GL (Fig. 3.14d); then SL thickness gradually decreases. Whereas SL has a thickness of around 1.56 μm before the tilting date (average of all samples), it is reduced to around 0.6 μm when the GL thickness remains stable. One can consider that the gradual change in SL thickness is due to the sudden change in the signal that modified the function of the cell, stopping the development of the SL to start the deposition of a GL. Therefore, cells with SL of intermediate thickness correspond to cells that already differentiated but were not mature at the tilting date, whereas cells with a thinner SL and a thick GL were differentiated after the tilting date.

3.2.6. Growth rate

Growth rate which is consider as ratio of cell production per time can help to found how cell production speed change during different time after bending the trees. This value is obtained by counting the number of cells and the distance from the tilting position to the cambium. Growth rates are given in Table 3.2. The number of cells formed per day slightly increased after 7 days to 14 days after tilting, and then decreased strongly during the last period.

Table 3.2 Radial growth rates, expressed as the number of cells formed after tilting, and as the mean distance of the cell produced during tilting to the cambium. Each value is an average of three radial lines measured for each tree. Gray background corresponds to the average of the three trees sampled at a given date. * indicates that the growth rate was estimated according to the previous period.

Period of growth	Tree	Mean number of cells per day	Mean distance per day (μm)
0-7	T7-1	9.4	119
	T7-2	8	107
	T7-3	6.6	95
	Mean T7	8	107
0-14	T14-1	9.6	126
	T14-2	9.9	124
	T14-3	9.2	128
	Mean T14	9.5	126
0-25	T25-1	7.7	100
	T25-2	6	89
	T25-3	7	100
	Mean T25	6.9	96
7-14*		11	145
14-25*		3.5	58

3.2.7. SL thickness before tilting

After longitudinal and radial expansion, cells undergo wall thickening phase. In this stage measurement of increasing thickness of SL was possible thanks to high contrast image of phase contrast microscope and ImageJ soft-ware. Thickness of SL from ring boundary to tilting position considered as SL thickness before tilting. Table 3.3 summaries the mean values and the significance of relationships between changes in thickness and distance to the cambium for each measured sample. The average thickness of SL before tilting (Fig. 3.14 stage e) was measured on all the trees sampled at T7, T14 and T25 with a mean value of 1.56 μm (standard deviation (SD): 0.13) and a mean relative thickness of 0.097 (SD: 0.004). However, this thickness is not constant as it increases from ring boundary to tilt position (Fig. 3.14 stage e). This increase was statistically significant in 7 samples out of 9 (Table 3.3). In the two samples where the correlation was not significant, some GL are observed before tilting (as in Fig. 3.14 stage e). The presence of GL can largely affect the SL thickness and explain the disturbed relationship. The presence of GL in upright trees is commonly observed and can be considered as a normal behaviour considering the need for the tree to stay up-right. Some other trees presented a thin GL before tilting, which weakly affected the present relationship (Fig. 3.14).

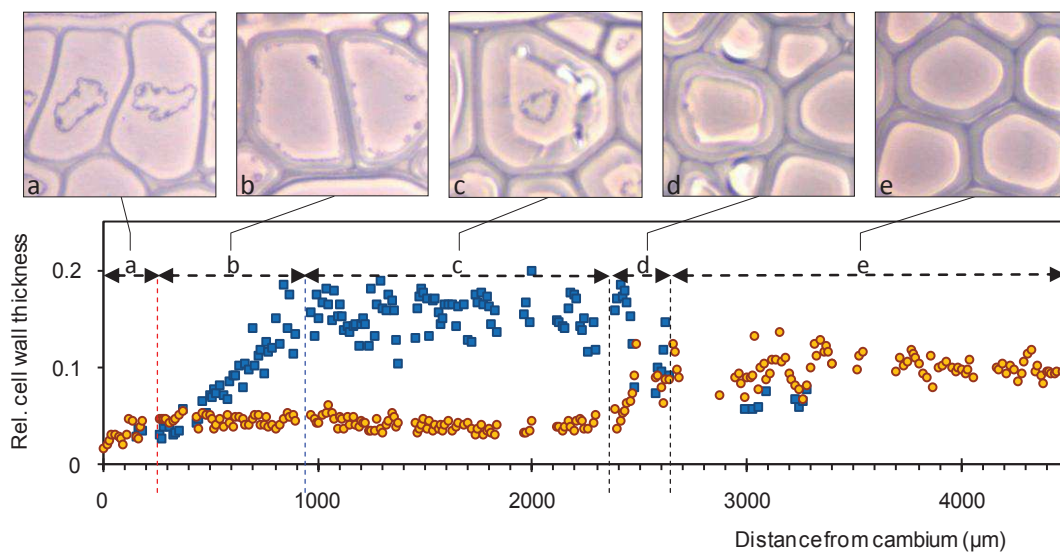

Figure 3.14 GL and SL relative thickness change from the cambium to the ring boundary in a tree sampled 25 days after tilting. a: SL thickening, b: GL thickening, c: GL constant thickness, d: tilting, e: before tilting. Blue squares: GL, orange circles: SL. Dotted line: left (red): end of SL thickening, center (blue): end of G thickening, right (black): tilting date.

Table 3.3 Mean value of the measured thickness and statistical analysis of the change in thickness versus distance to the cambium (DC) in the different stages presented on Fig. 3.13. r: correlation coefficients calculated of the relative thickness vs. distance from cambium. SLTh and GLTh: respectively SL and GL thickness (in μm). Slopes were measured using the “real” thickness to illustrate the thickening in $\mu\text{m}/\text{mm}$. Grey background indicates that measurements were not performed as it was meaningless to measure a mature GLTh when it cannot be certified that GL reached its final thickness. Seven days after tilting, SLTh after tilting (stage b+c) was too small to compute the correlation between SL thickness and distance to the cambium.

Tree number	SL thickening vs DC ($\mu\text{m}/\text{mm}$) (stage a)	GL thickening vs DC ($\mu\text{m}/\text{mm}$) (stage b)	Mean SLTh after tilting (stage b+c)	SLTh after tilting vs DC: r / p value (stage b+c)	Mean mature GLTh (stage c)	Mature GLTh vs DC: r / p value (stage c)	Mean SLTh before tilting (stage e)	SLTh before tilting vs DC: r / p value (stage e)
T7-1	1.92	3.28	0.63				1.19	-0.59 / <0.001
T7-2	1.69	3.12	0.58				1.31	0.16 / 0.402
T7-3	1.53	3.22	0.62				1.78	-0.73 / <0.001
T14-1	2.13	3.13	0.56	-0.57 / <0.001	2.44	0.29/0.070	1.69	-0.57 / <0.001
T14-2	2.56	3.10	0.61	-0.60 / <0.001	2.68	0.24/0.084	1.60	-0.06 / 0.725
T14-3	1.99	2.81	0.60	-0.68 / <0.001	2.58	0.01/0.901	1.79	-0.36 / 0.004
T25-1	3.10	2.12	0.52	-0.49 / <0.001	2.35	0.08/0.449	1.52	-0.75 / <0.001
T25-2	2.23	2.36	0.62	-0.67 / <0.001	2.26	0.13/0.283	1.44	-0.77 / <0.001
T25-3	2.97	3.11	0.69	-0.51 / <0.001	2.66	0.13/0.223	1.72	-0.78 / <0.001

3.2.8. Change in SL thickness after tilting

Sudden reduction in SL thickness is the key sign of tilting which happened after rather constant (or slightly increasing) thickness of cells before tilting. After the tilting date, SL again has a rather constant thickness in mature wood (i.e., except in the differentiating zone near the cambium), around 2.6 times thinner than before tilting. A careful investigation of SL thickness in this stable zone shows however that SL thickness slightly increases (Fig. 3.15) when the distance to the cambium decreases with a significant negative correlation between SL thickness and distance from cambium (Table 3.3). This negative correlation is significant in trees sampled at T14 and T25. In trees sampled after 7 days, the relationship is meaningless as the stable zone is too short.

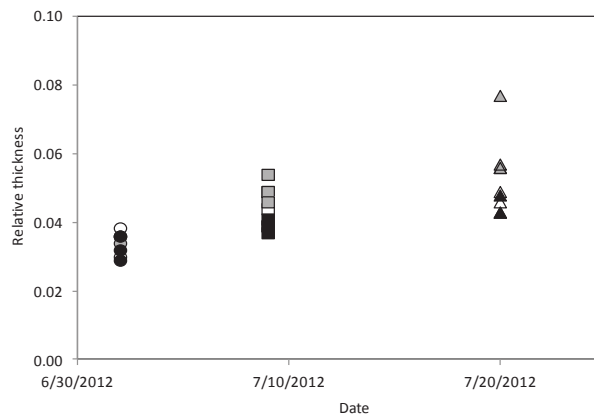

Figure 3.15 SL thickness of mature fibres in stable zone near cambium (different shapes represent different date and different shades represent different trees).

3.2.9. Kinetics of GL deposition vs. SL thickening

In most of the recorded radial lines, GL thickening occurs synchronously or soon after completion of the SL thickening (Fig 3.16). Three radial lines (out of the 27 measured ones) presented a peculiar behaviour as the GL deposition started slightly before the end of SL thickening, so that SL and GL thickness continue to increase simultaneously (Fig. 3.16). The late increase in the thickness of SL is only observed after a long time of tilting (T25). Moreover, it has to be noticed that the GL is generally not observable or measurable in its early stage of deposition, as attested by the absence of measured thickness between 0 and 0.3 μm (Fig. 3.17). This induces an over-estimation of SL in this portion as attested by the steep decrease in SL thickness at the position where the first GL is detected in Fig. 3.16 where an empirical correction is proposed. It can therefore be supposed that GL deposition starts slightly earlier than what is recorded in some other samples and therefore this behaviour could be more common than the few cases observed.

After the end of its thickening, final GL thickness was found to be 2.5 μm (SD: 0.17) on average. This value takes into account only radial lines from trees sampled at T14 and T25 as it is difficult to be sure that the GL thickening period was finished for trees sampled at T7 and before.

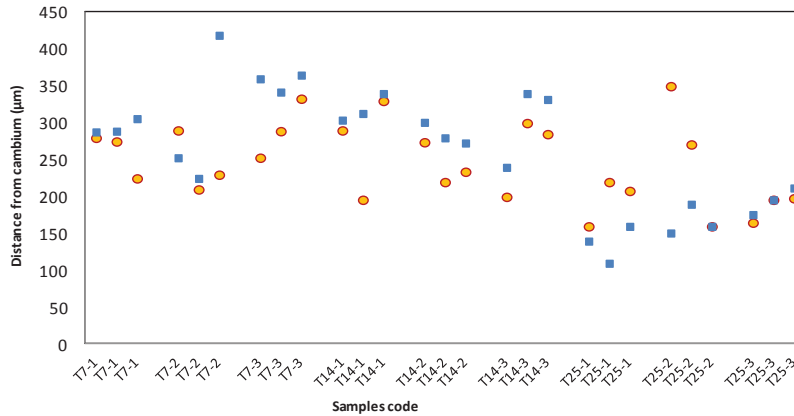

Figure 3.16 Distance from cambium of the end of SL thickening (yellow circle) and the start of GL thickening (blue square). GL thickening occurs after end of the SL thickening in most trees sampled up to 14 days after tilting. In trees sampled after 25 days, GL thickening often occurs before the end of SL thickening. .

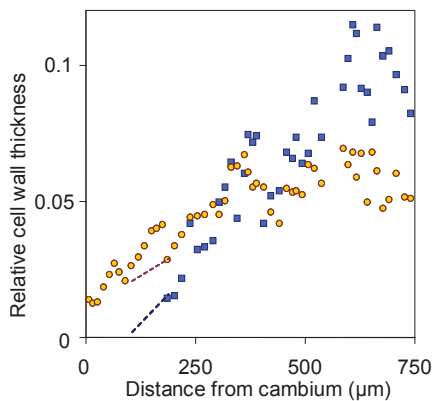

Fig. 3.17 detailed view of sample T25-1 where the GL (blue squares) deposition starts before the end of SL (orange circles) thickening. Lower dotted blue line is an empirical extrapolation to correct the lack of GL measurement when its thickness is too thin. This lack induces an over-estimation of SL in this portion as attested by the steep decrease in SL thickness at the position where the first GL is detected. The upper dotted line (orange) thus proposes a corrected trend of SL thickness in this area taking the linear extrapolation of the GL thickness into account.

The GL thickening period is considered to be the distance between the first occurrence of GL in young cells near the cambium to where they reached a constant thickness (stage b in Fig. 3.14). GL thickening period varies from 570 to 982 μm (Fig. 3.18), with, as a general trend, a longer period for trees sampled at T25 compared to trees sampled at T14 (Fig. 3.18 and 3.19). No general trend can be detected for the relationship between mean GL thickness (or relative thickness) and GL thickening period (Fig. 3.18).

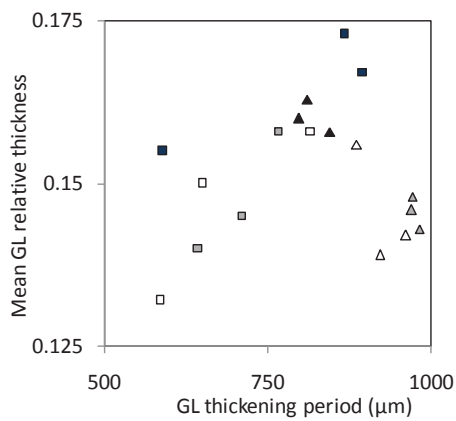

Fig. 3.18 relationship between the mean GL thickness (plotted as relative thickness) and the GL thickening period. Squares: T14, triangles: T25. Different shades represent different trees.

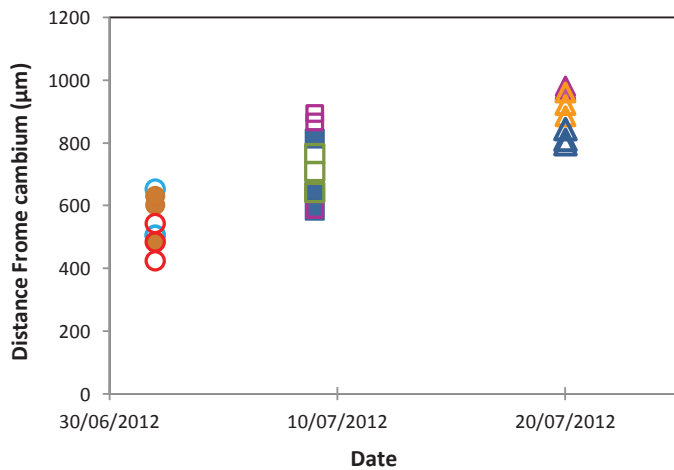

Figure 3.19 GL thickening period according to date. (different shapes represent different date and different colures represent different trees).

3.2.10. GL and SL growth rates

Table 3.3 gives the slope of the SL and GL thickening vs. the distance to cambium. This slope can be expressed as an increase in the wall thickness in μm by distance to the cambium in mm which can be considered as wall deposition speed. It gives an estimate of the growth rate at the cell wall level under the assumption of a constant cell growth rate. Although the validity of this assumption is uncertain, it is interesting to compare these stages of cell wall building in a single tree and even more in a single radial line of cells. In 8 of the 9 measured trees, the slope of the SL thickening was lower than the slope of GL thickening, whatever the growth rate in the considered period as presented in Table 3.3.

3.2.11. Cell wall thickening in opposite wood during tension wood formation

The marking of the tilting position in opposite wood (OW) side is much less clear than in tension wood (TW) as there is no GL development or steep decrease in SL. Moreover, TW and OW have different growth rates; it is therefore problematic to compare the cell wall thickening on both sides of the stem from their distance to the cambium, as cells are not produced at the same date. Therefore, tilting position was determined assuming a similar growth rate all around the stem before tilting. In order to compare cell wall thickness at the same date in TW and OW, the remaining cells produced after tilting (from the tilting position to the cambium) are then assumed to grow at different but proportional speed on both sides.

Before tilting, cell wall thickness of OW fibres shows a similar trend as observed in TW side (Fig. 3.20 stage e) as, at that time, trees were upright and no differences are expected on both sides. After tilting (stage b+c), the trend observed before tilting is disturbed in all trees. In several trees, an increase of the SL thickness is observed consecutively to the tilting. However, no general trend was observable from tree to tree.

In T25 samples, average SL thickness in OW after tilting (stage b+c) was $1.78 \mu\text{m}$ whereas it was $1.64 \mu\text{m}$ before tilting. This should be compared to the total cell wall thickness on the TW side, which measured $3.01 \mu\text{m}$ after the GL had been formed.

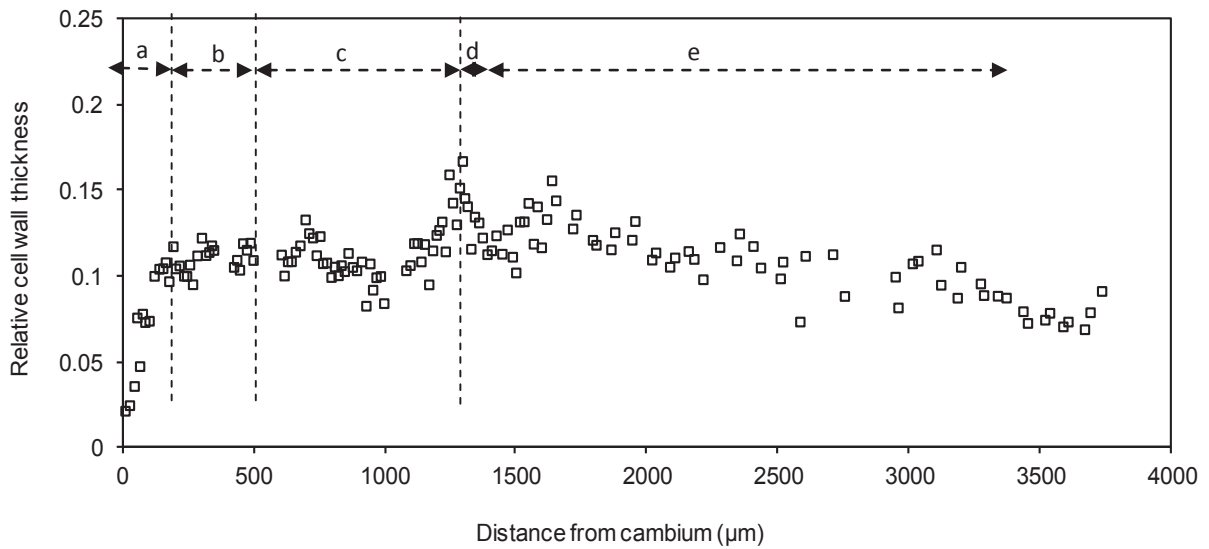

Figure 3.20 SL thickness variation in opposite wood (OW) of the sample T25-2 from the cambium to the ring boundary. The different stages of TW cell wall development as defined in Fig. 3.14 are indicated in the top of this figure to emphasise the change in OW due to tilting (at d).

3.2.12. Cell wall thickening at the end of growing season

Although G-layer thickness variation was clear during 25 days but observation of this process at the end of growing season was also interesting (Fig. 3.21). At the end of growing season thickness of SL increased and thickness of G-layer decreased compare to middle of growing season. This result indicates that at the end of growing season tree concentrate more on secondary cell wall thickening than G-layer thickening.

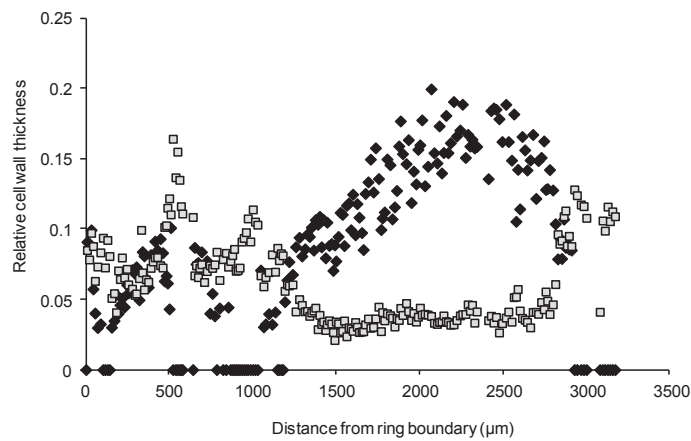

Figure 3.21 G-layer and SL thickness change at the end of growing season. GL relative thickness (Black diamonds), SL relative thickness (gray squares)

It seems that tension wood is preferentially observed in the earlywood of temperate species, but it can also be observed in latewood (Ruelle, 2014 mentioned by Jourez 1997a, b)). Jourez (1997) also remarked that although tension wood can be extend to the whole ring, there would never gelatinous fibers in a 5 to 6 last cell layers late wood.

3.2.13. Cell death

Differentiation into tracheary elements (TEs) is a typical example of programmed cell death in higher plants, and mature TEs are completed by the loss of cell contents including the nucleus, plastids, mitochondria, Golgi apparatus, and the endoplasmic reticulum, and by the partial digestion of the primary walls (Fukuda, 1996). The final stages of fibre cell death are accompanied by changes in turgor, as reflected by relaxation of the condensed nuclei, swelling of the remaining organelles, bursting of the vacuole, and mega-autolysis of the remaining cell contents. Cellular debris is often retained for a long time in the cell lumen, but ultimately the fibres are cleared completely (Courtois-Moreau et al., 2009).

In this study distance of dead cells from cambium measured to investigate cell life duration in G-fibers. Cell death distance from cambium considered as point that fibers cleared completely. It seems that life duration of the cells with G-layer is more than cells without G-layer at the same distance from cambium. Cells without G-layer lost their contents sooner. Some of the G-fibers were still alive after 14 days after tilting, even if they were far from cambium zone. While at the same distance from cambium cells without GL in adjacent line lost their cytoplasm and are completely clean. In Fig 3.22 young live cell with cytoplasm and nucleus, maturing cells and mature cell is observable.



Figure 3.22 Cells which were losing their cytoplasm by maturing. (a) young cells near cambium, (b) cells far from cambium, (c) dead cells.

However, our method is not sufficient to distinguish cell death just according to presence of cell debris, because some cells retain their debris even after death.

3.3. Discussion

3.3.1. Cell wall developing in TW

Cell wall developing process in TW is highly differed from NW and OW by deposition of thick GL. The present study allows us to reconstruct the general developmental pattern of fibre cell wall layers in tilted trees before and after tilting as presented in Fig. 3.23. Developing cells and mature cells are two main stages in this diagram. The developing fibres part contained young cells in which cell wall thickening is in progress with first the deposition of CML (not presented) followed by the formation of SL and GL.

Measurements of wood cell wall thickness before tilting show the progressive increase of SL during the growing season. An increase in cell wall thickness is commonly observed in softwoods (e.g., Mork 1928 in Denne 1988) and the change in wall thickness at the ring transition is also reported for hardwoods (IAWA Committee, 1989) but, we were unable to find reference reporting quantitative measurements of changes in fibre wall thickness during the growing season. It may be noticed that the seasonal SL thickness change in our poplar samples is very slight compared to what is observed in softwood, such as *Abies alba*, *Picea abies* or *Pinus sylvestris*, where a factor of more than 2.5 is observed for the tracheids wall thickness change during a season (Cuny et al. 2014).

Interestingly, this trend of increasing SL thickness remains true in tension wood with the presence of GL. This observation, always observed in our sampling, confirms some earlier unrecorded observations (Clair et al. 2011, Yoshinaga et al. 2012, Chang et al. 2014) and proves that this increase is not linked to the development of the GL but is a common trend throughout the growing season both in normal wood and tension wood in poplar trees.

The GL thickness remains nearly constant in mature wood. This stability may be attributed to the constant stimulus as the stem is attached to a pole. However, the secondary layer increases significantly during the growing season. This would indicate that, whatever the needs for up-righting, poplar trees cannot allocate all of their resources to the production of the GL and some trade-off is needed to ensure its sustainability all along the season.

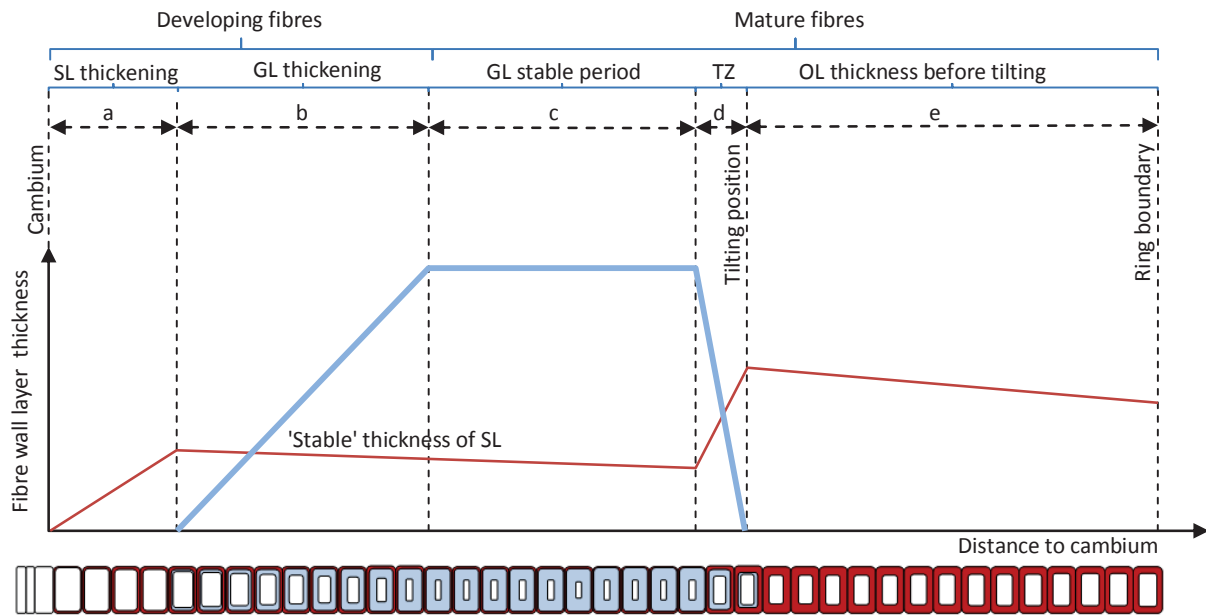

Figure 3.23 Schematic of the development pattern of fibre cell wall layers in a tilted tree producing GL. Thick line: GL, thin line: SL. -- TZ: transition zone is the zone where already differentiated fibres change in function and develop a GL later.

3.3.2. Transition zone at the tilting date

Around the tilting position different type of fibres are observable: 1- Fibres without GL in normal wood zone, considered to have already finished their maturation before tilting, in these cells the tilting has no effect on their cell wall thickness (Figs. 3.14, 3.23: e); 2- Fibres with decreasing SL thickness and increasing GL thickness in the transition zone (tilting), these cells already started their SL thickening before tilting then received the reaction signal and changed in function during their development, halting their SL formation in a rather thick state to start a GL at the end of the maturation (Fig. 3.14, 3.23: d). 3- Fibres that were in the cambial zone at tilting time, these cells have a thin SL and constantly thick GL (Fig. 3.14, 3.23: c). This interpretation of the timing of cell wall deposition assumes that a signal is received soon after the tilting. Jourez and Avella-Shaw (2003) have shown that a stimulus is perceived in poplar after only few hours, however modifications of the wood cell wall was more visible in opposite wood than in tension wood, thanks to a dedicated protocol using double tilting. A G-layer was observed in their study from 6 h to 48 h after tilting, depending on the trees. In our sampling, the reaction may have been slightly slower as GL was visible in one of the trees cut after 3 days and all of the trees sampled after 7 days of tilting.

Concerning the modification of the cell during maturation to adapt to the new mechanical needs of the plant, it is interesting to note that this behaviour is much more reactive in poplar than what was observed by Yoshizawa et al. (1985) in softwood. In their study on artificially tilted *Taxus*

cuspidata, they have shown that only small modifications in cell wall structure occur in tracheids that were already in the enlargement or thickening zones when the stimulus starts. We could therefore propose that this ability to transform fibres already formed is an efficient way to react to tilting and may allow poplar trees to be more efficient to react with tension wood formation than *T. cuspidata* with compression wood formation.

SL thickness decreased markedly from normal wood to tension wood confirming that in tension wood, GL replaces part of the S2 layers (Saiki and Ono 1971). Total thickness also increased compared to normal wood cells before tilting and opposite wood cells that were formed after tilting. This shows that the GL is thicker than the replaced layer that exist in normal fibres, as already observed by Fang et al. (2007).

3.3.3. Timing of GL versus SL deposition

In most of the samples, GL formation starts after SL reached its maximum thickness. It means that SL thickening was completed before GL formation. However, in some samples, especially 25 days after tilting, SL thickness seems to increase even after the start of GL formation. This would mean that the SL is able to continue thickening when GL deposition already started. The building of the GL before the end of SL thickening is surprising as layers are supposed to be deposited one after one. Considering the presupposed assumption of the study that several cells along a radial line are considered as a single cell during maturation one could suspect a misinterpretation. In order to verify it, let us consider a second interpretation: as soon as the GL starts to be observable, the SL may be supposed to have reached its final thickness. As we observed an increasing SL thickness after GL deposition, the pattern of thickening would indicate a decrease in SL thickness from ring to cambium. This pattern has never been observed in our samples; reversely the opposite pattern was statistically significant in all our samples. Moreover, at the end of the growing season, near the ring boundary, SL tends to be thicker with no more GL (3.21) as previously shown by Jourez and Avella-Shaw (2003). Thus, even if surprising, our observations indicate that in some samples, the SL continues its thickening after GL started to be deposited. This observation can be discussed in the light of what has been observed by Yoshinaga et al. (2012). These authors observed a continuation of the lignification of the SL after the start of the GL deposition. They suggest that monolignols may be transported through the developing GL during the lignification of the SL or propose an alternative hypothesis of an external synthesis in the rays. Our observation of an increase in SL thickness could be the result of the swelling of the wall during this lignification process.

3.3.4. GL thickening period

Our results indicate that GL thickening distance (i.e., the number of cells from the beginning of GL deposition to the end of GL thickening) is higher in trees sampled after 25 days than in trees sampled after 14 days (Fig. 3.18 & 3.19). This observation can be interpreted in two ways: the time to mature is longer or the cell production is faster (higher growth rate). According to the

computation of the number of cells produced after tilting and the distance of the tilting position to the cambium (Table 3.2), growth rate was more than 3 times higher during the period from 7 to 14 days than during the period from 14 to 25 days. It is therefore clear that this increase in GL thickening period refers to a longer maturation process. Tension wood is reported to have a longer maturation process than normal wood (Bollhöner et al., 2012). However, the reason for this great change in maturation time remains enigmatic. No relationship was observed between the time of thickening and the final GL thickness. This indicates that thickness is not directly linked to the time of maturation.

The slope of the GL or SL thickening vs. distance to the cambium can be interpreted as thickening speed of the layers and be expressed as $\mu\text{m}/\text{mm}$. This allows us to compare cell wall layer thickening under the assumption of a constant growth rate. It is therefore not possible to compare layers thickening at different dates or to compare TW to OW, but it remains reasonable to compare SL and GL thickening in a single TW sample. GL appears to grow faster than SL, i.e., 1.9 and 1.4 times faster in T7 and T14 respectively. At T25, around the same thickening speed was measured on average in the 3 trees in SL and GL because in one of the trees, the slope was lower for GL than for SL. This could be attributed to limited resources such as a decrease in light or temperature between T14 and T25 that affect cell division and growth rate for that tree in T25. Regarding the faster growth rate of GL compared to SL, it may be speculated that this would be a consequence of its lower carbon cost due to the lack of lignin (Pilate et al. 2004) and the high mesoporosity (Clair et al. 2008) in the GL. This would allow a faster production of thick GL, which has been recognized to be the driving force of the maturation stress generation (Fang et al. 2008, Clair et al. 2011). Following this idea, the lack of lignin in GL would be a strategy for a fast recovery when reaction is needed. It will be interesting in the future to test this hypothesis, especially comparing species producing TW with a GL to species where the GL is absent in TW.

Conclusions and future prospects

Wood formation is a dynamic process derived from the vascular cambium activity during a growing season. TW formation is the mechanical reaction of tree to reorient their stem axis to the vertical position by implying variations on cambial activity. The radial sequence of TW formation at tissue and cell wall level is presented here.

- This investigation indicates that an increase of the cambial activity in the TW side, along with the production of a higher number of cambial cells at the beginning of the growing season. On the other side, a lower cambial activity (i.e., lower number of cambial cells) leads to a narrower growth ring in OW side and thus eccentric pith position.
- Higher cell production and consequence stem eccentricity in TW side comes from higher cambial activity and longer growth period in TW side.
- In spite of a higher cell production in tension wood side, average global growth of bent and upright trees was similar, which results from a lower cell production in the OW side. In conclusion, we claim that, although wood production in TW was more than NW and OW, the sum of wood production in bent and upright trees was the same. Just the distribution of cell production is changed.
- In all bent and upright trees, May was an important month as the number of cambium cells, enlarging cells and wall thickening cells was at their maximum. OW start its lignification latter than TW and NW. Cessation of cambium activity occurred during the end of July to mid August in all trees. Maturation process for first derivatives of cambium cells last near 2 month or less.
- TW needs a longer time to develop the majority of the xylem growth ring than NW and OW. It means TW growth ring develops longer than NW and OW.
- Except the GL formation in TW side, cell differentiation pattern was not different between TW, NW and OW, while the presence of GL had a significant effect on wall thickening pattern in TW cells at cell wall level. SL thickness decreased markedly from NW to TW confirming that in TW, GL replaces part of the SL layers. Total thickness in TW also increased compared to NW cells before tilting and OW cells that were formed after tilting. This shows that the GL is thicker than the replaced layer that exists in normal fibres.
- During the wall thickening phase, the originally thin cell walls started to thicken. This process was observed carefully in both tissue and at the cell wall level in bent trees. Synthesis of multi-layered secondary cell wall started in third week of April and those cells undergo lignification less than two weeks later. Vessels were the first cells that shine under polarized light (i.e., linked to cellulose deposition) and whose wall thickens. Then wall thickening spread in other fiber cells. At the cell wall level, increase cell wall thickness of SL in a zone near cambium, before deposition of GL observed at this phase.

- In seven year olds field grown poplar trees, GL was observed less than 2 weeks after onset of growing season and after the beginning of the lignification phase in SL. In poplar saplings, which were tilted in the middle of the growing season, GL was visible in one of the trees cut after 3 days and in all of the trees sampled after 7 days of tilting. GL formation starts after SL reached its maximum thickness. It means that SL thickening was completed before GL formation. However, in some samples, especially 25 days after tilting, SL thickness seems to increase even after the start of GL formation.
- Wall thickening measurements showed that GL appears to grow faster than SL. We speculated that this would be a consequence of its lower carbon cost due to the lack of lignin and the high mesoporosity in the GL.

Perspectives:

- The precise observation of TW formation sequences will require the sampling of thicker natural bent trees, with a higher time resolution especially at the beginning of the growing season, and the use of more effective staining and microscopy methods to distinguish cessation of the lignification phase especially in TW cells, and also to follow cells death process in TW.
- Using novel statistical approaches such as parametric generalized linear models (GLMs) and ‘data-driven’ generalized additive models (GAMs) instead of Gompertz function to describe seasonal changes in cell numbers in each of the xylem differentiation phases and to calculate the timing of cell development is suggested.
- Investigation of more precise embedding and sectioning methods is necessary to observe SL thickness change during early stage of GL formation.
- It will be interesting in the future to test the origin of the faster growth rate of GL compared to SL, especially comparing species producing TW with GL to species without GL.

REFERENCES

- Abdul Khalil HPS, Ireana Yusra AF, Bhat AH, Jawaid M, (2010)** Cell wall ultrastructure, anatomy, lignin distribution, and chemical composition of Malaysian cultivated kenaf fiber. *Industrial Crops and Products* 31: 113-121
- Alméras T, Fournier M (2009)** Biomechanical design and long-term stability of trees: morphological and wood traits involved in the balance between weight increase and the gravitropic reaction. *Journal of Theoretical Biology* 256: 370-381
- Archer R (1986)** Growth stresses and strains in trees. Timell E (ed.) Springer-Verlag, Berlin, Heidelberg, New York, 240 pp.
- Andersson-Gunneräs S, Mellerowicz EJ, Love J, Segerman B, Ohmiya Y, Coutinho PM, Nilsson P, Henrissat B, Moritz Th & Sundberg B (2006)** Biosynthesis of cellulose-enriched tension wood in *Populus*: global analysis of transcripts and metabolites identifies biochemical and developmental regulators in secondary wall biosynthesis. *The Plant Journal* 45: 144–165
- Barlow PW, Powers SJ (2005)** Predicting the environmental thresholds for cambial and secondary vascular tissue development in stems of hybrid aspen. *Annals of Forest Science* 62: 565–573
- Begum S, Nakaba S, Oribe Y, Kubo T, Funada R (2007)** Induction of cambial reactivation by localized heating in a deciduous hardwood hybrid poplar (*Populus sieboldii* x *P. grandidentata*). *Annals of Botany* 100: 439-447
- Begum S, Nakaba S, Bayramzadeh V, Oribe Y, Kubo T, Funada R (2008)** Temperature responses of cambial reactivation and xylem differentiation in hybrid poplar (*Populus sieboldii* × *P. grandidentata*) under natural conditions. *Tree Physiology* 28: 1813–1819
- Begum S, Nakaba S, Oribe Y, Kubo T, Funada R (2010)** Cambial sensitivity to rising temperatures by natural condition and artificial heating from late winter to early spring in the evergreen conifer *Cryptomeria japonica*. *Trees* 24: 43–52
- Berger RD (1980)** Compression of the Gompertz and logistic equations to describe plant disease progress. *Phytopathology* 71:716-719
- Bollhöner B, Prestele J, Tuominen H (2012)** Xylem cell death: emerging understanding of regulation and Function. *Journal of Experimental Botany* 63: 1081–1094
- Boyd JD (1972)** Tree growth stress V: Evidence of an origin in differentiation and lignification. *Wood science and Technology*. 6: 251-262.
- Chang SS, Clair B, Ruelle J, Beauchêne J, Di Renzo F, Quignard F, Zhao GJ, Yamamoto H, Gril J (2009b)** Mesoporosity as a new parameter for understanding tension stress generation in trees. *Journal of Experimental Botany* 60: 3023-3030
- Chang SS, Quignard F, Di Renzo F, & Clair B (2012)** Solvent polarity and internal stresses control the swelling behavior of green wood during dehydration in organic solution. *BioResources* 7: 2418-2430.
- Chang SS, Salmén L, Olsson AM & Clair B (2014)** Deposition and organisation of cell wall polymers during maturation of poplar tension wood by FTIR microspectroscopy. *Planta*, 239: 243-254
- Clair B, Ruelle J, Thibaut B (2003)** Relationship between growth stress, mechanical–physical properties, and proportion of fibre with gelatinous layer in chestnut (*Castanea sativa* Mill.). *Holzforschung* 57:189–195
- Clair B, Gril J, Baba K, Thibaut B & Sugiyama J (2005)** Precautions for the structural analysis of the gelatinous layer in tension wood. *IAWA Journal*,26: 189-195
- Clair B, Alméras T, Yamamoto H, Okuyama T, Sugiyama J (2006a)** Mechanical behavior of cellulose microfibrils in tension wood, in relation with maturation stress generaton. *Biophysical Journal* 91:1128-1135
- Clair B, Ruelle J, Beauchêne J, Prévost MF & Fournier Djimbi M (2006b)** Tension wood and opposite wood in 21 tropical rain forest species. 1. Occurrence and efficiency of the G-layer. *IAWA Journal* 27: 329-338

- Clair B, Gril J, Di Renzo F, Yamamoto H & Quignard F (2008)** Characterization of a gel in the cell wall to elucidate the paradoxical shrinkage of tension wood. *Biomacromolecules*, 9: 494-498
- Clair B, Alméras T, Pilate G, Jullien D, Sugiyama J & Riekel C (2011)** Maturation stress generation in poplar tension wood studied by synchrotron radiation microdiffraction. *Plant Physiology*, 155: 562-570
- Coutand C, Loup C, Chanson B, Jeronimdis G (2004)** Comparison of mechanical properties of tension and opposite wood in populus. *Wood Science and Technology* 38: 11-24
- Coutand C, Fournier M, and Bruno Moulia B (2007)** The Gravitropic Response of Poplar Trunks: Key Roles of Prestressed Wood Regulation and the Relative Kinetics of Cambial Growth versus Wood Maturation. *Plant Physiology* 144: 1166–1180
- Côté WA, Day AC & Timell TE (1969)** A contribution to the ultrastructure of tension wood fibers. *Wood Science and Technology*, 3: 257–271
- Čufar K, Prislan P, de Luis M, Gričar J (2008a)** Tree-ring variation, wood formation and phenology of beech (*Fagus sylvatica*) from a representative site in Slovenia, SE Central Europe. *Trees* 22, 749–758
- Čufar K, Prislan P, Gričar J (2008b)** Cambial activity and wood formation in beech (*Fagus sylvatica*) during the 2006 growth season. *Wood Research* 53: 1–12
- Cuny HE, Rathgeber CB, Kiessé TS, Hartmann FP, Barbeito L, Fournier M (2013)** Generalized additive models reveal the intrinsic complexity of wood formation dynamics. *Experimental Botany* 64, 1983–1994
- Cuny HE, Rathgeber CB, Frank D, Fonti P, Fournier M (2014)** Kinetics of tracheid development explain conifer tree-ring structure. *New Phytologist* 203: 1231-41
- Dadswell HE & Wardrop AB (1955)** The structure and properties of tension wood. *Holzforschung* 9: 98–104
- Denne MP (1988)** Definition of latewood according to Mork (1928). *IAWA Bulletin n.s.*, 10: 59-62
- Déjardin A, Laurans F, Arnaud D, Breton C, Pilate G, Leplé JC (2010)** Wood formation in angiosperms. *Comptes Rendus Biologies* 333: 325-334
- De Luis M, Gričar J, Čufar, K, Raventós J, (2007)** Seasonal dynamics of wood formation in *Pinus halepensis* from dry and semi-arid ecosystems in Spain. *IAWA Journal* 28(4), 389- 404
- Deslauriers A, Rossi S, Anfodillo T, Saracino A, (2008)** Cambial phenology, wood formation and temperature thresholds in two contrasting years at high altitude in southern Italy. *Tree Physiology* 28, 863-871
- Donaldson LA (2001)** Lignification and lignin topochemistry-an ultrastructural view. *Phytochemistry* 57: 859-873
- Du S, Yamamoto F (2003)** Ethylene evolution changes in the stems of *Metasequoia glyptostroboides* and *Aesculus turbinata* seedlings in relation to gravity-induced reaction wood formation. *Trees* 17: 522– 528
- Dünisch O, Rühmann O (2006)** Kinetics of cell formation and growth stresses in the secondary xylem of *Swietenia mahagoni* (L.) Jacq. and *Khaya ivorensis* A. Chev. (Meliaceae). *Wood Science and Technology* 40: 49-62
- Dyckmans J, Flessa H, Brinkmann K, Mai C and Polle A (2002)** Carbon and nitrogen dynamics in acid detergent fiber lignins of beech (*Fagus sylvatica* L.) during the growth phase. *Plant Cell Environ.* 25:469–478
- Eriksson ME, Israelsson M, Olsson O and Moritz T (2000)** Increased gibberellin biosynthesis in transgenic trees promotes growth, biomass production and xylem fiber length. *Nature Biotechnol.* 18: 784–788.
- Fang CH, Clair B, Gril J & Alméras T (2007)** Transverse shrinkage in G-fibers as a function of cell wall layering and growth strain. *Wood Science and Technology* 41: 659-671
- Fang CH, Clair B, Gril J & Liu Sh (2008)** Growth stresses are highly controlled by the amount of G-layer in Poplar tension wood. *IAWA Journal* 29: 237–246
- Forster T, Schweingruber FH and Denneler B (2000)** Increment puncher—a tool for extracting small cores of wood and bark from living trees. *IAWA J.* 21:169–180
- Funada R, Miura T, Shimizu Y, Kinase T, Nakaba S, Kubo T, Sano Y (2008)** Gibberellin-induced formation of tension wood in angiosperm trees, *Planta* 227:1409–1414

- Fournier M, Alméras T, Clair B, Gril J (2014)** Biomechanical action and biological functions. In: Gardiner B, Barnett J, Saranpää P & Gril J. eds. *The biology of reaction wood*, Springer Series in Wood Science, Berlin Heidelberg: 139-170
- Fujita M, Saiki H & Harada H (1974)** Electron microscopy of microtubules and cellulose microfibrils in secondary wall formation of poplar tension wood fibers. *Mokuzai Gakkaishi* 20: 147-156
- Gindl W, Grabner M, Wimmer R (2000)** The influence of temperature on latewood lignin content in treeline Norway spruce compared with maximum density and ring width. *Trees* 14: 409–414
- Gričar J, Čufar K, (2008)** Seasonal dynamics of phloem and xylem formation in silver fir and Norway spruce as affected by drought. *Russian Journal of Plant Physiology* 55: 538-543
- Gričar J, Čufar K, Oven P, Schmitt U (2005)** Differentiation of terminal latewood tracheids in silver fir during autumn. *Annals of Botany* 95: 959-965
- Giovannelli A, Deslauriers A, Fragnelli G, Scaletti L, Castro G, Rossi S, and Crivellaro A (2007)** Evaluation of drought response of two poplar clones (*Populus canadensis* Mönch ‘I-214’ and *P. deltoides* Marsh. ‘Dvina’) through high resolution analysis of stem growth, *Journal of Experimental Botany* 58: 2673–2683
- Grünwald C, Ruel K, Schmitt U (2002)** Differentiation of xylem cells in. rolC transgenic aspen trees – A study of secondary cell wall development. *Annals of Forest Science* 59: 679-685
- Hellgren JM, Olofsson K, Sundberg B (2004)** Patterns of auxin distribution during gravitational induction of reaction wood in poplar and pine. *Plant Physiology* 135: 212–220
- Horacek P, Šlezingerova J, Lezingerova L, Gandelova (2003)** Analysis of cambial activity and formation of wood in *Quercus robur* L. under conditions of a floodplain forest. *Journal of forest science* 49: 412–418
- IAWA Committee (1989)** IAWA list of microscopic features for hardwood identification. Wheeler, EA, Baas, P & Gasson, PE Eds). *IAWA Journal* n.s. 10: 219-332
- Joseleau JP, Imai T, Kuroda K, Ruel K (2004)** Detection in situ and characterization of lignin in the G-layer of tension wood fibres of *Populus deltoides*. *Planta* 219: 338-345
- Jourez B, Riboux A & Leclercq A (2001)** Anatomical characteristics of tension wood and opposite wood in young inclined stems of poplar (*Populus euramericana* cv ‘Ghoy’). *IAWA Journal* 22: 133-157
- Jourez B & Avella-Shaw T (2003)** Effet de la durée d’application d’un stimulus gravitationnel sur la formation de bois de tension et de bois opposé dans de jeunes pousses de peuplier (*Populus euramericana* cv ‘Ghoy’). *Annals of Forest Science* 60: 31-41
- Jukić D, Kralik G, Rudolf Scitovski R (2004)** Least-squares fitting Gompertz curve. *Journal of Computational and Applied Mathematics* 169: 359–375
- Li X, Liang E, Gričar J, Prislan P, Rossi S, Čufar K (2013)** Age dependence of xylogenesis and its climatic sensitivity in Smith fir on the south-eastern Tibetan Plateau. *Tree Physiology* 33: 48–56
- Little C H A, Savidge RA, (1987)** The role of plant growth regulators in forest tree cambial growth. *Plant Growth Regul.* 6: 137–169
- Marion L, Gričar J, Oven P (2007)** Wood formation in urban Norway maple trees studied by the micro-coring method. *Dendrochronologia* 25 (2): 97-102
- Matsuzaki J, Masumori M, & Tange T (2007)** Phototropic bending of non-elongating and radially growing woody stems results from asymmetrical xylem formation, *Plant, Cell and Environment* 30: 646–653
- Mellerowicz EJ, Baucher M, Sundberg B, Boerjan (2001)** W: Unraveling cell wall formation in the woody dicot stem. *Plant Molecular Biology* 47:239-274
- Mellerowicz E.J & Sundberg B (2008)** Wood cell walls: biosynthesis, developmental dynamics and their implications for wood properties, *Plant Biology*, 11:293–300
- Michelot A, Simard S, Rathgeber C, Dufrêne E, Claire D (2012)** Comparing the intra-annual wood formation of three European species (*Fagus sylvatica*, *Quercus petraea* and *Pinus sylvestris*) as related to leaf phenology and non-structural carbohydrate dynamics, *Tree Physiology* 32: 1033–1043
- Mikshina P, Chernova T, Chemiksova S, Ibragimova N, Mokshina N & Gorshkova T (2013)** Cellulosic Fibers: Role of Matrix Polysaccharides in Structure and Function, in: van de Ven T & Godbout L eds. *Cellulose - Fundamental Aspects*, InTech 91-112

- Nugroho WD, Yamagishi Y, Nakaba S, Fukuhara S, Begum S, Nugroho S, Marsoem, Ko JH, Jin HO, Funada R (2012)** Gibberellin is required for the formation of tension wood and stem gravitropism in *Acacia mangium* seedlings, *Annals of Botany* Page 1 of 9.
- Norberg PH & Meier H (1966)** Physical and chemical properties of the gelatinous layer in tension wood fibre of aspen (*Populus tremula* L.). *Holzforschung* 20: 174-178
- Koch G (2004)** Topochemical characterization of lignins and phenolic extractives in wood cell walls, *Lenzinger Berichte* 83: 6-12
- Kwon M (2008)** Tension wood as a model system to explore the carbon partitioning between lignin and cellulose biosynthesis in woody plants. *Journal of Applied Biological Chemistry* 51(3):83–87
- Oladi R, Pourtahmasi K, Eckstein D, Bräuning A (2010)** Seasonal wood formation of Iranian beech (*Fagus orientalis*) Along an Altitudinal Gradient. Phd thesis, University of Tehran, Karadj, Iran.
- Okumura S, Harada H & Saiki H (1977)** Thickness variation of the G-layer along a mature and a differentiating tension wood fiber in *Populus euramericana*. *Wood Science and Technology* 11: 23-32.
- Okuyama T (1993)** Growth stress in tree. *Journal of the Japan Wood Research Society* 39:747-756
- Okuyama T, Yamamoto H, Yoshida M, Hattori Y, Archer RR (1994)** Growth stresses in tension wood: role of microfibrils and lignification. *Annals of Science Forest* 51: 291-300
- Onaka F (1949)** Studies on compression and tension wood. *Wood research, Bulletin of the Wood research Institute, Kyoto University, Japan* 24(3): 1-88
- Pilate G, Chabbert B, Cathala B, Yoshinaga A, Leplé JC, Laurans F, Lapierre C, Ruel K (2004)** Lignification and tension wood. *Comptes rendus Biologies* 327: 889–901
- Pilate G, Déjardin A, Laurans F, Leplé JC (2004)** Tension wood as a model for functional genomics of wood formation, *New Phytologist*, 164: 63–72
- Plomion C, Leprovost G, Stokes A (2001)** Wood Formation in Trees. *Plant Physiology*, 127:1513–152
- Prodhan AKMA, Funada R, Ohtani J, Abe H & Fukazawa K (1995)** Orientation of microfibrils and microtubules in developing tension-wood fibres of Japanese ash (*Fraxinus mandshurica* var. japonica). *Planta*, 196: 577-585
- Prodhan AKMA, Ohtani J, Funada R, Abe H, Fukazawa K (1995)** Ultrastructural investigation of tension wood fiber in *Fraxinus-Mandshurica* Rupr. Var. *japonica Maxim*. *Annals of Botany* 75:311-317
- Rathgeber CBK, Longuetaud F, Mothe F, Cuny H, Le Moguédec G (2011a)** Phenology of wood formation: data processing, analysis and visualisation using R (package CAVIAR). *Dendrochronologia* 29:139–149
- Rossi S, Anfodillo T, Menardi R (2006a)** Trephor: a new tool for sampling microcores from tree stems. *IAWA Journal* 27, 89-97
- Rossi S, Deslauriers A, Anfodillo T (2006b)** Assessment of cambial activity and xylogenesis by microsampling tree species: an example at the Alpine timberline. *IAWA Journal* 27: 383-394
- Rossi S, Deslauriers A, Anfodillo T, Carrer M (2008)** Age-dependent xylogenesis in timberline conifers. *New Phytologist* 177: 199-208
- Ruelle J, Clair B, Beauchene J, Prévost MF, Fournier M (2006)** Tension wood and opposite wood in 21 tropical rain forest species. 2. Comparison of some anatomical and ultrastructural criteria. *IAWA Journal* 27: 341-376
- Ruelle J, Yamamoto H, Thibaut B (2007 a)** Growth stresses and cellulose structural parameters in tension and normal wood from three tropical rainforest angiosperms species. *BioResources* 2: 235-251
- Ruelle J (2014)** Morphology, Anatomy and ultrastructure of reaction wood. In: Gardiner B, Barnett J, Saranpää P & Gril J. (eds). *The biology of reaction wood*, Springer, Berlin Heidelberg: 13-35
- Saiki H & Ono K (1971)** Cell wall organization of gelatinous fibers in tension wood. *Bull. Kyoto University Forest* 42: 210–220
- Schmitt U, Jalkanen R, Eckstein D (2004)** Cambium dynamics of *Pinus sylvestris* and *Betula* spp. in the northern boreal forest in Finland. *Silva Fennica* 38 (2): 167-178
- Samuels AL, Kaneda M, Rensing KH (2006)** The cell biology of wood formation: from cambial division to mature xylem. *Canadian Journal of Botany* 84: 631-639

- Schmitt U, Grünwald C, Gričar J, Koch G, Čufar K (2003)** Wall structure of terminal latewood tracheids of healthy and declining silver fir trees in the dinaric region, Slovenia. *IAWA Journal*. 24(1): 41–51
- Schmitz N (2010)** Sampling wood for microtomy, Manual for Laboratory work.
- Schrader J, Nilsson J, Mellerowicz E, Berglund A, Nilsson P, Hertzberg M, Sandberg G (2004)** A high-resolution transcript profile across the wood-forming meristem of poplar identifies potential regulators of cambial stem cell identity. *Plant Cell*, 16: 2278-2292
- Schuetz M, Smith R, Ellis B (2012)** Xylem tissue specification, patterning, and differentiation mechanisms, *Journal of Experimental Botany*, 1-21
- Sultana RS, Ishiguri F, Yokota S, Iizuka K, Hirawa T, Yoshizawa N (2010)** Wood anatomy of nine Japanese hard wood species forming reaction wood without gelatinous fibers. *IAWA Journal* 31: 191-202
- Srivastava LM (2002)** Plant growth and development, Hormones and environment. Cell wall, cell division and cell growth ISBN: 978-0-12-660570-9. 772 p.
- Sultana RS, Rahman M (2013)** A review on structures of secondary wall in reaction wood fiber of hardwood species. *Plant* 1(5): 54-59
- Schweingruber FH (2007)** Wood structure and environment, Springer Series in Wood Science, Springer, Heidelberg, 279 pp.
- Thibeault-Martel M, Krause C, Morin H, & Rossi S (2008)** Cambial activity and intra-annual xylem formation in roots and stems of *Abies balsamea* and *Picea mariana*. *Annals of Botany* 102: 667–674
- Timell TE (1986)** Compression wood in gymnosperms. Springer-Verlag, Heidelberg.
- Tsai CJ, Chien CT, Lee CM, Chen SJ, Kuo-Huang LL (2006)** Anatomical characteristics of artificially induced tension wood in seedlings of Honduras mahogany, *Taiwan Journal of Forest Science* 21(2):147-154
- Wada M and Okano T (1995)** Characterization of tension and normally lignified wood cellulose in *Populus maximowiczii*. *Cellulose* 2: 223-233
- Washusen R, Ilic J & Waugh G (2003)** The relationship between longitudinal growth strain and the occurrence of gelatinous fibers in 10 and 11-year-old *Eucalyptus globulus* Labill. *Holz Roh- Werkstoff* 61: 299–303
- Yamamoto H (1998)** Generation mechanism of growth stresses in wood cell walls: roles of lignin deposition and cellulose microfibril during cell wall maturation. *Wood Science and Technology* 32: 171-182
- Yoshida M, Okuda T & Okuyama T (2000)** Tension wood and growth stress induced by artificial inclination in *Liriodendron tulipifera* Linn. and *Prunus spachiana* Kitamura f. *ascendens* Kitamura. *Annals of Forest Science* 57: 739-746
- Yoshida M, Ohta H, Yamamoto H, Okuyama T (2002b)** Tensile growth stress and lignin distribution in the cell walls of yellow poplar, *Liriodendron tulipifera* Linn. *Trees* 16: 457-464
- Yoshinaga A, Fujita M, Saiki H (1992)** Relationships between cell evolution and lignin structural varieties in oak xylem evaluated by microscopic spectrophotometry with separated cell walls. *Mokuzai Gakkaishi*. 38: 629–637
- Yoshinaga A, Kusumoto H, Laurans F, Pilate G & Takabe K (2012)** Lignification in poplar tension wood lignified cell wall layers. *Tree Physiology* 32:1129–1136
- Yoshizawa N, Koike S & Idei T (1985)** Formation and structure of compression wood tracheids induced by repeated inclination in *Taxus cuspidata*. *Mokusai Gakkaishi*, 31:325–333
- Zhang J, Nieminen K, Serra JAA, Helariutta Y (2014)** The formation of wood and its control. *Current Opinion in Plant Biology* 17:56–63