



**HAL**  
open science

# Contributions to road safety: from abstractions and control theory to real solutions, discussion and evaluation

Mariana Netto

► **To cite this version:**

Mariana Netto. Contributions to road safety: from abstractions and control theory to real solutions, discussion and evaluation. Automatic. UNIVERSITE DE PARIS XI, PARIS SUD, 2013. <tel-01213481>

**HAL Id: tel-01213481**

**<https://hal.science/tel-01213481v1>**

Submitted on 25 Jan 2016

**HAL** is a multi-disciplinary open access archive for the deposit and dissemination of scientific research documents, whether they are published or not. The documents may come from teaching and research institutions in France or abroad, or from public or private research centers.

L'archive ouverte pluridisciplinaire **HAL**, est destinée au dépôt et à la diffusion de documents scientifiques de niveau recherche, publiés ou non, émanant des établissements d'enseignement et de recherche français ou étrangers, des laboratoires publics ou privés.



HAL Authorization

Université Paris Sud XI

**Contributions to road safety : from abstractions and  
control theory to real solutions, discussion and  
evaluation**

Mémoire pour l'obtention de  
l'Habilitation à Diriger des Recherches en Sciences

Présenté par : **Mariana Netto**  
Chargée de Recherche à l'IFSTTAR

Laboratoire LIVIC, Dept Cosys  
77, Rue des Chantiers  
78000, Versailles, FRANCE  
courriel : mariana.netto@ifsttar.fr

Devant le jury composé par :

Prof. Jamal Daafouz,	University of Nancy	Rapporteur
Prof. Jean-Baptiste Lesort,	ENTPE	Rapporteur
Prof. Sarah Spurgeon,	University of Kent	Rapporteur
Dr. Anuradha Annaswamy,	MIT	Examineur
Dr. Nour Eddin El Faouzi,	IFSTTAR	Examineur
Dr. Françoise Lamnabhi-Lagarrigue,	CNRS	Examineur
Prof. Said Mammar,	University of Evry	Examineur
Prof. Hugues Mounier,	University of Paris-Sud	Examineur

Versailles, le 4 septembre 2013



# Table des matières

<b>I</b>	<b>Preface</b>	<b>7</b>
<b>II</b>	<b>Résumé des activités</b>	<b>13</b>
<b>1</b>	<b>Curriculum vitæ</b>	<b>15</b>
1.1	État civil . . . . .	15
1.2	Titres universitaires . . . . .	16
1.3	Déroulement de carrière . . . . .	17
1.4	Séjours à l'étranger . . . . .	18
<b>2</b>	<b>Activités d'enseignement</b>	<b>19</b>
2.1	Enseignements . . . . .	19
2.2	Rédaction de documents pédagogiques . . . . .	21
<b>3</b>	<b>Activités liées à la recherche</b>	<b>23</b>
3.1	Prix reçus et rapporteur pour l'attribution de prix . . . . .	23
3.1.1	Prix reçus . . . . .	23
3.1.2	Rapporteur pour l'attribution de prix . . . . .	23
3.2	Activités d'animation de la recherche . . . . .	23
3.2.1	Création et co-animation d'un groupe de travail au sein des GDRs .	23
3.3	Appartenance à de groupes d'experts . . . . .	24
3.3.1	Membre du comité technique de l'IFAC Transportation Systems .	24
3.3.2	Membre du groupe de travail Road Automation à la Commission Européenne . . . . .	24
3.3.3	Participation au T-AREA-SoS Support Action . . . . .	24
3.3.4	Participation à la rédaction de documents de prospective . . . . .	24
3.4	Participation à de comités de suivi et à de jurys de soutenance de thèses .	25
3.4.1	Comités de suivi de thèse . . . . .	25
3.4.2	Jurys de soutenance de thèse . . . . .	25
3.5	Représentations . . . . .	25
3.5.1	Représentation du partenaire LCPC dans PReVENT à la Commis- sion Européenne . . . . .	25
3.5.2	Représentation du LIVIC, Meeting Scientifique en Chine, Beijing .	25
3.5.3	Participation au Core Groupe (CG) de PReVENT . . . . .	25

3.5.4	Représentation de HYCON2 dans le meeting du T-AREA-SoS Support Action . . . . .	26
3.6	Collaborations, Réseaux Internationaux et Projets . . . . .	26
3.6.1	Collaborations . . . . .	26
3.6.2	Réseaux Internationaux . . . . .	27
3.6.3	Accueil des professeurs visiteurs . . . . .	28
3.6.4	Projets Nationaux et Européens . . . . .	28
3.6.5	Nouveaux Projets déposés en 2012 . . . . .	29
3.7	Administration liée à la recherche . . . . .	29
3.8	Relecture d'articles de revue . . . . .	30
3.9	Campagnes de tests in-situ . . . . .	30
<b>4</b>	<b>Encadrement</b>	<b>31</b>
4.1	Post-doctorants . . . . .	31
4.2	Doctorants . . . . .	32
4.3	Stages et CDD de niveau M2 . . . . .	35
4.4	Bilan quantitatif . . . . .	36
<b>5</b>	<b>Publications</b>	<b>37</b>
5.1	Tableau récapitulatif de toutes les publications . . . . .	37
5.2	Livres ou chapitres de livres . . . . .	37
5.3	Articles dans des revues internationales . . . . .	38
5.4	Articles dans des revues nationales . . . . .	39
5.5	Articles dans des conférences internationales . . . . .	39
5.6	Articles dans des conférences nationales . . . . .	42
5.7	Documents de prospectives . . . . .	43
5.8	Rapports de recherche . . . . .	43
<b>6</b>	<b>Séminaires, présentations et divulgation scientifique</b>	<b>47</b>
6.1	Posters, communications orales dans des congrès . . . . .	47
6.2	Séminaires présentés . . . . .	47
6.3	Divulgation scientifique . . . . .	48
<b>7</b>	<b>Synthèse des travaux</b>	<b>49</b>
7.1	Contrôle actif du véhicule . . . . .	49
7.2	Evaluation de systèmes de sécurisation de la conduite . . . . .	50
7.3	Recherche Théorique en Automatique . . . . .	50
<b>III</b>	<b>Scientific contributions</b>	<b>51</b>
<b>8</b>	<b>Transportation challenges : an overview</b>	<b>53</b>
8.1	The transportation context . . . . .	53
8.2	A view on ADAS systems for road safety . . . . .	57

<b>9</b>	<b>Scientific contributions and discussions</b>	<b>61</b>
9.1	First steps to the scientific contributions . . . . .	62
9.1.1	A hybrid system from a new idea for NLP control . . . . .	63
9.1.2	Hybrid modeling of a LDA system . . . . .	70
9.1.3	Using hybrid systems to simplify nonlinear systems . . . . .	74
9.2	Contributions to control theory . . . . .	76
9.3	Contributions to road safety . . . . .	78
9.3.1	Lane departure prevention . . . . .	79
9.3.2	Evaluation of ADAS systems . . . . .	88
9.4	Other contributions . . . . .	89
9.5	Multidisciplinary discussions . . . . .	90
<b>10</b>	<b>Conclusions et perspectives</b>	<b>97</b>
<b>IV</b>	<b>Bibliography</b>	<b>101</b>
<b>V</b>	<b>Annexed publications</b>	<b>107</b>
<b>VI</b>	<b>Control for the non expert reader</b>	<b>163</b>
<b>11</b>	<b>Notions on control theory</b>	<b>165</b>
11.1	Notions on Lyapunov theory . . . . .	165
11.1.1	Direct and indirect methods . . . . .	166
11.1.2	Stability in the sense of Lyapunov . . . . .	166
11.2	Notions on adaptive control . . . . .	170
11.2.1	What is an adaptive control system? . . . . .	170
11.2.2	An example : the adaptive control of a scalar plant . . . . .	170
11.2.3	Why with nonlinear parameterization it is so hard as a problem? . . . . .	173
11.3	Notions on the hybrid systems theory . . . . .	175
11.3.1	What is a hybrid system? . . . . .	175
11.3.2	Examples of a Hybrid Automaton . . . . .	176
11.3.3	Formal definition of a hybrid automaton . . . . .	177
11.3.4	Challenges in the hybrid systems stability analysis . . . . .	178



# Première partie

## Preface



This manuscript aims to describe my career in the transportation domain, putting in evidence my contributions in different levels, as for example thesis advising, teaching, research animation and coordination, projects construction and participation in expert committees, among others, besides my scientific research itself. The goal, besides the HDR diploma itself, is to show very clearly, including to myself, this ‘pack’ of contributions in order to look for better contributions to the transportation and control communities or to other communities in the future, and also which research directions I will define to work on in the following.

I obtained my PhD degree in the Laboratoire des Signaux et Systèmes - L2S<sup>1</sup> in collaboration with MIT, in 2001, having worked in a purely theoretical automatic control topic scarcely known in the literature - the adaptive control of systems with nonlinear parameterization problem. Arriving in 2002 as a permanent researcher to the former LCPC (Laboratoire Central des Ponts et Chaussées), now called IFSTTAR (Institut Français des Sciences et Technologies des Transports, de l’Aménagement et des Réseaux), I have been faced to real problems to solve in practice, and faced to the new community of transportation, with a completely different philosophy of work. I have nowadays this double vision - of the very applied transportation domain with concrete problems to be solved that touch the citizen every day, and the vision of a very rich high-level theoretical research in automatic control with powerful tools to solve the real problems, or on the other hand, with control problems that appear because of the need for new tools to solve the real problems. I consider this as an important characteristic for my future contributions.

Besides the knowledge in Transportation itself, my eleven years of career in IFSTTAR gave me as well the following new features :

1. From the individual research, I have learned also how to coordinate work (in projects for example, as in the PReVAL sub-project of the European PReVENT project, in which I co-lead one workpackage, or for research teams, as the control team of LIVIC, coordinated by myself from 2006 to 2009). I have also learned how to animate research (by coordinating research working groups or organizing scientific events and workshops - see for example the working group RSEI and the related scientific event below that I have organized in June 2012) and how to advise students.

2. Besides the double vision I have described above, the experience gave me also the acquisition of a quite multidisciplinary view of the problems in the domain. Firstly, arriving in LIVIC, in the frame of the French consortium ARCOS, I have worked for two years in close cooperation with experts in cognitive sciences (the PsyCoTech group from IRCCyN, Nantes) on designing driving assistance systems to a human driver. After this work, I have continued the collaboration with experts in human sciences within the PReVAL subproject of PReVENT on driving assistance systems evaluation and within the French ANR PARTAGE project, that I have constructed together with the PsyCoTec team of IRCCyN and led the IFSTTAR partner for one year. In addition, through my participation in PReVENT at different levels (in two meetings of the Core Group, in PReVAL by co-leading the workpackage 3 on Technical Evaluation of ADAS - ADAS is the shortcut for Advanced Driving Assistance Systems - and in the SAFELANE subproject), I have learned many different aspects of ITS systems. I consider this as an add-on value

---

1. le L2S est un laboratoire de recherche commun entre le CNRS, Supélec et l’Université Paris Sud

for my 'pack of knowledge'.

3. What I call "from abstractions to real problems : coming back and forth to solve these real problems" has been matured in my mind, and I am very grateful to my students, with whom I have learned and that helped me in this maturing process. By this sentence, I mean, with a problem to solve in hands, and after building an abstraction, or a simplified view of the problem, and the design of a solution, how to apply it, and to come back again to the theory to change it and to come back to the practice, and so on. This is exactly one of the pillars of the NoE HYCON2, for making interact the theory with the application domains, as shown in the figure below.

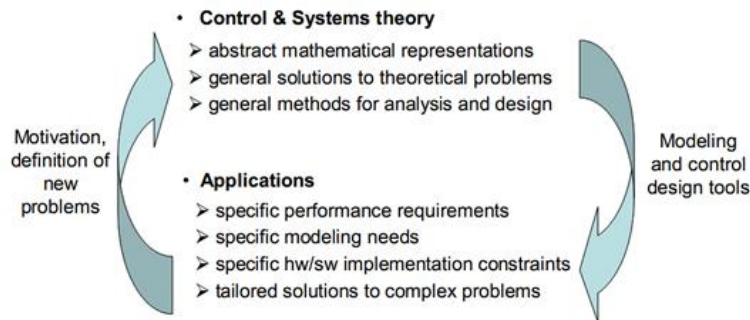

FIGURE 1 – Illustrative Diagram from the NoE HYCON2 showing the interaction of theoretical challenges with the real challenges.

4. Considering a problem inserted into the societal context, or inserted within its related context, has been another maturing for myself that I consider very important, notably in the transportation domain, that represents a very complex context containing many different parameters, scenarios and objectives and in addition all the uncertainties linked to the human behavior. I think that it is very important to have a very large view of the context in which the specific problem we are treating is placed. Without this, one cannot say in most of the cases, from my point of view, that the problem is solved. This point will be discussed in Chapter 9.5.

5. Another point that I consider important and where I have been contributing recently is the road mapping work. The acquisition of the multidisciplinary knowledge and a larger view of the domain that I have mentioned in the preceding items, together with my theoretical knowledge in automatic control, allowed myself to start contributing to the road mapping work in Transportation (through my participation in the imobility forum, in HYCON2 and the in the support action T-Area-SoS on Systems of Systems - all these actions to give advice to the European Commission on the priority areas to be considered in the new Calls, notably in the frame of the H2020 program).

I had also the pleasure of opening again books and thesis that I had studied in my PhD work, this time now for advising students in the frame of other very different problems. The very beautiful thesis of Mikael Johansson, Lund University, on piecewise linear systems stability theory is an example. My previous study on switched systems, and the implication

of switched Lyapunov functions on stability helped me also in advising my students (Post-Docs, PhD, and M.Sc. students), this time for real applications, with very interesting results blooming up from their work. I realize also that the experience that I have described in the five items above must be put in favor of students since this kind of knowledge cannot be found in the books.

Concluding, in these last eleven years, from 2002 to 2013, I could bring to the scientific community and to my students a set of contributions of different kinds. I will try to make clear these contributions for the reader in the next two chapters (written in English and in French)

This document is organized in the following way :

Part II contains my complete curriculum vitae (in french) where all these contributions will be described in detail. Part III contains then the scientific contributions of the manuscript. What I aim in this chapter is to describe, but further, to analyze them with a distanced look and providing a critical view, announcing perspectives, and placing and discussing the obtained results in the societal context. This is in straight relation with item 4 above. Also, I prefer to adopt, as far as possible, a form comprehensible to the non-automatic control expert, with, as far as possible as well, qualitative explanations and then appropriated references containing the theorems and the definitions corresponding to the qualitative explanations will be provided. In the case it is necessary, they are provided within the text.

The Part III is structured in the following chapters. Chapter 8 contains an overview of the global transportation scenario with the associated challenges and a description of the driving assistance systems context. Chapter 9 contains my scientific contributions. These include my research results, my contributions in students advising, in the coordination of research groups, and the collaborative works. It is structured in 3 sections : Section 9.1 introduces what will be the greed for a part of the main contributions, that are described in Sections 9.2 and 9.3. Section 9.1 is also dedicated to showing to the reader how theory and abstractions can be very important for solving real problems. Chapter 9.4 describes other contributions that are the result of collaborative works.

A discussion from a multidisciplinary view is provided in Chapter 9.5 based on a survey paper of myself.

Chapter 10 will be finally dedicated to the perspectives and the general conclusions.

Then last Part contains as annexes a selection of the publications that I consider the most illustrative of my contributions described in Chapter 9.

Finally, since the described work is in the intersection of two communities - the transportation and the control theory communities - I decided to write a part of the document dedicated to the non control experts readers. This is Part VI of the document whose aim is to provide some fundamental notions on control theory in a very simple qualitative description whose understanding will help the different readers to understand the contributions.



Deuxième partie  
Résumé des activités



# Chapitre 1

## Curriculum vitæ

### 1.1 État civil

Nom :	Netto
Prénom :	Mariana
Date et lieu de naissance :	24 Juillet 1968 à Rio de Janeiro (Brésil)
Nationalité :	Française
Situation de famille :	Mariée avec un enfant
Situation actuelle :	Chargée de Recherche 1ère Classe
Établissement :	Institut Français des Sciences et Technologies des Transports, de l'Aménagement et des Réseaux (IFSTTAR)
Département :	Composants et Systèmes (COSYS)
Laboratoire :	Laboratoire Interactions Véhicule-Infrastructure-Conducteur (LIVIC)
Adresse administrative :	LIVIC, IFSTTAR/Dept COSYS 77, rue des Chantiers 78 000 Versailles
Tél :	01.30.84.40.23
Mél :	mariana.netto@ifsttar.fr

## 1.2 Titres universitaires

2001	<p><i>Doctorat ès Sciences, mention très honorable</i>          Spécialité Automatique et Traitement du Signal          Laboratoire des Signaux et Systèmes (L2S)          UMR CNRS/Supélec/Université Paris-Sud XI.          Thèse intitulée : La Commande Adaptative de          Systèmes Non linéairement Paramétrés</p>
1997	<p><i>Master in Sciences Degree en Génie Électrique</i>          Spécialité Automatique          Coordination de la Recherche et des Projets en Ingénierie (COPPE)          Université Fédérale de Rio de Janeiro (UFRJ).          Thèse intitulée : Commande de Robots avec          des articulations flexibles par modes glissants</p>
1995	<p><i>Ingénieur Électronicien (option Automatique)</i>          École Polytechnique de          l'Université Fédérale de Rio de Janeiro (UFRJ)</p>

**École Polytechnique de l'Université Fédérale de Rio de Janeiro (UFRJ).** Cette école d'ingénieurs parmi les plus prestigieuses et sélectives du Brésil m'a donné la possibilité d'acquérir une solide formation en électronique et en automatique. Ces années d'études ont été réalisées avec une forte composante de formation par la recherche. Au Brésil, il y a une forte tradition où les étudiants qui souhaitent suivre une carrière scientifique, se présentent aux laboratoires de recherche de l'université, et si acceptés, s'impliquent dans des activités de recherche et sont gratifiés par des bourses. J'ai ainsi entamé mes activités de recherche pendant mon cursus universitaire, d'abord au département des mathématiques (2 ans de bourse) et ensuite au laboratoire d'automatique de la COPPE (2 ans de bourse). Ma première publication (voir [C56n] dans le chapitre 5) date de cette époque. J'ai présenté alors mes travaux au CNMAC, congrès national au Brésil de mathématiques appliquées, et mon travail a été ensuite publié dans une revue interne de l'UFRJ).

Ma formation initiale ainsi que celle acquise pendant ces 4 années de recherche initiale m'ont conforté dans mon choix de carrière dans la recherche, et plus précisément dans le domaine de l'automatique appliquée.

**Thèse de Master in Science (M.Sc.) en Automatique.** Il est nécessaire de préciser que la thèse de M.Sc. sur le continent américain est plutôt équivalente à l'ancien titre de docteur-ingénieur de France. Il n'est ouvert qu'aux détenteurs du diplôme d'ingénieur ou un diplôme universitaire d'un niveau minimum BAC+5 (le Master français).

Le M.Sc. est constitué d'une première année de cours (normalement mixte avec les étudiants de doctorat), et est suivie d'une à deux années pour la préparation d'une thèse scientifique (évidemment d'un niveau moindre qu'une thèse de doctorat). La soutenance de cette thèse d'une durée de 45 minutes est faite devant un jury composé d'au moins deux examinateurs, un externe à l'Université, l'autre étant le directeur de thèse.

Mon travail de thèse de M.Sc. a été porté sur la commande des robots avec des articulations flexibles par modes glissants.

**Thèse de Doctorat en Automatique.** A partir de septembre 1997, j'ai préparé une thèse au Laboratoire des Signaux et Systèmes L2S - CNRS/Supélec sous la direction de M. Roméo Ortega. Cette thèse, intitulée *La Commande Adaptative de Systèmes Non-linéairement Paramétrés* a été soutenue le 12 Novembre 2001 devant la commission d'examen composée de

Éric Walter	Président	Directeur de Recherches au CNRS
Mohammed M'Saad	Rapporteur	Professeur à l'Université de Caen
Ioan Doré Landau	Rapporteur	Directeur de Recherches Émérite au CNRS
Anuradha Annaswamy	Examinateur	<i>Senior Research Scientist</i> au MIT
Liu Hsu	Examinateur	Professeur à l'Université Fédérale de Rio de Janeiro
Roméo Ortega	Directeur de Thèse	Directeur de Recherches au CNRS

Cette thèse a été obtenue avec la mention très honorable.

**L'université d'Orsay ne délivre plus des félicitations du jury.**

### 1.3 Déroulement de carrière

Après la soutenance de ma thèse en novembre 2001, j'ai été qualifiée en février 2002 en section 61 puis classée dans les établissements suivants.

*Résultat de mon classement pour le concours Mcf. en 2001 (pour prise de fonctions en septembre 2002) :*

- Classée 1ère sur le poste de Maître de Conférences à l'IUT de Rennes.
- Classée 2ème sur le poste de Maître de Conférences à l'IUT d'Orsay.
- Classée 2ème sur le poste de Maître de Conférences à l'Université d'Amiens.
- Classée 2ème sur le poste de Maître de Conférences à l'École Nationale Supérieure de Physique de Strasbourg.

J'ai été également classée au poste de chargée de recherches au LCPC pour affectation à l'unité de recherche LIVIC, poste lequel j'ai décidé d'occuper. J'ai alors intégré le LCPC en septembre 2002 pour travailler au sein de l'équipe contrôle-commande du LIVIC en étroite collaboration avec toutes les autres équipes du LIVIC tels que les équipes Perception de l'Environnement et Validation Expérimentale.

Entre septembre 2001 et Août 2002, et donc pendant l'année de transition entre la thèse et ma prise de fonctions au LCPC, j'ai occupé le poste d'Attaché Temporaire d'Enseignement et de Recherches (ATER) à l'Université Paris-Sud XI (1/2 poste) et j'ai réalisé ma recherche pendant cette année au sein du Laboratoire des Signaux et Systèmes, à Supélec, en collaboration avec l'équipe dirigée par Mme Françoise Lamnabhi-Lagarrigue.

## 1.4 Séjours à l'étranger

<i>Université de Rome - Tor Vergata, Italie</i>	
3 jours	Février 2008
<i>Massachusetts Institute of Technology - MIT, États-Unis</i>	
1 mois	Nov-Déc 2000
<i>Massachusetts Institute of Technology - MIT, États-Unis</i>	
1 mois	Nov-Déc 1999

Le séjour à l'université de Rome Tor Vergata a été réalisé dans le cadre d'une Invitation du Professeur Marino pour que j'intègre le jury de la soutenance de thèse de M. Stefano Scalzi. Pendant mon séjour à Tor Vertaga, nous avons discuté la collaboration qui s'est établie par la suite. M. Scalzi est venu ensuite en stage post-doctoral sous ma direction pour travailler dans la thématique du contrôle latéral du véhicule.

Mes deux séjours au MIT ont eu pour but d'avancer les recherches sur la commande adaptative des systèmes paramétrés non-linéairement en utilisant la convexité. Si la théorie de contrôle-commande pour ces systèmes est encore très peu connue, à l'époque elle était quasiment inexistante. Au MIT, j'ai travaillé eu sein du Département de Génie Mécanique en collaboration avec le Professeur Annaswamy. J'ai étudié également le problème de la compensation adaptative du frottement des masses en mouvement lent, dont une des modélisations possibles est non-linéairement paramétrée.

# Chapitre 2

## Activités d'enseignement

### 2.1 Enseignements

Les établissements dans lesquels j'assure (ou j'ai assuré) des enseignements sont listés ci-dessous :

- ESME/Sudria - École Spéciale de Mécanique et d'Électricité.
- IFIPS - Institut de Formation d'Ingénieurs de Paris Sud (il s'agit de l'école d'ingénieurs de l'Université Paris Sud).
- UEVE - Université d'Évry Val d'Essonne.
- ENPC - École Nationale des Ponts et Chaussées.
- UVSQ - Université de Versailles Saint-Quentin.
- ESTACA - École supérieure des techniques aéronautiques et de construction automobile.

Les tableaux suivants contiennent une synthèse de mes enseignements. Pour la simplicité, j'utilise les abréviations suivantes :

- RM : Responsable de Module.
- SIT : Systèmes Intelligents de Transports.
- IMDA : Ingénierie en méthodes de Diagnostique Automobile.
- CSER : Capteurs, Systèmes Électroniques et Robotique.
- CL : Contrôle Latéral.
- ACA : Assistance à la conduite automobile.

<b>Année 2000 – 2001, durant la thèse</b>			
TP	Électronique	ESME/Sudria, 1ère année	100
Projets	Électronique	ESME/Sudria, 1ère année	50
<b>Total</b>			<b>150</b>

<b>Année 2001 – 2002 en demi poste ATER à UPSud</b>			
TD	Outils de Trait. du Signal	1ère année, IFIPS	18
TP	Signal et Image	2ème année, IFIPS	36
TP	Langage C	1ère année, IFIPS	30
Projets	Électronique	1ère année, IFIPS	30
<b>Total</b>			<b>114</b>

<b>Année 2002 – 2003, après prise de fonctions à l'IFSTTAR</b>			
Cours	Automatique Avancée	M2 Pro, UEVE	12
TD	Informatique (bureautique)	Licence, Dept. GLT, IUT, UEVE	32
<b>Total</b>			<b>44</b>

<b>Année 2004 – 2005</b>			
Cours	Automatique Avancée	M2 Pro, UEVE	12
Cours	Automatique Avancée	M2 Pro, UEVE (alt)	18
TD	Modélisation et Technologie	Licence, UEVE	18
<b>Total</b>			<b>48</b>

<b>Année 2005 – 2006</b>			
Cours	ACA	Mastère SIT, ENPC	1,5
Cours	Automatique Avancée	M2 Pro, UEVE	6
Cours	Automatique Avancée	M2 Pro, UEVE (alt)	16
Cours	Contrôle de véhicules	M2 Rech, UEVE	1,5
TD + TP	Automatique Avancée	M2 Pro, UEVE	20
TD	Modélisation et Technologie	Licence, UEVE	15
TD	Contrôle de véhicules	M2 Rech, UEVE	1,5
<b>Total</b>			<b>61,5</b>

<b>Année 2006 – 2007</b>			
Cours	ACA	Mastère SIT, ENPC	3
Cours	Contrôle de véhicules	M2 Rech, UEVE	1,5
Cours et RM	CL et ACA	LP IMDA, IUT, UEVE	15
<b>Total</b>			<b>19,5</b>

<b>Année 2007 – 2008</b>			
Cours et RM	CL et ACA	LP IMDA, IUT, UEVE	12
Cours	Contrôle de véhicules	M2 Rech, UEVE	1,5
Cours	ACA	Form. continue, ESTACA	21
TD	Contrôle de véhicules	M2 Rech, UEVE	1,5
<b>Total</b>			<b>36</b>

<b>Année 2008 – 2009</b>			
Cours et RM	CL et ACA	LP IMDA, IUT, UEVE	9
Cours	Contrôle de véhicules	M2 Rech, UEVE	1,5
Cours	ACA	Form. continue, ESTACA	3,5
Cours	ACA et introd. au CL du véh.	M2 CSER, UVSQ	6
TD	Contrôle de véhicules	M2 Rech, UEVE	1,5
<b>Total</b>			<b>21,5</b>

<b>Année 2009 – 2010</b>			
Cours	ACA et introd. au CL du véh.	M2 CSER, UVSQ	6
Cours	ACA	Form. continue, ESTACA	7
<b>Total</b>			<b>13</b>

<b>Année 2011 – 2012</b>			
Cours	ACA	Form. continue, ESTACA	7
<b>Total</b>			<b>7</b>

<b>Année 2012 – 2013</b>			
Cours	ACA et introd. au CL du véh.	M2 CSER, UVSQ	6
Cours	ACA	Form. continue, ESTACA	7
<b>Total</b>			<b>13</b>

## 2.2 Rédaction de documents pédagogiques

Rédaction des polycopiés suivants :

Systèmes non-linéaires et théorie de Lyapunov (120 transparents), 2003, support de cours pour le module Automatique Avancée, Mastère 2 Pro de l'Université d'Évry.

J'ai préparé ensuite une version simplifiée en théorie et plus axée sur des applications réelles pour le Mastère 2 Pro en alternance.

Le contrôle latéral d'un véhicule (93 transparents), 2005, support de cours pour le module Contrôle de Véhicules, Mastère 2 Recherche de l'Université d'Évry.

Après la préparation de ce premier support de cours en contrôle de véhicules, je l'ai fait évoluer, d'une année à l'autre, afin de construire de versions adaptées aux groupes d'étudiants avec des besoins très différents auxquels j'assure les cours (IUT, Master ENPC, ESTACA, etc).



# Chapitre 3

## Activités liées à la recherche

### 3.1 Prix reçus et rapporteur pour l'attribution de prix

#### 3.1.1 Prix reçus

Prix de la meilleure présentation scientifique, catégorie jeune chercheur, dans le CTS-HYCON Workshop on Nonlinear and Hybrid Control, 10-12 juillet 2006, Paris. Les contributions scientifiques du travail et la qualité de la présentation ont constitué les deux critères de sélection.

#### 3.1.2 Rapporteur pour l'attribution de prix

J'ai été invité en 2013 par la présidence de l'EDF pour analyser les travaux de thèse d'un candidat au prix Paul Caseau. Ce prix, crée en 2012 et attribué par l'Académies des Technologies et l'EDF rend hommage à la mémoire de Paul Caseau, fondateur de l'Académie des technologies. J'ai accepté de réaliser ce travail, la remise des prix étant prévue pour le 6 juin 2013.

### 3.2 Activités d'animation de la recherche

#### 3.2.1 Création et co-animation d'un groupe de travail au sein des GDRs

Il s'agit du groupe de travail RSEI - **Réseaux et Systèmes Électriques Intelligents**, inter trois GDRs **MACS-SEEDS-ISIS** (le premier en France), dont j'ai crée en collaboration avec un collègue, initialement au sein du GDR MACS. L'objectif du GT RSEI est d'animer une réflexion collective dans le domaine des Réseaux et des Systèmes Électriques Intelligents (RSEI), un domaine interdisciplinaire par excellence. Nous sommes 5 chercheurs en France à animer le groupe, assurant ainsi le travail transversal inter-GDR. Les Smart Grids et la problématique de la connexion des véhicules électriques aux Smart Grids sont abordés. L'étude profonde sur une nouvelle structure visant la ville dite durable et l'optimisation des systèmes de transport constituent des enjeux majeurs actuels dans notre société, avec un rôle prépondérant du véhicule électrique. Le concept des Smart

Grids est par conséquent très connecté à ces changements, ce qui inclut également le génie civil puisque certains systèmes pour le bâtiment intelligent nécessitent d'être prévus dès sa construction. Mon rôle dans l'animation du GT RSEI consiste à organiser, en collaboration avec mes 4 collègues, des journées scientifiques réunissant des chercheurs spécialistes en Smart Grids et de chercheurs travaillant sur les nouveaux concepts de transformation de la ville actuelle dans une ville dite durable. La raison est que ces deux thématiques sont en effet très liées l'une à l'autre et les échanges scientifiques entre ces deux communautés sont très nécessaires. Dans ce cadre, j'ai coordonné en 2012, l'organisation de la journée scientifique *Le véhicule électrique et son insertion urbaine*, avec participation de l'ENSAM, de l'Université d'Évry, de Télécom Paris, de Supélec, et du LTE/IFSTTAR. La journée s'est réalisée le 8 juin 2012, à l'école des Mines de Paris avec la présence de 43 participants. Et s'est finie par un débat motivé entre les participants.

### 3.3 Appartenance à de groupes d'experts

#### 3.3.1 Membre du comité technique de l'IFAC Transportation Systems

J'ai été invitée, en novembre 2011, par Janan Zaytoon, responsable du GDR MACS, à intégrer le comité technique TC7.4 Transportation Systems de l'IFAC. J'ai accepté l'invitation et ma nomination au comité technique TC7.4 a été confirmée début 2012.

#### 3.3.2 Membre du groupe de travail Road Automation à la Commission Européenne

J'ai intégré le groupe de travail (*working group on road automation*) début 2012. L'objectif du groupe est d'aider la Commission Européenne dans la formulation des lignes de recherche prioritaires dans ce domaine pour la formulation des prochains appels d'offre. Ce groupe fait partie du Forum iMobility (<http://www.icarsupport.eu/esafety-forum/>).

#### 3.3.3 Participation au T-AREA-SoS Support Action

T-AREA-SoS signifie Trans-Atlantic Research and Education Agenda on Systems of Systems. Site web : <http://www.t-area-sos.eu/>.

Le T-AREA-SoS réalise un travail de prospectives pour aider la Commission Européenne dans le choix des thématiques prioritaires dans le domaine de "Systèmes des Systèmes". J'apporte de contributions à ce travail.

#### 3.3.4 Participation à la rédaction de documents de prospective

J'ai contribué à la rédaction du document : "Prospectives en automatique, horizon 2020 : Contribution de l'Automatique aux défis, à l'HORIZON 2020, des Sciences et Technologies de l'Information et de Communication et de leurs Interactions". Voir [P58] dans le Chapitre 5.

## 3.4 Participation à de comités de suivi et à de jurys de soutenance de thèses

### 3.4.1 Comités de suivi de thèse

Membre du comité de suivi de thèse de Louay Saleh, doctorant à l'IRCCyN, thèse sous la direction de P. Chrevrel et J.-C. Lafay, Professeurs à l'IRCCyN.

### 3.4.2 Jurys de soutenance de thèse

Membre du jury de soutenance de thèse de M. Stefano Scalzi, soutenue en février 2009 à Université de Rome Tor Vergata, sous la direction du Professeur Riccardo Marino, thèse soutenue avec succès. Membre du jury de soutenance de thèse de M. Louay Saleh, soutenance le 4 avril 2012, à Nantes, sous la direction des Professeurs P. Chevrel et J.-C. Lafay, thèse soutenue avec succès.

## 3.5 Représentations

### 3.5.1 Représentation du partenaire LCPC dans PReVENT à la Commission Européenne

J'ai réalisé deux présentations à la Commission Européenne, la première a eu lieu en 2006 et la deuxième en 2008, lors de l'évaluation par la commission européenne du projet européen PReVENT. En 2006, j'ai présenté pour la CE les résultats du WP 31.420, *Actuator System*, sous-projet Safelane, et, en 2008, les résultats du WP3, *Technical Evaluation*, sous-projet PReVAL.

### 3.5.2 Représentation du LIVIC, Meeting Scientifique en Chine, Beijing

Il s'agit d'un meeting qui a été réalisé entre l'INRETS (4 unités de recherche présentes), l'EPFL, l'Université de Tchingua et l'Université de Tokyo pour établir de futures collaborations. J'ai représenté le LIVIC dans le meeting. J'ai également réalisé une présentation des activités de recherche du LIVIC.

### 3.5.3 Participation au Core Groupe (CG) de PReVENT

J'ai participé au *Core Group*<sup>1</sup> du projet européen intégré PReVENT lors de deux occasions. En décembre de 2007, j'ai représenté J.M. Blosseville, suite à une demande de sa part car il ne pouvait pas être présent (M. Blosseville est le fondateur du LIVIC et actuellement directeur délégué du site IFSTTAR de Satory). En juillet de 2007, j'ai

---

1. Le Core Group est le comité constitué des experts qui discutent les décisions de haut niveau à prendre ainsi que la planification d'un projet européen.

représenté J. Scholliers (leader de PREVAL), suite également à une demande de sa part, lors du meeting joint entre le Core Group et les responsables des sous-projets de PreVENT.

### 3.5.4 Représentation de HYCON2 dans le meeting du T-AREA-SoS Support Action

J'ai représenté le REX HYCON2 lors du meeting le 30-31 janvier 2013 à Bruxelles. L'objectif de ma présence a été de croiser des connaissances entre HYCON2 et le T-AREA-SoS.

## 3.6 Collaborations, Réseaux Internationaux et Projets

### 3.6.1 Collaborations

#### Collaborations Scientifiques Internationales

**Massachusetts Institute of Technology – MIT**, collaboration avec le Professeur **A. Annaswamy**, depuis 1999.

Le sujet de recherche abordé est purement théorique. Il porte sur le développement de lois de commande pour certaines classes de systèmes non-linéaires (publications [L1], [C33] et [C18], voir Chapitre 5).

**Université de Rome Tor Vergata**, collaboration avec le Professeur **R. Marino** et avec **S. Scalzi**, depuis 2008.

Le sujet de recherche abordé porte sur le contrôle latéral du véhicule (publications [R2], [R4], [C19], [C20], [C21], [C22], [24], [C50n], [C57s], voir Chapitre 5).

#### Collaborations Scientifiques en France

**Laboratoire des Signaux et Systèmes (L2S), Supélec**, depuis 2009. Un des sujets de la collaboration porte sur le contrôle de la dynamique du véhicule en situations limite de conduite (publications [C21], [C22], [C50n], voir Chapitre 5). Le deuxième sujet de collaboration porte sur le développement d'observateurs pour les algorithmes ABS, encadrement joint d'une thèse à ce sujet - projet DIM LSC Regeneo).

#### Collaborations axées industrie et projets

J'ai travaillé en contact direct avec différentes industries dans le cadre du projet intégré PreVENT. Tel est le cas de VTEC (Volvo Technology), Delphi, FIAT, FORD, TNO et Daimler Chrysler.

J'ai également fortement collaboré dans le cadre du projet PREVENT, avec les instituts de recherche en transports en Europe suivants :

- Fraunhofer, Allemagne ([http : //www.ivi.fraunhofer.de/frames/english/index.html](http://www.ivi.fraunhofer.de/frames/english/index.html))
- IKA, Allemagne ([http : //www.ika.rwth-aachen.de/index-e.php](http://www.ika.rwth-aachen.de/index-e.php).)
- VTT, Finlande ([http : //www.vtt.fi/lang=en](http://www.vtt.fi/lang=en).)
- ICCS, Grèce. ([http : //i-sense.iccs.ntua.gr/](http://i-sense.iccs.ntua.gr/))

- Université de Hannover ([http : //www.uni – hannover.de/en/index.php](http://www.uni-hannover.de/en/index.php).)

### 3.6.2 Réseaux Internationaux

#### Réseau d'Excellence Européen HYCON2

Le Réseau d'Excellence Européen HYCON2, "Highly complex and networked control systems" du 7ème PCRD de l'Union Européenne, est dédié à la commande des systèmes complexes et en réseau. J'assure la coordination du partenaire IFSTTAR dans HYCON2.

Le réseau est structuré en quatre workpackages :

- Analysis of complex systems
- Networked control systems
- System-wide coordination and control
- Self-organizing systems and control

et trois domaines d'application :

- Transportation
- Energy
- Biological and Medical systems

Les partenaires du réseau sont :

Centre National de la Recherche Scientifique - CNRS	Universita Di Pisa
European Embedded Control Institute - EECI	Universidad de Sevilla
Institut National de Recherche en Informatique et en Automatique - INRIA	Lunds Universitet
Institut Français des Sciences et Technologies des Transports et de l'aménagement et des Réseaux - IFSTTAR	Universitaet Kassel
Eidgenossische Technische Hochschule Zurich - ETHZ	Universita Degli Studi di Trento
Technische Universitaet Dortmund	Technische Universitaet Berlin
Rijksuniversiteit Groningen - RUG	Universita Degli Studi di Padova
Technische Universiteit Eindhoven	Ruhr-Universitaet Bochum
Universita Degli Studi di Cagliari	Universidad de Valladolid
Consiglio Nazionale delle Ricerche - CNR	Technische Universiteit Delft
Universita Degli Studi Dell'aquila	Universita Degli Studi di Pavia
Kungliga Tekniska Hoegskolan - KTH	

### 3.6.3 Accueil des professeurs visiteurs

J'ai invité et accueilli au sein du LIVIC les professeurs suivants, spécialistes en automatique :

- Professeur Sira-Ramirez, CINEVESTAV- IPN, México, 1 journée, janvier 2003.
- Professeur Liu Hsu, docteur d'état en France, COPPE/UFRJ, Brésil, 2 journées, 2004. Le Professeur L. Hsu a reçu, en 2010, le Prix de l'Ordre National du Mérite Scientifique.
- Professeur Riccardo Marino, Université de Rome Tor Vergata, 1 semaine, février 2008.

### 3.6.4 Projets Nationaux et Européens

#### Projets Nationaux

**Projet PREDIT ARCOS, action de recherche pour une conduite sécurisée,** construit pour assurer quatre fonctions techniques d'assistance à la conduite :

- Fonction 1 : la gestion des distances entre véhicules.
- Fonction 2 : l'alerte en amont d'un accident ou d'un incident.
- Fonction 3 : la prévention des collisions.
- Fonction 4 : la prévention des sorties de route.

A mon arrivée au LIVIC, en 2002, j'ai intégré l'équipe participante de la fonction 4, la prévention des sorties de route. ARCOS a été achevé en 2004 (début en 2001).

**Projet ANR PARTAGE, Contrôle partagé entre conducteur et assistance à la conduite automobile pour une trajectoire sécurisée, 2009-2011.**

J'ai construit et assuré la coordination du partenaire IFSTTAR (ex-LCPC) dans le projet ainsi que la coordination de deux tâches au sein du projet jusqu'à août 2010 (voir note 1.1\*\*\*) :

Tâche 2 : Cibles technologiques. Cette tâche a consisté à définir l'ensemble des systèmes d'aide au conducteur, cibles à construire par les automaticiens au long du projet pour ensuite être évaluées par les partenaires spécialistes en SHS travaillant dans le projet.

Tâche 6 : Conception et évaluation des assistances et de la coopération homme-machine. La tâche 6 contient l'ensemble de synthèses de lois de commande ainsi que l'évaluation des nouveaux systèmes conçus au sein du projet (ou conçus préalablement au projet).

**Projet DIM LSC Regeneo, Stabilité des véhicules actionnés par des moteurs-roues électriques : gestion des défaillances et impact du freinage régénératif, 2010-2014.**

Je suis le coordinateur du projet dont les partenaires sont le L2S, le LIVIC et le LTN (Laboratoire des technologies Nouvelles, unité de recherche IFSTTAR). Regeneo finance la thèse de M. Trong-Bien, encadrée par William Pasillas-Lépine, Alexandre de Bernardinis et moi-même.

## Projets Européens

**Projet PReVENT, Preventive and active safety applications contribute to the road safety goals on European roads, 2004-2008** . Il s'agit d'un projet du type IP (integrated project) du FP6 (Six Framework Programme).

J'ai participé à deux sous-projets de PReVENT :

- Sous-projet PReVAL, sur l'évaluation de systèmes d'aide à la conduite.
- Sous-projet SAFELANE, sur le contrôle latéral du véhicule pour la prévention des sorties de voies.

J'ai assuré également un travail de coordination (décrit par la suite dans la session 6.10).

### 3.6.5 Nouveaux Projets déposés en 2012

#### CSS IEEE Outreach Fund

J'ai coordonné la construction d'une proposition de projet visant la réalisation d'un workshop de nature multidisciplinaire autour de la thématique de la coopération entre de systèmes automatisés et l'humain. A cette finalité, j'ai déposé une demande de fonds au IEEE CSS Outreach pour coordonner la réalisation du workshop :

*Automatic Control for the Human Welfare - bringing together multidisciplinary experts and users to identify the new challenges in Human-Machine Systems.*

avec les partenaires suivants : CNRS (L2S), MIT, University of Kent, Honeywell, University of Minnesota, TU Berlin/Max Planck et IFSTTAR.

L'idée du workshop a été très appréciée par le comité de sélection du CSS. Le comité nous a demandé de retravailler certains points clés dans la proposition et d'envoyer la nouvelle version au CSS Outreach en 2013. Je prévois la réalisation de ce workshop au printemps de 2014.

#### MIT France SEED Fund

Title : *Putting Smarts in Smart Grid : Adaptive Control Architectures for Pluggable Hybrid Electric Vehicles and PV-inverters* (Anuradha M. Annaswamy, Mariana Netto et Gilney Damm). Le projet n'a pas été retenu, à cause du nombre trop élevé de demandes pour l'année 2013.

## 3.7 Administration liée à la recherche

J'énumère ci-dessous mes responsabilités à l'IFSTTAR depuis 2002.

- Responsable, avec J.M. Blosseville, du WP3 de PReVAL, sous-projet du projet européen PReVENT, 2006 - 2008. La recherche que nous avons réalisée et dirigée dans le WP3 de PReVAL a porté sur l'évaluation technique des systèmes d'aide à la conduite proposés dans PReVENT. Nous avons coordonné 8 partenaires, soit

une quinzaine de personnes, pendant 2 ans (2006-2008). Un des résultats est un guide pour l'évaluation technique de systèmes d'aide à la conduite (voir Chapitre 7 et Partie *Scientifique Contents*) ainsi qu'un article publié (voir article [R3] publié dans IEEE Transactions on Intelligent Transportation Systems, référence détaillée dans le Chapitre 5 ci-dessous).

- Responsable de l'axe de recherche systèmes d'aide au contrôle dans l'opération adhérence et contrôlabilité, du programme K de IFSTTAR, 2005 - 2009 (le programme K a été titré Sécurité Routière). Note : la recherche au sein de l'IFSTTAR est structurée en programmes portant sur des thèmes divers. Chaque programme est structuré en opérations de recherche dont plusieurs unités de recherche de l'institut en font partie.
- Responsable de l'équipe Contrôle-Commande du LIVIC de juillet 2006 à juillet 2009.
- Responsable du partenaire IFSTTAR pour le projet ANR PARTAGE de mai 2009 jusqu'à août 2010.
- Responsable du partenaire IFSTTAR pour le réseau européen HYCON2 (2010-2014).

### 3.8 Relecture d'articles de revue

Je réalise la relecture d'articles pour les revues suivantes : *IEEE transactions on Intelligent transportation Systems*, *Control Engineering Practice* et *Engineering Applications of Artificial Intelligence*, Elsevier.

### 3.9 Campagnes de tests in-situ

Participation active dans la préparation et dans la réalisation de deux campagnes de tests sur circuit d'essai (la première en décembre 2003 et la deuxième en juin 2004) pour l'évaluation de systèmes d'assistance au maintien du véhicule sur la voie (systèmes d'avertissement sur sortie de voie). Les expériences ont été construites pour l'étude de la coopération homme-machine lors de l'utilisation par l'humain de ces systèmes (20 personnes ont conduit le véhicule prototype équipé du système d'assistance). Ce travail s'est réalisé dans le cadre d'une collaboration entre le LIVIC et l'équipe PsyCoTec de l'IRCCyN, dont les études portent sur la psychologie de la conduite. L'IRCCyN est un laboratoire de l'École Centrale de Nantes (voir la publication de revue [R14n] ci-dessous dans le Chapitre 5).

# Chapitre 4

## Encadrement

### 4.1 Post-doctorants

**Stefano Scalzi**, encadrement à 100%

Financé par le projet ANR PARTAGE.

**Période** : de avril 2009 à octobre 2009 (7 mois)

**Descriptif** : les travaux de M. Scalzi ont porté sur deux thèmes principaux. Dans le cadre de la poursuite de ses travaux de thèse (réalisés à Rome Tor Vergata, sous la direction du Prof. Marino), nous avons travaillé sur l'extension de l'analyse de sensibilité paramétrique d'un contrôle pour automatiser le mode latéral du véhicule développé dans le cadre de sa thèse. L'analyse que nous avons réalisée a permis de prendre en compte un modèle plus complet (ces travaux, en collaboration avec l'Université de Rome Tor Vergata, ont été publiés en 2011 dans [R4], Control Engineering Practice).

J'ai proposé ensuite à M. Scalzi de commander le modèle non-linéaire de la dynamique latérale du véhicule via une modélisation affine par morceaux. Le but était de pouvoir gérer de situations de très forte instabilité, dont le besoin de commander un modèle non-linéaire. Cela rejoint l'approche affine par morceaux que j'ai proposée également à mon doctorant M. Benine-Neto (dans le cadre d'un contrôle simultané pour maîtriser la dynamique et le positionnement du véhicule sur la voie de circulation).

J'ai encadré M. Scalzi et M. Benine-Neto sur des sujets proches donnant comme fruit 4 articles de conférence. Une collaboration avec M. PasillasLepine, chargé de recherche au L2S, CNRS, a été initiée dans ce cadre.

**Publications** : (encadrement de M. Scalzi et de M. Benine-Neto, en collaboration avec le L2S) : 4 articles de conférence (ACC 2010 [C21], CIFA 2010-session invité [C50n], IEEE IV [C22], IEEE ITSC [C20]).

J'ai également participé à l'encadrement de M. Scalzi dans un travail cependant cette fois-ci mené principalement par le Professeur Riccardo Marino portant sur le contrôle partagé entre le conducteur et l'automate. La solution fait suite aux travaux du Professeur italien Mario Milanese (les résultats ont été publiés dans le European Journal of Control [R2]).

## 4.2 Doctorants

**Trong-Bien Hoang**, encadrement à 20% (sur les trois ans)

**Période** : démarrée en octobre 2010 (en cours)

**Titre de la thèse** : Gestion électro-automatique des défaillances dans un véhicule électrique en traction-freinage répartis par des moteurs-roues indépendants en vue d'une sécurité accrue. Conception de lois de commande et validation expérimentale.

**Directeur de thèse** : W. Pasillas-épine, L2S

Il s'agit d'une thèse réalisée dans le cadre du projet Regeneo, Digiteo DIM LSC, dont je suis le responsable.

L'encadrement est réalisé comme résultat d'une collaboration entre trois laboratoires : le L2S - Supélec (William Pasillas-Lépine, taux 50%), le LTN - IFSTTAR (Alexandre De-Bernardinis, taux 30% et le LIVIC - IFSTTAR (Mariana Netto, taux 20%).

Lors du montage du projet Regeneo, nous avons prévu que je dirige la thèse de M. Hoang et l'école doctorale STITS avait accepté mon dossier de dérogation pour la direction de cette thèse. Toutefois, lors de l'inscription du doctorant Trong-Bien Hoang, en début de l'année scolaire 2010-2011, étant donné les incertitudes liées à ma situation (j'ai été en arrêt de travail par une grossesse à risque), j'ai trouvé, vis-à-vis du doctorant, qu'il serait plus prudent de transférer la direction de la thèse à un collègue. J'ai proposé donc la direction de la thèse à William Pasillas-Lépine qui a bien accueilli ma demande ainsi que l'école doctorale STITS, qui lui a accordé une dérogation. Après cette première année, j'ai re-intégré donc, en novembre 2011, l'équipe d'encadrement pour les deux années suivantes en tant qu'encadrante.

**Descriptif** : le contexte des travaux de recherche est le véhicule électrique propulsé par 2 ou 4 moteurs-roues indépendants en mode traction-freinage électrique répartis. Les moteurs roues sont alimentés par des convertisseurs électroniques avec un contrôle-commande spécifique. Le sujet de thèse porte sur le développement d'un système capable de gérer certains de ces modes de défaillance, et sur son intégration avec des fonctions classiques d'aide à la conduite (telles que l'ABS, l'ASR ou l'ESP), par la conception de lois de commande appropriées.

La première année de thèse, encadrée par mes collègues, a été consacrée à l'ABS. Pour cela, une étude a été menée sur l'élimination de bruits de mesure dans l'accélération angulaire de la roue. Ces bruits de mesure peuvent activer le ABS dans des moments inappropriés. Alors, la synthèse d'un filtre est nécessaire. Cette tâche n'est pas cependant simple car la variation très rapide de la fréquence du bruit peut rendre le filtre instable. Ce problème a été résolu par la synthèse d'un filtre notch stable capable d'éliminer les bruits de mesure de l'accélération angulaire de la roue, même avec une vitesse variable du véhicule. Les simulations montrent que le filtre Notch réduit les oscillations dans la pression de freinage lors de la commande du glissement de la roue et améliore la robustesse de l'algorithme ABS 5 phases. Les résultats ont été publiés par le doctorant et mes collègues dans la conférence AVEC, 2012. L'algorithme sera alors implanté dans le banc d'essai de l'Université de Delft, dont les résultats seront soumis à une revue.

Dans un deuxième temps, le travail a porté sur la synthèse d'un observateur pour estimer le extended braking stiffness (XBS). L'observateur élimine des hypothèses complexes abordées dans la littérature. Le résultat est un observateur stable et simple pour le XBS

et qui a été couplé à un algorithme de commande de l'accélération des roues.

**Publications** : Le travail décrit a été accepté pour le ACC 2013 [C16] et, complété d'un deuxième observateur robuste aux incertitudes de l'adhérence, a été soumis à IEEE Transactions on Control Systems Technology [S57].

**André Benine-Neto**, encadrement à 43%.

**Période** : de octobre 2008 à octobre 2011.

J'ai encadré M. Benine-Neto la première année à un taux de 80% et la deuxième année à un taux de 50%. Étant donné que j'ai été absent pendant la dernière année de thèse (en arrêt de travail par une grossesse à risque), l'encadrement de la dernière année ainsi que la soutenance ont été réalisés et organisés entièrement par le directeur de thèse. Cela résulte alors à un taux d'encadrement total de 43% pour les trois ans.

**Titre de la thèse** : Contrôle de trajectoire en virage, vers le ESP Perceptif

**Directeur de thèse** : S. Mammar (encadrement à 57%)

**Descriptif** : l'objectif de cette thèse a été d'achever un système très performant, capable de gérer des situations d'extrême instabilité du véhicule. Ces situations incluent par exemple, l'évitement très soudain d'un obstacle sur la voie de circulation, un changement de voie sous fortes contraintes et la prévention de sorties de voies dans le cadre d'une faible adhérence.

La modélisation des forces de contact pneumatique-chaussée à prendre en compte est dans ce cas non-linéaire, ce qui requiert de techniques spécifiques. Étant donné la complexité du problème, j'ai proposé à M. Benine-Neto une modélisation affine par morceaux (PWA) du modèle non-linéaire. Si cela simplifie en grande partie le problème à résoudre, celui-ci reste encore très complexe, car la preuve de stabilité d'un système PWA, qui est également un système hybride, représente un enjeu théorique. Un double objectif a été traité : le contrôle de la dynamique du véhicule et le contrôle du positionnement du véhicule sur la voie ou vis-à-vis les autres véhicules (en fonction de l'objectif établi).

L'approche PWA pour le contrôle de la dynamique du véhicule a donné lieu à plusieurs publications dans des conférences internationales (ACC 2010 [C20], IEEE IV [C21]) et nationales (CIFA 2010-session invité [C49n]). La thèse de M. Benine-Neto qui traite essentiellement de la commande d'un système non-linéaire et qu'utilise des contrôleurs dynamiques, fait suite à la thèse de Mme Minoiu-Enache qui a abordé le contrôle sur un modèle linéaire du véhicule par retour statique de l'état du système.

Pendant les deux ans d'encadrement de M. Benine-Neto, je lui ai apporté du support également pour : acquérir un ensemble de connaissances en automatique (en lui proposant la lecture de mon cours en théorie de Lyapunov, le livre de H. Khalil en systèmes non-linéaires, les photocopies de Karl H. Johansson en systèmes hybrides, la thèse de Mikael Johansson sur les systèmes affines par morceaux ainsi que la thèse de Mme Minoiu-Enache et en étant disponible d'une façon quotidienne pour répondre à toute question) ; la raison étant que le doctorant n'était pas un automaticien à son arrivée en thèse ; je lui ai proposé également de participer à des événements tels que les journées doctorales à Évry et la journée du GT SDH du GDR MACS afin de se faire connaître. J'ai également proposé une collaboration entre M. Benine-Neto et mon post-doctorant M. Scalzi en assurant l'encadrement des deux. De la même façon que mes directeurs de thèse m'ont appris, j'ai également insisté en permanence sur la rigueur théorique.

Étant donné que le travail sur une modélisation affine par morceaux était assez exploratoire, j'ai proposé à M. Benine-Neto et à M. Scalzi de faire évoluer l'algorithme de correction de la trajectoire du véhicule proposé dans la thèse de Mme Minoiu-Enache par introduction d'un retour dynamique de l'état du système. Le but de ce travail a consisté à obtenir une erreur nulle en état stationnaire lors du retour du véhicule vers le centre de la voie. M. Scalzi avait déjà travaillé sur le contrôle dynamique par modèle interne à l'Université de Rome Tor Vergata, sous la direction du Professeur Marino et a pu apporter de contributions au travail de M. Benine-Neto. Pendant la dernière année de thèse, le doctorant a également validé expérimentalement le contrôle via l'approche affine par morceaux sur le véhicule d'essai du LIVIC.

**Publications** : déjà citées ci-dessus (encadrement de M. Scalzi et de M. Benine-Neto, en collaboration avec le L2S) : 4 articles de conférence (ACC 2010 [C21], CIFA 2010-session invité [C50n], IEEE IV [C22], IEEE ITSC [C20])).

**Nicoleta Minoiu-Enache**, encadrement à 50%.

**Période** : octobre 2005 à novembre 2008.

**Titre de la thèse** : Assistance préventive à la sortie de voie

**Directeur de thèse** : S. Mammar (encadrement à 50%)

**Descriptif** : l'objectif principal de ce travail de thèse a porté sur le développement et l'implantation d'une assistance active pour l'évitement des sorties involontaires de la voie de circulation. Les caractéristiques de cette assistance se déclinent en plusieurs sous-objectifs : intervention dans les moments d'inactivité du conducteur alors que la sortie de voie devient imminente et rétablissement de la situation de maintien de voie ; action partagée avec le conducteur sur la direction du véhicule ; fonctionnement sur une route rectiligne et à forte adhérence ; extension des résultats à une route à courbure non-nulle et à une route à faible adhérence ; L'optimisation convexe linéaire et bilinéaire combinées à une approche par Lyapunov ont permis de trouver une solution au problème posé. La commande ainsi synthétisée a été implantée sur véhicule et les objectifs ont été bien atteints. La thèse a fait une suite directe au stage de M2R (ci-dessous).

Pendant mon encadrement de Mme Minoiu-Enache, je l'ai assuré le support théorique pour notamment les théories des systèmes hybrides et de Lyapunov, dont un premier formalisme avait été réalisé dans le cadre de son stage de DEA (voir ci-dessous). Un point important de mon encadrement, étant donné en plus que la thèse comporte une partie théorique assez importante, a été d'offrir un support constant pour la rigueur mathématique des approches proposées ainsi que pour les preuves mathématiques présentées. J'ai eu moi-même deux directeurs de thèse très exigeants (le Prof. Roméo Ortega, L2S-Supélec, pour la thèse de doctorat et le Prof. Liu Hsu, de l'Université Fédérale de Rio de Janeiro - Brésil, pour la thèse de Master in Sciences). Ces professeurs m'ont appris à toujours constituer un formalisme très rigoureux ce qui a été important pour ma carrière et je transmets cela également à mes étudiants.

**Publications** : 3 articles de revue ([R6], [R7], [R13n]) + 6 articles de congrès ([C23], [C25], [C29], [C30], [C32], [C35]). Prix de meilleure thèse GDR-MACS, session 2009.

## 4.3 Stages et CDD de niveau M2

**Nicoleta Minoiu**, encadrement à 50%.

**Stage Master-2 Recherche, 5 mois**, année universitaire 2004-2005. Université Paris XI/Supélec.

**Titre** : commande hybride partagée d'un véhicule.

**Descriptif** : la thématique du stage a été centrée sur le développement d'un système d'évitement de sorties de voies coopératif avec le conducteur. Une modélisation hybride a été adoptée afin de formaliser le partage de la conduite entre l'automate et le conducteur. Le formalisme hybride ainsi construit, la théorie de Lyapunov et certaines hypothèses sur le mouvement du véhicule quand celui est gouverné par le conducteur ont été combinés pour assurer la stabilité du système commuté. Ces concepts ont été poursuivis par Mme Minoiu-Enache en thèse. En termes de formation de l'étudiante, en début du stage, j'ai assuré à Mme Minoiu-Enache le support nécessaire sur le formalisme et les théorèmes principaux de la théorie de systèmes hybrides. Cet encadrement, a permis la constitution de nouveaux concepts d'assistance à la conduite qui ont été ensuite évolués en thèse vers des systèmes très performants.

**Publications** : Le stage a conduit à la publication [C35], qui a été travaillée en début de thèse.

**Khadidja Benzemrane**, encadrement à 50%.

**Stage de fin d'études ingénieur, 5 mois**, année universitaire 2004-2005. Institut Polytechnique Saint Louis.

**Titre** : Contrôle latéral dans la prévention des sorties de voie

**Descriptif** : la thématique a été centrée également sur le développement d'un système d'évitement de sorties de voies, également coopératif avec le conducteur. La solution apportée a permis de repositionner le véhicule vers le centre de la voie, par le biais d'une planification de trajectoire. Des contraintes de performance (dépassement maximal sur la voie) et de confort (accélération maximale à ne pas dépasser) ont été prises en compte simultanément. La loi de commande a été conçue pour être robuste à de possibles pertes de détection des marquages, en utilisant uniquement les informations du positionnement du véhicule sur la voie de circulation. Des capteurs pour mesurer la dynamique du véhicule ne sont pas nécessaires. Un seuil maximal (fixé a priori) sur l'accélération latérale pendant la correction est toujours respecté. La loi de commande a été testée et validée en simulation pour 7000 scénarios différents. L'action se fait par l'angle de braquage des roues (Les travaux de F. Tovo, étudiante à Télécom Paris, en stage de deuxième année d'une durée de 2 mois encadrée par moi, en 2009, a permis de simuler ce système).

**Salim Chaib**, encadrement à 100%

**Stage Master-2 Recherche, 6 mois**, année universitaire 2002-2003. Université de Versailles Saint-Quentin (UVSQ).

**Titre** : Développement et évaluation de lois de contrôle latéral du véhicule pour un prototype de véhicule automatisé.

**Descriptif** : le travail de stage de M. Chaib a porté sur la synthèse d'une loi de commande pour l'automatisation du mode latéral du véhicule via une approche par commande adaptative. Cela a permis l'achèvement d'une solution avec des très bonnes performances

pour des variations sur la vitesse, l'adhérence et la distance de visé du capteur de détection des marquages. Un deuxième travail réalisé dans ce stage a été la comparaison du système de contrôle proposé avec trois autres systèmes existants dans la littérature. J'ai encadré ensuite M. Chaib en CDD - de septembre 2003 à juin 2004 (dans le cadre du projet ARCOS).

**Publications** : Le stage a conduit à deux publications ([C41], [C42]).

**Armand Mouchmoulian**, encadrement à 50%.

**Stage Master-2 Recherche, 5 mois**, année universitaire 2005-2006. Université Paris Sud XI/Supélec.

**Titre** : Conception d'un ESP perceptif

**Descriptif** : Le travail a porté sur la conception d'un système de contrôle, synthétisé sur le modèle linéaire bicyclette du véhicule, capable d'agir sur le volant et sur le moment de lacet (par freinage différentiel) simultanément en intégrant des informations sur la perception de l'environnement. Le but a été de rendre le système ESP anticipatif. Le ESP (Electronic Stability Program) est un système qui freine les roues d'une façon différentielle pour générer un moment de lacet capable de stabiliser la dynamique du véhicule lors d'un très fort dérapage. Il a été récemment rendu obligatoire dans les véhicules de série. Ce sujet est en lien direct avec la thèse de M. Benine-Neto.

**Gabriel Zakarian**, encadrement à 100%

**CDD ingénieur, 1 an**, période : 2004-2005.

**Titre** : Assistance à la conduite : état de l'art et synthèse du mode limite.

**Descriptif** : la thématique principale du travail de M. Zakarian a été la conception et implantation sur véhicule d'essai d'un système d'assistance au conducteur pour le contrôle latéral du véhicule dans le cadre d'éviter une sortie de voie : le système a été conçu pour limiter l'action du conducteur sur le braquage du véhicule via un couple résistant. La logique est d'augmenter progressivement ce couple résistant avec l'augmentation du déplacement latéral du véhicule sur la voie. M. Zakarian a réalisé également un état de l'art sur les différents types de colonnes de direction et sur les méthodes et projets existants portant sur le contrôle latéral du véhicule.

## 4.4 Bilan quantitatif

Le tableau ci-dessous décrit les principaux encadrements et co-encadrements que j'ai effectués depuis ma prise de fonctions à l'IFSTTAR en 2002.

Post doctorants	Stefano Scalzi	de avril 2009 à oct 2009	100 %
Thèses de doctorat	Trong-Bien Hoang	depuis nov 2011	20 %
	André Benine-Neto	de oct 2008 à août 2010	43 %
	Nicoleta Minoui Enache	de oct 2005 à nov 2008	50 %
Stages de DEA/M2R	Armand Mouchmoulian	5 mois, année 2005-2006	50 %
	Nicoleta Minoui Enache	5 mois, année 2004-2005	50 %
	Salim Chaib	6 mois, année 2002-2003	100 %
Stages ingénieur	Khadidja Benzemrane	5 mois, année 2004-2005	50%
CDD Ingénieur	Gabriel Zakarian	1 an, 2004-2005	100 %

# Chapitre 5

## Publications

### 5.1 Tableau récapitulatif de toutes les publications

Le tableau ci-dessous indique, classé par type et par année, le nombre de publications que j'ai obtenues depuis 1998.

	Rev I	Rev F	Chap.	Conf. I	Conf. F	Total	
1998	0	0	0	1	0	<b>1</b>	
1999	0	0	0	2	1	<b>3</b>	
2000	1	0	0	0	0	<b>1</b>	
2001	1	0	0	1	0	<b>2</b>	
2002	2	0	0	0	0	<b>2</b>	
2003	0	0	0	1	0	<b>1</b>	
2004	0	0	0	4	1	<b>5</b>	
2005	0	1	0	3	0	<b>4</b>	
2006	1	1	1	5	1	<b>9</b>	
2007	0	0	0	3	0	<b>3</b>	
2008	0	0	0	5	2	<b>7</b>	
2009	1	1	0	2	0	<b>4</b>	
2010	2	0	0	4	1	<b>7</b>	
2011	2	0	0	0	0	<b>2</b>	
2012	1	0	0	2	0	<b>3</b>	
2013	0	0	0	1	0	<b>2</b>	
<b>Total</b>	<b>11</b>	<b>3</b>	<b>1</b>	<b>34</b>	<b>6</b>	<b>56</b>	

### 5.2 Livres ou chapitres de livres

[L1] Netto, M., Annaswamy, A., Mammar, N. Minoiu, S. A new adaptive controller for systems with multilinear parameterization : n-parameters case. in the ISTE book "Taming Heterogeneity and Complexity of Embedded Control" Eds, F. Lamnabhi-Lagarrigue, A. Loria, E. Panteley and S. Laghrouche, 2006.

### 5.3 Articles dans des revues internationales

#### 2012

[R2] Riccardo Marino, Stefano Scalzi et Mariana Netto. Integrated Driver and Active Steering Control for Vision-Based Lane Keeping, *European Journal of Control*, Vol 18, no. 5, 2012.

#### 2011

[R3] J. Scholliers, S. Joshi, M. Gemou, F. Hendriks, M. Ljung Aust, J. Luoma, M. Netto, J. Engström, S. Leanderson, R. Kutzner, F. Tango, A. Amditis, J.-M. Blosseville and E. Bekiaris. Development and Application of an Integrated Evaluation Framework for Preventive Safety Applications, *IEEE Transactions on Intelligent Transportation Systems*, Mars 2011, Vol 12, Issue 1, Pages 211-220, ISSN : 1524-9050.

[R4] Riccardo Marino, Stefano Scalzi, Mariana Netto. Nested PID steering control for lane keeping in autonomous vehicles, *Control Engineering Practice*, Volume 19, Issue 12, décembre 2011, Pages 1459–1467.

#### 2010

[R5] A. Amditis, M. Bimpas, G. Thomaidis, M. Tsogas, M. Netto, S. Mammar, A. Beutner, N. Möhler, T. Wirthgen, S. Zipser, A. Etemad, M. De Lio, R. Cicilloni. A Situation Adaptive Lane Keeping Support System : Overview of the Safelane Approach, *IEEE Transactions on Intelligent Transportation Systems*, Juillet 2010, Vol 11, Issue 3, Pages 617–629, ISSN 1424–9050.

[R6] N. Minoiu–Enache, S. Mammar, M. Netto, B. Lusetti. Driver steering assistance for lane departure avoidance based on hybrid automata and on composite Lyapunov function, *IEEE Transactions on Intelligent Transportation Systems*, vol 11, no.1, pp. 28–39, 2010.

#### 2009

[R7] N. Minoiu–Enache, M. Netto, S. Mammar and B. Lusetti. Driver steering assistance for lane departure avoidance, *Control Engineering Practice*, vol 17, pp. 642–651, 2009.

#### 2006

[R8] Mammar S., Glaser S., Netto M., Time to Line Crossing for Lane Departure Avoidance : Theoretical Study and an Experimental Setting, *IEEE Transactions on Intelligent Transportation Systems*, 2006.

#### 2002

[R9] Astolfi, A., Hsu, L., Netto, M. et Ortega, R. Two Solutions to the Visual Servoing Problem., *IEEE Transactions on Robotics and Automation*, Vol. 18, No. 3, pp. 387–392, 2002.

[R10] Moya, P., Ortega, R., Netto, M., Praly, L. et Pico, J. Application of Nonlinear Time–Scaling for Robust Controller Design of Reaction Systems. *International Journal of Robust and Nonlinear Control*. Vol. 12, No. 1, pp.57–69, 2002.

#### 2001

[R11] Chang, G.W., Hespanha, J.P., Morse, A.S., Netto, M. et Ortega, R. Supervisory Field–Oriented Control of Induction Motors with Uncertain Rotor Resistance. Special Issue of the International Journal of Adaptive Control and Signal Processing, entitled Switching and Logic in Adaptive Control. Vol. 15, No. 3, pp. 353–375, 2001.

**2000**

[R12] Netto, M., Annaswamy, A., Ortega, R. et Moya, P. Adaptive Control of a Class of Nonlinearly Parametrized Systems using Convexification. International Journal of Control. Vol. 73, No. 14, pp. 1312-1321, 2000.

## 5.4 Articles dans des revues nationales

**2009**

[R13n] N. Minoiu–Enache, B. Lusetti, S. Mammar, M. Netto. Preventive active lane departure avoidance system for curvy roads. Journal Européen des systèmes automatisés, v. 43, no. 6, pp. 615–646, 2009.

**2006**

[R14n] Hoc J.M., Mars F., Mileville–Pennel I., Jolly E., Netto M., Blosseville J.M. Evaluation of human–machine cooperation modes in car driving for safe lateral control in bends : function delegation and mutual control modes, Le travail humain, Volume 69, pp. 153–182, 2006/2.

**2005**

[R15n] Mammar S., Glaser S., Netto M. Automatique et Assistance à la Conduite Automobile, Génie Logiciel - Le Magazine de l'ingénierie du logiciel et des systèmes, No.75, pp. 26-34, 2005.

## 5.5 Articles dans des conférences internationales

**2013**

[C16] Hoang, T.–B., Pasillas–Lépine, W. and Netto, M. Closed–loop wheel acceleration control based on an extended braking stiffness observer, American Control Conference - ACC, 2013, accepté.

**2012**

[C17] M. Netto. In-Vehicle Embedded Control Systems for Safety : a Survey, in the proceedings of the IFAC Symposium on Control in Transportation (IFAC CTS), Sophia, Bulgarie, 10-12 septembre 2012.

[C18] M. Netto et A. M. Annaswamy, Adaptive control of a class of multilinearly parameterized systems by using noncertainty equivalence control, in the proceedings of the 51th IEEE Conference on Decision and Control - CDC, Maui, 10-13 décembre 2012.

**2010**

[C19] M. Netto, S. Scalzi et J.M. Blosseville. Vehicle Low Cost and High Performance Active Safety : Concepts and Control, in Transport Research Arena Europe 2010, Bruxelles, 2010.

[C20] A. Benine–Neto, S. Scalzi, S. Mammar, M. Netto, Dynamic controller for lane keeping and obstacle avoidance assistance system, 13th International IEEE Conference on Intelligent Transportation Systems, September 2010, pg. 1363–1368.

[C21] S. Scalzi, A. Benine–Neto, M. Netto, W. Pasillas–Lépine, S. Mammar, Active Steering Control Based on Piecewise Linear Regions, American Control Conference – ACC2010, Baltimore, Maryland, Etat–Unis, 2010.

[C22] A. Benine–Neto, S. Scalzi, M. Netto, S. Mammar, W. Pasillas–Lepine, Vehicle Yaw Rate Control Based on Piecewise Affine Regions, accepté à IEEE Intelligent Vehicles Symposium – IV 2010.

### 2009

[C23] S. Mammar, N. Minoiu Enache, B. Lusetti, M. Netto, Y. Sebsadji, Invariant set based vehicle longitudinal control assistance, IAVSD, 2009.

[C24] R. Marino, S. Scalzi, M. Netto, A Nested PID Steering Control for Lane Keeping in Vision Based Autonomous Vehicles, American Control Conference - ACC2009, Saint Louis, Missouri, USA, June 10-12, 2009.

### 2008

[C25] N. Minoiu, M. Netto, S. Mammar, B. Lusetti, Driver steering assistance to avoid unintended lane departure by lane keeping and steering suggestions, 17th IFAC World Congress, Seoul, Corée du Sud, juillet 2008.

[C26] J.Scholliers, F. Hendriks, M. Ljung Aust, J. Luoma, M. Netto, J. Engström, S. Leanderson, R. Kutzner and F. Tango. An Integrated Evaluation framework for preventive safety applications, IEEE Intelligent Vehicles Symposium, IV, Eindhoven, Pays–Bas, 2008.

[C27] M. Netto, J.–M. Blosseville, F. Hendriks, J. Scholliers, J. Chen, K. Heinig, M. Ljung Aust, New framework for evaluating preventive safety functions : focusing on technical evaluation. ITS World Congress, New York, 2008.

[C28] J.M. Blosseville, M. Netto, S. Glaser, Evaluating Safety Benefits of Collision Mitigation Systems (CMS) : A Challenge, ITS World Congress, New York, 2008.

[C29] N. Minoiu–Enache, S. Mammar, B. Lusetti, M. Netto. Driver steering assistance : lane departure prevention for curvy roads using feedforward correction and BMI optimization. AVEC, Kobe, oct. 2008.

### 2007

[C30] N. Minoiu, M. Netto, S. Mammar, B. Lusetti, A switched optimized approach for road–departure avoidance : implementation results, 2007. IEEE Intelligent Vehicles Symposium – IV, Istanbul, 2007.

[C31] J.Scholliers, F. Hendriks, M. Ljung, A. Virpi, M. Netto, J. Engström, K. Heinig, A. Amditis. Evaluation framework for preventive safety applications, ITS World Congress, Beijing, 2007.

[C32] N. Minoiu, M. Netto, S. Mammar, Assistance control based on a composite Lyapunov function for lane departure avoidance, IEEE Mediteranean Conference on Control and Automation, Athènes, 2007.

## 2006

[C33] Netto, M., Annaswamy, A., Mammar, S., Glaser, S. A new adaptive control algorithm for systems with multilinear parameterization, American Control Conference – ACC, Minneapolis, Etas–Unis, 2006.

[C34] Netto, M., Blosseville, J.–M., Lusetti, B., Mammar, S. A new robust control system with optimized use of the lane detection data for vehicle full lateral control under strong curvatures, IEEE Conference on Intelligent Transportation Systems, Toronto, Canada, 2006.

[C35] Minoiu N., Netto M. et Mammar S., A switched optimized approach for road departure avoidance, IEEE Conference on Intelligent Transportation Systems, Toronto, Canada, sept. 2006

[C36] Mammar S., Glaser S, Netto M., Vehicle lateral dynamics estimation using Unknown Input Proportional–Integral Observers, American Control Conference, Minesota, 2006.

[C37] Minoiu N., Netto M., Mammar S. et Glaser S., A new strategy for lane departure avoidance, IEEE International Conference on Control Applications, Munich, 2006.

## 2005

[C38] Chaïbet A., Mammar S., Nouvelière L, Netto M., Backstepping Control Synthesis for Automated Low Speed Vehicle, American Control Conference, États–Unis, 2005.

[C39] Chaibet A., Nouveliere L., Mammar S., Netto M., Labayrade R., Backstepping control synthesis for both longitudinal and lateral automated vehicle, IEEE Intelligent Vehicles Symposium, 2005.

[C40] Glaser S., Mammar S., Netto M., Lusetti B., Experimental time to line crossing validation, IEEE Conference on Intelligent Transportation Systems - ITSC, 2005.

## 2004

[C41] M. Netto, S. Chaib et S. Mammar. Lateral adaptive control for vehicle lane keeping. American Control Conference – ACC, Boston, États–Unis, 2004.

[C42] S. Chaib, M. Netto et S. Mammar. Hinfinité, adaptive, PID and fuzzy control : a comparison of controllers for vehicle lane keeping. IEEE Intelligent Vehicles Symposium, Parma, Italie, 2004.

[C43] S. Mammar, M. Netto. Integrated longitudinal and lateral control for vehicle low speed automation, IEEE Conference on Control Applications – CCA, Taipei, Taiwan, 2004.

[C44] Mammar S., Glaser S., Netto M., Blosseville J.M., Time to line crossing and vehicle dynamics for lane departure avoidance , 7th International IEEE Conference on Intelligent Transportation Systems – ITSC, Washington, D.C., États–Unis, 2004.

### 2003

[C45] M. Netto, R. Labayrade, S.–S. Ieng, B. Lusetti, J.M. Blosseville et S. Mammar. Different Modes on Shared Lateral Control, 10th ITS World Congress, Madrid, Espagne, 2003.

### 2001

[C46] Astolfi, A., Hsu, L., Netto, M. et Ortega, R. A Solution to the Adaptive Visual Servoing Problem., IEEE Conference on Robotics and Automation, 21–26 mai 2001, Seoul, Korea.

### 1999

[C47] Moya, P., Netto, M., Ortega, R. et Picó, J. Nonlinear Time-Scaling for Analysis and Controller Design of Reaction Systems in proc. The Eighth IEEE International Conference on Control Application (CCA), 22-26 août 1999, Hawaii.

[C48] Netto, M., Moya, P., Ortega, R. et Annaswamy, A. Adaptive Control of a Class of First-Order Nonlinear Systems Using Convex Reparametrizations in proc. CDC - Conference on Decision and Control, 7-10 déc.1999, Phoenix, USA.

### 1998

[C49] Chang, G., Hespanha, J.P., Morse, A.S., Netto, M. et Ortega, R. Supervisory Field-Oriented Control of Induction Motors with Uncertain Rotor Resistance. IFAC Symposium ACASP'98 : Adaptive Systems in Control and Signal Processing, pp. 485 - 490, 26-28 août 1998, Glasgow, UK.

## 5.6 Articles dans des conférences nationales

### 2010

[C50n] A. Benine-Neto, S. Scalzi, M. Netto, W. Pasillas-Lépine et S. Mammar, La conduite en conditions limite : contrôle d'un modèle non linéaire du véhicule par une approche affine par morceaux via le suivi d'une référence en vitesse de lacet. CIFA, Nancy, France, 2010, en session invitée.

### 2008

[C51n] M. Netto, S. Leanderson, J.M. Blosseville, J. Scholiers, S. Mammar, L.Nouveliere, PReVAL–PReVENT : Assistanes à la conduite, évaluation des systèmes et trajectoires, Séminaire Trajectoires et sécurité routière, LCPC, Nantes, Mars 2008 (séminaire en interne du LCPC, avec préparation d'un article).

[C52n] N. Minoiu–Enache, B. Lusetti, S. Mammar, M. Netto, Assistance préventive à la sortie de voie : Cas de la conduite en virage, Conférence Internationale Francophone d'Automatique – CIFA, sept. 2008.

**2006**

[C53n] Mammam S., Glaser S., Netto M., Le temps à sortie de voie : une mesure et un critère pour l'assistance au contrôle latéral, Conférence Internationale Francophone d'Automatique—CIFA, Bordeaux, 2006, en session invitée.

**2004**

[C54n] S. Mammam, A. Chaïbet, L. Nouvelière, M. Netto. Suivi de véhicule par modes glissants pour l'automatisation basse vitesse des véhicules, Conférence Internationale Francophone d'Automatique – CIFA, Douz, Tunisie, 2004.

**1999**

[C55n] Netto, M., Moya, P., Ortega, R. et Annaswamy, A. Commande Adaptative d'une Classe des Systèmes du Première Ordre avec Paramétrisation Non—linéaire in proc. Journées Doctorales d'Automatique – JDA, pp. 205–208, 21–23 sept. 1999, Nancy, France.

**1991** (conférence nationale au Brésil)

[C56n] Netto, M. et Santos, A. R. Eradicating the Malaria or Exterminating life? (Eradicação da Malária ou Extermínio da Vida?). XIV Congresso Nacional de Matemática Aplicada e Computacional ( XIV CNMAC ) - sept. 1991, Nova Friburgo, Brésil. Publié dans la revue de l'institut de mathématiques Iniciação Científica em Revista, No. 1, pp. 29 - 36, I.M./UFRJ (1991).

[S57] Hoang, T.B., Pasillas-Lépine, W., De-Bernardinis, A. et Netto, M. Extended braking stiffness estimation based on a switched observer, IEEE Transactions on Control Systems Technology, soumis, 2013.

## 5.7 Documents de prospectives

[P58] Participation dans la rédaction du document suivant de prospectives en automatique : 'Prospectives en automatique, horizon 2020 : Contribution de l'Automatique aux défis, à l'HORIZON 2020, des Sciences et Technologies de l'Information et de Communication et de leurs Interactions ". Ce document a été rédigé par les membres de HYCON2 et du GDR MACS sous la coordination de Françoise Lamnabhi-Lagarrigue. La version anglaise de ce document est devenue le document de référence de prospectives en automatique de la Commission Européenne.

## 5.8 Rapports de recherche

**PREVENT : sous—projet PReVAL**

J'ai contribué aux livrables suivants :

[R59] D16.4 Project final report and recommendations for future assessments, janvier 2008, et Annex E to D16.4 Framework for the assessment of preventive and active safety functions.

[R60] D16.3 Proposal of procedures for assessment of preventive and active safety functions, déc. 2007.

[R61] D16.2 Analysis and results of validation procedures for preventive and active safety functions, août 2007.

[R62] D16.1 Review of validation procedures for preventive and active safety functions, juin 2007.

### **PreVENT : sous-projet SAFELANE**

J'ai contribué aux livrables suivants :

[R63] D31.10.2 Final Report, février 2007.

[R64] D31.31 Specification Catalogue, juillet 2004.

[R65] D31.32 System concept, août 2004.

[R66] D31.42 Actuator system, février 2006 (responsable du livrable).

[R67] D31.32 System concept, juillet 2006.

[R68] D31.51 Demonstration Vehicles, septembre 2006.

[R69] D31.51 Demonstration Vehicles, décembre 2006.

### **PARTAGE**

J'ai contribué aux livrables et rapports suivants :

[R70] L2-1a Cibles Technologiques, juin 2010 (responsable du livrable).

[R71] Rapport tâche 6, T6-6-1a La conduite en conditions limite : contrôle d'un modèle non linéaire du véhicule par une approche affine par morceaux via le suivi d'une référence en vitesse de lacet, 2011.

[R72] Rapport Tâche 6, T6-6-1a Les systèmes actifs d'aide au conducteur à haute performance : les concepts, l'analyse fonctionnelle, le contrôle-commande et la conception avec réduction du coût. 2012 (rédacteur du rapport).

[R73] Rapport Tâche 6 T6-6-1b Système d'assistance par contrôleur dynamique pour le suivi de voie et l'évitement d'obstacles , 2011.

[R74] Rapport Tâche 6 T6-6-1b Contrôle latéral PID du véhicule par vision : comment associer peu de mesures avec une forte robustesse à de scénarios de conduite difficile ?, 2012 (rédacteur du rapport).

### **REGENEO**

[R75] First Year and Second Year Activity Reports 2010-2011 et 2011-2012.

### **HYCON2**

J'ai contribué aux livrables suivants :

[R76] Livrable D5.5.1. Document of Guidelines for the Development of Bechmarks, fév. 2012. (C. de Prada, A. Rodriguez, R. Mazaeda, A. Merino, L. F. Acebes, D. Sarabia, M. Netto).

[R77] Livrable D4.1.1 : Decision-making in self-organizing systems based on a hierarchical or on distributed information structure, juillet 2012. J'ai rédigé le chapitre suivant pour ce livrable (M. Netto. The road transportation network as a self-organising system : a survey on the reduction of accidents problem addressed by the control of each agent)

[R78] M. Netto. Contributeur au livrable : Mid-Term Report on Joint Workshops and New Challenges, juil 2012.

[R79] M. Netto. Contributeur au rapport annuel de HYCON2 (Second Periodic Project Report - PPR2).

J'ai rédigé le livrable suivant :

[R80] M. Netto. Livrable D9.5.1 – Making a bridge between the roadmapping work in transportation within the i–mobility forum steered by the European Commission and the European Network of Excellence HYCON2, juillet 2012.



# Chapitre 6

## Séminaires, présentations et divulgation scientifique

### 6.1 Posters, communications orales dans des congrès

#### Communications orales

J'ai assuré la présentation orale des articles suivants [C18], [C25], [C34], [C35], [C43], [C45], [C48], [C49], [C51n], [C53n], [C55n], [C56n]. J'ai présenté également en poster l'article [C41].

#### Présentations en Session invitée

J'ai présenté l'ensemble de travaux réalisés au sein du sous-projet PReVAL (j'ai représenté pour cela les responsables des WP 4 et 5 en plus du WP3) dans une session invitée dédiée à de projets européens, congrès ITS World, 2007, Beijing, Chine. Le coordinateur du projet PReVENT a présidé la séance.

#### Autres présentations

M. Netto, A. Benine-Neto, S. Scalzi, W. Pasillas-Lepine, S. Mammar. La conduite en conditions limites par contrôle sur un modèle non-linéaire du véhicule : approche affine par morceaux, robustesse prouvée". J'ai réalisé cette présentation en 2009 à Montpellier, pour une réunion du GT MOSAR, GDR MACS.

#### Chairman

Co-chairman dans IEEE ITSC, Toronto, 2006.

### 6.2 Séminaires présentés

J'ai présenté les séminaires suivants :

- A Northeastern University, Boston, Etas-Unis. Séminaire *Convexification : a new tool for the adaptive control of non-linearly parametrized systems*, novembre 1999. J'ai présenté ce séminaire pour l'équipe du Professeur Stankovic.
- A l'Université Fédérale de Rio de Janeiro, Rio de Janeiro, Brésil. *Cours-séminaire sur la commande Supervisory appliqué au contrôle des moteurs à induction*, septembre 1998. J'ai présenté ce séminaire pour l'équipe du Professeur Liu Hsu.

## 6.3 Divulgence scientifique

J'ai préparé, en collaboration avec Digiteo, un film contenant une synthèse des résultats du LIVIC (en suivant la logique : perception de l'environnement et action, en cas de danger, par de systèmes actifs d'assistance à la conduite) pour la fête de la science au Grand Palais en 2008. J'ai assuré la présentation de ce film pour le grand public lors de cet événement.

Les systèmes de contrôle actifs décrits dans le Chapitre 7 (ci-dessus) sont apparus dans les émissions suivantes de télévision :

- Journal télévisé FR3, Octobre 2004.
- La voiture du futur, France Inter, Septembre 2004.
- Reportage dans Turbo, M6 sur l'achèvement du projet ARCOS.
- Automoto : l'évolution de la sécurité passive, février 2010.

# Chapitre 7

## Synthèse des travaux

Mes recherches (personnelles et via l'encadrement d'étudiants) à partir de mon arrivé au LIVIC ont porté principalement sur le développement et l'évaluation de systèmes actifs d'assistance au conducteur, avec validation sur véhicule d'essai. En automatique, j'ai traité principalement la problématique du contrôle latéral du véhicule, aussi bien pour assister que pour automatiser la conduite. En évaluation, j'ai coordonné, en collaboration avec un collègue, une équipe de professionnels (de l'industrie et d'instituts de recherche en Europe) pour construire un guide d'évaluation de systèmes de sécurisation de la conduite. Enfin, appartenant au départ à la communauté de recherche en automatique, je me suis intégrée à la communauté de recherche sur l'automobile. J'ai également poursuivi mes recherches en théorie pure d'automatique. Un résumé de l'ensemble des résultats est mis en évidence ci-dessous :

### 7.1 Contrôle actif du véhicule

En contrôle du véhicule, j'ai travaillé et encadré plusieurs étudiants pour la conception de différents systèmes d'aide au conducteur, dont la plupart d'entre eux sont opérationnels sur véhicule d'essai. Chacun de ces systèmes vise à aider le conducteur dans une situation différente de danger sur la route, et donc leur usage n'est pas la même. La construction d'un système d'aide est toujours liée à un scénario de danger (établi par des études en accidentologie), que l'on appelle également en anglais use cases. Ainsi, certains traitent de la problématique de correction de la trajectoire du véhicule sur une ligne droite, d'autres aident le conducteur à l'intérieur d'un virage. Plus loin, les situations de forte instabilité de la conduite ont été traitées par la prise en compte de modèles non-linéaires des forces de contact pneumatique-chaussée. Des systèmes à faible coût, avec un minimum de capteurs, ou à un coût plus élevé mais plus performant sont aussi disponibles. L'ensemble de ces systèmes a été décrit dans le Chapitre 4. J'ai également travaillé sur deux systèmes pour automatiser la conduite du véhicule, l'un d'entre eux avec validation in-situ.

## 7.2 Evaluation de systèmes de sécurisation de la conduite

**Evaluation technique.** J'ai réalisé ce travail au sein du Workpackage 3 du sous-projet PReVAL du projet européen PReVENT. Pendant les deux premières années de PReVENT, à l'intérieur de chaque sous-projet vertical (huit au total, voir dans le chapitre 9 quelques éléments sur la structure de PReVENT), plusieurs systèmes ont été développés et évalués (e.g. alerte sur collision latérale, régulation de vitesse,...). Dans PReVAL, sous-projet horizontal de PReVENT, j'ai coordonné, en collaboration avec un collègue, une équipe de 8 partenaires pour analyser l'ensemble des évaluations (des systèmes proposés) réalisées au sein de chaque sous-projet de PReVENT. Par une analyse approfondie de la méthodologie et de la mise en œuvre de ces évaluations, nous avons construit, comme résultat, un guide d'évaluation de systèmes de sécurisation de la conduite. Ce guide tient compte de résultats de projets antérieurs sur le thème évaluation, tels que les projets CONVERGE et APROSYS. Le guide d'évaluation technique proposé fait partie du livrable D16.3 Proposal of procedures for assessment of preventive and active safety functions (dans l'annexe). Ce guide est devenu une référence en Europe pour l'évaluation de systèmes d'aide à la conduite.

**Collaboration avec des experts en SHS.** Un autre point important de mon parcours professionnel concerne le travail que je réalise en collaboration très proche avec des experts en psychologie cognitive (groupe PsyCoTech, IRCCyN, Nantes). L'objet de cette collaboration porte sur l'étude de l'interaction de l'homme avec les systèmes de sécurisation de la conduite (ou automates), afin de mieux régler ces systèmes pour une acceptation accrue par les passagers. Le mot clé est la coopération homme-machine. Il s'agit d'une collaboration entre deux groupes avec de compétences très complémentaires (automatique et psychologie cognitive) où un dialogue et une compréhension des deux langages par les deux parties ont été acquis. Mon travail avec le groupe PsyCoTech a commencé dans le cadre du projet ARCOS à mon arrivée au LIVIC et s'est poursuivi par le projet ANR PARTAGE, dont j'ai coordonné le partenaire ex-LCPC jusqu'à août 2010. J'ai également travaillé en collaboration très proche, au sein du projet PReVAL, avec une équipe dédiée à l'étude de l'évaluation tenant compte des facteurs humains (workpackage 4 de PReVAL). Cette équipe a été coordonnée par VTEC (Volvo Technology), et les résultats ont été intégrés au même livrable contenant le guide d'évaluation technique décrits ci-dessus. Des similarités et interactions entre l'évaluation technique et l'évaluation des facteurs humains ont été identifiées et mises en évidence dans le livrable.

## 7.3 Recherche Théorique en Automatique

Ma recherche en théorie pure d'automatique porte sur la commande adaptative des systèmes non-linéaires et non-linéairement paramétrés. Peu de résultats sont disponibles dans la littérature dans ce domaine, dont une partie aborde le problème via certaines propriétés liées à la convexité de fonctions. J'ai construit, pendant ces années, de résultats permettant la commande adaptative d'une classe de systèmes contenant une paramétrisation multilinéaire, de laquelle plusieurs systèmes physiques font partie (donnant lieu aux publications jointes entre le MIT et moi (publications [L1], [C33] et [C18]).

Troisième partie  
Scientific contributions



# Chapitre 8

## Transportation challenges : an overview

This Part of the manuscript is dedicated to introducing and discussing the scientific results whose details will be available in the annexes as a selection of papers. It is organized in the following way. Chapter 8.1 contains an overview of the transportation context and a structuring of the driving assistance systems design problem. The goal is to come from ‘*Macro*’ to ‘*Micro*’, that is to first have an overview on a set of challenges linked to Transportation including on how to structure the problem of increasing road safety by embedding systems in the vehicle, to only after this, talking on how to design (by using control theory) these systems or on how to evaluate them.

This part is organized as follows : After the transportation context is discussed in Chapter 8.1 , Chapter 9 contains my scientific contributions. These include my research results, my contributions in students advising, in the coordination of research groups, and the collaborative works. It is structured in 3 sections : Section 9.1 introduces what will be the greed for a part of the main contributions, that are described in Sections 9.2 and 9.3. Section 9.1 is also dedicated to showing to the reader how theory and abstractions can be very important for solving real problems. Chapter 9.4 describes some results from collaborative works.

A discussion from a multidisciplinary view is provided in Chapter 9.5 through a survey paper of myself.

Since the results here are in the intersection of the control theory and the transportation communities, Part VI provides some fundamental notions on control theory - by adopting a qualitative description - to help the non control readers to understand the contributions.

### 8.1 The transportation context

This section aims in giving an overview of different contextual elements in transportation. The citizens quality of life, the sustainable development, and the road safety are for example discussed below.

We will also show that the Europeans directives point out to a global approach in transportation and in the development of Intelligent Transport Systems. Indeed, given the complexity and the importance of the transportation systems to the citizens, a global

approach is the only way to achieve improvements with respect to a large set of different objectives (safety, reduction of green house gases, minimum travel times, better mobility, etc) [10].

In this sense, ITS must be of an “integrated” nature. This is defined in [1] as :

“ITS integrate telecommunications, electronics and information technologies with transport engineering in order to plan, design, operate, maintain and manage transport systems. The application of information and communication technologies to the road transport sector and its interfaces with other modes of transport will make a significant contribution to improving environmental performance, efficiency, including energy efficiency, safety and security of road transport, including the transport of dangerous goods, public security and passenger and freight mobility, whilst at the same time ensuring the functioning of the internal market as well as increased levels of competitiveness and employment.”

Let us see also the directives of the European Parliament on the priority areas for Intelligent Transport Systems (ITS) [1]. First, it is defined that the need for ITS comes from : “The increase in the volume of road transport in the Union associated with the growth of the European economy and mobility requirements of citizens is the primary cause of increasing congestion of road infrastructure and rising energy consumption, as well as a source of environmental and social problems.”

The priority areas for the development and use of specifications and standards are identified in [1] below :

- Optimal use of road, traffic and travel data
- Continuity of traffic and freight management ITS services
- ITS road safety and security applications
- Linking the vehicle with the transport infrastructure

We will see in the following a functional analysis to list some of the very broad and wide range of elements involved, that can give then an idea of the challenges.

**The citizens quality of life.** The following points are for example involved :

- The noise pollution : noise increases the stress.
- The time travels and the quality of the day to day travels. Without traffic jam it is much better... no stress.
- The transport must be accessible to all and then well adapted to disabled and elder people.
- The safety must be integrated and improved being in all cases a necessary condition.

**The sustainable development.** Some key points are :

- Greenhouse gases reduction. There are different ways to reduce the GHG. One of them is to improve the combustion engine technology, and to search for alternative fuels. With this goal, following an agreement between the European Commission and industry [3], CO<sub>2</sub> emissions from new passenger cars sold in the EU have decreased by 12.4% between 1995 and 2004. Following this agreement, research and technological development co-funded by the EU has had a strong focus on clean and energy efficient vehicle technologies and alternative fuels, such as biofuels, hydrogen and fuel cells [4]. The deployment of electric vehicles is another way of reducing GHG emissions.

- Consumption reduction : this involves research on how to help the driver to drive reducing consumption.
- The eco-vehicle : electric and hybrid vehicles, regenerative braking.
- Systems to optimize the vehicle energy taking into account the road traffic.
- Integration of the electric vehicles in the smart grids and the involved challenges.
- The environment around the town and the associated ecosystem : a road that goes through a national park ; a road that goes through urban environment ; a road in an agricultural region.

**Road safety.** Many different elements and research topics are involved, such as :

- To work on the driving schools to make the youth people conscious of different and very important information : for example on the effects of the speed increase on the accident[9] ; Also, it is recommended that the driver and the passengers stop the car each 2 hours to a restroom. This can save a life in the case an accident occurs. However, unfortunately few people know that.
- The driver can be helped by a driving assistance system but, except for the automated driving context, it is very important that he keeps the responsibility of driving, and does not rely too much on the system in order to avoid negative effects like the complacency effect [5].
- Questions of reliability of the electric vehicles.
- The road automation concepts and the road safety : automation can bring comfort and bring better health for example to people that need to take the highways everyday to go to work. One of the expected benefits in automation is the mobility improvement - fluidity of the traffic - , but the reliability questions, including the human-machine cooperation issues are fundamental and many challenges exist before constructing a reliable and operational system [6].
- The different existing and under research systems for road safety : embedded in the vehicle, installed in the infrastructure, or both ; of warning or of intervening type ; systems to avoid the accident or systems to reduce the severity or the consequences of the collision (collision mitigation systems or passive safety). Also, driving assistance systems are not dissociated from the type of the road network [7].
- Different needs exist for driving assistance systems : to protect the passengers from collisions with fixed objects on the road side as trees for rural roads or other objects in the urban environment. To protect the vulnerable road users (VRUs : this is very important in the urban context .

... but different solutions can be necessary depending on the road network type :

**Some common needs to all types of road networks.** The points below are concerned for all the network types.

- The greenhouse gases emissions reduction.
- The improvement of the traffic fluidity (reduction of the traffic jams).
- The augmentation of the road safety.
- Human-machine cooperation studies : for all discussed systems the HMC studies must be present.

**Different priorities can exist depending on the road network.** Let us consider the two different cases below :

**1. In terms of safety :**

- in highways, the avoidance of secondary accidents is of major importance given the high speed of the vehicles. Warning systems based on telecommunications to inform the coming vehicles of accidents on the road allow the coming vehicles to reduce their speeds with enough anticipation.
- Many secondary roads are of double direction and the relative speeds can increase up to 180km/h or more. [8] underlines that the speed is an important risk factor since it is almost always present as an occurrence and/or gravity factor. As a matter of fact, independently on the origin of the accident, the reaction margin of the drivers to avoid the collision is determined by their speeds. In addition, the gravity of the accident depends on the collision energy and then on the speeds before and in the moment of the collision. The speed (inadapted or excessive) would play a major role in more than 40% of the mortal accidents. Lane departure prevention systems is probably more important then in secondary roads then in highways where the number of accidents is much smaller (the number of deaths in highways in 2012 represents 7% of the total while in the secondary roads it represents 66% of the total number [9])
- In urban areas, one of the fundamental features is the high number of VRUs : pedestrians, cyclists, rollers, children, mothers with pushchairs, elder people, etc. It is fundamental then to protect them. Systems for VRUs protection is certainly much more important in urban areas than in highways.
- In terms of the advanced driving assistance systems (ADAS) : certainly the public buses in urban areas ask for different ADAS than the buses for inte-city travels via highways. The reason is that the problem definition changes since as discussed the safety challenges are not the same (for example, the maximum allowed speeds are very different in urban areas from the maximum allowed speeds in highways). Also, the urban areas contain vehicles that other areas do not, as for example the autolibs.

**2. In terms of the quality of life :**

- The reduction of the noise pollution is certainly more critical in urban areas.
- In terms of sustainable development : there are also further questions like the (short and long) term effects of the noise pollution in the roads in the middle of the forests.

Having in mind the complexity of the transportation context, we can now look at the specific problem of improving road safety by the design of driving assistance systems. This problem, although it is a subset of the transportation global problem, it is itself a very complex problem as well, since it involves a diversity of road scenarios and human cooperation studies since the human being is in direct contact with the assistance system. The following section gives a structure from the European PReVENT Project, that helps to formulate a specific problem for ADAS synthesis.

## 8.2 A view on ADAS systems for road safety

As described in the Preface, after the thesis, I have continued to dedicate part of my time to my original research topics on control theory, but focusing most of my research in the transportation domain in which I have dedicated myself mainly to the topic of road safety. I will show nevertheless in the following sections how these two very different research lines (theoretical and founded on abstractions ; and the research focused on the solution to concrete problems) have merged to the design of solutions to a real road safety problem.

To begin, I firstly clarify how usually car manufacturers and academicians structure the problem of increasing the road safety by the introduction of advanced driving assistance systems (ADAS) in the vehicle. ADAS can be seen as a subset of ITS systems. The road safety is, as described in the previous section, a very complex problem. So, as all complex problems, this complex context needs to be structured, in order that solutions can be searched for and designed. One very known decomposition of the problem of increasing the road safety by designing new systems to embed in the vehicle has been done in the PReVENT European Project (<http://www.ertico.com/prevent>). This structuring/decomposition of the problem of designing systems to assist the driver takes into account the following :

- The different systems needed according to the different time-to-collision (from 0 to 10 sec ; or bigger than 10sec)
- The spatial regions around the vehicle that need to be covered by different assistance systems
- Two road scenarios (intersections ; or vehicles driving in a two-lane road)
- If the ADAS are communications-based or not
- The following two types of challenges : the design of the system itself to help the driver ; or the design of new tools/regulations necessary for the new systems design and deployment.

Figures 8.1 and 8.2 below (available in the PReVENT public deliverable [7]) illustrate the proposed structure. The first figure shows :

- A classification of the driving assistance systems as a function of the time to the accident - or Time To Collision (TTC) - in the range from 500ms and 10sec - and as a function of the spatial region around the vehicle in which the system is designed to avoid the accident - avoidance of frontal, side or rear collisions for example.
- This figure shows in addition two scenarios : the intersection safety scenario and the prevention of accidents in the context of a vehicle in a two-lane road.
- Also, essentially two kinds of systems are also illustrated in this same figure : communications-based systems for foresighted driving ( $TTC > 10$  sec) and in-vehicle embedded sensors based systems for avoiding accidents within 500ms to 10 secs of Time-To-Collision.

We can moreover define that designing driving assistance systems involves two different research needs : the research related to the design of the system itself for a defined scenario (a system for improving safety in intersections as above for example) ; and the research to improve the "tools" used as input to these systems - as the maps, sensors and perception algorithms - and further the research to make progress all the necessary connected fields

as for example on how to evaluate the proposed systems, on the legal aspects so that the systems can be deployed, etc. These are usually called the *vertical* and the *horizontal* research and in particular, in the case of PReVENT, have been denoted as *functional* and *cross-functional fields* respectively (see the figure 8.2).

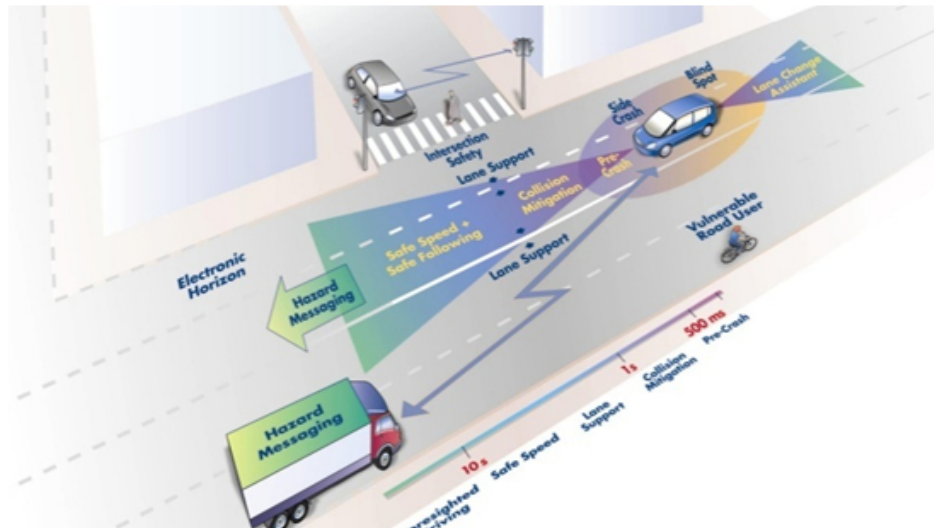

FIGURE 8.1 – Illustration of the different levels of temporal frames associated to different driving assistance systems

In PReVENT, the functional (or vertical) fields corresponded to the need for the design of systems (or functions) to assist the driver ensuring the following :

- V1. A safe speed and a safe following (vehicle longitudinal assistance),<sup>1</sup>
- V2. The monitoring of the driver and the region around the vehicle (360 degrees) to prevent lateral collisions and lane departures.
- V3. The improvement of safety in the intersections
- V4. The protection of the vulnerable road users and the protection of the passengers in case of accidents (reduction of the severity of the collision, pre-crash)

The defined cross-functional (or horizontal) fields are listed below :

- H1. The evaluation of the proposed systems and the study of the legal aspects linked to their deployment
- H2. The research on the evolution of the Maps and location-related tasks
- H3. The research on Environment perception (sensors and data fusion)
- H4. The integration of the vertical functions in one demonstrator vehicle.

The Figure below shows the PReVENT sub-projects associated to each field : in the functional field safe speed and safe following one example is the SASPENSE subproject that proposed systems to alert the driver in the case of inappropriate speed ; in the cross-functional field Code of Practice and Evaluation, the PReVAL subproject studied

1. Here the term 'safe speed' is also part of the research since it depends on a large number of parameters (eg. the road curvature, whether conditions, etc) and its calculation has also to be investigated.

the evaluations carried out within the PReVENT subprojects for proposing of a new evaluation guide.

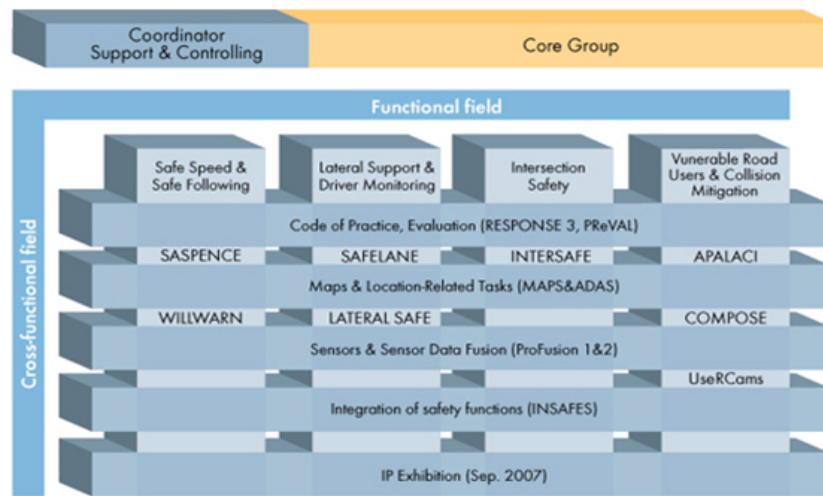

FIGURE 8.2 – Structure of the Integrated PReVENT project in vertical and in horizontal sub-projects.

After this overview on road safety and on how to structure the research on the design of driving assistance systems, Chapter 9 will show the main results, including the contributions for lane departure avoidance that, with respect to the structure above, belong to the functional field “lateral support and driver monitoring” just described.

Part VI is available for the non expert control reader to introduce some important notions on control theory that are necessary for the understanding of the contributions below.



# Chapitre 9

## Scientific contributions and discussions

In this chapter, while exposing the results (which details will be available in the annexes), I will discuss fundamental and applied research to show that using both of them together is very important in many cases to achieve original and performing solutions to solve or to make advances to real day-to-day problems.

As a matter of fact, very often, the design of theoretical solutions to real problems is preceded by the construction of abstractions (for example the design of diagrams that structure problems with a high degree of complexity). The subsequent steps after a theoretical solution is achieved are the experimental validation of the solution in simulators (or test benches) followed by its validation for real life deployment. Even though we frequently concentrate our skills in one of the steps, being aware of the whole chain from abstract to real and the challenges involved allows us also to better design the solution and to better communicate with complementary research teams or industry in order that all the steps of the chain are gone through and achieved. It is also very important to recall that very often original and innovative solutions have their origin in brainstorming procedures that lead frequently to apparently very nonsense abstractions or to completely abstract concepts, that will be after all the starting point for original and performing solutions. The research in MIT, in the media lab for example, follows often this philosophy. In general, in the text, it is aimed, in coherence with the preface, to show the importance of both :

- 1) A profound knowledge on the theoretical tools for the synthesis and analysis of systems (e.g. on control theory) and
- 2) The deep knowledge and a thorough analysis of the real problem. Indeed, both of them are of major importance in many applications. The second point will be further discussed in Chapter 9.5.

I also show in this chapter that mathematical similarities appear in completely different problems and the theory to deal with one problem is often very useful to deal with others. This clears up also the link between fundamental and applied research since one control theory can potentially be used to solve completely different practical applications. I also discuss how very preliminary abstractions can evolve to become the foundations of concepts for the design of consistent solutions to real problems.

The next section will be organized in three parts. In each one of them I describe what will be the “greed” for the results in Sections 9.2 and 9.3. One of the goals is as mentioned to show to the reader the importance of leaving place for originality even though in the beginning the first ideas may seem very far from the practical needs. Also, as discussed, similarities appear in very different problems and very often the same theory can be used to study these very different problems. As a matter of fact, the experience gained in the work described in Section 9.1.1 is used to the applied problems in Sections 9.1.2 and 9.1.3. Finally, the last goal is to show the need to come from the theory to the practice and then, very often to come back to the theory to face very difficult new problems that come from the practical implementation of the proposed solution. This last point will be further illustrated in Section 9.3 in which, after a solution using LMIs is proposed, it is pointed out that the performance could be quite improved if instead of using the vehicle lateral Ackerman model with linear parameterization (obtained by overparameterization), one could design the control directly to the original Ackerman model that is nonlinearly parameterized. This is however a very difficult problem that we cannot even know if it is solvable, but in any case, that brings us back to the class of problems studied in Sections 9.1.1 and in Section 9.2.

## 9.1 First steps to the scientific contributions

We will see below that part of my contributions have its pillars in the hybrid systems theory. In this section, I introduce the fundamentals for the proposed solutions to three different problems (two in the frame of the vehicle control and one in control theory), the three of them belonging to the class of hybrid systems. However, the hybrid modeling appears for a different reason in each one of these problems, as follows.

- The first considered hybrid system has become hybrid because of the nature of the proposed solution (H1) : it is the theoretical problem of the estimation of nonlinear regressions described in details in my PhD thesis [27]. In this case, it is the solution I proposed that made the system to become hybrid leading to an analysis by discontinuous Lyapunov functions. The stability could not however be proved because of the difficulties in using discontinuous Lyapunov functions (intrinsic to the approach) to prove stability.
- The second considered hybrid system is a system that is hybrid by itself (H2) : it is the system composed by the vehicle, the driver and a lane departure function that is activated in case of danger and replaces the driver action during a certain amount of time. In other words, the control of the vehicle will switch between the driver and the assistance function in the case a threshold associated with a defined "risk criterion" is attained. It is then natural to model the ‘vehicle driven by a driver or by an automatic control system to prevent lane departure’ as a hybrid system.
- The third considered hybrid system became hybrid because of the simplification of its model (H3) - we approximate a nonlinear model by a piece-wise affine model : with the goal considering the control of the vehicle lateral dynamics and positioning in the case of strong solicitations in the tire-road contact forces, a piecewise linear model has been used as an approximation of the nonlinear curves of the tire contact

forces. The resulting system is also of hybrid nature.

Summarizing, the hybrid nature of each one of the systems above appears because of very different reasons : in the first case (a purely mathematical problem consisting in the estimation of nonlinear regressions), a hybrid model together with a discontinuous Lyapunov function appears because of the nature of the proposed approach (the proposed estimation laws switches as a function of the estimated output error). In the second case (the road safety problem of lane departure prevention), the system driver-automat-vehicle is hybrid by itself since the control of the vehicle will be given either to the driver or to the automat as a function of certain criteria. A hybrid model comes then naturally. And in the third problem (vehicle lateral control in the case of strong solicitations in the tire contact forces), the hybrid modeling is used for the simplification of a strong non-linearity coming from the tire contact forces. These three hybrid systems will be described below in sections 9.1.1, 9.1.2 and 9.1.3, to introduce part of the results that follows further in this same chapter.

### 9.1.1 A hybrid system from a new idea for NLP control

This section is structured in five parts. The first part gives the geometric definition of a convex function. The second presents an important property of a convex (concave) function that will be fundamental for the understanding of my contributions for the control of NLP systems (Section 9.2). The third part explains how this property is useful for the NLP systems control and finally Sections the two last parts recall an idea from my PhD thesis that consisted in transforming a non-convex function into a convex/concave function by two reparameterizations of the system aiming to ensure stability in all the state-space. We will see however that the approach leads to discontinuous Lyapunov functions and the stability cannot be ensured. Nevertheless another solution blows up from this first approach. This solution will be introduced in Section 9.2 containing the contributions in control theory will all the details in the annexes.

#### Geometric definition of convexity (concavity)

Let us first consider the geometric meaning of a convex function. If we consider the function  $f(\alpha)$  in the figure below,  $f(\alpha)$  convex means that the line segment between  $(\alpha, f(\alpha))$  and  $(\alpha', f(\alpha'))$ , for all  $\alpha'$  and  $f(\alpha')$  lies above the graph of  $f$ . The mathematical definition of a convex function can be found for example in [30] and [32] and is omitted here since it is not directly used in this manuscript. Instead, we give below an important property of a convex (concave) function that will be fundamental for the understanding of my contributions on adaptive control theory.

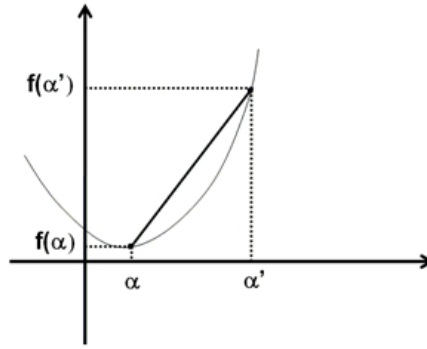

FIGURE 9.1 – Geometric definition of convexity.

### An important property of a convex (concave) function

The inequality below describes a property that holds when the convex function  $f$  is differentiable.

**Theorem 1** [32] *Let  $f$  be a function differentiable on an open set  $\Omega \subset \mathbb{R}^n$ , and let  $C$  be a convex subset of  $\Omega$ . Then (i)  $f$  is convex on  $C$  if and only if*

$$f(\alpha) \geq f(\alpha_0) + \left. \frac{\partial f(\alpha)}{\partial \alpha} \right|_{\alpha_0}^T (\alpha - \alpha_0) \quad (9.1)$$

for all  $(\alpha, \alpha_0) \in C \times C$ , where  $\frac{\partial f(\alpha)}{\partial \alpha}$  denotes the gradient. (ii)  $f$  is strictly convex on  $C$  if and only if strict inequality holds in (9.1) whenever  $\alpha \neq \alpha_0$ . If the inequality (9.1) is inverted ( $\geq$  is replaced by  $\leq$ ), then  $f$  is concave.

### Adaptive control of convexly/concavely parameterized systems

The motivation to consider convex parameterizations can be easily understood by considering the task of regulating to a constant reference the scalar plant [17]

$$\dot{x} = f(x, \alpha) + u \quad (9.2)$$

where  $x, u \in \mathbb{R}$ ,  $\alpha \in \mathbb{R}^l$  is a vector of unknown parameters and the scalar function  $f(x, \alpha)$ , is differentiable in  $\alpha$ .

If the parameters are known, the control  $u = -f(x, \alpha) - Ke$ , with  $e = x - \bar{x}$ , where  $\bar{x}$  is the constant reference input, achieves the objective since the closed-loop system becomes  $\dot{e} = -Ke$ , implying the convergence of the error signal  $e$  to zero and then the convergence of the state  $x$  to the reference  $\bar{x}$ . In the case of unknown parameters we might adopt the certainty equivalence approach to get

$$u = -f(x, \hat{\alpha}) - Ke \quad (9.3)$$

where  $\hat{\alpha}$  is an estimate of the unknown parameters. Equations (9.2) and (9.3) lead to the closed-loop system

$$\dot{e} = -Ke + f(x, \alpha) - f(x, \hat{\alpha}) \quad (9.4)$$

Suppose we use an estimation law based on the gradient as in the linearly parametrized case as

$$\dot{\tilde{\alpha}} = \left. \frac{\partial f(x, \alpha)}{\partial \alpha} \right|_{\hat{\alpha}} e \quad (9.5)$$

where  $\tilde{\alpha} = \hat{\alpha} - \alpha$ , and study the error system defined by (9.4) and (9.5). To this end, consider the candidate Lyapunov function

$$V = \frac{1}{2}(e^2 + |\tilde{\alpha}|^2) \quad (9.6)$$

Its derivative yields

$$\dot{V} = -Ke^2 + e \left[ f(x, \alpha) - f(x, \hat{\alpha}) + \left( \left. \frac{\partial f(x, \alpha)}{\partial \alpha} \right|_{\hat{\alpha}} \right)^T \tilde{\alpha} \right] \quad (9.7)$$

When  $f$  is convex in  $\alpha$  (on a nonempty convex set  $\Theta$  in  $\mathbb{R}^l$ ), we use Theorem [32] to have :

$$f(x, \alpha) \geq f(x, \hat{\alpha}) + \left. \frac{\partial f(x, \alpha)}{\partial \alpha} \right|_{\hat{\alpha}}^T (\alpha - \hat{\alpha}) \quad (9.8)$$

for all  $\alpha, \hat{\alpha} \in \Theta$  and all  $x$ .

Therefore, when  $e \leq 0$ , Eqs. (9.7) and (9.8) imply that  $\dot{V} \leq -Ke^2$ .

However, when  $e > 0$ , if  $f$  is nonlinear in  $\alpha$ , we cannot ensure the sign-definiteness of  $\dot{V}$ .

If  $f(x, \alpha)$  is concave in  $\alpha$ , inequality (9.8) above holds with the sign inverted which implies that  $\dot{V} \leq -Ke^2$  when  $e \geq 0$ , that is, in the complementary half of the state space with respect to the first case. Many new ideas starting from this property have given place for some first results for the NLP systems control in the case of convex/concave parameterizations as in [17], [18] and [21]. In spite of 15 years of research, though some advances have been achieved, the literature is still quite scarce (see the literature review in the annexed paper [33]).

### Making convex by reparameterizing

In [20] and [27], my results in collaboration with MIT for the adaptive control of convexly parameterized systems show that some classes of NLP systems can be reparameterized such that the original non-convex parameterization becomes convex and so, the adaptive control results cited just above for convexly parameterized systems could be used.

### Reparameterization to convexify and concavify

In the control of convexly-parameterized systems, we have shown above that convexity ensures that the adaptive law based on the gradient search "goes in the right direction" when the error is non-positive. However, when the error is non-negative, we could not ensure the sign-definiteness of the Lyapunov function. For concave functions, the opposite situation holds, the adaptive law based on the gradient search "goes in the right direction" when the error is non-negative. This suggests that it would be interesting to have some convexity and concavity properties at the same time so that we could ensure the negative semi-definiteness of the derivative of the Lyapunov function along the system trajectories in all the state-space. In order to have some convexity and concavity properties at the same time I have asked myself the following question : is it possible to find two different reparameterizations, one that convexifies and another that concavifies the nonlinear parametrization? Is this property useful to prove stability? This idea is illustrated in [27] with three precise examples when dealing with the problem of identification of nonlinear regressions.

However, what happens is that when coming back from the two reparameterizations to the original state-space, the corresponding two parts of the Lyapunov functions change their forms in the original parameter space and the resulting Lyapunov function can then be discontinuous. The consequence is that the trajectories can then escape! The Figure below illustrates a discontinuous Lyapunov function and the trajectories that, as a consequence, can escape.

For the following, let us first define what is a CC-function (convexifiable-concavifiable function) as in [27], to present after this one of the above cited examples to illustrate the idea and the blocking point because of the discontinuous Lyapunov function, that will serve as the starting point to a new solution.

Let us define what we call a CC-function (convexifiable-concavifiable function), as below.

**Definition 1** [27]  $\phi(x(t), \theta) : \mathbb{R}^n \times \Theta \rightarrow \mathbb{R}$ , with  $\Theta$  a convex subset of  $\mathbb{R}^\ell$ ,  $\phi \in C_1$ , is a CC-function (convexifiable-concavifiable function) if

$\exists \psi_i(\theta) : \Theta \rightarrow \Theta$ ,  $i = \alpha, \beta$ , such that  $\psi_i$  are diffeomorphisms and

i)  $\phi_\alpha(x(t), \alpha) \triangleq \phi(x(t), \psi_\alpha^{-1}(\alpha))$  is convex with respect to  $\alpha$  (uniformly in  $x$ ).

ii)  $\phi_\beta(x(t), \beta) \triangleq \phi(x(t), \psi_\beta^{-1}(\beta))$  is concave with respect to  $\beta$  (uniformly in  $x$ ).

### Identification of nonlinear regressions

*Identification of nonlinear regressions problem.* Consider the function  $\phi(x(t), \theta)$ , nonlinear in  $x(t)$  and in  $\theta$ . The problem consists in finding an adaptive law  $\dot{\hat{\theta}} = f(x(t), \hat{\theta})$  for the estimate  $\hat{\theta}$  of  $\theta$  such that the error  $\tilde{y} \triangleq \phi(x(t), \theta) - \phi(x(t), \hat{\theta})$  tends to zero.

#### Example

In the following we consider the example

$$\phi(x(t), \theta) = f(x(t))^T g(\theta), \quad \text{with } f : \mathbb{R}^n \rightarrow \mathbb{R}^p, g : \mathbb{R}^\ell \rightarrow \mathbb{R}^p$$

where  $f(x(t))$  and  $g(\theta)$  are given by :

$$f(x(t)) = [(\cos^2 x(t) + 1), (\sin^2 x(t) + 1)]$$

$$g(\theta) = [\theta_1\theta_2, \theta_1\theta_2^2]$$

with  $\theta_1 > 0$ ,  $\theta_2 > 0$ .

In this case  $\phi(x(t), \theta)$  is given by

$$\phi(x(t), \theta) = \theta_1\theta_2(\cos^2 x(t) + 1) + \theta_1\theta_2^2(\sin^2 x(t) + 1) \triangleq y$$

and we will take its estimate as

$$\phi(x(t), \hat{\theta}) = \hat{\theta}_1\hat{\theta}_2(\cos^2 x(t) + 1) + \hat{\theta}_1\hat{\theta}_2^2(\sin^2 x(t) + 1) \triangleq \hat{y}$$

We choose the reparameterizations  $\psi_\alpha(\theta)$  and  $\psi_\beta(\theta)$  as

$$\begin{aligned} \psi_\alpha(\theta) &= [\alpha_1, \alpha_2]^T = [\theta_1^{-1}, \theta_2^{-1}]^T \\ \psi_\beta(\theta) &= [\beta_1, \beta_2]^T = [\theta_1^2, \theta_2^4]^T \end{aligned}$$

The reparameterized functions  $\phi_\alpha(x(t), \alpha)$  and  $\phi_\beta(x(t), \beta)$  are given by

$$\begin{aligned} \phi_\alpha(x(t), \alpha) &= \alpha_1^{-1}\alpha_2^{-1}(\cos^2 x(t) + 1) \\ &+ \alpha_1^{-1}\alpha_2^{-2}(\sin^2 x(t) + 1) \end{aligned} \quad (9.9)$$

$$\begin{aligned} \phi_\beta(x(t), \beta) &= \beta_1^{\frac{1}{2}}\beta_2^{\frac{1}{4}}(\cos^2 x(t) + 1) \\ &+ \beta_1^{\frac{1}{2}}\beta_2^{\frac{1}{2}}(\sin^2 x(t) + 1) \end{aligned} \quad (9.10)$$

where the convexity of the function (9.9) and the concavity of the function (9.10) can be proven for  $\theta_1, \theta_2 > 0$  as shown in [33] (available in the annexes).

Consider the estimator as the gradient of the convex  $\phi_\alpha$  and of the concave  $\phi_\beta$  functions, as follows :

$$\begin{aligned} \dot{\hat{\alpha}} &= \left. \frac{\partial \phi_\alpha(x(t), \alpha)}{\partial \alpha} \right|_{\alpha=\hat{\alpha}\tilde{y}}, \quad \tilde{y} \leq 0 \\ \dot{\hat{\beta}} &= \left. \frac{\partial \phi_\beta(x(t), \beta)}{\partial \beta} \right|_{\beta=\hat{\beta}\tilde{y}}, \quad \tilde{y} > 0 \end{aligned}$$

that brought back to the original parameter space through the transformations  $\dot{\hat{\beta}} = \frac{\partial \psi_\beta}{\partial \theta}(\hat{\theta}) \dot{\hat{\theta}}$  and  $\dot{\hat{\alpha}} = \frac{\partial \psi_\alpha}{\partial \theta}(\hat{\theta}) \dot{\hat{\theta}}$ , become :

$$\dot{\hat{\theta}} = \begin{cases} \left[ \frac{\partial \psi_\alpha}{\partial \theta}(\hat{\theta}) \right]^{-1} \left. \frac{\partial \phi_\alpha(x(t), \alpha)}{\partial \alpha} \right|_{\alpha=\psi_\alpha(\hat{\theta})\tilde{y}}, & \tilde{y} \leq 0 \\ \left[ \frac{\partial \psi_\beta}{\partial \theta}(\hat{\theta}) \right]^{-1} \left. \frac{\partial \phi_\beta(x(t), \beta)}{\partial \beta} \right|_{\beta=\psi_\beta(\hat{\theta})\tilde{y}}, & \tilde{y} > 0 \end{cases} \quad (9.11)$$

where  $\frac{\partial \psi_i}{\partial \theta}$  denotes the Jacobian of  $\psi_i$ ,  $i = \alpha, \beta$ , and  $\tilde{y} = y - \hat{y}$ .

Consider also the ‘‘Lyapunov-like function’’ :

$$V(\theta, \hat{\theta}) = \begin{cases} \frac{1}{2} |\tilde{\alpha}|^2 = \frac{1}{2} \left| \psi_\alpha(\hat{\theta}) - \psi_\alpha(\theta) \right|^2 \triangleq V_\alpha(\theta, \hat{\theta}), & \tilde{y} \leq 0 \\ \frac{1}{2} |\tilde{\beta}|^2 = \frac{1}{2} \left| \psi_\beta(\hat{\theta}) - \psi_\beta(\theta) \right|^2 \triangleq V_\beta(\theta, \hat{\theta}), & \tilde{y} > 0 \end{cases} \quad (9.12)$$

where  $\tilde{\alpha} = \hat{\alpha} - \alpha$  and  $\tilde{\beta} = \hat{\beta} - \beta$ .

It can be concluded (for the details see [27]) that if  $\theta_i, \hat{\theta}_i > 0$ ,  $i = 1, 2$ , then

$$\dot{V}_\alpha \leq -\tilde{y}^2, \text{ when } \tilde{y} \leq 0 \quad (9.13)$$

$$\dot{V}_\beta \leq -\tilde{y}^2, \text{ when } \tilde{y} > 0 \quad (9.14)$$

Let us now analyze the form of the ‘‘Lyapunov-like function’’ that we have used. When applied to this example, this function becomes

$$V(\theta, \hat{\theta}) = \begin{cases} \frac{1}{2} \left( \frac{1}{\hat{\theta}_1} - \frac{1}{\theta_1} \right)^2 + \frac{1}{2} \left( \frac{1}{\hat{\theta}_2} - \frac{1}{\theta_2} \right)^2 \triangleq V_\alpha(\theta, \hat{\theta}), & \tilde{y} \leq 0 \\ \frac{1}{2} \left( \hat{\theta}_1^2 - \theta_1^2 \right)^2 + \frac{1}{2} \left( \hat{\theta}_2^2 - \theta_2^2 \right)^2 \triangleq V_\beta(\theta, \hat{\theta}), & \tilde{y} > 0 \end{cases}$$

We also know that the switching surface is

$$\begin{aligned} \tilde{y} &= \phi(x(t), \theta) - \phi(x(t), \hat{\theta}) \\ &= \left( \theta_1 \theta_2 - \hat{\theta}_1 \hat{\theta}_2 \right) (\cos^2 x(t) + 1) \\ &\quad + \left( \theta_1 \theta_2^2 - \hat{\theta}_1 \hat{\theta}_2^2 \right) (\sin^2 x(t) + 1) = 0 \end{aligned}$$

By a simple observation, we note that the above switching surface is not a fixed curve in the  $\hat{\theta}_1, \hat{\theta}_2$ -plane for all  $t$ . Instead, if  $x(t)$  is not constant for any chosen time interval  $\Delta t$ , then we will have that  $\tilde{y} = 0$  will correspond to a different curve for each  $t$ . As a consequence, once  $\tilde{y}$  becomes identically zero, we cannot assure that it will remain zero. Then,  $\tilde{y} = 0$  is not an invariant set, and then the convergence of  $\tilde{y}$  to zero cannot be proven by a qualitative analysis as for example a phase plane analysis, by showing that the vector fields point to an invariant set corresponding to the desired control goal (in this case  $\tilde{y} = 0$ ) (one should note that this example is the 3rd one in [27], where in the two first ones, despite the switching Lyapunov function, it has been possible to prove the convergence of  $\tilde{y}$  to zero by a qualitative analysis).

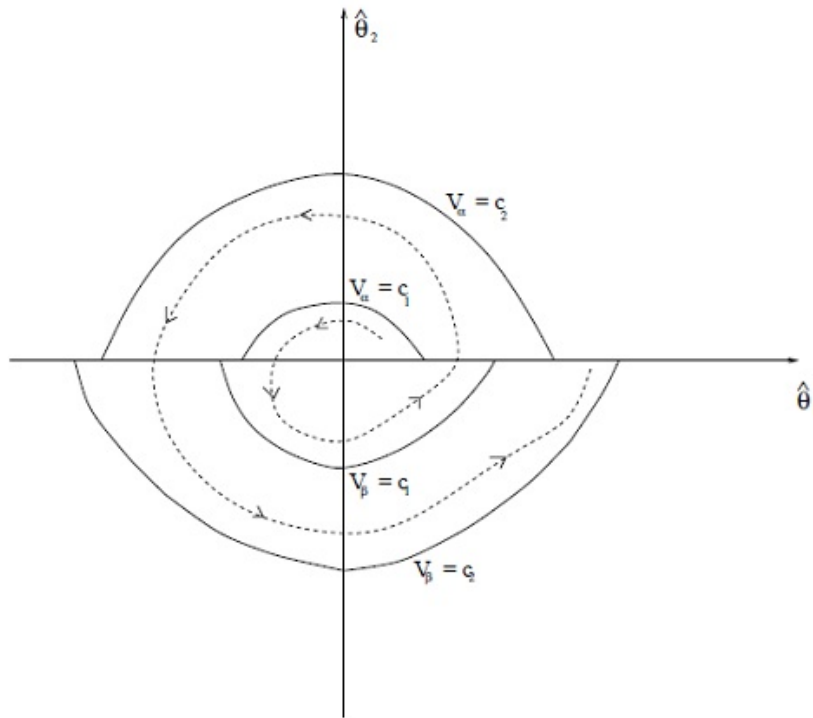

FIGURE 9.2 – In the example shown in the figure because of the discontinuity of the Lyapunov function, the trajectories can escape, and then stability cannot be ensured.

We illustrate here an undesirable situation, where the properties (9.13) and (9.14) are not enough to ensure stability. Indeed, due to the discontinuity of  $V$ , the level curves are not closed and the trajectories can escape to infinity. See Figure 9.2.

In the example above, based on the property of a CC-function that there exists two reparameterizations, one to convexify and another to concavify it, we have constructed estimation laws and discontinuous “Lyapunov-like functions” in order to study the stability of the system. We have seen in the example that the discontinuity in the Lyapunov function turns out to be a main blocking point in the stability proof. Indeed, simulations have shown that the convergence of  $\tilde{y}$  to zero may not happen.

In summary, we have proposed a new idea for the estimation of nonlinear regressions non-linearly (and non-convexly/non-concavely) parameterized, which is founded on the existence of two reparameterizations able to convexify/ concavify the original parameterization. The proposed estimation laws, are gradient-based and combine both reparameterizations to ensure a “good” search direction in both half of the state space. The use of discontinuous Lyapunov functions is intrinsic to the approach, and stability of the overall switched system cannot be easily ensured.

A solution to a problem similar to this one is described in the next chapter where stability can be achieved using a judiciously chosen non-certainty equivalence based control

structure coupled to switching adaptive and control laws. That is, somehow, the use of discontinuous adaptive and control laws with non-certainty equivalence has allowed to prove the stability with a *continuous Lyapunov function*, eliminating the above described difficulty.

The system described above is in reality a hybrid system (H1 in Section 9.1), with two different dynamics corresponding to the two different estimation laws where the guard condition is based on the sign of the switching variable  $\tilde{y}$ .

### 9.1.2 Hybrid modeling of a LDA system

Which is the relation of the theory recalled in Part VI (Lyapunov, adaptive control and hybrid systems), the example proposed just above and the lane departure avoidance problem? This is the subject of this section that serves as introduction to the results presented in Section 9.3.1. It involves the investigation on how to make use of a hybrid modeling for the system automat-driver-vehicle (that had been proposed in another in Mr. Chaibet Master's work in LIVIC), a very difficult problem. The main challenge comes from the fact that it involves proving the stability of a hybrid system in which a human-being takes part. The contents in this section have been worked by Mrs Minoiu-Enache during her Masters work under my supervision [43]. We will see that we ended up with a different formulation of the problem, after the introduction of a hypothesis on the driver behavior.

#### First Model

If a driving assistance system is activated in the case of danger, the system composed by the Vehicle, the Driver and the Assistance System is in reality a hybrid system as already described since the control of the vehicle will be switching between the driver and the automat, as a function of a certain risk criterion to be carefully chosen. We will see below that we have chosen this criterion to be the torque in the vehicle steering column as a measure of the driver attentiveness, but nevertheless we show that all the stability proofs hold if another measure of the driver awareness is chosen to replace the torque.

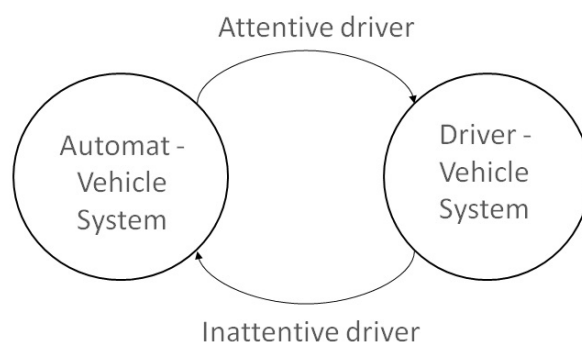

FIGURE 9.3 – Hybrid modeling of a lane departure avoidance system in which the control of the vehicle will be switching between the driver and the automat as a function of a measure of the driver attentiveness.

So, a first idea has been to analyze the stability of the resulting hybrid system by using two different Lyapunov functions, one corresponding to each dynamical system : the vehicle in closed loop with the automat and the vehicle in closed loop with the driver.

Unfortunately, since the driver behavior is in principle unpredictable, it is not possible to study the stability of the closed-loop system driver-vehicle by the use of a Lyapunov function. The vehicle is in this case in closed-loop with a control system - the driver - that could do ‘any’ maneuver and thus one could not ensure à priori properties in the trajectories of the closed-loop system driver-vehicle. The consequence is that it is not possible then, even by searching an adequate control law for the automat, to prove the stability or the boundedness of the hybrid system composed by the systems automat-vehicle and driver-vehicle illustrated in the figure above, if we do not introduce additional hypothesis.

Let us keep in mind the challenges on hybrid systems that we have discussed in the previous chapter above. In a hybrid automaton composed by two different systems each one containing its own dynamics, very unusual behavior can happen : even in the case the two sub-systems are stable, the resulting hybrid system can have an unstable behavior as it is shown in figure 9.4 below. On the other hand, the opposite situation can happen : even in the case the two sub-systems are unstable, the resulting hybrid system can be stable. But, in the case of a driver driving his vehicle, since the human being is an unpredictable system and in principle, he can do any maneuver, one could not prove the stability of the hybrid system in figure 9.3, even by changing the automat control law, without introducing additional hypothesis on the motion of the driver.

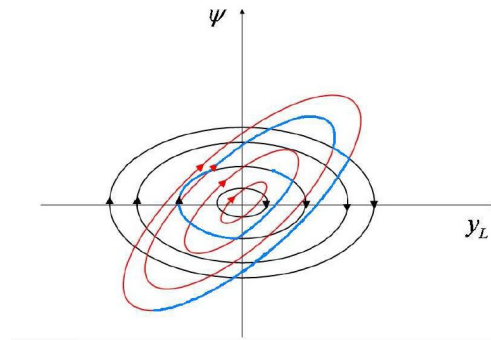

FIGURE 9.4 – The figure illustrates that the use of switching Lyapunov functions can lead to instability.

As in the first problem of the control of NP - parameterized systems, we are stuck on an obstacle. How to deal then with this obstacle to propose a solution to the problem? While in the nonlinear regressions problem, one could not prove stability that however could hold (since Lyapunov functions ensure only sufficient conditions, the fact that one cannot prove the stability by Lyapunov's direct method, does not mean that the system is not stable), in this problem, since the driver can do 'any' maneuver as discussed, the system 'can' become unstable and so it is not a matter of changing the control or changing the Lyapunov function to prove the stability. Certainly, a new (consistent) hypothesis need to be introduced. Or, the considered scenario is lane departure prevention in the case the driver is non attentive or falls asleep. On the other hand, the proposed hybrid model above considers that when the driver is controlling the vehicle, he is aware and neither asleep nor inattentive. So, we assumed the hypothesis that when the driver is controlling the vehicle (and then 'aware'), he is driving 'normally'. Mathematically, we have formulated the hypothesis of driving 'normally' by a driver staying inside a bounded region in the state space of a hypercubic form as illustrated in the Figure 9.5 below. It means that we assume that the state of the vehicle system, when the driver is driving the car, is kept inside a hypercube delimited by the maximum and the minimum values of the system state variables. In other words, we suppose that when the driver is driving, he keeps the vehicle dynamics and positioning variables bounded.

### Reformulating the control objective

The initial idea was to analyze the hybrid system driver-automat-vehicle with two Lyapunov functions : one for the system driver-vehicle and another for the system automat-vehicle, and this after the synthesis of the control law for the automat. Because we have shown that this is not possible, we have introduced the hypothesis of a zone inside which the driver stays when he is attentive (this corresponds to the case when the automat is turned off, since the driver is attentive). After the introduction of this new hypothesis, we come back now to how synthesize the control law for the automat. For this, having in mind the challenges involved in the stability proof of hybrid systems described above, we

have reworked on the reformulation of the problem. In some words, the new objective has been reformulated as :

- The objective is, during the time intervals the vehicle lateral assistance system is activated, to keep the vehicle inside a region matching as much as possible the one defining the normal driving zone in which the driver is assumed to stay. This will avoid, during the transient, that the automat drives the vehicle to a region in the state-space - outside the normal driving zone - in which the driver would not know how to control the vehicle, in the case the control of the vehicle is given back to the driver when he is in this region. This situation could happen since the system can switch in all moments of time, under a driver request, to give the control of the vehicle back to the driver.

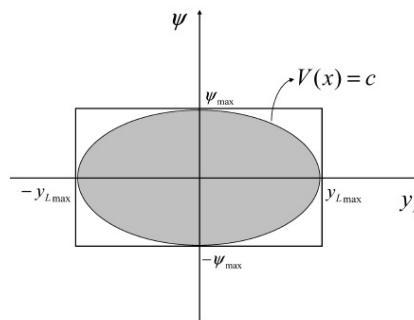

FIGURE 9.5 – The figure illustrates the assumed hypothesis on the driver behavior when he is attentive : in this case, he drives normally, keeping the vehicle state variables inside a hypercube in the state-space ; On the other hand, when the driver is not attentive, the control of the vehicle is given to the automat. The control objective is now to find a Lyapunov function such that to keep the vehicle + the automat in an invariant region (the ellipsoid in the figure) matching as much as possible the region in which the driver is supposed to drive.

From this reformulation of the problem, since it seems difficult to match exactly the hypercubic zone by the use of quadratic Lyapunov functions - that give invariant regions of ellipsoidal forms - we reformulate once more the problem to consider two hypercubes, where the larger one (see figure 9.6) represents a security zone chosen such that the vehicle is kept inside the lane borders and such that the driver shall still be able to control the vehicle if vehicle control is given back to him in this region.

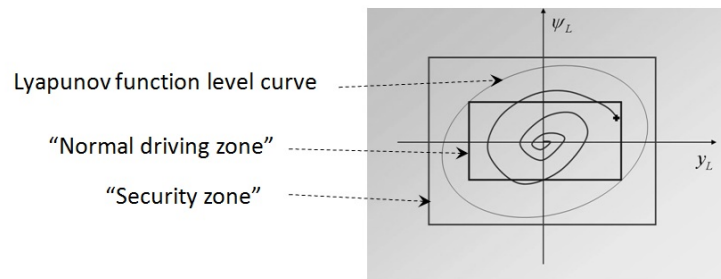

FIGURE 9.6 – In comparison with figure 9.5, a security zone is introduced.

We will see in Section 9.3.1, that starting from this greed, the work of my PhD student Minoiu-Enache has led to very well performing lane departure avoidance systems implemented in the LIVIC Prototype vehicles and validated in the Versailles test tracks. Further details will be available in the Annex in one of the related publications. I will show also that, surprisingly, the proposed solutions make us come back to the challenge of the non-linearly parameterized systems control. In this case, we will see that by considering the original Ackerman vehicle lateral model that is non-linearly parameterized instead of the linearly-parameterized version of it (obtained by an overparameterization), one could improve the results of the optimization problem used in the approach by augmenting the range of speeds in which the stability of the system is ensured. This will be discussed in Section 9.3. Let me recall that one of the hearts of the NoE HYCON2 is precisely this one : the coming back and forth from theory to real problems, as illustrated by figure 1 in the Preface.

### 9.1.3 Using hybrid systems to simplify nonlinear systems

In Mrs. Minoiu-Enache’s PhD work, the context of “slow” lane departures has been mainly considered. By “slow”, I mean “well behaved” lane departures, in the sense that high instability effects, and then no strong solicitations in the tire contact forces were present in the considered use cases. Though as extensions of the proposed approaches, two control laws have been also proposed for “strong” lane departures, this has not been the heart of the studies. The nonlinear nature of the lateral forces has been approximated by a linear model with time-varying coefficients, with consistent results but still the real nonlinear model has not been taken into account.

In order to consider the nonlinear tire contact forces model, I have proposed to my PhD student André Benine-Neto and to my post-doctoral student Stefano Scalzi to model the nonlinear tire lateral contact forces by a piecewise affine approach. As already mentioned above, this kind of modeling results also in a hybrid system and then all the associated control challenges to ensure the stability of hybrid systems had to be studied. In order to simplify, and because the hybrid system driver-automat-vehicle had been widely studied in the precedent thesis, I have proposed to Mr. Benine-Neto and to Mr Scalzi, as a first approach, to consider the problem of controlling the vehicle lateral bicycle model under the piecewise affine approximation of the nonlinear tire contact forces, with only the

automat controlling the vehicle, not considering the switchings between the driver and the automat in the control of the vehicle, that would introduce a second hybrid nature to the system.

Mainly, two different problems have been addressed in M. Benine-Neto's PhD work - the problem of stabilizing the *vehicle dynamics* under strong tire contact forces solicitations; and the simultaneous problem of stabilizing the *vehicle dynamics plus the positioning of the vehicle with respect to the lane center* also under strong tire contact forces solicitations.

One will see in the next sections that the hybrid problems studied in Mrs Minoiu-Enache's PhD work and the hybrid problems studied in M. Benine-Neto's PhD work need different treatments. The reason is mainly because of two fundamental differences between them :

1. The *first modeling integrates the driver as a part of the model* while the second does not.
2. The *second modeling integrates the nonlinear nature of the tire contact forces as a part of the model*, whether the first does not.

In the first, the heart of the stability analysis has been done by the choice of the Lyapunov function and the corresponding invariant sets combined with suitably chosen switching strategies (guard conditions), that is, it has been shown that triple "invariant set, normal driving zone, switching strategy" if well chosen, can result in a stable system. In the PWA modeling of the vehicle the stability analysis of a hybrid system is requested. Section 9.3.1 will describe some of the the achieved results.

Figure 9.7 below shows the nonlinear nature of the lateral tire contact forces and the different forms of the curves when the adhesion coefficient varies from 1 to 0,3 ( $\mu = 1$ ,  $\mu = 0,7$  and  $\mu = 0,3$ ), where  $\mu = 1$  stands for dry road. An illustration of a piecewise affine approximation is provided in figure 9.8.

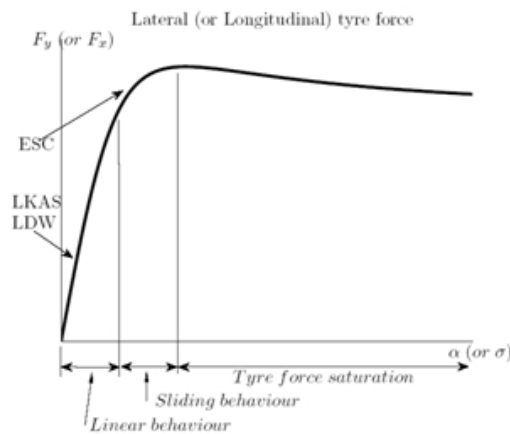

FIGURE 9.7 – Tire lateral (or longitudinal) contact force as a function of the slip angle.

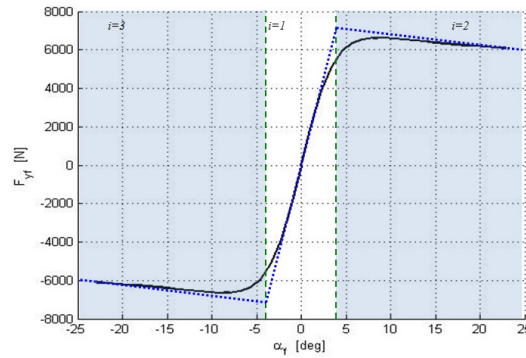

FIGURE 9.8 – PWA approximation of the tire contact force.

The next two sections will be dedicated to presenting the achieved results. Section 9.2 is dedicated to the contributions in control theory and section 9.3 is dedicated to the contributions in road safety. The contributions in road safety are split in two parts : lane departure prevention systems design and evaluation of driving assistance systems.

## 9.2 Contributions to control theory

As mentioned, NLP systems are of major importance in many different practical problems but there are nowadays unfortunately very few control theory to treat this class of systems. Different examples of important practical applications can be identified in [27], [33], [35].

The studied class of nonlinear and nonlinearly-parameterized systems is shown below. Note that the nonlinear parameterization is of multilinear type. Moreover, one can observe that the nonlinear parameterization depends on the state. This last observation is important since, because the NL parameterization depends on the state, it is not even possible to overparameterize the system to force it to become LP and then to make use of the adaptive control theory to LP systems. The considered class of systems is then :

$$\begin{aligned} \dot{X}_p(t) = & A_p X_p(t) + \\ & + b \left[ \sum_{i=1}^p \theta_1^{n_{1i} w_{1i}(X_p)} \theta_2^{n_{2i} w_{2i}(X_p)} \dots \theta_l^{n_{li} w_{li}(X_p)} \phi_i(X_p(t)) \right. \\ & \left. + u(t) \right] \end{aligned} \quad (9.15)$$

where  $X_p \in \mathbb{R}^n$  is the plant state,  $u(t) \in \mathbb{R}$  is the control input,  $\theta_j$ ,  $j = 1, \dots, l$  are scalar unknown parameters,  $A_p \in \mathbb{R}^{n \times n}$  is unknown and  $b \in \mathbb{R}^n$  is known with  $(A_p, b)$  controllable, and  $\phi_i$  are nonlinear functions of  $X_p$ . The functions  $w_{ji}(X_p)$  ( $j = 1, \dots, l$ ,  $i = 1, \dots, p$ ) are functions of the state belonging to the class of all non-negative upper-bounded functions. Also, it is assumed that  $k_{\ell_j} < \theta_j < k_{u_j}$ ,  $j = 1, \dots, l$ , with  $\text{sign}(k_{\ell_j}) = \text{sign}(k_{u_j})$ ,  $n_{ji} \geq 0$ ,  $j = 1, \dots, l$ ,  $i = 1, \dots, p$ .

The control goal is, even though the parameterization is NL and dependent on the state, to design an adaptive controller such that the system state follows the output of a defined reference model, and such that the adaptive control is able also to *keep the number of estimates equal to the number of unknown parameters*. We will control the system then directly in its original form, that is, multilinear in  $\theta_1, \theta_2, \dots, \theta_l$  (the reader is referred to paper [33] in the annexes for the precise control goal).

The main idea of the work comes from section 9.1 and has its origin in combining two parameterizations - one to convexify and another to concavify the nonlinear function of the unknown parameters - because this can allow gradient search based adaptation in all the state-space (see sections 9.1.1 and 9.1.1). As described, this approach leads however to discontinuous Lyapunov functions. In the proposed approach, this *difficulty is overcome by the proposition of a switching non-certainty equivalence based adaptive and control laws that allow the use of a standard quadratic Lyapunov function* that is a continuous function, avoiding then the previous problems of discontinuity in the Lyapunov function.

Another challenge to achieve the solution has been the proof of some key constructed concave functions (constructed to lie above the convex functions in the interval of interest). These concave functions are used in the stability proof. However, the proof of the concavity of these functions requires the proof of the positive semi-definiteness of an  $l$ -dimensional matrix that is a challenge by itself. Lemmas 3.3 and 3.5. in Section III.B of paper [33] in the Annexes show the concave functions and the corresponding proofs of concavity.

Let me recall the evolution of this work starting from my PhD thesis. Paper [20] shows that a certain class of NLP systems (inspired from the control of Fed-Batch fermentation processes, see for example [38]) can be reparameterized to become convex, allowing then the use of controllers to convexly-parameterized systems. In paper [35], the control of the above class of plants, with  $w_{ji}(X_p) = 1$  and *two parameters* has been addressed. [36] generalizes the results in [35] *to an arbitrary number of unknown parameters*. Finally [33] considers the class of systems above, with an arbitrary number of unknown parameters and the *parameterization dependent on the state*.

Let me explain briefly the main ideas involved in the construction of the solution, referencing to the equations corresponding to the two-parameters case in paper [33] available in the Annex below.

Since the original parameterization was non-convex and non-concave, the first step has been to reparameterize the system 9.15 to obtain a convexly-parameterized system. The used reparameterization is :

$$\gamma_j = \frac{1}{c_j} \ln \left( \frac{|\theta_j|}{k_{\ell_j}} \right) \text{ with } c_j = \ln \left( \frac{\bar{k}_{u_j}}{k_{\ell_j}} \right), \text{ that implies } |\theta_j| = \bar{k}_{\ell_j} e^{c_j \gamma_j}.$$

The resulting system after applying this reparameterization is shown in Eq. (21), with  $f$  given by Eq. (11).

Since the system is convexly-parameterized, we have already seen in Section 9.1.1, that a standard gradient-based adaptive control law can be used in part of the state-space. This corresponds to the control and the adaptive laws in (18) and (19) with  $S_i$  and  $L_i$  given by the upper parts of equations (16) and (17) (mathematically, we use this control and adaptive laws when  $\bar{\phi}_i(X_p)e_c \leq 0$ )

And which control and adaptive laws shall we use when  $\bar{\phi}_i(X_p)e_c > 0$ ?

The answer to this question is the key point for the results. We construct for this the

concave function  $g$  in Eq. (12) that can be proven to lie above the convex function  $f$  in Eq. (11) ([35] and [36] outline how the function has been constructed). The proof of concavity of this function is given in Section III.B.

We see then that when  $\bar{\phi}_i(X_p)e_c > 0$ , the control and the adaptive laws are given as before by Eqs. (18) and (19) but with  $S_i$  and  $L_i$  given by lower part of Eqs. (16) and (17).

This is the *non-certainty equivalence part* of the control and adaptive laws. To answer why this proposed adaptive controller results in a stable system, **the key point is inequality (23)**. Inequality (23) holds because of the way we constructed the concave function  $g$  lying above the function  $f$ .

Firstly, inequality (22) that comes from the convexity of the function  $f$  (see Eq. 9.1, Theorem 1 from [32], in Section 9.1.1) ensures that the time-derivative of the Lyapunov function candidate :

$$V = \frac{1}{2} \left[ e_c^2 + \tilde{\gamma}^T \Gamma_\gamma^{-1} \tilde{\gamma} + \tilde{\beta}^T \Gamma_\beta^{-1} \tilde{\beta} \right]$$

is given by  $\dot{V} \leq -ke_c^2$  when  $\bar{\phi}_i(X_p)e_c \leq 0$

And, also, when  $\bar{\phi}_i(X_p)e_c > 0$ , inequality (23) is used to ensure as well that  $\dot{V} \leq -ke_c^2$  implying finally that :

$$\dot{V} \leq -ke_c^2 \tag{9.16}$$

in all the state-space.

Standard arguments (including Barbalat's Lemma - see for example [11]) can be used to complete the proof and to show that  $E \rightarrow 0$ . All the details are available in the annexed publication [33].

### 9.3 Contributions to road safety

This section, containing two parts, is dedicated to presenting in a qualitative form the contributions to road safety. The details will be available in the papers in the Annex. The first part, starting from Sections 9.1.3 and 9.1.2, show the main points in the design of systems to prevent lane departure. The presented results correspond to the PhD works of Mme Minoiu-Enache and M. Benine-Neto and to the post-doctoral work of M. Stefano Scalzi.

The second part will describe in a concise form a work, co-led by myself (in collaboration with a colleague), in the frame of PReVAL (see Section 8.2). The research subject under investigation has been to make advances in a methodology for the technical evaluation of driving assistance systems, a very complex problem. This work has resulted in an evaluation guide for driving assistance systems that has become a reference for the subsequent investigations on the topic. The the annexed publication [39] appeared on IEEE Transactions on Intelligent Transportation Systems gives an overview of the PReVAL results (including WPs 3, 4, and 5, on technical, human factors and impact evaluations).

### 9.3.1 Lane departure prevention

Unintended road departures caused by a mistake or inattention of the driver or degraded road adhesion (rain, snow, ice) represent a significant part of the accidents. The motivation for designing systems to prevent lane departure comes from statistical data that show this. Some data is given below.

In the 16 European Union countries between 1999 and 2008 (European Road Safety Observatory, see [37]), more than 106000 people were killed in *single vehicle accidents* representing *one third of all traffic accident fatalities*.

Data recorded from 2005 to 2008, reports that 40% of these accidents are due to incorrect lateral motion (including lane departure) for the European Union 23 (EU-23) countries.

8% of multiple vehicle accidents are also because of this reason.

Concerning the weather conditions, in the EU-23 countries, *more than one third of the total fatalities recorded when it snows are due to single vehicle accidents*, whereas the respective percentage for rainy weather is less than 30% [37].

Accidents due to the drivers' lack of attention also represent a significant proportion. In [37], reporting the accidents in EU-23, the critical events such as no action or late action are related, respectively, to 25% and 16% of multiple vehicle accidents. Regarding single vehicle accidents, 36% of the causes are linked to fatigue while 25% are linked to distraction, these two causes of accidents being among the 10 most frequent.

Another important information (see bilan ONISR, 2012 [9]) is that in France, 66% of the fatal accidents happen in secondary roads. In this kinds of roads, we find very often very high relative speeds. As an example, in a two-lane road, the relative speed increases easily up to 180 km/h, with no protection between the vehicles. Lane departure avoidance systems appear then as important. This fact will be discussed later in the Section dedicated to the discussions.

This section is then dedicated to give the most important elements in the design of the systems to assist the driver in the case a lane departure is imminent. With respect to section section 8.2, where the problem of designing driving assistance systems has been structured, this problem is included in the functional field V2 "The monitoring of the driver and the region around the vehicle (360 degrees) to prevent lateral collisions and lane departures."

#### Hybrid model of driver-automat-vehicle for LDA systems

This chapter is dedicated in showing a set of systems developed for lane departure prevention in the frame of Mrs. Minoiu-Enache's PhD thesis.

I describe below in a qualitative form the most important ideas involved in these systems. The objective is to make possible for the reader, with this qualitative description, to understand the main ideas of the results. It is important to note that the designed systems have been tested and validated in the LIVIC prototype vehicles. Not all the results will be discussed here, but the fundamental ideas (see paper [40] in the Annexes).

*Vehicle Model*

The used model for the synthesis of these systems is the classical 4th order lateral Ackerman model. In one of the work lines (see the publication Eq. (1) in [40], available in the Annexes), the model includes also the electrical steering assistance.

### Main Ideas

The starting point has been the problem redefinition in Section 9.1.2, illustrated by Figure 9.5. Let's see some of the main ideas.

The goal of the systems in some words can be synthesized as : “to avoid the road departure in the case the driver is inattentive during *normal driving*”, as formulated in Section 9.1.2. Four ideas can be used to sketch the fundamentals of the proposed approaches, as follows :

**1st idea :** to model the driver behavior when he is attentive by a normal driving zone, as described in Section 9.1.2.

1) Figure 9.5 in Section 9.1.2 shows a first very simple model of a driver driving normally.

2) Figure 9.9 below shows a normal driving zone that considers in addition that a driver while driving normally stays within the lane borders.

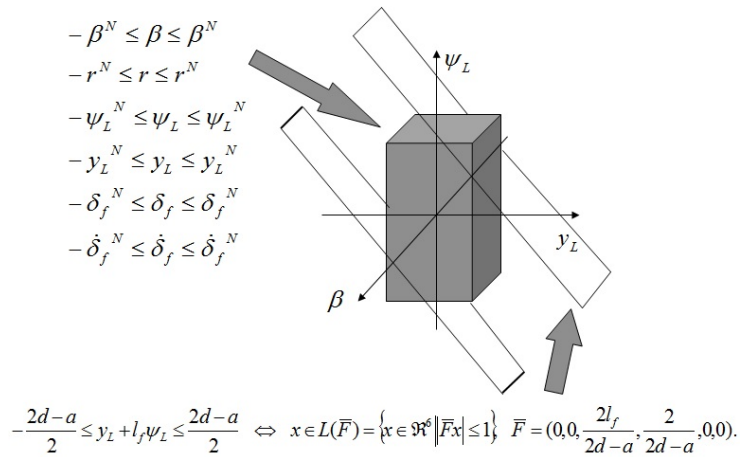

FIGURE 9.9 – Normal driving zone that considers, besides the hypercubic region signifying that an attentive driver keeps the vehicle dynamics and positioning variables bounded, that a driver while driving normally stays within the lane borders. The resulting normal driving zone is the part of the hypercube lying between the two hyperplanes.

**2nd idea :** to approach the normal driving zone by invariant regions.

1) Figure 9.6 shows the first very simple approximation of the hypercubic normal driving zone by an ellipsoid, integrating also a second hypercubic zone called “security zone” in which the system should in any case stay.

2) Figure 9.10 shows the proposition of a composite Lyapunov function such that the level curves approach better the hypercubic normal driving zone. This should make closer the normal driving zone from the security driving zone and improve the performances.

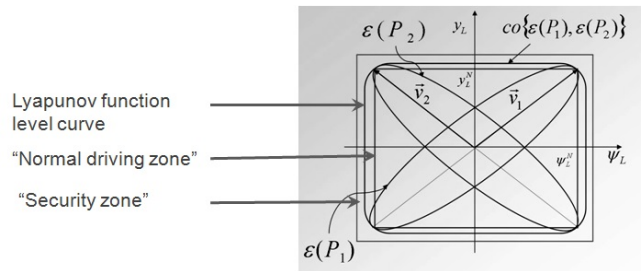

FIGURE 9.10 – The approximation of the hypercubic normal driving zone by the levels curves of a composite Lyapunov function should make closer the normal driving zone from the security driving zone.

**3rd idea :** optimization of the lateral correction. The following conditions have been expressed as LMIs (Linear Matrix Inequalities) and integrated in the optimization problem : the asymptotic stability, the controlled overshoot with respect to the lane, the passengers comfort by limiting the maximal assistance torque delivered, and the robustness of the system with respect to variations in the longitudinal speed.

The first condition is directly obtained by the Lyapunov stability conditions that can in the case of a linear system be expressed by the Lyapunov equation (see Eq. (13) in the publication [40], available in the Annexes). The second condition is to have a controlled overshoot with respect to the lane. The way this idea has been implemented is illustrated by the figures 9.11 and 9.12 below.

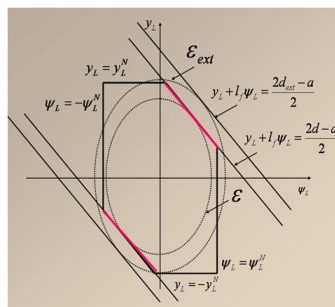

FIGURE 9.11 – The figure shows the implementation of the condition of having a controlled overshoot : a second invariant set  $\epsilon_{ext}$  is constructed in such a way that if the vehicle is kept inside it, it is ensured that the overshoot of the vehicle with respect to the lane will be within some pre-chosen values (from which invariant set  $\epsilon_{ext}$  has been constructed).

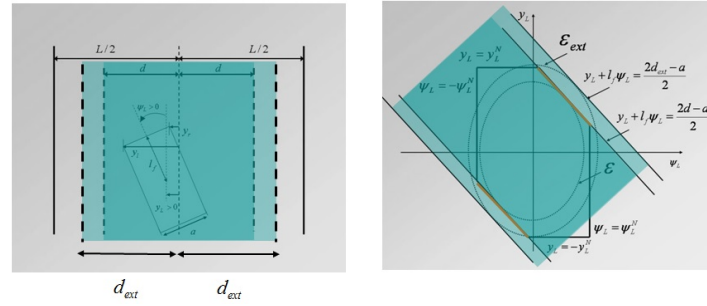

FIGURE 9.12 – The figure shows the relation between the construction of the second invariant set  $\epsilon_{ext}$  and the region in the lane in which the vehicle will be ensured to stay.

The third condition to ensure the passengers comfort by limiting the maximal assistance torque delivered can also be expressed in terms of LMI (see Eq. (18) in the publication [40] in the Annexes)).

The fourth condition is the robustness of the system with respect to variations in the longitudinal speed. Since the Ackerman model is nonlinearly parameterized with respect to the longitudinal speed  $v$ , the Lyapunov equation (13) in [40] ensures the asymptotic stability for a constant speed  $v$ . To design a controller robust to variations in the longitudinal speed, a linearization is done (see Section 4.4, page 646 in [40], Annexes) so that the system becomes linearly parameterized. However, as pointed out in the paper [40] (see the discussion in the end of Section 4.4), to ensure stability for a range of speeds in a chosen interval  $[v_{min}, v_{max}]$ , additional conditions to the optimization problem have to be introduced (see Eq. (22)) and this can lead to very conservative results.

The control problem becomes then an optimization problem that is shown to be expressed in terms of LMIs (linear matrix inequalities).

**4th idea :** switching strategy from the driver to the automat : we are studying a hybrid system as we have already discussed. Besides ensuring that the system is activated when a lane departure announces to happen, the switching strategy is also very well chosen in order to play a role to ensure the stability of the system.

### Switching Strategies

Let me talk about one of the chosen switching strategies. Note that the driver torque has been used as a measure of the driver attentiveness. However, the constructed approaches are such that the driver torque can be replaced by any other measure of the driver attentiveness provided that they are not dependent on the state-space variables, being an independent measure obtained by a sensor - for example a driver monitoring system) without changing the stability properties of the system. Qualitatively, the switching strategies for the NDZ are as defined in Fig. 9.9 are as follows.

- automat activation : if (driver inattentive (driver torque  $<$  threshold)) and (if lane is left like the arrows shown in the figure)
- automat deactivation : if (driver attentive (driver torque  $>$  threshold)) and (if driver is come back to inside the NDZ)

### Stability Aspects

- 1) by hypothesis, the attentive driver is always inside the NDZ
- 2) the activation is done if the driver is inattentive and for lane departures like shown in Figure 9.13.
- 3) during the automat activation the trajectories are constrained to the ellipsoid  $\epsilon_{ext}$
- 4) *The deactivation is chosen to be always inside the NDZ if the driver has become attentive again*

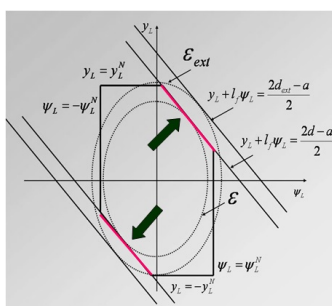

FIGURE 9.13 – The figure illustrates how the stability of the hybrid system driver-automat-vehicle is ensured.

The figure below illustrates the way the stability of the hybrid system driver-automat-vehicle is ensured. Note that in the logic above, points 2) and 4) corresponding to the transitions between ‘mode driver’ and ‘mode automat’ are fundamental to ensure that the sequencing of switching between the driver and the automat – driver drives normally, lane departure begins because driver has fallen asleep, the system activates, the trajectory of the vehicle is inside the ellipsoid  $\epsilon_{ext}$ , the driver is attentive again and then the control of the vehicle is given back to him – will always result in an asymptotically stable system. In this last point, after the driver has become attentive again, the control of the vehicle is only given back to him after the vehicle has entered again the normal driving zone. This avoids giving the control of the vehicle back to the driver in a region outside the normal driving zone in which the driver could not know how to drive. Moreover, point 2) above ensures that once the system has been activated, the vehicle will be kept inside the ellipsoid  $\epsilon_{ext}$  till the automat is deactivated according to the 4th point.

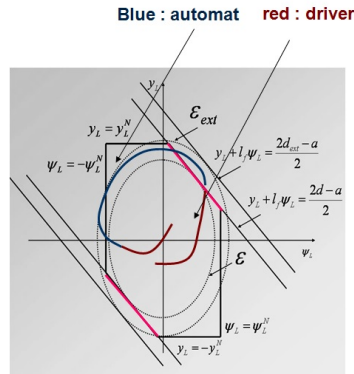

FIGURE 9.14 – The figure illustrates how the stability of the hybrid system driver-automat-vehicle is ensured.

Paper [40] founded on the NDZ as in Figure 9.9 and on the described optimization formulation is available in Part V.

The proposed approach has led to satisfactory simulations and practical results, as it is shown in the paper.

*Some Comments* : As pointed out, the original Ackerman model is nonlinearly parameterized with respect to the longitudinal speed  $v$ . This has been treated above by a linearization so that a linear parameterization is obtained. In the case one wishes to consider other parameters of the Ackerman model, an overparameterization must be necessary. This can augment considerably the number of LMIs to be introduced in the optimization problem and being able to study the original NL-parameterized system and maintaining the original number of parameters could considerably improve the corresponding solution. This is however a very difficult and open problem. We come back here to challenging theoretical problems asking for research from the theoretic community! This brings us back to the discussions in section 9.1.

### Hybrid model of the nonlinear tire contact forces for the lateral dynamics stabilization

This section is dedicated in designing control algorithms to the vehicle lateral dynamics taking into account the nonlinear behavior of the tire forces. A piecewise linear modeling is used as introduced in Section 9.1.3. I have advised two students, Mr. Benine-Neto, during the first two years of his PhD thesis and Mr. Scalzi, in his postdoctoral work during 7 months.

The first considered problem has been the stabilization of the vehicle lateral dynamics under strong solicitations in the tire contact forces. For this a simplified single track vehicle model is considered to capture the essential vehicle lateral steering dynamics (see Eq. (1) in the annexed publication [45]). Qualitatively, the problem consists in designing a controller for the vehicle steering (angle or torque) such that, in case of high instability, the control of the vehicle is given to the automat to stabilize the vehicle dynamics. Certainly, this problem formulation is a first step for towards other control goals since human-

machine cooperation problems will certainly be involved in the real context (notably, because it is a control for a huge instability situation) and also the problem of controlling the vehicle positioning during the lateral dynamics stabilization. But given the challenges of the vehicle control under strong tire forces solicitations, we considered this simplified problem.

While the control design/stability analysis for the hybrid systems including the driver modeling in the precedent section has been done by making use of some certain degrees of freedom intrinsic to the problem formulation - that are the choice of the invariant set, the choice of the switching strategies, together with the control synthesis - in the present problem, we cannot make use of these degrees of freedom, since the problem formulation is different. First, the invariant set modeling is not used since in the previous work it is used to approach the modeled behavior of the driver (when the driver is attentive, it has been assumed that he drives in certain regions of the state-space) and we do not consider the driver in the present problem formulation. Also, the switchings could hardly be changed (unless by making more partitions) since from a practical point of view, once the vehicle enters in an unstable state, we *need* to activate the controller, while for *slow* lane departures, one could think that the activation could be done a little bit later.

As before, I do not describe all the results, but the most representative ideas. Let us begin by a controller synthesis on the vehicle model integrating a PWA approximation of the tire contact forces.

Due to the challenges involved in the hybrid systems stability analysis pointed out in Section 11.3.4, we have adopted the following approach :

- to model the tire contact forces by a PWA approach.
- to derive the piecewise linear vehicle model, with each linear system corresponding to a region in the state-space.
- to close the loop of each linear system with a robust (dynamic) controller and then write the piecewise linear (augmented) model of the complete system (vehicle + controller)
- to search for a piecewise quadratic Lyapunov function to prove the stability of the augmented piecewise linear system.

The figure below shows the approximated by PWA functions.

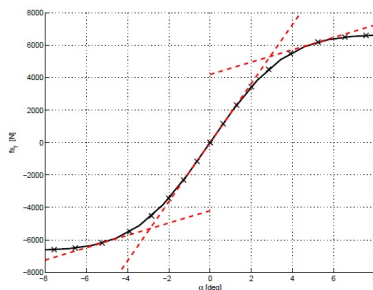

FIGURE 9.15 – PWA approximation of the tire contact forces.

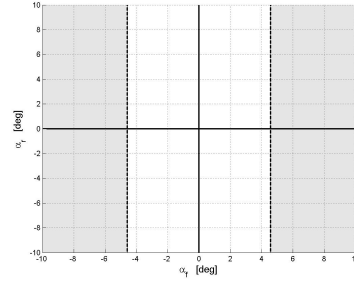

FIGURE 9.16 – Partitions for the under-steering vehicle model in the simulator CarSim.

The obtained piecewise linear system has the form :

$$\dot{x} = A_i x + B_i u + a_i \quad (9.17)$$

where  $i$  refers to each partition of the state space and the corresponding dynamics. Figure 9.16 shows the chosen partitions for the vehicle model in the CarSim simulator. The matrices  $A_i$ ,  $B_i$  and  $a_i$  are given in the annexed publication [45].

The proposed control strategy involves the design of two control loops. The first control loop is a state feedback (it also requires the measurement of the vehicle sideslip angle  $\beta$  which can be estimated or measured as done in [41]) and it is designed to improve the vehicle dynamics using the pole placement techniques. The second controller is a dynamic active steering approach. The control law is then :

$$\delta_f = -K_{xi}x + \delta_{fPI} \quad i = 1, 2 \quad (9.18)$$

The dynamic active steering approach ( $\delta_{fPI}$ ) is as in [49] : a PI control is used to ensure the tracking of constant yaw rate reference signal ( $\dot{r}_d = 0$ ) on the basis of the yaw rate tracking error  $\tilde{r} = r - r_d$  despite constant disturbances and parameters uncertainties. The desired yaw rate is computed from the driver input  $\delta_p$  (see Eqs. (10) and (11) in the annexed publication [45]). Diagram 9.17 illustrates the approach but already including the improvement in paper [46], where only the yaw rate is necessary to decide the switchings. See comments below.

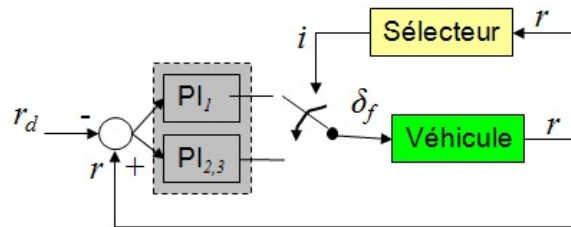

FIGURE 9.17 – Illustration of the controller structure.

The second control loop is defined as :

$$\begin{aligned}\delta_{fPI} &= -K_{Pi}(r - r_d) - K_{Ii} \int_0^t (r - r_d) d\nu \\ &= -K_{Pi}(r - r_d) - K_{Ii}\alpha_0. \quad i = 1, 2\end{aligned}\quad (9.19)$$

where  $\alpha_0$  is the additional state introduced by the dynamic control (9.19). The closed-loop system leads to the augmented piecewise model :

$$\dot{x}_a = A_{ai}x_a + B_{ai}u_a + a_{ai} \quad (9.20)$$

The following step has been to use Theorem 1 in [44] to construct a piecewise quadratic Lyapunov function (Figure 9.18) for the system.

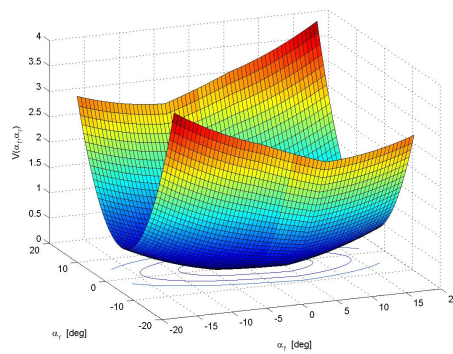

FIGURE 9.18 – Piecewise quadratic Lyapunov function computed for the stability proof.

Several simulations, including disturbances rejections and step references, have been carried out. The robustness with respect to unmodeled effects such as combined lateral and longitudinal tire contact forces, pitch, roll and driver dynamics has been tested with performing results. The simulations confirm that the proposed PWL control can greatly improve the vehicle stability and may be advantageous in very demanding maneuvers also in comparison with the use of the proposed controller designed for the linear region only. See annexed publication [45].

The next step has been done in [46] where, as a continuation of this work, the controller switches depend only on the low cost measurable variable yaw rate. The key point has been a steady-state analysis of the model in order to link the tire contact forces to the yaw rate, that is available for measurement. See Figure 9.17.

We also proposed to improve the previous results on the lane departure avoidance systems for curved roads in Mrs Minoui-Enache's PhD thesis. In order to do that we integrate a dynamic controller, able then to reject the curvature disturbances, in the previous results for curvy roads in [42]. The results are presented in the annexed publication [46].

The strategy used the internal model principle to integrate the disturbances in the controller as a family of known functions. The figures below illustrate the approach : figures 9.19 and 9.20 construct a dynamic model of the road geometry and Figure 9.21 shows the architecture of the control with internal model.

**Road Geometry:**

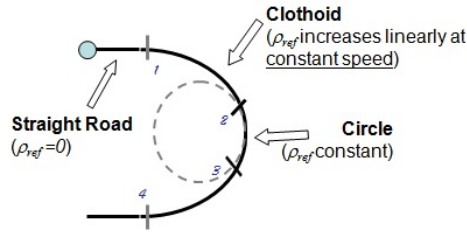

FIGURE 9.19 – modeling of the road geometry.

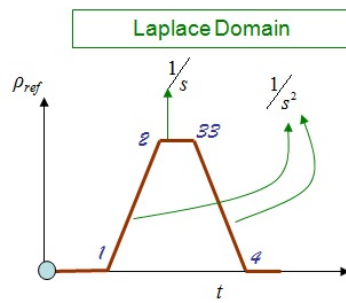

FIGURE 9.20 – Illustration of the internal model construction.

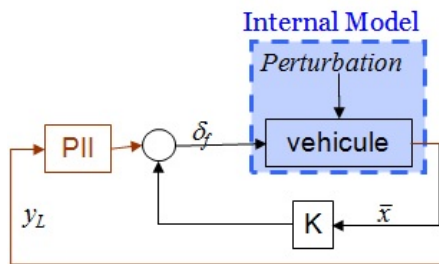

FIGURE 9.21 – Illustration of the internal model approach.

### 9.3.2 Evaluation of ADAS systems

Once a driving assistance system has been designed, the next step is to check if the system works according to the objectives. Furthermore, once implemented in the vehicle, unpredictable behaviors can happen, for example in terms of human-machine cooperation issues. Also, for real deployment, intensive testing is necessary, given the complexity of

the transportation scenario. This is an important and challenging subject of investigation and has been the research subject in PReVAL.

PReVAL has been a horizontal (or cross-functional field) subproject of PReVENT (see Figure 8.2 in Section 8.2). It has begun in the middle of the PReVENT project and its goal has been to analyze the evaluation plans and the evaluation results and all the corresponding deliverables carried out within the 8 following subprojects of PReVENT :

- SASPENSE, on the prevention of accidents because of inadequate longitudinal speeds.
- WILLWARN, on the design of driving assistance systems by telecommunications.
- MAPS&ADAS, on the design of driving assistance systems founded on digital maps to construct an extended electronic horizon.
- SAFELANE, on lane departure prevention.
- LATERALSAFE, for the avoidance of lateral and rear collisions.
- INTERSAFE, to assist the driver in the intersections.
- APALACI-COMPOSE, that focused mainly in collision mitigation and pre-crash systems.

My main contribution here has been the co-leading (with a colleague) of the research in workpackage 3 on technical evaluation. The resulting evaluation guide has become a reference for the investigations on the evaluation of driving assistance systems after PReVAL. A synthesis of the integrated - technical, human and impact - PReVAL evaluation framework has been published in IEEE Transactions on Intelligent Transportation Systems [39], available in Part V containing the annexed publications. It has been by this time, that I have learned how to coordinate research.

## 9.4 Other contributions

This section describes briefly other contributions from collaborative works.

### **Collaboration with experts in cognitive sciences.**

Between 2002 and 2004, within the french consortium ARCOS (*action de recherche pour une conduite sécurisée*), I have been highly involved in the collaborative work between the LIVIC and the PsyCoTech group of IRCCyN on cognitive sciences. The targeted goal was to evaluate from the point of view of the cognitive sciences, systems to assist the driver and/or to automate one of the functions of the vehicle (in the case, the lateral motion of the vehicle). I have worked first in close collaboration with the experimental validation team of LIVIC in the synthesis of a control law to automate the lateral mode of the vehicle, to make it operational in the vehicle. [51].

In the intersection of two domains, the control and the human sciences, it involved an effort of both sides for understanding the other community skills and vocabulary.

Two sequences of one week tests (called CHM1 and CHM2) have took place in the Satory tracks with the prototype vehicles equipped with the automatic control systems, and the vehicles driven by external drivers.

The results have been published in the Journal Le travail Human[52]. Some of the knowledge that I could learn along the years by working with experts in human sciences

appear in the Section 9.5, by a survey paper that I published in the IFAC Control in Transportation Symposium, 2012.

### **Collaboration with University of Rome Tor Vergata**

This work, in collaboration with Tor Vergata, consisted in synthesizing a robust output feedback lateral controller for automation, with rejection of the curvature perturbation. I proposed some improvements in the analysis of the sensitivity of the control algorithm (proposed by Tor Vergata) with respect to a set of parameters and advised Mr. Scalzi in the this work. The resulting algorithm has been tested in the Versailles test tracks and published in Control Engineering Practice [53].

### **Collaborative advising work**

As described in Chapter 4, I coordinate the DIM LSC Regeneo project (partners L2S and IFSTTAR). Regeneo sponsors the PhD thesis of Mr. Hoang Trong-Bien advised as a joint collaboration from the L2S (William Pasillas-Lépine), the LTN-IFSTTAR (A. De-Bernardinis) and the LIVIC-IFSTTAR (myself). We have submitted the joint work in [54] to IEEE Transactions on Control Systems Technology in 2013 as a result from this collaboration. The work in [54] is on the synthesis of an observer for the extended braking stiffness (XBS) that avoids complex hypothesis in the literature. The result is a simple and stable observer for the XBS that has been coupled to an algorithm for the control of the wheels acceleration. It is interesting to point out that the original model is nonlinearly parameterized and it should be interesting to future investigations to consider the model as it is to compare the performances. Paper [55], to appear in the American Control Conference, 2013, is available in Part V.

## **9.5 Multidisciplinary discussions**

The work below discusses with a multidisciplinary view the design of driving assistance systems raising up questionings that take into account for example : the temporal frame for which the assistance system is designed and the related scenarios (like in Figure 8.1); the related human-machine cooperation level (see in Section 2.2 in the paper, the Michon levels), the sensors needed for each case, and pointing out the different parameters that need to be looked on carefully for a successful system design and choice. It has been published in [50].

# In-Vehicle Embedded Control Systems for Safety: a Survey

Mariana Netto\*

*\*French Institute of Sciences and Technologies for Transport, Development and Networks, IFSTTAR, 14 route de la Minière, bât 824, Satory-Versailles, France (e-mail: mariana.netto@ifsttar.fr).*

---

**Abstract:** The design of a control system embedded in the vehicle to help the driver in the case a potential danger appears on the road – called also a driver assistance system - is a very complex problem, and needs knowledge from different domains. Generally speaking, an active driver assistance system can be defined as follows: if a calculated risk is bigger than a threshold (where the risk has also to be defined and this definition is itself a challenge), a control system acting on one or more actuators is activated to bring the vehicle back to a safe state. The control is deactivated when the risk is smaller than the threshold. However, rather than searching only a solution to a control problem, a set of very different elements must be integrated to the control design for the achievement of an effective system. For example, the following items, that are in addition often very closely linked between them, need to be considered : i) the traffic scenario on which the accidental situation to be handled is situated; ii) “the time before the accident” on which the system will be activated (also called time-to-the-accident); iii) the duration of the control system activation; iv) the reliability of the vehicle localization inputs to the control (lane markers detection, obstacle detection...) ; v) the inputs from human-machine-cooperation (HMC) studies, for example the positive and negative interferences between the driver and the machine; vi) if an open-loop or a closed loop control should be used; to name a few. The main contribution of the paper is then to make a review of a series of parameters and different elements, as point out, that need to be sum up and integrated one to the other for addressing the complex task of helping by active control a human-being when he is driving.

**Keywords:** Intelligent Transportation Systems, Intelligent Vehicles, Safety and Warning devises, Human Factors, Embedded Sensors.

---

## 1. INTRODUCTION

Making in-vehicle embedded control systems (ECS), with a suited choice of the set of units (mainly the actuators and the sensors), and the control algorithm to connect them, at the same time ensuring positive human-machine interactions, is not a simple task. The first step should be the definition of the scope of action of the assistance system, that is based on the macroscopic level of the traffic situation for which the system is expected to increase safety. This will help in the following step to begin to set the choice of the mode on which the system will act: lateral, longitudinal or both. If we use a top-down reasoning, three groups of assistance systems, based on the time-to-the-accident, the associated sensors and the connection with the infrastructure, can be defined (see Scholliers et al (2011) for a description of these groups). If accident precaution more than prevention is concerned, communicating warning based systems (see Dötzer et al (2005) and Kay Fuerstenberg (2006)) are to be used. In the case of the continuous monitoring of the surround of the vehicle for frontal, rear and lateral collision avoidance, warning and active control systems are required (Scholliers et

al (2007)). Finally, if the accident is imminent, control is necessarily required. The needed sensors and communicating systems, depend on which group the assistance system belongs. The time-to-the-accident is also called temporal frame of the system.

Going further, the assistance system temporal frame is in turn closely related to the level of cooperation with the human-being: as an example, if the system is constructed to be the less intrusive as possible with the human action, it should be then activated in the last moment, when it would not be possible at all to the human-being to recover the vehicle stability. With respect to this situation, in the case of longitudinal collision, mitigation systems follow this philosophy and do not avoid the accident but are made to reduce its consequences. Different cooperation levels between the driver and the system are then related to the group on which the assistance system belongs (Scholliers et al (2011) and Hoc et al (2006) provide studies on Human-Machine Cooperation for embedded in-vehicle control systems).

This work analyses a set of different scenarios and use cases for which assistance systems are built to improve safety or mobility, some recent control algorithms proposed by us as well as others proposed in the literature, discussing the advantages/disadvantages of each one, the sensors, the actuators, and then the related cost, the need for communication systems or not and the chosen temporal frames, including HMI information, as well as robustness issues linked to the inputs to the systems (lane detection by camera for example).

**2. CONCEPTION OF SYSTEMS WELL SUITED TO THE HUMANS FOR A GIVEN SITUATION: THE MULTIDISCIPLINARY ASSOCIATED RESEARCH**

**2.1. Traffic Scenarios Illustrated by PReVENT Systems**

This section illustrates four traffic scenarios, with illustrations from the European PReVENT project (Figures 1-4 are from <http://prevent.ertico.webhouse.net/en/>). To these four scenarios are associated in the following sections three human cognitive levels and sensor challenges.

**Scenario 1: Intersection managing**



Figure 1 : The figure illustrates the intersection management problem: a communicating system between the vehicle and the traffic light as well as prevention of collision with other vehicles are illustrated.

**Scenario 2: Vehicle travelling on the road and the monitoring of the surround of the vehicle**

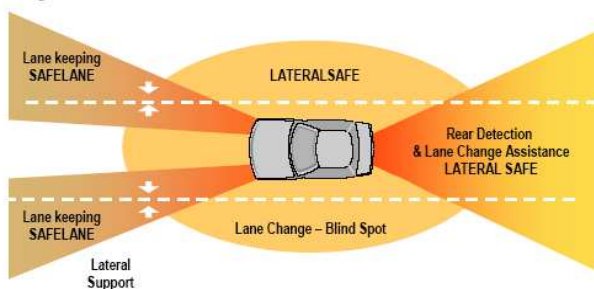

Figure 2 : Two sub-projects of the IP PReVENT related to this scenario are shown in the figure: LATERALSAFE and SAFELANE

**Scenario 3: Managing critical events with high anticipation**

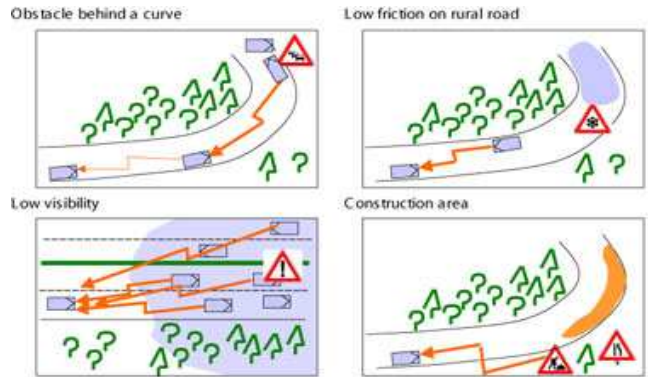

Figure 3 : The figure shows four situations of communication based safety systems treated in WILLWARN sub-project of PReVENT.

**Scenario 4: Managing critical events with no anticipation**



Figure 4 : Pre-crash and collision mitigation as a function of the time-to-collision are illustrated in the figure (APALACI and COMPOSE PReVENT sub-projects).

**2.2 Human-Machine Cooperation and Classification of the Human Cognitive Levels**

**Michon levels :** In driving, the goals and the corresponding control processes in the human mind can be described at different levels. A widely adopted scheme has been proposed by Michon (1985) who proposed a description of the driving task on three levels:

- (1) The operational level. The operational level refers to the moment-to-moment vehicle handling. Anticipation is minimum and the driver has no time to plan.
- (2) The tactical level. Tactical level tasks include the selection of speed and following distance, decision to overtake etc.). The driver has some time to plan.
- (3) The strategic level. Tasks on the strategic level involve e.g. route planning and navigation. The driver has time to think and plan what he will do a lot time in advance.

**Situational control concept for understanding and evaluating the improvements in safety by the introduction of ADAS -** In modern ADAS-supported driving the vehicle

control is shared between the driver and the vehicle. Dötzer et al (2005) defines the situational control concept that is related to considering the driver-plus-vehicle as a single system - the Joint Driver-Vehicle System (JDVS Brooke, J. and Sus). In general terms, control can be understood as the ability to direct and manage the development of events (Brooke, J. and Sus). Controlling a process involves selecting actions in order to achieve and/or maintain a consistent goal state.

Finally, in the context of driving, a situation can be understood as a set of relevant driver-, vehicle and environment elements within a volume of time and space. Based on these concepts, the situational control can be defined as the degree of control that a JDVS exerts over a specific situation. It should be stressed that the term, as defined here, applies to all three levels of the driving tasks in Michon's model. The situational control concept is very useful for the evaluation of ADAS taking into account the human-machine cooperation.

Hoc (2001) studies Human-Machine Cooperation and interferences between agents (in this case, the automat and the driver) within these three cognitive levels of abstraction. Hoc (2001) underlines that within the tactical level, that he calls planning level, a common reference frame between the driver and the system is necessary.

**Complacency phenomena:** Among the difficulties usually encountered in human-machine cooperation, Hoc places particular emphasis on the complacency phenomenon (Moray, 2003; Parasuraman, Molloy, & Singh, 1993). Under particular conditions (multi-task situations, high workload level, etc.), the delegation of a function to a machine can generate complacency with regard to the result produced by the machine; Although the concept remains ill defined, there is a consensus on some of its main features — the information necessary to perform the function by the driver is neglected, as is supervision, and finally there is no correction by the driver. A minimal level of trust is usually considered as being necessary to the development of complacency, although the two concepts are different. Hoc et al (2006) studies these phenomena by real experiments on tracks.

### *2.3. Temporal Frames, the Associated Technological Challenges, and the Link to the Human Cognitive levels*

An essential step for constructing an embedded system for ADAS is to identify the temporal frame in which the system will act. The reader finds below a classification near from the one we proposed in PReVAL subproject of the PReVENT project (Scholliers et al (2011)). Driving assistance systems are classified in three groups, as follows:

**G1 Tight interactions** - very short temporal frame (<1s) : the risks of accidents in presence are immediate collisions with obstacles. The time and distance constants are very short, consequently the technologies able to address those circumstances can be based on perception sensors located onboard. The explored concepts are based on pre-crash, collision prevention and mitigation systems. Perception of the

environment, since the time to act is very short, is a challenge. Some of these systems are built not for avoiding the accident but to reducing its effects and are then less intrusive with the driver. Collision mitigation systems are an example. Some can be made to avoid the accident, but this in general demands very complex control systems often based on nonlinear models, since high solicitations on the tyre-road-tire contact forces can be present. This group of systems is typically associated with the Michon level (1), "Operational level", since a very minimal anticipation is involved and the system acts when the driver could not at all manage the accidental situation.

**G2 Short interactions with other moving objects constantly managed by the driver** - medium temporal frame (1 to 5s): the solutions can be addressed again by on board technologies. Frontal, rear and lateral interactions with other vehicles and with the lane and road sides are addressed. The cooperation level between the driver and the assistance is higher demanding a stronger effort in the HMI conception and testing. Perception of the environment is also a challenge since the system should monitor 360 degrees around the vehicle, and reliability is an issue for technical reasons as well as for human acceptance of the system. This group of assistance systems is associated to the Michon level (2) "Tactical level".

**G3 Distant interactions** - large temporal frames (>5s): The related time and distance constants are longer. The decision time is not critical, the systems are related more to precaution than to accident prevention. The concept is based on the creation of an electronic horizon that enables foresighted driving, by digital maps and GPS localization or by V-V or V-I communications. Informative mode is concerned. Human-machine cooperation between the driver and the system is usually not a big challenge since warning systems are mainly concerned. The Michon level (3) "Strategical level" is the driver cognitive level on which these types of assistance systems help the driver.

**Intersection systems** have been classified within G1 in Scholliers et al (2007). However, we could say that they constitute a group apart from the 3 groups above. The reason is that helping the drivers in intersections is a highly complex problem that could need tight (G1), short interactions (G2), or distant interactions (G3) by communication between the vehicle and the traffic light for example.

Netto et al (2010) constructs a new concept for dealing with high instability situations on the road that needs features of the three groups above.

### *2.4. Sensing the Environment*

Figure 5 provides an overview of the sensors range according to the temporal frame on which the assistance system is based. In G1 very precise sensing systems are required since the temporal frame is very short. In G2, to achieve lateral monitoring for detection of possible collisions with neighbouring vehicles, a large set of sensors is required to monitor all the surround of the vehicle (see figure 6), whereas in lane detection for lane departure avoidance, lane detection

with sufficient reliability is one of the most important open sensing problems. This becomes more critical as already explicit, if closed-loop vehicle control is required.

front in a medium temporal frame (from 1 to 5 sec). Longitudinal detection in a medium temporal frame can be considered the simplest sensing problem. This is due to two reasons: the tolerated longitudinal detection errors in G2 are much bigger than the tolerated lateral errors in G2 (an error of 1 meter for lateral purposes is enough to compromise the efficacy of the system, since the lane width is around 3,6 meters, whether in the case of collision avoidance in G2, 1meter can often be tolerated). The second reason is that detection in G2, as already mentioned, is less critical than in G1. The biggest challenges in G3, rather than the technical equipment embedded in the vehicle for communications, is hazard detection. This means, how to distinguish which messages received by the vehicle concern the vehicle itself. Maps updating is as well a challenge.

For intersection safety systems, sensing is far from being achieved since the environment is rather complex. Especially, the vehicles trajectories prediction for collisions prediction is a challenging problem.

### 2.5. Some key Points on Control

**Closed-loop and open-loop systems** – it may sound strange to the control community to talk about open-loop control, especially in the vehicle context. However, depending on the use case and the Human-Machine-Cooperation desired level, an open-loop control could be much better suited to help the driver and moreover with increased reliability and reduced cost than a closed loop one (Section 4 will develop this idea).

**Linear and nonlinear control** – in the case the vehicle dynamics stops to evolve within its linear approximated model, nonlinear models and nonlinear control become necessary. We distinguish two main situations that could lead to nonlinear control, depending on whether the instability is linked to the vehicle itself or to its surrounding objects (other vehicles, VRUs.): 1) the vehicle enters in an instability situation – e.g. the road is icy and the vehicle slides, or simply the driver is sleepy and loses the vehicle control 2) the vehicle state is stable but a collision avoidance in a short temporal frame is necessary – e.g. an animal appears in front of it. Then, in order to avoid the accident, a rather “reactive” control is necessary. In this case, nonlinear models can be necessary, depending of course on the time-to-the-accident and the necessary reactivity and also to the mode on which the system will act: lateral or lateral coupled to longitudinal.

**Time variant and time invariant systems** – the standard approach of simplifying a nonlinear model by an Linear model with varying parameters (LPV) is also used in the case of vehicle control. An example is the Ackerman lateral model (Ackerman (1993)), where the longitudinal speed of the vehicle appears as a parameter in the linear lateral model. Often the speed is supposed constant or a gain scheduling is used for taking into account the varying speed. In general, if we can consider the varying parameter as constant or not depends also on the scenario on which the assistance system is built to help the driver and on how much time the assistance system will stay activated. For example, if a critical situation with no anticipation (scenario 4) needs

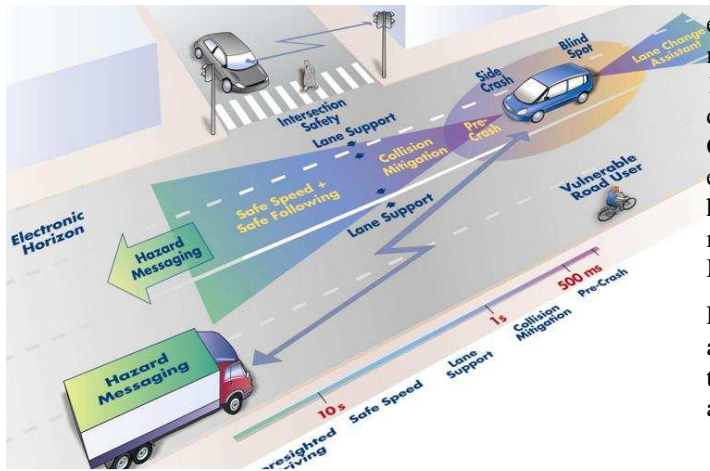

Figure 5 : Assistance systems and the sensors range (source : PREVENT web site).



Figure 6 : Set of sensors for vehicle lateral monitoring in Lateralsafe sub-project of PREVENT (three short range radars (SRR, in yellow colour) on each side, one long range radar (LRR, in blue colour), and two cameras (in green colour)).

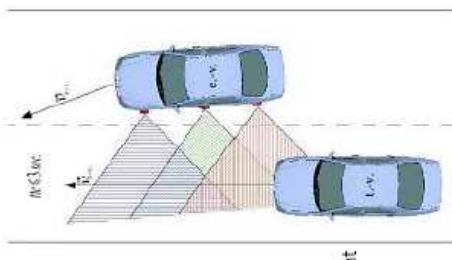

Figure 7 : Illustration of the three short range radars in one side of the vehicle for the vehicle lateral monitoring in Lateralsafe sub-project of PREVENT.

In G2, the longitudinal monitoring in front of the vehicle for preventing collisions, requires the calculation of the relative longitudinal distance and speed with respect to the vehicle in

obstacle avoidance, certainly, as already mentioned, even the linear model could not be used. On the other hand, in the case of a slow lane departure avoidance (within scenario 2), a simple lateral controller built on the basis of the lateral linear model activated within the driver reaction time is a good solution to avoid the accident (see Khadidja (2005)). The logic is that since no very “reactive” control is necessary, the linear Ackerman model can be used. Moreover, since the system stays activated for a short period, the speed can be considered as constant.

**Output-feedback and state-feedback** - state-feedback in most of the cases should be avoided, especially, depending on the model, if expensive sensors are involved. These sensors should only be kept for a real unavoidable safety reason, as an example, if they are needed in the case of managing high instability situations.

**Static feedback and dynamic feedback** – Dynamic feedback builds a memory of the past evolution of the system. This “keeping” of information allows giving two features to systems controlled by a dynamic feedback: robustness with respect to uncertain measures, like the road curvature, and the reduction of the necessary measures to control the system, generating then dynamic output feedback.

## 2.6 Vehicle Control in Relation with the Previous Sections

We recall in this section five lane departure prevention systems by action on the vehicle steering wheel. They present different features that are in relation with the control elements discussed just above.

**(Open-loop) lateral controller with reduced number of sensors and increased robustness with respect to lane detection** - this control strategy, detailed in Khadidja (2005) is constructed on a cinematic vehicle model. Besides the vehicle longitudinal speed given already (approximately) in all vehicles, the control uses only a camera as a sensor (to detect the lane markers). The accidental situations covered are slow lane departures in straight lines or low curvature roads. The robustness of the system with respect to lane detection errors is very high, since the lane markers information is needed only in the moment the system is activated (when the vehicle leaves the coloured zone in the figure).

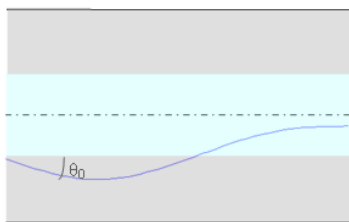

Figure 8 : Illustration for System 1.

**State-feedback lateral control with improved return to the lane centre** - in Minoiu et al (2009), a state-feedback control (and then closed-loop) with an “intelligent” algorithm that allows an improved quality of the return to the lane centre is proposed. It uses the Ackerman dynamic lateral model. Switching strategies are built in such a way that the resulting hybrid system driver-assistance system is stable. The system treats slow lane departures. Different versions of this system allow its use in low and higher road curvatures and in low and high instability situations (defined by the tire-road contact forces). It uses the inertial sensor, camera and the corevit to measure the slip angle.

**State-feedback dynamic lateral control for curvature rejection** - Benine-Neto et al (2010) extends S2 for ensuring zero steady-state lateral displacement error even in the presence of curvy roads (one of the versions of S2 deals with curvy roads by optimization however not ensuring zero state SS error). It is the introduction of the dynamics in the controller that allows zero steady-state error.

**Nested PID dynamic controller (output-feedback) for curvature rejection** - Marino et al (2011) rejects the curvature perturbation and perturbations on the tire-road contact forces by dynamic output feedback. This is allowed by the introduction of triple integration in the controller dynamics, with then a better memory of past events kept by the system. Only inertial and camera sensors are used. The result is that low and some high instability situations (the multi-split manoeuvre has been tested in the CarSim simulator) are dealt by the system.

**Closed-loop nonlinear lateral control** - Scalzi et al (2010) builds a controller on a nonlinear model that takes into account the nonlinear tire-road contact forces. An approximation of the nonlinearity by a piece-wise affine system is used. The system deals with the vehicle stabilization problem (not positioning within the lane). The system is built to deal with stronger solicitations on the tire-road contact, scenarios where the vehicle is in an unstable situation.

## 3. CONCLUSIONS AND DISCUSSIONS

In this section we discuss the fact that all the different elements above must in reality be analysed one in connection to the other if a real effective system, suited to the driver and to the situation it treats is to be achieved. We list again the six elements from the abstract:

- i. the traffic scenario on which the accidental situation to be handled is situated
- ii. time-to-the-accident on which the system will be activated
- iii. the duration of the control system activation
- iv. the reliability of the vehicle localization inputs to the control

- v. the inputs from human-machine-cooperation (HMC) studies, for example the positive and negative interferences between the driver and the machine;
- vi. if an open-loop or a closed loop control should be used

To illustrate the links that often appear between these elements, let's think about the duration of the control system activation – DCSA (item iii). This parameter is very related to the complacency phenomenon studied by experts on Human-Machine-Cooperation. Complacency, as explained, is a negative interference ( item v) between the driver and the automat that may happen in the case the driver thrusts the system too much, augmenting often his inattention. Then, in a lane departure scenario because of driver inattentiveness, if we keep the assistance system too much time activated, complacency may happen and instead of helping the driver, the system can make he become even more inattentive. In relation to item iv, the control system can stay for a long time activated if the reliability of the lane detection is very high. Furthermore, in the case of medium reliability of the lane markers detection, closed-loop control with a long activation time could hardly be used since reliable positioning inputs all the time are not available. In this case, a solution could be an open loop control (item vi) that allows to control the vehicle with the positioning information taken uniquely in the instant of time the control is activated (where the control is activated on a defined risk criteria, as mentioned). In this case, since a closed-loop control is not used, for safety reasons, the control must stay activated for a short interval of time. This kind of systems though control-based, works almost as a warning system, to help the driver, giving quickly the control of the vehicle back to the driver. Its effectiveness depends also on the study of the traffic scenario for which the system is designed (item i) since in case of lane departure, a quickly activation could be enough for a one-way rural road but not for a two-way road. This brief analysis illustrates the deep cooperation between from experts in different domains like in control, in sensing and in human sciences and many other for the study on the increase of vehicle safety. Further new emerging concepts on mobility also need to be integrated to safety goals.

#### ACKNOWLEDGEMENT

The research leading to these results has received funding from the European Union Seventh Framework Programme [FP7/2007-2013] under grant agreement no 257462 HYCON2 Network of excellence.

#### REFERENCES

- Ackermann, A. Bartlett, D. Kaesbauer, W. Sienel, and R. Steinhauser (1993), Robust control: systems with uncertain physical parameters, *Springer*, London.
- Benzemrane, K. (2005), Contrôle latéral dans la prévention des sorties de voie, *Internal report*, LIVIC.
- Benine-Neto, S. Scalzi, S. Mammam, M. Netto (2010), Dynamic controller for lane keeping and obstacle avoidance assistance system, *13th International IEEE Conference on Intelligent Transportation Systems*, pp. 1363-1368.
- Brooke, J. and Sus (1996). A “quick and dirty” usability scale <http://www.usabilitynet.org/trump/documents/Suschap t.doc>.
- Dötzer, F., Strasberger, Kosch, M.T (2005). Classification for traffic related inter-vehicle messaging, *5th International Conference on IST Telecommunication*, Brest, France.
- Hoc, J.M (2001). Towards a cognitive approach to human-machine cooperation in dynamic situations. *International Journal of Human-Computer Studies*, 54, pp. 509-540.
- Hoc J.M., Mars F., Mileville-Pennel I., Jolly E., Netto M., Blosseville J.M. (2006) Evaluation of human-machine cooperation modes in car driving for safe lateral control in bends: function delegation and mutual control modes, *Le travail humain*, 69, pp. 153-182.
- Kay Fuerstenberg, Intersection safety 2006), *3rd International Workshop on Intelligent Transportation*, Hamburg, Germany.
- N. Minoiu, M. Netto, S. Mammam and B. Lusetti (2009). Driver steering assistance for lane departure avoidance, *Control Engineering Practice*, vol 17, pp. 642-651.
- J. A. Michon (1985), “A critical view of driver behavior models: What do we know, what should we do?” in *Human Behavior and Traffic Safety*, L. Evans and R. Schwing, Eds. New York: Plenum, pp. 485–525.
- M. Netto, S. Scalzi et J.M. Blosseville. (2010) Vehicle Low Cost and High Performance Active Safety: Concepts and Control, in *Transport Research Arena Europe Bruxelles*.
- Parasuraman, R., Molloy, R., & Singh, I.L. (1993). Performance consequences of automation-induced “complacency”. *The International Journal of Aviation Psychology*, 3, pp. 1-23.
- Moray, N. (2003). Monitoring, complacency, scepticism and eutactic behaviour. *Industrial Ergonomics*, 31, pp.175-178.
- R. Marino, S. Scalzi, M. Netto (2011). Nested PID steering control for lane keeping in autonomous vehicles, *Control Engineering Practice*, 19(12), pp. 1459-1467.
- Scholliers, J, Joshi, S., Gemou, M., Hendriks, F., Ljung Aust, M., Luoma, J., Netto, M., Engström, J., Leanderson, S., Kutzner, R. Tango, F. Amditis, A., Blosseville, J.-M. and Bekiaris (2011), E.. Development and Application of an Integrated Evaluation Framework for Preventive Safety Applications, *IEEE Transactions on Intelligent Transportation Systems*, 12(1), pp. 211 – 220.
- S. Scalzi, A. Benine-Neto, M. Netto, W. Pasillas-Lepine, S. Mammam (2010), Active Steering Control Based on Piecewise Linear Regions, *American Control Conference - ACC*, Baltimore, Maryland, Etat-Unis.
- J. Scholliers, M. Netto, J.M. Blosseville, S. Leanderson et al (2007), ‘D16.3 Proposal of procedures for assessment of preventive and active safety functions’, *PREVAL-PReVENT deliverable*.

# Chapitre 10

## Conclusions et perspectives

En ce moment, le secteur automobile mondial évolue significativement et ces évolutions sont également très liées à des changements importants dans d'autres secteurs de la société. Par exemple, en ce qui concerne le secteur automobile, l'évolution de la mobilité des citoyens via l'introduction de nouvelles philosophies et nouveaux concepts, notamment en ville, est au cur des discussions dans les pôles de compétitivité concernés en France. L'autopartage et la construction de voies dédiées à des navettes électriques automatisées, entre autres, sont des exemples. Cette évolution permettra à la société (et au citoyen) de s'investir dans le développement durable et en même temps de faire face à la crise du pétrole. L'aide au déplacement des personnes à mobilité réduite s'intègre également dans ce cadre (par de navettes automatisées). En même temps, la communauté scientifique et industrielle en France réalise une réflexion (qui en réalité émerge à un niveau mondial) dans le domaine des systèmes électriques intelligents (SEI). Ces systèmes permettront l'intégration des énergies renouvelables dans les réseaux de génération et de distribution de l'énergie ainsi que la gestion optimale (ou intelligente) de cette énergie. L'intégration des véhicules électriques à ces nouveaux systèmes de gestion optimale de l'énergie (SEI) devient aussi nécessaire. De plus, le véhicule électrique demande la résolution de nouveaux problèmes : il faut par exemple être capable de gérer une défaillance dans un des moteurs-roues pour un véhicule électrique à 4 moteurs-roues.

Nous témoignons donc une restructuration de la ville à plusieurs niveaux : une nouvelle structuration des systèmes de transport ainsi que l'apparition du nouveau concept des smart grids dans lequel les transports sont intégrés par la recharge des véhicules électriques. Ces deux nouvelles structururations, je dirai fondamentales pour la société, émergent donc ensemble. De plus, la problématique de la coopération entre l'homme et la machine doit être considérée, et cela dans des différents cadres : pour les systèmes de transport, mais aussi pour d'autres nouveaux systèmes émergents (il faudra par exemple que les nouvelles interfaces H-M dans le bâtiment intelligent soient bien accessibles à tous - jeunes, personnes âgés et à mobilité réduite sont des exemples). Ma recherche future s'insère dans ce contexte élargi. Au niveau très spécifique, dans le cadre du projet DIM LSC Regeneo, pour lequel je suis responsable, je participe à l'encadrement d'une thèse sur les systèmes ABS. Il s'agit d'un encadrement joint L2S-LTN-LIVIC dont trois chercheurs : W. Pasillas-Lépine, A. De-Bernardinis et moi-même sommes impliqués. En parallèle, je poursuis également ma recherche de nature purement théorique, sur la commande de systèmes

à fortes non-linéarités, que j'estime importante comme fondement pour les applications réelles.

A un niveau plus large, mes contributions à la communauté scientifique portent sur l'animation du GT RSEI, inter 3 GDR : MACS-SEEDS-ISIS (le premier en France), en collaboration avec 4 collègues en France sur la thématique décrite ci-dessus. J'ai créée le GT RSEI en 2010 avec un collègue, initialement au sein du GDR MACS. Au niveau international, je pense pouvoir également contribuer par la coordination de l'organisation de workshops dans les thématiques sur lesquelles j'ai travaillé (voir section ci-dessus *nouveaux projets déposés*).

Concernant les systèmes actifs d'aide à la conduite, une réflexion approfondie me semble nécessaire pour tenir compte des changements actuels dans le monde des transports. Il s'agit donc aussi pour moi d'un moment de réflexion à partir de mes actuels travaux vers de nouvelles directions à entreprendre dans le long terme, tout en tenant compte des changements dans la société, et aussi du large étendu des possibilités offertes par le réseau d'excellence HYCON2 (pour lequel je porte le partenaire IFSTTAR). Le travail sur les systèmes d'aide à la conduite réalisé en collaboration avec mes collègues psychologues de la conduite me laisse penser que les systèmes peu intrusifs sont beaucoup plus efficaces en termes de coopération homme-machine car ils sont mieux acceptés par l'être humain. La route communicante (c.a.d. avec le déploiement de communications véhicule-véhicule et véhicule-infrastructure) permettra d'avertir le conducteur très en amont sur le danger, par de systèmes d'alerte évitant ainsi de trop agir sur les actionneurs. Les systèmes d'aide à la conduite nécessitent donc d'être revus dans ce nouveau contexte. Concernant la mobilité, n'est-ce pas cela plus important de travailler, au moins dans le contexte urbain, pour sécuriser la mobilité, au lieu d'équiper chaque véhicule avec de systèmes sophistiqués et parfois chers ? Dans quelles situations devra-t-on donc utiliser les systèmes actifs d'assistance à la conduite ? Autant de questions très intéressantes à se poser. Il est donc nécessaire de définir cet ensemble de situations faisant appel aux systèmes actifs d'aide à la conduite.

Comme conclusion, mes recherches après la thèse ont porté principalement sur le développement et l'évaluation de systèmes actifs pour la conduite sécurisée de véhicules et pour la mobilité des citoyens. Mon poste de chargée de recherche au LIVIC m'a permis d'appliquer les théories de l'automatique acquises pendant la thèse à différentes problématiques réelles dans le domaine des transports. Des changements importants dans le monde de l'automobile, et des transports d'une manière générale sont indéniables nécessitent de répondre à de nouvelles questions. Actuellement, je réoriente mes acquis scientifiques de ces dernières années pour répondre à certaines de ces nouvelles problématiques posées, notamment en ce qui concerne l'environnement urbain, et en tenant compte de la coopération entre l'homme et la machine. Je revois également mes travaux et résultats récents pour les repositionner dans ce nouveau contexte. Enfin, je poursuis mes activités de recherche en automatique théorique, afin de conserver un recul indispensable à la proposition de solutions originales à des problèmes concrets.

En plus de ces thèmes très spécifiques de recherche et du GT RSEI, mon projet inclut des activités de coordination de la recherche, dans un contexte plus élargi, à moyen terme par le NoE HYCON2. Cela mettra certainement en évidence de nouvelles problématiques importantes à résoudre et de nouvelles voies de recherche auxquelles je pourrai apporter

des solutions, dans le long terme.

Un de mes souhaits est également de poursuivre mes enseignements afin d'apporter mes connaissances acquises aux étudiants (dans la limite des heures autorisées par l'IFST-TAR) ; et par l'encadrement de doctorants et stagiaires, à qui je souhaite mettre à profit l'ensemble de mes connaissances pour leurs proportionner de grandir dans sa carrière, et pour les doctorants je peux leur proposer également de séjours à l'étranger dans des établissements de recherche de haut niveau.



# Quatrième partie

## Bibliography



- [1] Directive 2010/40/EU of the european parliament and of the council of 7 July 2010. Official Journal of the European Union, 6 august 2010.
- [2] Communication from the commission to the council and the European parliament. Keep Europe moving - Sustainable mobility for our continent. Mid-term review of the European Commission's 2001 Transport White Paper, 22 june 2006.
- [3] Commission of the european communities. Green paper : Towards a new culture for urban mobility. COM(2007) 551 final. Brussels, 25.9.2007.
- [4] Communication from the Commission to the European Parliament, the Council, the European Economic and Social Committee and the Committee of the Regions - Towards Europe-wide Safer, Cleaner and Efficient Mobility : The First Intelligent Car Report - COM(2007) 541, 17.9.2007.
- [5] J.M. Hoc, M.S. Young, and J.M. Blosseville. Cooperation between drivers and automation : implications for safety. Theoretical Issues in Ergonomics Science, Vol. 10, No. 2, pp. 135-160, mars 2009.
- [6] Workshop Automation in Road Transport, iMobility Forum, 7 mars 2013 <http://www.icarsupport.eu/events/workshop-automation-in-road-transport/>.
- [7] Schulze, M., Makinen, T., Irion, J., Flament, M., Kessel, T. PReVENT Final Report, 2008.
- [8] Observatoire de vitesses : résultats de l'année 2011. Observatoire National Interministériel de Sécurité Routière, 2012.
- [9] La Documentation Française. La sécurité routière en france - bilan de l'année 2011. Observatoire National Interministériel de Sécurité Routière, 2012.
- [10] Final White Paper. Roadmap to a Single European Transport Area -Towards a competitive and resource efficient transport system. EC, Brussels, 28.3.2011. COM(2011) 144.
- [11] J.J.E. Slotine, W. Li, et al. Applied nonlinear control, volume 461. Prentice hall, Englewood Cliffs, New Jersey, 1991.
- [12] Lyapunov, A.M. Stability of Motion, Math. in Science and Engineering, vol. 30, Academic Press, New York, 1966.
- [13] Khalil, H.K. Nonlinear Systems, Prentice Hall, Upper Saddle River, New Jersey, 2002.
- [14] Narendra,K. and Annaswamy, A.M. Stable Adaptive Systems, Prentice-Hall, Englewood Cliffs, NJ, 1989.
- [15] Margolis, M. and Leondes,C.T. A parameter tracking servo for adaptive control systems, IRE Transactions on Automatic Control vol 4, pp. 100-111, Nov. 1959.
- [16] R. Marino, P.Tomei, Non Linear Control Design, Geometric, Adaptive, Robust, London, UK, Prentice Hall, 1995.
- [17] Fradkov,A. and Ortega,R. and Bastin,G., Semi-adaptive control of convexly parametrized systems with application to temperature regulation of chemical reactors, Intern. J. of adaptive control and signal processing, Vol. 15, pp. 415-426, 2001.
- [18] Annaswamy,A.M. and Skantze,F.P. and Loh,A.P., Adaptive control of continuous-time systems with convex/concave parametrization, Automatica, Vol 34, No. 1, pp. 33-49, 1998.

- [19] Loh,A.P. and Annaswamy,A.M. and Skantze,F.P. Adaptation in the presence of a general nonlinear parametrization : an error model approach. IEEE Transactions on Automatic Control, Vol 44, No. 9, pp. 1634-1652, september 1999.
- [20] Netto,M. and Annaswamy,A.M. and Ortega,R. and Moya,M. Adaptive Control of a class of nonlinearly parametrized systems using convexification, Internat. J. Control, Vol 73, No. 14, pp. 1312-1321, 2000.
- [21] Ortega,R., Some remarks on adaptive neuro–fuzzy systems, Internat. J. Adaptive Control and Signal Processing, Vol 10, pp. 79-83, 1996.
- [22] Lygeros, J., Johansson, K. H., Simic, S., N., Zhang, J., Sastry, S., Dynamical Properties of Hybrid Automata, IEEE Transactions on Automatic Control, Vol. 48, No 1., 2003.
- [23] Johansson, K.H., Lectures, Berkeley University of California, [http://robotics.eecs.berkeley.edu/~koo/EE291E/Sp02/.](http://robotics.eecs.berkeley.edu/~koo/EE291E/Sp02/), 2002.
- [24] Johansson, M., Piecewise Linear Control Systems, PhD thesis, Lund Institute of Technology, Sweden, 1999.
- [25] Lygeros, J., Lectures,
- [26] M. Johansson, Piecewise Linear Control Systems, Springer, 2002.
- [27] Netto, M., La Commande Adaptative de Systèmes Non linéairement Paramétrés, PhD thesis, Laboratoire des Signaux et Systèmes (L2S), CNRS/Université Paris Sud XI/Supélec, France, 2001.
- [28] Polanski, A., On Infinity Norms as Lyapunov Functions for Linear Systems, IEEE Transactions on Automatic Control, Vol. 40, No.7, pp. 1270-1274, 1995.
- [29] Kiendl, H., Adamy, J., Stelzner, P., Vector Norms as Lyapunov Functions for Linear Systems, IEEE Transactions on Automatic Control, Vol. 37, No.6, pp. 839-842, 1992.
- [30] Rockafellar, R.T., Convex Analysis, Princeton University Press, 1996.
- [31] Boyd,S. and Vandenberghe,L., Convex Optimization, Course Reader for EE364 : Introduction to Convex Optimization with Engineering Applications, 1999.
- [32] Hiriart,J.B. and Lemarechal, Convex Analysis and Minimization Algorithms, Springer-Verlang, Berlin, 1993.
- [33] Netto, M. et Annaswamy, A.M., Adaptive control of a class of multilinearly parameterized systems by using noncertainty equivalence control, 51th IEEE Conference on Decision and Control - CDC, Maui, 10-13 december 2012.
- [34] Bemporad, A. and Morari, M. Control of systems integrating logic, dynamics, and constraints. Automatica, Vol 35, No.3 , pp. 407-427, 1999.
- [35] Netto, M., Annaswamy, A., Mammar, S., Glaser, S. A new adaptive control algorithm for systems with multilinear parameterization, American Control Conference - ACC, Minneapolis, USA, 2006..
- [36] Netto, M., Annaswamy, A.M., Mammar, S., Minoiu-Enache, N. A new adaptive controller for systems with multilinear parameterization : n-parameters case. in the ISTE book "Taming Heterogeneity and Complexity of Embedded Control" Eds, F. Lamnabhi-Lagarrigue, A. Loria, E. Panteley and S. Laghrouche, 2006.

- [37] J. Broughton and J. Knowles. Traffic safety basic facts 2010 - single vehicle accident. Technical report, European Road safety Observatory Deliverable D3.2 of the EC FP7 project DaCoTA., 2011.
- [38] Boskovic, J.D. and Narendra, K.S., Comparison of linear, nonlinear and neural-network-based adaptive controllers for a class of fed-batch fermentation processes, *Automatica*, 1995, 6, 31, pp. 817-840.
- [39] J. Scholliers, S. Joshi, M. Gemou, F. Hendriks, M. Ljung Aust, J. Luoma, M. Netto, J. Engström, S. Leanderson, R. Kutzner, F. Tango, A. Amditis, J.-M. Blosseville and E. Bekiaris. Development and Application of an Integrated Evaluation Framework for Preventive Safety Applications, *IEEE Transactions on Intelligent Transportation Systems*, Mars 2011, Vol 12, Issue 1, Pages 211-220, ISSN : 1524-9050.
- [40] N. Minoiu-Enache, M. Netto, S. Mammar and B. Luseti. Driver steering assistance for lane departure avoidance, *Control Engineering Practice*, vol 17, pp. 642-651, 2009.
- [41] Minoiu-Enache, N., S. Mammar, M. Netto, B. Luseti. Driver steering assistance for lane departure avoidance based on hybrid automata and on composite Lyapunov function, *IEEE Transactions on Intelligent Transportation Systems*, vol 11, no.1, pp. 28-39, 2010.
- [42] Minoiu-Enache, N., Luseti, B., Mammar, S., Netto, M. Preventive active lane departure avoidance system for curvy roads. *Journal Européen des systèmes automatisés*, v. 43, no. 6, pp. 615-646, 2009.
- [43] Minoiu-Enache, N. Commande hybride partagée d'un véhicule. Mémoire de fin d'études, Master-2 Recherche, Supélec, Université Paris Sud. Juin 2005.
- [44] Johansson, M. and Rantzer, A., Computation of piecewise quadratic lyapunov functions for hybrid systems. *IEEE Transactions on Automatic Control*, Vol. 43, No. 4, pp. 555-559, April, 1998.
- [45] S. Scalzi, A. Benine-Neto, M. Netto, W. Pasillas-Lepine, S. Mammar, Active Steering Control Based on Piecewise Affine Regions, *American Control Conference*, Baltimore, Baltimore, Maryland, USA, pp. 5362-5367, June 2010.
- [46] A. Benine-Neto, S. Scalzi, M. Netto, S. Mammar, W. Pasillas-Lepine, Vehicle Yaw Rate Control Based on Piecewise Affine Regions, *IEEE Intelligent Vehicles Symposium*, pp. 20-25, San Diego, USA, June 2010.
- [47] A. Benine-Neto, S. Scalzi, S. Mammar, M. Netto, Dynamic controller for lane keeping and obstacle avoidance assistance system, *13th International IEEE Conference on Intelligent Transportation Systems*, Funchal-Portugal, pg. 1363-1368, September 2010.
- [48] Benine-Neto, A. and Scalzi, S. and Netto, M. and Pasillas-Lepine, W. and Mammar, S., La conduite en conditions limite : contrôle d'un modèle non linéaire du véhicule par une approche affine par morceaux via le suivi d'une référence en vitesse de lacet. CIFA, Nancy, France, 2010, *en session invitée*.
- [49] G. Baumgarten. Motor Vehicle Steering System Having a Yaw Rate Controller, *Baye-rische Motoren Werke*. United States Patent Pub. No. US 20040070268 April 15/2004.

- [50] In-Vehicle Embedded Control Systems for Safety : a Survey, in the proceedings of the IFAC Symposium on Control in Transportation (IFAC CTS), Sophia, Bulgaria, 10-12 september 2012.
- [51] Netto, M., Blosseville, J.-M., Lusetti, B., Mammar, S. A new robust control system with optimized use of the lane detection data for vehicle full lateral control under strong curvatures, IEEE Conference on Intelligent Transportation Systems, Toronto, Canada, 2006.
- [52] Hoc J.M., Mars F., Mileville–Pennel I., Jolly E., Netto M., Blosseville J.M. Evaluation of human–machine cooperation modes in car driving for safe lateral control in bends : function delegation and mutual control modes, *Le travail humain*, Volume 69, pp. 153–182, 2006/2.
- [53] Marino, R., Scalzi, S., Netto, M. Nested PID steering control for lane keeping in autonomous vehicles, *Control Engineering Practice*, Volume 19, Issue 12, december 2011, Pages 1459–1467.
- [54] Hoang, T.B., Pasillas-Lépine, W., De-Bernardinis, A. et Netto, M. Extended braking stiffness estimation based on a switched observer, *IEEE Transactions on Control Systems Technology*, soumis, 2013.
- [55] Hoang, T.-B., Pasillas-Lépine, W. and Netto, M. Closed-loop wheel acceleration control based on an extended braking stiffness observer, *American Control Conference - ACC*, 2013, to appear.

Cinquième partie  
Annexed publications



# Adaptive control of a class of multilinearly parameterized systems by using noncertainty equivalence control

Mariana Netto and Anuradha M. Annaswamy

**Abstract**— We propose in this work a new adaptive controller for a class of non-linearly parameterized systems with multilinear parametrization dependent on the state containing an arbitrary number  $l$  of parameters. The proposed controller is non-certainty equivalence based and only the original parameters are adapted. Moreover, since the parameterization depends on the state, a trivial solution by overparameterization is not possible.

The main idea of the paper is to combine two parameterizations, one to convexify and another to concavify the nonlinear function of the unknown parameters, because this permits the use of gradient search based convergence in the entire state-space. This leads however to discontinuous Lyapunov functions, and the use of a non-certainty equivalence based control eliminates any possibility of discontinuity, allowing then a standard Lyapunov function to be used. The stability proof relies on the concavity proof of some special functions, that requires in turn the proof of the positive semi-definiteness of an  $l$ -dimensional matrix, that is a challenge by itself.

## I. INTRODUCTION

Historically, adaptive control has been created with the hypothesis of the system assumption of linearity in the parameters [1], [2]. In spite of the known theoretical challenge that represents the control of nonlinearly parameterized systems, the nineties have witnessed a set of advances in different directions: new controllers have been designed for convex/concave parameterizations in [3], [4] and [5]; some special classes of nonconvex parameterizations have been shown to be convexified by simply reparameterizing the original system in [6], [7] to allow then the use of the new controllers for convex systems; the construction of new kinds of Lyapunov functions have been explored in [8]; in [9], output-feedback has been designed for nonlinearly parameterized systems; and finally [10] has generalized [4] to control general nonlinear parameterizations. Nonlinearly parameterized systems have also been treated by interval analysis [11]

Still in the nineties, when it comes to application of nonlinearly parameterized systems [12], [13], [14] address the friction compensation problem and the hierarchical control proposed in [15] addresses the visual servoing problem for a planar robot. Nonlinear parameterization has also been used for avoidance of unstable pole-zero cancellation [16].

M. Netto is a Senior Researcher at IFSTTAR - Institut Francais des Sciences et Technologies des Transports de l'Aménagement et des Réseaux, 14, Route de la Minière, Bat 824, 78000, Versailles, France (mariana.netto@ifsttar.fr).

A. M. Annaswamy is the Director of the Active Adaptive Control Laboratory, Department of Mechanical Engineering, Massachusetts Institute of Technology, Cambridge, MA 02139, U.S.A. (aanna@mit.edu).

New directions have been achieved after the third millennium has begun. Reference [17] designs an adaptive controller for nonconvex parameterizations. [18] designs a global adaptive switching output-feedback control of nonlinear systems in output feedback form with the unknown parameters entering nonlinearly. [19] proposes an adaptive controller with parameter estimation in systems with unstable target dynamics. [20] designs adaptive observers for a nonlinearly parameterized class of nonlinear systems. [21] adaptive stabilizes high-order stochastic systems with nonlinear parameterization. [22] presents a method to identify the range of a static object using a moving paracatadioptric system with measurable position. The estimator is based on the work in [4] and is able to compensate for the nonlinear parameterization intrinsic to the model. [23] treats the estimation of unknown parameters in systems with nonlinearly parameterized perturbations. [24] extends these results to partial state measurement in the case of linear systems. In [25], Immersion and Invariance and the construction of a monotone mapping are used for the control of nonlinear systems with nonlinear parameterization, with the establishment of answers for the solvability conditions of the PDEs.

Multilinear parameterizations have been addressed in [26] and [27], though in the latter, the algorithm uses more estimates than the original number of parameters. Such parameterizations are found in automotive control, in aircraft control, in robotics problems and in the control of switched reluctance motors. It appears as well in the numerator and denominator polynomials of the RLC transfer function of electrical circuits and also in their mechanical analogs [28].

This paper continues our works in [7], [29] and [30], and we propose a solution to the adaptive control of systems containing multilinear parameterizations dependent on the state.

We consider in this work the following class of multilinearly parameterized systems

$$\begin{aligned} \dot{X}_p(t) &= A_p X_p(t) + \\ &+ b \left[ \sum_{i=1}^p \theta_1^{n_{1i}} w_{1i}(X_p) \theta_2^{n_{2i}} w_{2i}(X_p) \dots \theta_l^{n_{li}} w_{li}(X_p) \right] \phi_i(X_p(t)) \\ &+ u(t) \end{aligned} \quad (1)$$

where  $X_p \in \mathbf{R}^n$  is the plant state,  $u(t) \in \mathbf{R}$  is the control input,  $\theta_j$ ,  $j = 1, \dots, l$  are scalar unknown parameters,  $A_p \in \mathbf{R}^{n \times n}$  is unknown and  $b \in \mathbf{R}^n$  is known with  $(A_p, b)$  controllable, and  $\phi_i$  are nonlinear functions of  $X_p$ . The functions  $w_{ji}(X_p)$  ( $j = 1, \dots, l$ ,  $i = 1, \dots, p$ ) are functions of the state belonging to the class of all non-negative upper-bounded functions. Also, it is assumed that  $k_{\ell_j} < \theta_j < k_{u_j}$ ,  $j = 1, \dots, l$ , with  $sign(k_{\ell_j}) = sign(k_{u_j})$ ,

$$n_{ji} \geq 0, j = 1, \dots, l, i = 1, \dots, p.$$

The goal is then to design in this paper an adaptive controller for this class of plants such that the number of estimates does not depend on  $p$ . Our goal can be further explicited in terms of controlling this system as it is, that is, multilinear in  $\theta_1, \theta_2, \dots, \theta_l$ , and then keeping the number of estimates equal to the number of unknown parameters.

One should note in addition that it is not possible to control (1) by overparameterizing it to force the system to become linearly parameterized, since the reparameterization depends on the state.

The main idea of the paper is perhaps to combine two parameterizations - one to convexify and another to concavify the nonlinear function of the unknown parameters - because this can allow gradient search based adaptation in all the state-space. This approach leads however to discontinuous Lyapunov functions, a difficulty that is overcome by the proposition of a non-certainty equivalence based solution that allows the use of a standard Lyapunov function.

Moreover, we think important to highlight that the proof relies on the construction of a class of concave functions and the proof of concavity that we propose requires the proof of the positive semi-definiteness of an  $l$ -dimensional matrix (the Hessian of the concerned function with the sign changed) - that is a challenge by itself. This proof is given in the paper.

It is also interesting to note that the reasoning of the approach is not based on projections. The projections were introduced for only ensuring the concavity of the constructed functions and are not needed for stability.

## II. THE SEARCH OF A SOLUTION BY CONCAVIFICATION/CONVEXIFICATION OF THE NONLINEAR PARAMETERIZATION

It is known that in the control of convexly-parametrized systems, convexity ensures that the adaptive law based on the gradient search goes in the right direction when the error is non positive (see [29] and all the references that are cited in this paper). However, when the error is non negative, we could not ensure the sign-definiteness of the Lyapunov function. For concave functions, the opposite situation holds, the adaptive law based on the gradient search “goes in the right direction” when the error is non negative.

This suggests that it would be interesting to have some convexity and concavity properties at the same time so that we could ensure the negative semi-definiteness of the derivative of the Lyapunov function along the system trajectories in all the state-space. In our former works [6],[7], we have shown that some classes of functions can be convexified through a reparametrization. In order to have some convexity and concavity properties at the same time we ask here ourselves the following question: is it possible to find two different reparametrizations, one that convexifies and another that concavifies the nonlinear parametrization? Is this property useful to prove stability? This idea is illustrated in [7] with three precise examples when dealing with the problem of identification of nonlinear regressions. However, to carry out the stability analysis, discontinuous Lyapunov

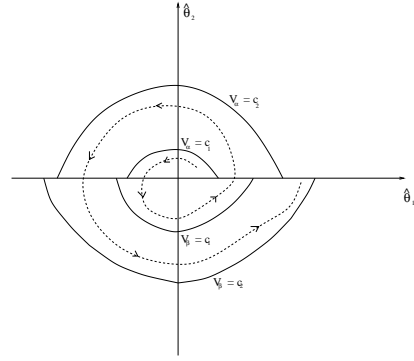

Fig. 1. Illustrative example in which the discontinuous Lyapunov function does not allow to prove stability.

functions need to be used, which turns out to be a main obstacle in the proof of stability. Figure 1 illustrates this situation. Indeed, due to the discontinuity of  $V$ , the level curves are not closed and the trajectories can escape to infinity.

We show in the next section that stability can be achieved using a judiciously chosen non-certainty equivalence switched based control structure. This structure allows the use of a standard continuous Lyapunov function to prove stability. Then, in a certain way, non-certainty equivalence replaces the need for a switched Lyapunov function.

## III. CONTROL OF NON-LINEARLY - MULTILINEAR TYPE - PARAMETERIZED SYSTEMS WITH A PARAMETERIZATION DEPENDENT ON THE STATE

### A. Problem statement

We consider the class of plants in (1) where  $X_p \in \mathbf{R}^n$  is the plant state,  $u(t) \in \mathbf{R}$  is the control input,  $\theta_j, j = 1, \dots, l$  are scalar unknown parameters,  $A_p \in \mathbf{R}^{n \times n}$  is unknown and  $b \in \mathbf{R}^n$  is known with  $(A_p, b)$  controllable, and  $\phi_i$  are nonlinear functions of  $X_p$ . Also, it is assumed that  $k_{\ell_j} < \theta_j < k_{u_j}, j = 1, \dots, l$ , with  $sign(k_{\ell_j}) = sign(k_{u_j}), n_{ji} \geq 0, j = 1, \dots, l, i = 1, \dots, p$ .

Our *control goal* is to find an input  $u$  such that the closed-loop system has globally bounded solutions and so that  $X_p$  tracks the state  $X_m$  of an asymptotically stable reference model specified as  $\dot{X}_m = A_m X_m + br$ , with  $det(sI - A_m) = (s + k)R(s), k > 0, r$  bounded and with  $A_p + b\beta^T = A_m$  for some unknown vector  $\beta \in \mathbf{R}^n$ .

As mentioned, we want to do the adaptation in the original parameter space, keeping then the number of estimates equal to the number of parameters.

### B. Preliminary lemmas

This section is dedicated to the proof of the convexity and the concavity of some functions that are used in the stability proofs. I Note specially the proofs of Lemmas 3.3 and 3.5 that involve the proof of the positive semi-definiteness of  $l$ -dimensional matrices, that it consists in not a trivial problem.

Let us define first the parameter vector :  $\gamma = \begin{bmatrix} \gamma_1 \\ \gamma_2 \\ \vdots \\ \gamma_l \end{bmatrix} \in \mathbf{R}^l$ .

**Lemma 3.1:**  $f(\gamma) = e^{(\gamma_1-1)n_1} e^{(\gamma_2-1)n_2} \dots e^{(\gamma_l-1)n_l}$ , with  $n_j \in \mathbf{R}, j = 1, \dots, l$ , is convex with respect to  $\gamma$ .

*Proof:* The reader is referred to [30] for the proof. ■

**Lemma 3.2:** Consider  $l = 2$ . The function  $g(\gamma) = [a\gamma_1^{\frac{1}{2}} + b] [c\gamma_2^{\frac{1}{2}} + d]$ , where  $a, b, c, d \in \mathbf{R}_{\geq 0}$ ,<sup>1</sup> is concave with respect to  $\gamma$ , for  $\gamma_i \geq 0, i = 1, 2$ .

*Proof:* the reader is referred to [7] for the proof. ■

The generalization of Lemma 3.2 and its proof is provided below.

**Lemma 3.3:** Consider an arbitrary  $l$  and let :

$g(\gamma) = [a_1\gamma_1^q + b_1] [a_2\gamma_2^q + b_2] \dots [a_l\gamma_l^q + b_l]$ , with  $q \leq 1/(2l-1), q > 0$  and where  $a_j, b_j \in \mathbf{R}_{\geq 0}, j = 1, \dots, l$ .

Then, the function  $g(\gamma)$  is concave with respect to  $\gamma$ , for  $1 \leq \gamma_j \leq 2, j = 1, \dots, l$ .

*Proof:* Since a sum of concave functions is concave and  $\gamma_j^q$  are already concave, to prove that

$$g(\gamma) = [a_1\gamma_1^q + b_1] [a_2\gamma_2^q + b_2] \dots [a_l\gamma_l^q + b_l]$$

is concave, we need to prove that<sup>2</sup>

$$g_{z_1 z_2}(\gamma) = \prod_{j=z_1}^{z_2} \gamma_j^q, \quad z_1 = 1, \dots, l; \quad z_2 = z_1 + 1, \dots, l;$$

are all concave functions.

In order to ensure that  $g_{z_1 z_2}(\gamma)$  are concave for all  $z_1, z_2$ , it is enough to prove that a multiplication of  $k$  terms of the concave functions  $\gamma_j^q$ , with  $k \leq l$ , is concave. Let's take,

without loss of generality,  $g_{1k}(\gamma) \triangleq \bar{g} = \prod_{j=1}^k \gamma_j^q$

**Claim 1:** If the condition<sup>3</sup>

$$v \triangleq \begin{bmatrix} 1-q & -q & -q & \dots & -q \\ -q & 1-q & -q & \dots & -q \\ -q & -q & 1-q & \dots & -q \\ \vdots & \vdots & \vdots & \ddots & \vdots \\ -q & -q & -q & \dots & 1-q \end{bmatrix} \begin{bmatrix} \gamma_1^{-1} \\ \gamma_2^{-1} \\ \gamma_3^{-1} \\ \vdots \\ \gamma_k^{-1} \end{bmatrix} \geq 0 \quad (2)$$

is satisfied, then,  $\bar{g}$  is concave.

Let us first prove that the conditions of Lemma 3.3, that is,

$$q \leq 1/(2l-1), q > 0, \text{ and } 1 \leq \gamma_j \leq 2,$$

allow Claim 1 to be satisfied.

Denoting the first element of  $v$  as  $v_1$ , we have that

$$v_1 \geq 0 \quad (3)$$

$$\Leftrightarrow (1-q)\gamma_1^{-1} - q\gamma_2^{-1} - q\gamma_3^{-1} - \dots - q\gamma_k^{-1} \geq 0 \quad (4)$$

$$\Leftrightarrow (1-q)\gamma_1^{-1} \geq q\gamma_2^{-1} + q\gamma_3^{-1} + \dots + q\gamma_k^{-1}$$

<sup>1</sup> $\mathbf{R}_{\geq 0}$  denote the nonnegative real numbers  $\{x \in \mathbf{R} : x \geq 0\}$

<sup>2</sup>Note also that each of these functions will be multiplied by a coefficient, that by assumption, are non-negative.

<sup>3</sup>We have used the following notation : a vector  $v \geq 0$  means an elementwise condition on nonnegativity, that is,  $v_i \geq 0$ , where  $v_i$  are the elements of  $v$ .

Take the worst case in the interval of interest corresponding to  $\gamma_j$  (replace  $\gamma_j$  by 2 in the left-hand side and  $\gamma_j$  by 1 in the right-hand side). Then, (4) becomes

$$\frac{(1-q)}{2} \geq (k-1)q$$

that is satisfied by the choice of  $q$ , since  $k \leq l$ .

We now prove Lemma 3.3 by proving Claim 1, using the following four steps:

1) calculation of the Hessian of  $\bar{g}$

2) decomposition of the Hessian (multiplied by -1) in a key sum of matrices, where this decomposition is done such that all matrices except for one, are positive semi-definite

3) Proof that the condition stated in claim 1 is sufficient to ensure that this last matrix of the sum is also positive semi-definite

4) Since a sum of positive semi-definite matrices is also positive semi-definite, then the Hessian (multiplied by -1) is positive semi-definite, wrapping up the proof of concavity of  $\bar{g}$ .

**Step 1 :**

$$-\frac{\partial^2 \bar{g}}{\partial \bar{g}^2} \triangleq H = \begin{bmatrix} D_1 & -H_{12} & -H_{13} & \dots & -H_{1k} \\ -H_{21} & D_2 & -H_{23} & \dots & -H_{2k} \\ -H_{31} & -H_{32} & D_3 & \dots & -H_{3k} \\ \vdots & \vdots & \vdots & \ddots & \vdots \\ -H_{k1} & -H_{k2} & -H_{k3} & \dots & D_k \end{bmatrix}$$

where  $H_{gh} = H_{hg} \triangleq q^2 \bar{g} \gamma_g^{-1} \gamma_h^{-1}$ , and corresponds to the  $(h, g)$ th element (in absolute value) with  $g \neq h$ ; and  $D_m \triangleq q(1-q)\bar{g}\gamma_m^{-2}$ ,  $m = 1, \dots, k$ , are the diagonal elements of  $H$ .

**Step 2 :**

Define the number  $n_D = \sum_{i=1}^{l-1} i$ . The matrix  $H$  can then be decomposed as :

$$H = \sum_{\substack{g=2, \dots, k \\ h=1 \dots g-1}} H_{Dgh} + H_{diag}$$

The matrices  $H_{Dgh}$  are constructed to be symmetric matrices of rank one with diagonal non-negative elements such as to be positive semi-definite (see Lemma 1 in [6]).  $n_D$  is the number of matrices  $H_{Dgh}$  that is equal to the number of elements in the lower (or upper) triangular part of  $H$ . Each  $H_{Dgh}$  is constructed as a matrix of zero elements except for 4 elements. These are : the element  $H_{gh}$ , with negative sign, in the lower triangular, its correspondent, in the upper triangular part, with negative sign as well, completed by  $H_{gh}$  belonging to the diagonal of  $H$ , such that to make a rank one matrix, in the following way :

$$H_{Dgh} = \begin{bmatrix} H_{gh} & 0 & -H_{gh} & \dots & 0 \\ 0 & 0 & 0 & \dots & 0 \\ -H_{gh} & 0 & H_{gh} & \dots & 0 \\ \vdots & \vdots & \vdots & \ddots & \vdots \\ 0 & 0 & 0 & 0 & 0 \end{bmatrix} \quad (5)$$

$H_{diag}$  is constructed in the following form :

$$H_{diag} = \begin{bmatrix} H_{diag1} & 0 & 0 & 0 & 0 \\ 0 & H_{diag2} & 0 & 0 & 0 \\ 0 & 0 & H_{diag3} & 0 & 0 \\ \vdots & \vdots & \vdots & \ddots & \vdots \\ 0 & 0 & 0 & 0 & H_{diagk} \end{bmatrix}$$

where we have defined  $H_{diag} i = D_i - \sum_{j=1, j \neq i}^k H_{ij}$ .

### Step 3:

We now prove that  $H_{diag}$  is positive semi-definite. Since  $H_{diag}$  is diagonal, its positive semi-definiteness holds if each element of the diagonal is non-negative, and so if:

$$H_{diag} i = D_i - \sum_{j=1, j \neq i}^k H_{ij} \geq 0$$

that is equivalent to :

$$\begin{aligned} \bar{g}\gamma_1^{-1}q \left[ (1-q)\gamma_1^{-1} - q\gamma_2^{-1} - q\gamma_3^{-1} - \dots - q\gamma_k^{-1} \right] &\geq 0 \\ \bar{g}\gamma_2^{-1}q \left[ (1-q)\gamma_2^{-1} - q\gamma_1^{-1} - q\gamma_3^{-1} - \dots - q\gamma_k^{-1} \right] &\geq 0 \\ \bar{g}\gamma_3^{-1}q \left[ (1-q)\gamma_3^{-1} - q\gamma_1^{-1} - q\gamma_2^{-1} - q\gamma_4^{-1} \dots - q\gamma_k^{-1} \right] &\geq 0 \\ &\vdots \\ \bar{g}\gamma_k^{-1}q \left[ (1-q)\gamma_k^{-1} - q\gamma_1^{-1} - q\gamma_2^{-1} - q\gamma_3^{-1} - \dots - q\gamma_{k-1}^{-1} \right] &\geq 0 \end{aligned} \quad (6)$$

Since  $\gamma_j$ ,  $q$  and  $\bar{g}$ , by assumption are non-negative, (6) is equivalent to the condition (2), stated in Claim 1, wrapping up the proof. ■

**Lemma 3.4:** Consider  $l = 2$ . The function  $g(\gamma, X_p) = \left[ a\gamma_1^{qw_1(X_p)} + b \right] \left[ c\gamma_2^{qw_2(X_p)} + d \right]$ , where  $a, b, c, d \in \mathbf{R}_{\geq 0}^4$ ,  $w_i(X_p) \geq 0$ , with  $qw_1(X_p) + qw_2(X_p) \leq 1$ ,  $q > 0$  is concave with respect to  $\gamma$ , for  $\gamma_i \geq 0$ ,  $i = 1, 2$ , and for all  $X_p$ .

*Proof:* The proof can be carried out similarly to the proof of Lemma 3.2 ■

**Lemma 3.5:** Consider an arbitrary  $l$  and let :

$$g(\gamma, X_p) = \left[ a_1\gamma_1^{qw_1(X_p)} + b_1 \right] \left[ a_2\gamma_2^{qw_2(X_p)} + b_2 \right] \dots \left[ a_l\gamma_l^{qw_l(X_p)} + b_l \right] \quad (7)$$

with  $qw_j(X_p) \leq \frac{1}{2}l$ ,  $w_l(X_p) \geq 0$ ,  $q > 0$ , and where  $a_j, b_j \in \mathbf{R}_{\geq 0}$ ,  $j = 1, \dots, l$ .

The function  $g(\gamma, X_p)$  is concave with respect to  $\gamma$ , for  $1 \leq \gamma_j \leq 2$ ,  $j = 1, \dots, l$  and for all  $X_p$ .

*Proof:* The proof can be carried out in a similar way as the proof of Lemma 3.3, where now we need to prove that

$$g_{1k}(\gamma, X_p) \triangleq \bar{g} = \prod_{j=1}^k \gamma_j^{qw_j(X_p)}, k \leq l$$

Claim 1 in the proof of Lemma 3.3 is replaced by :

<sup>4</sup> $\mathbf{R}_{\geq 0}$  denote the nonnegative real numbers  $\{x \in \mathbf{R} : x \geq 0\}$

Claim 1.1. : If the condition<sup>5</sup>

$$v \triangleq \begin{bmatrix} 1 - qw_1 & -qw_2 & \dots & -qw_k \\ -qw_1 & 1 - qw_2 & \dots & -qw_k \\ \vdots & \vdots & \ddots & \vdots \\ -qw_1 & -qw_2 & \dots & 1 - qw_k \end{bmatrix} \begin{bmatrix} \gamma_1^{-1} \\ \gamma_2^{-1} \\ \vdots \\ \gamma_k^{-1} \end{bmatrix} \geq 0 \quad (8)$$

is satisfied, then,  $\bar{g}$  is concave.

The proof that the conditions of Lemma 3.5, that is,  $w_j \geq 0$ ,  $qw_j \leq 1/(2l)$ ,  $q > 0$  and  $1 \leq \gamma_j \leq 2$ , allow Claim 1.1. to be satisfied can be done as well in a similar way.

In step 1,  $H_{gh}$  and  $D_m$ , in the matrix  $H$ , are replaced by

$$H_{gh} = H_{hg} \triangleq q^2 w_g w_h \bar{g} \gamma_g^{-1} \gamma_h^{-1} \quad (9)$$

$$D_m = qw_m (1 - qw_m) \bar{g} \gamma_m^{-2} \quad (10)$$

Steps 2 and 3 are carried out in a similar way with  $H_{gh}$  and  $D_m$  replaced by (9), (10).

Condition (6) becomes

$$\begin{aligned} M_1 \left[ (1 - qw_1)\gamma_1^{-1} - qw_2\gamma_2^{-1} - \dots - qw_k\gamma_k^{-1} \right] &\geq 0 \\ M_2 \left[ (1 - qw_2)\gamma_2^{-1} - qw_1\gamma_1^{-1} - qw_3\gamma_3^{-1} \dots - qw_k\gamma_k^{-1} \right] &\geq 0 \\ &\vdots \\ M_k \left[ (1 - qw_k)\gamma_k^{-1} - qw_1\gamma_1^{-1} - \dots - qw_{k-1}\gamma_{k-1}^{-1} \right] &\geq 0 \end{aligned}$$

where we have defined  $M_j = \bar{g}\gamma_j^{-1}qw_j$ .

This condition is satisfied provided that condition (8) in Claim 1.1 is satisfied since  $\bar{g}$ ,  $\gamma_j$ ,  $q$  and  $w_j$  by assumption are non-negative, wrapping up the proof. ■

### C. Control design : two parameters case

The algorithms to control (1), with  $w(X_p) = 1$ , that corresponds to a nonlinear parameterization non dependent on the state, for  $l = 2$  and  $l$  arbitrary, can be found in [7], [29] and [30].

In this section, we present our solution to control the class of systems (1) where the **nonlinear parameterizations depend on the state**  $X_p$ . For sake of clarity, we consider first the case  $l = 2$  (two parameters) and generalize our results to  $l$  arbitrary in the next section.

We first define the class of functions  $C_{wx}$  in the following way :

**Definition 3.1:**  $C_{wx}$  is the class of all functions of the state  $X_p$ , denoted here generically by  $w(X_p)$ , with  $w(X_p)$  satisfying :

$$w(X_p) \geq 0, \forall X_p$$

$$w(X_p) \leq W_L, \forall X_p \text{ for a positive finite number } W_L.$$

Before presenting the main theorem, let us first define the functions  $f_i$ ,  $g_i$  and  $\bar{\phi}_i$  :

$$f_i(\gamma, X_p) = e^{c_1 n_{1i} w_{1i}(X_p) \gamma_1} e^{c_2 n_{2i} w_{2i}(X_p) \gamma_2} \quad (11)$$

$$g_i(\gamma, X_p) = \left[ \left( e^{c_1 n_{1i} w_{1i}(X_p)} - 1 \right) \gamma_1^{\frac{1}{2}} + 1 \right] \times$$

$$\times \left[ \left( e^{c_2 n_{2i} w_{2i}(X_p)} - 1 \right) \gamma_2^{\frac{1}{2}} + 1 \right] \quad (12)$$

<sup>5</sup>In the following for sake of simplicity where it will appear the functions  $w_j(X_p)$ , we will simply note  $w_j$ . We simplify in the same way, all functions that depend on  $w_j(X_p)$ , by dropping out the argument  $X_p$  from them.

and

$$\begin{aligned} \bar{\phi}_i(X_p) &= \bar{k}_{\ell_1}^{n_{1i} w_{1i}} \bar{k}_{\ell_2}^{n_{2i} w_{2i}} \times \\ &\times [\text{sign}(\theta_1)]^{n_{1i} w_{1i}} [\text{sign}(\theta_2)]^{n_{2i} w_{2i}} \phi_i(X_p) \end{aligned} \quad (13)$$

where  $c_j$ ,  $\bar{k}_{\ell_j}$  and  $\bar{k}_{u_j}$  are given by :

$$c_j = \ln \left( \frac{\bar{k}_{u_j}}{\bar{k}_{\ell_j}} \right)$$

$$\begin{aligned} \bar{k}_{\ell_1} &< |\theta_1| < \bar{k}_{u_1} \\ \bar{k}_{\ell_2} &< |\theta_2| < \bar{k}_{u_2} \end{aligned}$$

with  $\bar{k}_{\ell_1}$ ,  $\bar{k}_{\ell_2}$ ,  $\bar{k}_{u_1}$  and  $\bar{k}_{u_2}$  defined as follows :

$$\bar{k}_{\ell_j} = k_{\ell_j}; \bar{k}_{u_j} = k_{u_j} \quad \text{if } k_{\ell_j} > 0 \quad (14)$$

$$\bar{k}_{\ell_j} = |k_{u_j}|; \bar{k}_{u_j} = |k_{\ell_j}| \quad \text{if } k_{\ell_j} < 0 \quad (15)$$

Let us define as well the functions  $S_i$  and  $L_i$  :

$$S_i(\hat{\gamma}, \bar{\phi}_i, e_c, X_p) = \begin{cases} f_i(\hat{\gamma}, X_p), & \text{if } \bar{\phi}_i(X_p) e_c \leq 0 \\ g_i(\hat{\gamma}, X_p), & \text{if } \bar{\phi}_i(X_p) e_c > 0 \end{cases} \quad (16)$$

$$L_i(\hat{\gamma}, \bar{\phi}_i, e_c, X_p) = \begin{cases} \frac{\partial f_i(\gamma, X_p)}{\partial \gamma} \Big|_{\hat{\gamma}}, & \text{if } \bar{\phi}_i(X_p) e_c \leq 0 \\ \frac{\partial g_i(\gamma, X_p)}{\partial \gamma} \Big|_{\hat{\gamma}}, & \text{if } \bar{\phi}_i(X_p) e_c > 0 \end{cases} \quad (17)$$

where  $e_c$  is a composite scalar error which is defined as  $e_c = h^T E$ , with  $h^T (sI - A_m)^{-1} b = 1/(s+k)$ ,  $k$  and  $r$  are as defined in Section III-A and  $E \triangleq X_p - X_m$ , and  $\hat{\gamma}_j$  are the estimations of the reparameterized parameters  $\gamma_j = \frac{1}{c_j} \ln \left( \frac{|\theta_j|}{k_{\ell_j}} \right)$ .

The according control input and adaptation law for  $\gamma$  are:

$$u = - \sum_{i=1}^p S_i(\hat{\gamma}, \bar{\phi}_i, e_c, X_p) \bar{\phi}_i(X_p) + \beta^T X_p + r \quad (18)$$

$$\dot{\hat{\gamma}} = \Gamma_\gamma \left[ \sum_{i=1}^p L_i(\hat{\gamma}, \bar{\phi}_i, e_c, X_p) \bar{\phi}_i(X_p) \right] e_c \quad (19)$$

where  $\Gamma_\gamma \in \mathbf{R}^{2 \times 2}$  and the estimate  $\hat{\beta}$ , that is introduced due to the fact that  $A_p$  is unknown, is updated according to

$$\dot{\hat{\beta}} = -\Gamma_\beta e_c X_p, \quad (20)$$

Let us now present the main theorem :

**Theorem 3.1:** Consider the plant (1) with  $w_{ji}(X_p) \in C_{wx}$ ,  $l = 2$ , in closed-loop with the control input in (18) and the adaptive laws in (19) and (20). Then if  $\hat{\gamma}_1(t) > 0$ ,  $\hat{\gamma}_2(t) > 0$  for all  $t \geq t_0$  and  $\phi_i^6$  are bounded functions of their arguments, then the closed-loop signals are globally bounded,  $\hat{\gamma} \in \mathcal{L}_\infty$ ,  $\hat{\beta} \in \mathcal{L}_\infty$  and  $E \rightarrow 0$ .

*Proof:* For lack of space, we do not present the entire proof since it can be carried out similarly to in [30] and [29], provided that (22) and (23) in the following are ensured. Also, for the reader to understand why we constructed adaptive laws for  $\gamma_j$  rather than for  $\theta_j$ , we recall that the proof begins with a reparameterization of the plant (1), as follows ([31] proposes a similar reparameterization):

<sup>6</sup>Note that, as before,  $X_p$ ,  $E$  and  $\hat{\gamma} = \begin{bmatrix} \hat{\gamma}_1 \\ \hat{\gamma}_2 \end{bmatrix}$  are functions of the time  $t$  and we have suppressed the argument  $t$  from them for sake of simplicity.

$\gamma_j = \frac{1}{c_j} \ln \left( \frac{|\theta_j|}{k_{\ell_j}} \right)$  with  $c_j = \ln \left( \frac{\bar{k}_{u_j}}{k_{\ell_j}} \right)$ , that implies  $|\theta_j| = \bar{k}_{\ell_j} e^{c_j \gamma_j}$ . Note that the reparameterization provides also that  $\gamma_1$  and  $\gamma_2$  satisfy  $0 < \gamma_1 < 1$  ;  $0 < \gamma_2 < 1$  in the defined intervals of interest for  $\theta_1$  and  $\theta_2$ .

The reparameterized plant (1) is written then as follows :

$$\dot{X}_p = A_p X_p + b \left[ \sum_{i=1}^p f_i(\gamma) \bar{\phi}_i + u \right] \quad (21)$$

And, this is the reason why the functions  $f_i(\gamma)$  appear in the control and in the adaptive laws.

The first key point consists in ensuring that for  $w_{ji} \in C_{wx}$ , the defined functions  $g_i(\gamma, X_p)$  are concave what is ensured by Lemma 3.4.

Finally,  $g_i(\gamma, X_p)$  and  $f_i(\gamma, X_p)$  must satisfy  $g_i(\gamma, X_p) \geq f_i(\gamma, X_p)$ , ensured by construction for  $0 < \gamma_j < 1$ .

Then, we can prove as in [30], that the two inequalities below hold :

$$f_i(\gamma) - f_i(\hat{\gamma}) - \frac{\partial f_i(\gamma)}{\partial \gamma} \Big|_{\hat{\gamma}} (\gamma - \hat{\gamma}) \geq 0, \quad \text{for } \gamma_j, \hat{\gamma}_j \geq 0 \quad (22)$$

$$f_i(\gamma) - g_i(\hat{\gamma}) - \frac{\partial g_i(\gamma)}{\partial \gamma} \Big|_{\hat{\gamma}} (\gamma - \hat{\gamma}) \leq 0, \quad \text{for } 0 \leq \gamma_j \leq 1, \hat{\gamma}_j \geq 0 \quad (23)$$

To complete the proof, these two inequalities can be used as in [30] to establish that the derivative of  $V = \frac{1}{2} [e_c^2 + \tilde{\gamma}^T \Gamma_\gamma^{-1} \tilde{\gamma} + \tilde{\beta}^T \Gamma_\beta^{-1} \tilde{\beta}]$  is given by

$$\dot{V} \leq -k e_c^2 \quad (24)$$

and then Barbalat's Lemma can be used to ensure that  $E \rightarrow 0$ . ■

#### D. Control design : arbitrary number of parameters

Let us first redefine  $f_i(\gamma, X_p)$  and  $g_i(\gamma, X_p)$  in (11) and (12) as follows :

$$\begin{aligned} f_i(\gamma, X_p) &= e^{c_1 n_{1i} (\gamma_1 - 1) w_{1i}(X_p)} e^{c_2 n_{2i} (\gamma_2 - 1) w_{2i}(X_p)} \\ &\dots e^{c_l n_{li} (\gamma_l - 1) w_{li}(X_p)} \end{aligned} \quad (25)$$

$$\begin{aligned} g_i(\gamma, X_p) &= \left[ \gamma_1^q + e^{c_1 n_{1i} w_{1i}(X_p)} \right] \left[ \gamma_2^q + e^{c_2 n_{2i} w_{2i}(X_p)} \right] \\ &\dots \left[ \gamma_l^q + e^{c_l n_{li} w_{li}(X_p)} \right] \end{aligned} \quad (26)$$

and consider the  $S_i$  and  $L_i$  in (16) and (17), the control input in (18) and the adaptive law for  $\gamma$  in (19), with  $f_i$  and  $g_i$  replaced by their new definitions in (25) and (26).  $\bar{\phi}_i(X_p)$  is the analogous of (13) for  $l$  parameters.

Let us state the main theorem for the generalized  $l$ -parameters nonlinear parameterization dependent on the state:

**Theorem 3.2:** Consider the plant (1) with  $w_{ji}(X_p) \in C_{wx}$ ,  $l$  arbitrary, in closed-loop with the control input in (18), adaptive law in (19), redefined according to the new definitions of  $f_i$  and  $g_i$  in (25) and (26) and the additional adaptive law in (20). Then if  $1 \leq \hat{\gamma}_j(t) \leq 2$  for all  $t \geq t_0$  and  $\phi_i$  are bounded functions of their arguments, then the closed-loop signals are globally bounded,  $\hat{\gamma} \in \mathcal{L}_\infty$ ,  $\hat{\beta} \in \mathcal{L}_\infty$  and  $E \rightarrow 0$ .

*Proof:* The proof can be carried out in the same way as in the proof of Theorem 3.1, by noting that the two key points stated in the proof of Theorem 3.1 hold for  $f_i$  and  $g_i$  defined as in (25) and (26). By construction,  $g_i$  are above  $f_i$  in the interval of interest, that corresponds in this case to  $1 < \gamma_j < 2$ . Lemma 3.5 ensures that the constructed  $g_i$  in (26) are concave. ■

#### IV. CONCLUSIONS

We have proposed in this work a new adaptive controller for a class of multilinearly parameterized systems with the nonlinear parameterization containing an arbitrary number of parameters and dependent on the state. The proposed controller ensures a number of estimates matching the number of unknown parameters. In addition, because the nonlinear parameterization is dependent on the state, finding a solution by overparameterization would not even in principle be feasible. To carry out the stability proof of the system, we proved the concavity of some defined concave functions and for this, the positive semi-definiteness 1-dimensional matrices, a challenge for itself.

#### ACKNOWLEDGEMENT

The research leading to these results has received funding from the European Union Seventh Framework Programme [FP7/2007-2013] under grant agreement no 257462 HY-CON2 Network of excellence. A part of the work reported here was carried out when the second author was a Hans Fischer Senior Fellow at the Institute for Advanced Study, Technische Universitat Munchen, Germany.

#### REFERENCES

- [1] I.D. Landau, *Adaptive control: the model reference approach*, Marcel Dekker, New York, 1979.
- [2] K. Narendra and A.M. Annaswamy, *Stable Adaptive Systems*, Prentice-Hall, Englewood Cliffs, NJ, 1989.
- [3] A. Fradkov, R. Ortega, and G. Bastin, "Semi-adaptive control of convexly parameterized systems with application to temperature regulation of chemical reactors", *Intern. J. of adaptive control and signal processing*, vol. 15, pp. 415–426, 2001.
- [4] A.M. Annaswamy, F.P. Skantze, and A.P. Loh, "Adaptive control of continuous-time systems with convex/concave parameterization", *Automatica*, vol. 34, no. 1, pp. 33–49, 1998.
- [5] R. Ortega, "Some remarks on adaptive neuro-fuzzy systems", *Internat. J. Adaptive Control and Signal Processing*, vol. 10, pp. 79–83, 1996.
- [6] M. Netto, A.M. Annaswamy, R. Ortega, and M. Moya, "Adaptive control of a class of nonlinearly parameterized systems using convexification", *Internat. J. Control*, vol. 73, no. 14, pp. 1312–1321, 2000.
- [7] M. Netto, *Adaptive Control of Nonlinearly Parameterized Systems*, PhD thesis, LSS–Supelec, France, 2001.
- [8] S.S. Ge, C.C. Hang, and T. Zhang, "A direct adaptive controller for dynamic systems with a class of nonlinear parameterizations", *Automatica*, vol. 35, pp. 741–747, April 1999.
- [9] R. Marino and P. Tomei, "Global adaptive output-feedback control of nonlinear systems, part ii : nonlinear parameterization", *IEEE Trans. on Aut. Contr.*, vol. 38, no. 1, pp. 33–48, January 1993.
- [10] A.P. Loh, A.M. Annaswamy, and F.P. Skantze, "Adaptation in the presence of a general nonlinear parameterization: an error model approach", *IEEE Transactions on Automatic Control*, vol. 44, no. 9, pp. 1634–1652, September 1999.
- [11] L. Jaulin, M. Kieffer, O. Didrit, and E. Walter, *Applied interval analysis*, Springer, London, 2001.
- [12] K.M. Misovec and A.M. Annaswamy, "Friction compensation using adaptive non-linear control with persistent excitation", *International Journal of Control*, vol. 72, no. 5, pp. 457–479, 1999.
- [13] Y. Tan and I. Kanellakopoulos, "Adaptive nonlinear friction compensation with parametric uncertainties", in *Proceedings of the American Control Conference*, San Diego, CA, June 1999.
- [14] N. Barabanov and R. Ortega, "Necessary and sufficient conditions for passivity of the lugre friction model", *IEEE Transactions on Automatic Control*, vol. 45, no. 4, pp. 830–832, April 2000.
- [15] L. Hsu, R.R. Costa, and P. Aquino, "Stable adaptive visual servoing for moving targets", in *Proc. of the American Control Conference (ACC)*, Chicago, June 2000.
- [16] A.S. Morse, "Supervisory control of families of linear set-point controllers - part I: Exact matching", *IEEE Trans. on Aut. Contr.*, vol. 41, no. 10, Oct. 1996.
- [17] I.Y. Tyukin, D.V. Prokhorov, and V.A. Terekhov, "Adaptive control with nonconvex parameterization", *IEEE Transactions on Automatic Control*, vol. 4, no. 48, pp. 554–567, April 2003.
- [18] X. Ye, "Switching adaptive output-feedback control of nonlinearly parameterized systems", *Automatica*, vol. 9, no. 41, pp. 983–989, 2005.
- [19] I.Y. Tyukin, D.V. Prokhorov, and C.V. Leeuwen, "Adaptation and parameter estimation in systems with unstable target dynamics and nonlinear parameterization", *IEEE Transactions on Automatic Control*, vol. 9, no. 52, pp. 1543–1559, September 2007.
- [20] M.a Farza, M.a M'Saad, T.a b Maatoug, and M.b Kamoun, "Adaptive observers for nonlinearly parameterized class of nonlinear systems", *Automatica*, vol. 45, no. 10, pp. 2292–2299, 2009.
- [21] X.-J.a b Xie and J.c Tian, "Adaptive state-feedback stabilization of high-order stochastic systems with nonlinear parameterization", *Automatica*, vol. 45, no. 1, pp. 126–133, 2009.
- [22] N. Nath, E. Tatlicioglu, and Dawson D.M., "Range identification for nonlinear parameterizable paracatadioptric systems", *Automatica*, vol. 46, pp. 1129–1140, 2010.
- [23] H.F.a Grip, T.A.a Johansen, L.a b Imsland, and G.-O.c Kaasa, "Parameter estimation and compensation in systems with nonlinearly parameterized perturbations", *Automatica*, vol. 46, no. 1, pp. 19–28, 2010.
- [24] H.F.a b Grip, A.a Saberi, and T.A.b Johansen, "Estimation of states and parameters for linear systems with nonlinearly parameterized perturbations", *Systems and Control Letters*, vol. 60, no. 9, pp. 771–777, 2011.
- [25] X.a c Liu, R.b Ortega, H.c Su, and J.c Chu, "On adaptive control of nonlinearly parameterized nonlinear systems: Towards a constructive procedure", *Systems and Control Letters*, vol. 60, no. 1, pp. 36–43, 2011.
- [26] Dasgupta, "Adaptive identification of systems with polynomial parameterizations", *IEEE Transactions on Circuits and Systems*, vol. 35, pp. 599–603, 1988.
- [27] S. Dasgupta, B.D.O. Anderson, and R.J. Kaye, "Identification of physical parameters in structured systems", *Automatica*, vol. 24, pp. 217–225, 1988.
- [28] S. Dasgupta and B.D.O. Anderson, "Physically based parameterizations for designing adaptive algorithms", *Automatica*, vol. 23, no. 4, pp. 469–477, 1987.
- [29] M. Netto, A. Annaswamy, S. Mammar, and S. Glaser, "A new adaptive control algorithm for systems with multilinear parameterization", in *American Control Conference - ACC*, Minneapolis, USA, 2006.
- [30] M. Netto, A.M. Annaswamy, S. Mammar, and N. Minoiu, "A new adaptive controller for systems with multilinear parameterization : n-parameters case", *ISTE book "Taming Heterogeneity and Complexity of Embedded Control"*, 2006, Eds, F. Lamnabhi-Lagarigue, A. Loria, E. Panteley and S. Laghrouche, 2006.
- [31] R.T. Rockafellar, *Convex Analysis*, Princeton University Press, 1996.

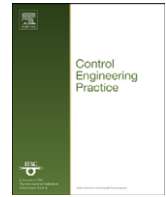

## Driver steering assistance for lane departure avoidance

N. Minoiu Enache<sup>a,\*</sup>, M. Netto<sup>a</sup>, S. Mammar<sup>b</sup>, B. Lusetti<sup>a</sup>

<sup>a</sup> LCPC/INRETS - LIVIC Laboratoire sur les Interactions Véhicules-Infrastructure-Conducteurs, 14 route de la minière, 78000 Versailles, France

<sup>b</sup> IBISC/CNRS-FRE 3190, Université d'Evry Val d'Essonne, 40 Rue du Pelvoux, CE 1455, 91025 Evry, Cedex, France

### ARTICLE INFO

#### Article history:

Received 18 August 2007

Accepted 22 October 2008

Available online 11 December 2008

#### Keywords:

Active safety

Lane departure avoidance

Lateral vehicle control

Lyapunov function

LMI

Switched system

### ABSTRACT

In this paper, a steering assistance system is designed and experimentally tested on a prototype passenger vehicle. Its main goal is to avoid lane departures when the driver has a lapse of attention. Based on a concept linking Lyapunov theory with linear matrix inequalities (LMI) optimization, the following important features are ensured during the assistance intervention: the vehicle remains within the lane borders while converging towards the centerline, and the torque control input and the vehicle dynamics are limited to safe values to ensure the passengers' comfort. Because the steering assistance takes action only if necessary, two activation strategies have been proposed. Both activation strategies were tested on the prototype vehicle and were assessed as appropriate. However, the second strategy showed better reactivity in case of rapid drifting out of the lane.

© 2008 Elsevier Ltd. All rights reserved.

### 1. Introduction

The failure of a driver to remain in the correct lane due to inattention, illness, or sleepiness is one of the most important causes of accidents. NHTSA (2006) estimated that running off the road caused about 28% of the fatal motor vehicle crashes in the US in 2005. Moreover, drowsy, sleeping, or fatigued drivers and inattentive drivers caused about 2.6% and 5.8% of the fatal crashes, respectively.

In order to prevent this type of accident, vehicles have increasingly been equipped with electronic control systems that provide active safety (Isermann, 2008). New steering assistance systems have been developed both to decrease the driver's workload and to prevent lane departures (LeBlanc et al., 1996; Nagai, Mouri, & Raksincharoensak, 2002; Rossetter, Switkes, & Gerdes, 2004; Shimakage, Satoh, Uenuma, & Mouri, 2002). Eidehall, Pohl, and Gustafsson (2007) proposed an integrated road geometry estimation method using vehicle tracking to improve the activation accuracy of an emergency lane assist system.

The work presented in this paper aims at developing a steering assistance system that helps the driver guide the vehicle to the center of the lane during diminished driving capability due to inattention, fatigue, or illness. For vehicles equipped with a conventional steering column, an important issue in implementing a steering assistance system arises: How to introduce automation to

help the driver simultaneously with his own actions on the steering wheel? Any intrusion by an automatic steering system might be immediately felt by the driver on the steering wheel. Reciprocally, any torque imposed on the steering wheel by the driver could be considered by the automatic control system as a disturbance input.

To overcome this difficulty, a switching strategy coupled with a designed lateral control law is proposed in this work. The switching strategy assigns the steering control either to the driver or to the steering assistance system. More specifically, the steering assistance system has been developed to take over the driver's action when it is determined that he has lost attention and to return control of the vehicle upon the driver's request when the vehicle is out of danger.

The main contributions of this paper are:

- (1) A theoretical framework for handling the interactions between the driver and the steering assistance system that ensures bounded dynamics of the switched system.
- (2) Guaranteed bounds for the displacement of the front wheels with respect to the center of the lane, as well as a control torque input that is limited by the design method during the assistance intervention.
- (3) Validation of the theoretical results by experimental tests using a prototype vehicle.

The contents of this paper are organized as follows. Section 2 presents the vehicle model, including the electrically powered steering column. The specifications of the steering assistance system are given in Section 3.1, while Sections 3.2 and 3.3 address

\* Corresponding author. Tel.: +33 1 40432919; fax: +33 1 40432930.

E-mail addresses: [nicoleta.minoiu@lcpc.fr](mailto:nicoleta.minoiu@lcpc.fr) (N. Minoiu Enache), [mariana.netto@lcpc.fr](mailto:mariana.netto@lcpc.fr) (M. Netto), [said.mammar@iup.univ-evry.fr](mailto:said.mammar@iup.univ-evry.fr) (S. Mammar), [benoit.lusetti@lcpc.fr](mailto:benoit.lusetti@lcpc.fr) (B. Lusetti).

the definition of a “normal driving” situation and the design of the switching strategy. Sections 4 and 5 describe the design of the steering control law, and subsequently the evolution of the trajectories of the switched system. Section 6 contains the results of the practical implementation of the steering assistance system under the first switching strategy. Following these results, new activation rules for a second switching strategy are developed and practically implemented in Section 7. Conclusions are presented in Section 8.

## 2. Vehicle model with electrically powered steering

Since this study is focused on the lateral control of a vehicle, a classical fourth order linear model (“bicycle model”, Fig. 1) was used (Ackermann, Guldner, Siemel, Steinhauser, & Utkin, 1995). The effect of road curvature was neglected and the road was assumed to be straight, which is realistic for the highway driving environment addressed in this work. The steering torque necessary for the assistance is provided by a DC motor mounted on the steering column, for which a second order model was adopted. The vehicle model, including the electrical steering assistance model, is given by

$$\dot{\mathbf{x}} = \mathbf{A} \cdot \mathbf{x} + \mathbf{B} \cdot (T_a + T_d), \quad (1)$$

$$\mathbf{A} = \begin{pmatrix} a_{11} & a_{12} & 0 & 0 & b_1 & 0 \\ a_{21} & a_{22} & 0 & 0 & b_2 & 0 \\ 0 & 1 & 0 & 0 & 0 & 0 \\ v & l_s & v & 0 & 0 & 0 \\ 0 & 0 & 0 & 0 & 0 & 1 \\ \frac{T_{S\beta}}{I_s R_s} & \frac{T_{S_r}}{I_s R_s} & 0 & 0 & -\frac{2K_p c_f \eta_t}{I_s R_s^2} & \frac{B_s}{I_s} \end{pmatrix}, \quad (2)$$

$$\mathbf{B} = \left( 0, 0, 0, 0, 0, \frac{1}{R_s I_s} \right)^T, \quad (3)$$

where

$$\begin{aligned} a_{11} &= -\frac{2(c_r + c_f)}{mv}, & a_{12} &= -1 + \frac{2(l_r c_r - l_f c_f)}{mv^2}, \\ a_{21} &= \frac{2(l_r c_r - l_f c_f)}{J}, & a_{22} &= -\frac{2(l_r^2 c_r + l_f^2 c_f)}{Jv}, \\ c_r &= c_{r0} \mu, & c_f &= c_{f0} \mu, \\ b_1 &= \frac{2c_f}{mv}, & b_2 &= \frac{2c_f l_f}{J}, \\ T_{S\beta} &= \frac{2K_p c_f \eta_t}{R_s}, & T_{S_r} &= \frac{2K_p c_f l_f \eta_t}{R_s v}. \end{aligned} \quad (4)$$

The definitions and the numerical values of the above parameters are given in Table 2 at the end of the paper. The state vector is  $\mathbf{x} \triangleq (\beta, r, \psi_L, y_L, \delta_f, \dot{\delta}_f)^T$ , where  $\beta$  denotes the side slip angle,  $r$  is the yaw rate,  $\psi_L$  is the relative yaw angle,  $y_L$  is the lateral offset with respect to the lane centerline at a look-ahead distance  $l_s$ ,  $\delta_f$  is the steering angle, and  $\dot{\delta}_f$  is its derivative. The inputs for the system given in Eq. (1) are the driver’s torque  $T_d$  and the assistance torque  $T_a$ . The whole state vector is considered to be available for measurement.

**Remark 1.** It can easily be shown that the system given in Eq. (1) is controllable except for a longitudinal speed  $v$  equal to zero. The matrix  $\mathbf{A}$  has two poles at the origin, indicating instability of the linear system.

## 3. Steering assistance requirements and problem formulation

### 3.1. Steering assistance requirements

The proposed steering assistance system aims at avoiding unintended lane departures during “normal driving”. “Normal driving” is defined as a driving situation during which the driver is following the center of the lane without performing any special maneuver (e.g., overtaking, cornering, change of direction). The steering assistance system should accomplish its task by means of

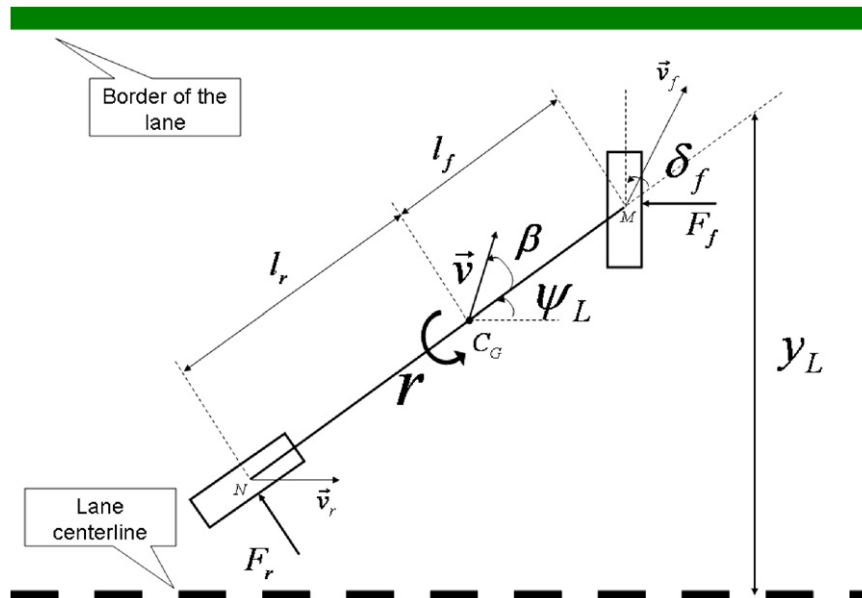

Fig. 1. Vehicle “bicycle” model.

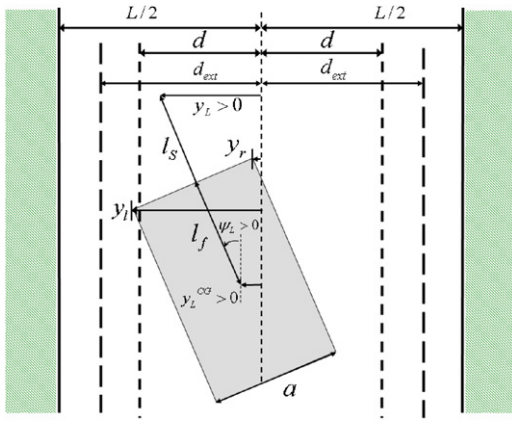

Fig. 2. Vehicle in the lane.

two intelligent modules:

- (1) A switching strategy module that activates and deactivates the steering assistance system depending on the driver's attention and on the danger of lane departure.
- (2) A second module that contains a steering control law should drive the vehicle during the driver's inattention. The steering control law should satisfy the following requirements: (a) the closed loop system vehicle-steering control law has to be asymptotically stable to zero steady state, (b) the vehicle shall not cross the lane borders during the assistance intervention period, (c) moreover, the overshoot of the front wheels with respect to a fixed predefined center lane strip has to be as small as possible, and (d) the vehicle state variables and the steering assistance torque have to be bounded to guarantee safety and comfort.

### 3.2. Mathematical definition of the "normal driving" zone

First of all, the qualitative description of the "normal driving" situation has to be transposed into a formal mathematical description. Such a driving situation can be characterized by the positions of the vehicle's front wheels, which are generally confined to a strip along the center of the lane during a normal lane keeping maneuver. This center strip is assumed to have a width of  $2d$ , where the total lane width is  $L$  and  $2d < L$ , as shown in Fig. 2. On the other hand, during "normal driving", the vehicle state variables are assumed to have a limited range, bounded within a region in the state space. This region was defined by the maximum absolute values:  $|\beta| \leq \beta^N$ ,  $|r| \leq r^N$ ,  $|\psi_L| \leq \psi_L^N$ ,  $|y_L| \leq y_L^N$ ,  $|\delta_f| \leq \delta_f^N$ , and  $|\dot{\delta}_f| \leq \dot{\delta}_f^N$ .

The coordinates of the two front wheels  $y_l$  and  $y_r$  are calculated with respect to the center of the lane from the geometrical model in Fig. 2. The relative position of the vehicle with respect to the lane, represented in Fig. 2, is characterized by a relative yaw angle  $\psi_L$ , a lateral offset from the centerline  $y_L^{CG}$  at the vehicle center of gravity, and a lateral offset  $y_L$  measured at a look-ahead distance  $l_s$ .<sup>1</sup> Assuming a small relative yaw angle  $\psi_L$ , the following equalities can be written:

$$\begin{aligned} y_l &= y_L^{CG} + l_f \psi_L + \frac{a}{2}, \\ y_r &= y_L^{CG} + l_f \psi_L - \frac{a}{2}, \end{aligned} \quad (5)$$

<sup>1</sup> The lateral offsets  $y_L^{CG}$  and  $y_L$  are considered positive on the left side of the lane. The relative yaw angle  $\psi_L$  is considered positive for trigonometric rotations with the origin in the centerline.

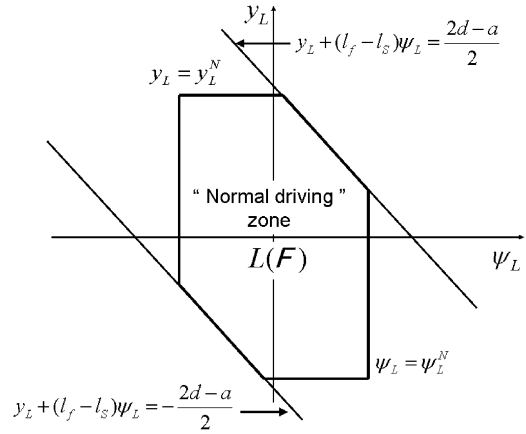
Fig. 3. "Normal driving" zone represented in a two-dimensional state space  $(y_L, \psi_L)$ .

where  $l_f$  is the distance from the vehicle center of gravity to the front axle and  $a$  is the vehicle width.<sup>2</sup> Generally, the vehicle road sensing system used for lateral control is limited to a camera mounted with a frontal view and image processing algorithms to measure the lateral offset and the relative yaw angle. For this reason, for a straight road and for a small angle  $\psi_L$ , the following equality containing  $y_L$  was deduced from Eq. (5) by using the approximation  $y_L^{CG} \cong y_L - l_s \cdot \psi_L$ , as is shown in Fig. 2:

$$y_l = y_L + (l_f - l_s)\psi_L + \frac{a}{2}, \quad y_r = y_L + (l_f - l_s)\psi_L - \frac{a}{2}. \quad (6)$$

From Eq. (6), the condition that the coordinates of the front wheels  $y_l$  and  $y_r$  are located simultaneously inside the fixed center lane strip  $\pm d$  can be written as

$$-\frac{2d-a}{2} \leq y_L + (l_f - l_s)\psi_L \leq \frac{2d-a}{2}. \quad (7)$$

Hence, the state  $\mathbf{x}$  that fulfills the above inequalities (7) belongs to the set

$$L(\bar{\mathbf{F}}) \triangleq \{\mathbf{x} \in \mathbb{R}^6 : |\bar{\mathbf{F}}\mathbf{x}| \leq 1\}, \quad (8)$$

where  $\bar{\mathbf{F}} \in \mathbb{R}^{1 \times 6}$ ,  $\bar{\mathbf{F}} = (0, 0, 2(l_f - l_s)/(2d - a), 2/(2d - a), 0, 0)$ . This set contains the state space region between two parallel hyperplanes, which are characterized by the vector  $\bar{\mathbf{F}}$  and  $|\bar{\mathbf{F}}\mathbf{x}| = 1$ , as shown in Fig. 3.

**Remark 2.** As detailed later in Section 3.3, a situation is considered to be dangerous when at least one of the two front wheels crosses one of the edges of the center lane strip  $\pm d$ , which means  $|\bar{\mathbf{F}}\mathbf{x}| = 1$ .

A second characteristic defining "normal driving" is that the vehicle state  $\mathbf{x}$  remains in a bounded space region. Supposing that  $|x_i| \leq x_i^N$  for  $i = 1, \dots, 6$ , where  $x_i$  denotes the  $i$ -th component of the state vector  $\mathbf{x}$ , then for "normal driving" the state vector  $\mathbf{x}$  belongs to the set

$$L(\mathbf{F}^N) \triangleq \{\mathbf{x} \in \mathbb{R}^6 : |\mathbf{f}_i^N \mathbf{x}| \leq 1, i = 1, \dots, 6\}, \quad (9)$$

where  $\mathbf{F}^N \in \mathbb{R}^{6 \times 6}$ ,  $\mathbf{f}_i^N$  represent the rows of  $\mathbf{F}^N$ ,  $f_{i,i}^N = (x_i^N)^{-1}$  and  $f_{i,j}^N = 0$  for  $i \neq j$ ,  $i, j = 1, \dots, 6$ .  $L(\mathbf{F}^N)$  represents a hypercube in the state space characterized by the diagonal matrix  $\mathbf{F}^N$ .

<sup>2</sup> Values for the parameters  $l_f$  and  $a$  are given in Table 2 at the end of the paper.

Hence, the formal description of “normal driving” defined by the two above sets is  $\mathbf{x} \in L(\mathbf{F})$  (see Fig. 3), where

$$L(\mathbf{F}) \triangleq L(\bar{\mathbf{F}}) \cap L(\mathbf{F}^N) = \{\mathbf{x} \in \mathbb{R}^6 : |\mathbf{f}_i \mathbf{x}| \leq 1, \mathbf{f}_i = \mathbf{f}_i^N, i = 1, \dots, 6, \mathbf{f}_7 = \bar{\mathbf{F}}\}. \quad (10)$$

$L(\mathbf{F})$  represents a finite polyhedron in the state space (a polytope) characterized by the matrix  $\mathbf{F} \in \mathbb{R}^{7 \times 6}$ ,  $\mathbf{F} = ((\mathbf{F}^N)^T, \bar{\mathbf{F}}^T)^T$ .

### 3.3. Switching strategy

The steering assistance system was designed to switch on only in particular situations. This establishes two distinct continuous time systems, which represent the vehicle consecutively. One of the systems,  $\Sigma_1$ , describes the vehicle controlled by the driver alone:  $\dot{\mathbf{x}} = \mathbf{A} \cdot \mathbf{x} + \mathbf{B} \cdot T_d$ , while the other,  $\Sigma_2$ , reflects the vehicle lateral motion under the automatic steering assistance system, and perhaps influenced by the inattentive driver:  $\dot{\mathbf{x}} = \mathbf{A} \cdot \mathbf{x} + \mathbf{B} \cdot (T_a + T_d)$ . The transitions between  $\Sigma_1$  and  $\Sigma_2$  are considered instantaneous and depend on the driver’s attention and on the danger for lane departure.

For the measure of the driver’s attention level, the readers are referred to the concept of driver monitoring (Bullock & Zelek, 2005; Petersson, Fletcher, & Zelinsky, 2005). In the present paper, it is assumed that only the driver’s torque  $T_d$  on the steering wheel is accessible to evaluate the driver’s attention. More specifically, it is assumed that the driver is inattentive for an applied torque below a threshold  $\sigma_1$ ,  $|T_d| < \sigma_1$ , and is attentive otherwise. However, the analysis presented here remains valid if another variable, or threshold, is chosen to measure the driver’s attention, as long as it yields the result of an “attentive” or “not attentive” driver.

The transition from  $\Sigma_1$  to  $\Sigma_2$  switches on the assistance system when a driver’s lack of attention during “normal driving” may lead to an unintended lane departure<sup>3</sup>:

$$T_r^{12} : (|T_d| < \sigma_1) \wedge (\mathbf{x} \in L(\mathbf{F})) \wedge (|\bar{\mathbf{F}}\mathbf{x}| = 1). \quad (11)$$

The steering control system has to be switched off (transition from  $\Sigma_2$  to  $\Sigma_1$ ) whenever the driver recovers attention but, for safety reasons, should occur only if the vehicle is in the “normal driving” zone. However, to handle the case of an emergency situation, the assistance should be removed whenever the driver considers it necessary and applies a strong torque  $|T_d| \geq \sigma_2$  to the steering wheel. The associated logical condition is

$$T_r^{21} : [(\sigma_1 \leq |T_d| < \sigma_2) \wedge (\mathbf{x} \in L(\mathbf{F}))] \vee (|T_d| \geq \sigma_2). \quad (12)$$

## 4. Control law design

This section proposes a control law for the steering torque provided by the DC motor mounted on the steering column. The main requirements for this control law are closed loop asymptotic stability, minimal overshoot with respect to the fixed center lane strip of width  $2d$ , and passengers’ comfort. For the simplicity of the computation and the implementation, a linear state feedback control is chosen with a compensation for the driver’s torque:  $T_a = \mathbf{K}\mathbf{x} - T_d$ . Thus, the closed loop system  $\dot{\mathbf{x}} = (\mathbf{A} + \mathbf{B}\mathbf{K})\mathbf{x}$  is obtained from Eq. (1). The following paragraphs express the control requirements as linear matrix inequalities (LMI) that allow the computation of the vector  $\mathbf{K}$ .

### 4.1. Asymptotic stability of the closed loop system

Concerning the system stability, the existence of a Lyapunov function  $V(\mathbf{x}) = \mathbf{x}^T \mathbf{P}\mathbf{x}$  with  $\mathbf{P}$  a symmetric, positive definite matrix

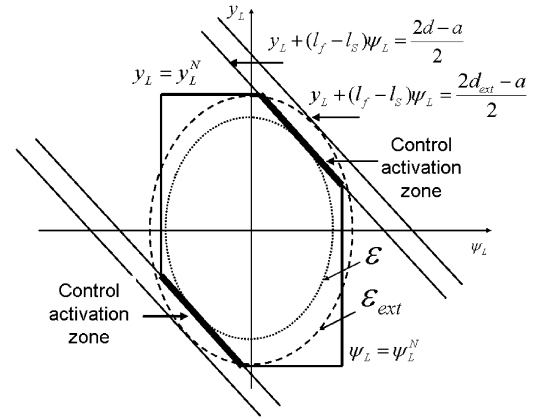

Fig. 4. The polyhedron  $L(\mathbf{F})$  and the ellipsoids  $\varepsilon$  and  $\varepsilon_{ext}$ , represented in a two-dimensional state space  $(y_L, \psi_L)$ .

satisfying  $(\mathbf{A} + \mathbf{B}\mathbf{K})^T \mathbf{P} + \mathbf{P}(\mathbf{A} + \mathbf{B}\mathbf{K}) < 0$  guarantees the asymptotic stability of the system  $\Sigma_2$ . With the bijective transformation  $\mathbf{Q} = \mathbf{P}^{-1}$  and  $\mathbf{Y} = \mathbf{K}\mathbf{Q}$ , the above nonlinear matrix inequality becomes linear (Boyd, El Ghaoui, Feron, & Balakrishnan, 1994)<sup>4</sup>:

$$\mathbf{Q}\mathbf{A}^T + \mathbf{A}\mathbf{Q} + \mathbf{B}\mathbf{Y} + \mathbf{Y}^T \mathbf{B}^T < 0. \quad (13)$$

### 4.2. Minimum overshoot with respect to the fixed center lane strip

The ideal solution of the minimal overshoot problem would be zero overshoot. That would be possible if the system  $\Sigma_2$  accepted  $L(\mathbf{F})$  as a polyhedral invariant set, since in this case each trajectory that starts in the set  $L(\mathbf{F})$  would remain inside it (for details on the invariant set theory, see Blanchini (1999)). As this control objective is difficult to attain for physical and control design reasons, an outer invariant approximation of the polyhedron  $L(\mathbf{F})$  is used. This approximation is given by an ellipsoidal set (Minoiu, Netto, & Mammari, 2006).

Therefore, an ellipsoid  $\varepsilon = \{\mathbf{x} : \mathbf{x}^T \mathbf{P}\mathbf{x} \leq 1\}$  is first sought such that it is included in  $L(\mathbf{F})$  and is located as close as possible to the control activation zone  $(|\bar{\mathbf{F}}\mathbf{x}| = 1) \cap L(\mathbf{F}^N)$  (see Fig. 4). These constraints can be written as LMI expressions (Hu & Lin, 2000):

(1) Inclusion of the ellipsoid  $\varepsilon$  in  $L(\mathbf{F})$

$$\begin{pmatrix} 1 & \mathbf{f}_i \mathbf{Q} \\ (\mathbf{f}_i \mathbf{Q})^T & \mathbf{Q} \end{pmatrix} \geq 0, \quad i = 1, \dots, 7, \quad (14)$$

where  $\mathbf{f}_i$  are the row vectors of the matrix  $\mathbf{F}$  in Eq. (10).

(2) Approaching the activation zone  $(|\bar{\mathbf{F}}\mathbf{x}| = 1) \cap L(\mathbf{F}^N)$

$$\begin{aligned} &\text{minimize} && -\alpha \\ &\text{subject to} && \alpha \leq \bar{\mathbf{F}}^T \mathbf{Q} \bar{\mathbf{F}}, \\ &&& \bar{\mathbf{F}}^T \mathbf{Q} \bar{\mathbf{F}} < 1. \end{aligned} \quad (15)$$

Once found, the ellipsoid  $\varepsilon$  is expanded until it includes the above mentioned control activation zone, that is  $((|\bar{\mathbf{F}}\mathbf{x}| = 1) \cap L(\mathbf{F}^N)) \subset \varepsilon_{ext} = \{\mathbf{x} : \mathbf{x}^T \mathbf{P}\mathbf{x} \leq V_{ext}\}$  (Fig. 4). This computation is achieved by maximizing the nonlinear function  $V(\mathbf{x})$  under linear constraints:

$$V_{ext} = \max(V(\mathbf{x})) = \max(\mathbf{x}^T \mathbf{P}\mathbf{x})$$

<sup>3</sup>  $\wedge$  denotes the logical “and” and  $\vee$  denotes the logical “or”.

<sup>4</sup> “ $< 0$ ”, “ $\leq 0$ ”, denote negative definite, resp. semi-definite, matrices, “ $> 0$ ”, “ $\geq 0$ ”, denote positive definite, resp. semi-definite, matrices.

subject to  $\bar{\mathbf{F}}\mathbf{x} = 1$ ,  
 $\mathbf{x} \in L(\mathbf{F}^N)$ . (16)

The LMI optimization problem given in Eq. (15) provides a minimum expansion of the interior ellipsoid  $\varepsilon$  to  $\varepsilon_{ext}$ .

The quadratic Lyapunov function  $V(\mathbf{x}) = \mathbf{x}^T \mathbf{P} \mathbf{x}$  guarantees that the trajectories of the system  $\Sigma_2$  will not leave the  $\varepsilon_{ext}$  state space region after the assistance system is activated. Consequently, all system trajectories that start in  $(|\bar{\mathbf{F}}\mathbf{x}| = 1) \cap L(\mathbf{F}^N)$  will not leave the ellipsoidal invariant set  $\varepsilon_{ext}$ .

Furthermore, the hyperplanes tangent to  $\varepsilon_{ext}$  and parallel to  $|\bar{\mathbf{F}}\mathbf{x}| = 1$  are equivalent to the center lane strip of width  $2d_{ext}$ , where the two front wheels are guaranteed to remain during activation of the assistance system (Figs. 2, 4):

$$d_{ext} = \frac{2d - a}{2} \sqrt{V_{ext} \bar{\mathbf{F}} \mathbf{Q} \bar{\mathbf{F}}^T} + \frac{a}{2}. \quad (17)$$

#### 4.3. Passengers' comfort

For comfort reasons, and also for technical reasons, the maximum assistance torque is bounded at a pre-defined value for vehicle states  $\mathbf{x} \in \varepsilon$ , denoted here by  $T_M$ . This is achieved by imposing the ellipsoidal invariant set  $\varepsilon$  to be contained in the polyhedron  $L(\mathbf{K}) = \{\mathbf{x} \in \mathbf{R}^6 : |\mathbf{K}\mathbf{x}| \leq T_M\}$ , which is equivalent to the following LMI condition:

$$\begin{pmatrix} 1 & \frac{1}{T_M} \mathbf{Y} \\ \frac{1}{T_M} \mathbf{Y}^T & \mathbf{Q} \end{pmatrix} \geq 0. \quad (18)$$

Furthermore, by expanding the ellipsoid  $\varepsilon$  to  $\varepsilon_{ext}$ , the guaranteed maximum torque for  $\mathbf{x} \in \varepsilon_{ext}$  is greater than  $T_M$ . Therefore, the torque limit  $T_M$  was chosen to be smaller than the maximum torque supported by the DC motor. In addition, an upper bound of the motor torque used to bring the vehicle to the correct trajectory from a vehicle state  $\mathbf{x}$  in  $\varepsilon_{ext}$  is given by  $T_{M_{ext}} = \max_{\mathbf{x} \in \varepsilon_{ext}} (\mathbf{K}\mathbf{x}) = \sqrt{V_{ext} \sqrt{\mathbf{K} \mathbf{P}^{-1} \mathbf{K}^T}}$ .

Putting together the conditions from Sections 4.1–4.3, the feedback control vector  $\mathbf{K}$  based on the Lyapunov function  $V(\mathbf{x}) = \mathbf{x}^T \mathbf{P} \mathbf{x}$  can be obtained as a result of the following LMI linear cost optimization problem:

minimize  $-\alpha$   
 subject to Eq. (13) (system stability),  
 Eq. (14) (inclusion in the “normal driving” set),  
 Eq. (15) (approaching the activation zones),  
 Eq. (18) (bounding the steering torque). (19)

This LMI optimization problem has  $\mathbf{Q}$  and  $\mathbf{Y}$  as matrix variables.  $\mathbf{P} = \mathbf{Q}^{-1}$  and  $\mathbf{K} = \mathbf{Q}^{-1} \mathbf{Y}$  are obtained afterwards.

The range of the state variables during the assistance intervention can also be considered to reflect the passengers' comfort. This range can be computed only a posteriori, after the controller design is completed. Therefore, multiple iterations may be potentially be required to achieve acceptable values. Upper bounds for these variables are given by projecting the ellipsoid  $\varepsilon_{ext}$  on the six state coordinates. These projections are defined by  $x_i^M$ , where  $|x_i| \leq x_i^M$ ,  $x_i^M = \sqrt{Q_{i,i}}$  for  $i = 1, \dots, 6$  and  $Q_{i,i}$  is an element of the diagonal of matrix  $\mathbf{Q}$ .

#### 4.4. Robustness against vehicle speed and adhesion variations

The system description given in Eq. (1) depends nonlinearly on the vehicle speed  $v$ . The control law developed in Section 4 provides the required performance only for a fixed predefined

longitudinal velocity  $v$ . In this part of the paper, a valid extension of the control law to a speed interval is proposed.

By choosing  $\xi_v \in [-1; 1]$ , a parameter that describes the variation of  $v$  between a lower limit  $v_{min}$  and an upper limit  $v_{max}$ , the following can be written (Raharjjoana, 2004):

$$\frac{1}{v} = \frac{1}{v_0} + \frac{1}{v_1} \xi_v, \quad v \cong v_0 \left(1 - \frac{v_0}{v_1} \xi_v\right),$$

$$\frac{1}{v^2} \cong \frac{1}{v_0^2} \left(1 + 2 \frac{v_0}{v_1} \xi_v\right). \quad (20)$$

Setting  $\xi_v = -1$ ,  $v = v_{min}$  and  $\xi_v = 1$ ,  $v = v_{max}$ ,  $v_0$  and  $v_1$  can be written as following:

$$v_0 = \frac{2v_{min}v_{max}}{v_{max} + v_{min}}, \quad v_1 = -\frac{2v_{min}v_{max}}{v_{max} - v_{min}}. \quad (21)$$

With these expressions for  $v$ ,  $1/v$ , and  $1/v^2$ , the matrix  $\mathbf{A}$  of the system given in Eq. (1) can be written as  $\mathbf{A} = \mathbf{A}^* + \mathbf{A}^{**} \xi_v$ . Hence, the matrix  $\mathbf{A}(v)$  evolves into a matrix polytope for  $v \in [v_{min}, v_{max}]$ .

The LMI optimization problem given in Eq. (19) of Section 4 can be modified for a varying vehicle speed  $v \in [v_{min}, v_{max}]$ . Indeed, only the matrix  $\mathbf{A}$  of the LMI problem is speed dependent. Due to the linear convex property of the matrix polytope, in Eq. (13) holds for any  $v \in [v_{min}, v_{max}]$  if the following holds:

$$\mathbf{Q}(\mathbf{A}^* \pm \mathbf{A}^{**})^T + (\mathbf{A}^* \pm \mathbf{A}^{**})\mathbf{Q} + \mathbf{B}\mathbf{Y} + \mathbf{Y}^T\mathbf{B}^T < 0. \quad (22)$$

The above considerations mean that if the matrix variables  $\mathbf{Q}$  and  $\mathbf{Y}$  are obtained such that they minimize the LMI problem from Eq. (19), for both  $\mathbf{A} = \mathbf{A}^* - \mathbf{A}^{**}$  and for  $\mathbf{A} = \mathbf{A}^* + \mathbf{A}^{**}$ , then the control vector  $\mathbf{K}$  stabilizes the system given in Eq. (1) for any varying speed  $v \in [v_{min}, v_{max}]$ , while satisfying the required performance.

As condition (22) is conservative, it may lead to poor performance over the speed range. Thus, taking into account many speed intervals  $[v_{min}^i, v_{max}^i]$ ,  $[v_{min}^{i+1}, v_{max}^{i+1}]$ ,  $v_{min}^{i+1} < v_{max}^i$ , and the corresponding feedback vectors  $\mathbf{K}^i$ ,  $\mathbf{K}^{i+1}$ , gain scheduling can be carried out (Stilwell & Rugh, 1997).

The same reasoning can be used for the adhesion  $\mu$  as for the vehicle speed. Furthermore, the matrix  $\mathbf{A}$  already depends linearly on  $\mu$ . Considering that  $\mu \in [\mu_{min}, 1]$ , the vertices of the new matrix polytope are obtained for  $\{\mu_{min}, 1\}$ . If variations of both  $v$  and  $\mu$  are considered, the matrix  $\mathbf{A}$  becomes multi-affine, and thus a linear fractional representation (LFR) can be adopted (Scherer, Gahinet, & Chilali, 1997).

## 5. Discussion of the trajectories of the switched system driver steering assistance

The trajectories of the switched system are briefly analyzed in this section. This explains the choice of the switching strategy in Section 3.3 and of the control law in Section 4.

By design, the set  $\varepsilon_{ext}$  contains the control activation zones  $(|\bar{\mathbf{F}}\mathbf{x}| = 1) \cap L(\mathbf{F}^N)$ . However, the steering assistance system switches on if one of these zones is crossed, and hence is inside  $\varepsilon_{ext}$ . If the driver recovers attention, in which case  $\sigma_1 \leq |T_d| < \sigma_2$ , or if the driver requires an urgent deactivation ( $|T_d| \geq \sigma_2$ ), the switching off of the steering assistance system always takes place inside  $\varepsilon_{ext}$  (due to the invariant set property of  $\varepsilon_{ext}$ ).

The driver then regains control of the vehicle. Excursions outside the invariant set  $\varepsilon_{ext}$  are very likely to occur when the driver undertakes maneuvers outside of “normal driving”. The assistance activation will in this case always be inhibited, independent of the driver's attention, according to the switching rules. If the driver performs maneuvers outside “normal driving” (for instance, lane changing or cornering), during the subsequent lane following the vehicle's trajectory will evolve into the “normal

driving” set  $L(F)$ . The next assistance activation will occur necessarily within the activation zone and the reasoning can be repeated. Thus, it can be concluded that the switching does not induce the divergence of the vehicle trajectory.

## 6. Driving test results

### 6.1. Control law computation

For the control law computation, bounds defining “normal driving” were fixed. In the literature, few statistical studies about the variation ranges of vehicle’s state variables for a lane keeping task exist (Pilutti & Ulsoy, 1999; Pomerleau et al., 1999). The bounds used in this paper take into account values given by Bar and Page (2002), who analyzed accidents due to different types of lane departure. The limits defining the set  $L(F^N)$  are given in the column  $x_i^N$  of Table 1. The center lane strip related to “normal driving” was fixed at  $d = \pm 1.1$  m with respect to the center of the lane. During testing, these values were found to be wide enough to allow to the driver safe displacement of the front wheels of the vehicle with respect to the centerline while staying in the lane. The vehicle speed was considered to vary within the interval  $v \in [18 \text{ m/s}; 22 \text{ m/s}]$ .

Using these values, the matrix  $\mathbf{P}$  and the vector  $\mathbf{K}$  were computed. The resulting vector  $\mathbf{K}$  is given by

$$\mathbf{K} = (-198.5, -69.3, -355.9, -17.7, -409.9, 5.5).$$

The closed loop vehicle model was simulated for  $v \in [18 \text{ m/s}; 22 \text{ m/s}]$  and the system poles were computed. The system has two real poles and two pairs of complex conjugate poles. All the poles have their real parts located to the left of  $-0.6$  in the complex plane. The damping factors remain below 1.18, showing good robustness properties.

The system trajectories are guaranteed to remain below the limits given in the column  $x_i^M$  of Table 1 during activation of the control system. The upper bound for the assistance steering torque was found to be 26.22 N m. According to the numerical results, the trajectories of the front wheels of the vehicle do not exceed  $d_{ext} = 1.76$  m during the assistance system activation. It was assumed that the driver is inattentive for a steering torque  $\sigma_1$  below 2 N m, and the emergency deactivation limit  $\sigma_2$  was set to 6 N m.

### 6.2. Test environment

Tests were conducted on a track located in Satory, 20 km west of Paris, France. The track is 3.5 km long with various road profiles including a straight lane and tight bends. The experimental vehicle was equipped with a CORREVIT sensor that measures the side slip angle  $\beta$ , an Inertial Navigation System to measure the

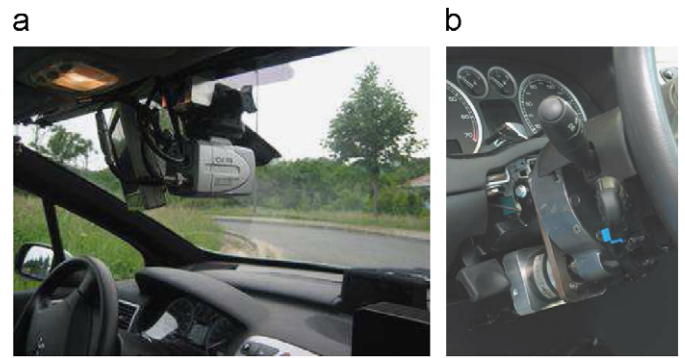

Fig. 5. (a) Video camera in the front of the vehicle. (b) DC motor on the steering column.

yaw rate  $r$ , and an odometer for the vehicle longitudinal velocity  $v$ . The steering angle  $\delta_f$  was obtained from an optical encoder and its derivative  $\dot{\delta}_f$  was computed numerically. The driver torque was measured by a load cell sensor integrated into the steering wheel. The assistance torque was provided by a DC motor mounted on the steering column (Fig. 5(b)). The look-ahead lateral offset and the relative yaw angle were measured using a video camera that detects the lane markers using vision algorithms (Labayrade, Douret, Laneurit, & Chapuis, 2006) (Fig. 5(a)).

### 6.3. Practical implementation results

To perform the tests, a segment of the test track with a road curvature less than  $0.001 \text{ m}^{-1}$ , which corresponds to a nearly straight road, was chosen. The driver drove the instrumented vehicle following the center of the lane, occasionally taking his hands off the steering wheel, or relaxing the steering control to simulate a lack of attention (see Electronic Annex 1 in the online version of this article). The activation of the steering assistance was linked to a “beep” sound. Once the assistance had been activated, the driver acted on the steering wheel after a few seconds to recover the control of the vehicle.

Fig. 6(a) shows the trajectories of the front wheels on the lane, as well as the limits for the control activation at  $\pm 1.1$  m, the guaranteed overshoots limits at  $\pm 1.76$  m, and the border of the lane at  $\pm 1.75$  m with respect to the center of the lane.<sup>5</sup> It is apparent that after activation of the control system, the trajectories of the front wheels did not cross the border of the lane. Moreover, they remained within the “normal driving” zone, inside the  $\pm 1.1$  m lane strip. At the first reaction after the system activation, the assistance system counter-steered using a torque of about 10 N m (see Fig. 6(b)), and the trajectories of the front wheels occasionally crossed the opposite line of the  $\pm 1.1$  m center strip. Subsequently, the vehicle was driven to the center of the lane and experienced low frequency, small amplitude oscillations around the centerline. The vehicle speed during the test varied between 18 and 22 m/s.

Note that the assist torque represented in Fig. 6(b) is higher than the driver torque, since in manual mode the driver is assisted by the motor itself, which works in this mode as a classical electrically powered assistance (electric power steering, EPS). The driver torque is measured at the steering wheel, which is

Table 1

Bounds  $x_i^N$  corresponding to the “normal driving” set and guaranteed bounds by control design  $x_i^M$  and  $(x_i^M)_{new}$  for the cases of use of the first and second switching strategies, respectively.

	$x_i^N$	$x_i^M$	$(x_i^M)_{new}$	
$\beta$	0.0104	0.0297	0.0507	rad
$r$	0.1047	0.2789	0.4752	rad/s
$\psi_L$	0.0349	0.0801	0.1365	rad
$y_L$	0.8	1.02	1.73	m
$\delta_f$	0.0261	0.0584	0.0995	rad
$\dot{\delta}_f$	0.2094	0.5739	0.9779	rad/s

<sup>5</sup> In each figure that presents the test results, the assistance activation is represented by a two-valued figure; the higher value corresponds to the situation in which the driver controls the vehicle, while the lower value corresponds to the situation in which the assistance system controls the vehicle. For better understanding, the two values are different for each figure and are adapted to the figure scale.

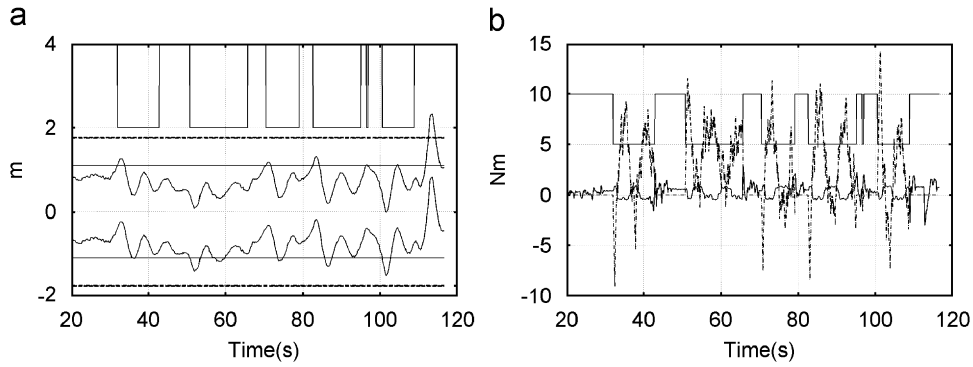

**Fig. 6.** (a) Trajectories of the front wheels (solid line), predefined lane strip  $\pm d = \pm 1.1$  m (solid line), computed driving lane strip  $\pm d_{ext} = \pm 1.76$  m (dashed line), lane borders at  $\pm 1.75$  m (dash-dot line, this coincides with the previous dashed line), assistance activated on 2 (first activation rules). (b) Driver's torque (solid line), assistance torque (dash-dot line), assistance activated on 5 (first activation rules).

upstream of the EPS multiplication factor. In Fig. 6(b) the driver's torque is represented, and is not the result of the driver's torque multiplied by the EPS.

During the intervention of the assistance system, the electric motor provides the necessary steering torque, which results from the control law. It was assumed that during the assistance system intervention, the driver is not able to drive. The assistance system takes over for the driver, but it is switched off as soon as the driver recovers attention. Consequently, the driver feels the assistance acting on the steering wheel only during the moments of system deactivation. At these times, the driver feels a small resistance in the steering wheel, which disappears quickly.

These results confirmed the expected performance, which is guaranteed by the control design method. In addition, it was noticed that the computed maximum bounds are fairly conservative compared to the real data. This might be due to an overestimation of the polyhedron  $L(F)$  by the exterior ellipsoid  $\tilde{\mathcal{E}}_{ext}$ . Consequently, an important shortcoming of the above presented assistance system, the activation conditions, could be improved. By intensive testing, it was noticed that the activation rules are sometimes too conservative and prevent the steering assistance from switching on, as for example in Fig. 6(a), at  $t = 112$  s. Therefore, Section 7 presents an alternative switching strategy.

## 7. Improving the switching strategy and new testing

### 7.1. New activation rules

In examining the activation/deactivation situations during the tests, it was noticed that when slowly drifting out of the lane with a relatively small yaw angle and yaw rate, the condition that the vehicle state still resides in the "normal driving" zone is always satisfied when the vehicle leaves the  $\pm d$  center lane strip. On the contrary, for rapid lane departures, the steering assistance did not switch on because the "normal driving" zone had previously been exceeded by the vehicle.

Hence, the developed control law was kept unchanged and the constraint  $\mathbf{x} \in L(\mathbf{F}^N)$  was eliminated from the switching condition  $T_r^{12}$  given in Eq. (11), while the constraint  $|\dot{\mathbf{F}}\mathbf{x}| = 1$  (crossing of the  $\pm d$  center lane strip) was maintained. Nevertheless, to satisfy some safety limits for the lateral displacement of the front wheels, a new activation condition was added. It required that for any activation, the maximum expected displacements of the front wheels  $\tilde{d}_{ext}(\mathbf{x})$  would be less than  $\tilde{d}_{ext} = 2.5$  m. Taking into account the conservatism noticed in the experimental phase of the first switching strategy, this value was chosen to be higher than the

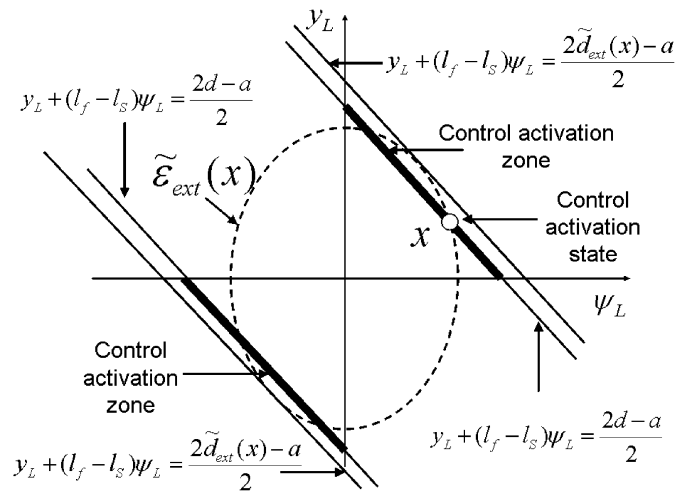

**Fig. 7.** Control activation for the new switching strategy.

value corresponding to the lane borders (1.75 m). More specifically, for each state  $\mathbf{x}$  for which the front wheels reach the lane strip limits at  $\pm d$ , the expected displacement  $\tilde{d}_{ext}(\mathbf{x})$  can be computed by using Eq. (17) for  $V_{ext}(\mathbf{x}) = \mathbf{x}^T \mathbf{P} \mathbf{x}$ , as shown in Fig. 7. Moreover, the guaranteed maximum bounds for the state variables during the control activation were computed for the new ellipsoid  $\tilde{\mathcal{E}}_{ext}$  related to  $\tilde{d}_{ext} = 2.5$  m, and are given in Table 1, column  $(\mathbf{x}_i^M)_{new}$ .

In addition, the transition  $T_r^{12}$  has to be triggered only if the vehicle is heading towards a lane edge. This behavior might be characterized by a lateral offset and a yaw angle that are simultaneously positive or negative.

For the deactivation of the steering assistance, the same conditions were used as in the first switching strategy, in order to ensure safety when switching the system off and the trajectory limits with respect to the switchings.

The proposed new switching strategy is illustrated in Fig. 7 and summarized in the following logical equations:

$$T_r^{12} : (|T_d| < \sigma_1) \wedge (\tilde{d}_{ext}(\mathbf{x}) < 2.5 \text{ m}) \wedge (|\dot{\mathbf{F}}\mathbf{x}| = 1) \wedge ((\psi_L \cdot y_L) > 0), \quad (23)$$

$$T_r^{21} : [(\sigma_1 \leq |T_d| < \sigma_2) \wedge (\mathbf{x} \in L(\mathbf{F}))] \vee (|T_d| \geq \sigma_2). \quad (24)$$

### 7.2. Practical implementation

During the testing of the second switching strategy, the driver followed the lane and occasionally applied a strong torque on the

steering wheel in an attempt to force drifting from the lane. He then removed his hands from the steering wheel. Under these conditions, the state variables were forced to approach and exceed the “normal driving” zone at the crossing of the  $\pm d$  lane strip bounds. With this new strategy, the activation of the steering assistance system occurred for almost all fast lane departures, except for very severe cases. In general, the expected maximum lateral offset of the front wheels,  $\tilde{d}_{ext}(\mathbf{x})$ , stayed below 2.5 m. Fig. 8(a) shows that the front wheels of the vehicle exceeded the lane borders, but they remained below 2 m with respect to the center of the lane. The expected theoretical value of  $\tilde{d}_{ext}(\mathbf{x})$  again turned out to be conservative with respect to the experimental results. Figs. 9–11 show that the state variables remained below

their maximum expected values given in Table 1, column  $(x_i^M)_{new}$ . The limits of the “normal driving” zone are also represented as dashed lines in these Figs. 9–11 in order to get show the difference between the guaranteed maximum bounds and the recorded data.

### 7.3. Comparison of the activation rules

In order to compare the activation of the two switching strategies, the following test was performed. In the first stage, the equipped vehicle was driven on the test track with the steering assistance system disabled, and it was allowed to leave the lane, with the driver simulating a lack of attention. Subsequently, the

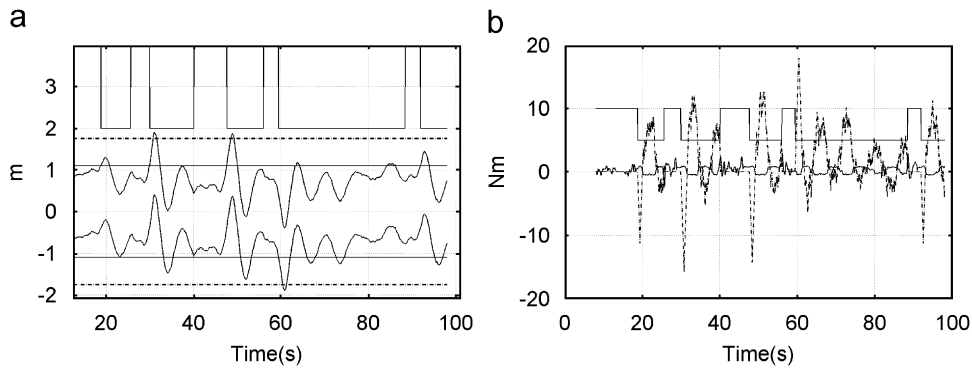

Fig. 8. (a) Trajectories of the front wheels (solid line), predefined lane strip  $\pm d = \pm 1.1$  m (solid line), lane border (dash-dot line), assistance activated on 2 (second activation rules). (b) Driver torque (solid line), assistance torque (dash-dot line), assistance activated on 5 (second activation rules).

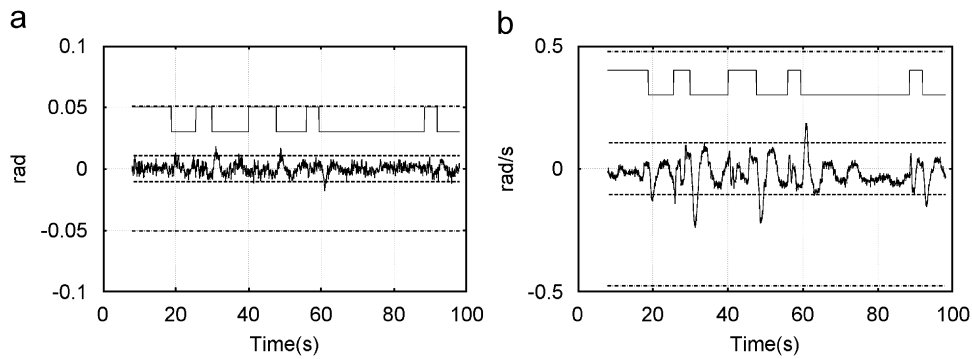

Fig. 9. (a) Side slip angle  $\beta$  (solid line), “normal driving” value  $\beta^N$  (dashed line), maximum computed bound  $\beta^M$  (dash-dot line), assistance activated on 0.03 (second activation rules). (b) Yaw rate  $r$  (solid line), “normal driving” value  $r^N$  (dashed line), maximum computed bound  $r^M$  (dash-dot line), assistance activated on 0.3 (second activation rules).

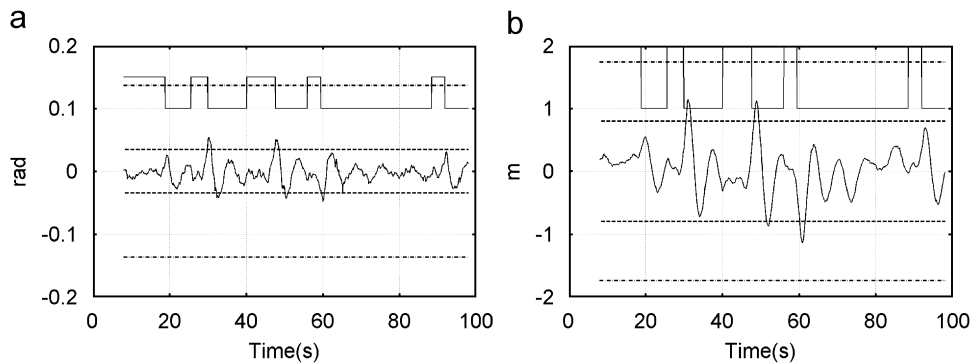
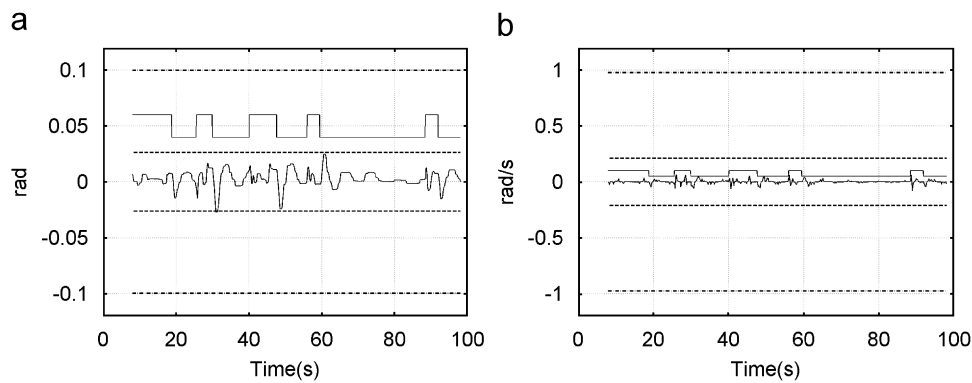
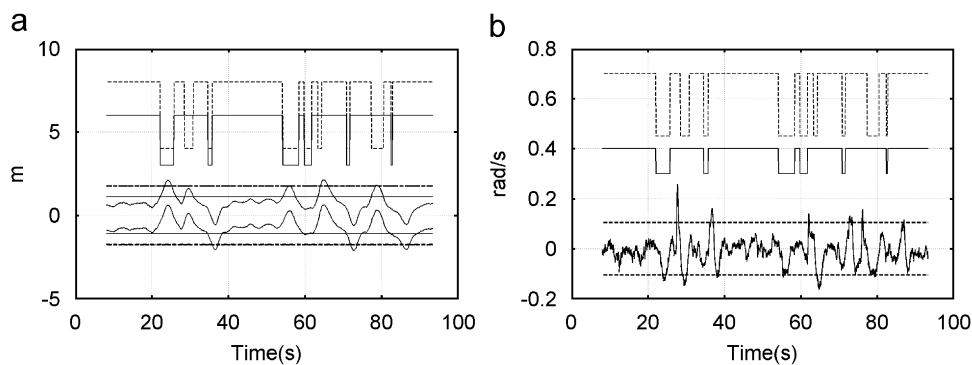

Fig. 10. (a) Relative yaw angle  $\psi_L$  (solid line), “normal driving” value  $\psi_L^N$  (dashed line), maximum computed bound  $\psi_L^M$  (dash-dot line), assistance activated on 0.1 (second activation rules). (b) Lateral offset  $y_L$  (solid line), “normal driving” value  $y_L^N$  (dashed line), maximum computed bound  $y_L^M$  (dash-dot line), assistance activated on 1 (second activation rules).



**Fig. 11.** (a) Steering angle  $\delta_f$  (solid line), "normal driving" value  $\delta_f^N$  (dashed line), maximum computed bound  $\delta_f^M$  (dash-dot line), assistance activated on 0.04 (second activation rules). (b) Steering angle rate  $\dot{\delta}_f$  (solid line), "normal driving" value  $\dot{\delta}_f^N$  (dashed line), maximum computed bound  $\dot{\delta}_f^M$  (dash-dot line), assistance activated on 0.05 (second activation rules).



**Fig. 12.** (a) Trajectories of the front wheels (solid line), predefined lane strip  $\pm d = \pm 1.1$  m (solid line), lane border (dash-dot line), assistance activated for the first switching strategy on 3 (solid line), assistance activated for the second switching strategy on 4 (dashed line). (b) Yaw rate  $r$  (solid line), "normal driving" value  $r^N$  (dashed line), assistance activated for the first switching strategy on 0.3 (solid line), assistance activated for the second switching strategy on 0.45 (dashed line).

**Table 2**

Values of the vehicle parameters.

Parameter	Value
$B_s$ , steering system damping coefficient	15
$c_{f0}$ , front cornering stiffness	40 000 N/rad
$c_{r0}$ , rear cornering stiffness	35 000 N/rad
$I_s$ , inertial moment of steering system	0.05 kg m <sup>2</sup>
$J$ , vehicle yaw moment of inertia	2454 kg m <sup>2</sup>
$K_p$ , manual steering column coefficient	1
$l_f$ , distance from CG to front axle	1.22 m
$l_r$ , distance from CG to rear axle	1.44 m
$l_s$ , look-ahead distance	0.95 m
$a$ , vehicle width	1.5 m
$m$ , total mass	1600 kg
$R_s$ , steering gear ratio	14
$v$ , longitudinal velocity	[18;22] m/s
$\eta_t$ , tire length contact	0.13 m
$\mu$ , adhesion	1
$L$ , lane width	3.5 m

vehicle trajectory was corrected by the driver to the center of the lane, and the procedure was repeated several times. All the variables necessary for the computation of the switching conditions were recorded during the test. In the second stage, the activation conditions were computed off-line for the two switching strategies, and were compared to each other. The deactivation condition was reduced to a driver torque higher than 1.5 N m, to enforce a rapid deactivation of the system. The trajectories of the front wheels are given in Fig. 12(a). There are three cases of activation using the second strategy in the absence of system activation using the first strategy. In all three cases, the absence of

the activation for the first switching strategy is due to a yaw rate that exceeded its normal value  $r^N$  (see Fig. 12(b)). This result raises several questions concerning the driving behavior during a "normal driving" situation and the moment of loss of attention. As few statistical studies providing bounds of the vehicle state variables during a usual lane keeping task are available, it is thus difficult to determine whether these missed activations for the first switching strategy are dangerous or not.

To summarize, it can be noticed that with the two activation strategies of the steering assistance system, there is a place for calibrations and settings that take users' opinions into account. The first activation conditions are more restrictive, but they ensure a vehicle trajectory that is confined to the lane while remaining within comfortable and safe limits for the state variables during the control activation. The second activation rules are more reactive and cover fast drifting from the lane, but the danger to depart from the lane to collide with adjacent vehicles cannot be excluded.

## 8. Conclusions and future work

This paper presented the design and implementation of an automatic lane departure avoidance assistance system in a prototype passenger vehicle. The steering assistance system switches on as soon as the front wheels cross a center lane strip, and brings the vehicle back to the center of the lane.

The lateral control law is based on a new concept linking Lyapunov theory with LMI optimization. It ensures four important features during its intervention: asymptotic convergence of the vehicle trajectory to the lane centerline, a guarantee that the front

of the vehicle remains inside a safety zone within the lane during the assistance activation, bounded vehicle dynamics, and control torque input.

For the switching strategy, two activation rules with different degrees of reaction with respect to the driver's actions and vehicle position have been proposed, implemented on the prototype vehicle, and tested. Using both rules, unintended lane departures are avoided, without leaving the lane in the first case and with a small overshoot with respect to the lane borders in the second case. As a trade-off, the second activation rule ensures better reactions for fast drifting out the lane.

In the future, we intend to perform an acceptance study of the proposed steering assistance systems using test drivers. This study could be extended by a complementary statistical study concerning the limits of the vehicle dynamic variables during "normal driving", especially if the driver experiences moments of inattention. The topic of avoiding unintended lane departure for curvy roads is a topic of current research.

#### Appendix A. Supplementary data

Supplementary data associated with this article can be found in the online version at doi:[10.1016/j.conengprac.2008.10.012](https://doi.org/10.1016/j.conengprac.2008.10.012).

#### References

- Ackermann, J., Guldner, J., Sienel, W., Steinhauser, R., & Utkin, V. U. (1995). Linear and nonlinear controller design for robust automatic steering. *IEEE Transactions on Control Systems Technology*, 132–143.
- Bar, F., & Page, Y. (2002). *Les sorties de voie involontaires*. CEESAR—LAB Technical Report ARCOS.
- Blanchini, F. (1999). Set invariance in control. *Automatica*, 35, 1747–1767.
- Boyd, S., El Ghaoui, L., Feron, E., & Balakrishnan, V. (1994). *Linear matrix inequalities in system and control theory*. Philadelphia, PA: Society for Industrial and Applied Mathematics.
- Bullock, D., & Zelek, J. (2005). Towards real-time 3-D monocular visual tracking of human limbs in unconstrained environments. *Real-Time Imaging*, 11, 323–353.
- Eidehall, A., Pohl, J., & Gustafsson, F. (2007). Joint road geometry estimation and vehicle tracking. *Control Engineering Practice*, 15, 1484–1494.
- Hu, T., & Lin, Z. (2000). On enlarging the basin of attraction for linear systems under saturated linear feedback. *Systems and Control Letters*, 40, 59–69.
- Isermann, R. (2008). Mechatronic systems—innovative products with embedded control. *Control Engineering Practice*, 16, 14–29.
- Labayrade, R., Douret, J., Laneurit, J., & Chapuis, R. (2006). A reliable and robust lane detection system based on the parallel use of three algorithms for driving safety assistance. *IEICE Transactions on Information and Systems Online*, E89-D, 2092–2100.
- LeBlanc, D. J., Venhovens, P. J. Th., Lin, C.-F., Pilutti, T. E., Ervin, R. D., Ulsoy, A. G., et al. (1996). Warning and intervention system to prevent road-departure accidents. *Vehicle System Dynamics*, 25(Suppl.), 383–396.
- Minoiu, N., Netto, M., & Mammari, S. (2006). A switched optimized approach for road departure avoidance. In *Proceedings of the IEEE conference on intelligent transportation systems* (pp. 133–138).
- Nagai, M., Mouri, H., & Raksincharoensak, P. (2002). Vehicle lane-tracking control with steering torque input. *Vehicle System Dynamics Supplement*, 37, 267–278.
- National Highway Traffic Safety Administration (2006). *Traffic safety facts 2005*. Washington: U.S. Department of Transportation.
- Petersson, L., Fletcher, L., & Zelinsky, A. (2005). A framework for driver-in-the-loop driver assistance systems. In *Proceedings of the IEEE conference on intelligent transportation systems* (pp. 771–776).
- Pilutti, T., & Ulsoy, A. G. (1999). Identification of driver state for lane keeping tasks. *IEEE Transactions on Systems, Man, and Cybernetics—Part A: Systems and Humans*, 29(5), 486–502.
- Pomerleau, D., Jochem, T., Thorpe, C., Batavia, P., Pape, D., Hadden, J., et al. (1999). *Run-of-road collision avoidance using IVHS countermeasures*. Technical Report DOT HS 809 170, U.S. Department of Transportation National Highway Traffic Safety Administration.
- Raharijoana, T. (2004). *Commande robuste pour l'assistance au contrôle latéral d'un véhicule routier*. Ph.D. thesis, Université Paris XI Orsay.
- Rosseter, E. J., Switkes, J. P., & Gerdes, J. C. (2004). Experimental validation of the potential field lanekeeping system. *International Journal of Automotive Technology*, 5, 95–108.
- Scherer, C., Gahinet, P., & Chilali, M. (1997). Multiobjective output-feedback control via LMI optimization. *IEEE Transactions on Automatic Control*, 42, 896–911.
- Shimakage, M., Satoh, S., Uenuma, K., & Mouri, H. (2002). Design of lane-keeping control with steering torque input. *JSAE Review*, 23, 317–323.
- Stilwell, D. J., & Rugh, W. J. (1997). Interpolation of observer state feedback controllers for gain scheduling. *IEEE Transactions on Automatic Control*, 44, 1225–1229.

## Active Steering Control Based on Piecewise Affine Regions

Stefano Scalzi<sup>1</sup>, Andre Benine-Neto<sup>2</sup>, Mariana Netto<sup>2</sup>, William Pasillas-Lepine<sup>3</sup>, Saïd Mammar<sup>4</sup>

**Abstract**—This paper shows that an active front steering control can be designed taking into account the nonlinear behaviour of the tire-road forces considering the vehicle dynamics with respect to the tire sideslip angle and by approximating the tire force characteristics by piecewise affine functions. The proposed control strategy involves the design of two control loops: the first one is a state feedback and it is designed to improve the vehicle dynamics using the pole placement techniques while the second control loop uses a PI control to ensure the tracking of constant yaw rate reference signal on the basis of the yaw rate tracking error despite constant disturbances and parameters uncertainties. Several simulations, including disturbances rejections and step references, are carried out on a standard CarSim D-Class vehicle model to explore the robustness with respect to unmodelled effects such as combined lateral and longitudinal tire forces, pitch, roll and driver dynamics. The simulations confirm that the proposed PWL control can greatly improve the vehicle stability and may be advantageous in very demanding manoeuvres in comparison with the use of the proposed controller designed for the linear region only.

### I. INTRODUCTION

Many vehicle control systems were implemented in the last years with the goal of increasing safety; the active steering control technology has been introduced in some production vehicles or on steer by wire prototypes in which the conventional steering elements are replaced by two electrical actuators which are positioned in the front corners of the vehicle to turn the front wheels. Many patents (see for example [1] and [2]) and papers [3] - [6] have been proposed. In [7], [8] and [9] the nonlinear behaviour of the tire-road forces is also taken into account in the design of the control law. In [7] a simple rational tire model is used to preserve vehicle stability in extreme handling situations designing a gain scheduled active steering control solving linear matrix inequality (LMI). In [8] multiple linearized models of the vehicle dynamics are used to defined the steering controller which is based on model predictive control (MPC) theory obtaining a multiple linear internal model steering controller. In [9] a nonlinear model predictive control approach is followed to improve the responses near the limits of the maneuvering capability of the vehicle: the controlled outputs are the lateral offset, the yaw rate and the yaw angle; the

controller is designed both on a nonlinear and a linear vehicle model using lateral and longitudinal vehicle speed, yaw angle and yaw rate measurements.

In this paper the nonlinear behaviour of the tire forces, which is approximated by piecewise affine, (PWA) functions, is taken into account in the design of the proposed active front steering control. The proposed control strategy involves the design of two control loops: the first one is a state feedback and it is designed to improve the vehicle dynamics using the pole placement techniques while the second control loop uses a PI control to ensure the tracking of constant yaw rate reference signal on the basis of the yaw rate tracking error despite constant disturbances and parameters uncertainties. Both piecewise linear (PWL) control loops are designed depending on the defined regions in which the tire forces are approximated. To prove the stability, the controlled system is described in the framework of PWA systems in which the partitions correspond to subsets of the state space. To formulate the overall dynamics as a PWA system, where the partitions are defined on the state space, the chosen state space variables are the tire sideslip angles. Finally, several simulations, including disturbances rejections and step references, are carried out on a standard CarSim D-Class vehicle model to explore the robustness with respect to unmodelled effects such as combined lateral and longitudinal tire forces, pitch, roll and driver dynamics. The simulations confirm that the proposed PWL control can greatly improve the vehicle stability and may be advantageous in very demanding manoeuvres in comparison with the use of the proposed controller designed for the linear region only.

### II. NONLINEAR VEHICLE MODEL

A detailed standard CarSim D-Class vehicle model is used in numerical simulations to analyze the responses of both the uncontrolled and the controlled vehicle. However, to design the controller, a widely used simplified single track vehicle model [10] is considered to capture the essential vehicle lateral steering dynamics:

$$\begin{aligned} m(\dot{v}_y + rv_x) &= f_{sf} \cos \delta_f + f_{sr} \\ J\dot{r} &= l_f f_{sf} \cos \delta_f - l_r f_{sr}, \end{aligned} \quad (1)$$

where  $r$  is the vehicle yaw rate,  $v_x$  and  $v_y$  are the longitudinal and lateral vehicle speed,  $\delta_f$  is the steering angle,  $m$  is the vehicle mass,  $l_f$  ( $l_r$ ) is the distance from the front (rear) axle to the centre of gravity (CG),  $J$  is the vehicle inertia respect to the vertical axle through the CG,  $f_{si}$ , with  $i = f, r$ , are the front and rear lateral forces which are modelled according

<sup>1</sup>University of Rome Tor Vergata, Electronic Engineering Department, Via del Politecnico 1, 00133 Rome - Italy. (e-mail: scalzi@ing.uniroma2.it)

<sup>2</sup>LCPC/INRETS - LIVIC, 14 Route de la Minière, 78000 Versailles, France. {netto, andre.benine-neto}@lcp.fr

<sup>3</sup>LSS-Suplec, Plateau du Moulon, 3, rue, Joliot-Curie 91192 Gif-sur-Yvette, France. (e-mail: pasillas@lss.supelec.fr)

<sup>4</sup>IBISC - CNRS FRE 3190 UEVE, 40 rue du Pelvoux 91020 Evry cedex - France. (e-mail: said.mammar@inrets.fr)

to the Pacejka tire model [11].

$$f_{si}(\alpha_i) = D \sin \{C_{atan} [(1 - E) B\alpha_i + E \tan(B\alpha_i)]\} \quad (2)$$

$$\alpha_f = \delta_f - \frac{v_y + l_f r}{v_x}, \quad \alpha_r = -\frac{v_y - l_r r}{v_x} \quad (3)$$

where  $\alpha_f$  ( $\alpha_r$ ) is the front (rear) tire sideslip angle. The simple nonlinear model (1) shows, as well known in literature (see for example [12]), a limited stability region which also depends on the driver steering wheel angle, two unstable equilibrium points and a stable one (bifurcation analysis). The causes of the instability are due to the nonlinear behaviour of the tire-road forces.

### III. PIECEWISE LINEAR VEHICLE MODEL

In order to take into account the nonlinearities the front and rear tire forces are approximated by PWA functions. In this approach the state-space is divided into subsets, denominated  $X_i$ , where  $i$  is the index of the corresponding region and dynamics. The front and rear tyre lateral forces can be then described by:

$$\begin{aligned} f_{sf}(\alpha_f) &= e_{fi} + d_{fi}\alpha_f \\ f_{sr}(\alpha_r) &= e_{ri} + d_{ri}\alpha_r, \end{aligned} \quad (4)$$

where  $d_{fi}$ ,  $d_{ri}$ ,  $e_{fi}$  and  $e_{ri}$  depend on the front and rear tire force approximations. For the region that include the origin (region 1) the commonly used linear tire forces approximation is obtained by setting  $e_{f1} = 0$ ,  $e_{r1} = 0$ ,  $d_{f1} = c_f$  and  $d_{r1} = c_r$  where  $c_f$  and  $c_r$  are related to the parameters in the Pacejka's formula as follows:

$$\begin{aligned} c_f &= B_f C_f D_f \\ c_r &= B_r C_r D_r, \end{aligned} \quad (5)$$

The parameters of the Pacejka magic formula (2) are given by a CarSim D-Class vehicle model used in the numerical simulations with 225/65R17 front and rear tires.

Similarly to the approach followed in [13], for a traction control using a MPC control strategy and implementing an explicit PWL form of the MPC law, the front and rear tyre lateral forces are approximated by the PWA functions as shown in Fig. 1. Even though this approximation can be refined, it is shown in the simulation section that improved performance can be obtained by simply approximating the tire forces with two PWA functions.

System (1) is linearized about uniform rectilinear motion ( $v_x = v = \text{constant}$ ), under the assumption that angles remain small and taking into account the PWA functions (4) adopted to approximate the nonlinear tire forces. The vehicle dynamics can be represented by the PWA system given by:

$$\dot{x} = A_i x + B_i u + a_i, \quad \text{for } x \in X_i, \quad (6)$$

where  $i$  refers to each partition of the state space. The front wheel angle  $u = \delta_f$  is the control input while the vehicle sideslip angle  $\beta$  (which replaces  $v_y$  since  $v_y = v \sin \beta$ ) and the yaw rate  $r$  are the state variables  $x = [\beta, r]^T$ . The corresponding dynamics are:

$$A_i = \begin{bmatrix} -\frac{d_{fi} + d_{ri}}{mv} & -1 - \frac{d_{fi} l_f - d_{ri} l_r}{mv^2} \\ \frac{d_{ri} l_r - d_{fi} l_f}{J} & -\frac{d_{fi} l_f^2 + d_{ri} l_r^2}{Jv} \end{bmatrix}, \quad (7)$$

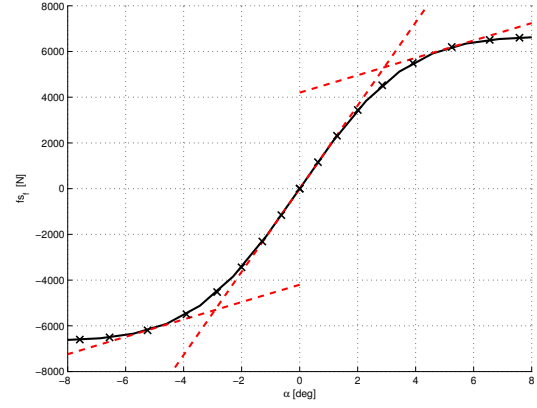

Fig. 1. Front and rear tire forces described by the Pacejka magic formula.

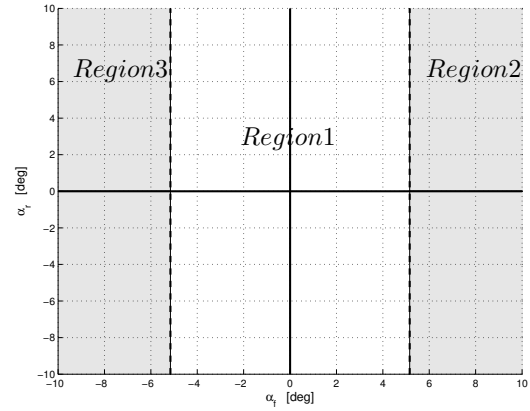

Fig. 2. Partitions adopted for the understeering CarSim model.

$$B_i = \begin{bmatrix} \frac{d_{fi}}{mv} \\ \frac{d_{fi} l_f}{J} \end{bmatrix}, \quad a_i = \begin{bmatrix} \frac{e_{fi} + e_{ri}}{mv} \\ \frac{e_{fi} l_f - e_{ri} l_r}{J} \end{bmatrix}, \quad (8)$$

where the vehicle parameters for the simplified single track vehicle model (1) are identified from a CarSim D-Class vehicle model. In general, the vehicles have an understeering behaviour, therefore only the vehicle saturation of the front wheel is considered in this work, and it is assumed that  $d_{ri} = c_r$  and  $e_{ri} = 0$ ; nevertheless the steps performed in the control design and in the stability analysis can be done for an oversteering vehicle (considering  $d_{fi} = c_f$  and  $e_{fi} = 0$ ) as well. Fig. 2 exemplifies the partitions adopted for the understeering CarSim D-Class vehicle model.

### IV. CONTROL DESIGN

The proposed control strategy involves the design of two control loops as shown in Fig. 3 and the control law can be written as follows:

$$\delta_f = -[K_{\beta i} \quad K_{r i}] x + \delta_{fPI} \quad i = 1, 2, 3 \quad (9)$$

The first control loop is a state feedback (it requires the measurement of the vehicle sideslip angle  $\beta$  which can be estimated [14] or measured as done in [15]) and it is designed to improve the vehicle dynamics using the pole placement

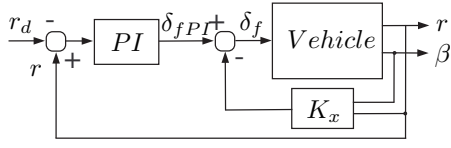

Fig. 3. Controlled system scheme.

techniques. The second controller is designed following the active steering approach in [1]: a PI control has been used to ensure the tracking of constant yaw rate reference signal ( $\dot{r}_d = 0$ ) on the basis of the yaw rate tracking error  $\tilde{r} = r - r_d$  despite constant disturbances and parameters uncertainties. The desired yaw rate is computed from the driver input, based on the steering wheel angle,  $\delta_p$ , as follows:

$$r_d = K_\delta \delta_p \quad (10)$$

in which  $K_\delta$  is computed as:

$$K_\delta = \lim_{s \rightarrow 0} C_1 [sI - A_1]^{-1} B_1 \quad (11)$$

with  $C_1 = [0 \ 1]$ , so that the second control loop is defined as:

$$\begin{aligned} \delta_{fPI} &= -K_{Pi}(r - r_d) - K_{Ii} \int_0^t (r - r_d) d\nu \\ &= -K_{Pi}\hat{\alpha}_0 - K_{Ii}\alpha_0, \quad \text{for } i = 1, 2, 3 \end{aligned} \quad (12)$$

where  $\alpha_0$  is the additional state introduced by the dynamic control (12). The ratio between the steering wheel and the yaw rate reference,  $K_\delta$ , which depends on the vehicle speed,  $K_\delta(v)$ , is chosen to be the same as in the uncontrolled vehicle (11). To take into account the nonlinearities of the Carsim vehicle, used in the simulation section, the gain  $K_\delta(v)$  is obtained from the uncontrolled vehicle measurements by storing the steady state yaw rate values in a lookup table for different steering angles and vehicle velocities ( $K_\delta(v, \delta_p)$ ). Substituting (9) in (6) leads to the augmented vehicle state space description in which the internal model of the constant reference is enclosed to the PWA system:

$$\dot{x}_a = A_{ai}x_a + B_{ai}u_a + a_{ai}, \quad (13)$$

where  $x_a = [\beta, r, \alpha_0]$  and  $u_a = r_d$ . The followed active steering approach [1] can track constant yaw rate while showing good performance also during transient as shown in the simulation section. The controller for each of the PWA subsystems is designed to be stable, but the proof of stability of the whole system requires the use of PWA systems theory [16], [17].

## V. STABILITY ANALYSIS

The stability proof of the proposed control schema is based on the search of a continuous piecewise quadratic Lyapunov function. In order to use the theorem, developed in [17], it is required that the partitions are described in terms of state space variables. To formulate the overall dynamics as a PWA system, where the partitions are defined on the state space, a coordinate change is performed by replacing the expression

for  $\delta_f$  in (9) into equation (3); such that the new chosen state space variables are  $\alpha_f$ ,  $\alpha_r$  and  $\alpha_0$ . A transformation matrix  $S$  can be defined:

$$S = \begin{bmatrix} -K_{\beta i} - 1 & -\frac{l_f}{v} + K_{r i} + K_{P i} & -K_{I i} \\ -1 & \frac{l_r}{v} & 0 \\ 0 & 0 & 1 \end{bmatrix}, \quad (14)$$

such that

$$\bar{x} = \begin{bmatrix} \alpha_f \\ \alpha_r \\ \alpha_0 \end{bmatrix} = Sx_a + \begin{bmatrix} K_{P i} \\ 0 \\ 0 \end{bmatrix} r_d. \quad (15)$$

In the new coordinates the PWA system (13) can be written as follows:

$$\dot{\bar{x}} = \bar{A}_i \bar{x} + \bar{a}_i, \quad (16)$$

where:

$$\begin{aligned} \bar{A}_i &= SA_{ai}S^{-1} \\ \bar{a}_i &= \left( -SA_{ai}S^{-1} \begin{bmatrix} K_{P i} \\ 0 \\ 0 \end{bmatrix} + SB_{ai} \right) r_d + Sa_{ai}. \end{aligned} \quad (17)$$

In the next section it is described how to treat the affine terms conveniently and some auxiliary matrices are defined for the application of the stability proof theorem proposed in [17].

### A. Piecewise Quadratic Lyapunov Functions

For convenient treatment of the affine terms we define the vector  $\bar{x}_e$  as the extended state vector:

$$\bar{x}_e = [\bar{x} \ 1]^T \quad (18)$$

so that (16) becomes:

$$\dot{\bar{x}}_e = \bar{A}_{e(i)} \bar{x}_e + \bar{B}_{e(i)} r_d, \quad (19)$$

where

$$\bar{A}_{e(i)} = \begin{bmatrix} \bar{A}_i & \bar{a}_i \\ 0_{1 \times 3} & 0 \end{bmatrix} \quad \text{and} \quad \bar{B}_{e(i)} = \begin{bmatrix} \bar{B}_i \\ 0 \end{bmatrix}. \quad (20)$$

A compact matrix parametrization of continuous piecewise quadratic functions on polyedral partitions, named *Continuity matrix*  $\bar{F}_i = [F_i \ f_i]$ , is defined as:

$$\bar{F}_i \bar{x}_e(t) = \bar{F}_j \bar{x}_e(t) \quad \text{for} \quad \bar{x}(t) \in X_i \cap X_j. \quad (21)$$

Using the results of [17], a potential continuous piecewise quadratic Lyapunov function candidate could be:

$$V(x) = \bar{x}_e^T \bar{F}_i^T T \bar{F}_i \bar{x}_e \quad \text{for} \quad \bar{x}(t) \in X_i \quad (22)$$

where  $T$  is a symmetric matrix of compatible dimension.

Applying this parametrization to the proposed PWA problem yields:

$$\begin{aligned} \bar{F}_1 &= \begin{bmatrix} 0_{1 \times 4} \\ I_{3 \times 3} & 0_{3 \times 1} \end{bmatrix}, \quad \bar{F}_2 = \begin{bmatrix} 1 & 0 & 0 & -\bar{\alpha}_f \\ I_{3 \times 3} & 0_{3 \times 1} \end{bmatrix} \quad \text{and} \\ \bar{F}_3 &= \begin{bmatrix} 1 & 0 & 0 & \bar{\alpha}_f \\ I_{3 \times 3} & 0_{3 \times 1} \end{bmatrix} \end{aligned} \quad (23)$$

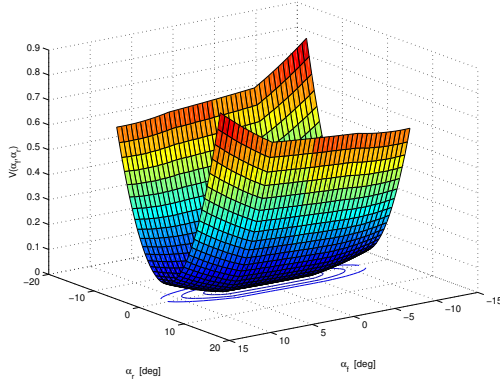

Fig. 4. Piecewise quadratic Lyapunov function computed for the given understeering CarSim vehicle.

In order to express the restriction that  $\bar{x} \in X_i$  via a linear form in  $\bar{x}$ , as required in the computations, *Cell Bounding matrices*,  $\bar{E}_i = [E_i \ e_i]$  are defined in [16], as follows:

$$\bar{E}_i \bar{x}_e \geq 0 \quad \text{if} \quad \bar{x}(t) \in X_i \quad (24)$$

For the considered case study, the following  $\bar{E}_i$  matrices are defined:

$$\begin{aligned} \bar{E}_1 = 0_{1 \times 4}, \quad \bar{E}_2 = \begin{bmatrix} 1 & 0 & 0 & -\bar{\alpha}_f \\ 0 & 0 & 0 & 1 \end{bmatrix} \quad \text{and} \\ \bar{E}_3 = \begin{bmatrix} -1 & 0 & 0 & -\bar{\alpha}_f \\ 0 & 0 & 0 & 1 \end{bmatrix}. \end{aligned} \quad (25)$$

The stability of the PWA model (16) can be proved using the theorem in [17]. It follows:

Consider symmetric matrices  $T$ ,  $U_i$  and  $W_i$  such that  $U_i$  and  $W_i$  have non negative entries, while:

$$P_i = F_i^T T F_i, \quad \bar{P}_i = \bar{F}_i^T T \bar{F}_i. \quad (26)$$

satisfy:

$$\begin{cases} \bar{A}_i^T P_i + P_i \bar{A}_i + E_i^T U_i E_i < 0 \\ P_i - E_i^T W_i E_i > 0 \end{cases} \quad \text{for } i = 1 \\ \begin{cases} \bar{A}_{e(i)}^T \bar{P}_i + \bar{P}_i \bar{A}_{e(i)} + \bar{E}_i^T \bar{U}_i \bar{E}_i < 0 \\ \bar{P}_i - \bar{E}_i^T \bar{W}_i \bar{E}_i > 0 \end{cases} \quad \text{for } i = 2, 3 \end{cases} \quad (27)$$

then, every trajectory  $\bar{x}(t)$  of the PWA model (16) tends to zero exponentially.

Solving the LMIs problem (27), piecewise quadratic Lyapunov functions of the form (22) have been computed proving the stability of (16). The computed Lyapunov function for  $r_d = 0$  is shown In Fig. 4, for a given  $\alpha_0$  ( $\alpha_0 = 0$ ).

Although the stability LMI conditions are shown to be feasible only under  $r_d = 0$ , the simulations described in the next section verify the performance of the system in the presence of disturbances and sudden direction change.

## VI. SIMULATION RESULTS ON A CARSIM VEHICLE

Several simulations in the CarSim environment have been performed to:

- validate the proposed control system with respect to additional dynamics and nonlinear combined lateral and longitudinal tire forces effects which were neglected at the control design stage,
- evaluate the improvements of the proposed PWL controller, by comparison with the a standard PI controller (as in [1]) designed in the linear region only.

The simulations were performed on the same vehicle in three different configurations:

- the uncontrolled vehicle (unc);
- a vehicle equipped with the designed controller in the linear region, equation (9) with  $i = 1$ , (lin. contr) only;
- a vehicle equipped with the proposed PWL control strategy, equation (9) with  $i = 1, 2, 3$ , (PWL contr).

CarSim vehicle uses detailed nonlinear tire models according to combined slip theory and takes into account the major kinematics and compliance effects of the suspensions (nonlinear spring models) and steering systems. The standard CarSim D-Class vehicle, used to analyze the responses of both the uncontrolled and the controlled vehicles, has a nonlinear second order speed depending rack and pinion ratio steering system; for the active steering a realistic actuator with a bandwidth of 10Hz is considered. The simulations are performed at a vehicle speed of  $v = 33 \text{ m/s}$ .

### A. Reference Model Design

The generation of the desired reference signal  $r_d$ , which is given by the driver, is computed as in [18]. The steering wheel angle  $\delta_p$  is the input of a nonlinear first order reference model which, according to the velocity  $v$ , generates the yaw rate reference signals  $r_d$  or, equivalently, for a given velocity, the lateral acceleration reference  $a_{yd}$ . The nonlinear reference model is defined as:

$$\begin{aligned} \dot{a}_{yd} &= -\lambda_{ref}(v) \left( a_{yd} - \frac{sat}{a_{y \max}} [K_\delta(v, \delta_p) \delta_p v] \right) \\ r_d &= \frac{a_{yd}}{v} \end{aligned} \quad (28)$$

where  $\lambda_{ref}(v)$  is a positive design parameter and  $K_\delta(v, \delta_p)$  is the imposed static gain between  $\delta_p$  and  $r$  which may depend on  $\delta_p$  and on tire-road adherence conditions. The gain  $K_\delta(v, \delta_p)$  is obtained from the uncontrolled vehicle by storing the steady state yaw rate values in a lookup table for different steering angles, vehicle velocities and adherence conditions so that the ratio between the steering wheel and the yaw rate reference is equal to the uncontrolled one and the controlled and the uncontrolled vehicle responses can be compared.

### B. Response to Sudden Disturbances

To analyze the improved performance of the active steering system, the vehicle is subjected to two increasing sudden disturbances on both the lateral and the yaw dynamics as shown in the second subplots of Fig. 5 and Fig. 7. If the disturbances are sufficiently small such that the vehicle does not reach the region in which  $\alpha_f > \bar{\alpha}_f$ , as shown in the second subplot of Fig. 6, the proposed PWL control action is equal to the action performed by the controller designed

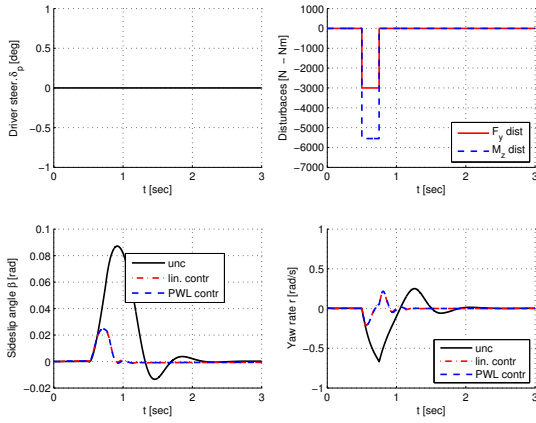

Fig. 5. Response to a small sudden disturbance on the uncontrolled (unc) and both controlled ((lin. contr), (PWL contr)) cars.

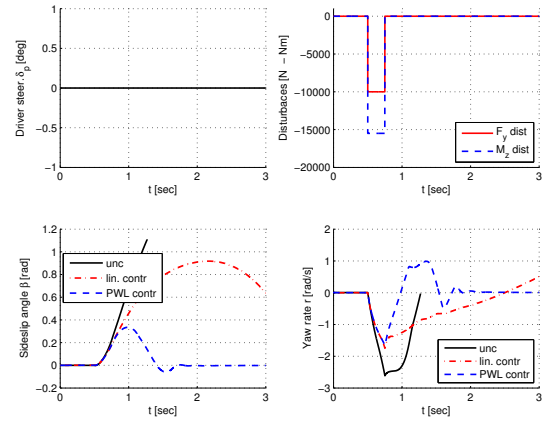

Fig. 7. Response to a sudden disturbance on the uncontrolled (unc) and both controlled ((lin. contr), (PWL contr)) cars.

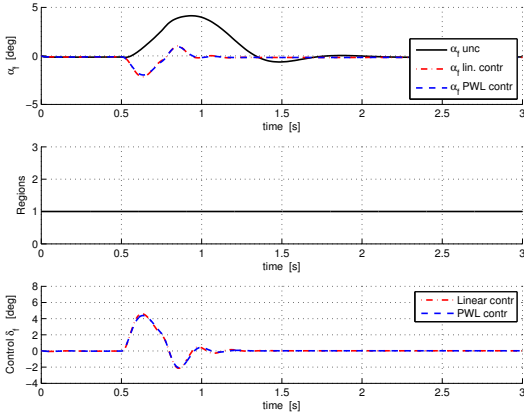

Fig. 6. Response to a small sudden disturbance on the uncontrolled (unc) and both controlled ((lin. contr), (PWL contr)) cars.

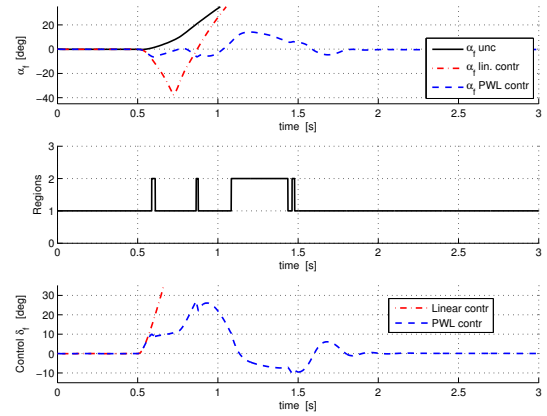

Fig. 8. Response to a sudden disturbance on the uncontrolled (unc) and both controlled ((lin. contr), (PWL contr)) cars.

for the linear region. In the third and the fourth subplots of Fig. 5 it is shown that the controlled vehicle sideslip and yaw rate are improved by both the performed control actions (shown in the third subplot of Fig. 6) in comparison to the uncontrolled vehicle.

The sudden disturbance shown in the second subplot of Fig. 7, on both the lateral and the yaw dynamics, is performed in order to show the improvements due to the PWA approach. In this case, since  $\alpha_f > \bar{\alpha}_f$  (as shown by the second subplot of Fig. 8) for some time intervals, the control signal (PWL contr) is different from (lin. contr). In the third and the fourth subplots of Fig. 7 it is shown that only the vehicle controlled by the proposed PWL control strategy is stabilized. The control signal shown in the third subplot of Fig. 8 switches, according to the chosen partitions, maximizing the front lateral tire forces while reducing the yaw rate error.

### C. Sudden Direction Change

Several sudden direction changes have been simulated to show the tracking of the desired yaw rate, the faster response of the controlled vehicle and the improved performance.

Fig. 9 and Fig. 10 depict a sudden direction change performed by the driver action shown in the first subplot of Fig. 9. The manoeuvre is very demanding as can be seen by the lateral acceleration shown in the second subplot of Fig. 9. In this case, only the PWL control approach performs satisfactory result as shown in the third and fourth subplots of Fig. 9 in which the vehicle sideslip and the yaw rate are depicted. The PWL control action shown in the third subplot of Fig. 10 switches, according to the chosen partitions, maximizing the lateral acceleration (second subplot of Fig. 9) while reducing the yaw rate error.

The proposed PWL control can greatly improve the vehicle stability and may be advantageous in very demanding manoeuvres also with respect to the use of the proposed controller designed for the linear region.

## VII. CONCLUSIONS

This paper shows that an active front steering control can be designed taking into account the nonlinear behaviour of tire forces by approximating their characteristics by two PWA functions. The proposed control strategy is able to improve the vehicle responses near the limits of the ma-

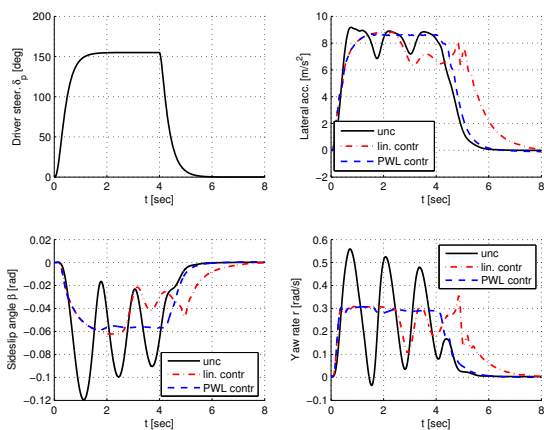

Fig. 9. Response to the driver input on steering wheel causing a sudden direction change on the uncontrolled (unc) and both controlled ((lin. contr), (PWL contr)) cars.

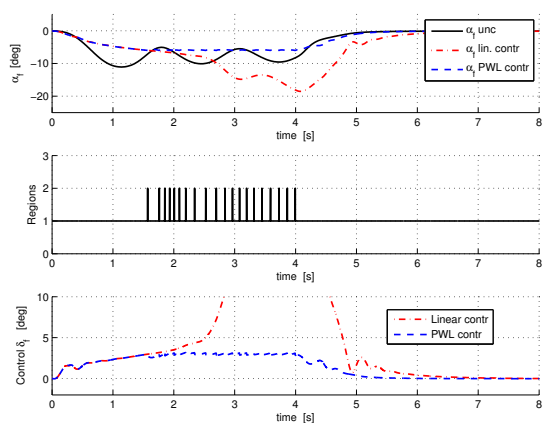

Fig. 10. Response to a sudden direction change on the uncontrolled (unc) and both controlled ((lin. contr), (PWL contr)) cars.

neuvering capability of the vehicle. The theory that extends the Lyapunov equation for PWA systems leading to an LMI problem is applied to ensure stability.

Several simulations, including disturbances rejections and step references, have been carried out on a standard CarSim D-Class vehicle model to explore the robustness with respect to unmodelled effects. The simulations confirm that the proposed PWL control can greatly improve the vehicle stability and may be advantageous in very demanding manoeuvres with respect to the use of the proposed controller designed for the linear region only.

A drawback, common to the most automotive control systems, is the dependence of the reference model from the coefficient of adherence: to overcome it on-line estimation schemes should be incorporated in the controller or a robustness analysis should be performed. This is the subject of future works. In order to avoid measurement of the sideslip angle, for which the sensors are costly, the perspectives also include the design of output feedback controller based on yaw rate or the incorporation of sideslip angle estimators. The possibility of using differential braking as a second

control input to generate yaw moments should also be explored, as it can potentially enhance the performance of the active steering system.

#### ACKNOWLEDGMENT

This work has been sponsored by the french ANR consortium PARTAGE.

#### REFERENCES

- [1] G. Baumgarten, "Motor Vehicle Steering System Having a Yaw Rate Controller", Bayerische Motoren Werke, United States Patent Pub. No. US 20040070268, April, 15/2004.
- [2] A. Pauly, G. Baumgarten, "Overlay Steering System and Method for Motor Vehicles", Bayerische Motoren Werke, United States Patent Pub. No. US 6854558, Feb 15/2005.
- [3] J. Ackermann, "Robust Car Steering by yaw rate control", IEEE Conference on Decision and Control, pp. 2033-2034, 1990.
- [4] J. Ackermann, "Robust Decoupling, Ideal Steering Dynamics and Yaw Stabilization of 4WS Cars", Automatica, vol. 30, No. 11, pp. 1761-1668, 1994.
- [5] R. S. Sharp and V. Valtetsiotis, "Optimal Preview Car Steering Control", Vehicle System Dynamics No. 35, pp. 101 - 117, 2001.
- [6] C.C. MacAdam, "Application of an Optimal Preview Control for Simulation of Closed-Loop Automobile Driving", IEEE Trans. on Systems, Man, and Cybernetics, Vol. 11, pp. 393-399, June 1981.
- [7] S. C. Baslamisli, I. Polat, I. E. Kose, "Gain Scheduled Active Steering Control Based on a Parametric Bicycle Model", Proceedings of the 2007 IEEE Intelligent Vehicles Symposium, Istanbul, Turkey, June 13-15, pp. 1168-1173, 2007.
- [8] S. D. Keen, D. J. Cole, "Steering control using model predictive control and multiple internal models", Proceedings of the 8th International Symposium on Advanced Vehicle Control, Taipei, Taiwan, August 20-24, 2006.
- [9] P. Falcone, F. Borrelli, J. Asgari, H. E. Tseng and D. Hrovat, "Predictive Active Steering Control for Autonomous Vehicle Systems", IEEE Trans. on Control Systems Technology, Vol. 15, NO. 3, pp. 566-580, May 2007.
- [10] J. Ackermann, "Robust Control", Springer, London 2002.
- [11] H.B. Pacejka, "Tire and Vehicle Dynamics", Elsevier - Butterworth Heinemann, 2004.
- [12] Eiichi Ono, S. Hosoe, H. D. Tuan, S. Doi, "Bifurcation in Vehicle Dynamics and Robust Front Wheel Steering Control" IEEE Trans. on Control System Technology, Vol 6, No. 3, pp. 9-14, May 1998.
- [13] F. Borrelli, A. Bemporad, M. Fodor and D. Hrovat, "A Hybrid Approach to Traction Control", Springer Berlin / Heidelberg, Vol. 2034, pp. 162-174, January 01, 2001.
- [14] M. Doumiati, G. Baffet, D. Lechner, A. Victorino and A. Charara "Embedded Estimation of the Tire/Road Forces and Validation in a Laboratory Vehicle", Proceedings of 9th International Symposium on Advanced Vehicle Control, Kobe Japan, pp. 533-538 October 2008.
- [15] N. M. Enache, M. Netto, S. Mammari, B. Lusetti, "Driver Steering Assistance for Lane Departure Avoidance", Control Engineering Practice, Vol. 17, pp. 642-651, October 2008.
- [16] M. Johansson, "Piecewise Linear Control Systems. A Computational Approach", Springer, London 2003.
- [17] M. Johansson and A. Rantzer, "Computation of Piecewise Quadratic Lyapunov Functions for Hybrid Systems", IEEE Transactions on Automatic Control, Vol. 43, No. 4, pp. 555-559, April 1998.
- [18] R. Marino, S. Scalzi, and F. Cinili "Nonlinear PI front and rear steering control in four wheel steering vehicles", Vehicle System Dynamics, Vol. 45, No. 12, pp. 1140-1168 October 2007.

# Dynamic Controller for Lane Keeping and Obstacle Avoidance Assistance System

André Benine-Neto<sup>1</sup>, Stefano Scalzi<sup>2</sup>, Saïd Mammam<sup>3</sup>, Mariana Netto<sup>1</sup>

**Abstract**—This paper presents the design and simulation tests of a steering assistance for passenger vehicles based on a dynamic state feedback controller. Its main purpose is to avoid unintended lane departure and collisions. The design of the proposed lane keeping system takes into account the road curvature, considered as an exogenous input, into its internal model. The computation of the control law has been achieved by linking Lyapunov theory of stability to Bilinear Matrix Inequalities which considers bounds in the control input and minimises the reachable set of the vehicle after activation. This control strategy ensures convergence of the lateral offset to zero, even in curvy roads. Simulations show the performance of the controller and an extended application for collision avoidance.

## I. INTRODUCTION

Many highway accidents occur due to unintended lane departure caused by the drivers lack of attention. In the recent years, many driving assistance systems have been developed, including lane keeping systems. These systems may consist of only providing warnings to the drivers [11], while others may share the action with the driver ([10] and [17]).

However, ergonomic and psychology studies for driving aid classify steering assistance systems in different cognitive levels linked to short or enlarged temporal frames [9]. When assisting the driver in emergency situations, the driver usually does not have time to think and plan. There is only time to react in order to re-establish a safe state, therefore sharing the control with the driver is not really an advantage, and in these cases, as stated in [9], it is better that the controller takes completely the responsibility during the control duration.

Many possibilities are shown in the literature concerning the activation strategies of lane keeping systems. In [5] the system perceives the driver intention based on the vehicle dynamics and tracks the environment (road geometry, obstacles/vehicles on current and adjacent lanes) to compute the risk of the manoeuvre using the time to cross lane (TCL) to predict a collision. In [4], the driver has control over the manoeuvres, but the automated lane keeping brings the vehicle back to the centre of the lane when there is no driver steering action. A combination of risk of lane departure and driver attentiveness is considered simultaneously in [6]. The

<sup>1</sup> LCPC/INRETS - LIVIC, 14 Route de la Minière, 78000 Versailles, France (andre.benine-neto@lpc.fr, netto@lpc.fr)

<sup>2</sup> University of Rome Tor Vergata, Electronic Engineering Department - DIE, Via del Politecnico 1, 00133 Roma - Italy, (e-mail: scalzi@ing.uniroma2.it)

<sup>3</sup> IBISC - EA 4526 UEVE, 40 rue du Pelvoux CE1455, 91020, Evry, Cedex, France (e-mail: said.mammam@inrets.fr)

positioning of the front wheels with respect to the lanes is used to evaluate the risk of lane departure while torque sensors in the steering column allow an estimation of the driver awareness.

Several control strategies for lane keeping systems have been developed in order to avoid unintended lane departure. In [19], [14] and [8] the authors explore the use of fuzzy logic in the controller design. The work [4] proposes a controller for typical highway conditions and the control problem is implemented by solving a SISO disturbance attenuation problem, formulated in the  $H_{\infty}/\mu$  framework in the presence of uncertain parameters. A comparison of four controllers, implemented at LIVIC, is presented in [13]. The controllers are based on output feedback self-tuning,  $H_{\infty}$ , fuzzy logic and proportional. In [6] the design consists of a simultaneous computation of state feedback gain and an invariant set by means of an Bilinear Matrix Inequality (BMI) optimisation problem which minimises the reachability set of the initial states.

This paper addresses the problem of designing a steering controller that switches between the driver and the assistance system, based on the attentiveness of driver and the risk of either lane departure or collision. Moreover, the proposed control law consists of a dynamic state feedback controller, which ensures zero lateral offset in steady state, even in the presence of road curvatures, considered as disturbances. It also takes into account physical limitations of the actuators in the design phase by bounding the control input. In section II, the vehicle model is presented, as well as a model for the perturbation, which is taken into account in the internal model. The control strategy and the activation strategy of the steering assistance system are presented in section III. Simulations of the system are shown in IV confirming the performance of the system. Section V concludes the paper showing some perspectives for future work.

## II. VEHICLE MODEL

A classical fourth order linear model (bicycle model) has been used [2]. The vehicle linear system is given by:

$$\begin{cases} \dot{\bar{x}} = \bar{A}\bar{x} + \bar{B}_u u + \bar{B}_w w \\ \bar{y} = \bar{x}, \quad t \in \mathbb{R}^+, \bar{x} \in \mathbb{R}^4, u \in \mathbb{R}^1, w \in \mathbb{R}^1. \end{cases} \quad (1)$$

The input  $u$  designates the steering angle,  $\delta_f$ , while the state vector is described by:

$$\bar{x} \triangleq [\beta, r, \psi_L, \psi_L]^T, \quad (2)$$

where  $\beta$  denotes the sideslip angle and  $r$  the yaw rate, as shown in Fig. 1.  $r$  can be easily measured and  $\beta$  can be either measured as in [6] or estimated as in [3]. The additional state variables for the lane keeping purpose are  $\psi_L$  and  $y_L$ , which are assumed to be measured by video sensor.  $\psi_L$  is the relative yaw angle which represents the angle between the vehicle direction and the tangent to the road. The lateral offset,  $y_L$ , denotes the distance from the lane centreline at the sensor location, denoted look-ahead distance,  $l_s$ .

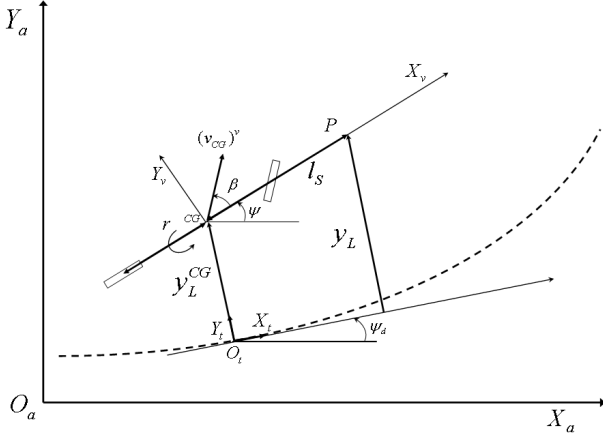

Fig. 1. Bicycle model for vehicle with variables for dynamics and positioning

The exogenous input  $w$  is a normalised variable that permits a parametrisation of the road curvature  $\rho_{ref}$ , defined as  $\rho_{ref} = 1/R$ , with  $R$  the curvature radius. A maximal value,  $\rho_{ref}^{max}$ , bounds  $w$  as follows:

$$w \triangleq \frac{\rho_{ref}}{\rho_{ref}^{max}}. \quad (3)$$

The matrices describing the linear system are:

$$\bar{A} = \begin{bmatrix} a_{11} & a_{12} & 0 & 0 \\ a_{21} & a_{22} & 0 & 0 \\ 0 & 1 & 0 & 0 \\ v & l_s & v & 0 \end{bmatrix}, \quad (4)$$

$$\bar{B}_u = [b_1 \quad b_2 \quad 0 \quad 0]^T, \quad (5)$$

$$\bar{B}_w = \rho_{ref}^{max} [0 \quad 0 \quad -v \quad 0]^T. \quad (6)$$

The coefficients appearing in the matrices (4) and (5) which may depend on the longitudinal velocity,  $v$  and on uncertain physical parameters are:

$$\begin{aligned} a_{11} &= -\frac{(c_f + c_r)}{mv}, & a_{12} &= -1 - \frac{(c_f l_f - c_r l_r)}{mv^2}, \\ a_{21} &= -\frac{(c_f l_f - c_r l_r)}{J}, & a_{22} &= -\frac{(c_f l_f^2 + c_r l_r^2)}{Jv}, \\ b_1 &= \frac{c_f}{mv}, & b_2 &= \frac{c_f l_f}{J}. \end{aligned} \quad (7)$$

The definitions and the numerical values of the above parameters are given in Table I.

TABLE I  
VALUES OF THE VEHICLE PARAMETERS.

Parameter	Value
$c_f$ , front cornering stiffness	40000 N/rad
$c_r$ , rear cornering stiffness	35000 N/rad
$l_f$ , distance form CG to front axle	1.22 m
$l_r$ , distance form CG to rear axle	1.44 m
$l_s$ , look-ahead distance	0.95 m
$m$ , total mass	1600 kg
$J$ , vehicle yaw moment of inertia	2454 kgm <sup>2</sup>
$v$ , longitudinal velocity	17 m/s

In order to design a controller that is able to avoid lane departure despite road curvatures, it is required to consider, the exogenous input within the vehicle model, building an internal model as described in the following section.

### III. CONTROL STRATEGY

#### A. Internal Model

An adequate strategy for the synthesis of control laws, considering the uncertainties of parameters or perturbations, consists in integrating the perturbations, for instance, in the controller by means of an internal model, which represents the disturbances as a family of known functions [7].

The road curvature can be modelled as straight, circular and clothoid sections. Clothoids ensure a smooth transition between different road curvature values (e.g. straight to circular roads), [16]. For a vehicle travelling at a constant speed, the curvature in a clothoid is considered as increasing linearly with respect to time. Therefore a ramp and constants are appropriate functions to model this disturbance. Considering the two additional states  $\alpha \triangleq [\alpha_0, \alpha_1]^T$  the internal model, which uses the lateral offset  $y_L$  as input, is described as:

$$\begin{cases} \dot{\alpha} = \begin{bmatrix} 0 & 1 \\ 0 & 0 \end{bmatrix} \alpha + \begin{bmatrix} 0 \\ y_L \end{bmatrix} \\ y_{im} = \begin{bmatrix} 1 & 0 \\ 0 & 1 \end{bmatrix} \alpha \end{cases} \quad (8)$$

The additional variables introduced by the internal model are included in the state vector, resulting in:

$$x \triangleq [\beta, r, \psi_L, y_L, \alpha_0, \alpha_1]^T, \quad (9)$$

and the augmented system becomes:

$$\begin{cases} \dot{x} = Ax + B_u u + B_w w \\ y = x, \quad t \in \mathbb{R}^+, x \in \mathbb{R}^6, u \in \mathbb{R}^1, w \in \mathbb{R}^1, \end{cases} \quad (10)$$

with the system matrices:

$$A = \begin{bmatrix} & \bar{A} & & & & \\ & & & & 0_{4 \times 2} & \\ 0 & 0 & 0 & 0 & 0 & 1 \\ 0 & 0 & 0 & 1 & 0 & 0 \end{bmatrix} \quad (11)$$

$$B_u = [\bar{B}_u^T, 0, 0]^T, \quad (12)$$

$$B_w = [\bar{B}_w^T, 0, 0]^T. \quad (13)$$

It is possible, with the double integration of  $y_L$  to find an adequate state feedback control law that steers the vehicle

to a zero-lateral-offset condition even in the presence of curvatures.

### B. Controller Synthesis

Since we intend to apply a control law that enables the vehicle to perform curves,  $\rho_{ref} \neq 0$ , the equilibrium point is no longer fixed at the origin (as in the case of straight lines). Therefore, to make use of the Lyapunov theory of stability, it is necessary to ensure that the state trajectories converge to a subset containing all the equilibrium points which must be invariant.

As presented in [6], it is possible to find a state feedback gain, at the same time as a quadratic Lyapunov function, which guarantees the invariant set properties, by means of Bilinear Matrix Inequalities (BMI) optimisation problems, even in the presence of disturbances.

By applying in system (10) a state feedback of the form:

$$u = Kx, \quad (14)$$

the closed loop system becomes:

$$\dot{x} = (A + B_u K)x + B_w w. \quad (15)$$

An ellipsoidal invariant sets of the form:

$$\mathcal{E}(P) \triangleq \{x \in \mathbb{R}^n : x^T P x \leq 1\}, \text{ with } P = P^T \text{ and } P \succ 0, \quad (16)$$

can be obtained from a quadratic Lyapunov function:

$$V(x) = x^T P x, \text{ with } P \succ 0 \text{ and } \dot{V}(x) < 0. \quad (17)$$

The invariant set must contain all trajectories starting from a subset which represents the states at the activation of the assistance system. This subset of initial conditions is a polytope  $L(T^N)$  defined as:

$$x \in L(T^N) \triangleq \{x \in \mathbb{R}^6 : |T^N x| \leq 1\}, \quad (18)$$

where  $T^N \in \mathbb{R}^{6 \times 6}$  is a diagonal matrix with the following elements:

$$T^N \triangleq \text{diag}[(\beta^N)^{-1}, (r^N)^{-1}, (\psi_L^N)^{-1}, (y_L^N)^{-1}, \dots, (\alpha_0^N)^{-1}, (\alpha_1^N)^{-1}]. \quad (19)$$

where the values  $\beta^N$  and  $r^N$  can be set as the equilibrium point of (15) for  $\rho_{ref} = \rho_{ref}^{\max}$  and the remaining parameters are chosen based on safety condition.

Minimising the ellipsoid (16) that contains the polytope (18) at the same time as satisfying the conditions  $\dot{V} < 0$ ,  $V(x) \geq 1$ ,  $w^T w \leq 1$  and bounded input can be expressed in terms of BMI as follows:

$$\begin{aligned} & \text{Minimise: } \text{tr}(Q), \text{ det}(Q) \text{ or } \lambda_{\max}(Q) \\ & \text{Subjected to: } \theta \succ 0, \\ & \quad Q \succ 0, \\ & \left( \begin{array}{cc} QA^T + Y^T B_u^T + AQ + B_u Y + \theta Q & B_w \\ B_w^T & -\theta \end{array} \right) \preceq 0, \\ & \left( \begin{array}{cc} 1 & z_i^T \\ z_i & Q \end{array} \right) \succeq 0, \quad i = 1, \dots, g/2, \\ & \left( \begin{array}{cc} 1 & \frac{1}{\delta_f^{\max} - \delta_f} Y \\ \frac{1}{\delta_f^{\max} - \delta_f} Y^T & Q \end{array} \right) \succeq 0, \end{aligned} \quad (20)$$

where  $\theta$  is a real constant,  $Q = P^{-1}$ ,  $Y = KP^{-1}$ , and  $z_i$  represents each of the  $g$  vertices of the hypercube (18).

The third constraint represents the stability of the closed-loop system, with the conditions  $V(x) \geq 1$  and  $w^T w \leq 1$ . The fourth represents the inclusion of the polytope in the ellipsoid. The fifth constraint is added to bound the control input  $\delta_f$  to a predefined value  $\delta_f^{\max}$ , see [6].

If the optimisation problem stated above is feasible, the resulting controller is able to reject the disturbances of road curvature and it ensures that all the state is bounded by the invariant set  $\mathcal{E}(P)$ . The parameters of (18) can be adjusted to enhance the performance of the controller.

### C. Steering Assistance Activation Law

The human interactions play an important role in the driving assistance systems, therefore an adequate strategy of activation is required. The strategy chosen for this work takes into account the driver's attentiveness as well as the risk of either lane departure or collision.

The driver's attentiveness is estimated by measuring the driver's input torque on the steering wheel, denominated  $\tau$ . If  $\tau < 5Nm$  the driver is considered inattentive. The driver has priority and control of the vehicle whenever his awareness is recovered, which corresponds to  $\tau > 2Nm$ . These assessment of awareness and thresholds were implemented in [6]. Nevertheless, these values can be adjusted according to road types and curving conditions.

The risk of lane departure is estimated by the state variables  $\bar{x}$ . A reduced polytope, for the activation strategy is defined as:

$$x \in L(\bar{T}^N) \triangleq \{\bar{x} \in \mathbb{R}^4 : |\bar{T}^N \bar{x}| \leq 1\} \quad (21)$$

where  $\bar{T}^N \in \mathbb{R}^{4 \times 4}$  is a diagonal matrix with the following elements:

$$\bar{T}^N \triangleq \text{diag}[(\beta^N)^{-1}, (r^N)^{-1}, (\psi_L^N)^{-1}, (y_L^N)^{-1}] \quad (22)$$

If one of the variables describing the dynamics or positioning reach values, that exits the polytope for activation (21), the risk of lane departure is enabled.

The assessments of driver's awareness and risk of lane departure presented in this paper are chosen due to the simplicity of implementation, since it is the first step in the design of the assistance system. More sophisticated strategies can be used with the controller but they are beyond the scope of this work.

An important feature that should be added to advanced driver assistance systems is the ability to avoid obstacles.

Obstacle detection and risk analysis can be performed by systems as presented in [18]. When the risk analysis determines that, for example, a double lane change is the safest manoeuvre, a new path to be followed is computed and a Boolean variable  $CO$  is enabled. The controller functions no longer with respect to the lane centreline, but integrating the lateral offset with respect to the new computed path. In a collision avoidance situation, defined by  $CO = True$ , the

condition of activation zone (21) described above is not taken into account for the activation of the controller.

The activation and deactivation of the assistance system follows:

- Activate if  $(\tau < 5Nm)$  &  $(|\bar{T}^N_x| = 1) \mid CO$ ,
- Deactivate if  $(\tau \geq 2Nm)$ ,

where & and  $\mid$  are the Boolean operations *AND* and *OR* respectively.

#### IV. RESULTS AND SIMULATIONS

In order to solve the BMI problem (20) the software PENBMI was used. The maximum road curvature was considered  $\rho_{ref}^{max} = 0.02m^{-1}$ . The polytopic region  $T^N$  was adjusted with the following values:

$$T^N = [0.013, 0.174, 0.017, 0.2, 0.005, 0.005]. \quad (23)$$

A maximum control input was defined as  $\delta_f^{max} = 10$  degrees. The computed gain from the optimisation problem (20) is certain to stabilise asymptotically the system for bounded disturbances  $|\rho_{ref}| \leq \rho_{ref}^{max}$ , since all real parts of the eigenvalues of  $(A + B_u K)$  are negative. The eigenvalues of (15) at  $v = 17m/s$  are:

$$\lambda = \begin{bmatrix} -5.4131 + 1.0935i \\ -5.4131 - 1.0935i \\ -3.1836 \\ -1.7615 + 1.1934i \\ -1.7615 - 1.1934i \\ -1.6654 \end{bmatrix}, \quad (24)$$

and the corresponding gain is given by:

$$K = \begin{bmatrix} -0.7031, & -0.1328, & -1.8120, \\ -0.2824, & -0.1929, & -0.3680 \end{bmatrix} \quad (25)$$

Simulations have been carried out with the proposed control strategy on a widely used simplified nonlinear single track vehicle model [1], which is considered to capture the essential vehicle lateral steering dynamics.

$$\begin{aligned} m(\dot{v}_y + rv) &= F_{yf} \cos \delta_f + F_{yr} \\ Jr &= l_f F_{yf} \cos \delta_f - l_r F_{yr} \end{aligned} \quad (26)$$

where  $F_{si}$ , with  $i = f, r$ , are respectively the front and rear lateral forces which are modelled according to the Pacejka tire model [15].

$$F_{si}(\alpha_i) = D \sin \{ \text{Catan} [(1 - E)B\alpha_i + E \text{atan}(B\alpha_i)] \} \quad (27)$$

$$\alpha_f = \delta_f - \frac{v_y + l_f r}{v}, \quad \alpha_r = -\frac{v_y - l_r r}{v} \quad (28)$$

where  $\alpha_f$  ( $\alpha_r$ ) is the front (rear) tire sideslip angle. And the lateral velocity  $v_y$  is given by  $v_y = v \sin \beta$ . The variables for the positioning of the vehicle  $(\psi_L, Y_L)$  and internal model  $\alpha$  follow the linear model (11).

In order to render the simulations more realistic, white noises of 20% of each measured variable were considered. Besides randomly distributed error with maximum amplitudes of 5cm for the lateral offset and 0.1 for sideslip angle and relative yaw angle were added to each measurement.

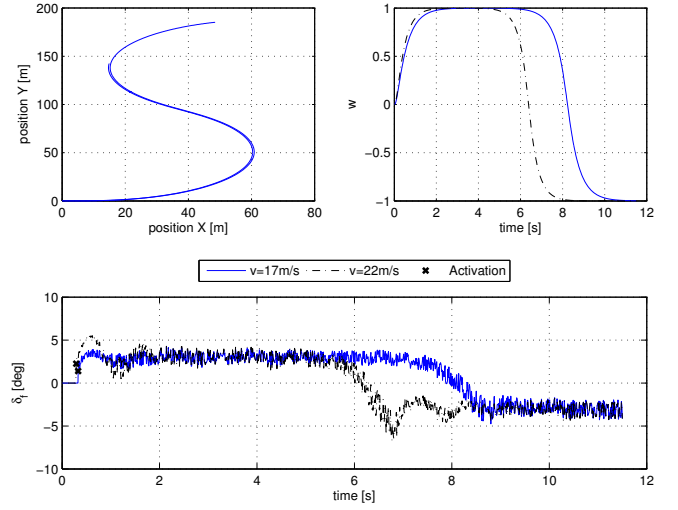

Fig. 2. Upper Left: Road Path. Upper-right: Parametrised road curvature,  $w$ . Bottom: control input,  $\delta_f$  to follow wet curvy road.

The driver was considered inattentive throughout the simulations. The results presented show the performance in two scenarios, the first in a curvy road with deteriorated road adherence at  $v = 17m/s$  (design parameter) and  $v = 22m/s$  (maximal speed for acceptable performance). A second scenario for simulation consists of an obstacle avoidance manoeuvre.

##### A. Simulations of change in direction

The first simulation scenario corresponds to the vehicle following the path shown in the top left subplot of Fig. 2. The corresponding normalised parametrisation of the road curvature,  $w$ , for each of the simulated speeds are shown on the upper-right plot. The road adhesion coefficient is  $\mu = 0.7$ , which corresponds to wet pavement. This condition is incorporated in the parameters of (27) by changing  $B$  to  $(2 - \mu)B$ ,  $C$  to  $(\frac{5}{4} - \frac{\mu}{4})C$  and  $D$  to  $\mu D$ , [12].

The required control input to reject the disturbance and avoid lane departure is depicted in the bottom of the Fig. 2. In Fig. 3 it is shown the vehicle dynamics  $\beta$  and  $r$ , while Fig. 4 shows the positioning, described by the relative yaw angle  $\psi_L$  and lateral offset,  $y_L$ , at look-ahead distance. From these results it is possible to notice that the proposed control strategy is able to satisfactorily follow curvy tracks, with zero lateral offset in steady-state and less than 0.2m in transient regime. The controller performs robustly for a certain range of longitudinal velocities larger than the design specification, as shown by the results at the maximum speed for an acceptable performance  $v = 22m/s$ , for which the lateral offset remains smaller than 0.4m.

##### B. Obstacle avoidance manoeuvre

The second scenario simulates a manoeuvre in an imminent collision in dry road ( $\mu = 1$ ). The proposed controller has been simulated following the ISO-3888-2 standard,

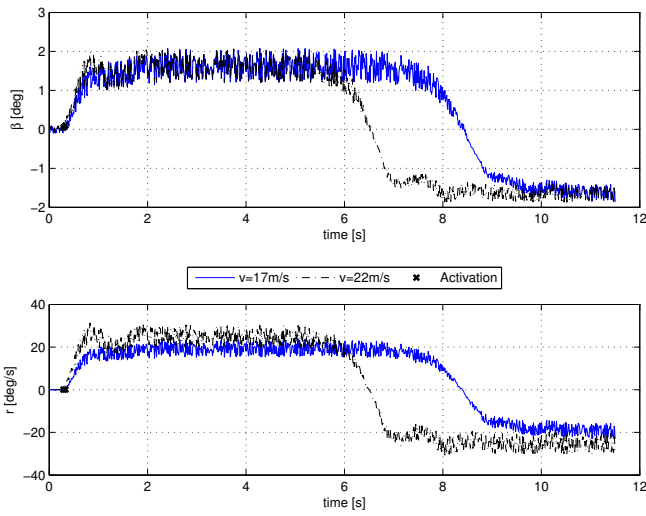

Fig. 3. Vehicle dynamics for wet curvy road. Upper: Vehicle side-slip angle,  $\beta$ . Bottom: Vehicle yaw rate,  $r$

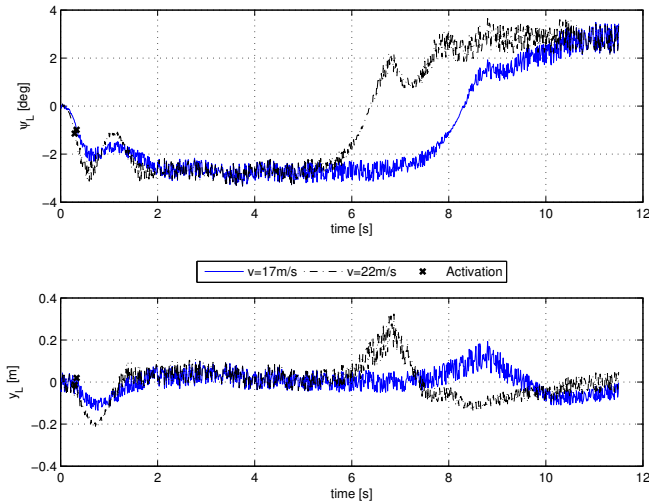

Fig. 4. Vehicle positioning for wet curvy road. Upper: Relative yaw angle,  $\psi_L$ . Bottom: Lateral offset at look-ahead distance,  $y_L$ .

which prescribes a severe lane change test with obstacle avoidance. The corresponding path is shown in the upper-left subplot of Fig. 5.

The road curvature for the new computed path surpasses the design parameter, reaching  $\rho_{ref} = -0.0252m^{-1}$  as shown by the parametrised disturbance depicted in the upper-right subplot of Fig. 5. The required control input to perform the manoeuvre is depicted on the bottom subplot of Fig. 5. It can be seen that the input does not lie within the specified design value  $|\delta_f| < \delta_f^{max}$ , but it remains within the realistic values for such a demanding manoeuvre.

The vehicle sideslip angle and yaw rate are shown respectively in the upper and bottom subplots of Fig. 6. Both variables reach higher values than specified in the design phase, due to the fact the maximal road curvature is also

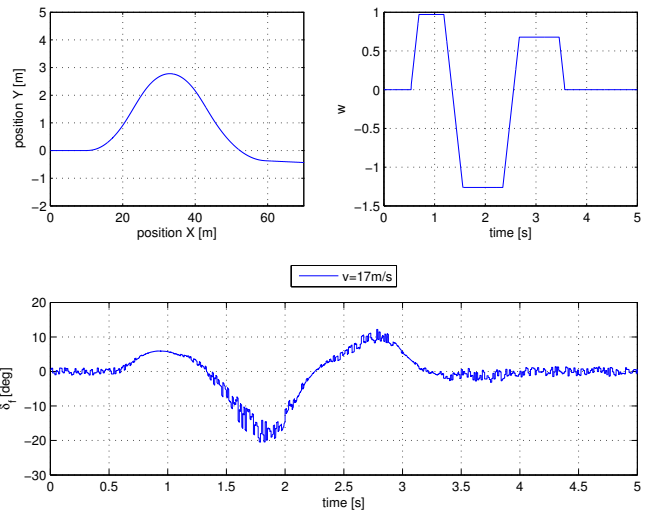

Fig. 5. ISO-3888-2 manoeuvre, Upper Left: Computed reference Path. Upper-right: Parametrised road curvature,  $w$ . Bottom: Performed control input,  $\delta_f$ .

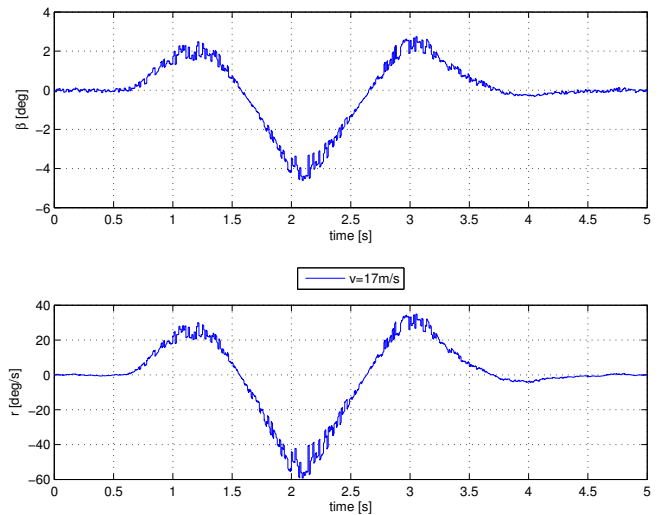

Fig. 6. Vehicle dynamics during ISO-3888-2 manoeuvre. Upper: Vehicle side-slip angle,  $\beta$ . Bottom: Vehicle yaw rate,  $r$

overshot. Nevertheless the vehicle remains in the lane, as it can be seen from the results obtained for positioning, shown in Fig. 7.

The vehicle trajectory is plotted in Fig. 8, where the thicker black line represents the desired path. It can be noticed from these results that the controller is able to perform satisfactorily the ISO-3888-2 standard.

## V. CONCLUSIONS

This work has proposed a lane keeping assistance system which takes into account simultaneously the attentiveness of the driver and the risk either of unintended lane departure or collision. Moreover, it was shown that it is possible to reject the disturbances, steering the vehicle to zero lateral offset,

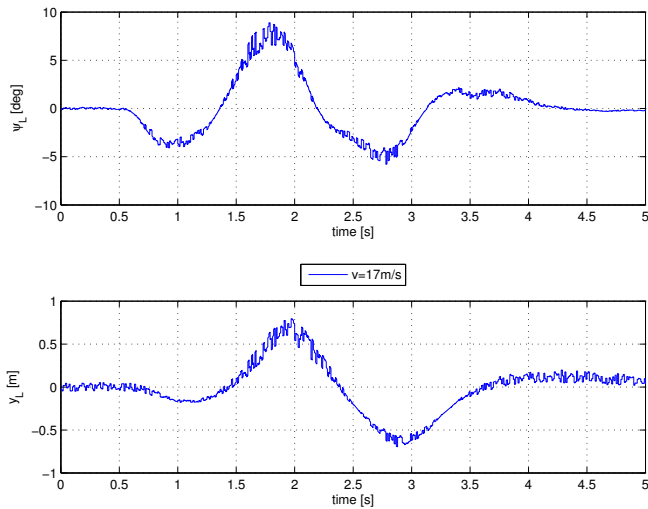

Fig. 7. Vehicle positioning during ISO-3888-2 manoeuvre. Upper: Relative yaw angle,  $\psi_L$ . Bottom: Lateral offset at look-ahead distance,  $y_L$ .

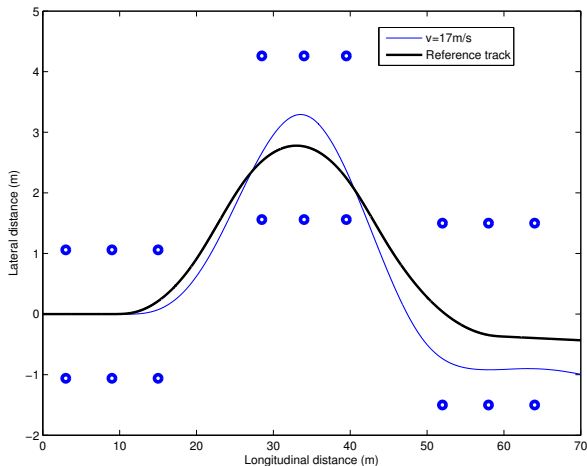

Fig. 8. Reference and vehicle trajectory during ISO-3888-2 manoeuvre.

by modelling the exogenous input (road curvature) into an internal model with two integrations of the lateral offset signal. The compensation of the disturbances is guaranteed by the dynamic state feedback controller. The design of the controller also takes into account restriction in the control input.

The problem of finding a feedback gain that stabilises the system with bounded control input, can be casted as a BMI optimisation problem.

The performance of the controller was shown by numerical simulations. It also includes simulations in less favourable conditions as lower road adherence and higher speeds. Although different controllers may usually be used for lane keeping and obstacle avoidance purposes, the results of the simulation from the standard ISO-3888-2 confirm the potential application of the controller with internal model in obstacle avoidance assistance systems.

As for future work, efforts should be concentrated in developing activation strategies that are closer to the actual driver behaviour and a controller that does not depend on the measurement of sideslip angle, due to the high costs of the inertial units. Moreover field validation should be carried over.

#### ACKNOWLEDGMENT

This work has been partially sponsored by the french ANR consortium PARTAGE.

#### REFERENCES

- [1] J. Ackermann. *Robust Control*. Springer, London, 2002.
- [2] J. Ackermann, J. Guldner, W. Sienel, R. Steinhauser, and V. I. Utkin. Linear and nonlinear controller design for robust automatic steering. *IEEE Transactions on control Systems Technology*, 3(1):132–143, March 1995.
- [3] G. Baffet, A. Charara, D. Lechner, and D. Thomas. *An Estimation Process for Tire-Road Forces and Sideslip Angle for Automotive Safety Systems*. Book Series Lecture Notes in Electrical Engineering. Springer Berlin Heidelberg, 2008.
- [4] V. Cerone, M. Milanese, and D. Regruto. Combined automatic lane-keeping and driver's steering through a 2 dof control strategy. *IEEE Transactions on control Systems Technology*, 17(1):135–142, January 2009.
- [5] A. Eidehall, J. Pohl, and F. Gustafsson. A new approach to lane guidance systems. In *IEEE Conference on Intelligent Transportation Systems Vienna, Austria*, pages 776–770, September 2005.
- [6] N. Minoiu Enache, B. Lusetti, S. Mammar, and M. Netto. Assistance active de prevention des sorties de voie. prise en compte des virages. *Journal Europeen des Systemes Automatiss*, 43(6):615–646, 2009.
- [7] B.A. Francis and W.M. Wonham. The internal model principle of control theory. *Automatica*, 12(5):457–465, 1976.
- [8] T. Hessburg and M. Tomizuka. A fuzzy rule-based controller for automotive vehicle guidance. Technical report, California Partners for Advanced Transit and Highways, PATH research report UCB-ITS-PRR-91-18, 1991.
- [9] J.-M. Hoc, M. S. Young, and J.-M. Blosseville. Cooperation between drivers and automation: implications for safety. *Theoretical Issues in Ergonomics Science*, 10(2):135–160, 2009.
- [10] S. Ishida and J. E. Gayko. Development evaluation and introduction of a lane keeping assistance system. In *Proc. IEEE Intelligent. Vehicles Symposium., Parma, Italy*, pages 139–144, June 2004.
- [11] A. Kullack, I. Ehrenpfordt, K. Lemmer, and F. Eggert. Reflektas: lane departure prevention system based on behavioural control. *IET Intelligent Transport System*, 2(4):285–293, 2008.
- [12] S. Mammar and D. Koenig. Vehicle handling improvement by active steering. *Vehicle System Dynamics*, 38(3):211–242, 2002.
- [13] S. Mammar, S. Chaib, and M. Netto. H-infinity, adaptive, pid and fuzzy control: a comparison of controllers for vehicle lane keeping. In *Proc. IEEE Intelligent. Vehicles Symposium., Parma, Italy*, pages 139–144, June 2004.
- [14] S. Mammar, N. Minoiu Enache, S. Glaser, B. Lusetti, and A. Benine-Neto. Lane keeping automation at tire saturation. In *Proceeding of the 2010 American Control Conference, Baltimore*, June 2010.
- [15] H.B. Pacejka. *Tire and Vehicle Dynamics*. Elsevier Butterworth-Heinemann, 2004.
- [16] R. Rajamani. *Vehicle Dynamics and Control*, chapter 2 - Lateral Vehicle Dynamics, pages 43–46. Springer, 2006.
- [17] E. J. Rosseter and J. C. Gerdes. Lyapunov based performance guarantees for potential field lane keeping assistance system. *Journal of Dynamic Systems, Measurement and Control - Transactions of the ASME*, 128:510–522, September 2006.
- [18] B. Vanholme, S. Glaser, S. Mammar, and D. Gruyer. Manoeuvre based trajectory planning for highly autonomous vehicles on real road with traffic. In *In Proceedings of ECC09, Budapest, Hungary*, August 2009.
- [19] S.-J. Wu, H.-H. Chiang, J.-W. Perng, C.-J. Chen, B.-F. Wu and T.-T. Lee. The heterogeneous systems integration design and implementation for lane keeping of a vehicle. *IEEE Transactions on Intelligent Transportation Systems*, 9(2):246–263, June 2008.

# Development and Application of an Integrated Evaluation Framework for Preventive Safety Applications

Johan Scholliers, Somya Joshi, Maria Gemou, Falke Hendriks, Mikael Ljung Aust, Juha Luoma, Mariana Netto, Johan Engström, Susanna Leanderson Olsson, Ralf Kutzner, Fabio Tango, Angelos J. Amditis, Jean-Marc Blosseville, and Evangelos Bekiaris

**Abstract**—Preventive safety functions help drivers avoid or mitigate accidents. No quantitative methods have been available to evaluate the safety impact of these systems. This paper describes a framework for the assessment of preventive and active safety functions, which integrates procedures for technical performance, human factors, and safety assessments in one holistic approach. The concept of *situational control*, which is defined as the degree of control that a joint driver–vehicle system exerts over a traffic situation, has been introduced. Assessment involves *technical evaluation*, which assesses that the system and all subsystems work according to the functional and technical specifications, *human factors evaluation*, which assesses the behavioral situational control parameters, and *safety potential evaluation*, which performs a detailed assessment of internal and external impact mechanisms that change the situational control at the traffic level. The methodology has been applied to the INSAFES project, which integrates lateral and longitudinal control functions.

**Index Terms**—Active safety, assessment, human factors, intelligent vehicle systems, safety impact, technical evaluation.

Manuscript received December 12, 2008; revised October 1, 2009, February 14, 2010, and July 20, 2010; accepted September 5, 2010. Date of publication October 18, 2010; date of current version March 3, 2011. This work was supported through the PReVAL and INSAFES projects, which are part of the Integrated Project (IP) PREVENT, cosponsored by the European Commission under the Sixth Framework Programme. The Associate Editor for this paper was R. W. Goudy.

J. Scholliers is with VTT Technical Research Centre of Finland, 33101 Tampere, Finland (e-mail: johan.scholliers@vtt.fi).

S. Joshi and A. J. Amditis are with the Institute of Communication and Computer Systems, 15773 Athens, Greece (e-mail: s.joshi@iccs.gr).

M. Gemou and E. Bekiaris are with the Hellenic Institute of Transport, Centre for Research and Technology Hellas, 57001 Thessaloniki, Greece (e-mail: mgemou@certh.gr).

F. Hendriks is with TNO Automotive, 5708 HN Helmond, The Netherlands (e-mail: falke.hendriks@tno.nl).

M. Ljung Aust is with Volvo Cars Safety Centre, 405 31 Göteborg, Sweden (e-mail: mljung4@volvocars.com).

J. Luoma is with VTT Technical Research Centre of Finland, 02044 Espoo, Finland (e-mail: juha.luoma@vtt.fi).

M. Netto is with Vehicle–Infrastructure–Driver Interactions Research Laboratory, French National Institute on Civil Engineering/French National Institute on Transportation and Safety, 78000 Versailles, France (e-mail: mariana.netto@lcp.fr).

J. Engström and S. Leanderson Olsson are with Volvo Technology Corporation, 405 08 Göteborg, Sweden (e-mail: johan.a.engstrom@volvo.com; susanna.leanderson.olsson@volvo.com).

R. Kutzner was with Leibniz Universität Hannover, 30167 Hannover, Germany. He is now with Technische Universität Braunschweig, 38106 Braunschweig, Germany (e-mail: r.kutzner@tu-braunschweig.de).

F. Tango is with the Advanced Driver Assistance Systems Department, Centro Ricerche Fiat, 10126 Turin, Italy (e-mail: Fabio.Tango@crf.it).

J.-M. Blosseville is with French National Institute on Transportation and Safety, 78000 Versailles, France (e-mail: jean-marc.blosseville@inrets.fr).

Digital Object Identifier 10.1109/TITS.2010.2080357

## I. INTRODUCTION

IN RECENT years, much research has been performed on safety functions that help drivers avoid or mitigate accidents through the use of in-vehicle systems, which sense the nature and significance of developing risk situations and communicate these perceived risks to the driver [1]. During the PReVENT integrated project [2], various preventive safety applications have been developed and demonstrated, such as safe speed and safe following, hazard messaging, lateral support (lane support [3] and lane-change assistant), intersection safety, collision mitigation, and precrash protection systems [4], [5].

The safety potential of a preventive safety function is determined by several factors. These factors include the technical reliability and performance, the ability to improve driver response, and the impact that these factors, taken together, have on the traffic safety level (safe operation of the traffic system and interaction between users and nonusers) [6]–[8]. Thus, assessment is organized according to the following three aspects: 1) technical evaluation; 2) human factors evaluation; and 3) safety potential assessment. In general, assessment serves the following two purposes: 1) to assure the functionality of the system, i.e., that the system works as required, and 2) to assess and quantify the system's impact on the traffic. These purposes need to sequentially be fulfilled. To make a qualified impact assessment, first, the functional boundaries of the system and its influence on driving performance and driver behavior under all relevant conditions need to be established.

An assessment framework for preventive safety systems, which produces comparable and reproducible results, has been developed in the PReVAL project, which is a subproject of the PReVENT integrated project. This paper first describes the key concepts of the methodology, i.e., the situational control concept and the adapted V-shaped design and evaluation cycle, including the different phases of the evaluation process. The proposed evaluation procedures have been applied to the functions in the INSAFES project [9], in which different subsystems developed in a set of PReVENT projects were integrated into a single vehicle. The feedback from INSAFES has then been used to update the different proposed PReVAL procedures into a single holistic framework.

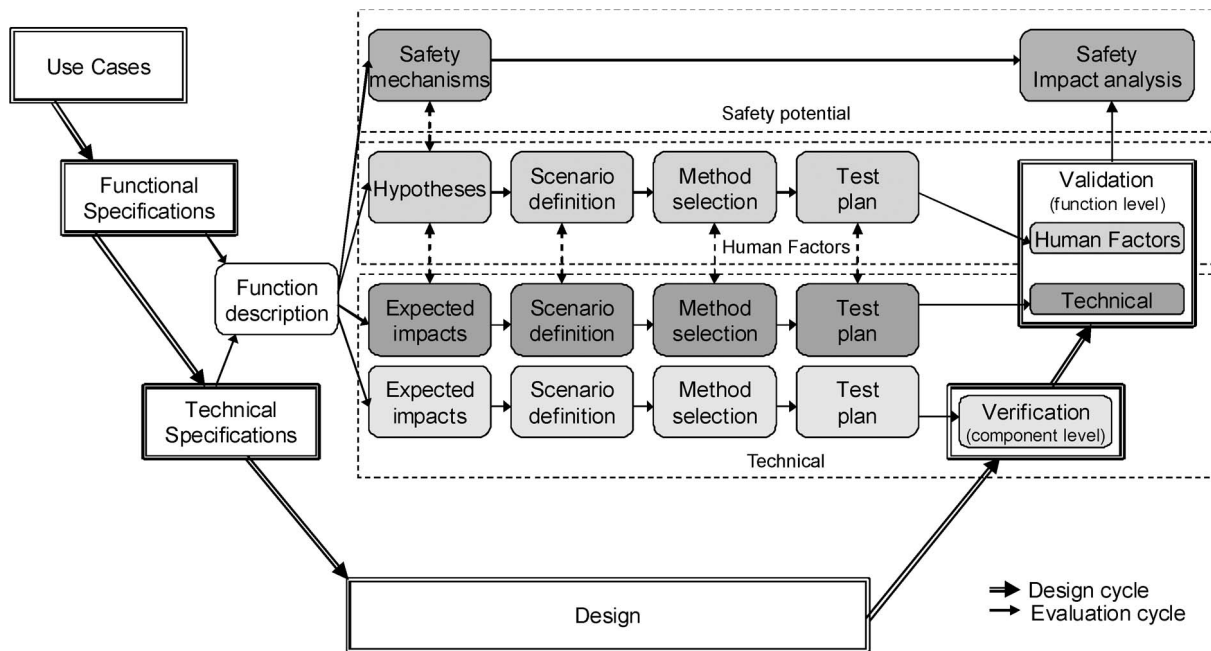

Fig. 1. Adapted V-shape design and evaluation cycle, showing the relation between technical, human factors, and safety potential evaluation and the different steps in the evaluation processes.

## II. ASSESSMENT FRAMEWORK

### A. Overview

The first purpose of assessment is to evaluate whether the system works as required; therefore, the entire design cycle (including system specifications) is considered rather than merely the evaluation process. The V design cycle, which is commonly used in the automotive industry, is extended by including different steps of the evaluation process. Fig. 1 shows the different parts of the framework and how they are linked to each other. The framework builds on the extensive expertise from various European research projects on telematics and vehicle safety applications during the last decade. The CONVERGE project [10], [11] developed a general methodology and guidelines for the validation of telematic applications. This methodology has been the basis for the evaluation in many research projects, including the integrated PReVENT project, in which new preventive and active safety systems have been developed. Other relevant projects include APROSYS [12], which has developed a methodology for the technical assessment of passive safety systems, AIDE [13], which has studied the evaluation of advanced driver-assistance systems (ADAS), including the human-machine interface (HMI), and eIMPACT [14], which assessed the socioeconomic effects of intelligent vehicle safety systems (IVSS) and their impact on traffic safety and efficiency. By comparing and assessing the evaluation methodologies in the different projects, a workflow that consists of six steps, which are outlined as follows, has been developed:

- 0) system and functions description, which is common for all defined assessments and is done in a consistent way to assure that all information needed to develop the

evaluation plan is available and that similar systems can be compared;

- 1) expected impacts;
- 2) test scenario definition;
- 3) evaluation method selection;
- 4) test plan;
- 5) execution and reporting.

The concept of situational control is introduced as a general concept that links technical, human factors and safety potential evaluation of preventive safety systems within a common framework. Situational control is defined as the degree of control that a joint driver-vehicle system exerts over a specific traffic situation. With this concept, the general purpose of a preventive safety system can be understood as an attempt to increase situational control. Consequently, the general goal of evaluation here becomes to assess the extent to which this goal is achieved. Situational control is based on the established term controllability by RESPONSE 3 [14], which is also associated with liability issues. However, situational control has another perspective, searching for the safety impact of the functions on traffic safety as a whole.

### B. Technical Evaluation

The technical evaluation focuses on the technical performance and reliability of the system, as well as its ability to detect imminent risks of losing situational control, i.e., its competence in detecting dangerous situation developments. Technical evaluation is performed in the following two phases: 1) verification and 2) validation.

The main purposes of verification are to assess whether all subsystems work according to the technical specifications,

which describe how well the subsystems should perform (e.g., performance of object detection and classification), and to draw conclusions about the performance with respect to the defined specifications. Verification of the subsystems provides knowledge on the limitations of the complete system and a sensitivity analysis with respect to operational conditions. If the technical specifications are not met, either the specifications should be redefined or the components should be improved such that the specifications are met. When the system is an early prototype, the results obtained by subsystems verification give a more precise knowledge of the topics to be addressed in further research.

The main purpose of validation (or functional assessment) is to assess whether the system works according to the functional specifications, which describe how the complete system should work (e.g., emergency braking in specified situations). If these goals are not met, either the specifications should be redefined or recommendations should be given to redesign the system such that the specifications are met.

The application of the framework (see Fig. 1) to technical evaluation is explained as follows.

Step 1 involves describing the expected performance, i.e., the extent to which the system can perform threat assessment under typical targeted situation conditions (weather, road type, lighting, speed, and threat type). If the system uses autonomous actuators, i.e., intervenes in the targeted situation without involving the driver in the control loop, hypotheses on the intervention performance also need to be formulated. The expected impacts of the system should be described at a sufficient level of detail to make it possible to evaluate the performance of the system. Different types of indicators are needed for the following purposes: 1) for evaluation of the threat assessment process (e.g., time to collision, time to lane crossing); 2) for assessment of the potential improvement of situational control; and 3) for system dependability [e.g., missed-alarm rate (MAR), correct-alarm rate (CAR), and false-alarm rate (FAR)]. If the system uses autonomous actuators, indicators for measuring intervention performance are also needed (e.g., the lateral acceleration applied by an active lane-keeping system).

To measure the indicators in a reliable way, reference measurements are needed, which can be of absolute or relative nature. Reference measurements should preferably be more accurate than the system under test.

In step 2, the test scenarios have to be described in a very detailed way, containing all situational descriptors that have to be varied, such as longitudinal and lateral velocities, positions and accelerations for host and target, the characteristics of the target object for detection, and the operational conditions. To have significant and coherent data statistics, the scenario must be easy to reproduce under the same conditions for more repetitions. Special attention has to be taken to dummies used to represent obstacles; they should be representative for the real targets. The relevant characteristics depend on the sensor technology used (e.g., reflection coefficient, temperature of the object, or radio signals that the object can transmit). Standardization work has been performed on the target characteristics in the case of radar and Light Detection and Ranging (LIDAR) [16], but work is also needed for the targets for detection systems based on cameras and image processing.

Evaluation methods (step 3) include simulations, hardware-in-the-loop tests, and trial tests on test tracks or in the real world. Simulations allow going through a large number of scenarios, identifying the most critical cases for subsequent tests in a hardware-in-the-loop environment. Comparison between the time needed for generating events with different methods include the following approaches: 1) software simulation (about 100 events per minute); 2) hardware-in-the-loop simulations (about 1 event per 10 min); 3) test tracks (about 1 event per 30 min); and 4) road tests (about 1 event per 100 h).

The test plan (step 4) should include the number of measurements needed for statistical relevance and the sampling methodology, as well as the parameters for the sensitivity testing plan, including degraded conditions assessment according to targeted situations. The data collection should, as much as possible, be controlled and homogeneous. The test plan should guarantee completeness, i.e., concentrating the resources on the most important aspects instead of spreading efforts with the consequence of low statistical significance. All the influence factors should be considered. No bias, except for accidental ones, should be introduced in the test plan.

### C. Human Factors Evaluation

The main goal of the human factors evaluation is to assess the extent to which the system succeeds in generating the intended behavioral responses from the driver once the risk for loss of control is detected, hence, to assess the ability of the function to affect situational control through the driver by providing information and/or warnings. A human factors evaluation potentially involves all aspects related to the driver's response to the system, including acceptance, usability, and (intended and nonintended) behavioral effects that can empirically be assessed.

**Usability** refers to how easy the system is, to be used for the intended purpose, as mainly determined by the HMI design. In the case of ADAS functions, one key issue is the extent to which the warning is comprehended and acted upon in the intended way by the driver. Usability could be conceptualized in terms of the match between the user's mental model of how a system works and the actual operation of the system [17].

**Acceptance** relates to the extent to which the driver views the system as useful and satisfactory. This approach is determined, for example, by technical performance (e.g., if warnings are not precise enough, the driver may be annoyed and lose confidence in the system) and usability (if the system is difficult to use due to bad design of the HMI, the acceptance will be affected).

A human factors evaluation study may involve both the direct assessment of behavioral situational control parameters (e.g., whether an intended change in speed occurs) and the specific assessment of acceptance and/or usability.

The application of the framework (see Fig. 1) to human factors evaluation is explained as follows.

Step 1 involves generating hypotheses on how the system can be expected to change the driver's situational control in the targeted situations. The main hypotheses to be addressed by the evaluation should clearly be stated. The hypotheses should generally be about the potential effects of the functions on

situational control or the factors that affect it, i.e., usability and acceptance. Hypotheses about the intended effects should normally follow directly from the function description. The conditions for evaluating the hypotheses should be derived; corresponding indicators and metrics for evaluating the targeted situations should be specified. The characteristics, for example, improved lane keeping, could quite generally be described. One corresponding indicator could then be, for example, the standard deviation of lateral position. Hypotheses about unintended effects are also very important to consider. However, they need to be based on existing empirical or theoretical knowledge outside the evaluation project and will generally not follow directly from the system specifications. They should be included, when necessary, based on existing research.

In step 2, the test scenarios are defined to address the general hypotheses defined in step 1. The key issue here is to define the level of specificity of the scenarios and to select the driver, vehicle, and environment parameters that are most relevant for testing the hypotheses defined in step 1. The specific test scenarios, defining the detailed evolution of events (e.g., exactly when a lead car should brake), are defined in the step that concerns the measurement plan.

In step 3, the evaluation methods to be used for addressing the stated hypotheses (step 1) in the selected test scenarios (step 2) are selected. In general, the selection of an evaluation method depends on the quality of results needed, the availability of resources, the stage of development of the system, and the effects in which the experimenter is interested, i.e., the effects defined in the hypotheses. The choice of indicators also affects the selection of methods. One simple example could be the choice between a test track and a driving simulator study. In some cases, several types of methods may be chosen.

Step 4 involves the detailed design of the studies to be performed, including the number and characteristics of subjects, and the experimental design (e.g., within/between groups), independent conditions and dependent indicators, operational definition of metrics, methods for data analysis, and general study logistics. This step also includes the detailed test scenarios (e.g., exactly when a lead car should brake).

The final step (step 5) includes the interpretation and reporting of results. This step involves the actual execution of the study, the subsequent data analysis, and the final interpretation and documentation of the results.

#### D. Safety Potential Assessment

The goal of safety potential assessment is to make an aggregate-level assessment of the preventive system's effects on relevant harm metrics (usually the number of fatalities) in targeted situations.

The behavioral effect approach, which has been developed in the eIMPACT project [14], is used to estimate the safety potential by the ADAS introduction. The rationale of this approach is to assess a number of safety impact mechanisms (see Table I), which describe how a system can create changes in situational control both inside and outside the system's targeted situations. The impact assessment is based on the assessments of technical performance and behavioral effects and makes use

TABLE I  
MECHANISMS THROUGH WHICH ADAS AFFECTS SAFETY [18]

1.	Direct in-car modification of the driving task
2.	Direct influence by roadside systems
3.	Indirect modification of user behavior
4.	Indirect modification of non-user behavior
5.	Modification of interaction between users and non-users
6.	Modification of road user exposure
7.	Modification of modal choice
8.	Modification of route choice
9.	Modification of accident consequences

of accident statistics, estimations of fleet penetration rates, and other relevant tools.

Starting from an analysis of the function description and a literature survey, a list of the impact mechanisms judged relevant for the system under evaluation is compiled. Next, the system's behavioral effects through the mechanisms are projected into relative and/or absolute changes in fatality numbers based on disaggregated and classified accident data. Apart from the results from the technical and human factors evaluation, the projection work makes use of previous research results that relate to the relationship between driver behavior and crash risk and/or consequence or desktop estimates based on expert judgments. Finally, the projected safety impact of the system is modified based on its estimated penetration at chosen key years.

### III. FUNCTION FIELDS AND EVALUATION CHALLENGES

Preventive safety systems can be classified into three function fields, which correspond to different types of interactions, with the time to risk being the major key differentiated parameter. Directly related to the time to risk is the horizon size (in time or distance). These function fields are consequently fed by technologies that show complementary information access capabilities in terms of time and distance. The three function fields described as follows are closely related to three temporal human-machine cooperation levels [19], [20], each one corresponding to a different cognitive interaction. For each function group, different evaluation challenges, tools, and methods should accordingly be prioritized.

Function field 1: Tight interactions (time to risk is less than 1 s).

The risks are immediate collisions with obstacles. The time and distance constants are very short, and hence, the technologies that can address those situations are based on perception sensors located onboard. This function field includes precrash, collision prevention, and mitigation systems, in which the cooperation between the system and the driver is very low. The main challenges for these systems, particularly for precrash and collision-mitigation systems, are the detection and classification of potential obstacles in very short time intervals.

Function field 2: Short interactions (time to risk is 1–5 s). The related time and distance constants are short and can be addressed by onboard technologies. The cooperation between driver and assistance is more intense due to the larger time available; therefore, the user interface design becomes more important. One major challenge is the design of a decision system, which selects the type of assistance

and the prioritization of warnings, particularly if different systems are integrated in the vehicle.

Function field 3: More distant interactions (time to risk is longer than 5 s). The decision time is not critical, and the implied correction operations can be assimilated to precaution more than accident prevention. A distinction is made between the following two classes of addressed risks: 1) permanent and on-road risks, which can be addressed by positioning technologies and digital maps, and 2) nonpermanent risks, which require dynamic access through the use of telecommunications and positioning technologies. The challenges here are the interface for map data and the use of telecommunication technologies for driving assistance objectives.

#### IV. APPLICATION OF THE FRAMEWORK: THE INSAFES CASE

INSAFES [9] is a second-phase PReVENT project [1], the main goals of which are to develop new integrated lateral and longitudinal control functions and to improve the functionality of applications developed within the first phase of the PReVENT project. Although these first-phase applications were generally focused on specific scenarios, supervision areas, and accident types, INSAFES was concerned with monitoring the area all around the vehicle, thus developing and/or improving a wide range of functions—from precrash and collision mitigation, all-around collision warning to safe speed, and safe distance functions. The functions developed and demonstrated in INSAFES are listed in Table II.

##### A. INSAFES Evaluation Plan

The evaluation plan of INSAFES was based on the PReVAL evaluation framework, which was adjusted to the specific needs of the project. Both a technical validation and a human factors evaluation plan were developed according to PReVAL guidelines. The first prerequisite for technical and human factors evaluation was the generation of the evaluation research hypotheses, primarily expressed in terms of intended and unintended effects in short and long terms, whenever applicable. The main scope of the overall evaluation was to provide results and conclusions on the validity of the identified hypotheses. In the context of the detailed experimental plan of INSAFES, the identified intended and unintended effects were mapped to specific application scenarios, emerging from the corresponding use cases, and their conditional variables, as well as to specific indicators, which were applicable in each case, and the evaluation methods (in terms of techniques and tools), setting, this way, the experimental basis for the evaluation and the transition from the research evaluation objectives to implementation objectives.

Note that the INSAFES technical performance assessment included only technical validation tests on the functional level and not technical verification tests, because the specifications provided by the respective suppliers were taken for granted by the INSAFES applications developers.

Technical validation tests were performed with different truck (Volvo FH12 truck) and personal car (Volvo Cars S80, FIAT Nuova Croma) demonstrators developed in the context of INSAFES through on-road tests in dedicated test tracks. MAR, CAR, and FAR were measured for each scenario and function and were afterward compared with the initial target. Other function-dedicated indicators were measured ad hoc and were further processed and analyzed.

For human factors evaluation, tests were performed for on-road trials for two demonstrators. During the tests, specific traffic scenarios were performed with and without the system. Driver performance data were collected during the evaluation of the adaptive lane-keeping support function, i.e., changes in driving behavior when using the system, compared with when driving without the system, have been studied to capture the possible effects on traffic safety. Subjective questionnaires were filled in by the subjects after the trials completion and under the guidance of the tests supervisor, aiming at capturing the following four factors:

- 1) user acceptance;
- 2) subjective assessment on the HMI;
- 3) willingness to have the system;
- 4) recommendations for further improvement of the tested functions.

Workload assessment within INSAFES has been conducted through the standardized National Aeronautics and Space Administration Task Load Index (NASA TLX) workload questionnaire, which aims at measuring workload against mental, physical, and temporal demands, performance, effort, and the level of the user's frustration in engaging with a given technology. The profiles of the users were also captured and correlated, when applicable, with the emerging results.

At the end of the evaluation, the corresponding test supervisor filled in the RESPONSE 3 checklist for each function, addressing both technical and human factor aspects. Finally, the preliminary safety impact assessment was conducted based on the PReVAL framework against the mechanisms defined therein and considered applicable for each function. An overview of the INSAFES functions evaluated, the tests performed, and the technical validation results is provided in Table II, whereas a short overview of the human factors evaluation results is provided in Section IV-C.

##### B. INSAFES Technical Evaluation Results

Table II gives an overview of the main results of the technical evaluation. In general, the results are very positive: The performance was good, particularly taking into account the prototype form of the functions. However, there is a need for further improvements. Better accuracy is needed for lateral monitoring to correctly assess the lateral distance to a target vehicle, particularly in damp and rainy weather.

##### C. INSAFES Human Factors Evaluation Results

Table III provides a summary of the test results for the usefulness and satisfaction factors (the Van der Laan scale).

TABLE II  
INSAFES TECHNICAL VALIDATION TESTS AND RESULTS GENERAL OVERVIEW

INSAFES Functions	Traffic safety functionalities	Technical evaluation	Human factors evaluation	Demonstrator
Adaptive Lane Keeping Support with lateral monitoring	Help the driver to adjust the truck in lane position with respect both to lane markers and to vehicles in adjacent lanes on both sides of the truck. The truck can actively steer to keep the desired lateral offset to vehicle(s) and lane markings.	Better lateral resolution and accuracy is needed for lateral monitoring in order to correctly assess the lateral distance to a target vehicle, especially in humid and rainy weather. Even with lanes well over 2.5m, the sensors sometimes assessed vehicles in third lane as being in the next lane. The sensor performance was better in dry weather when the protective sensor covers were removed. Targets were sometimes lost when sensor performance was degraded, but this affected the behaviour of the system only to a limited extent, since filtering of the signal and a switch off delay of the HMI indication often covered short periods of target tracking failure. However, longer periods resulted in missed alarms.	√	Volvo FH12 truck
Active Lane change warning with haptic steering wheel feedback and corrective action	Inform and warn the driver for vehicles in the side blind spots during an intended lane change. If a vehicle is present in the adjacent lane and the driver uses his/her turn indicator, a red LED in the A-pillar provides a warning (blinking followed by a solid light) and a counteracting torque is applied to the steering wheel if the driver starts turning. In case of critical collision risk, steering wheel vibrations are also applied as an additional warning.	The function proved to be very accurate and neither missed alarms nor false alarms were encountered when the target vehicle was approaching from behind in the next lane. However, when a target vehicle was approaching in third lane (> 4 m lateral distance), the same problem as in the Adaptive Lane Keeping Support function was noticed. Also in this case, better lateral accuracy is needed in order to correctly assess the lateral distance to a target vehicle and to tune the application.	√	Volvo FH12 truck
Enhancement of start-inhibit and low speed obstacle warning	The Start-Inhibit function, which was developed in the first phase PReVENT project APALACI which developed Pre-crash, Collision Mitigation and Vulnerable Road Users protection systems, was extended to a general Proximity-warning function at low speeds. The function covers both frontal blind spots. Furthermore, the start-inhibit function prevents take-off from stationary in case of risk of hitting an obstacle in the right front blind spot.	The function worked perfectly in slow driving scenarios and good weather conditions. Better accuracy and sensitivity (for pedestrians) are needed for lateral monitoring in order to correctly assess the lateral distance to a target vehicle in damp and rainy weather conditions. More sensitive sensors are needed to support the pedestrian detection.	√	Volvo FH12 truck
Curve speed warning function	Recommend a suitable speed for driving into and through an upcoming curve. The speed recommendation is given with higher intensity if a stronger deceleration is needed.	The curve speed warning worked perfectly. However, the tests were carried out using only a few curves. Since the timing of functionality is very much depending on the quality of the map information, this high level of performance may not be obtained everywhere.	√	Volvo FH12 truck
All-around monitoring (truck implementation)	Inform the driver about adjacent vehicles in front of and on both sides of the truck with the help of a presentation in a display. Alternatively, the solution with distributed LED's can be used.	The all-around monitoring function performance proved to work satisfactory in clear weather conditions and without sensor covers. As in other cases, sensor performance was significantly degraded in damp and rainy weather conditions with sensor covers mounted. The longitudinal accuracy was experienced as adequate for supporting timely warnings or indications.		Volvo FH12 truck
All systems together	-	-	√	Volvo FH12 truck
All-around monitoring (car implementation)	Inform the driver about adjacent vehicles in front of and on both sides of the car with the help of a presentation in a display. Alternatively the solution with distributed LEDs can be used.	-	√	Volvo Cars S80
Integrated Longitudinal Support	Warn about front danger for multiple reasons, the level of warning increases when approaching from far to near. Vehicles warn other cars (oncoming, following) in their vicinity of detected hazards (obstacles, reduced visibility, reduced friction).	The measured performances were good and always according to the targeted performances. All the warnings and actions were inside the expected range, measured in terms of longitudinal deceleration or Time to Collision indicators. This underlines, for the tested scenarios, the high potential of the integration of warning and active functions for integrated longitudinal support.	-	FIAT Nuova Croma
All-around collision warning	Warn about dangerous obstacles all-around the vehicle.	The All-around Collision Warning function performances were also good. These situations are associated to the test track, which was selected for the possibility to perform the test in a more precise manner. The tests also involved scenarios that would be dangerous to be performed in real traffic conditions. Moreover, it allowed the possibility to repeat tests in the same scenarios.	-	FIAT Nuova Croma
Warning Manager	Primary tasks are to minimize the reaction time and workload for the driver in a complex multi warning and information situation. This involves prioritisation and management of warnings as well as integration of warning functions.	The warning manager met in a satisfactory level the respective requirements set. In specific, the technical validation has shown that it is possible for the Warning Manager to integrate different functions. By making use of variables from two ADAS functions, the warning manager enhanced a Lane Change Warning to a Lateral Collision Warning. Future implementations should take other variables into account such as driver stress level, weather conditions and time of day.	√	Volvo Cars S80

According to the human factors evaluation performed, all functions evaluated were considered useful and satisfactory.

Users considered that the tested functions are expected to improve traffic safety mainly because of their ability to make the driver more attentive to objects in the blind spot areas. On the other hand, too many warnings may be disturbing and irritating and have the opposite result (in many cases, drivers

expressed their intention to deactivate the system if possible). In addition, overconfidence and reliance issues may arise. In general, INSAFES functions got positive rates; however, many issues, which deal mostly with integration issues (particularly on the HMI level) and improvement of the warnings themselves to avoid user dissatisfaction and desire for system deactivation, need further investigation. It is obvious that, as safety systems

TABLE III  
INSAFES HUMAN FACTORS EVALUATION RESULTS [MV: MEAN VALUE;  
StDev: MEAN STANDARD DEVIATION]

	Usefulness		Satisfaction	
	MV	StDev	MV	StDev
Adaptive Lane Keeping Support	1.06	0.46	0.56	0.64
Active Lane Change Warning	0.87	0.62	0.67	0.70
Start-inhibit	1.08	0.38	0.81	0.39
Curve speed warning	0.41	0.60	0.19	0.67
All systems together	1.01	0.53	0.96	0.82
All-around monitoring (for cars)	0.73	0.95	0.71	0.61
Warning manager – prioritisation	0.97	0.61	0.98	0.75
Warning manager – Lateral Collision Warning	1.27	0.64	0.67	0.67

much more penetrate into the market, aside from the need for technical performance that is as perfect as possible (dependent on sensors and actuators), consistency on the overall HMI level (including the warning strategies) across the various systems is a must, which implies that the need for standardization is more obvious than ever.

For example, the Warning Manager trials proved that users would welcome a system that integrates multiwarnings, as long as this system would not turn to be so irritating that it would lead to deactivation of the system. It is important to clarify, however, that the Warning Manager aims at reducing the workload of the driver only through the prioritization of warnings in multiwarning traffic situations and not through the reduction of the number of false warnings, which is an issue for the individual ADAS warning functions.

The survey around the usefulness and satisfaction over the integrated system in the truck has provided positive results and is the first indication on how users would react to an integrated system.

It should be underlined that the INSAFES tests have been conducted in a limited number of scenarios and with a limited sample of users (19 and 12 users in two different tests). The main reason for the limited amount of users was the limited resources for the tests. This limitation is also reflected in some cases, where the mean standard deviations are rather small.

#### D. INSAFES Safety Potential Assessment

In addition to technical and human factors evaluation, a safety potential assessment of the INSAFES functions was performed. The impact on fatalities for the truck applications (for 100% penetration for trucks) is 0.4%–1.7%, and for the car longitudinal support applications, the impact is 1.6%–5.2% of all fatalities (with 5.2% for the collision mitigation function).

#### E. Conclusions of the INSAFES Evaluation

The knowledge gained from the INSAFES evaluation activities allowed the identification of some critical points that were then fed back to the PReVAL team for fine tuning and improvement of the methodology. Experiences from INSAFES indicated that collaboration is needed between technical and human factors evaluation design teams. For example, technical and functional specifications, together with research hypotheses design, should be addressed in an integrated manner from an

early stage to avoid unnecessary repetitions and overlapping. Generic hypotheses have to be decomposed into subhypotheses that can reach even the technical (module and component) level, if needed, and cover the evaluation objectives in an overall way, rather than separately covering the technical validation and human factors evaluation.

In general, results that emerge from INSAFES functions have been very positive from both the technical and human factor aspects point of view. However, the need for further improvements was identified, dealing mostly with better lateral accuracy and further optimization of the warnings and the integration on HMI level. In addition, emerging results have served as the cross check of the applications conformance to the original requirements and specifications of the INSAFES functions, as well as an indication of their impact on traffic safety, whereas the identification of gaps, deficiencies, and features, which were not well accepted by the users, will allow their optimization toward more market-mature products with high potential for their optimum penetration in the near-future market.

## V. CONCLUSION

This paper has described the framework for the assessment of preventive and active safety functions, which has been developed by the PReVAL project. A workflow for different assessments (technical, human factors and safety potential) has been proposed, which is based on a modification of the V-shape design cycle and the experience gained in PReVENT and other projects. The concept of situational control, which refers to the level of control jointly exerted by the driver and the vehicle in a specific driving situation, links the different evaluations to one another and allows us to measure the effect of ADAS.

The approach has been applied to the INSAFES project, in which different subsystems developed in other PReVENT projects were integrated into a single vehicle. The knowledge gained through INSAFES evaluation activities allowed the identification of some critical points that were then offered for the PReVAL evaluation framework's fine tuning and improvement.

The major difficulty in the planning of the evaluation of a complex system is the tradeoff between the scope of the evaluation and the limited resources. It is therefore of importance to concentrate on the most important aspects instead of trying to carry too wide an evaluation. For the human factors evaluation, this condition demands for clear hypotheses prior to the evaluation. Clear hypotheses and indicators will help prioritize how we can define and set up a test; in the end, this approach will make data analysis after the trials easier.

A key for achieving significant and reliable results is the use of a scientifically calculated value of the needed sample size in user tests. Collection of data from large test groups, which represent the actual driver population, is essential to achieve results, which have a significant effect, and implies practical meaning. Handling of large test groups is resource demanding with respect to both carrying out the tests and analyzing the data afterward. This condition may hence require reducing the number of hypotheses addressed with a consequent reduction

of the amount of data recorded in the tests and again stresses the importance of focusing on the most essential issues in evaluation, prioritizing among the possible aspects of evaluation. A possible solution and balance is needed with regard to the use of the software and hardware simulation tools in technical evaluation to optimize the resources.

In addition, test conditions are challenging. To perform statistically significant technical results, the conditions should be, as much as possible, controlled and repeatable, and all possible bias should be avoided. For human factors evaluation, this condition can be challenging, because it may involve learning effects by the driver. Giving too much guidance to the driver to get repeatable results may influence the driver behavior. Testing of safety-related systems in a real environment may be difficult due to the related safety risks.

## REFERENCES

- [1] A. Vahidi and A. Eskandarian, "Research advances in intelligent collision avoidance and adaptive cruise control," *IEEE Trans. Intell. Transp. Syst.*, vol. 4, no. 3, pp. 143–153, Sep. 2003.
- [2] M. Schulze, T. Mäkinen, J. Irion, M. Flament, and T. Kessel, PREVENT final report, PREVENT project deliverable IP D15, 2008. [Online]. Available: <http://www.prevent-ip.org>
- [3] N. M. Enache, S. Mammari, M. Netto, and B. Lusetti, "Driver steering assistance for lane-departure avoidance based on hybrid automata and composite Lyapunov function," *IEEE Trans. Intell. Transp. Syst.*, vol. 11, no. 1, pp. 28–39, Mar. 2010.
- [4] S. Pietzsch, D. V. Trung, J. Burlet, O. Aycard, T. Hackbarth, N. Appenrodt, J. Dickman, and B. Radig, "Results of a precrash application based on laser scanner and short-range radars," *IEEE Trans. Intell. Transp. Syst.*, vol. 10, no. 4, pp. 584–593, Dec. 2009.
- [5] A. Broggi, P. Cerri, S. Ghidoni, P. Grisleri, and H. G. Jung, "A new approach to urban pedestrian detection for automatic braking," *IEEE Trans. Intell. Transp. Syst.*, vol. 10, no. 4, pp. 594–605, Dec. 2010.
- [6] O. M. J. Carsten and L. Nilsson, "Safety assessment of driver assistance systems," *Eur. J. Transp. Infrastructure Res.*, vol. 1, no. 3, pp. 225–243, 2001.
- [7] M. Lu, "Modeling the effects of road traffic safety measures," *Accid. Anal. Prev.*, vol. 38, no. 3, pp. 507–517, May 2006.
- [8] T. A. Dingus, S. G. Klaier, V. L. Neale, A. Petersen, S. E. Lee, J. Sudweeks, M. A. Perez, J. Hankey, D. Ramsey, S. Gupta, C. Bucher, Z. R. Doerzaph, J. Jermeland, and R. R. Knippling, "The 100-car naturalistic driving study: Phase II—Results of the 100-car field experiment, Nat. Hwy. Traffic Safety Admin., Washington, DC, Rep. DOT HS 810 593. [Online]. Available: [www.fmcsa.dot.gov](http://www.fmcsa.dot.gov)
- [9] A. Sjögren, A. Amditis, and A. Polychronopoulos, "Functional integration: Possibilities and challenges—INSAFES project," in *Proc. 13th World Congr. Exhib. Intell. Transp. Syst. Serv.*, London, U.K., Oct. 10, 2006.
- [10] D. Maltby, S. Morello, K. Perrett, and J. Hopkin, Checklist for preparing a validation plan: Updated ver., CONVERGE project deliverable D2.4.1, 1998. [Online]. Available: <ftp.cordis.europe.eu>
- [11] X. Zhang, P. Kompfner, C. White, and B. Sexton, Guidebook for assessment of transport telematics applications: Updated ver., CONVERGE project deliverable D2.3.1, 1998. [Online]. Available: <ftp.cordis.europe.eu>
- [12] A. Eggers and R. de Lange, Proposed evaluation methodology for advanced safety systems, APROSYS project deliverable 1.3.2, 2006. [Online]. Available: [www.aprosys.com](http://www.aprosys.com)
- [13] W. Janssen, E. Nodari, J. Plaza, J. Östlund, A. Keinath, A. Toffetti, M. Alonso, M. Rimini-Doering, R. Brouwer, V. Portouli, D. Horst, C. Marberger, and H. Vega, Development of AIDE evaluation methodology, AIDE project Deliverable 2.1.4, 2008. [Online]. Available: [www.aide-eu.org](http://www.aide-eu.org)
- [14] K. Malone, I. Wilmink, M. van Noort, and G. Klunder, "eIMPACT: Impact assessment of in-vehicle safety systems," in *Proc. 14th World Congr. Intell. Transp. Syst.*, Beijing, China, Oct. 9–13, 2007.
- [15] A. Knapp and J. Schwartz, Code of practice for the design and evaluation of ADAS, RESPONSE 3 project deliverable D11.2, 2006. [Online]. Available: [www.prevent-ip.org](http://www.prevent-ip.org)
- [16] Transport Information and Control Systems: Adaptive Cruise Control Systems—Performance Requirements and Test Procedures, ISO Std. 15622:2002, 2002.
- [17] D. Norman, *The Design of Everyday Things*. New York: Doubleday, 1988.
- [18] I. Wilmink, W. Janssen, E. Jonkers, K. Malone, M. van Noort, G. Klunder, P. Rämä, N. Sihvola, R. Kulmala, A. Schirokoff, G. Lind, T. Benz, H. Peters, and S. Schönebeck, Socioeconomic impact assessment of stand-alone and cooperative intelligent vehicle safety systems (IVSS) in Europe: Impact assessment of intelligent vehicle safety systems, eIMPACT project deliverable D4, 2008. [Online]. Available: [www.eimpact.eu](http://www.eimpact.eu)
- [19] J. A. Michon, "A critical view of driver behavior models: What do we know, what should we do?" in *Human Behavior and Traffic Safety*, L. Evans and R. Schwing, Eds. New York: Plenum, 1985, pp. 485–525.
- [20] J. M. Hoc, M. S. Young, and J. M. Blossville, "Cooperation between drivers and automation: Implications for safety," *Theor. Issues Ergonom. Sci.*, vol. 10, no. 2, pp. 135–160, Mar. 2009.



**Johan Scholliers** received the M.Sc. degree in electromechanical engineering and the Ph.D. degree from the Katholieke Universiteit Leuven, Leuven, Belgium, in 1986 and 1992, respectively.

He is currently a Senior Research Scientist with the Vehicle Information and Communication Technologies and Service Systems Group of VTT Technical Research Centre of Finland, Tampere, Finland. He has been a Project Coordinator of several European research projects and was the Project Leader of PREVAL. His research interests include the

evaluation of telematics applications and ICT applications for vehicle safety, mobility, and logistics.



**Somya Joshi** is a Research Scientist with the Institute of Communication and Computer Systems, Athens, Greece. She has experience working with a range of partners from academia, industry, non-governmental organizations, and international development organizations toward the common goal of facilitating inclusive development. She is the author or a coauthor of articles published in top peer-reviewed journals and a Presenter at several international conferences, both on innovative methodological practices and results from her experiments

in human-computer interaction. Her research interests include ICT for social inclusion, with emphasis on the applied context of technological innovation, particularly in relation to education, health, mobility, and governance.



**Maria Gemou** was born in Athens, Greece, in 1980. She received the B.Sc. degree in mechanical and aeronautical engineering from the University of Patras, Patras, Greece, in 2003. She is currently pursuing the Ph.D. degree with the Aristotle University of Thessaloniki, Thessaloniki, Greece.

She is a Research Associate with the Hellenic Institute of Transport, of the Centre for Research and Technology Hellas, Athens. She is the Head of the Traffic Safety Sector, Driver, and Vehicle Department. She has participated as a Technical Supervisor

in more than 12 European research projects and as a Subproject Leader in the Open Accessibility Everywhere: Groundwork, Infrastructure, Standards (AEGIS) project. She is a coauthor of three books and the author or a coauthor of 15 articles in international and European conference proceedings and three articles in scientific journals.



**Falke Hendriks** received the M.Sc. degree in biomechanical engineering and the Ph.D. degree in biomedical engineering from Eindhoven University of Technology, Eindhoven, The Netherlands, in 1999 and 2005, respectively.

Since 2005, she has been with TNO Automotive, Helmond, The Netherlands, working on vehicle dynamics, cooperative driving and development, and evaluation of precrash and advanced driver-assistant systems, including testing in the Vehicle Hardware-In-the-Loop (VeHIL) Laboratory.



**Johan Engström** received the M.Sc. degree in evolutionary and adaptive systems from Sussex University, Brighton, U.K., in 2000.

He is currently a Senior Specialist in Safety Analysis and Human–Machine Interaction with Volvo Technology Corporation, Göteborg, Sweden.



**Mikael Ljung Aust** received the M.Sc. degree in cognitive science in 2002. He is working toward the Ph.D. degree with the Vehicle and Traffic Safety Center (SAFER), Chalmers University of Technology, Göteborg, Sweden.

He is currently with Volvo Cars Safety Centre, Göteborg, as a Driver Behavior Specialist.



**Susanna Leanderson Olsson** received the M.Sc. degree in engineering physics from Chalmers University of Technology, Göteborg, Sweden, in 2003.

From 2004 to 2006, she was a System Design Engineer for restraints electronics, Volvo Car Cooperation. Since 2006, she has been a Systems Engineer for active safety with Volvo Technology Corporation, Göteborg. Her research interests include the system development of driver drowsiness monitoring systems and the development of test and evaluation methods for active safety systems.



**Juha Luoma** received the M.Sc. degree in transportation engineering and the Ph.D. degree in industrial psychology from the Helsinki University of Technology, Espoo, Finland, in 1980 and 1984, respectively.

He is currently a Research Professor of traffic safety with VTT Technical Research Centre of Finland, Tampere, Finland. Before joining VTT, he was with the Helsinki University of Technology, University of Helsinki, and the University of Michigan Transportation Research Institute,

Ann Arbor. His main research interests include human factors and safety aspects of driving. Examples of his recent research topics include evaluations of road safety measures, intelligent vehicle safety systems, vehicle lighting and signaling, pedestrian nighttime visibility, driver behavior at level crossings, and trespassing on railways.



**Ralf Kutzner** was born in Halle (Saale), Germany, on March 28, 1981. He received the M.Sc. degree in transportation engineering in 2007 from Technische Universität Dresden, Dresden, Germany, where he specialized in intelligent transportation systems.

He was a Researcher with Leibniz Universität Hannover, Hannover, Germany. He is currently with Technische Universität Braunschweig, Braunschweig, Germany, working on several projects that are mainly focused on traffic control, traffic safety, and cooperative systems.



**Fabio Tango** received the Laurea degree in physics (solid state) in 1995 and the Ph.D. degree in computer science from the University of Turin, Turin, Italy.

Since 1999, he has been with the Advanced Driver Assistance Systems Department, Centro Ricerche Fiat, Turin, Italy, working on preventive safety systems. His research interests include human–computer interaction modeling, pattern recognition and analysis, data fusion and object classification, and applications in image processing.



**Mariana Netto** received the B.Sc. degree in electronic engineering and the M.Sc. degree in automatic control from the Federal University of Rio de Janeiro, Rio de Janeiro, Brazil, in 1995 and 1997, respectively, and the Ph.D. degree in automatic control from the Université Paris Sud, Orsay, France, in 2001, including two stays in the Massachusetts Institute of Technology, Cambridge, in 1999 and 2000.

She is currently a Researcher and the Head of the control group with the Vehicle–Infrastructure–Driver

Interactions Research Laboratory, French National Institute on Civil Engineering/French National Institute on Transportation and Safety (LCPC/INRETS), Versailles, France. She is the Leader of LCPC/INRETS for the French consortium Safe trajectory shared control between driver and car-driving assistance systems (PARTAGE). Her research interests are focused on linear and nonlinear control, including the control of nonlinearly parameterized systems, full and shared lateral controls for driving-assistance systems, and intelligent transportation systems.



**Angelos J. Amditis** was born in Sydney, Australia, in 1968. He received the Diploma degree in electrical and computer engineering and the Ph.D. degree in electrical and computer engineering (telecommunications) from the National Technical University of Athens (NTUA), Athens, Greece, in 1992 and 1997, respectively.

He has been teaching various courses (e.g., communication and computer networks and communication theory) with the Department of Electrical and Computer Engineering of NTUA, of the Institute of

Communication and Computer Systems (ICCS), Athens, and of the Hellenic Naval Academy for the last years. He is currently a Senior Researcher with the ICCS. He is the author or a coauthor of several journal papers and conference proceedings and a coauthor of two books. His current research interests include human–machine interfaces, sensors for monitoring purposes, telematics, driver monitoring, virtual reality, telecommunications systems, electromagnetic compatibility/electromagnetic interference, and radars. He has participated in a large number of research projects and has been responsible for more than 20 research projects over the last five years (e.g., INTERACTIVE, HAVE-IT, PREVENT, SAFESPOT, HUMANIST, and SENSATION). He is also the Leader of the main subproject of AIDE.



**Jean-Marc Blosseville** received the Ph.D. degree in mathematics and statistics from the University of Paris VI, Paris, France.

He was the Director of several French National Institute on Transportation and Safety (INRETS) laboratories, including the Department of Analysis and Traffic Modeling from 1994 to 1998, Vehicle–Infrastructure–Driver Interactions Research Laboratory, the joint laboratory of INRETS and the French National Institute on Civil Engineering, from 1999 to 2006, and the Laboratory of Cooperative

Mobility Measurement from 2007 to 2008. He is currently the Director of INRETS, Versailles, which includes four laboratories. He is the holder of six patents. He is the author of more than 200 publications. His research interests include transport concern modeling flows, the development of traffic sensors based on image processing, and the analysis of interactions between vehicles, infrastructure, and drivers, with applications on the measurement, monitoring, and regulation of road traffic and on the assistance and automation of the driving.

Dr. Blosseville is a member of several scientific committees of French and European programs and conferences.



**Evangelos Bekiaris** was born in Athens, Greece, in 1965. He received the B.Sc. degree in mechanical engineering and the Ph.D. degree in engineering design from the National Technical University of Athens in 1988 and 1991, respectively.

He is currently the Research Director with the Hellenic Institute of Transport of the Centre for Research and Technology Hellas, Athens, and the Head of the Driver and Vehicle Department. He has been a Project Coordinator of 16 research projects and a Technical Coordinator of another eight

research projects. His research interests include road safety to specialized telematics applications for private vehicles and public transportation and even ships. He also has profound experience in technology for the integration of people with special needs, with emphasis on accessible transportation systems.



# Nested PID steering control for lane keeping in autonomous vehicles

Riccardo Marino<sup>a</sup>, Stefano Scalzi<sup>a,\*</sup>, Mariana Netto<sup>b</sup>

<sup>a</sup> University of Rome Tor Vergata, Electronic Engineering Department - DIE, Via del Politecnico 1, 00133 Roma, Italy

<sup>b</sup> LCPC/INRETS, LIVIC Vehicle-Infrastructure-Driver Interactions Research Unit, 14 Route de la minière, 78000 Versailles, France

## ARTICLE INFO

### Article history:

Received 12 November 2010

Accepted 18 August 2011

Available online 9 September 2011

### Keywords:

Vehicle dynamics

Integrated automotive control

Lane keeping

Autonomous vehicles

## ABSTRACT

In this paper a nested PID steering control in vision based autonomous vehicles is designed and experimentally tested to perform path following in the case of roads with an uncertain curvature. The control input is the steering wheel angle: it is designed on the basis of the yaw rate, measured by a gyroscope, and the lateral offset, measured by the vision system as the distance between the road centerline and a virtual point at a fixed distance from the vehicle. No lateral acceleration and no lateral speed measurements are required. A PI active front steering control based on the yaw rate tracking error is used to improve the vehicle steering dynamics. The yaw rate reference is computed by an external control loop which is designed using a PID control with a double integral action based on the lateral offset to reject the disturbances on the curvature which increase linearly with respect to time. The proposed control scheme leads to a nested architecture with two independent control loops that allows us to design standard PID controls in a multivariable context (two outputs, one input). The robustness of the controlled system is theoretically investigated with respect to speed variations and uncertain vehicle physical parameters. Several simulations are carried out on a standard big sedan CarSim vehicle model to explore the robustness with respect to unmodelled effects. The simulations show reduced lateral offset and new stable  $\mu$ -split braking manoeuvres in comparison with the model predictive steering controller implemented by CarSim. Finally the proposed control law is successfully tested by experiments using a Peugeot 307 prototype vehicle on the test track in Satory, 20 km west of Paris.

© 2011 Elsevier Ltd. All rights reserved.

## 1. Introduction

Intelligent vehicles and automated highway systems have attracted a growing attention in the last years (as can be seen from the research activity overview presented in Shladover, 2007 and the progress done in the last decade as shown in Urmson, Duggins, Jochem, Pomerleau, & Thorpe, 2008) with the aim of increasing safety and comfort: see for instance Enache, Mammar, and Netto (2008, 2009), Raharijaona, Duc, and Mammar (2004), Kang, Hindiyeh, Moon, Gerdes, and Yi (2008), Cerone, Chinu, and Regruto (2002), Cerone, Milanese, and Regruto (2009), Hatipoglu, Redmill, and Özgüner (1997), MacAdam (1981), Falcone, Borrelli, Asgari, Tseng, and Hrovat (2007), Takahashi and Asanuma (2000), Broggi, Bertozzi, Fascioli, Lo Bianco, and Piazzini (1999), Foote et al. (2006), Montemerlo et al. (2006), Ackermann, Sienel, Steinhauser, and Utkin (1995), Liu, Nagai, and Raksincharoensak (2008), Baumgarten (2004) and Pauly and Baumgarten (2005). In Enache et al. (2008, 2009) a feedback from lateral and longitudinal vehicle speeds, yaw angle error and yaw rate is used to help the driver to

steer the vehicle back to the lane during diminished driving capability due to inattention. The control strategy is based on the Lyapunov theory and LMI optimization by defining polytopic and hypercubic state space regions in which the driving task is considered safe; the main idea is to approximate these regions by standard and composite Lyapunov level curves. In Raharijaona et al. (2004) a  $H_\infty$  controller is designed to minimize the effect of the disturbances on the measured lateral offset and the desired yaw angle. In Kang et al. (2008) a steering controller, which uses finite preview optimal control methods, is proposed to control the measured lateral offset, the yaw angle and their derivatives. In Cerone et al. (2009) a closed loop control strategy which feeds back the lateral offset is proposed: an automatic lanekeeping is combined with the driver's steering with no need of switching strategies between the driver and the lane keeping control. In Cerone et al. (2002) a control system based on the loop shaping technique is tested by experiments using a feedback from the lateral offset. In Hatipoglu et al. (1997) a nonlinear observer based control strategy is investigated by measuring the lateral offset, its derivative, the yaw angle and the yaw rate. In MacAdam (1981) a model predictive steering controller is used to emulate the driver behavior in the CarSim environment: it is designed on the basis of a simplified linear model and on longitudinal and lateral speed, yaw

\* Corresponding author. Tel.: +39 06 7259 7412.

E-mail address: scalzi@ing.uniroma2.it (S. Scalzi).

angle and yaw rate measurements to predict the error with respect to a given target path. Also in [Falcone et al. \(2007\)](#) a model predictive control approach is followed: the controlled outputs are the lateral offset, the yaw rate and the yaw angle; the controller is designed both on a nonlinear and a linear vehicle model using lateral and longitudinal vehicle speeds, yaw angle and yaw rate measurements. In [Takahashi and Asanuma \(2000\)](#) a feedforward and a feedback action on the lateral offset and the yaw angle error is experimented. In [Broggi et al. \(1999\)](#) a gain scheduling based proportional feedback from the lateral offset is experimented. In [Foote et al. \(2006\)](#) a feedforward term from road curvature and a PID based on a weighted sum of the heading error and the lateral offset are used as steering controller in the DARPA Grand Challenge. In the same competition the yaw angle and a nonlinear term proportional to the lateral offset are used in [Montemerlo et al. \(2006\)](#) to design the steering controller. Furthermore, to improve safety, driver comfort and vehicle performance, several driver assistance systems are investigated in the literature. In [Liu et al. \(2008\)](#) a steering assistance control system with a feedback from the lateral offset and lateral speed is designed to follow the desired path while an assistance torque is applied in order to improve the vehicle handling and steering feel. In [Baumgarten \(2004\)](#) and [Pauly and Baumgarten \(2005\)](#) the active front steering is proposed and implemented on BMW 5 Series vehicle. In [Baumgarten \(2004\)](#) a PI active front steering control based on the yaw rate tracking error with different gains for braked and unbraked driving condition is used while in [Pauly and Baumgarten \(2005\)](#) a patented method is proposed to ensure safety during active steering system failure computing the steering wheel angle as the sum of the proposed control and the driver steering action.

Most control algorithms employed in lane keeping make use of pole placement, model predictive and observer based techniques or require the difficult measurements of lateral speed, vehicle absolute position and orientation. The simplest algorithm ([Broggi et al., 1999](#)) only implements a proportional feedback from the lateral offset. Since in addition to lateral offset measurements from vision systems the yaw rate measurements are easily obtained by an on board gyroscope, in [Ackermann et al. \(1995\)](#) the steering angle time derivative is designed as a proportional feedback from the yaw rate in addition to a PID controller from the lateral offset measurements showing the obtained performance by simulations.

In this paper a new nested PID control scheme which integrates the active steering action based on the yaw rate error with the lane keeping action based on the lateral offset is proposed and tested by experiments (a preliminary work which did not include experiments and a complete robustness analysis has been presented in [Marino, Scalzi, Netto, & Orlando, 2009](#)). No lateral speed measurement is used since it can be hardly measured and, in addition, with high cost and low accuracy and reliability. A PI active front steering control based on the yaw rate tracking error is designed to reject constant disturbances and the effect of uncertain parameters while improving the vehicle steering dynamics; in order to integrate the additional lateral offset measure the yaw rate reference is viewed as the control signal in an external control loop; it is designed using a PID control (with an additive double integral action) on the lateral offset to reject the disturbances on the curvature which are assumed to increase linearly with respect to time. Also in [Ackermann et al. \(1995\)](#) the desired yaw rate reference signal  $r_d$  is first designed: an observer is used on the basis of both the yaw rate and the lateral offset which makes use of the look ahead distance while in this paper  $r_d$  is designed on the basis of lateral displacement measurements only leading to two independent nested control loops. Hence the proposed control scheme is called nested while the controller in [Ackermann et al. \(1995\)](#) is referred to as a

cascaded control. The nested control structure with two independent control loops allows to design standard PID controls in a multivariable context (two outputs, one input). The design is inherently robust since it makes no use of system parameters (such as the look-ahead distance  $l_s$ ) which are largely uncertain. The independence of the two control loops gives high flexibility: the outer loop can be switched from vision based autonomous to human driver without changing the beneficial inner loop. The overall control for the steering wheel angle is designed on the basis of the yaw rate measured by a gyroscope and the lateral offset measured by the vision system as the distance between the road centerline and a virtual point at a fixed distance from the vehicle. Sufficient conditions for robust stability of the controlled system, with respect to speed variation, look-ahead distance and uncertainties on vehicle physical parameters such as the front and rear cornering stiffnesses and the vehicle mass are given by using the theorem presented in [Vidyasagar and Kimura \(1986\)](#) and [Paoletti, Grasselli, and Menini \(2004\)](#). It is shown how the robustness of the controlled system decreases as speed increases as expected. The asymptotic stability is however ensured for all perturbations in the range of interest. Several simulations, such as the tracking of a CarSim environment default path and a standard sudden braking action on surfaces with different adherence conditions ( $\mu$ -split braking manoeuvre), are carried out on a standard big sedan CarSim vehicle model to explore the robustness with respect to unmodelled effects, such as combined lateral and longitudinal tire forces, pitch and roll. The simulations show reduced lateral offset and new stable  $\mu$ -split braking manoeuvres with respect to the CarSim model predictive steering controller which requires lateral speed. Due to the good performances of the proposed control law, which are shown in the simulation section, a practical implementation has been successfully performed: a Peugeot 307 prototype vehicle has been used on the 3.4 km long test track located in Satory, 20 km west of Paris. The experimental setup and the track test results are described and illustrated in Section 5.

## 2. Vehicle model

A detailed standard big sedan CarSim vehicle model is used in numerical simulations to analyze the responses of both the uncontrolled and the controlled vehicle. The CarSim vehicle model uses nonlinear tire forces according to combined sideslip theory as described in [Pacejka \(2004\)](#), nonlinear spring models, and incorporates the major kinematics and compliance effects in the suspensions and steering systems including differential load transfer for each wheel. However, to design the controller, a widely used simplified single track vehicle model, shown in [Ackermann \(2002\)](#), is considered which captures the essential vehicle steering dynamics:

$$m(\dot{v}_x - rv_y) = f_{lf} \cos \delta_f - f_{sf} \sin \delta_f + f_{lr}$$

$$m(\dot{v}_y + rv_x) = f_{lf} \sin \delta_f + f_{sf} \cos \delta_f + f_{sr}$$

$$J\dot{r} = l_f(f_{lf} \sin \delta_f + f_{sf} \cos \delta_f) - l_r f_{sr} \quad (1)$$

$$f_{si}(\alpha_i) = D \sin\{C \operatorname{atan}[(1-E)B\alpha_i + E \operatorname{atan}(B\alpha_i)]\} \quad (2)$$

$$\alpha_f = \frac{v_y + l_f r}{v_x} - \delta_f, \quad \alpha_r = \frac{v_y - l_r r}{v_x} \quad (3)$$

where  $f_{si}$ , with  $i=f,r$ , are the front and rear lateral forces and  $f_{li}$ ,  $i=f,r$  are the front and rear longitudinal forces which are modelled according to the Pacejka tire model, as described in [Pacejka \(2004\)](#). The tire sideslip angle and consequently the sign of the lateral forces are computed as in (3) according to CarSim tire

**Table 1**  
Vehicle nomenclature:

$v$	vehicle velocity
$r$	vehicle yaw rate
$a_y$	lateral acceleration
$\delta_p$	driver steering angle
$m$	vehicle mass
$l_f$	front axle-CG dist.
$l_s$	look-ahead distance
$f_{l,s}$	log./lateral forces
$\alpha_{f,r}$	tire sideslip angle
$B_{f,r}$	Pacejka parameter
$D_{f,r}$	Pacejka parameter
$v_{x,y}$	long. lateral speed
$\beta$	vehicle sideslip angle
$c_a$	aerodynamic coeff.
$\delta_f$	front steering angle
$J$	vertical axle inertia
$l_r$	rear axle-CG dist.
$\mu$	adherence coefficient
$\rho$	road curvature
$c_{f,r}$	cornering stiffness
$C_{f,r}$	Pacejka parameter
$E_{f,r}$	Pacejka parameter

**Table 2**  
Vehicle parameters for the linear model (5).

$m$	2023 kg
$l_f$	1.26 m
$c_f$	2.864e+5 N/rad
$J$	6286 kg m <sup>2</sup>
$l_r$	1.90 m
$c_r$	1.948e+5 N/rad

$$a_{21} = -\frac{(c_f l_f - c_r l_r)}{J}, \quad a_{22} = -\frac{(c_f l_f^2 + c_r l_r^2)}{Jv}$$

$$b_1 = \frac{c_f}{mv}, \quad b_2 = \frac{c_f l_f}{J} \quad (6)$$

where  $c_f$  and  $c_r$  are the front and the rear tire cornering stiffness which are the linear approximation of (2) and are related to the parameters in Pacejka's formula as follows:

$$c_f = B_f C_f D_f$$

$$c_r = B_r C_r D_r \quad (7)$$

The vehicle parameters for the simplified single track vehicle model (5), whose values are identified from a big sedan CarSim vehicle model, are given in Appendix (Table 2); since a lumped vehicle model is used the tire cornering stiffnesses shown in Table 1 are two times the cornering stiffnesses of the front and the rear CarSim vehicle wheels.

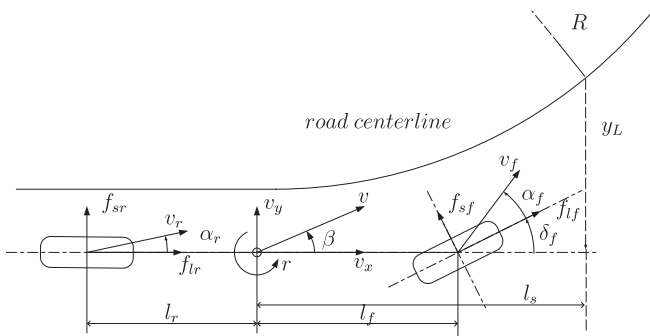

**Fig. 1.** Single track vehicle model.

model (SAE ISO standard, see Pacejka, 2004). All variables and parameters are defined in the Appendix (Table 1). The CCD camera measures the lateral deviation  $y_L$  from the centerline at a distance  $l_s$  from the vehicle; the  $y_L$  dynamics can be modeled as in Enache et al. (2009) as follows:

$$\dot{y}_L = \beta v + l_s r + v \psi \quad (4)$$

where  $\psi$  is the relative yaw angle,  $y_L$  is the lateral offset from the road centerline at a preview distance  $l_s$  (see Fig. 1) and  $\beta$  is the vehicle sideslip angle that can be computed from  $v_y = v \sin \beta$  which becomes  $v_y = v \beta$  considering small angle approximation. The system (1) is linearized about uniform rectilinear motion ( $v_x = v = \text{constant}$ ,  $r=0$ ,  $v_y=0$ ,  $\delta_f=0$ ): the longitudinal dynamics is decoupled from the lateral dynamics and can be neglected for control purposes. The reduced linear system,  $\dot{x} = Ax + Bu$ , which includes the lateral offset dynamics (4) is given by

$$\begin{bmatrix} \dot{\beta} \\ \dot{r} \\ \dot{\psi} \\ \dot{y}_L \end{bmatrix} = \begin{bmatrix} a_{11} & a_{12} & 0 & 0 \\ a_{21} & a_{22} & 0 & 0 \\ 0 & 1 & 0 & 0 \\ v & l_s & v & 0 \end{bmatrix} \begin{bmatrix} \beta \\ r \\ \psi \\ y_L \end{bmatrix} + \begin{bmatrix} b_1 \\ b_2 \\ 0 \\ 0 \end{bmatrix} \delta_f + \begin{bmatrix} 0 \\ 0 \\ -v \\ 0 \end{bmatrix} \rho \quad (5)$$

where  $\rho$  is the road curvature defined as  $\rho = 1/R$ , with  $R$  the curvature radius. The coefficients appearing in system (5), which may depend on  $v$  and on uncertain physical parameters are

$$a_{11} = -\frac{(c_f + c_r)}{mv}, \quad a_{12} = -1 - \frac{(c_f l_f - c_r l_r)}{mv^2}$$

### 3. Control strategy

#### 3.1. Control design

The proposed control strategy is illustrated in Fig. 2. It involves the design of two nested control blocks. The first one, called  $C_1$ , has to ensure the tracking of a yaw rate reference signal on the basis of the yaw rate tracking error in spite of constant disturbances and parameter uncertainties; the second one, called  $C_2$ , has to generate the yaw rate reference signal on the basis of the lateral offset in order to drive the lateral offset  $y_L$  to the desired lateral offset  $y_d$  which is equal to zero.

The task of  $C_1$  is to steer to zero the difference between the measured yaw rate  $r$  and desired yaw rate  $r_d$ .

Following the active steering approach shown in Baumgarten (2004) a PI control has been used for  $C_1$ :

$$C1 : \delta_f = -K_{p1}(r - r_d) - K_{i1} \int_0^t (r - r_d) dv = -K_{p1}(r - r_d) - K_{i1} \alpha_0 \quad (8)$$

where  $\alpha_0$  is the additional state introduced by the dynamic control (8). The feedback from the yaw rate  $r$  improves the transients by changing the eigenvalues displacement of the steering dynamics. Substituting (8) in (5) leads to the augmented vehicle state space description:

$$\dot{x}_{as} = \begin{bmatrix} a_{11} & a_{12} - K_{p1} b_1 & 0 & 0 & -b_1 K_{i1} \\ a_{21} & a_{22} - K_{p1} b_2 & 0 & 0 & -b_2 K_{i1} \\ 0 & 1 & 0 & 0 & 0 \\ v & l_s & v & 0 & 0 \\ 0 & 1 & 0 & 0 & 0 \end{bmatrix} x_{as} + \begin{bmatrix} K_{p1} b_1 \\ K_{p1} b_2 \\ 0 \\ 0 \\ -1 \end{bmatrix} r_d + \begin{bmatrix} 0 \\ 0 \\ -v \\ 0 \\ 0 \end{bmatrix} \rho \quad (9)$$

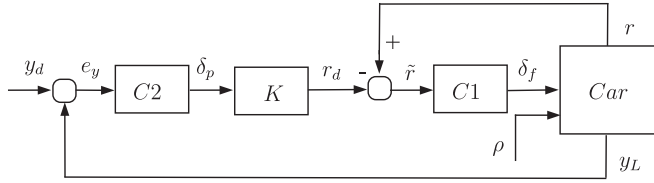

Fig. 2. Controlled system scheme.

where

$$x_{as} = [\beta \ r \ \psi \ y_L \ \alpha_0]^T.$$

Once the regulator  $C_1$  is designed, the key idea is to integrate the additional lateral offset measure considering the yaw rate reference signal  $r_d$  in (9) as the control input to be designed to drive the output  $y_L$  to zero. Therefore, to design the desired yaw rate reference, it is necessary to model the dynamics of the road curvature, considering it as a disturbance on the lateral offset. In the case of a constant road curvature one integral term is needed to reject the disturbance. Road building standards define that the clothoids are to be used to interconnect straight roads to constant curvature roads and, at constant speed, this implies that the road curvature increases linearly with respect to time:

$$\rho = \frac{1}{F^2} q \quad (10)$$

where  $F$  is a fixed scale parameter and  $q$  is the length measured along clothoid which increases linearly at constant vehicle speed. Hence the road curvature may be considered as increasing linearly with respect to time. An additional integral term is necessary to obtain zero steady state tracking error and the regulator  $C_2$  becomes

$$\begin{aligned} C_2 : \delta_p &= -K_{P2}y_L - K_{I2} \int_0^t y_L \, dv \\ &\quad - K_{I3} \int_0^t \int_0^v y_L \, d\eta \, dv - K_d y_{Ld} \\ &= -K_{P2}y_L - K_{I2}\alpha_2 - K_{I3}\alpha_1 - K_d y_{Ld} \end{aligned} \quad (11)$$

where

$$\dot{\alpha}_1 = y_L \quad (12)$$

$$\dot{\alpha}_2 = \alpha_1 \quad (13)$$

and the signal  $y_{Ld}$  is given by

$$\dot{\alpha}_3 = -\frac{1}{\tau} \alpha_3 + y_L \quad (14)$$

$$y_{Ld} = -\frac{1}{\tau^2} \alpha_3 + \frac{1}{\tau} y_L \quad (15)$$

where  $\tau$  is the filter time constant.

The final structure of the control algorithm is shown in Fig. 2 in which  $C_1$  is given by (8),  $C_2$  is given by (11)–(15) and the reference model for the linearized system is given by  $r_d = K\delta_p$  in which  $K$  is a design parameter.

### 3.2. Control properties

To choose the seven control gains and the look-ahead distance the bandwidth of the transfer function between  $r_d$  and  $\delta_f$ , of the closed loop linear system (9) and (11), is constrained to be about 10 Hz which is the actuator bandwidth in the experiments. The Simulink Response Optimization toolbox was used to tune the design parameters through numerical optimization: the design requirements are expressed in terms of rise time, settling time and overshoot on the response of the lateral deviation  $y_L$  to a unit

step reference input  $y_d$  for the nonlinear vehicle model available by CarSim. The gains are obtained from a Sequential Quadratic Programming method as described in Gill, Murray, and Wright (1981). The rise time has been chosen according to the actual industrial steering actuator (also according to the available steering actuator in the LIVIC research center). Different optimization procedures (see for example Grassi et al., 2001 in which the parameters of the controller are tuned by a convex optimization algorithm, minimizing a weighted difference between the actual loop transfer function) can be used to maximize a performance index. The resulting control parameters are

$$K_{P1} = 20, \quad K_{I1} = 10, \quad K_{P2} = 30$$

$$K_{I2} = 0.01, \quad K_{I3} = 0.01, \quad K_d = 0.05 \quad (16)$$

while  $K$  (see Fig. 2) is chosen as

$$K = \lim_{s \rightarrow 0} C[sI - A]^{-1} B \quad (17)$$

in which

$$C = [0, 1, 0, 0] \quad (18)$$

and

$$B = [b_1, b_2, 0, 0]^T \quad (19)$$

with nominal parameters.

The controlled system (9) and (11)–(15) is then

$$\dot{x}_c = A_c x_c + B_c \rho \quad (20)$$

$$A_c = \begin{bmatrix} a_{c11} & a_{c12} & 0 & a_{c14} & a_{c15} & a_{c16} & a_{c17} & a_{c18} \\ a_{c21} & a_{c22} & 0 & a_{c24} & a_{c25} & a_{c26} & a_{c27} & a_{c28} \\ 0 & 1 & 0 & 0 & 0 & 0 & 0 & 0 \\ v & l_s & v & 0 & 0 & 0 & 0 & 0 \\ 0 & 1 & 0 & a_{c54} & 0 & a_{c56} & a_{c57} & a_{c58} \\ 0 & 0 & 0 & 1 & 0 & 0 & 0 & 0 \\ 0 & 0 & 0 & 0 & 0 & 1 & 0 & 0 \\ 0 & 0 & 0 & 1 & 0 & 0 & 0 & \frac{1}{\tau} \end{bmatrix}$$

$$B_c = [0, 0, -v, 0, 0, 0, 0, 0]^T \quad (21)$$

with

$$x_c = [\beta, r, \psi, y_L, \alpha_0, \alpha_1, \alpha_2, \alpha_3]^T \quad (22)$$

and the equilibrium point  $x_{ce}$  is shown below:

$$x_{ce} = - \begin{bmatrix} \frac{(b_2 a_{12} - b_1 a_{22})v}{a_{11} b_2 - a_{21} b_1} \\ -v \\ \frac{(a_{42}(a_{11} b_2 - a_{21} b_1) + a_{41}(b_1 a_{22} - b_2 a_{12}))v}{a_{43}(a_{11} b_2 - a_{21} b_1)} \\ 0 \\ -\frac{(a_{11} a_{22} - a_{21} a_{12})v}{K_{I1}(a_{11} b_2 - a_{21} b_1)} \\ 0 \\ \frac{v}{KK_{I2}} \\ 0 \end{bmatrix} \rho, \quad (23)$$

where  $\tau$  is set equal to  $\tau = 0.01$  and  $l_s$  is chosen equal to  $l_s = 12$  m while the parameters  $a_{cij}$  are shown in Table 3. Since the look-ahead distance varies due to road hills or bumps a robustness analysis is carried out in the related Section 3.3. With the chosen gains (16) the controlled system stability is guaranteed since the poles are on the left hand side of the complex plane. In addition, the stability will be proved to be robust with respect to vehicle parameter variations in the robustness analysis section. The frequency behavior of the controlled system (20) has been analyzed. In Fig. 3 the behavior of the controlled system with respect to the road curvature  $\rho$  is shown for an increasing speed ( $v = [15, 35]$  m/s).

**Table 3**  
Substitutions.

$a_{c11} = a_{11}$	$a_{c12} = a_{12} - K_{p1} b_1$
$a_{c14} = \frac{-K_{p1} b_1 K (K_{p2} \tau + K_d)}{\tau}$	$a_{c15} = -b_1 K_{11}$
$a_{c16} = -K_{p1} b_1 K K_{13}$	$a_{c17} = -K_{p1} b_1 K K_{12}$
$a_{c18} = \frac{K_{p1} b_1 K K_d}{\tau^2}$	$a_{c21} = a_{21}$
$a_{c22} = a_{22} - K_{p1} b_2$	$a_{c24} = \frac{-K_{p1} b_2 K (K_{p2} \tau + K_d)}{\tau}$
$a_{c25} = -b_2 K_{11}$	$a_{c26} = -K_{p1} b_2 K K_{13}$
$a_{c27} = -K_{p1} b_2 K K_{12}$	$a_{c28} = \frac{K_{p1} b_2 K K_d}{\tau^2}$
$a_{c54} = K \frac{K_{p2} \tau + K_d}{\tau}$	$a_{c56} = K K_{13}$
$a_{c57} = K K_{12}$	$a_{c58} = \frac{-K K_d}{\tau^2}$

**Table 4**  
Substitutions.

$h_7 = 1251.7$	$h_6 = 7.4 \times 10^5$	$h_5 = 582 \times 10^5$	$h_4 = 3981 \times 10^5$
$h_3 = 11231 \times 10^5$	$h_2 = 7434 \times 10^5$	$h_1 = 1373 \times 10^5$	$h_0 = 1.3 \times 10^5$

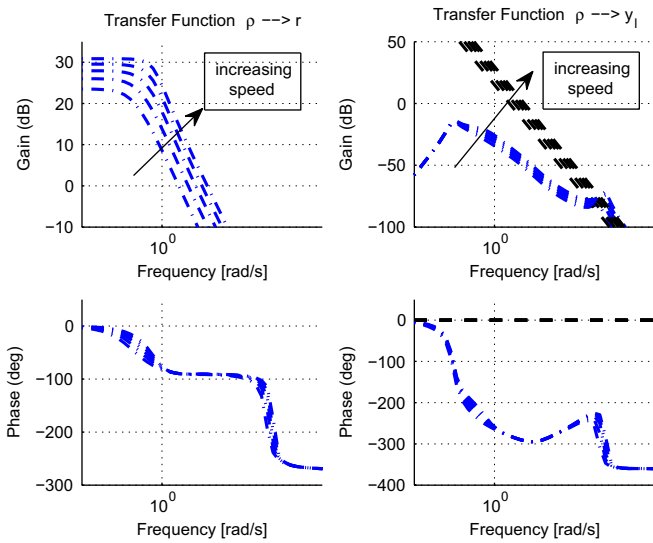

**Fig. 3.** Bode diagram of the transfer functions between  $\rho$  and  $r$  of the controlled system and Bode diagram of the transfer functions between  $\rho$  and  $y_L$  of the controlled system (dash-dot) and the uncontrolled system (dash-dash) for an increasing vehicle speed.

On the left hand side of Fig. 3 the transfer function from the road curvature to the yaw rate is shown while, on the right hand side of Fig. 3, the reduction of the road curvature effect on the lateral offset is shown with respect to the uncontrolled system. The transfer function between  $\rho$  and  $y_L$  for a speed  $v$  equal to  $v=36$  m/s is computed below to show the double zeros at the origin which ensure the rejection of disturbances that increase linearly with respect to time (the remaining zeros are negative as can be also observed on the right hand side of Fig. 3):

$$y_L = -1296 \frac{s^2(s+0.05)(s+6.69)(s+100)(s+1157)}{s^8+h_7s^7+h_6s^6+h_5s^5+h_4s^4+h_3s^3+h_2s^2+h_1s+h_0} \rho; \tag{24}$$

For completeness, the transfer functions between  $\rho$  and  $y_L$  of the uncontrolled system is reported below:

$$y_L = -\frac{v^2}{s^2} \rho \tag{25}$$

the coefficients  $h_i$  are shown in Table 4.

3.3. Robustness

Many variations may occur from the nominal vehicle parameters: the cornering stiffnesses may change due to different

road adherence conditions and/or low tire pressure, the vehicle mass and moment of inertia change from unloaded to full load conditions; moreover the look-ahead distance can also vary due to road hills or bumps. To analyze the robustness of the proposed nested lane keeping approach the transfer function from the steering angle to the lateral offset is considered by varying the uncertain parameters of interest  $c_f$ ,  $c_r$ ,  $m$  and  $l_s$  for different values of the vehicle speed  $v$ ; the considered parameters' variations also influence the inner loop and this has been taken into account in the following. The vehicle's moment of inertia variations are approximated taking into account the variations of the vehicle mass  $J = l_f l_r m$ .

The following definitions are used:  $\Sigma_0$  as the closed loop system (20) with unperturbed parameters;  $\Sigma$  as the closed loop system with perturbations on  $c_f$ ,  $c_r$ ,  $m$  and  $l_s$ ,  $\Delta_P = P - P_0$  as the perturbation, where  $P$  and  $P_0$  are the transfer functions of the perturbed and of the nominal vehicle model between the wheel angle  $\delta_f$  and the lateral offset  $y_L$  respectively;  $V_0$  as the control sensitivity function that is the transfer function between the control input  $\delta_f$  and the given reference  $y_d$ ;  $\bar{\sigma}$  as the operator that gives the greater singular value of a transfer function. The following theorem (see Paoletti et al., 2004; Vidyasagar & Kimura, 1986) can be applied.

**Theorem 1** (Paoletti et al., 2004; Vidyasagar and Kimura, 1986). If:

- ( $\alpha_0$ )  $\Sigma_0$  is well-posed and asymptotically stable,
- ( $\alpha_1$ )  $\bar{\sigma}[V_0(j\omega)] \leq 1/l_a(\omega) \forall \omega \in \mathfrak{R}^+$ ,

then  $\Sigma$  is asymptotically stable for all variations or perturbations of  $P$  from  $P_0$  such that:

- ( $\beta$ ) the number of eigenvalues of  $A$  in  $C^-$  is equal to the number of eigenvalues of  $A_0$  in  $C^-$ ,
- ( $\gamma$ )  $\Sigma$  is well-posed,
- ( $\delta$ )  $\bar{\sigma}[\Delta_P(j\omega)] < l_a(\omega), \forall \omega \in \mathfrak{R}^+$ ,

where  $l_a(\omega)$  is a positive and continuous function of  $\omega \in \mathfrak{R}^+$ .  $\square$

Given the control scheme in Fig. 2 the control sensitivity function can be computed as follows:

$$\delta_f = \frac{C_2 K C_1}{1 + C_1 P_r} e_y \tag{26}$$

$$e_y = \frac{1}{1 + C_2 K \bar{P}_{L1}} y_d \tag{27}$$

so that

$$V_0 = \frac{\delta_f}{y_d} = \frac{C_2 K C_1}{(1 + C_1 P_r)(1 + C_2 K \bar{P}_{L1})} \tag{28}$$

in which  $P_r$  is the transfer function between  $\delta_f$  and  $r$  of the system (5) under parameter variations

$$P_r = \frac{r}{\delta_f} = C(sI - A)^{-1} B \tag{29}$$

and  $\bar{P}_{L1}$ , which take into account the parameter variations also in the first internal loop, is the transfer function between  $r_d$  and  $y_L$  of the system (9)

$$\bar{P}_{L1} = \frac{y_L}{r_d} = \frac{C_1 P_y}{1 + C_1 P_r} \quad (30)$$

with

$$P_y = \frac{y_L}{\delta_f} = [0 \ 0 \ 0 \ 1](sI - A)^{-1}B. \quad (31)$$

By choosing  $l_d(\omega)$  equal to the inverse of  $\bar{\sigma}[V_0(j\omega)]$ , Theorem 1 is satisfied for different speeds and perturbations on the tire parameters such as the cornering stiffnesses  $c_r, c_f$ , the vehicle mass  $m$  and the look-ahead distance  $l_s$ . Considering a vehicle speed of  $v=20$  m/s and a perturbation of 30% with respect to the nominal parameters the hypothesis ( $\delta$ ) of the theorem is satisfied as shown in Fig. 4. By increasing the perturbation up to 40% the theorem does not ensure the asymptotic stability as shown in Fig. 5. For all the perturbations that satisfy the hypothesis ( $\delta$ ), the hypothesis ( $\gamma$ ) is satisfied since the system is well-posed: there is no direct connection between the input and the output signals of the system (5); moreover also the hypothesis ( $\beta$ ) is satisfied: the parameter variations only change the eigenvalues ( $\lambda_1, \lambda_2$ ) of the steering dynamics ( $\beta, r$ ) since the system (5) is lower triangular

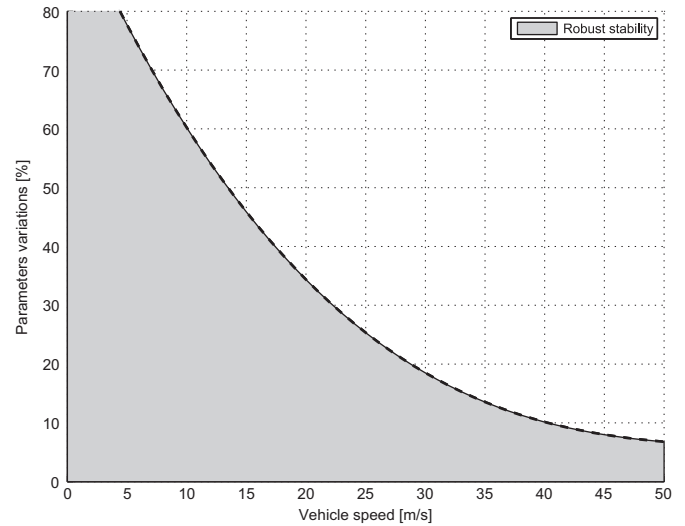

Fig. 6. Robustness with respect to parameter variations for increasing speed.

and, in addition, these changes modify  $\lambda_1, \lambda_2$  so that they always belong to the left complex plane for the perturbations range that satisfy the hypothesis ( $\delta$ ). On the Y-axis of Fig. 6 the percentage of variation of all the parameters  $c_r, c_f, m$  and  $l_s$  for which the Theorem is satisfied for different speeds is shown. The robustness decreases as the speed increases as shown in Fig. 6, in which a speed variation from 1 m/s to 50 m/s is considered; the asymptotic stability of  $\Sigma$  is guaranteed by the theorem for all the area under the curve of Fig. 6 in which the hypothesis ( $\beta$ ), ( $\gamma$ ) and ( $\delta$ ) are satisfied. However the above-mentioned theorem gives only sufficient conditions and after some simulations performed on wet road, it is reasonable to think that the effective robustness may be greater than the robustness guaranteed by the theorem. Moreover it is interesting to observe that when the theorem fails it is due to the cornering stiffness and/or the vehicle mass while the control stability is really robust with respect to the look-ahead distance. This property is important in the test track especially in the case of road bumps and in the case in which the image processing algorithms are not able to perform the path following at the chosen look-ahead distance; in this case the algorithm provides a new look-ahead distance according to Labayrade, Ieng, & Aubert (2004, 2006) while the control is robust with respect to this variations.

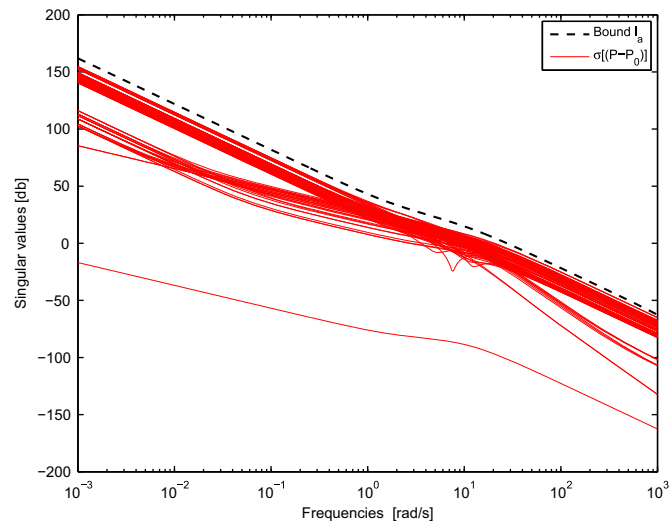

Fig. 4. Singular values analysis at a vehicle speed of  $v=20$  m/s and a perturbation of 30%.

#### 4. CarSim simulations

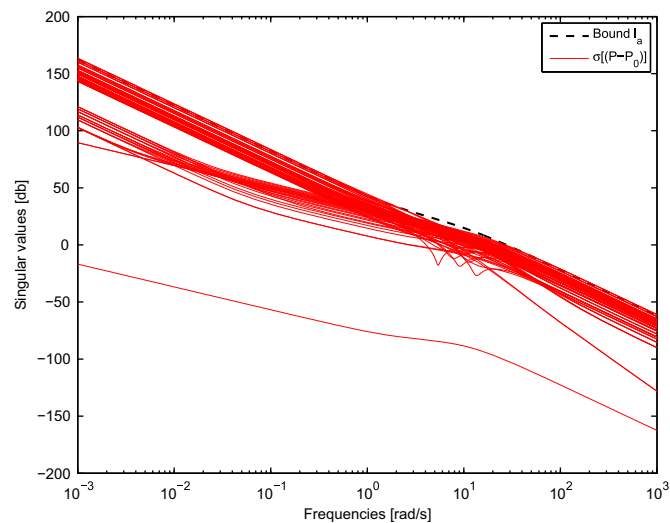

Fig. 5. Singular values analysis at a vehicle speed of  $v=20$  m/s and a perturbation of 40%.

Several simulations in the CarSim environment have been performed to compare the proposed nested PID control with the CarSim driver model (designed to emulate an average driver) which is based on a model predictive control system designed in MacAdam (1981) and makes also use of state feedback: vehicle lateral speed and yaw rate. Moreover the performed simulations with the CarSim big sedan vehicle are performed to evaluate the robustness with respect to the neglected dynamics and the performances with respect to vehicle time varying parameters since, due to the load transfer for instance, the cornering stiffness varies. The CarSim vehicle model uses detailed nonlinear tire models according to combined slip theory and takes into account the major kinematics and compliance effects of the suspensions (nonlinear spring models) and steering systems. The vehicle has a nonlinear, second order, speed depending rack and pinion ratio steering system; for the active steering a realistic actuator with a bandwidth of 10 Hz is considered. The first simulation, shown in

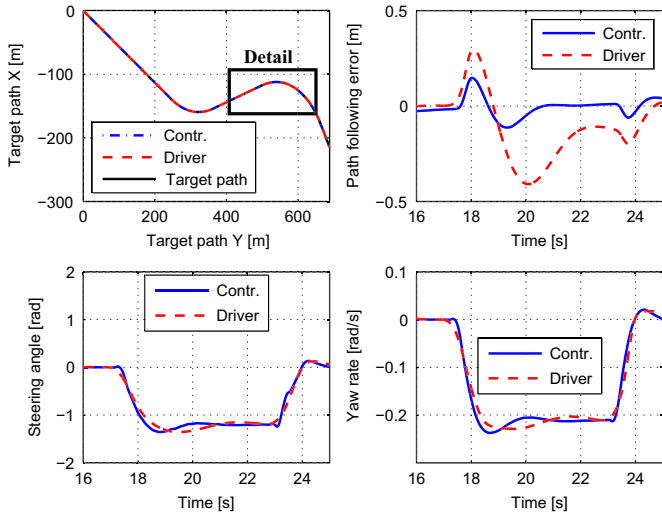

Fig. 7. Standard CarSim path following maneuver ( $v=30$  m/s).

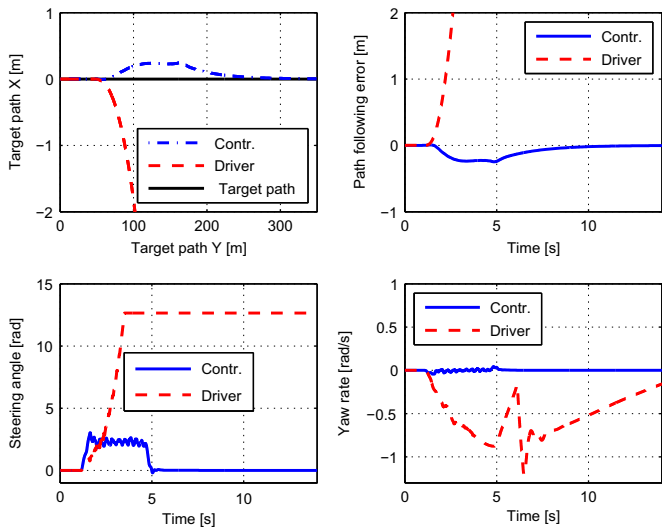

Fig. 8.  $\mu$ -split braking maneuver.

Fig. 7, concerns a path following in the case of a typical highway road curvature profile at a vehicle speed of 30 m/s. In Fig. 7 the XY-trajectory, the path following error, the steering angle and the yaw rate are shown for the vehicle controlled by the CarSim driver model and by the proposed control. To emphasize the simulation results only a detail of the path following maneuver is depicted as shown in the top-left subplot of Fig. 7: in that curve the vehicle reaches a lateral acceleration of  $7.8 \text{ m/s}^2$ . Both controllers achieve the path following; however, as shown in the top-right subplot of Fig. 7, a more accurate lane keeping and a reduced path following maximum error in the lateral direction of 70% are obtained by the proposed control law.

To analyze the performance of the proposed controlled system with respect to tire-road adherence variations a  $\mu$ -split braking maneuver is performed ( $\mu=0.1$  on the left hand side and  $\mu=0.8$  on the right hand side in the CarSim model). A sudden braking action of 15 MPa at a velocity of 40 m/s is given on both the vehicle with the MPC and the vehicle with the nested PID control strategy: the proposed control system ensures the lane keeping (top-left subplot of Fig. 8) while the vehicle controlled by the CarSim driver model leaves the lane. The CarSim steering action

saturation at the maximum allowed mechanical constraint that is equal to  $720^\circ$  (12.56 rad in Fig. 8) while small oscillations on the steering signal provided by the proposed control, due to the ABS that prevents wheel lock while ensuring greater decelerations can be observed (bottom-left subplot of Fig. 8). In this situation the proposed feedback on the yaw rate error, which has a faster dynamics with respect to the lateral offset dynamics, really improve the performance of the overall proposed control system. The manoeuvre shown in Fig. 8 has been performed with the same MPC controller, which has been used to emulate the driver in the CarSim framework, and with the proposed lane keeping controller without any change in the control parameters.

### 5. Test track and experimental setup

Experimental tests were conducted on the test track located in Satory, 20 km west of Paris, France. The track is 3.5 km long with various road profiles including a straight lane and tight bends (see Fig. 9). The experimental vehicle, a Peugeot 307, was equipped with an inertial system that makes use of MEMS-based gyroscopes and accelerometers (Crossbow IMU440) which is used to measure the yaw rate; the vehicle speed is measured by the Hall sensors mounted on the four wheels and a Trimble GPS is used to describe the position of the vehicle in the track. The steering angle has been obtained from an optical encoder. The look-ahead lateral offset is measured by means of a front view camera installed on the top-middle of the windshield; the look-ahead distance has been fixed to 12 m according to the performed analysis and the computed simulations. This camera can detect the lane markers using image processing algorithms and provides the lateral offset (see Labayrade et al., 2004, 2006). In the case in which image processing algorithms is not able to perform the path following at the chosen look-ahead distance the algorithm provides a new look-ahead distance according to Labayrade et al. (2004, 2006). The proposed control is able to achieve good results also in spite of variations on  $l_s$  as computed from the robust analysis with respect to  $l_s$  and as shown by the test track. The vehicle is equipped with a 48 V electric drive d.c. motor mounted on the steering wheel which is mechanically connected to the wheel. The controller is written in C code and runs at 10 ms, and on a PC equipped with an AMD Athlon 2.0 GHz processor. The lateral offset is available with a sampling time of 40 ms. Sensors, PC and the actuator communicate through CAN bus, Ethernet and RS232.

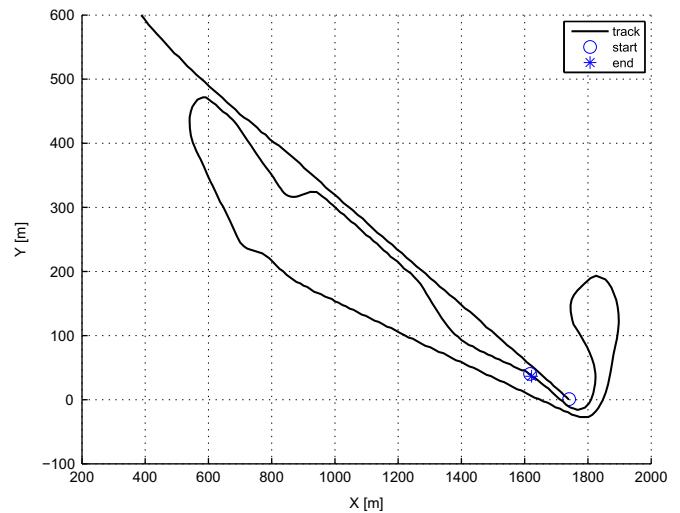

Fig. 9. Paris test track.

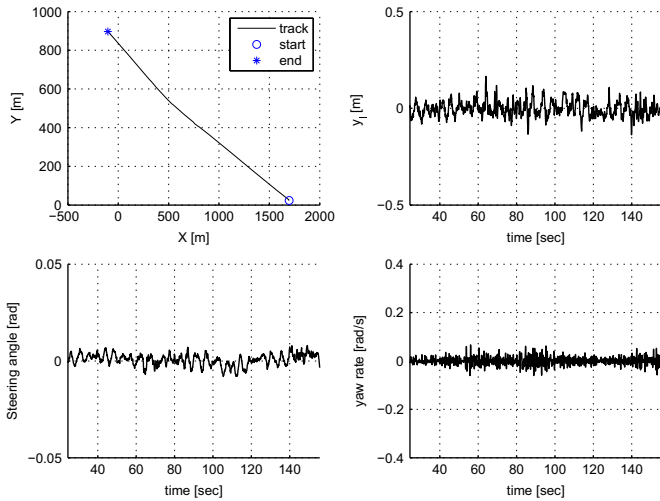

Fig. 10. Straight line following maneuver performed by the Peugeot 307 on the test track ( $v \in [20-25]$  m/s).

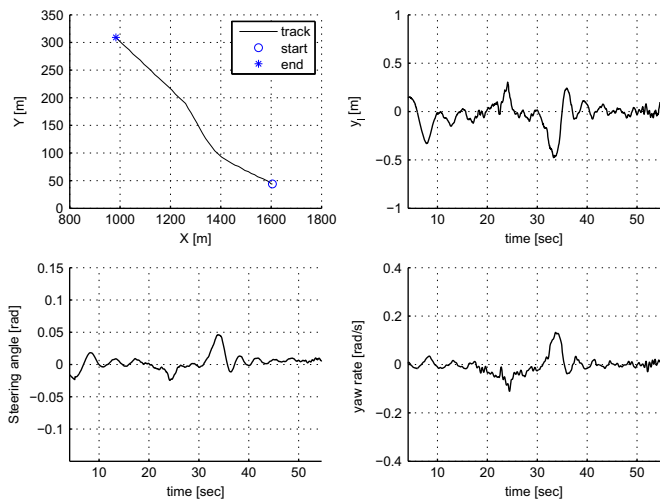

Fig. 11. Path following maneuver performed by the Peugeot 307 on the test track ( $v \in [14-16]$  m/s).

The first test is performed on the straight road. In Fig. 10 the XY-trajectory, the path following error, the steering angle and the yaw rate measured by the experimental vehicle are shown. The control, shown in the bottom-left subplot, is able to keep the lane while compensating the effects of road bank angles and very small changes in the road direction performing a very small lane keeping error as shown in the top-right subplot.

The second test is performed on the curved road shown in the top-left subplot of Fig. 11 with a maximum road curvature of about 0.01 (1/m). The control is activated at  $t=8$  s by the driver through a button while he was driving the vehicle from 0 to 8 s. The control is able to keep the vehicle within the lane performing a maximum lateral error of 0.5 m as shown in the top-right subplot of Fig. 11.

The third test is performed on a more demanding section of the test track which is shown in the top-left subplot of Fig. 12 with a maximum road curvature of about 0.015 (1/m). The control, shown in the bottom-left subplot, is deactivated at  $t=174$  s by the driver since not all the test track is equipped for lane keeping. The control is able to keep the vehicle within the lane performing a maximum lateral error of 0.6 m as shown in the top-right subplot of Fig. 12.

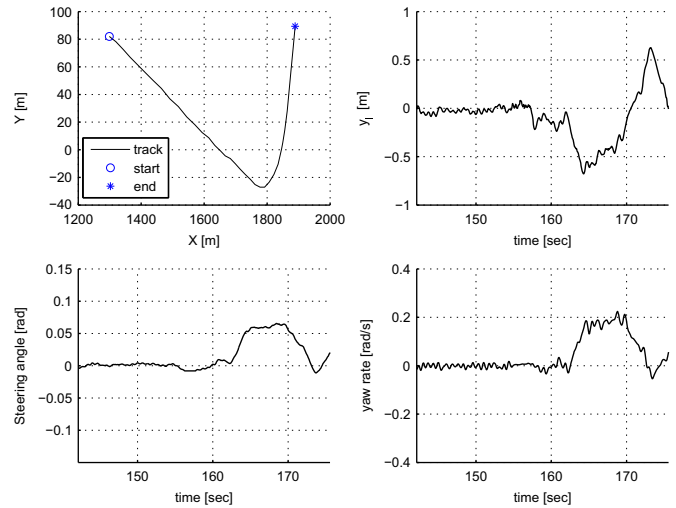

Fig. 12. Demanding path following maneuver performed by the Peugeot 307 on the test track ( $v \in [15-16.5]$  m/s).

## 6. Conclusions

A vision based lane keeping control for autonomous vehicles has been proposed, simulated and experimentally tested providing both lane keeping and yaw rate stabilization at the same time on the basis of yaw rate and lateral offset measurements only. As a first step, on the basis of lateral displacements at a look-ahead distance provided by a vision system, a reference yaw rate signal is designed using PID control techniques with a double integral action. As a second step the steering angle is designed as a PI control based on the yaw rate tracking error following well established active steering design. A multivariable control problem (two outputs, one input) has been solved via two independent PID nested loops. The robustness of the proposed control with respect to speed variations, look-ahead distance and parameter uncertainties such as mass, front and rear cornering stiffnesses has been theoretically analyzed. Simulations in the CarSim environment illustrate the performance achieved by the proposed lane keeping control strategy both on a standard path and during a  $\mu$ -split braking maneuver. The proposed controller is compared by simulation with the MPC used in CarSim as steering control which also requires the vehicle lateral speed and orientation: a reduced lateral offset and new stable  $\mu$ -split braking manoeuvres are obtained by the proposed controller. The experimental test, performed by a Peugeot 307 prototype vehicle on the test track in Satory, 20 km west of Paris, successfully validates the controller; tests are performed both for straight lines and curves and show good performance. Future work will explore the interactions of the proposed controller with the driver both during normal driving and in emergency conditions.

## Acknowledgments

The authors would like to thank the experimental group in LIVIC (Vehicle-Infrastructure-Driver Interactions Research Unit) for their help and support in making the in-vehicle implementation possible.

## References

- Ackermann, J. (2002). *Robust control*. London: Springer.
- Ackermann, J., Sienel, J., Steinhauser, R., & Utkin, V. I. (1995). Linear and nonlinear controller design for robust automatic steering. *IEEE Transactions on Control Systems Technology*, 3(1), 132–143.

- Baumgarten, G. (2004). *Motor vehicle steering system having a yaw rate controller*, Bayerische Motoren Werke, United States Patent Pub. No. US 20040070268, April 15/2004.
- Broggi, A., Bertozzi, M., Fascioli, A., Lo Bianco, C. G., & Piazzi, A. (1999). The ARGO autonomous vehicle's vision and control systems. *International Journal of Intelligent Control and Systems*, 3(4), 409–441.
- Cerone, V., Chinu, A., & Regruto, D. (2002). Experimental results in vision-based lane keeping for highway vehicles. In *Proceedings of the American control conference*, Anchorage, AK, May 8–10.
- Cerone, V., Milanese, M., & Regruto, D. (2009). Combined automatic lane keeping and driver's steering through a 2-dof control strategy. *IEEE Transactions on Control Systems Technology*, 17(1), 135–142.
- Enache, N. M., Mammar, S., & Netto, M. (2008). Driver steering assistance for lane departure avoidance based on hybrid automata and on composite lyapunov function. *IEEE Transactions on Intelligent Transportation Systems*, 11(1).
- Enache, N. M., Netto, M., Mammar, S., & Lusetti, B. (2009). Driver steering assistance for lane departure avoidance. *Control Engineering Practice*, 17(6), 642–651.
- Falcone, P., Borrelli, F., Asgari, J., Tseng, H. E., & Hrovat, D. (2007). Predictive active steering control for autonomous vehicle systems. *IEEE Transactions on Control Systems Technology*, 15(3), 566–580.
- Foote, T. B., Cremean, L. B., Gillula, J. H., Hines, G. H., Kogan, D., & Kriechbaum, K. L., et al. (2006). Alice: An information-rich autonomous vehicle for high-speed desert navigation. *Journal of Field Robotics*, 23(9), 777–810.
- Gill, P. E., Murray, W., & Wright, M. H. (1981). *Practical optimization*. London, UK: Academic Press.
- Grassi, E., Tsakalis, K. S., Dash, S., Gaikwad, S. V., MacArthur, W., & Stein, G. (2001). Integrated system identification and PID controller tuning by frequency loop-shaping. *IEEE Transactions on Control Systems Technology*, 9(2), 285–294.
- Hatipoglu, C., Redmill, K., & Özgüner, Ü. (1997). Steering and lane change: A working system. In *IEEE conference on intelligent transportation systems* (pp. 272–277), Boston, MA.
- Kang, J., Hindiyeh, R. Y., Moon, S., Gerdes, J. C., & Yi, K. (2008). Design and testing of a controller for autonomous vehicle path tracking using GPS/INS sensors. In *Proceedings of the 17th IFAC World congress*, Seoul, Korea, July 6–11.
- Labayrade, R., Douret, J., Laneuric, J., & Chapuis, R. (2006). A reliable and robust lane detection system based on the parallel use of three algorithms for driving safety assistance. *IEICE Transactions on Information and Systems*, E89-D(7), 2092–2100.
- Labayrade, R., Ieng, S. S., & Aubert, D. (2004). A reliable road lane detector approach combining two vision-based algorithms. In *IEEE intelligent transportation systems conference*, Washington, DC, USA, October 3–6.
- Liu, L., Nagai, M., & Raksincharoensak, P. (2008). On torque control of vehicle handling and steering feel for avoidance maneuver with electric power steering. In *Proceedings of the 17th IFAC World congress*, Seoul, Korea, July 6–11.
- MacAdam, C. C. (1981). Application of an optimal preview control for simulation of closed-loop automobile driving. *IEEE Transactions on Systems, Man, and Cybernetics*, 11, 393–399.
- Marino, R., Scalzi, S., Netto, M., & Orlando, G. (2009). A nested PID steering control for lane keeping in vision based autonomous vehicles. In *American control conference*, St. Louis, Missouri, USA, June 10–12.
- Montemerlo, M., Thrun, S., Dahlkamp, H., Stavens, D., Aron, A., Diebel, J., et al. (2006). Stanley: The robot that won the DARPA grand challenge. *Journal of Field Robotics*, 23(9), 661–692.
- Pacejka, H. B. (2004). *Tire and vehicle dynamics*. Elsevier, Butterworth Heinemann.
- Paoletti, S., Grasselli, O. M., & Menini, L. (2004). A comparison between classical robust stability conditions. *International Journal Robust and Nonlinear Control*, 14, 249–271.
- Pauly, A., & Baumgarten, G. (2005). *Overlay steering system and method for motor vehicles*, Bayerische Motoren Werke, United States Patent Pub. No. US 6854558, February 15/2005.
- Raharijaona, T., Duc, G., & Mammar, S. (2004).  $H_\infty$  controller synthesis and analysis with application to lateral driving assistance. In *IFAC symposium on advance in automotive control*, Salerno, Italy, April.
- Shladover, S. E. (2007). PATH at 20—history and major milestones. *IEEE Transactions on Intelligent Transportation Systems*, 8(4).
- Takahashi, A., & Asanuma, N. (2000). Introduction of HONDA ASV-2 (advanced safety vehicle-phase 2). In *Proceedings of the IEEE intelligent vehicles symposium*, Dearborn, MI, USA, October 3–5.
- Urmson, C., Duggins, D., Jochem, T., Pomerleau, D., & Thorpe, C. (2008). From automated highways to urban challenges. In *Proceedings of the 2008 IEEE international conference on vehicular electronics and safety*, Columbus, OH, USA, September 22–24, 2008.
- Vidyasagar, M., & Kimura, H. (1986). Robust controllers for uncertain linear multivariable systems. *Automatica*, 22(1), 85–94.

# Closed-loop wheel-acceleration control based on an extended braking stiffness observer\*

Trọng Biên Hoàng<sup>1</sup>, William Pasillas-Lépine<sup>1</sup>, and Mariana Netto<sup>2</sup>

**Abstract**—In the context of hybrid anti-lock brake systems (ABS), we provide a closed-loop wheel-acceleration controller based on the observation of the extended braking stiffness (XBS). Its objective is to improve the system’s robustness with respect to changes in the environment (as changes in road conditions, brake properties, etc.). In our design, we take advantage of Burckhardt’s tyre model, in order to obtain a wheel acceleration dynamics that is linear up to time-scaling. The XBS is one of the state variables of this model. Our main result is an observer that estimates this unmeasured variable. The observer’s convergence analysis is established using tools for switched linear systems that allow us to ensure its uniform exponential stability (provided that a dwell-time condition is satisfied). Our simulation results confirm the convergence properties predicted by our main theorem.

## I. INTRODUCTION

The Anti-lock Brake System (ABS) is now mandatory on modern cars, in order to prevent the vehicle’s wheels from locking up and thus limit the risk of skidding. Drivers can still control the car while braking, even in the case of an emergency braking. Most commercial ABS systems use a regulation logic based on wheel deceleration thresholds (see [1] and [8]). Nevertheless, one cannot find in the literature a detailed description of the commercial ABS algorithms implemented on production vehicles. Recently, a simple five-phase hybrid ABS strategy was proposed in [13] to investigate the basic phase-plane behavior of ABS. However, it fails to cycle and remains blocked in an arbitrary phase when there are significant changes in the environment (as changes in road conditions, brake properties, etc.). The aim of our paper is to propose a modified version of this five-phase hybrid ABS strategy in which a closed-loop wheel-acceleration control (based on an extended braking stiffness observer) is used, in order to make it more robust to any change in road conditions.

The problem of closed-loop wheel acceleration control has been studied in [3], [4], [14], and [16]. These methods are, however, confronted to two critical points. Either they require specific sensors that are not normally used on commercial cars (in order to measure the longitudinal tyre force) or they

assume that the extended braking stiffness (i.e, the derivative of the tyre characteristic with respect to the wheel slip, which cannot be measured) is known precisely.

In the literature, one can find several interesting methods to estimate the extended braking stiffness ([11], [17], and [18]). In [11], the extended braking stiffness is estimated by applying the on-line least squares method to wheel rotational velocity. The main drawback of this method is that it assumes that the XBS is constant. Another method has been proposed in [17], but it requires a measurement of the wheel slip, which is difficult to measure. The method proposed in [18] is a combination of elementary diagnostic tools and new algebraic techniques for filtering and estimating derivative of noisy signals. The main difficulty of this method is to obtain numeric derivative estimators such that a good trade-off between filtering and reactivity is achieved.

In our approach, we present a new nonlinear wheel acceleration dynamics for which the extended braking stiffness enters as one of the state variables. Then, a new control law is proposed to stabilize the system and ensure that the wheel acceleration follows the reference trajectory, in both the transition and steady-state regimes. In particular, the extended braking stiffness  $\mu'(\lambda)$  that is used in our control law is estimated by a simple stable observer. The observer’s stability is established thanks to standard tools for switched linear systems.

Compared to previous works, we believe that the interest of our method comes both from its simplicity in the estimation of the extended braking stiffness and its robustness with respect to environment changes. Although we only estimate the value of one of the three parameters that appear in the tyre characteristic model of Burckhardt, the observer still gives an accurate estimation of the extended braking stiffness when there are changes on road conditions.

This paper is organized as follows. In Section 2, we describe the system modelling. The main results including the design and the stability analysis of wheel acceleration control law coupled to a stable observer are presented in Sections 3 and 4. Then, simulation results are shown in Section 5. Finally, Section 6 contains concluding remarks and our perspectives for future research.

## II. SYSTEM MODELLING

The basic dynamics of the wheel, which will be central to our study, can be analyzed with a single-wheel model. The reason we use this very simple model is that all the basic phenomena related to ABS appear in it.

\* The research leading to these results has received funding from the European Union Seventh Framework Programme [FP7/2007-2013] under grant agreement no 257462 HYCON2 Network of excellence. It has also been supported by the Region Ile-de-France through the Regeneo project (RTRA Digiteo and DIM LSC).

<sup>1</sup>T. B. Hoàng is with LSS-Université Paris Sud-Supélec, 3, rue Joliot-Curie, 91192 Gif-sur-Yvette, France.

<sup>1</sup>W. Pasillas-Lépine is with CNRS-LSS-Supélec, 3, rue Joliot-Curie, 91192 Gif-sur-Yvette, France. pasillas@lss.supelec.fr.

<sup>2</sup>M. Netto is with LIVIC-IFSTTAR, 58, boulevard Lefebvre, F-75732 Paris, France.

### A. Wheel slip and wheel acceleration dynamics

The angular velocity  $\omega$  of the wheel has the following dynamics:

$$I \frac{d\omega}{dt} = -R F_x + T_w, \quad (1)$$

where  $I$  denotes the inertia of the wheel,  $R$  its radius,  $F_x$  the longitudinal tyre force, and  $T_w$  the torque applied to the wheel. The torque  $T_w = T_e - T_b$  is composed of the engine torque  $T_e$  and the brake torque  $T_b$ . We assume that during ABS braking the clutch is open and thus neglect the engine torque. In other words,  $T_b = \gamma_b P_b$ , where  $P_b > 0$  denotes the brake pressure and  $\gamma_b > 0$  the brake efficiency.

The longitudinal tyre force  $F_x$  is often modelled by the relation

$$F_x = \mu(\lambda) F_z, \quad (2)$$

where  $F_z$  denotes the vertical load,  $\lambda = \frac{R\omega - v_x}{v_x}$  the wheel slip,  $v_x$  the longitudinal speed of the vehicle. We assume that  $v_x > 0$ . In a braking manoeuvre, we have  $\lambda < 0$  and  $F_x < 0$ . The tyre characteristic  $\mu(\lambda)$  will be discussed in more detail in the next subsection.

### B. Tyre characteristic

In the literature, one can find several mathematical formulas that have been used to describe the tyre characteristic such as trigonometric functions in [12], second order rational fractions in [8] and [13], and exponentials in [2]. In this paper, we will use Burckhardt's model

$$\mu(\lambda) = c_1(1 - e^{-c_2\lambda}) - c_3\lambda, \quad (3)$$

where the coefficients  $c_i$  are constants depending on road conditions, tyre characteristics, tyre pressure, etc. Therefore, for the sake of robustness, the ABS algorithms should be able to handle the uncertainty associated with these coefficients.

### C. Simplified wheel acceleration dynamics

We define the state variables

$$x_1 = \lambda \quad \text{and} \quad x_2 = R \frac{d\omega}{dt} - a_x(t), \quad (4)$$

where  $a_x(t) = \frac{dv_x}{dt}$  is the longitudinal acceleration. The state  $x_1$  is the wheel slip. The state  $x_2$  is the wheel acceleration offset. That is, the difference between the acceleration of the wheel and that of the vehicle. These variables evolve with the following dynamics

$$\begin{aligned} \frac{dx_1}{dt} &= \frac{1}{v_x(t)} (-a_x(t)x_1 + x_2) \\ \frac{dx_2}{dt} &= -\frac{a\mu'(x_1)}{v_x(t)} (-a_x(t)x_1 + x_2) + \frac{R}{I} \frac{dT_w}{dt} - \frac{da_x(t)}{dt}, \end{aligned} \quad (5)$$

where  $a = \frac{R^2}{I} F_z$ . The extended braking stiffness  $\mu'(\cdot)$  is the derivative of the tyre characteristic  $\mu(\cdot)$  with respect to  $\lambda$ .

In order to simplify the control design and the observer analysis, we assume that  $(-a_x x_1 + x_2) \simeq x_2$ . This approximation is exact only at constant speed but, in the case of an ABS braking, its error remains small. The validity of this approximation has been checked a posteriori, by

simulation the control law and the observer on the original (non-simplified) model. Our approximation leads to a simpler dynamics

$$\begin{aligned} \frac{dx_1}{dt} &= \frac{1}{v_x(t)} x_2 \\ \frac{dx_2}{dt} &= -\frac{a}{v_x(t)} \mu'(x_1) x_2 - \frac{R\gamma_b}{I} u, \end{aligned} \quad (6)$$

where  $u = \frac{dP_b(t)}{dt}$ .

The control objective is to make the wheel acceleration offset  $x_2(t)$  follow a reference trajectory that will be defined in Section III. In order to fulfill this objective, we need to estimate the value of the extended braking stiffness, which cannot be measured. To that end, we take advantage of Burckhardt's model. Indeed, a simple mathematical formula for the extended braking stiffness can be obtained by differentiating this model with respect to  $\lambda$ . From this formula and from the second derivative of Burckhardt's model, we establish a differential equation that describes the evolution of these variables. In this paper, we consider the extended braking stiffness and the parameter  $c_3$  of Burckhardt's model as the states of the wheel acceleration dynamics. This can be seen as a generalization of the model proposed in [11]. Indeed, if we define the state variables

$$\begin{aligned} z_1 &= x_2 \\ z_2 &= \mu'(x_1) = c_1 c_2 e^{-c_2 x_1} - c_3 \\ z_3 &= -c_2 c_3, \end{aligned} \quad (7)$$

we obtain the dynamics of angular wheel acceleration

$$\begin{aligned} \frac{dz_1}{dt} &= \frac{-a}{v_x(t)} z_1 z_2 + b u \\ \frac{dz_2}{dt} &= (c z_2 + z_3) \frac{z_1}{v_x(t)} \\ \frac{dz_3}{dt} &= 0, \end{aligned} \quad (8)$$

where  $b = \frac{-R\gamma_b}{I}$  and  $c = -c_2$  are two constants.

## III. CONTROL DESIGN

### A. The five-phase hybrid ABS strategy

A five-phase hybrid algorithm that uses the wheel acceleration logic-based switching of (5) is described in Figure 1. All parameters  $u_i$  and  $\epsilon_i$  are positive. The choice of thresholds  $\epsilon_i$  is presented in [13]. The parameters  $u_i$  are taken from the maximum brake pressure derivatives allowed by the brake actuator. More details on choosing  $u_i$  can be found in [5]. Each of the five phases of the algorithm defines the control action  $u = dP_b/dt$  that should be applied to the brake. The control is either kept constant or changed very quickly. The switch between these phases will be triggered by given thresholds  $\epsilon_i$ , based on the value of the wheel acceleration offset  $x_2$ . The purpose of the algorithm is to keep the wheel slip in a small neighborhood of the optimal value  $\lambda_{opt}$ , where the longitudinal tyre force is maximal, with the aim of minimizing the braking distances while keeping steerability at a reasonable level, without using explicitly the value of

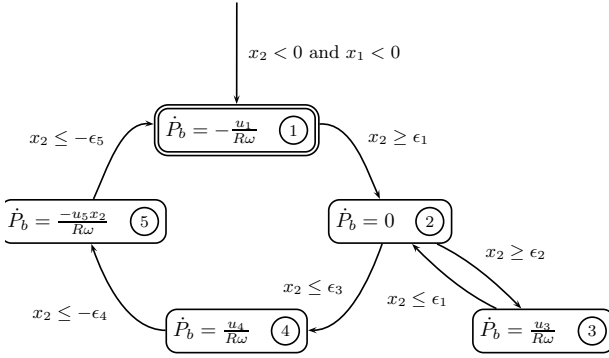

Fig. 1. The academic five-phase hybrid ABS strategy proposed in [13].

the optimal setpoint. We refer the reader to [13] for more details of the five-phase hybrid ABS algorithm.

### B. The modified five-phase hybrid ABS strategy

The academic five-phase hybrid ABS has been validated in the tyre-in-loop experimental facility of Delft University of Technology (see [5]). However, it fails to cycle and remains blocked in an arbitrary phase when there are significant changes in the environment (as changes in road conditions, brake properties, etc.). In this subsection, we present a modified five-phase hybrid ABS strategy in which we control (during phases 1, 3, and 4) the wheel acceleration in closed loop (based on an extended braking stiffness observer). The control action during phases 2 and 5 is left untouched. Thanks to the new control law, we do not need to tune the open-loop parameters of the phases 1, 3, and 4.

In the following, we will clarify the choice of the pre-computed trajectory  $z_1^*(t) = r_m(s)$ , with  $m = \{1, 3, 4\}$ , during phases 1, 3, 4. The time  $s := t - t_0$ , where  $t_0$  is the instant at which a given phase begins. We define  $T$  as the time needed by the reference trajectory  $r_m$  to go from the actual threshold to the next threshold. Ideally, we want  $T$  to be as small as possible. However, the reference trajectory  $r_m$  must remain within the physical limitations of the brake actuator. Furthermore, the sensitivity to actuator delays is proportional to the rate of change of  $z_1$  at the end of each phase. Therefore, it is natural to reduce  $dr_m/ds$  to zero when  $r_m$  approaches  $\epsilon_i$ , in order to minimize this sensitivity [5].

A possible choice for a reference trajectory  $r_m$  that goes from  $\epsilon_i$  to  $\epsilon_j$  is

$$r_m(s) = a_0 + a_1s + a_2s^2 + a_3s^3. \quad (9)$$

The coefficients  $a_k$ , with  $k = 1 \dots 4$ , are calculated as

$$\begin{aligned} a_0 &= \epsilon_i, & a_2 &= \frac{-3(\epsilon_i - \epsilon_j)}{T^2}, \\ a_1 &= 0, & \text{and } a_3 &= \frac{2(\epsilon_i - \epsilon_j)}{T^3}. \end{aligned} \quad (10)$$

Notice that there exists a lower bound on the achievable  $T$ 's. Indeed, the brake pressure rate is limited due to the hydraulic

line and the servo-valve. We define  $\dot{P}_b^M$  as the maximum brake pressure derivative that the actuator can deliver. For the reference trajectory  $r_m$ , we must therefore have  $|\dot{P}| \leq \dot{P}_b^M$ , which implies  $T \geq \frac{3}{2b} \frac{|\epsilon_i - \epsilon_j|}{\dot{P}_b^M}$ .

We define the tracking error

$$e = z_1 - z_1^*, \quad (11)$$

and the control law

$$u(t) = \frac{1}{b} \left( \frac{a}{v_x} z_1 \hat{z}_2 + \frac{dz_1^*}{dt} - \alpha e \right), \quad (12)$$

where  $\alpha > 0$  is the control gain, and  $\hat{z}_2$  is the estimation of the extended braking stiffness  $z_2$ . In the absence of estimation error, i.e.  $z_2 = \hat{z}_2$ , we have the following error dynamics of the wheel acceleration

$$\frac{de}{dt} = -\alpha e. \quad (13)$$

The controlled error system is thus exponentially stable if the control gain  $\alpha$  is taken big enough. Observe, however, that the gain  $\alpha$  is limited by the delay margin of the system [7]. Nevertheless, one might be surprised by the fact that we only control the variable  $x_2$ . Actually, the stability of the other variables comes from the fact that they are bounded functions of  $x_1$ , and that  $x_1$  can be controlled quite easily by either a continuous [14] or a hybrid control [13] law, provided that the wheel acceleration offset  $x_2$  follows an appropriate reference.

## IV. OBSERVER DESIGN

The control law (12) is only implementable when all state variables of (8) are available. But, in practice, we can only measure the wheel acceleration offset  $z_1$ . Indeed, a method for measuring  $z_1$  is proposed in the Appendix 1 of [5]. It uses a linear regression on the raw encoder pulsed signal in order to fit a parabola to the time/displacement measurements. The wheel acceleration is computed by the second derivative of this parabola. Unfortunately, the obtained wheel acceleration is corrupted by oscillations. But this problem can be solved using the dynamic notch filter proposed in [7].

Since, unlike  $z_1$ , the extended braking stiffness  $z_2$  is not directly measurable, it must be estimated using an observer. We propose the following one

$$\begin{aligned} \frac{d\hat{z}_1}{dt} &= \frac{-a}{v_x} z_1 \hat{z}_2 + bu + \frac{K_1(z_1)}{v_x} z_1 (z_1 - \hat{z}_1) \\ \frac{d\hat{z}_2}{dt} &= (c\hat{z}_2 + \hat{z}_3) \frac{z_1}{v_x} + \frac{K_2(z_1)}{v_x} z_1 (z_1 - \hat{z}_1) \\ \frac{d\hat{z}_3}{dt} &= \frac{K_3(z_1)}{v_x} z_1 (z_1 - \hat{z}_1), \end{aligned} \quad (14)$$

where  $\hat{z}_i$  are the observer states.

In (14), the observer gains  $K_i(z_1)$ , with  $i = \{1, 2, 3\}$ , have to be chosen depending on the value of  $z_1$  in order to ensure the observer's stability, independently of the sign of  $z_1$ . We will thus define

$$K_i(z_1) = \begin{cases} K_i^+ & \text{if } z_1 > 0 \\ K_i^- & \text{if } z_1 < 0. \end{cases} \quad (15)$$

We introduce the observer errors

$$e_{obs_i} := z_i - \widehat{z}_i, \quad (16)$$

where  $i = 1, 2, 3$ .

By subtracting equation (14) from equation (8), we obtain the observer error dynamics

$$\frac{de_{obs}}{dt} = \frac{z_1}{v_x} \begin{pmatrix} -K_1(z_1) & -a & 0 \\ -K_2(z_1) & c & 1 \\ -K_3(z_1) & 0 & 0 \end{pmatrix} e_{obs}. \quad (17)$$

#### A. A New Time-scale

Observe that if the right hand side of (17) is divided by  $z_1/v_x$  then the observer error dynamics is transformed into a linear system. This leads to the idea of changing the time-scaling. Indeed, let

$$s(t) := \int_0^t \frac{|z_1(\tau)|}{v_x(\tau)} d\tau, \quad (18)$$

which ensures that  $dt/ds > 0$ , independently of the values of  $z_1$ . For more details on the well-posedness of this kind of time-scalings, we refer the reader to [15]. For any function  $\varphi : \mathbb{R} \rightarrow \mathbb{R}^n$ , we have

$$\frac{d\varphi}{ds} = \frac{d\varphi}{dt} \frac{dt}{ds} = \frac{d\varphi}{dt} \frac{v_x}{|z_1(t)|}. \quad (19)$$

Therefore, defining  $\dot{\varphi}(s) := \frac{d\varphi}{ds}$  we obtain

$$\frac{de_{obs}}{ds} = \begin{cases} A_1 e_{obs} = \begin{pmatrix} -K_1^+ & -a & 0 \\ -K_2^+ & c & 1 \\ -K_3^+ & 0 & 0 \end{pmatrix} e_{obs} & \text{if } z_1 > 0 \\ A_2 e_{obs} = \begin{pmatrix} K_1^- & a & 0 \\ K_2^- & -c & -1 \\ K_3^- & 0 & 0 \end{pmatrix} e_{obs} & \text{if } z_1 < 0. \end{cases} \quad (20)$$

#### B. Stability Conditions

Observe that the system (20) is in the form of an autonomous switched linear system. Thus, we can use tools like those of [6] to prove the observer's stability. In a first step, the conditions on observer gains for which all subsystems are stable are computed. It is well known, however, that the stability of a switched linear system depends not only on the dynamics of each subsystem but also on the behavior of the switching signals. Indeed, a switched linear system may lose its stability even when all subsystems are stable [9]. Therefore, in a second step, we show that the switch in our observer is slow. And, using the results on the stability of switched linear systems under slow switching, we prove the observer's stability in the new time-scaling.

The two subsystems are stable if the matrices  $A_1, A_2$  are Hurwitz. The conditions on observer gains can be derived using Routh's criterion. We must have

$$\begin{aligned} K_1^+ &> c, & K_2^+ &< -\frac{c}{a}K_1^+, & \text{and} \\ \frac{-(cK_1^+ + aK_2^+)(c - K_1^+)}{a} &< K_3^+ &< 0, \end{aligned} \quad (21)$$

and

$$\begin{aligned} K_1^- &< c, & K_2^- &< -\frac{c}{a}K_1^-, & \text{and} \\ 0 < K_3^- &< \frac{-(cK_1^- + aK_2^-)(c - K_1^-)}{a}. \end{aligned} \quad (22)$$

Slow switching means that there exists a certain bound on the time interval between any two successive switchings. For our switched linear system, the switch occurs when the wheel acceleration offset  $z_1$  changes its sign. As described above, the duration of each phase in the five-phase hybrid ABS strategy cannot be taken too small due to the physical limitations of the brake actuator. Thus, the duration of the phases such that  $z_1$  is positive or negative is always bigger than a certain bound. The proof is further described in Appendix.

Following [6], we write the switched linear system (20) in the form

$$\frac{de_{obs}}{ds} = A_\sigma e_{obs}, \quad (23)$$

where  $\sigma : [0, \infty) \rightarrow \mathcal{P}$ , with  $\mathcal{P} := \{1, 2\}$ , denotes a piecewise constant signal that selects a matrix from a parameterized compact family of  $3 \times 3$  matrices  $\{A_p : p \in \mathcal{P}\}$ . Now, with the help of Theorem 4 of [6], one can obtain the following result (proved in the Appendix).

**Theorem 1** Assume that the three following conditions are satisfied

- (i) The gain  $K^+ = (K_1^+ \ K_2^+ \ K_3^+)$  satisfies (21).
- (ii) The gain  $K^- = (K_1^- \ K_2^- \ K_3^-)$  satisfies (22).
- (iii) The gains  $K^+, K^-$  satisfy

$$\begin{aligned} \frac{(c - K_1^-)}{aK_3^-} &= \frac{(c - K_1^+)}{aK_3^+} = \Gamma > 0 \quad \text{and} \\ (cK_1^+ + aK_2^+) &= (cK_1^- + aK_2^-) = \Omega < 0. \end{aligned} \quad (24)$$

Then, the system (23) is uniformly globally exponentially stable.

## V. SIMULATION RESULTS

The proposed control law coupled to the stable observer is simulated for the single-wheel model of Section II, using equations (1) and (2). The system's parameters are:  $I = 1.2\text{kg}\cdot\text{m}^2$ ,  $R = 0.3\text{m}$ ,  $F_z = 2500\text{N}$ , and  $\gamma_b = 17.5\text{N}\cdot\text{m}/\text{bar}$ . In order to ensure the observer's stability, following Theorem 1, we took the following observer gains:  $K_1^+ = c + \beta$ ,  $K_2^+ = -(c + \beta)^2/a$ , and  $K_3^+ = -(\beta^2)(c + \beta)/2a$  for positive  $z_1$ 's; and  $K_1^- = c - \beta$ ,  $K_2^- = -(c^2 + \beta^2)/a$ , and  $K_3^- = (\beta^2)(c + \beta)/2a$  for negative  $z_1$ 's, where  $\beta$  is a positive constant.

The simulation of a braking ABS scenario, with a change of road conditions is shown on Figure 2. The braking manoeuvre lasts for 5 seconds. The car runs on dry asphalt between  $0.0\text{ s}$  and  $2.0\text{ s}$ , and from  $3.5\text{ s}$  to  $5.0\text{ s}$ . Between the time instants  $2.0\text{ s}$  and  $3.5\text{ s}$ , the friction coefficient of the road is modified, and the car runs on snow. The observer is not informed of these changes of the friction coefficient, and it assumes that the road is always dry. It is nevertheless

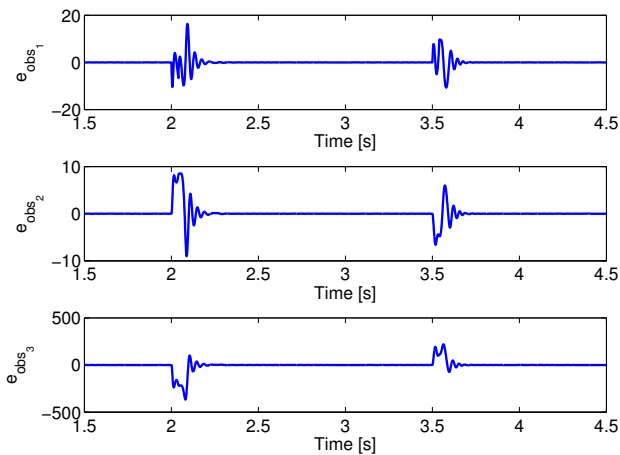

(a) Observer errors.

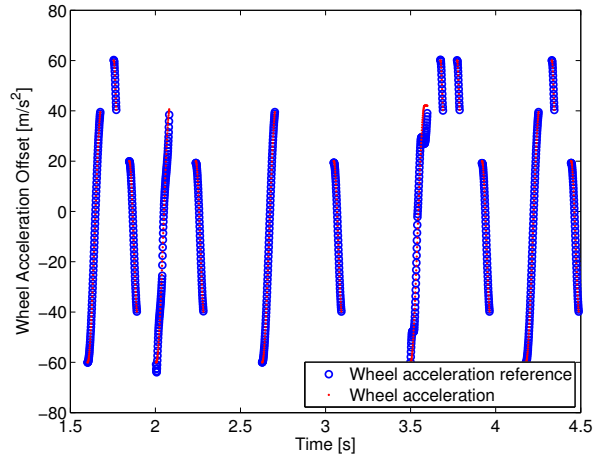

(b) Wheel acceleration tracking.

Fig. 2. Simulation of the modified academic five-phase hybrid ABS algorithm based on closed-loop wheel acceleration control coupled to an observer, with changes of road conditions. The observer assumes that the road is always dry. The change in road conditions make the observer errors different from 0. However, they converge to 0 in a very short time. During the phase 1, 3, and 4 of five-phase ABS algorithm, the tracking of the wheel acceleration is pretty good thanks to the effects of the control law coupled to the stable observer.

able to estimate quickly and accurately the corresponding changes on the XBS (Figure 2).

In the previous scenario, the parameter  $c_2$  was kept unchanged, because the value of  $c_2$  is necessary in order to build the observer. The parameters of Burckhardt's model, for a positive wheel slip, can be found in [8]. In our case, the parameter  $c_2^{snow}$  is equal to  $c_2^{dry}$ . The other parameters are modified in such a way that we obtain the same tyre characteristics on snow as Burckhardt's model.

## VI. CONCLUSION

In the context of anti-lock brake systems (ABS), we presented in this paper a closed-loop wheel-acceleration controller based on an extended braking stiffness observer that increases the algorithm's robustness, with respect to changes of road characteristics. By imposing particular conditions on the observer gains, we obtained a uniform exponential stability of the observer error (under dwell-time conditions). Simulation results showed that our method drives the wheel acceleration towards its reference trajectory and keeps the wheel slip  $\lambda$  in a neighborhood of the optimal point  $\lambda_{opt}$ . Nevertheless, a first limitation of our method is that the observer can only estimate the value of  $c_3 = -z_3/c_2$  provided that the parameter  $c_2$  in Burckhardt's tyre model is known. Although the observer is robust with respect to moderate changes in road conditions, we could expect the performance of the ABS algorithm to be increased if we are able to estimate the three parameters of the tyre model. A second limitation of our work is that we didn't prove the combined convergence of our observer and our control law. One could expect, however, that such a proof is obtainable via cascaded design arguments [10].

## APPENDIX

*Proof:* [of Theorem 1] *Step 1.* The characteristic polynomial of the matrix  $A_1$  is given by

$$\eta^3 + (K_1^+ - c)\eta^2 - (cK_1^+ + aK_2^+)\eta - aK_3^+ = 0. \quad (25)$$

Using the Routh criterion for (25) leads directly to condition (21). The same argument, but applied to  $A_2$ , gives condition (22).

*Step 2.* We suppose that the observer gains  $K^+$  and  $K^-$  satisfy, respectively, the conditions (21) and (22). In order to understand the following steps, we refer the reader to Theorem 4 in [6]. Our objective is to show that there exists a family  $\mathcal{P} = \{P_1, P_2\}$ , of symmetric positive definite matrices satisfying all the conditions required by that theorem, for an appropriately defined set of matrices  $\{C_1, C_2\}$ . Observe that the compactness of the set  $\{P_p : p \in \mathcal{P}\}$  is trivial because every set consisting of a finite number of matrices is compact.

Define  $C_1 = (c_1^+ \ 0 \ 0)$  and  $C_2 = (c_1^- \ 0 \ 0)$ , where  $c_1^+, c_1^- \neq 0$ . It is easy to check that the pairs  $(A_1, C_1)$  and  $(A_2, C_2)$  are observable.

*Step 3.* In order to satisfy the conditions of [6, Theorem 4], we will look for a matrix  $P$  that satisfies simultaneously the equations  $A_1^T P + P A_1 = -C_1^T C_1$  and  $A_2^T P + P A_2 = -C_2^T C_2$ . Observe that  $P$  only defines a non-strict Lyapunov function, because the symmetric matrices  $C_i^T C_i$  are only non-negative. Denote by  $(p_{ij})$  the elements of  $P$ . One can easily deduce from  $A_1^T P + P A_1 = -C_1^T C_1$  that

$$\begin{aligned} p_{11} &= \frac{c^2 - (cK_1^+ + aK_2^+)}{a^2} p_{22}, & p_{12} &= \frac{c}{a} p_{22}, \\ p_{13} &= \frac{1}{a} p_{22}, & p_{23} &= 0, & \text{and} & p_{33} &= \frac{(c - K_1^+)}{aK_3^+} p_{22}, \end{aligned} \quad (26)$$

where  $p_{22} > 0$ . With the elements of  $P$  computed as in (26),

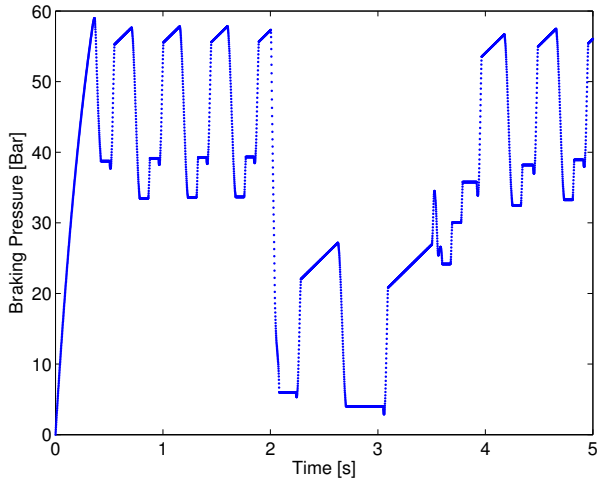

Fig. 3. When there is a transition from dry asphalt to snow, the brake pressure is reduced as a consequence of the reduction of the tyre force potential. It increases again when the car leaves the snowy surface.

we obtain

$$c_1^+ = \pm \sqrt{2 \frac{(c - K_1^+)(cK_1^+ + aK_2^+) + aK_3^+}{a^2} p_{22}} \neq 0. \quad (27)$$

The term in the square root is positive because of (21) and  $p_{22} > 0$ .

Similarly, since  $P$  has to satisfy the condition  $A_2^T P + P A_2 = -C_2^T C_2$ , it follows that the elements of  $P$  are also of the form

$$\begin{aligned} p_{11} &= \frac{c^2 - (cK_1^- + aK_2^-)}{a^2} p_{22}, & p_{12} &= \frac{c}{a} p_{22}, \\ p_{13} &= \frac{1}{a} p_{22}, & p_{23} &= 0, & \text{and} & & p_{33} &= \frac{(c - K_1^-)}{aK_3^-} p_{22}. \end{aligned} \quad (28)$$

From (26) and (28), we obtain more conditions on the observer gains  $K^+$ ,  $K^-$

$$\begin{aligned} \frac{(c - K_1^-)}{aK_3^-} &= \frac{(c - K_1^+)}{aK_3^+} = \Gamma > 0 & \text{and} & & (29) \\ (cK_1^+ + aK_2^+) &= (cK_1^- + aK_2^-) = \Omega < 0. \end{aligned}$$

The element  $c_1^-$  of  $C_2$  is also different from 0 because of (22) and  $p_{22} > 0$

$$c_1^- = \pm \sqrt{-2 \frac{(c - K_1^-)(cK_1^- + aK_2^-) + aK_3^-}{a^2} p_{22}}. \quad (30)$$

*Step 4.* For our switched linear system, the switches occur when the wheel acceleration offset  $z_1$  changes its sign. During phases 2 and 3 of five-phase hybrid ABS algorithm, the wheel acceleration offset  $z_1$  is always positive while it is negative in phase 5. In phase 1,  $z_1$  goes from a negative value  $-\epsilon_5$  to a positive value  $\epsilon_1$ ; and it goes, in the opposite direction, from a positive value  $\epsilon_3$  to a negative value  $-\epsilon_4$  in phase 4.

We define  $T_1^+$ ,  $T_1^-$ ,  $T_4^+$ ,  $T_4^-$  as the times for which  $z_1$  is, respectively, positive or negative in phases 1, 4. And

define  $T_2, T_3, T_5$  as the times for which  $z_1$  stays, respectively, in phases 2, 3, and 5. Finally, we define  $T^+$ ,  $T^-$  as the total times for which  $z_1$  is, respectively, positive or negative. Then, we have  $T^+ = T_1^+ + T_2 + T_3 + T_4^+$  and  $T^- = T_1^- + T_4^- + T_5$ . Therefore, the minimum between  $T^+$  and  $T^-$ , which is strictly positive, defines a bound on the minimal time interval between two successive switchings. In other words, the switching signal has a strictly positive minimal dwell-time. This last fact, combined with the conditions on gains  $K^+$ ,  $K^-$  of Theorem 1, prove that the origin of the observer error dynamics (23) is uniformly globally exponentially stable [6, Theorem 4]. ■

## REFERENCES

- [1] R. Bosch. *Bosch Automotive Handbook*, volume 74. Bentley, Cambridge, 2004.
- [2] M. Burckhardt. *Fahrwerktechnik: Radschlupf-Regelsysteme*. Vogel-Verlag, Germany, 1993.
- [3] M. Corno, M. Gerard, M. Verhaegen, and E. Holweg. Hybrid ABS control using force measurement. *Control Systems Technology, IEEE Transactions on*, 20(5):1223–1235, 2012.
- [4] E. de Bruijn, M. Gerard, M. Corno, M. Verhaegen, and E. Holweg. On the performance increase of wheel deceleration control through force sensing. In *Control Applications (CCA), 2010 IEEE International Conference on*, pages 161–166. IEEE, 2010.
- [5] M. Gerard, W. Pasillas-Lépine, E. De Vries, and M. Verhaegen. Improvements to a five-phase ABS algorithm for experimental validation. *Vehicle System Dynamics*, 50(10):1585–1611, 2012.
- [6] J.P. Hespanha. Uniform stability of switched linear systems: Extensions of LaSalle’s invariance principle. *Automatic Control, IEEE Transactions on*, 49(4):470–482, 2004.
- [7] T.B. Hoang, W. Pasillas-Lépine, and A. De Bernardinis. Reducing the impact of wheel-frequency oscillations in continuous and hybrid abs strategie. In *Proceedings of the 11th International Symposium on Advanced Vehicle Control*, 2012.
- [8] U. Kiencke and L. Nielsen. *Automotive Control Systems*. Springer-Verlag New York, Inc., 2000.
- [9] D. Liberzon and A.S. Morse. Basic problems in stability and design of switched systems. *Control Systems, IEEE*, 19(5):59–70, 1999.
- [10] A. Loría and E. Panteley. Cascaded nonlinear time-varying systems: Analysis and design. In F. Lamnabhi-Lagarrigue, A. Loría, and E. Panteley, editors, *Advanced topics in control systems theory*, pages 579–579. Springer, 2005.
- [11] E. Ono, K. Asano, M. Sugai, S. Ito, M. Yamamoto, M. Sawada, and Y. Yasui. Estimation of automotive tire force characteristics using wheel velocity. *Control Engineering Practice*, 11(12):1361–1370, 2003.
- [12] H. Pacejka. *Tyre and Vehicle Dynamics*. Butterworth-Heinemann, 2005.
- [13] W. Pasillas-Lépine. Hybrid modeling and limit cycle analysis for a class of five-phase anti-lock brake algorithms. *Vehicle System Dynamics*, 44(2):173–188, 2006.
- [14] W. Pasillas-Lépine, A. Loría, and M. Gerard. Design and experimental validation of a nonlinear wheel slip control algorithm. *Automatica*, 2012.
- [15] W. Respondek, A. Pogromsky, and Henk Nijmeijer. Time scaling for observer design with linearizable error dynamics. *Automatica*, 40(2):277–285, 2004.
- [16] S. Savaresi, M. Tanelli, and C. Cantoni. Mixed slip-deceleration control in automotive braking systems. *Journal of Dynamic Systems, Measurement, and Control*, 129(1):20–31, 2007.
- [17] M. Tanelli, L. Piroddi, and S. Savaresi. Real-time identification of tire-road friction conditions. *Control Theory & Applications, IET*, 3(7):891–906, 2009.
- [18] J. Villagra, B. d’Andréa Novel, M. Fliess, and H. Mounier. A diagnosis-based approach for tire–road forces and maximum friction estimation. *Control Engineering Practice*, 19(2):174–184, 2011.



## Sixième partie

### Control for the non expert reader



# Chapitre 11

## Notions on control theory

Since the described work is in the intersection of two very different communities - the automatic control and the transportation communities - this chapter is dedicated mainly to the non control expert reader. Its aim is in introducing through a qualitative description, some main concepts in control theory, necessary for the understanding of the work. It is composed in three sections : the first one, Section 11.1, describes the main ideas and principles of the Lyapunov stability theory ; the second, Section 11.2 aims to bring out, through a very simple example, what an Adaptive Control is ; and the third, Section 11.3, describes some of the basic fundamentals of the hybrid systems theory and shows what a hybrid automaton is.

To introduce the material from the control theory, it is used, whenever possible, a qualitative description, so that a non control expert can follow the main ideas as well. References containing the formal related theorems will be provided throughout the text whenever necessary. Theorems and definitions considered as essential for the understanding of the work will be presented in the text.

### 11.1 Notions on Lyapunov theory

Slotine and Li [11] write about stability and about the Lyapunov's work : *"Given a control system, the first and most important question about its various properties is whenever it is stable, because an unstable control system is typically useless and potentially dangerous. Qualitatively, a system is described as stable if starting the system somewhere near its desired operating point implies that it will stay around the point ever after. The motions of a pendulum starting near its two equilibrium points, namely, the vertical up and down positions, are frequently used to illustrate unstable and stable behavior of a dynamical system. For aircraft control systems, a typical stability problem, is intuitively related to the following question : will a trajectory perturbation due to a gust cause a significant deviation in the later flight trajectory ? Here, the desired operation point of the system is the flight trajectory in the absence of disturbance. Every control system, whether linear or nonlinear, involves a stability problem which should be carefully studied. The most useful and general approach for studying the stability of nonlinear control systems is the theory introduced in the late 19<sup>th</sup> century by the Russian mathematician Alexandr Mikhailovich Lyapunov. Lyapunov's work, The General Problem of Motion Stability[12],*

*includes two methods for stability analysis (the so-called linearization method (called also indirect method) and the direct method) as was first published in 1892.*" Lyapunov's pioneering work on stability received little attention outside Russia and it has been in the early 1960's that the theory brought the attention of the larger control engineering community. Many refinements of the Lyapunov's methods have since been developed. Today, Lyapunov's linearization method has come to represent the theoretical justification of linear control, while Lyapunov's direct method has become the most important tool for nonlinear system analysis and design. Together, the linearization method and the direct method constitute the so-called Lyapunov stability theory.

### 11.1.1 Direct and indirect methods

As described, the Lyapunov theorems on the stability of systems are one of the basis for the modern control theory<sup>1</sup> and the Lyapunov theory includes the so-called direct and indirect methods. The direct method is written in theorems that give sufficient conditions for the stability properties of an equilibrium point of a nonlinear dynamical system, always considered to be in the origin. This is done by constructing a scalar "energy-like" function for the system and examining the function's time variation. The indirect method allows the proof of the local asymptotic stability or the instability of an equilibrium point of a nonlinear system by the analysis of its linearized analog. I will describe below the main ideas involved in the Lyapunov's direct method, but before let me give below a notion on what means stability in the sense of Lyapunov.

### 11.1.2 Stability in the sense of Lyapunov

Let us first talk briefly about the definitions of stability in the sense of Lyapunov. Lyapunov has written its theorems always with respect to the stability of an equilibrium point and has moreover always considered the equilibrium point in the origin (" $x=0$ ") of the studied dynamical system. One should note that in the case the equilibrium point is not in the origin, a change of coordinates can in most of the cases be used so that the equilibrium point in the new coordinates is placed in the origin of the dynamical system in the new coordinates and then the Lyapunov theorems can be applied. Qualitatively, an equilibrium point is stable (in the sense of Lyapunov) if it is possible to stay arbitrarily near it. The figure below illustrates the definition of stability in the sense of Lyapunov : the system is stable if for any "ball", of radius  $\epsilon$ , around the origin, another "ball", of radius  $\delta$ , around the origin can be found such that all the trajectories with initial conditions inside the ball of radius  $\delta$  will stay inside the ball of radius  $\epsilon$ . In other words, if we want the system trajectories to stay within a defined ball of radius  $\epsilon$ , then it will be always possible, if the system is stable in the sense of Lyapunov, to find another ball of radius  $\delta$  such that if we place the system initial conditions inside it, then the system trajectories will stay forever within the ball of radius  $\epsilon$ . Then, this means that it is possible to stay arbitrarily near the equilibrium point by well choosing the set of initial conditions. The asymptotic stability involves besides stability, also convergence to the equilibrium point

---

1. Classic control is founded on input-output synthesis and analysis. With modern control, the state-space representation of a system and the control on this modelling has been introduced.

(the precise definitions can be obtained for example in Slotine's book [11], pages 48-50, or in Khalil's book [13]). Furthermore, stability and asymptotic stability can hold locally or globally (that is, valid in a region around the equilibrium point or in all the state-space).

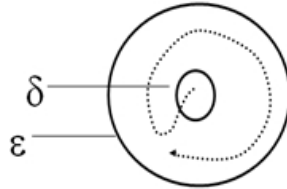

FIGURE 11.1 – Illustration of the Lyapunov stability definition

### Stability analysis by Lyapunov (direct method)

To establish his direct method, Lyapunov inspired himself in the physical fact that if the total energy of a given physical system is nonincreasing, then the system is "stable". Moreover, if the total energy of the physical system is strictly decreasing then the system is "asymptotically stable". Two classical examples are the pendulum and the mass-spring systems (see Figures 11.2 and 11.3) as already mentioned. In the mass-spring system, if we consider the hypothetic case of no friction and no air resistance, then the total energy of the system (potential + kinetic) will be forever constant (and as a consequence nonincreasing) and then in this case the system is stable : the pendulum will (hypothetically) oscillate forever with constant amplitude of oscillation. In the case there is friction and/or air resistance, then, the total energy will decrease to zero and the system will be asymptotically stable. Physically, in this case the mass will oscillate with decreasing amplitudes of oscillation till stop. The same happens will the pendulum.

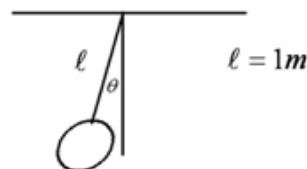

FIGURE 11.2 – The Lyapunov stability theorems have been inspired by the behavior of the total energy of a physical system. The total energy of the pendulum illustrates the idea.

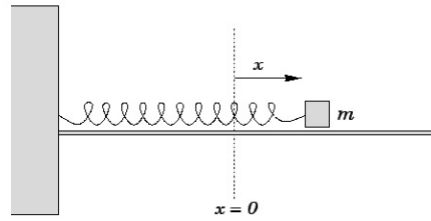

FIGURE 11.3 – Mass-spring system as an illustration of the Lyapunov ideas.

Inspired by these physical observations, Lyapunov has "enlarged" this idea for any system and any "energy-like function" (the name energy here is now used by pure analogy, since these functions are defined mathematically and do not anymore correspond to the physical energy of the system) provided that some conditions on the "energy-like function" and on the derivative of the "energy-like function" along the system trajectories are satisfied. Mathematically, the "energy-like function" has to be positive definite (positive everywhere and zero in the origin). This corresponds to a function with a form of a bowl, as in Figure 11.4. Global stability asks for some additional properties of the function besides its positive definiteness. These conditions need to ensure that the level curves of the Lyapunov function are closed curves. The interested reader can find in [11], page 64, the details and the related mathematical conditions for global stability.

The Lyapunov direct method allows also the computation of invariant sets in which it can be ensured that the system trajectories will stay. This is illustrated also by the Figure 11.4 below in which the "energy" evolution of an asymptotically stable dynamical system with initial energy value  $V_1$  is represented. The two horizontal axis ( $x_1$  and  $x_2$ ) represent the dynamical system state variables and the vertical axis the associated "energy-like function", a quadratic positive definite "energy-like function". The level curve corresponding to the initial "energy" level  $V_1$  (calculated from a given initial state  $(x_{10}, x_{20})$  of the system) is also shown. The blue "energy trajectory" illustrates the strictly decreasing nature of the energy evolution starting from the initial "energy" level  $V_1$ . Visually, one can see that the trajectories of the system beginning in an initial state with corresponding energy level  $V_1$  will be constrained in the interior of the corresponding level curve. Figure 11.5 shows moreover, that in the case of an asymptotically stable system, the system trajectories, in each instant of time, will always enter the following level curve (corresponding to a lower "energy-like" level). For the interested reader, the Lyapunov theorems on the stability of systems can be found for example in [13] and [11].

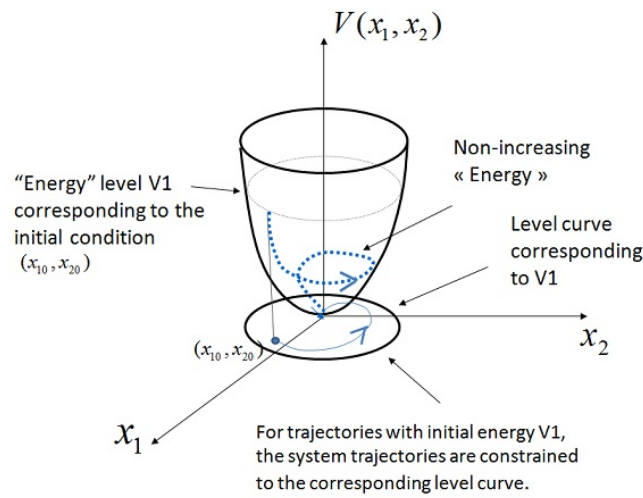

FIGURE 11.4 – The figure illustrates that if the system has a Lyapunov function, at least locally, the trajectories of the system will be constrained in the interior of the level curve corresponding to the energy level computed from the initial state of the system.

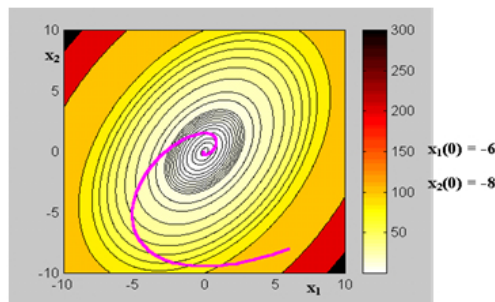

FIGURE 11.5 – The figure illustrates that in an asymptotically stable system, its trajectories go from one level curve always to the interior of the next level curve – corresponding to a lower energy level – and so on.

It is interesting to understand what happens when the Lyapunov function candidate is not in the form of a bowl : even if the  $V$  is decreasing along the trajectories of the system (curve in blue in figure 11.6), the trajectories can escape since the level curves are not closed<sup>2</sup>.

2. The figure is from the course : M.Kawski, APM 581 Introduction to Lyapunov theory. November 15, 2009

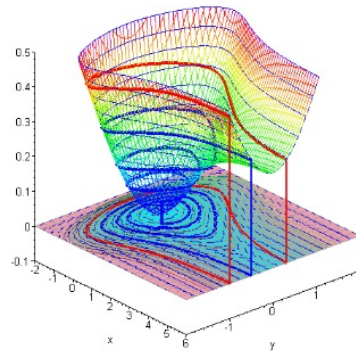

FIGURE 11.6 – The figure illustrates that if the Lyapunov function candidate is not in the form of a bowl, even if the  $V$  is decreasing along the trajectories of the system (curve in blue), the trajectories can escape since the level curves are not closed.

## 11.2 Notions on adaptive control

Given that Lyapunov has been introduced, this section aims at introducing what an adaptive control is. For this, let us first see one definition of an adaptive control system and then understand the main idea behind adaptive control through a very simple example.

### 11.2.1 What is an adaptive control system ?

In [14], one of the given definitions, from [15], is : "An adaptive control system is defined as a feedback control system intelligent enough to adjust its characteristics in a changing environment so as to operate in an optimum manner according to some specific criterion"

As pointed out also in [14], the definitions of adaptive systems are innumerable. In this manuscript, to be simple, I keep only this one since the aim is to introduce notions of adaptive control to non-control experts readers, and not to focus on the description of the adaptive control theory. Further information on adaptive control can be found for example in [14], [16] and [13].

Adaptive control is useful for example in the case we wish to control a dynamical system in which the parameters are unknown. One of my contributions that will be described in details in the next Chapter, belongs to this case.

### 11.2.2 An example : the adaptive control of a scalar plant

We introduce in the following the main ideas of the adaptive control through an example from [14]. The example is a scalar plant with unknown parameters described by the scalar differential equation (11.1) below. Since the parameters are unknown, the adaptive control is used to control the system even though some knowledge on the system is missing (the parameters values).

Let us consider then the scalar plant :

$$\dot{x}_p(t) = a_p x_p(t) + k_p u(t) \quad (11.1)$$

where  $a_p(t)$  and  $k_p(t)$  are plant parameters. A reference model is described by the first-order differential equation

$$\dot{x}_m(t) = a_m x_m(t) + k_m r(t) \quad (11.2)$$

where  $a_m < 0$ ,  $a_m$  and  $k_m$  are known constants, and  $r(t)$  is a piecewise-continuous bounded function of time. It is assumed that  $a_m$ ,  $k_m$  and  $r(t)$  have been chosen so that  $x_m(t)$  represents the desired output of the plant at time  $t$ . The aim is to determine a bounded control input  $u$  so that all the signals in the system remain bounded and :

$$\lim_{t \rightarrow \infty} |x_p(t) - x_m(t)| = 0 \quad (11.3)$$

that is, the output of the plant converges to the output of the reference model.

*Feedback Control :*

*Known parameters :* If  $a_p$  and  $k_p$  are known constants so that the plant is given by Eq. (11.1), repeated below :

$$\dot{x}_p(t) = a_p x_p(t) + k_p u(t)$$

then a control input of the form

$$u(t) = \theta^* x_p(t) + k^* r(t) \quad (11.4)$$

can be chosen where :

$$\theta^* \triangleq \frac{a_m - a_p}{k_p} ; \quad k^* \triangleq \frac{k_m}{k_p} \quad (11.5)$$

Using the expression of (11.5) in Eq. (11.4), it is seen that the transfer function of the plant together with the controller will be the same as that of the reference model so that the objective in Eq. (11.3) is achieved. We are assured of the existence of such a  $\theta^*$  and  $k^*$  provided  $k_p \neq 0$ , that is when the plant is controllable [13].

*Unknown parameters :* When  $a_p$  and  $k_p$  are unknown, the control input is chosen with the same form as (11.4) but replacing the parameters  $\theta^*$  and  $k^*$  by estimates, leading then to the following form of the control input :

$$u(t) = \theta(t) x_p(t) + k(t) r(t) \quad (11.6)$$

where  $\theta(t)$  and  $k(t)$  are the adjustable parameters of the controller to estimate  $\theta^*$  and  $k^*$ . The plant given by Eq. (11.1) together with the adaptive controller in Eq. (11.6), which we shall refer to henceforth as the *system*, can be described by

$$\dot{x}_p(t) = (a_p + k_p \theta(t)) x_p(t) + k_p k(t) r(t) \quad (11.7)$$

Defining the output error  $e$  and the parameter errors  $\phi$  and  $\psi$  as

$$e(t) \triangleq x_p(t) - x_m(t), \quad \phi(t) \triangleq \theta(t) - \theta^*, \quad \psi(t) \triangleq k(t) - k^* \quad (11.8)$$

we obtain the dynamical error equation from the difference between the reference model dynamics in Eq.(11.2) and the closed-loop system dynamics in Eq. (11.7) as

$$\dot{e}(t) = a_m e(t) + k_p \phi(t) x_p(t) + k_p \psi(t) r(t) \quad (11.9)$$

We will show in the following uniquely the case *Case  $k_p$  Known* since it is enough to illustrate the essence of adaptive control, that is the objective of this section.

*Case  $k_p$  Known* : In this case, the control parameter  $k(t)$  can be directly chosen to be equal to  $k^*$  so that the control input, from equation (11.6) is of the form

$$u(t) = \theta(t) x_p(t) + k^* r(t) \quad (11.10)$$

and only one parameter  $\theta(t)$  has to be adjusted. The dynamical error equation becomes then

$$\dot{e}(t) = a_m e(t) + k_p \phi(t) x_p(t) \triangleq f(\phi(t), e(t), x_p(t)) \quad (11.11)$$

Let us take the gradient law for updating  $\theta(t)$  (or  $\phi(t)$ ) as in the following

$$\dot{\theta}(t) = \dot{\phi} = \left. \frac{\partial f}{\partial \phi} \right|_{\phi} e(t) = -k_p e(t) x_p(t) \quad (11.12)$$

and the justification for the choice of such an adaptive law is provided by demonstrating the existence of a Lyapunov function that assures the global stability of the resultant nonlinear system.

*Stability analysis by Lyapunov* : Let a candidate for the Lyapunov function be given by

$$V(e, \phi) \triangleq \frac{1}{2} [e^2 + \phi^2] \quad (11.13)$$

The time derivative of Eq. (11.13) evaluated along the trajectories of Eqs. (11.11) and (11.12) is

$$\dot{V}(e, \phi) = e\dot{e} + \phi\dot{\phi} = a_m e^2 \leq 0$$

that is nonincreasing and then the origin in Eqs. (11.11) and (11.12) is stable. By the use of standard arguments from control it can in addition be proved (see for example [14] for the explanations) that

$$\lim_{t \rightarrow \infty} e(t) = 0$$

One should note that asymptotic stability of the origin in the  $(e, \phi)$  space cannot be directly concluded, since  $\dot{V}$  is only nonincreasing (negative semi-definite) in the  $(e, \phi)$  space (and not strictly decreasing in the  $(e, \phi)$  space). Though it is possible to prove the convergence of  $x_p(t)$  to the desired reference  $x_m(t)$  (equivalent to prove that the error

$e(t)$  goes to zero), one cannot prove the convergence of  $\theta(t)$  to the desired value  $\theta^*$ , which depends on some specific conditions on the reference input  $r$ , named Persistency of Excitation. The reader is referred to [14] for explanations on this condition that we do not detail here since it is out of the scope of the presented work (in the adaptive control problem treated here, only output convergence is studied).

*The Certainty Equivalence Approach* : it is the approach of designing the structure of the control as if the parameters were known and then replacing them by their estimates. This is the standard procedure in Adaptive Control and the one that has been used in the illustrative example above (this can be seen by comparing Eqs. (11.4) and (11.6)). However, Non Certainty can lead often to important results but it is a non standard way of proceeding and involves in most of the cases very hard investigation for the control synthesis.

### 11.2.3 Why with nonlinear parameterization it is so hard as a problem ?

In order to understand some of the difficulties involved in the control of dynamical systems in which the parameters enter in a nonlinear way in the dynamical equations (that is, the control of nonlinearly parameterized (NLP) systems), let us take the very simple following NLP plant :

$$\dot{x}(t) = e^{\alpha x(t)} + u(t) \stackrel{\Delta}{=} f_1(x, \alpha) + u(t) \quad (11.14)$$

with  $\alpha$  the unknown parameter. We can see that  $\alpha$  enters in a nonlinear way in the dynamical equation. We take the control goal to find  $u(t)$  and an adaptive law to estimate  $\alpha$  such that all signals are bounded and so as to asymptotically stabilize  $x(t)$  to zero.

Let us consider first the case where the parameter  $\alpha$  is known. In this case, by choosing the control input :

$$u = -e^{\alpha x(t)} - ax(t) \stackrel{\Delta}{=} f_1(x, \alpha) - ax(t) \quad (11.15)$$

with  $a > 0$ , one can easily see that the closed-loop system dynamics is given by

$$\dot{x}(t) = -ax(t)$$

which implies

$$x(t) \rightarrow 0$$

exponentially and then the control goal is achieved.

Let us use, as in the previous example, the NonCertainty Equivalence Principle to choose the adaptive control to be

$$u = -e^{\hat{\alpha}x(t)} - ax(t) \quad (11.16)$$

with  $\hat{\alpha}$  being the estimate for the unknown  $\alpha$ . The closed-loop system dynamics is then given by :

$$\dot{x}(t) = e^{\alpha x(t)} - e^{\hat{\alpha} x(t)} - ax(t) \triangleq f(\alpha, \hat{\alpha}, x(t)) = f_1(x, \alpha) - f_1(x, \hat{\alpha}) - ax(t) \quad (11.17)$$

Let us define as before the parameter estimation error signal  $\phi(t) \triangleq \hat{\alpha} - \alpha$ . The output tracking error in this case is equal to the state  $x(t)$ , since the desired reference is zero (that is, the control goal is to drive  $x(t)$  to zero and then  $e(t) = x(t) - 0 = x(t)$ ). Let us take as before the gradient law to update  $\hat{\alpha}$  (or  $\phi(t)$ )

$$\dot{\hat{\alpha}}(t) = \dot{\phi}(t) = \left. \frac{\partial f}{\partial \alpha} \right|_{\hat{\alpha}} x(t) = \left. \frac{\partial f_1}{\partial \alpha} \right|_{\hat{\alpha}} x(t) \quad (11.18)$$

and as before the Lyapunov function candidate :

$$V(x, \phi) \triangleq \frac{1}{2} [x^2 + \phi^2] \quad (11.19)$$

The time-derivative of the  $V(x, \phi)$  along the system trajectories can then be calculated as :

$$\begin{aligned} \dot{V}(x, \phi) &= x\dot{x} + \phi\dot{\phi} = x[f_1(x, \alpha) - f_1(x, \hat{\alpha}) - ax(t)] + \phi \left. \frac{\partial f_1}{\partial \alpha} \right|_{\hat{\alpha}} x \\ &= -ax^2 + \left\{ f_1(x, \alpha) - f_1(x, \hat{\alpha}) + (\hat{\alpha} - \alpha) \left. \frac{\partial f_1}{\partial \alpha} \right|_{\hat{\alpha}} \right\} x \\ &= -ax^2 + \left\{ f_1(x, \alpha) - f_1(x, \hat{\alpha}) + [-\alpha + \hat{\alpha}] \left. \frac{\partial f_1}{\partial \alpha} \right|_{\hat{\alpha}} \right\} x \end{aligned} \quad (11.20)$$

We see that differently from before, the terms in  $\dot{V}$  do not cancel!

Then, in order to ensure that the derivative of the Lyapunov function candidate is nonincreasing along the system trajectories, we need to ensure that

$$\left\{ f_1(x, \alpha) - f_1(x, \hat{\alpha}) + [-\alpha + \hat{\alpha}] \left. \frac{\partial f_1}{\partial \alpha} \right|_{\hat{\alpha}} \right\} x \leq 0$$

When the function  $f_1(x, \alpha)$  is linear in  $\alpha$ , that is, when  $f_1(x, \alpha)$  is linearly parameterized, we can show that we fall in the previous case. In this case,  $f_1(x, \alpha)$  can be written as  $f_1(x, \alpha) = g(x)\alpha$  and it holds that :

$$\begin{aligned} &\left\{ f_1(x, \alpha) - f_1(x, \hat{\alpha}) + [-\alpha + \hat{\alpha}] \left. \frac{\partial f_1}{\partial \alpha} \right|_{\hat{\alpha}} \right\} \\ &= \{g(x)\alpha - g(x)\hat{\alpha} + [-\alpha + \hat{\alpha}]g(x)\} \\ &= 0 \end{aligned}$$

and then

$$\dot{V}(x, \phi) = -ax^2$$

that is nonincreasing, implying the stability of the closed-loop system (11.17). And as in the former example, with standard additional arguments, the convergence of the state  $x$  to zero can also be ensured.

But, the question is "how to ensure that  $\dot{V}(x, \phi)$  is nonincreasing ( $\dot{V}$  negative semi-definite) in the case the function  $f_1(x, \alpha)$  is nonlinear in  $\alpha$ , that is the case of system (11.14)?"

We need to ensure then that  $x \{ f_1(x, \alpha) - f_1(x, \hat{\alpha}) + [-\alpha + \hat{\alpha}] \frac{\partial f_1}{\partial \alpha} |_{\hat{\alpha}} \} \leq 0$ . However the answer is not trivial.

We will show further in the text that if the function  $f_1(x, \alpha)$  is convex or concave, some very useful properties can be derived. Some authors (see for example [18],[17], [19], [20]) have made use of these properties to introduce new results for the control of NLP systems. But there are still few results for the nonconvex/nonconcave case. In other words, very few theory exist in spite of the innumerable practical applications! (the reader is referred to the papers on NLP control in the annexes in which the citation for innumerable practical applications can be found).

## 11.3 Notions on the hybrid systems theory

### 11.3.1 What is a hybrid system ?

Informally defining, from [23], "Hybrid systems are dynamical systems that require more than one modeling language to characterize their dynamics. A subset are the systems with interacting continuous and discrete components. As examples of continuous dynamics [23] cites movement of mechanical systems, linear circuits and chemical reactions and as examples of discrete dynamics [23] cites collisions in mechanical systems, switches in circuits, valves and pumps in chemical plants. For the interested reader, a number of very different examples of hybrid systems like a rocking block, a computer-controlled system, an automatic gear box control, a thermostat, a Highway system are described in [23], and [23]. Going further, hybrid systems include a very large variety of practical problems and large-scale complex systems need very often hybrid modeling as it is described in the European Network of Excellence HYCON2 (<http://www.hycon2.eu/>).

Mixed discrete-continuous systems can be formally described by what is called a Hybrid Automaton. These systems evolve with a certain continuous dynamics till a certain condition happens when the system begins to evolve with a different continuous dynamics. Hybrid automata may be represented as a directed graph with continuous dynamics in each node. The continuous flow evolve according to the differential equation specified in the current node of the graph. When certain conditions are fulfilled, a discrete transition may take place from one node to another if the nodes are connected by an edge. The continuous flow is then forced to satisfy the differential equation in the new node. Depending on the number of discrete states (nodes) and the differential equation in each state, the hybrid automaton may show a more or less complex behavior. The ultimate

cases are on one side a hybrid automaton with only one discrete state and no edges and on the other side a hybrid automaton with trivial continuous dynamics ( $f(x) = 0$ ) in each discrete state. The first case corresponds to a continuous-time dynamical system and the second to a purely discrete system.

I show in the next subsection two examples of a hybrid automaton.

### 11.3.2 Examples of a Hybrid Automaton

Example 1 : Two Tanks with Only One Tap. This is illustrated by the figure below. The tap fills the tank 1 (and then there is the corresponding continuous dynamics) till the water level in the tank 2 falls below the level  $r_2$ , when the system commutes, and the tap is turned to tank 2, to fill it and make the level of the water increase to the level  $r_2$ .

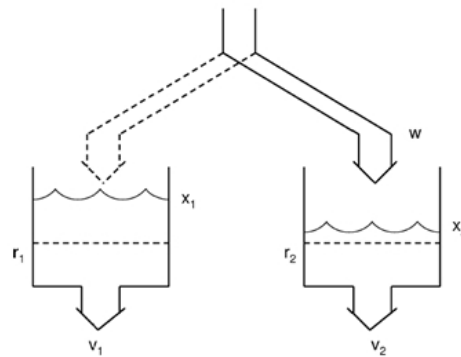

FIGURE 11.7 – Illustration of a hybrid automaton modelling two tanks with only one tap.

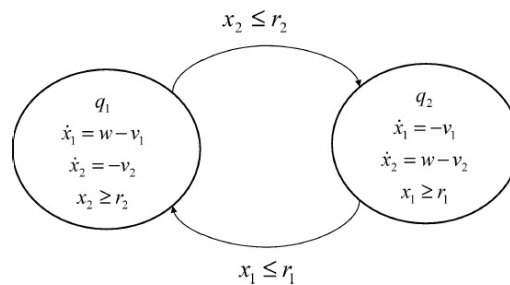

FIGURE 11.8 – Graph illustrating the hybrid system "Two Tanks with Only One Tap"

Example 2 : Control problem of heating a room. Assume that a thermostat is used as a controller, but that we do not have an exact model of how the thermostat functions. It is only known that the thermostat turns on the radiator when the temperature is between 68 and 70 and it turns the radiator off when the temperature is between 80 and 82. This

heating system can be modelled as the hybrid automaton in Figure 11.9, where  $x$  denotes the temperature. This hybrid automaton is non-deterministic in the sense that for a given initial condition it accepts a whole family of different executions (solutions).

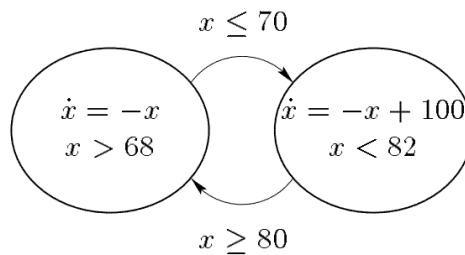

FIGURE 11.9 – Graph illustrating a hybrid automaton modelling a thermostat and the heating of a room.

A hybrid automaton asks for new definitions and stability theorems suited to systems containing mixed discrete and continuous dynamics. This chapter aims, as already pointed out, to explain in a qualitative form, basic concepts of the control theory necessary to understand the described work providing citations to the full theory. So, I present in the following, the formal definition of a Hybrid Automaton, and a qualitative explanation of two Stability theorems for Hybrid systems. The reader can refer to [23] and [23] for further information on Hybrid systems.

### 11.3.3 Formal definition of a hybrid automaton

To formally define a hybrid automaton, the discrete and the continuous states, as well as the continuous dynamics corresponding to each of the discrete states need to be described. Also, the definition shall take into account the set of possible initial conditions (corresponding to the discrete and the continuous states), the set of invariant conditions, the set of all possible transitions, the conditions that make a transition happens (called guard conditions) and the reset function that corresponds to the new value of the state after a transition. The example of the two tanks with only one tap is graphically represented in Figure 11.8 and illustrates a system then with two discrete states ( $q_1, q_2$ ), the continuous dynamics corresponding to each discrete state, and the guard conditions that make the transitions happen. The formal complete definition of a hybrid automaton is then provided.

**Definition 2** *A hybrid automaton is a 8-plet  $H = (Q, X, f, Init, D, E, G, R)$  that verifies :*

- $Q$  is a finite set of discrete states. It represents the discrete dynamics of  $H$ .
- $X = \{x_1, x_2, \dots, x_n\}$ ,  $n \geq 0$  is a finite set of real continuous variables. It represents the continuous dynamics of  $H$ .

- $f : Q \times X \rightarrow TX$  is a vector field. It describes, by the differential equation  $\dot{x} = f(q, x)$  the continuous flow for each discrete state  $q \in Q$ .
- $\text{Init} \subseteq Q \times X$  is the set of possible initial states  $(q, x)$  of the hybrid automaton  $H$ .  $q \in Q$  is the discrete initial state,  $x \in \mathbb{R}^n$  is the initial value of  $x$ .
- $D : Q \rightarrow P(X)$  is the set of invariant conditions of  $H$ . If the discrete state  $q$  is in  $Q$ , then the state  $(q, x)$  of the system  $H$  will belong to  $P(X)$ <sup>3</sup>.
- $E \subset Q \times Q$  is the set of transitions.
- $G : E \rightarrow P(X)$  is a guard condition that puts to each  $(q_i, q_j) \in E$  a condition expressed as a function of the continuous variable  $x$ .
- $R : E \times X \rightarrow P(X)$  is the reset application. If the guard condition  $G(q_i, q_j)$  is satisfied, then the system  $H$  will go from state  $q_i$  to the state  $q_j$  and the initialization value for  $x$  will be  $R(q_i, q_j, x)$ .

### 11.3.4 Challenges in the hybrid systems stability analysis

According to the given qualitative introduction on the Lyapunov stability theory, if it can be proven the existence of a certain "energy-like function" satisfying some precise conditions, then, the (asymptotic) stability of the system can be ensured. I will introduce very briefly below the idea behind two equivalent stability theorems for hybrid systems. Let us present first two definitions from [23] that are necessary to the understanding of the following. The first defines an equilibrium point for a hybrid system and the second a switching system. The full and detailed understanding of a hybrid system involves the comprehension of many other definitions like the hybrid time trajectories, executions, deterministic and non-blocking hybrid automata, Zeno hybrid automata, etc such that the normal definitions of continuous systems are redefined for hybrid systems and such that some phenomena that can arrive on hybrid systems are well defined like in the Zeno hybrid automata. Reference [23] contains these re-definitions and the characterization of the Zeno hybrid automata.

**Definition 3** *The point  $x^* \in X$  is an equilibrium point for the hybrid automaton  $H$  if*

- $x^* \in \overline{D(q)}$  for a certain  $q \in Q$  implies that  $f(q, x^*) = 0$ <sup>4</sup>,
- $x^* \in G(e)$  for a certain  $e \in E$  implies that  $R(e, x^*) = x^*$ .

Considering a unique discrete state  $q$ , this definition is the same that for the systems with continuous dynamics : in one equilibrium point, the vector field is zero. The second condition assures that a changing of discrete state  $q$  keeps the hybrid automaton in the equilibrium point.

**Definition 4** *A switching system is defined as*

$$\dot{x} = f_\sigma(x) \tag{11.21}$$

where  $\sigma : [0, \infty) \rightarrow \{1, \dots, N\}$  is a piecewise constant function and  $f_1, \dots, f_N$  is a family of continuous and differentiable vector fields ( $f_i : \mathbb{R}^n \rightarrow \mathbb{R}^n$ ).

---

3.  $\overline{P(X)}$  represents the set of all subsets of  $X$ .  
 4.  $\overline{D(q)}$  represents the cloture of the set  $D$ .

The switching system defined like above is a hybrid automaton.

**Remark 1**  $\sigma$  can depend on the state ( $\sigma = \sigma(x(t))$ ), on the time ( $\sigma = \sigma(t)$ ) or can depend on both ( $\sigma = \sigma(x(t), t)$ ).

For sake of simplicity, I omit here the definition of stability in the sense of Lyapunov for a hybrid automaton whose idea is the same as the stability in the sense of Lyapunov for continuous systems. The reader is referred for example to [23] for the details.

### Lyapunov stability theorems for hybrid automata

**Multiple Lyapunov functions.** The theorem for the stability proof of a hybrid automaton by multiple Lyapunov functions (see for example [23]) assumes two hypothesis : the first one is the existence of multiple Lyapunov functions, each one nonincreasing along the trajectories of each system in (11.21), corresponding to  $\sigma(t) = k$ , for the different  $k$ 's. The second one is an additional condition due to the use of multiple Lyapunov functions. This condition, illustrated by Figure (11.10), asks that the value of the function  $V_k$  must, in each instant of time that the system accepts the discrete state  $k$ , be inferior of its precedent value for the same state  $k$ . In other words, if instead of only one Lyapunov function for all discrete states, we consider multiple Lyapunov functions (one for each discrete state), the stability of the equilibrium point holds under the condition of the nonincreasiness of the formed sequences (one for each discrete state) of the initial values of the Lyapunov functions corresponding to each discrete state each time the state is active. The mathematical formalism of this theorem can be found in [23]

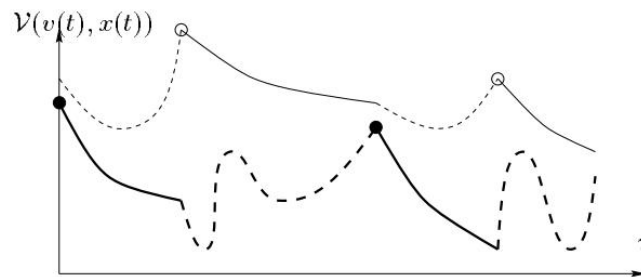

FIGURE 11.10 – Evolution of the multiple Lyapunov function for a stable case.

**Simultaneous Lyapunov function** Differently from the previous stability tool, the main hypothesis here is the existence of only one Lyapunov function (a simultaneous Lyapunov function) such that its derivative along the trajectories of all subsystems in (11.21) are nonincreasing. The mathematical formalism of this theorem can also be found in [23]

The two theorems above involves some quite big constraints. The first implies to check a condition that is very difficult to check and the second can be very conservative since

there is the need to find only one Lyapunov function that proves the stability for all subsystems. Other tools are possible like the stability proof by a piecewise linear or a piecewise quadratic Lyapunov function (the author is referred to the very beautiful PhD work of Prof Mikael Johansson [24]). The study of the infinite norm as a Lyapunov function is another approach that offers the advantage of providing invariant sets in the form of Polyhedra ([28], [29]). Information about these two tools will be given further in the text in Section 9.1.3.

It shall become clear now that if proving the stability of continuous nonlinear systems by Lyapunov is already not a very simple task, to prove the stability of hybrid systems (with possibly also nonlinear dynamics associated to one or more discrete states) is still a more complex challenge.