



HAL
open science

Etude et réalisation d'un système de communications par lumière visible (VLC/LiFi). Application au domaine automobile.

Alin Cailean

► To cite this version:

Alin Cailean. Etude et réalisation d'un système de communications par lumière visible (VLC/LiFi). Application au domaine automobile.. Optique / photonique. Université de Versailles Saint-Quentin en Yvelines, 2014. Français. NNT: . tel-01156468

HAL Id: tel-01156468

<https://hal.science/tel-01156468>

Submitted on 27 May 2015

HAL is a multi-disciplinary open access archive for the deposit and dissemination of scientific research documents, whether they are published or not. The documents may come from teaching and research institutions in France or abroad, or from public or private research centers.

L'archive ouverte pluridisciplinaire **HAL**, est destinée au dépôt et à la diffusion de documents scientifiques de niveau recherche, publiés ou non, émanant des établissements d'enseignement et de recherche français ou étrangers, des laboratoires publics ou privés.

UNIVERSITÉ “STEFAN CEL MARE” DE SUCEAVA

THÈSE

pour obtenir le grade de

Docteur

De l'Université de Versailles Saint-Quentin-en-Yvelines

Spécialité : OPTOELECTRONIQUE

**Study, implementation and optimization
of a visible light communications system.**

Application to automotive field.

Présentée par

Alin-Mihai CĂILEAN

Directeurs de thèse: Luc Chassagne et Valentin Popa

Co-encadrant: Barthélemy Cagneau

Jury :

Co-directeur de thèse:	Luc CHASSAGNE	Université de Versailles, LISV
Co-directeur de thèse:	Valentin POPA	Université de Suceava, Roumanie
Co-encadrant:	Barthélemy CAGNEAU	Université de Versailles, LISV
Rapporteurs :	Gheorghe BREZEANU	Université “Politehnica” de Bucarest, Roumanie
	Moncef KADI	ESIGELEC/IRSEEM
Examineur :	Patrick HÈNAFF	Université de Lorraine
Invité	Mihai DIMIAN	Université de Suceava, Roumanie

Décembre 2014

A

Thank you God!

I would like to sincerely thank all the persons that helped me during these years, during the previous years and to those that will help me in the years to come!

I thank to my thesis director Luc Chassagne for his patience and for his constant help! I thank to my thesis co-director Valentin Popa for his help during this PhD! I would like to thank to my supervisor, Barthélemy Cagneau, for his precious assistance and support! I thank to Mihai Dimian for the advices and the support in pursuing this PhD!

Thank you for guiding me to become a better researcher!

I thank to the reviewers and to the members of the jury that accepted to judge this thesis! I know it is time consuming effort!

I thank to all the personnel and to all the colleagues from LISV and from Suceava!

I thank to all my family for their love and care! Thank you Petruta for being close to me, for your numerous lessons and for all that you did for me! Thank you pr. Dragos for helping me in my worst moments!

Thank you for guiding me to become a better person!

I succeed thanks to You and I fail because of me!

Ω

Acknowledgements



This work was supported in part by the University of Versailles Saint-Quentin and Valeo Industry.

A part of the financial support is granted by the Fond Unique Interministériel (FUI) project named *Co-Drive*, supported by the Pôle de Compétitivité Mov'eo.

This work received financial support through project “Sustainable performance in doctoral and post-doctoral research – PERFORM”, Contract no. POSDRU/159/1.5/S/138963, Project co-financed by European Social Fund through the Sectorial Operational Program, Human Resources Development 2007-2013. Priority Axis 1 - Education and training in support of economic growth and development of a knowledge based society. Major intervention field 1.5 - "Doctoral and postdoctoral programs in support of research".



UNIUNEA EUROPEANĂ



GUVERNUL ROMÂNIEI
MINISTERUL MUNCII, FAMILIEI,
PROTECȚIEI SOCIALE ȘI
PERSOANELOR VÂRSTNICE
AMPOSDRU



Fondul Social European
POS DRU 2007-2013



Instrumente Structurale
2007-2013



MINISTERUL
EDUCAȚIEI
NAȚIONALE
OIPOSDRU



Study, implementation and optimization of a visible light communications system. Application to automotive field.

Abstract

The scientific problematic of this PhD is centered on the usage of Visible Light Communications (VLC) in automotive applications. By enabling wireless communication among vehicles and also with the traffic infrastructure, the safety and efficiency of the transportation can be substantially increased. Considering the numerous advantages of the VLC technology encouraged the study of its appropriateness for the envisioned automotive applications, as an alternative and/or a complement for the traditional radio frequency based communications.

In order to conduct this research, a low-cost VLC system for automotive application was developed. The proposed system aims to ensure a highly robust communication between a LED-based VLC emitter and an on-vehicle VLC receiver. For the study of vehicle to vehicle (V2V) communication, the emitter was developed based on a vehicle backlight whereas for the study of infrastructure to vehicle (I2V) communication, the emitter was developed based on a traffic light. Considering the VLC receiver, a central problem in this area is the design of a suitable sensor able to enhance the conditioning of the signal and to avoid disturbances due to the environmental conditions, issues that are addressed in the thesis. The performances of a cooperative driving system integrating the two components were evaluated as well.

The experimental validation of the VLC system was performed in various conditions and scenarios. The results confirmed the performances of the proposed system and demonstrated that VLC can be a viable technology for the considered applications. Furthermore, the results are encouraging towards the continuations of the work in this domain.

L'étude, la réalisation et l'optimisation d'un système de communication par lumière visible. Application au domaine de l'automobile.

Résumé

La problématique scientifique de cette thèse est centrée sur le développement de communications par lumière visible (Visible Light Communications - VLC) dans les applications automobiles. En permettant la communication sans fil entre les véhicules, ou entre les véhicules et l'infrastructure routière, la sécurité et l'efficacité du transport peuvent être considérablement améliorées. Compte tenu des nombreux avantages de la technologie VLC, cette solution se présente comme une excellente alternative ou un complément pour les communications actuelles plutôt basées sur les technologies radio-fréquences traditionnelles.

Pour réaliser ces travaux de recherche, un système VLC à faible coût pour application automobile a été développé. Le système proposé vise à assurer une communication très robuste entre un émetteur VLC à base de LED et un récepteur VLC monté sur un véhicule. Pour l'étude des communications véhicule à véhicule (V2V), l'émetteur a été développé sur la base d'un phare arrière rouge de voiture, tandis que pour l'étude des communications de l'infrastructure au véhicule (I2V), l'émetteur a été développé sur la base d'un feu de circulation. Considérant le récepteur VLC, le problème principal réside autour d'un capteur approprié, en mesure d'améliorer le conditionnement du signal et de limiter les perturbations dues des conditions environnementales. Ces différents points sont abordés dans la thèse, d'un point de vue simulation mais également réalisation du prototype.

La validation expérimentale du système VLC a été réalisée dans différentes conditions et scénarii. Les résultats démontrent que la VLC peut être une technologie viable pour les applications envisagées.

Table of Contents

Introduction	1
Chapter 1 - Introduction to Visible Light Communications (VLC)	5
1.1 Introduction	5
1.2 The architecture of a VLC system	6
1.2.1 The VLC emitter.....	7
1.2.2 The VLC receiver	8
1.2.3 The VLC channel	9
1.3 VLC Advantages and Drawbacks	10
1.3.1 VLC Advantages	10
1.3.2 VLC weak-points.....	13
1.4 VLC Applications	14
1.5 VLC state of the art	19
1.6 Conclusions	25
Chapter 2 - Visible Light Communications in Automotive Applications	27
2.1 Introduction	27
2.2 Considerations on the Intelligent Transportation System	28
2.3 On the ability of RF communications to support communication based vehicle safety application	31
2.4 The potential usage of VLC in ITS	33
2.5 VLC in the ITS – state of the art	37
2.6 VLC research direction and future challenges	43
2.7 Conclusions	44
Chapter 3 - Considerations on the coding techniques used in Visible Light Communications	46

3.1 The IEEE 802.15.7 Standard for Short-Range Wireless Optical Communication using Visible Light.....	46
3.2 Considerations regarding the coding techniques used for VLC.....	52
3.2.1 Introduction	52
3.2.2 OOK coding techniques for VLC applications	53
3.3 Comparative evaluation of Manchester and Miller code	57
3.3.1 Considerations on multi-channel capabilities for Manchester and Miller codes	58
3.3.2 Flickering issues concerning the Manchester and the Miller code VLC usage	61
3.3.3 Sensitivity to noise	64
3.4 Conclusions	69
Chapter 4 – Development, modelling and evaluation of a Digital Signal Processing VLC architecture.....	71
4.1 Introduction	71
4.2 The premises of the simulations	72
4.3 VLC model development and preliminary evaluation	77
4.4 Evaluation of a multi-data rate DSP VLC architecture	86
4.4.1 The VLC emitter model	86
4.4.1.1 Considerations on the frame structure	87
4.4.2 The VLC receiver model	88
4.4.2.1 VLC Receiver System Model Blocks	89
4.5 The Performance Results of the VLC Model	95
4.6 Conclusions	99
Chapter 5 - Implementation and performance evaluation of a VLC system for vehicle applications	101
5.1 The Co-Drive Project	102
5.1.1 Description of the Co-Drive project.....	102

5.1.2 Main objectives of the Co-Drive project	102
5.2 VLC System implementation and characteristics	104
5.2.1 Considerations regarding the data broadcasting module.....	104
5.2.2 Considerations regarding the data receiving module	107
5.3 VLC System performance evaluation	113
5.3.1 V2V setup and experimental results.....	114
5.3.2 I2V setup and experimental results	117
Experiment 1 – preconditioning stage sensitivity	118
Experiment 2 – Automatic Gain Control Unit	119
Experiment 3 – System calibration by pulse width measurement.....	121
Experiment 4 – Bit Error Ratio for Manchester and Miller coding	122
5.3.3 VLC cooperative architecture setup and experimental results	125
5.4 Conclusions	130
Conclusions and perspectives.....	133
Bibliography	139

List of figures

1 Usage of the LEDs lighting systems for safety message transmission	2
1.1 Architecture of a VLC system: a). Emitter; b). Receiver.	7
1.2 Distribution of the electromagnetic spectrum with the visible light in it.	11
1.3 VLC usage for wireless internet (Li-Fi).....	15
1.4 VLC usage for indoor localization.....	16
1.5 VLC usage in a museum.	16
1.6 Illustrations VLC usage in for data exchange in automotive applications.	17
1.7 VLC usage inside a plane.	18
1.8 VLC prototypes developed by HHI a). VLC emitter; b). VLC receiver; c). Video transmission using VLC.....	21
1.9 VLC prototypes developed at Oxford University.....	22
1.10 VLC prototype developed at Boston University.....	24
1.11 Evolution of the VLC data rates between 2008 and 2014.	25
2.1 ITS architecture including the three major components.	29
2.2 Integration of LEDs lighting systems in series vehicles.....	34
2.3 Examples of LED usage as part of the transportation infrastructure.	35
2.4 VLC usage in a highway scenario.	36
2.5 Experimental setup for the I2V.....	40
2.6 VLC prototype for V2V communication developed at Boston University	42
3.1 IEEE 802.15.7 topologies.	47
3.2 Frequency Division Multiplexing for the three PHY types.....	47
3.3 Structure of the IEEE 802.15.7 data frame	50
3.4 On – Off Keying data coding.	54
3.5 Manchester data encoding.	56
3.6 Miller data encoding.	57
3.7 PSD for NRZ, Manchester and Miller code at 11.67 kHz.....	59
3.8 Simulation for a five channels configuration, using the Manchester code.	60
3.9 Simulation for a five channels configuration, using the Miller code.	60

3.10 Simulation results showing the bytes percentage for different brightness intensities.	62
3.11 Simulation results showing the percentage of MFTP for different brightness percentages. .63	
3.12 Sketch of the VLC receiver.....	65
3.13 Illustration of the possible pulse widths in Manchester and in Miller code.	65
3.14 Simulation results for Manchester and Miller code pulse widths: a). Manchester case b). Miller case.	66
3.15 Average pulse width variation for Manchester and Miller codes, with respect to the SNR..67	
3.16 The output of a 2 nd order filter for a Miller/Manchester encoded signal.	68
3.17 Bit error ratio for Manchester and for Miller codes.	69
4.1 Simplified VLC model.	73
4.2 The architecture of the proposed VLC receiver.....	78
4.3 Manchester pulse widths.....	79
4.4 Pulse width distortion for the Butterworth, Chebyshev and Elliptic filters.....	80
4.5 The influence of the filter order on the filtering quality.	81
4.6 The influence of the cutoff frequency on the filtering quality for the short a.) and the long b.) Manchester pulses.	81
4.7 The influence of the cutoff frequency on the pulse error rate.....	82
4.8 Output of a 2 nd order Butterworth filter for a cutoff frequency of 1.5 (red) respectively 3 (blue) times the modulation frequency.	82
4.9 Pulse error rate for different thresholds.	83
4.10 Structure of the digital frame.	84
4.11 Bit and frame error rate results.	84
4.12 The influence of the sampling frequency on the filtering quality for the short a). and the long b). Manchester pulses.	85
4.13 Synopsys of the VLC emitter.....	86
4.14 Structure of the data frame.....	88
4.15 Synopsis of the VLC receiver model.	89
4.16 The effect of the saturation block on the data signal: a). input of the saturation block and the thresholds; b). output signal for the next filtering block with (red signal) and without (black signal) using the saturation block.	91
4.17 Illustration of the adaptive thresholds.	92

4.18 False triggering prevention using adaptive thresholds; a). no adaptive threshold; b). with adaptive threshold.	93
4.19 Modifications of the signal throughout the blocks of the model: i) representation of the original Manchester encoded message, ii) representation of data message with AWGN (SNR=1 dB), iii) output of a 2 nd order Butterworth filter, iv) representation of the signal after the first reconstruction attempt, v) input for the signal reconstruction block, vi) representation of the reconstructed square signal used for data decoding.....	94
4.20 BER performances at 11.67 kHz.	96
4.21 BER performances at 24.44 kHz.	96
4.22 BER performances at 48.89 kHz.	97
4.23 BER performances for 73.30 kHz.....	97
4.24 BER performances for 100 kHz.....	98
5.1 Cooperative driving based on integrated information technologies	103
5.2 Visible light communication system.	104
5.3 Hardware structure of the VLC emitter.	105
5.4 Structure of the proposed frame.....	106
5.5 Representation of the visible light receiver.	108
5.6 Example of electric signals on the reception board; a). output of the pre-conditioning board; b). output of the conditioning part and c). output of the decoding and decision block. It illustrates that the derivative part emphasizes the front edges.	111
5.7 The flowchart of the AGC gain selection algorithm.	113
5.8 Back light illuminance distribution.....	115
5.9 V2V prototype for data transmission using VLC.	115
5.10 Bit Error Ratio (BER) for Miller and Manchester codes at 10 kHz modulation frequencies.	116
5.11 Traffic light illuminance distribution.....	117
5.12 Sketch of the experiment with the receiver prototype.	118
5.13 Experiment showing the sensitivity of the front stage of the sensor and example of a spectrum in the case of Miller code.	119
5.14 Gain value with respect to the distance when AGC is performed.	120

5.15 Histograms of received pulse widths for both Manchester and Miller configurations; a). Manchester case b). Miller case.....121

5.16 Illustration of the factors that affect the sensor’s performances in the case of green light..124

5.17 Illustration of the proposed cooperative scenario: the traffic light sends a message that is received by the first car and retransmitted to the car behind. 126

5.18 Experimental setup for the VLC cooperative architecture; the LED traffic light broadcasts traffic safety messages127

5.19 Illustration of the second cooperative scenario: both the vehicles are within traffic light’s service area but there is no LoS with the second vehicle. 128

List of Tables

3.1 Device classification according to IEEE 802.15.7.50

3.2 4B6B coding table according to the IEEE 802.15.7 standard.55

4.1 Traffic Signal Violation Warning Data Message Set Requirements 76

4.2 Ratio between BER and FER85

5.1 Bit Error Ratio (BER) for Miller and Manchester codes at 15 kHz modulation frequency using a photodiode as a photosensitive element.122

5.2 Bit Error Ratio (BER) for Miller and Manchester codes at 15 kHz modulation frequency; green and red light have been tested in different conditions.123

5.3 Cooperative setup - Bit Error Ratio (BER) for Miller and Manchester codes at 15 kHz - Scenario 1..... 127

5.4 Bit Error Ratio (BER) for Miller and Manchester codes at 15 kHz for I2V, V2V and I2V2V – Scenario 2129

List of abbreviations:

ADC	Analog to Digital Converter
AWGN	Additive White Gaussian Noise
ASCII	American Standard Code for Information Interchange
AGC	Automatic Gain Control
BER	Bit Error Ratio
CSMA/CA	Carrier Sense Multiple Access/ Collision Avoidance
DC	Direct Current
DD	Direct Detection
DMT	Discrete Multi-tone Modulations
DOT	Department Of Transportation
DSP	Digital Signal Processing
DSRC	Dedicated Short Range Communications
DSSS	Direct Sequence Spread Spectrum
FDM	Frequency Division Multiplexing
FOV	Field of View
FPGA	Field Programmable Gate Array
HPA	Half Power Angle
IEEE	Institute of Electrical and Electronic Engineers
IM	Intensity Modulation
IR	Infrared
ITS	Intelligent Transportation System
IVX	Inter-Vehicle Communication
I2V	Infrastructure to Vehicle
LED	Lighting Emitting Diode
Li-Fi	Light Fidelity
LoS	Line of Sight
MAC	Medium Access Control
MCS	Modulation and Coding Scheme
MFTP	Maximum Flickering Time Period

List of abbreviations

ML	Message Length
MIMO	Multi Input Multi Output
NRZ	Not Return to Zero
OFDM	Orthogonal Frequency Division Multiplexing
OLED	Organic Lighting Emitting Diode
OOK	On Off Keying
OPD	Organic Photodetectors
PDR	Packet Delivery Ratio
PHY	Physical Layer
PWM	Pulse Width Modulation
PN	Pseudo Noise
PWM	Pulse Width Modulation
PSD	Power Spectral Density
RLL	Run Length Limiting
RSU	Road Side Unit
RF	Radio Frequency
SIK	Sequence Inverse Keying
SNR	Signal to Noise Ratio
VANET	Vehicular Ad-hoc Networks
V2V	Vehicle-to-Vehicle
VLC	Visible Light Communications
VLCC	Visible Light Communication Consortium
VVLC	Vehicular Visible Light Communications
VPPM	Variable Pulse Position Modulation
WDM	Wave Division Multiplexing
WAVE	Wireless Access Vehicular Environments

Introduction

Context

Visible light communication (VLC) is an emergent wireless communication technology which uses the visible light not just for illumination or signaling purposes but also as a carrier for digital transmission. Basically, a VLC emitter modulates the message to send onto the instantaneous power of the light. At the receiver side, the data is extracted using a photosensitive element able to detect the variations of the light intensity. A main advantage of VLC is the usage of the existing LEDs lighting systems which makes it omnipresent and significantly reduces its implementation cost. The VLC technology is developing in the context of an increasing demand for wireless communications in more and more areas. Furthermore, the radio frequency based communications begin to show their limitations. The limited availability of the spectrum and the increasing number of nodes affect the performances and the reliability of the link. Under these circumstances, it is obvious that a new wireless communication technology is required. Besides its ubiquitous character, VLC offers a huge bandwidth available free of charge, enabling high data rate communications.

A particular domain in which wireless communications are required is in transportation, especially in the automotive field. By using wireless communications, safety messages can be transmitted from the traffic infrastructure to the approaching vehicles and also from one vehicle to another. Furthermore, vehicles share data concerning their state (e.g. location, velocity, acceleration, etc.). The received data increases the vehicle awareness and enables the development of a new generation of vehicle active safety systems. Beside safety, communications can be used to increase the efficiency of the transportation system by providing location services and optimized alternative routes.

In the context in which the LED lighting began to be widespread in transportation, being integrated in traffic infrastructures (in traffic lights, street lighting and traffic signs) and in the vehicle lighting systems, VLC seems to be appropriate for providing wireless data exchange for automotive applications. In this domain, the VLC usage does not exclude radio frequency communications, since the two are fully compatible with each other. Furthermore, the necessity of using VLC in vehicular applications is well motivated. In high traffic densities, as in crowded cities or on highways, the ability of radio frequency communications to support vehicular

communications is rather questionable because of the mutual interferences. On the other hand, since VLC is a line of sight technology, it is able to successfully support communications even in high traffic density.

Motivation of the work and sketch of the thesis

Considering the advantages of the VLC technology, *the main objective of this thesis is the implementation and the evaluation of a VLC system aimed for long distances and suitable to work in outdoor conditions*. A possible application for the system would be in vehicular communications. The systems should use the light produced by the LEDs integrated in traffic infrastructures, such as a traffic light, and/or in the vehicle lighting system to enable wireless data transfer. As illustrated in Figure 1, by using the light produced by the fast switching LEDs, traffic safety information exchange should be enabled with the purpose of improving the safety and the efficiency of the transportation system. In order to be able to work outdoor, the proposed system should be highly robust to perturbations, as the sunlight or the artificial light. The cost of the whole system must be reduced to make sure that a high market penetration is possible.

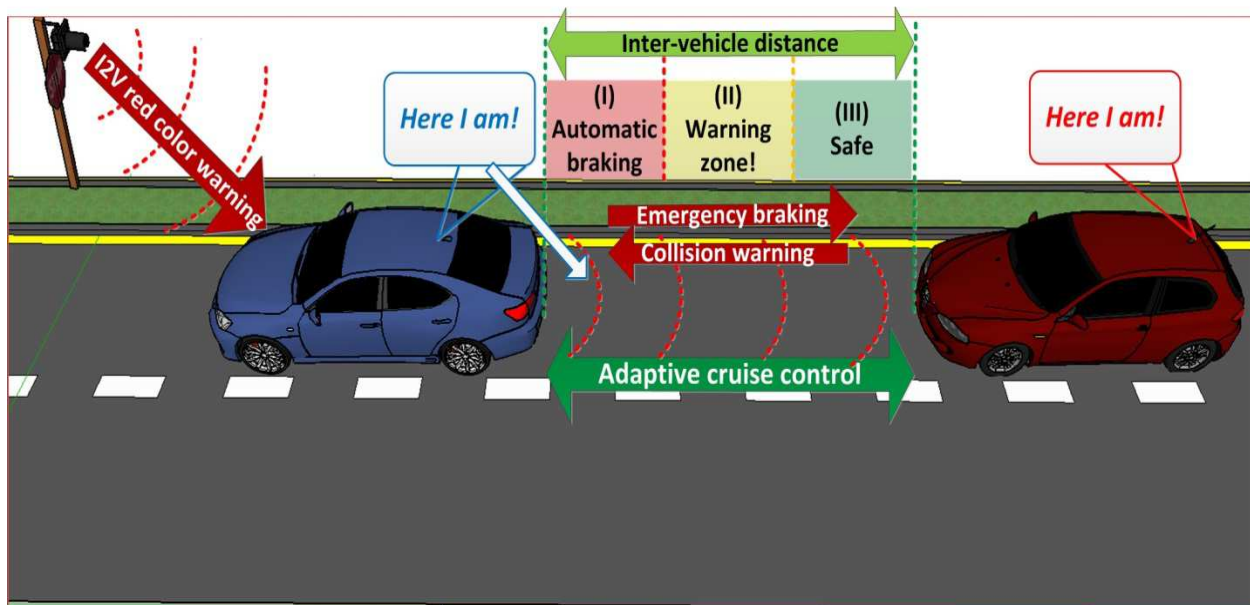

Figure 1: Usage of the LEDs lighting systems for safety message transmission.

This thesis contains in its structure five main chapters:

The first chapter of the thesis, titled “*Introduction to Visible Light Communications*” aims to present the concepts of the VLC technology. This chapter presents the general structure of a VLC system, discussing the issues related to it. It intends to answer the “*Why VLC?*” question by highlighting the advantages of this new wireless communication technology. However, like any emergent technology, VLC also has its drawback, which are being discussed and analyzed. Further on, from the analysis of the advantages and disadvantages, the possible applications of VLC are identified and debated. This chapter also describes the research efforts made in the VLC development. The most representative research directions as well as the corresponding results are exposed and geographically structured. This way, a VLC timeline evolution is presented.

The second chapter, entitled “*Visible Light Communications in automotive applications*” addresses the specific issues related to the usage of wireless communications in vehicle applications. This chapter discusses some of the requirements imposed for such applications and points out some of the weaknesses of the radio frequency communications in certain scenarios. Next, this chapter presents the reasons for using VLC in some of the situations. It also illustrates the state of the art in this field. The chapter ends by pointing out the challenges related to the VLC usage in vehicular communications.

The third chapter, entitled “*Considerations on the coding techniques used in Visible Light Communications*” begins with an analysis of the IEEE 802.15.7 standard for wireless communications using the visible light and with a brief description of the coding techniques specified by the standard for the case of the outdoor applications. However, considering the future requirement for parallel VLC, the Miller code is introduced as well. The rest of this chapter presents the results of a series of tests meant to investigate the performances of the standard Manchester code, comparing them to those of the proposed Miller code. The results showed that the Miller code is fully compatible with VLC and in addition it offers the premises for future Multiple Input Multiple Output (MIMO) applications.

The fourth chapter, entitled “*Development, modeling and evaluation of a Digital Signal Processing VLC architecture*” proposes a digital structure for the VLC receiver. The proposed VLC receiver uses numerical signal processing and is designed for multi-data rate communications. Its suitability for the envisioned applications is investigated and we evaluate

the influence of the modulation frequency, of the noise and of the message length on its performances.

The fifth chapter, entitled “*Implementation and performance evaluation of a VLC system for vehicle applications*” presents a series of contributions towards the employment of a new VLC prototype meant for automotive applications. The second part of this chapter presents the experimental performance evaluation and the experimental results. This part proves the performances of the prototype and its suitability for the envisioned applications.

The final chapter, entitled “*Conclusions and perspectives*” ends this thesis, summarizing the theoretical, practical and experimental contributions of the thesis. This chapter also draws the future research directions and the future developments.

Chapter 1

Introduction to Visible Light Communications (VLC)

Contents

1.1 Introduction.....	5
1.2 The architecture of a VLC system	6
1.2.1 The VLC emitter	7
1.2.2 The VLC receiver.....	8
1.2.3 The VLC channel	9
1.3 VLC Advantages and Drawbacks.....	10
1.3.1 VLC Advantages	10
1.3.2 VLC weak-points	13
1.4 VLC Applications	14
1.5 VLC state of the art.....	19
1.6 Conclusions.....	25

This chapter aims at providing an introduction to the VLC technology. It illustrates the architecture of a VLC system, highlighting the advantages and the drawbacks of the technology. Based on these features, several top applications of VLC are identified and discussed, pointing out the benefits of VLC usage. This chapter also presents the main VLC research topics and the leading working groups from each of the fields. Thus, the chronological and the regional evolution of the VLC systems are illustrated. The chapter ends with several conclusions about the VLC state of the art.

1.1 Introduction

In recent years, the modern society presented an increasing interest in wireless communication technologies and the demand for wireless data transfer it is expected to increase exponentially in the next five years [1]. The solution for this unprecedented demand was, in

most cases, satisfied by radio frequency (RF¹) type communications. Due to the maturity level and wide acceptance, RF communications are at this time the best solution for wireless communications. However, this technology has its drawbacks, such as the limited bandwidth. Besides this, there are some cases or scenarios where the use of RF can cause interferences such as in aircrafts, airports or hospitals.

Meanwhile, the development of the Solid State Lighting (SSL) devices, especially of Light-Emitting-Diodes (LEDs), had a huge growth. Nowadays, LEDs are highly reliable, energy efficient and have a life-time that exceeds by far the classical light sources. Considering the numerous advantages, LEDs began to be used in more and more lighting applications and it is considered that, in the near future, they will completely replace the traditional lighting sources [2] - [5]. Beside these remarkable characteristics, LEDs are capable of rapid switching, which enables them to be used not only for lighting but also for communication.

Visible Light Communication (VLC) represents a new communication technology that uses energy efficient solid-state LEDs for both lighting and wireless data transmission. VLC uses the visible light (380-780 THz) as a communication medium, which offers huge bandwidths free of charge, it is not limited by any law and it is safe to human body, allowing for high power transmissions. VLC has the potential to provide low-price, high-speed wireless data communication. Even if VLC is a new technology, it had a fast development, which is a proof of its huge potential. In just 6 years, the maximum data rate reported for VLC systems evolved from 80 Mb/s in 2008 [6] to 3000 Mb/s in 2014 [7].

1.2 The architecture of a VLC system

A VLC system mainly consists of a VLC transmitter that modulates the light produced by LEDs and a VLC receiver based on a photosensitive element (photodiode) that is used to extract the modulated signal from the light. The transmitter and the receiver are physically separated from each other, but connected through the VLC channel. For VLC systems, the line-of-sight (LoS) is a mandatory condition. A schematic of a VLC system is illustrated in Figure 1.1.

¹ Within this thesis, the terms “radio” or “radio frequency” (“RF”) refer to the frequency band from 3 kHz up to 300 GHz, including the frequency bands that are referred to as “radio frequency”, “microwaves” and “millimeter waves”.

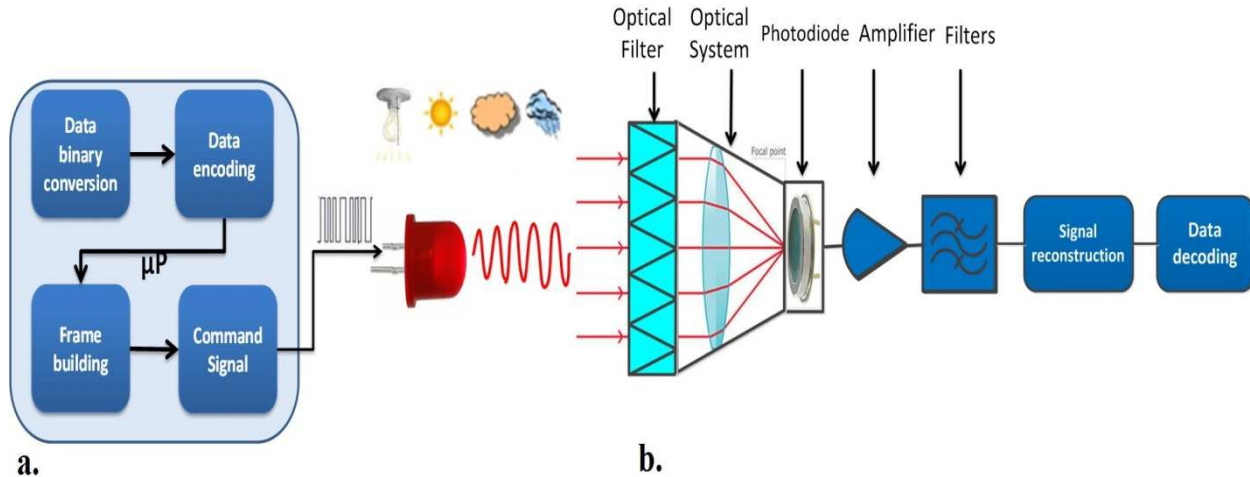

Figure 1.1: Architecture of a VLC system: a. Emitter; b. Receiver.

1.2.1 The VLC emitter

A VLC emitter is a device that transforms data into messages that can be sent over the free space optical medium by using visible light. The purpose of the VLC emitter is to emit light and to transmit data at the same time. However, the data transmission must not affect in either way the primary goal of the appliance which is illumination or signaling. From this concern, the VLC emitter must be able to adapt to the lighting requirements. It means that it is supposed to use the same optical power or if the application requires it, to allow for dimming. Also, the VLC emitter must not induce any noticeable flickering.

The core component of the VLC emitter is the encoder which converts the data into a modulated message. The encoder commands the switching of the LEDs according to the binary data and to the imposed data rate. The binary data are thus converted into an amplitude modulated light beam. Generally, the light produced by the LEDs is current modulated with On-Off Keying (OOK) amplitude modulation, but other modulation techniques, like Orthogonal Frequency Differential Modulation OFDM [8], Discrete Multi-Tone modulation (DMT) [9] or Direct Sequence Spread Spectrum (DSSS) [10] can be used. A cost effective solution for the encoder is represented by the usage of microcontrollers. In most of the cases, their performances are high enough to ensure relatively good performances. However, in more complex applications, the microcontroller can be replaced by a Field Programmable Gate Array (FPGA) which will be able to provide enhanced performances with the help of digital signal processing techniques.

The parameters of the VLC emitter are mainly limited by the characteristics of the LEDs. The data rate (transmission frequency) depends on the switching abilities of the LEDs while the emitter's service area depends on the transmission power and on the illumination pattern (emission angle). Currently, the SSL industry is able to produce LEDs that can offer switching frequencies of few tens of megahertz.

1.2.2 The VLC receiver

The VLC receiver is used to extract the data from the modulated light beam. It transforms the light into an electrical signal that will be demodulated and decoded by the embedded decoder module. Depending on the required performances and on the cost constraints, the decoder can be a microcontroller or a FPGA. The careful design of the VLC receiver represents a serious issue because in most applications, the VLC receiver's performances have the greatest influence on the performances of the VLC system, determining the communication range and the resilience against interferences.

Generally, the VLC receivers are based on photosensitive elements which have high bandwidth and offer the possibility of high-speed communications. However, since the incident light is not only due to the emitter but also from other light sources (artificial or natural), the receiver is subject to significant interferences. The performances of the VLC receiver can be enhanced using an optical filter that rejects the unwanted spectrum components, such as the IR component. Moreover, in high speed applications using white LEDs, the optical filter allows only the passage of a narrowband radiation, corresponding to the blue color. The reason for this choice is that the white light is obtained from blue LEDs and yellow phosphor, and since the switching time of the blue LEDs is shorter, higher data rates are enabled [6], [11].

The effect of the interferences can be also reduced by narrowing the receiver field of view (FOV), which influences the service area. A wider FOV enables a wider service area but this comes with the disadvantage of capturing more noise, leading to SNR degradation. However, indoor short-range applications require increased mobility and the possibility of narrowing the FOV is not considered in most of the cases. On the other hand, for outdoor long-range applications, where the range induces small angles, the narrow FOV is an effective solution. Theoretical and experimental studies showed that a narrow FOV helps VLC systems improve their robustness to noise due to daylight or from other VLC transmitters [12]. The

receiver FOV is determined by the FOV of the optical system, which also concentrates the light on the photodetector by using a lens. The photodetector is usually based on a reverse biased silicon photodiode operating in photoconductive mode that generates a current proportional to the incident light. The value of the photocurrent also depends on the photodiodes spectral sensitivity. From this reason, increasing the area of the photodetector can enhance the performances of the system. However, the area of the photodetector strongly influences its capacitance, which in turn influences the achievable bandwidth. In these circumstances, choosing the photodetectors area represents a tradeoff between SNR and bandwidth. Next, due to the small values of the generated photocurrent, a transimpedance circuit is used to transform the small current into a voltage. The transimpedance solution offers a fair trade between gain-bandwidth product (GBP) and noise. The voltage provided by the transimpedance circuit is amplified and filtered to remove high and low frequency noise, and also the DC component. After all these operations, the signal should correspond to the emitted signal containing the data. The data processing unit decodes the information from the reconstructed signal obtaining the binary message.

1.2.3 The VLC channel

The two main components of VLC are interconnected through the free space optical communication channel. As the visible light is an electromagnetic radiation, similar to all electromagnetic radiations, its intensity decreases with the square root of the distance as it passes through the communication channel, making the signal that arrives at the receiver to be very low. Moreover, the VLC channel could contain numerous sources of optical noise. In daytime, the most important source of noise is the sun. Other sources of noise are represented by VLC transmitters or any source of light with or without data transmission capabilities. Artificial light switching or the dynamic conditions make also the VLC channel very unpredictable. In the case of outdoor VLC applications, the unpredictability is even greater because of the weather. Water particle from rain, snow, or heavy fog can affect the VLC link by causing scattering of the light containing the data. The multitude of noise sources, together with the low signals especially at long distance, significantly affects the SNR in VLC. Another characteristic of the VLC channel comes from the stringent LoS conditions, which limits the multipath propagation. In VLC the multipath has a limited effect which is experienced only at short emitter – receiver distances

[12]. As already mentioned, the SNR can be enhanced at the receiver by using optical filters, by an adequate design of the optical system, or by using adaptive gain and adaptive filtering.

1.3 VLC Advantages and Drawbacks

Due to the unique characteristics and advantages, VLC is considered to be the next generation of wireless communications. VLC seems to be the solution for some of the problems that remained unsolved until now. It comes with the benefits of the visible light namely: high-bandwidth free of charge which allows for high data rates, unlicensed spectrum, and safety for human body and for high-precision electronic equipment. VLC is also considered more secure than RF and the data transmission is available in addition to the lighting function. Besides these benefits, VLC is a low cost technology and is easy to implement. The advantages and the drawback of the VLC will be further analyzed in the following sections.

1.3.1 VLC Advantages

High bandwidth

The RF communications come with an available spectrum of 300 GHz, which is used for different types of applications such as: AM and FM radio broadcasting, television broadcasting, GSM, military applications or satellite communications. In this case, operating a certain band implies having a license for it. Due to the many applications which use the RF spectrum, the networks are often saturated. The extension of the bandwidth is very expensive and in most of the cases this is not even possible. Furthermore, while moving to the higher frequency spectrum, the complexity of the equipment increases, making such devices very expensive. The Industrial, Scientific and Medical (ISM) band offers unlicensed access but the available bandwidth is limited.

On the other hand, as illustrated in Figure 1.2, VLC takes full advantage of the usage of the visible light spectrum which is between 380 and 780 THz, adding 400 THz off available bandwidth for wireless communications. In these circumstances it can be stated that VLC comes with worldwide, unregulated and almost unlimited bandwidth offering the premises for multi-Gb/s data rates compared with RF, which rarely can provide data rates above 100 Mb/s.

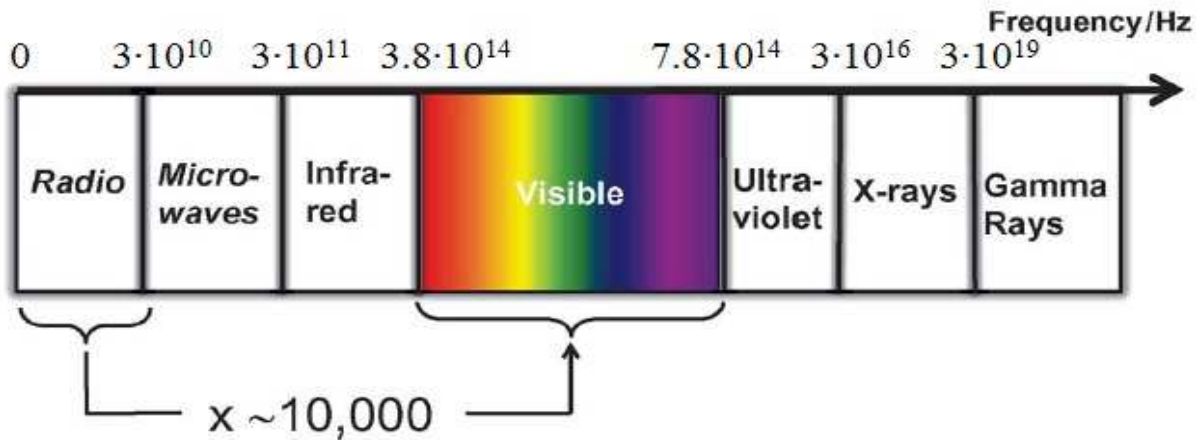

Figure 1.2: Distribution of the electromagnetic spectrum with the visible light in it.

Safe for the human health

The usage of the visible light as a carrier for the data enables VLC to be completely safe for the human health. Even if the RF negative effect on the human health is not fully demonstrated, there are many voices from the medical area which point out this fact. Moreover, RF electromagnetic waves are currently classified as a possible cause of cancer in humans by the World Health Organization [13], [14]. Regarding the infra-red light (IR) which is also used for wireless communications, it is well known that it has a heating effect on the incident surface. From this reason, high power IR light can cause irreversible thermal damage of the cornea, making it harmful for the human eye [15]. Under these conditions, being safe for the human body can be one of VLC's strongest advantages. Being safe to human health enables the possibility of high power transmissions which is another advantage of VLC.

Unrestricted technology

RF communication can cause malfunctions of the high precision electronic equipment as the one found in hospitals or in aircrafts and for this reason, such places are RF restricted. On the other hand, besides being safe for the human body, VLC is safe also for the high precision electronic equipment, enabling its usage in such places.

Security

Unlike RF waves, the light cannot penetrate through walls, providing VLC with high security against eavesdropping. In VLC, one can basically see the data and ensure the security of

the data simply by closing the door. This makes VLC to be suitable in military applications or in areas of high security.

Low cost implementation

Compared with other wireless technologies, VLC comes at a lower price thanks to some of its characteristics. Unlike RF, that uses a regulated band, VLC uses the visible light for communication, which is in an unlicensed region of the electromagnetic spectrum. Since no cost for a license is implied, the implementation cost is significantly reduced.

A second advantage that helps VLC reducing the implementation cost of such systems is its ubiquitous nature. VLC will rely on existing infrastructures that is already accepted and widespread across the world, thanks to the numerous advantages offered by LED lighting sources. This feature will make the implementation of VLC simple, without requiring complex modifications on the existing infrastructure.

The third aspect which enables VLC to reduce the implementation cost is its reduced complexity. VLC basically uses LED emitters and photodiode receivers, components which are inexpensive.

Green wireless communication technology

While the Earth's population is increasing and the human society is developing, the natural resource consumption and the climate deteriorations are also increasing. Greenhouse gas emissions have reached alarming levels that are producing significant climate changes that affect the whole ecosystem [16]. The natural resource consumption and the pollution can be significantly reduced by decreasing the energy consumption. Artificial lighting, commonly provided by electric lights, represents a significant percent of the energy consumption. Worldwide, approximately 19% of electricity is used for lighting, while electricity represents 16% of the total energy produced [17], [18].

Besides the upper mentioned advantages, VLC is also a green wireless communication technology. VLC is green firstly because it does not use additional power for the communication. The same light which is used for illuminating or signaling is used for carrying the data. Another important advantage of VLC is the usage of LEDs which provides substantial energy savings, reducing the CO₂ emissions.

1.3.2 VLC weak-points

As exposed by now, VLC is a technology that has plenty of important advantages. However, like any other technology, VLC has also several drawbacks. Some of the disadvantages are due to the early stage of the VLC technology and could be overtaken as the technology is fully developed. The others ones are due to the usage of the light and its characteristics. For the later ones, it will be difficult to completely mitigate them, but their effects could be reduced or the communication could be adapted to the situations. The strongest disadvantages of VLC and the possible solutions for their mitigation will be further discussed.

Stringent LoS condition

Generally, LoS maximizes the power efficiency and minimizes multipath distortion. In some of the cases the mandatory LoS condition can be considered as an advantage because the interferences from other receivers are limited and the communication security is enhanced. However, there are other applications where this issue is considered as a strong disadvantage. Non-LoS communications are considered to be more reliable, flexible and robust. The mandatory LoS condition has a negative effect on mobility and, in some areas, it represents VLC's greatest disadvantage because an object interposed between emitter and received can block the communication, unless an alternate route is available.

Possible solution:

By using multi-hop communications and retransmissions, the data can reach at users that are located outside the emitter's LoS but are in the LoS of another transceiver. An alternative solution for this problem is to combine VLC with RF as proposed in [19]. In this case, when a node cannot be addressed by VLC it is addressed by RF.

Limited transmission range

When considering the transmission range, VLC cannot compete with RF communications. Even if the VLC transmission range can be increased by optimizing the emitter and receiver parameters, VLC communication range is still significantly shorter than RF communication range. On the emitter's side, the communication range can be increased by increasing the transmission power or by using a more directive light beam. On the receiver's side, the range can be increased by using different techniques for Signal to Noise Ratio (SNR)

enhancement, such as narrow Field of View (FOV) receiver, optical lens or different filtering techniques.

Possible solution:

Besides the enhancement of the emitter and receiver, the multi-hop networking can be again a solution that significantly increases the communication range of VLC systems.

Susceptibility to interferences

Another disadvantage of the VLC is its susceptibility to interferences. VLC is likely to be affected by other illuminating devices such as incandescent or fluorescent light sources. Generally, these light sources produce low frequency noise which can be removed with a high pass filter. Besides the artificial light sources, in outdoor applications, the sunlight represents a very strong perturbing factor. The sun produces unmodulated light which introduces a strong DC component that can be removed with capacitive DC filters. However, high intensity optical noise can saturate the receiver, blocking the communication.

Possible solution:

The effect of other light sources can be reduced by using optical filters, by reducing the receiver FOV and by filtering the unwanted frequencies. Even if the mentioned techniques mitigate the effect of the interferences, high levels of noise still affect the communication performances.

1.4 VLC Applications

By taking benefit of the upper mentioned advantages, the VLC technology has numerous applications in which it could fit in. In some of the application VLC seems to be the only choice, whereas in others it can be a complementary solution for the RF communications, improving the overall performances. Hereafter, some of the most representative applications envisioned for VLC are discussed.

Li-Fi

One of the most important applications envisioned for VLC is providing of Light-Fidelity or “optical Wi-Fi”. Thanks to the huge available bandwidth, VLC could enable high speed internet connections from the ceiling lamp. Li-Fi is favored in this case by the fact that the distances involved are just of few meters, equivalent to the distance between ceiling and office.

In this area, VLC is considered to be able to provide multi Gb/s connections. As illustrated in Figure 1.3, the data coming from the internet is transformed by a Li-Fi router into a signal which is applied to the light source. The light source will switch on and off at frequencies, unperceivable by the human, according to the data to send. The receiver transforms the light signal into numerical data which will be delivered to the mobile terminal. Concerning the upload, it can be performed using an infrared link.

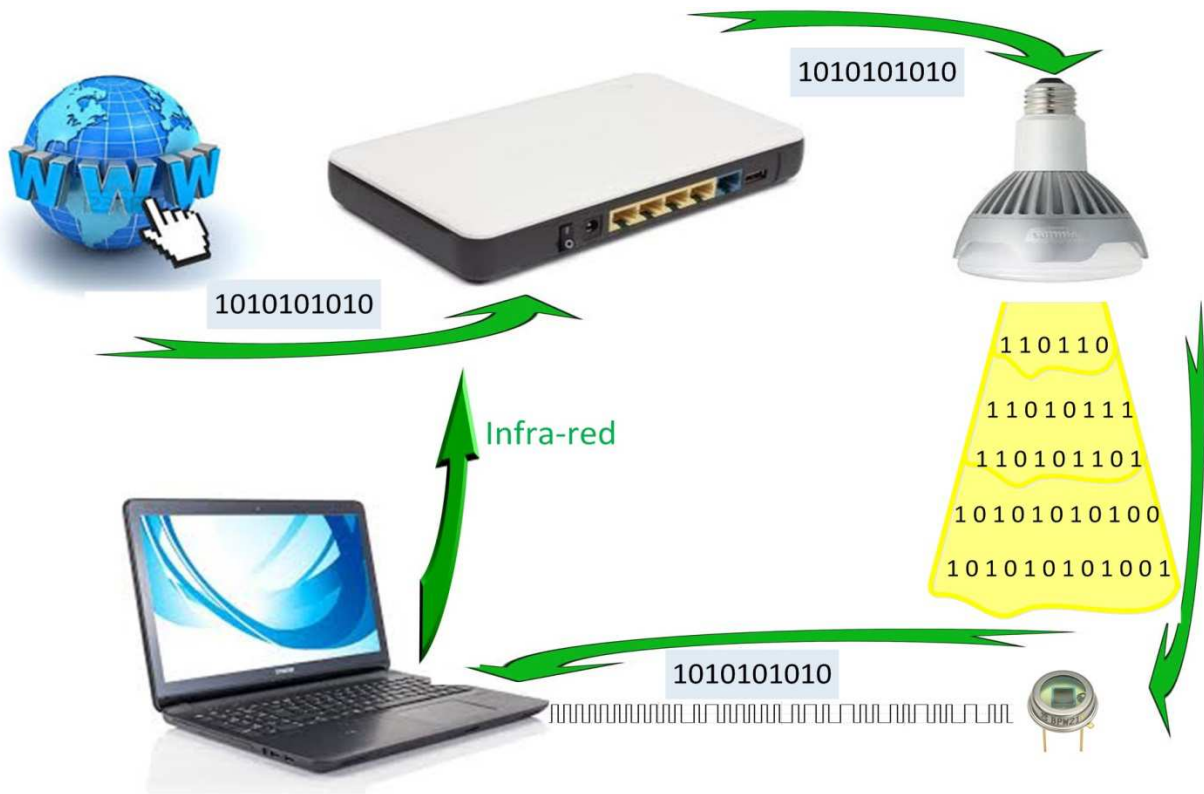

Figure 1.3: VLC usage for wireless internet (Li-Fi).

The fast evolution and the huge potential of the Li-Fi technology contributed to the foundation of the Li-Fi Consortium in 2011 [20]. The organization brings together the leading companies and research institutions from the optical communication technology and aims at contributing to the development of the technology.

Indoor localization

In addition to Li-Fi, VLC can provide very efficient indoor localization. By determining the received signal strength or the time of flight and by using the triangulation technique, VLC is able to provide localization at centimeter accuracy. In this type of applications VLC is very

convenient since the classical GPS is not able to work inside buildings. Such a scenario, where VLC is used for indoor localization, is proposed in [21] and illustrated in Figure 1.4. The indoor localization is also possible by providing the ID of the lamp, which includes its coordinates.

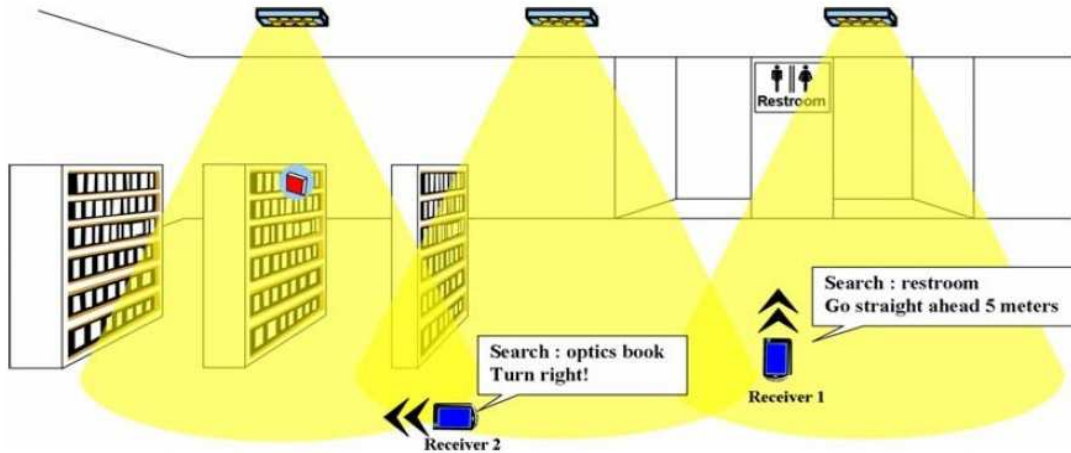

Figure 1.4: VLC usage for indoor localization[21].

Creating smart places

VLC could be also used to create smart places as in museums, by providing geo-localized information. This way, the information about the exhibits can be provided to users' smartphones or tablets by using the indoor light. The usage of VLC in a museum is illustrated in Figure 1.5.



Figure 1.5: VLC usage in a museum [22].

Transportation

The intelligent transportation system (ITS) is a particular area where VLC could be very useful. An important segment of both the academia and the industry considers that VLC could be

used in ITS to enable vehicle-to-vehicle (V2V) and/or infrastructure-to-vehicle communication (I2V). Even if VLC cannot compete with RF in terms of range at this time, VLC appears to be the solution in the case of high traffic density scenario, where RF is most likely to present severe issues that question the reliability of the communication. The ability of the RF communications to support the envisioned vehicular application will be investigated in the next chapter, where numerous arguments will be provided.

In ITS, VLC has the advantage that LEDs lighting systems already began to be integrated in traffic infrastructures and in the vehicle lighting systems. A scenario of using VLC for traffic applications is illustrated in Figure 1.6. A security vehicle can proceed on a damaged car and communicate about the situation around the accident area. One car receives the data and relays the information on its line. This information can be transmitted to the front car with the headlights and also to the followers with the red back-lights. Data are thus propagated on the motorway. Furthermore, cars on the same line can also communicate with each-other about their mechanical state, like speed, acceleration, braking action or other data to enhance the traffic and its security.

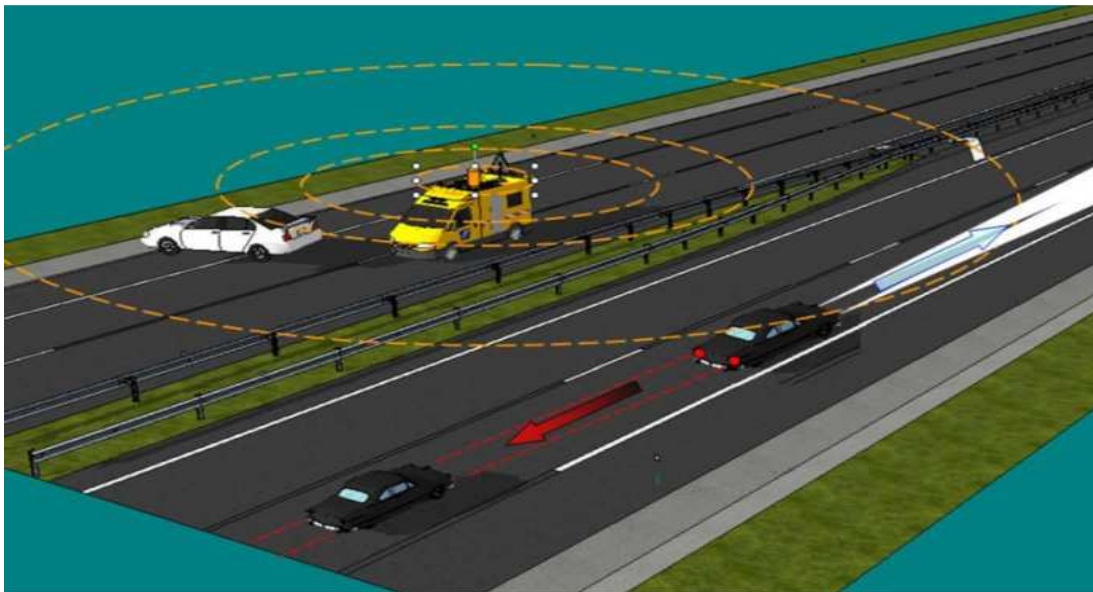

Figure 1.6: Illustrations VLC usage in for data exchange in automotive applications.

RF spectrum relief

The usage of VLC does not exclude or affect in either way the usage of RF based communications, meaning that the two could be used together. In this case, VLC can take some

of the load from the already over crowded RF spectrum. A proposed cooperation of the two wireless technologies considers the usage of VLC for high data rate broadcast from the Li-Fi router to the mobile terminal while the mobile terminal will communicate with the router by using RF.

Provide wireless communication in RF restricted areas

Due to its nature, VLC can be safely used to provide wireless communications in areas where RF communications are restricted. For example, due to the risk they pose [23], the usage of RF communications in hospitals and in health care units are restricted, especially in operating theatres and around MR (magnetic resonance) scanners. However, in such places the information exchange is possible by using a VLC system as the one presented in [24]. Aviation is a restricted area for RF communications. VLC can be also used in hazardous environments where there is a risk of explosions, such as in mines, chemical plants or oil rigs. In all these areas, where RF communications are restricted due to the risk they pose, VLC can be successfully used, not mentioning that the communication capability is a complement to the already existing lighting systems.



Figure 1.7: VLC usage inside a plane [25].

Underwater communications

Unlike RF communications which are not able to provide under water communications, VLC can be used in this environment. In this case, VLC can provide short range communications which can enable divers to communicate with each other or with the base station.

1.5 VLC state of the art

The potential advantages of the VLC technology convinced research groups from different parts of the world to put their efforts into the development of this technology. However, in the early years, the VLC research was mostly considered in the Asian countries. As the huge potential of VLC began to be revealed, research laboratories from Europe and USA began to work in this field and added significant contributions to the VLC progress. The following section presents some of the most representative VLC research directions along with the most representative research centers working on the specific fields. Some of the most representative results for each direction are also illustrated.

VLC research in Asia

The usage of the LED light for communication purposes was firstly considered and developed in Asia. From the Asian countries, Japan was the most active one in the VLC research, being a pioneer in this area. The interest for this technology was confirmed in November 2003 with the establishment of the Visible Light Communication Consortium (VLCC) [26]. VLCC joined together the major companies of Japan and part of the academia, with the aim of developing, publicizing and standardizing the VLC technology. They considered that VLC can add value to numerous industry fields by taking advantage of its simplicity and its ubiquitous characteristic. The activity of the VLCC has significantly contributed to the VLC development and worldwide extending.

Keio University (Japan)

The pioneers of the indoor VLC are Nakagawa et al. from the Keio University. As the performances of the new high brightness LEDs began to be confirmed and as their improved performances were indicating that in future the lighting systems will be LED-based, the researchers from Keio University saw the opportunity that the new lighting technology brings. So, in 2000 [27] and 2001 [28], they published the first papers in which they analyzed the potential performances of the indoor VLC systems. Even from this early stage, the usage of the OOK and OFDM modulations was considered with achievable data rates of up to 400 Mb/s. In the next phase of the study, they proposed the usage of VLC in an integrated communication network where the LEDs are controlled using the existing power line through the usage of Power Line Communications (PLC) [29]. In 2004, they published a complex fundamental analysis of

VLC and concluded that data rates up to 10 Gb/s are achievable [30]. In 2007, they also took into consideration the brightness control methods and analyzed the impact of the Pulse Width Modulation (PWM) and of the changing modulation depth technique for brightness control [31]. In 2008 and 2009, they consider the usage of VLC for high-accuracy positioning [32], [33].

Even if the work of the Nakagawa et al. is mainly concerned of the theoretical and numerical analysis of VLC, they have the merit of identifying, even from the early stages, the main application areas of VLC. It is also worth mentioning that the Keio University research group was part of the VLCC and that it had clearly dominated VLC research until 2007, year when several other research groups from different parts of the world began to focus their research efforts toward VLC.

Yonsei University (South Korea)

The researchers from Yonsei University are also very active in the development of VLC, their research efforts being focused on VLC usage for indoor positioning. In 2011 they proposed a positioning method based on carrier allocations. The receiver location is determined with 6 cm accuracy, using the information provided by three VLC emitters. The receiver determines its relative location based on the Received Signal Strength (RSS) and by using the trilateration method [34]. These results were obtained for emitters – receiver distance of 60 cm. An even more accurate system is proposed in 2012, where location codes are used [35]. To mitigate the interferences between the three emitters, the location codes are sent by using time division multiplexing. The experimental results demonstrate the high accuracy of the proposed method, with location errors below 2 cm for emitter - receiver distance of 150 cm. The group took their research further, and developed a 3D localization system. In this case, the localization error is below 4 cm for emitters – receiver distances of 90-160 cm [36], [37].

VLC research in Europe

Even if in Europe the VLC research had begun later compared with the Asian countries, the European research laboratories performed very well in this domain during the recent years. Some of the most successful European groups are presented hereafter with their most representative results.

Fraunhofer Institute for Telecommunications from Heinrich Hertz Institute (HHI)

One of the most important VLC research groups, not just from Europe but worldwide, is the group from the HHI, Germany. They began their research as part of the Omega project which

was founded by the European Union. The Omega project involved the collaboration with other research groups such as Siemens Technology or France Telecom and aimed towards the development of high performances wireless gigabit home networks.

The work of the HHI was focused on the development of high data rate VLC systems. This is one of the groups that continuously improved their results establishing new standards in VLC. Their first experimental results were presented in 2008 [38]. By using a PIN photodiode based receiver, they were able to obtain a data rate of 40 Mb/s using OOK and of 101 Mb/s using DMT. Starting from these results, the performances of their systems continuously evolved. So, in 2009, by using OOK, they achieved a data rate of 125 Mb/s for a range of 5 m [39]. In the same year, this time by using DMT, a data rate of 200 Mb/s was achieved [40]. In [41] they showed that the data rate performances can be substantially improved by using an avalanche photodiode instead of a PIN photodiode.

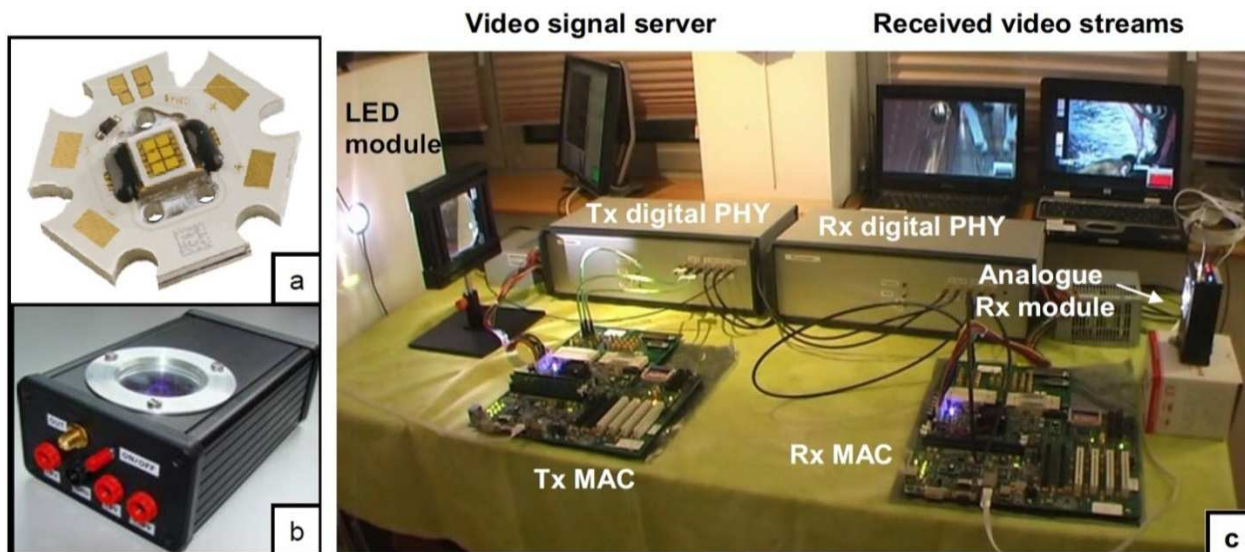

Figure 1.8: VLC prototypes developed by HHI a. VLC emitter; b. VLC receiver; c. Video transmission using VLC [9].

In the following years, the data rate performances continued to improve to 503 Mb/s [42], 803 Mb/s [43] and 1.25 GB/s [44] in 2010, 2011 and 2012 respectively. It is worth mentioning that while improving their performances, the VLC systems developed by HHI set new world records in terms of data rate. The mentioned results were obtained using standard illumination levels. However, in some of the cases the results were obtained using post-processing techniques.

University of Oxford

At University of Oxford, O'Brien et al. took a different approach in the development of high data rate VLC systems. In order to improve the data rate performances, they considered the usage of MIMO systems. Their first experimental results were published in 2008. At that time, the proposed system achieved a data rate of 40 Mb/s using 16 parallel channels [45]. In the same year they achieved a data rate of 80 Mb/s by using a single link [6]. The 80 Mb/s data rate was achieved using a blue LED with a bandwidth of 45 MHz and the pre-equalization technique. In 2009, they improved the performances of the system up to a data rate of 100 Mb/s, at a distance of 0.1m [46]. These results were obtained using OOK – NRZ. In 2010, they reported 220 Mb/s at 1 m achieved by using a 9 channels MIMO setup and OFDM [47]. In 2013, the researchers from Oxford University reported a 1 GB/s data rate using OFDM. This data rate was achieved in a 4 channels MIMO configuration, each having a data rate of 250 Mb/s [48]. In the case of these experiments, the communication range was of 1 m.

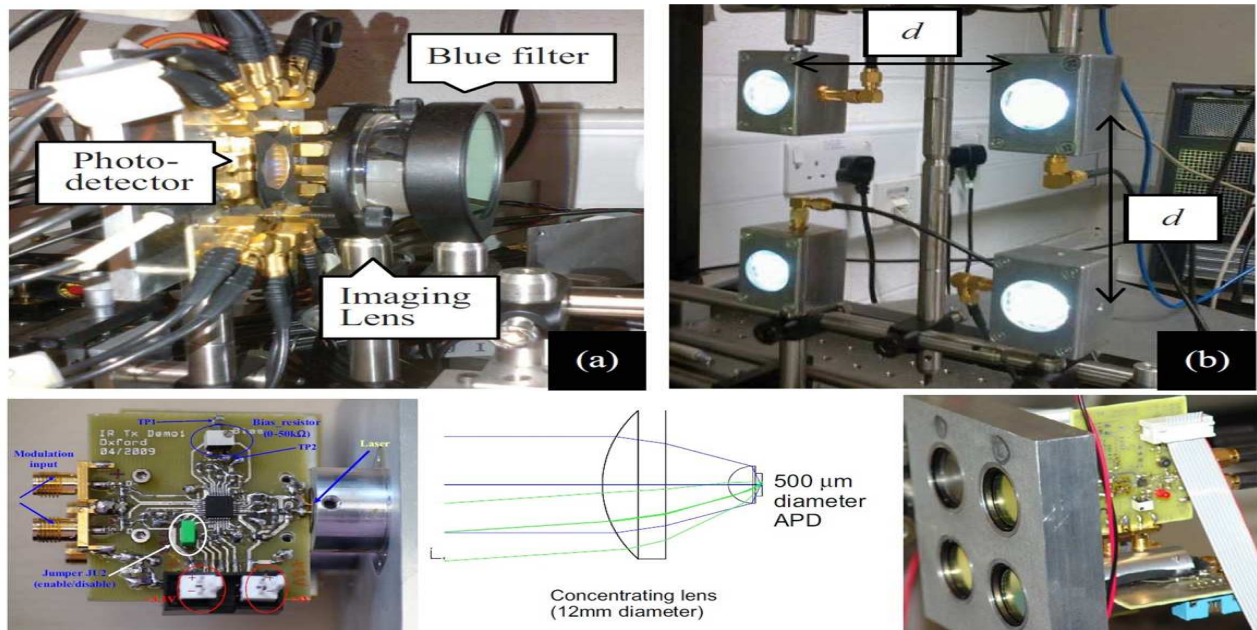

Figure 1.9: VLC prototypes developed at Oxford University [48].

As observed from the results, the merits of this research group are the development of high data rate MIMO VLC systems. In 2014, the researchers from the University of Oxford, this time in a partnership with University of Edinburg and with University of Glasgow, have achieved the fastest single channel VLC link, with a data rate of 3 Gb/s over a distance of 5 cm [7].

University of Bremen

University of Bremen was one of the first European research centers which considered VLC for their studies. By 2006, the research on VLC using OFDM was mostly theoretical. In this context, they publish their first experimental results for such a system. The system was based on OFDM VLC with a communication range of 1 m and with a BER of 10^{-3} [8]. One year later, the performances of the systems were improved, up to a BER of 10^{-5} at 90 cm [49]. In both cases, the results were obtained by using a single LED for the emitter and a PIN silicon photodiode based received. The communication distance was increased to 2.25 m by increasing the number of LEDs to 9 [50]. They also address the problem of MIMO techniques for VLC. In order to improve the performances of the MIMO communication they considered the technique called optical spatial modulation (OSM) [51], [52], [53]. In OSM, only one transmitter is active at a time and the others are turned off. This way, the interferences from the adjacent emitters are mitigated. Numerical simulations indicate that the proposed technique allows for low BER in moderate SNR conditions.

Optical communication research group of Northumbria University

This research group extended their investigations on the usage of organic LEDs (OLEDs) for VLC. So, in 2011, they present their first experimental proof-of-concept demonstration of a VLC link using OLEDs. In order to compensate for the reduced bandwidth of the OLEDs, the equalization technique has been chosen for the data rate improving. In these conditions, they showed that by using a 150 kHz bandwidth a potential data rate of 2.15 Mb/s can be achieved [54]. This proof-of-concept prototype confirmed its potential in 2013. By using DMT modulation based on 32-level quadrature amplitude modulation (QAM), they experimentally achieved a data rate of 1.4Mb/s, the fastest data rate achieved by OLED systems at that time [55]. The bandwidth of the used OLEDs was below 100 kHz. Just few months later, this time by using 4-PPM the data rate performances were increased to 2.7 Mb/s, again fastest data rate for OLED systems [56]. Another, premiere of the group was also in 2013, when they presented the first ever experimental demonstration of a MIMO VLC system with four LEDs emitter and four organic photodetectors (OPDs) as receivers [57]. The proposed system uses OOK and is able to achieve a data rate of 200 kb/s without the use of equalization techniques. Significantly better performances, that can go up to 1.8 Mb/s, are achieved when an artificial neural network was used for signal classifying and error correction.

VLC research in USA

Smart Lighting Engineering Research Center of Boston University

Founded in 2008, the Smart Lighting Engineering Research Center of Boston University is the result of partnership between Boston University, Rensselaer Polytechnic Institute and University of New Mexico, with the aim of developing smart lighting technologies. Their purpose was to develop simple and low cost VLC solutions for indoor illumination and communication. Under these conditions, they developed several systems able to provide wireless communication for distances of few meters and data rates of 1 to 4 Mb/s [58]. Their work was also extended in the indoor routing protocols [59] that should increase mobility and mitigate the LoS problem [60]. Another issue approached by this research center was the usage of heterogeneous networks that combine VLC and RF, and offer increased benefits [19]. In this purpose, they worked on developing protocols that optimize the performances of such networks and facilitate the handover between the two.

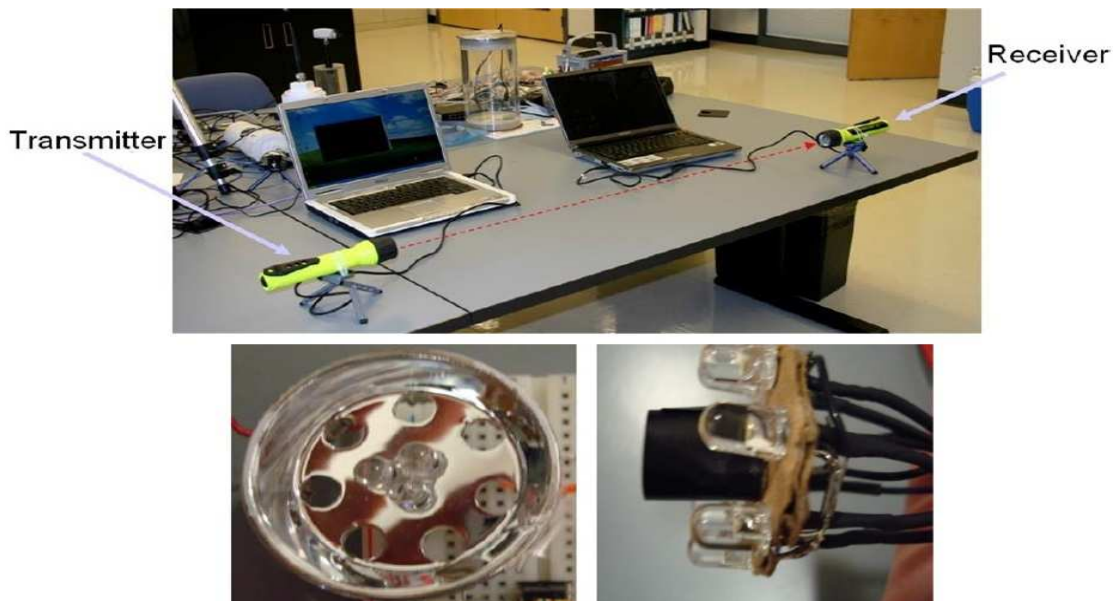

Figure 1.10: VLC prototype developed at Boston University [58].

Trends in the VLC research

As exposed by now, the VLC development began recently, in the 2000s. In the first years, up until 2006 – 2007, VLC research was mostly at a theoretical level, with few prototypes developed. Starting with 2007, the VLC research attracted some of the top universities from

Europe and USA, which lead to the development of VLC prototypes with continuously improved performances. After 2011, when the potential of VLC was already confirmed, numerous other research groups began to be interested in VLC. In this context, starting with 2012, several other groups have managed to report data rates above 1 Gb/s [61]-[65].

The evolution in time of the data rate achieved by VLC systems is illustrated in Figure 1.11. In some of the cases, the results were obtained by using a RGB LED with wave division multiplexing (WDM) which enabled the usage of the three carriers, enhancing this way the data rate. On the other hand, other results were obtained by using a VLC emitter that used a single carrier. This explains why the highest data rate reported in 2013 is higher than the one from 2014.

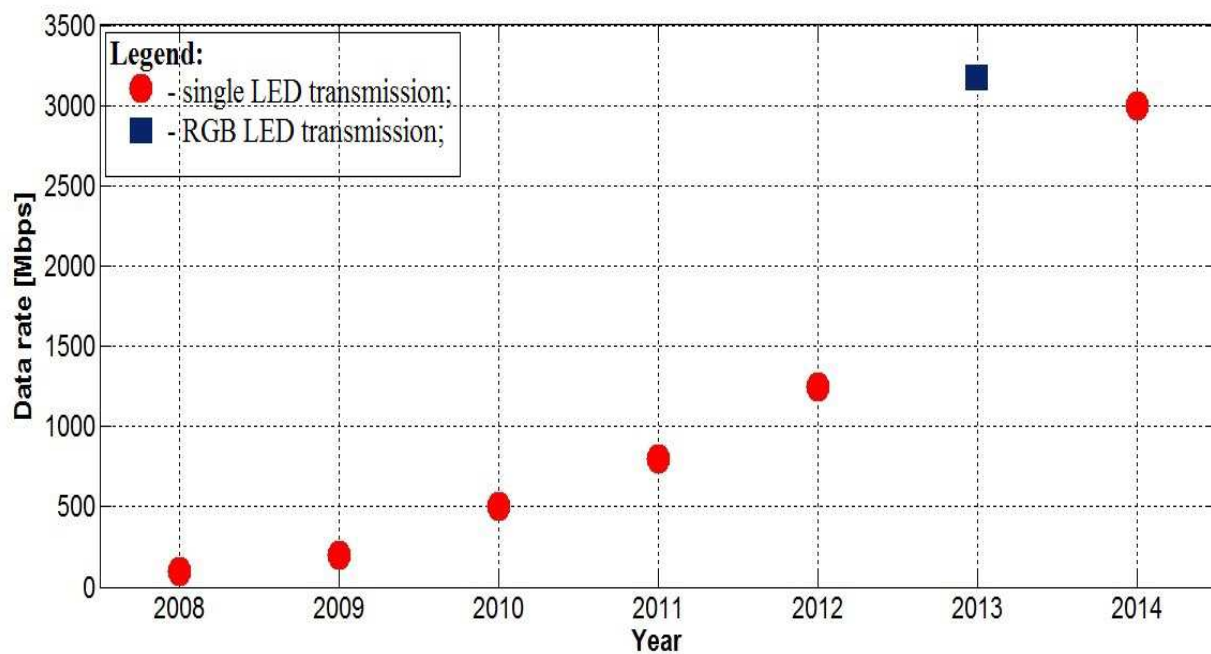

Figure 1.11: Evolution of the VLC data rates between 2008 and 2014.

1.6 Conclusions

VLC emerged and developed in the context of an increasing demand for wireless communication technologies. The fast evolution of VLC was sustained by the advances from the SSL industry which constantly increased the LEDs performances.

This chapter has introduced the basic principles of VLC, presenting the architecture of such a system. By pointing out the advantages of this technology, the main applications of VLC were

identified whereas by highlighting the weak points of VLC, the main challenges were presented. Within this chapter, the main research trends and research groups were identified, emphasizing the state of the art in this area. This chapter showed how the VLC technology evolved and what are the performances achieved at this time. It was observed that one of the main application domains for VLC is to provide high data rate indoor links that could be used for fast internet connection or fast data broadcast. In this area, the scientific community has made significant efforts, which allowed VLC to obtain impressive results.

Another challenging application domain for VLC is represented by the communication between vehicles and/or between traffic infrastructures and vehicles. However, this domain has been rather neglected by the scientific community. In indoor applications, the challenge was to provide high data rate links with communication ranges of up to 1 or 2 meters. On the other hand, in automotive applications, the challenge is to achieve long range communications (tens of meters), at the cost of the data rate. A second challenge in this domain is to increase the robustness to noise. These two challenges are addressed by this thesis, which has as main objective the development, the implementation and the experimental evaluation of a VLC system suitable for automotive applications. The next chapter approaches the issues related to the advantages, the requirements and the challenges associated with wireless communications usage in automotive applications.

Chapter 2

Visible Light Communications in Automotive Applications

Contents

2.1 Introduction.....	27
2.2 Considerations on the Intelligent Transportation System.....	28
2.3 On the ability of RF communications to support communication based vehicle safety application.....	31
2.4 The potential usage of VLC in ITS.....	33
2.5 VLC in the ITS – state of the art.....	37
2.6 VLC research direction and future challenges.....	43
2.7 Conclusions.....	44

This chapter presents the importance of vehicular communication and aims to evaluate the potential role of VLC in automotive applications, focusing mostly on the communication-based safety applications. This chapter will illustrate the manner in which the VLC systems aimed for vehicle application evolved in time and will present the performances of the existing VLC systems.

2.1 Introduction

The number of vehicles that use the transportation infrastructure increases every year. For this reason, it is mandatory to continuously improve the safety and the efficiency of the transportation system. Even if the automobile industry has progressed a lot and today cars are safer than ever before, road accidents kill more people with every year. More than 1.3 million people die every year because of car accidents while 20 to 50 million are injured. Road accidents are the leading cause of death among young people aged between 15 to 29 years. Furthermore, the forecasts are even worse: it is estimated that by 2020 road accidents will be the sixth cause of death, with 1.9 million victims yearly [66], [67]. In this context, the concern for reducing the number of road accidents and the associated victims is increasing. The United Nations has declared in 2010 a Decade of Action for Road Safety with the purpose of improving the safety of vehicles and roads.

The increasing number of road fatalities is a paradox because today's cars integrate high performance safety equipment and advanced driver assistance systems. Electronic Stability Control (ESP), Anti-lock Braking System (ABS) or electronic brake-force distribution are some of the most popular active driver assistance systems meant to increase the safety of the transportation system and to reduce the number of road fatalities. Each of these systems proved their efficiency on individual vehicles but still, the number of crashes increases. For the next generation of car safety systems there is a strong need for vehicle awareness, obtained from different vehicles that work together by sharing information in order to increase the safety. To be able to create a highly-efficient road accident prevention system there is the need to enable cooperation among vehicles and between vehicles and transportation infrastructure. Accordingly, the best solution to the problem of road accidents is to add intelligence to the transportation system. The Intelligent Transportation System (ITS) combines intelligent vehicles and intelligent infrastructure, working together to increase the safety and the efficiency of the transportation system [68]. ITS integrates advanced wire and wireless communication technologies for data gathering and distribution. ITS has the potential of changing the point of view regarding road accidents: if until now the problem was how to help people survive accidents, ITS's future objective will be to help people avoiding accidents. By enabling wireless communications among vehicles and between vehicles and infrastructure, the safety and the efficiency of road traffic can be substantially improved. Inter-Vehicle Communication (IVC) or Vehicle-to-Vehicle Communication (V2V) systems allow modern vehicles to communicate with each other and to share information regarding their mechanical state (position, velocity, acceleration, engine state, etc) or information about the traffic. At the same time IVC systems have the potential to improve the passenger's comfort.

2.2 Considerations on the Intelligent Transportation System

ITS adds value to the transportation system by offering real-time access to traffic information. ITS continuously gathers information, analyzes it and distributes it to increase efficiency. The gathered data is used in order to automatically adapt the transportation system to different traffic situations. From this consideration, an important requirement for the ITS is the widespread distribution. In order for the system to be operative it needs as many intelligent vehicles as possible so that interoperability is possible. A large geographical distribution of the intelligent

infrastructure is also required so that the system is able to gather more data and to be able to distribute it efficiently. At the same time, a major challenge for the ITS, is to keep the implementation cost as low as possible but without affecting its reliability.

ITS is concerned by three major issues: safety, congestion and environment. The safety of the transportation system can be improved by increasing vehicle awareness. Studies show that combining V2V and V2I communication has the potential to reduce by 81 percent of all-vehicle target crashes annually [69]. Enabling V2I communication can help the transportation system by providing real-time data regarding traffic, data that can help in managing the transportation system in order to increase efficiency and to reduce traffic jams, which can help reducing the gas consumption and the CO₂ emissions. The benefits of adding intelligence to the transportation system are the efficient monitoring and management of the traffic which will help reduce congestion and provide optimized alternative routes depending on the traffic situation. Increasing the efficiency of the transportation system will help save time, money and will reduce pollution. But, the most important benefit of the ITS will be the millions of saved lives. The primary beneficiaries of the ITS are the travelers that will travel in safety and will use optimized travel routes but also the transportation companies and the industry.

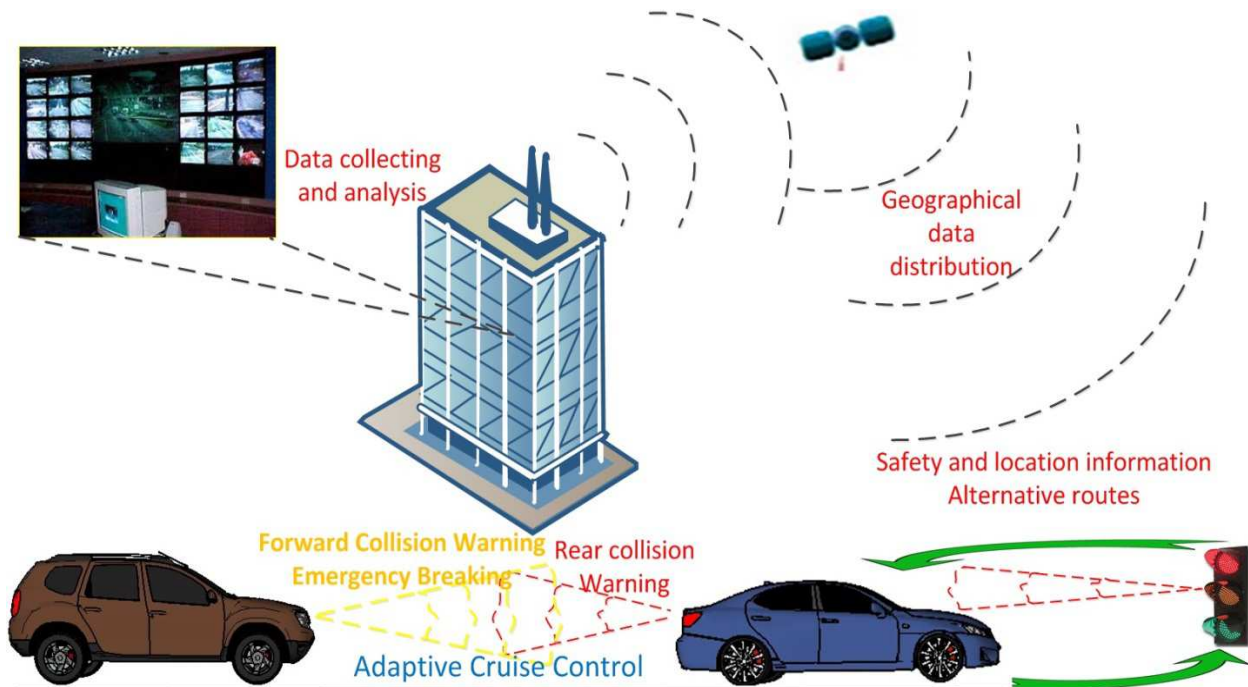

Figure 2.1: ITS architecture including the three major components.

ITS has three major components connected together by wireless and/or wire communication technologies. The three components are:

- the intelligent vehicles;
- the intelligent infrastructure;
- the traffic center.

The interconnectivity of the ITS components is illustrated in Figure 2.1.

Intelligent vehicles equipped with on board equipment for wireless communication are connected together and to the intelligent infrastructure forming a Vehicular Ad-hoc Network (VANET) [70]. The intelligent infrastructure also uses wireless communication technologies to communicate with the intelligent vehicles and wired communications to connect with the traffic center and for interconnections.

The intelligent infrastructure is basically the connection between the intelligent vehicles and the traffic center. This way, the infrastructure has the role of fixed gateways for the communication network while the vehicles are the mobile nodes. The intelligent infrastructure has two basic functions: data distribution and data collection. It gathers information from the vehicles and sends it to the traffic center. The traffic center analyzes the data, decides the required measures and distributes the results geographically to vehicles, through the intelligent infrastructure. The distributed information can be either safety related information, like accident warnings or traffic sign warning, information regarding the weather or messages containing alternative routes.

IVC along with vehicle to infrastructure communication (I2V/V2I) are the two major research preoccupations in the development of the intelligent transportation system (ITS). Vehicular communications enable intelligent vehicles, that use wireless short-range communications, to connect to each other and to form the VANETs. V2V communications have the potential to address 79% of all vehicle crashes [69]. I2V communications connect the vehicles with the road infrastructure thru wireless short-range communication technologies. I2V communications have the potential to target 26% of all vehicle crashes [69]. An important component of the I2V communications is represented by the broadcast of traffic safety information from the traffic infrastructure to vehicles. This way, the presence of stop signs, signal status, speed limits, surface conditions, and pedestrian crosswalks are transmitted, helping the drivers/vehicles to take the necessary safety measurements. The other component of the

I2V/V2I is the data gathering component. In this case, the vehicles transmit data to the traffic infrastructure. The data is then analyzed and redistributed.

2.3 On the ability of RF communications to support communication based vehicle safety application

Several technologies were proposed and investigated for the communication between vehicles and infrastructures such as Infra-red [71], Bluetooth [72], 3G [73], [74], LTE [75] or even combinations of these technologies [76]. However, the strongest focus is on the radiofrequency Dedicated Short Range Communication (DSRC). DSRC is regulated by the IEEE 802.11p standard for Wireless Access in Vehicular Environments (WAVE) [77].

The IEEE 802.11p standard was developed based on the IEEE 802.11a standard but with the improvement of the PHY and MAC layers. The enhancements performed on the standard aim to provide higher robustness and to adapt to the fast movement conditions imposed by the vehicular applications. The DSRC channel is divided into 7 channels of 10 MHz for different applications, whereas each channel is divided into 52 sub-channels which have a bandwidth of 156.25 kHz. All the safety related messages are broadcasted using the control channel which is the center channel. Depending on their criticalities, the messages are categorized into 4 priority categories, with the purpose of reducing latency of the high importance messages. As a collision preventing mechanism, the IEEE 802.11p standard uses the well-known Carrier Sense Multiple Access/Collision Avoidance (CSMA/CA). DSRC involves half-duplex communication with data rates from 3 to 27 Mbps. As a modulation technique, it uses orthogonal frequency division multiplex (OFDM) to ensure data multiplex. DSRC is aiming to achieve communication ranges of up to 1000 meters.

Even if the standard was developed considering the difficult conditions of the vehicular application, numerous studies report issues related to its ability to support vehicular communications. **Channel congestion** affects the communication performances and represents the major impediment for a reliable communication [78]. Channel congestion is determined mainly by the vehicle density, message generation rate and transmission range. Since communication-based vehicular safety applications aim to exchange a large amount of real-time dynamic data, it is obvious that this will generate serious issues. In the case of VANETs, the different nodes will increase the channel congestion causing mutual interferences and the

phenomenon called “broadcasting storm” [79]. VANETs are considered as extremely dynamic topologies with strict constraints concerning delays and packet delivery. The quality of the channel modifies randomly in time and is difficult to predict since it depends on the behavior of each individual communication link. Furthermore, each node (vehicle) creates interferences that cover an area wider than the covered communication area.

Another significant problem encountered in high traffic densities is related to the CSMA/CA. Recent studies showed that when such conditions are fulfilled, the behavior of the CSMA/CA is approaching towards the one of ALOHA, meaning that *the nodes transmit their message after a random time*, without sensing other transmissions [80], [81]. This phenomenon generates packet decoding failure even for the communication between closed-by vehicles. The failure of the CSMA mechanism in high traffic densities was also observed in [82]-[84]. These aspects are very significant, especially in traffic safety applications which require latencies as low as 20 ms [85]. Under these circumstances, in high traffic densities, such as on highways or in crowded cities, the reliability of the communications is rather questionable [86]. The fact that the WAVE cannot ensure a properly message delivery in high traffic, not even for high priority messages, was also demonstrated in [87]. This paper concluded that DSRC *cannot ensure time critical message distribution*.

Analysis of the DSRC in a highway scenario also points out that even if the latencies requirements could be satisfied, the reliability requirements are difficult to meet, mainly due to external collisions [88]. The same study points out that *the hidden node* is a stringent problem in the highway scenario, which significantly affects the packet delivery ratio.

In addition to channel congestion, another disturbing phenomenon affecting the DSRC is *the Doppler spread*. The Doppler spread is causing signal spread that leads to a broader spectrum compared with the transmitted signal. The channel variations cause sub-carrier interference which degrades the performances. The negative effect of the Doppler spread is affecting both BER and throughput performances [89]. The effect of the Doppler spread is proportional to the velocity of the vehicles and to the distance separating the vehicles [90].

The multipath effect is also a perturbing phenomenon for DSRC. The multipath distortions are mainly caused by different length paths resulted due to unwanted reflections. Due to the highly dynamic nature of VANETs, this application area is characterized as a rich multipath environment. The multipath components also widen the Doppler spectrum.

The no line of sight (NLoS) condition represents a stringent problem not just for VLC but also for the case of 802.11p. Buildings situated at the crossroads pose a major problem to the communication [91]. The roadside vegetation blocks the communication in the case of tight curves [92]. In case of steep crest, the NLoS condition makes the communication impossible [92]. Also, vehicles interposed between emitter and receiver lead to packet losses or even to communication breakdown [93]. In all these instances the connectivity is lost almost immediately after the LOS is altered.

To conclude this section it can be observed that DSRC is mainly affected by high traffic densities, NLoS and high velocities. These factors reduce the communication range, cause numerous packet collisions, increase the delays and reduce reliability. Considering the upper mentioned analytical and experimental results it can be observed that DSRC systems are fully reliable just in ideal conditions. However, in real situations, the perturbing factors previously mentioned will cumulate in plenty of the cases (eq. high speed with NLoS) leading to even poorer performances compared with the ones described above. Moreover, it is also observed that the communication breakdowns are occurring mostly in the situations for which they were meant. At high speed, in tight curves, is the moment when these systems are required the most. Taking into account that [78]-[93] represent just a narrow segment of studies that question the DSRC capability to face all problems related to vehicular communications, the competition for the winning communication technology in vehicular networks remains open.

2.4 The potential usage of VLC in ITS

Whereas IVC has been in the attention of the academic society for more than 20 years, due to its early stage, only recently VLC was considered as a possible solution to enable IVC. The main advantages of VLC usage in automotive applications are represented by the low complexity, reduced implementation cost and the ubiquitous character. All these characteristics can facilitate a rapid and wide market penetration, which represents a strong consideration (argument) in the favor of VLC.

LEDs are highly reliable, energy efficient and have a life-time that exceeds by far the classical light sources. These unique features made the car manufacturers to think of replacing the classical halogen lamps by LED lighting systems. At this moment, as illustrated in Figure 2.2, vehicle lighting systems based on LEDs are common.



Figure 2.2: Integration of LEDs lighting systems in series vehicles – processed using [95].

The efficiency of the LEDs made them being used also for LED-based traffic lights. This new generation of traffic lights is becoming more and more popular and is beginning to be used on extended scale. The main advantages of these traffic lights are: low maintenance cost, long life and low energy consumption but also the better visibility. These advantages had already convinced some of the cities authorities to replace the classical traffic lights with new generation LED-based traffic lights. Meanwhile, other cities are progressively following their footsteps. The standard sizes for the traffic lights are 200 and 300 mm in diameter [96]. The LED-based traffic light consists of a large number (100-200) of HB-LEDs that offer besides the signaling function, the possibility for data communication. The enhancement of the LED traffic light with communication capabilities does not affect its compliance with the standards [96].

Considering the trends in the lighting industry, it is expected that in the near future, the street lighting will be LEDs based, so the road illumination will also be able to provide communication support [97], [98]. In this case, the constant short distance between the street light and vehicle, along with the high power implied, allows for high data rates and increased communication stability. Under these circumstances, this particular case of I2V VLC has a huge developing potential. Moreover, due to the low-cost and high reliability, LEDs begun to be



Figure 2.3: Examples of LED usage as part of the transportation infrastructure – processed using [99].

integrated in traffic signs as well, in order to improve the visibility. For the moment, this type of traffic signs are used mainly on the road segments which are considered with a high accident risk. Several examples of LED usage as part of the transportation infrastructure are represented in Figure 2.3.

In this context, one can see that LED-based lighting will be part of the transportation system, being integrated in vehicles and also in the infrastructure. The large geographical area in which LEDs lighting will be used, combined with VLC technology will allow ITS to gather data from a widespread area and can enable the distribution of high quality communications. These additional functions will be possible without affecting in any way the primary goal which is signaling or lighting.

The success of the ITS is largely dependent on its penetration. Insufficient penetration means insufficient data collection and distribution. If it is to think of RF solutions for the ITS, this will not be possible for a long time ahead because in order the system to be effective it is needed that all intersection and streets to be equipped with RF units, which implies a huge

implementation cost. One of the greatest advantages of VLC compared with DRSC is its low complexity and the reduced implementation cost. Being already half integrated in the existing transportation infrastructure as well as in vehicle lighting systems makes VLC a ubiquitous technology and ensures it a fast market penetration. In the case of RF, the problem of market penetration is considered a serious issue that can block the deployment. It is estimated that in order for such a system to begin to be effective it requires at least a 10% market penetration [100]. However, to achieve this it would require few years in which the systems brings little or no benefits, meaning that the deployment cost is mostly supported by the early buyers. Notwithstanding that a significant part of the consumers replace the car in this period without having any benefice from the purchased system. An example of VLC usage in a highway scenario is illustrated in Figure 2.4. The safety vehicles proceed on the damaged cars and transmit the information in the neighborhood of this area. The neighboring cars receive the data by using light sensors and send them further to the next nearest neighbors by using their head/back lights. Data are thus propagated throughout the highway. The traffic infrastructure contributes as well to the information broadcast. Furthermore, the cars can also communicate with each other regarding their mechanical state or other issues needed to enhance the traffic safety and the security. The fact that VLC is able to satisfy the requirements imposed in vehicular networks in real working conditions has been confirmed [12]. Furthermore, VLC was also found compatible with platooning [101].

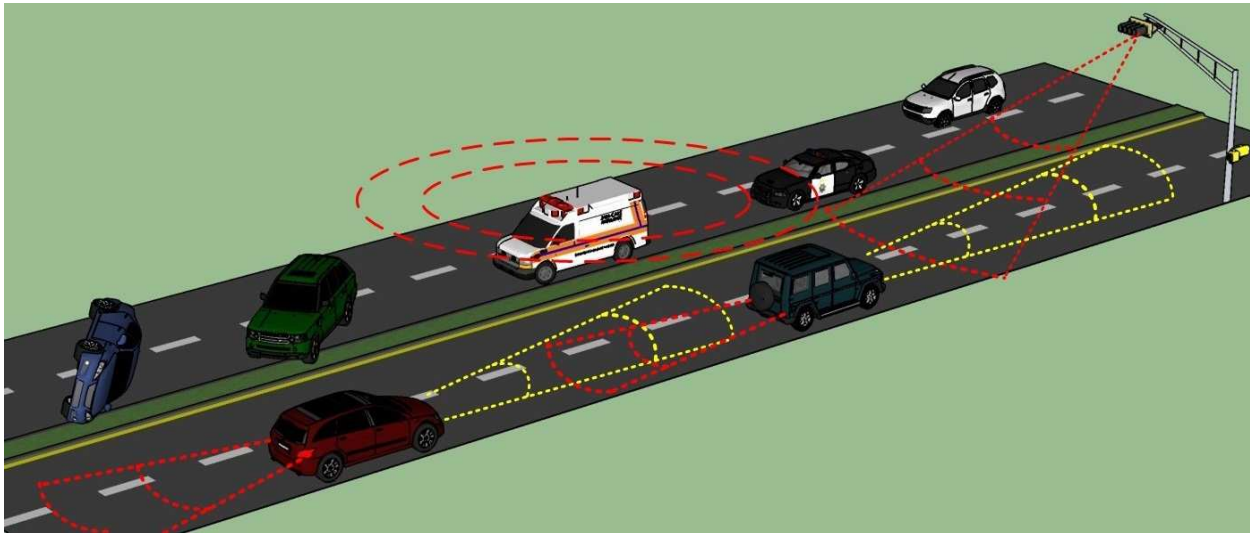

Figure 2.4: VLC usage in a highway scenario.

2.5 VLC in the ITS – state of the art

Using VLC to increase traffic safety by enabling vehicular communications and I2V communications is a hot research topic studied by several research groups. The simulation and experimental results obtained by now, prove that the use of VLC for road safety applications is possible, but in order to make the step towards the implementation, the performances of such systems still need to improve. The fact that LED lighting is implemented on more and more vehicles, and LED-based traffic lights are replacing the classical traffic light represents a major advantage of VLC and also proves the future role of LED lighting in vehicle safety applications. In order to better illustrate the evolution of VLC systems and to present the performances of the existing systems, the following section will present the work of some of the most representative research groups in the area of VLC automotive usage.

Hong Kong University

One of the pioneers of VLC systems for traffic safety is G. Pang from University of Hong Kong – China and his research group. Convinced by the unique characteristics of the LEDs, he considered that LEDs have the potential to replace the classical light sources and to be integrated in traffic lights, traffic signaling devices or into traffic display boards and he also saw the opportunity represented by their fast switching ability. Back in 1998, he presented at the World Congress on Intelligent Transport System two papers that were presenting possible traffic safety applications that were using LEDs for information broadcasting towards vehicles. The authors propose the replacement of all traffic lights and signaling devices with LEDs to reduce power consumption and to increase traffic safety. The LEDs long life expectancy, even in unfriendly working conditions, is extremely important since a burned traffic light can be a major risk factor. On the other hand, the communication capabilities of the LEDs can be used to further increase the safety of the transportation. Under these circumstances, the authors demonstrated the dual use of LEDs in the ITS: signaling and communication. To support their arguments, the research group presented a prototype traffic light that besides the traditional signaling purpose also transmits audio information through visible light [102]. In a second paper, the research group proposes an intelligent traffic light system for broadcasting of vehicle location and navigation information with audio support for the driver [103]. The presentation of these two prototypes is considered a major breakthrough since this was the first demonstration of VLC usage. Audio

broadcasting through LEDs traffic light is also presented in [104] where the transmission range is over 20 meters.

The same group presents a different approach for traffic light to vehicle communication in [105]. This time, in order to increase the FOV of the receiver, the photodiode based receiver is replaced by a digital camera based receiver, which leads to an increase in receiver FOV from 5° to 30° . The paper also presents a new approach for data encoding. The surface of the traffic light is divided into individually controlled regions. A microcontroller commands the regions to form different visual patterns that contain the encoded information. The digital camera captures the images and decodes them by using image-processing techniques in order to obtain the transmitted message.

Keio University

Although the researchers from Keio University were mainly focused on studying VLC for indoor applications, this group was also involved in studying VLC for automotive applications. In 2001 they published one of the first studies containing an analytical performance evaluation of the communication between LED traffic lights and vehicles [106]. The paper considered the traffic light service area, analyzed the modulation techniques that could be used, the required SNR, the amount of receivable data and concluded that the usage of a LED traffic light for information broadcast is viable. In [107], they performed an analysis on the improvements that could come with the usage of a two dimensional image sensor instead of a photodiode. The paper points out the dependence between the SNR and the number of pixels of the image sensor and considers this approach better thanks to the wider service area and the increased mobility. In [108], they approach the problem of VLC usage for inter-vehicle communication and as well as for inter-vehicle ranging. In this study, they consider the usage of an image sensor based receiver considering it more resilient to noise. A novel approach considering the VLC receiver implementation is proposed in [109], where the performances of the system are increased by using a narrow angle photodiode based receiver enhanced with a wide angle camera system. The wide camera is used for traffic light detection and based on the coordinates a motor adjusts the position of the photodiode receiver allowing it to receive the data signal. By narrowing the photodiode reception angle the effect of the background noise is reduced. The analytical and

experimental results confirmed the performances of the proposed method, allowing for the system to be able to receive 4.8 kb/s data at 90 meters.

Nagoya University

The researchers from the Nagoya University have an impressive background in the development of VLC systems meant for ITS, being one of the first groups working in this area. In 2005 they proposed a parallel VLC system meant to broadcast traffic safety information from a LED-based traffic light to a high-speed camera-based receiver [110]. The authors had chosen the high-speed camera and not a photodiode-based receiver in order to enable parallel communication. The LED-traffic light contains 192 LEDs and is divided into seven LED partitions. Each LED partition is modulated individually at a frequency of 250 Hz, in order to transmit parallel data. Image processing techniques are being used to demodulate the data. This prototype has achieved a speed of 2.78 kbps over a range of 4 meters. The performances of the system can be enhanced in terms of reliability by using hierarchical coding depending of the priority of the data [111], [112]. This way, the high priority data is transmitted at lower frequency improving the BER performances.

In 2007, they propose a novel concept of VLC receiver prototype that aims to solve the main problems associated with the use of VLC in the ITS: the necessity of long-distance high-speed transmission and the dynamic conditions. The proposed integrated a wide angle camera used for the traffic light detection and a photodiode based receiver for high data rate communication [113]. Even if this first attempt to solve these problems by combining the performances of a camera and of a photodiode had unpersuasive results, still, the novelty of the proposed solution must be highlighted. Moreover, the performances of the concept were confirmed in 2009 [114]. The camera based tracking system proved its ability to detect and adapt the position of the photodiode receiver. To respond to the vibrations caused by the movement of the vehicle the system was enhanced with a gyro sensor, which detects and responds to the vehicle's vibrations. The experimental results showed a 2 Mb/s communication speed and a BER was below 10^{-6} for distances up to 40 meters.

The performances of the high-speed camera based receivers were improved in the years that followed with the development of the hierarchical coding scheme and as higher performance cameras became available. The communication distance was increased up to distances of 120 meters, however at a high BER of 10^{-2} - 10^{-1} [115]. The usefulness of the hierarchical coding is

also confirmed in field tests performed with the receiver mounted on a moving vehicle [116]. However, these experiments showed that the movement of the vehicle strongly affects the communication performances.



Figure 2.5: Experimental setup for the I2V [116].

Toyota R&D labs and Shizuoka University (Japan)

The collaboration between Shizuoka University and the Applied Optics laboratory from Toyota enabled the development of a high performance VLC system. They have developed a high sensitivity CMOS image sensor which is able to achieve 1000 fps. With the integration of the image sensor in a VLC receiver, their V2V prototype was able to achieve data rates of 10 Mb/s for distances that can go up to 20 meters [117]. The communication range of the systems can be increased up to 50 meters by decreasing the data rate to 32 kb/s, or even up to 100 meters for data rates of 2 kb/s [118].

University of Aveiro

In Europe, one of the leading groups in the research of VLC usage for automotive applications is in Portugal, at University of Aveiro. The group has proposed and analyzed in detail the use of LED-based traffic lights as Road-Side-Units (RSU) in the ITS for I2V data broadcast. The group introduced the concept of VIDAS - Visible light communications for Advanced Driver Assistant Systems (ADAS), which represents the use of VLC for traffic safety applications [119], [120]. VIDAS considers the usage of the existing road infrastructure with possible slight changes in order to enable traffic safety information broadcast. This research

group has considered the usage of photodiode based receivers and proposed the use of direct sequence spread spectrum (DSSS) sequence inverse keying (SIK) as a modulation technique [121]. The test results show that this modulation technique is suitable for outdoor VLC since it reduces the effect of noise produced by artificial light sources [122], [123]. The proposed system has been tested in controlled outdoor conditions both in daytime and in night time. The system is able to transmit data up to more than 40 meters with a BER between 10^{-6} at 10 meters and 10^{-2} at 45 meters. Concerning the data rate, the proposed systems achieved a 20 kb/s.

Smart Lighting Engineering Research Center of Boston University

In USA, the research group from the Smart Lighting Engineering Research Center of Boston University is involved in the usage of VLC for inter-vehicle communications as well. The research team has developed a prototype used for vehicular networking based on optical transceivers [124]. The system uses short-range directional optical transceivers to share vehicle state data. Each transceiver contains isolated transmitter and receiver circuits. The four transceivers, mounted on every side of the vehicle, broadcast periodic messages that are received by the transceivers found in the emitter's field of view. Localization of neighboring vehicles is possible by transmitting the GPS coordinates. The information containing the location and the speed of the neighboring vehicles is displayed for the user. The communication between vehicles is dual-simplex.

A detailed comparative analysis between omni-directional 802.11 RF communications and directional VLC, with application in vehicular communications is presented in [125] and [126]. The results show that in high traffic density, VLC offers better performances in terms of packet delivery ratio (PDR), throughput and average packet delay, at the cost of a shorter communication range. In the case of 802.11, as the number of vehicles increases from 10 to 100 vehicles/km, the PDR and the throughput are rapidly decreasing, while the packet delay is increasing due to collisions. In the case of VLC, the PDR and the throughput are decreasing but not as fast, whereas the packet delay is remaining at the initial value. The authors consider multi-hop networking as the solution to overcome the VLC LOS limitation.

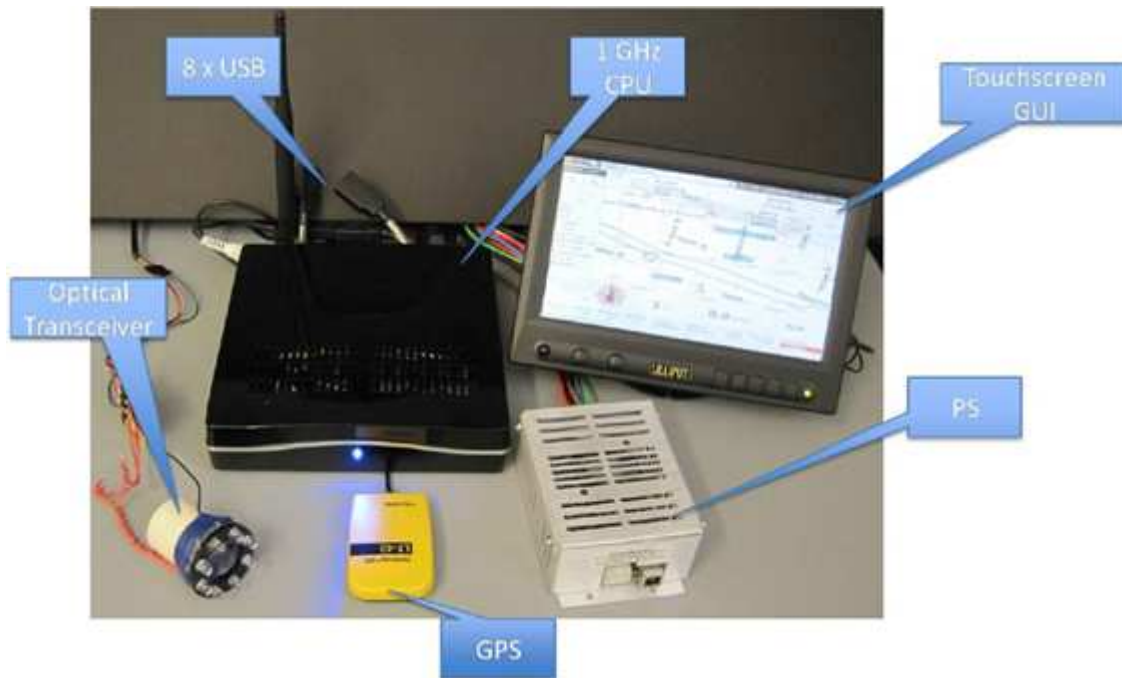

Figure 2.6: VLC prototype for V2V communication developed at Boston University [125].

Rice University

Another research group that has obtained interesting experimental results is the group of professor Knightly from Rice University USA. In [12], they presented a detailed analysis of Vehicular Visible Light Communications (V2LC) networks. The group has developed a research platform with high robustness to noise on which they made experiments in different conditions and for different scenarios. The paper presents experimental results that show that VLC offers the possibility of robust vehicular communication in real traffic conditions. Experiments showed that V2LC is resilient to diurnal noise sources (the sun) except for the case of direct line of sight with the sun, case encountered during sunset and sunrise and also to nocturnal noise sources represented by VLC transmitters or other light sources. The paper also shows that in dense traffic conditions, VLC satisfies the latency and the reachability requirements imposed by the vehicle safety applications.

Intel Corporation

The concern for VLC is manifesting not just in the academia but also in the industry area. Roberts et al. from the Intel Corporation considered the usage of VLC for automotive applications. They investigated the performances that could be achieved for the communication between a traffic light and a photodiode-based receiver, concluding that a 1 Mb/s data rate is

achievable for distances up to 75 meters [127]. They also consider that VLC can enable smart automotive lighting systems that represent a promising alternative to DSRC [128]. Besides communications, they considered that VLC can also provide inter-vehicle distance measurement and localization [129]. The localization is possible by using positioning equations based on the phase difference of arrival. Under these conditions, VLC is considered to be able to provide a simple and low cost solution for high accuracy positioning. Recently, they considered investigating the performances of VLC using low cost camera systems like those implemented in smartphones [130]. This type of cameras has a limited number of frames per second which requires a modulation that can support an undersampled frequency. Even if the proposed technique has the advantage of using low cost equipment and seems to be compatible with MIMO applications [131], the performances of such systems are, at least for the moment, very limited.

2.6 VLC research direction and future challenges

Concerning the VLC receivers, it has been observed that in their development there are two major directions. One considers using camera systems as receiver and the other one considers the usage of photoelements, generally photodiodes. The usage of embedded cameras has as the main advantage the wider angle which increases the mobility. Such systems can achieve communication ranges that can go up to 100 meters, but at a high BER (as high as $10^{-2} - 10^{-1}$). Decent BER results can be obtained for distances up to few tens of meter, in the best cases. As for the data rate, VLC links that can achieve few Mb/s have been reported. However, the performances of the communication are strictly related to those of the camera, meaning that the camera has to be a high speed model, which is still too expensive for a broad distribution regarding the automotive industry. Under these circumstances, the usage of high speed cameras seems to be actually reserved for laboratories prototypes.

On the other hand, photosensing elements like photodetectors are quite efficient regarding noise performances and can be used over long distances. Their fast response time enables them to be used for high data rates and come at considerably lower prices. Such systems can achieve communication ranges of 40 - 50 meters, at data rates of few tens of kb/s. It was seen that the performances of such systems can be enhanced with optical systems that focus the light on the photoelement and improve the SNR. Active control of the position of the sensing element was

found to also enhance the performances. In the case of photosensors, the main challenge is to minimize the interference of the ambient light, which significantly affects the SNR, especially as the emitter – receiver distance is increasing. A central problem in this area is the design of a suitable receiver, able to enhance the conditioning of the signal and to avoid disturbances due to the environmental conditions.

Even if VLC is a relatively new communication technology, the fast evolution indicates the huge potential. The development of VLC is an impressive one, but still there is a long way ahead. In order to be suitable for automotive applications, VLC still needs to enhance the communication range and the robustness to noise. This could be achieved by using an adaptive gain circuit that will greatly improve the communication range in low and medium light conditions without affecting the robustness of the communication in bright conditions. Using higher complexity filters, combined with optical filtering can also improve the SNR and increase the communication range.

As for the stringent LoS condition, in vehicular networks, the problem can be solved by using multi-hop networking. Vehicles can retransmit the original message for vehicles that are outside the LOS of the initial transmitter. This way, high-priority messages can be propagated through the VANET and reach to vehicles outside the LOS. Multi-hop networking can substantially increase the communication range.

2.7 Conclusions

This chapter has introduced the concept of ITS, presenting its objectives, the key components and the involved strategies. The potential usage and the role of VLC in the ITS have been discussed. In ITS, VLC appears to be the solution especially for urban high-traffic densities. When such conditions are fulfilled, RF-based communication technologies seem to be affected by severe collisions which lead to a decrease of the packet delivery ratio (PDR) and to an increase of the latencies, making RF communications not suitable for traffic safety applications. In transportation-related applications, VLC also has the advantage that next-generation vehicles, and next-generation traffic infrastructures will be LED-based, which will facilitate the implementation. This chapter also highlighted the current trends in the development of VLC systems and the challenges in the domain.

Chapter 3

Considerations on the coding techniques used in Visible Light Communications

Contents

3.1 The IEEE 802.15.7 Standard for Short-Range Wireless Optical Communication using Visible Light.....	46
3.2 Considerations regarding the coding techniques used for VLC	52
3.2.1 Introduction	52
3.2.2 OOK coding techniques for VLC applications	53
3.3 Comparative evaluation of Manchester and Miller code.....	57
3.3.1 Considerations on multi-channel capabilities for Manchester and Miller codes	58
3.3.2 Flickering issues concerning the Manchester and the Miller code VLC usage	61
3.3.3 Sensitivity to noise	64
3.4 Conclusions.....	69

The first part of this chapter introduces the IEEE 802.15.7 standard for short-range wireless optical communication using visible light. It aims to provide an overview about some of the technical challenges related to VLC. Starting from the general guidelines of the standard, the second part of this chapter approaches the issues related to the coding techniques used in VLC.

This chapter investigates the future aspects concerning the demand for Multiple Input Multiple Output (MIMO) VLC applications and the usage of a code with better perspectives for such application. Even if the upper mentioned standard does not mention the Miller code, its appropriateness for outdoor VLC usage in ITS application is examined. The Miller code is compared to the Manchester code, which is the standard code for such applications. Simulation results show that the Miller code clearly outperforms the Manchester code in terms of bandwidth and channel coexistence. The investigation of the BER performances revealed that the two codes exhibit similar performances. Since the IEEE 802.15.7 standard selects the usage of the Manchester code taking into consideration its flickering performances, an analysis on the

flickering performances of the Miller code is also performed. This is the first detailed analysis that focuses on the Miller code potential usage in VLC.

This chapter also presents the simulation results concerning the negative effects of noise on the received data signal, specially focusing on the pulse width distortions. The analysis is performed on messages coded using the Manchester and the Miller code. The simulations were carried out based on a signal that was digitally processed.

This chapter contains theoretical contributions sustained by simulation results which confirm the suitability of the Miller code for the envisioned applications and its potential in future MIMO applications.

3.1 The IEEE 802.15.7 Standard for Short-Range Wireless Optical Communication using Visible Light

The IEEE 802.15.7 standard [132] for short-range wireless optical communication using visible light had become available at the end of 2011. The standard states that the data transfer is achieved by using intensity modulation of optical devices, such as LEDs, at frequencies imperceptible for human eyes.

The standard covers the physical layer (PHY) and the medium-access control (MAC). Currently, the MAC supports three access topologies: peer-to-peer, star, and broadcast, as illustrated in Figure 3.1. The star topology implies the existence of a central node, called coordinator, which is dedicated to the control of the communication. In this case, an independent network will be created, with a unique VLC personal area network (VPAN) identifier. The devices that did not join the network cannot communicate with the ones inside the network even if the coverage area allows it. However, the coordinator will allow other users to join the network. In the peer-to-peer topology, every device will be able to communicate directly with all the devices within its vicinity. For this case, one of the two nodes involved will act as the coordinator, usually the node that initiates the communication. The broadcast topology implies the transmission of data, from one node to another or to more nodes, without forming a network. This type of communication is unidirectional and no destination address is required. The VLC devices are identified by using a 64 bits address, but as soon as a device becomes a coordinator a shorter 16 bits address will be used.

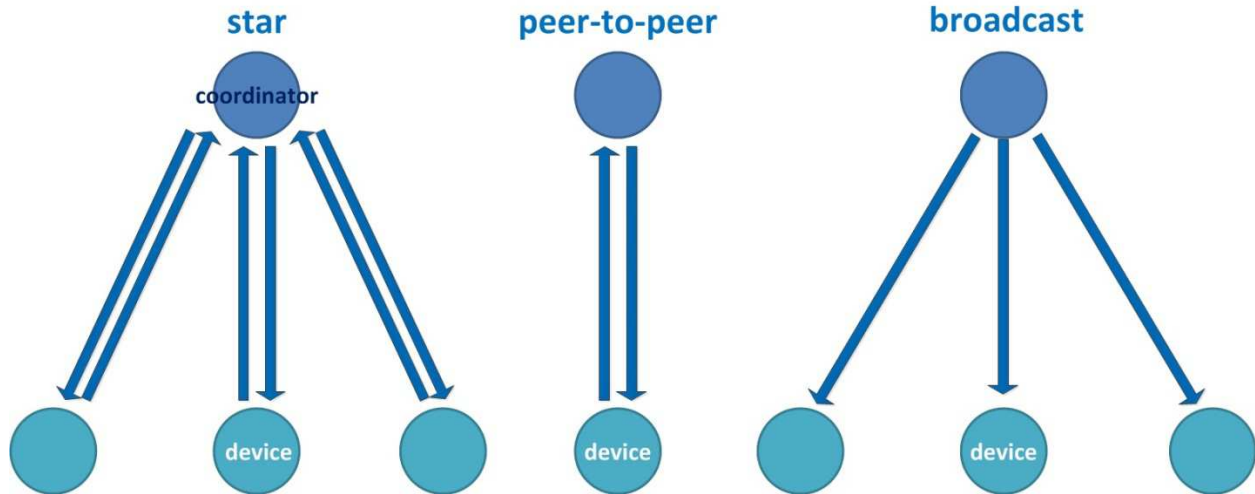

Figure 3.1: IEEE 802.15.7 topologies [132].

The IEEE 802.15.7 standard comes with three PHY types, grouped by data rates and by the intended applications. PHY I is intended for outdoor low data rate applications and it uses on-off-keying (OOK) and variable pulse position modulation (VPPM). For this mode, the standard specifies data rates between 11.67 and 267 kb/s. PHY II is intended for indoor moderate data rate applications and it uses OOK and VPPM, as well. For this mode, data rates between 1.25 and 96 Mb/s are specified. PHY III is intended for color-shift-keying applications with data rates between 1.25 and 96 Mb/s. The three PHY types can coexist but are not able to interoperate. PHY I occupies different spectral regions in the modulation spectrum from PHY II or PHY III. As shown in Figure 3.2, this enables frequency division multiplexing (FDM) as a coexistence technique.

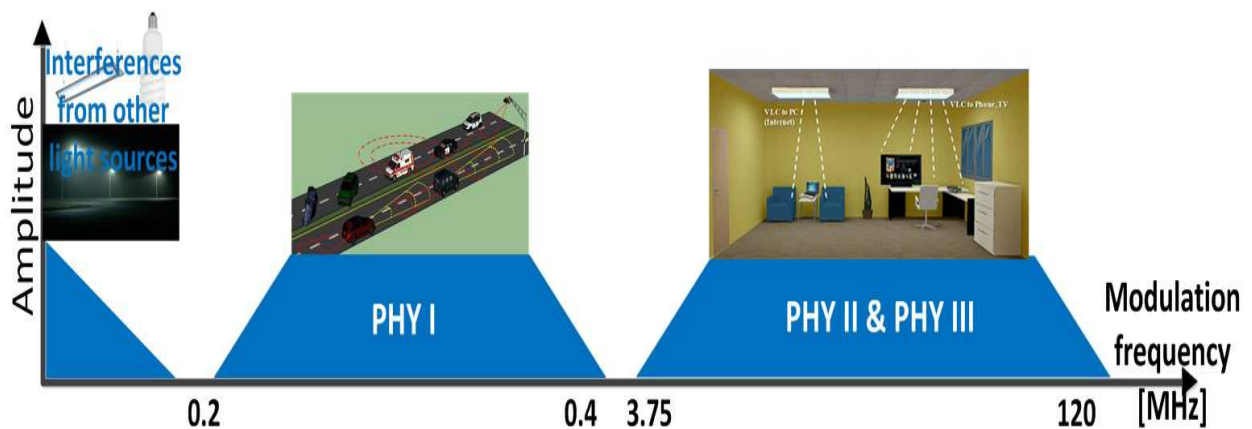

Figure 3.2: Frequency Division Multiplexing for the three PHY types.

The standard considers the issues related to the mobility of the link, the impairments caused by noise and interference from other light sources. Unlike other wireless communication technologies, the light wave carrier is perceivable for the human eye in VLC. This imposes that the modulation process must not cause any noticeable flickering that might affect the human health. Another unique feature of VLC is the requirement for supporting communications while light source dimming. These two aspects are taken into consideration by the standard, imposing strict limits for flickering and high resolution dimming.

Concerning the dimming, the standard provides two different dimming options, specific for the selected modulation. For OOK, the dimming is provided without any effect on the communication range which remains constant. This is possible because the intensity levels of the ON and OFF states remain constant. In this case, the dimming is accomplished by adapting the data rate through the insertion of compensation times. The compensation time means that the light is completely turned on or off for a necessary period of time. The period depends on the required dimming level. However, the insertion of the compensation time can lead to loss of synchronization. Additional short resynchronization patterns are thus required to overcome this problem. On the other hand, in VPPM, the dimming is supported while providing a constant data rate but at the cost of the communication range. In this case, the dimming is achieved by controlling the pulse width.

Regarding the flickering, the standard aims to prevent any potential light intensity oscillation caused by the light source modulation. For this purpose, the standard considers the usage of run length limited (RLL) coding. The RLL coding prevents flickering by avoiding long series of ones or zeros. RLL codes an equal number of ones and zeros and are DC balanced. Concerning the outdoor applications, the standard defines the usage of Manchester and 4B6B RLL coding, respectively for OOK and VPPM. PHY II indoor applications use the 8B10B coding instead of Manchester for the OOK.

Concerning the forward error correction (FEC), for the case of indoor applications the standard specifies the usage of the Reed Solomon (RS) codes. Compared to the indoor applications, the outdoor ones are more affected by path loss as the involved ranges increase. Outdoor VLC applications are also affected by stronger interferences from daylight, and in some cases, from artificial light. To compensate for these difficult conditions, the standard specifies the usage of convolutional codes (CC) in addition to the RS. In this case, the RS and the CC

block are separated by an interleaver providing a 1dB performance enhancement. Besides the low complexity, the mentioned FEC codes have the advantage that they perform well in combination with the RLL codes, which also have error detection capabilities, providing again a 1 dB performance improvement.

As illustrated in Figure 3.3, the structure of the proposed data frame is a complex one, consisting of three main fields. The synchronization header or the preamble field contains a locking pattern field with of a series of at least 64 ones and zeros. The locking pattern is used by the receiver for the optical clock synchronization. The second part of the preamble contains a series of four topology dependent patterns that help establishing the selected PHY topology. The standard specifies that the preamble is transmitted using OOK modulation without any channel coding. The PHY header provides the receiver with information regarding the transmission mode, the number of the communication channel, the selected PHY, the transmission data rate and the message length. The header is protected using a 16 bits cyclic redundancy check sequence. The third field of the PHY header contains several optional fields that are used only in certain situations. For PHY I with OOK, one of the optional fields will contain a sequence of six tail bits of zeros. When dimmed OOK is used, the second optional field will contain additional data that will be used to provide information about the number and the length of compensation symbols and also the lengths of the resynchronization symbols. The optional fields used for dimming support are protected by an 8 bits check sequence. The third optional field is used along with PHY III and contains an 8 bits sequence used for channel estimation. Concerning the header transmission, the standard specifies that it is transmitted using OOK with Manchester encoding. The transmission of the header is made at the lowest data rate.

The data field has a variable length and is protected by a frame check sequence. For the outdoor applications, the standard considers the usage of short frames, whereas for the high data rate indoor applications long data frames are considered. Referring to the PHY I applications, the payload can be up to 1023 bytes. The data field ends with a series of 6 bits of zero when the 11.67, 24.44 or the 48.89 kb/s data rates are used.

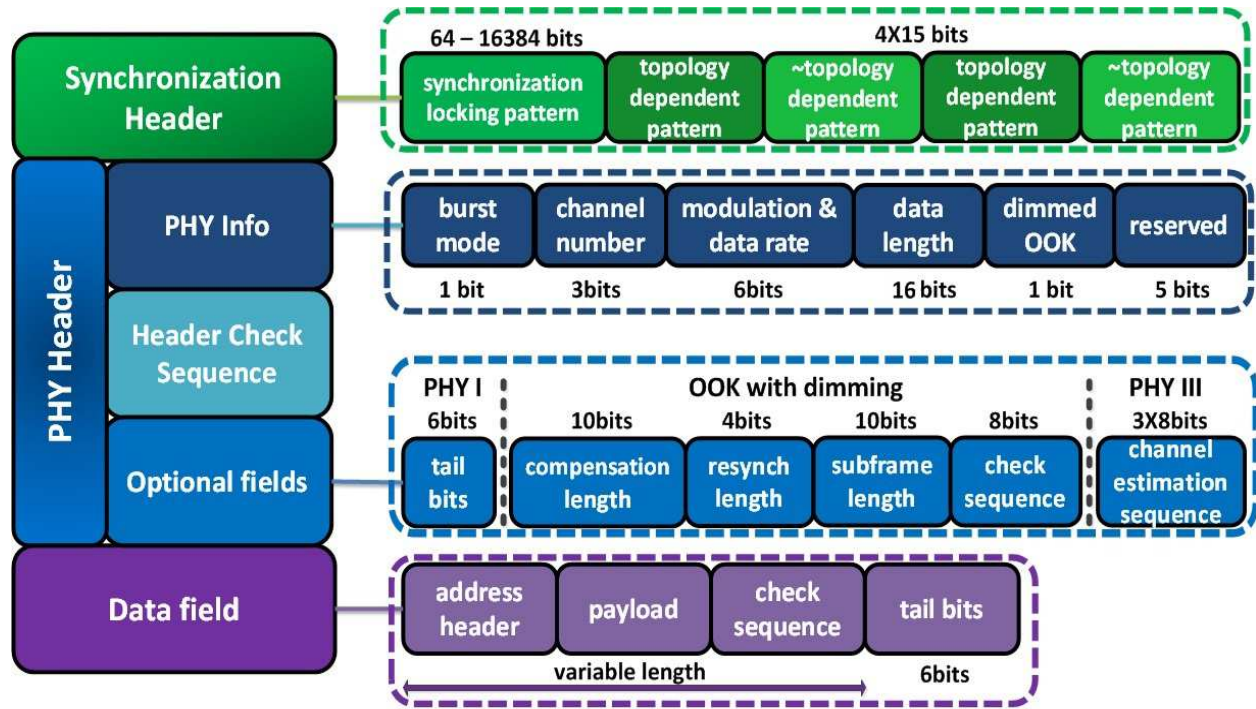

Figure 3.3: Structure of the IEEE 802.15.7 data frame.

Concerning the VLC devices, the standard mentions three different classes. The specific characteristics for each class are presented in Table 3.1. It can be seen that the standard considers as a possible application field the ITS domain, for communication between vehicles and also with the traffic infrastructure, defining several of the aspects related to the networking and to the requirements imposed in this area. The inclusion on the ITS applications in the IEEE 802.15.7 standard is an encouraging factor for continuing the research in this domain.

Table 3.1 – Device classification according to IEEE 802.15.7 [132].

	Infrastructure	Mobile	Vehicle
Fixed coordinator	Yes	No	No
Power supply	Ample	Limited	Moderate
Form factor	Unconstrained	Constrained	Unconstrained
Light source	Intense	Weak	Intense
Physical mobility	No	Yes	Yes
Range	Short/long	Short	Long
Data rates	High/Low	High	Low

The IEEE 802.15.7 standard was developed focusing on the aspects related to the PHY and the MAC layers and did not take into considerations the parallel transmissions as a way to enhance the performances of future VLC systems. However, such applications began to be considered more and more. For indoor applications, the parallel transmissions are accomplished using different colors of the light and optical filters but the ranges involved were limited to 1 or 2 meters [12]. Concerning the vehicle applications, only a few systems have been developed. The existing MIMO systems for automotive applications use high speed camera systems as receivers to extract data by using complex images processing techniques. For photodiode based receivers, the problem of parallel communications is more complex because of the mutual interferences. The separation of the channels can be accomplished by using band-pass filters centered on the incoming frequency. However, the close by frequency bands will cause false triggering, leading to decoding errors. The problem could be reduced by increasing the gap between adjacent channels. Concerning the Manchester code, it is well known that it does not use the bandwidth in an efficient way. Expanding every bit on a two bit period significantly increases the bandwidth requirement. For this reason, the separation of two adjacent channels is more difficult to accomplish. On the other hand, the Miller code is considered to be less bandwidth consuming. From this consideration, the performances of the Miller code will be evaluated, even if it is not a code considered by the IEEE 802.15.7 standard.

As illustrated in Figure 3.2, for the indoor applications, the standard stipulates the usage of a 3.75 – 120 MHz optical clock for data. For the outdoor applications, the clock rate is lowered to 200 kHz for OOK and to 400 kHz for VPPM. The motivation of this decision was to move the communication to a frequency where other sources of light cannot perturb it and also to prevent flickering. However, the flickering effect is prevented even for a modulation frequency corresponding to the lowest data rate of the standard (11.67 kHz). Concerning the perturbing effect of other light sources, this is rarely experienced at frequencies above 1 kHz. Therefore, the usage of a 200 kHz optical clock for outdoor VLC is not fully justified. Moreover, this would significantly increase the complexity and the cost of the equipment without a proportional benefit for the system performances. Under these conditions, even if there are several papers approaching the issues related to the standard requirements [133]-[136], there are no papers presenting hardware prototypes designed for outdoor applications that comply with it. This is in spite of the fact that there are more than two years from the standard release. On these grounds,

and to maintain the complexity and the cost as low as possible, the data transmission will be made at the base frequency, without using a modulated carrier.

3.2 Considerations regarding the coding techniques used for VLC

3.2.1 Introduction

In general, Intensity Modulation (IM) is considered to be the most appropriate modulation technique for VLC. IM implies modulating the desired waveform onto the instantaneous power of the carrier. The receiver extracts data from the modulated light beam by using Direct Detection (DD). The photodetector generates an electrical current proportional to the incident power. This current is further transformed into a voltage by a transimpedance circuit. The transimpedance circuit has low distortion and large gain-bandwidth product, to achieve, according to many studies, the best compromise between bandwidth and noise [122], [137]. Further on, the amplified signal passes through several filtering stages where the low and the high frequency noise components are removed. Finally, by using a triggering circuit, the data signal is reconstructed.

Depending on the application, many modulations techniques were proposed and investigated for VLC usage. Orthogonal Frequency Division Multiplexing (OFDM) [47-49] and discrete multi-tone modulations (DMT) [40] techniques offer the premises for high data rates and are used mainly for indoor static applications. Moreover, these modulations are suitable for short range applications, the distance between ceiling and office for example. Furthermore, complex modulations lead to a difficult transceiver design, increasing the cost of the system, which in the transportation field should be maintained as low as possible. For applications that require dimming, Pulse Width Modulation (PWM) [31] is considered as an alternative. For low data rates applications, meant for outdoor usage, where the Signal-to-Noise Ratio (SNR) is low, simpler modulations techniques, such as OOK are generally used. The solution considered by the IEEE 802.15.7 standard is proven to be quite efficient. OOK modulation is regularly used with Non Return to Zero (NRZ) or with Manchester codes. The usage of Pulse Position Modulation (PPM) or of Inverted-PPM [138] has also been investigated. Compared with OOK, PPM and I-PPM can achieve higher data rates transfer but require more bandwidth, higher peak power and are more sensitive to noise. In order to reduce the effect of noise, the usage of Direct Sequence Spread Spectrum (DSSS) sequence inverse keying (SIK) has been investigated and implemented

[121]-[123]. This approach uses a pseudo noise (PN) sequence to encode the bit ‘1’, whereas for bit ‘0’ it uses its opposite. This type of coding has error detecting capabilities and enables multiple transmitters.

As presented in the previous section, the IEEE 802.15.7 standard specifies for the PHY I outdoor applications, the exploitation of OOK and Variable Pulse Position Modulation (VPPM) as possible modulation techniques. VPPM is an improved modulation technique that combines the characteristics of pulse position modulation (2-PPM) for non-flicker and of Pulse Width Modulation (PWM) for dimming control and brightness control. VPPM is similar to 2-PPM but it allows the pulse width to be controlled, for light dimming. All VPPM PHY I modes use 4B6B encoding. VPPM is intended mostly for applications that require a high resolution dimming without affecting the data rate. However, in its case, the data rate is maintained by reducing the communication range. Reducing the energy consumption is indeed a hot topic [139], [140] for applications based on intensity control. Thereby, VPPM could be used to enable I2V communication between the street lighting infrastructure and vehicles. However, V2V and the communication between a traffic light and a vehicle are two relevant examples for applications in which the connectivity and the communication range are far more important than the data rate. For such applications, OOK is considered more appropriate and for this reason, the following investigations will be centered on OOK modulation rather than VPPM.

3.2.2 OOK coding techniques for VLC applications

As illustrated in Figure 3.4, OOK is a simple modulation technique in which the digital ‘1’ is represented as the presence of the signal, corresponding to the “ON” state whereas the ‘0’ data is represented as a signal whose value is equal to zero, or the “OFF” state. The “ON” and the “OFF” represent two distinct amplitude levels, required for the purpose of communication and not necessarily imply that the light source is turned OFF completely. For OOK, the IEEE 802.15.7 standard mentions the usage of the Manchester code, with five different data rates, namely 11.67, 24.44, 48.89, 73.3 and 100 kb/s.

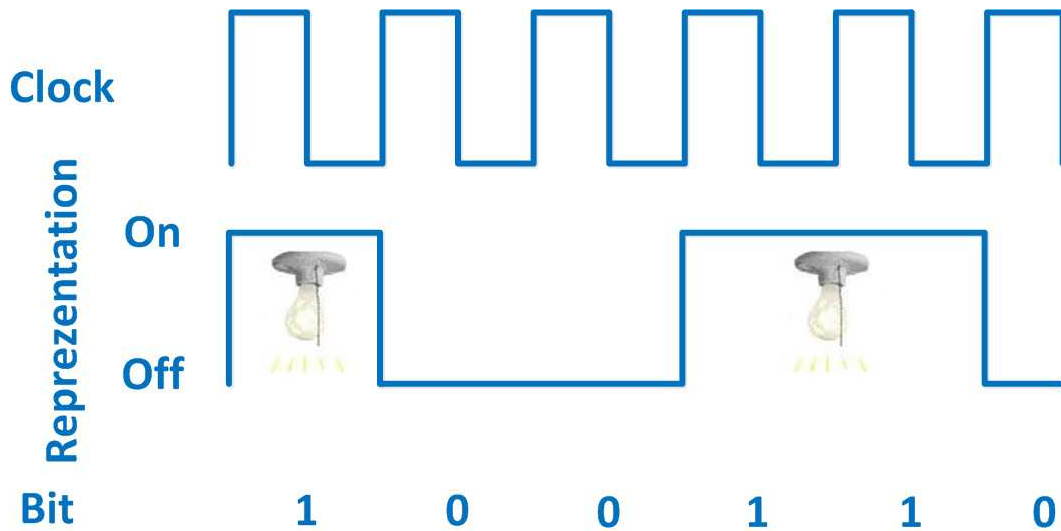

Figure 3.4: On – Off Keying data coding.

3.2.2.1 The 4B6B code

The 4B6B code is a simple data transmission code specified in the IEEE 802.15.7 standard. The standard considers it for outdoor applications with VPPM or for indoor applications with OOK. The description of the block code is done based on a coding table (Table 3.2), which contains the output codes associated to the input codes. The code involves series of ‘0’ and ‘1’ pulses. The 4B6B code expands every 4 bits into 6 bits, with the number of 1s equal with the number of 0s. It is DC balanced and has a 50% duty cycle. The code also offers a reasonable clock recovery. For generating the line codes the notion of digital sum is used. The purpose is to get word codes with the digital sum equal to zero.

$$d = \frac{n(+)-n(-)}{2}, \quad (3.1)$$

where $n(+)$ and $n(-)$ are the number of positive respectively zero pulses from the coded message.

To decode a 4B6B coded message, it is necessary to divide the message into 6 bits blocks. In order to properly accomplish this operation, the decoder must use a procedure that defines the data segmentation moments. This procedure is called block alignment.

The eventual errors inside the message can be identified with the help of the digital sum. In this case the decoder is monitoring the digital sum and when it is different from 0, the error is signalized.

Table 3.2 – 4B6B coding table according to the IEEE 802.15.7 standard [132].

4B input	6B output
0000	001110
0001	001101
0010	010011
0011	010110
0100	010101
0101	100011
0110	100110
0111	100101
1000	011001
1001	011010
1010	011100
1011	110001
1100	110010
1101	101001
1110	101010
1111	101100

The 4B6B code's main disadvantage is due to the extra bits added for the coding, decreasing the throughput by 1/3. If we also consider the minimal 158 bits overheads of the IEEE 802.15.7 standard, for a regular 528 bits safety message [85], the overheads will count for 334 out of 862 bits. This does not take into account the additional bits required for error correcting. However, the 4B6B has the advantage of error correcting capabilities, which enhances the BER. The performances of the 4B6B will not be addressed because the purpose of this work is to examine the performances of the OOK modulation and to focus on the physical layer without the usage of error correcting techniques.

3.2.2.2 The Manchester code

Manchester coding is an instantaneous transition code developed by University of Manchester, in which each bit has at least one transition that occurs at the mid-bit position. This feature allows the extraction of the clock signal period from the data frame. The DC component

of the Manchester code is zero.

As showed in Figure 3.5, in Manchester coding a binary ‘1’ is represented by a high to low transition, whereas a binary ‘0’ is represented by a low to high transition. Basically, each bit is expanded in an encoded 2 bit pair, and so, compared with NRZ, Manchester code requires twice the baseband bandwidth.

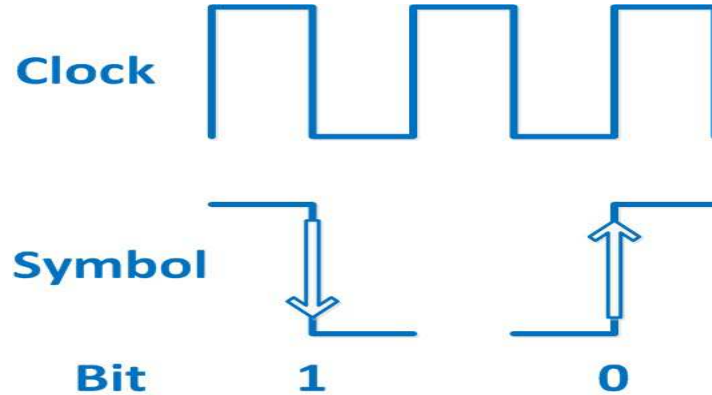

Figure 3.5: Manchester data encoding.

The Power Spectral Density (PSD) of Manchester code is given by eq. 3.2:

$$S_{Man}(f) = V^2 T \cdot \left[\left(\frac{\sin^2(\pi f T / 2)}{\pi f T / 2} \right) \right]^2 \quad (3.2)$$

where V is the signal amplitude, $T=1/R$ is the bit duration, R is the bit rate in bits per second and f is the frequency for which the PSD is calculated.

According to the IEEE 802.15.7 standard, the Manchester code is well suited for outdoor applications with a low data rate, such as the communication between vehicles. The standard specifies five possible data rates form 11.67 kb/s up to 100 kb/s. Besides the advantages mentioned above, another reason that made the Manchester code being selected by the upper mentioned standard is its flickering performances. In Manchester code, flickering is prevented by ensuring the same brightness for both ‘1’ and ‘0’ bits, since the positive pulses period is equal with the negative pulses period.

3.2.2.3 Delay Modulation (Miller code)

The Miller code [141] can be easily constructed from the Manchester code. The Miller

code is also a transition code but with memory, meaning that the information is encoded in the change of the pulse level, considering the previous bit. In Miller code, '1' is represented as a transition on the mid-bit position, '0' is represented by no transition on the mid-bit position whereas '0' followed by '0' is represented as a transition at the end of the first 0's period. These three encoding possibilities are presented in Figure 3.6. The Miller code offers good timing and also has the advantage that it requires a low bandwidth.

Even if the Miller code is not as popular as the Manchester code, its evaluation is necessary because it could be convenient for further Multiple Input Multiple Output (MIMO) applications. In its case, the bandwidth usage is more efficient.

As presented in [142], the Miller code behavior seems to be very suitable in order to perform multi-channels communication. This can be observed from the Power Spectral Density (PSD) formula which is given by eq. 3.3:

$$S_{Miller}(f) = \frac{V^2 T}{2(\pi f T)^2 \cdot [17 + 8\cos(2\pi f T)]} \cdot [23 - 2\cos(\pi f T) - 22\cos(2\pi f T) - 12\cos(3\pi f T) + 5\cos(4\pi f T) + 12\cos(5\pi f T) + 2\cos(6\pi f T) - 8\cos(7\pi f T) + 2\cos(7\pi f T)] \quad (3.3)$$

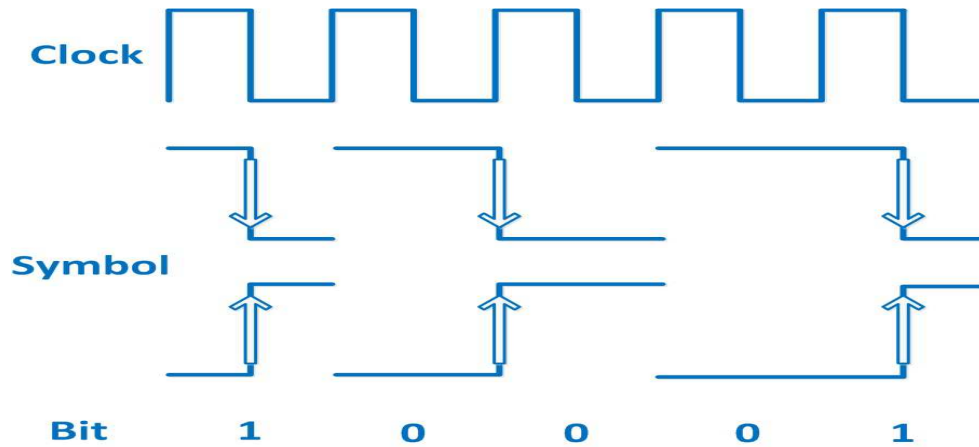

Figure 3.6: Miller data encoding.

3.3 Comparative evaluation of Manchester and Miller code

The Manchester code is stated in the IEEE 802.15.7 standard as the leading code for VLC applications such as V2V or I2V. Under these conditions, further investigation and evaluation of the Manchester code is strongly imposed.

However, in the context of a strong requirement for MIMO application, the investigation of a code suited for such applications is also necessary. For this reason, the usage of the Miller code in VLC under the PHY I layer of the IEEE 802.15.7 standard is investigated as well, in parallel with the Manchester code.

This investigation will take into consideration several key points related to the code performances, such as:

- the multi-channel capabilities;
- the flickering performances;
- the sensitivity to noise;
- the error occurrence;
- the bit error ratio (BER).

3.3.1 Manchester and Miller codes multi-channel capabilities evaluation

The Manchester code, also called the biphasic code, is a classical code, in which '0' is encoded as '01', whereas '1' becomes '10'. This coding technique has numerous advantages like DC balance, easy clock and data recovery, decent BER performances. However, even if it has plenty advantages, Manchester code's bandwidth requirements are higher compared to other codes. For example, it requires twice the bandwidth of Non-Return to Zero (NRZ). On the other hand, the Miller code, also known as delay modulation, appears to be more convenient for Multiple Input Multiple Output (MIMO) applications. In this case, the power is concentrated in a narrower frequency band, with limited expansion on neighboring channels.

The PSD shows how the energy is distributed over the frequency components. The PSD plot is an efficient way that can be used to illustrate the manner in which the two codes make usage of the available bandwidth. Therefore, it is used to evaluate their multi-channel capabilities. Even if the performances of the NRZ code are not addressed by this study, it has been introduced as a reference. Figure 3.7 presents the MATLAB simulation results containing the corresponding curves for the three codes with a modulation frequency of 11.67 kHz. It can be noticed that the Manchester code requires twice the bandwidth of the NRZ code. For the Miller code's PSD, the maximum energy is at a frequency of around $2/5$ of the modulation frequency, whereas for the Manchester code, the maximum energy is at approximately $4/5$ of the modulation frequency. As the power is concentrated at a lower frequency, the Miller code is less

bandwidth consuming. Figure 3.8 and Figure 3.9 present the MATLAB simulation results containing the PSDs of five adjacent channels for Manchester and Miller code respectively. The five channels correspond to the data rates specified by the IEEE 802.11.7 standard for OOK. It can be observed that for the Manchester code, the five carriers significantly overlap, making the separation quite difficult and introducing decoding errors. In the case of the Miller code, only the adjacent channels overlap but in a lower extent compared to the Manchester code. In this case, the Miller code usage enables parallel communication on two non-adjacent channels, which can be well distinguished. For this purpose, the sub-carriers can be filtered by band-pass filters, either analog or digital. If we take a look on the graph and focus on the first and the third channel, it can be observed that the two can well coexist in a bandwidth as low as 35 kHz. As a consequence, the results demonstrate that the Miller code is better suited for multi-channel communication, even in a relatively narrow band. However, for the two considered channels, a problem is that the first harmonic of the first channel is positioned at a frequency which corresponds to the channel's three peak. This could introduce some decoding errors. The same phenomenon can be also observed for the second and the fifth channels. The phenomenon is also observed for the Manchester code, which points out that multi-channel usage with parallel transmissions was not considered in the development of the standard.

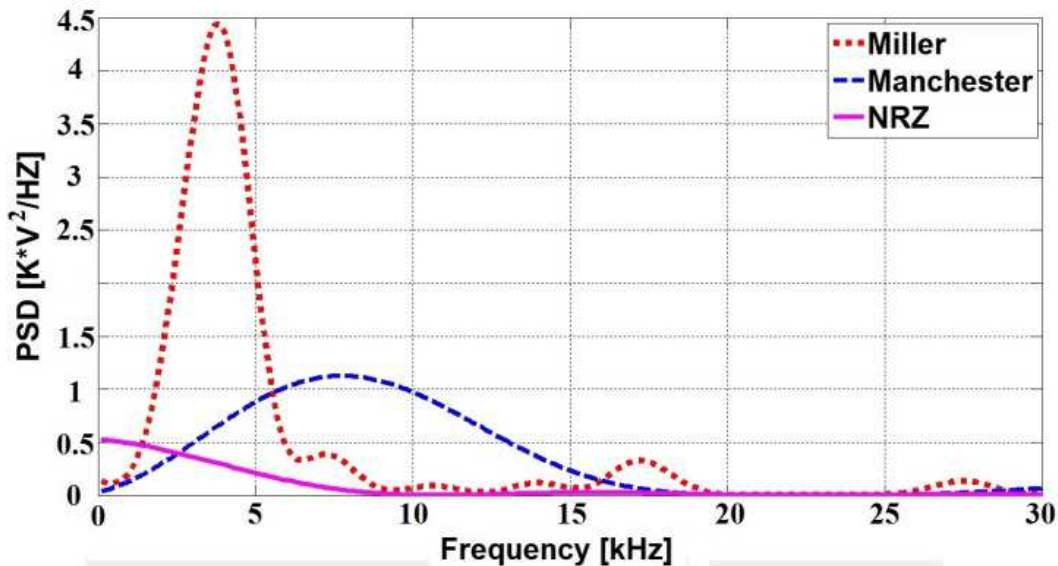

Figure 3.7: PSD for NRZ, Manchester and Miller code at 11.67 kHz.

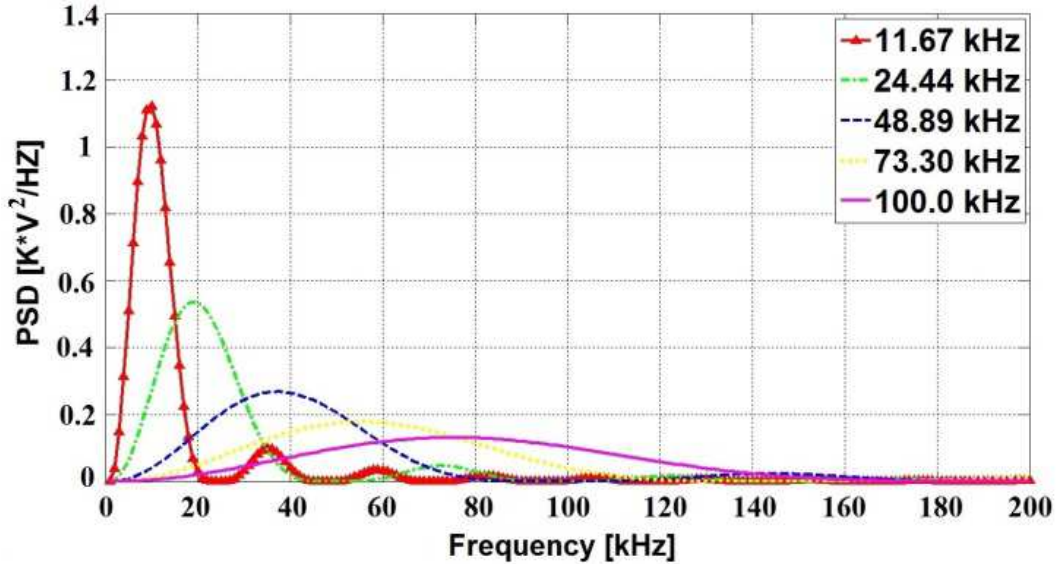

Figure 3.8: Simulation for a five channels configuration, using the Manchester code.

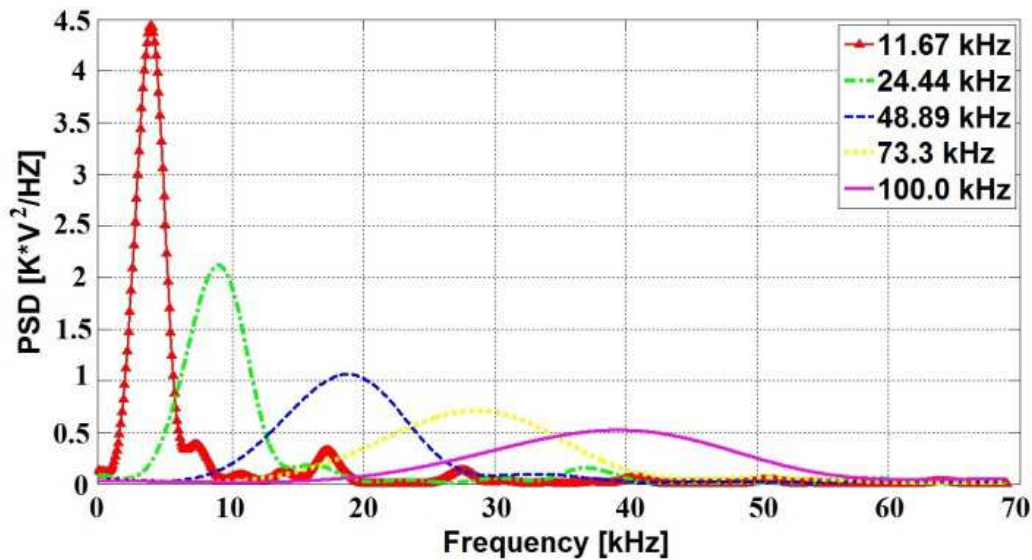

Figure 3.9: Simulation for a five channels configuration, using the Miller code.

The curves are proportional to a scale factor K depending on the amplitude V of the signal, but nevertheless, the key point is the relative scale between curves. However, to illustrate the impact of K , its value increases proportionally with the square of the input signal amplitude.

3.3.2 Flickering issues concerning the Manchester and the Miller code VLC usage

The VLC technology adds communication capabilities to the classical lighting. However, VLC must not affect in either way the primary role of the appliance, which is lighting or signaling. Flickering mitigation is one of the main concerns regarding the VLC. Flickering represents the light intensity fluctuation caused by the modulation technique, and it is classified as inter-frame flickering and as intra-frame flickering. From the visibility point of view, flickering is classified as visible and as invisible flickering. The visible flickering is consciously perceivable by the human and is associated with frequencies up to 70 Hz. It is considered that because of the biological human response to it, there might be a health risk associated with flickering. Its effects on the human health may include epileptic seizures, headaches or reduced visual capabilities [143] - [145]. Besides the visible flickering, it has been showed that the human retina reacts to light modulation at frequencies between 100 and 160 Hz [146], even if in these cases the flickering is too fast to be consciously perceived. The biological effects of invisible flickering are less evident and lead to headaches in most cases. For the case of LED lighting systems, the modulation norms and the biological effects of flickering are considered by the IEEE Standards PAR1789 group [147].

In VLC, flickering is prevented when the light intensity changes within the Maximum Flickering Time Period (MFTP). In this case, the human eye does not notice and does not react to the light intensity changes. Even if an optimal flicker frequency is not widely accepted, it is considered that a MFTP smaller than 5 ms (200 Hz) is safe [132], [146]. The IEEE 802.15.7 standard specifies the usage of Run Length Limiting (RLL) line coding, such as Manchester, 4B6B or 8B10B code, as a technique for preventing perceivable flickering. The RLL codes prevent long runs of '1's and '0's that can cause flickering and also ensure better clock and data recovery. For outdoor applications, the IEEE 802.15.7 standard specifies for the OOK, the usage of Manchester code as a technique for preventing perceivable flickering, whereas for VPPM, it specifies the usage of the 4B6B code. For both the modulations, the non-flickering characteristic is achieved by having the same brightness for bits '1' and '0'.

To determine the flickering characteristic of the Miller code, several MATLAB simulations have been performed. A number of 10^5 messages, containing 64 random ASCII characters (512 bits) were generated. The messages were encoded using the Miller code. Due to

its characteristics, the Miller code cannot ensure the same brightness for bits ‘1’ and ‘0’. Because bit ‘1’ is encoded as a mid-bit transition, every bit ‘1’ has the same brightness, corresponding to an ‘ON’ period equal with half the bit period. Then again, for ‘0’, the brightness can be either twice the brightness of ‘1’ (“ON” for the entire bit period) or it can be zero (state “OFF” for the entire bit period). Under these considerations, instead of determining the brightness of Miller coded messages on an individual bit level, the determination is performed on a byte level. It appears that as long as the modulation period is at least eight times shorter than the MFTP, if each byte’s brightness is equal, no noticeable or perceivable flickering is induced. The brightness of each byte is determined by measuring the “ON” time, as a percentage of the total byte time. Regarding the Manchester code, it can be observed that because every bit has a mid-bit transition, the “ON” time is equal with half of the bit period. Thereby, for the case of these tests it is considered that 100% brightness is achieved when the light is on for half of the byte time. The simulation results concerning the brightness intensity variations at the byte level are presented in Figure 3.10. It can be observed that the brightness of the bytes is 100% for 37.46% of the cases, varies in 49% of the cases by $\pm 12.5\%$, in 12.5% of the cases by $\pm 25\%$, whereas in 0.7% of the cases by $\pm 37.5\%$.

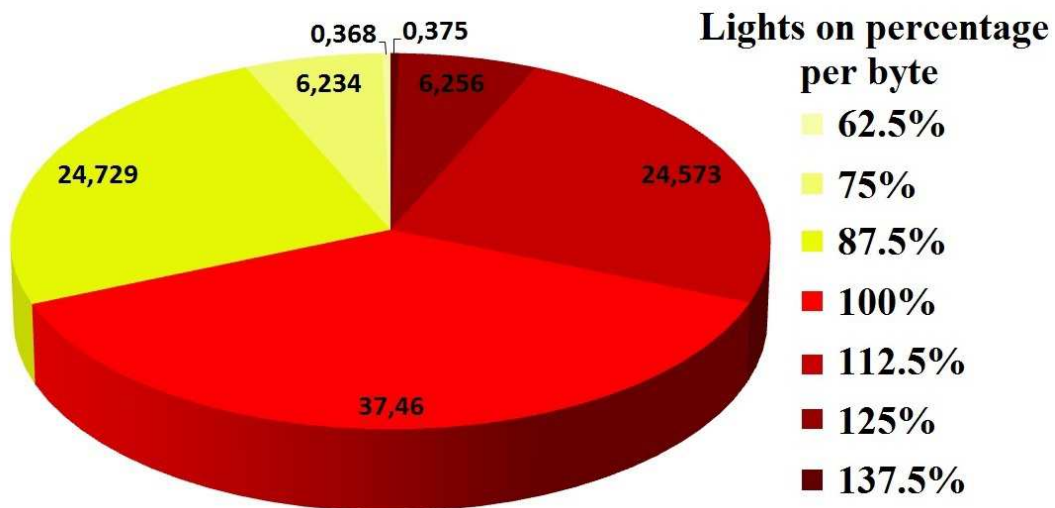

Figure 3.10: Simulation results showing the bytes percentage for different brightness intensities.

Based on these results, one can conclude that unlike the Manchester code, the Miller code exhibits some brightness variations from one byte to another. However, since the byte period is

significantly shorter than the MFTP, flickering at the byte level cannot be perceived. In the following step, the light intensity level of each MFTP will be determined, for the five data rates mentioned in the standard. The MATLAB simulation results are presented in Figure 3.11. It can be observed that the brightness distribution with respect to the MFTP has a Gaussian distribution, centered on the 100% brightness intensity, which gets narrower as the modulation frequency increases. In this case, the 100% brightness intensity is achieved when the light is on for half of the time. The results show that even at the lowest data rate, more than 96% of the MFTPs have a brightness variation bellow $\pm 10\%$. As the modulation frequency increases, the brightness variation gets even lower. Furthermore, the human eye does not have a linear response to changes in light intensity. According to [148], the relation between the perceived light and the measured light is given by eq. 3.4. This relation further reduces brightness variation sensation, limiting the flickering effect perceived by the human eye. Based on these considerations, it can be stated that the Miller code may present slight brightness variations, but without them being perceivable by the human eye.

$$Perceived\ light(\%) = 100 \times \sqrt{\frac{Measured\ light(\%)}{100}} \quad (3.4)$$

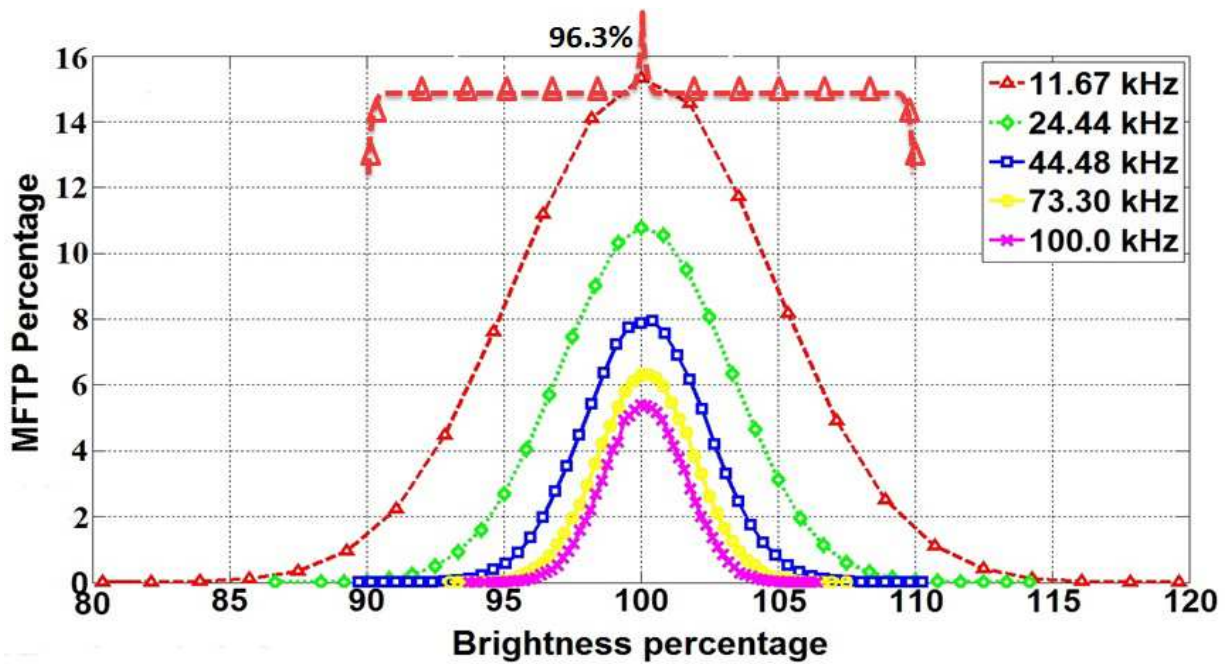

Figure 3.11: Simulation results showing the percentage of MFTP for different brightness percentages.

Based on all these facts, it can be concluded that the light intensity fluctuation introduced by the Miller code is rather limited and it is not perceivable by the human eye. Furthermore, in outdoor high speed conditions, as in transportation, there are numerous other light sources which are changing the perceived light intensity (e.g. sun light obstructed by different objects, other passing vehicles, different displays). In these circumstances, the Miller code usage in outdoor applications can be considered safe.

3.3.3 Sensitivity to noise evaluation

Intensity modulation with direct detection implies the usage of a photodetector element that produces an electrical current proportional to the power of the incident light. This current will be further processed in order to obtain the data it contains. However, the incident light does not only contain the data signal but also noise. The outdoor VLC channel is considered to be extremely noisy. Sun light, street light and vehicle lighting systems represent major background noise sources for VLC. The weather conditions, such as fog or rain, also have a negative impact on the VLC data signal. Moreover, due to the dynamic nature of the traffic, in such applications, the VLC receiver will experience high variations of the SNR. Of course, different mitigation mechanisms such as narrow angle receiver, optical filters, or different signal processing techniques are used at the receiver side. However, high levels of noise will still affect the quality of the communication. Therefore, an analysis of the effects of the noisy optical channel on the data signal is strongly needed.

In order to determine the noise influence on the pulse width, several MATLAB/Simulink simulations have been performed. The simulations involve the coding of random messages using both the Manchester and the Miller code. The messages are transmitted using a modulation frequency of 11.67 kHz and at different SNR levels. The simulated receiver, illustrated in Figure 3.12, assumes the use of a 12 bits ADC module. In order to be able to insure decent signal processing, the sampling frequency is 100 times the data frequency, leading to 1.167 MHz. The filtering is performed by two low-pass Butterworth 2nd order cascading filters separated by a partial signal reconstruction block. After filtering, the signal passes through a triggering block that outputs the replication of the emitted signal. The reconstructed pulse widths are then measured and analyzed in order to determine the noise influence on the pulse widths. The full

details related to the parameters of the used receiver architecture are provided in Chapter 4. More complex signal processing techniques, higher order filtering or adaptive threshold algorithms can minimize the effect of the current noise levels, but as the SNR continues to depreciate the effects on the pulse widths are similar.

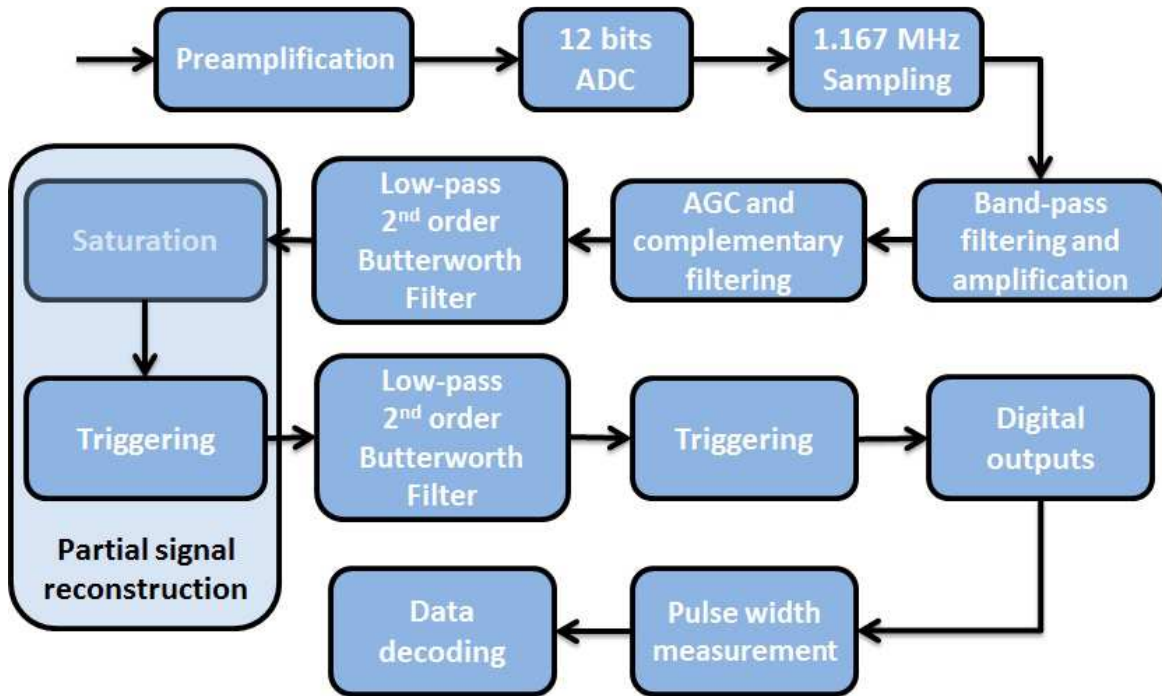

Figure 3.12: Sketch of the proposed VLC receiver.

For the purpose of these experiments, random messages were encoded in Manchester and Miller codes. The main parameter of the encoded signal is the width of the elementary pulses corresponding to the digital bits. For the Manchester code, there are only two symbols (positive edge and negative edge) and it leads statistically to only two combinations of widths: either one elementary bit width, either twice. For the Miller code, the memory effect on its construction leads to three possible combinations: either one momentary width, or one and a half or twice the widths [149], [150]. The possible variations of the pulse widths for the two codes are presented in Figure 3.13.

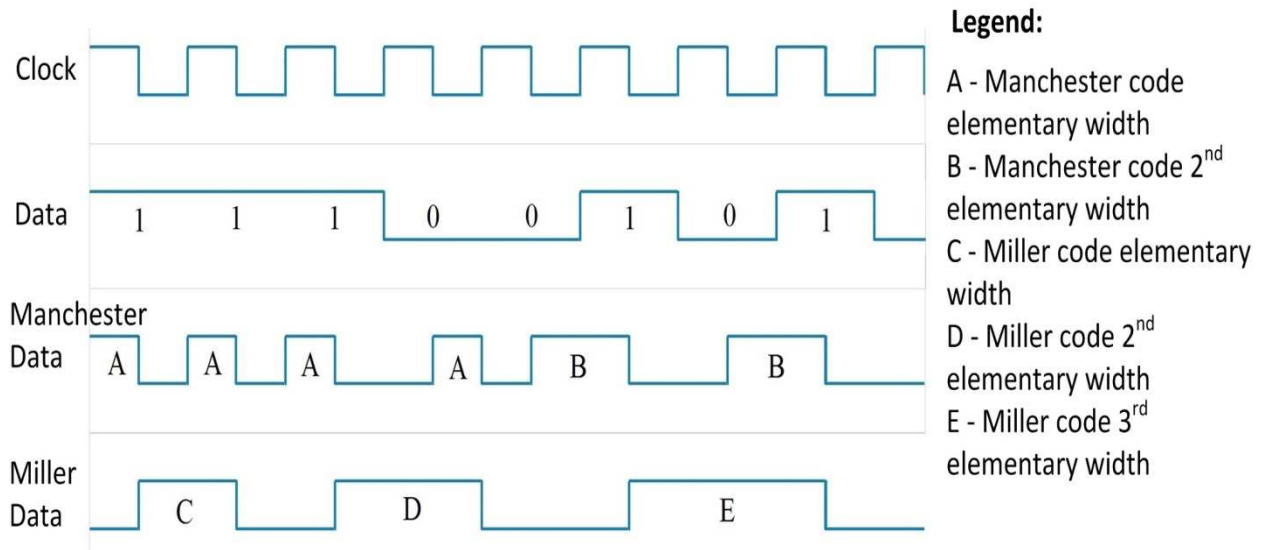

Figure 3.13: Illustration of the possible pulse widths in Manchester and in Miller code.

At the receiver side, the pulse width measurements of 10^5 pulses from each of the pulse widths types were saved and then analyzed for both codes. It has to be mentioned that for both Manchester and Miller code, a coded frame does not contain an equal number of pulses from the two respectively the three pulse width types. The number of pulses from each category depends on each message. For this reason, the data gathering process continued until the 10^5 number of pulses from each of the pulse width types was achieved. Even if the purpose of this analysis is not message decoding, it is important to mention that the decoding is performed based on the identification of the rising and falling edges and on the pulse width measurement. In this case, it is obvious that pulse distortions above certain tolerances will cause decoding errors.

The results concerning the noise effects on the pulse width are plotted in Figure 3.14 for three SNR levels for the Manchester and for the Miller code. It can be observed how the SNR decrease affects the pulses by producing distortions. It also points out the relationship between the SNR decrease and the number of pulses that are affected by distortions, for the case of the considered DSP VLC receiver. The pulse width distortions do not represent a significant problem as long as they do not affect the pulse width in a percent that leads to decoding errors.

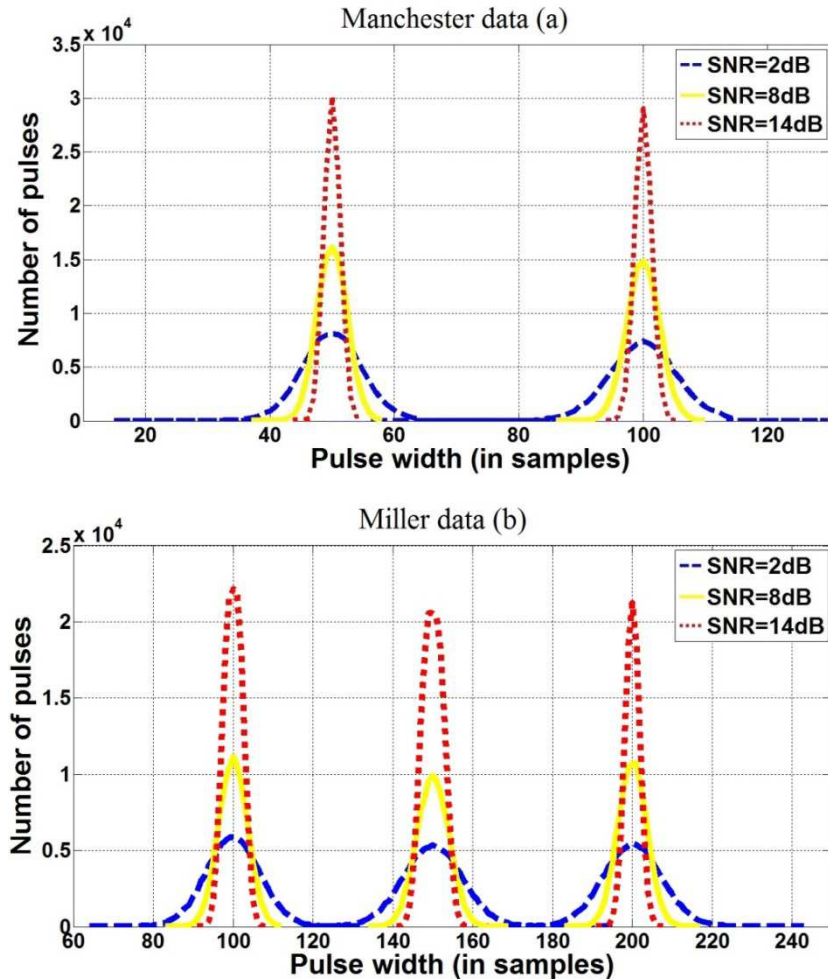

Figure 3.14: Simulation results for Manchester and Miller code pulse widths: a) Manchester case b) Miller case.

It can be observed in Figure 3.15 that in the case of the Miller code, the distortion percentage is not as high as for the Manchester code. At low SNR levels, 1 – 4 dB, the Miller code exhibits a 1/3 lower distortion percentage, whereas as the SNR enhances, the difference between the two codes decreases. This can be explained because of a greater number of samples per pulse for the same modulation frequency due to its larger pulse width. As a result, the quality of the filtering is increased. Figure 3.16 shows the output of a 2nd order Butterworth filter for a Miller (a.) respectively a Manchester (b.) encoded signal for a SNR level of 1dB. The same message is transmitted and the same noise sequence is used. The superior filtering of the Miller encoded signal is visible. However, due to its nature, the Miller code is more sensitive to variation of pulse length. In this case, pulse width variations above 25% for the short pulse and above 12.5% for the double length pulse create decoding errors. In the case of the Manchester

code, the distortion percentage that leads to decoding errors is double.

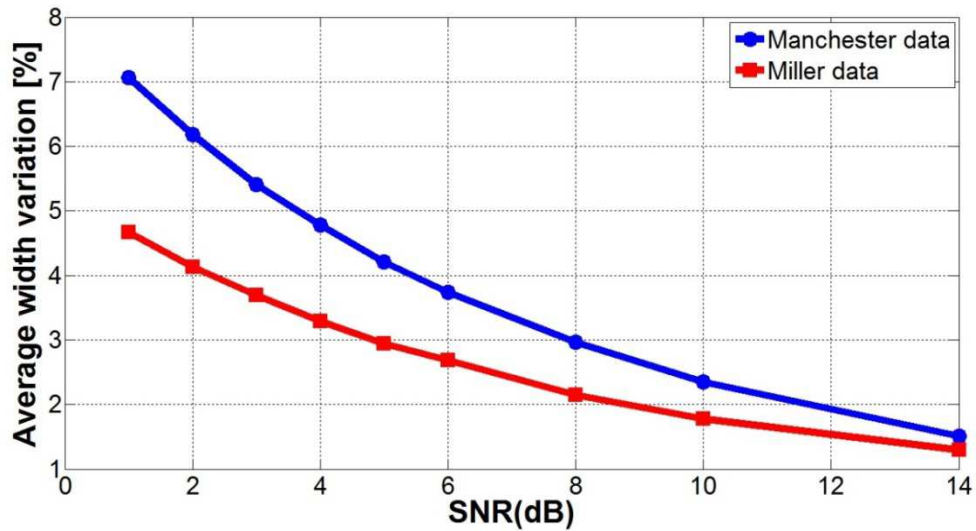

Figure 3.15: Average pulse width variation for Manchester and Miller codes, with respect to the SNR.

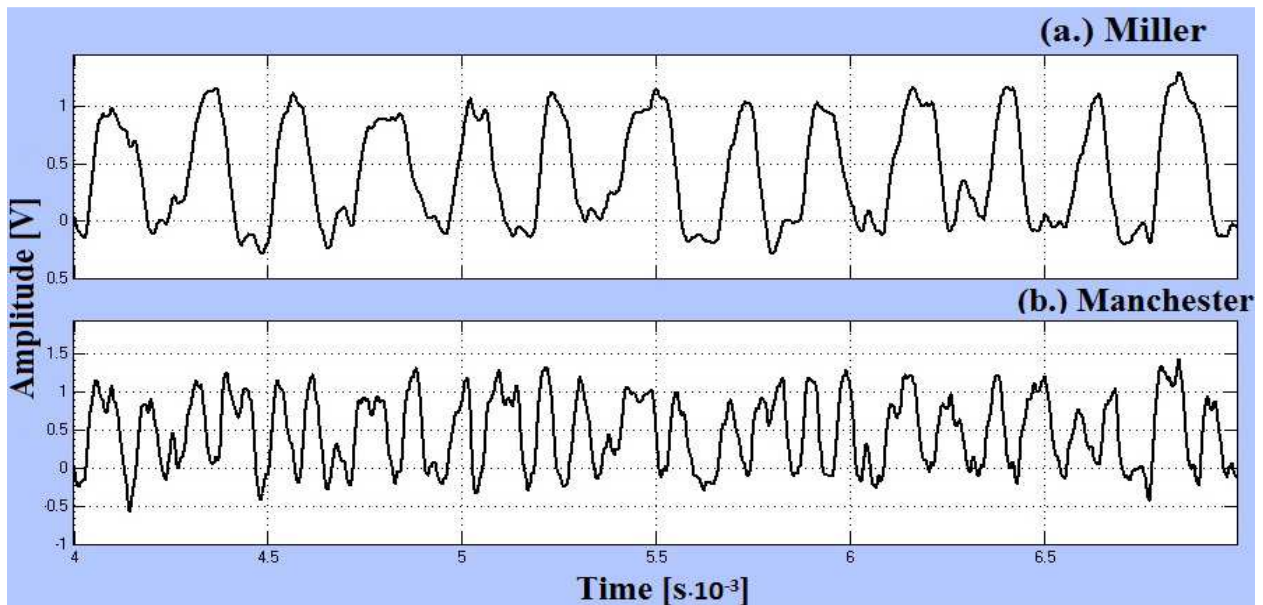

Figure 3.16: The output of a 2nd order filter for a Miller/Manchester encoded signal.

Regarding the BER results, these are represented in Figure 3.17. It can be noticed that for a low SNR, the Miller code and the Manchester code present almost similar results with a 10% lower BER in the case of the Miller code. However, as the SNR improves (4 – 5 dB), the BER performances seem to be equal. This behavior can be attributed, once again, to the nature of the

two codes. For low SNR levels, the improved filtering performances of the Miller code give it a slight advantage over the Manchester code. As the SNR gets higher, the Manchester coded signal is decently filtered while the Miller coded signal is affected by the stricter tolerance limits.

These results can be improved by using a higher sampling frequency, higher level filtering, improved pulse reconstruction algorithms or other signal processing techniques, that will mitigate the noise effects on the pulse width to lower SNR levels. However, when considering the hardware implementation, all these improvements increase the complexity and the cost of the equipment.

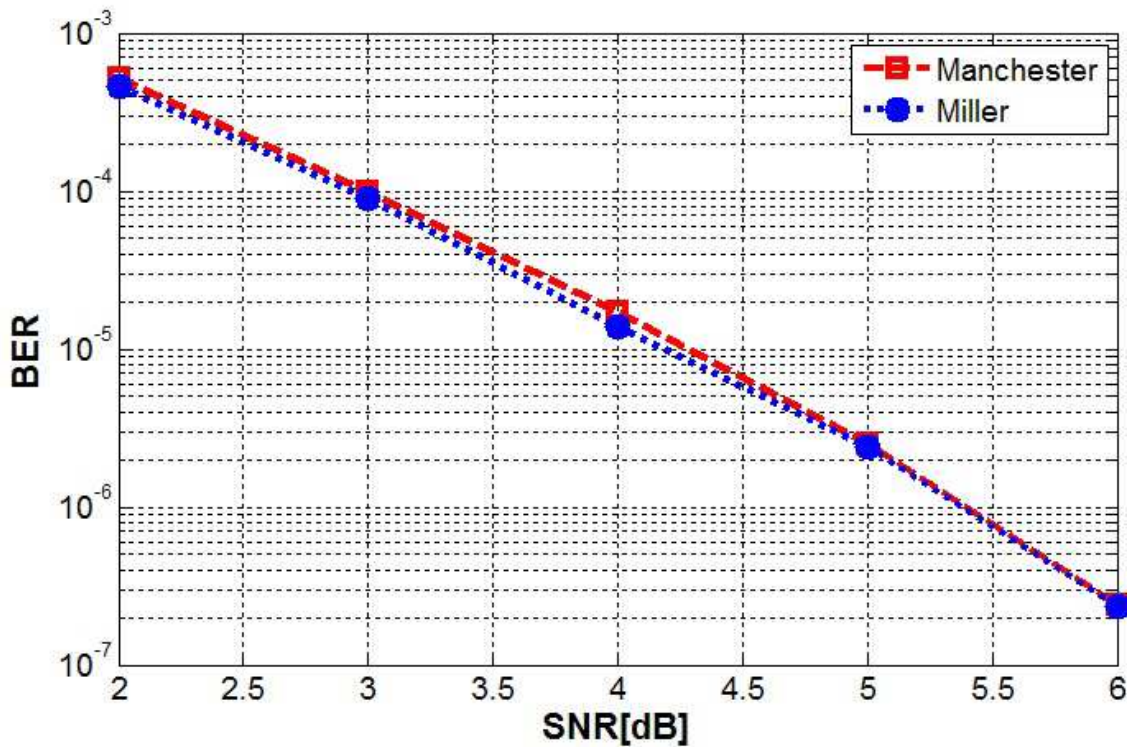

Figure 3.17: Bit error ratio for Manchester and for Miller codes.

3.4 Conclusions

This chapter presented a comparative analysis over the coding techniques used in VLC, focusing on the Manchester and on the Miller codes. The simulation results show that in terms of BER, the Manchester and the Miller codes have similar results. However, in terms of spectral distribution, Miller code clearly outperforms Manchester code, and offers the premise for future

MIMO applications. The IEEE 802.15.7 standard motivates the usage of the Manchester also considering its flickering performances. Due to this reason, this chapter analyzed the flickering performances of the Miller code as well. The results show that even at modulation frequencies as low as 11.67 kHz, the flickering effect is very limited. Since the Miller code is more efficient regarding the bandwidth usage, its employment for VLC application was found to be suitable and we can expect future perspectives in MIMO applications.

Chapter 4

Development, modelling and evaluation of a Digital Signal Processing VLC architecture

Contents

4.1 Introduction.....	71
4.2 The premises of the simulations	72
4.3 VLC model development and preliminary evaluation.....	77
4.4 Evaluation of a multi-data rate DSP VLC architecture	86
4.4.1 The VLC emitter model	86
4.4.1.1 Considerations on the frame structure	87
4.4.2 The VLC receiver model.....	88
4.4.2.1 VLC Receiver System Model Blocks.....	89
4.5 The Performance Results of the VLC Model	95
4.6 Conclusions.....	99

4.1 Introduction

Simulations are a useful tool to reproduce the behavior of a complex system. They allow for systems' performances analysis and to gain insights into a technology. Generally, the simulation processes rely on the theoretical and on the numerical analysis of the behavior of the system being modeled. However, these analyzes are built on different approximations and estimations so that the precision of the results depends on the accuracy of the implemented model. Even under these circumstances, the simulations are extremely useful in testing different setups and configurations, offering valuable information which helps optimizing the system and its performances. Another benefit of the simulations is the possibility of reproducing certain conditions or scenarios in a repetitive manner and in a time-efficient way. From this point of view, the simulations represent a necessary step towards the implementation and the testing of a system.

In order to perform an analysis concerning the performances of a VLC architecture, a Matlab/Simulink model has been developed and implemented. The model integrates a VLC emitter, the communication channel and a VLC receiver which uses Digital Signal Processing (DSP) techniques for data recovering. The functionality of these components will be detailed in the following sections.

The motivations and the objectives of this study are:

- i) to propose and to test a configuration for a self-adjusting VLC receiver;
- ii) determine if the proposed receiver architecture is well suited for outdoor VLC;
- iii) determine the noise influence on the VLC BER performances;
- iv) determine the data rate influence on the VLC BER performances;
- v) determine the influence of message length on the VLC BER performances;
- vi) to get an overview of the limits for a decent communication under diverse conditions;
- vii) to implement and to test an adaptive digital filter which will be required for Multi Input Multi Output (MIMO) applications;

The VLC architecture (model) is presented hereafter with a brief description of the used signal processing blocks. In order to enhance the performances and the efficiency of the model, a series of tests have been performed, using different parameters. The chapter ends with the presentation of the results and with the conclusions that were drawn from them.

4.2 The premises of the simulations

a) The noise influence

The VLC performances are strongly influenced by the communication channel. A VLC channel can be modeled as a baseband linear system, with instantaneous power $X(t)$, output photocurrent $Y(t)$ and impulse response $h(t)$. The channel is subject to signal independent additive noise $N(t)$, as presented in Figure 4.1.

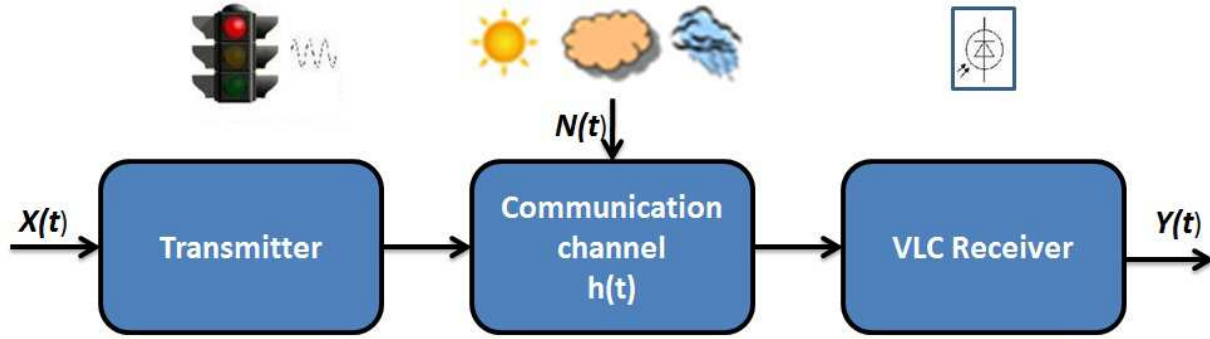

Figure 4.1: Simplified VLC model.

Outdoor VLC applications are subject to multiple external noise sources which affect the communication performances. For VLC, the major noise source is represented by the background light. The background light can be either from artificial sources either from natural sources. The bright sky light and the direct sun light are the natural light sources affecting VLC. For a VLC, these two sources are the most disturbing due to their high power, which can saturate the photoelement, making it blind. The artificial noise sources are represented by classical light sources with no communication capabilities, such as incandescent sources or fluorescent lights which produce a strong 100 Hz parasitic signal and also a DC component. In most of the cases, these sources have a power much higher compared with the power of the desired signal. Beside these unmodulated light sources, the data transmitting light emitters can also affect the VLC.

Both sunlight and artificial light affect the communication by introducing a high intensity shot noise component. The shot noise is proportional to the optical power incident on the receiver. The effect of the shot noise can be minimized by using optical filters, but this is still a perturbing noise source limiting the communication's performances. In day-time, the shot noise is the dominant noise component, for outdoor applications. The shot noise current is given by eq. 4.1:

$$i_{shot} = \sqrt{2qIB}, \quad (4.1)$$

where q is the electronic charge ($1.602 \cdot 10^{-19}$ C), B is the detector bandwidth and I is the produced photocurrent whose value is given by eq. 4.2:

$$I = S \cdot P_{total}, \quad (4.2)$$

where P_{total} is the power of the light incident on the receiver and S is the photodetector spectral sensitivity.

According to eq. 4.2, the shot noise induced in the receiving circuit is influenced by the total optical power incident on the effective light collection area, which is given by eq. 4.3.

$$P_{total} = P_{noise} + P_{signal} \quad (4.3)$$

where P_{noise} is the power of all the noises of the channel and P_{signal} is the power of the useful signal.

It can be observed that the shot noise is proportional with the total detected optical power incident on the photoelement. However, in daylight configuration, the contribution of the useful signal to the shot noise is quite limited compared with the one of the background noise or even with the one of the preamplifier thermal noise. From this consideration, the shot noise can be considered as a signal independent noise. In a first step, due to the high intensity, the shot noise component can be modeled as white Gaussian noise.

The preamplifier thermal noise is another perturbing factor for the VLC receiver. In the absence of background light, the preamplifier thermal noise is the predominant noise source. This noise type is also a signal independent Gaussian noise. The value of the thermal noise is given in eq. 4.4.

$$i_{thermal} = \sqrt{\frac{4KTB}{R}} \quad (4.4)$$

where K is Boltzmann's constant ($1.381 \cdot 10^{-23}$) and T is the temperature.

Beside the shot and the thermal noise, another main type of noise is the flicker noise. However, because the effect of the flicker noise is encountered at low frequencies, its effect on VLC is rather limited. In this case, the shot and the thermal noise represent the main sources of noise affecting VLC. In these conditions, the total noise is given by:

$$i_{total} = \sqrt{i_{shot}^2 + i_{thermal}^2} \quad (4.5)$$

Since both the shot noise and the thermal noise are signal-independent and Gaussian, the following simulations will concentrate on the effect of these noises on VLC.

b) The alignment and the link

The next simulations use the premises of a direct line of sight (LoS) between emitter and receiver, necessary for a VLC system to work. Surrounding surfaces can cause unwanted reflections or can scatter the VLC signal, creating multipath effects that can affect the communication. However, it has been demonstrated that the multipath effects do not affect outdoor VLC [12], except in the case of short distances (1 meter), which are not usually fulfilled under normal traffic conditions. *For this reason, non-LoS and multipath signal are not included in this simulation.*

The asynchronous transmission is encountered in hardware systems in order to maintain the complexity level and the implementation cost as low as possible. Furthermore, concerning the outdoor VLC applications, the frequencies involved are low enough and the decoding system has no need of time accuracy. *In the simulations, the clock of the receiver is not synchronized with phase locked-loop for simplicity.*

c) The frequencies involved

As previously mentioned, the IEEE 802.15.7 standard specifies for outdoor low data rate applications the usage of OOK with Manchester coding. The data rates mentioned in this case are 11.67, 24.44, 48.89, 73.3 and 100 kb/s. In this chapter, the performances of these five communication frequencies will be further investigated, in order to determine their influence on the communication performances. The effect of noise on each of the data rates will also be subject to investigations.

d) The message length

In wireless communications, the message length influences the BER performances [87]. This problem is extremely stringent for the RF based communications, where the message length influences the communication performances due to the mutual interferences of the different nodes [87]. Concerning the VLC, an elaborated study concerning the influence of the message length on the BER performances is not available. In order to determine this influence on the VLC, three message lengths will be investigated in different SNR conditions and at different data rates. A short message of 120 bits, a medium size message of 600 bits and a long message of 1024 bits have been considered. Regarding the length of the messages used in communication-based vehicle safety applications, in [12] based on the requirements from [85] a message of 481

bits is considered to be representative. A close message length is considered in [87], where 500 bits were used. Based on these considerations, the 600 bits message length can be considered appropriate for VLC, whereas 120 and 1024 bits are used as references, in order to determine the behavior of the communications. In traffic safety communications, the message length and the required information fields depend on the application. The U.S. Department of Transportation (DOT) [151] has defined the minimum information field requirements for different situations. In the case of a traffic light, the minimum information requirements are presented in Table 4.1.

Table 4.1 Traffic Signal Violation Warning Data Message Set Requirements [85].

<i>Description</i>	<i>Number of bits</i>
Traffic signal status information	
Current phase	8
Date and time of current phase	56
Next phase	8
Time remaining until next phase	24
Road shape information	
Data per node	32
Data per link to node	72
Road condition/surface	8
Intersection information	
Data per link	120
Location (lat/long/elevation)	96
Stopping Location (offset)	32
Directionality	16
Traffic signal identification	48
Message type	8
Total	528

e) The model's truthfulness

The truthfulness of the proposed model for the considered situations aims to be a high one. An advantage of the proposed model comes from the limited usage of the Matlab/Simulink built-in blocks. User-defined functions had been used instead. Such functions, allow the user to

write his own functions and algorithms in a similar way as on a DSP hardware system, in a language similar to the C language. The advantages of this approach are numerous because in this case, the simulations will accurately replicate the behavior of the hardware equipment. This approach also facilitates the implementation, since the developed code can be easily uploaded in a DSP equipment. In this case the system will have results similar to the simulation, because the flowchart for the two cases will be identical. The resemblance between the simulation and the experimental results will depend mostly on the DSP system's hardware parameters, as the ADC resolution or the sampling frequency. However, not all the scenarios that can occur were considered. Generally, artificial lighting produces parasitic signals of frequencies up to 1 kHz. However, in some case the perturbations can go up to frequencies of 20 - 30 kHz [152], especially when the light switching occurs. In such cases, the light will cause false triggering that will lead to decoding errors. The effects of such particular events or of similar ones have not been considered because the aim of this study was the investigation of a base VLC link.

4.3 VLC model development and preliminary evaluation

For most of the existing outdoor VLC prototypes, the output of the transimpedance circuit is processed mostly by using analog techniques (see [102 - 104], [109], [113], [119-123]). Even if this approach has the advantage of a lower implementation cost, future VLC prototypes could take advantage of the use of DSP techniques. The central element of a DSP system is the digital filter. The digital filters can achieve far better results compared with the analogical ones. These make the DSP systems very attractive. Since the outdoor VLC channel is strongly affected by noise, the superiority of the digital filters represents a major advantage that can enhance the performances of future VLC receivers.

In order to investigate the performances of such a system, a VLC receiver architecture is proposed and presented in Figure 4.2 [153]. This architecture has been implemented using Matlab/Simulink and has been evaluated through simulations. The description of the blocks is detailed in Section 4.4.2.1. The proposed model aims to replicate in part some of the characteristics of the hardware systems but to use DSP instead. As in a real system, the proposed model uses a high-pass filter to remove the DC and the low frequency noise components. Although it is disabled for the configuration tests, the model contains an Automatic Gain Control (AGC) unit which is used to compensate for the modification of the emitter-receiver distance.

The low-pass filters remove the high frequency noise as the shot and the thermal noise. In order to enhance the receiver performances, the model uses two filtering blocks separated by the partial signal reconstruction block with the purpose of performing a progressive signal reconstruction. Concerning the triggering, the DSP model allows the evaluation of an improved algorithm based on adaptive thresholds. Similar as in a hardware analogical receiver, the decoding is made based on the pulse width measurement and on the identification of the rising and of the falling edges. For the following preliminary tests a modulation frequency $F=11.67$ kHz is considered. This first structural design is an intermediate model used to determine the optimal settings for the main blocks. This model is used in the following simulations.

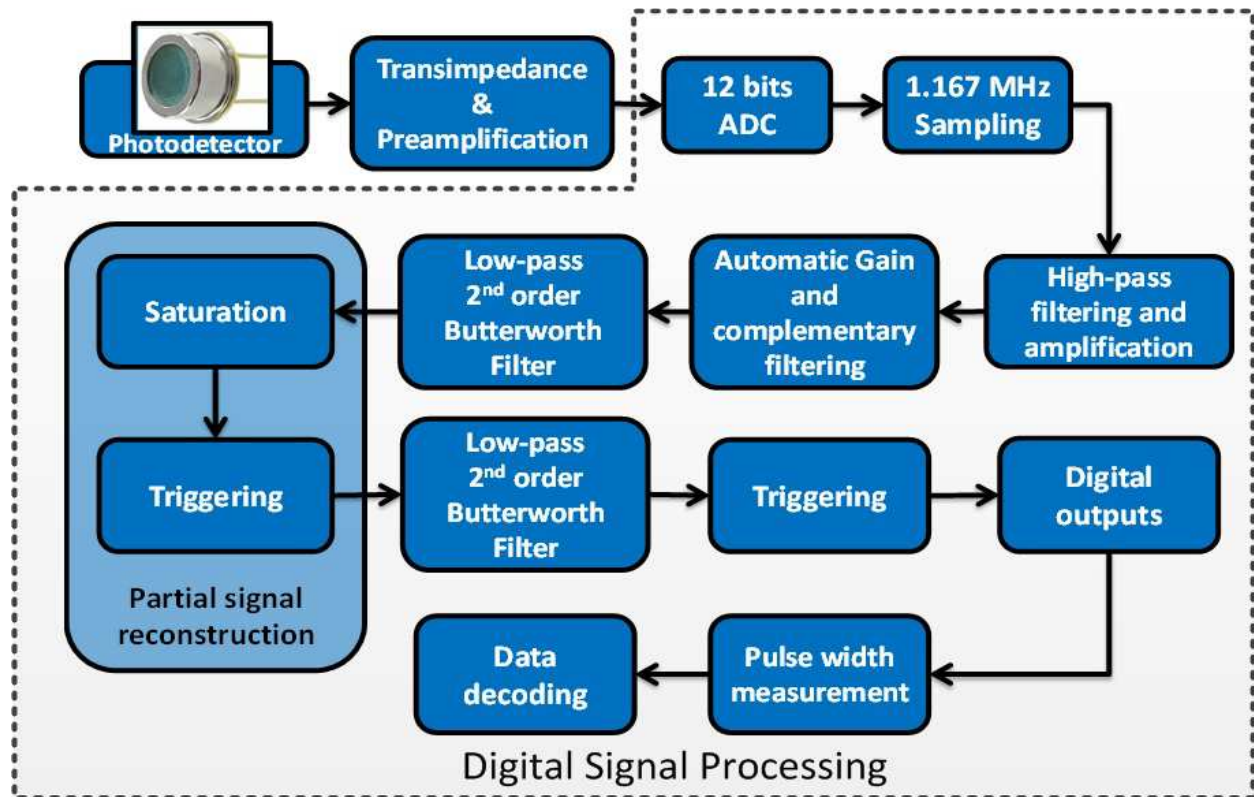

Figure 4.2: The architecture of the proposed VLC receiver.

The digital filters are the central elements of the DSP system and for this reason it is very important to determine the suitable filter and its parameters. The two main classes of digital filters are the Finite Impulse Filters (FIR) and the Infinite Impulse Filters (IIR). In an N order IIR filter, the output is obtained by using the values of $N+1$ inputs and of N outputs. The usage of the outputs implies the utilization of a feedback topology.

For the case of a FIR filter of order N , the output is determined by using the values of the last $N+1$ input samples. These types of filter are simpler to implement because they do not require any feedback. Not requiring a feedback also has as advantage the fact that the rounding errors affecting the output aren't used in other iterations. The FIR filters are also considered to be more stable. However, FIR filters have a major disadvantage represented by the fact that there are less efficient in implementation. Compared with the IIR filters, the FIR filters require significantly more computations in order to meet a set of imposed specifications.

Considering the superior efficiency of the IIR filters, in the development of the proposed model, such filters will be used. Some examples of classical IIR filters are the Butterworth, the Elliptic, the Chebyshev or the Bessel filters. The Butterworth filter [154] has as main advantage the fact that it has no ripples in the pass band. Compared with the Elliptic or the Chebyshev filters, the Butterworth filters also have a better phase response but have as disadvantage a slower roll-off. The next simulation aims to confirm the suitability of the Butterworth filters by comparing it with the Elliptic and the Chebyshev filters. In other to evaluate the performances of the three filters the pulse length of the reconstructed pulse was measured and distortions of the pulses were determined for a Manchester encoded message. As illustrated in Figure 4.3, and detailed in Chapter 3.3, the Manchester encoding leads to two types of pulses: one that has the period equal with half the bit period, corresponding with the clock rate of the modulation frequency and one that has twice this period.

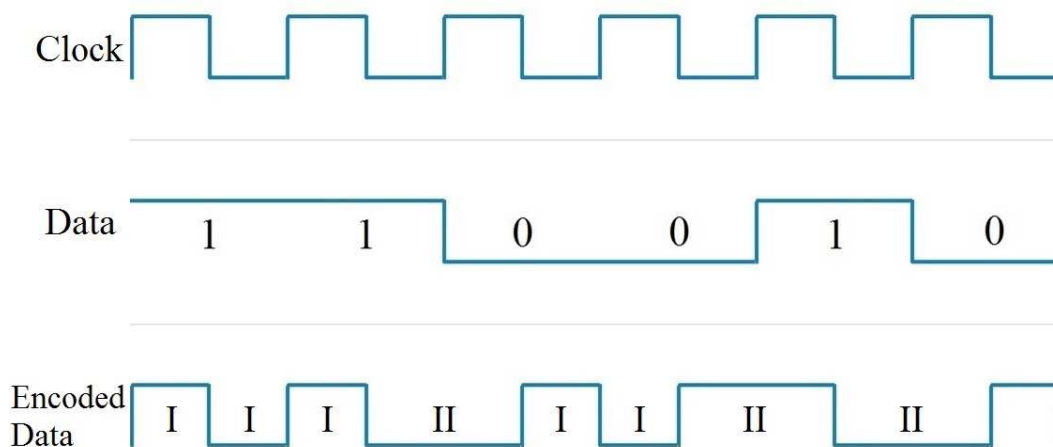

Figure 4.3: Manchester pulse widths.

The effects of the noise and of the filters on the two types of pulses are different. Because the pulse distortions are strictly related with the error occurrence, in the following simulations, this criterion will be used as an evaluation instrument. However, in some of the cases, the pulse error rate (PER) is used instead because, in those cases, it was found to better highlight the differences between the considered situations.

The simulation results confirmed that in the given context, the Butterworth filter exhibits better performances. The pulse width distortions for the three types of filters and for the two types of pulses (short Figure 4.4.a. and long Figure 4.4.b.) are illustrated in Figure 4.4.

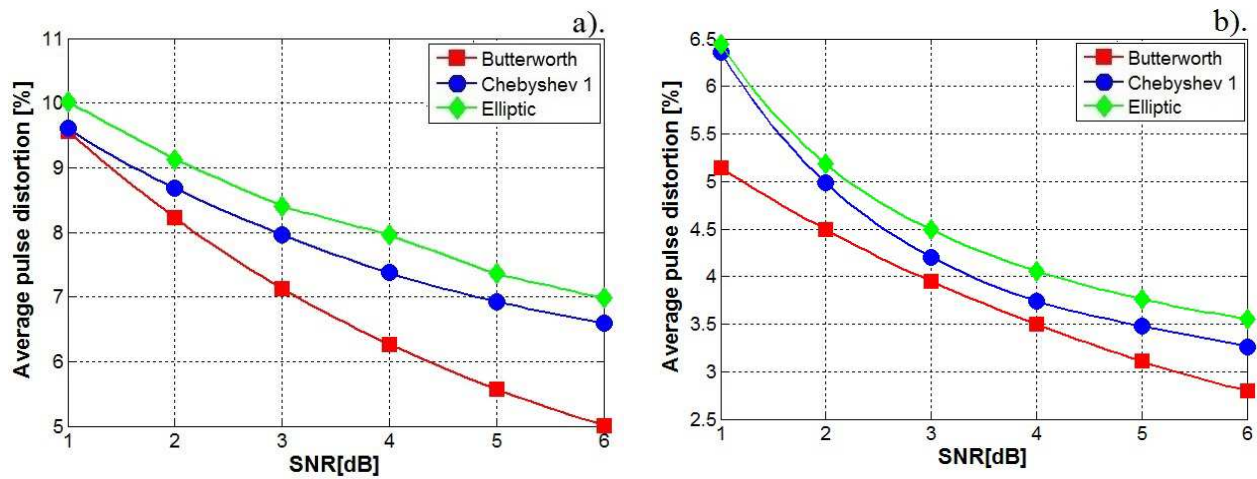

Figure 4.4: Pulse width distortion for the Butterworth, Chebyshev and Elliptic 2nd order filters, for the short a). and for the long b). Manchester pulse.

After selecting the nature of the filter, the next step is to select the order of the filter. Selecting the order of a digital filter represents a tradeoff between the quality of the filtering and the number of mathematical operations performed for each input sample. A higher filter order will provide a better output with lower distortions but will require more computational resources, which will increase the cost of the system. Figure 4.5 illustrates how the order of the filter influences the quality of the filtering for the case of the Butterworth filter. It can be observed that starting with the 2nd order, the filters have comparable performances in terms of PER. Based on these results and aiming not to increase the cost of the receiver, the 2nd order filter was considered as a fair trade between performances and resource requirement.

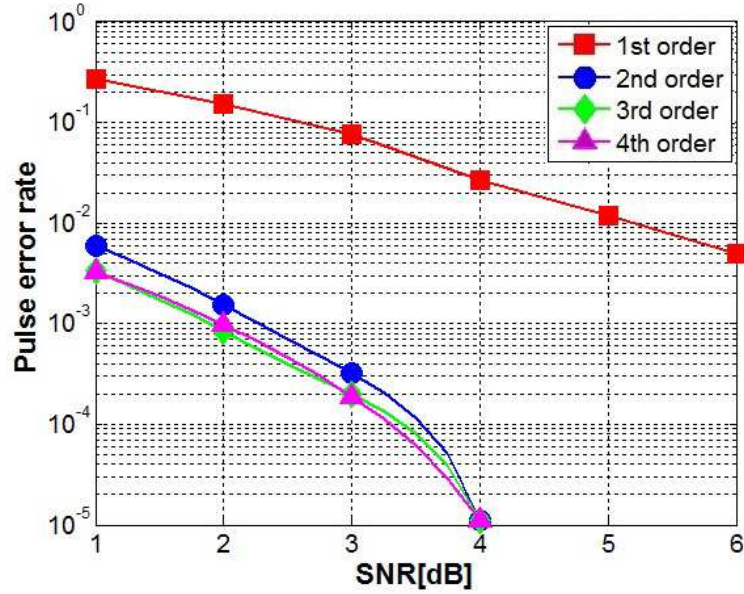

Figure 4.5: The influence of the filter order on the filtering quality.

The purpose of the next simulations is to determine the optimal cutoff frequency. In this case, several cutoff coefficients, from 1.25 to 3 times the modulation frequency F , have been chosen and their efficiency has been evaluated for the proposed receiver. The average distortion for the two types of pulses is presented in Figure 4.6.

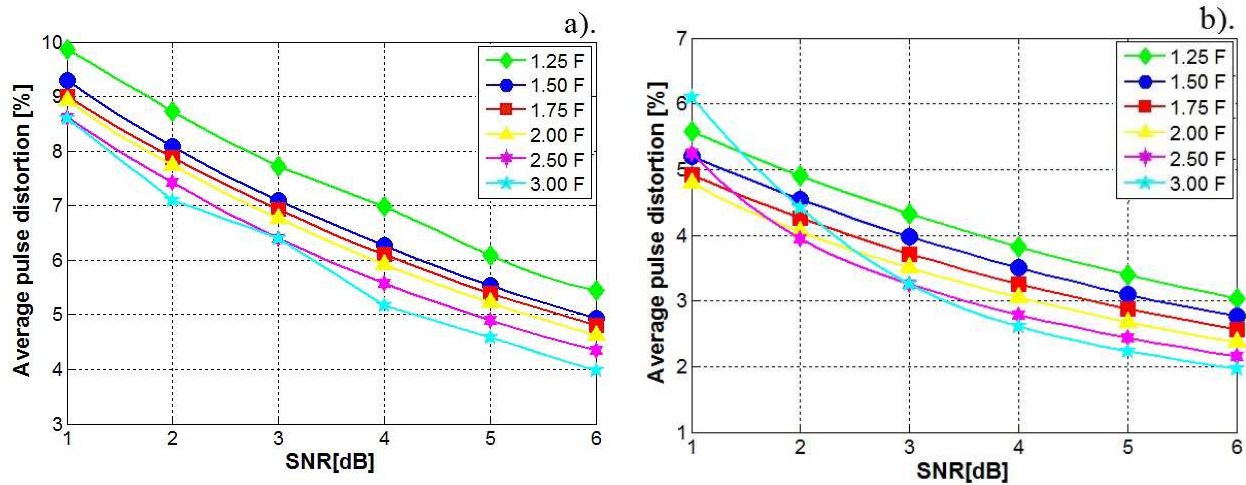

Figure 4.6: The influence of the cutoff frequency on the filtering quality for the short a). and the long b). Manchester pulses.

It can be observed that for the selected coefficients, as the coefficient is increasing, there is slight decrease in the distortion. However, as presented in Figure 4.7, the number of pulses that

are affected by errors is increasing, fact that seems to be a paradox. The reason for this inconsistency is observed in Figure 4.8, by comparing the outputs of a 2nd order Butterworth filter with a cutoff frequency coefficient of 1.5 respectively 3 times the modulation frequency. The output of the filter that uses a higher cutoff frequency coefficient has steeper edges, which explain the smaller pulse distortions. On the other hand, it is obvious that the noise is improperly filtered which leads to false triggering and to decoding errors. Due to this reason, a cutoff frequency of 1.5 times the modulation frequency was considered.

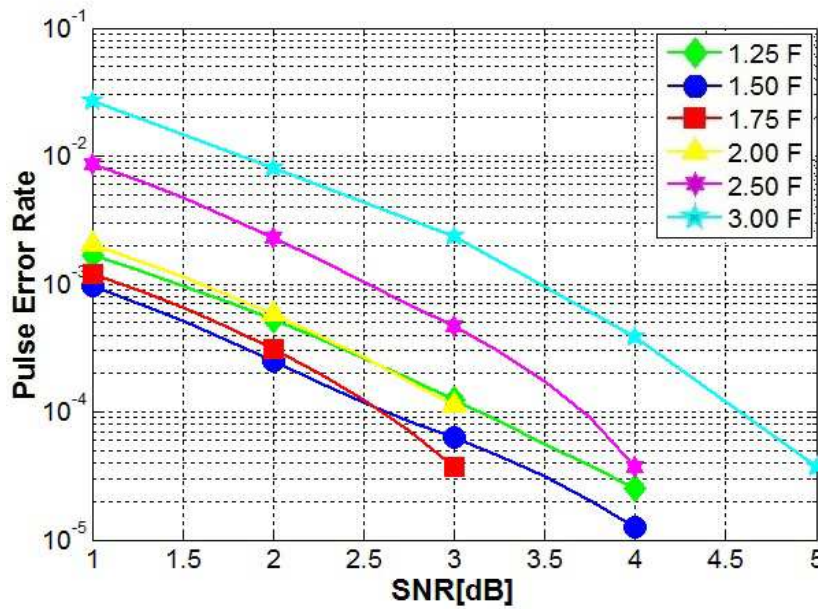

Figure 4.7: The influence of the cutoff frequency on the pulse error rate.

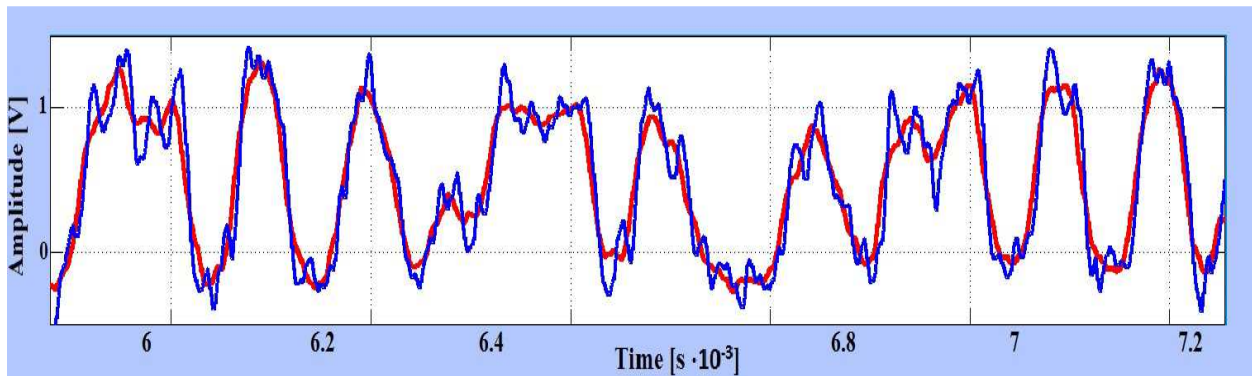

Figure 4.8: Output of a 2nd order Butterworth filter for a cutoff frequency of 1.5 (red) respectively 3 (blue) times the modulation frequency.

Considering the square pulse reconstruction, this is made based on triggering, according to the values of the thresholds. At this level, two approaches were considered and investigated: one based on symmetric triggering and one based on asymmetric triggering. For the symmetric approach, the threshold is set at the same value for both the rising and the falling edges, in this case half the data signal's amplitude. For the asymmetric approach, the thresholds for the rising and for the falling edges have different values. The employment of asymmetric thresholds seemed an adequate option because in some cases, the noise leads to the occurrence of peeks that can reach amplitude levels that can go as high as half the useful signal amplitude or even above. In these cases, the increase of the rising edge threshold prevents false triggering. To compensate the effect of this increase, the threshold for the falling edge must be symmetrically decreased. Under these circumstances, two asymmetric thresholds were investigated: 0.6 and 0.4 respectively 0.65 and 0.35 the signal amplitude. Even if in some specific cases this approach was found useful, its usage has not been found to improve the overall performances. As showed in Figure 4.9, the results for these tests showed that the symmetric signal reconstruction had better results in terms of PER.

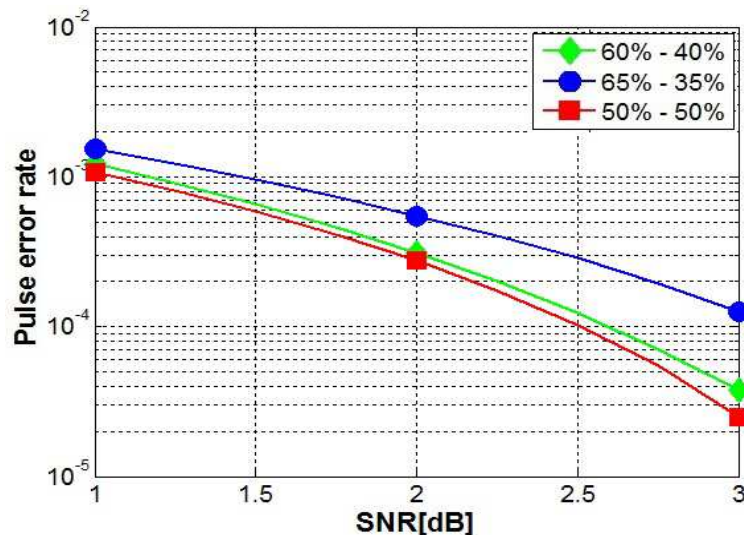

Figure 4.9: Pulse error rate for different thresholds.

The final tests were performed in order to determine the Bit Error Ratio (BER) and the Frame Error Ratio (FER) results for the proposed receiver architecture. A digital frame has been defined, as illustrated in Figure 4.10. Compared with the IEEE 802.15.7 frame, this one has been significantly simplified. The frame consists of 17 synchronization bits, a start bit, the data bits and a stop bit. For these tests, short messages of 64 data bits (8 ASCII characters) were sent in

different noise conditions. Because all the messages had the same parameters (length, modulation frequency, coding), the field containing this information has been removed from the frame. The results for these tests are presented in Figure 4.11. It can be observed how the noise affects the BER and the FER results. The results show that for a SNR above 4 dBs, the BER is higher than 10^{-5} . Since the results were obtained without any error correction technique, it can be considered that the proposed receiver architecture is suitable for outdoor VLC. The usage of the Convolutional and of the Reed Solomon codes will further improve the receiver performances.



Figure 4.10: Structure of the digital frame.

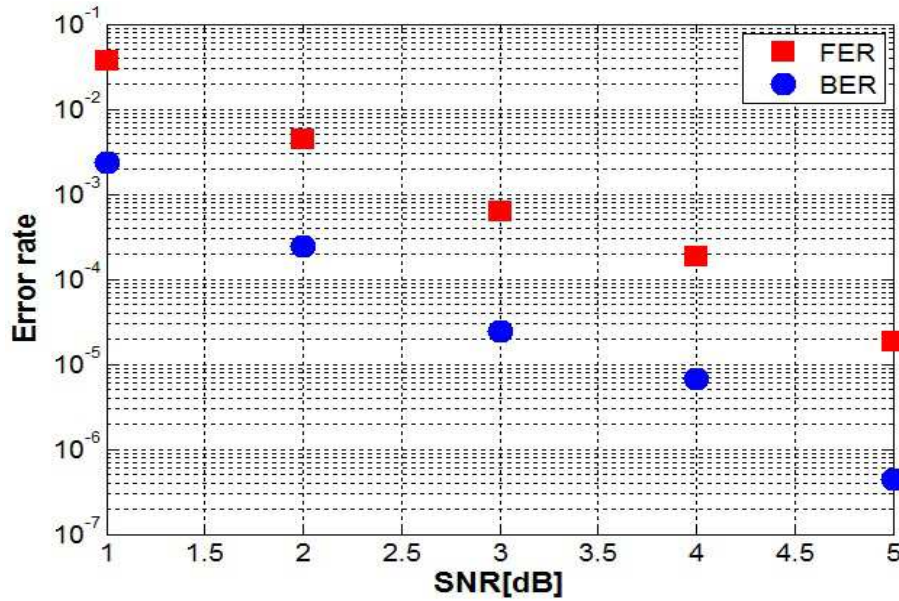

Figure 4.11: Bit and frame error rate results.

Concerning the ratio between the BER and the FER, since one frame has a 64 bit length, in ideal conditions, this ratio is supposed to be 1/64. However, it has been found that in some cases, when a bit error occurs, it affects some of the following bits as well. This is explained by the fact that in these cases, due to the improperly filtered noise, the triggering block missed to identify one or several edges (rising or falling). In this case, more than one bit was affected which increased the BER and decreased the report between BER and FER. Table 4.2 illustrates how the BER/FER is affected by the noise.

Table 4.2: Ratio between BER and FER.

SNR [dB]	1	2	3	4	5
BER/FER	1/12.49	1/18.28	1/25.56	1/27.41	1/42.65

The simulation results confirmed the suitability of the proposed receiver for VLC even at SNR levels, below 5 dBs, and also confirmed that the selection of the parameters was a proper one. However, the performances of the proposed receiver can be greatly improved by using a higher sampling frequency to improve the filtering. In this case, the analog to digital conversion was performed by a 12 bits ADC unit at a sampling frequency of 1.167 MHz which, for the selected modulation frequency, seemed a fair tradeoff between the achieved performances and the implementation cost. However, for improved performances or for comparative results at higher data rates, a higher sampling frequency is a good option. Figure 4.12 illustrates the influence of the sampling frequency on the pulse distortion in the case of a 2nd order Butterworth filter with a cutoff frequency of 1.5·F, with respect to the SNR. It can be observed that by doubling the sampling frequency, the average pulse distortion can be reduced with 1/3.

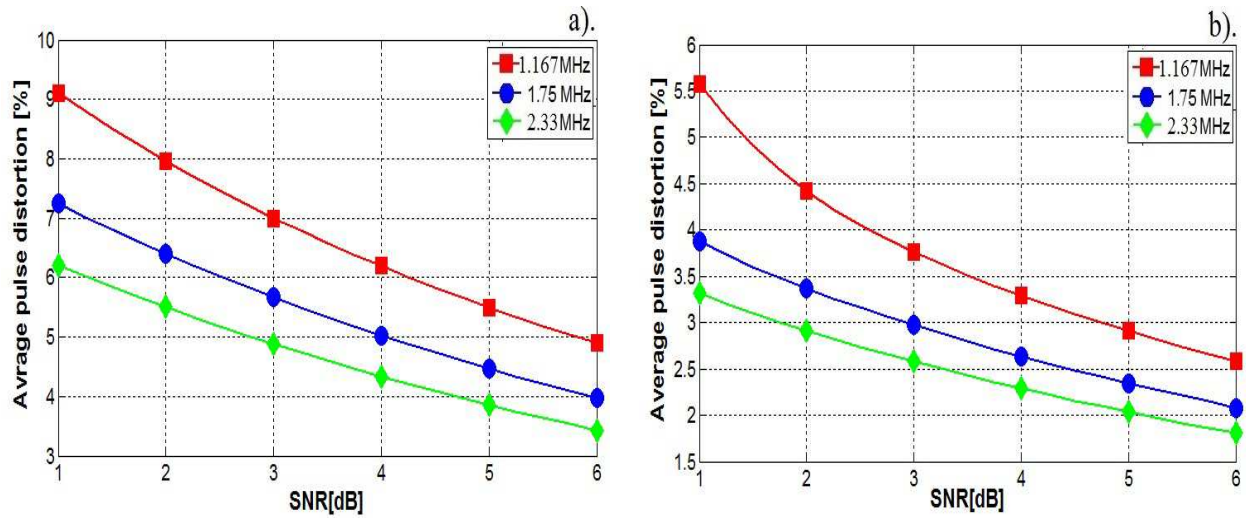

Figure 4.12: The influence of the sampling frequency on the filtering quality for the short a). and the long b). Manchester pulses.

4.4 Evaluation of a multi-data rate DSP VLC architecture

It is well known that in vehicular communication applications the connectivity and the robustness to noise are more important than the data rate. However, when possible, a higher data rate is desirable. Considering these aspects and based on the parameters determined in the previous section, an enhanced VLC architecture with variable data rates is proposed and detailed in the following section. For this purpose, a VLC emitter architecture and a new data frame is proposed, according to the requirements imposed for the multiple data rate scenario.

4.4.1 The VLC emitter model

The synopsis of the VLC emitter is represented in Figure 4.13. Based on the data rate and on the coding settings, this emitter transforms the text message into an OOK modulated message, ready to be sent throughout the communication channel. It performs the ASCII to binary conversion, the message coding and the message packaging according to the data frame format. The frame will be further modulated according to the selected data rate by a Matlab/Simulink *Repeating Sequence Stair* block. For test purposes, the message length is limited to 128 characters or 1024 bits, but it can be increased if required.

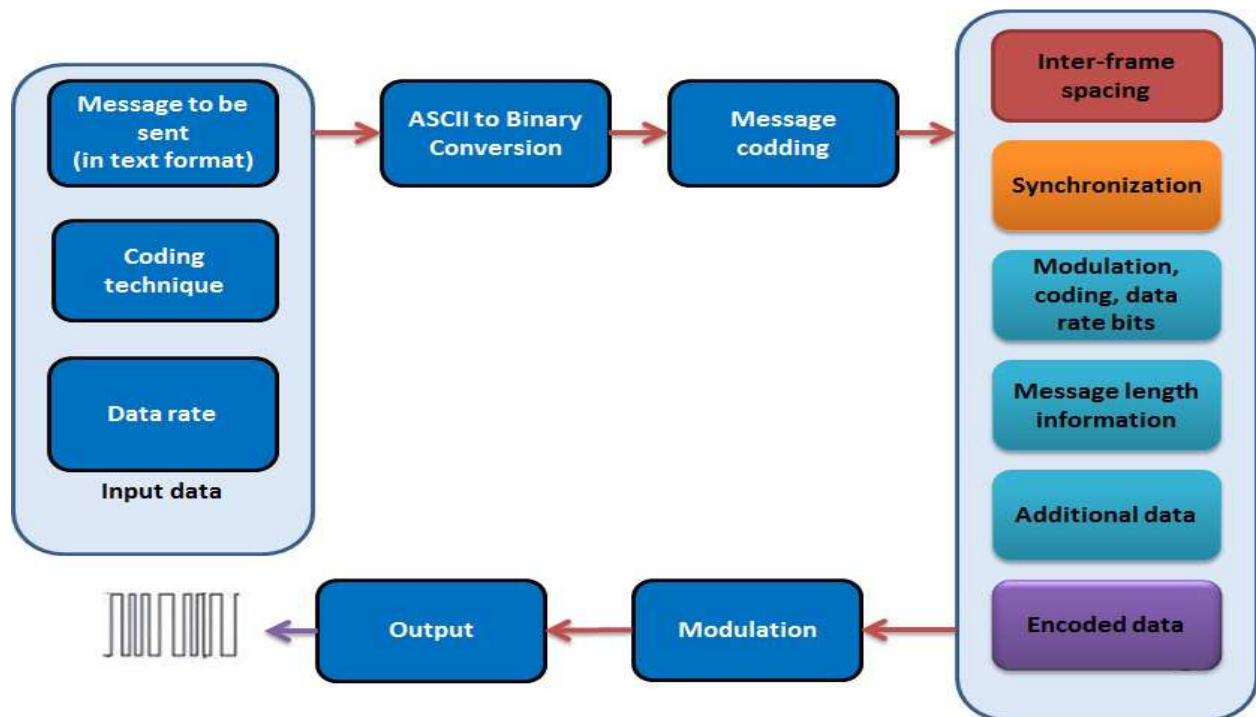

Figure 4.13: Synopsis of the VLC emitter.

The structure of the proposed model is similar to the one of a real VLC emitter. In this case the microcontroller builds the data frame according to the user's preferences and the frame structure, whereas with the help of a digital power switch, the LEDs are controlled. The structure of the data frame and the purpose of each field are detailed in the section below. The output signal of the emitter model is shown in Figure 4.19i).

4.4.1.1 Considerations on the frame structure

The structure of the frame is based on the structure from the IEEE 802.15.7 standard but it has been slightly simplified and adjusted. As presented in Figure 4.14, the structure of the frame contains a header field and a data field. The header field consists of 41 bits. It begins with a 17 bits preamble used for synchronization. This field enables the receiver to achieve synchronization. It consists of a sequence of zeroes and ones and it can have a variable length. Compared with the preamble from the upper mentioned standard which contains a variable size preamble of at least 64 bits, the header contained by the implemented frame is significantly shorter. The length of the synchronization represents a tradeoff between frame overheads and false data acquisitions.

The following field of the header is the Modulation and Coding Scheme (MCS) field. The MCS field uses 6 bits to provide the receiver with information regarding the selected modulation, coding technique and also about the data rate. The next field of the header, consisting of 10 bits, is the Message Length (ML) field, which provides the receiver with information concerning the number of bits to be received. The last field of the header consists of 8 bits that are not used for the moment. These bits can be used to provide information about dimming or other type of information that could improve the data decoding process. The header field is transmitted at the lowest frequency, namely 11.67 kHz using OOK modulation. The preamble field of the header is transmitted without any line coding, whereas for the other three fields, the Manchester code is used.

The data field has a variable length which can extend from 8 to 1024 bits. This field is transmitted at variable frequency, between 11.67 kHz and 100 kHz according to the data rates specified by the IEEE 802.15.7 standard for outdoor low data rates applications. According to the same standard, the data bits and the header bits are transmitted using the Manchester coding.

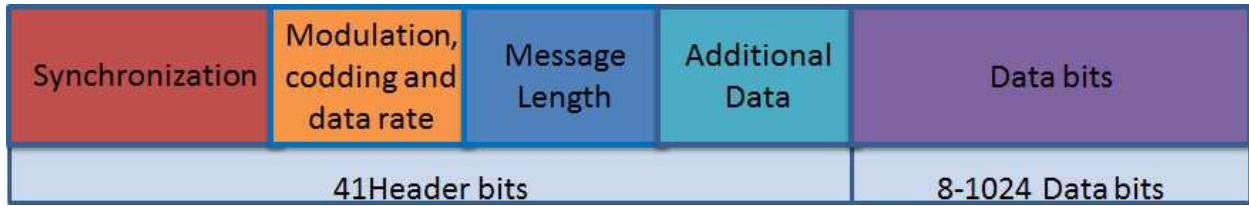

Figure 4.14: Structure of the data frame.

Since the purpose of this study is to investigate the effect of noise on the quality of the data transmission and on the BER at the physical layer, the use of error correcting codes has been put aside. However, checksum fields can be easily added for both header and data fields.

4.4.2 The VLC receiver model

The proposed model aims to be a close replication of a real VLC receiver. It uses the same functionalities and the same working principle. At the same time, it tries to address the challenges imposed in real situations. Basically, the system is meant to be a self-adjusting one, able to respond and to adapt to the environment and to different working conditions (such as mobile conditions or different data rates).

The proposed model addresses several key challenges regarding its adaptability. The receiver model is designed in order to receive and properly decode messages coming at different data rates. This requires an adaptive filtering mechanism able to distinguish between several frequency bands and also able to commute between different frequency bands. This way, the incoming signal containing the data is situated in the filter's band-pass at all time.

Dynamic conditions, as the ones encountered in traffic situations where the vehicles are in continuous movement, lead to significant variations of the emitter-receiver distance. This phenomenon involves significant variations of the SNR. This problem can be addressed by using an Automatic Gain Control (AGC) mechanism, which maintains a constant signal level and prevents photodetector saturation at short distances whereas insufficient signal amplification is prevented at long distances.

The synopsis of the VLC receiver is presented in Figure 4.15. In order to be compatible with the higher data rates, this receiver has been slightly enhanced compared with the one used for the configuration tests. Beside the 2 MHz ADC, a third filtering block and an improved signal reconstruction block has been added. These blocks are meant to further reduce the signal

distortion and to prevent the occurrence of decoding errors. In order to be able to adapt to variable modulation frequencies, the filtering blocks have been enhanced as well.

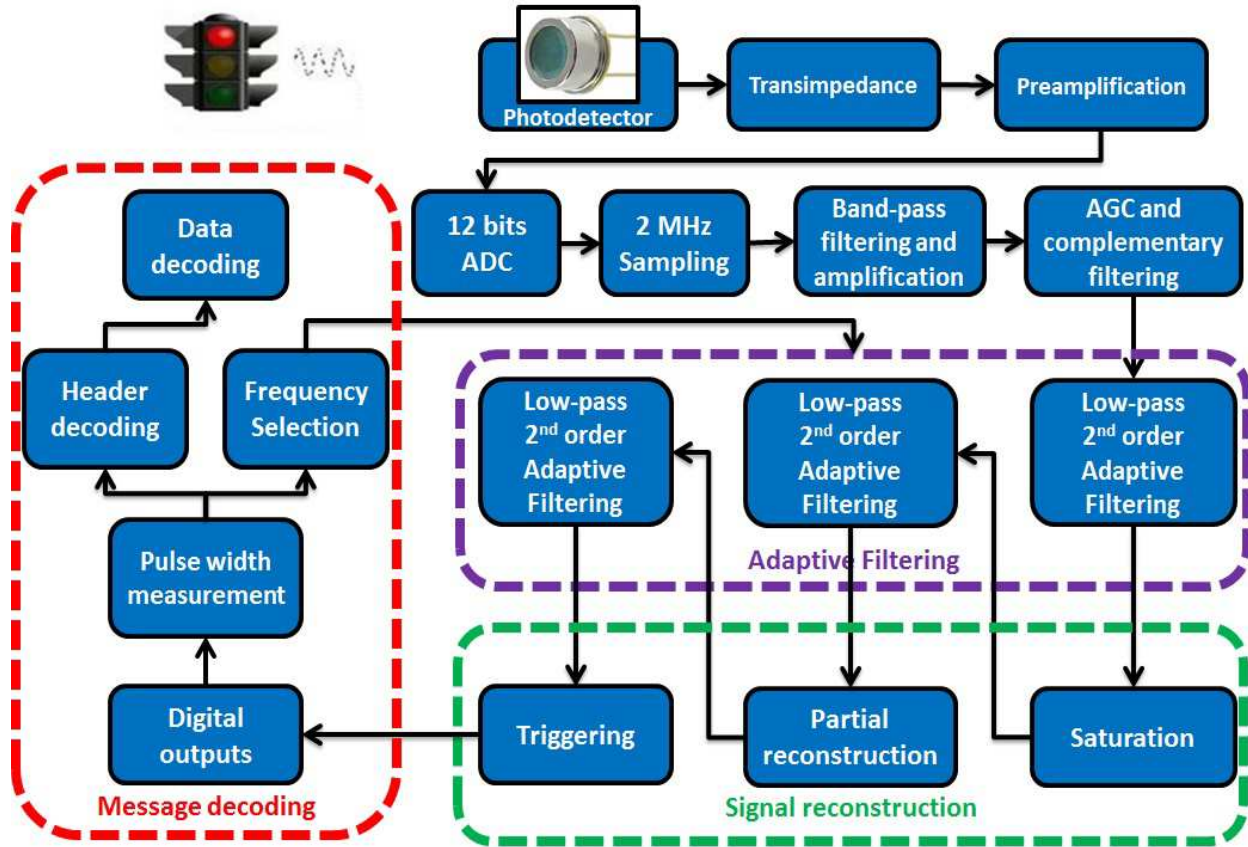

Figure 4.15: Synopsis of the VLC receiver model.

4.4.2.1 VLC Receiver System Model Blocks

The following section presents a brief description of the blocks used by the proposed VLC receiver. The parameters and the working principle of the blocks are provided.

Preamplification

Since the degradation of the signal is proportional with the square of the distance, this block is required to ensure a first amplification. This block multiplies the input by a constant value (gain). Besides the gain provided by this block, depending on the power of the received signal, complementary amplification might be required.

ADC Quantizer Block

The ADC block is set to sample the signal at a frequency of 2 MHz and at a resolution of 0.008 V, corresponding to a 12 bits ADC resolution for a 3.3 V input. This block provides the following block with the numerical values corresponding to the discrete signal, enabling from this point the digital signal processing.

Automatic Gain Control

This block helps maintaining a constant signal level required for proper message decoding. It adds a complementary gain to the fixed gain. The complementary gain value is computed based on the current value of the signal. To determine the current signal amplitude in an accurate way, a number of readings are performed and based on these readings an average value is considered as the signal amplitude value. The AGC block ensures a high and steady amplitude level. It considers an optimal signal value with minimum and maximum thresholds. Whenever the signal's amplitude rises above or falls below the maximum or the minimum thresholds, the new gain value is computed in order to set the signal at the optimum value.

High-pass Butterworth Filter

The classical lighting sources, without data communication capabilities, produce low frequency noise components. For example, the fluorescent lights produce a strong 100 Hz parasitic signal which is added to the useful signal. The high-pass 1st order Butterworth filter block attenuates these low frequency noise components. The cutoff frequency of the filter is set to 1 kHz.

Adjustable Butterworth Low-Pass Filters

The adjustable low-pass filters remove the unwanted high frequency noise component of the signal. These are two input filters: one input is for the input samples (the signal to filter) and the second input is for the cutoff frequency. The second input is connected with the message decoding block, which is continuously commanding the cutoff frequency. As detailed in the previous section, the data frame consists of a header transmitted at a constant modulation frequency and of a field containing the data which can be transmitted using different modulation frequencies. While the message decoding block is waiting for an incoming message, it commands the filter so that the base 11.67 kHz frequency of the header to be in the band-pass.

After completing the synchronization, the message decoding block decodes the header and extracts the information containing the data modulation frequency. Based on this frequency, it commands the switching of the filters. The digital filters adapt their cutoff frequency simply by using a different set of coefficients, corresponding to the new cutoff frequency. The impact of a Butterworth 2nd order filter on a noisy input signal is shown in Figure 4.19 iii).

Saturation Block

This block is used between two filtering block with the purpose of enhancing the signal. It removes part of the high frequency noise and helps improve the signal's quality. Basically, this block uses low and high limit thresholds that limit the signal's amplitude. The effect of the saturation block on the signal is illustrated in Figure 4.16.a. It can be observed that not every pulse is modified by this block, but only the pulses that were strongly affected by the noise. Figure 4.16.b illustrates the output of the second filtering block with and without the usage of the saturation block. When the saturation block is used, the signal is less distorted.

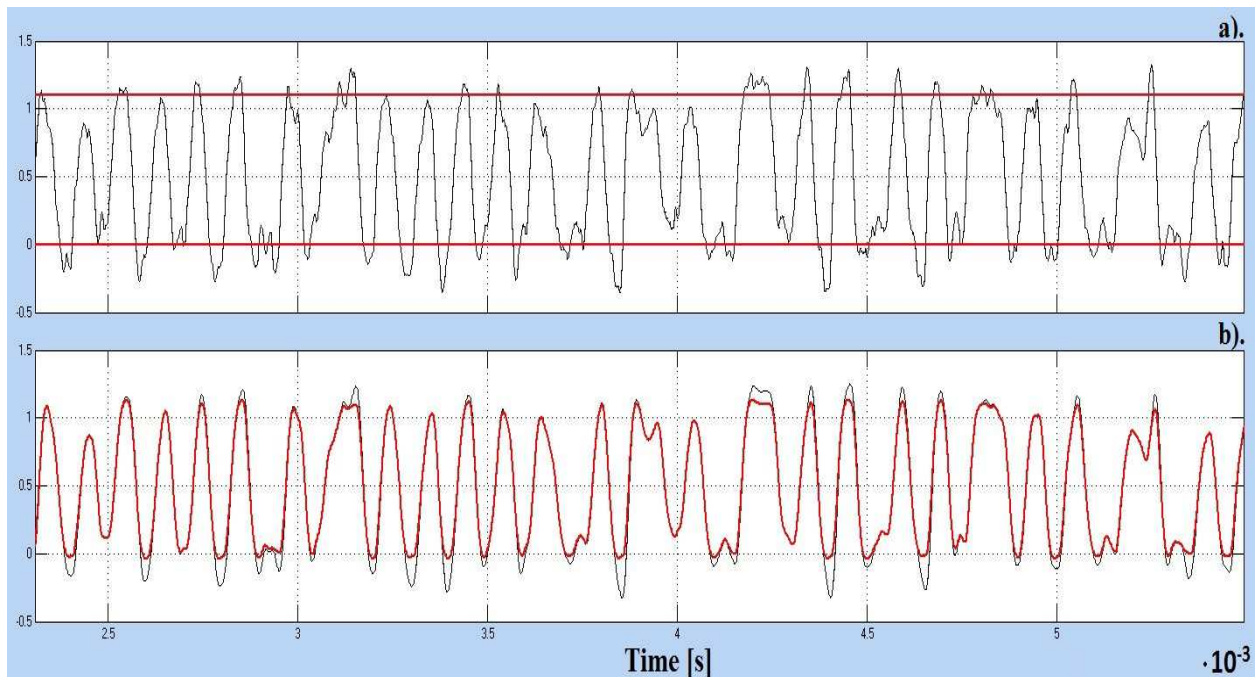

Figure 4.16: The effect of the saturation block on the data signal: a). input of the saturation block and the thresholds; b). output signal for the next filtering block with (red signal) and without (black signal) using the saturation block.

Partial Pulse Reconstruction Block

Besides the saturation block, the partial reconstruction block also prepares the signal before the square signal reconstruction, accomplishing in this way a progressive reconstruction. This block enhances the signal by smoothing the lower and the upper part of the signal. The output of this block is a partial square signal which represents an intermediate step towards the signal reconstruction.

To improve the performances of this block, the triggering is performed based on adaptive thresholds. An efficient algorithm for threshold computation has been developed. This way, the threshold is continuously changing its value, within certain limits, based on the input samples and on the values of the previous samples. For every pulse, the values of the previous samples are used to determine the signal minimum and the maximum, values that will be used for the threshold computation. As illustrated in Figure 4.17, the threshold for the falling edge of the signal depends on the maximum value of the signal.

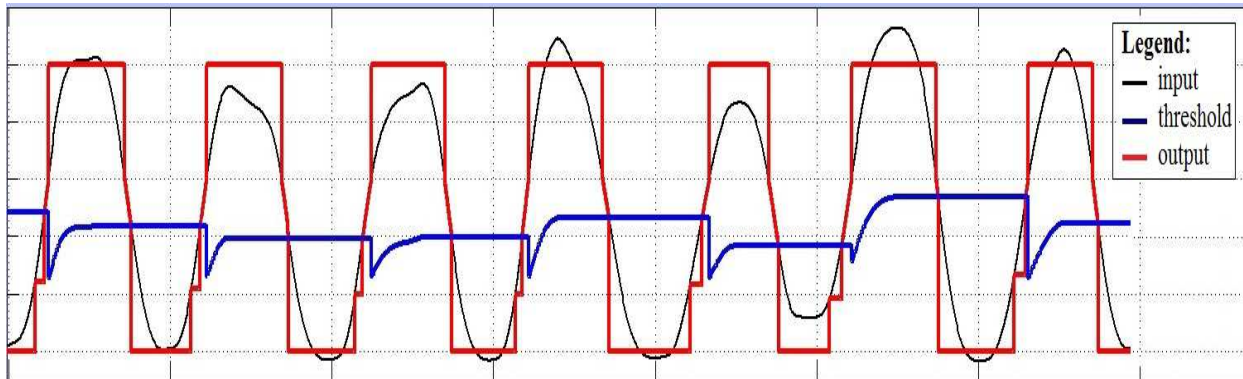

Figure 4.17: Illustration of the adaptive thresholds.

In order to prevent false triggering, the values of the thresholds are modified with respect to their values according to the input signal. An example that illustrates the necessity of the adaptive triggering is illustrated in Figure 4.18.a. The triggering is effectuated when the input level is above the limit but immediately after, because of the noise, the signal decreases and the trigger commutes to '0'. To prevent such false triggering, right after the threshold limit is exceeded, the value of the threshold is set to the lowest value, value which is increasing gradually while the signal amplitude is rising. The effectiveness of this approach is illustrated in Figure 4.18.b.

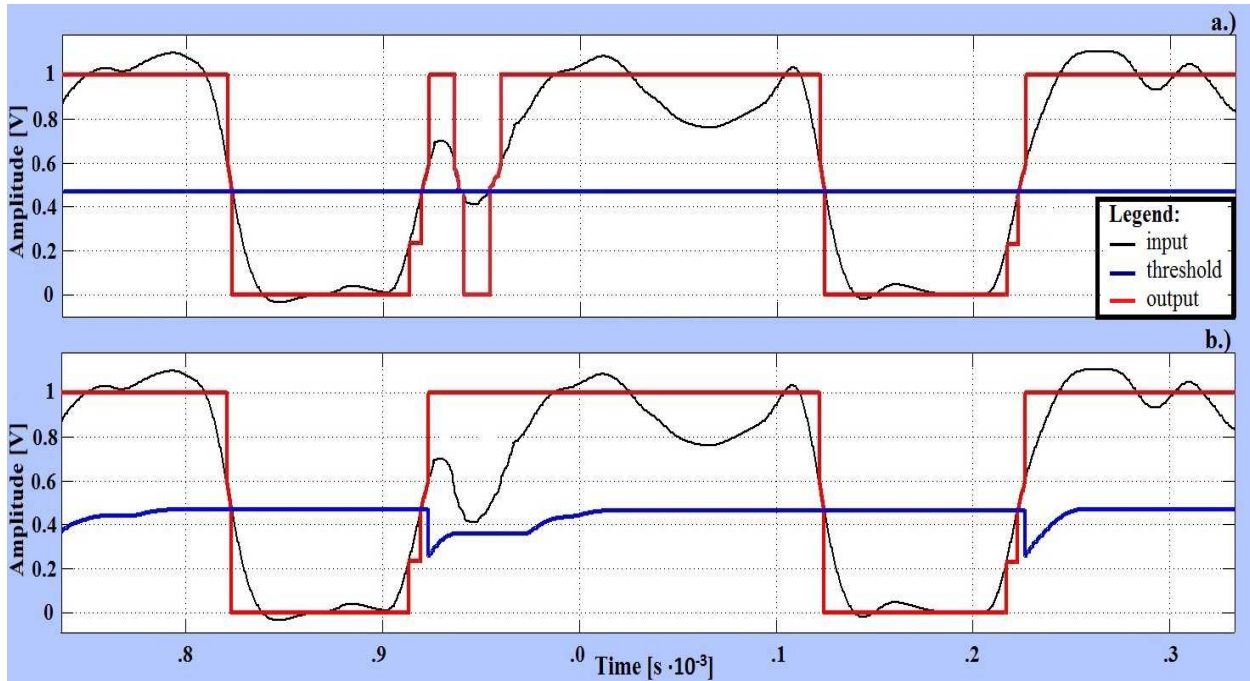

Figure 4.18: False triggering prevention using adaptive thresholds; a.) no adaptive threshold; b.) with adaptive threshold.

Pulse Reconstruction Blocks

This block is responsible for the final signal reconstruction. It outputs the replication of the transmitted square signal. For this block, simulations have showed that the usage of a classical triggering algorithm, with symmetric threshold has the best results in terms of pulse distortion. The input and the output signal of the pulse reconstruction block are shown in Figure 4.19 v) and vi).

Pulse Width Measurement Block

Since the decoding is performed based on the detection of the rising and falling edges and on pulse width measurement, a block responsible for these operations is required. This block identifies the beginning and the end of each pulse and determines its width. This information is transmitted to the Data Decoding block.

Data Decoding and Processing Block

This block is responsible for the final processing of the signal. It is responsible for synchronization, header decoding and message decoding. As mentioned previously, this block is also responsible for commanding the adaptive filters.

Another operation performed by this block is the processing of the data. This way, it provides information related to the quality of the communications, such as the total number of bits, the number of incorrect bits, the total number of messages and the number of messages containing errors.

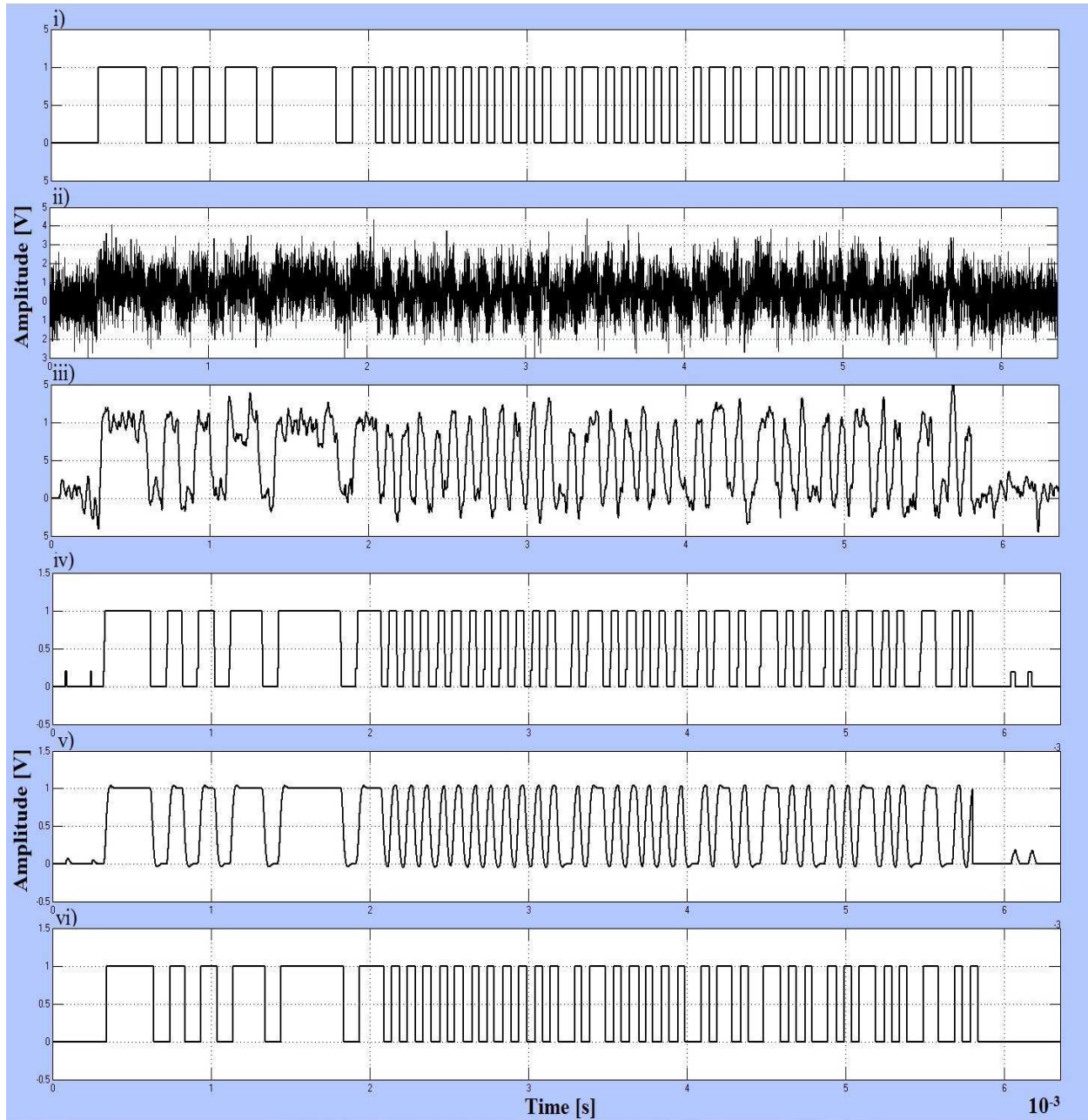

Figure 4.19: Modifications of the signal throughout the blocks of the model: i) representation of the original Manchester encoded message, ii) representation of data message with AWGN (SNR=1 dB), iii) output of a 2nd order Butterworth filter, iv) representation of the signal after the first reconstruction attempt, v) input for the signal reconstruction block, vi) representation of the reconstructed square signal used for data decoding.

4.5 The Performance Results of the VLC Model

This section presents the VLC model BER performance evaluation. The DSP receiver was tested for five modulation frequencies, corresponding to the data rates mentioned by the IEEE 802.15.7 standard. In the evaluation process, different SNR levels have been considered.

The results show the manner in which the noise affects the BER performances. It can be observed that the BER increase is limited in the case of low frequencies. The simulation results clearly show that higher frequencies are more sensitive to noise. One of the main reasons for this is the insufficient filtering, which makes the signal reconstruction more difficult. The tolerance to noise at higher data rates could be enhanced by using a higher sampling frequency.

In VLC, the signal strength decreases as the range increases. Consequently, the SNR is affected by the emitter – receiver distance as well. Since higher data rates require higher SNR levels, it can be concluded that they are adequate for shorter ranges whereas as the distance is increasing the data rate should be decreased.

The results also show how the message length influences the BER performances. It can be noticed that this factor does not influence significantly the communication performances. So, for normal priority messages, any length between 120 and 1024 bits could be used. As mentioned in the previous section, the average length of a safety related message is around 500-600 bits. The purpose of these tests was not to determine an optimal message length but to determine the influence of message length on the BER performances. This test is just a guidance trial since, depending on the application, different message lengths are specified and the use of predefined lengths is not efficient.

Based on these results, an adaptive data rate algorithm could be developed. By using different sensors, the VLC emitter could determine the SNR for different regions within its service area and then, according to the imposed BER requirements, it could adjust its data rate.

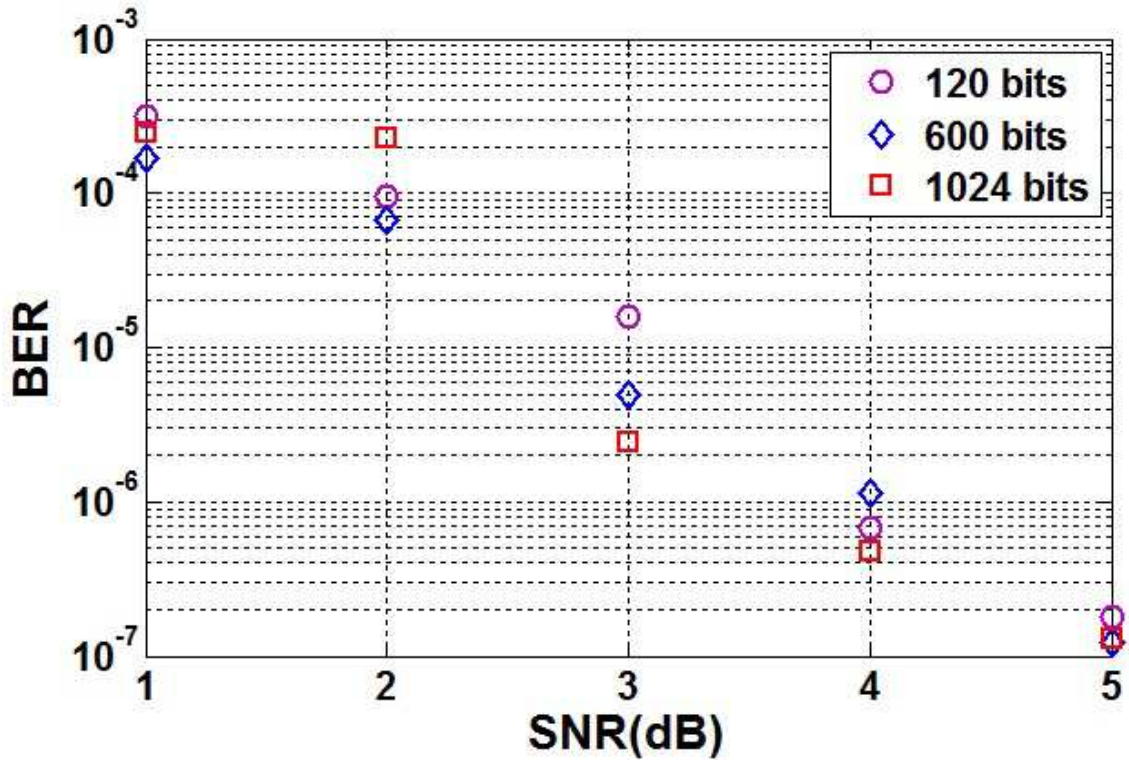

Figure 4.20: BER performances at 11.67 kHz.

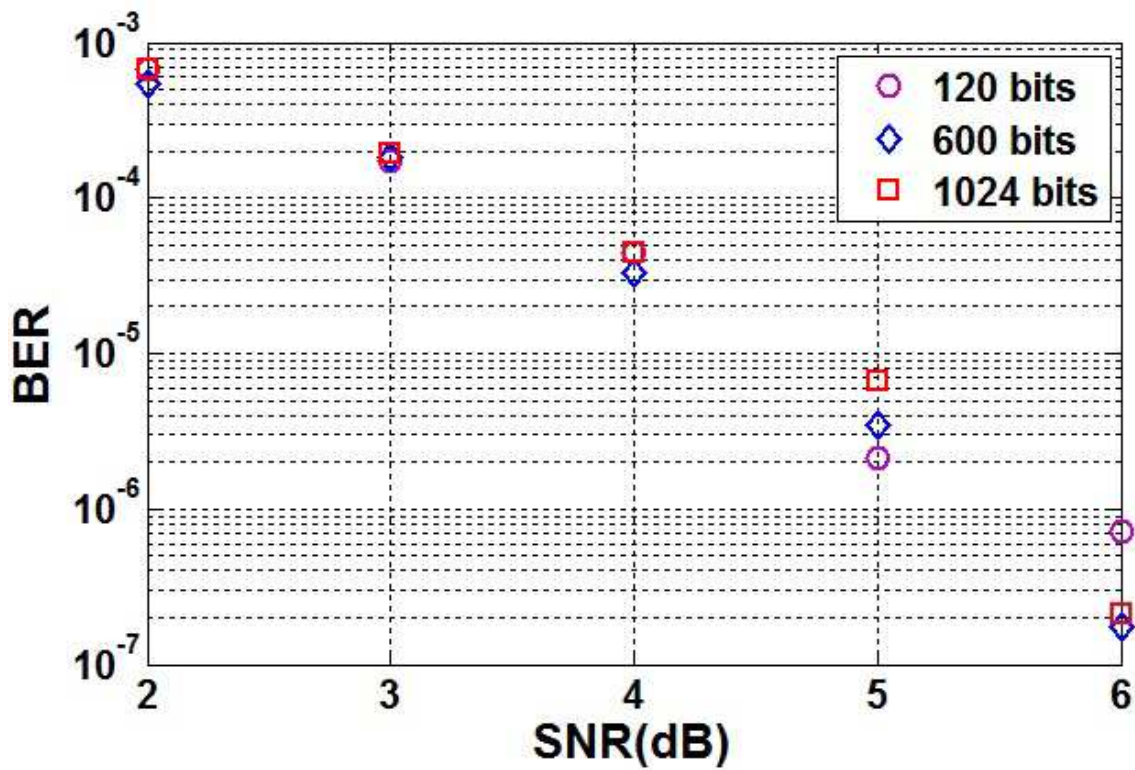

Figure 4.21: BER performances for 24.48 kHz.

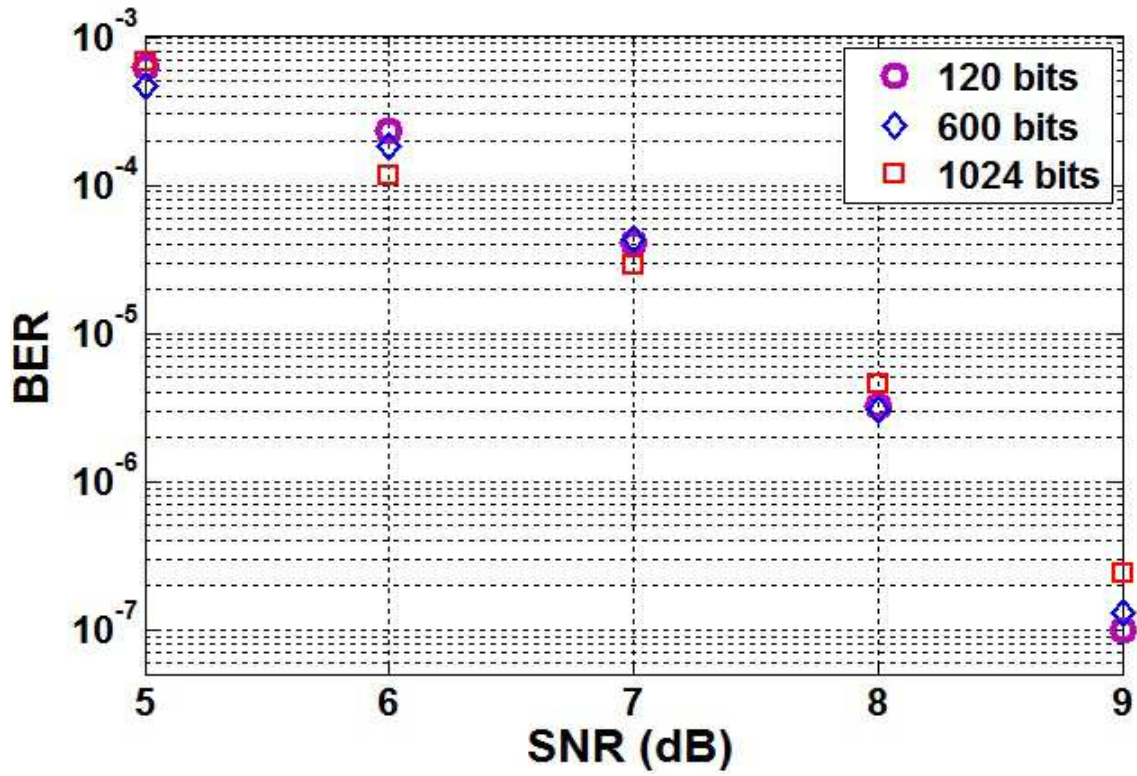

Figure 4.22: BER performances for 48.89 kHz.

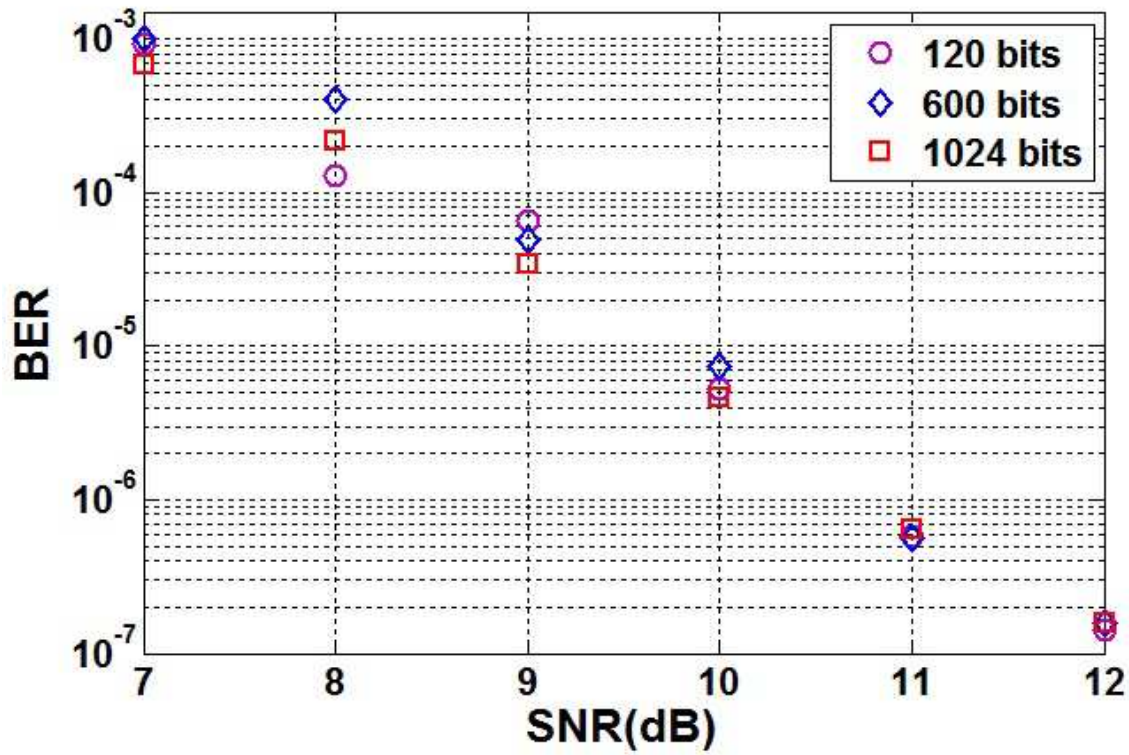

Figure 4.23: BER performances for 73.30 kHz.

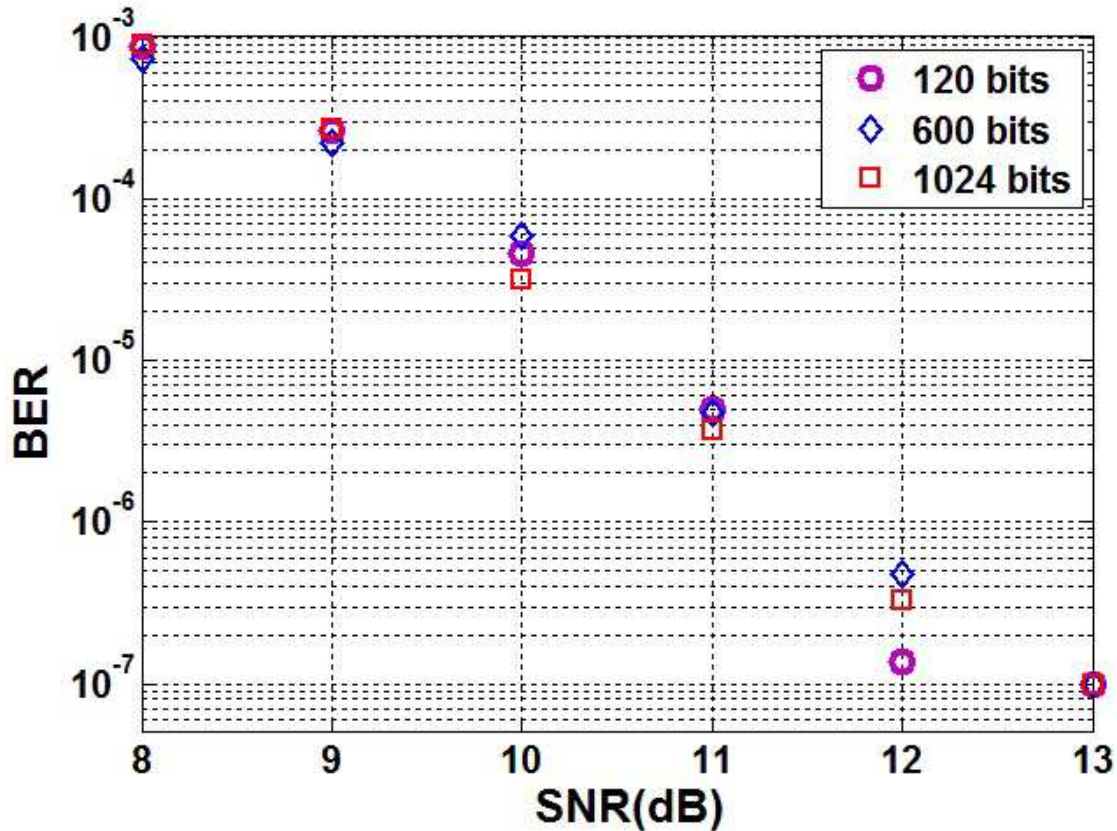

Figure 4.24: BER performances for 100.00 kHz.

The proposed model has as main advantages its adaptive and self-adjusting character. It is able to properly decode messages coming at variable data rates in a simple and efficient manner. Its performances are increased due to several mechanisms. The usage of the digital filters allows it to be suitable even at low SNR levels. Furthermore, the digital filters allow the system to adapt to variable data rates simply by adjusting the coefficients of the filters, proving this way their flexibility. The filtering is made in several stages, each stage contributing to the enhancement of the signal. The progressive filtering along with the progressive message reconstruction improves the quality of the signal reconstructions and implicitly the communication performances. The adaptive threshold mechanism proved to be efficient in preventing false triggering. The AGC block ensures a high and steady amplitude level, enabling the decoding for variable power input signals. Another advantage of the model is the easy to implement character. Since the model is developed using user-defined coding, it can be easily

translated and uploaded on a hardware DSP system. In this case, if the testing conditions are similar, it is expected that the experimental results will resemble with the simulated ones.

However, as mentioned before, the model is only focused on a direct LoS communication and it only considers the two main sources of noise: the shot noise and the thermal noise. The VLC channel it is well known to present an increased unpredictability. For example, artificial light switching generates some transient pulses that have a strong negative effect on VLC, producing decoding errors. Furthermore, in outdoor conditions, the fog, the snow or the rain will absorb and scatter the light affecting the transmission. The proposed model also did not consider the case when the receiver is in the LoS of more than one VLC emitter. Again, this particular case will increase the number of errors. Even if the proposed model considers only the basic VLC channel, each of these particular cases could be developed on top of it.

4.6 Conclusions

This chapter has introduced a new VLC DSP architecture aimed for multi-channel communication. The performances of the proposed receiver were evaluated through simulations. Based upon the simulation results, it was observed the manner in which the noise, the modulation frequency and the message length influence the VLC BER performances. The results showed that the proposed system is suitable for the envisioned applications.

Chapter 5

Implementation and performance evaluation of a VLC system for vehicle applications

Contents

5.1 The Co-Drive Project.....	102
5.1.1 Description of the Co-Drive project	102
5.1.2 Main objectives of the Co-Drive project	102
5.2 VLC System implementation and characteristics	103
5.2.1 Considerations regarding the data broadcasting module	104
5.2.2 Considerations regarding the data receiving module	107
5.3 VLC System performance evaluation	113
5.3.1 V2V setup and experimental results	114
5.3.2 I2V setup and experimental results	117
Experiment 1 – Preconditioning stage sensitivity	118
Experiment 2 – Automatic Gain Control Unit	119
Experiment 3 – System calibration by pulse width measurement	120
Experiment 4 – Bit Error Ratio for Manchester and Miller coding	122
5.3.3 VLC cooperative architecture setup and experimental results	125
5.4 Conclusions.....	130

This chapter presents the development, the optimization and the performance evaluation of a Visible Light Communications (VLC) prototype aimed for vehicle applications. The testing of the system was performed in different situations and environmental conditions. Since the usage in automotive applications implies mobility, the proposed solution allows the system to work at variable distances. The results are encouraging and prove that the VLC technology is a strong candidate for wireless data transfer in traffic safety applications. This chapter approaches every issue regarding the communication-based safety applications and investigates the appropriateness of the VLC technology for both Infrastructure to Vehicle (I2V) and for Vehicle to Vehicle (V2V) communications. Furthermore, the cooperation between the two is investigated and experimentally demonstrated for the first time.

A discussion about the Manchester and Miller codes was conducted within Chapter 3. Simulation results showed that the two codes exhibit similar Bit Error Ratio (BER) performances and noise sensitivity [149]. Concerning the flickering performances of the Miller code, it has been showed that it does not introduce perceivable flickering. However, in terms of spectral efficiency, the Miller code clearly outperformed the Manchester code [141]. The IEEE 802.15.7 standard for wireless communication using visible light [131] specifies the usage of the Manchester code for the case of outdoor applications. The simulation results confirmed its performances and it can be considered that the code is suitable for single channel communication. However, for the future MIMO applications, the Miller code seems better suited. Due to these reasons, this chapter continues the investigation of the two codes and presents the experimental performance evaluation.

The work presented in this chapter was part of an industrial project called “Co-Pilot for an intelligent road and vehicular communication system” or “Co-Drive” for short [155].

5.1 The Co-Drive Project

5.1.1 Description of the Co-Drive project

Co-Drive is a French FUI intended to increase the safety and the efficiency of the transportation system. The project had a duration of 36 months and a 6.8 million euro budgeted with 2.8 million € of public funding. Coordinated by Valeo, the project brings together several industrial companies (Clemessy, APRR, Mediamobile, Sopemea, Comsis, Vivitec, Tecris, Citilog, Navecom) and research institutions (INRIA, INRETS, INSA Rouen, University of Versailles).



5.1.2 Main objectives of the Co-Drive project

As illustrated in Figure 5.1, Co-Drive aims to design and develop a cooperative driving system that will bring together information from vehicles and infrastructures, in order to enhance mobility by offering secure and optimized alternative routes for the user. Fitted on a vehicle, the system provides the user with information regarding the traffic, like speed limits or traffic conditions (e.g. weather, accidents, road closures, road-works, etc.), guiding the driver, or even taking actions meant to enhance the security and to improve the efficiency.



Figure 5.1: Cooperative driving based on integrated information technologies [155].

A reliable user-orientated traffic management service will be developed in the project. This service offers guidance for the driver by listing relevant data coming from neighboring vehicles and/or traffic infrastructure. The traffic management tool enables data collection and dissemination between vehicles and the traffic infrastructure. The project has to provide technical specifications to ensure the system's robustness.

At the end of the project, it is expected that a demonstration of the system, consisting of intelligent infrastructure and intelligent vehicle, will take place. Last but not least, the project analyses the impediments and provides solutions taking into account the user acceptability, the legal constraints and the application norms. One can say that Co-Drive project aims to provide today, a vision on tomorrow's transportation system.

Cooperative driving involves the usage of wireless communication technologies that will enable data exchange between intelligent traffic infrastructure and vehicles. For this purpose, the Co-Drive project, considers the investigation of the traditional RF communications. However, since VLC is an emergent technology with a vast potential, its usage is investigated as well.

5.2 VLC System implementation and characteristics

This section presents some of the aspects regarding the design and the implementation of a VLC system and justifies the choices made in the different implementation phases. The issues

concerning both the transmitter and the receiver modules are approached. As showed in Figure 5.2 and presented in [156], the system consists of a broadcast station unit represented by a LED-based emitter and a photodiode based receiver that is supposed to be embedded on a vehicle. Both emitter and receiver are interfaced with PCs. The purpose of the system is to be representative for the I2V and for the V2V scenarios. In both cases, the communication will be only in one way, broadcast type.

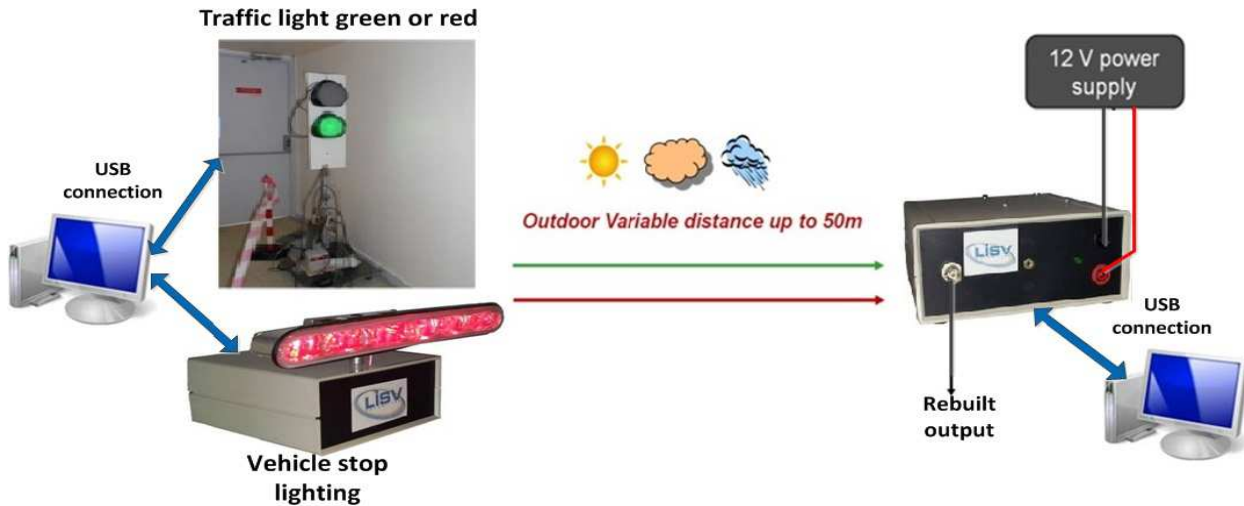

Figure 5.2: Visible light communication system.

5.2.1 Considerations regarding the data broadcasting module

In order to fit in the traffic regulation standard, the diameter of traffic lights has to be 200 mm or 300 mm [95]. In the case of the proposed system, the VLC emitter module was developed based on a 200 mm commercial LED-based traffic light and not on a custom made traffic light as in other works [101]-[103], [108]-[122]. In the case of the custom-made traffic lights, some of the parameters can be enhanced in order to increase the communication's performances. A larger number of LEDs or an optimized irradiation pattern are the main improvements that can increase the communication range. The mentioned enhancements can be implemented on the traffic light without affecting the compliance with the traffic regulation standards. Nevertheless a commercial traffic light was chosen in order to prove that any traffic light can become a data broadcast unit with small modifications and at an extremely low implementation cost. In the case of VLC, any source of light can become a broadcast station unit, without affecting the original

purpose of signaling. However, because of the on-off light switching, the light is turned on only for half of the time (Manchester coding) meaning that the average intensity of the light is proportionally reduced. As a consequence, in some cases, the emitted power should be increased, by using more or stronger LEDs.

The heart of the emitter module, responsible for data processing and decisions is represented by a low-cost 8-bit microcontroller, namely Microchip PIC18F2550. It converts the message into a binary array and deals with data encoding and encapsulation. After creating the data frames, the microcontroller commands a digital power switch that handles the switching of the LEDs according to the digital data and the modulation frequency. These aspects are schematically illustrated in Figure 5.3. Due to the limited computation power of the microcontroller, the modulation frequency cannot exceed 40 kHz in this configuration. However, the purpose of the setup is to demonstrate the reliability of the VLC system for outdoor communication. This aspect must not be considered an impediment, since for outdoor VLC the data rates are as low as 11.67 kHz [131]. Moreover, in vehicle safety applications, the connectivity and the robustness are prior to the data rate. However, for higher modulation frequencies, a better microcontroller should be used.

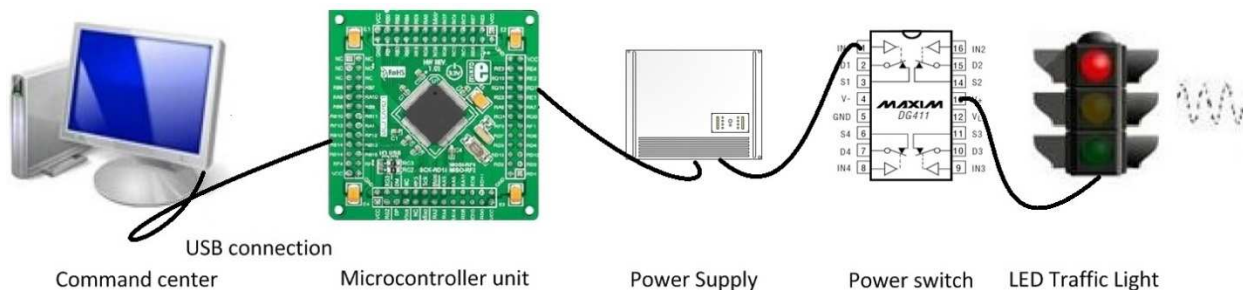

Figure 5.3: Hardware structure of the VLC emitter.

As a modulation technique, the usage of On-Off Keying (OOK) amplitude modulation was considered, according to the IEEE 802.15.7 standard. As a coding technique, two types of coding were analyzed and implemented: the biphase (Manchester code) and the Miller code. Both the codes are simple OOK based, without having any error detecting or error correcting capabilities. To facilitate the testing of different configuration without rebooting or uploading new commands, the used coding technique is specified by the frame, so that the receiver can decode messages encoded using both codes. The reasons for the selection of these two codes are

detailed in Chapter 3.

To maintain the complexity level and the implementation cost as low as possible, the system uses asynchronous transmission. A digital frame has been defined as illustrated in Figure 5.4. The frame structure is a classical one. The message begins with several synchronization bits to inform the receiving board that a message has been sent. The rest of the frame consists of start, stop and data bits. The synchronization field informs the receiver that a new message is being received and enables the receiver to achieve synchronization. It consists of a sequence of ‘1’ and ‘0’ and it can have a variable length. In the case of the performed experiments, the synchronization contained 12 – 17 bits. Its length represents a trade-off between frame overhead and false data acquisitions. Besides the synchronization purpose, this field also contains information concerning the encoding, informing the receiver if the message is Manchester or Miller encoded. The start bit informs the receiver that the data message begins and is helpful in the case when codes with memory are used, where the coding of the current bit is a function of the previous one. This field has a fixed size of one bit and it was set to ‘1’. The data field contains message payload. Depending on the length of the transmitted message, this field has variable size, from 8 bits corresponding to a single character, to 768 bits corresponding to 96 characters. The stop field informs the receiver that the message comes to an end and a new message will arrive. This field has a fixed size of one byte.



Figure 5.4: Structure of the proposed frame.

The designed emitting light has two operating modes. In the first one, it can work independently, broadcasting a predefined message, (e.g. the speed limit or road works in progress). Concerning the I2V scenario, in this operating mode, it is able to control the changing of the traffic light and to broadcast data regarding the time before the next color change. This information can be used by the system to alert the driver. Furthermore, as the law enforcement changes, the data can be used to enable the vehicle to take action in case of an imminent dangerous situation, as part of an active safety system. In the context of the growing interest for fuel savings and pollution reduction, the information can be also used to improve the performances of the Stop&Go systems. In this case, if the vehicle “knows” how much time it has

to wait for the green light, it can wisely decide to stop or not the engine. In the second operating mode, it can be connected with a PC through an USB link, broadcasting in real time any message coming from a traffic center (e.g. traffic jams, alternative routes, etc).

5.2.2 Considerations regarding the data receiving module

The VLC receiver is a crucial component of the VLC system. Its design determines the overall system performances. Concerning the VLC sensors, they use sensing elements which can be either camera systems or photodetectors. The usage of embedded cameras was considered based on the fact that new generation vehicles are already equipped with cameras used for pedestrians and traffic lane detection. However, the automotive industry considers the usage of low-cost cameras like the ones used in smart phones. The noise performances of such CCD (Charge Coupled Device) cameras are lower than for independent photo-elements. The performances of VLC sensors that use such sensing elements are also affected by the camera's limited number of frames per second (fps). Under these conditions, such VLC systems can cover distances of 1-2 m with data rates around 1 kb/s [157], [158], which is insufficient for such applications. Better performances are achieved when high speed cameras are used. For example, the detection of a led traffic light with embedded high speed camera has been demonstrated in [114]. The traffic light is composed of a led matrix and the perception and the recognition of the form can be subject to complex image processing. BER lower than 10^{-3} has been obtained over tens of meters for low data bit rate. Nevertheless, the camera must be a high speed model which is still too expensive for a broad distribution according to the requirements of the automotive industry. On the other hand, photosensing elements like photodetectors are quite efficient regarding noise performances and can be used over long distances. However, long range induces small angles and directional conditions. The photosensing element must be integrated in the vehicle with an optical system in order to focus the light and to increase the signal to noise ratio. Mechanical and optical systems must be precisely adjusted since the solid angles are very small. Active control of the position of the sensing element has been achieved to enhance the BER [113]. For shorter ranges, the solid angle of emission of the light is wide enough for a passive photosensing element to be efficient without active control of the position.

The receiver module is responsible for data recovery from the amplitude modulated light beam. The sketch of the reception module is presented in Figure 5.5, whereas the section bellow

describes its functionality. Despite, the electronics are not embedded, all the components have been chosen for their low cost and their compactness. In the next paragraphs, the VLC receiver implementation process is presented along with some of the encountered challenges.

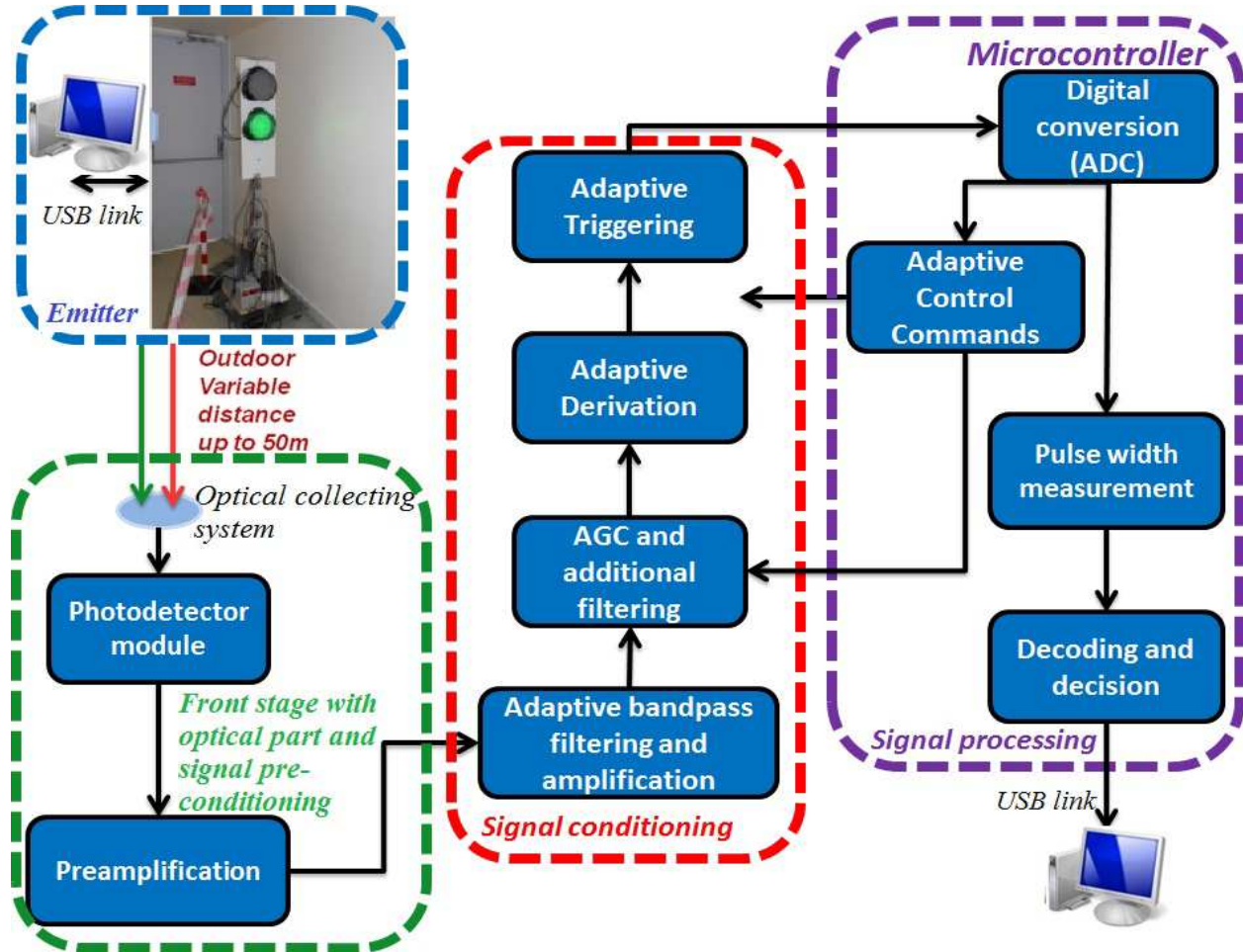

Figure 5.5: Representation of the visible light receiver.

Considering the upper mentioned aspects, developing a VLC receiver that uses a photodiode as light sensing element was considered as the most appropriate choice. The photodiode's quick response enables the possibility of high-speed communications. However, the performances of such a system are affected by the unwanted captured light which can lead to low SNR levels. To understate the effect of the background light, the usage of an optical concentrator is an effective solution. An optical concentrator that reduces the receiver's Field of View (FOV) increases the robustness against noise from daylight or from other VLC transmitters [12]. The concentrator comes with a gain which is given by eq. 5.1 [136], [159].

$$g(\psi) = \begin{cases} \frac{n^2}{\sin^2\psi}, & 0 \leq \psi \leq \Psi_c \\ 0, & \Psi > \Psi_c \end{cases} \quad (5.1)$$

where $g(\psi)$ is the concentrator's gain, n is the refractive index, ψ is the useful signal reception angle and Ψ_c is the concentrator's FOV.

Reducing the receiver FOV has the disadvantage of narrowing the service area, which accordingly reduces the mobility. Under these conditions, selecting the optical concentrator represents a trade-off between the gain and FOV. In the case of the implemented system, the optical reception system reduces the reception angle to $\pm 10^\circ$. The light is focused on the silicon photodiode after passing through the optical lens. The photodiode generates an electrical current proportional to the power of the incident light.

In the next step, the signal from the light sensitive element is processed through a classical transimpedance circuit for signal pre-conditioning. This circuit limits the bandwidth to 100 kHz according to eq. 5.2, and prevents the photoelement's saturation in case of direct exposure to high intensity light (e.g. sunlight). The saturation is prevented by selecting a limited gain for this stage. The value of the gain was determined in order to prevent the saturation, considering an ambient light intensity of 100k lux, corresponding to full sun conditions. As far as 100 kbps, this data rate is sufficient for most of the applications.

$$BW = \sqrt{\frac{GBP}{2\pi(C + C_p)R}} \quad (5.2)$$

where GBP is the gain-bandwidth product of the operational amplifier, R the gain resistance, C_p the capacitive part of the photodetector and C the capacitive part of the amplifier.

This approach experimentally proved its efficiency, regarding the saturation. However, when the distance is increased and consequently the SNR decreases, the limited gain has a negative effect on the communication distance. To overcome this new problem, a solution is to use an Automatic Gain Control (AGC) mechanism, which will be further described. This way, for this stage, the system is able to work with two pre-amplification values: one for short distance and one for long distance. By using this approach, the pre-amplification ensures

minimum magnitude level of the useful signal on the order of tens of millivolts whatever the distance (up to 50 m).

The second stage of the sensor is an analog conditioning board. An analog band-pass filter suppresses the offset due to the daylight and filters high frequencies noise. Within the filtering stage, the 100 Hz frequency perturbations from artificial lighting sources, such as fluorescent or incandescent lamps, are also attenuated. After the filtering process, the signal is amplified until it reaches a value of few volts. For small to medium distances, the current gain is sufficient for proper data recovery, however, when the distance increases, the data recovery process is affected.

In dynamic conditions such as those met in traffic situations, where the vehicles are continuously changing their locations, there are significant variations of the signal's intensity and modifications of the SNR. Experimental evaluation have been performed and showed that when these conditions are fulfilled, a static value of the amplification is a significant impediment, leading to photodiode saturation or to insufficient signal amplification. Due to these reasons, the prototype integrates an AGC stage responsible for the system's adaptation to the signal's intensity. After the filtering and amplification stages, the signal is digitalized with the Analog-to-Digital Converter (ADC) included in the microcontroller. Based on the average of the ADC values, the signal level is continuously monitored by the microcontroller. When the signal drops under or raises above the accepted threshold values, the microcontroller computes a new value for the gain and commands the selection of the required gain. The AGC block is able to magnify the signal and its intensity can thus be maintained while the emitter-receiver distance is changing.

The heart of the sensor is a derivative analog module with slightly adjusted cutoff frequency. The reconstruction process from this stage is mainly based on the pulse width rather than on the level. In this stage, the signal passes through a high-pass filter resulting in a derived signal consisting of alternating positive and negative pulses. The positive pulses are the equivalent of the rising edges whereas the negative ones are the equivalent of the falling edges. Based on these pulses, the signal is turned into a digital signal corresponding to light on and off. The electrical signals processed during the reconstruction process are illustrated in Figure 5.6. In the figure, the reconstructed signal (c) is inverted compared to the photodiode output (a).

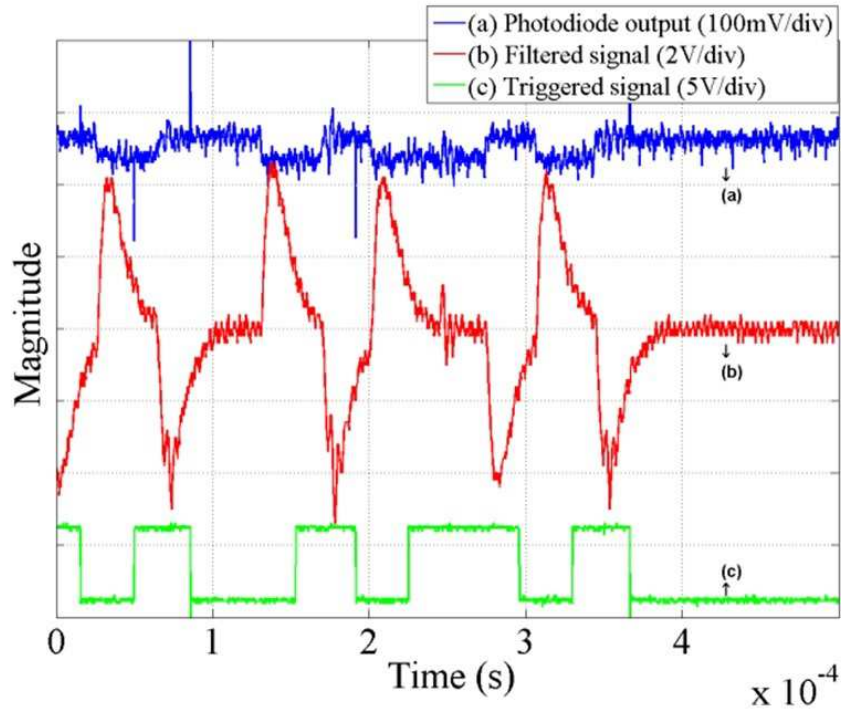

Figure 5.6: Example of electric signals on the reception board; a) output of the pre-conditioning board; b) output of the conditioning part and c) output of the decoding and decision block. It illustrates that the derivative part emphasizes the front edges.

The third stage of the sensor is responsible for signal processing, information treatment and decision making. This stage is controlled by a low-cost 8-bit microcontroller Microchip 18F2550. The microcontroller is also responsible for data decoding in real time. Within this stage, the signal is digitalized with the ADC included in the microcontroller that is the core element of the signal processing. Depending on the level of the signal, the microcontroller uses a precise algorithm to select the values of the analog conditioning board, values which correspond to different gains and cutoff frequencies. Both the signal monitoring and the settings selection are performed in real time. The message decoding is based on the detection of the falling and of the rising edge and on pulse width measurement. For the pulse width measurement, the microcontroller uses the precise clock of an external quartz crystal operating at a frequency of 20 MHz. To facilitate the monitoring of the results, the receiver is connected with a PC through USB. The receiver's clock is not synchronized with phase locked-loop for simplicity and for considerations about the price. This aspect does not affect data decoding as long as the frequencies involved do not exceed a few tens of kilohertz.

Variable Gain for robustness

Due to the mobility of the vehicles in real traffic conditions, the distance between the emitter and the receiver may quickly change. The ambient noise also depends on the traffic conditions. These two factors lead to significant variations of the SNR. In dynamic conditions like those meet on a road, it is strictly imposed that the system reacts to the modification of the communication conditions and adapts its settings accordingly. The system must adapt its response to different levels of SNR, corresponding to different distances, angles and conditions. Under these circumstances, the performances of a VLC system meant for automotive applications can be substantially improved with the integration of an AGC module which will adjust the gain for different levels of the input signal.

For the first version of the AGC stage, a simple and effective solution has been implemented. This approach is based on digital switches that connect or disconnect parallel resistors and modify the value of the equivalent resistor responsible for the gain selection. The first version of the AGC stage uses four digital switches to control 4 resistors. The combination of the 4 switches results in 16 possible gain combinations. Under these conditions, the objective is to control the 4 switches involved in order to adjust the amplification that maintains the signal level at convenient values. In this way, the communication is possible at variable distances, from less than 1 meter up to the maximum distance. The digital switches are controlled by the microcontroller (Microchip 18F2550), which responds to the variations of the input signal. In the preconditioning stage, the microcontroller is able to select between two available gains: one for short distances and one for the long ones. The two available gains are also useful to prevent the photodiode saturation in sunny conditions.

Besides the hardware implementation of the AGC circuit, the software control of the architecture is also required. The microcontroller must be always able to select the optimal gain value for the board. A problem encountered during the first experiments came at particular levels of the input signal. The problem was that the signal level was under the threshold lower bound with current amplification and above the threshold upper bound when increasing the amplification to the next available value. These particular cases result in a continuous increase and decrease of the gain, resulting into errors in message decoding. The solution for these problems is to develop an efficient switching control algorithm which computes the value of the signal and calculates the required level of amplification. The control algorithm is described in the

flowchart from Figure 5.7.

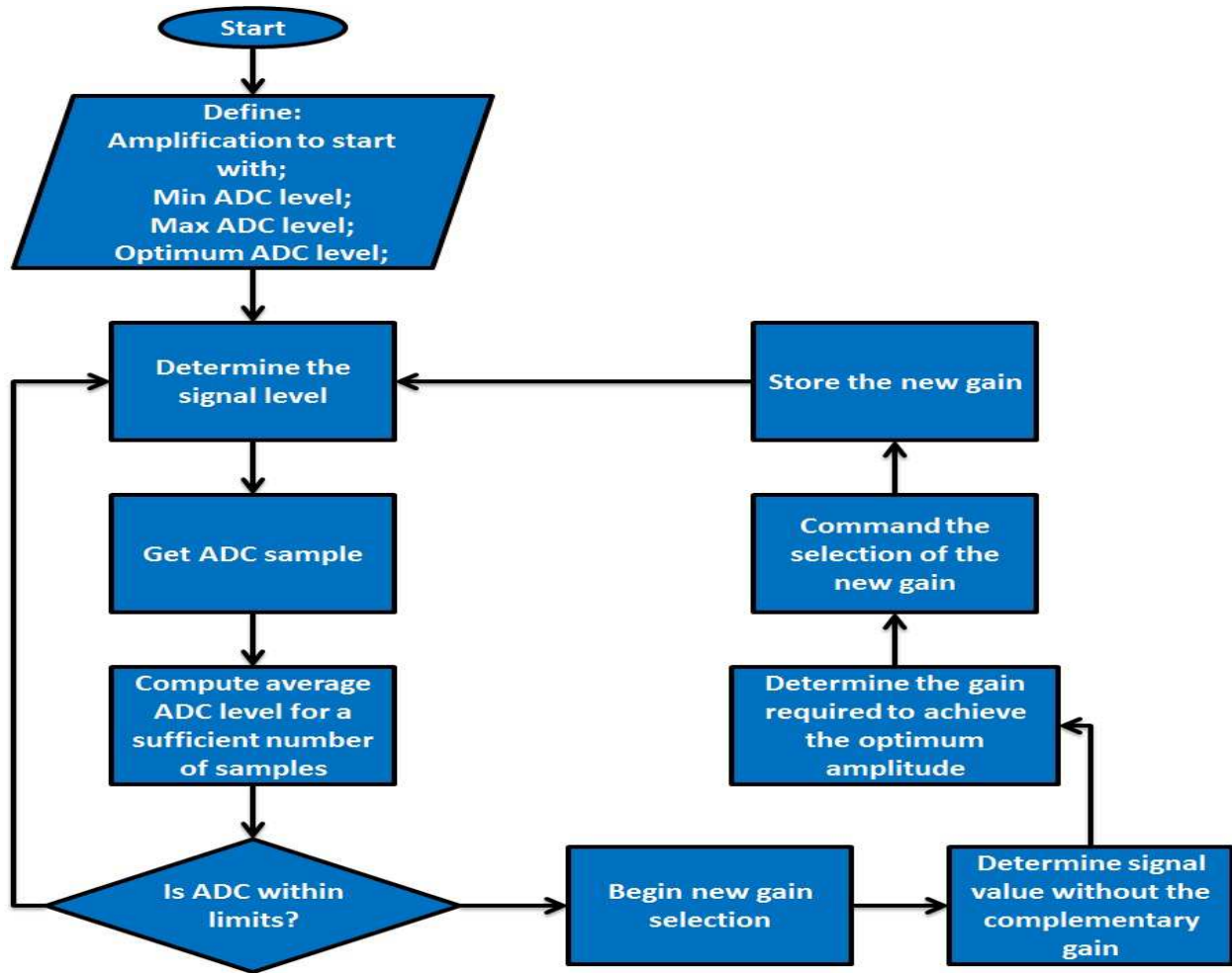

Figure 5.7: The flowchart of the AGC gain selection algorithm.

5.3 VLC System performance evaluation

The majority of the existing studies about VLC systems for automotive applications are focused on theoretical analysis and conceptual design [160], [161], without a step towards the implementation of the concept. Experimental verification of a system can point out some of the weak points, highlight its advantages and validate the theoretical model. Another significant part of the existing work is conducted concerning VLC systems for indoor environment [27]-[65], where the required communication range is 1 - 3 m. However, the problematic of outdoor VLC is more complex due to the multiple noise sources, their high levels of power and because of signal degradation with respect to the distance. Consequently, it can be considered that there is a gap

concerning the hardware development of VLC systems intended for outdoor long range applications.

Within this section, the experimental verification of the proposed VLC system is presented. The systems were evaluated based on the requirements of the ITS, in order to cover the V2V and the I2V communications. The cooperation of the two is also evaluated considering several scenarios that are meant to be similar to the ones encountered in real situations.

5.3.1 V2V setup and experimental results

In the context in which V2V communication represent one of the most important aspects related to the communication-based vehicle safety applications, the developed VLC system was tested for this configuration. For the VLC emitter, a vehicle red back light had been used. The optical power of the backlight, measured at 0.5 meters, is of 60 lux. Figure 5.8 illustrates the manner in which the optical power decreases with respect to the emitter – receiver distance and also with respect to the axial distance. If considering a 1.5 meters wide vehicle, with one tail light on each side it can be observed that after 1 meter, the data can be distributed on the entire width of the lane.

The testing scenario and the components of the tested architecture are illustrated in Figure 5.9 and in [162]. Since the power of the back light is relatively low compared to the power of a traffic light, the purpose of this configuration is to ensure a highly robust data transmission for short or medium distances, up to 15 meters. This VLC system is able to facilitate the transmission of data between vehicles, which is crucial to communicate information concerning the state of the vehicle (e.g. brake, speed, acceleration, engine failure, etc).

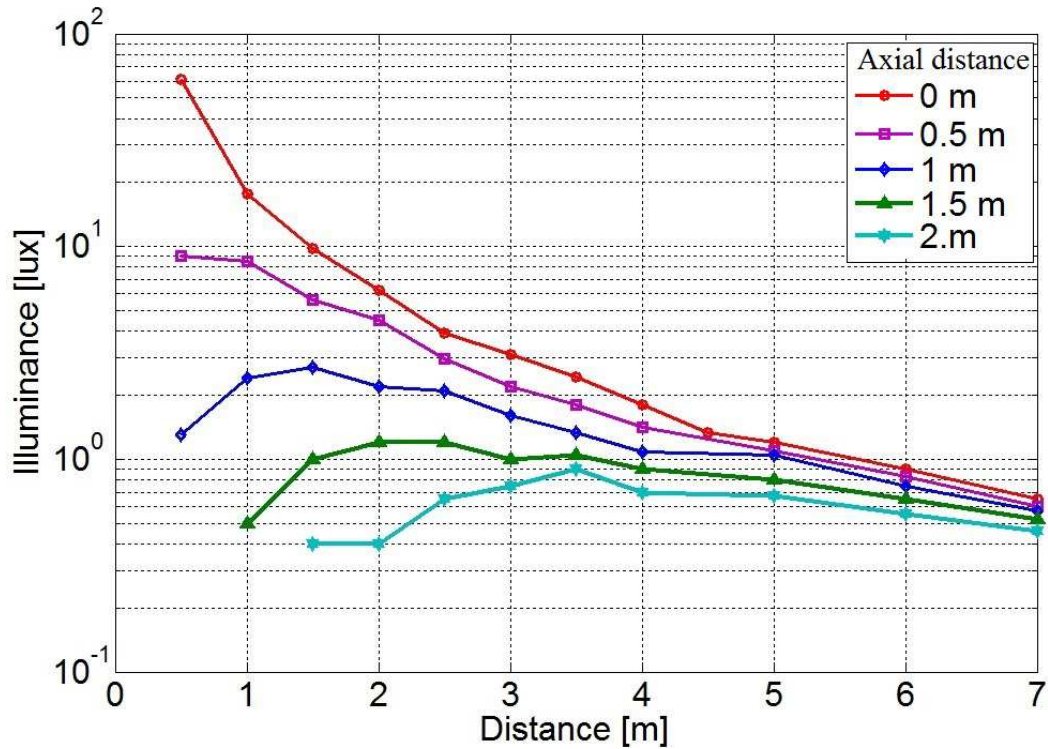

Figure 5.8: Back light illuminance distribution.

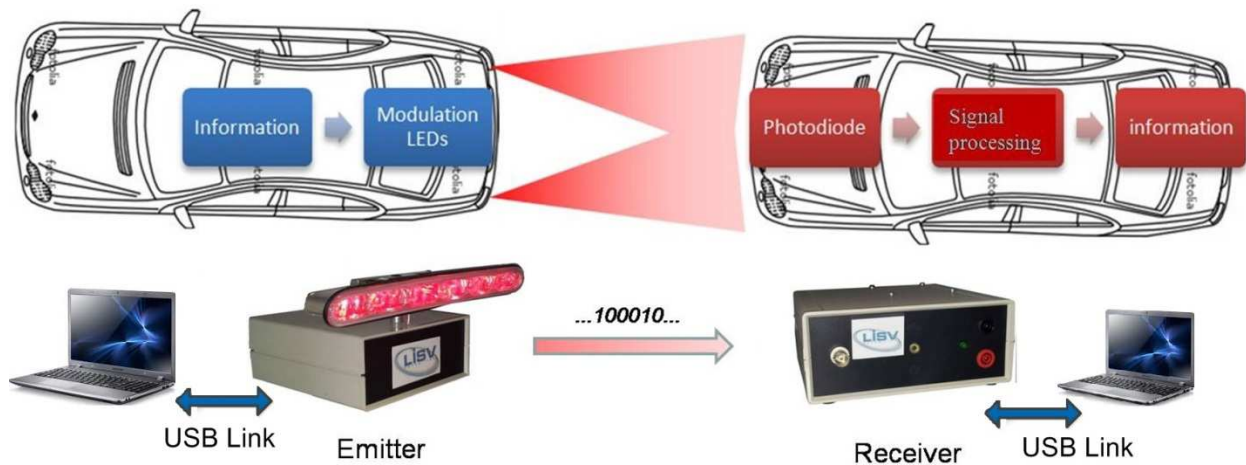

Figure 5.9: V2V prototype for data transmission using VLC.

This section presents the experimental results obtained for a V2V communication setup. The main objective is to demonstrate that the setup is suitable to transmit data using the visible light. As previously mentioned, the emitter and the receiver are controlled by microcontrollers, more precisely two Microchip PIC18F2550, as they are low cost and widely used. In order to

facilitate the communication with the emitter and receiver modules, the two are interfaced with a PC through USB.

Basically, the message transmitted during the experiment is sent to the emitter and the frame indicates if Miller or Manchester code is selected. The message is therefore converted into a binary array. The red backlight is then set-up to blink periodically according to these values. Then, the receiver decodes the data in real-time and an algorithm counts the wrong bits by comparing the received message to the original one, stored in the memory.

The experimental results for this setup are presented in Figure 5.10. As it can be observed, the BER is lower than $3 \cdot 10^{-5}$ over a distance of few meters. However, it quickly increases when the distance is higher than 10 m. Both curves have been made with a 10 kHz modulation frequency, a 12 synchronization bits configuration and a data length of 4 ASCII characters (4×8 useful bits). The data sets had about 3 million bits for both configurations.

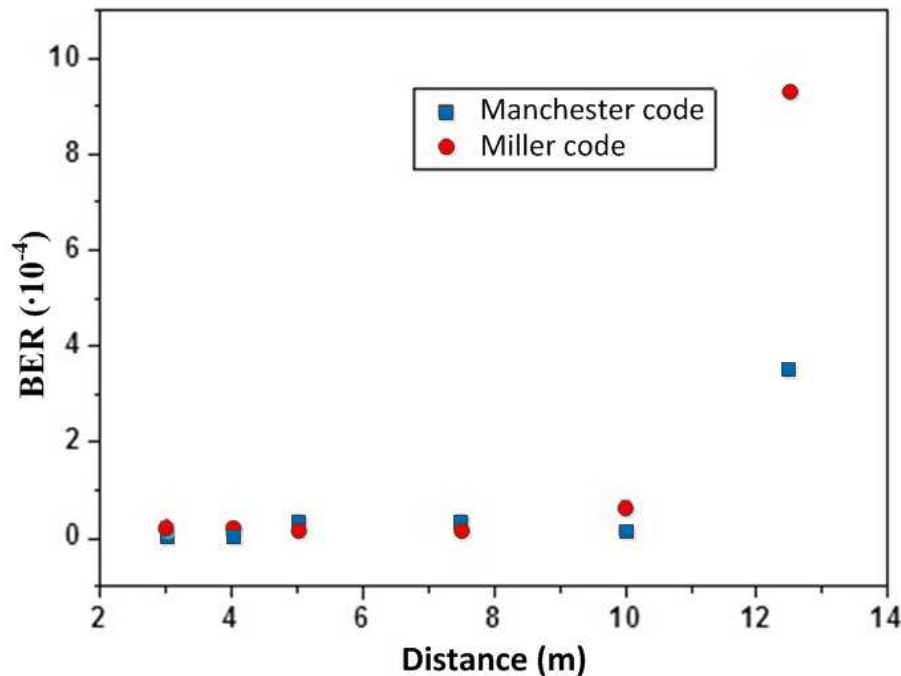

Figure 5.10: Bit Error Ratio (BER) for Miller and Manchester codes at 10 kHz modulation frequencies.

These results demonstrate that the prototype is well suited to transmit data over a short distance. However, it is a limitation as far as the communication between vehicles (e.g. on a motorway) is concerned. One of the main reasons is due to the fact that the gain was intentionally limited. For these experiments, the AGC was disabled and which leads to a BER

degradation over the distance. As the purpose of this system is to be used in any weather conditions, special attention was paid to select the gain so that the system is not saturated because of sunlight, and consequently it was set quite low. The second main reason is that the clock of the receiver is not synchronized with the transmitted frame. The analog electronics has been aimed to be very simple and no phase locked-loop is included. Nevertheless some analog filters are included that can modify the bit width, or rising and falling edges. The decoder includes an algorithm based on edges detection with tolerances on the values. To reduce the distortion, the electronic part has to be improved or the decoding tolerances have to be adapted as presented in the following section.

5.3.2 I2V setup and experimental results

The work that concerns VLC between infrastructures and vehicles is mainly focused on the communication between traffic light and vehicles. This is mainly because of the high power of traffic light, which allows for long distance transmissions. For this case, the illuminance of the traffic light, measured at 0.5 meters is 680 and 630 lux for the green and the red color respectively. Figure 5.11 shows how these values are affected as the distance is increasing. The stronger green light does not represent an inconvenience because in fact, the ratio between the three colors of a traffic light Red:Yellow:Green should be 1:2.5:1.3.

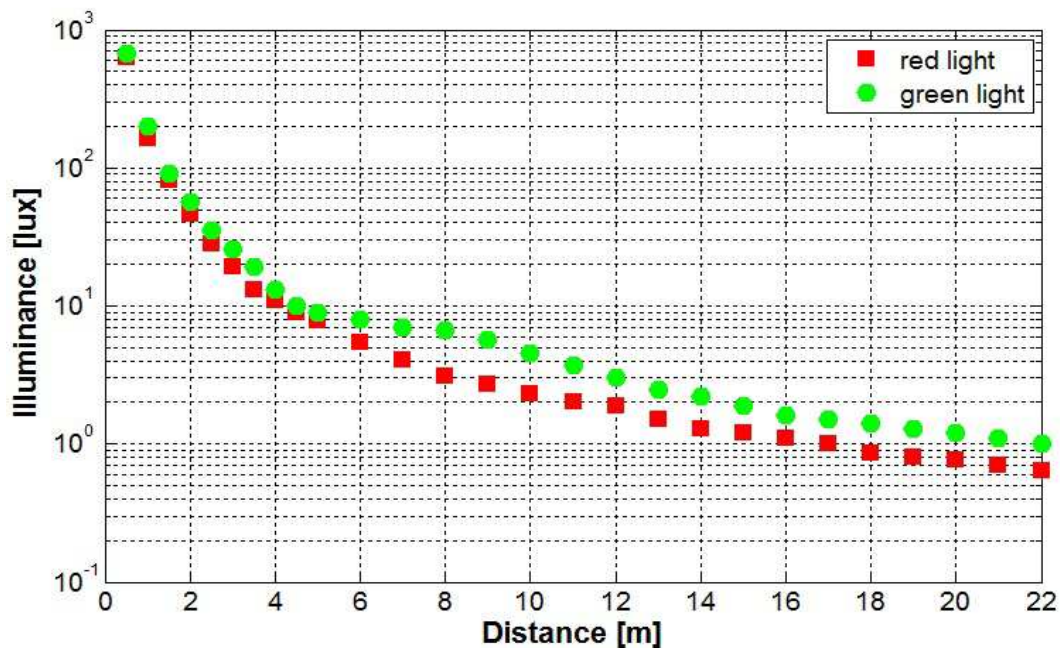

Figure 5.11: Traffic light illuminance distribution.

In order to evaluate the visible light I2V communication, a general test bench of LED traffic light communications has been arranged. The system is presented in Figure 5.12 and detailed in [163]. The emitter consists of the commercial traffic light, red or green can be switched, put on a mobile platform that allows varying the distance and the positioning. The receiver is only supplied by a 12 V battery to be easily embedded. The data can be sent with Manchester or Miller encoding and is composed of a traditional frame, as previously mentioned.

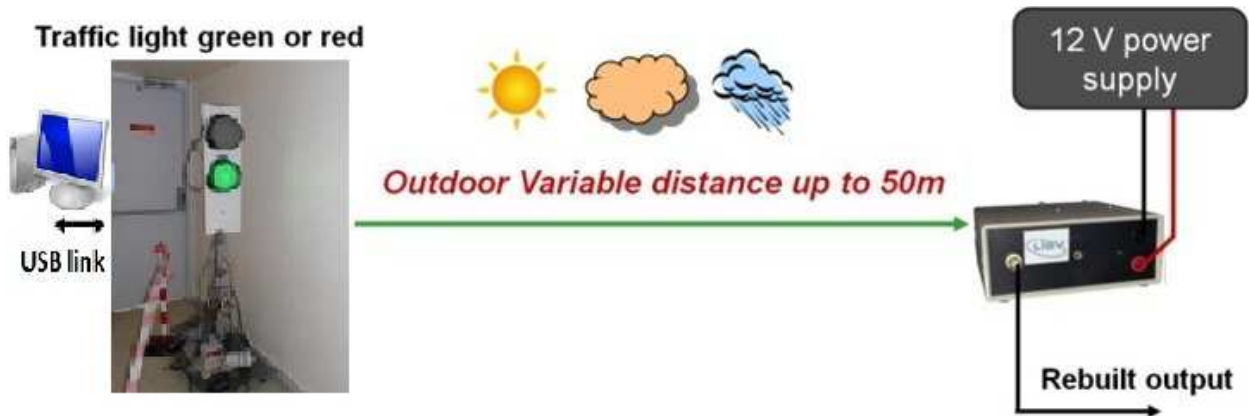

Figure 5.12: Sketch of the experiment with the receiver prototype.

Experiment 1 – Preconditioning stage sensitivity

The purpose of the first experiment related to the I2V configuration was to show the sensitivity of the pre-conditioning stage of the VLC receiver. The experiments were performed in the absence of any incoming signal to point out the receiver's noise performances. To highlight the signal to noise ratio, the receiver was also tested with an incoming data signal. The results are presented in Figure 5.13. Two spectrums are plotted: the noise in dark condition, when the photodetector is hidden and an example of spectrum in Miller case. The experiment has been realized at a short distance (8 m) of the emitter, in the laboratory. One can see that the signal to noise ratio is above 10 dB and that the sensitivity is around -80 dBm for frequencies above 3 kHz.

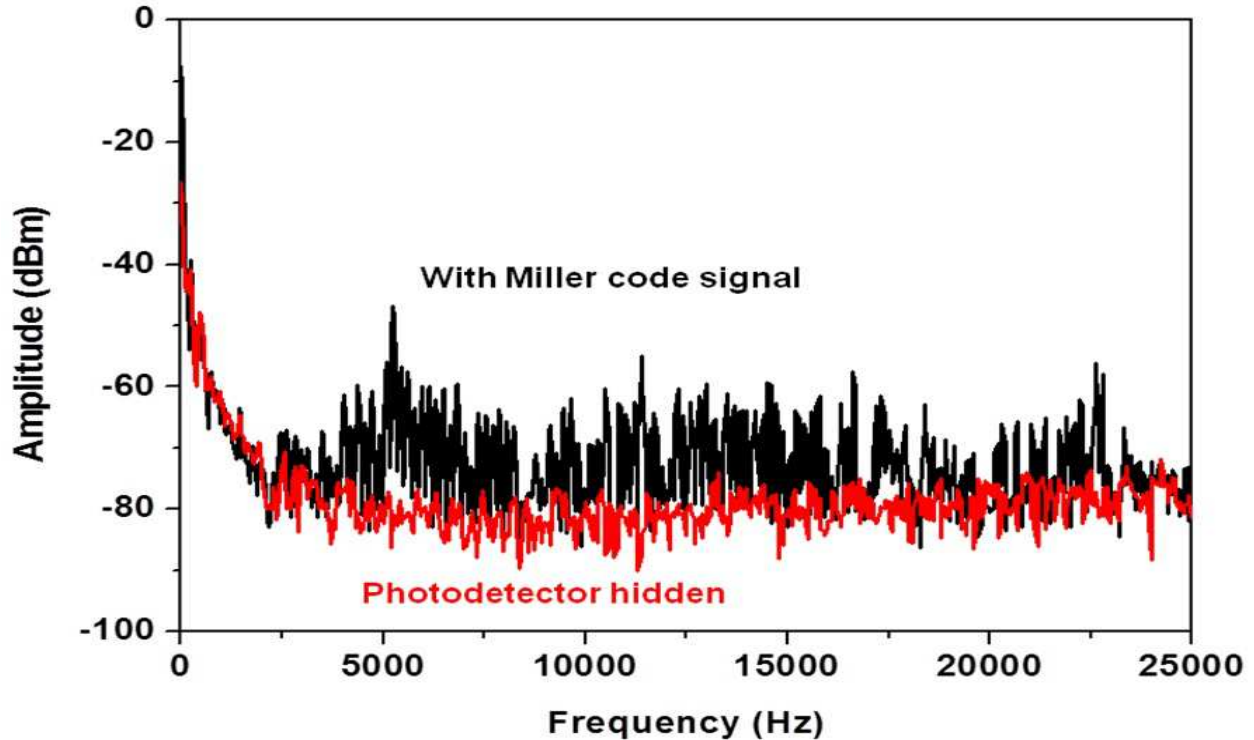

Figure 5.13: Experiment showing the sensitivity of the front stage of the sensor and example of a spectrum in the case of Miller code.

Experiment 2 – Automatic Gain Control Unit

The aim of the second experiment is to test the functionality of the AGC stage. For these experiments the distance between the emitting traffic light and receiver was changed and the response of the receiver was monitored. While modifying the emitter - receiver distance, the microcontroller computes the gain value in real time. The results illustrating how this value is affected are presented in Figure 5.14 for some distances. One can see how the gain of this stage is amplified with a factor 10 between the shortest and the longest distance. The amplification factor had as purpose to maintain the signal amplitude between the threshold limits. The values of the thresholds were determined experimentally. It was observed that when the signal decreased to half its value, or even below, the signal reconstruction process is not affected. This is possible because, like previously mentioned, the triggering is mainly based on the identification of the rising and of the falling edges rather than the signal's amplitude. This is why, even if the distance decreases 20 times and so the signal's amplitude (at this point), an amplification factor of 10 is sufficient to maintain the signal level between the optimum

thresholds.

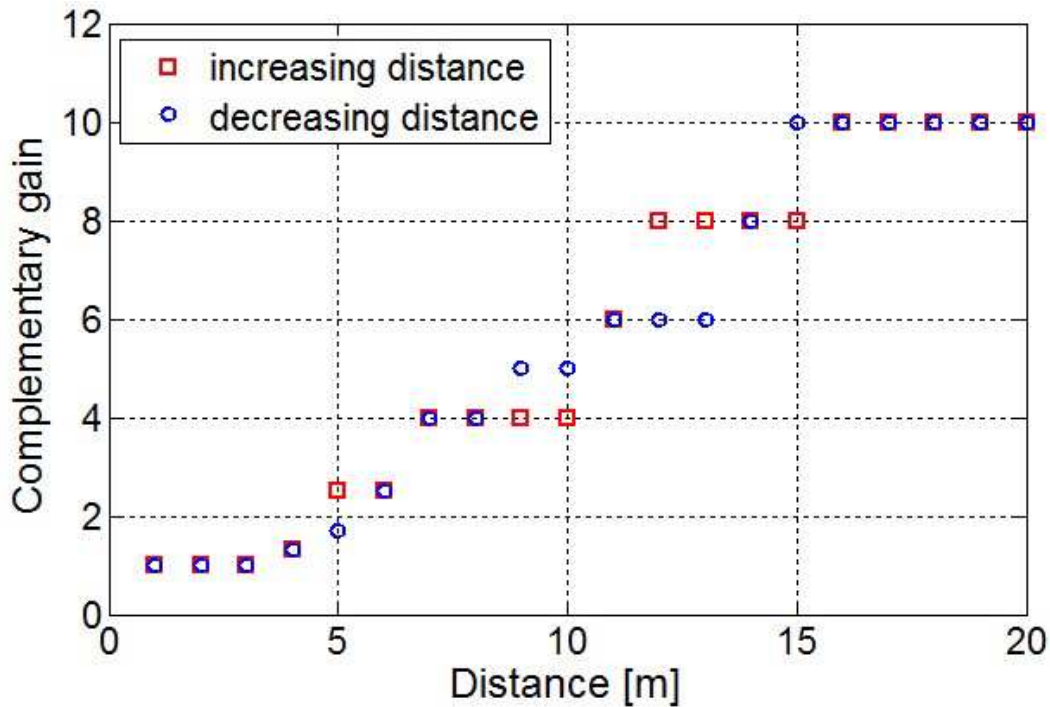

Figure 5.14: Gain value with respect to the distance when AGC is performed.

When AGC is performed, the system responds in real time to the variations of the intensity of the incoming signal. This enables the system to maintain a decent BER for the entire length of the service area (SA). The experimental results showed that when the AGC stage is disabled the communication range is reduced if an insufficient gain is preselected. Otherwise, when a high gain is preselected the system becomes unsuitable at short distances, as in the case when the car is too close to the traffic light, which leads to the saturation of the receiving module.

Experiment 3 – System calibration by pulse width measurement

As previously mentioned, the microcontroller performs the message decoding based on edge detection and by using tolerances for the pulse width measurements. Manchester code leads statistically to a message composed of two main pulse widths separated by front edges. In this case, the elementary modulation width is around 400 clock ticks of the microcontroller. The accuracy and the stability of the clock of the microcontroller are good enough and there is no requirement to synchronize the emitter and reception modules.

The distribution width measurements are illustrated in Figure 5.15 for approximately 5000 bits. Manchester case is reported in case Figure 5.15a. One can see two groups of peaks: one around 400 ticks and the second one around 800 ticks (twice the first width). The two groups are divided into two subgroups because of low-level and high-level values. This phenomenon is due to the triggering electronics part. The threshold to trigger the signal is asymmetrical to separate low-level and the high-level values. The amplitudes of the peaks are lower for the second group because the message sent is not random. One can see also that the four distributions are clearly separated. The most important thing is that the two groups are fully kept away from each other which is the equivalent of no decoding errors. The microcontroller is then counting the width of the pulses with a high frequency clock and determines the digital information easily.

The Figure 5.15b illustrates the same distribution measurements for a Miller configuration. Three groups of peaks are visible (elementary width of 800 ticks, one and a half and twice this value) with also subgroups for low and high levels values. In the same manner, the amplitude is only significant of the specific sent message which is not purely random. These distributions are useful to adjust the tolerance parameters on the detection threshold for the embedded microcontroller software.

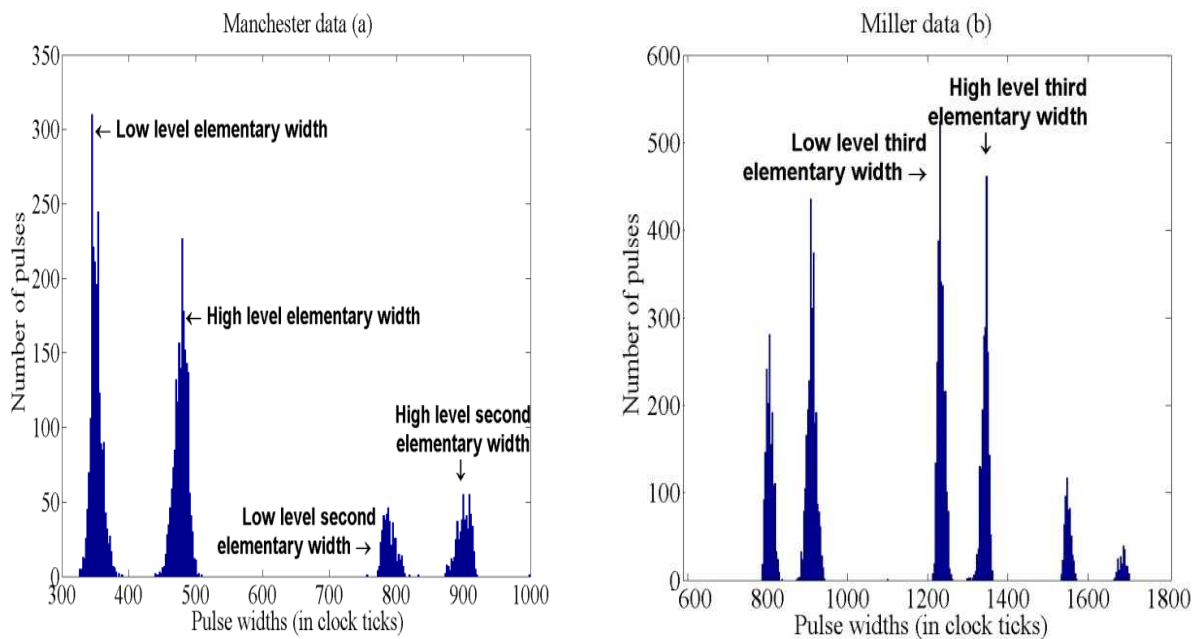

Figure 5.15: Histograms of received pulse widths for both Manchester and Miller configurations; a) Manchester case b) Miller case.

In the case of this experiment, the purpose was to determine the characteristics of the pulses, and to experimentally determine the decoding parameters in real working conditions. The usage of this approach allowed for a significant system performances improvement.

Experiment 4 – Bit Error Ratio for Manchester and Miller coding

The fourth experiment for the I2V configuration has been realized to compute the BER. A sequence of frames starts and the received bits are compared to the ones of the sent message. The system performs a loop which is stopped when the pre-determined quantity of bits is reached. The experiments are performed either with red light or green light alternatively. Sets of data of 10 million bits have been sent. Even if there are no precise norms for this, it can be considered that for most of road applications, a BER lower than 10^{-7} is suitable. Furthermore, the BER has been computed without error detecting codes, correlation techniques, or redundancy coding frames or protocols. This means that only the hardware aspects affecting the receiver’s performances were evaluated.

The experiments have been realized inside a building, in a corridor with and without artificial lights. The neon lights provide a strong parasitic 100 Hz signal which is added on the useful signal. Table 5.1 summarizes the main results for these sets of data.

Table 5.1: Bit Error Ratio (BER) for Miller and Manchester codes at 15 kHz modulation frequency using a photodiode as a photosensitive element.

Code	Conditions	BER
Manchester	1 - 25 m indoor, no artificial light. Red/Green light	$< 10^{-7}$
Miller	1 - 25 m indoor, no artificial light. Red/Green light	$< 10^{-7}$
Manchester	1 - 25 m indoor, with neon light on. Red/Green light	$< 10^{-7}$
Miller	1 - 25 m indoor, with neon light on. Red/Green light	$< 10^{-7}$

The results show that the system is able to provide a secure communication for distances that can go up to 25 meters, even in the presence of the fluorescent lights, situated at approximately 1.5 meters above the receiver.

For the next set of experiments, the silicon photodiode used as light sensing element has been replaced by an industrial light sensor developed by VALEO. Even though the VLC receiver's front end stage has been changed, the rest of the signal processing part was the same as for the photodiode. The increased complexity of the industrial sensor had improved the system's performances, as it can be observed in Table 5.2.

Table 5.2: Bit Error Ratio (BER) for Miller and Manchester codes at 15 kHz modulation frequency; green and red light have been tested in different conditions.

Code	Conditions	BER
Manchester	50 m outdoor, daylight. Red light	$< 10^{-7}$
Miller	50 m outdoor, daylight. Red light	$< 10^{-7}$
Manchester	36 m outdoor, daylight. Green light	$< 10^{-7}$
Miller	36 m outdoor, daylight. Green light	$< 10^{-7}$
Manchester	20 m inside a building with neon light on Red light	$< 10^{-7}$
Miller	20 m inside a building with neon light on Green light	$< 10^{-7}$

These results demonstrate that the prototype is well adapted for data transmission over short or medium distances up to 50 m. Results show 0 errors for 10^7 bits sent for both Manchester and Miller codes, confirming the simulation that were indicating that the two codes have similar BER performances, at least up to the 10^{-7} level.

The indoor experiments have been made in a corridor, limited to 20 m range because of the limited length of the building. To also evaluate the immunity to parasitic signals some of the experiments were performed with the artificial lights on. The neon lights provide a strong 100 Hz parasitic signal which is successfully eliminated by the filters without having any influence on

the 10^{-7} BER. Some errors can appear when the light is switched on or off because of the transient pulses that can affect the frames. However, this is a minor drawback. For the indoor experiments, both red and green lights have the same performances.

The outdoor experiments have been made in different uncontrolled sun expositions, for distances up to 50 m. The sensor shows lower performances for the green light and the associated maximum distance is around 36 m. This is mainly due to three factors. Firstly, the sensitivity of the silicon photodetector is lower for the wavelength corresponding to the green light than for the red one. Secondly, the sun spectrum is more disturbing in green range than in red one. And thirdly, the used lens is slightly chromatically treated and the transmission coefficient is better for red light. The performances of the receiver for the wavelength corresponding to the green color can be enhanced by using higher gain or plastic color filtering to reduce the influence of the sun light and to improve the signal to noise ratio. The influence of the first two factors is represented in Figure 5.16.

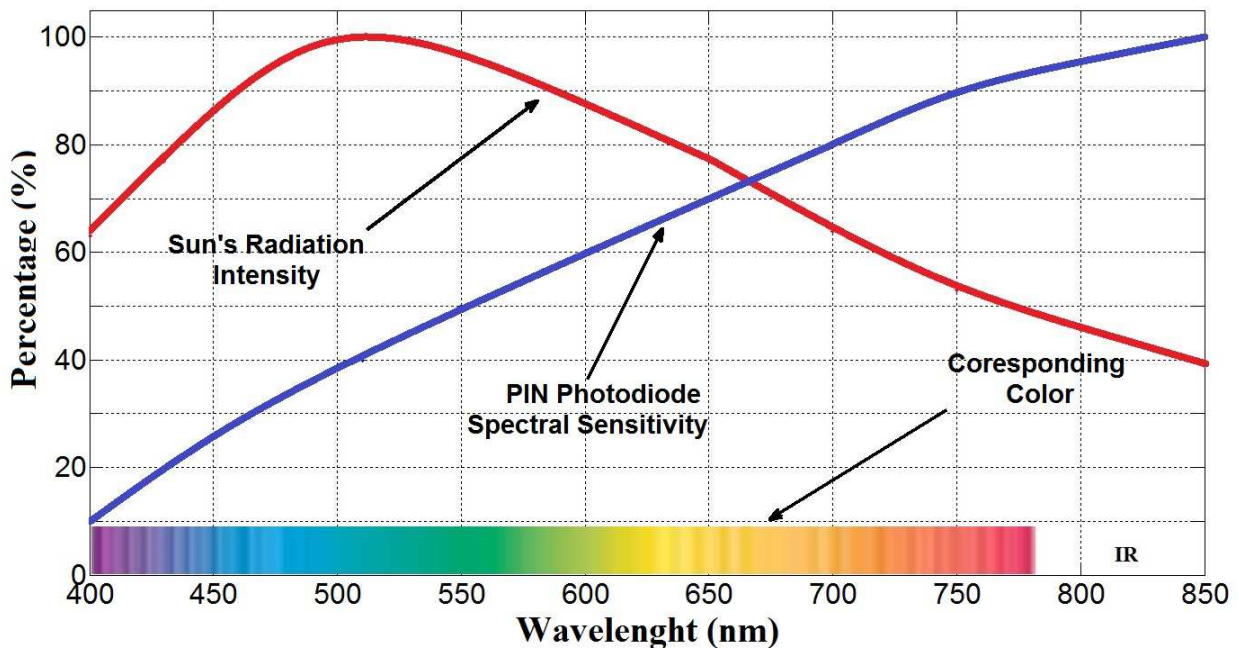

Figure 5.16: Illustration of the factors that affect the sensor's performances in the case of green light.

5.3.3 VLC cooperative architecture setup and experimental results

ITS involves cooperative driving technologies, based on wireless communication that allow vehicles and/or road infrastructure to exchange a large amount of dynamic data which will generate a large data flow. A serious problem is that the wireless communication technologies, on which the cooperative driving relies on, are known to be subject to different type of interferences. This problem is even more acute in the case of VANETs, where different nodes will cause mutual interferences. Under these circumstances, the Line-of-Sight (LoS) condition which is a major disadvantage of VLC, limiting the communication range, may act here as an advantage, preventing the interferences.

Considering the upper mentioned, the aim of the following work is to perform one of the firsts experimental demonstration of the cooperation between the two major components of the ITS: I2V and V2V communications. For the purpose of this experiment, the two prototypes of led-light communications that have been presented in the previous sections were tested together, as part of a complex system, as described in [164]. The aim was to enable the cooperation between the two communication systems. The first one is an example of I2V communication, between a commercial LED traffic light as a RSU emitter and a transceiver. The second one is an example of V2V communication and uses a vehicle's rear-light emitter, to transmit the original message received from the traffic light to the following vehicles. Of course, additional information, like a time stamp or vehicles coordinates can be added. Both the prototypes transmit the digital information by using OOK modulation.

The proposed cooperative system has several advantages. First, it enables short to medium communication between road infrastructure and also among vehicles without causing mutual interferences. The message is forwarded from node to node, so it can reach to network nodes (vehicles) that are outside the communication area. So, by using multi-hop networking both LoS problem and limited communication range are solved. This scenario is presented in Figure 5.17, where the first vehicle, which is in the Service Area (SA) of the traffic light, retransmits the received message to the following vehicle, which is outside the traffic light's SA.

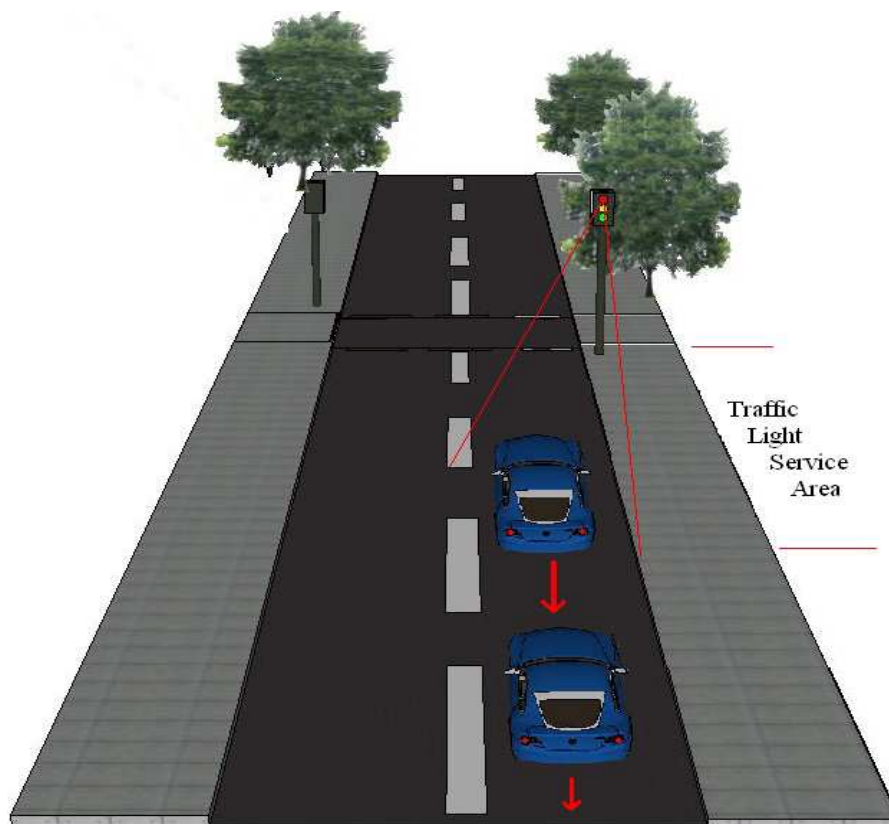

Figure 5.17: Illustration of the proposed cooperative scenario: the traffic light sends a message that is received by the first car and retransmitted to the car behind.

The experiments were conducted in laboratory conditions. The traffic light transmits data sets of 10 million bits. The message transmitted contains 7 ASCII characters of 8 bits, however longer messages can be sent. The frame of the message indicates to the receivers if the Miller or the Manchester code is used. The transceiver receives the data and decodes it in real-time. The transceiver also resends the message for the second receiver by using the tail lights. An algorithm allows post-processing or calculation of errors to determine the BER. The BER is determined by comparing the received bits with the emitted ones. For these experiments, a predefined message is sent continuously at a 15 kHz modulation frequency. The experimental setup for these tests is presented in Figure 5.18.

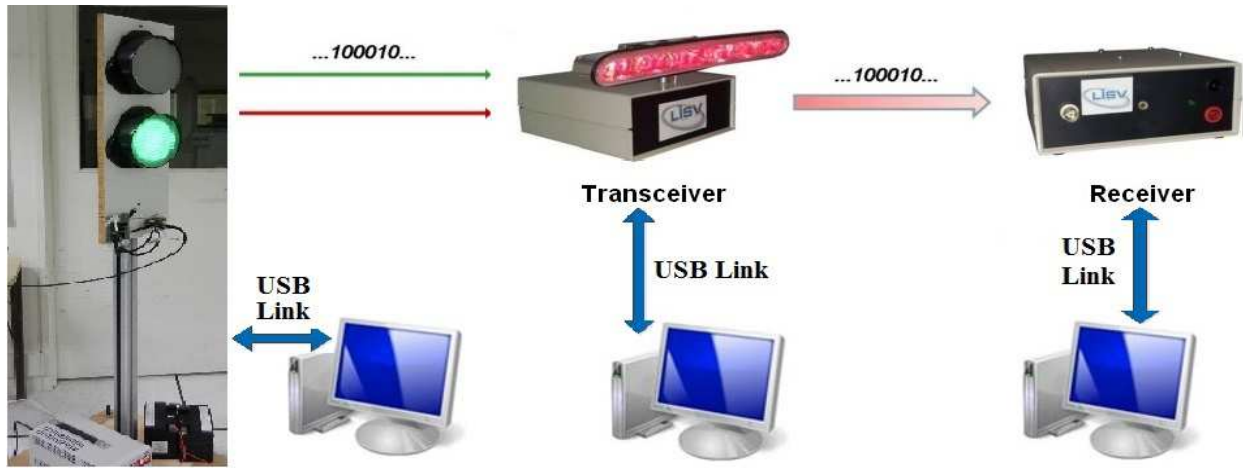

Figure 5.18: Experimental setup for the VLC cooperative architecture; the LED traffic light broadcasts traffic safety messages; the transceiver receives the message and resends it for the second receiver.

Two scenarios were tested. In the first scenario, the transceiver is situated in the traffic light’s SA whereas the second receiver is situated outside the traffic light’s SA, as illustrated in Figure 5.17. The purpose of this setup is to show that the limited communication range can be increased by using an extra node which retransmits the message. The experiments began by setting the transceiver 20 meters away from the traffic light and the receiver 1 meter behind it, with no LoS with the traffic light. Afterwards, the distance between the transceiver and receiver was gradually increased and the BER was measured. Due to space limitation imposed by the building, the distances involved were limited, but the purpose of the experiment was to demonstrate that VLC communication can reach to a vehicle outside the service area. The results obtained for this scenario are presented in Table 5.3.

Table 5.3: Cooperative setup - Bit Error Ratio (BER) for Miller and Manchester codes at 15 kHz - Scenario 1.

Communication	Distance [m]	BER for Manchester	BER for Miller
I2V	20	$<10^{-7}$	$<10^{-7}$
V2V	1		
	2		
	3		
I2V2V	21		
	22		
	23		

In the second scenario, illustrated in Figure 5.19, both the transceiver and the receiver are situated in the traffic light's SA, but there is no LoS between the traffic light and the receiver, as in the case when a bigger vehicle is interposed between the traffic light and the vehicle behind. The aim of this experiment is to demonstrate that the communication is possible even in the absence of the mandatory LoS, by using an intermediate node which retransmits the message.

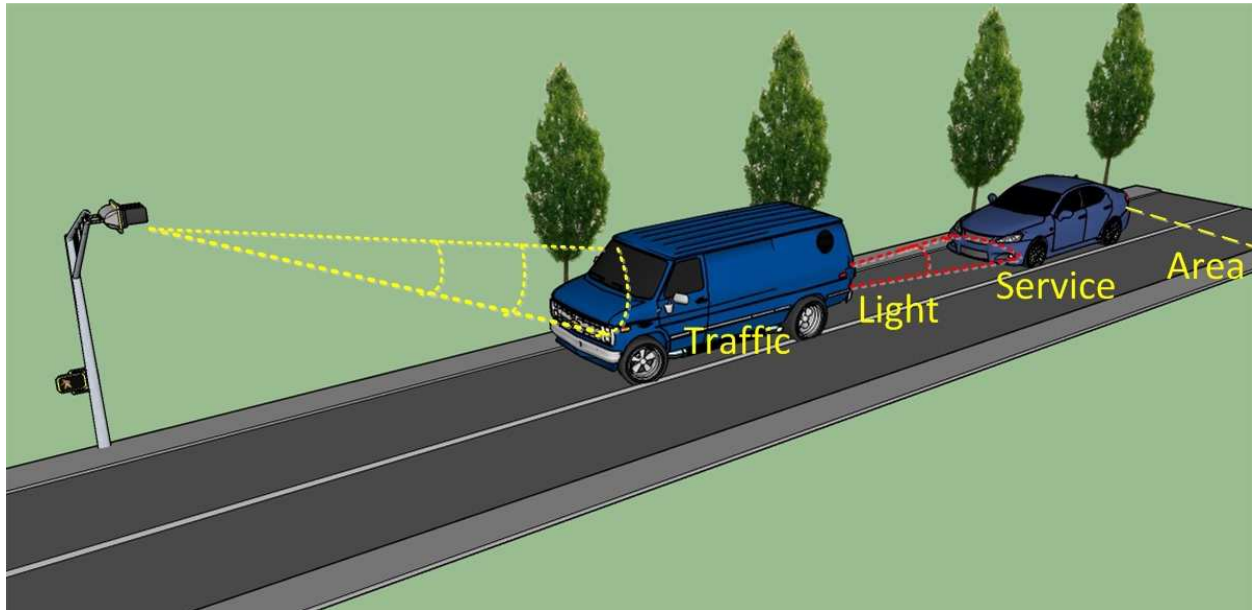

Figure 5.19: Illustration of the second cooperative scenario: both the vehicles are within traffic light's service area but there is no LoS with the second vehicle.

The transceiver was set 1 meter away from the traffic light and the receiver 1 meter behind it. In the next steps, the distance between the transceiver and the receiver was increased and also the distance between the traffic light and transceiver was varied. The BER was processed both for the I2V and for V2V communication and the results are presented in Table IV. The results prove that the transmitted message can be received even by a node which is outside the emitter's LoS.

Table 5.4: Bit Error Ratio (BER) for Miller and Manchester codes at 15 kHz for I2V, V2V and I2V2V – Scenario 2.

Distance I2V [m]	Distance V2V [m]	Distance I2V2V (I2V+V2V) [m]	BER for Manchester	BER for Miller
1	1	2	10^{-7}	10^{-7}
	2	3		
	3	4		
5	1	5		
	2	7		
	3	8		
10	1	11		
	2	12		
	3	13		
15	1	16		
	2	17		
	3	18		

The experimental results show a BER $<10^{-7}$ for both I2V and V2V communication for variable distances. These communication distances can be increased especially in the case of the I2V where the power emitted by the traffic light is high enough to allow longer distances. For such a communication the BER of 10^{-7} can be maintained for distances of up to 50 meters whereas, for V2V the communication the range can be increased in this configuration up to 10 - 12 meters, as presented in the previous sections. Even so, it is difficult to achieve communication ranges comparable with those of radio communication, which aim to achieve 1000 meters.

The results demonstrate that the prototypes are well adapted for data transmission over short or medium distances, for I2V and for V2V, using both Manchester and Miller codes. However, the main objective of the experiment was to test and demonstrate the cooperation between an I2V communication system and a V2V communication system which will be the case for the real traffic scenario.

This experiment also demonstrated that the limitation represented by the LoS condition and the limited communication range of VLC, can be overcome by using multi-hop networking.

It was showed that the communication between a RSU and a vehicle that is outside its SA is possible with the help of a second vehicle that is found inside the SA and that forwards the message. The same working principle could be applied in the case of radio communication. This will allow the emitters to reduce the emission power, just to allow communication with the nearest neighbor, minimizing the interferences to the other vehicles. Of course, in the real traffic case, more complex routing protocols will be required.

5.4 Conclusions

This chapter presented some of the aspects related to the implementation, optimization and the experimental verification of a VLC system aimed for automotive applications. Throughout the development of the system, special attention was given to maintain the implementation cost as low as possible, facilitating this way the future deployment of the system towards large scale production for the automotive industry.

This chapter has highlighted the importance of an AGC stage within the VLC receiver. This stage is used to adjust the gain in order to compensate for the variation of the emitter-receiver distance and it can enable the system to maintain a decent BER for the entire service area.

The proposed system was tested for V2V and I2V configurations. Moreover, the experiments were performed in various conditions in order to verify its reliability in the presence of natural and artificial light. The experimental results, confirmed that the proposed VLC architecture is suitable for the intended applications. Mainly focusing on the hardware part, the system was able to achieve BER results lower than 10^{-7} for distances of up to 50 m. These results are very promising knowing that no error-correcting codes have been used. Errors detecting codes, correlation techniques, or redundancy coding frames or protocols are some possible solutions that can further improve the system performances.

If it is to compare this prototype with some other existing VLC systems, this one has as main advantage the fact that it is able to achieve a relatively *long communication range while maintaining a very low BER*. A relatively similar VLC system concept, also based on a PIN photodiode, is proposed by Kumar et al. [119 - 122]. Their system is able to achieve a comparable communication range. However, the BER is much higher, between 10^{-6} at 10 m and

10^{-2} at 45 m. A VLC system with better performances is proposed in [116], [117]. In this case, a better data rate (10 Mb/s) is achieved at short distances (up to 20 m), whereas by reducing it (4.8 kb/s), communication ranges that can go up to 100 m can be accomplished. Nevertheless, these results were achieved using a receiver based on a high performance camera system which is much more expensive.

Beside the V2V and I2V configurations, a cooperative VLC architecture was demonstrated for the first time. This way, it was showed that the communication range of VLC systems can be increased by using multi-hop communications and that the emitter - receiver LoS conditions can be overcome with the help of retransmissions.

Concerning the coding techniques, this chapter has further investigated the performances of the Manchester and of the Miller codes. The experimental results confirmed the simulations that were indicating that the two codes have similar performances in terms of BER. Consequently, it has been demonstrated that the Miller code is also suitable for VLC outdoor applications.

Conclusions and perspectives

Conclusions

Even if VLC is an early stage technology, it has numerous advantages and a huge potential of development. This potential has been partially explored regarding the VLC usage in indoor applications. In this application area, the performances of VLC systems have been proven. However, the study of VLC usage in long-range outdoor applications has been rather neglected. Moreover, the number of such prototypes is quite limited. Within this context, in this thesis, the usage of the VLC technology for vehicular communications has been explored in detail.

Since outdoor applications involve the presence of other light sources, such a system must be highly robust to perturbations. For outdoor VLC systems, the sunlight is the strongest noise source, introducing a high DC component or even saturating the receiver. Consequently, a crucial issue is to design an appropriate VLC receiver, able to enhance the conditioning of the signal and to diminish the effect of environmental conditions.

In this context, *the main contribution of this thesis is the development, the implementation and the experimental evaluation of a VLC system aimed for outdoor low-data rate applications*. Considering the upper mentioned, *a VLC prototype has been developed*. In order to better highlight the applicability of the system in real situations and to prove the “*ready to deployment*” character, its usage in the automotive field has been considered. The automotive field has been considered taking into account the broad distribution of the LED lighting systems, as part of the transportation infrastructure and in commercial vehicles as well.

Consequently, the VLC emitter is developed to be representative for two cases. In the first one, the VLC emitter is based on a vehicle tail light. The applicability of such a system is in vehicle to vehicle communications. For example, when a vehicle is hard braking, the proposed VLC system can be used to send this information to the following vehicle and this way, a crash can be prevented. For the second case, the VLC emitter is based on a commercial LED traffic light. This choice was made in order to prove how easily any LED lighting or signaling device can become a road side broadcasting unit. The usefulness of such a system is to increase the

vehicle awareness. A vehicle approaching the traffic light can receive the information concerning the state, the time until the next phase shift, the location and so on.

The VLC receiver is the most important part of a VLC system. Its performances are the ones that determine the overall system performances. Therefore, during the development of the receiver, special attention was focused to enhance its ability to work in environmental conditions similar to the ones encountered in automotive applications. The proposed receiver is designed to withstand perturbations from other sources of light, such as the sun or the artificial lighting. Furthermore, the receiver is designed to withstand mobile conditions. For this purpose, it is enhanced with an automatic gain control unit which adjusts the gain according to the power of the incoming light. This way, the receiver is able to work at short emitter – receiver distances without saturating. As the distance increases, the receiver adjusts its gain in order to compensate for the decrease of the incoming power. The gain is adjusted in real time, without affecting the message decoding.

In order to demonstrate the performances of the prototype, its *experimental performance evaluation* has been performed for *different scenarios* and *environmental conditions*. The proposed system was tested for automotive applications. In these circumstances, the system was tested in the V2V scenario, using the tail light VLC emitter and in the I2V scenario, using the traffic light emitter. Moreover, the system's robustness to noise was tested in the presence of artificial lighting and also in uncontrolled sun light conditions.

The *experimental results confirmed* the system's *performances* and the suitability for the envisioned applications. Depending on the configuration, the developed system was able to achieve a *communication range up to 50 m*. Concerning the BER performances, the system proved to be very good, allowing the transmission of 10 million bits series without any error ($BER < 10^{-7}$). Furthermore, these results were obtained focusing mostly on the hardware aspects, without the usage of any error correcting codes or algorithms. The utilization of such techniques can further improve the system's performances. Besides the VLC usage in the V2V and in the I2V scenarios, *the cooperation* between the two has been *experimentally demonstrated for the first time*. This way, it has been shown that the communication range can be increased with the help of retransmissions. The same for the mandatory LoS condition, which can be overcome with the help of an additional node.

Taking into consideration the efficiency of the digital filters compared to the analogical ones, a second *VLC architecture based on digital signal processing is proposed*. Unlike the hardware prototype, this one is modeled using the Matlab/Simulink software. This architecture allowed for the *study of the effects of the noise, data rate and message length on the BER performances*.

Another significant contribution of the thesis is related to the analysis and the evaluation of the coding techniques suitable for VLC. In a first step, the evaluation of the Manchester code is considered. The reason of this choice is related to the fact that the Manchester code is stated by the IEEE 802.15.7 standard for such applications. The simulation and the experimental results confirmed its suitability and performances. Furthermore, taking into consideration the future development of the system and the growing interest towards MIMO applications, the evaluation of the Miller code has been considered as well. Thus, it has been found, that in terms of BER, the Miller code exhibits similar performances as the Manchester code. In terms of flickering, it has been shown that its effect is very limited. However, the evaluation of the spectral efficiency revealed that the Miller code clearly outperforms the Manchester code. All this together, prove the appropriateness of the Miller code for the envisioned applications and also indicate the future perspectives in MIMO uses. It must be highlighted that this thesis is *the first work that analyses the opportunity of using Miller code for outdoor VLC applications and that proves its suitability*.

All these contributions were preceded by a deep analysis of the existing VLC literature. This allowed the identification of the advantages, weaknesses, trends and challenges related to the VLC development.

This research was part of an industrial project, called “*Co-Pilot for an intelligent road and vehicular communication system*” or “*Co-Drive*” for short. The project was coordinated by VALEO and involved several other companies and research institutions. The project had as main goal the development of a cooperative driving system that will improve the safety and the efficiency of the transportation system. It can be considered that the developed prototype can be well integrated in the project, since it is able to use the wireless data transfer in order to enhance the driving experience. Furthermore, the prototype was developed focusing on maintaining the

implementation cost as low as possible, which offers the premises for large scale usage in automotive related applications.

Depending on the application, the automotive industry requires wireless communication systems able to provide ranges that can go up to few hundred of meters. The current system cannot provide such communication distances, meaning that it is suitable just in some applications or traffic situations. However, just as it is, the system can be used in the development of a more efficient low-cost “*Stop&Go*” system. In this case, based on the information received from the traffic lights, the vehicles can decide if stopping the engine while waiting for the green color is fuel-saving or not. Furthermore, using the demonstrated cooperative architecture, data is propagated from one vehicle to another in the entire chain. Such a system can bring fuel saving and can reduce the CO₂ emissions. This proves that beside the scientific contributions, *the conducted research concretized* in a “*ready to use*” *product*, able to bring practical benefits. Furthermore, the system can be improved towards the enlargement of its application area.

Future developments and perspectives

VLC is an emerging technology with huge potential. Its suitability in the automotive field has been demonstrated with theoretical analyses and with experimental results. However, even if there are numerous traffic applications and situations in which VLC is well suited, it cannot be stated that VLC is able to support all the requirements and applications imposed in vehicular communications. In order to fully comply with the usage in vehicular communications, VLC still needs to enhance its performances. Following, some of the key issues that should be approached towards this goal are discussed.

The communication range

One of the most important issues that should be improved is the communication range. In this case, the problem is that the power of the signal and consequently the SNR drops significantly when the communication range increases. Increasing the receiver gain is a suitable solution but still, it has its limits, meaning that additional measures should be taken.

The developed prototype is based on a single photosensitive element used for the entire visible light spectrum, from 380 to 780 nm. Its spectral sensitivity gets higher as the wavelength

increases. This fact resulted in a shorter communication range for the green light compared to the red light. An efficient way to increase the communication range would be to design a receiver that uses an array of photodetectors, each of them dedicated to a specific wavelength (e.g. red, yellow, green). This way, the additional light corresponding to the other colors is filtered using an optical filter, leaving just the wavelength containing the data signal. The SNR level can be thus significantly enhanced and the communication range increased.

Mobility

In order to improve the SNR, the effect of the background noise is usually reduced by narrowing the receiver field of view. Even if this solution is helpful concerning the SNR improvement, it has a downside: the narrow signal reception angle reduces the mobility. However, for the usage in vehicular communications, VLC also has to fully comply with the mobility of the vehicles. Furthermore, in the case of the proposed VLC system, the experimental evaluation was performed with the emitter and the receiver relatively aligned. However, for real situations, the traffic light is set at a height between 2.5 and 5 meters above the road. This is for sure a serious issue that again, will significantly influence the performances of the system, limiting the service area.

A solution for this problem is the integration of a tracking mechanism based on a low cost camera with active control of the position. Another solution would be to use more photodetectors orientated for different reception angles. The microcontroller should analyze the signals from each photodetectors and decide which signal(s) can be used for the message reconstruction. The problem can be solved in a similar manner by using more than one sensor, for example one or two on each side of the vehicle.

MIMO applications

The work from this thesis confirmed the suitability of the Miller code for outdoor VLC applications and future perspectives in MIMO applications.

Further efforts should be made towards the investigation and the development of a system compatible to MIMO applications. The problem in this case is represented by the false triggering because of the parallel transmissions. The usage of an adaptive digital filter, as the one implemented in the proposed DSP receiver, seems a good option but still, false edges will introduce some decoding errors. Probably, the most efficient way to solve all these problems

would be to use different optical clocks for each parallel transmission, as in the frequency division multiple access technique. This approach has as main disadvantage a higher cost for the system.

Data rate improvement

In indoor and at short distance VLC proved to be able of achieving very high data rates that can go up to 3 Gb/s. The high data rates are obtained using more complex modulations like OFDM or multi-level codes. In outdoor applications, the data rates are rarely above few tens of kb/s.

To improve this situation, future research should investigate the behavior of the indoor modulation techniques in the outdoor scenario.

Adaptability of the data rate

In vehicular communications the packet delivery ratio is more important than the data rate. The delivery ratio is even more essential when high priority messages are involved. Nevertheless, the data rate is not negligible and a higher one is desirable. In these conditions, forthcoming work should focus on harmonizing between the two requirements, meaning that the data rate should be increased without affecting the packet delivery ratio.

A possible solution would be the implementation of a communication protocol in which the data rate is adapted depending on the priority of the message. This way, the high priority messages can be sent at a low data rate to ensure the safe delivery, whereas the less important messages can be sent at a higher data rate.

Another interesting issue would be the development and the implementation of a duplex VLC system in which the two transceivers adapt the data rate based on the SNR level and on the imposed BER requirements. The VLC receiver can easily determine the noise level by analyzing the input signals when the data bit '0' is received.

All these improvements can further increase the performances of VLC and insure it a bright future. However, VLC still needs the support of the solid state lighting industry and of the photodiode industry as well. Future faster switching LEDs will enable higher data rates in indoor applications, whereas more sensitive photoelements will enable longer communication distances.

Bibliography

- [1] Cisco, "Cisco Visual Networking Index: Global Mobile Data Traffic Forecast Update, 2013-2018," Whitepaper, February 2014.
- [2] Steigerwald, D.A.; Bhat, J.C.; Collins, D.; Fletcher, Robert M.; Holcomb, M.O.; Ludowise, M.J.; Martin, P.S.; Rudaz, S.L., "Illumination with solid state lighting technology," *Selected Topics in Quantum Electronics, IEEE Journal of*, vol.8, no.2, pp.310,320, Mar/Apr 2002.
- [3] Shur, M.S.; Zukauskas, A, "Solid-State Lighting: Toward Superior Illumination," *Proceedings of the IEEE*, vol.93, no.10, pp.1691,1703, Oct. 2005
- [4] Azevedo, I.L.; Morgan, M.G.; Morgan, F., "The Transition to Solid-State Lighting," *Proceedings of the IEEE*, vol.97, no.3, pp.481,510, March 2009.
- [5] Cole, M.; Clayton, H.; Martin, K., "Solid state lighting: The new normal in lighting," *PCIC Europe (PCIC EUROPE), 2013 Conference Record*, vol., no., pp.1,9, 28-30 May 2013.
- [6] Hao Le Minh; O'brien, D.; Faulkner, G.; Lubin Zeng; Kyungwoo Lee; Daekwang Jung; Yunje Oh, "80 Mbit/s Visible Light Communications using pre-equalized white LED," *Optical Communication, 2008. ECOC 2008. 34th European Conference on*, vol., no., pp.1,2, 21-25 Sept. 2008.
- [7] Tsonev, D.; Hyunchae Chun; Rajbhandari, S.; McKendry, J.J.D.; Videv, S.; Gu, E.; Haji, M.; Watson, S.; Kelly, AE.; Faulkner, G.; Dawson, M.D.; Haas, H.; O'Brien, D., "A 3-Gb/s Single-LED OFDM-Based Wireless VLC Link Using a Gallium Nitride uLED," *Photonics Technology Letters, IEEE*, vol.26, no.7, pp.637,640, April 1, 2014.
- [8] Afgani, M.Z.; Haas, H.; Elgala, H.; Knipp, D., "Visible light communication using OFDM," *Testbeds and Research Infrastructures for the Development of Networks and Communities, 2006. TRIDENTCOM 2006. 2nd International Conference on*, vol., no., pp.6 pp.,134.
- [9] Vučić, J.; Fernández, L.; Kottke, C.; Habel, K.; Langer, K.-D., "Implementation of a real-time DMT-based 100 Mbit/s visible-light link," *Optical Communication (ECOC), 2010 36th European Conference and Exhibition on*, vol., no., pp.1,5, 19-23 Sept. 2010.
- [10] Terra, D.; Kumar, N.; Lourenco, N.; Alves, L.N.; Aguiar, Rui L., "Design, development and performance analysis of DSSS-based transceiver for VLC," *EUROCON - International Conference on Computer as a Tool (EUROCON), 2011 IEEE*, vol., no., pp.1,4, 27-29 April 2011.
- [11] Hanzo, L.; Haas, H.; Imre, S.; O'brien, D.; Rupp, M.; Gyongyosi, L., "Wireless Myths, Realities, and Futures: From 3G/4G to Optical and Quantum Wireless," *Proceedings of the IEEE*, vol.100, no.Special Centennial Issue, pp.1853,1888, May 13 2012.
- [12] Liu, C.; Sadeghi, B.; Knightly, E. W., "Enabling vehicular visible light communication (V2LC) networks," *Proceedings of the Eighth ACM international workshop on Vehicular inter-networking (VANET '11)*, ACM, New York, NY, USA, 41-50, 2011.

- [13] International Agency for Research on Cancer, World Health Organization, "IARC Classifies Radio Frequency Electromagnetic Fields as Possible Carcinogenic to Humans", Press Release No. 208, 31 May 2011.
- [14] World Health Organization. (June 2011). Fact Sheet 193 – Electromagnetic fields and public health: mobile phones.
- [15] Devereux, H.; Smalley, M., "Are infra red illuminators eye safe?," *Security Technology, 1995. Proceedings. Institute of Electrical and Electronics Engineers 29th Annual 1995 International Carnahan Conference on*, vol., no., pp.480,481, 18-20 Oct 1995.
- [16] Walsh, J., et al., 2014: Ch. 2: Our Changing Climate. *Climate Change Impacts in the United States: The Third National Climate Assessment*, J. M. Melillo, Terese (T.C.) Richmond, and G. W. Yohe, Eds., U.S. Global Change Research Program, 19-67.
- [17] U.S. Department of Energy, Report: "Criticals Materials Strategy", December 2010.
- [18] Exxon Mobil, Report: "2012 The Outlook for Energy: A view to 2040", available at: exxonmobil.com/energyoutlook.
- [19] Rahaim, M.B.; Vegni, AM.; Little, T. D C, "A hybrid Radio Frequency and broadcast Visible Light Communication system," *GLOBECOM Workshops (GC Wkshps), 2011 IEEE*, vol., no., pp.792,796, 5-9 Dec. 2011.
- [20] www.lificonsortium.org
- [21] Hyun-Seung Kim; Deok-Rae Kim; Se-Hoon Yang; Yong-Hwan Son; Sang-Kook Han, "An Indoor Visible Light Communication Positioning System Using a RF Carrier Allocation Technique," *Lightwave Technology, Journal of*, vol.31, no.1, pp.134,144, Jan.1, 2013.
- [22] <http://postscapes.com/wifi-lights>
- [23] Witters, D.; Seidman, S.; Bassen, Howard, "EMC and wireless healthcare," *Electromagnetic Compatibility (APEMC), 2010 Asia-Pacific Symposium on*, vol., no., pp.5,8, 12-16 April 2010.
- [24] Cheong, Y.-K.; Ng, X.W.; Chung, W.-Y., "Hazardless Biomedical Sensing Data Transmission Using VLC," *Sensors Journal, IEEE*, vol.13, no.9, pp.3347,3348, Sept. 2013.
- [25] <http://www.gps4us.com/news/post/Biologically-friendly-Visible-Light-Communication-technology-20111207.aspx>
- [26] http://www.vlcc.net/?ml_lang=en
- [27] Tanaka, Y.; Haruyama, S.; and Nakagawa, M., "Wireless optical transmission with the white colored LED for the wireless home links," Proc. of the 11th Int. Symp. on Personal, Indoor and Mobile Radio Communications (PIMRC 2000). London, UK, pp. 1325-1329, 2000.
- [28] Tanaka, Y.; Komine, T.; Haruyama, S.; Nakagawa, M., "Indoor visible communication utilizing plural white LEDs as lighting," *Personal, Indoor and Mobile Radio Communications, 2001 12th IEEE International Symposium on*, vol.2, no., pp.F-81,F-85 vol.2, Sep/Oct 2001.

- [29] Komine, T.; Nakagawa, M., "Integrated system of white LED visible-light communication and power-line communication," *Personal, Indoor and Mobile Radio Communications, 2002. The 13th IEEE International Symposium on* , vol.4, no., pp.1762,1766 vol.4, 15-18 Sept. 2002.
- [30] Komine, T.; Nakagawa, M., "Fundamental analysis for visible-light communication system using LED lights," *Consumer Electronics, IEEE Transactions on* , vol.50, no.1, pp.100,107, Feb 2004.
- [31] Sugiyama, H.; Haruyama, S.; Nakagawa, M., "Brightness Control Methods for Illumination and Visible-Light Communication Systems," *Wireless and Mobile Communications, 2007. ICWMC '07. Third International Conference on* , vol., no., pp.78,78, 4-9 March 2007.
- [32] Yoshino, M.; Haruyama, S.; Nakagawa, M., "High-accuracy positioning system using visible LED lights and image sensor," *Radio and Wireless Symposium, 2008 IEEE* , vol., no., pp.439,442, 22-24 Jan. 2008.
- [33] Serththi, C.; Tsuji, E.; Nakagawa, M.; Kuwano, S.; Watanabe, K., "A Switching Estimated Receiver Position Scheme For Visible Light Based Indoor Positioning System," *Wireless Pervasive Computing, 2009. ISWPC 2009. 4th International Symposium on* , vol., no., pp.1,5, 11-13 Feb. 2009.
- [34] Hyun-Seung Kim; Deok-Rae Kim; Se-Hoon Yang; Yong-Hwan Son; Sang-Kook Han, "Indoor positioning system based on carrier allocation visible light communication," *Quantum Electronics Conference & Lasers and Electro-Optics (CLEO/IQEC/PACIFIC RIM), 2011* , vol., no., pp.787,789, Aug. 28 2011-Sept. 1 2011.
- [35] Se-Hoon Yang; Deok-Rae Kim; Hyun-Seung Kim; Yong-Hwan Son; Sang-Kook Han, "Indoor positioning system based on visible light using location code," *Communications and Electronics (ICCE), 2012 Fourth International Conference on* , vol., no., pp.360,363, 1-3 Aug. 2012.
- [36] Se-Hoon Yang; Eun-Mi Jeong; Deok-Rae Kim; Hyun-Seung Kim; Yong-Hwan Son; Sang-Kook Han, "Three-dimensional localization based on visible light optical wireless communication," *Ubiquitous and Future Networks (ICUFN), 2013 Fifth International Conference on* , vol., no., pp.468,469, 2-5 July 2013.
- [37] Yang, S.-H.; Jeong, E.-M.; Kim, D.-R.; Kim, H.-S.; Son, Y.-H.; Han, S.-K., "Indoor three-dimensional location estimation based on LED visible light communication," *Electronics Letters* , vol.49, no.1, pp.54,56, January 3 2013.
- [38] Grubor, J.; Randel, S.; Langer, K.-D.; Walewski, J., "Bandwidth-efficient indoor optical wireless communications with white light-emitting diodes," *Communication Systems, Networks and Digital Signal Processing, 2008. CNSDSP 2008. 6th International Symposium on* , vol., no., pp.165,169, 25-25 July 2008.
- [39] Vucic, J.; Kottke, C.; Nerreter, S.; Habel, K.; Buttner, A.; Langer, K.-D.; Walewski, J., "125 Mbit/s over 5 m wireless distance by use of OOK-Modulated phosphorescent white

- LEDs," *Optical Communication, 2009. ECOC '09. 35th European Conference on* , vol., no., pp.1,2, 20-24 Sept. 2009.
- [40] Vučić, J.; Kottke, C.; Nerreter, S.; Buttner, A.; Langer, K.-D.; Walewski, J., "White Light Wireless Transmission at 200 + Mb/s Net Data Rate by Use of Discrete-Multitone Modulation," *Photonics Technology Letters, IEEE* , vol.21, no.20, pp.1511,1513, Oct.15, 2009.
- [41] Vučić, J.; Kottke, C.; Nerreter, S.; Habel, K.; Buttner, A.; Langer, K.-D.; Walewski, J.W., "230 Mbit/s via a wireless visible-light link based on OOK modulation of phosphorescent white LEDs," *Optical Fiber Communication (OFC), collocated National Fiber Optic Engineers Conference, 2010 Conference on (OFC/NFOEC)* , vol., no., pp.1,3, 21-25 March 2010.
- [42] Vucic, J.; Kottke, C.; Nerreter, S.; Langer, K.-D.; Walewski, J.W., "513 Mbit/s Visible Light Communications Link Based on DMT-Modulation of a White LED," *Lightwave Technology, Journal of* , vol.28, no.24, pp.3512,3518, Dec.15, 2010.
- [43] Vucic, J.; Kottke, C.; Habel, K.; Langer, K.-D., "803 Mbit/s visible light WDM link based on DMT modulation of a single RGB LED luminary," *Optical Fiber Communication Conference and Exposition (OFC/NFOEC), 2011 and the National Fiber Optic Engineers Conference* , vol., no., pp.1,3, 6-10 March 2011.
- [44] Kottke, C.; Hilt, J.; Habel, K.; Vucic, J.; Langer, K.-D., "1.25 Gbit/s visible light WDM link based on DMT modulation of a single RGB LED luminary," *Optical Communications (ECOC), 2012 38th European Conference and Exhibition on* , vol., no., pp.1,3, 16-20 Sept. 2012.
- [45] Hao Le Minh; O'Brien, D.; Faulkner, G.; Lubin Zeng; Kyungwoo Lee; Daekwang Jung; Yunje Oh, "High-Speed Visible Light Communications Using Multiple-Resonant Equalization," *Photonics Technology Letters, IEEE* , vol.20, no.14, pp.1243,1245, July15, 2008.
- [46] Hoa Le-Minh; O'brien, D.; Faulkner, G.; Lubin Zeng; Kyungwoo Lee; Daekwang Jung; Yunje Oh; Eun Tae Won, "100-Mb/s NRZ Visible Light Communications Using a Postequalized White LED," *Photonics Technology Letters, IEEE* , vol.21, no.15, pp.1063,1065, Aug.1, 2009.
- [47] Azhar, A.H.; Tuan-Anh Tran; O'brien, D., "Demonstration of high-speed data transmission using MIMO-OFDM visible light communications," *GLOBECOM Workshops (GC Wkshps), 2010 IEEE* , vol., no., pp.1052,1056, 6-10 Dec. 2010
- [48] Azhar, A.H.; Tran, T.; O'Brien, D., "A Gigabit/s Indoor Wireless Transmission Using MIMO-OFDM Visible-Light Communications," *Photonics Technology Letters, IEEE* , vol.25, no.2, pp.171,174, Jan.15, 2013.
- [49] Elgala, H.; Mesleh, R.; Haas, H.; Pricope, B., "OFDM Visible Light Wireless Communication Based on White LEDs," *Vehicular Technology Conference, 2007. VTC2007-Spring. IEEE 65th* , vol., no., pp.2185,2189, 22-25 April 2007.

- [50] Elgala, H.; Mesleh, R.; Haas, H., "Indoor broadcasting via white LEDs and OFDM," *Consumer Electronics, IEEE Transactions on* , vol.55, no.3, pp.1127,1134, August 2009.
- [51] Mesleh, R.; Elgala, H.; Haas, H., "On the performance of coded optical spatial modulation," *Personal Indoor and Mobile Radio Communications (PIMRC), 2010 IEEE 21st International Symposium on* , vol., no., pp.820,824, 26-30 Sept. 2010
- [52] Mesleh, R.; Mehmood, R.; Elgala, H.; Haas, H., "Indoor MIMO Optical Wireless Communication Using Spatial Modulation," *Communications (ICC), 2010 IEEE International Conference on* , vol., no., pp.1,5, 23-27 May 2010.
- [53] Mesleh, R.; Elgala, H.; Haas, H., "Optical Spatial Modulation," *Optical Communications and Networking, IEEE/OSA Journal of* , vol.3, no.3, pp.234,244, March 2011.
- [54] Le Minh, H.; Ghassemlooy, Z.; Burton, A; Haigh, P.A, "Equalization for organic light emitting diodes in visible light communications," *GLOBECOM Workshops (GC Wkshps), 2011 IEEE* , vol., no., pp.828,832, 5-9 Dec. 2011.
- [55] Haigh, P.A; Ghassemlooy, Z.; Papakonstantinou, I, "1.4-Mb/s White Organic LED Transmission System Using Discrete Multitone Modulation," *Photonics Technology Letters, IEEE* , vol.25, no.6, pp.615,618, March15, 2013.
- [56] Haigh, P.A; Ghassemlooy, Z.; Papakonstantinou, I; Hoa Le Minh, "2.7 Mb/s With a 93-kHz White Organic Light Emitting Diode and Real Time ANN Equalizer," *Photonics Technology Letters, IEEE* , vol.25, no.17, pp.1687,1690, Sept.1, 2013.
- [57] Haigh, P.A; Ghassemlooy, Z.; Papakonstantinou, I; Tedde, F.; Tedde, S.F.; Hayden, O.; Rajbhandari, S., "A MIMO-ANN system for increasing data rates in organic visible light communications systems," *Communications (ICC), 2013 IEEE International Conference on* , vol., no., pp.5322,5327, 9-13 June 2013.
- [58] Little, T. D C; Dib, P.; Shah, K.; Barraford, N.; Gallagher, B., "Using LED Lighting for Ubiquitous Indoor Wireless Networking," *Networking and Communications, 2008. WIMOB '08. IEEE International Conference on Wireless and Mobile Computing* , vol., no., pp.373,378, 12-14 Oct. 2008.
- [59] Vegni, AM.; Little, T. D C, "Handover in VLC systems with cooperating mobile devices," *Computing, Networking and Communications (ICNC), 2012 International Conference on* , vol., no., pp.126,130, Jan. 30 2012-Feb. 2 2012
- [60] Wu, Z.; Little, T., "Network solutions for the line-of-sight problem of new multi-user indoor free-space optical system," *Communications, IET* , vol.6, no.5, pp.525,531, March 27 2012.
- [61] Khalid, A M.; Cossu, G.; Corsini, R.; Choudhury, P.; Ciaramella, E., "1-Gb/s Transmission Over a Phosphorescent White LED by Using Rate-Adaptive Discrete Multitone Modulation," *Photonics Journal, IEEE* , vol.4, no.5, pp.1465,1473, Oct. 2012.

- [62] Cossu, G.; Khalid, AM.; Choudhury, P.; Corsini, R.; Ciaramella, E., "2.1 Gbit/s visible optical wireless transmission," *Optical Communications (ECOC), 2012 38th European Conference and Exhibition on* , vol., no., pp.1,3, 16-20 Sept. 2012.
- [63] Fang-Ming Wu; Chun-Ting Lin; Chia-Chien Wei; Cheng-Wei Chen; Hou-Tzu Huang; Chun-Hung Ho, "1.1-Gb/s White-LED-Based Visible Light Communication Employing Carrier-Less Amplitude and Phase Modulation," *Photonics Technology Letters, IEEE* , vol.24, no.19, pp.1730,1732, Oct.1, 2012.
- [64] Kubo, T.; Yamada, T.; Suzuki, K.; Yoshimoto, N.; Umeki, T.; Asobe, M.; Kolev, D. R.; Matsumoto, M., "1.25-Gb/s 2-m indoor visible light transmission employing wavelength conversion with quasi phase matching device," *Optical Wireless Communications (IWOW), 2012 International Workshop on* , vol., no., pp.1,3, 22-22 Oct. 2012.
- [65] Fang-Ming Wu; Chun-Ting Lin; Chia-Chien Wei; Cheng-Wei Chen; Zhen-Yu Chen; Hou-Tzu Huang, "3.22-Gb/s WDM visible light communication of a single RGB LED employing carrier-less amplitude and phase modulation," *Optical Fiber Communication Conference and Exposition and the National Fiber Optic Engineers Conference (OFC/NFOEC), 2013* , vol., no., pp.1,3, 17-21 March 2013.
- [66] World Health Organization. (May 2014). Fact Sheet 310 - The top 10 causes of death.
- [67] World Health Organization. (March 2013). Fact Sheet 358 Road Traffic Injuries.
- [68] Papadimitratos, P.; La Fortelle, A.; Evensen, K.; Brignolo, R.; Cosenza, S., "Vehicular communication systems: Enabling technologies, applications, and future outlook on intelligent transportation," *Communications Magazine, IEEE* , vol.47, no.11, pp.84,95, November 2009.
- [69] U.S. Department of Transportation Research and Innovative Technology Administration, Report: Frequency of Target Crashes for IntelliDrive Safety Systems, October 2010.
- [70] Yousefi, S.; Altman, E.; El-Azouzi, R.; Fathy, M., "Analytical Model for Connectivity in Vehicular Ad Hoc Networks", *IEEE Transactions on Vehicular Technology*, vol. 57, pp. 3341-3356, 2008.
- [71] Fujii, H.; Hayashi, O.; Nakagata, N., "Experimental research on inter-vehicle communication using infrared rays," *Intelligent Vehicles Symposium, 1996., Proceedings of the 1996 IEEE* , vol., no., pp.266,271, 19-20 Sep 1996.
- [72] Sawant, H.; Jindong Tan; Qingyan Yang; Qizhi Wang, "Using Bluetooth and sensor networks for intelligent transportation systems", *Intelligent Transportation Systems, 2004. Proceedings. The 7th International IEEE Conference on* , vol., no., pp.767,772, 3-6 Oct. 2004.
- [73] Lequerica, I; Ruiz, P.M.; Cabrera, V., "Improvement of vehicular communications by using 3G capabilities to disseminate control information," *Network, IEEE* , vol.24, no.1, pp.32,38, Jan.-Feb. 2010.

-
- [74] Qingwen Zhao; Yanmin Zhu; Chao Chen; Hongzi Zhu; Bo Li, "When 3G Meets VANET: 3G-Assisted Data Delivery in VANETs," *Sensors Journal, IEEE* , vol.13, no.10, pp.3575,3584, Oct. 2013.
- [75] Kato, S.; Hiltunen, M.; Joshi, K.; Schlichting, R., "Enabling vehicular safety applications over LTE networks," *Connected Vehicles and Expo (ICCVE), 2013 International Conference on* , vol., no., pp.747,752, 2-6 Dec. 2013.
- [76] Fernandes, P.; Nunes, U., "Platooning with DSRC-based IVC-enabled autonomous vehicles: Adding infrared communications for IVC reliability improvement," *Intelligent Vehicles Symposium (IV), 2012 IEEE* , vol., no., pp.517,522, 3-7 June 2012.
- [77] IEEE Standard for Information technology-- Local and metropolitan area networks-- Specific requirements-- Part 11: Wireless LAN Medium Access Control (MAC) and Physical Layer (PHY) Specifications Amendment 6: Wireless Access in Vehicular Environments," *IEEE Std 802.11p-2010*, vol., no., pp.1,51, July 15 2010.
- [78] Jiang, D.; Taliwal, V.; Meier, A.; Holfelder, W.; Herrtwich, R., "Design of 5.9 ghz dsrc-based vehicular safety communication," *Wireless Communications, IEEE* , vol.13, no.5, pp.36,43, October 2006.
- [79] Tonguz, O.K.; Wisitpongphan, N.; Parikh, J.S.; Fan Bai; Mudalige, P.; Sadekar, V.K., "On the Broadcast Storm Problem in Ad hoc Wireless Networks," *Broadband Communications, Networks and Systems, 2006. BROADNETS 2006. 3rd International Conference on* , vol., no., pp.1,11, 1-5 Oct. 2006.
- [80] Subramanian, S.; Werner, M.; Liu, S.; Jose, J.; Lupoiaie, R.; Wu, X., "Congestion control for vehicular safety: Synchronous and asynchronous mac algorithms". In *Proceedings of the ninth ACM international workshop on Vehicular Inter-NETworking (VANET)*, pp. 63-72, June 2012.
- [81] Nguyen, T.V.; Baccelli, F.; Kai Zhu; Subramanian, S.; Wu, X., "A performance analysis of CSMA based broadcast protocol in VANETs," *INFOCOM, 2013 Proceedings IEEE* , vol., no., pp.2805,2813, 14-19 April 2013.
- [82] Wang Z., and Hassan, M., "How much of DSRC is available for nonsafety use?" In *Proceedings of the fifth ACM international workshop on Vehicular Inter-NETworking, VANET '08*, 2008.
- [83] Hartenstein, H., and Laberteaux, K.P., "A tutorial survey on vehicular adhoc networks". *IEEE Communications Magazine*, Jun. 2008.
- [84] Torrent-Moreno, M.; Jiang, D.;Hartenstein, H., "Broadcast reception rates and effects of priority access in 802.11-based vehicular ad-hoc networks". In *ACM VANET*, pages 10–18, 2004.
- [85] U.S. Department of Transportation. Vehicle Safety Communications Project Task 3 Final Report. <http://www.ntis.gov/>.

- [86] Bilstrup, K.; Uhlemann, E.; Strm, E.; Bilstrup, U., "On the ability of the 802.11p MAC method and STDMA to support real-time vehicle-to-vehicle communication," *EURASIP Journal on Wireless Communications and Networking* 2009, 2009:902414.
- [87] Eichler, S., Performance evaluation of the IEEE 802.11p WAVE communication standard. In *IEEE 66th Vehicular Technology Conference (VTC)*, pages 2199–2203, Oct. 2007.
- [88] Yuan Yao; Lei Rao; Xue Liu, "Performance and Reliability Analysis of IEEE 802.11p Safety Communication in a Highway Environment," *Vehicular Technology, IEEE Transactions on* , vol.62, no.9, pp.4198,4212, Nov. 2013.
- [89] Luo, T.; Wen, Z.; Li, J.; Chen, H.-H., "Saturation throughput analysis of WAVE networks in Doppler spread scenarios," *Communications, IET* , vol.4, no.7, pp.817,825, April 30 2010.
- [90] Lin Cheng; Henty, B.E.; Stancil, D.D.; Fan Bai; Mudalige, P., "Mobile Vehicle-to-Vehicle Narrow-Band Channel Measurement and Characterization of the 5.9 GHz Dedicated Short Range Communication (DSRC) Frequency Band," *Selected Areas in Communications, IEEE Journal on* , vol.25, no.8, pp.1501,1516, Oct. 2007.
- [91] Karedal, J.; Tufvesson, F.; Abbas, T.; Klemp, O.; Paier, A.; Bernado, L.; Molisch, A.F., "Radio Channel Measurements at Street Intersections for Vehicle-to-Vehicle Safety Applications," *Vehicular Technology Conference (VTC 2010-Spring), 2010 IEEE 71st* , vol., no., pp.1,5, 16-19 May 2010.
- [92] Bohm, A.; Lidström, K.; Jonsson, M.; Larsson, T., "Evaluating CALM M5-based vehicle-to-vehicle communication in various road settings through field trials," *Local Computer Networks (LCN), 2010 IEEE 35th Conference on* , vol., no., pp.613,620, 10-14 Oct. 2010.
- [93] Karlsson, K.; Bergenhem, C.; Hedin, E., "Field Measurements of IEEE 802.11p Communication in NLOS Environments for a Platooning Application," *Vehicular Technology Conference (VTC Fall), 2012 IEEE* , vol., no., pp.1,5, 3-6 Sept. 2012.
- [94] http://en.wikipedia.org/wiki/Automotive_lighting, <http://www.hidled.com>
- [95] ECN, "EN 12368: Traffic Control Equipment - Signal Heads," ed:European Committee for Standardization, April 2006.
- [96] Kitano, S.; Haruyama, S.; Nakagawa, M., "LED road illumination communications system," *Vehicular Technology Conference, 2003. VTC 2003-Fall. 2003 IEEE 58th* , vol.5, no., pp.3346,3350 Vol.5, 6-9 Oct. 2003.
- [97] Kumar, N., "Smart and intelligent energy efficient public illumination system with ubiquitous communication for smart city," *Smart Structures and Systems (ICSSS), 2013 IEEE International Conference on* , vol., no., pp.152,157, 28-29 March 2013.
- [98] http://www.weiku.com/products/8508482/LED_Warning_Banner.html, <http://www.alibaba.com/>, <http://www.adwaasign.com/rtd.php>

-
- [99] Ergen, M., "Critical penetration for vehicular networks," *Communications Letters, IEEE* , vol.14, no.5, pp.414,416, May 2010.
- [100] Abualhoul, M.Y.; Marouf, M.; Shagdar, O.; Nashashibi, F., "Platooning control using visible light communications: A feasibility study," *Intelligent Transportation Systems - (ITSC), 2013 16th International IEEE Conference on* , vol., no., pp.1535,1540, 6-9 Oct. 2013.
- [101] Pang, G.K.H., Chan, C.H., Liu, H., Kwan, T., "Dual use of LEDs : Signaling and communications in ITS", *Proceedings of fifth World Congress on Intelligent Transport Systems*, Paper 3035, Seoul, Korea, 12-16 Oct.1998.
- [102] Pang, G.K.H., Liu, H., Chan, C.H., Kwan, T., "Vehicle Location and Navigation Systems based on LEDs", *Proceedings of fifth World Congress on Intelligent Transport Systems*, Paper 3036, Seoul, Korea, 12-16 Oct. 1998.
- [103] Pang, G.K.H., Kwan, T.O., Chi-Ho Chan, Liu, H.S., "LED Traffic Light as Communication Device," *Proceedings of IEEE International Conference on Intelligent Transport Systems*, Tokyo, Japan, pp. 788-793, Oct. 5-8 1999.
- [104] Hugh Sing Liu; Pang, G., "Positioning beacon system using digital camera and LEDs," *Vehicular Technology, IEEE Transactions on* , vol.52, no.2, pp.406,419, March 2003.
- [105] Akanegawa, M.; Tanaka, Y.; Nakagawa, M., "Basic study on traffic information system using LED traffic lights," *Intelligent Transportation Systems, IEEE Transactions on* , vol.2, no.4, pp.197,203, Dec 2001.
- [106] Binti Che Wook, H.; Komine, T.; Haruyama, S.; Nakagawa, M., "Visible light communication with LED-based traffic lights using 2-dimensional image sensor," *Consumer Communications and Networking Conference, 2006. CCNC 2006. 3rd IEEE* , vol.1, no., pp.243,247, 8-10 Jan. 2006.
- [107] Tsubasa Saito, Shinichiro Haruyama, Masao Nakagawa: Inter-vehicle communication and ranging method using LED rear lights. *Communication Systems and Networks 2006: 278-283.*
- [108] Saito, T.; Haruyama, S.; Nakagawa, M., "A New Tracking Method using Image Sensor and Photo Diode for Visible Light Road-to-Vehicle Communication," *Advanced Communication Technology, 2008. ICACT 2008. 10th International Conference on* , vol.1, no., pp.673,678, 17-20 Feb. 2008.
- [109] Wada, M.; Yendo, T.; Fujii, T.; Tanimoto, M., "Road-to-vehicle communication using LED traffic light," *Intelligent Vehicles Symposium, 2005. Proceedings. IEEE* , vol., no., pp.601,606, 6-8 June 2005.
- [110] Okada, H.; Masuda, K.; Yamazato, T.; Katayama, M., "Successive Interference Cancellation for Hierarchical Parallel Optical Wireless Communication Systems," *Communications, 2005 Asia-Pacific Conference on* , vol., no., pp.788,792, 5-5 Oct. 2005.

- [111] Arai, S.; Mase, S.; Yamazato, T.; Endo, T.; Fujii, T.; Tanimoto, M.; Kidono, K.; Kimura, Y.; Ninomiya, Y., "Experimental on Hierarchical Transmission Scheme for Visible Light Communication using LED Traffic Light and High-Speed Camera," *Vehicular Technology Conference, 2007. VTC-2007 Fall. 2007 IEEE 66th* , vol., no., pp.2174,2178, Sept. 30 2007-Oct. 3 2007.
- [112] Hara, T.; Iwasaki, S.; Yendo, T.; Fujii, T.; Tanimoto, M., "A New Receiving System of Visible Light Communication for ITS," *Intelligent Vehicles Symposium, 2007 IEEE* , vol., no., pp.474,479, 13-15 June 2007.
- [113] Okada, S.; Yendo, T.; Yamazato, T.; Fujii, T.; Tanimoto, M.; Kimura, Y., "On-vehicle receiver for distant visible light road-to-vehicle communication," *Intelligent Vehicles Symposium, 2009 IEEE* , vol., no., pp.1033,1038, 3-5 June 2009.
- [114] Nagura, T.; Yamazato, T.; Katayama, M.; Yendo, T.; Fujii, T.; Okada, H., "Improved Decoding Methods of Visible Light Communication System for ITS Using LED Array and High-Speed Camera," *Vehicular Technology Conference (VTC 2010-Spring), 2010 IEEE 71st* , vol., no., pp.1,5, 16-19 May 2010.
- [115] Nagura, T.; Yamazato, T.; Katayama, M.; Yendo, T.; Fujii, T.; Okada, H., "Tracking an LED array transmitter for visible light communications in the driving situation," *Wireless Communication Systems (ISWCS), 2010 7th International Symposium on* , vol., no., pp.765,769, 19-22 Sept. 2010.
- [116] Takai, I; Ito, S.; Yasutomi, K.; Kagawa, K.; Andoh, M.; Kawahito, S., "LED and CMOS Image Sensor Based Optical Wireless Communication System for Automotive Applications," *Photonics Journal, IEEE* , vol.5, no.5, pp.6801418,6801418, Oct. 2013.
- [117] Yamazato, T.; Takai, I; Okada, H.; Fujii, T.; Yendo, T.; Arai, S.; Andoh, M.; Harada, T.; Yasutomi, K.; Kagawa, K.; Kawahito, S., "Image-sensor-based visible light communication for automotive applications," *Communications Magazine, IEEE* , vol.52, no.7, pp.88,97, July 2014.
- [118] Kumar, N.; Lourenco, N.; Spiez, M.; Aguiar, RL., "Visible Light Communication Systems Conception and VIDAS". IETE Tech Review, vol. 25, no. 6, 2008.
- [119] Kumar, N.; Alves, L.N.; Aguiar, Rui L., "Visible Light Communication for Advanced Driver Assistant Systems," 7th International Conference on Telecommunication (ConfTele'09), Feb. 2009.
- [120] Terra, D.; Kumar, N.; Lourenco, N.; Alves, L.N.; Aguiar, Rui L., "Design, development and performance analysis of DSSS-based transceiver for VLC," *EUROCON - International Conference on Computer as a Tool (EUROCON), 2011 IEEE* , vol., no., pp.1,4, 27-29 April 2011, doi: 10.1109/EUROCON.2011.5929371.
- [121] Kumar, N.; Terra, D.; Lourenco, N.; Alves, L.N.; Aguiar, Rui L., "Visible light communication for intelligent transportation in road safety applications," *Wireless Communications and Mobile Computing Conference (IWCMC), 2011 7th International* , vol., no., pp.1513,1518, 4-8 July 2011, doi: 10.1109/IWCMC.2011.5982762.

-
- [122] Kumar, N.; Lourenco, N.; Terra, D.; Alves, L.N.; Aguiar, Rui L., "Visible light communications in intelligent transportation systems," *Intelligent Vehicles Symposium (IV), 2012 IEEE* , vol., no., pp.748,753, 3-7 June 2012.
- [123] Ganick, A.; Figueroa, M.; Lobo, J.; Schimitsch, P.; Rich, T.; Little, T.D.C., "Vehicular Networking Using Optical Transceivers," Poster and Demonstration Program, *MobiSys 2010*, San Francisco, CA, June 15, 2010.
- [124] Agarwal, A; Little, T. D C, "Role of directional wireless communication in vehicular networks," *Intelligent Vehicles Symposium (IV), 2010 IEEE* , vol., no., pp.688,693, 21-24 June 2010.
- [125] Little, T. D C; Agarwal, A; Chau, J.; Figueroa, M.; Ganick, A; Lobo, J.; Rich, T.; Schimitsch, P., "Directional communication system for short-range vehicular communications," *Vehicular Networking Conference (VNC), 2010 IEEE* , vol., no., pp.231,238, 13-15 Dec. 2010.
- [126] Kaiyun Cui; Gang Chen; Zhengyuan Xu; Roberts, R.D., "Experimental characterization of traffic light to vehicle VLC link performance," *GLOBECOM Workshops (GC Wkshps), 2011 IEEE* , vol., no., pp.808-812, 5-9 Dec. 2011.
- [127] Shun-Hsiang Yu; Shih, O.; Hsin-Mu Tsai; Roberts, R., "Smart automotive lighting for vehicle safety," *Communications Magazine, IEEE* , vol.51, no.12, pp.50,59, December 2013.
- [128] Roberts, R.; Gopalakrishnan, P.; Rathi, S., "Visible light positioning: Automotive use case," *Vehicular Networking Conference (VNC), 2010 IEEE*, vol., no., pp.309-314, 13-15 Dec. 2010.
- [129] Roberts, R.D., "Undersampled frequency shift ON-OFF keying (UFSOOK) for camera communications (CamCom)," *Wireless and Optical Communication Conference (WOCC), 2013 22nd* , vol., no., pp.645-648, 16-18 May 2013.
- [130] Roberts, Richard D., "A MIMO protocol for camera communications (CamCom) using undersampled frequency shift ON-OFF keying (UFSOOK)," *Globecom Workshops (GC Wkshps), 2013 IEEE* , vol., no., pp.1052,1057, 9-13 Dec. 2013.
- [131] IEEE Standard for Local and Metropolitan Area Networks--Part 15.7: Short-Range Wireless Optical Communication Using Visible Light," *IEEE Std 802.15.7-2011* , vol., no., pp.1,309, Sept. 6 2011, doi: 10.1109/IEEESTD.2011.6016195
- [132] Sarbazi, E.; Uysal, M., "PHY layer performance evaluation of the IEEE 802.15.7 visible light communication standard," *Optical Wireless Communications (IWOW), 2013 2nd International Workshop on* , vol., no., pp.35,39, 21-21 Oct. 2013, doi: 10.1109/IWOW.2013.6777772.
- [133] Musa, A; Dani Baba, M.; Mansor, H.M.AH., "Performance analysis of the IEEE 802.15.7 CSMA/CA algorithm based on Discrete Time Markov Chain (DTMC)," *Communications (MICC), 2013 IEEE Malaysia International Conference on* , vol., no., pp.385,389, 26-28 Nov. 2013, doi: 10.1109/MICC.2013.6805859.

- [134] Roberts, R.D.; Rajagopal, S.; Sang-Kyu Lim, "IEEE 802.15.7 physical layer summary," GLOBECOM Workshops (GC Wkshps), 2011 IEEE , vol., no., pp.772,776, 5-9 Dec. 2011, doi: 10.1109/GLOCOMW.2011.6162558.
- [135] Rajagopal, S.; Roberts, R.D.; Sang-Kyu Lim, "IEEE 802.15.7 visible light communication: modulation schemes and dimming support," Communications Magazine, IEEE , vol.50, no.3, pp.72,82, March 2012, doi: 10.1109/MCOM.2012.6163585.
- [136] Kahn, J.M.; Barry, J.R., "Wireless infrared communications," *Proceedings of the IEEE* , vol.85, no.2, pp.265,298, Feb 1997.
- [137] Jong-Ho Yoo; Rimhwan Lee; Jun-Kyu Oh; Hyun-Wook Seo; Ju-Young Kim; Hyeon-Cheol Kim; Sung-Yoon Jung, "Demonstration of vehicular visible light communication based on LED headlamp," *Ubiquitous and Future Networks (ICUFN), 2013 5th Int. Conf. on* ,pp.465,467,July 2013.
- [138] Lavric, A.; Popa, V.; Finis, I., "The design of a street lighting monitoring and control system," *Electrical and Power Engineering (EPE), 2012 International Conference and Exposition on*, vol., no., pp.314,317, 25-27 Oct. 2012.
- [139] Lavric, A; Popa, V., "Hardware design of a street lighting control system with vehicle and malfunction detection," *Advanced Topics in Electrical Engineering (ATEE), 2013 8th International Symposium on*, vol., no., pp.1,4, 23-25 May 2013.
- [140] Hecht, M.; Guida, A., "Delay modulation," *Proceedings of the IEEE* , vol.57, no.7, pp.1314,1316, July 1969.
- [141] **Cailean, A-M.**; Cagneau, B.; Chassagne, L.; Dimian, M.; Popa, V., "Miller code usage in Visible Light Communications under the PHY I layer of the IEEE 802.15.7 standard," *Communications (COMM), 2014 10th International Conference on* , vol., no., pp.1,4, 29-31 May 2014, doi: 10.1109/ICComm.2014.6866699.
- [142] Fisher, R., Harding, G.F.A., Erba, G., Barkley, G.L., and Wilkins, A.J. (2005) Photic and pattern-induced seizures: a review for the Epilepsy Foundation of America Working Group. *Epilepsia*, 46(9),1426-41.
- [143] Burns, S.A., Elsner, A.E., and Kreitz, M.R. (1992) "Analysis of nonlinearities in the flicker ERG". *Optom Vis Sci.*,69(2), 95-105.
- [144] Wilkins, A; Veitch, J.; Lehman, B., "LED lighting flicker and potential health concerns: IEEE standard PAR1789 update," Energy Conversion Congress and Exposition (ECCE), 2010 IEEE , vol., no., pp.171,178, 12-16 Sept. 2010.
- [145] Berman, S. M., Greenhouse, D. S., Bailey, I. L., Clear, R. and Raasch, T. W., "Human electroretinogram responses to video displays, fluorescent lighting and other high frequency sources," *Optometry and Vision Science* 68:645–662, 1991.
- [146] <http://grouper.ieee.org/groups/1789/>
- [147] M. Rea, Illumination Engineering Society of North America (IESNA) Lighting Handbook, 9th ed., July 2000.

- [148] The mobile communications handbook, 2nd edition, CRC Press LCC, 1999.
- [149] **Cailean, A.-M.**; Cagneau, B.; Chassagne, L.; Popa, V.; Dimian, M., "Evaluation of the noise effects on Visible Light Communications using Manchester and Miller coding," *Development and Application Systems (DAS), 2014 International Conference on* , vol., no., pp.85,89, 15-17 May 2014, doi: 10.1109/DAAS.2014.6842433.
- [150] www.dot.gov
- [151] Moreira, A. J. C.; Valadas, R. T.; de Oliveira Duarte, A. M., "Optical interference produced by artificial light," in *Wireless Networks*, 05-1997, Volume 3, Issue 2, pp 131-140.
- [152] Butterworth, S., "On the Theory of Filter Amplifiers," *Wireless Engineer*, vol. 7, pp. 536,541, 1930.
- [153] Mov'eo: French Automotive Cluster <http://www.pole-moveo.org/EN/index.php>
- [154] **Cailean, A.-M.**; Cagneau, B.; Chassagne, L.; Topsis, S.; Alayli, Y.; Dimian, M., "Design and implementation of a visible light communications system for vehicle applications," *Telecommunications Forum (TELFOR), 2013 21st* , vol., no., pp.349,352, 26-28 Nov. 2013 doi: 10.1109/TELFOR.2013.6716241.
- [155] Danakis, C.; Afgani, M.; Povey, G.; Underwood, I.; Haas, H., "Using a CMOS camera sensor for visible light communication," *Globecom Workshops (GC Wkshps), 2012 IEEE* , vol., no., pp.1244,1248, 3-7 Dec. 2012.
- [156] Ji, P.; Tsai, H.-M.; Wang, C.; Liu, F.-Q., "Vehicular Visible Light Communications with LED Taillight and Rolling Shutter Camera," IEEE Vehicular Technology Conference 2014 Spring, May 2014.
- [157] Ning, X.; Winston, R.; O'Gallagher, J., "Dielectric totally internally reflecting concentrators," *Appl. Optics*, vol. 26, no. 2, pp. 300–305, Jan. 1987.
- [158] Cheng-Chun Chang; Yuan-Jun Su; Kurokawa, U.; Byung Il Choi, "Interference Rejection Using Filter-Based Sensor Array in VLC Systems," *Sensors Journal, IEEE* , vol.12, no.5, pp.1025,1032, May 2012.
- [159] Lee, I.E.; Sim, M.L.; Kung, F.W.L., "Performance enhancement of outdoor visible-light communication system using selective combining receiver," *Optoelectronics, IET* , vol.3, no.1, pp.30,39, February 2009.
- [160] **Cailean, A.**; Cagneau, B.; Chassagne, L.; Topsis, S.; Alayli, Y.; Blossville, J-M, "Visible light communications: Application to cooperation between vehicles and road infrastructures," *Intelligent Vehicles Symposium (IV), 2012 IEEE* , vol., no., pp.1055,1059, 3-7 June 2012, doi: 10.1109/IVS.2012.6232225.
- [161] **Cailean, A.**; Cagneau, B.; Chassagne, L.; Topsis, S.; Alayli, Y.; Dimian, M., "A robust system for visible light communication," *Wireless Vehicular Communications (WiVeC), 2013 IEEE 5th International Symposium on* , vol., no., pp.1,5, 2-3 June 2013 doi: 10.1109/wivec.2013.6698223.
- [162] **Cailean, A.-M.**; Cagneau, B.; Chassagne, L.; Topsis, S.; Alayli, Y.; Dimian, M., "Visible light communications cooperative architecture for the intelligent transportation system,"

Communications and Vehicular Technology in the Benelux (SCVT), 2013 IEEE 20th Symposium on, vol., no., pp.1,5, 21-21 Nov. 2013 doi: 10.1109/SCVT.2013.6736001.

Publications:

- [1] **Cailean, A.**; Cagneau, B.; Chassagne, L.; Topsu, S.; Alayli, Y.; Blossenville, J-M, "Visible light communications: Application to cooperation between vehicles and road infrastructures," *Intelligent Vehicles Symposium (IV), 2012 IEEE* , vol., no., pp.1055,1059, Madrid – Spain, 3-7 June 2012, doi: 10.1109/IVS.2012.6232225, (ISI Proceedings).
- [2] **Cailean, A.**; Cagneau, B.; Chassagne, L.; Topsu, S.; Alayli, Y.; Dimian, M., "A robust system for visible light communication," *Wireless Vehicular Communications (WiVeC), 2013 IEEE 5th International Symposium on* , vol., no., pp.1,5, Dresden – Germany, 2-3 June 2013, doi: 10.1109/wivec.2013.6698223, (ISI Proceedings).
- [3] **Cailean, A.-M.**; Cagneau, B.; Chassagne, L.; Topsu, S.; Alayli, Y.; Dimian, M., "Visible light communications cooperative architecture for the intelligent transportation system," *Communications and Vehicular Technology in the Benelux (SCVT), 2013 IEEE 20th Symposium on* , vol., no., pp.1,5, Namur – Belgium, 21-21 Nov. 2013 doi: 10.1109/SCVT.2013.6736001, (IEEE Explore).
- [4] **Cailean, A.-M.**; Cagneau, B.; Chassagne, L.; Topsu, S.; Alayli, Y.; Dimian, M., "Design and implementation of a visible light communications system for vehicle applications," *Telecommunications Forum (TELFOR), 2013 21st* , vol., no., pp.349,352, Belgrade – Serbia, 26-28 Nov. 2013 doi: 10.1109/TELFOR.2013.6716241, (IEEE Explore).
- [5] **Cailean, A.-M.**; Cagneau, B.; Chassagne, L.; Dimian, M.; Popa, V., "Miller code usage in Visible Light Communications under the PHY I layer of the IEEE 802.15.7 standard," *Communications (COMM), 2014 10th International Conference on* , vol., no., pp.1,4, Bucharest – Romania, 29-31 May 2014, doi: 10.1109/ICComm.2014.6866699, (ISI Proceedings).
- [6] **Cailean, A.-M.**; Cagneau, B.; Chassagne, L.; Popa, V.; Dimian, M., "Evaluation of the noise effects on Visible Light Communications using Manchester and Miller coding," *Development and Application Systems (DAS), 2014 International Conference on* , vol., no., pp.85,89, Suceava – Romania, 15-17 May 2014, doi: 10.1109/DAAS.2014.6842433, (IEEE Explore).
- [7] **Cailean, A.-M.**; Cagneau, B.; Chassagne, L.; Popa, V.; Dimian, M., "Design and performance evaluation of a DSP visible light communication receiver," *Communications and Vehicular Technology in the Benelux (SCVT), 2014 IEEE 21th Symposium on* , vol., no., pp.1,5, Delft – The Netherlands, 10 Nov. 2014, (IEEE Explore).
- [8] **Cailean, A.-M.**; Cagneau, B.; Chassagne, L.; Popa, V.; Dimian, M., "A survey on the usage of DSRC and VLC in communication-based vehicle safety applications," *Communications and Vehicular Technology in the Benelux (SCVT), 2014 IEEE 21th Symposium on* , vol., no., pp.1,5, Delft – The Netherlands, 10 Nov. 2014, (IEEE Explore).

