



HAL
open science

Dynamic Mechanical Properties of Automotive Thin Sheet Steel in Tension, Compression and Shear

M. Quik, K. Labibes, C. Albertini, T. Valentin, P. Magain

► **To cite this version:**

M. Quik, K. Labibes, C. Albertini, T. Valentin, P. Magain. Dynamic Mechanical Properties of Automotive Thin Sheet Steel in Tension, Compression and Shear. *Journal de Physique IV Proceedings*, 1997, 07 (C3), pp.C3-379-C3-384. 10.1051/jp4:1997366 . jpa-00255523

HAL Id: jpa-00255523

<https://hal.science/jpa-00255523>

Submitted on 4 Feb 2008

HAL is a multi-disciplinary open access archive for the deposit and dissemination of scientific research documents, whether they are published or not. The documents may come from teaching and research institutions in France or abroad, or from public or private research centers.

L'archive ouverte pluridisciplinaire **HAL**, est destinée au dépôt et à la diffusion de documents scientifiques de niveau recherche, publiés ou non, émanant des établissements d'enseignement et de recherche français ou étrangers, des laboratoires publics ou privés.

Dynamic Mechanical Properties of Automotive Thin Sheet Steel in Tension, Compression and Shear

M. Quik, K. Labibes, C. Albertini, T. Valentin* and P. Magain*

European Commission, Joint Research Centre, Institute for Systems, Informatics and Safety, TP.480, 21020 Ispra (Va), Italy

** R&D Cockerill Sambre Group, Domaine Universitaire du Sart-Tilman B57, 4000 Liège, Belgium*

Abstract: Thin sheet steel has been tested at different strain rates ranging (10^{-3} to 10^{+3} s $^{-1}$) under different deformation modes. The specimens were cut from thin sheet at 0 and 90 degrees with respect to the rolling direction. It was found that pre-strained specimens in tension are characterised by higher initial yielding and a strong decrease of the strain hardening. Specimens at 90 degrees show at increasing strain rate a higher yielding stress with respect to 0 degrees specimens emphasising the importance of anisotropy effects in sheet metals. Furthermore, the equivalent flow curve at relatively large strain values do not coincide at different deformation modes (shear, compression and tension).

Résumé: Une tôle mince a été testée à différentes vitesses (10^{-3} à 10^{+3} /s) et modes de déformation. Les échantillons ont été découpés à 0 et 90 degrés par rapport à la direction de laminage. Les échantillons prédéformés en traction montrent une augmentation de la contrainte d'écoulement et une diminution de l'écrouissage. Les échantillons découpés à 90 degrés montrent que la valeur de la contrainte d'écoulement est plus sensible à la vitesse de déformation par rapport à ceux découpés à 0 degré ce qui montre l'importance des effets d'anisotropie dans les tôles minces. De plus, la contrainte d'écoulement équivalente aux fortes déformations ne coïncide pas pour les différents modes de sollicitation (cisaillement, compression et traction).

1. INTRODUCTION

In this paper results of the first part of a project in co-operation between the JRC-Ispra and the steel company Cockerill Sambre R&D. The project consists of studying the mechanical properties of thin sheet steel used in the automotive industry at strain rates ranging between 10^{-3} and 10^{+3} s $^{-1}$ at different deformation modes.

Improving precision and reliability of experimental data will improve the analytical and numerical modelling of mechanical material properties at large strains and high strain rates. This will be the main aim of the project.

In the recent past we have shown for austenitic steel AISI 316 and ARMCO iron that the equivalent flow curve at high strain rate in tension and shear following Von Mises' criteria are not coincident [1] questioning the validity (especially at large strain and strain rate values) of an equivalent flow curve concept independent of the deformation mode. The verification of such a theory for automotive thin sheet metals could be of great importance since the equivalent stress strain concept is always used in computer simulations.

2 TEST PROGRAM

The material tested is normal carbon steel sheet subjected to the following tests at room temperature. Table 1 shows the different types of experiments performed.

| deformation mode | pre-straining | low strain rate Tensometer | medium strain rate Hydropneumatic | high strain rate Hopkinson Bars |
|------------------|-----------------|-------------------------------|--|------------------------------------|
| TENSION | 0% (0 degrees) | $1E-03 \text{ s}^{-1}$ | 2.5 s^{-1} and 12 s^{-1} | 1000 s^{-1} |
| | 0% (90 degrees) | $1E-03 \text{ s}^{-1}$ | 2.5 s^{-1} and 12 s^{-1} | 1000 s^{-1} |
| | 4.5% | $1E-03 \text{ s}^{-1}$ | 2.5 s^{-1} and 12 s^{-1} | 1000 s^{-1} |
| | 13.4% | $1E-03 \text{ s}^{-1}$ | 2.5 s^{-1} and 12 s^{-1} | 1000 s^{-1} |
| SHEAR | ----- | $2E-02 \text{ s}^{-1}$ | 40 s^{-1} | 1300 s^{-1} |
| COMPRESSION | ----- | ----- | ----- | 1300 s^{-1} |

Table 1: Test program

3 SPECIMEN

The first step of the experimental programme required the development of a special tension (figure 1) and shear specimen (figure 2) starting from the original thickness (1.2 mm) of thin sheet steel.

The shear specimen design was derived considering a longitudinal slice of the cylindrical specimen used for the test performed in [1] and whose stress analysis was published in [2]. In stead of welding a gluing technique was used for attaching the tension and shear specimen to the apparatus avoiding any heating of the specimen. The gauge part was cut by wire electro-erosion.

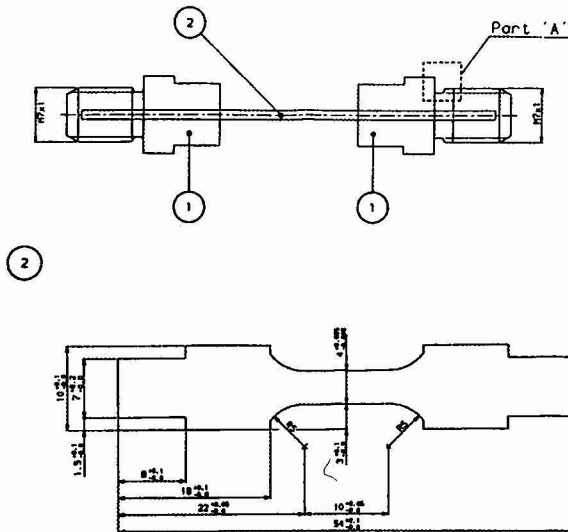

Figure 1: Tension specimen

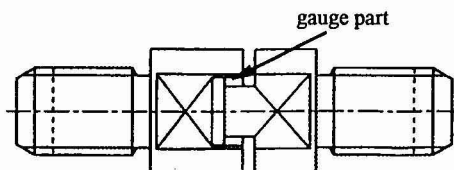

Figure 2: Shear specimen

4 TEST EQUIPMENT

4.1 High strain rate

4.1.1 Tension

In the case of thin sheet metallic specimens, dynamic testing in tension is difficult because the specimen shows a relatively large deformation. At high strain rate, the classical Hopkinson pressure bar can be used to test these specimens taking into account two important points: first the pulse should be inverted from compression to tension; second this pulse should be long enough to load the specimen throughout the deformation. In 1974 Albertini and Montagnani [3] proposed a modification of the Hopkinson bar to a direct tension bar which allows the satisfaction of these conditions. Many experiments have been performed ever since with specimens from the nuclear field [4] and with thin sheet metal specimens used in the automotive industry [5].

The modified tension Hopkinson bar of the Joint Research Centre consists of a pre-stressed bar, an incident bar, a transmitter bar and a specimen inserted between the last two bars (figure 3). By loading the pre-stressed bar in tension an elastic energy is stored. A brittle intermediate piece between the pre-stressed bar and the incident bar is broken and a tensile stress wave is generated with a rise time of ~25 microseconds. The wave propagates along the incident bar, it loads the specimen and propagates along the transmitter bar as in the classical Hopkinson bar technique. The advantage of this modification is that a pure tensile pulse is generated and that the pre-stressed bar can be as long as needed without introducing vibrations as would appear in the usual case of non perfectly plane impact of a long projectile. In our case, the present pre-stressed bar has a 2 meter length and 10 mm diameter, but pre-stressed bars in the range of 0,5 and 10 meters have been used in the past depending on the specific test requirements.

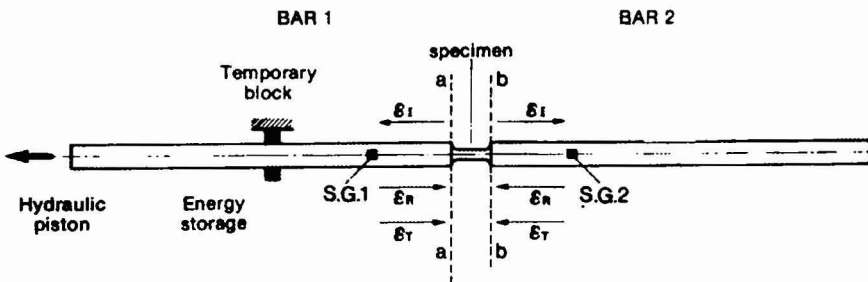

Figure 3: JRC direct tensile Hopkinson bar for large deformations

4.1.2 Compression

The experiments in compression at high strain rate have been performed by a new type of Hopkinson pressure bar [6] whose configuration is shown in figure 4. Also in this case the energy needed to deform the specimen up to fracture is stored in a pre-stressed bar generating a long compression pulse and avoiding complications of launching and correctly impacting long projectiles.

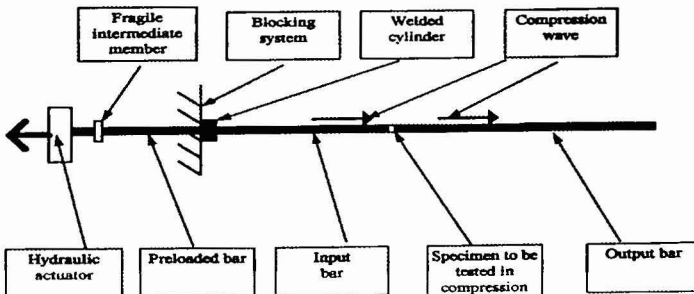

Figure 4: Hopkinson Compression Bar

4.1.3 Shear

The tests were performed on the tensile Hopkinson bar shown in figure 3.

4.2 Medium strain rate

It is well known that the tests performed at medium strain rates with the commercial hydraulic machines introduce some oscillations which spoil the measurements. These oscillations are caused by inertia effects. For this reason tensile and shear tests have been performed using a hydropneumatic machine developed at the JRC-Ispra [4] with a light weight piston avoiding oscillations. This device permits tests at strain rates ranging between 10^{-1} s^{-1} and 10^{+2} s^{-1} . Due to its small dimensions and the relatively small displacement of the shear specimen two electro-optical camera systems have been used to measure the displacement during the experiments in shear.

4.3 Low strain rate

At low strain rate the experiments in tensile and shear were performed on a Hounsfield Tensometer capable of obtaining strain rates between 10^{-4} s^{-1} and 10^{-2} s^{-1} .

5. TEST RESULTS

Figure 5 shows the results of tension tests at different strain rates confronting them with the results of the pre-stained specimen. A confrontation of specimen cut out at 0 and 90 degrees of the rolling direction is shown in figure 6.

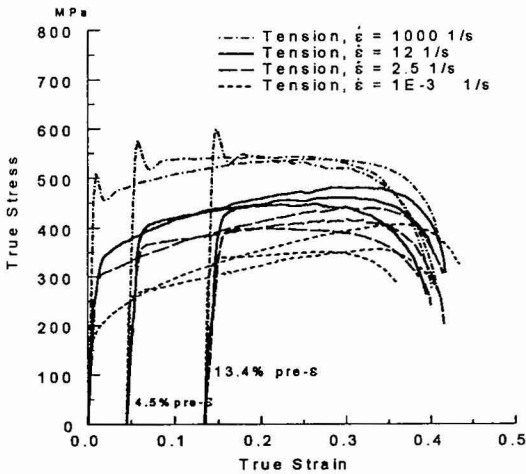

Figure 5: Comparison of σ - ϵ curves for 0% - 4.5% 13.4% pre-stained steel specimens

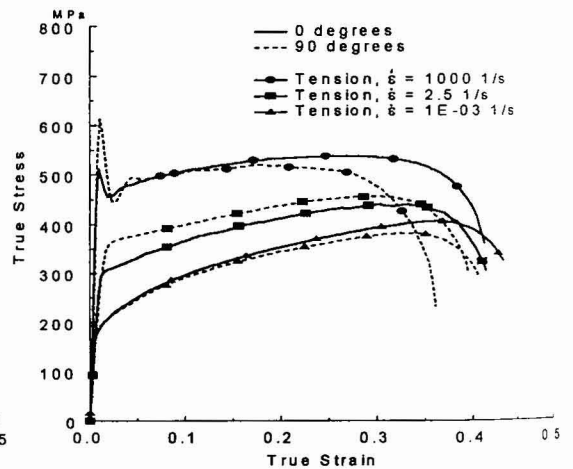

Figure 6: Comparison of σ - ϵ curves for 0 degrees and 90 degrees steel specimens

We observe:

- The strong strain rate sensitivity of the material strength which increases in average about two times by increasing the strain rate from 10^{-3} to 10^3 s^{-1} while ductility remains nearly constant.
- The flow curve at high strain rate is characterised by initial yielding instability and by a flow with very low strain hardening.

- The pre-strained material shows an enhancement of initial yielding and a decrease of strain hardening.
- Specimens at 90 degrees show at increasing strain rate a higher yielding stress emphasising the importance of anisotropy [7] effects in sheet metals.

The equivalent stress-strain curves according to Von Mises for the experiments in shear have been obtained by calculating the equivalent stress and strain by (1) and (2) as suggested by Polakowski and Ripling [7]:

$$\sigma_{eqv.} = \sqrt{3}\tau \quad (1)$$

$$\varepsilon_{eqv.} = \frac{2}{\sqrt{3}} \left[\sqrt{\left(1 + \frac{\varepsilon^2}{4}\right)} + \frac{\varepsilon}{2} \right] \quad (2)$$

with τ = shear stress and ε = shear strain.

In figure 7 the equivalent flow curves in shear, tension and compression are shown.

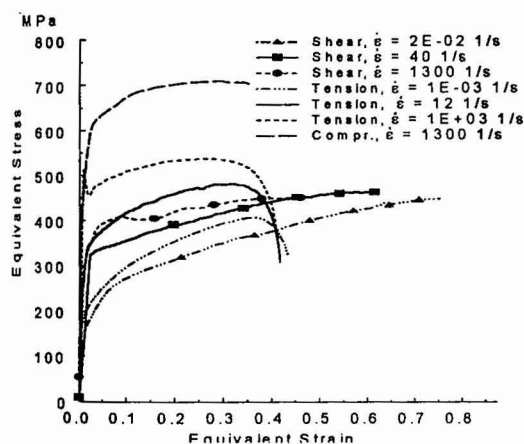

Figure 7: Eq. σ - ε curves for Tension, Shear and Compression

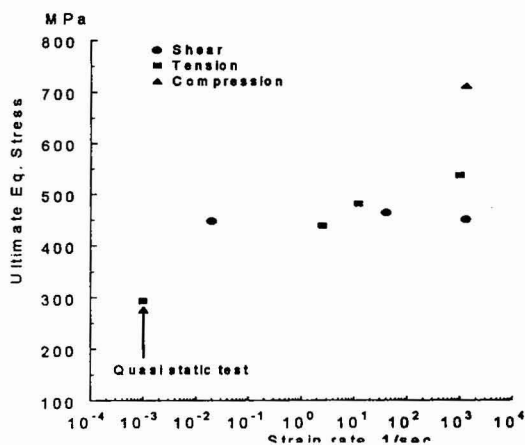

Figure 8: Ultimate Eq. Stress vs. Strain rate

We notice

- necking instability occurs quite early in the flow curve for tension with respect to the tests in shear and compression making the latter two deformation modes more suitable for large strain studies of metals.
- a great discrepancy in the Von Mises' equivalent flow curves for the three different deformation modes. Especially in case of shear deformation we find a substantially lower stress strain curve.
- the strength (figure 7 and 8) in compression is higher than the strength in tension and shear. One reason for this characteristic might be that the strain rate during our experiments in compression was a little higher than the strain rate in tension. Secondly, during the production process the thin sheet metal is obtained by rolling; therefore the sheet has already been deformed in tension during the rolling production process before being tested. This possibly affects the behaviour of our material when tested in different modes. More study on the material microstructure will be needed to better understand this phenomenon.

6. CONCLUSION

The experimental results for thin sheet steel show complex strain rate dependent flow curves with the appearance of yielding instabilities, strain history effects and anisotropy effects. Furthermore, the deformation modes in tension, shear and compression give completely different equivalent stress-strain diagrams. These characteristics will be the most challenging aspects of material behaviour to be described by analytical and numerical models.

We notice that Von Mises' criteria is mainly valid in case of small deformations. In the follow up of the flow curves a significant difference in stress and strain behaviour can be found questioning an equivalent flow curve independent of the deformation mode.

References

- [1] Albertini, C., Montagnani, M., Pizzinato, E.V., Rodis, A., Comparison of the Equivalent Flow Curves in Tension and Shear at Low and High Strain Rate for AISI 316 and ARMCO Iron, SMiRT 11 (1991), Tokyo, Japan.
- [2] Albertini, C., Montagnani, M., Zyczkowski, M., Optimal design of a Bicchierino Specimen for double Shear, International Journal of Mechanical Sciences, 1990.
- [3] Albertini, C., Montagnani, M., Testing techniques Based on the Split Hopkinson Bar (Institute of Physics, London, 1974) Conf. Ser. No. 21, p.22-31.
- [4] Albertini, C., Montagnani, M., Dynamic material properties of several steels for fast breeder reactor safety analysis, EUR 5787 EN, 1977.
- [5] Rodis, A., Albertini, C. et al., Strain rate effects on the Mechanics Properties of some Thin Sheet Carbon Steels and Glass Fibre Reinforced Composites, Technical Note No. 1.92.134, 1992.
- [6] Albertini, C., Labibes, K., European Patent Application No 96309085.7-1234.
- [7] Albertini, C., Cadoni, E., Labibes, K., Anisotropy and Strain Rates effects on Dynamic Testing of Thin Sheet Boxes used as Automotive Crash Energy Absorbers, Proceedings of 2nd ISIE'96, Beijing, China.
- [8] Polakowski, N.H. , Rippling, E.J. Strength and Structure of Engineering Materials, Prentice-Hall, Inc. Englewood Cliffs, pp 382-383, 1966.