



HAL
open science

Magnesium alloys for structural applications ; recent advances

H. Westengen

► **To cite this version:**

H. Westengen. Magnesium alloys for structural applications ; recent advances. Journal de Physique IV Proceedings, 1993, 03 (C7), pp.C7-491-C7-501. 10.1051/jp4:1993780 . jpa-00252200

HAL Id: jpa-00252200

<https://hal.science/jpa-00252200>

Submitted on 4 Feb 2008

HAL is a multi-disciplinary open access archive for the deposit and dissemination of scientific research documents, whether they are published or not. The documents may come from teaching and research institutions in France or abroad, or from public or private research centers.

L'archive ouverte pluridisciplinaire **HAL**, est destinée au dépôt et à la diffusion de documents scientifiques de niveau recherche, publiés ou non, émanant des établissements d'enseignement et de recherche français ou étrangers, des laboratoires publics ou privés.

Magnesium alloys for structural applications; recent advances

H. WESTENGEN

Norsk Hydro Research Centre, 3901 Porsgrunn, Norway

Abstract

Magnesium alloys possess unique properties, which when fully exploited can open up for major inroads into important markets for structural applications. A density of $2/3$ that of Al, and only slightly higher than for fibre reinforced plastics, combined with excellent mechanical and physical properties as well as processability and recyclability, make magnesium alloys an obvious choice when designing for light weight. The paper summarizes some basic aspects of magnesium alloying practice, and describes the main commercial alloys. A selection of special developments are described with emphasis on the interaction between material properties and processing parameters.

1. Introduction

In the search for lightweight solutions, a wide spectrum of materials is presently available for the innovative product designer. Although the versatility of the various engineering plastics has made a strong impact on material utilization, the metals have defended their strong position as materials for high performance, loaded structures. The use of materials by the automotive industry, provides an excellent example of a materials selection process where material properties, processability, price, availability, environmental issues, recyclability etc. are all determining factors. The extremely rapid growth in the application of fiberreinforced plastics and thermoplastics, experienced during the last 15 years will probably decline. Further weight savings are believed to result mainly from substitution of steel and cast iron by light metal components and systems. Currently the use of light metal castings are growing rapidly for products like engine heads, engine blocks, housings, covers, wheels, suspension parts, panels, brackets, seats etc. In a longer perspective, wrought products for body structures and panels are expected to show a major impact (1). The total annual consumption of magnesium alloys for structural applications is approximately 50.000 metric tonnes, of which wrought materials represent less than 10.000 metric tons, die casting

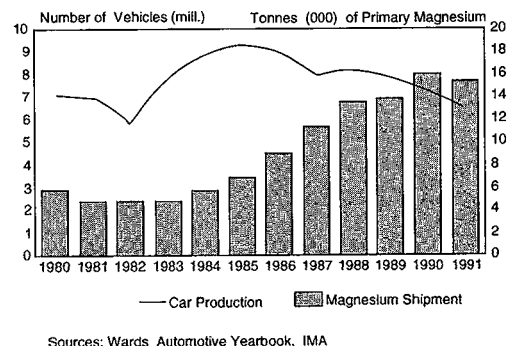

Figure 1. North American car production and magnesium shipments for die casting (2).

approximately 40.000 metric tons. Magnesium alloys are presently accounting for only 1 % of the total market for light metal castings. When the magnesium industry is looking for signs of market growth, the outstanding example is provided by the use of Mg-alloy die castings by the North American automotive industry, fig. 1 (2). Initially, this development was mainly driven by the need for weight reductions (Corporate Average Fuel Economy standards). However, through development of highly efficient production equipment, and innovative exploitation of the excellent processability and properties of Mg-alloys, cost saving has become a key success factor.

2. Fabrication methods for magnesium alloy components

Shape casting

Magnesium alloys can be cast into products by a variety of methods including high pressure die casting, low pressure permanent mould and sand casting, gravity permanent mould and sand casting, plaster/investment casting, as well as squeeze- and thixocasting. These methods cover a very wide range of processing parameters, emphasizing the need to tailor alloys and processes to obtain the required product performance. By far the most dominating casting method is high pressure die casting, fig. 2. During high pressure die casting, the mould, which is clamped together by hydraulic forces, is filled in a short time (10-100 ms) by moving the piston in the shot sleeve. After injection, a high pressure (10 -150 bars) is exerted on the liquid metal to secure proper mould filling. The metal solidifies at high cooling rates (100-1000 K/s) leaving a fine grained material with secondary dendrite arm spacing in the range 5-10 μm . For high performance casting of Mg-parts special consideration of the machine performance is needed (3). Of particular importance is injection speed, and proper handling of the liquid alloy to secure satisfactory metal quality.

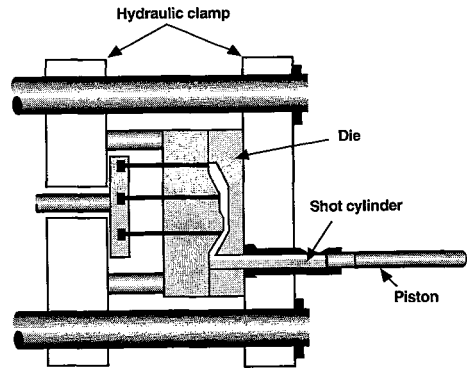

Figure 2. Schematic diagram of cold chamber high pressure die casting.

Wrought applications

Due to the hexagonal structure, magnesium alloys must be formed plastically at temperatures exceeding 200 °C to allow the necessary number of slip systems to operate. Extrusion is usually carried out in two steps, involving preextrusion of large format billets into smaller diameter billets, which are subsequently extruded into the final shape. The specific pressure is higher than for the standard Al-alloys, and the extrusion speed is limited by hot shortness caused by local melting, a phenomena which increases in severity as the alloying content increases. Despite these disadvantages, Mg-extrusions are finding important uses for applications where the unique properties of Mg-alloys can be utilized. This include aerospace applications, lightweight frames and racks, anodes for cathodic protection etc. Computer parts is a growing market due to light weight, high damping capacity for vibrations and excellent machinability. There is also a strong interest in Mg-extrusions for automotive applications as members of space frame constructions or light weight seats etc. Extrusions are frequently used as feedstock for forged applications.

An important development, which is expected to have a major impact on the competitiveness of Mg-extrusions, is the introduction of multistrand air-slip hot top casting of billets, fig. 3 (4). By this method,

the two step extrusion process, will be replaced by a single step process, as commonly used for Al-extrusion.

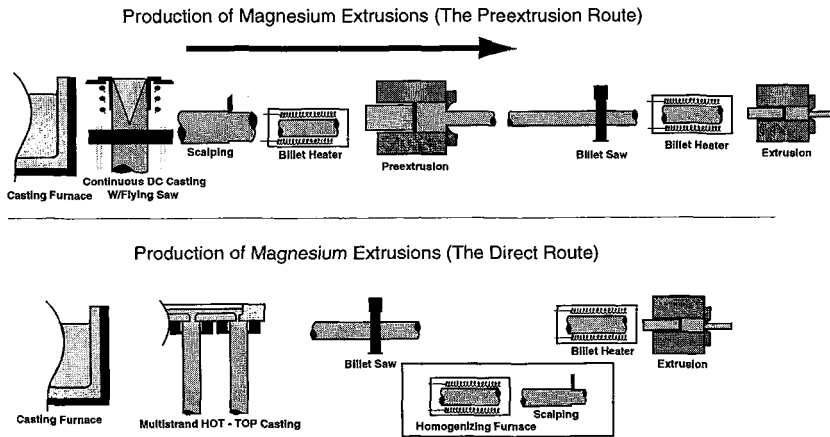

Figure 3. Alternative production routes for Mg-extrusions (4).

3. Magnesium alloying. General principles

Pure Mg is produced by electrolysis of $MgCl_2$ or by silico-thermic reduction of MgO , and generally show a purity exceeding 99.9 wt%. In its pure form the metal is soft and can only be hardened by deformation. For structural applications a variety of alloys have been developed. The alloying elements are added both to secure adequate processability of the metal, and to obtain the performance required by the various applications.

Alloying elements

A basic requirement for an alloying element to be used in conventionally liquid metallurgy processed alloys, is that it shows a sufficiently high solubility in liquid magnesium. The periodic table, fig. 4, shows elements which possess extensive, limited or negligible solubility in liquid Mg (5,6). The solubility will of course be changed in ternary and higher order systems, however, the binary systems indicate the general behaviour of the elements. The solid solubility is another important property of an alloying element, which strongly influences its effect on alloy properties. In practice the major alloying elements of interest are limited to (in order of increasing atomic number): Li, Al, Si, Ca, Mn, Cu, Zn, Sr, Y, Zr, Ag and Rare Earth (RE) elements. Some minor alloying elements are used, even if both the liquid and solid solubility are negligible. These elements include C, Be and Ti.

The overall properties of a fabricated Mg-alloy component depends upon its microstructure, which is determined through a complex interaction between the alloy chemistry and the processing parameters. Salient features include type, amount and distribution of elements in solid solution, age hardening precipitates, dispersoids, intermetallic constituents, dendrite arm spacing, grain size and shape, metallic and nonmetallic impurity elements.

In the following paragraphs some basic aspects of commercial Mg-alloy processing are discussed, followed by examples of recent developments.

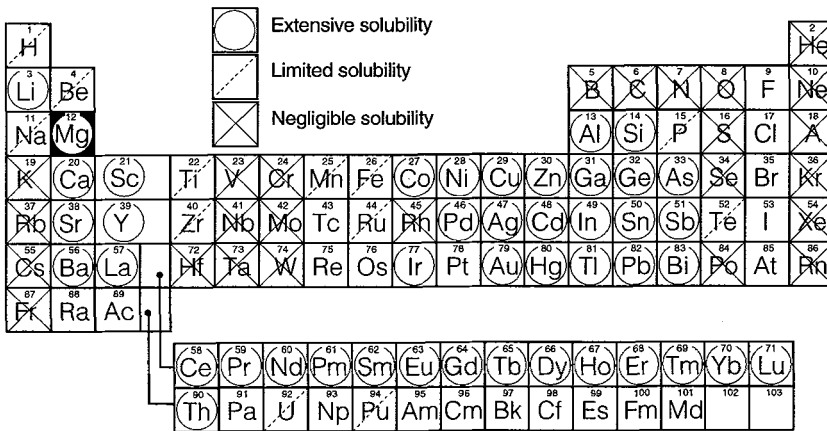

Figure 4. Periodic table indicating elements with extensive solubility, limited solubility and negligible solubility in liquid magnesium.

Control of heavy element impurities

Since the excellent paper by Hanawalt et al. (7), it has been realized that the impurities Fe, Ni and Cu strongly influence the corrosion properties of Mg-alloys. No simple ways are known to remove Ni and Cu since both elements exhibit extensive liquid solubility. Hence these elements must be limited by proper control of raw materials, and any Ni and Cu contamination must be avoided during processing. Current high purity standards limit the content of these elements to 10 and 300 ppm respectively. The Fe-level can be controlled by liquid metal treatment aimed at precipitating the Fe by adding elements which reduce its liquid solubility. For this purpose Mn is commonly used. It is generally agreed that the corrosion mechanism is microgalvanic in nature caused by microcells, where Fe-rich intermetallics constitute the cathode. The galvanic current, measured during potentiostatic polarization of isolated intermetallic particles, provides a measure of the impact on corrosion properties of the various phases, fig. 5 (8). It was observed that intermetallic compounds, containing more than a few percent Fe are detrimental, because they function as efficient cathodes. On the other hand, binary Al-Mn phases with a low Al/Mn ratio may also exhibit a relatively high cathodic current output. It can be concluded that the best corrosion properties are obtained by keeping the Mn-additions at a level which is necessary to reduce the Fe-content (<50 ppm), and at the same time minimize forma-

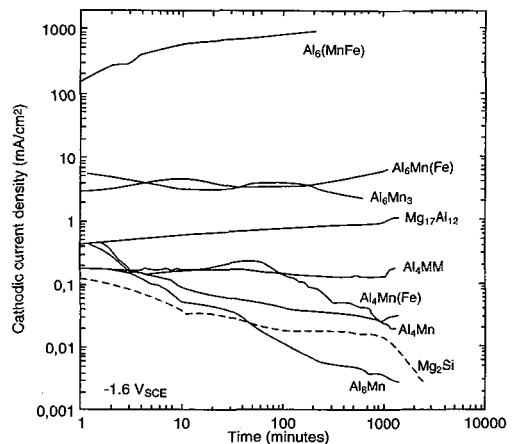

Figure 5. Cathodic current density of intermetallic compounds vs. time. Applied potential of $-1.6 V_{SCE}$ in deaerated 5% NaCl saturated with $Mg(OH)_2$ (8).

tion of Mn-rich particles. Other elements which precipitates Fe include Zr, combinations of Zr and Si, Ti and RE-elements.

Control of melt reactivity

Protective gases (mixtures of SF₆, CO₂, Ar and air) as well as salt containing fluxes are used to prevent oxidation of the liquid alloys. Due to the adverse effect on working environment, disposal problems, as well as a possible deterioration of metal cleanliness due to salt inclusions, gas protection is now the principal melt protection method. The oxidation rate is also influenced by alloying elements. Al-additions reduce the tendency to melt oxidation, and Be is strongly reducing oxidation at a few ppm level (5-15 ppm). Other elements such as RE, Li, Ca and Sr increase the oxidation rate, and special precautions must be taken (gas protection).

Control of grain size

Control of the grain structure is a key factor during solidification processing of metals and alloys. The spatial distribution of alloying elements and phases present, as well as the hot cracking tendency and distribution of porosity are strongly influenced by the grain structure. A variety of grain refining methods are employed for casting of Mg (5). These include constitutional grain refining, rapid cooling, Zr-additions and carbon inoculation. For alloys containing Al and Mn as alloying elements, a common grain refining method is to add hexachlorethane, C₂Cl₆. However, due to environmental concerns regarding emission of chlorinated hydrocarbons, this method is questionable. A new grain refining additive using the principle of carbon inoculation has been developed (9). The grain refining effect of this additive is illustrated in fig. 6. Although the effect is most pronounced at higher melt temperatures, satisfactory results are obtained also at lower melt temperatures after considerable holding times.

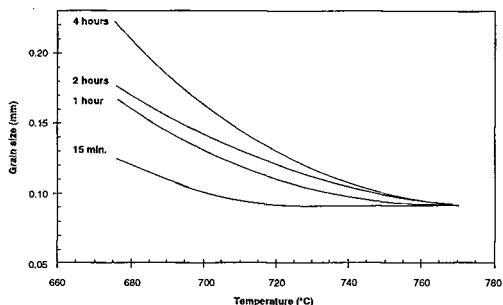

Figure 6. Grain size of carbon-inoculated AZ91 D vs. melt temperature at various holding times (9).

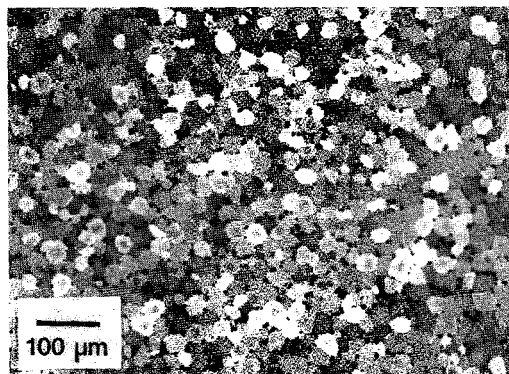

Figure 7. Grain structure of Zr treated alloy ZE41.

For alloys which do not contain Al or Mn, Zr-additions are commonly used for grain refining. Zr-inoculation is extremely efficient, and the resulting grain structure is completely nondendritic, fig. 7. The grain size is determined by the cooling rate in a similar manner as the secondary dendrite arm spacing.

4. Commercial alloy systems

Mg-alloys, including cast and wrought alloys, table I and II, can be broadly divided into two groups: Magnesium-Aluminium alloys and Zirconium containing alloys.

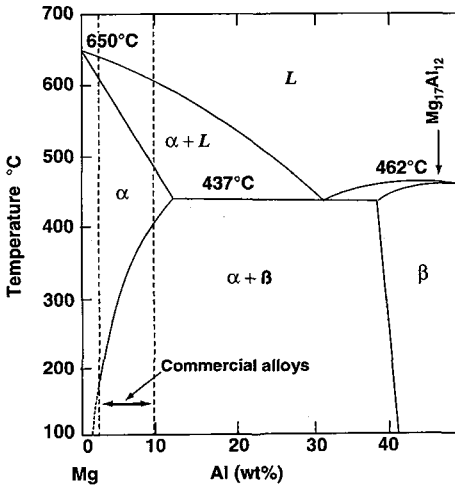

Figure 8. The Mg-rich part of the Mg-Al phase diagram

Magnesium-Aluminium alloys

The majority of Mg-alloys contains Al as the main alloying addition. A section of the binary Mg-Al phase diagram is shown in fig. 8. For practical purposes, the Al-content is limited to about 10 wt% due to the formation of a brittle eutectic containing about 72 wt% of the β - $Mg_{17}Al_{12}$ phase. This means that Mg-Al casting alloys have compositions, which normally are considered as typical for wrought alloys. Unlike Al-Si casting alloys, the Mg-Al based casting alloys can be heat treated into a single phase material. The consequence is that Mg-Al alloys are somewhat less castable than Al-Si alloys, however, a superior ductility can be obtained. In practical casting processes, solidification occurs at relatively high cooling rates, and according to the Scheil equation, a relatively large fraction of eutectic is formed, even at lower Al-levels. This secures the necessary castability of the alloys. Mn and Zn are commonly added at levels 0.2-0.3 and 0.5-2 wt%, respectively, to improve corrosion resistance and strength. A typical microstructure of as cast (permanent mould) AZ91D is shown in fig. 9, where β - $Mg_{17}Al_{12}$, AlMn(Fe) intermetallics, and discontinuously precipitated β - $Mg_{17}Al_{12}$ can be seen. Following a solution and artificial ageing heat treatment, platelets of semicoherent β - $Mg_{17}Al_{12}$ are formed on the (0001) planes of the Mg-matrix, resulting in a moderate hardening effect.

Table I. Mg-based casting alloys. Nominal chemical composition (wt%).

Designation	Al	Zn	Mn*	Si	Zr	Y	Ag	Others
AM20	2.0	<0.1	0.4	<0.1				
AM50	5.0	<0.1	0.2	<0.1				
AM60	6.0	<0.2	0.25	<0.1				
AS21	2.2	<0.1	0.2	1.0				
AS41	4.5	<0.1	0.2	1.0				
AE42	4.0	<0.2	0.25	<0.1				2.0-3.0 RE (Ce-rich)
AZ63	6.0	3.0	0.15	<0.3				
AZ91	9.0	0.7	0.15	<0.1				
EZ33	2.7				0.6			3.3 RE (Ce-rich)
ZE41	4.2				0.7			1.2 RE (Ce-rich)
EK31					0.7			3.7 RE (Nd-rich)
EQ21				0.5		1.5		2.1 RE (Nd-rich)
QE22					0.7	2.5		2.1 RE (Nd-rich)
WE54				0.5	5.3			3.5 RE (Nd-rich)
WE43				0.5	4.0			3.0 RE (Nd-rich)

* Min. values

Table II. Mg-based wrought alloys. Nominal chemical composition (wt%).

Designation	Al	Zn	Mn	Si	Zr	Y	Ag	Others
M1 A			1.5	<0.1				
AZ31 B	3.0	1.0	0.20	<0.1				
AZ61 A	6.5	1.0	0.15	<0.1				
AZ80 A	8.5	0.5	0.12	<0.1				
ZK30 A	3.0				0.6			
ZK60 A	5.5				0.4			
WE43					0.5	4.0		3.0 RE (Nd-rich)

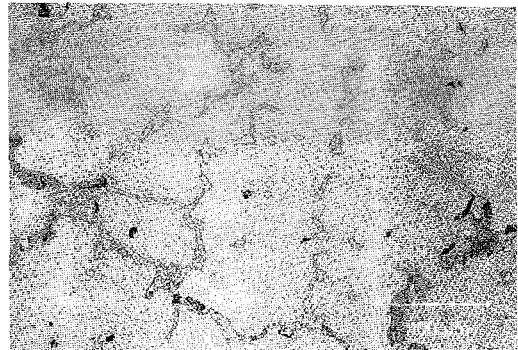

Figure 9. Microstructure of permanent mould cast AZ91 D.

Fig. 10 illustrates the remarkable ductilities which can be obtained in high pressure die cast specimens, by reducing the level of Al and hence the volume fraction of eutectic constituents (10).

For applications exposed to working temperatures exceeding about 120 °C, the Mg-Al alloys may show inadequate creep properties. A reduction in the creep rate is obtained by addition of Si, which has a negligible solid solubility, causing formation of a fine dispersion of Mg_2Si precipitates, fig. 11. This led to the introduction of the creep resistant alloys AS41 and AS21.

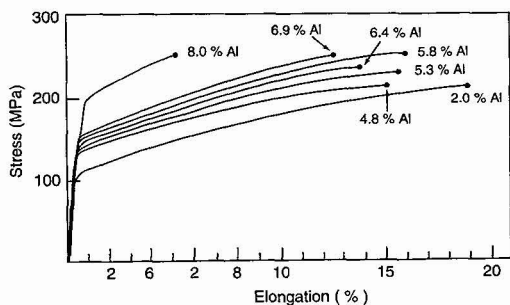

Figure 10. Nominal stress-strain curves of high pressure die casts AM-alloys with varying Al-content (10).

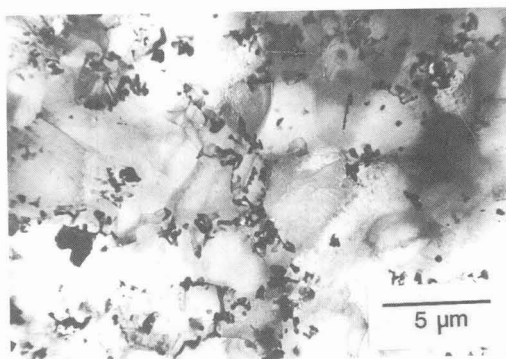

Figure 11. Finely dispersed Mg_2Si particles in AS21 alloy (11).

More recently, alloys containing RE-elements, e.g. Ce, La and Nd ('mischmetal') have been introduced. In these alloys a dispersion of Al_4RE particles is formed, while simultaneously reducing the amount of the low-melting eutectic $\alpha(Mg) + \beta(Mg_{17}Al_{12})$. At elevated temperatures, these eutectic regions soften considerably due to the high homologous temperatures. The alloy AE42 is currently undergoing extensive testing for applications exposed to elevated temperatures due to the favourable creep properties, fig. 12 (12).

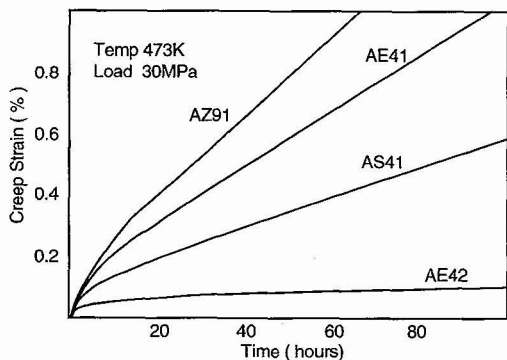

Figure 12. Creep strain vs. time for various alloys at 200 °C, load 30 MPa (12).

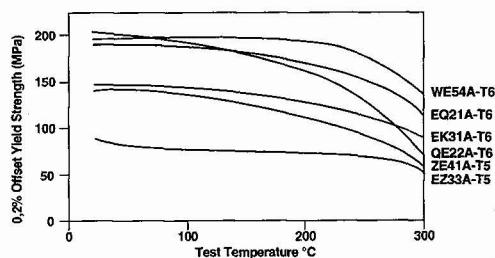

Figure 13. Temperature dependence of the 0.2% offset yield strength for various Zr grain refined alloys (13).

Zirconium grain refined alloys

Due to the extremely efficient grain refining effect of Zr, a series of alloys, especially suited for sand casting, has been developed (13). Unfortunately, the presence of elements like Al and Mn suppresses the liquid solubility of Zr, precluding the exploitation of this grain refining mechanism in the common Mg-Al alloys.

Elements compatible with Zr include Zn, RE, Ag and Y. While binary Mg-Zn alloys show inferior mechanical properties and castability to Mg-Al alloys, effective grain refinement by Zr, combined with additions of RE-elements to reduce microporosity, led to the introduction of alloys such as EZ33 and ZE41. The ZE63 alloy is a high strength variant, for which solution heat treatment in hydrogen

atmosphere is employed to remove some of the embrittling MgZnRE grain boundary phases by formation of RE-hydrides. At the same time Zn becomes available for age hardening. An age hardening system containing Ag, Nd-rich mischmetal (a mixture of rare earth elements) and Zr, shows high mechanical strength and good creep properties at temperatures approaching 250 °C (EQ21 and QE22). The most recent alloy system, which has been evaluated, is the WE series, containing Y and Nd-rich mischmetal in addition to Zr. The WE54 alloy shows considerable strength up to 300 °C, fig. 13. Due to a certain embrittling effect caused by long term ageing at elevated temperatures, a slight reduction in alloying content has been suggested, and WE43 has now been introduced. These alloys are used in the fully aged condition.

5. Special developments

Ultra light alloys

Alloying Mg with Li (density 0.54 g/cm³), provides possibilities to design alloys with density below 1.5 g/cm³. Various wrought alloys have been standardized including LA141A and the Russian alloys MA18 and MA21. The principal alloying constituents for Mg-Li alloys are Li, Al, Zn, Mn, Ce and Cd. For improved corrosion resistance and ductility, Fe, Ni, Na and Ca are controlled to low levels.

In addition to low specific weight, the Mg-Li alloys show improved formability due to the presence of the cubic β -Li solid solution. It has recently been reported that sheet material of a duplex Mg-8 wt% Li-1 wt% Al alloy exhibits superplasticity during deformation at 573 K (14).

High pressure die cast parts of Mg-Al-Li show exceptional ductilities in the range 30-40 %, with a 0.2 % proof stress of 120-140 MPa, and an ultimate tensile strength of 170-180 MPa. The microstructure of a Mg-8 wt% Li-2 wt% Al die casting is shown in fig. 14. A duplex structure of α (Mg) solid solution and β -Li solid solution, with a fine dispersion of AlLi and LiMgAl precipitates is observed.

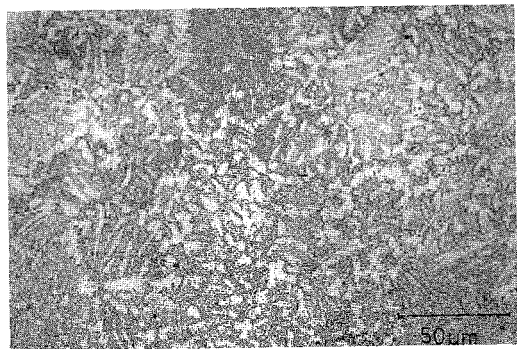

Figure 14. Microstructure of die cast Mg-8 wt% Li-2 wt% Al.

Heat resistant alloys

As described in section 4.2, alloys containing Y and Nd-rich mischmetal show excellent high temperature properties, due to the formation of a finely dispersed distribution of temperature stable precipitates. Prerequisites to obtain good high temperature mechanical strength are as follows:

- i) The alloying elements should have a high solubility in solid magnesium, falling sharply with decreasing temperature, allowing formation of a high density distribution of precipitated particles.
- ii) A high amount of magnesium should be contained in the strengthening phase of the alloys to secure a high volume fraction of precipitates.
- iii) The precipitated particles should be stable with a high melting point and corresponding low solubilities of the alloying elements to reduce the coarsening rate.

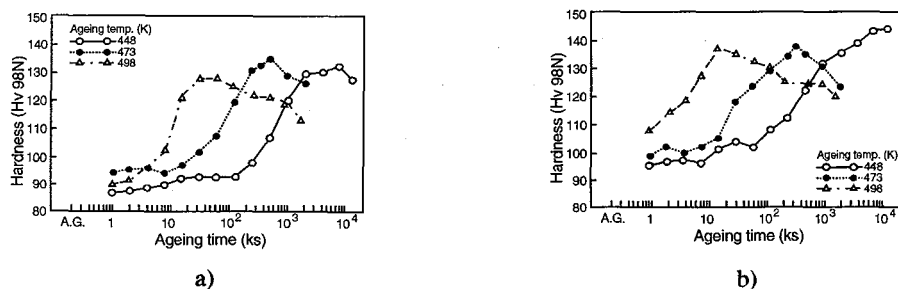

Figure 15. Age hardening behaviour of a) Mg-20 wt% Tb, b) Mg-20 wt% Gd (15).

Elements which fulfil these requirements are provided by Y, Gd and Tb. The ageing response of Mg-20 wt% Tb and Mg-20 wt% Gd are shown in fig. 15 (15). It is reported that a Mg-20 wt% Tb alloy shows an ultimate tensile strength at 300 °C in the range 280-300 MPa and a 0.2 % proof stress of 220-250 MPa (16).

Thixotropic materials

Thixotropic forming is attracting considerable attention. It represents a field where an intimate coupling of material and processing technology determine the outcome. Various methods have been developed to secure a globulitic, fine grained structure in the feedstock (17). A simplified route has been developed for Mg-alloys, based on effective grain refining and controlled solidification (18). Standard casting methods for the feedstock can be applied, such as permanent mould casting and Direct Chill casting. Examples of microstructures obtained after reheating the materials to the two phase region are shown in fig. 16. Squeeze casting or a modified cold chamber die casting process have been used for the final forming operation.

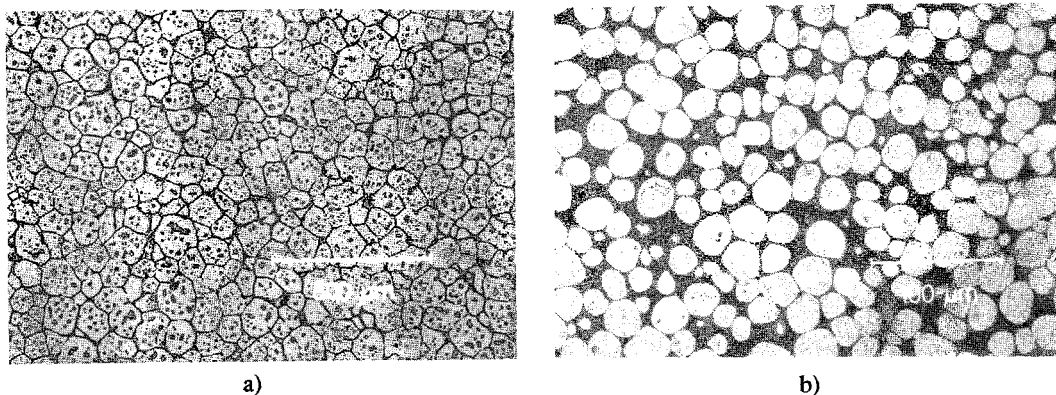

Figure 16. Microstructures of thixotropic ingots reheated to the two phase region. a) AZ91 D, b) ZE53 (18).

Rapid solidification

A wide spectrum of rapidly solidified magnesium alloys have been investigated (19,20). Unlike rapidly solidified Al-alloys, which may show considerable supersaturation of the alloying elements, rapidly solidified Mg-alloys are mainly characterized by a refinement of grain structure and dispersion of intermetallic particles. In extruded materials, the dramatic increase in mechanical properties at ambient

temperatures can be attributed to the grain size effect, fig. 17. Due to the reduced grain size, elevated temperature creep properties are relatively poor for rapidly solidified materials, fig. 18. However, introduction of alloying elements, which form stable intermetallic compounds, improves the creep properties, both by stabilizing the grain boundaries, and by increasing the melting point of the alloy by removing low melting point eutectics. An example is provided by adding Ca to AZ91, fig. 19. Other elements forming stable dispersed precipitates include Si, Mn, RE, Sr etc.

The fine grained structure is relatively stable when dispersed particles are present, and superplastic behaviour has been reported at temperatures 275-300 °C at strain rates 10^{-1} to 10^{-2} (21).

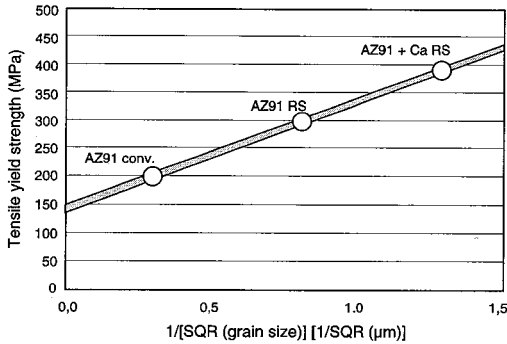

Figure 17. Hall Petch relation describing the influence of grain size on tensile yield strength (20).

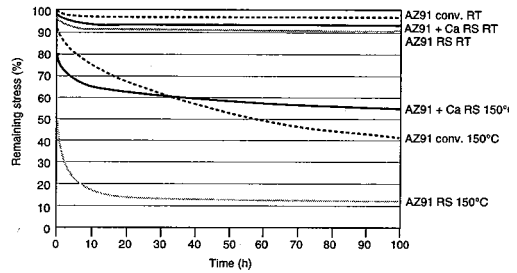

Figure 18. Stress relaxation behaviour of conventional and rapidly solidified materials at room temperature (150 °C) (20).

Amorphous alloys

Although formation of amorphous materials usually involves rapid solidification techniques like melt spinning or planar flow casting, amorphous Mg-based alloys have been produced by low pressure casting in a Cu-mould (22). Alloys of the type Mg-TM-Ln, where TM is a transition metal like Cu, Ni or Zn and Ln a lanthanide metal, Y, La, Ce or Nd are reported to show a large glass-forming capacity.

An example is provided by the alloy Mg(80 at%) - Cu(10 at%) - Y(10 at%), which when cast into a 1.5 mm dia. cylinder showed a tensile strength at room temperature exceeding 800 MPa, fig. 19. The yield strength remains high at temperatures below 373K. At higher temperatures, strength decreases rapidly as a viscous supercooled liquid state was reached, prior to the onset of crystallization.

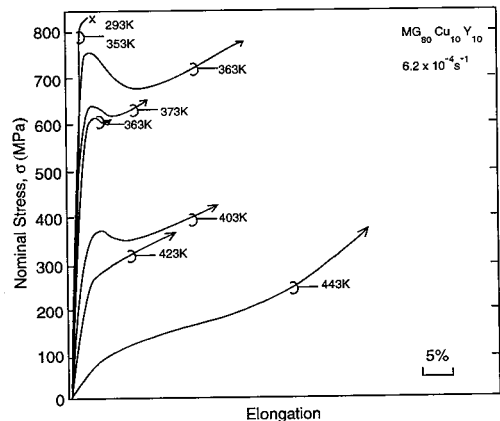

Figure 19. Nominal stress-strain curves at various temperatures. Amorphous Mg(80 at%)-Cu(10 at%)-Y(10 at%) (22).

In-situ composites

In the binary Mg-Si system a eutectic reaction occurs at 638 °C at 1.4 wt% Si: Liquid \rightarrow Mg + Mg₂Si. The solid solubility of Si is negligible and stable Mg₂Si particles promote dispersion hardening. Near eutectic alloys are reported to show exceptionally good damping characteristics (23). Hypereutectic alloys with primary Mg₂Si phases refined by small additions of Ca, embedded in a lamellar eutectic structure have

been investigated for use in pistons (24). Additional hardening can be obtained by adding elements providing solid solution hardening.

6. Summary

The main current market for structural applications is high pressure die cast parts. The high purity version of magnesium alloys show corrosion properties comparable to Al die casting alloys, and special purpose alloys including high ductility, energy absorbing alloys, and alloys for use at elevated temperatures open up for new applications. More cost efficient production routes for extruded products are believed to create new opportunities for this market segment. Considerable efforts have been directed at innovative developments of Mg-based materials, some of which have been discussed in this paper. A further promising field is magnesium based composites. These developments demonstrate the versatility of Mg-alloys, and provide an incentive for further efforts to establish new applications.

References

1. Gjostein, N.A., *Adv. Mat. & Proc.* 1 (1990), 73
2. Foley, P.T. and Gilbert, K., *Proc. 49th IMA Conference, Chicago*, 7
3. Berkmortel, J. and Hegel, R., *Proc. 48th IMA Conference, Quebec*, 1991, 1
4. Kittilsen, B. and Pinfeld, P., *Proc. Conf. 'Magnesium Alloys and Their Applications', Garmisch-Partenkirchen, DGM 1992*, 85
5. Emley, E.F., *Principles of Magnesium Technology*, Pergamon Press, Oxford, 1966
6. Nayeb-Hashemi, A.A. and Clark, J.B., *Phase Diagrams of Binary Magnesium Alloys*, ASM International, Ohio, 1988
7. Hanawalt, J.O., et. al., *Trans Am. Inst. Mining and Met. Engr.*, vol. 147, 1942, 273
8. Lunder, O., Nisancioglu, K. and Hansen, R.S., *Proc. Conf. 'Magnesium Properties and Applications for Automobiles', SAE 1993*, paper 930755
9. Karlsen, D.O., et. al, To be published, 32nd Ann. Conf. of Metallurgists, CIM, Quebec, Sept. 1993
10. Aune, T.K. and Westengen, H., *Proc. Conf. 'Magnesium Properties and Applications for Automobiles', SAE 1993*, paper 930418
11. Simensen, C.J., Central Institute for Industrial Research, Oslo, Internal report.
12. Aune, T.K. and Westengen, H., *Proc. Conf. 'Magnesium Alloys and Their Applications', Garmisch-Partenkirchen, DGM 1992*, 221
13. Unsworth, W., *Int. J. of Mat. and Prod. Techn.*, vol. 41, no. 4, 1989, 359
14. Inoue, M., et. al., *J. of Jap. Inst. of Light Met.*, vol. 42, no. 2, 1991, 67
15. Kamado, S., et. al., *J. of Jap. Inst. of Light Met.*, vol. 42, no. 12, 1992, 727
16. Rokhlin, L.L., Nikitina, N.I. and Abrukina, N.P., *Proc. Conf. 'Adv. Aluminium and Magnesium Alloys', ASM, Amsterdam 1990*, 805
17. Kenney, M.P., et. al., in *Metals Handbook*, 9th Ed., vol. 15, ASM, Metals Park, Ohio 1988, 327
18. Gjestland, H., *Proc. Conf. 'Magnesium Properties and Applications for Automobiles', SAE 1993*, paper 930753.
19. *Proc. Conf. 'Magnesium Alloys and Their Applications', Garmisch-Partenkirchen, DGM 1992*, 479-557 (various authors)
20. Gjestland, H., et. al. *Proc. Conf. 'Rapidly Quenched Materials', RQ7, Stockholm 1990*, Elsevier, 1197
21. US patent 5 129 960, 1992
22. Inoue, A., et. al., *Materials Transactions JIM*, vol. 32, no. 7, 1991, 609
23. Suisse patent CH 667 674 A5, 1988
24. Beer, S., et. al., *Proc. Conf. 'Magnesium Alloys and Their Applications', Garmisch-Partenkirchen, DGM 1992*, 317