



HAL
open science

MATERIALS AND INTERFACES CHARACTERIZATION BY MICRO-RAMAN SPECTROSCOPY

P. Huong

► **To cite this version:**

P. Huong. MATERIALS AND INTERFACES CHARACTERIZATION BY MICRO-RAMAN SPECTROSCOPY. Journal de Physique IV Proceedings, 1991, 01 (C6), pp.C6-151-C6-162. 10.1051/jp4:1991624 . jpa-00250709

HAL Id: jpa-00250709

<https://hal.science/jpa-00250709>

Submitted on 4 Feb 2008

HAL is a multi-disciplinary open access archive for the deposit and dissemination of scientific research documents, whether they are published or not. The documents may come from teaching and research institutions in France or abroad, or from public or private research centers.

L'archive ouverte pluridisciplinaire **HAL**, est destinée au dépôt et à la diffusion de documents scientifiques de niveau recherche, publiés ou non, émanant des établissements d'enseignement et de recherche français ou étrangers, des laboratoires publics ou privés.

MATERIALS AND INTERFACES CHARACTERIZATION BY MICRO-RAMAN SPECTROSCOPY

P.V. HUONG

Laboratoire de Spectroscopie Moléculaire et Cristalline, U.R.A. 124 - C.N.R.S., Université de Bordeaux I, 351 Cours de la Libération, F-33405 Talence, France

Abstract : Several aspects of Raman and micro-Raman spectroscopy are shown and applied for the characterization of semiconductor materials and bi-layers of semiconductor on semiconductor and insulator on semiconductor.

As a molecular technique, Raman spectroscopy will inform not only on the nature of elements but also on chemical bonds between atoms.

Raman spectroscopy also permits the studies of disordered or amorphous materials.

Based on the anisotropy in Raman scattering, the determination of the orientation of surfaces and thin layers becomes also easy.

Micro-Raman spectroscopy, with a spatial resolution of the order of $1 \mu\text{m}^2$, allows the study of heterogenous or very small materials. This technique is very helpful in the determination of heterogeneity, stress and gradient in semiconductors.

On step-etched or bevelled samples of a bi-layer, micro-Raman spectroscopy helps to examine the epitaxy quality of the deposit *versus* its thickness and also to detect eventual chemical bonds between deposit and substrate.

1 - INTRODUCTION

In materials sciences, final application is of course a very important end. But this stage is necessarily preceded by syntheses and characterization steps and the explanation of mechanisms and properties.

Morphological and elemental characterization methods are widely used for new advanced materials. Vibrational spectroscopy, especially Raman spectroscopy has the advantage to be a molecular method. By the examination of Raman frequencies, intensities and band shapes, one can deduce the nature and the force of chemical bonds linking the atoms in the examined samples [1-6]. As these spectral characteristics change with the interaction between a group of atoms of the system ; a study of these changes can inform on the nature and the forces of the interaction.

When approaching the exciting light energy to that of a chromophore (Fig.1), resonance Raman effect can appear and gives an intensity enhancement reaching more than one million of time [7,8]. In consequence, the concentration or amount of submitted sample can be reduced by the same factor.

In addition, by coupling an optical microscope to a Raman spectrometer (Fig.2), spatial resolution can be reduced to less than $1 \mu\text{m}^2$. Thus, small samples, as well as different spots of a sample or heterogenous materials can give specific Raman spectra by this non destructive technique [9].

In this paper, we shall present an application of micro-Raman spectroscopy in the studies of materials and interfaces interesting for particular microelectronics.

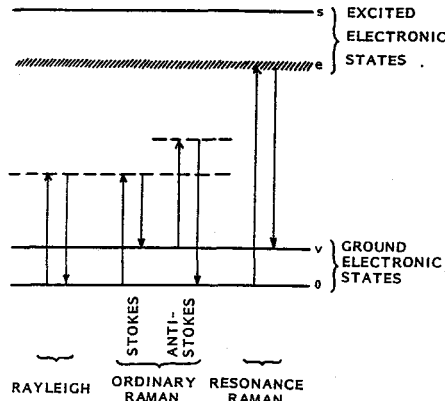

Fig.1 - Energy scheme in light scattering.

2 - SEMICONDUCTORS: STRUCTURES AND RAMAN SPECTRA

2.1 - Phonons and elements identification.

For single element materials, the phonon frequencies can inform on the nature of the element.

For covalent materials with cubic diamond structure such as silicium or germanium, the optic modes are degenerate and only one first-order mode is active in Raman scattering. For crystalline silicon, the Raman first phonon appears at 521 cm⁻¹, while for germanium it is located at 300 cm⁻¹ and for diamond itself, a strong Raman peak is recorded at 1331 cm⁻¹. The heavier oscillator vibrates at the lower frequency.

For diatomic AB species, the frequency of vibration along the chemical bond is given, in the harmonic approximation, by

$$\nu = \frac{1}{2\pi c} \sqrt{\frac{K}{\mu}}$$

where K is the force constant, μ the reduced mass $1/\mu = 1/m_A + 1/m_B$, c the velocity of light ; m_A and m_B are the atomic masses of A and B atoms.

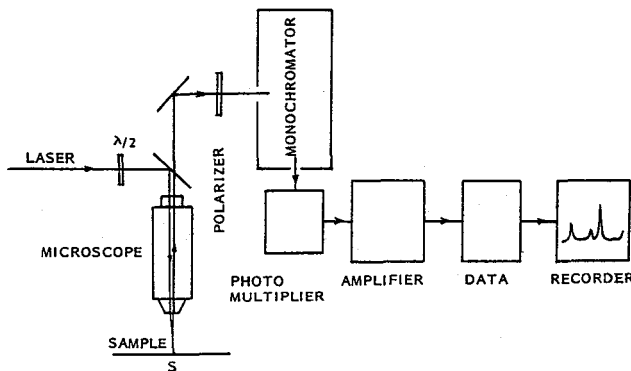

Fig.2 - Scheme of a micro-Raman spectrometer.

In fact, in the solid state, a motion of each atom induces the motion of its neighbouring atoms ; thus, a vibration is not strictly localized on a chemical bond but represents an oscillation or phonon of the whole solid network : all vibrations in a unit cell and the three rotations of the unit cell become optic vibrations of the crystal, while the three translations of the unit cell remain as translations or acoustic modes of the crystal. The latter modes have zero frequency in the Brillouin zone centre. The oscillation mode is called longitudinal or transverse when the polarization or electric dipole moment of the medium is parallel or perpendicular to the phonon propagation direction or wave vector in the medium.

In diamond structure materials, the two TO (transverse optic) and LO (longitudinal optic) modes coincide by degeneracy.

2.2 - Bi-phonons, multiphonons.

In fact, the harmonic approximation is only a simplifying treatment, as on a Raman spectrum of a solid material, not only first order phonon is observed, but biphonons, even multiphonons can also appear. Such is the case of crystalline silicon which shows first order phonon at 521 cm^{-1} , bi-phonons around 1000 cm^{-1} and tri-phonons near 1500 cm^{-1} (Fig.3).

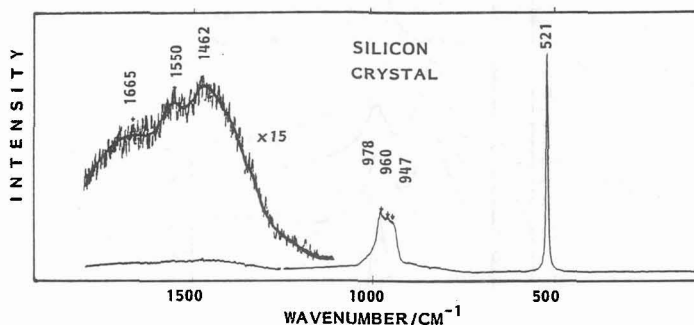

Fig.3 - Bi and tri-phonons of crystalline silicon.

2.3 - Zinc blende structure materials

For non centro-symmetric crystals with zinc blende structure such as GaAs, InP, etc ... the degeneracy is split and both TO and LO modes can appear in Raman scattering (Fig.4).

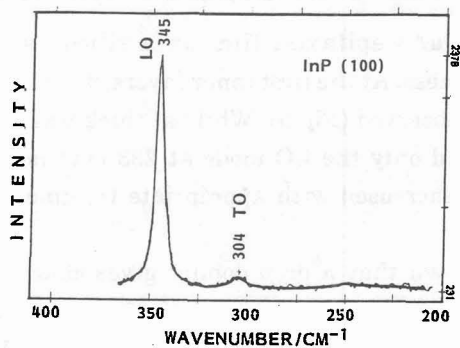

Fig.4 - TO and LO modes in InP.

The relative intensity of these two phonons depends on the orientation, on the disorder or on the doping [10-15].

Materials	TO	LO
ZnS	273	351
ZnSe	205	250
ZnTe	177	205
GaAs	269	292
GaP	367	403
GaSb	231	241
InP	304	345

TABLE I - Transverse and longitudinal optic modes, in cm^{-1} , of zinc blende structure semiconductor crystals [16].

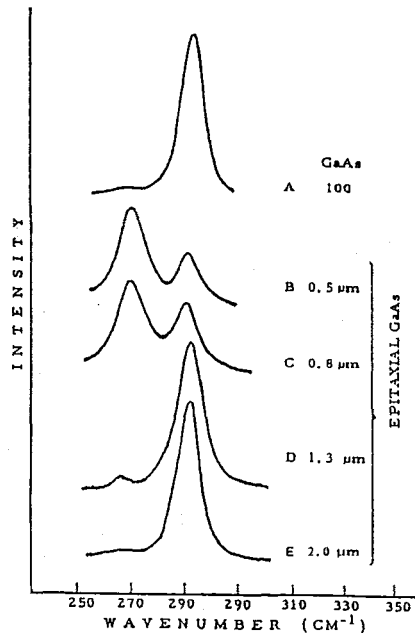

Fig.5 - TO and LO modes of GaAs at various thicknesses.

For instance, a GaAs epitaxial film on a silicon substrate does not give good orientation at every thickness. At the first inner layers, due to lattice mismatch, both TO and LO Raman phonons are observed (Fig.5). While at thickness h higher than $1.3 \mu\text{m}$ the layer becomes good oriented and only the LO mode at 293 cm^{-1} is observed [17]. Of course, the quality of the epitaxy is increased with appropriate treatment of the substrate before the deposition.

It is also well-known that n or p doping gives characteristic modifications of the Raman spectrum of III-V semiconductors, in particular resonant conditions can be realized which gives rise to spectral features due to coupled plasmons-LO phonons [13].

2.4 - Effect of charge

Among dopants in inclusion or partners in semiconductors, oxygen is frequently present. Raman spectroscopy can help to detect it. The frequency of this homopolar diatomic species is very sensitive to the effect of charge [18] on the oscillator (Table II).

	O_2^+	O_2	O_2^-	O_2^{2-}
ν (cm^{-1})	1865	1580	1097	~ 766
K ($mdyn/\text{\AA}$)	16.39	21.76	5.67	~ 2.76

TABLE II - Frequencies and force constants of homopolar diatomic oxygens.

2.5 - Disorder, stress, amorphicity

Although vibrational spectroscopy is only an indirect method for the structural determination, this technique presents some advantage in comparison to other direct diffraction methods, in the studies of amorphous or disordered materials [19].

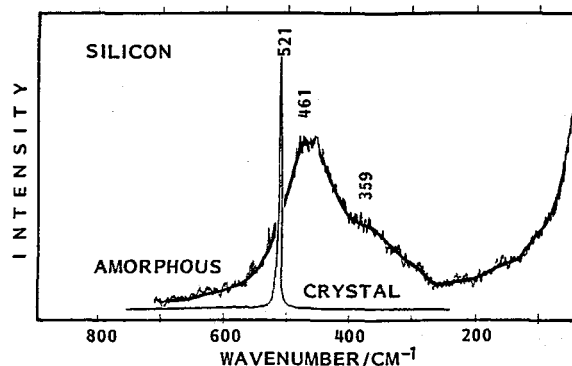

Fig.6 - Raman spectrum of amorphous silicon.

For silicon, it is not only easy to distinguish crystalline silicon from amorphous silicon (Fig.6) but one is able to follow several degrees of amorphicity by measuring the frequency, varying from 461 cm^{-1} in totally amorphous, to 521 cm^{-1} in bulk crystalline silicon. Of course, the band width at half intensity or the band shape can also help to understand the dynamic aspect of the silicon motion inside of the disordered network. This technique is particularly helpful in the characterization of a silicon annealed by laser (1).

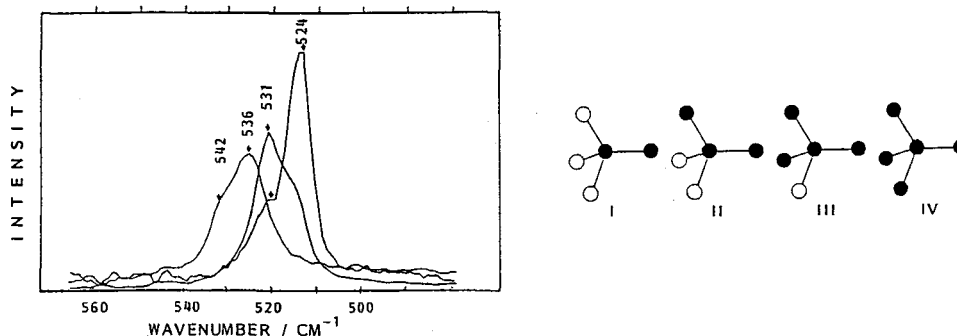

Fig.7 - Raman spectra of small silicon aggregates.

Recently, small aggregates, silicon dimers, trimers, etc... in a silicon-carbide matrix has been shown [22] as having characteristic Raman frequency, higher than 521 cm^{-1} of bulk silicon, from 524 to 542 cm^{-1} , the latter corresponds to Si-Si dimers (Fig.7).

The stretching frequency is also sensitive to the stress in the material [20].

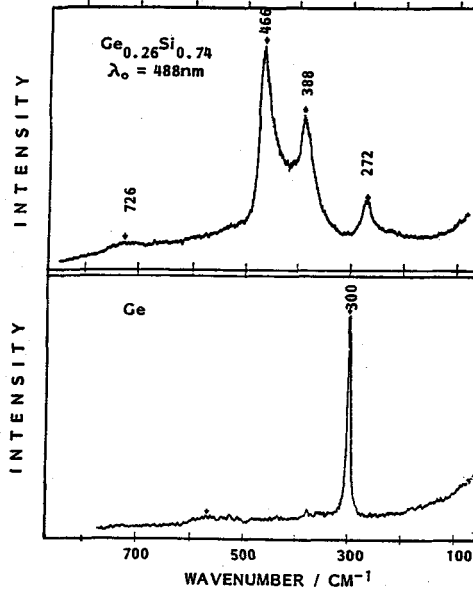

Fig.8 - Raman spectrum of Ge-Si alloy.

3 - CHEMICAL BONDS IN SEMICONDUCTORS.

3.1 - Heteroatom chemical bonds.

While many techniques can inform on the nature of the elements of a material sample, Raman spectroscopy can also give the evidence of chemical bonds between atoms, either the sample is in the gaseous, liquid or solid state.

The Raman spectrum of a $\text{Ge}_{0.74}\text{Ge}_{0.26}$ alloy (Fig.8), shows not only bands characteristic of Si-Si bond at 466 cm^{-1} and Ge-Ge bond at 272 cm^{-1} but also Ge-Si bond at

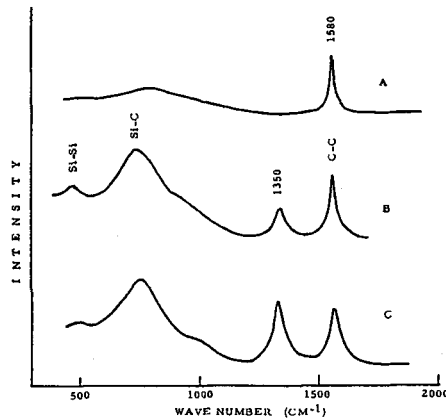

Fig.9 - Raman spectrum of carbon impurity in silicon.

388 cm^{-1} [21]. In addition, the frequency and the relative intensity of these bands compared to those of pure Si (521 cm^{-1}) and Ge (300 cm^{-1}) also indicate the aggregate composition and geometry of the alloy.

3.2 - Impurities in silicon

Among the impurities which are present in silicon, carbon is frequently found. Raman spectroscopy is an easy technique to detect it, not only for its identification, but also for the characterization of its degree of graphitization [22,23], as amorphous carbon possesses two Raman peaks at 1350 and 1580 cm^{-1} , while graphite of high graphitization degree presents only one C-C band at 1580 cm^{-1} . Chemical bonds between C and Si are also detected (Fig.9).

3.3 - High temperature semiconductors : diamond.

Diamond films are now obtained by simple chemical vapour deposition methods at low temperature and pressure.

By Raman spectroscopic examination, two kinds of diamond films can be distinguished. One of them has the Raman peak characteristic of diamond (Fig.10), with its

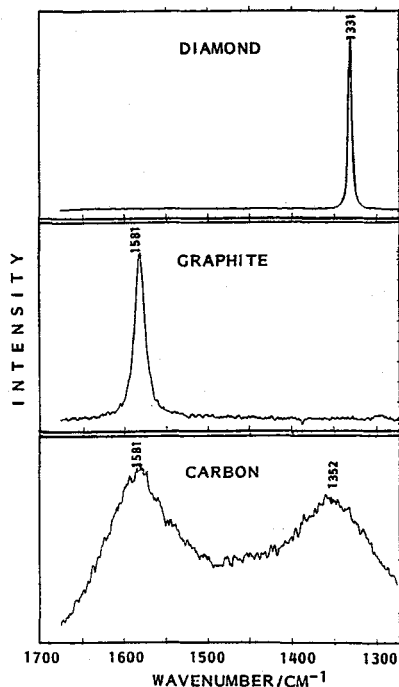

Fig.10 - Raman spectrum of diamond

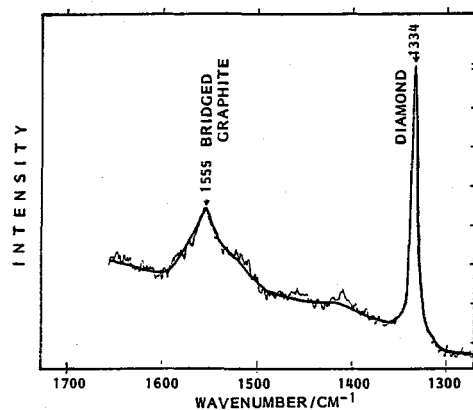

Fig.11 - Raman spectrum of "diamite" or "bridged graphite".

frequency varying from 1331 to 1345 cm^{-1} and half-band-width from 1.7 to 15 cm^{-1} depending on its distortion from the ideal cubic structure. The second series are diamond-like and has its C-C "stretching" frequency around $1540 \pm 20 \text{ cm}^{-1}$ (Fig.11). This corresponds to a new structure named "diamite" or "bridged graphite" where some carbon atoms get out of the graphitic layer making possible the bonding between adjacent layers [23].

3.4 - Phase conversions

In the series of new Y-Ba-Cu-O copper oxides, $YBa_2Cu_3O_6$ is semiconductor. When the vacancies in its structure are partially occupied by oxygen, the material becomes a superconductor. With $YBa_2Cu_3O_7$, the T_c reaches 92 K. Raman spectroscopy is an easy method to identify them (Fig.12). In addition, the Raman frequency ν_H corresponding mainly to the stretching of the Cu^2O^1 bonds along the c axis allows a rapid evaluation [6,24,25] of the oxygen content in $YBa_2Cu_3O_x$:

$$x = 0.025 \nu_H - 5.57 \quad \Delta x = \pm 0.05$$

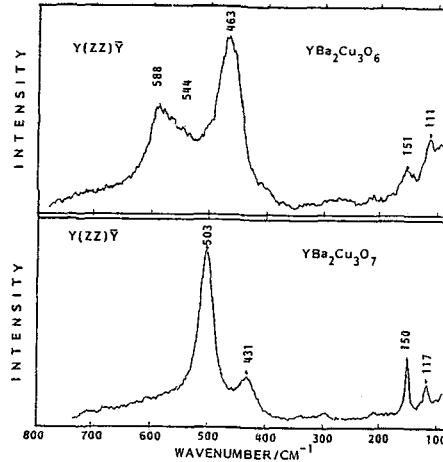

Fig.12 - ZZ polarized Raman spectra of $YBa_2Cu_3O_6$ and $YBa_2Cu_3O_7$.

In $YBa_2Cu_3O_7$ (Y_{123}), there is one Cu^1O^4 layer between the two BaO^1 layers. Very recently a new and very promising material presents two Cu^1O^4 layers between the two BaO^1 layers : $YBa_2Cu_4O_8$ (Y_{124}) (leading to two Raman Cu-O bands in polarized spectrum along c axis (Fig.13). The conversion of Y_{124} into Y_{123} is easily followed by Raman spectroscopy : the frequency shifts also help to explain the change in bond length and in the size of their unit cell, in particular in the c axis.

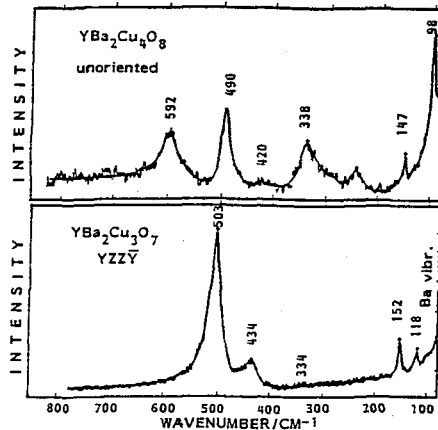

Fig.13 - Raman spectrum of $YBa_2Cu_4O_8$.

4 - ORIENTATION OF SURFACES AND THIN LAYERS

Based on strong anisotropy frequently existing in Raman scattering (Fig.14), the orientation of a surface on thin layer can be determined [25,27-29] by recording its perpendicular back-scattering and by referring to a calibration made with polarized Raman spectra of known oriented single crystals.

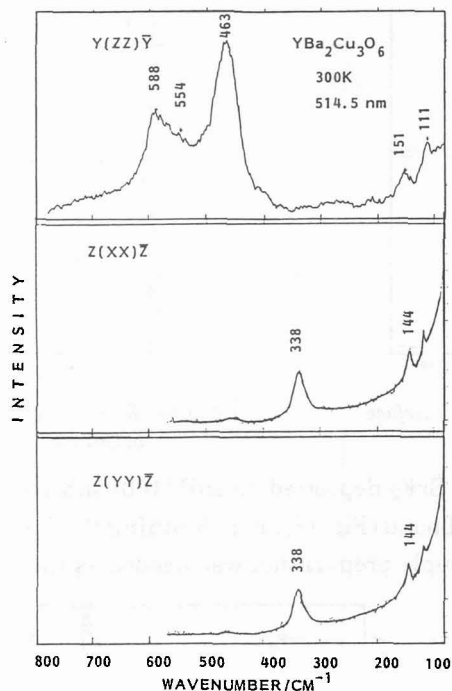

Fig.14 - Polarized Raman spectra of $YBa_2Cu_3O_6$ single crystal.

5 - INTERFACE - CHEMICAL BONDING BETWEEN DEPOSIT AND SUBSTRATE

In bi-layers of semiconductor on semiconductor or semiconductor on insulator, the nature of the interface depends strongly on the lattice mismatch and on the preparation conditions. Raman spectroscopy can help to detect structural modifications around the interface and eventually new chemical bonds which can occur between deposit and substrate by applying the method described above on step-etched or bevelled samples (Fig.15).

With GaAs on Ge [17], both Ga-Ge and As-Ge bonds were shown (Fig.16). With GaAs on Si [11,30], only As-Si bonds are detected (Fig.17).

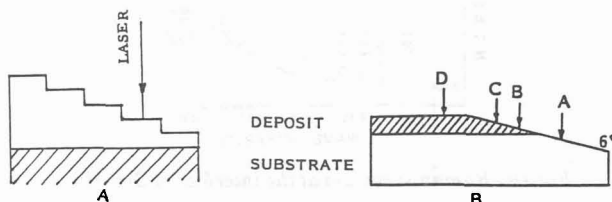

Fig.15 - Step-etched and bevelled bi-layers.

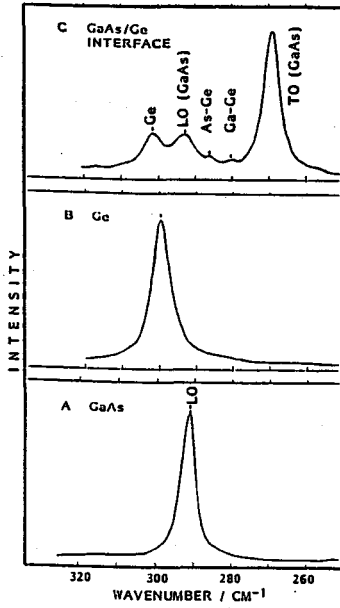

Fig.16 - Raman spectrum at the interface of GaAs/Ge.

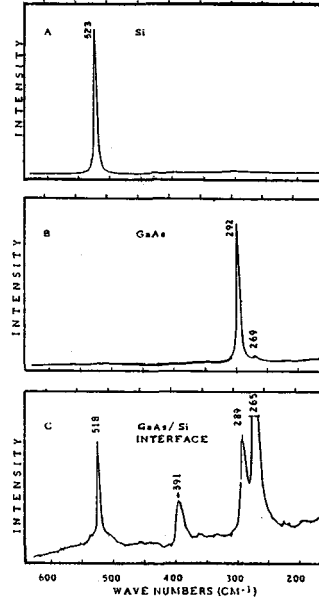

Fig.17 - Raman spectrum at the interface of GaAs/Si.

For insulator SrF₂ deposited on InP (100) substrate [31], P-F seemed to be the only one existing chemical bond (Fig.18). For obtaining the Raman spectrum of the interface in this case, no further sample preparation was needed as the insulator SrF₂ is transparent to the laser used.

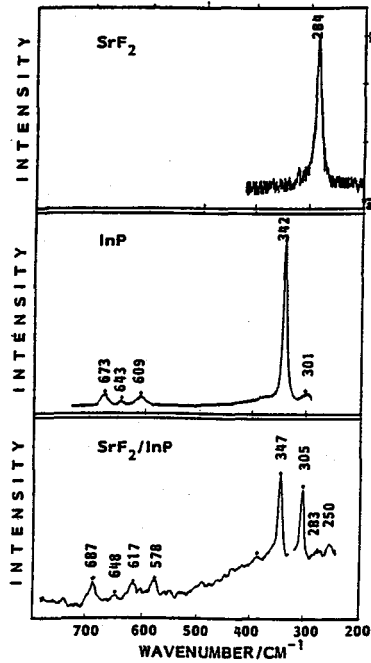

Fig.18 - Raman spectrum at the interface of SrF₂/InP.

6 - CONCLUSION

Some above examples illustrate the ability of Raman and micro-Raman in the characterization of semiconductor bulk materials, surfaces and interfaces.

The technique informs not only in the nature of the elements, but also on the chemical bonds between atoms. It presents also the advantage in the studies of amorphous and disordered materials.

Due to high anisotropy observed in Raman polarization, the determination of the orientation of a surface or thin layer becomes easy.

Finally, thanks to the spatial resolution of the order of $1 \mu\text{m}^2$ of micro-Raman technique, the studies of heterogenous or very small samples, as well as that of stress or gradient become also easy.

Acknowledgements. A grant from the Indo-Fench Centre for the Promotion of Advanced Research is appreciated.

REFERENCES

- 1 "Raman Spectroscopy : Linear and non Linear".
J.LASCOMBE, Pham V. HUONG, (Eds), Wiley, Chichester, New-York, 1982.
- 2 "Le Silicium".
Pham V. HUONG, (Ed.), Masson, Paris, 1983.
- 3 "Le Silicium à finalité microélectronique et photovoltaïque" (Tome I).
Pham V. HUONG, (Ed.), Masson, Paris, 1986.
- 4 "Le Silicium à finalité microélectronique et photovoltaïque" (Tome II).
Pham V. HUONG, (Ed.), Masson, Paris, 1987.
- 5 Pham V. HUONG, in "Lasers and Applications", H.D.Bist and J.S.Goela (Eds)., Tata McGraw-Hill, Bombay 1984.
- 6 Pham V. HUONG, in "Analysis of Micro-electronic Materials and Devices"
M.Grasserbauer, H.W.Werner (Eds).Wiley, Chichester/New-York, 1991.
- 7 P.V. HUONG, in "Vibrational Spectra and Structure".
J.R.Durig Ed., Elsevier, New-York, Amsterdam, 1980.
- 8 Pham V. HUONG, in "Reviews on Analytical Chemistry".
L.Niinisto Ed., Akademia Kiado, Budapest 1982, 209.
- 9 P.V.HUONG, A.L.VERMA, J.P.CHAMINADE, L.NGANGA, J.C.FRISON,
Materials Science and Engineering, 1990, B5, 255.
- 10 A.FREUNLICH, A.LEYCURAS, J.C.GRENET, C.VERIE , Pham V.HUONG,
Appl.Phys.Lett., 1987, 51, 1352.
- 11 P.V. HUONG, A.LEYCURAS, A.FREUNDLICH,
Raman Spectroscopy, R.J.H.Clark, D.A.Long Eds.,
Wiley, Chichester/New York, 1988, p.393
- 12 Pham V. HUONG,
Materials Sci. & Engineering, 1991,
- 13 G.ABSTREITER, M.CARDONA, A.PINCZUK,
in "Light Scattering in Solid IV", M.Cardona, G.Guntherodt (Eds),
Springer, Berlin 1984, p.5.

- 14 B.A.WEINSTEIN, G.J.PIERMERINI,
Phys.Lett., 48A (1974) 14.
- 15 B.TROMMER, H.MULLER, M.CARDONA, P.VOGT,
Phys.Rev. B21 (1980) 4869.
- 16 B.A.WEINSTEIN, R.ZALLEN,
in "Light Scattering in Solid IV", M.Cardona, G.Guntherodt (Eds),
Springer, Berlin 1984, p.463.
- 17 P.V. HUONG, A.LEYCURAS,
Thin Solid Films, 1990, 184, 423.
- 18 K.NAKAMOTO, in "Infrared and Raman spectra of Inorganic compounds",
Wile, New York, 1978.
- 19 Pham.V. HUONG, J.L.VUOTTO,
Ann.Chim.Paris, 1986, 11, 683.
- 20 J.L.VUOTTO, J.DEVAURE, P.V. HUONG,
Ann.Chim., Paris, 1986, 11, 667.
- 21 G.VILLELA, Pham V. HUONG, J.L.VUOTTO,
Ann.Chim., Paris, 1987, 12, 445.
- 22 P.V. HUONG, O.SECOND, P.GENTILINI, R.CAVAGNAT,
Applied Surface Sci., 1989, 43, 256.
- 23 Pham V. HUONG,
Diamond and Related Materials, 1991, 1,33.
- 24 L.NGANGA., Pham V. HUONG, J.P.CHAMINADE, P.DORDOR,
K.FRÖLICH, M.JERGEL,
J.Less.Common Metals, 1990, 164 & 165, 208-214.
- 25 Pham V. HUONG,
J.Less.Common Metals, 1990, 164 & 165, 1193-1200.
- 26 P.V. HUONG, J.P.CHAMINADE, J.C.FRISON, Y.K.PARK, J.C.PARK,
K.H.KIM, J.S.PARK,
High temperature superconductor thin-films. Properties and applications.
L.Correra (Ed), Elsevier, Amsterdam, 1991
- 27 P.V. HUONG,
High temperature superconductor thin-films. Properties and applications.
M.D.Crescenzi (Ed), Elsevier, Amsterdam, 1991,
- 28 P.V. HUONG, J.C.BRUYERE,,
in "*Modern Aspects of Superconductivity*", R.Suryanaryanan (Ed.),
I.L.T.T., Paris, 1989, p.149
- 29 P.V. HUONG, J.C.BRUYERE, E.BUSTARRET, P.GRANCHAMP,
Solid State Comm., 1989, 72, 191.
- 30 P.V. HUONG, P.BOUTINAUD, S.KAZAOUI, A.LEYCURAS,
Microbeam Analysis, San Francisco Press, 1988, 23rd, 167.
- 31 P.V. HUONG, E.OLLIER, S.DELAVOYE, R.CAVAGNAT,
B.MOMBELLI, A.S.BARRIERE, A.L.VERMA,
Non stoichiometry in semiconductors, K.J.Backmann, H.L.Hwane (Eds),
Elsevier, Amsterdam, 1991.