



HAL
open science

Thermal conduction through a vented support

S. Buhler

► **To cite this version:**

S. Buhler. Thermal conduction through a vented support. Journal de Physique III, 1994, 4 (4), pp.663-669. 10.1051/jp3:1994156 . jpa-00249135

HAL Id: jpa-00249135

<https://hal.science/jpa-00249135>

Submitted on 4 Feb 2008

HAL is a multi-disciplinary open access archive for the deposit and dissemination of scientific research documents, whether they are published or not. The documents may come from teaching and research institutions in France or abroad, or from public or private research centers.

L'archive ouverte pluridisciplinaire **HAL**, est destinée au dépôt et à la diffusion de documents scientifiques de niveau recherche, publiés ou non, émanant des établissements d'enseignement et de recherche français ou étrangers, des laboratoires publics ou privés.

Classification
 Physics Abstracts
 07.20M — 07.20F

Thermal conduction through a vented support

S. Buhler

Institut de Physique Nucléaire, 91406 Orsay Cedex, France

(Received 15 July 1993, revised 25 October 1993, accepted 15 November 1993)

Abstract. — A simplified theory of thermal conduction in a support vented with cold vapour is described which allows the construction of convenient graphs for practical applications. The very same model is employed to extend the Wexler correlation [1] beyond its classic limits and corresponding diagrams are presented for helium and nitrogen.

1. The vented support.

Consider a solid support vented with cold vapours in a counter-current way with the following assumptions (Fig. 1) :

- Temperatures T_1 and T_2 respectively on each end of the support are in steady-state ;
- Conducting cross-section $A = \text{Constant}$;

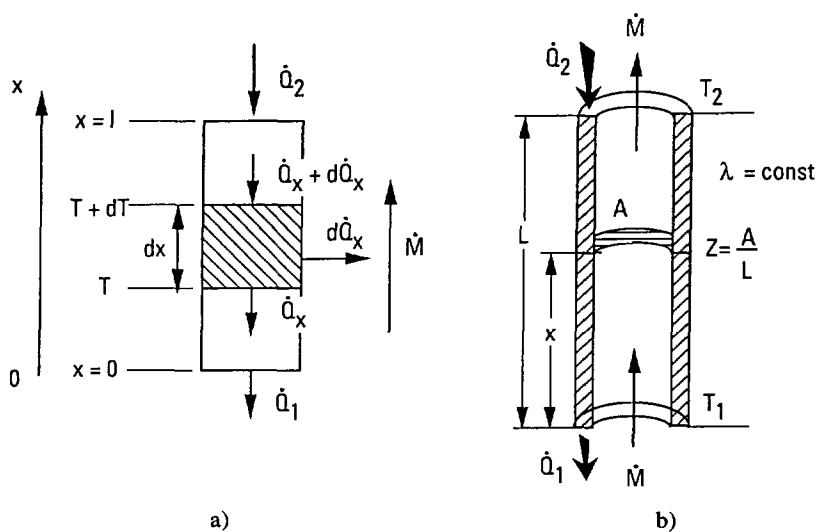

Fig. 1. — Heat flow balance, a) on a infinite element, b) on a given support.

- The average thermal conductivity is given by λ_m where

$$\lambda_m = \frac{1}{T_2 - T_1} \int_{T_1}^{T_2} \lambda \, dT = \text{Constant} ;$$

- Specific heat of the vapour $c_p = \text{Constant} ;$

If we assume a perfect heat exchange between the solid conductor and the vent mass flow, \dot{M} , we can establish two heat balances :

Heat flow $\dot{Q}(x)$ in the wall of the support :

$$\dot{Q} = - \lambda \cdot A \cdot \frac{dT}{dx} . \quad (1)$$

Perfect heat exchange from vapour to wall ; corresponding heat balance

a) on a finite element dx :

$$d\dot{Q}(x) = \dot{M} \cdot c_p \cdot dT \quad (2)$$

b) on the total length of the support :

$$\dot{Q}_2 - \dot{Q}_1 = \dot{M} \cdot c_p \cdot (T_2 - T_1) . \quad (3)$$

From equations (1) to (3) we determine \dot{Q}_1 or its reduced value with $Z = A/L$:

Outflowing heat \dot{Q}_1/Z from the support (at cryogenic temperature T_1) :

$$\frac{\dot{Q}_1}{Z} = \frac{\frac{\dot{M}}{Z} \cdot c_p \cdot (T_2 - T_1)}{\exp\left[\frac{\dot{M} \cdot c_p}{Z \cdot \lambda}\right] - 1} \quad (5)$$

also the.

Inflowing heat \dot{Q}_2/Z into the support (at ambient temperature T_2) :

$$\frac{\dot{Q}_2}{Z} = \frac{\dot{M}}{Z} c_p (T_2 - T_1) \cdot \left[\frac{\exp\left[\frac{\dot{M} \cdot c_p}{Z \cdot \lambda}\right]}{\exp\left[\frac{\dot{M} \cdot c_p}{Z \cdot \lambda}\right] - 1} \right] . \quad (6)$$

Likewise we establish the temperature profile $T(x)$, or, with $\psi = x/L$, expressed in a reduced form.

Temperature profile :

$$T(\psi) = (T_2 - T_1) \cdot \left[\frac{\exp\left[\frac{\dot{M} \cdot c_p \cdot \psi}{Z \cdot \lambda}\right] - 1}{\exp\left[\frac{\dot{M} \cdot c_p}{Z \cdot \lambda}\right] - 1} \right] + T_1 . \quad (7)$$

A practical application for the heat flow at low temperature \dot{Q}_1/Z is represented in figure 2a for different materials of a helium vented support between 4 to 300 K ; figure 2b shows the evolution of its temperature profile under these conditions.

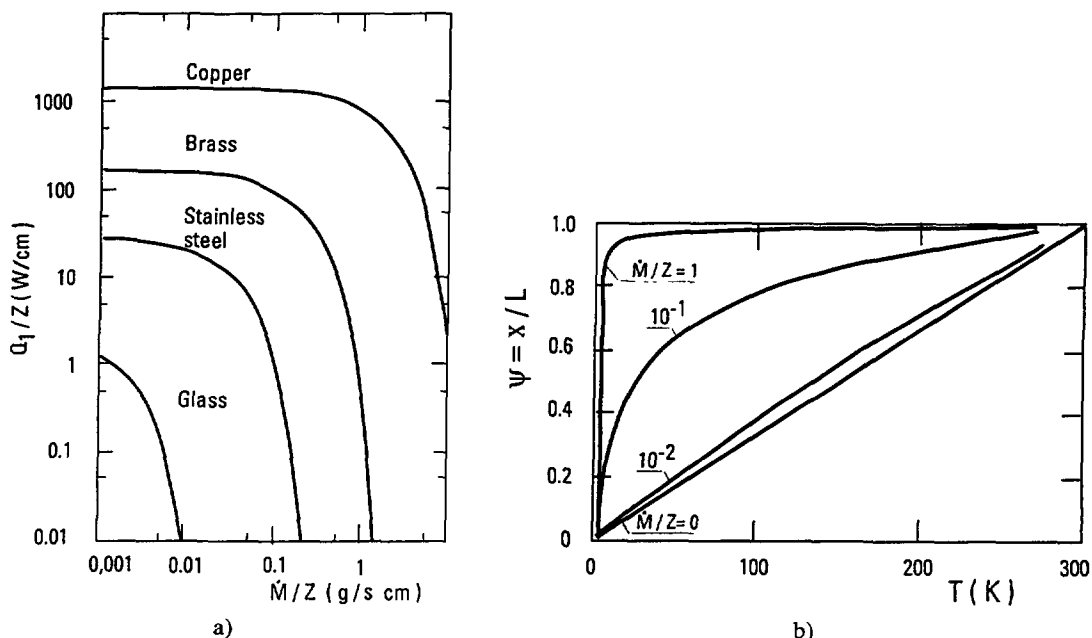

Fig. 2. — Vented supports with cold helium vapours from 4 to 300 K. a) Residual heat flow $\dot{Q}_1/Z = f(\dot{M}/Z)$ at 4 K. b) Temperature profile $T = f\left(\frac{x}{L}, \frac{\dot{M}}{Z}\right)$ for stainless steel.

2. Wexler correlation.

Wexler [1] has investigated the boil-off rate of a LHe reservoir, in particular when he enhanced it artificially with an immersed electric heater (Fig. 3a). This procedure allowed him to distinguish the radiation and the residual conduction components within the total heat flow (Fig. 3b) which is absorbed through a continuous evaporation of the saturated cryoliquid (latent heat of vaporization ℓ_v).

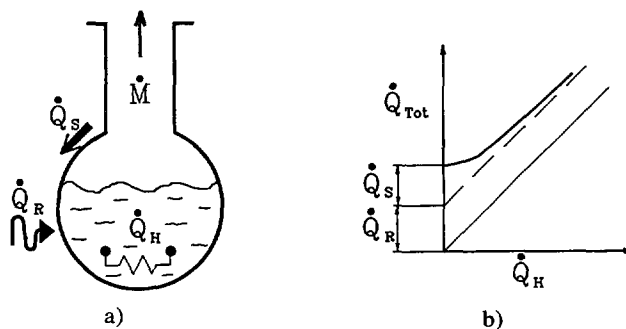

Fig. 3. — a/b) Classic Wexler set-up and diagram.

Wexler's model, however, is restrictive, since the total produced vapour flow always has to vent the single neck of his reservoir.

Figure 4a shows the principle of a different cryostat with two separate escape lines. The total boil-off \dot{M}_{tot} may be split into a support vent flow, \dot{M}_V , and its complement, \dot{M}_B , diverted through a by-pass such that

$$\dot{M}_V = \dot{M}_{tot} - \dot{M}_B \tag{8}$$

The Wexler correlation

$$\dot{Q}_V = \dot{Q}_{S1} + \dot{Q}_R + \dot{Q}_H \tag{9}$$

where

$$\dot{Q}_{S1} = f(\dot{M}_V)$$

is now valid for any mass flow distribution : for $\dot{M}_B = 0$ one finds the classic Wexler configuration with $\dot{Q}_H \geq 0$, whereas for $\dot{M}_B > 0$ one has to extend it to virtual but negative values $\dot{Q}_H < 0$.

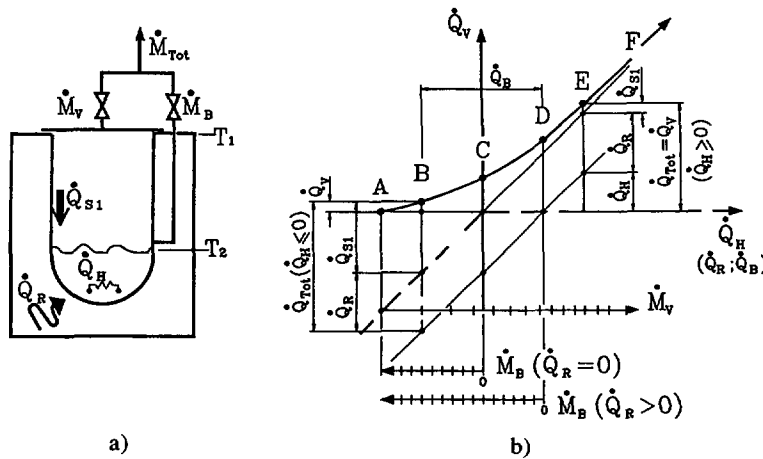

Fig. 4. — a) Cryostat with two exhausts for cold vapours. b) Principle of the extended Wexler diagram.

Table I. — Specificity of the points (A) to (F) in an extended Wexler diagram.

Point	Mass flow \dot{M}		Heat flow		Comment
	\dot{M}_V	\dot{M}_B	\dot{Q}_R	\dot{Q}_H	
Ref.	\dot{M}_V	\dot{M}_B	\dot{Q}_R	\dot{Q}_H	Mode
A	0	\dot{M}_{tot}	0	< 0	Adiabatic conduction through a nonvented support
B	$0 < \dot{M}_{tot}$	$> \dot{M}_{tot}$	0	< 0	Subvented support
C	\dot{M}_{tot}	0	0	0	Self-vented support (conduction only)
D	\dot{M}_{tot}	0	> 0	0	Self-vented reservoir (conduction and radiation)
E	\dot{M}_{tot}	0	> 0	> 0	Moderately enhanced ventilation
F	\dot{M}_{tot}	0	> 0	$\rightarrow \infty$	Extremely enhanced ventilation

Figure 4b shows a new Wexler diagram, now extended to 6 different vent flow modes explained in the table below.

Table II. — *Parameters definition for figure 4b.*

\dot{M}_V	Vent mass flow	(g/s)
\dot{M}_B	By-pass mass flow	(g/s)
\dot{M}_{tot}	Total mass flow (produced boil-off)	(g/s)
\dot{Q}_{S1}	Outflowing heat from vented support	(W)
\dot{Q}_R	Radiative heat flow into the cryoliquid	(W)
\dot{Q}_H	Additional heat flow from immersed heater	(W)
\dot{Q}_{tot}	Total heat flow absorbed from the cryoliquid	(W)
\dot{Q}_V	Heat flow evacuated from the vent only	(W)
ℓ_v	Latent heat of vaporization of the cryoliquid	(J/g)

3. Calculation of the extended Wexler correlation.

For general practice it is advisable to express mass and heat flows in their reduced form, divided by $Z = A/L$.

Selection of the fixed parameters :

- Gas nature ($\rightarrow c_p, \ell_v$ for nitrogen, helium...)
- Temperatures T_1, T_2 on each end of the support
- Supports material (stainless steel, brass.. $\rightarrow \lambda_m$).

Calculation procedure :

- choose any value for \dot{Q}_{tot}/Z
- calculate

$$\frac{\dot{M}_{tot}}{Z} = \frac{\dot{Q}_{tot}}{\ell_v \cdot Z}$$

- since

$$\dot{M}_{tot} = \dot{M}_B + \dot{M}_V$$

select any \dot{M}_B and corresponding \dot{M}_V where $0 \leq \dot{M}_B \leq \dot{M}_{tot}$

- calculate

$$\frac{\dot{Q}_B}{Z} = \frac{\dot{M}_B}{Z} \cdot \ell_v \quad \text{and} \quad \frac{\dot{Q}_{S1}}{Z} = f\left(\frac{\dot{M}_V}{Z}\right)$$

- determine

$$\frac{\dot{Q}_R + \dot{Q}_H}{Z} = \frac{\dot{Q}_{tot} - \dot{Q}_{S1}}{Z}$$

- and finally

$$\frac{\dot{Q}_V}{Z} = \frac{\dot{Q}_{S1}}{Z} + \frac{\dot{Q}_R + \dot{Q}_H}{Z} - \frac{\dot{Q}_B}{Z}$$

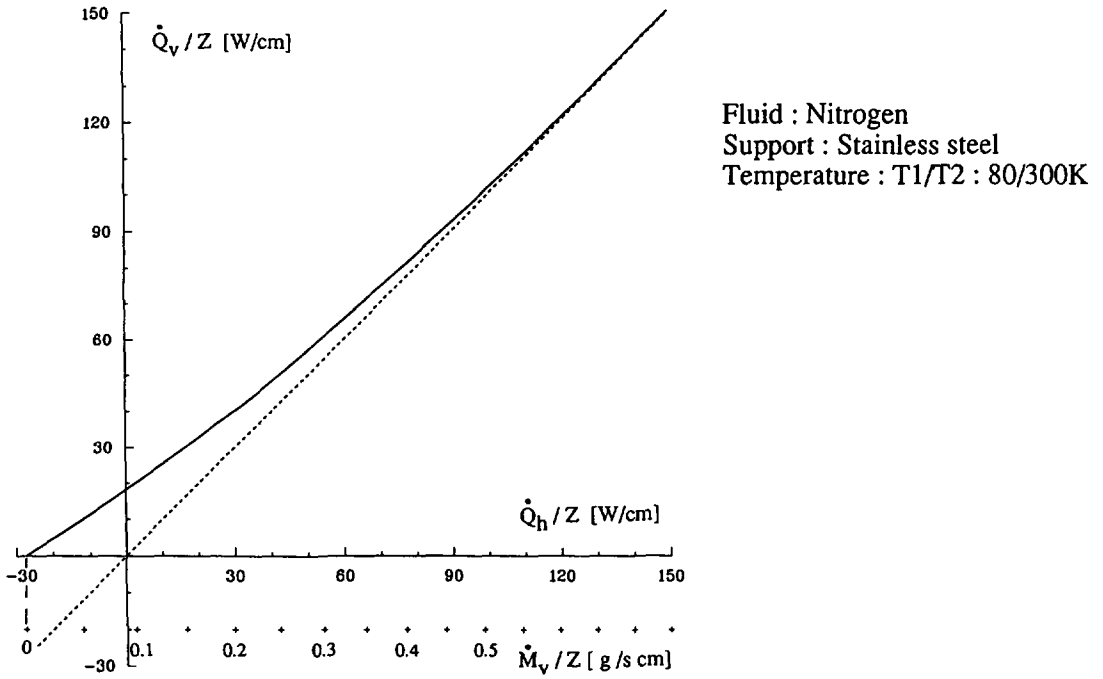

Fig. 5. — Extended Wexler diagram for nitrogen.

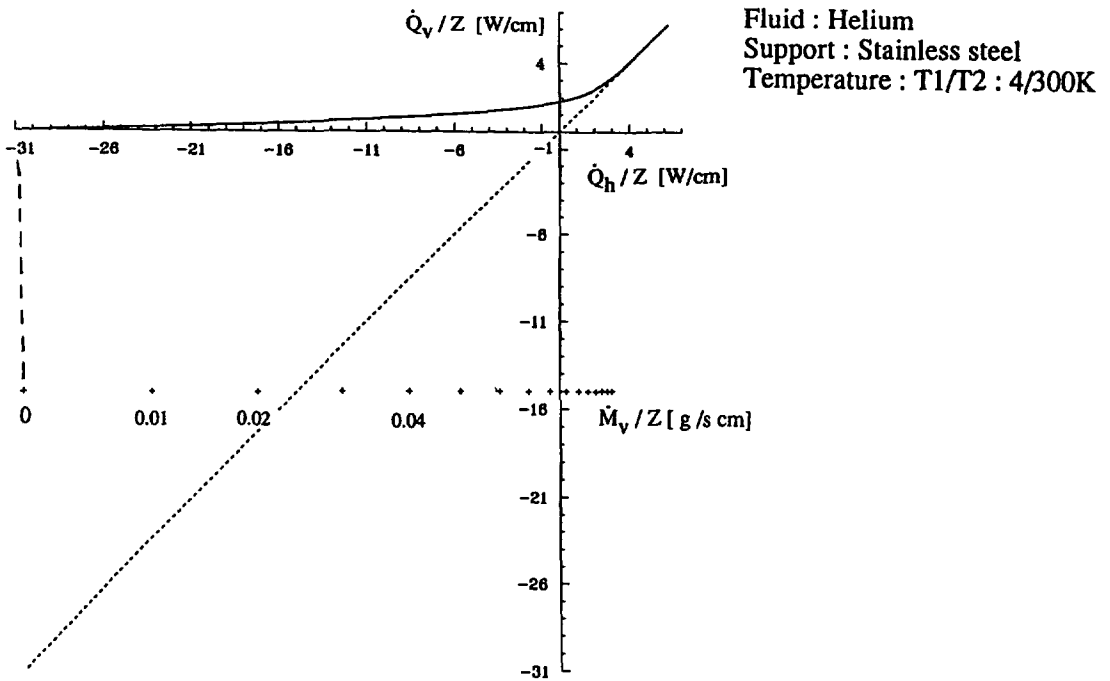

Fig. 6. — Extended Wexler diagram for helium.

As \dot{Q}_V depends on the vent mass flow, \dot{M}_V , we can introduce $\dot{Q}_V = f(\dot{M}_V)$ as a secondary scale in the same diagram. We also may proceed analogously for $\dot{Q}_V = f(\dot{M}_B)$, but the starting point of this third scale will be different for any given cryostat, depending on its specific \dot{Q}_R .

Figures 5 to 7 represent the extended and reduced Wexler diagrams for nitrogen and helium in well defined conditions.

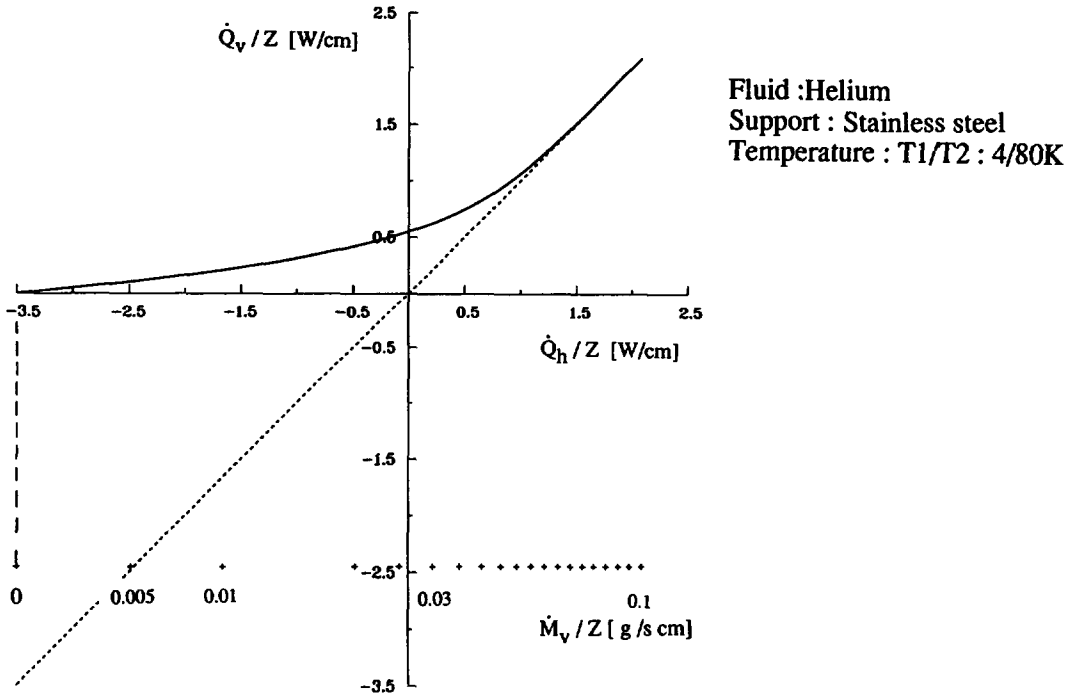

Fig. 7. — Extended Wexler diagram for helium.

4. Discussion and conclusions.

The proposed calculation procedure for a vented support should be considered as a first approach intended to fix the order of magnitude. However the method is convenient and straight-forward if one makes use of the appropriate diagrams.

We notice that the so-called « Wexler effect » (i.e. a moderate change of the boil-off rate resulting from a substantial increase of the heat Q_H dissipated) is rather pronounced for LHe but far less perceivable for LN.

The validity of the model used is certainly restricted and should be compared with some experimental data [2].

References

[1] Wexler A., Evaporation rate of liquid helium, *J Appl. Phys* **22**, no. 12 (1951).
 [2] Khemis O., Optimisation des réservoirs cryogéniques, Thèse Univ., Paris VI (in preparation).