



HAL
open science

The frequency control of laser diodes

M. de Labacherie, C. Latrassé, P. Kemssu, P. Cerez

► **To cite this version:**

M. de Labacherie, C. Latrassé, P. Kemssu, P. Cerez. The frequency control of laser diodes. Journal de Physique III, 1992, 2 (9), pp.1557-1589. 10.1051/jp3:1992200 . jpa-00248827

HAL Id: jpa-00248827

<https://hal.science/jpa-00248827>

Submitted on 4 Feb 2008

HAL is a multi-disciplinary open access archive for the deposit and dissemination of scientific research documents, whether they are published or not. The documents may come from teaching and research institutions in France or abroad, or from public or private research centers.

L'archive ouverte pluridisciplinaire **HAL**, est destinée au dépôt et à la diffusion de documents scientifiques de niveau recherche, publiés ou non, émanant des établissements d'enseignement et de recherche français ou étrangers, des laboratoires publics ou privés.

Classification
Physics Abstracts
42.60

The frequency control of laser diodes

M. de Labachellerie, C. Latrasse, P. Kemssu and P. Cerez

Laboratoire de l'Horloge Atomique, Unité de recherche du CNRS, Bât. 221, Université Paris-Sud, 91405 Orsay Cedex, France

(Received 4 February 1991, accepted 6 April 1992)

Abstract. — It is shown that spectral characteristics of laser diodes are rather poor and that frequency control methods are needed to be able to use laser diodes in numerous applications. We describe precisely the problems encountered with laser diodes and attempt to explain their origin. Various means used to control laser diodes frequency are then reviewed ; each of them can be used in order to obtain a better control on a particular feature needed for a given application. However, we put an emphasis on the Extended-Cavity laser solution which is shown to solve satisfactorily each problem. Another challenge consists in obtaining a good frequency control with high power laser diodes. We also describe the state of the art for this purpose and discuss the experiments already made.

1. Introduction.

Wide wavelength tunability, low power operation, direct modulation capabilities and low prices make laser diodes very attractive light sources for many laser applications in the red and near infra-red regions of the spectrum. However, in practice, we have to moderate our enthusiasm when we consider, for instance, the spectral purity of laser diodes. Laser diodes are generally not satisfactory if the relevant applications needs a high spectral purity, an easy tunability at a precise wavelength or an absolute frequency stability. Such properties are desired in coherent optical communications [1], length and frequency metrology [2], atomic physics and spectroscopy [3], sensor technology [4], because they have a significant influence upon the accuracy and resolution in spectroscopy and metrology, and upon detection signal-to-noise ratio in communication systems.

The aim of this paper is to review the problems encountered with the frequency control of laser diodes. Then, we shall see how such problems can be solved. A particular attention is paid to the extended-cavity laser structure which appears to be the most efficient solution at present time.

2. Laser diode frequency control review.

2.1 SINGLE MODE OPERATION OF LASER DIODES. — Laser diodes may be classified in two types (Fig. 1) :

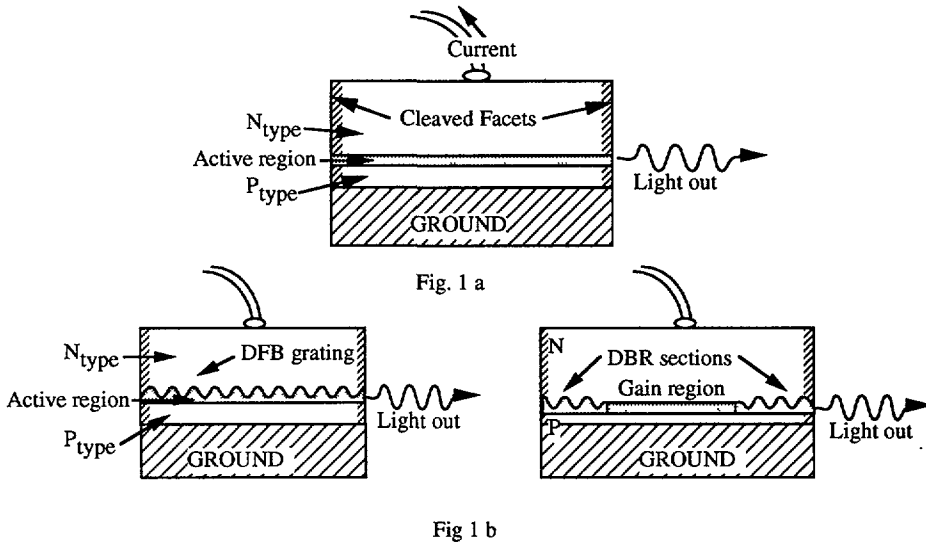

Fig. 1. — a) Schematic illustration of a Fabry-Perot semiconductor laser. b) Schematic illustrations of DFB and DBR lasers.

- Conventional Fabry-Perot structures (FP).
- Lasers based on distributed feedback (DFB) and distributed Bragg reflector (DBR) structures.

The first category of lasers is the most common. Index-guided AlGaAs FP lasers are generally single frequency under CW operation in the 750 to 850 nm range although the visible InGaAlP lasers and infrared InGaAsP lasers (1 300-1 500 nm) will have their power distributed in several longitudinal modes. The modal discrimination is poor in the FP laser structures because it only comes from the gain curve itself which is very wide in semiconductor lasers. At 850 nm, it amounts to 40 nm while the mode spacing is on the order of 0.3 nm which shows that adjacent modes have practically the same gain and losses, therefore often leading to a multimode output.

DFB and DBR lasers are specially designed to deliver a single frequency output. The internal optical losses are made wavelength dependent in order to favour only a few modes. In DBR structures, the output mirrors are replaced by gratings that are etched in the longitudinal direction, in the vicinity of the junction plane near cavity ends (Fig. 1b). These unpumped corrugated regions act as wavelength selective mirrors which are called Bragg reflectors.

In DFB lasers, a grating is etched under the active layer, all over the cavity length. Internal forward propagating waves are gradually scattered backward by the grating and feeds the backward wave which is scattered likewise. The various scattered waves interfere constructively for a limited wavelength range and therefore, only a few wavelengths can grow in such a structure. The measure of spectral purity is given by the side-mode suppression ratio which is the ratio of the main mode power to the maximum side modes power. DFB and DBR lasers exhibit a single frequency output with high side mode suppression (> 30 dB).

2.2 OSCILLATING MODE CONTROL.

2.2.1 Mode control using temperature/current control. — Frequency tuning of semiconductor lasers is possible because both the cavity refractive index μ and maximum gain wavelength

shifts with temperature and injection current. The lasing mode wavelength λ_m shifts with refractive index variations according to :

$$\delta \lambda_m / \lambda_m = \delta \mu / \mu . \quad (1)$$

In FP lasers, the tuning curve *versus* temperature follows a typical staircase pattern (Fig. 2). This shape arises from the velocity difference between gain curve shift (0.25 nm/K) and optical length shift (0.05 nm/K). For any temperature variation, the selected mode will thus shift but at the same time, the next adjacent mode will progressively be favoured, which lead to the observed periodic mode hops. Although the mode hop should normally occur between adjacent modes, it is often observed that the wavelength jumps several intermodes or even jumps in the wrong direction. This phenomenon comes from technological defects. In FP diodes, the wavelength selectivity is so low that any parasitic wavelength selectivity, such as weak internal reflections inside the laser waveguide, can become dominant and lead to a random tuning behaviour. An important consequence of this fact is the existence of forbidden wavelength bands leading to an uncomplete spectral coverage of the diode amplifying band. This is a major drawback to the use of FP lasers in atomic physics or spectroscopy for instance because sometimes, it is impossible to attain a fixed desired wavelength. Moreover, it has been observed that the forbidden wavelengths drift during laser diode aging [7]. There is then no certainty that the laser will keep its wavelength once the desired wavelength is attained.

Variations of injection current affect the diode refractive index through two independent mechanisms that are junction temperature variations and injected carriers density. For low frequency variations ($\Omega < 1$ MHz), the two contributions are summed which lead to a frequency shift of -2 GHz/mA. Above 1 MHz, the carrier density contribution only remains and the frequency shift *versus* current is divided by ten.

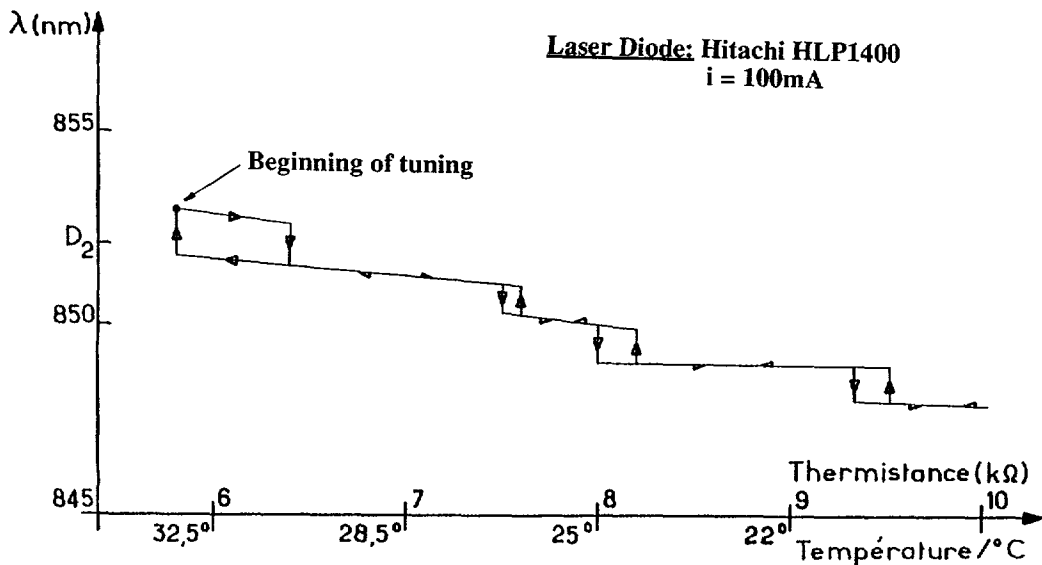

Fig. 2. — Typical wavelength tuning curve of a FP laser *versus* temperature (reprinted from G. Avila, thesis, Orsay, 1984).

DFB and DBR lasers outperform FP lasers with respect to the tunability *versus* temperature (Fig. 3). The same unique longitudinal mode can be maintained in a great temperature range without mode hops. Of particular interest are three sections DBR lasers which exhibit a large electrically controlled tuning range. A schematic view of such lasers is shown in figure 4. One of the mirrors is a Bragg reflector (first section) which provides the modal selectivity while the other is a cleaved facet. The other two sections are the gain and phase shift sections. Tuning is achieved by increasing the current injection in the phase shift region which lowers its refractive index, thus giving a higher mode frequency. A large free of mode hops tuning range can be obtained if the Bragg wavelength tracks the longitudinal modes frequencies, which can be obtained by maintaining a suitable relationship between the driving currents of the Bragg and phase shift section. The total frequency span can be as wide as 800 GHz.

2.2.2 *Mode control using an ultra short external-cavity (SXC).* — It is possible to force a laser diode to oscillate in a given longitudinal mode by using an external spectrally selective

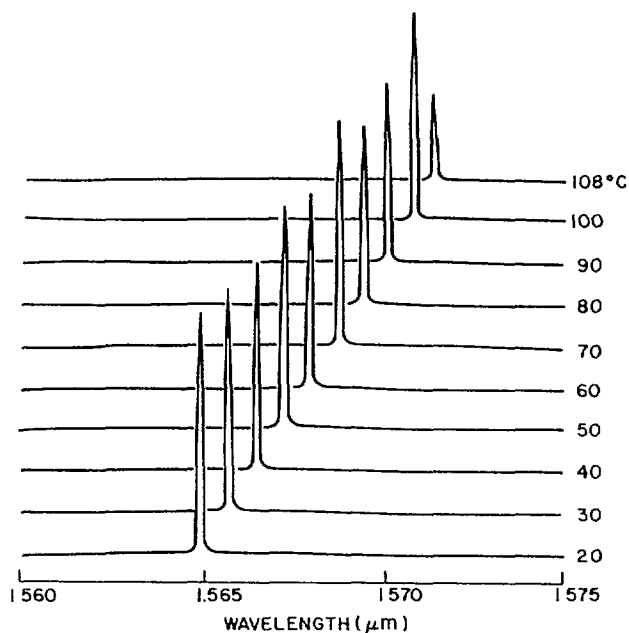

Fig. 3. — Longitudinal mode spectra of a DFB laser at several temperatures (After Ref. [8]).

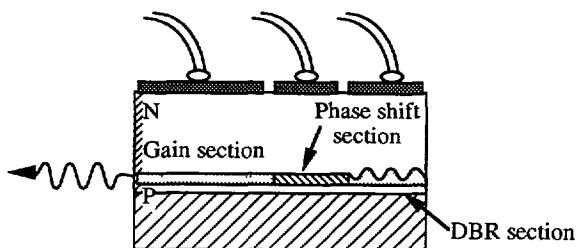

Fig. 4. — Schematic illustrations of a three sections electrically tunable DBR laser.

element. This element can be a Fabry-Perot etalon which modifies the effective reflectivity of one laser facet.

An external etalon is formed by placing a mirror of reflection coefficient R_{ex} at a distance L_{ex} close to one diode facet of reflectivity R (Fig. 5). We define the effective reflection coefficient ρ (or « feedback ratio ») as the fraction of laser output power reflected by the external reflector and effectively coupled back in the laser diode :

$$\rho = R_{ex} \eta \tag{2}$$

where η is a geometrical factor describing the coupling of reflected light in the laser diode optical guide.

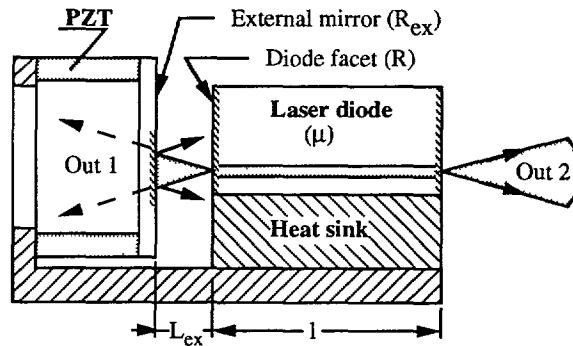

Fig. 5. — Experimental setup for the mode control of a laser diode using an ultra-short external-cavity.

The laser diode facet is thus replaced by a Fabry-Perot etalon which acts as a wavelength dependent mirror of « effective » reflectivity R_{eff} given for $\rho \ll 1$ by :

$$R_{eff} = R \left[1 + 2 \sqrt{\rho} \frac{1 - R}{\sqrt{R}} \cos (2 k_0 L_{ex}) \right] \tag{3}$$

where k_0 is the wave vector in vacuum ($k_0 = 2 \pi / \lambda_0$).

Therefore, the cavity losses *versus* wavelength are periodically decreased with a period $\Delta\lambda_{EC} = \Delta\lambda_d \cdot (\mu l / L_{ex})$ corresponding to the external-cavity modes. If the distance L_{ex} is smaller than the diode optical length ($\Delta\lambda_{EC} \gg \Delta\lambda_d$), one diode mode will be favoured each $\Delta\lambda_{EC}$. The selected mode with highest gain will oscillate and the other selected modes are usually too far from gain peak to oscillate simultaneously. For a mirror displacement of $\lambda / 2 (L_{ex} / \mu l)$ the external cavity modes will select the next diode mode and the laser frequency jumps to this mode. This mirror position variation should be very precise and requires to mount the external mirror on a piezoelectric transducer (PZT).

— If the solitary diode is initially single mode, this method allows to introduce a selective mechanism much stronger than any parasitic selective mechanism responsible for the uncomplete spectral coverage of laser diodes. Any mode among the ten dominant modes which are located at the diode gain peak can thus be selected, and any frequency can be attained in the $\Delta\lambda_{EC}$ spectral range.

We have used a microscope glass plate with a $R_{ex} = 30 \%$ reflective coating, placed between the diode and a collimating objective at about $100 \mu m$ from the output facet, to control the

frequency of a 0.85 μm Hitachi HLP1400 laser diode. A 3 nm PZT tuning range has been obtained at a fixed temperature, and we could reach the Cesium D₂ resonance at 852.1 nm that has not been reached with the solitary laser. However, it is difficult to set L_{ex} with enough stability (about $\lambda/20$) to avoid jumps to neighbouring modes induced by variations of external reflector position. In our experiments the stability of the selected mode was limited by PZT drifts to a few hours and attempts to glue the reflector at the desired position have failed. However, it is possible to use a servo control which locks the etalon spectral position to a laser diode mode [10]. When temperature variations are used to shift the gain peak frequency, it is possible to obtain an entire spectral coverage over 20-40 nm with the same laser diode.

— This method has also been used to obtain single frequency operation of 1.3-1.5 μm Fabry-Perot InGaAsP diodes [11, 12]. For $\rho > -20$ dB the loss modulation attains a few cm^{-1} which is enough to provide a single-mode operation with a high side-mode suppression ratio (about 30 dB). In order to obtain such a high value of ρ , it is however necessary to use a focusing element to increase the coupling of the external reflector to the diode. It is possible to use a grinrod lens [13] or a spherical mirror [14]. Single mode operation and external tuning have been obtained with lasers that exhibited as much as ten modes in free running operation. However, the method seems to be less efficient for lasers that had initially more longitudinal modes.

2.3 LONG-TERM WAVELENGTH STABILIZATION. — Because of their high wavelength tunability, laser diodes present bad frequency stability in free-running conditions. Their frequency is very sensitive to small changes in injection current and temperature, therefore it has to be stabilized in many metrological applications. Such a long-term frequency locking requires a stable optical frequency reference. Laser diodes gain curve is very broad and thus, it cannot be taken as a reference like in He/Ne lasers. Therefore, it has been necessary to use external frequency references to improve their frequency stability. Many studies have been carried out on this subject and to date, two main methods were proposed using atomic or molecular absorption lines or Fabry-Perot interferometers. As their resonance frequency may change with mechanical vibrations, acoustic noise and temperature, stabilizations on Fabry-Perot interferometers will not be discussed here. It is preferable to use atomic or molecular absorption lines to improve the long term stability and accuracy because they are very stable frequency references by nature.

2.3.1 Frequency references. — The main wavelength regions in which laser diodes are widely spread are 0.78-0.85 μm and 1.3-1.5 μm , because of weak attenuations at these wavelengths in optical fibers. In the 0.8 μm spectral region, interesting transitions are available in alkali vapours such as Cesium (852.1 nm) [15], Rubidium (780.0 nm, 794.8 nm) [16] or Potassium (766.5 nm, 769.9 nm) [17]. Water vapour [18] or Krypton [19] have also been used. These references are usually gases or vapours contained in a glass cell under a low pressure ($P < 20$ torr) in order to reach a Doppler limited minimal absorption linewidth (500 MHz-1 GHz at room temperature).

Absorption lines around 1.3-1.5 μm generally involve transitions from upper vibrational states of molecules. They are therefore often very weak and no systematic studies have been made to find the most absorbing lines. However, a few molecules showed interesting lines and were used to realize lasers stabilizations. Absorption lines were reported in Hydrogen fluoride (HF) [20], Ammonia (NH₃) [21, 22], Acetylene (C₂H₂) [23], water (H₂O) [24], Carbon dioxide (CO₂) [25] or Cyanhydric acid (HCN) [26] and atoms like Argon (Ar), Krypton (Kr) and Neon (Ne) [27] or Rubidium (Rb) [28].

Sub-Doppler reference lines : using saturated absorption techniques allows to detect

narrow resonances inside Doppler lines of atoms and molecules. It consists in saturating a transition with a high intensity beam (pump beam) and detecting the absorption of a counterpropagating beam (probe beam) [29]. If the frequency is swept over the absorption line (by sweeping the laser current or the temperature), a narrow Doppler-free spectrum can be observed on the Doppler-broadened background in the probe beam absorption signal. The saturated absorption lines are usually 100 times narrower than the Doppler line. Depending on the absorbing medium, a more or less high power pump beam is required. The very low power required for Cesium (852 nm) or Rubidium (780 nm) transitions has led to many successful realizations with these gases. On the other hand, the known lines around 1.3-1.5 μm seems to be difficult to saturate with the available laser diode power and have not yet been detected.

2.3.2 Frequency stabilization using a frequency modulation. — An interesting feature of laser diodes is that frequency modulation up to several gigahertz can be achieved by directly modulating the injection current [30]. A first method consists in using this interesting property.

a) Low frequency current ($\Omega_m < 1$ MHz) modulation. — The laser beam is slightly frequency modulated in order to elaborate an error signal using a lock-in amplifier (Fig. 6). After being absorbed in a cell containing the gas, it is detected by a photodetector and fed in the lock-in amplifier. The lock-in amplifier output is proportional to the derivative of the absorption line; it thus cancels at the top of the absorption line which is a very stable frequency reference. This signal is an interesting error signal that can be applied to the current or temperature driver through a servo integrator in order to lock the diode frequency to the top of the absorbing line. However, an additional amplitude modulation is superimposed to the useful signal because of the output power dependence on the injection current. However, this effect usually only leads to a slight offset on the locking point because the amplitude modulation is generally much lower than the frequency modulation converted to amplitude modulation by the absorbing gas.

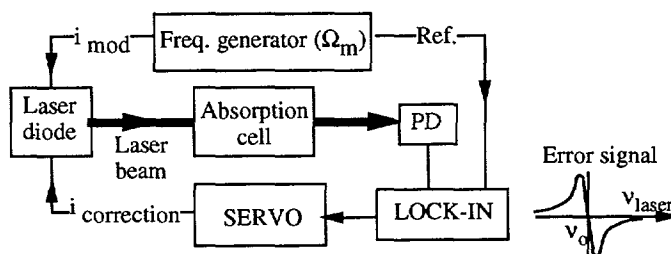

Fig. 6. — Basic setup used for laser diode frequency stabilization on a reference line, using a low frequency modulation.

At 1 277 nm, a hydrogen fluoride (HF) line obtained with a 9.5 cm long cell was used to stabilize an InGaAsP semiconductor laser [20]. Around 1.52 μm , Ammonia (NH_3) lines were used to lock an InGaAsP DFB lasers. A 50 cm-long absorption cell with a pressure of 20 torr provided an absorption of about 13 % at the center wavelength. The frequency drift of about 100 MHz under free-running conditions was lowered to less than 2 MHz by frequency stabilization [21]. Strong absorption lines in C_2H_2 and $^{13}\text{C}_2\text{H}_2$ were used [22] to stabilize DFB lasers around 1.53 μm . A 2 cm-long absorption cell filled under 20 torr pressure could provide a 57 % absorption at 1 531.59 nm. All these experiments led to stability results in the 10^{-10} - 10^{-11} range expressed in terms of the square root of the Allan variance

$\sigma(2, \tau)$ for τ between 1 and 100 s. Successful stabilizations were also realized [27] using glow lamps filled with neon. Ohtsu *et al.* stabilized a 1.56 μm DFB laser on an atomic ^{87}Rb line using internal second harmonic (ISH) generated from the laser itself. The absorption of this ISH (2 pW optical power) from a ^{87}Rb absorption line at 780 nm was detected to stabilize the 1.56 μm fundamental frequency. The resulting stability was estimated to be around $9 \cdot 10^{-12}$ for an averaging time τ of 100 s [28].

Many stabilizations were also performed with 0.8 μm laser diodes. The use of Krypton lines at 769.4 nm led to a 10^{-11} stability [19]. An absorption line of water vapor (with a 10 cm long cell under 20 torr) at 824.3 nm led to stability of 1×10^{-11} and a Rubidium- D_2 line (vapor pressure of 10^{-5} torr) at 780.0 nm gave a 1.4×10^{-12} stability for a 100 s observation times [31].

Influence of the transition linewidth. — It is obvious that the precision of a frequency reference is given by its linewidth, therefore, the narrower the reference line, the better the obtained frequency stability. In order to obtain a significant improvement in stability, it is highly recommended to use saturated absorption lines. This method has widely been used with Cesium and Rubidium lines to stabilize 0.8 μm lasers. Hori *et al.* stabilized the frequency of an GaAlAs laser on a Doppler-free Cs- D_2 line (852.1 nm) using a 5 cm long cell, using a direct modulation method. A stability below 10^{-11} for τ between 0.1 and 1 000 s was obtained [17, 32]. Barwood *et al.* used a similar configuration to lock a laser on a Doppler-free rubidium line at 795 nm and obtained a stability around 2×10^{-10} for $\tau = 30$ s [33].

Influence of the laser noise. — Although better than with Doppler lines, the improvements obtained with saturated absorption lines are not as great as expected from the transition linewidth reduction. We believe that the laser stability was rather limited by the laser frequency noise. One must keep in mind that the detection signal is a convolution of the absorption line and the laser line. As saturated absorption lines are usually narrower than the laser line, the observed line will be limited by the laser line. A stability improvement has been observed when using a semiconductor laser with a low linewidth, such as lasers associated to an external cavity.

It can be seen in figure 7 that the detection lines observed with an extended-cavity laser are much less noisy than those obtained with a solitary diode. Using a saturated absorption

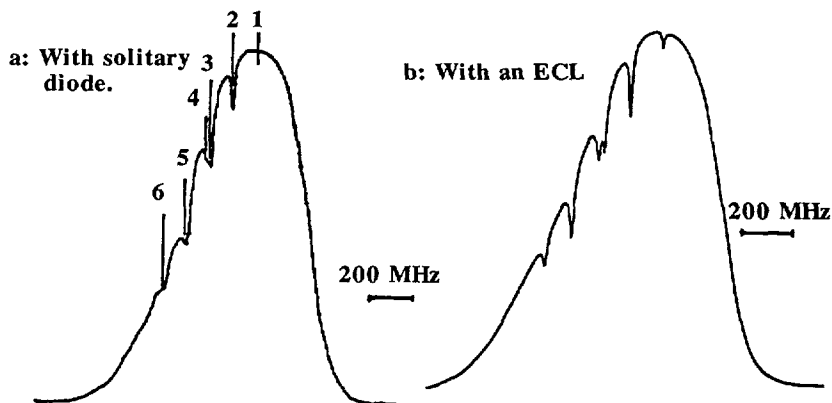

Fig. 7. — Saturated absorption spectrum of Cesium D_2 line at $\lambda = 852$ nm illustrating the strong influence of laser frequency noise on the reference signal. The various saturated lines are labeled from 1 to 6. a) Spectrum obtained with a solitary laser diode. b) The same line obtained with a low linewidth extended-cavity laser. The lines are better resolved and the spectrum is much less noisy.

technique, we have successfully stabilized on a Cesium line, a 852 nm extended-cavity laser with a 10^{-12} stability for a 1 s observation time [2]. A laser linewidth reduction using an external confocal Fabry-Perot has also led with the same stabilization method, to a significant stability improvement [14]. The obtained stability was 4×10^{-13} for a 50 s averaging time.

b) High frequency ($\Omega_m > 1$ MHz) current modulation. — Using the same current modulation, it is possible to modulate at high frequencies (1 MHz-1 GHz), a laser diode output frequency. For a low modulation index, the observed optical spectrum is close to a pure FM modulation spectrum with lateral bands at $\pm \Omega_m$ from the carrier, however, the residual amplitude modulation leads to a characteristic distortion [35]. The laser beam is passed through the absorbing cell, and detected with a high speed detector. Figure 8 illustrates the detection principle : in case of a pure FM output, the detector should not detect any amplitude modulation if the lateral bands have the same magnitude. When the laser frequency reaches the transition frequency, the lateral bands are not absorbed equally unless the carrier frequency is perfectly centered on the top of the line. The photodetector electrical signal has thus a Fourier component at Ω_m which is detected with standard RF methods and which cancels at the top of the line. The experimental set-up is the same as in the previous description for the servo control of the frequency.

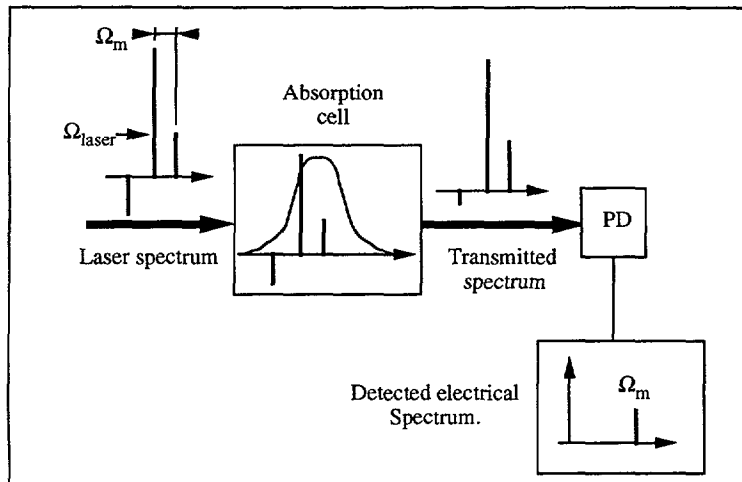

Fig. 8. — Basic principle of frequency modulation spectroscopy.

The advantage of this method is its high sensitivity, because the signal is detected at high frequencies at which electronic noise and laser noise is generally very low. However, with this method residual amplitude modulation seems to be a major problem.

External frequency modulation. — A very similar method consists in realizing the frequency modulation with an external phase modulator in order to minimize residual amplitude modulation. This method can be very suitable for modulating external-cavity lasers because of their poor modulation efficiency. Yanagawa *et al.* used this method to stabilize an InGaAsP DFB laser and a Fabry-Perot cavity laser to an absorption line of NH_3 at 1 513.7 nm with an external LiNbO_3 frequency modulator. They obtained a stability around 10^{-11} which was better by one or two orders of magnitude than a direct modulation method [36].

2.3.3 Frequency stabilization without laser frequency modulation. — For some applications a laser frequency modulation is troublesome and a frequency stabilization without frequency modulation is then required.

a) Stabilization to the edge of the line. — The experimental scheme is shown in figure 9. The laser beam is divided in two parts with a beam splitter. One beam is directly detected by a first photodiode giving a signal proportional to the laser intensity. The other beam passes through a gas cell before being detected by a second photodiode. The two signals are fed in a differential amplifier to obtain an error signal which is applied to the laser frequency control via a servo-loop. The laser frequency will thus be locked on the edge of the absorption line. The advantage of this method is a great simplicity and non-modulated output, however, it is much less accurate because the locking point is not defined absolutely and may drift with the temperature dependence of the absorption linewidth.

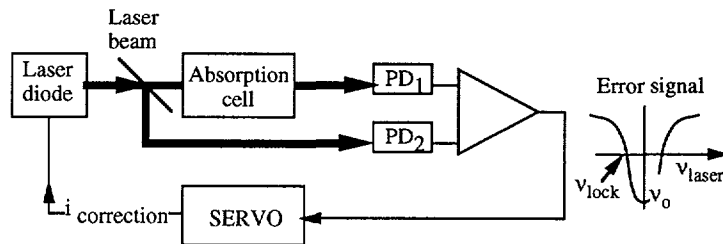

Fig. 9. — Basic setup used for laser diode frequency stabilization on the edge of an absorption line.

We have stabilized an extended-cavity laser (using a grating) on an NH_3 absorption line at 1 513.99 nm. A 60 cm long cell under 10 torr pressure provided around 70 % absorption, and the locking point on the side of the line was reached by a PZT controlling the grating position. This lead to stability values of 10^{-10} up to 10^3 s which increased to about 5×10^{-9} for 10^5 s. Using a modulation method, the stability stayed around 10^{-10} [21].

b) Reference line modulation. — When the line frequency depends strongly on a physical parameter such as magnetic or electric field strength, it is also possible to modulate the line frequency while keeping the laser unmodulated. The error signal is obtained with a lock-in amplifier in the same way as for a laser frequency modulation [38].

2.4 LINEWIDTH REDUCTION.

2.4.1 Laser diode linewidth. — Experimental measurements have shown that the linewidth of semiconductor lasers [38-40] was in the Megahertz range, which was unusually large for a laser oscillator. This large linewidth value is now well explained with standard laser theories [41, 42].

— The main frequency noise source in semiconductor lasers is spontaneous emission in the lasing mode. This noise source which is often referred as quantum noise is unavoidable in a free-running laser. A small part of spontaneously emitted photons is coupled in the lasing spatial mode and randomly added to the oscillating field. Each spontaneous emission event leads to a small phase and amplitude fluctuation of the coherent optical wave [43-45].

The random amplitude fluctuations of the lasing field are damped by gain saturation, with a characteristic resonance frequency Ω_R . The associated output amplitude noise is flat at low frequencies with a resonance peak for $\Omega = \Omega_R$.

The spontaneous phase fluctuations are not modified by the laser dynamics and can be described as a white frequency noise which is simply added to the coherent optical wave. The phase jitter $\Delta\Phi_\tau(t) = \phi(t + \tau) - \phi(t)$ of the output optical field for an observation time τ is the sum of many uncorrelated elementary random phase variations, it can thus be assumed Gaussian, with a variance $\langle \Delta\Phi_\tau^2 \rangle$ proportional to observation time. Such a noise leads to a Lorentzian spectrum whose linewidth is given by the Schawlow Townes formula [46] :

$$\delta\nu_s = \frac{\langle \Delta\Phi_\tau^2 \rangle}{2\pi\tau} = \frac{1}{2\pi} \frac{R_{\text{spont}}}{2S_m} \quad (4)$$

where R_{spont} is the number of photons emitted per second in the lasing mode and S_m the total number of photons in the spatial mode.

When expressed in terms of easily measured quantities, we find :

$$\delta\nu_s = \left(\frac{V_g}{L} \right)^2 \frac{\eta_{\text{sp}} h\nu}{16\pi P_j} (2\alpha_i \ell - \text{Log} \sqrt{R_1 R_2}) \alpha_j \quad (5)$$

with

$$\alpha_j = -\text{Log}(R_j) . \quad (6)$$

Where ℓ and L are respectively the length of amplifying medium and optical cavity, V_g is the group velocity of light, $h\nu$ is the photon energy, η_{sp} is the spontaneous emission factor ($\eta_{\text{sp}} = 2$), α_i are internal losses, P_j is the output power from mirror j with reflectivity R_j . It has been shown that this expression holds for a monolithic DFB lasers if the end-loss factor α_j is replaced by $(\pi/\kappa\ell)^2$ [1], where κ is the DFB coupling coefficient.

This result clearly shows that the linewidth associated with spontaneous emission noise is inversely proportional to the laser cavity optical length. More precisely, it depends on the « photon lifetime » which is the decay time for any coherent wave due to the losses in the passive cavity. Since the optical cavity of a semiconductor laser is much shorter than most single-mode lasers (optical length ≈ 1 mm), a direct application of Schawlow Townes formula shows that its linewidth is much wider and lies in the Megahertz range. The broad linewidth of laser diodes is thus well explained by a standard theory, however, the exact measured linewidth value was always broader than $\delta\nu_s$ [47]. This discrepancy was explained by Henry [43] and arises from a phase/amplitude coupling that is particularly important to explain laser diodes specific features.

— In laser oscillators, any optical power variation δP in the gain medium is compensated by a gain variation δg which restores the laser to steady state through gain saturation mechanisms. In laser diodes, gain compensation is provided by electron concentration variations which always lead, due to material properties, to refractive index variations $\delta\mu$. The change of μ versus g is described by the α « linewidth broadening factor » [48] defined as :

$$\alpha = -2k_0 \frac{\delta\mu}{\delta g} \quad (7)$$

where k_0 is the wave vector in vacuum ($k_0 = 2\pi/\lambda_0$).

This parameter has an experimental value of $\alpha = 4-7$ [48].

— An additional effect of spontaneous emission on laser diode linewidth arises from this phase/amplitude coupling : the amplitude noise leads to a refractive index noise which is directly transformed into phase noise in laser output. Therefore, the frequency fluctuation spectrum is the sum of the previously described white noise contribution, and a contribution which has the shape of the amplitude fluctuation spectrum [49], with a strong resonance peak

at Ω_R . The corresponding optical spectrum (Fig. 10) is composed of a main Lorentzian peak with a linewidth $\delta\nu = (1 + \alpha^2) \delta\nu_s$, which takes in account the phase/amplitude coupling. The resonance at relaxation frequency Ω_R has the same effect on the optical spectrum as a frequency modulation : it thus leads to small lateral peaks located at $\pm \nu_R = \pm \Omega_R/2\pi$ from the main peak. However, these peaks can only be seen at low power ($P_J < 1$ mW) and they can often be neglected for high enough power. The main peak linewidth which is usually 10-50 times larger than $\delta\nu_s$ is fairly well explained with this interpretation.

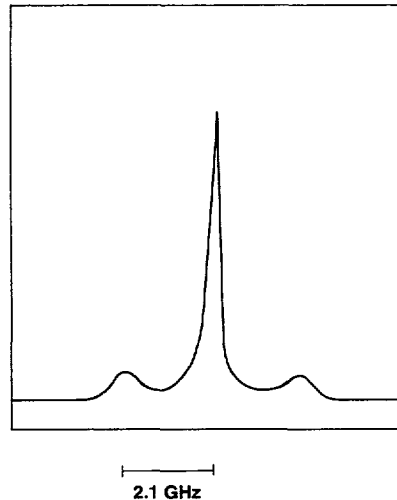

Fig. 10. — Measured spectral lineshape for a solitary laser diode at low power (After Ref. [123]).

— Another kind of frequency noise which seems to have nothing to do with spontaneous emission has been observed in laser diodes spectral output. This noise becomes dominant for a low level of spontaneous emission noise :

— At high output power, the spontaneous emission noise is reduced as P^{-1} (Eq. (5)) but the linewidth cannot be reduced under a fixed value often referred as the « power independent contribution » to the laser diode linewidth [50].

— When spontaneous emission is lowered using an external optical cavity, it has been observed that the optical spectrum is no more Lorentzian which indicates that another kind of noise is present and becomes dominant [51].

This additional noise seems to be flicker noise whose origin is not clearly known. It may come from current/temperature noise sources or even from internal noise processes [52-55].

2.4.2. Laser diode linewidth reduction using an electrical negative feedback. — The main contribution to the large laser diode linewidth is the power spectral density of frequency fluctuations in the Fourier range of $\Omega \leq 100$ MHz. It is possible to reduce this noise using a negative electrical feedback control. The frequency fluctuations are detected using a frequency discriminator and an error signal is produced and feedback on the diode temperature or injection current in order to countermodulate its frequency. However, since the temperature control is slow, it is more favourable to control the injection current in order to make a wide bandwidth feedback control. The frequency reference and discriminator may be a Fabry-Perot interferometer. Although its resonance frequency may change with acoustic and ambient temperature fluctuations, this drift is negligibly small for Fourier frequencies greater than 100 Hz, and it is therefore possible to use it to improve short term frequency

fluctuations. As the spectral linewidth of the semiconductor laser may be as wide as several dozen of megahertz, the feedback system bandwidth must be close to this value. This is an important point for the practical realization because such bandwidths are not easy to obtain. It has also been shown experimentally that with a high gain and low noise servo-loop, the frequency fluctuations can become lower than the quantum noise limit of the free-running conditions [56], the ultimate limit is then the noise magnitude generated from the feedback loop itself [57]. We used this method and obtained a servo loop bandwidth of about 400 kHz [58], however our experiment was very sensitive to optical feedback, a high optical isolation is thus required. Ohtsu *et al.* [59] used this method to improve the spectral linewidth of a 0.8 μm AlGaAs laser. They obtained a frequency fluctuation reduction of more than 60 dB and showed that it was practically possible to reduce the frequency fluctuations below the quantum noise limit. The measured spectral power density of the frequency fluctuations was an order of magnitude smaller than the quantum noise limit for the range 100 Hz-4.4 MHz.

2.4.3 Laser diode linewidth reduction using a small optical feedback. — It is well known that reflection of laser light into the optical cavity has a perturbing effect on the laser output amplitude and frequency. This effect is observed with HeNe lasers but only when the external reflector is very well aligned with the laser cavity. When using laser diodes however, it is striking to observe that a very small amount of optical feedback can produce huge variations in amplitude and frequency of the laser. As we have already considered the case of an external reflector very close to diode output facet, we will now focus on the case of external reflectors placed at a distance $L_{\text{ex}} > \mu \ell$ from the diode. The effective reflection coefficient ρ (or « feedback ratio ») is defined as in equation (2). Spectral effects of optical feedback have been measured for feedback ratios as low as $\rho = -80$ dB [60]. In order to classify the effects of optical feedback, it is necessary to distinguish between three main laser regimes :

— In the low feedback regime (ρ lower than -30 to -40 dB) the laser output amplitude and optical spectrum depend on the phase $\varphi_{\text{ex}} = k_0 L_{\text{ex}}$ of the unperturbed laser reflected field. The efficiency of feedback can be measured by the feedback parameter X given by :

$$X = \frac{L_{\text{ex}}}{\mu \ell} \frac{1 - R}{\sqrt{R}} \sqrt{\rho (1 + \alpha^2)} \quad (8)$$

R is the diode output facet reflectivity and α the linewidth enhancement factor. It is interesting to notice that the X parameter is a linear function of the external cavity length. The effect of optical feedback can thus be very strong even for low external reflexions if the external reflector is far from the diode.

It has been found [61] that the emission frequency mean value ν_0 will stay unperturbed only for $X < 1$ which is generally obtained for a high isolation from feedback, however, the linewidth can either be enlarged or reduced depending on the phase of the optical feedback. For higher $X > 1$ values, several external-cavity modes are possible solutions, their frequencies are around ν_0 with a frequency separation roughly equal to $c/2 L_{\text{ex}}$ and they are spectrally shifted for any variation of L_{ex} . The laser frequency then jumps quickly between several external-cavity modes for $X = 1-5$ [61] but the lower linewidth mode is favoured in this process [62] and for $X = 5-10$ the laser becomes single-frequency on a particular external-cavity mode. It is important to realize that in this regime, the phase is completely controlled by the external cavity, but the laser amplitude is only very weakly changed. As the photon lifetime in the composite cavity is increased, the spontaneous emission related frequency fluctuations noise level is greatly reduced and the linewidth of the laser mode is given by :

$$\delta \nu_{\text{laser}} = \frac{\delta \nu_{\text{Solitary laser}}}{(1 + X)^2} \quad (9)$$

It is worth noticing that in that case, the frequency fluctuations related to spontaneous emission are reduced at all Fourier frequencies. It has also been shown [63] that optical feedback also leads to a reduction in $1/f$ frequency noise cutoff

— For higher feedback levels (ρ higher than -30 dB but lower than -10 dB) the reflected field begins to perturb deeply the laser amplitude and carrier density. The amplitude resonance at Ω_R is enhanced and the laser attains a chaotic regime which is referred as « coherence collapse » [64]. The coherence length is greatly reduced and the laser output is very unstable. Such a behaviour must generally be avoided.

The linewidth reduction obtained with optical feedback has been used by several authors to make coherent optical sources with laser diodes. There are three main structures :

— The simpler only uses a reflecting element far from the diode. It can be a plane mirror which reflects a fraction of the laser diode beam collimated with an objective [65], or the end facet reflection of an optical fiber [66]. Such a method provides a low linewidth (30 kHz have been obtained [67]), however, the main problem is to control perfectly the phase of the reflected wave, otherwise, the frequency will hop between external cavity mode for any parasitic phase variation.

— A slight refinement of this technique consists in using a spectrally selective reflecting element such as a diffraction grating [68] which enables a slight tuning capability because the laser will oscillate on the wavelength reflected by the grating. However, as a very low feedback level is required in order to avoid coherence collapse, the tunability of such a laser remains very poor.

— An interesting possibility consists in using the reflection of a resonant optical cavity such as a Confocal Fabry-Perot cavity (CFP) instead of a single reflecting element (see Fig. 11) [69-71]. In such an arrangement, the transmission beam of the CFP is reflected back to the diode. The external cavity mode frequencies depend on the CFP mode frequencies and also on the optical distance L_{ex} from the diode to the CFP. If the latter is well chosen and correctly controlled, the diode frequency will be optically frequency locked to a CFP mode. The linewidth of the laser line is then given by an expression similar to equation (5), except that L_{ex} is replaced by $L_{CFP} \mathcal{F}_{CFP} / \pi$ where L_{CFP} is the CFP length and \mathcal{F}_{CFP} its finesse [72] :

$$\delta \nu_{\text{laser}} = \frac{\delta \nu_{\text{Solitary laser}}}{(1 + X')^2} \quad \text{where} \quad X' = X \frac{L_{CFP} \mathcal{F}_{CFP}}{\pi L_{ex}} \quad (10)$$

This expression accounts for the increase in the photon lifetime of the composite cavity. In order to keep a stable optical locking, it is possible to control automatically the optical path

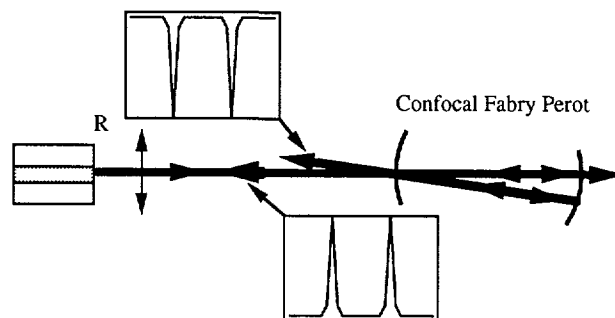

Fig. 11. — Optical frequency stabilization of a SC laser using a resonant optical feedback from a confocal Fabry-Perot cavity. The transmission beam (maximum power at resonance) is reflected back to the diode.

from the diode to the CFP by using a mirror mounted on a piezoelectric element. As the laser frequency follows the CFP mode, laser tuning is obtained by spectrally shifting the Fabry-Perot modes. If the CFP mode is too much detuned from the initial diode frequency, the optical locking will cease, however, a limited continuous tuning can be obtained if the current is simultaneously varied. This method is very efficient to reduce the diode linewidth and does not require any modification of the diode, however the experimental setup is rather complicated and does not give a mean to tune the laser on a wavelength which cannot be attained by the solitary diode.

2.4.4 Laser diode linewidth reduction using an extended-cavity laser. — When the optical feedback on a laser diode becomes very strong ($\rho > -10$ dB), the effect of the diode own cavity becomes negligible and it can be considered that the diode steady state gain as well as frequency are completely controlled by the external-cavity. The operation of the diode in such a regime requires an anti-reflection coating on the output facet of the laser diode. If the anti-reflection coating is perfect, the laser diode cannot oscillate alone, it only acts as an optical amplifier and has no influence on the laser output frequency. The device behaves like a laser whose optical cavity is much longer than the amplifying section. The linewidth of such a structure can be obtained by the same analysis are exposed above. As it is inversely proportional to the square of the cavity optical length, a 10-20 kHz linewidth can be obtained [73] using a quite reasonable 50 mm cavity length. Such a structure has other interesting features which will be reviewed in the next section.

3. Extended-cavity lasers.

3.1 PRINCIPLE AND DEFINITIONS. — As described previously, many structures designed to improve the spectral coherence of laser diodes use external cavities. We will define an extended-cavity lasers as an *anti-reflection coated* laser diode coupled to a passive external cavity with the characteristic feature that the laser diode does not provide any laser emission without the external cavity. In a more realistic case, the anti-reflection coating is not perfect and the diode is likely to oscillate for a sufficiently high drive current, the extended-cavity operation is then obtained if the lasing threshold is much lower than the solitary AR-coated laser diode threshold.

Some lasers have been made with a laser diode AR-coated on both facets and external reflectors on each side of the laser [74], but most of the experimental realizations only use one AR-coated facet coupled to the external cavity, with the other facet unchanged. It has been verified experimentally that no phenomenon, such as, for instance spatial hole burning in the laser diode, justifies the use of a two-sided extended-cavity. It is thus better to use a simpler single-sided structure which minimizes alignment problems and optical power losses.

The most interesting feature of an extended-cavity structure is to give to the user new means to control the lasing action. In addition to the temperature and current control, it is possible to control the wavelength of the intra-cavity optical feedback and its spectral bandwidth if a spectrally selective external mirror is used. It allows to select the output optical frequency regardless of the gain peak spectral position. In addition, it must be noticed that the number of laser cavity axial modes per unit frequency increases with the cavity length. A spectrally selective element is thus actually necessary if a single-frequency operation is desired, otherwise, the gain rejection between the dominant and side-modes would be even lower than in the solitary laser and multimode operation would be highly probable.

3.2 EXTENDED-CAVITY LASERS REVIEW. — An easy way to classify the various possible extended-cavity lasers consists in reviewing their spectrally selective element.

3.2.1 Extended-cavities using a diffraction grating. — The most popular extended-cavity structure uses a diffraction grating as the frequency selective element [73-78]. The diode light

should be collimated by a high aperture optical element (Fig. 12) such as a microscope objective, and directed toward the grating that is mounted in Littrow position (first order reflected in the incident beam direction). The various wavelengths emitted by the diode and dispersed on the grating first order, are spread in a line perpendicular to the grating rulings, which is focused back to the laser diode facet by the collimating objective. When this spectral line is aligned with the diode output spot, a small part of the line, corresponding to a narrow wavelength band centered at λ , is coupled back in the laser guide. The oscillation wavelength λ which corresponds to a perfect autocollimation, is related to the grating angle θ by the classical relationship :

$$\lambda = 2 p \sin \theta . \quad (11)$$

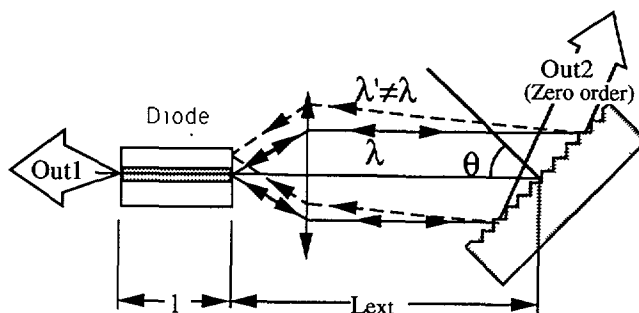

Fig. 12. — Schematic of an extended-cavity laser using a diffraction grating.

In order to minimize power losses, the grating period p should be chosen between $\lambda/2$ and λ to support only two diffraction orders at the diode emission wavelength (the first order and the unavoidable zero order). The laser has then only two output beams originating from the diode rear facet, and the grating zero order. Rotating the grating about an axis parallel to its rulings allows to tune the wavelength that is reflected in the diode optical guide. A 0.5 NA collimating objective and a 1 200 lines/mm diffraction grating are enough to obtain a ~ 20 GHz bandwidth and a feedback ratio of about 30 %.

Similar structures can be made with Acousto Optic devices acting as electrically controlled diffraction gratings [79]. The advantage of such a structure is that the wavelength can be tuned very quickly by controlling the AO device input frequency. However, problems associated with AO frequency shift [80] complicate the setup and lead to quite large power losses, which lowers the tuning range and output power.

Another interesting structure uses a self induced Bragg grating in a photorefractive material [81] which acts as a phase conjugate external mirror. Although having a certain spectral selectivity, such a structure is not tunable because it will always oscillate near the gain maximum. Its main advantage is the self alignment of the laser optical cavity.

3.2.2 Cavities using internal gratings (DFB, DBR). — The wavelength selector can be a Bragg diffraction grating included in the laser diode itself. A DFB laser coupled to an external non-selective cavity [82] associates the strong frequency control obtained with DFB lasers to a narrow linewidth, which is obtained by increasing the optical cavity length. However, it must be noticed that an internal feedback is already provided by the DFB grating in addition to the external feedback. The DFB parameters should thus be carefully chosen in order to provide a stable narrow linewidth laser [83].

3.2.3 Extended-cavities using interferometric spectral filters. — A spectral selection can be made by using two-waves interferometric devices similar to Michelson interferometers [84] or much more selective multi-waves interferometers such as Fabry-Perot Etalons [85]. The collimated beam is filtered by the interferometric element, the unwanted energy being reflected off-axis, and the filtered beam is directed back to the laser diode by an ordinary mirror. Tuning is obtained by etalon length variations. The main problem of such elements is their spectrally periodic selectivity which limits the extended-cavity tuning range. If the etalon is thin enough to provide a wide tuning range, it becomes difficult to maintain a narrow bandpass, which requires high reflectivity coatings, while keeping low power losses. Except for a few realizations [86, 87], more than one etalon is usually required to provide single frequency operation, which complicates the spectral tuning [88].

3.2.4 Extended-cavities using a polarizing filter. — In such structures, the TE polarized laser diode collimated beam crosses a retardation plate which transforms its state of polarization depending on its wavelength. Only periodically spaced wavelengths recover exactly their TE polarization after a round trip, while other wavelengths experience extralosses because they are not well coupled back in the original mode. The main advantage of such a structure is that the retardation plate can be an electro-optic element which allows to tune very quickly the lasing wavelength [89, 90], the FM bandpass being limited by the external-cavity length.

3.2.5 Monolithic extended-cavities. — The laser diode linewidth reduction which is obtained with extended-cavity lasers is a feature that has interesting applications in the coherent optical communications field. Therefore, many attempts have been made to make monolithic extended-cavity lasers. Figure 13 shows some examples of such structures.

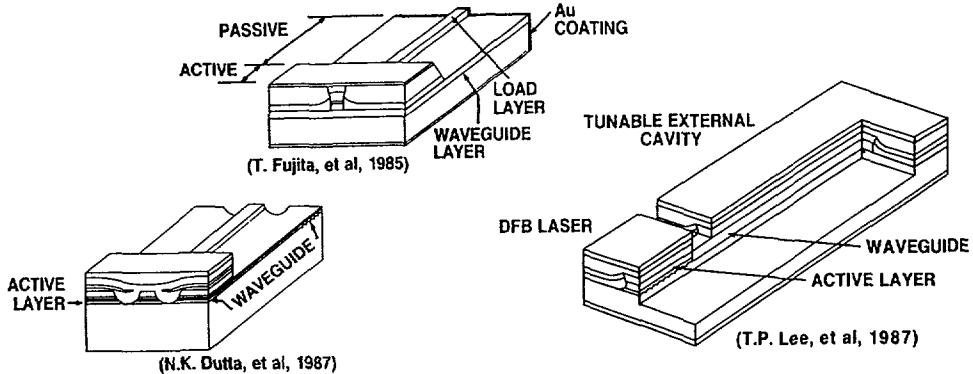

Fig. 13. — Various structures of monolithically integrated extended-cavity lasers (After Ref. [1]).

3.3 LASER FREQUENCY CONTROL (TUNABILITY, SINGLE FREQUENCY OPERATION).

3.3.1 Tunability of ECLs. — In an ECL, the wavelength selector defines a minimum loss wavelength λ_r . However, the lasing frequency should be one of the resonant cavity modes whose wavelength λ_q are regularly spaced, and only linked to the cavity length. The lasing mode is thus, in principle, the resonance wavelength λ_q which is the closest to λ_r .

Tuning the wavelength selector allows the user to obtain the wavelength of the extended-cavity mode which is the closest to the desired wavelength. In order to obtain exactly the desired wavelength, the mode wavelength should be shifted by varying finely the cavity length

using any classical mean (piezoelectric elements, tuning plates...). It should be noticed that variations of the diode current or temperature also provides fine wavelength tuning because it changes the cavity optical length through diode refractive index variations. The associated wavelength variations are given by :

$$\delta \lambda_m / \lambda_m = \delta L / L = \delta (\mu \ell) / L = (\mu \ell / L) (\delta \mu / \mu)$$

the sensitivity of lasing wavelength to diode refractive index variations is thus considerably reduced compared to the solitary diode case (see Eq. (1)), in the ratio of solitary diode to extended-cavity optical length.

The wavelength tuning range which can be obtained with an ECL depends on three main parameters :

— The spectral width of the laser diode gain curve which gives the maximum range of tuning without varying the temperature of the diode junction. With 0.85 μm standard laser diodes, we have obtained a tuning range of ± 15 nm (12.5 THz total frequency tuning range) roughly centered on the laser diode initial (i.e. : before AR coating) wavelength. With standard 1.5 μm diodes we have obtained up to 150 nm tuning range (see Fig. 14). This result can be compared to the above mentioned result at 0.85 μm by calculating the corresponding frequency tuning range, which amounts to 20 THz. However, much broader tuning ranges (up to 61 THz or 125 nm at 0.8 μm) have been obtained by using quantum well lasers which have broader gain curves [91]. Using a temperature variation of the diode extends this tuning capability, however a temperature tuning equivalent to the grating tuning requires about 100 °C of temperature variation, which may be difficult to produce easily.

— It is clear that the external feedback should be strong enough to enable an oscillation at a wavelength that is far from the gain peak. However, as the gain rolloff is generally rather sharp, we noticed that it is not worth optimizing the internal components for that purpose because special optics would not provide a high increase in the tuning range.

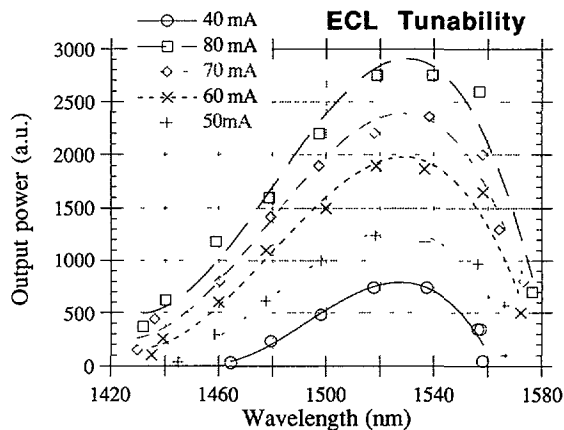

Fig. 14. — Tuning curve of an extended-cavity laser operating around 1 540 nm. The output power is plotted *versus* wavelength for various laser diode currents.

Influence of the diode residual reflection. — A non perfect AR coating degrades severely the ECL spectral behaviour.

— If the residual reflection R is too high, the internal oscillation at the gain peak

wavelength can be favoured instead of the external cavity oscillation, when it is tuned far from the gain peak, to a low gain wavelength. For instance, we have observed that the tuning range of an ECL was reduced from 30 nm to only 16 nm, only because the AR reflectivity varied from $< 1 \%$ to about 5% due to the disappearance of the last SiO layer with aging.

— Another important feature is the capability to attain any frequency in the laser tuning range. For a perfect AR coating, an ECL can always be tuned to any wavelength of the tuning band because the diode properties has no effect on the lasing frequency. However, the AR coating is never perfect, and the laser diode plays the role of an internal etalon which modulates spectrally the ECL losses. For a low residual reflectivity ($R < 0.1 \%$), it will only produce a modulation of the output power with the spectral periodicity of the diode modes, during the ECL tuning. For higher residual reflectivities ($R > 1 \%$), the internal diode etalon will prevent the ECL oscillation except for frequencies close to a laser diode mode [92]. In that case, it is still possible to attain any frequency in the tuning range, however it is more complicated because a current or temperature variation is needed to shift the diode mode to the desired frequency.

— When the residual reflectivity is too high, bistability is observed [93-95] in the spectral tuning of the ECL. This effect is directly related to the dependence of the diode refractive index on optical intensity, which leads to a power dependent shift of the internal etalon modes. As the ECL is tuned to the top of an etalon mode, the associated power variation will shift the etalon modes which tends to reinforce the laser power for an increasing wavelength and lowers this power for a decreasing wavelength. The periodic power variations *versus* selected wavelength are thus non-symmetric and show an hysteresis behaviour which leads to bistable operation points.

3.3.2 Single frequency operation of ECLs. — The single frequency operation of ECLs is the main condition which should always be satisfied for the usefulness of the device. In fact, it is always possible to force an ECL to single frequency operation, if the wavelength selector has a narrow enough transmission band. However, in practice, no known wavelength filter can be narrow enough to provide a high loss rejection of adjacent extended-cavity modes, and one should use two wavelength selectors (grating plus etalon for instance) to be sure to obtain a highly selective wavelength filter. The main drawback of such a solution is that the tuning procedure becomes quite tedious because two selectors have to be moved at the same time, in order to control the oscillation wavelength.

Fortunately, it appears that a single grating selector is generally sufficient to provide single frequency operation despite its low selectivity (more than twenty extended-cavity modes are often contained in the selected wavelength band at half-maximum). Homogeneous saturation of the amplifying medium associated with a greater wavelength selectivity than in solitary lasers [74] is certainly responsible for this quite easy single frequency behaviour. However, we have experimentally observed that ECLs single frequency capability did not only depend on the solitary diode behaviour.

— Though solitary InGaAsP Fabry-Perot diodes are not single-frequency, they easily oscillate on a single frequency in grating loaded extended-cavity laser.

— Some AlGaAs lasers that were initially single frequency were always multimode when inserted in a similar extended-cavity.

These observations suggest that the diode structure does not affect strongly single frequency operation in ECLs.

On the other hand, the residual reflection of the AR coating is a parameter that strongly affects the single frequency behaviour. When the wavelength selector is tuned in an ECL containing a poorly AR-coated diode, the emission becomes periodically multimode with the extended-cavity mode periodicity, and stays multimode on a wavelength band $\delta\lambda_m$ until the

mode hops to the next external-cavity mode. As the diode residual reflectivity is decreased, the multimode band $\delta\lambda_m$ is usually narrowed and for a good AR coating the mode hops suddenly, and no multimode behaviour is observed. We have repeatedly observed that a 5 % residual reflectivity led to high probability of multimode emission, while the probability of single frequency behaviour is dominant for a 1 % residual reflectivity.

3.3.3 Mode hop suppression in grating loaded ECLs. — If the wavelength selector is tuned without varying the cavity length, the lasing wavelength will jump from mode to mode. This mode hopping behaviour is observed in most of the tunable lasers, however, it is theoretically possible to get rid of mode hops if the resonant wavelength λ_q of longitudinal mode number q , and minimum loss wavelength λ_r are spectrally shifted at the same rate in order to keep the lasing mode in a low loss region (Fig. 15).

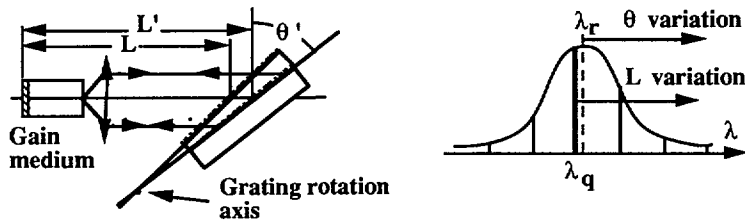

Fig. 15. — Principle of continuous tuning using a particular grating rotation : the grating spectral selection curve is shifted for θ variations and the resonance frequencies are shifted with L variations. For a good choice of the grating rotation axis, the resonances and the mode selection function are shifted at the same speed and the dominant mode remains dominant during tuning.

Such a condition was obtained in grating loaded ECLs [96, 97] by a rotation-translation combination of the grating position, and it has been shown experimentally that it is possible to tune an ECL employing a diffraction grating without mode hops, on very wide ranges (up to 82 nm around 1.5 μm) [96, 98].

It is also possible to use a simpler arrangement using only one particular grating rotation [96, 99] : if the rotation axis is not on the grating, the cavity length changes during its rotation, and the exact position of the rotation axis can be chosen to obtain mode-hop suppression (Fig. 16). Some appropriate rotation points have been demonstrated experimentally, (R_1 [96] or R_2 [99]), however, we have recently determined rigorously the optimal rotation axis position which should be located on the straight line ($R_1 R_2$) to suppress mode hopping to

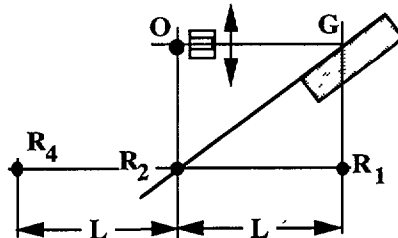

Fig. 16. — Particular rotation axes : R_1 , suggested in [96] ; R_2 , suggested in [99] ; R_4 , found with our model.

the first order, the best point being R_4 which can provide a theoretical tuning range broader than 30 nm free of mode hops around 1.5 μm [100].

These wide continuous tuning range can be obtained with a simple mechanical arrangement, and does not require servo controls. Such laser sources are of great practical interest for any application which require a precise tuning of the laser frequency such as spectroscopy or coherent optical communications.

3.3.4 ECL frequency modulation. — External-cavity lasers can be frequency modulated through two main mechanisms :

— Current/temperature variations which changes slightly the ECL optical length and thus the lasing frequency. In practice, the current dependent frequency sweep is reduced to about 50-100 MHz/mA for low frequencies, and the corresponding bandwidth is limited by the external-cavity photon lifetime to a few hundred Megahertz.

— When larger frequency sweeps are required, it is possible to change the external reflector position using a piezoelectric transducer. This mean provides tuning ranges that are only limited by mode-hops. Due to the PZT low bandwidth, the modulation bandwidth is limited to a few kilohertz.

3.4 ECL LINEWIDTH. — The linewidth of an ECL related to spontaneous emission noise can be obtained with the same formalism as a solitary laser diode. After a careful check of the underlying assumptions, we find that equation (5) is totally valid to express the ECL linewidth when the diode is perfectly AR-coated. In this expression, we have separated the optical cavity length from the laser diode length, and we can see that the laser diode linewidth is inversely proportional to the square of ECL optical length. When the diode is not well anti-reflection coated, equation (5) should be modified to take in account the difference in optical power stored inside and outside the amplifying medium. The linewidth can be described by the same equation if L is replaced by an « effective » cavity length which depends on the residual reflection of the AR coating [92, 63].

Experimental observations showed that the ECL linewidth varies as $1/L^2$ at least for short extended-cavities. When extending the cavity to about 10 cm, it has been observed that the linewidth reduction saturates to about 10 kHz [101]. This phenomenon could arise from excitation of low level side modes, or from the presence of $1/f$ noise that might not be reduced by extended-cavity operation. However, it is very difficult to measure precisely so low linewidths because it is necessary to get rid of environmental frequency noise, such as frequency noise related to acoustic perturbations, without affecting the result of the measurement. For instance, a self-heterodyne measurements has a low frequency cutoff which eliminates environmental noise but also low frequency components of the intrinsic laser noise.

An important reduction in the laser linewidth is anyway obtained. We have repeatedly observed laser linewidths on the order of 50 kHz as can be seen in figure 17, for extended-cavity lengths on the order of a several centimeters.

3.5 PRACTICAL CONSIDERATIONS AND INFLUENCE FROM EXTERNAL PERTURBATIONS. — The optical alignment of the cavity is a key point in the realization of ECLs. As the laser diode output spot is very small, the positioning tolerances should be very severe, and we have indeed measured that the output power or frequency of an ECL is sensitive to sub micronic displacements of the diode. In order to make a reliable laser, we use to glue the optical components on an Invar or temperature stabilized base, and we keep only one very fine mechanical movement to correct from small displacements that are observed in the first week after having glued the components. An example of such a structure is showed in figure 18. With such ECLs, we have observed single mode lasers that stayed on the same external-cavity mode for several months in free running operation [21].

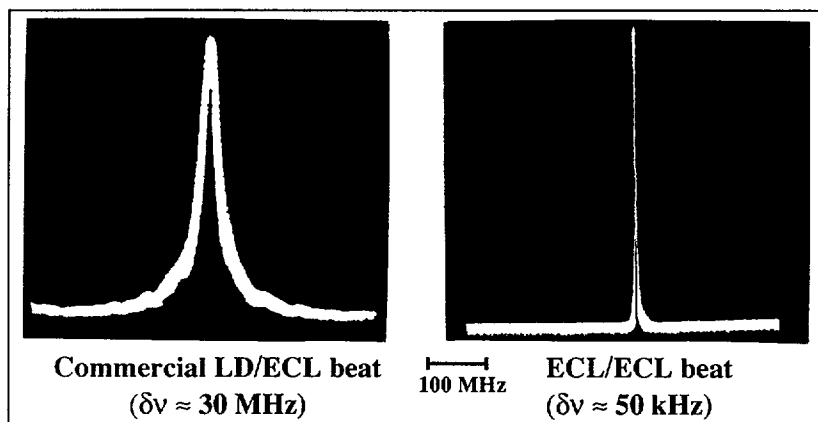

Fig. 17. — Extended-cavity laser linewidth illustration : a) Heterodyne beat signal between a commercial laser diode and an extended-cavity laser. The obtained spectrum is the commercial laser spectrum. b) Heterodyne beat signal between two extended-cavity lasers. The obtained spectrum is the convolution of the extended-cavities spectra. Its width is about twice their linewidth.

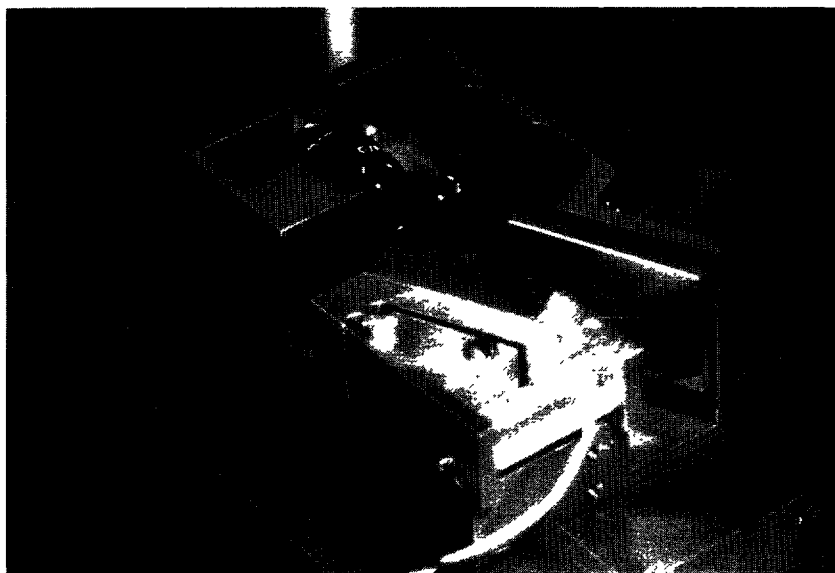

Fig. 18. — Photograph of a stable and reliable ECL operating at 1.514 nm.

A drawback of non-monolithic external cavity structures is that one part of the intra-cavity optical path is made of air whose refractive index depends on pressure variations. The lasing frequency thus depends strongly on acoustical perturbations as in gas lasers. In laboratory conditions, the practical linewidth that is obtained for long (> 1 s) observation times is on the order of one MHz thus still smaller than the solitary diode linewidth.

A great practical advantage of extended-cavity lasers should also be mentioned : as the sensitivity of a laser to a given level of optical feedback is inversely proportional to its cavity length, an extended-cavity laser is thus much less sensitive to optical feedback than a solitary laser diode. It is difficult to verify quantitatively the improvement, however it is obvious when working with ECLs that for many simple experiments (Fabry Perot analysis for instance), it is often possible to get rid of optical isolators that would have been absolutely necessary with solitary laser diodes.

4. High power semiconductor coherent laser sources.

4.1 ENCOUNTERED PROBLEMS. — At room temperature, the maximum CW optical power available from a conventional single frequency semiconductor laser with a $\sim 3 \mu\text{m}$ emitting area width, is on the order of 100 mW. This limitation arises from the high power density measured on the laser diode output facet which amounts to several Megawatts per square centimeter.

In order to obtain a higher power, it is necessary to use a broader emitting area which can be obtained by extending the laser stripe width (in the direction parallel to the junction) while maintaining the same vertical structure. Recent technological improvements have allowed to make uniform large area lasers [102] while retarding defects formation leading to damages. Such lasers have a $\sim 100 \mu\text{m}$ stripe width and deliver about 1 W optical power [103]. However, the laser active region is no more a single mode optical guide in the junction plane and such structures emit a lot of spatial modes simultaneously which limits the usefulness of such a device.

An alternative approach consists in making laser diode arrays which are broad area lasers on which a gain and/or index spatial modulation is added in the lateral direction [104]. The structure then looks like an array of parallel single stripe lasers that are closely spaced between the crystal facets (Fig. 19). This structure allows to relax the fabrication constraints and, due to an internal coupling of the spatial modes, it also reduces the number of spatial modes that are emitted simultaneously. Unfortunately, the remaining transverse spatial modes that are favoured by the structure exhibit a bi-lobe far field output [105], which has a total divergence much larger than the diffraction limit of the broad diode aperture. Two dimensional laser diode arrays have also been manufactured [106-109] and exhibit interesting properties, however, the spatial coherence of such lasers remains difficult to obtain.

Such structures cannot be used for a lot of applications that require spatial coherence. In addition, these structures also emit a multilongitudinal mode output which limit their

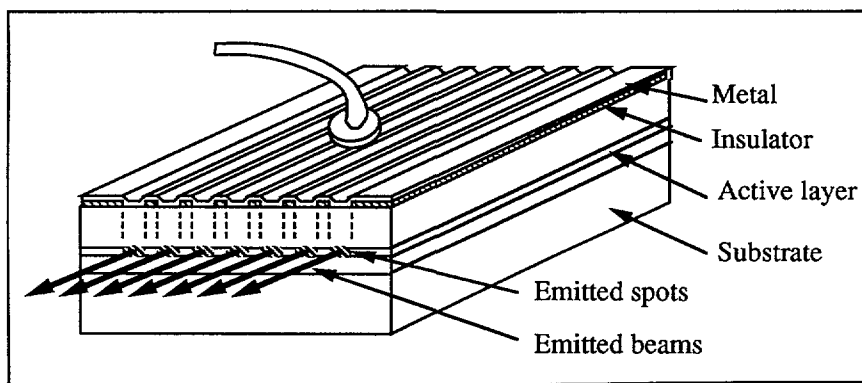

Fig. 19. — Schematic of a laser diode array.

usefulness for many other applications. Numerous experimental attempts have been made by the diode designers to improve the coherence of broad area laser diodes or arrays [110-114], however up to now, the results are rather disappointing because the production yield of coherent power diodes remains low and to date, such diodes are not commercially available. If a coherent powerful laser emission is needed it is thus necessary to imagine an external optical control.

4.2 COHERENCE IMPROVEMENT OF SINGLE STRIPE POWER LASERS. — As mentioned before, it is possible to obtain about 100 mW output power from recently developed single frequency diodes. These diodes are commercially available (STC model LT50, Spectra Diode Labs model 5410). However, the linewidth of such structures remains on the order of 10 MHz. These diodes can be used in ECLs in order to decrease the emission linewidth, but when increasing the power, we have repeatedly observed that it becomes more and more difficult to obtain a single frequency operation. It would require an additional spectral selector which adds losses and complicates the tuning procedure. The power that could be obtained from a standard ECL while maintaining a good spectral control was on the order of 15 mW.

In order to obtain a high power, low linewidth emission, we have used an injection locking method which appeared to be very satisfying. To that purpose we have injected the light of an ECL in a 80 mW laser diode (STC model LT 50) through an optical isolator. The ECL tunability allowed to reach the power diode wavelength and the injected power was estimated to be about 1 mW. Frequency locking of the power diode was easily obtained with a 3-4 GHz locking range. Figure 20 shows the Cesium 852 nm absorption line obtained with the *unmodulated* power laser whose frequency is optically driven by a frequency swept extended-cavity laser. It fully demonstrates the optical frequency control of the power laser. Though not measured, the linewidth reduction is also visible because the absorption signal is much less noisy than when obtained directly with the solitary power laser.

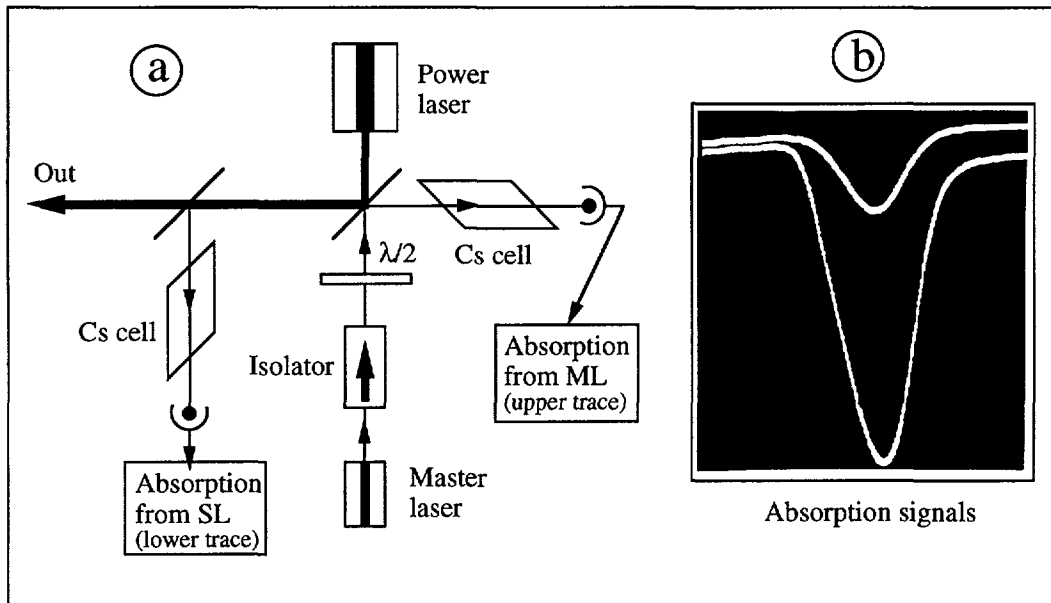

Fig. 20. — a) Experimental setup for the optical frequency locking of a 80 mW single stripe laser diode to a master ECL. b) Absorption feature of Cesium from the master laser (upper trace) and the slave laser which was unmodulated but followed the ECL frequency.

4.3 BROAD AREA LASER DIODE CONTROL. — The improvement of broad area lasers (including lasers arrays) is much more difficult than for a single stripe laser because it requires a spatial mode control that was not required in the above mentioned experiment.

In order to obtain a coherent emission at the highest possible power level, several methods have been explored. The most interesting one is injection locking from a coherent laser and spatial filtering in an extended-cavity.

4.3.1 Injection locking technique. — This technique allows to transfer the good spatial and spectral features of a master laser (ECL for instance) to a power laser. Figure 21 shows a typical experimental scheme of such a method. In order to obtain a single spatial mode, the master laser should inject power only in a few spatial modes of the power laser. If the injected power is high enough, this extra-power will provide a high rejection between the injected and non-injected modes and favour single mode oscillation in the injected modes. As high gain diode modes are likely to oscillate simultaneously, it is much better to inject power in these high gain modes in order to enhance the modal rejection. Such a configuration requires a spatially selective injection that can be obtained by limiting the injected beam to an angular bandwidth in which only high gain modes are injected. An optical isolator is absolutely required to prevent from reverse injection effects and a cylindrical lens is used to control the injection angle. We obtained a 200 mW single frequency, diffraction limited 0.3° divergent beam with 12 mW injected power using a standard SDL 200 mW, $100\ \mu\text{m}$ wide, laser diode array (Fig. 22). The laser emission was simultaneously single frequency, and we have verified that the power emission had a sub-Megahertz linewidth when the master laser was an ECL. However, we have to point out that these good results cannot always be obtained with other power diodes and even with other samples of the same structure. Up to one watt power has been obtained with higher power diodes by several authors [115, 116]. To date, this technique has thus demonstrated the best high power coherent emissions recorded with laser diodes

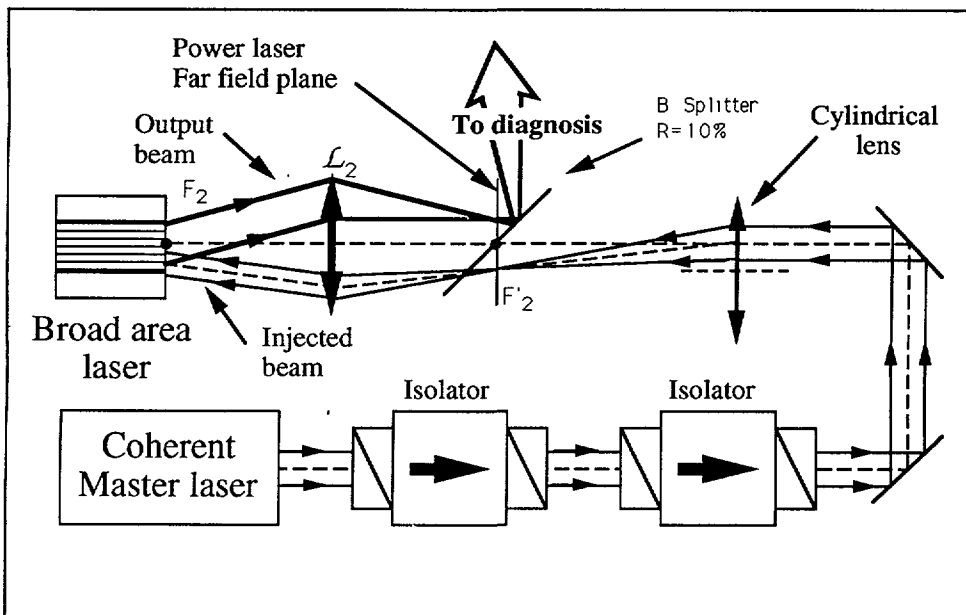

Fig. 21. — Injection locking experimental setup used for the coherence improvement of a 200 mW laser diode array.

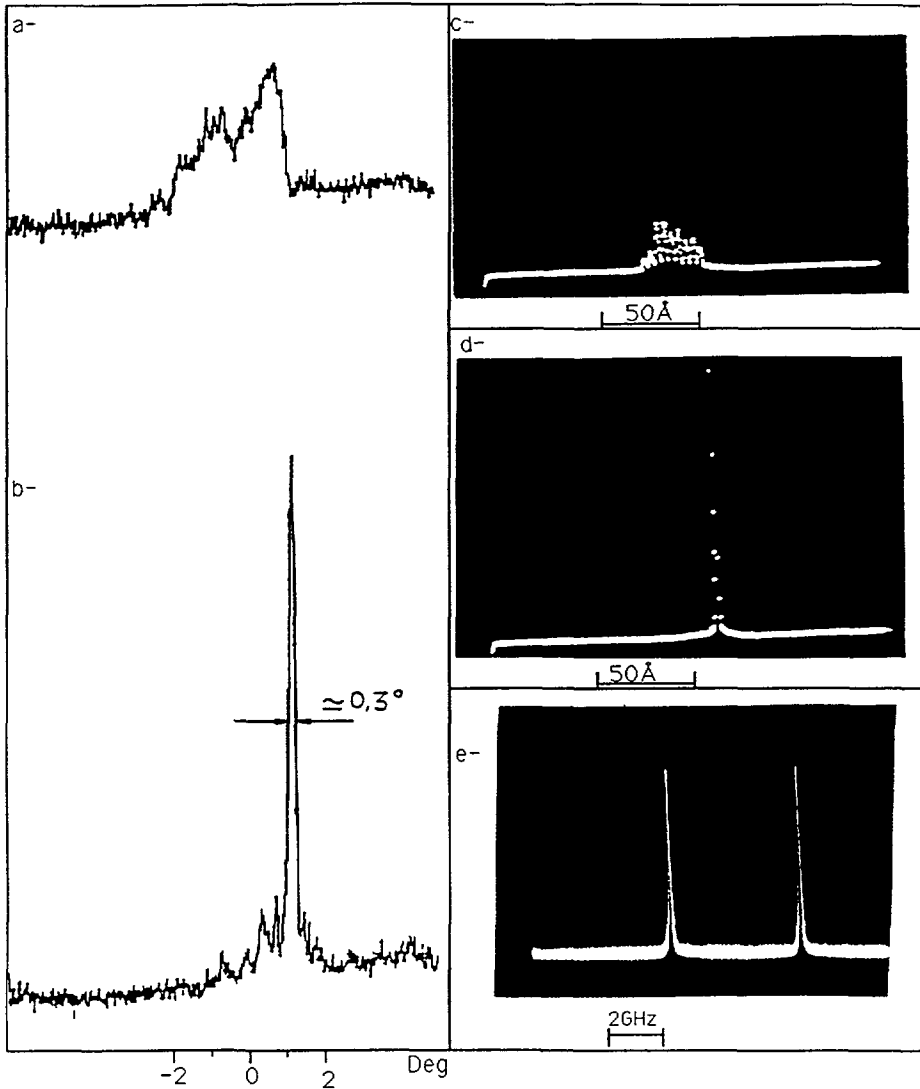

Fig. 22. — Experimental results obtained with an injection locking technique : a) Far field pattern in the junction plane for the free-running laser diode array. b) Corresponding far-field pattern under injection. c) Multilongitudinal mode spectrum of the free-running array. d) Corresponding single mode spectrum under injection. e) Fabry-Perot analysis showing that the injected power laser is single frequency.

[117]. However, the observed lack of reproducibility associated with a rather complicated experimental scheme, limits the development of injection locking methods.

4.3.2 Spatial filtering technique. — A much simpler scheme allows to obtain good improvements in high power lasers spatial coherence. The so-called « self injection locking » [118, 119] scheme allows to perform the same basic operation, namely providing extra energy to high gain laser diode modes. To this purpose, the power laser diode is inserted in an external-cavity which provides an angle-dependent optical feedback to the diode. This is obtained by

filtering the diode output beam in the Fourier transform plane located at the back focal plane of a collimating objective. Only a narrow angular band corresponding to high gain modes is then reflected back to the diode. Other external-cavity techniques have been successfully operated [120-122], but our experiments show that the highest mode selectivity is obtained with an off-axis optical feedback.

Such a structure leads to a considerable increase in the laser diode spatial coherence [118] with a much simpler method. However, we have observed that the output beam is generally not as clean as with an injection locking technique. The single-lobe emission is easily obtained with almost the totality of the diode initial output power, but a rather high part of the output energy is not completely transferred to the dominant coherent beam.

We are currently trying to improve this scheme because we think that it should be possible to obtain at a lower expense than with an injection locking technique, a comparable beam quality.

5. Conclusion and prospects.

We have listed the main problems encountered with frequency control of laser diodes. For applications which require a known stable optical frequency, such as metrology or coherent optical communications, the main problem is certainly the lack of spectral stability with laser diode aging which leads to unpredictable mode hops. For applications which require a high degree of coherence such as coherent detection and ranging, the large linewidth of laser diodes and their sensitivity to optical feedback are major limitations.

We have shown however, that numerous methods exist to improve the spectral properties of laser diodes. For each application, it is now possible to solve almost any spectral control problem that is found when using laser diodes. Most of the methods we have reviewed are quite simple to operate for anyone who needs, according to the application, an improved laser diode. If a versatile source is required to get rid of almost all the laser diodes spectral limitations at the same time, the use of extended-cavity lasers is highly recommended.

Grating tuned ECLs have demonstrated top-level spectral properties to many respects. A wide tunability associated to a narrow linewidth makes this class of lasers excellent tools for physical investigations. The fabrication of a reliable extended-cavity laser is a matter of stable mechanical design, and the key point to get a high performance ECL is the quality of the AR coating of the diode front facet. Today however, several laboratories and industries have developed good coatings on laser diodes and this point is no more a matter of technology but rather a matter of willingness. Despite a fairly good reliability that can be expected for well-designed ECLs, their industrial development is another question.

With the rapid development of laser diode technology, the monolithically integrated tunable DBR and DFB lasers should replace ECLs more or less rapidly for future applications. Thanks to their built-in spectral selector, such structures could lead to a perfect spectral stability, and their linewidth is expected to be on the order of 100 kHz for 1 cm cavity lengths. Despite a possible lower tuning range than ECLs, the great advantage of these structures is their almost perfect mechanical stability and their immunity to external perturbations.

However, one must keep in mind that the enormous investments required to make such sophisticated integrated structures must be justified by a huge market. Therefore, industrial development of such structures will probably not occur for wavelengths at which no mass production is expected. In that case, we believe that the present knowledge about hybrid structures can be very useful.

Acknowledgments.

We are grateful to F. Favre from the CNET for many interesting discussions and to J. C. Bouley and J. Landreau from the CNET for having provided several AR-coated laser diodes. Moreover, we are particularly grateful to J. L. Beylat (Alcatel Alsthom Recherche) for many fruitful information exchanges, and for having provided very useful AR-coated diodes.

References

- [1] LEE T. P., « Narrow linewidth and frequency tunable lasers for coherent optical communications », *SPIE Proc.* **988** (1988) 237-248.
- [2] BARWOOD G. P., GILL P., ROWLEY W. R. C., « A simple Rubidium stabilized laser diode for interferometric applications », *J. Phys. E, Scient. Inst.* **21** (1988) 966-971.
- [3] WIEMAN C. E., HOLLBERG L., « Using diode lasers for atomic physics », *Rev. Sci. Instrum.* **62** (1991) 1-20.
- [4] GIALLORENZI T. G., BUCARO J. H., DANDRIDGE A., SIEGEL G. W., COLE J. H., RASHLEIGH S. C., PRIEST R. G., « Optical fiber sensor technology », *IEEE J. Quantum Electron.* **QE-18** (1982) 626-665.
- [5] YAMADA M., SUEMATSU Y., « A condition of single longitudinal mode operation in injection lasers with index guiding structure », *IEEE J. Quantum Electron.* **QE-14** (1978) 727-736.
- [6] KOGELNIK H., SHANK C. V., « Coupled wave theory of distributed feedback lasers », *J. Appl. Phys.* **43** (1972) 2327-2335.
- [7] WITTEGREFE F., HOOGERLAND M. D., WOERDMAN J. P., « Semiconductor lasers for spectroscopy », *Meas. Sci. Technol.* **2** (1991) 304-311.
- [8] AGRAWAL G. P., DUTTA N. K., « Long wavelength semiconductor lasers » (Ed. Van Nostrand Reinhold Co.) 1986.
- [9] KITAMURA M., YAMAGUCHI M., MURATA S., MITO I., KOBAYASHI M., « Low threshold and high temperature single longitudinal mode operation of 1.55 μm -band DFB-DCPBH LDs », *Electron. Lett.* **20** (1984) 595-597.
- [10] CASSIDY D. T., BRUCE D. M., VENTRUDO B. F., « Short external-cavity module for enhanced single-mode tuning of InGaAsP and AlGaAs semiconductor diode lasers », *Rev. Sci. Instrum.* **62** (1991) 2385-2388.
- [11] SALATHE R. P., « Diode laser coupled to external resonators », *Appl. Phys.* **20** (1979) 118.
- [12] JIANGLIN W., HANYI Z., QUN W., BINGHUN Z., « Single mode characteristics of short coupled cavity semiconductor lasers », *IEEE J. Quantum Electron.* **QE-23** (1987) 1005.
- [13] LIOU K. Y., « Single longitudinal — mode operation of injection laser coupled to a grinrod external cavity », *Electron. Lett.* **19** (1983) 750.
- [14] LAURENT P., « Stabilisation en fréquence de diodes laser par couplage optique résonant sur une cavité Fabry-Perot confocale », Thesis in Optique and Photonique, Orsay University, France (1989).
- [15] AVILA G., GAIN P., DE CLERCQ E., CEREZ P., « New absolute wave number measurements of the D_2 line of Cesium », *Metrologia* **22** (1986) 111-114.
- [16] SUZUKI M., YAMAGUSHI S., « Frequency stabilization of a GaAs semiconductor laser by use of the optical-optical double-resonance effect of the Doppler-free spectrum of the Rb D_1 line », *IEEE J. Quant. Elect.* **24** (1988) 2392-2399.
- [17] YABUZAKI T., IBARAGI A., HORI H., KITANO M., OGAWA T., « Frequency-locking of a GaAlAs laser to a Doppler-free spectrum of the Cs- D_2 line », *Japan J. Appl. Phys.* **20** (1981) 451-454.
- [18] PEVTSCHIN V., EZEKIEL S., « Investigation of absolute stability of water-vapor-stabilized semiconductor laser », *Opt. Lett.* **12** (1987) 172-174.

- [19] YAMAGUSHI S., SUZUKI M., « Simultaneous stabilization of the frequency and power of an AlGaAs semiconductor laser by use of the optogalvanic effect of Krypton », *IEEE J. Quant. Elect.* QE-19 (1983) 1514-1519.
- [20] YAMAGUCHI S., SUZUKI M., « Frequency locking of an InGaAsP semiconductor laser of the first overtone vibration-rotation of hydrogen fluoride », *Appl. Phys. Lett.* 41 (1982) 1034-1036.
- [21] LABACHELERIE M., LATRASSE C., DIOMANDÉ K., KEMSSU P., CERZ P., « A 1.5 μm absolutely stabilized extended-cavity semiconductor laser », *IEEE Trans. Instrum. Meas.* 40 (1991) 185-190.
- [22] YANAGAWA T., SAITO S., YAMAMOTO Y., « Frequency stabilization of 1.5 μm InGaAsP distributed feedback laser to NH_3 absorption lines », *Appl. Phys. Lett.* 45 (1984) 826-858.
- [23] SUDO S., SAKAI Y., YASAKA H., IKEGAMI T., « Frequency stabilized DFB laser module using 1.53159 μm absorption line of C_2H_2 », *IEEE Photonics Technol. Lett.* 1 (1989) 281-284 ;
SUDO S., SAKAI Y., YASAKA H., IKEGAMI T., « Frequency stabilization of 1.5 μm DFB laser using vibrational-rotational absorption of $^{13}\text{C}_2\text{H}_2$ molecules », *IEEE Photonics Technol. Lett.* 1 (1989) 392-384.
- [24] OHTSU M., KOTANI H., TAGAWA H., « Spectral measurements of NH_3 and H_2O for pollutant gas monitoring by 1.5 μm InGaAsP/InP lasers », *Jpn J. Appl. Phys.* 22 (1983) 1553-1557.
- [25] HERTZBERG G., « Infrared and raman Spectra of Polyatomic molecules », Nostrand, Princeton NJ (1945).
- [26] SASADA H., « 1.5 μm DFB semiconductor laser spectroscopy of HCN », *J. Chem. Phys.* 88 (1988) 767-777.
- [27] MENOCAL S. G., ANDREADAKIS N., PATEL J. S., WERNER J., « Frequency locking of 1.5 μm DFB laser diode to a neon indicator lamp using the optogalvanic effect », *IEEE Photonics Technol. Lett.* 1 (1989) 285-287.
- [28] OHTSU M., IKEGAMI E., « Frequency stabilization of 1.5 μm DFB laser using internal second harmonic generation and atomic ^{87}Rb line », *Electron. Lett.* 25 (1989) 22-23.
- [29] LETOKHOV, CHEBOTAYEV, « Nonlinear Laser Spectroscopy » (Springer-Verlag) 1977.
- [30] KOBAYASHI S., YAMAMOTO Y., ITO M., KIMURA T., « Direct frequency modulation in AlGaAs semiconductor lasers », *IEEE J. Quantum Electron.* QE-18 (1982) 582-595.
- [31] TAKO T., OHTSU M., TSUCHIDA H., « Frequency stabilization of AlGaAs lasers based on the H_2O and Rb-D_2 lines », *Japan J. Appl. Phys.* 21 (1982) 561.
- [32] HORI H., KITAYAMA Y., KITANO M., YABUZAKI T., « Frequency stabilization of GaAlAs laser using a Doppler-free spectrum of the Cs-D_2 line », *IEEE J. Quant. Elect.* QE-19 (1983) 169-175.
- [33] BARWOOD G. P., GILL P., ROWLEY W. R. C., « Laser diode frequency stabilization to doppler-free rubidium spectra », *Electron. Lett.* 24 (1988) 769-770.
- [34] DE LABACHELERIE M., CERZ P., « Frequency locking of a 850 nm external-cavity semiconductor laser on a Doppler-Free Cs-D_2 line », *SPIE Proc.* 701 (ECOOSA 86, Florence, Sept. 1986) pp. 182-184.
- [35] BJORKLUND G. C., LEVENSON M. D., LENTH W., ORTIZ C., « Frequency modulation (FM) spectroscopy », *Appl. Phys. B* 32 (1983) 145-152 ;
LENTH W., « High frequency heterodyne spectroscopy with current-Modulated diode lasers », *IEEE J. Quantum Electron.* QE-20 (1984) 1045-1050.
- [36] YANAGAWA T., SAITO S., MACHIDA S., YAMAMOTO Y., NOGUCHI Y., « Frequency stabilization of an InGaAsP distributed feedback laser to an NH_3 absorption line at 15 137 Å with an external frequency modulator », *Appl. Phys. Lett.* 47 (1985) 117-119.
- [37] JINGQUAN D., YONGFSAN T., YUANHAI X., XIWEN Z., « Frequency stabilized laser for atomic frequency standards using saturated absorption by magnetic modulation », Proc. EFTF (Neuchâtel, March 1988) p. 555.
- [38] TAKAKURA T., IGA K., TAKO T., « Linewidth measurement of a single Longitudinal mode AlGaAs Laser with a Fabry-Perot interferometer », *Japan J. Appl. Phys.* 19 (1980) 725-727.
- [39] FLEMING M. W. and MOORADIAN A., « Fundamental Line Broadening of Single Mode (GaAl)As Diode Lasers », *Appl. Phys. Lett.* 38 (1981) 511-513.

- [40] YAMAMOTO Y., MUKAI T., SAITO S., « Quantum phase noise and linewidth of a semiconductor laser », *Electron. Lett.* **17** (1981) 327-329.
- [41] LAX M., « Classical Noise V. : Noise in Self Sustained Oscillators », *Phys. Rev.* **160** 290-307.
- [42] YARIV A. and CATON W. M., « Frequency, Intensity and Field Fluctuations in Laser Oscillators », *IEEE J. Quantum Electron.* QE-10 (1974) 509-515.
- [43] HENRY C. H., « Theory of the linewidth of semiconductor lasers », *IEEE J. Quantum Electron.* QE-18 (1982) 259-264.
- [44] VAHALA K., YARIV A., « Semiclassical theory of noise in semiconductor lasers », *IEEE J. Quantum Electron.* QE-19 (1983) 1096-1109.
- [45] HENRY C. H., « Theory of the phase noise and power spectrum of a single mode injection laser », *IEEE J. Quantum Electron.* QE-19 (1983) 1391-1397.
- [46] SCHAWLOW A. L., TOWNES C. H., « Infrared and optical Masers », *Phys. Rev.* **112** (1958) 1940-1949.
- [47] FLEMING M. W., MOORADIAN A., « Fundamental line broadening of single-mode GaAlAs diode lasers », *Appl. Phys. Lett.* **38** (1981) 511-513.
- [48] OSINSKI M., BUUS J., « Linewidth broadening factor in Semiconductor Lasers — An overview », *IEEE J. Quantum Electron.* QE-23 (1987) 9-29.
- [49] PIAZOLLA S., TAMBURRINI M., SPANO P., « Characterisation of phase noise in semiconductor lasers », *Appl. Phys. Lett.* **41** (1982) 695-696.
- [50] WELFORD D., MOORADIAN A., « Observation of linewidth broadening in GaAlAs diode lasers due to electron number fluctuations », *Appl. Phys. Lett.* **40** (1982) 560-562.
- [51] LAURENT P., CLAIRON A., BREANT C., « Frequency Noise analysis of optically self-locked diode lasers », *IEEE J. Quantum Electron.* QE-25 (1989) 1131-1142.
- [52] O'MAHONY M. J., HENNING I. O., « Semiconductor laser linewidth broadening due to $1/f$ carrier noise », *Electron. Lett.* **19** (1983) 1000.
- [53] OHTSU M., KOJAJIMA S., « Derivation of the spectral width of a 0.8 μm AlGaAs laser considering $1/f$ noise », *Japan J. Appl. Phys.* **23** (1984) 760.
- [54] KIKUCHI K., « Effect of $1/f$ type noise on semiconductor laser linewidth residual in high power limit », *IEEE J. Quantum Electron.* **25** (1989) 684.
- [55] KIKUCHI K., OKOSHI T., « Dependence of semiconductor laser linewidth on measurement time : evidence of predominance of $1/f$ noise », *Electron. Lett.* **21** (1985) 10-11.
- [56] YAMAMOTO Y., NILSSON O., SAITO S., « Theory of a Negative Frequency Feedback Semiconductor Laser », *IEEE J. Quantum Electron.* QE-21 (1985) 1919-1927.
- [57] OHTSU M., « Frequency stabilization in semiconductor lasers », *Opt. Quant. Electron.* **20** (1988) 283-300.
- [58] DESFORGES F. X., ANDRÉ Y., CEREZ P., « High frequency stabilization of an AlGaAs laser diode », *J. Phys. E Scient. Instrum.* **19** (1986) 731-733.
- [59] OHTSU M., MURATA M., KOUROGI M., « FM noise reduction and subkilohertz linewidth of an AlGaAs laser by negative electrical feedback », *IEEE J. Quantum Electron.* QE-26 (1990) 231-241.
- [60] SCHUNK N., PETERMANN K., « Minimum bit-rate of DPSK transmission for semiconductor lasers with a long external cavity and strong linewidth reduction », *J. Light Technol.* LT-5 (1987) 1309-1314.
- [61] TKACH R. W., CHRAPLYVY A. R., « Regime of feedback effect effects in 1.5 μm distributed feedback lasers », *J. Lightwave Technol.* LT-4 (1986) 1655-1661.
- [62] MORK J., TROMBORG B., « The mechanism of mode selection for an external-cavity laser », *IEEE Photon. Technol. Lett.* **2** (1990) 21-23.
- [63] BEYLAT J. L., « Etude des effets de la réalimentation optique sur les lasers à semiconducteurs », Thesis Physique-Electronique, Paris VI University (Nov. 1991) p. 126.
- [64] LENSTRA D., VERBEEK B., DEN BOEF A. J., « Coherence collapse in single mode semiconductor lasers due to optical feedback », *IEEE J. Quantum Electron.* QE-21 (1985) 674-679 ;
COHEN J. S., LENSTRA D., « Spectral properties of the coherence collapse state of semiconductor lasers with delayed optical feedback », *IEEE J. Quantum Electron.* QE-25 (1989) 1143.

- [65] GOLDBERG L., TAYLOR H. F., DANDRIDGE A., KELLER J. F., MILES R. O., « Spectral characteristics of semiconductor lasers with optical feedback », *IEEE J. Quantum Electron.* QE-18 (1982) 555-564.
- [66] KANADA T., NAWATA K., « Injection laser characteristics due to reflected optical power », *IEEE J. Quantum Electron.* QE-15 (1979) 559-565.
- [67] FAVRE F., LE GUEN D., « Spectral properties of a SC laser coupled to a single mode fiber resonator », *IEEE J. Quantum Electron.* QE-21 (1985) 1937.
- [68] NILSSON O., SAITO S., YAMAMOTO Y., « Oscillation frequency, linewidth reduction and frequency modulation characteristics for a diode laser with external grating feedback », *Electron. Lett.* 17 (1981) 589-591.
- [69] DAHMANI B., HOLLBERG L., DRULLINGER R., « Frequency stabilization of semiconductor lasers by resonant optical feedback », *Opt. Lett.* 12 (1987) 876.
- [70] CLAIRON A., LAURENT P., BREANT C., DAHMANI B., « Ultra narrow semiconductor laser linewidth for optically pumped Cesium clock », Proc. EFTF, Neuchâtel-Switzerland (March 1988) p. 537.
- [71] LI H., TELLE H. R., « Efficient frequency noise reduction of GaAlAs semiconductor lasers by optical feedback from an external high finesse resonator », *IEEE J. Quantum Electron.* QE-25 (1989) 257.
- [72] LAURENT P., CLAIRON A., BREANT C., « Frequency Noise analysis of optically self-locked diode lasers », *IEEE J. Quantum Electron.* QE-25 (1989) 1131-1142.
- [73] MELLIS J., AL CHALABI S. A., CAMERON K. H., WYATT R., REGNAULT J. C., DEVLIN W. J., BRAIN M. C., « Miniature package external-cavity SC laser with 50 GHz continuous electrical tuning range », *Electron. Lett.* 24 (1988) 988.
- [74] FLEMING M. W., MOORADIAN A., « Spectral characteristics of external-cavity controlled SC lasers », *IEEE J. Quantum Electron.* 17 (1981) 44.
- [75] BAGLEY M., WYATT R., ELTON D. J., WICKES H. J., SPURDENS P. C., SELTZER C. P., COOPER D. M. and DEVLIN W. J., « 242 nm continuous tuning from a GRIN-SC-MQW-BH InGaAsP laser in an Extended-Cavity », *Electron. Lett.* 26 (1986) 267-269.
- [76] TABUCHI H. and ISHIKAWA H., « External grating tunable MQW laser with wide tuning range of 240 nm », *Electron. Lett.* 26 (1986) 742-743.
- [77] NOTOMI M., MITOMI O., YOSHIKUNI Y., KANO F., TOHMORI Y., « Broad band tunable two section laser diode with external grating feedback », *IEEE Photon. Technol. Lett.* 2 (1990) 85-87.
- [78] ZORABEDIAN P., TRUTNA W. R., « Alignment stabilized grating tuned external-cavity semiconductor laser », *Opt. Lett.* 15 (1990) 483-485.
- [79] HIDAKA T., NAKAMOTO T., « Electric tuning of semiconductor laser using acousto-optic device », *Electron. Lett.* 25 (1989) 1320-1321.
- [80] COQUIN G. A., CHEUNG K. W., « Electronically tunable external-cavity semiconductor laser », *Electron. Lett.* 24 (1988) 599-600.
- [81] VAHALA K., KYUMA K., YARIV A., « Narrow linewidth, single frequency semiconductor laser with a phase conjugate external cavity mirror », *Appl. Phys. Lett.* 49 (1986) 1563-1565.
- [82] CHRAPLYVY A. R. *et al.*, « Simple narrow-linewidth 1.5 μm InGaAsP DFB external-cavity laser », *Electron. Lett.* 22 (1986) 88-89.
- [83] SUNAK H. R. D., ENGERT C. P., « Design of distributed feedback laser-based external-cavity structures for coherent communications », *SPIE Proc.* 988 (1988) 259-269.
- [84] PETUCHOWSKI S. J., MILES R. O., DANDRIDGE A., GIALLORENZI T. G., « Phase sensitivity and line narrowing in a Fox-Smith configured semiconductor laser », *Appl. Phys. Lett.* 40 (1982) 302-304.
- [85] VOUMARD C., « External-cavity controlled 32-MHz narrow band CW GaAlAs diode lasers », *Opt. Lett.* 1 (1977) 61-63.
- [86] HARRISON J. H., MOORADIAN A., « Linewidth and offset frequency locking of external cavity GaAlAs lasers », *IEEE J. Quantum Electron.* 25 (1989) 1152-1155.
- [87] KAHN J. M., BURRUS C. A., RAYBON G., « High stability 1.5 μm external-cavity semiconductor laser for phase lock applications », *IEEE Photon. Technol. Lett.* 1 (1989) 159-161.

- [88] HANYI Z., JIAN L., JIANGLIN W., BINGKUN Z., « Mode selectivity of multisegment composite-cavity semiconductor lasers », *Opt. Laser Technol.* **19** (1987) 304-308.
- [89] HEISMAN F. *et al.*, « Narrow linewidth electro-optically tunable InGaAsP-Ti:LiNbO₃ external cavity laser », *Appl. Phys. Lett.* **51** (1987) 164-166.
- [90] SALIM G., « Diode laser à cavité externe accordable en longueur d'onde par voie électro-optique à 1,5 μm », Thesis in Science from Université de Franche-Comté, Besançon-France (1990).
- [91] MEHUYS D., ENG L., MITTELSTEIN M., CHEN T. R., YARIV A., « Ultra-Broadband tunable external cavity Quantum Well lasers », *SPIE Proc.* **1219** (1990) 358-365.
- [92] SUNAK H. R. D., OH I. W., « Design of Fabry-Perot laser-based external-cavity structures for coherent communications », *SPIE Proc.* **988** (1988) 282-291.
- [93] BOGATOV V. Y. *et al.*, « Bistable operation and spectral tuning of injection laser with external dispersive cavity », *IEEE Proc.* **129** (1982) 77-82.
- [94] GLAS P., MULLER R., « Bistable operation of a GaAs-AlGaAs diode laser coupled to an external resonator of narrow spectral bandwidth », *Opt. Quantum Electron.* **14** (1982) 375-389.
- [95] ZORABEDIAN P., TRUTNA W. R., CUTLER L. S., « Bistability in grating tuned External-cavity semiconductor lasers », *IEEE J. Quantum Electron.* QE-23 (1987) 1855-1860.
- [96] FAVRE F., LE GUEN D., SIMON J. C., LANDOUSIES B., « External-cavity SC laser with 15 nm tuning range », *Electron. Lett.* **22** (1986) 795-796.
- [97] MELLIS J. *et al.*, « Miniature packaged external-cavity semiconductor laser with 50 GHz continuous electrical tuning range », *Electron. Lett.* **24** (1988) 988-989 ;
SCHREMER A. T., TANG C. L., « External cavity semiconductor laser with 1 000 GHz continuous Piezoelectric tuning range », *IEEE Photon. Technol. Lett.*, **2** (1990) 3-5.
- [98] FAVRE F., LE GUEN D., « 82 nm of continuous tunability for an external cavity semiconductor laser », *Electron. Lett.* **27** (1991) 183-184.
- [99] NILSSON Olle, GOBAR E., VILHELMSON K., « Continuously Tunable External-cavity laser », Proc. ECOC 90 (16-20 Sept. 1990, Amsterdam) pp. 373-376.
- [100] DE LABACHELERIE M., PASSEDAT G., « Mode hop suppression in grating tuned lasers », to be published.
- [101] KUO C.-Y., VAN DER ZIEL J. P., « Linewidth reduction of 1.5 μm grating loaded external cavity semiconductor laser by geometrical reconfiguration », *Appl. Phys. Lett.* **48** (1986) 885-887.
- [102] SAKAOMOTO M. and KATO Y., « High-power (710 mW cw) single-lobe operation of broad area AlGaAs double heterostructure lasers grown by metalorganic chemical vapor deposition », *Appl. Phys. Lett.* **50** (1987) 869-870.
- [103] LINDSTRON C., BURNHAM R. D., SCIFRES D. R., PAOLI T. L. and STREIFER W., « One Watt CW Visible Single Quantum-Well Lasers », *Electron. Lett.* **19** (1983) 80-81.
- [104] SCIFRES D. R., BURNHAM R. D. and STREIFER W., « Continuous Wave High-Power High Temperature Semiconductor Laser Phase-Locked Arrays », *Appl. Phys. Lett.* **41** (1982) 1030.
- [105] VERDIELL J. M. and FREY R., « A Broad-Area Mode-Coupling Model for Multiple-Stripe Semiconductor Lasers », *IEEE J. Quantum Electron.* QE-26, February 1990.
- [106] CARLSON N. W. *et al.*, « Dynamically stable 0° phase mode operation of a grating-surface-emitting diode-laser array », *Opt. Lett.* **13** (1988) 312-314.
- [107] DONNELLY J. P., GOODHUE W. D., WINDHORN T. H. and BAILEY R. J., « Monolithic two-dimensional surface-emitting arrays of GaAs/AlGaAs diode lasers », *Appl. Phys. Lett.* **51** (1987) 1138-1140.
- [108] OREINSTEIN M., KAPON E., STOFFEL N. G., HARBISON J. P., FLOREZ L. T. and WULLERT J., « Two-dimensional Phase-locked arrays of Vertical-cavity Semiconductor Lasers by Mirror Reflectivity Modulation », *Appl. Phys. Lett.* **58** (1991) 804-806.
- [109] CARLSON N. W., EVANS G. A., HAMMER J. M., LURIE M., CARR L. A., HAWRYLO F. Z., JAMES E. A., KAISER C. J., KIRK J. B., REICHERT W. F. and TRUXAL D. A., « High-power seven-element grating surface emitting diode laser array with 0.012° far-field angle », *Appl. Phys. Lett.* **52** (1988) 939-941.
- [110] ACKLEY D. E., « Single Longitudinal Mode Operation of High Power Multiple Stripe Injection Lasers », *Appl. Phys. Lett.* **42** (1983) 152-154.

- [111] WELCH D. F., SCIFRES D., CROSS P. and KUNG H., « High power CW operation of phased array diode lasers with diffraction limited output beam », *Appl. Phys. Lett.* **47** (1985) 1134-1136.
- [112] BOTEZ D., MAWST L., HAYASHIDA P., PETERSON G. and ROTH T. J., « High-power, diffraction-limited-beam operation from phase-locked diode-laser arrays of closely spaced « leaky » waveguides (antiguides) », *Appl. Phys. Lett.* **53** (1988) 464-466.
- [113] MEHUY D., WELCH D. F., PARKE R., WAARTS R. G., HARDY A., SCIFRES D., « High power, diffraction limited emission from monolithically integrated active grating master oscillator power amplifier », *Electron. Lett.* **27** (1991) 492-494.
- [114] BOTEZ D., HAYASHIDA P., MAWST L. J. and ROTH T. J., « Diffraction-limited-beam, high-power operation from X-junction coupled phase-locked arrays of AlGaAs/GaAs diode lasers », *Appl. Phys. Lett.* **53** (1988) 1366-1368.
- [115] GOLDBERG L. and WELLER J. F., « Injection locking and single-mode fiber coupling of a 40-element laser diode array », *Appl. Phys. Lett.* **50** (1987) 1713-1715.
- [116] GOLDBERG L. and CHUN M. K., « Injection Locking Characteristics of a 1 W Broad Stripe Laser Diode », *Appl. Phys. Lett.* **53** (1988) 1900-1902.
- [117] CORNWELL D. M., RALL J. A. R., ABSHIRE J. B., « Phase front measurements of an injection-locked laser-diode array », *Opt. Lett.* **14** (1989) 910-912.
- [118] GOLDBERG L., WELLER J. F., « Narrow lobe emission of high power broad stripe laser in external resonator cavity », *Electron. Lett.* **25** (1989) 112-114.
- [119] WANG S. C., STONE R. E., GACUSAN L. Z., « Self injection locking of high power gain-guided laser diode arrays », *Tech. Digest, WM8, CLEO 88* (April 88) pp. 212-213.
- [120] WAARTS R. G., HARDY A., MEHUY D., STREIFER W., WELCH D. F., « Coherent radiation from a broad area semiconductor laser in an external cavity », *SPIE Proc.* **1219** (1990) 172-178 ;
DIADIUK V., LIAU Z. L., WALPOLE J. N., CAUNT J. W. and WILLIAMSON R. C., « External-cavity Coherent Operation of InGaAsP Buried-Heterostructure Laser Array », *Appl. Phys. Lett.* **55** (1989) 2161-2163.
- [121] SHARFIN *et al.*, « High Power, Diffraction Limited, Narrow Band, External Cavity », *Appl. Phys. Lett.* **54** (1989) 1731-1733.
- [122] BEGLEY D. L., MARTIN D., VIVIAN B. and RICE R. R., « Compact Linear Array External Cavity Laser », *Appl. Opt.* **25** (1986) 3835-3837.
- [123] DANNO B., SPANO P., TAMBURRINI M. and PIAZZOLLA S., « Phase noise and spectral line shape in semiconductor lasers », *IEEE J. Quantum Electron.* **QE-19** (1983) 266-270.