



HAL
open science

Linear electroclinic coupling in ferroelectric liquid crystals

Laurent Dupont, M. Glogarová, J. Marcerou, H. Nguyen, C. Destrade, L. Lejček

► **To cite this version:**

Laurent Dupont, M. Glogarová, J. Marcerou, H. Nguyen, C. Destrade, et al.. Linear electroclinic coupling in ferroelectric liquid crystals. *Journal de Physique II*, 1991, 1 (7), pp.831-844. 10.1051/jp2:1991112 . jpa-00247559

HAL Id: jpa-00247559

<https://hal.science/jpa-00247559v1>

Submitted on 4 Feb 2008

HAL is a multi-disciplinary open access archive for the deposit and dissemination of scientific research documents, whether they are published or not. The documents may come from teaching and research institutions in France or abroad, or from public or private research centers.

L'archive ouverte pluridisciplinaire **HAL**, est destinée au dépôt et à la diffusion de documents scientifiques de niveau recherche, publiés ou non, émanant des établissements d'enseignement et de recherche français ou étrangers, des laboratoires publics ou privés.

Classification

Physics Abstracts

64.70M — 61 30G — 42 80K

Linear electroclinic coupling in ferroelectric liquid crystals

L Dupont, M. Glogarová (*), J P Marcerou, H. T Nguyen, C Destrade and L Lejček (*)

Centre de recherches Paul Pascal, Château Brivazac, Av Dr Schweitzer, F-33600 Pessac, France

(Received 16 January 1991, revised 08 March 1991, accepted 19 March 1991)

Résumé. — Nous avons étudié le couplage électroclinique (mode mou) près de la transition de phase smectique A-smectique C* pour différents composés chiraux. La principale originalité de notre montage est de permettre la mesure des quantités optiques et diélectriques dans un même échantillon. Nous pouvons ainsi déterminer les premiers coefficients du développement de Landau associé à la transition de phase. Les prédictions les plus simples de cette théorie sont vérifiées sans dépendances thermiques anormales des coefficients. D'un autre point de vue, celui des applications, la fréquence de relaxation de l'effet électroclinique est de l'ordre de 10 kHz à 1 MHz pour les composés étudiés.

Abstract. — We report a study of the electroclinic coupling (soft mode), close to the smectic A to smectic C* phase transition in several chiral compounds. The main characteristic of the technique used is to measure both optical and dielectric quantities on a single sample. This way one may derive the first coefficients of the Landau expansion describing the phase transition. The simplest expectations of this theory are found to hold well without unusual temperature dependences of the coefficients. Furthermore, the relaxation frequency of the electroclinic coupling, (which is essential for applications), is found to lie in the 10 kHz to 1 MHz range.

1. Introduction.

Ferroelectric smectic C* liquid crystals have great potentialities in display technology as they may be used to build bistable and fast nonlinear devices [1, 2] (i.e. they are insensitive to weak electric fields in multiplexed displays while they switch quickly when suitably addressed). Another promising property of these materials has been pointed out [3, 4], namely their great soft mode susceptibility in response to an external electric field (electroclinic coupling), in the high temperature smectic A phase, which can be used to design fast linear optical devices [5].

In this paper we report a study on the electroclinic coupling that allows the measurement of both optical and dielectric properties under the same conditions of temperature, applied electric field and alignment in a given sample [6]. This experimental technique gives the first coefficients of the Landau expansion together with the soft mode viscosity and relaxation frequency.

(*) *Permanent address* Institute of Physics, Czechoslovak Academy of Sciences, Na Slovance 2, 18040 Prague 8, Czechoslovakia

Section 2 describes the experimental quantities we measure, while section 3 reports on the results we obtained for three different compounds. An appendix reports theoretical expectations derived from the use of a general orientational order parameter.

2. Theoretical background.

2.1 ORDER PARAMETERS OF ORIENTATIONAL PHASE TRANSITIONS — The Smectic A-Smectic C (or ferroelectric C*) phase transition is described [7] by a two-dimensional order parameter $\theta e^{i\phi}$ that measures the tilt of the director \mathbf{n} at an angle θ with respect to the layer normal z , with a projection in the layer plane xy at an angle ϕ from x . Another notation has been used [8] that takes into account the tensorial character of the two components of the order parameter :

$$\begin{aligned}\theta_x &= \theta \cos \phi = n_x \times n_z = \xi_1 \\ \theta_y &= \theta \sin \phi = n_y \times n_z = \xi_2.\end{aligned}\quad (1)$$

This shows that, in order to depict the orientational phase transitions from a uniaxial phase like a smectic A to a biaxial one, smectic C or C* or biaxial smectic A [9], one has to use a tensorial order parameter measuring the deviations of a tensor like the dielectric permittivity ε_{ij} or the magnetic susceptibility χ_{ij} out of its equilibrium uniaxial value. This tensor may be defined as

$$Q_{ij} = \varepsilon_{ij} - \varepsilon_{ij}^0 \quad (2)$$

With Q_{ij} one may build, like we do in the appendix, a Landau free energy density [10] obeying the symmetry of the problem. This will be useful for the study of different problems which lie out of the scope of this paper, like transverse biaxiality or the occurrence of first order smectic A-smectic C* phase transition. For the study we report here, the tilt angle θ will be used.

2.2 LINEAR ELECTROCLINIC EFFECT (SOFT MODE) IN THE SMECTIC A PHASE — The expression (14) developed in appendix for the free energy F^* may be taken as a starting point for the study of the smectic A-smectic C* phase-transition with (Q_{xz}, Q_{yz}) playing the role of the primary order parameter. This is still an open field [11-13] we will not discuss, as we are interested here in the coupling of this order parameter with an applied electric field. This coupling is strong enough [13, 14] to induce tilt angles of a few degrees in the smectic A phase close to the transition so we will limit ourselves to the linear regime where θ is proportional to the applied field. We assume that the samples are in the ideal SSFLC configuration [2], where the spontaneous splay and twist of the director are removed by surface interactions. Last, the electric field E and the polarization P have a fixed direction in the plane of the layers determining the C_2 axis of the induced smectic C phase.

Under all these conditions, the first line of equation (14) developed up to fourth order in θ , with the addition of the applied electric field E yields

$$F^* = \frac{1}{2} B_{\perp} \theta^2 + \frac{1}{2 \varepsilon_0 \chi_{\perp}} P^2 - cP\theta + \frac{1}{4} b\theta^4 - P \cdot E - \frac{\varepsilon_{\infty}}{2} E^2 \quad (3)$$

where $B_{\perp} = \alpha (T - T_c)$, $\alpha > 0$ and $\varepsilon_{\infty} = \varepsilon_0(1 + \chi_{\infty}) = n_0^2$ contains high frequency molecular librations and electronic contributions to ε_{\perp} .

Minimization of F^* leads to θ and P proportional to the applied field E

$$\begin{aligned}B_{\perp} \theta - cP &= 0 \\ -\varepsilon_0 \chi_{\perp} c\theta + P &= \varepsilon_0 \chi_{\perp} E\end{aligned}\quad (4)$$

We shall call hereafter this situation the *linear regime* which will be valid provided that the quartic term θ^4 may be neglected with respect to the quadratic one θ^2 in F^* . In the mean field approximation θ and P in smectic A phase read :

$$\theta = \frac{\varepsilon_0 \chi_{\perp} c}{B_{\perp}^*} E, \quad P = \varepsilon_0 \chi_{\perp} E + \frac{\varepsilon_0^2 \chi_{\perp}^2 c^2}{B_{\perp}^*} E,$$

where

$$B_{\perp}^* = \alpha (T - T_c^*), \quad T_c^* = T_c + \frac{\varepsilon_0 \chi_{\perp} c^2}{\alpha} \quad (5)$$

One finds that the transition temperature is displaced in a chiral compound, due to the linear coupling $cP\theta$, as proved experimentally by Bahr [14] and recently checked [15] for one of the compounds we report on in this paper (C7 Valine) mixed with its enantiomer in varied proportions. From a dynamical point of view, if the applied field is a sine one $E e^{j\omega t}$, B_{\perp}^* is to be replaced by $B_{\perp}^* + j\omega\gamma_{\theta}$, where γ_{θ} is the soft mode viscosity. Then one expects the frequency dependence of θ and of the *electroclinic* component in P to be a Lorentzian with a relaxation frequency $B_{\perp}^*/2\pi\gamma_{\theta}$ proportional to $(T - T_c^*)^{-1}$.

If we now express the linearity condition $2B_{\perp}^*\theta^2 \gg b\theta^4$, we get :

$$E \ll \sqrt{\frac{2B_{\perp}^{*3}}{b\varepsilon_0^2\chi_{\perp}^2c^2}} \propto (T - T_c^*)^{3/2} \quad (6)$$

This relation, checked carefully as reported in figure 3, means that when studying the electroclinic effect in its linear regime, one has to apply an increasingly small electric field when approaching the phase transition. It expresses nothing but the usual definition of a susceptibility close to a phase transition.

$$\frac{\varepsilon_0 \chi_{\perp} c}{B_{\perp}^*} = \lim_{E \rightarrow 0} \frac{\theta}{E}$$

2.3 SOFT MODE IN THE SMECTIC C* PHASE — In the condensed smectic C* phase, the soft mode linked to the modulus of the order parameter θ is often hidden by the Goldstone mode linked to the phase ϕ . It is still present however as a perturbation $\delta\theta$ of the equilibrium value θ_0 . There also exists a perturbation δP_{ec} of the permanent polarization. They may be written in the linear regime, for a second order phase transition, as :

$$\begin{aligned} \delta\theta &= \frac{\varepsilon_0 \chi_{\perp} c E}{2B_{\perp}^* + j\omega\gamma_{\theta}} \\ \delta P_{ec} &= \frac{\varepsilon_0^2 \chi_{\perp}^2 c^2 E}{2B_{\perp}^* + j\omega\gamma_{\theta}} \end{aligned} \quad (7)$$

One recovers a Curie-Weiss law with a factor of 2 between the amplitudes of $\delta\theta$ and δP_{ec} in the smectic A and C* phases. In a similar way, the relaxation frequency in the condensed phase is twice the high symmetry one, at the same distance from T_c^* .

The same caution concerning the amplitude of the electric field applies here, showing that in thick samples where one has to apply a bias field [16] in order to unwind the smectic C* helix, the interpretation of the experiments should be difficult due to the non linearity of the problem.

3. Experimental study of the linear electroclinic effect.

Our aim is to measure, for a given compound or mixture in a single SSFLC² sample, the tilt angle θ and the polarization P as a function of the applied electric field E , angular frequency ω and temperature T . We developed the set-up described in figure 1 in which the transmitted light is detected by a PIN photodiode from Hamamatsu giving a signal proportional to θ while the electric current in the cell is measured independently with the help of a Tektronix A6302 current probe. Both signals are measured by a lock-in amplifier from E.G.G. (model 5206 up to 200 kHz and model 5202 from 100 kHz to the MHz range). The temperature is regulated with a stability of about 0.02 K. The studied compounds and their phase sequences are listed in table I.

The samples were aligned in the bookshelf SSFLC planar geometry [2] with a thickness of about 2 μm obtained without spacers for the Isoleucine compounds and a thickness of 15 μm with spacers for the C7 Valine compound. Without spacer, one minimizes the occurrence of chevrons [17], but the exact thickness of the sample and consequently the applied field are poorly known. One must notice that such thin planar smectic A samples show periodic

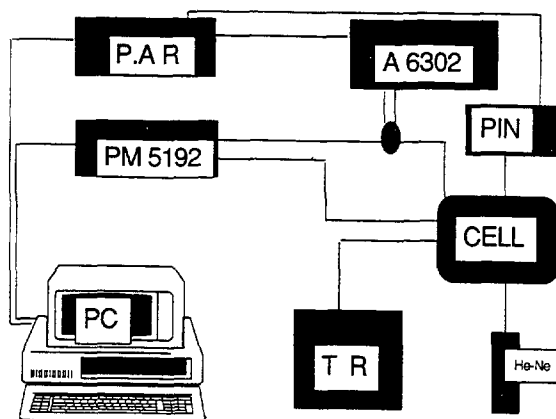

Fig 1 — Experimental set-up. P.A.R. lock-in amplifier, He-Ne laser, PIN : photodiode, A6302 current probe, Cell two stages oven, PM5192 frequency synthesizer, PC microcomputer, TR thermal regulation.

Table I — Studied compounds (the smectic phases in parentheses are monotropic).

Name		Formula	Phase sequence
COS-C10 Isoleucine	I	$\text{C}_{10}\text{H}_{21}\text{O}-\text{C}_6\text{H}_4-\text{COS}-\text{C}_6\text{H}_4-\text{O}_2\text{C}-\text{C}^*\text{HCIC}^*\text{HCH}_3\text{C}_2\text{H}_5$	Cryst -- SC* -- SA -- I 58 °C 66°C 74 °C
C6 Isoleucine	II	$\text{C}_6\text{H}_{13}\text{O}-\text{C}_6\text{H}_4-\text{C}_6\text{H}_4-\text{O}_2\text{C}-\text{C}^*\text{HCIC}^*\text{HCH}_3\text{C}_2\text{H}_5$	Cryst -- SC* -- SA -- I 47 °C 53.5 °C 61 °C
C7 Valine	III	$\text{C}_7\text{H}_{15}\text{O}-\text{C}_6\text{H}_4-\text{C}_6\text{H}_4-\text{O}_2\text{C}-\text{C}^*\text{HCIC}^*\text{H}(\text{CH}_3)_2$	(SG) -- (SC*) -- SA -- I 70.3 °C 74.1 °C 81 °C

patterns which have been attributed to chevron structure [18] or elongated parabolic focal conics, that are favored in chiral compounds when one applies an electric field [19] This superstructure was always present in the study we report here, and probably in all electroclinic experiments, so one must be aware that the accuracy of the quantitative tilt angle measurements is to be estimated at $\pm 10\%$, while relaxation frequency is more precise This is a limitation common to all electroclinic experiments made with thin (\approx some μm) planar samples

3.1 TILT ANGLE MEASUREMENT — As usual [20], we work in the linear regime of the light detection between crossed polarizers, the optical axis making at rest a $\pi/8$ angle with one of them In the limit of small deviation angles, the intensity of the transmitted light is proportional to the tilt angle and is modulated at the same frequency as the applied electric field

$$I\left(\frac{\pi}{8} + \delta\theta\right) = I\left(\frac{\pi}{8}\right) \times (1 + 4\delta\theta e^{j\omega t}) \tag{8}$$

According to the previous discussion, $\delta\theta$ must obey in the smectic A and smectic C* phases respectively

$$\begin{aligned} \delta\theta(T > T_c^*) &= \frac{\epsilon_0 \chi_{\perp} cE}{B_{\perp}^* + j\omega\gamma_{\theta}}, \\ \delta\theta(T < T_c^*) &= \frac{\epsilon_0 \chi_{\perp} cE}{2B_{\perp}^* + j\omega\gamma_{\theta}} \end{aligned} \tag{9}$$

where B_{\perp}^* is in first approximation [21] the only temperature dependent coefficient, $B_{\perp}^* = \alpha(T - T_c^*)$ in the mean field approximation or $\alpha(T - T_c^*)^{\gamma}$ otherwise The first step of our experimental procedure consists in the determination of the maximum value E_{max} of the electric field for which the response is still linear (Fig 2)

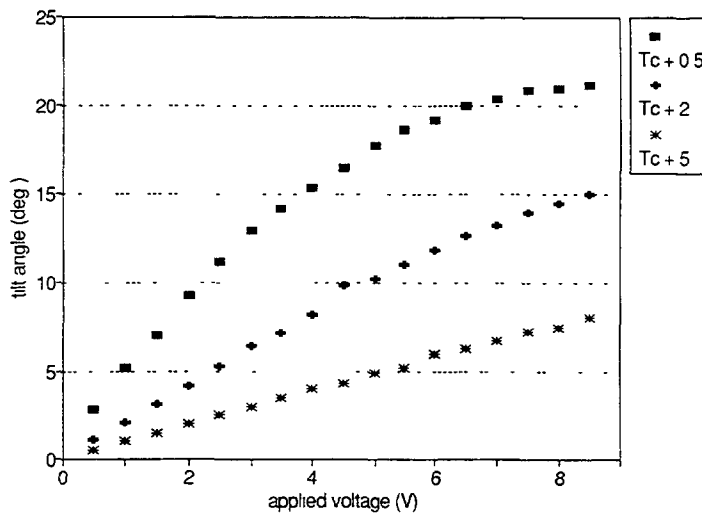

Fig 2 — Plot of the angle θ as a function of the applied voltage for different temperatures in a $2\ \mu\text{m}$ thick COSC10 Isoleucine sample

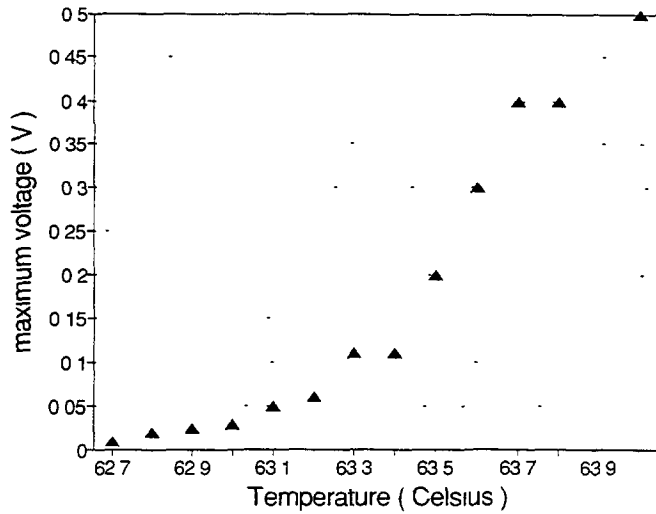

Fig 3 — Maximum applied voltage in smectic A phase of a 2 μm thick COSC10 Isoleucine sample as a function of temperature in agreement with the linearity condition expressed by equation (10)

If one plots this maximum E_{max} as a function of temperature, one recovers a curve (Fig 3) in agreement with equation (6) where the applied voltage has to be as low as 50 mV rms in a 2 μm thick sample close to T_c^*

$$(T - T_c^* \approx 0.5 \text{ K})$$

The second step of our experimental procedure consists then in recording at different temperatures the frequency dependence of the tilt angle in order to recover the expected Lorentzian law ($\theta(\omega)$ in Fig 4 and doubly logarithmic plot in Fig 5)

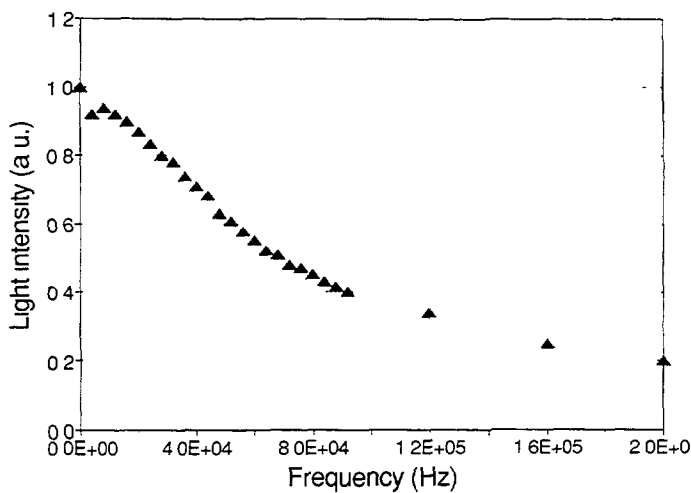

Fig 4 — Variation of light intensity proportional to tilt angle modulation in COSC10 Isoleucine at 64 $^{\circ}\text{C}$ ($\approx T_c + 1^{\circ}\text{C}$)

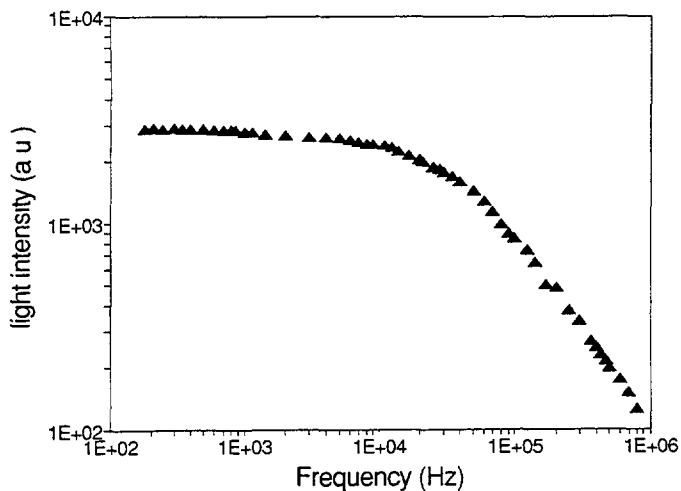

Fig 5 — Log-Log plot of tilt angle modulation in COSC10 Isoleucine showing unambiguously the -1 slope characteristic of the Lorentzian frequency dependence

One then gets the temperature dependence of the plateau of the Lorentzian and of its relaxation frequency in both smectic A and smectic C* phases (Figs 6-7).

These results will be discussed later on but one may already realize that the simplest expectations of equation (7) hold perfectly, at least for our most studied test compound COSC10 Isoleucine

3.2 ELECTRICAL CURRENT MEASUREMENT — We designed an original set-up in order to measure the current in the sample under exactly the same conditions as in optical measurements, i.e. the same temperature and applied voltage in the same cell. We took

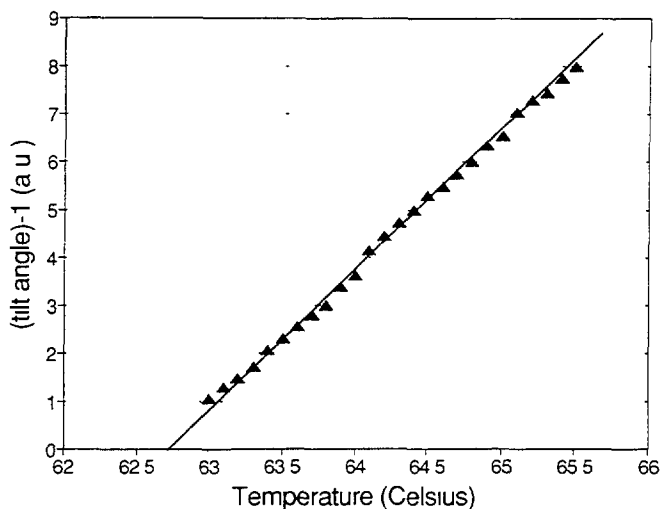

Fig 6 — Temperature dependence of the inverse of the tilt angle at 1 kHz in the smectic A phase of COSC10 Isoleucine

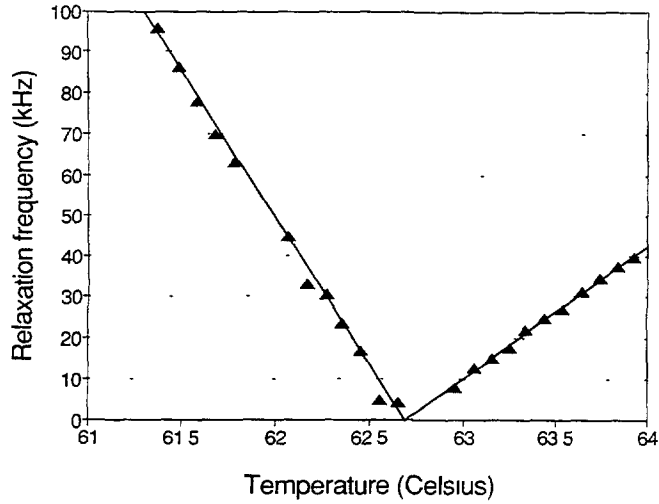

Fig 7 — Temperature dependence of the relaxation frequency in smectic A and smectic C* phase of COSC10 Isoleucine close to the phase transition. This shows the expected 1 – 2 ratio (see e.g. (Eq. 7))

advantage of our polarization measurement set-up [22] that uses a current probe (clipped around the electrical connection wire, see Fig 1), which is able to detect a current without adding a load to the impedance of the circuit. This one is made of a 1 nF capacitance due to studied sample in series with the 50 Ω resistance of ITO coating on the cell glasses. Then the relaxation frequency $1/2 \pi RC$ is expected to be about 3 MHz. Below this frequency, the measurement of the current yields directly the capacitance of the cell as $i(\omega) = j\omega C(\omega)$. The capacitance is directly proportional to the displacement D (Eq. (10)) in the cell which, in turn, contains a dielectric and an electroclinic component as given in equations (5) and (7). A typical experimental scan is shown in figures 8 and 9.

$$D = \frac{i(\omega)}{S\omega} = \left(\varepsilon_{\perp} + \frac{\Delta\varepsilon_{\perp}}{1 + j\omega\tau} \right) E$$

where

$$\varepsilon_{\perp} = \varepsilon_0(1 + \chi_{\infty} + \chi_{\perp})$$

$$\Delta\varepsilon_{\perp} = \frac{\varepsilon_0^2 \chi_{\perp}^2 c^2}{B_{\perp}^*}, \quad (10)$$

$$\tau = \frac{\gamma_{\theta}}{B_{\perp}^*}$$

The comparison of the two sets of experiments, θ and D measurements, allows testing of the coherence of our approach. We find that both obey the same temperature and frequency dependence laws i.e. with a response function $\propto [(T - T_c^{\wedge}) + j\omega\gamma_{\theta}]^{-1}$. The accuracy of the fit for current curves is lower than for tilt angle scans as there are three adjustable parameters (initial and final slopes together with the relaxation frequency) instead of two — amplitude and frequency. So, for the determination of the coefficients measured we decided to work on the whole frequency range with the optical measurement only, and to make dielectric measurements below the relaxation frequency with the help of a second capacitor in series

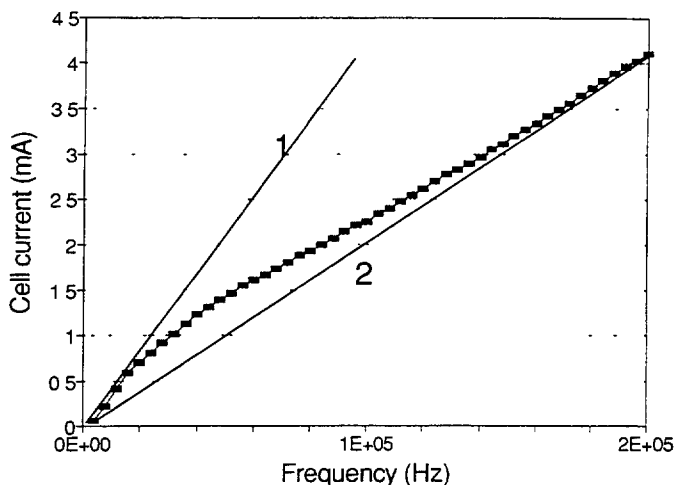

Fig 8 — Current $j\omega C(\omega)$ versus frequency, in COSC10 Isoleucine, showing an initial slope (1) with electroclinic contribution and a relaxation to a smaller one (2) at higher frequency

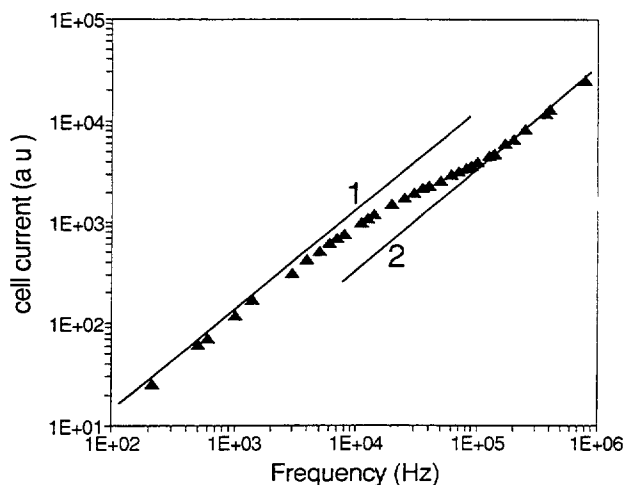

Fig 9 — Doubly logarithmic plot of $j\omega C(\omega)$ in COSC10 Isoleucine showing the relaxation at ≈ 50 kHz

with the cell. This allowed us eventually to plot the reduced quantities $\varepsilon_{r\perp} = D/\varepsilon_0 E$ versus θ/E at different temperatures, like in figure 10, where one gets separately the value of χ_{\perp} derived from the intercept $(1 + \chi_{\infty} + \chi_{\perp})$ of the straight line with the vertical axis, and the reduced electroclinic coefficient [27] $\chi_{\perp} c$ as the slope of the line. This shows unambiguously that these two coefficients are temperature independent in the linear regime.

4. Experimental results.

4.1 STUDIED COMPOUNDS — We studied three compounds: C6 Isoleucine which presents a first order SA-SC γ phase transition, COSC10 Isoleucine and C7 Valine for which the transition was found to be second order.

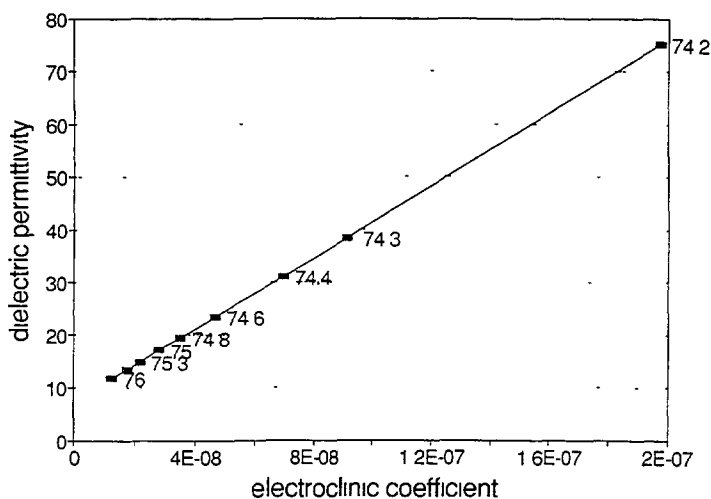

Fig 10 — $D/\epsilon_0 E$ (i.e. $\epsilon_{r,\perp}$) versus θ/E (electroclinic coefficient $\epsilon_0 \chi_{\perp} c/B_{-}^*$) in C7 Valine with $15 \mu\text{m}$ thickness at various temperatures (shown inside) and voltages

4.2 QUANTITATIVE RESULTS — As previously stated, our experimental procedure allows us to determine in the smectic A phase of a given compound the first coefficients derived from the Landau expansion, namely α , T_c^* , c and χ_{\perp} together with the soft mode viscosity γ_{θ} . Their values are given in SI units except for $\epsilon_0 \chi_{\perp} c$ which is expressed in $\text{nC cm}^{-2} \text{rad}^{-1}$ in order to compare it easily with usual P/θ ratios in smectic C* phase.

All our results are to be found in table II

Table II — First coefficients of the Landau expansion (3) and combined expressions for the three studied compounds

Compound	I	II	III
χ_{\perp}	5	6.3	5
$\epsilon_0 \chi_{\perp} c$ ($\text{nC cm}^{-2} \text{rad}^{-1}$)	1.3×10^2	2.1×10^2	3.0×10^2
c (SI)	2.9×10^7	3.8×10^7	6.8×10^7
α ($\text{N m}^{-2} \text{K}^{-1}$)	4.3×10^4	4.1×10^4	1.1×10^5
$\Delta T_c = \epsilon_0 \chi_{\perp} c^2 / \alpha$ (K)	1.1	1.9	1.3
$f_c(T_c^* - 1) = \alpha / 2 \pi \gamma_{\theta}$ (kHz)	30	100	350
γ_{θ} (Poiseuille)	0.23	0.067	0.05

A comment may be made on each of the quantities measured

— χ_{\perp} is measured with the help of the intercept of $D/\epsilon_0 E$ with $\theta/E = 0$ axis (see Fig 10)

Its typical value of 5 implies that $(1 + \chi_{\infty} + \chi_{\perp}) \approx 8$ at low frequencies in the absence of electroclinic coupling, which is quite reasonable

— $\varepsilon_0 \chi_{\perp} c$, obtained through the slope $\chi_{\perp} c$ of the same curve, has an order of magnitude of 100 and compares well to P/θ ratios in smectic C* phase. This should be used to determine the amount of non linearity (i.e. $P_s = \varepsilon_0 \chi_{\perp} c \theta + \lambda \theta^2 + \text{etc.}$) in a given compound.

— α (through the slope of θ^{-1} versus T) $\approx 4 \times 10^4$ means that $B_{\perp} \approx 10^7$ dynes cm^{-2} far from the transition, as expected for this elastic constant

— $\Delta T_c \approx 1$ to 2 K compares well again to the difference in transition temperatures between pure compounds and racemic mixtures

— f_c obtained from the fit of the Lorentzian $\theta(\omega)$ ranges from 30 to 350 kHz one K above T_c (i.e. more than 1 MHz at higher temperatures for C7 Valine)

— The value of γ_{θ} determined from f_c is rather common for liquid crystals

— No attempt has been made to calculate the critical exponent γ in B_{\perp} that is apparently [3, 6] close to the mean field value $\gamma = 1$. This requires a better understanding of the alignment and layer tilt in samples.

5. Summary.

We studied the electroclinic coupling in different compounds, measuring both optical and dielectric properties under the same conditions of temperature, applied electric field and alignment in a given sample. We show that one has to obey carefully the prerequisite condition that the applied electric field is low enough in order to work in the linear regime (tilt angle and induced polarization proportional to the field). We measure the first coefficients of the Landau expansion together with the soft mode viscosity and relaxation frequency. One finds that the simplest Landau theory of the transition works perfectly with only one temperature dependent coefficient (B_{\perp}^*), the other ones being constant within the smectic A temperature range, in the limits of our experimental accuracy.

Then the experiment we describe may be used both for systematic studies in search for better performances of chemical compounds, or from a fundamental point of view to study the different behaviors of the smectic A to smectic C* phase transition.

Appendix.

When expressing the free energy increase in the smectic A phase, due to the deviations of the order parameter out of its equilibrium value, two cases have to be distinguished, depending on the chirality of the molecules

A1. Achiral molecules.

The Landau free energy density reads

$$F = \frac{1}{2} B_{ijkl} Q_{ij} Q_{kl} + \frac{1}{3} \Omega_{ijklmn} Q_{ij} Q_{kl} Q_{mn} + \frac{1}{4} b_{ijklmnop} Q_{ij} Q_{kl} Q_{mn} Q_{op} \quad (11)$$

Using the x, y axes in the layer plane and z axis parallel to the layer normal, equation (11) reduces to

$$F = \frac{B_{\perp}}{2 \varepsilon_a^2} [Q_{xz}^2 + Q_{yz}^2] + \frac{b}{4 \varepsilon_a^4} [Q_{xz}^2 + Q_{yz}^2]^2 + \frac{1}{2} B'' [(Q_{xx} - Q_{yy})^2 + 4 Q_{xy}^2] + \Omega [(Q_{xx} - Q_{yy}) (Q_{xz}^2 - Q_{yz}^2) - 4 Q_{xy} Q_{xz} Q_{yz}] \quad (12)$$

This allows for the distinction of two modes. First, the smectic C mode is characterized by the order parameters Q_{xz} and Q_{yz} that are proportional to the parameters defined in equation (1) (namely $Q_{xz} = \varepsilon_a \theta_x$ and $Q_{yz} = \varepsilon_a \theta_y$ with $\varepsilon_a = \varepsilon_{\parallel} - \varepsilon_{\perp}$) if one forgets about the smectic layers displacement. The biaxial mode, on the other hand, is characterized by the order parameters $Q_{xx} - Q_{yy}$ and Q_{xy} describing the possibility of a new smectic A phase, where the x and y directions should no longer be equivalent [9]. These two modes are coupled by the last term of equation (12). The occurrence of a phase transition is determined by the thermal behavior of the quadratic coefficients B_{\perp} and B'' , depending on the one that cancels first. Until now, only S_A - S_C transitions are known for achiral compounds. This can be translated in the mean field approximation by :

$$B_{\perp} = \alpha (T - T_{AC}), \quad \alpha > 0, \quad B'' > 0$$

The S_A - S_C transition seems to be always second order, so that the quartic coefficient should be positive even after the renormalization due to minimization with respect to the (fast) biaxial fluctuations

$$b' = b - 2 \varepsilon_a^4 \Omega^2 / B'' > 0$$

A2. Chiral molecules.

In this case, the absence of inversion center allows new terms in the Landau free energy density representing essentially couplings with an electric polarization P in the layer planes

$$\begin{aligned} F^* = F + & \frac{\chi_{ij}^{-1}}{2 \varepsilon_0} P_i P_j + c_{ijk} Q_{ij} P_k + \beta_{ijkl} Q_{ij} P_k P_l \\ & + \lambda_{ijklm} Q_{ij} Q_{kl} P_m + h_{ijklmn} Q_{ij} Q_{kl} P_m P_n \\ & + \mu_{ijklm} Q_{ij} P_k P_l P_m + \nu_{ijklmno} Q_{ij} Q_{kl} Q_{mn} P_o \end{aligned} \quad (13)$$

F is given in equations (11) and (12) and takes into account the previous order parameters (Q_{xz}, Q_{yz}) for the smectic C mode and ($Q_{xx} - Q_{yy}, Q_{xy}$) for the biaxial mode while additional odd coupling terms come in F^* . Usually the smectic C mode condenses first, leading to a ferroelectric phase. Let us note however that a biaxial smectic A phase has been reported recently [9] in a chiral compound, meaning that the biaxial mode would have driven the transition. Although defined as a secondary order parameter [8], P represents the amount of permanent molecular dipoles aligned at point r where the free energy density is taken. This polarization consists of two contributions, the usual paraelectric one, proportional to any applied electric field and a new one, permanent in the smectic C* phase, which is proportional at first order to Q_{iz} .

In the x_1z frame, equation (13) reduces to

$$\begin{aligned} F^* = F + & \frac{1}{2 \varepsilon_0 \chi_{\perp}} [P_x^2 + P_y^2] + \frac{c}{\varepsilon_a} [Q_{xz} P_x - Q_{yz} P_y] \\ & + \beta [(Q_{xx} - Q_{yy}) (P_x^2 - P_y^2) + 4 Q_{xy} P_x P_y] \\ & + \lambda [(Q_{xx} - Q_{yy}) (Q_{yz} P_x + Q_{xz} P_y) + 2 Q_{xy} (Q_{yz} P_x - Q_{xz} P_y)] \\ & + \mu (Q_{yz} P_x - Q_{xz} P_y) (P_x^2 + P_y^2) \\ & + \nu (Q_{yz} P_x - Q_{xz} P_y) [Q_{xz}^2 + Q_{yz}^2] \\ & + f [Q_{xz}^2 + Q_{yz}^2] [P_x^2 + P_y^2] + g [Q_{yz} P_x + Q_{xz} P_y]^2 \\ & + h [Q_{yz} P_x - Q_{xz} P_y]^2 \end{aligned} \quad (14)$$

The first line in equation (14) contains all the quadratic terms to be used in the linear electroclinic effect we report on. It shows that the in-plane polarization is coupled to the order parameters and that it lies along the C_2 axis. In the smectic A phase close to the transition, one may minimize F^* with respect to P and to the biaxial mode, showing that in the smectic C^* cybotactic groups a polarization of order θ and a biaxiality of order θ^2 do exist.

Then, in first approximation, the remaining terms of equation (14) are of order θ^4 leading to a renormalization of the coefficient b of the quartic term in F . It has been previously proposed [23, 24], but the authors took only into account the last *biquadratic term*, that a sign change of the b coefficient is responsible for the observed first order character of the transition with some high polarization compounds [25, 26]. One should note that the biquadratic term is not specific to the chiral case and that on the contrary there are new antisymmetric terms (μ and ν) in equation (14) that would induce the sign change of b with chiral compounds only [27].

The gradient terms have not been included in these equations, but it is obvious that a term linear in $(\nabla_x Q_{1z} - \nabla_y Q_{xz})$ leads to the so-called spontaneous splay [28] and another one (the Lifshitz term [29] $Q_{xz} \nabla_z Q_{yz} - Q_{yz} \nabla_z Q_{xz}$) leads to the well known helicoidal structure of smectics C^* .

A3. Connection to linear electroclinic coupling.

In the general case, one should use the relation [6]: $Q_{xz} = \varepsilon_a \times \left(\theta_x + \frac{\partial u}{\partial x} \right)$ linking the tilt angle $\theta_x(\theta_y)$ to the order parameter $Q_{xz}(Q_{yz})$ and taking into account the layer displacement variable u . This will be useful when dealing with more involved problems [10, 30] like Rayleigh scattering due to thermal modes or smectic C-smectic C critical point. In the present experiment, where the tilt angle is forced in the y direction by an electric field applied parallel to x , one may forget about this and safely use the linear approximation $Q_{yz} = \varepsilon_a \theta$, $Q_{xz} = 0$.

References

- [1] MEYER R B, LIEBERT L, STRZELECKI L, KELLER P, *J. Phys Lett* **30** (1975) 69
- [2] CLARK N A, LAGERWALL S T, *Appl Phys Lett* **36** (1980) 899
- [3] GAROFF S, MEYER R B, *Phys Rev Lett.* **38** (1977) 848
- [4] MARTINOT-LAGARDE P, DURAND G, *J Phys.* **42** (1981) 269
- [5] ANDERSSON G, DAHL I, KELLER P, KUCZYNSKI W, LAGERWALL S T, SKARP K and STEBLER B, *Appl Phys Lett* **51** (1987) 640
- [6] DUPONT L, Thesis **476** Université de Bordeaux I (1990)
- [7] DE GENNES (P G), *The Physics of Liquid Crystals* (Clarendon Oxford Press, Oxford, 1974)
- [8] BLINC R, ZEKŠ B, *Phys Rev A* **18** (1978) 740
- [9] HIRAOKA K., TAGUCHI A, OUCHI Y, TAKEZOE H, FUKUDA A, *Jpn J Appl Phys* **29** (1989) L103
- [10] LALANNE J R, BUCHERT J, DESTRADE C., NGUYEN H T, MARCEROU J P, *Phys Rev Lett* **26** (1989) 3046
- [11] BIRGENEAU R J, GARLAND C W., KORTAN A R, LITSTER J D, MEICHLE M, OCKO B. M., ROSENBLATT C, YU L J, GOODBY J, *Phys Rev A* **27** (1983) 1251
- [12] GALERNE Y, *J Phys* **46** (1985) 733.
- [13] BENGUIGUI L, MARTINOTY P, *Phys Rev Lett* **63** (1989) 774
- [14] BAHR Ch, Glenn Brown award lecture 13th I L C C Vancouver (1990)
- [15] GLOGAROVA M *et al*, private communication
- [16] LEGRAND C, PARNEIX J P, *J Phys* **51** (1990) 787

- [17] CLARK N A., RIEKER T P, *Phys. Rev A* **37** (1988) 1053.
- [18] OUCHI Y., TAKANISHI Y, TAKEZOE H, FUKUDA A., *Jap J Appl. Phys.* **28** (1989) 2547
- [19] PAVEL J, GLOGAROVÁ M., *Liquid Crystals* in press
- [20] GAROFF S, MEYER R B, *Phys. Rev A* **19** (1979) 338
- [21] A temperature dependence of the electroclinic coupling coefficient has been nevertheless proposed by Z Li and C. Rosenblatt, *Phys Rev A* **39** (1989) 1594.
- [22] NGUYEN H T, BABEAU A., LÉON C, MARCEROU J P., DESTRADE C, SOLDERA A, GUILLON D, SKOULIOS A, *Liquid Crystals* **9** (1991) 253
- [23] CARLSSON T, ŽEKŠ B., FILIPIČ C., LEVSTIK A, *Phys. Rev A* **42** (1990) 877
- [24] LIU H Y, HUANG C. C, MIN T, WAND M D, WALBA D M, CLARK N A, BAHR C, HEPPKE G, *Phys Rev A* **40** (1989) 6759
- [25] BAHR C, HEPPKE G., *Phys. Rev. A* **39** (1989) 5459
- [26] DUPONT L, GALVAN J M, MARCEROU J P., PROST J, *Ferroelectrics* **84** (1988) 317
- [27] A careful study of the nature of the phase transition in a series of mixtures of left and right enantiomers presenting a first order transition should be carried out Obviously, the new antisymmetric terms would be zero in the racemic mixture, so the change of the character of the transition from first to second order would give an estimate of the actual influence of these terms Note that such a behavior seems to have been reported in .
LIU H Y, HUANG C C, BAHR C., HEPPKE G, *Phys Rev. Lett* **61** (1988) 345
- [28] HANDSCHY M A, CLARK N A., LAGERWALL S T., *Phys Rev Lett* **51** (1983) 471
- [29] INDENBOM V L, PIKIN S A, LOGINOV E B, *Kristallografiya* **21** (1976) 1093
- [30] PROST J, DEFONTAINES A D, private communication