



HAL
open science

Growth of CuInS₂ and its characterization

H.L. Hwang, C.Y. Sun, C.Y. Leu, C.L. Cheng, C.C. Tu

► **To cite this version:**

H.L. Hwang, C.Y. Sun, C.Y. Leu, C.L. Cheng, C.C. Tu. Growth of CuInS₂ and its characterization. *Revue de Physique Appliquée*, 1978, 13 (12), pp.745-751. 10.1051/rphysap:019780013012074500 . jpa-00244539

HAL Id: jpa-00244539

<https://hal.science/jpa-00244539>

Submitted on 4 Feb 2008

HAL is a multi-disciplinary open access archive for the deposit and dissemination of scientific research documents, whether they are published or not. The documents may come from teaching and research institutions in France or abroad, or from public or private research centers.

L'archive ouverte pluridisciplinaire **HAL**, est destinée au dépôt et à la diffusion de documents scientifiques de niveau recherche, publiés ou non, émanant des établissements d'enseignement et de recherche français ou étrangers, des laboratoires publics ou privés.

OPTOELECTRONIC MATERIALS II.

GROWTH OF CuInS_2 AND ITS CHARACTERIZATION (*)H. L. HWANG (**), C. Y. SUN (***), C. Y. LEU (****), C. L. CHENG (****)
and C. C. TU (****)

(**) Dept. of Electrical and Power Engineering

(*** Industrial Technology Research Institute, Hsin Chu, Taiwan, R.O.C.

(****) Dept. of Material Science, National Tsing Hua University, Hsin Chu, Taiwan, R.O.C.

Résumé. — Des nouvelles méthodes de synthèse de matériau, de croissance cristalline et de préparation de films de CuInS_2 ont été développées, quelques-unes de leurs propriétés ont été déterminées. Des monocristaux de CuInS_2 ont été obtenus par transport à l'iode en phase vapeur. Les plans de croissance étaient (112) et (110). Les paramètres du réseau étaient $a = 5,517 \text{ \AA}$, $c = 11,122 \text{ \AA}$ (tétraédral). Les cristaux bruts de croissance étaient de type n avec des résistivités de l'ordre de $10^6 \Omega \text{ cm}$. Huit modes de vibration du réseau ont été caractérisés par diffusion Raman. Les films minces ne présentant que la phase CuInS_2 ont été préparés par pulvérisation RF. Les films bruts de dépôt étaient de type p avec des résistivités de l'ordre de 10^{-1} à $10^1 \Omega \text{ cm}$. La rétrodiffusion des rayons X a été utilisée pour l'analyse des couches minces. La possibilité de déposer la seule phase CuInS_2 sous forme de films par évaporation flash a aussi été étudiée.

Abstract. — Novel methods for the material synthesis, crystal growth and film preparation of CuInS_2 were developed, some of their properties were characterized. CuInS_2 single crystals were grown by iodine vapour transport. The habit-planes were determined to be (112) and (110). The lattice parameters were determined to be $a = 5.517 \text{ \AA}$, $c = 11.122 \text{ \AA}$ (tetragonal). The as-grown crystals were n-type with resistivities in the order of $10^6 \Omega\text{-cm}$. Eight lattice vibration modes were characterized by Raman Scattering. Single phase CuInS_2 thin films were prepared by RF sputtering. The as-deposited films were p-type with resistivities in the range of 10^{-1} to $10^1 \Omega\text{-cm}$. Back scattering was used for the film analysis. The feasibility of using flash evaporation to deposit single phase CuInS_2 films has also been studied.

1. Introduction. — In recent years, the I-III-VI₂ ternary chalcopyrite compounds have found increasing interest in semiconductor science [1]. Mainly due to its direct gap of 1.55 eV, CuInS_2 could be used in high efficiency solar cells [2]. Single crystal platelets of CuInS_2 grown from melt have been reported [3-5]. Thin films of CuInS_2 obtained by double source evaporation have been reported [6]. In this work iodine vapour transport is proposed to grow crack-free and stoichiometric CuInS_2 single crystals. And CuInS_2 thin films have been deposited by RF sputtering and flash evaporation. An important feature of sputtering is that the chemical composition of a sputtered film will often be the same as that of the cathode from which it was sputtered. Flash evaporation was proposed to produce stoichiometric films of compounds whose constituents have widely different vapour pressure.

The CuInS_2 chalcopyrite structure is shown in figure 1. It possesses the tetragonal E1, structure-type space group 142d, with four formula units per cell. Figure 2 shows a portion of a (112) metallic plane. In those planes the Cu and In atoms *Zigzag* in the directions $[\bar{2}21]$ along alternate lines. (112) Sulfur

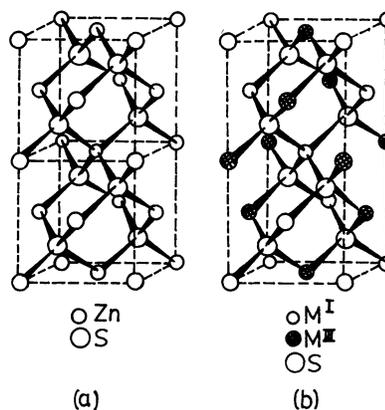

FIG. 1. — The tetragonal chalcopyrite structure illustrated for the I-III-VI₂ compounds. Two cubic zincblende structures are illustrated on the left.

planes can be seen to alternate with metallic ones [7]. I-III-VI₂ compounds can be regarded as the ternary analogs of the II-VI binary compounds [1]. If I- and III-atoms were replaced by with II-atoms, the cubic zincblende structure would result (Fig. 1). Thus the chalcopyrite structure is a superlattice of zincblende structure with the c/a ratio approximately equal to 2. The melting point of CuInS_2 is 1 000-1 050 °C [3]. The conductivity type of CuInS_2 could be

(*) This work was supported by National Science Council of Republic of China under contract No. NSC-67E-0404-03(01).

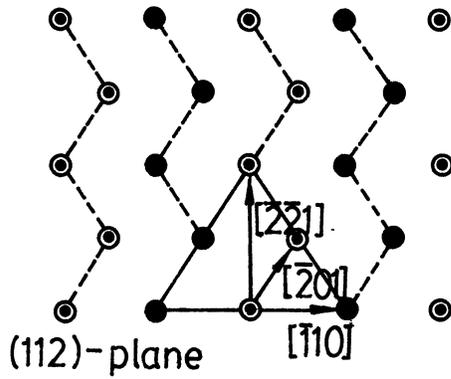

FIG. 2. — (112) metallic plane in the chalcopyrite structure. Solid circles indicate Cu atoms, the dotted circles are In.

changed by annealing under maximum S vapour pressure to give p-type or under minimum S vapour pressure to give n-type which could not be achieved for its binary analog [8]. Electrical properties on single crystals and thin films are tabulated in table I. The electron mobilities of CuInS_2 single crystals lie in the range from 100 to 200 $\text{cm}^2/\text{V-s}$, while hole mobilities are 1 to 15 $\text{cm}^2/\text{V-s}$. And mobilities of CuInS_2 thin films lie in the range from 10^{-1} to 10^1 $\text{cm}^2/\text{V-s}$.

Work on material synthesis, crystal growth are reported in section 2. Work on sputter-deposited and flash-deposited films are reported in sections 3 and 4, respectively.

2. Vapour-growth of CuInS_2 single crystals. —

Single phase CuInS_2 powders were synthesized and used for the crystal growth and film preparation. Stoichiometric amounts of the constituents were sealed in silica tubes under high vacuum. Due to the high vapour pressure of sulfur (2 atm at 493 °C) and to avoid explosion, the samples were heated at 600 °C for 1 day (to have the sulfur reacted with Cu and In completely) and held at 1 100 °C for another 2 days (to produce homogeneous materials by thermal

diffusion) then slowly cooled down. The powders were then identified to be single phase CuInS_2 by X-ray diffraction (Fig. 3).

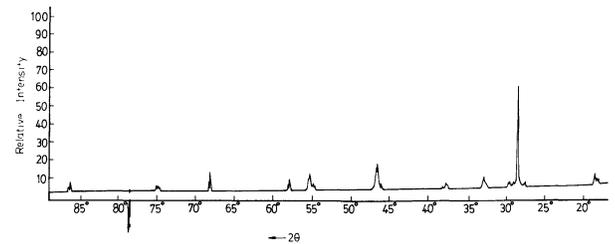

FIG. 3. — X-ray diffraction pattern of the synthesized CuInS_2 powders.

The single phase CuInS_2 powders, together with about 7 mg/cc-20 mg/cc iodine as the transport agent were sealed in a 14 mm I.D. silica tube under high vacuum (10^{-6} torr). Chemical transport were done in a single zone Linderberg furnace. The schematic diagram is shown in figure 4. The charge end was held at 800 °C while the optimal growth zone was determined to be in the range of 740-760 °C. The transport were done in eight days and the system was

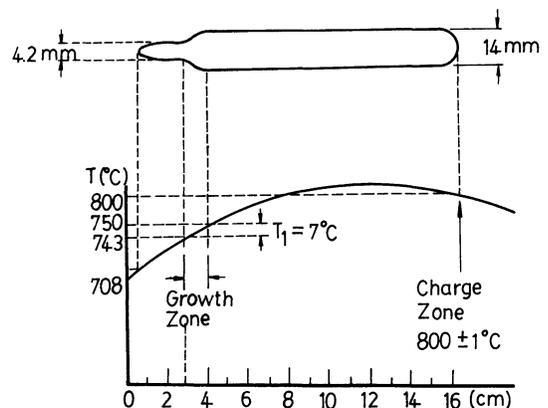

FIG. 4. — Experimental arrangement for crystal growth of CuInS_2 .

TABLE I

Comparison of properties of single crystals and thin films of CuInS_2

Form	Type	Resistivity ($\Omega\text{-cm}$)	Concentration (cm^{-3})	Mobility ($\text{cm}^2/\text{V-s}$)	Reference
Single crystal	N (*)	1	3×10^{16}	200	[9]
	P (**)	5	1×10^{17}	15	[10]
Films	N	0.1-800	$10^{14}\text{-}10^{19}$	1-20; 28	[6]
	P	0.8-400	$10^{13}\text{-}10^{16}$	0.2; 3.2 (***) 8.3 (****)	[6]

(*) Annealed under minimum S pressure.

(**) Annealed under maximum S pressure.

(***) Recrystallized in H_2S , initially N-type.

(****) Recrystallized in H_2S , initially P-type.

cooled down slowly at a rate of 9 °C/h to avoid straining of the crystals. The as-grown platelets are black, and the typical shape of the grown crystals is shown in figure 5.

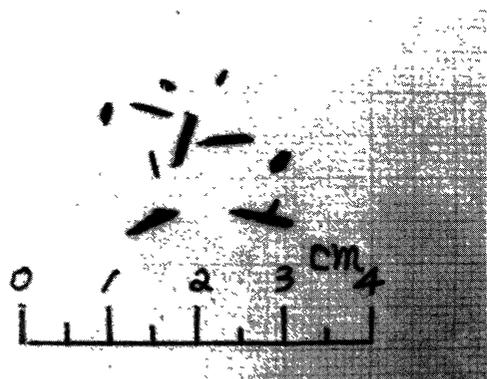

FIG. 5. — Typical shape of the grown CuInS₂ single crystals.

The orientation of the as-grown facets were determined to be (112) and (110) by Back-Reflection Laue method. The lattice parameters were determined, by X-ray rotating crystal method with Syntex diffractometer, to be $a = 5.517 \text{ \AA}$, $c = 11.122 \text{ \AA}$ (tetragonal). Furthermore, the grown crystals were grounded and examined by X-ray diffraction. The above X-ray results verify the grown crystals are CuInS₂ single crystals.

The as-grown CuInS₂ crystals were n-type with resistivity in the order of 10^6 \Omega-cm . Those grown from melt were p-type with resistivities of $5 \times 10^3 \text{ \Omega-cm}$ [9]. Since a large amount of iodine is present during the crystal growth, it is possible a significant amount of iodine could be incorporated into the vapour-grown CuInS₂ crystals. Whether the difference mentioned above is caused by iodine *doping* should be further investigated.

The Raman spectra of the grown CuInS₂ crystals at 300 K were recorded using 300 mW 5 145 Å laser. Figure 6 shows typical spectra obtained by the

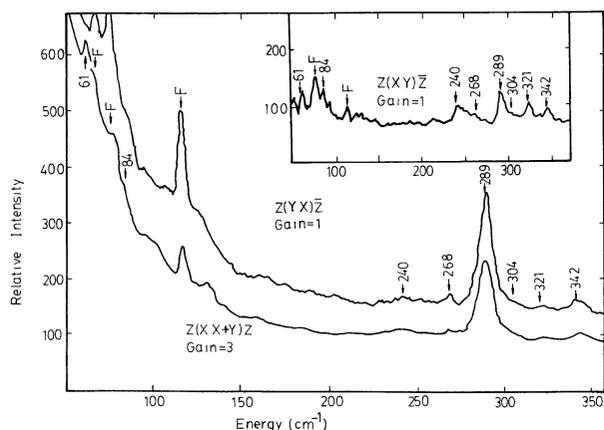

FIG. 6. — Backward Raman spectrum of CuInS₂ excited with 300 mW 5 145 Å laser line and recorded with 4 cm^{-1} spectrometer bandpass.

TABLE II

Lattice vibration modes characterized from Raman Spectrum

Mode Symmetry	Frequency (1/cm)
A ₁	289
B ₁	—
B ₁	—
B ₁	—
B ₂ (T), B ₂ (L)	—
B ₂ (T), B ₂ (L)	268 (q)
B ₂ (T), B ₂ (L)	342 (q)
E(T), E(L)	61
E(T), E(L)	84
E(T), E(L)	—
E(T), E(L)	240
E(T), E(L)	304, 321 (q)
E(T), E(L)	—

q : quasi.

backward Raman scattering from CuInS₂. Eight Lattice vibration modes were characterized and the results are listed in table II.

In a CuInS₂-I₂ closed system, when compared its equilibrium constants of the forward reaction with those of other reactions, only the following reaction was considered [11].

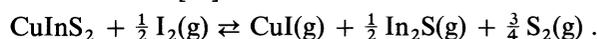

Theoretical transport equation have been derived by several works [12-14], and the computer calculation method developed by Arizumi and Nishinaga [14-16] was employed. Figure 7 shows the calculated transport

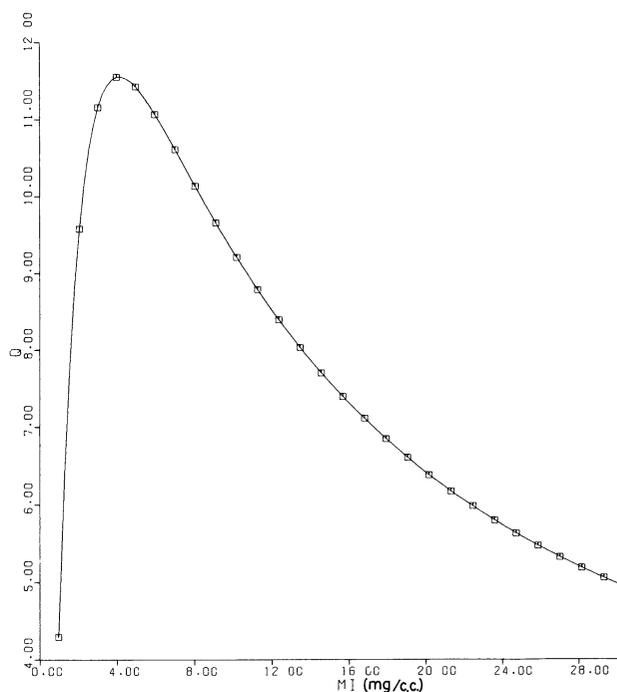

FIG. 7. — Functional relationship of Q_{CuInS_2} vs M_1 .

rate as a function of iodine concentration when the temperatures of the source and growth zones were maintained at 800 °C and 750 °C, respectively. This calculation indicates that the transport rate should strongly depend on the iodine concentration, and the relationship shown in figure 7 had the same tendency as the results on vapour growth of Ge [14] or GaAs [15] or ZnTe [17]. The only experimental transport rate data on the temperature conditions of the present calculation is 5.1548×10^{-7} mole CuInS_2/s at $M_1 = 7.25$ mg/cc. From this and figure 6, the gas phase diffusion coefficient thus determined is 0.251 cm^2/s at 300 K which is reasonable when compared with diffusion coefficients of the gaseous molecules listed in table III.

TABLE III

Binary gaseous diffusion coefficients

Gases	Diffusion coefficient D_0 ($\text{cm}^2 \text{s}^{-1}$)
$\text{H}_2\text{-D}_2$	1.13
He or H_2 -other gas	0.5-0.7
Two diatomic gases	0.2
Two triatomic gases	0.1

3. **Sputter-deposited CuInS_2 thin films.** — CuInS_2 thin films were deposited by RF sputtering using the system shown in figure 8. The well-characterized CuInS_2 powders were pressed into a $1\frac{1}{2}$ "-diameter disk under the pressure of 60,000 psi. This disk was used as the sputtering target. An earthed shield and a glass

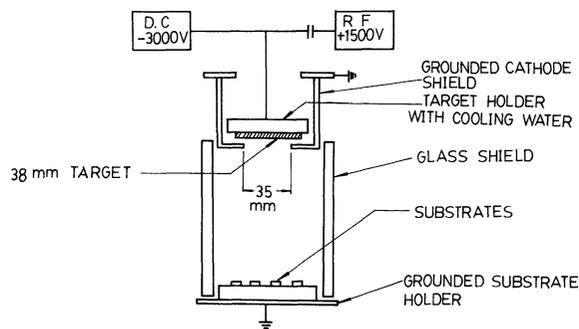
FIG. 8. — Experimental arrangement for RF sputtering of CuInS_2 .

shield were used to prevent the discharge at the back of the cathode and to limit the discharge to the cathode-anode region. The system was first evacuated to $< 10^{-7}$ torr, and the Ar pressure was kept between 20-40 μ , the d-c voltage was 2-3 keV, the discharge current was 5 mA, and the RF frequency was kept between 12 to 14 MHz. There is no substrate heating, and the deposition rate was about 1 200 $\text{\AA}/\text{h}$.

The as-deposited films on slide-glasses were verified to be single phase CuInS_2 by the X-ray diffraction (Fig. 9). Figure 10 shows the T.E.D. pattern, in which the indexing of the pattern is also shown. Since all rings are of CuInS_2 , this further identified the as-deposited films were single phase CuInS_2 chalcopyrite structure. The grain size, calculated from the line boarding of the X-ray diffraction patterns, are a few hundred angstroms. (T.E.M. photographs confirmed that the grain size are smaller than 1 000 \AA .) The as-deposited films were p-type and had the resistivities of the order of 10^{-1} to 10^1 $\Omega\text{-cm}$. These values are

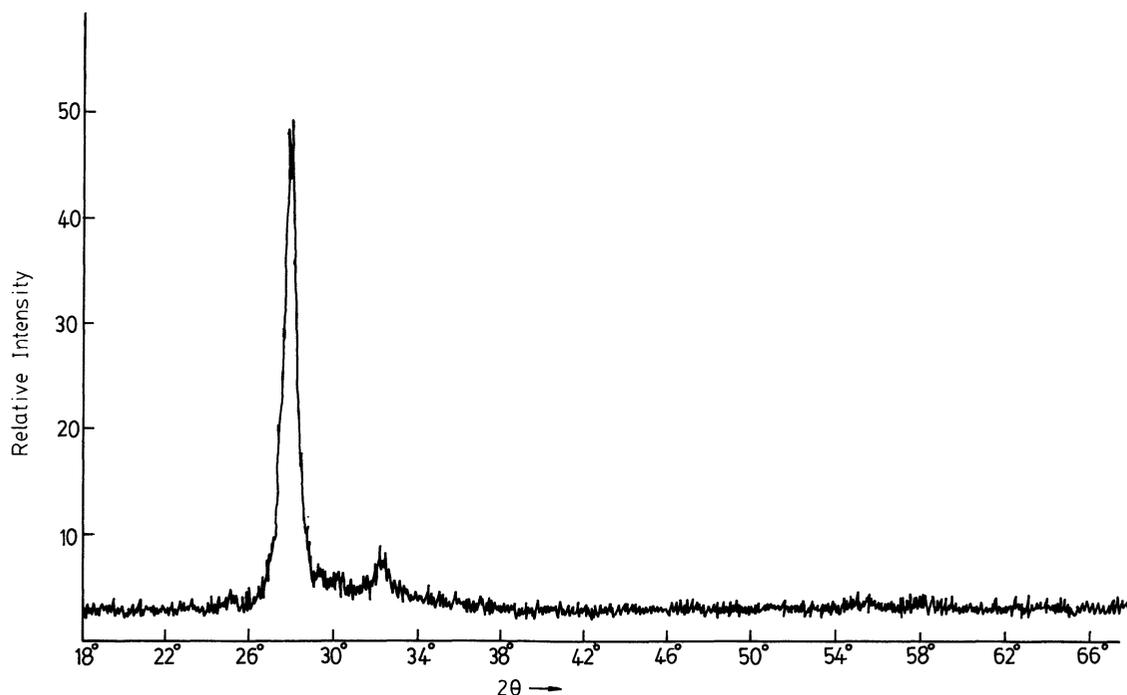
FIG. 9. — X-ray diffraction pattern of a RF sputter-deposited CuInS_2 film.

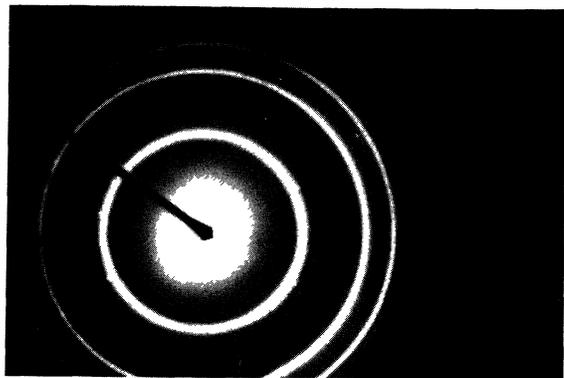

$$dr = \lambda L, \lambda = 0.037 \text{ \AA}, L = 113 \text{ cm.}$$

Ring no.	r (cm)	d_{exp} (Å)	Index	d_{cal} (Å)
1	1.32	3.17	(112)	3.16
2	1.53	2.73	(200) (004)	2.74
3	2.15	1.94	(220) (204)	1.94
4	2.5	1.67	(312) (116)	1.66
5	2.6	1.61	(224)	1.591
6	3.1	1.35	(400) (008)	1.370
7	3.3	1.27	(316) (332)	1.266
8	3.5	1.19	(404)	1.17
9	3.75	1.12	(228)	1.128
10	4.05	1.05	(336)	1.02

FIG. 10. — T.E.D. (Transmission electron microscopy) pattern of a RF sputter-deposited CuInS_2 film.

lower than those of Kazmerski [6], possibly due to the impurity and the variation of stoichiometry. Post heat treatments in static vacuum or in maximum sulfur vapour pressure were found to increase both the resistivity and the grain size. However, the increases were not substantial.

It was found that the target size are very critical to the composition of the deposited films. When using $\frac{3}{4}$ " target, the CuInS_2 and InS peaks as well as some unidentified peaks appear in the X-ray diffraction patterns. However, when using $1\frac{1}{2}$ " target, only CuInS_2 peaks were presented. It was also found when small amounts of sulfur were placed around the substrates during the sputtering, the X-ray diffraction pattern showed the change of the orientation preference in the thin films. The (220) peak became dominant while in general the (112) peak should dominate (Fig. 11).

Back-scattering were also done to analyze thin films. Approximate 200 Å thin films were deposited on graphite substrates in order to have distinct peaks for the corresponding elements. The backscattering spectrum of a typical sample is shown in figure 12, and the results for four samples are analyzed in table IV. It is seen that not only the sulfur content is increased but the Cu/In ratio is increased for sulfur added sputtering. Despite of the variation of stoichiometry, the films are still single phase. This indicates that the chalcopyrite structure for Cu-In-S system exists not only in the exact composition of CuInS_2 . It should be noted that chalcopyrite structure for

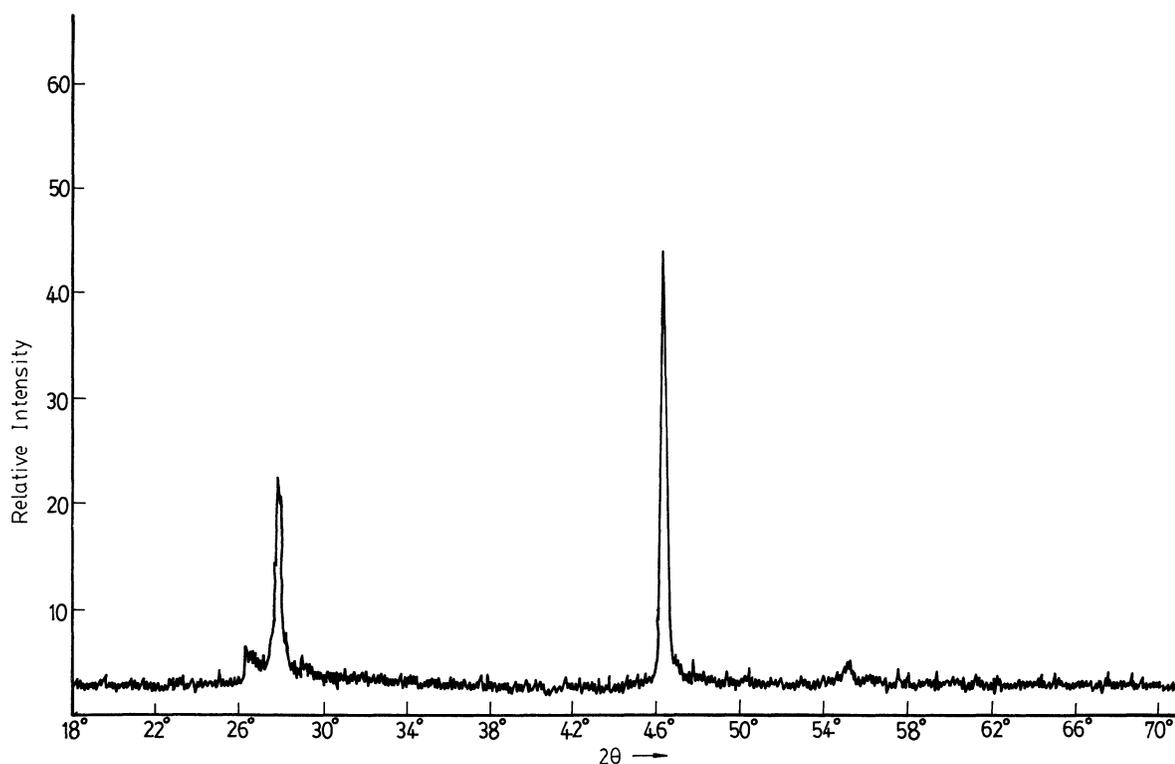

FIG. 11. — X-ray diffraction pattern of a RF sputter-deposited CuInS_2 film when small amount of sulfur were placed around the substrates.

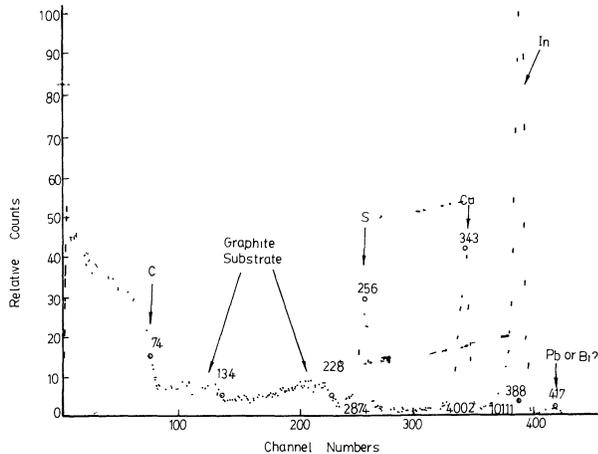

FIG. 12. — The back-scattering spectrum of a RF sputter-deposited CuInS_2 film on graphite substrate.

TABLE IV

Analyses of the back-scattering spectra of four samples

Sample No.	S : Cu : In
25S (*)	2.29 : 1.09 : 1
30S (*)	2.45 : 1.06 : 1
26 (**)	1.70 : 0.91 : 1
28 (**)	1.65 : 0.91 : 1

(*) Sputtered with sulfur added.

(**) Sputtered without sulfur added.

Cu-Ga-S system varies from CuGaS_2 to $\text{Cu}_{0.81}\text{GaS}_{1.9}$ in composition after Belova *et al.* [18]. Other than the variation of composition, the impurity contents were also checked by Back-scattering. Apparently, the oxygen and argon contents are lower than the resolution of backscattering technique. But there is a small peak exists in the high atomic weight range (around 82 or 83), which was verified to be Pb by Atomic absorption experiments. How it was introduced and what effect it might cause should still be investigated.

4. Flash-deposited CuInS_2 thin films. — Thin films were deposited by flash evaporation using the system shown in figure 13, in which the sinusoidal signals in the range of 50-100 Hz was amplified and sent to vibrate the powder reservoir. Single phase CuInS_2 powders were used as the evaporation source. The evaporations were done in a vacuum of 10^{-6} torr, in which an alumina crucible was used. For flash evaporation, slide glasses were used as the substrates, and the source temperature varied in the range of 1 000-1 500 °C and the substrate temperature varied between 25-400 °C. Thus far, single phase CuInS_2 thin films have not been obtained by Flash evaporation. At lower source temperature (1 000-1 300 °C), the dominant phases in the X-ray diffraction patterns

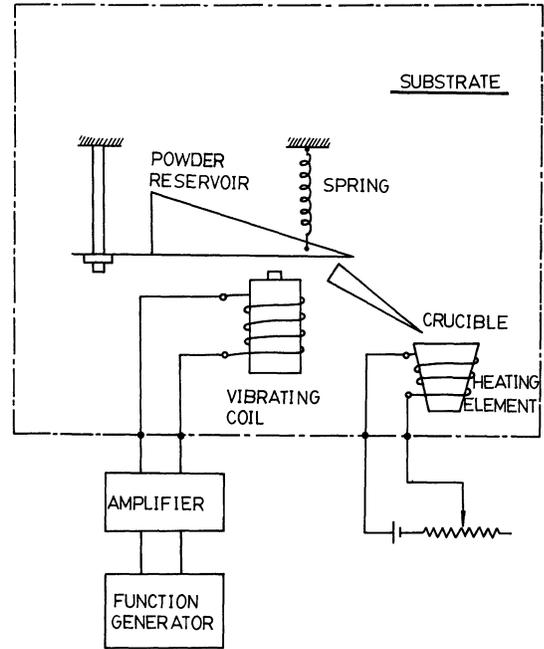
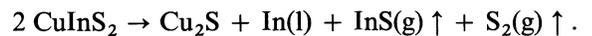

FIG. 13. — Experimental arrangement for flash-evaporation of CuInS_2 .

were In and InS. At higher source temperature (1 400 °C), the dominant phases were CuInS_2 , In and InS. The results are consistent with those of the atomic absorption experiments. At $T_{\text{sou.}} \approx 1\ 180$ °C and $T_{\text{sub.}} \approx 240$ °C, the Cu : In ratio of the flash-deposited films were determined to be $\approx 1 : 144$. At $T_{\text{sou.}} \approx 1\ 310$ °C and $T_{\text{sub.}} \approx 220$ °C, the ratio is $\approx 1 : 26$. At $T_{\text{sou.}} \approx 1\ 450$ °C (the highest temperature our system can attain) and $T_{\text{sub.}} \approx 300$ °C, the ratio is $\approx 1 : 1.66$. In the last case, the residual in the crucible has the Cu : In : S ratio of 1.28 : 0 : 1. The above results indicate that to produce single phase CuInS_2 films by flash evaporation, a higher source temperature could probably be needed. According to a simple estimation [19], in order to evaporate completely the 100-150 μm grains within 1 ~ 2 s, the source temperature should be in the range of 1 600-1 700 °C. Furthermore, from a detailed analysis [19], in which data of X-ray diffraction and atomic absorption were used, it was found that when the source temperature is in the range of 1 000-1 450 °C, the incongruent dissociation process of CuInS_2 in vacuum could probably be as follows :



Due to the dissociation of sulfur, and the large difference in vapour pressure of each constituent of the dissolution, it is therefore that even at a higher source temperature, the CuInS_2 grains can evaporate completely in a very short period, the films as-deposited will still be of sulfur-deficient structure. In addition, if raising too high the source temperature, some unnecessary contaminants may be incorporated [20].

For compound like CuInS₂ whose electrical properties are very sensitive to its stoichiometry and impurity contents, it would be very difficult to deposit single phase CuInS₂ thin films by flash evaporation.

5. Conclusions. — Novel methods for the material synthesis and crystal growth of CuInS₂ were developed. The suitable growth condition suggested are $T_2 = 800$ °C and $\Delta T = 50-60$ °C with 7.25-9.84 mg/cc iodine and powder source. The grown CuInS₂ were n-type with resistivity of 10^6 Ω-cm. The as-grown facets were (112) and (110). The lattice parameters were determined to be $a = 5.517$ Å, $c = 11.122$ Å (tetragonal). Eight vibration modes had been characterized at frequencies of 61, 84, 240, 268, 289, 304, 321 and 342 cm⁻¹. Preliminary thermodynamic calculations suggest that the transport rate of CuInS₂ solid phase in CuInS₂-I₂ closed system (in the temperature profile of $T_2 = 800$ °C, $\Delta T = 50-60$ °C) is strongly dependent on the initial iodine concentration.

Sputtering is a very useful and relatively simple method to produce CuInS₂ thin films. The use of a small target ($\frac{3}{4}$ ") is not recommended since the inhomogeneous distribution of the sputtered species may cause the film to be multiphases. Large target (1 $\frac{1}{2}$ ") produces

single phase CuInS₂ films. It has been found that the variation of the sulfur vapor pressure during sputtering can change not only the stoichiometry of the films but also the growth direction. The sulfur content and the Cu/In ratio is increased when sputtered under extra sulfur vapour pressure. The as-deposited films were P type and had resistivity in the range of 10^{-1} to 10^1 Ω-cm. The grain sizes were determined to be a few hundred angstroms, and post heat treatment can increase the resistivity and grain size.

Flash evaporation was also tried but with little success. When the source temperatures are in the range of 1 100-1 450 °C, the flash-deposited films all contain In and InS phases, the CuInS₂ peaks became more distinct at higher source temperature. The atomic absorption experiments indicate that the higher the source temperature, the closer the Cu/In ratio approaches unity. Since CuInS₂ is of incongruent dissociation, it would be very difficult to deposit single phase CuInS₂ thin films by flash evaporation.

Acknowledgments. — The authors wish to thank Prof. J. J. Loferski of Brown University for his encouragement in initiating this program, and Prof. D. M. Hwang of Tsing Hua University for his help with the Raman scattering experiments.

References

- [1] SHAY, J. L. and WERNICK, *Ternary Chalcopyrite Semiconductors : Growth, Electronic Properties, and Applications* (Pergamon Press, N.Y.) 1976.
- [2] LOFERSKI, J. J., *J. Appl. Phys.* **27** (1956) 777.
- [3] KASPER, H. M., Proc. of the 5th Materials Res. Symp. July (1972) 671.
- [4] LOOK, D. C. and MANTHURUTHIL, I. C., *J. Phys. Chem. Solids* **37** (1976) 173.
- [5] BRIDENBANGH, P. M. and MIGLIORATO, P., *Appl. Phys. Lett.* **26** (1975) 459.
- [6] KAZMERSKI, L. L., AYYAGARI, M. S. and SANBORN, G. A., *J. Appl. Phys.* **46** (1975) 4865.
- [7] KAZMERSKI, L. L., AYYAGARI, M. S., SANBORN, G. A., WHITE, F. R. and MERRILL, A. J., *Thin Solid Films* **37** (1976) 323.
- [8] TELL, B., SHAY, J. and KASPER, H. M., *J. Appl. Phys.* **43** (1977) 2469.
- [9] TELL, B., SHAY, J. L. and KASPER, H. M., *Phys. Rev.* **B 4** (1971) 2463.
- [10] TELL, B. and KASPER, H. M., *Phys. Rev.* **B 4** (1971) 4455.
- [11] LEU, C. Y., M.S. thesis, Tsing Hua Univ., Hsin Chu, Taiwan, R.O.C. June (1978).
- [12] SCHAFER, H., *Chemical Transport Reactions* (Academic Press, N.Y.) 1964.
- [13] LEVER, R. F. and MANDEL, G., *J. Phys. Chem. Solids.* **23** (1962) 599.
- [14] ARIZUMI, T. and NISHINAGA, T., *Japan. J. Appl. Phys.* **4** (1965) 165.
- [15] ARIZUMI, T. and NISHINAGA, T., *Japan. J. Appl. Phys.* **5** (1965) 21.
- [16] ARIZUMI, T. and NISHINAGA, T., *Japan. J. Appl. Phys.* **5** (1966) 588.
- [17] MITSUHIRO, N. *et al.*, *Japan. J. Appl. Phys.* **17** (1977) 571.
- [18] BELOVA, I. K., KOSHKIN, V. M. and PALATINK, L. S., *Izv. Akad. Nauk SSSR, Neorgan. Mater.* **3** (1967) 617.
- [19] TU, C. C., M.S. Thesis, Tsing Hua Univ., Hsin Chu, Taiwan, R.O.C. June (1978).
- [20] MULLER, E. K., NICHOLSON, B. T. and FRANCOMBE, M. H., *Electro. Chem. Technol.* (1963) 158.