



HAL
open science

Combined use of a lock-in detector and a multichannel analyser for 1/f noise application to tunneling spectroscopy

A. Léger, B. Delmas, J. Klein, S. de Cheveigne

► **To cite this version:**

A. Léger, B. Delmas, J. Klein, S. de Cheveigne. Combined use of a lock-in detector and a multichannel analyser for 1/f noise application to tunneling spectroscopy. *Revue de Physique Appliquée*, 1976, 11 (2), pp.309-319. 10.1051/rphysap:01976001102030900 . jpa-00244064

HAL Id: jpa-00244064

<https://hal.science/jpa-00244064>

Submitted on 4 Feb 2008

HAL is a multi-disciplinary open access archive for the deposit and dissemination of scientific research documents, whether they are published or not. The documents may come from teaching and research institutions in France or abroad, or from public or private research centers.

L'archive ouverte pluridisciplinaire **HAL**, est destinée au dépôt et à la diffusion de documents scientifiques de niveau recherche, publiés ou non, émanant des établissements d'enseignement et de recherche français ou étrangers, des laboratoires publics ou privés.

Classification
 Physics Abstracts
 8. 348 — 0. 660

COMBINED USE OF A LOCK-IN DETECTOR AND A MULTICHANNEL ANALYSER FOR $1/f$ NOISE APPLICATION TO TUNNELING SPECTROSCOPY (*)

A. LÉGER, B. DELMAS, J. KLEIN and S. DE CHEVEIGNE

Groupe de Physique des Solides de l'Ecole Normale Supérieure (**),
 Tour 23, 2, place Jussieu, 75221 Paris Cedex 05, France

(Reçu le 4 août 1975, accepté le 8 octobre 1975)

Résumé. — En spectroscopie par effet tunnel, il est très important d'obtenir un bon rapport signal sur bruit (S/B), cela a en effet souvent permis la découverte de nouveaux effets. La méthode habituelle pour obtenir les caractéristiques des jonctions tunnel consiste à leur appliquer une tension de modulation autour d'une polarisation continue, puis à détecter l'harmonique convenable avec une détection synchrone. On pourrait penser pouvoir augmenter indéfiniment le rapport S/B en augmentant la constante de temps de l'appareil (ainsi que la durée du balayage), mais l'expérience montre que *cela est illusoire, voire néfaste*, au-dessus de quelques secondes. Ceci provient de certaines fluctuations basse fréquence de l'appareillage mais aussi de celles qui *sont inhérentes à la caractéristique de la jonction* elle-même et qui échappent au déplacement vers les hautes fréquences qu'effectue la détection synchrone. Nous proposons d'utiliser un ensemble détection synchrone-analyseur multicanal afin de réaliser la moyenne de plusieurs (n) balayages, effectués rapidement, au lieu de n'en effectuer qu'un seul de longue durée. Nous calculons le rapport S/B lors d'une telle opération, et nous montrons que le résultat dépend complètement de la forme de la densité spectrale du bruit de caractéristique. Pour le cas d'un spectre en $1/f$, on gagne un facteur important (n) par rapport à la méthode traditionnelle, ceci *pour un même temps total d'expérience*. Nous décrivons un montage qui permet d'adapter un multicanal commercial au tracé des caractéristiques de jonctions, et nous effectuons des expériences qui illustrent les avantages de la méthode. En conclusion, nous insistons sur le fait que cette façon de procéder permet d'améliorer indéfiniment le rapport S/B lorsqu'on augmente le temps d'expérience, et qu'elle peut s'appliquer à de nombreuses autres spectroscopies.

Abstract. — Obtaining a good signal-to-noise ratio (S/N) is of great importance in tunneling spectroscopy, as it has often led to the discovery of new phenomena. The quantities of interest are the derivatives of the tunnel junction I-V curve; the usual approach to obtain these characteristics is to apply a modulation voltage around a D. C. bias and to detect the proper harmonic with a lock-in detector. In order to improve the S/N ratio, one would think of *increasing the detector time-constant* (and total sweep time), but experimentalists know that, above a few seconds, *such an increase is illusive* and even misleading. This is because there are low frequency instabilities in the equipment, but also because *there is noise present in the junction characteristic itself*. The combined use of a lock-in detector and a multichannel analyser is proposed, in order to average a large number (n) of short sweeps instead of using one single long sweep. The S/N ratio is calculated for such an experiment, and it is found that it depends strongly upon the noise spectral density. For a $1/f$ spectrum a *large improvement* (n) is obtained with respect to the usual method, *for the same total experimental duration*. A system for adapting a commercial multichannel to the plotting of junction characteristics is described, and experiments are performed that demonstrate the advantages of this method. In conclusion, it is emphasized that the limit of the possible improvement of the S/N ratio in tunneling spectroscopy is removed and that the system can be applied to many other types of spectroscopy.

1. **Introduction.** — 1.1 THE IMPORTANCE OF A GOOD SIGNAL-TO-NOISE RATIO IN TUNNELING SPECTROSCOPY. — During the last decade, tunnel junctions have been intensively studied since considerable physical infor-

mation can be obtained from their electrical characteristics, in such fields as superconductivity, tunneling spectroscopy... [1]. Because physical effects are reflected by small changes in the $I(V)$ curves, the information that can be extracted depends largely on the resolution achieved in the plots. As experimental techniques have improved, new effects have been discovered [2].

Numerous systems designed to determine the first, second and third derivatives of the $I(V)$ curves have

(*) Work supported, in part, by the D. R. M. E. contract n° 73/683.

(**) Laboratory associated with the C. N. R. S. and the University of Paris VII.

been constructed and described in the literature [3, 4, 5]. Circuitry capable of resolving relative changes of the conductance ($\delta\sigma/\sigma$) of 10^{-5} has been reported [4], but experimentalists in the field, however, know that such resolution is illusory because junctions may be too noisy to allow the ultimate sensitivity of the instruments to be used.

In this paper, we investigate various aspects of such noise and we describe a system which gives a better signal to noise ratio (S/N) than conventional methods. It becomes possible to use noisy junctions in which, previously, small physical peaks could not be distinguished from erratic phenomena.

Of course, such a system can be applied to many fields other than tunneling.

In order to extract the signal from noise, it is conventional, in tunneling spectroscopy, to use a lock-in detector. In theory, the S/N ratio increases, in power, as the lock-in time constant τ . In practice, experimentalists know that often, when τ is increased above 1 to 10 s, the S/N ratio is not significantly improved.

1.2 NOISE ENCOUNTERED IN TUNNEL JUNCTIONS. — Two different types of noise are met in tunnel junctions :

— *An ordinary noise* (probably shot noise) which is present when very small signals are studied in good junctions. This is the case in second or third derivative plots, when the modulation applied is small. In that case, increasing the time constant τ improves the S/N ratio as is expected when the detection bandwidth ($\Delta\omega \sim 1/\tau$) is reduced (see Fig. 1a).

— *An anomalous noise*, of greater amplitude, which is present when junctions are unstable. This happens with some specific diodes which are intrinsically noisy, or when characteristics are studied at high bias levels. Large values of τ are then unable to increase the S/N ratio : curves exhibit little apparent noise, but two successive plots do not superpose, and *peaks appear which are pure artefacts* (see Fig. 1b).

Clearly, such noise is of a different nature than the previous one. On the one hand, it is stronger than

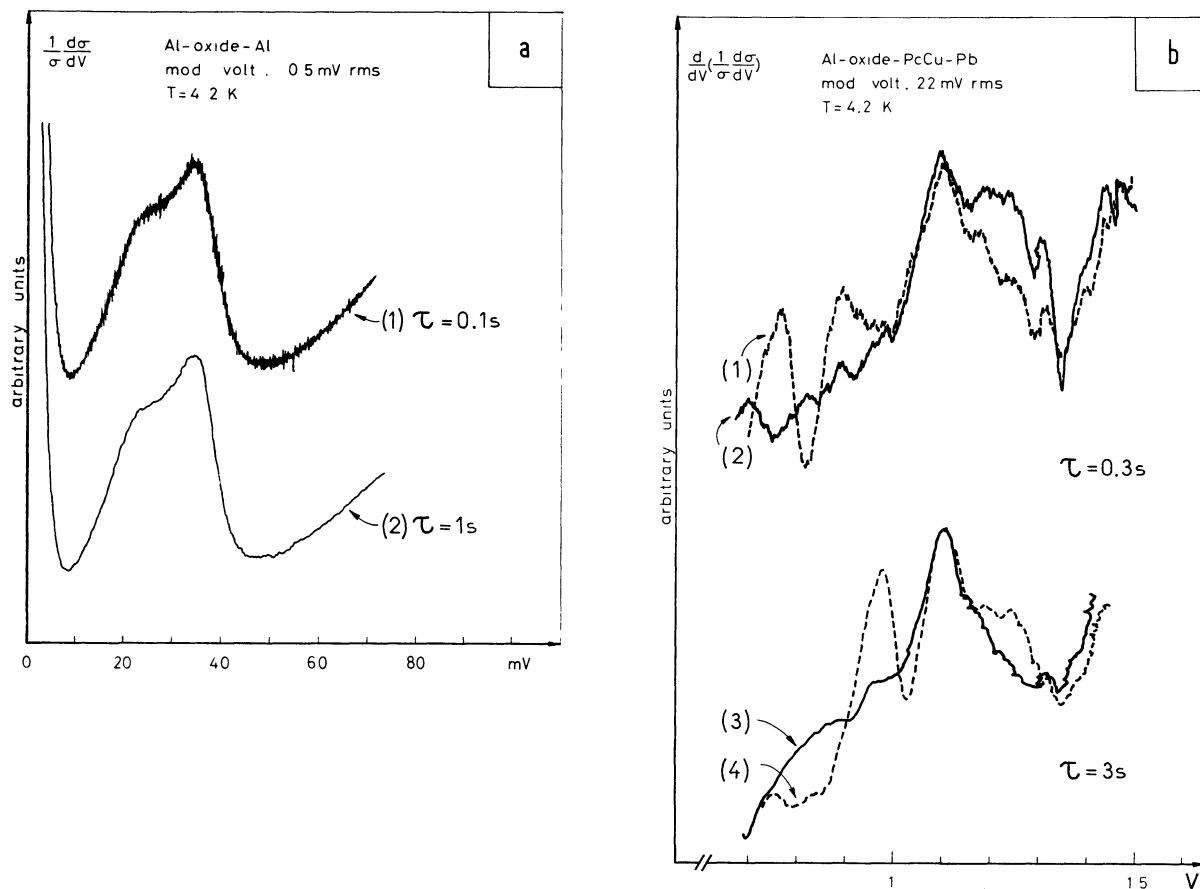

FIG. 1. — Attempts to improve the S/N ratio by increasing the lock-in time constant. *a*) Ordinary noise : second derivative of a granular Al junction at low bias. The increase of the time constant from $\tau = 0.1$ s to $\tau = 1$ s reduces the noise as expected, and the signal (Al phonon structure at 23 mV and 35 mV) is reproducible. *b*) Anomalous noise : third derivative of a Al-Pb junction doped with copper phthalocyanine at is large bias. 0.3 s and 3 s time constants are used, and for each time constant two plots are reported (1-2 and 3-4) to permit the estimation of noise. Increasing the time constant has suppressed the apparent (and harmless) high frequency noise, but erratic wide peaks remain with roughly the same amplitude (the interesting structure in the electronic transition peak at about 1.1 V). This type of noise appears not to obey the law of proportionality to the bandwidth of the detecting instrument ($\Delta\omega = 1/\tau$). Note that the junction resistance noise is so large that the recorder pen sometimes sweeps back, making *knots* in the curves. This is because the voltage supply does not have a low enough impedance to impose the voltage sweep.

ordinary noise, and on the other hand it violates the rule of proportionality to the detection band width. In some cases, the S/N ratio is not even improved when the signal is increased, for instance by increasing the modulation amplitude. This last point is important as it will lead us to an explanation of this anomalous noise.

2. Study of the characteristic noise. — 2.1 JUNCTIONS WITH CHARACTERISTIC NOISE. — We shall first briefly recall the principle of bias modulation used to obtain the derivatives of the $I(V)$ curve of a diode. We shall take the experimentally important example of the second derivative d^2I/dV^2 . A voltage

$$V(t) = V_0 + V_\Omega \cos \Omega t$$

is applied to the sample, with $V_\Omega \ll V_0$, and the resulting current $I[V(t)]$ is studied; the second derivative d^2I/dV^2 is obtained from a synchronous detector locked at frequency 2Ω . Conventionally [6], the noise is accounted for in such a measurement by introducing a superimposed noise function $n(t)$ on the signal.

A second order development, with respect to V_Ω/V_0 , gives :

$$I(t) = I_0 + I_\Omega \cos \Omega t + I_{2\Omega} \cos 2\Omega t + \dots + n(t), \quad (1)$$

where :

$$I_0 = I(V_0) + \frac{V_\Omega^2}{4} \frac{d^2I}{dV^2}(V_0)$$

$$I_\Omega = V_\Omega \frac{dI}{dV}(V_0)$$

$$I_{2\Omega} = \frac{V_\Omega^2}{4} \cdot \frac{d^2I}{dV^2}(V_0),$$

$n(t)$ is the noise function.

A lock-in detector at frequency 2Ω , with a time-constant τ , measures (Fig. 2) :

- the component of $I_{2\Omega}(t)$ at $\omega = 0$ with a band width $\Delta\omega \sim 1/\tau$,
- the component of $n(t)$ at $\omega = 2\Omega$ with the same bandwidth.

In such a simplified model, the quadratic mean value of noise is supposed to be :

$$\overline{n^2} = \gamma(2\Omega) \cdot 1/\tau$$

where $\gamma(\omega)$ is the noise spectral density function. This function has a white part (independent of ω) and a $1/f$ part which is large only at low frequencies. The interesting point, with a synchronous detection, is that we are sensitive to the value of γ at rather high frequency ($2\Omega \sim 1$ kHz) where the $1/f$ part is no longer important (Fig. 2). This implies that the noise *should decrease regularly when the time constant is increased*, as its power is proportional to $1/\tau$ and as the function $\gamma(\omega)$ is regular about $\omega = 2\Omega$. However experiments

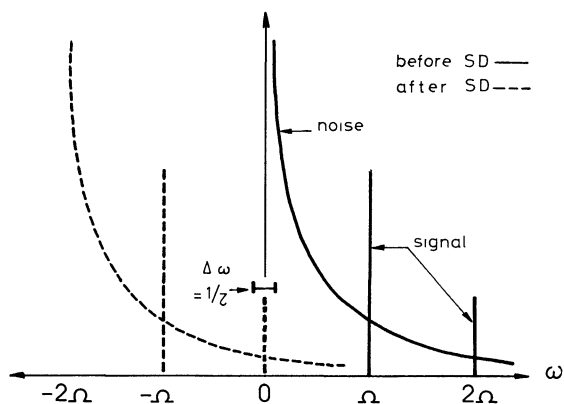

FIG. 2. — Diagram of the synchronous detection action on the noise and signal spectral densities as represented by eq. (1). After the frequencies shift, the lock-in detects signal in a bandwidth $\Delta\omega = 1/\tau$ around $\omega = 0$. For simplicity, only initially positive frequencies are represented. Note that, in this model for noise, the detection seems to be free from the low frequency peak in the noise spectral density.

yield quite the opposite result for *noisy* junctions and large values of τ .

In order to account for such noise, we propose to assume that the characteristic itself carries noise. Indeed the function :

$$I_{2\Omega}(t) = \frac{V_\Omega^2}{4} \cdot \left[\frac{d^2I}{dV^2} \right] (V_0(t)) \quad (2)$$

depends on time for two reasons : first because of the slow sweep of the bias V_0 , and secondly because the characteristic d^2I/dV^2 function can fluctuate with time. We shall call this last effect *characteristic noise*. We assume d^2I/dV^2 to be :

$$\frac{d^2I}{dV^2} = \Sigma(t) + N(t) \quad (3)$$

$\Sigma(t)$ being the signal, and $N(t)$ the characteristic noise function whose spectral density $\Gamma(\omega)$ is supposed to have a white part and $1/f$ part. We can see at a glance that the lock-in detection is now unable to avoid the $1/f$ part of $\Gamma(\omega)$ as it detects $I_{2\Omega}(t)$ about $\omega = 0$.

The origin of this characteristic noise can easily be imagined : phenomena such as ion migration in the 20 Å thick barrier, can make the junction conductance (σ) vary abruptly and give huge structures in the second derivative curve. It should therefore be possible to distinguish these variations of σ from the ones carrying physical information (such as those due to inelastic tunneling) occurring at fixed voltages. The first ones occur at random, the second are reproducible (see Fig. 3).

The method for reducing the characteristic noise clearly appears : an average over several plots should be taken. Some advantages of this method, with respect to the modulation-synchronous detection method, have already been pointed out by M. Klein

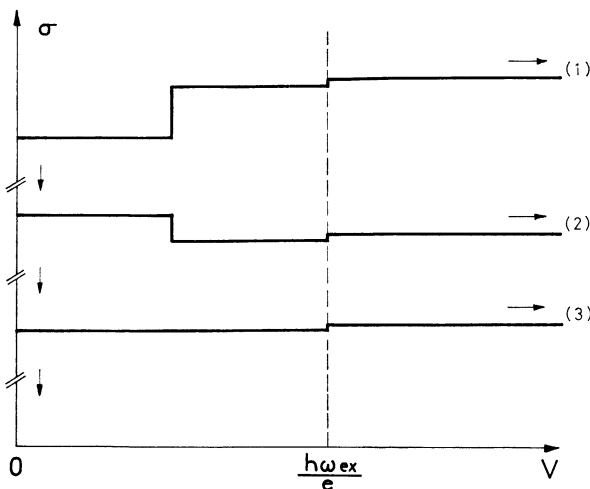

FIG. 3. — Diagram of a noisy junction conductance characteristic (σ) for three V_0 sweeps ((1) to (3)). For clarity, curves are vertically shifted. There may be large, but random, variations of σ and there is a small, but systematic, increase at $V_0 = h\omega_{ex}/e$. It appears that averaging will enhance the relative importance of this last structure with respect to the first ones.

and G. Barton [7]. They have shown that, contrary to lock-in detection, continuous averaging reduces all the low frequency noise generated by the measuring instruments. We shall see that the same technique leads to significant improvements when noise is present in the characteristic itself.

2.2 CALCULATION OF THE CHARACTERISTIC NOISE FOR THE AVERAGE OF SEVERAL PLOTS. — 2.2.1 *Definitions and hypothesis.* — T (60 s to 3 600 s) is the total time of the experiment ;

— We shall calculate the noise for two types of experiments :

- (1) a single sweep lasting $\theta_1 = T$,
- (2) n sweeps (10 to 1 000), each lasting $\theta_2 = T/n$.

— The optimum time constant τ of the lock-in is a fraction α ($\sim 10^{-2}$) of the sweep time θ (we shall make a detailed estimation for α further on). Then :

$$\begin{aligned} \tau_1 &= \alpha\theta_1 \\ \tau_2 &= \alpha\theta_2 . \end{aligned} \quad (4)$$

— We consider the noise in two extreme cases for the spectral density :

$$\begin{aligned} &+ \text{white noise, } \Gamma(\omega) = a \\ &+ 1/f \text{ noise, } \Gamma(\omega) = b/\omega . \end{aligned} \quad (5)$$

— With $1/f$ noise, we have to introduce a low frequency cut - off when performing the spectral density integration. The most natural one seems to be the inverse of the sweep time ($1/\theta$), but as is shown in appendix A, the exact value of this cut - off is of little importance for the final result.

2.2.2 $1/f$ characteristic noise. — The calculation of

the signal and the noise is illustrated by figure 4. For a single sweep one finds.

$$\left. \begin{aligned} \overline{N_1^2} &= \int_{1/T}^{1/\alpha T} \frac{b}{\omega} d\omega = b \text{Log} \frac{1}{\alpha} \\ S_1^2 &= \Sigma^2 . \end{aligned} \right\} \quad (6)$$

When n sweeps are added,

$$I_{2\Omega} = (I_{2\Omega})_1 + \dots + (I_{2\Omega})_n$$

one finds :

$$\left. \begin{aligned} \overline{N_2^2} &= n \int_{n/T}^{n/\alpha T} \frac{b}{\omega} d\omega = nb \text{Log} \frac{1}{\alpha} \\ S_2^2 &= n^2 \Sigma^2 , \end{aligned} \right\} \quad (7)$$

as quadratic values for noise are added during the sum of plots. We then get the important result :

$$\frac{S_2^2/\overline{N_2^2}}{S_1^2/\overline{N_1^2}} = n , \quad (8)$$

the S/N ratio increases, in power, as n .

2.2.3 *White characteristic noise.* — In a similar way, we obtain :

$$\begin{aligned} \overline{N_1^2} &= \frac{a}{T} \left(\frac{1}{\alpha} - 1 \right) , \\ \overline{N_2^2} &= n \cdot \frac{na}{T} \left(\frac{1}{\alpha} - 1 \right) , \end{aligned}$$

and then :

$$\frac{S_2^2/\overline{N_2^2}}{S_1^2/\overline{N_1^2}} = 1 , \quad (9)$$

with white noise, the S/N ratio is independant of n .

The result depends very much on the shape of the noise spectral density. But since it seems likely that the characteristic noise has a strong $1/f$ part (because it is an *anomalous* noise and frequencies involved are low (~ 1 Hz)), it appears to be worth while to average numerous rapidly-swept plots instead of a single slow one, during the same total experiment duration.

2.2.4 *Remarks.* — Since the white part of $\Gamma(\omega)$ is independant of f , it can be put either into $n(t)$ (1) or into $N(t)$ (3). This is why we find the usual result : it is equivalent to sweep once with a time constant τ , or to sweep n times with a time constant τ/n . But this is true *only if one ignores the $1/f$ part of the characteristic noise $\Gamma(\omega)$.*

— As was mentioned above, there are extreme experimental cases where the S/N ratio does not increase when the signal is increased by a larger modulation V_Ω . This seems to support our hypothesis of characteristic noise as expressed by relations (2) and (3).

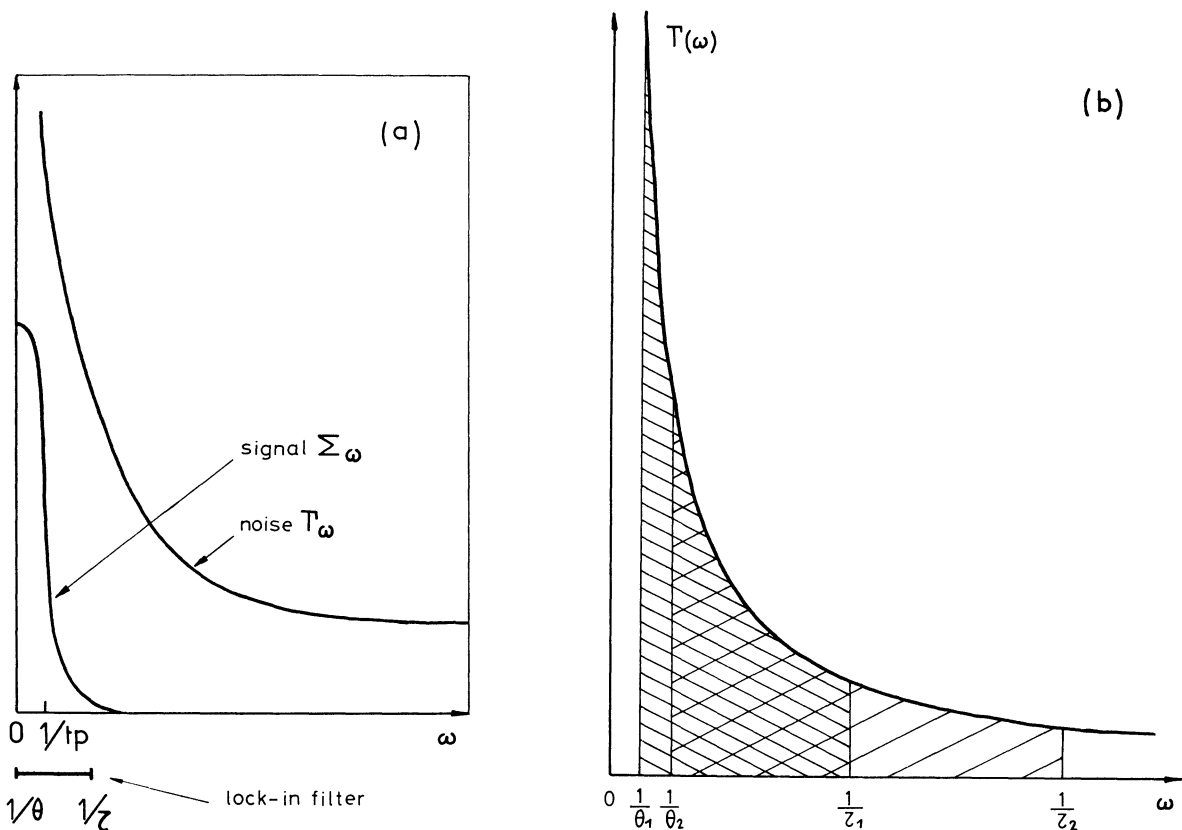

FIG. 4. — *a*) Diagram of spectral densities of signal (Σ_ω) and characteristic noise (Γ_ω). The characteristic noise has a $1/f$ part and a white part. The signal spectrum width is related to the inverse of the time necessary to sweep the sharpest peaks of the characteristic (t_p). *b*) Integration of $\Gamma(\omega)$ giving the characteristic noise for two experiments (1 and 2), with a $1/f$ spectrum. The low frequency cut-offs are assumed to be the inverses of the sweep times (θ_1 and θ_2), and the high frequency cut-offs are the inverses of the lock-in time constants (τ_1 and τ_2). Note that, in this model, because of the low frequency divergence of $\Gamma(\omega)$ the noise values are the same for a short sweep (1) and for a long one (2). On the contrary, an averaging procedure of n sweeps will reduce the noise as n .

— It can now be explained why the S/N ratio is not improved when the lock-in time constant is increased above a certain value (~ 10 s). This value probably corresponds to the frequency below which the $1/f$ part of the characteristic noise becomes preponderant. Then, eq. (6) indicates the independance of the S/N ratio with respect to τ (or T).

— Instabilities in the equipment, such as modulation generator fluctuations, variations in the gain of amplifiers, etc..., can be treated in a similar way. The measured quantity $I_{2\omega}(t)$, should be multiplied by $(1 + \eta(t))$ where $\eta(t)$ is a noise function with properties analogous to that of $N(t)$. This is the calculation which has been done by M. Klein and G. Barton [7] whose results agree with ours :

- a lock-in detection at high frequency, does not eliminate all the low frequency noise produced by the equipment [8]

- an averaging method eliminates such noise.

In tunneling spectroscopy, it has been proposed [4] to balance the junction resistance with a passive element and use a bridge technique to eliminate the generator fluctuations. The averaging method appears

to be an alternative solution which works even when the junction resistance has large variations with the applied bias, and moreover eliminates the lock-in gain fluctuations.

3. System for averaging characteristics. — 3.1 PRINCIPLE. — A system which is able to make the sum of several plots of a junction characteristic is schematically described in figure 5. Conventional circuitry [3, 4, 5] is used to obtain the desired characteristic $Y(V)$ at the output of the lock-in. The D. C. supply provides recurrent sweeps and the multichannel

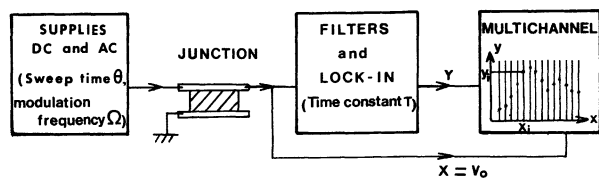

FIG. 5. — System making the sum of several plots of a junction characteristic $Y(V_0)$. Conventional bias modulation and harmonic detection are used to obtain Y at the lock-in output. The junction bias drives the X advance of the multichannel and, at each step, the Y value is recorded and added to the content of the corresponding channel.

makes the sum of the different functions $Y(V)$. The channel advance is driven by the D. C. voltage measured across the junction (V_0) and each channel records the corresponding output of the lock-in, $Y(V_0)$, by adding it to its pre-existing content.

The main difference between this system and M. Klein and G. Barton's one [7], is the address advance process. Here, the physical parameter (bias of the junction) is measured and drives the x address whereas in their case the x address advance is meant to control the variation of the physical parameter. This is of practical importance in tunneling because, in general, a current can be easily injected into a junction, but the resulting bias fluctuates with the junction resistance and then it cannot be controlled by an external parameter.

Clearly, this averaging system can be used for many other spectroscopy experiments.

3.2 CIRCUITRY. — See appendix B.

3.3 OPTIMUM CHOICE OF THE PARAMETERS CONTROLLING THE S/N RATIO. — As was seen in part 2 the parameters ruling the S/N ratio in an experiment are the number n of plots to be summed and the lock-in time constant τ . Their possible optimisation is now discussed, assuming a given total experiment time T and a given requirement for the resolution of peaks in the characteristics.

3.3.1 Choice of the sweep time. — The S/N ratio increases with the number n of plots (eq. (8)); therefore the sweep time $\theta = T/n$ should be chosen as small as possible, but there are limitations :

a) *Limitation due to the modulation frequency Ω* (Fig. 6)

If the peaks are to be resolved when their half height width is one percent of the maximum voltage :

$$\Delta V/V_m = 10^{-2},$$

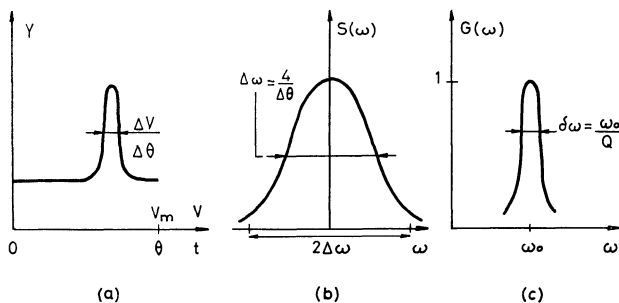

FIG. 6. — a) Example of the time dependence of the lock-in output Y during one sweep. The characteristic is supposed to have a peak, whose width is $\Delta\theta$, a fraction of the total sweep time θ . b) Fourier analysis of $Y(t)$. The peak in $Y(t)$ is assumed to be a Gaussian and therefore gives another gaussian for $S(\omega)$. Widths are defined at $e^{-1/2}$ of the full heights. c) Frequency response $G(\omega)$ of detection filters. Signals are preserved in a bandwidth $\delta\omega$. In order to realise a good restitution of the original signal, we need $\delta\omega \gtrsim 2\Delta\omega$. This will lead to a limitation for the shortest sweep time θ compatible with good resolution of characteristic structures.

then during a sweep (lasting θ) the output of the lock-in, $Y(t)$, will be a function of time with peaks of width :

$$\Delta\theta/\theta = 10^{-2}.$$

The Fourier transform of $Y(t)$ has a half height width, for gaussian curves given by

$$\Delta\omega = 4/\Delta\theta$$

In order to keep sufficient information when Y passes through the detection filter, the Fourier spectrum should be preserved in a band $\delta\omega$ of about twice this width.

For tuned filters centered at frequency Ω , with a quality factor Q , one has

$$\delta\omega = \frac{\Omega}{Q} = 2 \cdot \frac{4}{\Delta\theta}.$$

The minimum sweep time is, for $Q \sim 10$:

$$\theta \sim \frac{1\,000}{f_0}, \quad (10)$$

where f_0 is the modulation frequency ($\Omega = 2\pi f_0$).

b) *Limitations due to the electronics.* — The multi-channel used needs $55 \mu\text{s}$ per channel to enter information.

— The electronics driving the address need $15 \mu\text{s}$ per step.

— The filter at the bias measurement introduces an error that increases as the sweep speed, and 10^{-3} precision requires $\theta > 1 \text{ s}$ when operating at $f_0 = 1 \text{ kHz}$.

c) *Conclusion.* — If a precision of the order of 0.1% is required for the bias voltages, $1\,000$ channels will be used and for a 1 kHz modulation, the minimum sweep time will be 1 s .

3.3.2 Choice of the lock-in time constant (calculation of α). — The optimum time constant τ is determined by the sweep time. This is because the largest value of α ($\tau = \alpha\theta$) will give the best S/N ratio (eq. (7)) but there is a limitation from the lock-in response time. The rise time (10 % to 90 %) of a 6 dB/oct low pass filter is 2.2τ , and in order to resolve peaks with width $\Delta V/V_m = 10^{-2}$ the optimum time constant is :

$$\tau \simeq \frac{\theta}{200}, \quad \text{i. e.} \quad \alpha \simeq \frac{1}{200}. \quad (11)$$

4. Experimental results. — The system has been tested with Al-Pb tunnel junctions doped with organic molecules of copper phthalocyanine (P_cCu), in the voltage range where the electronic transition $S_0 \rightarrow T_1$ can be excited (1.15 V). This type of junction was chosen because it was known to exhibit anomalous noise. In figure 1b, plots of the third derivative characteristic are reported in the range $0.8 - 1.4 \text{ V}$ for 0.3 s and 3 s time constants. In figure 7 there are plots with

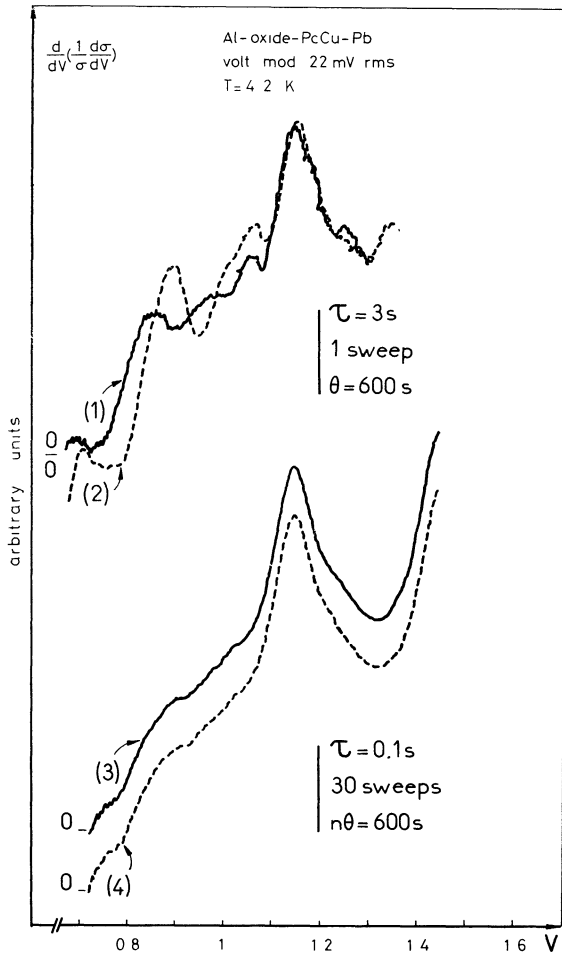

FIG. 7. — Experimental improvement of the quality of the $\frac{d}{dV} \left(\frac{1}{\sigma} \frac{d\sigma}{dV} \right)$ characteristic by averaging numerous plots on an Al-Pb junction at high bias. For each set of experimental conditions, two curves are shown to give an idea of the noise. The physical structure is the peak at 1.15 V associated with the electronic transition of the doping molecules (PcCu). For clarity, curves (3) and (4) are vertically shifted. The total experimental duration is the same for all the curves.

a 3s time constant and the average of 30 curves obtained with 0.1s (the total experimental duration being the same). In each case, two plots are reported to allow some estimation of the noise by studying the difference between curves: if $Y_1(V)$ and $Y_2(V)$ are the recorded functions, containing signal (S) and noise (N), one reads:

$$\begin{aligned} Y_1 &= S_1 + N_1 \\ Y_2 &= S_2 + N_2 \\ Y_2 - Y_1 &= 0 + N_2 - N_1 \end{aligned}$$

because the signal is the same for the two plots and the noise is not correlated. The noise mean value can be evaluated as:

$$\bar{N} \simeq \frac{1}{\sqrt{2}} \left[\frac{\int (Y_2 - Y_1)^2 dV}{\int dV} \right]^{1/2}$$

The curves of figure 1b illustrate the effect of increasing the time constant (and consequently the experimental time). The evaluation of the mean noise value gives $\bar{N} = 15$ (arbitrary units) for $\tau = 0.3$ s, and $\bar{N} = 12$ for $\tau = 3$ s: *the noise is practically not reduced when the time constant is multiplied by 10*. This illustrates one of the surprising results of our model: when $1/f$ characteristic noise is preponderant, the S/N ratio does not depend upon the lock-in time constant. Figure 7 demonstrates the efficiency of averaging numerous rapidly swept curves. Curves (1) and (2) are plotted with $\tau = 3$ s (total experimental time $\theta = 600$ s) and exhibit a mean value of noise: $\bar{N}_{1-2} = 10$. This is comparable to the value (12) obtained from other plots under the same conditions (Fig. 1b) (and also gives an idea of the precision that is expected in the evaluation of the noise). Curves (3) and (4) are the averages of 30 curves plotted with $\tau = 0.1$ s ($\theta = 20$ s), the total experimental time being also 600 s. Under these conditions, the mean value of the noise is only $\bar{N}_{3-4} = 1.6$. It is worth noting that *the improvement of the S^2/N^2 ratio is approximately $(^1)$ equal to n as expected with a pure $1/f$ characteristic noise*.

5. Conclusion. — Experimentalists working with lock-in detectors know the futility of increasing the time constant above a few seconds. Different reasons have been given for that; besides some equipment instabilities already mentioned by M. Klein and G. Barton [7], it appears that there are intrinsic causes, such as the characteristic noise of junctions in tunneling spectroscopy.

When using a synchronous detector alone, this leads to a severe limitation in the S/N ratio that can be achieved, whatever the experiment lasts, but if a multi-channel analyser is associated with the lock-in detector, this limit is removed to infinity (at the cost of the experimentalist's time).

It has also been shown that, *for a given experiment duration, the S/N ratio is usually greatly increased when using this last technique*.

It should be emphasized that the field of application of that technique is very large. Besides tunneling, N. M. R. and E. R. P. experiments, it can be used, to advantage, in most spectroscopies.

APPENDIX A

It is interesting to determine whether the result (8) for the S/N ratio with a $1/f$ characteristic noise depends strongly on the low frequency cut off, or not. Eq. (8),

(¹) In fact the improvement which is found (39.1) is slightly higher than \sqrt{n} (39.0). This may be due to a characteristic noise increasing faster than $1/f$ at low frequencies ($1/f^2$ for instance), but our evaluation of the noise is too rough to allow a definitive conclusion.

was obtained using a cut-off given by the inverse of the sweep time. Another possibility is to assume that there is some physical time \mathcal{T} which gives this cut off for the spectrum (with $\mathcal{T} \gg \tau$).

Calculations are straight forward :

$$\begin{cases} \bar{N}_1^2 = \int_{1/\mathcal{T}}^{1/\tau} \frac{b}{\omega} d\omega = b \text{Log} \frac{\mathcal{T}}{\tau} \\ \bar{S}_1^2 = \Sigma^2 \end{cases}$$

$$\begin{cases} \bar{N}_2^2 = n \int_{1/\mathcal{T}}^{n/\tau} \frac{b}{\omega} d\omega = nb \text{Log} \frac{n\mathcal{T}}{\tau} \\ \bar{S}_2^2 = n^2 \Sigma^2 \end{cases}$$

$$r = \frac{\bar{S}_2^2/\bar{N}_2^2}{\bar{S}_1^2/\bar{N}_1^2} = n^2 \frac{\text{Log} \mathcal{T}/\tau}{\text{Log} n + \text{Log} \mathcal{T}/\tau},$$

which leads to :

$$\frac{n}{1 + \text{Log} n} < r < n. \tag{12}$$

Thus, according to the exact relative value of \mathcal{T}/τ and n the S/N improvement (r) may vary from n to $1 + n/\text{Log} n$. For large values of n , these figures are of the same order of magnitude and it appears that *result (8) is but weakly sensitive to the low frequency cut off.*

APPENDIX B

Circuitry of the system. — Figure 8 outlines a system that sums several plots of the conductance logarithmic derivative

$$Y = \frac{1}{\sigma} \frac{d\sigma}{dV}.$$

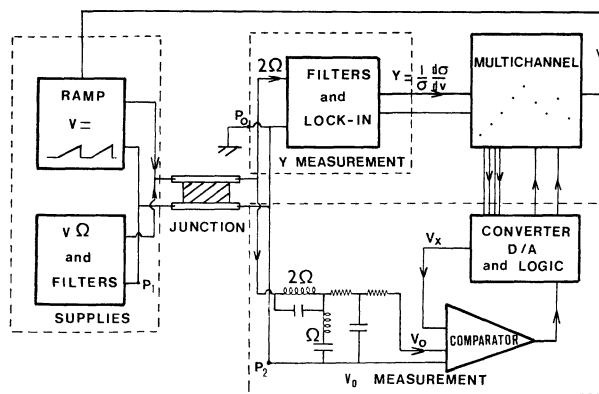

FIG. 8. — Block diagram of circuitry.

The circuitry used to obtain this characteristic at the output of the lock-in is described in reference [5]. The multichannel is a *Didac 4000* of Intertechnique

operating in the Multiscale mode. The arithmetic register (Y) capacity is 10^6 and the X address includes 4 000 channels. The *Didac 4000*, like most multichannels, is made to analyse recurrent signals as a function of time : the advance from one channel to the next is driven by an internal clock. But in tunneling, the important parameter is the D. C. voltage across the junction and not the time. Moreover, the sweep of this voltage is not necessarily linear as a function of time, or even reproducible (for instance if the junction resistance changes during the experiment). We therefore had to build an address advance driven by the bias V_0 . A converter was used for purpose, giving a voltage V_x proportional to the channel number and V_0 is continuously compared with this value V_x (Fig. 9)

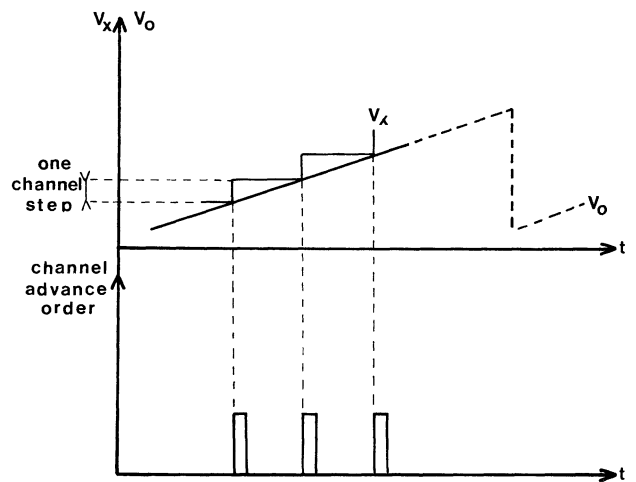

FIG. 9. — Address advance for the multichannel.

when $V_0 = V_x$, the address is ordered to advance one channel and a measurement of the lock-in output signal Y is performed and stored in the corresponding channel. Let us examine, in some detail, the D. C. supply and this channel advance system, after which we shall study the detection filters and the grounding problem.

B.1 D. C. SUPPLY (Fig. 10). — The D. C. supply is made with an operational amplifier working as an integrator. The sweep time θ (RC) can vary from 0.1 to 500 s. The integrator is followed by a variable voltage amplifier with a low impedance output. The upper value of the sweep can be selected from 50 mV to 5 V. The end of the ramp is ordered by a comparator : when V_0 reaches its upper value a signal resets to zero both the multichannel X address and the ramp. This reset signal is provided by a mono-stable oscillator ; therefore a rest time (t_r) can be assigned between two sweeps. t_r is variable from 0.1 to 10 s (Fig. 11). The minimum value of V_0 may be adjusted, from 0 to 4/5 of its maximum value, if a partial scanning of the junction bias is required.

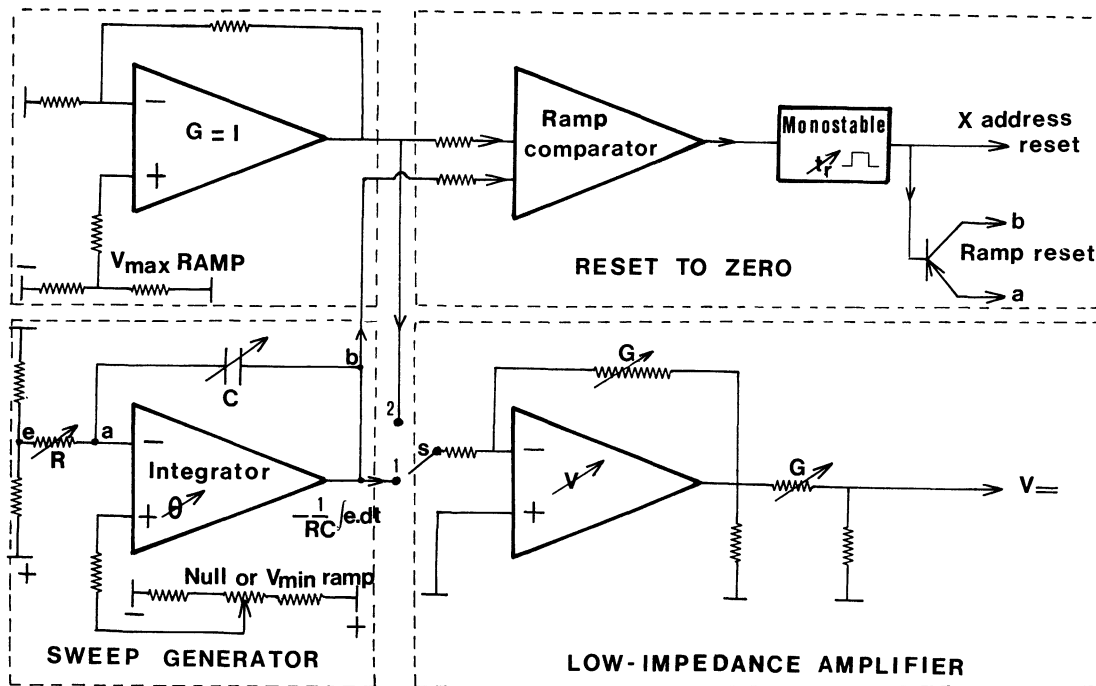

FIG. 10. — Ramp generator. When S is switched to position (2) the upper value of the sweep can be easily adjusted to experimental requirements. Note that the voltage supply V is different from the junction bias V_0 because of the voltage losses in the injection leads and junction films.

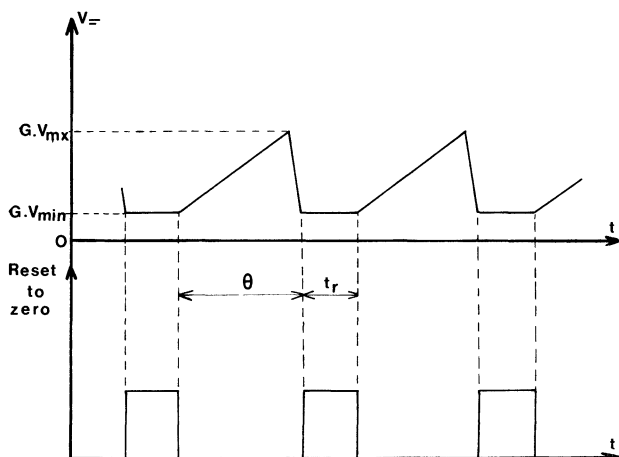

FIG. 11. — Junction bias voltage V_0 as a function of time.

B.2 MULTICHANNEL X ADDRESS ADVANCE (Fig. 12).

— B.2.1 *Junction bias measurement.* — Before being compared to V_x , the tension V_0 enters a variable voltage amplifier, so that the voltage calibration of one channel step can be set.

The minimum voltage sweep required is 25 mV and may be associated with 1 000 channels. The input circuit must therefore have a very low offset drift. We have chosen the Fairchild amplifiers μA 727 and μA 741; their input offset voltage drift is about $0.6 \mu V/^\circ C$. The calibration is made by a 4 decade attenuator (from 10 mV to 100 V). The offset compensations are adjusted for each calibration position. Another circuit permits an additional multiplication by a factor 1, 2 or 5.

B.2.2 V_x generation. — The X address of the multi-channel is available in BCD code. The corresponding analogic information (V_x), is obtained using a DAC 16/QM convertor (Analog Devices). The resolution is 4 digits (16 bits) and the linearity is better than 1.5×10^{-4} .

B.2.3 V_x/V_0 comparator. — The comparator provides an address advance order whenever $V_x \leq V_0$ (Fig. 9). A μA 709 (Fairchild) comparator is used with a $1.5 \mu s$ rise time which is shorter than the delay necessary for the multichannel to advance one channel after having performed a storage.

B.2.4 *Reset circuitry.* — The logic circuitry used to fulfill the different requirements of the multi-channel and the supply ramp providing recurrent sweeps is shown in figure 13. The gates used are SN 7 400 N (Texas Instr.).

B.3 BIAS MEASUREMENT FILTERS (Fig. 8). — Before entering the measuring circuitry, the bias V_0 passes through a double filter tuned at Ω and 2Ω to block these two frequencies. The filter at Ω permits the address to be driven by the mean bias $V_0(t)$ instead of the peak value of $V_0 + V_\Omega \cos \Omega t$. The one at 2Ω increases the impedance of the measuring circuit as is necessary to obtain the derivative

$$\frac{1}{\sigma} \frac{d\sigma}{dV}$$

(see reference [5]).

This tuned filter is followed by a RC low-pass filter ($RC = 50 \mu s$ when $\Omega = 1$ kHz) in order to eliminate

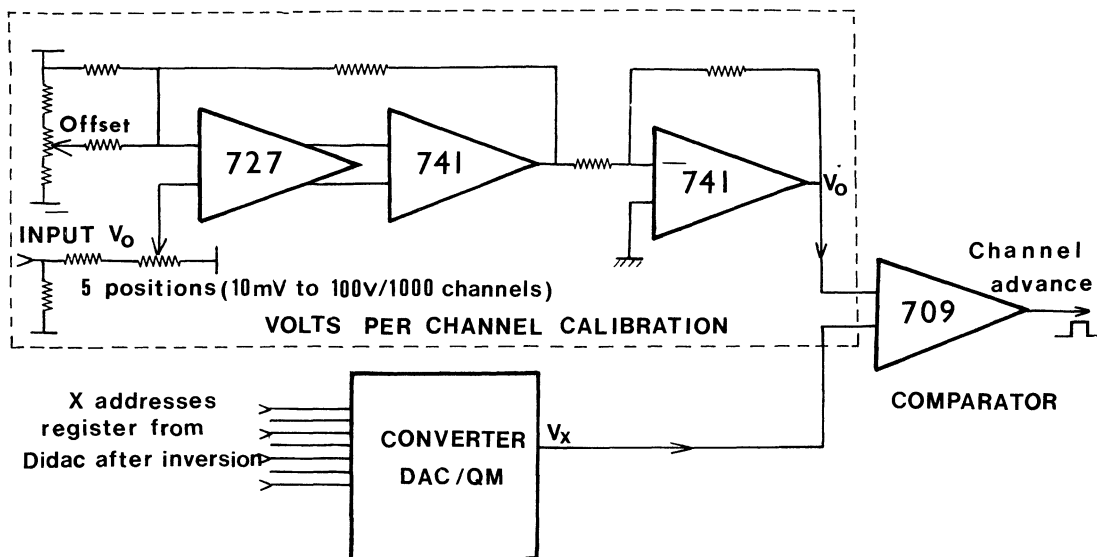

FIG. 12. — Multichannel address advance.

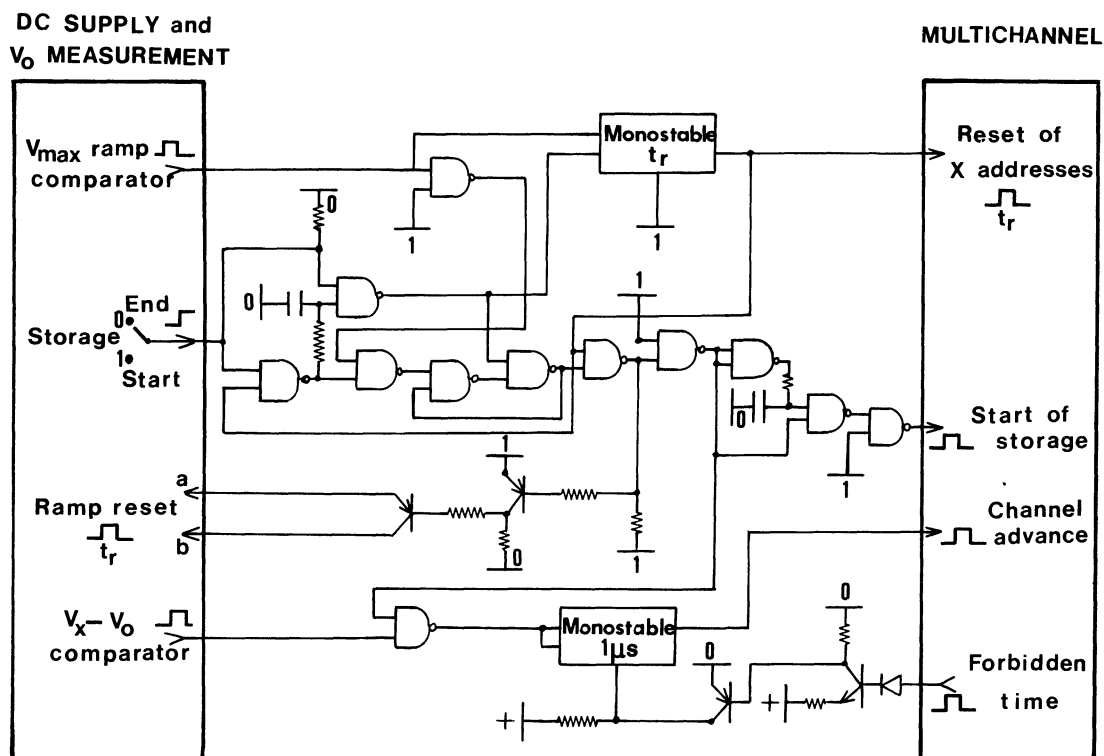

FIG. 13. — Logic circuitry.

any high frequency picked up by the sample. This RC filter reduces the measured voltages in a calibrated way (-2%) as does our other derivative equipment, which makes the resulting plots directly comparable to our usual ones.

B.4 GROUNDING PROBLEM (Fig. 8). — The grounding problem is of special importance in the electronics of tunneling as four probe measurements are necessary for the D. C. and A. C. voltages, and ground loops must be avoided. This prevents the use of the shield

ground for the different circuits. In this equipment, three grounds are used : P_0 , P_1 and P_2 . The multichannel and the logic circuits are operating with the chassis-shield (P_0). The grounds of the supplies (P_1) and measuring circuits (P_2) are connected to the ground P_0 in a single and common point. Consequently, there is a multiplication (by 3) of the different power supplies (-12 and $+12$ V, -15 and $+15$ V, $+5$ V). When connections are necessary between them (in the logic circuitry), the different points P_0 , P_1 , P_2 are connected by field effect transistors.

B.5 READING OUT OF RESULTS. — In order to read out the curves stored in the multichannel, the internal converter is used for X data ; but for Y data, the converter that is already used in V_x generation, is preferred because it gives a better resolution (10^4 points). The X channel advance is driven by an electronic clock (SFC 413) working from 1 to 100 channels/s.

References

- [1] See for instance : DUKE, C. B., *Tunneling in Solids* (Academic Press, N. Y.) 1969.
 - [2] ROWELL, J. M., CHYNOWETH, A. G. and PHILIPPS, J. C., *Phys. Rev. Lett.* **9** (1962) 59.
 - [3] GAUDEFROY-DEMONBYNES, A., GUYON, E., MARTINET, A. et SANCHEZ, J., *Revue Phys. Appl.* **1** (1966) 18.
 - [4] ADLER, J. G., CHEN, T. T. and STRAUS, J., *Rev. Sci. Instrum.* **42** (1971) 362.
 - [5] KLEIN, J., LÉGER, A., DELMAS, B., DE CHEVEIGNE, S., *Rev. Phys. Appl.* (ce numéro).
 - [6] See for instance : ANDREW, E. R., *Nuclear Magnetic Resonance* (Cambridge Univ. Press. N. Y.) 1958 ; GRIVET, P., BLAQUIÈRE, A., *Le bruit de fond* (ed. Masson, Paris).
 - [7] KLEIN, M. P. and BARTON, G. W., *Rev. Sci. Instrum.* **34** (1963) 754.
 - [8] See also : TOWNES, C. H. and SCHAWLOW, A. L., *Microwave Spectroscopy* (Mc Graw-Hill, N. Y.) 1955, p. 408.
-