



**HAL**  
open science

# HYDRODYNAMIC ASPECTS OF SELENIUM X-RAY LASER TARGETS

G. Charatis, G. Busch, C. Shepard, P. Campbell, M. Rosen

► **To cite this version:**

G. Charatis, G. Busch, C. Shepard, P. Campbell, M. Rosen. HYDRODYNAMIC ASPECTS OF SELENIUM X-RAY LASER TARGETS. Journal de Physique Colloques, 1986, 47 (C6), pp.C6-89-C6-98. 10.1051/jphyscol:1986612 . jpa-00225855

**HAL Id: jpa-00225855**

**<https://hal.science/jpa-00225855>**

Submitted on 4 Feb 2008

**HAL** is a multi-disciplinary open access archive for the deposit and dissemination of scientific research documents, whether they are published or not. The documents may come from teaching and research institutions in France or abroad, or from public or private research centers.

L'archive ouverte pluridisciplinaire **HAL**, est destinée au dépôt et à la diffusion de documents scientifiques de niveau recherche, publiés ou non, émanant des établissements d'enseignement et de recherche français ou étrangers, des laboratoires publics ou privés.

## HYDRODYNAMIC ASPECTS OF SELENIUM X-RAY LASER TARGETS

G. CHARATIS, G.E. BUSCH, C.L. SHEPARD, P.M. CAMPBELL and  
M.D. ROSEN\*

*KMS Fusion, Inc., 3621 S. State Road, Ann Arbor,  
MI 48106, U.S.A.*

*\*University of California, Lawrence Livermore National  
Laboratory, Livermore, CA 94550, U.S.A.*

### ABSTRACT

Recent experiments at KMS have been performed to investigate parameter variations of target component thickness, laser pulse duration and intensity, and one-sided vs two-sided irradiation in order to optimize the performance of the Livermore exploding foil selenium x-ray laser experiments. Preliminary experiments with selenium double foil targets were also conducted as a means of prolonging the duration and enlarging the spatial extent of the lasing conditions. Four-frame holographic interferometry was used in determining the time-dependence of density profiles obtained by Abel inversion of the interferometric fringe field and comparisons were made to LASNEX code calculations.

### SCOPE OF EXPERIMENTS

A series of experiments performed at KMS was designed to be used in the determination of optimum target and laser operating conditions of the successful Livermore selenium x-ray laser gain experiments. The principal experimental objective was to make use of KMSF's multiframe holographic interferometric capability to determine the temporal evolution of plasma density profiles of Formvar foil targets, coated on one side with selenium, together with concomitant variations in laser pulse length, intensity and target component thicknesses. Of particular interest was to answer the question: are electron density profiles equivalent for two-sided vs one-sided irradiation? If so, then gain length could be doubled for the same available laser energy. These profiles could then be used in checks of code simulations of planar and, particularly, cylindrically symmetric plasmas, useful in x-ray laser gain geometries. Of special interest was the desire to determine the extent to which exploding foil theory was applicable in two component targets of various thicknesses and irradiation conditions.

A second objective was to conduct a series of two-sided irradiation experiments using double-foil spaced targets in an attempt to prolong the duration and enlarge the plasma regions between the foils conducive to the x-ray lasing conditions.

Concurrent determinations of temperature profiles, though very informative, were not conducted at this time.

### EXPERIMENTAL SET-UP

Two beams of KMSF's 0.53 $\mu$ m CHROMA laser light were used to irradiate the targets with stacked flat-topped pulses in nominal lengths of 250, 500 and 750 ps, made up of roughly 110 ps pulses (FWHM) stacked at 108 ps intervals. Pulse length and shape

data were recorded with a streak camera. Two f/6 lenses of 120 cm focal length were used to focus the laser light at the two surfaces of the target. Nominal target irradiances of  $1 \times 10^{13}$ ,  $5 \times 10^{13}$  and  $10 \times 10^{13}$  W/cm<sup>2</sup> were obtained by varying the energy on target (EOT).

The experimental set-up is shown schematically in Fig.1. Both of the incoming beams were measured with full beam calorimeters for EOT determination of each shot. Target alignment was accomplished by irradiating the target with a CW argon/ion laser and viewing the target in back reflection with a TV camera.

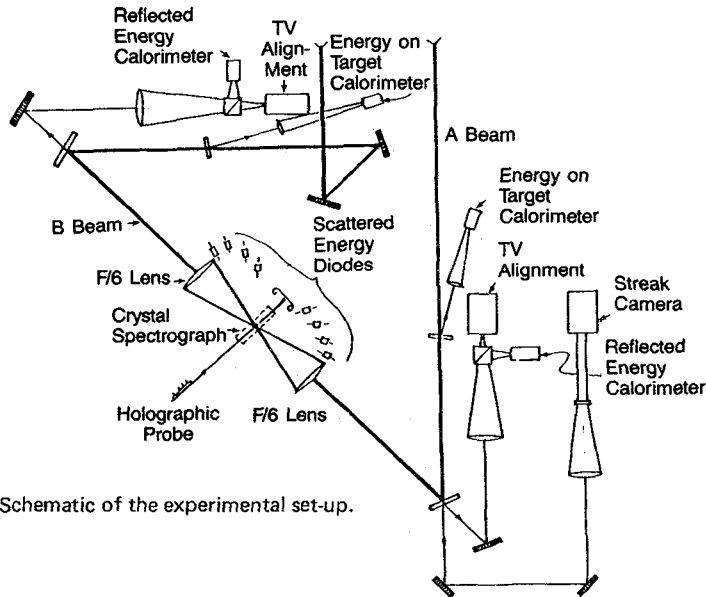

Fig. 1 Schematic of the experimental set-up.

The main pulsed laser light scattered by the target was in two parts: (1) direct backscatter through the f/6 lenses, measured using calorimeters, and (2) light side-scattered, outside the focusing cones of the f/6 lenses, measured by filtered and calibrated PIN diodes placed at various angles from the laser axis. A crystal spectrograph was mounted directly above the target, viewing the x-ray emission of the plasma on both surfaces of the target. A four-frame holographic probe directed normal to the laser axis provided the principal diagnostic of these experiments. Not shown are two pinhole cameras; one viewing the target at an angle of 10 degrees below the B-beam laser axis, while the second was in a plane normal to the laser axis. Single-sided irradiation was accomplished by either blocking one of the beams as it entered into the room, or at the f/6 lens.

#### FOUR-FRAME HOLOGRAPHIC INTERFEROMETRY

Four-frame holographic interferometry, developed at KMSF in 1984[2], was used in all of the target shots to yield electron density distributions of the expanding (exploding) Se/Formvar foil plasmas. Each frame exposure is of 20 ps duration 0.263 $\mu$ m light. The interval between each of the frames was set at 125 ps throughout the series. The four frames could be moved as a group, in time, relative to the peak of the first stacked CHROMA laser pulse. All frame probe times refer to this timing fiducial. This relationship is depicted graphically in Fig.2.

Each frame of an interferogram consists of two superimposed holograms, one taken during the plasma evolution time of interest and the other, either before or after, the shot, when no plasma is present. If exposed before, the interferogram contains

an image, in silhouette, of the the intact target, which also obscures the fringe pattern there. If exposed after, the resulting interferogram does not show an intact image of the target, but it does allow fringes to be recorded in its place. Since, the evolution of the peak density vs time is of primary interest in these measurements, the after second hologram recording scheme was employed for most all of the target shots.

Abel inversion is accomplished by first digitizing the two fringe pattern sides for each frame, and then, applying the inversion code developed earlier[3], a composite density distribution is obtained for each frame.

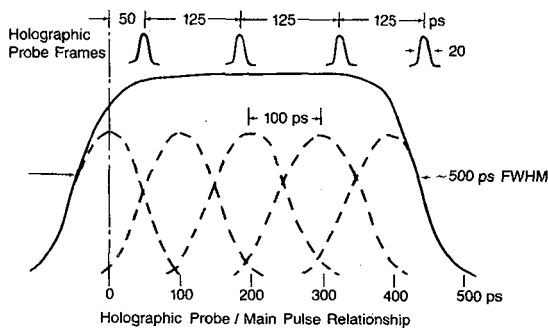

Fig. 2 Schematic of the 4-frame holographic probe pulses relative to the main laser pulse.

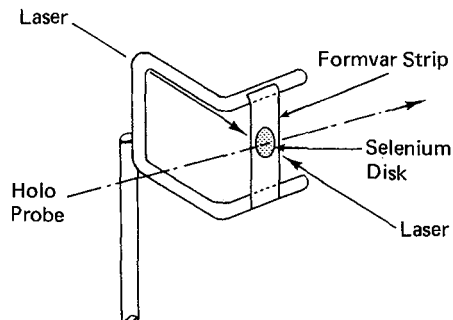

Fig. 3 Schematic of the Se/Formvar target design.

## TARGETS

The plasma distribution that was employed in the successful selenium x-ray lasing experiments at Livermore<sup>2</sup> was cylindrical, generated by focusing the laser beams into a line. Interferometric determinations of density can be done using Abel inversion techniques. Deconvolution of interferograms using this technique with only one probe beam direction requires the density distributions to be either spherical or axi-symmetric. This condition is more easily realizable if the targets and their laser irradiation patterns are concentric disks. Comparisons to cylindrical density profiles would then have to be made via code simulations. Since interferometric measurements were required close to the two target surfaces, the simple disk target supported by a washer was not adequate, since one of the surface regions could not be probed by the holographic laser pulse. A new target design, as seen schematically in Fig.3, was developed using 150 $\mu$ m nickel wire bent to hold the stretched Formvar containing the deposited Se disks. With no support structure to interfere with the interferometric probe beam, plasma density profile measurements could be made near both surfaces of the target.

Selenium metal was evaporated as 300 $\mu$ m diameter disks on to 350 $\mu$ m wide Formvar strips. Nominal target component thicknesses were 500 $\text{\AA}$ , 750 $\text{\AA}$ , and 1500 $\text{\AA}$  of selenium on 500 $\text{\AA}$  and 1500 $\text{\AA}$  Formvar. For each fabricated target the densities, in  $\mu\text{g}/\text{cm}^2$  for both selenium and its Formvar substrate, were determined using witness plates during the coating process. Using microradiography local thickness variations of the selenium coatings and their Formvar substrates were determined to be within 5-8% of their nominal values.

## SINGLE FOIL EXPERIMENTS

A total of 160 shots on all selenium/Formvar target combinations were undertaken in which total target irradiance (one-sided and two-sided) and laser pulse length was varied, as indicated above.

In Shot 7542 the multiple-frame probe was set with the first UV probe pulse 33 ps after the peak of the first stacked main laser pulse. The following three probe pulses were spaced 125 ps apart. With 31 joules of 0.53 $\mu$ m laser light incident on the selenium side, 28 joules on the Formvar side, and a total irradiance of  $0.9 \times 10^{13}$  W/cm<sup>2</sup>, the resulting interferograms from which on-axis density profiles were obtained are shown in Fig.4. The data points on the graphs represent density values provided by Abel inversion of the interferograms, while the full lines correspond to LASNEX code simulations. This shot is typical of the rapid decompression that takes place for thin foil Se/Formvar targets. The closed fringes observed at the center of the third interferogram (at 283 ps) represent density 'islands' which may be due to turbulence, beam non-uniformities, and perhaps filamentation. They have been observed, at random, on several shots, and need to be studied further because they introduce density gradients which may be deleterious to multiple pass configurations in actual x-ray laser geometries.

Setting the UV system to probe the plasma toward the end of the main laser pulse we obtain the multiple-time-frame interferograms and their on-axis profiles shown in Fig.5. The laser energy on the Formvar side was 27 joules, while on the selenium side it was 29 joules. The total irradiance was  $1.6 \times 10^{13}$  W/cm<sup>2</sup>. Of note here and in Fig.4 is the symmetry of the density profiles. It is maintained over 375 ps, corresponding to the interval between the first and fourth frames. In fact, since Fig.4 is typical of early probing shots and Fig.5 of later probing shots, one can safely assume the symmetry to have existed from the time of laser incidence out to the time of the last frame; i.e. 725 ps. Moreover, over this same interval, there does not appear to be any shift of the peak density from the original unirradiated target plane.

For a one-sided target shot in which the laser energy was 35.1 joules, pulse length 712 ps, and irradiance  $4.4 \times 10^{13}$  W/cm<sup>2</sup>, the density distributions are definitely skewed and shifted away from the original target plane, as seen in Figs.6 for the third probe frame of Shot 7633. This is typical for 70% of the one-sided shots, with the asymmetry being more pronounced for the thicker targets and irradiances below  $1 \times 10^{13}$  W/cm<sup>2</sup>. Both the asymmetry and the shift of the peak density are not predicted by the exploding-foil theory of laser/target interaction, and, in effect, preclude target irradiations which are one-sided in actual x-ray lasing experiments.

An interesting aside is the observation that the fringe patterns are 'squarish' for Se/Formvar shots. This is not so for targets in which the area covered in the irradiation has only one material component (e.g. all Se or Formvar). This can be explained by the fact that the plasma moves out from the target surface with a velocity in inverse ratio to the mass/area encountered locally by the irradiating beam.

A corollary observation is the nearly straight-line appearance of most all of the on-axis density profiles. This is expected of shots with long laser pulses on thick targets but not of exploding foil targets. Only, when the target mass/area was small or the energy on target was large did the on-axis profiles assume a curvature generally observed with exploding foil targets.

#### DOUBLE FOIL EXPERIMENTS

In the successful selenium x-ray laser experiments at LLNL in 1984 the FWHM duration of the two lasing lines was no more than 250 ps. From our holographic interferometry experiments we find the spatial extent axially of the lasing plasma density to be approximately 75  $\mu$ m. Clearly, if lasing within a mirror cavity is desirable, then the exploding foil plasma used to date would not last long enough for multiple pass techniques to be applicable.

Earlier work at KMSF has shown that under certain conditions two colliding plasmas can produce quasi-stagnating regions in the vicinity where they cross or meet. We therefore devised a target configuration, shown in Fig.7, in which two 750Å Se/1500Å Formvar targets were placed co-axially, with Se foils facing each other, spaced a distance apart.

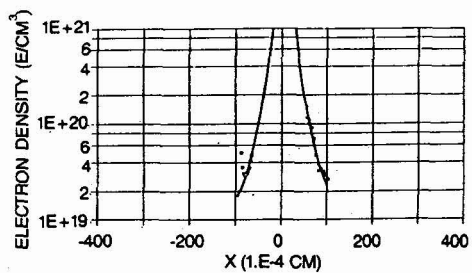
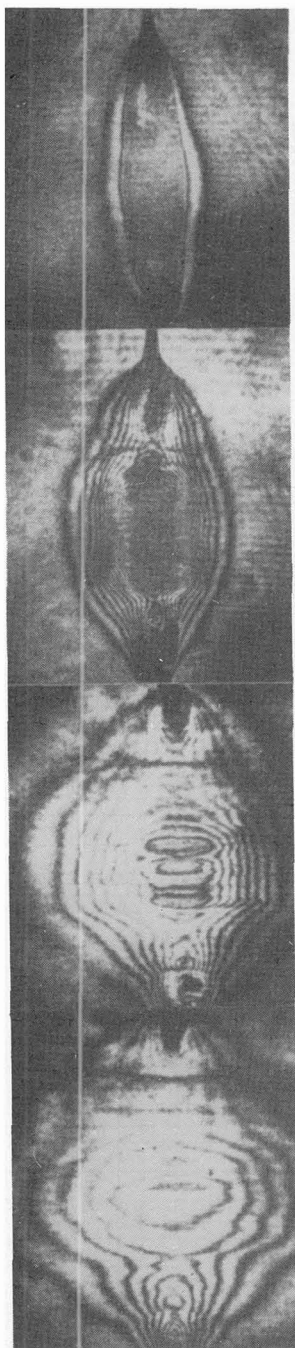

Probe time = 33 ps

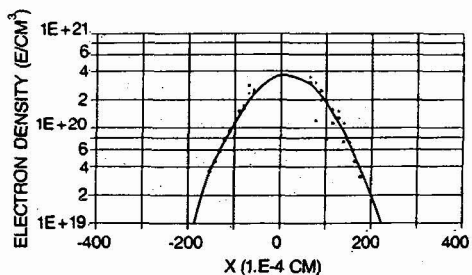

Probe time = 158 ps

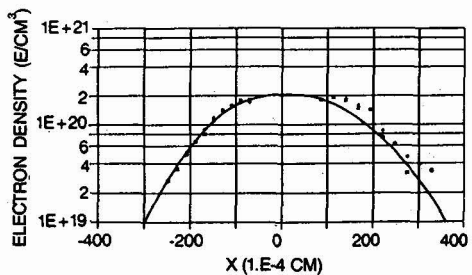

Probe time = 283 ps

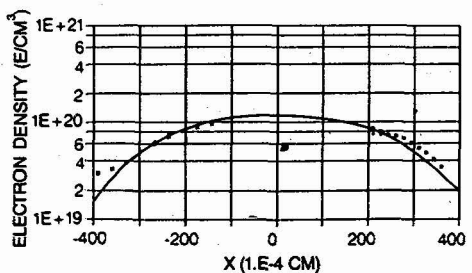

Probe time = 408 ps

Fig. 4 A four-frame set of holographic interferograms of Shot 7542, typical of the rapid decompression observed in thin foil Se/Formvar® targets. The data points in the graphs represent density values obtained with Abel inversion of the interferograms, while the full line curves correspond to LASNEX code simulations.

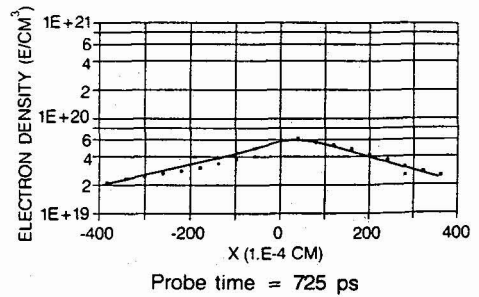
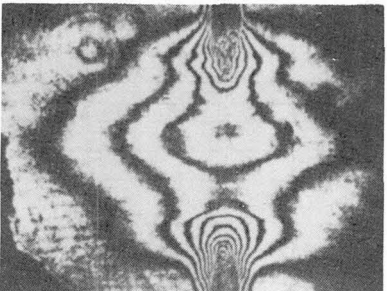
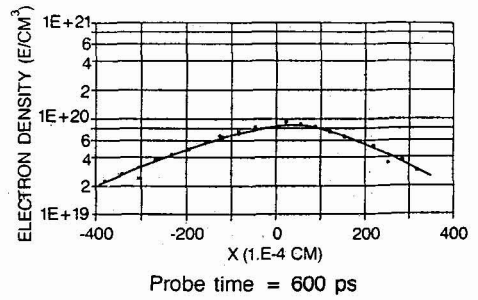
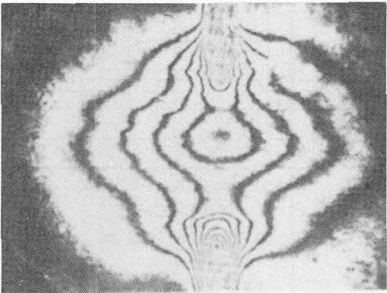
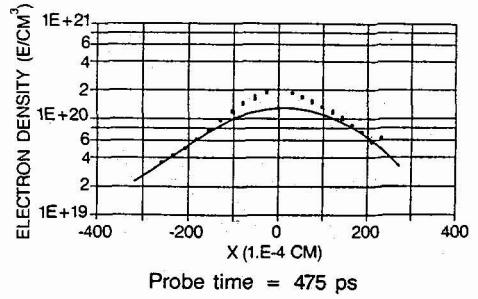
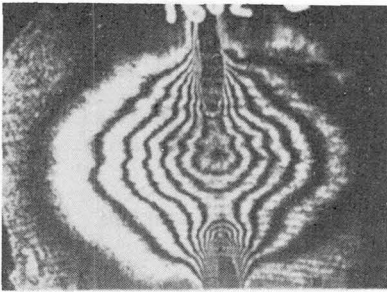
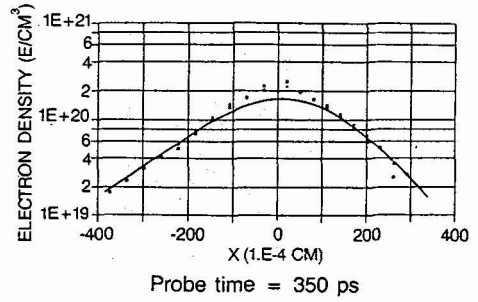
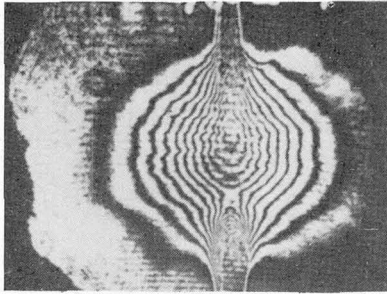

Fig. 5 Interferograms and on-axis density of Shot 7602. Probe times occur 317 ps later than in shot of Fig. 4. Note that both symmetry and lack of any axial shift are maintained out to 725 ps.

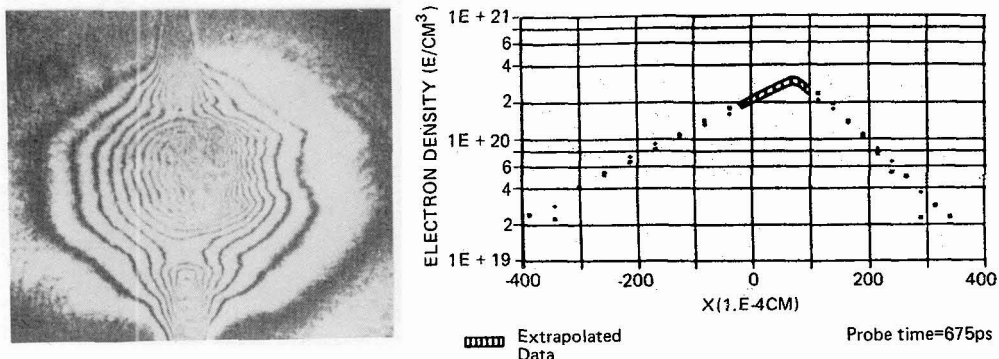

Fig. 6 Interferogram and on-axis density profile of Shot 7633 probed at 675 ps after peak of first stacked main laser pulse. Note asymmetry of the density distribution and the  $50\mu\text{m}$  shift of its peak density.

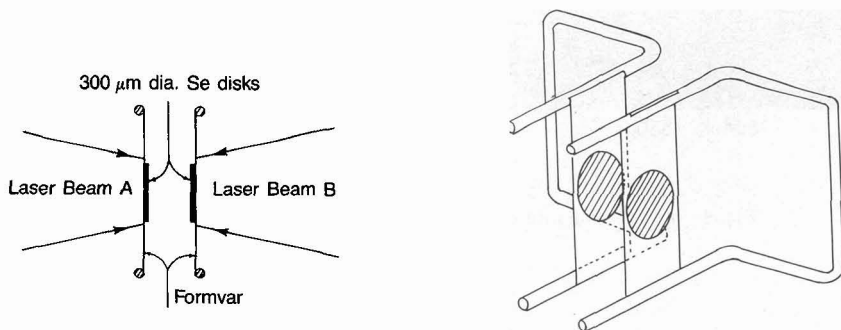

Fig. 7 Schematic diagram of a double foil target.

By irradiating this target, each foil with one of the laser beams, we expected to produce a rather flat plateau region sometime during the laser pulse in the space between the two foils. With a laser irradiance of  $11 \times 10^{13} \text{ W/cm}^2$  in 750 ps on each foil, Fig.8 shows the four frame sequence of Shot 7654 in which the reconstructions at 425 ps and 550 ps definitely show a rather flat region between the original foil positions of approximately  $400 \mu\text{m}$  in width.

Abel inversion of the extreme right and left fringe patterns of the third frame at 425 ps has yielded the on-axis right and left density profiles in the graph of Fig.9. Since the plasma between the foils is expected to expand symmetrically about the laser axis it is possible to obtain density information there as well. Inversion in a plane midway between the two foils indicates that the electron density on the axis there is reasonably close to the density just beyond the foils. Lasnex code simulations bridging the gaps between the data points indicate a rather flat profile over an axial extent of over  $500 \mu\text{m}$ , a factor of six larger than that obtained with a single foil under similar laser irradiance conditions.



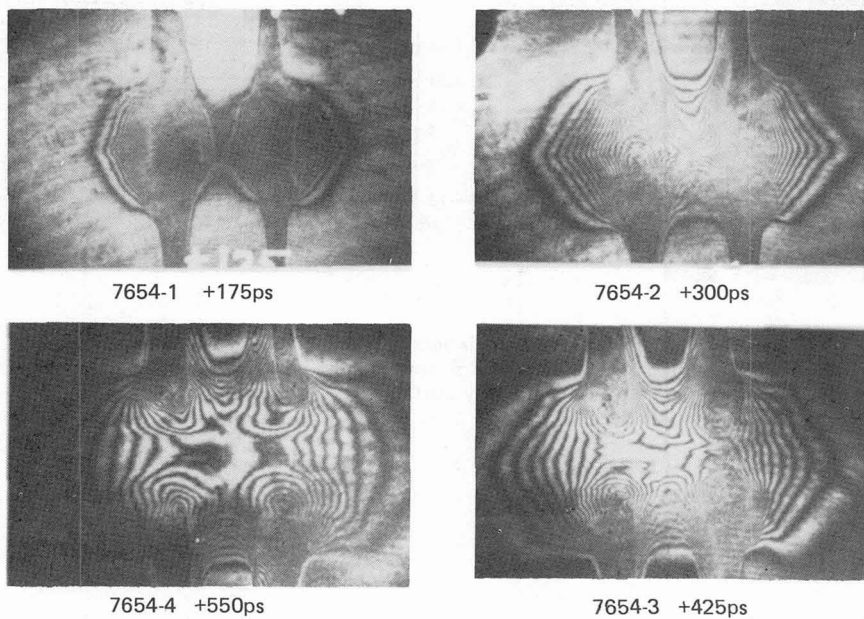

Fig. 8 Four-frame interferograms of a double foil target shot.

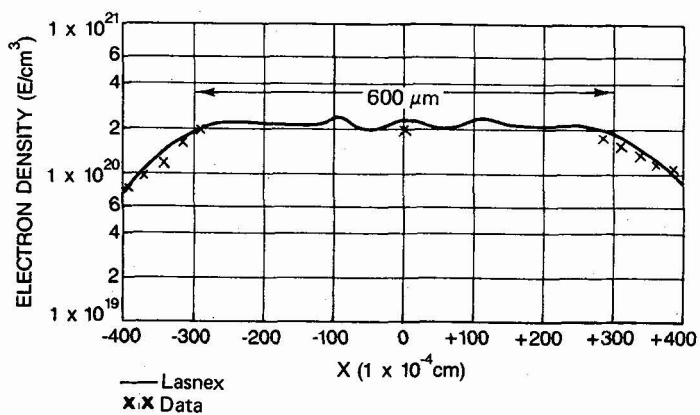

Fig. 9 On-axis density profile of the 425 ps frame of Fig. 8.

KMS hydrodynamic code simulations of the same target but with an irradiance of  $20 \times 10^{13} \text{ W/cm}^2$  show density troughs occurring for over 400 ps between the foils which can be helpful, via refraction, to contain the lasing beam, thereby yielding longer (i.e.  $> 3.5 \text{ cm}$ ) plasma lengths. In fact, by utilizing four Se strips on low Z (plastic) substrates, it may be possible to obtain density profiles which would contain the lasing beam, with minimum wander, along a direction, parallel to the Se strips, as shown schematically in Fig. 10.

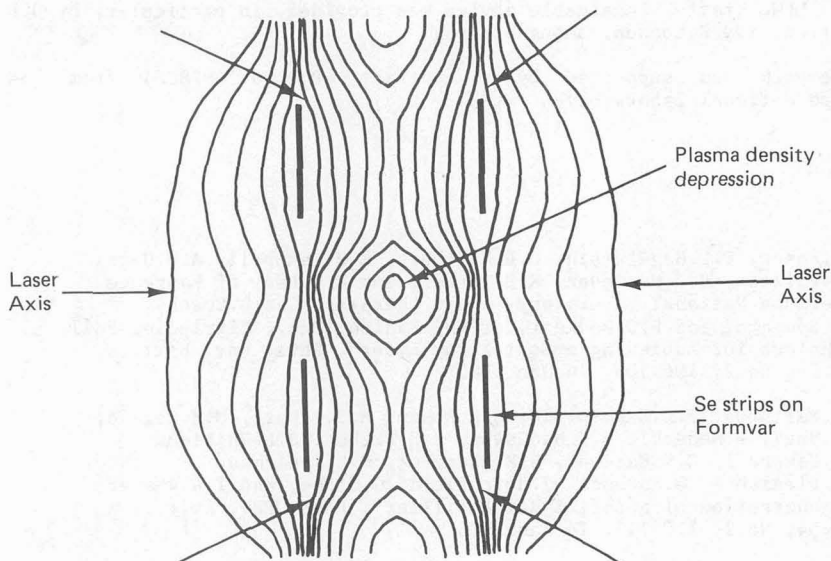

Fig. 10 Schematic representation of plasma iso-density profiles for a irradiation of 4-strip Se target configuration.

Only nine double foil shots were attempted in this preliminary series. By varying the spacing between the two foils, as well as the laser target parameters, it appears feasible, with more experimentation and code simulations, to optimize the conditions under which these double foils can provide information leading to meaningful cavity experiments.

## CONCLUSIONS

Multi-frame holographic interferometry has been applied to the temporal evolution of the plasma density profiles of several types of single foil Se/Formvar targets, under various laser conditions. In general, we have found that even for the thinnest (500Å Se/500Å Formvar) targets, single-sided irradiation approached the symmetric profiles expected of exploding foils only if the laser irradiance was greater than  $2 \times 10^{14} \text{ W/cm}^2$ . For the thicker target types two-sided irradiation is mandatory if symmetry is to be maintained.

The preliminary set of experiments in which two spaced foils were separately but simultaneously irradiated, indicate that it appears feasible to enlarge the volume and the duration of the x-ray lasing conditions. Thus, it may be possible to make use of synthetic multilayer reflectors in a selenium x-ray lasing cavity configuration.

## ACKNOWLEDGEMENTS

The authors gratefully acknowledge the superb effort by the experimental staff at KMSF in fielding the present series. Special thanks is extended to David Steinman and his staff for their diligence and resourcefulness in developing the special targets, to Kent Moncur's crew for providing a working CHROMA laser as needed, and to David Sullivan, who, with his assistants, put it all together and made it work!

Discussions were held during the course of the experiments with several members of the LLNL staff. Invaluable advice was provided, in particular, by D.L. Matthews, B.L. Whitten, and R. London, among others.

The work was supported by a contract (P.O.No.7092805) from the Lawrence Livermore National Laboratory.

## REFERENCES

- [1] M.D. Rosen, P.L. Hagelstein, D.L. Matthews, E.M. Campbell, A.U. Hazi, B.L. Whitten, B.J. MacGowan, R.E. Turner, and R.W. Lee, of Lawrence Livermore National Laboratory, and G. Charatis, Gar. E. Busch, C.L. Shepard, and P.D. Rockett, of KMS Fusion, Inc., "Exploding-Foil Technique for Achieving a Soft X-ray Laser", Phys. Rev. Lett., Vol. 54, No. 2, 106-109, 14 Jan 1985  
  
D.L. Matthews, P.L. Hagelstein, M.D. Rosen, M.J. Eckart, N.M. Ceglio, A.U. Hazi, H. Medeck, B.J. MacGowan, J.E. Trebes, B.L. Whitten, E.M. Campbell, C.W. Hatcher, A.M. Hawryluk, R.L. Kauffman, L.D. Pleasance, G. Rambach, J.H. Scofield, G. Stone, and T.A. Weaver, "Demonstration of a Soft X-Ray Amplifier", Phys. Rev. Lett., Vol. 54, No. 2, 110-113, 14 Jan 1985
- [2] Gar. E. Busch, C.L. Shepard, L.D. Siebert, and J.A. Tarvin, "Four-Frame Holographic Probing system for Plasma Density Measurement", Rev. Sci. Instrum. 56 (5), May 1985.
- [3] Computer Code written by D.W. Sweeney, Purdue University, See DOE Report No. C00-4001-6. This code has since been modified and improved by C.L. Shepard of KMS.