



HAL
open science

OPTICAL PHASE CONJUGATION IN LASER RESONATORS

C. Giuliano, R. Lind, T. O'Meara, G. Valley

► **To cite this version:**

C. Giuliano, R. Lind, T. O'Meara, G. Valley. OPTICAL PHASE CONJUGATION IN LASER RESONATORS. Journal de Physique Colloques, 1983, 44 (C2), pp.C2-45-C2-58. 10.1051/jphyscol:1983208 . jpa-00222580

HAL Id: jpa-00222580

<https://hal.science/jpa-00222580>

Submitted on 4 Feb 2008

HAL is a multi-disciplinary open access archive for the deposit and dissemination of scientific research documents, whether they are published or not. The documents may come from teaching and research institutions in France or abroad, or from public or private research centers.

L'archive ouverte pluridisciplinaire **HAL**, est destinée au dépôt et à la diffusion de documents scientifiques de niveau recherche, publiés ou non, émanant des établissements d'enseignement et de recherche français ou étrangers, des laboratoires publics ou privés.

OPTICAL PHASE CONJUGATION IN LASER RESONATORS

C.R. Giuliano, R.C. Lind, T.R. O'Meara and G.C. Valley

Hughes Research Laboratories, 3011 Malibu Canyon Road, Malibu, California 90265, U.S.A.

Résumé - L'utilisation de miroirs conjugués en phase dans des structures optiques oscillantes a suscité de l'intérêt récemment, aussi bien d'un point de vue expérimental que théorique. Un des aspects attrayant d'un résonateur en conjugaison de phase, RCP, est son aptitude à produire une onde émergente dont le front d'onde dépend seulement de la qualité du coupleur de sortie et est essentiellement indépendant des aberrations à l'intérieur de la cavité. Plusieurs concepts pour le RCP seront présentés dans lesquels soit le mélange de quatre ondes ou soit la diffusion Brillouin stimulée est utilisé comme un miroir conjugué en phase ; les avantages et inconvénients de chacun seront discutés.

Abstract - The use of phase conjugating "mirrors" in oscillating optical structures has been a subject of recent interest, both experimentally and theoretically. One of the attractive features of a phase conjugate resonator, PCR, is its ability to provide an output wave whose wavefront depends only on the quality of the output coupler and is essentially independent of intracavity aberrations. Several concepts for PCR's will be presented in which either degenerate four-wave mixing or stimulated Brillouin scattering is employed as the phase conjugate mirror; advantages and drawbacks of each will be discussed.

INTRODUCTION

Optical phase conjugation is an area that has received a considerable amount of attention in the past several years. The earliest reports of optical phase conjugation by workers in the Soviet Union^{1,2} were followed by several years of relatively little activity until reports suggesting potential applications began to appear in the open literature. In particular, the possible application to adaptive optics³ was one area which generated a great deal of interest because of the potential for correcting for atmospheric turbulence for high energy lasers and for compensating optical train distortions and pointing errors in laser fusion systems. A number of other potential applications have been pointed out as well^{4,5} but will not be discussed in this paper.

The interesting property of conjugate wave generation (also referred to as wavefront time reversal or phase reversal) that we will discuss here can be summarized in the following statement. When a wave enters a conjugator, a new wave is created traveling in the opposite direction with the sign of the transverse phase opposite to that of the incident wave. Hence, a diverging wave striking a conjugator at an angle θ will leave as a converging wave retracing the same path as the incident wave. Thus a conjugator can be thought of as a peculiar kind of mirror that combines reflection with phase reversal.

When one thinks of a conjugator as a type of reflector, it becomes logical to ask what would happen if such a reflector were incorporated as an element in an optical resonator - the subject of this paper. In the following pages we will briefly describe the properties of phase conjugate resonators, PCR's, and point out why they are of interest. We will briefly describe two of the most serious candidates for

conjugators, the nonlinear optical phenomena degenerate four wave mixing, DFWM, and stimulated Brillouin scattering, SBS. This will be followed by a description of different types of PCR's along with a discussion of some practical issues in their construction.

BACKGROUND

Phase conjugate resonators have interesting characteristics which differ significantly from those of conventional resonators (CR's).⁶⁻¹⁰ For example, and most important for this paper, the PCR can compensate for intracavity distortions. One can show that, when light is extracted from the "ordinary mirror" end of the PCR, the transverse phase of the wave depends only on the output mirror's figure (its detailed surface shape); the phase will not depend on any other sources of distortion within the body of the resonator.⁹ This feature has been demonstrated qualitatively in laboratory experiments.¹¹ Another contrasting feature of PCR's compared with CR's is that a PCR is always stable even if the ordinary mirror is convex.⁶ This property gives PCR's the ability to extract energy effectively in situations where conventional resonators require an unstable resonator design (i.e. large Fresnel numbers).

Another unique property is that a PCR with an "ideal" conjugate mirror will not have longitudinal modes that depend on cavity length. In a PCR the phase that is accumulated as the wave propagates from the ordinary mirror to the conjugate mirror is subtracted by the same amount on the way back to the ordinary mirror; in one round trip, the net accumulated phase is always zero. Consequently, a PCR of length L can support any wavelength consistent with the bandwidth of the gain medium and the conjugate mirror itself.

Hence, a PCR oscillating at a given wavelength will continue to oscillate at that wavelength, independent of variations of the cavity length. This in contrast to an ordinary resonator, whose spectral output will exhibit "mode hopping" and frequency drift as the cavity length changes.

If the phase conjugator mirror, PCM, is a four wave mixer FWM (see below) there can be transverse modes but, in contrast to a conventional resonator whose modes are spaced by $c/2L$ in frequency, the FWM PCR has modes that are spaced by $c/4L$ and occur in pairs symmetrically spaced around the central frequency.^{6,7,11} The central frequency always corresponds to the pump frequency of the PCM and is independent of the cavity length.

The types of PCR's that will be discussed in this paper utilize PCM's that are derived from either degenerate four wave mixing, DFWM, or stimulated Brillouin scattering, SBS. It is therefore appropriate to discuss briefly the physics of these nonlinear phenomena to the extent that they affect the properties of PCR's.

Four wave mixing is a nonlinear process in which three input waves mix to yield a fourth (output) wave. The three input waves consist of two planar counterpropagating pump waves, labeled E_f and E_b (f for forward and b for backward), and a probe wave, E_p , entering at an arbitrary angle to the pump waves. All three couple through the nonlinear susceptibility $\chi^{(3)}$, to yield a fourth wave, E_s , which is proportional to the spatial complex conjugate of E_p . The third order polarization - which yields the conjugate wave, $P_{n1} = \chi^{(3)} E_f E_b E_p^*$ - is proportional to the product of the amplitudes of the three input waves.

Stimulated Brillouin scattering involves the generation of a coherent acoustic wave when an intense optical wave interacts with a nonlinear medium. The mechanism generally acts through electrostriction - that is, the tendency of the medium's density to increase in proportion to the electric field intensity. Above some threshold intensity a light wave allowed to propagate in a nonlinear medium produces an intense back-scattered optical wave whose frequency is down-shifted by an amount equal to the acoustic frequency.

Analysis and experimental observation indicate that under appropriate conditions the scattered wave is the conjugate of the incident wave. Consequently an aberrated input wave yields an equally aberrated but conjugate scattered wave. Thus when the reflected wave retraces the incident path, the medium removes from it whatever phase errors were introduced in the first pass.

These two conjugation phenomena may be compared in terms of their impact as phase conjugate mirrors, PCM's.

- o Conjugation by SBS has an intensity threshold; DFWM does not.
- o DFWM requires separate pumps; SBS does not - hence an inherent simplicity for SBS.
- o SBS is accompanied by a frequency shift with each scattering step; DFWM produces a conjugate wave at the same frequency as the incident wave. This difference implies certain limitations for SBS PCR performance (see below).
- o DFWM can occur with conjugate reflectivities (E_s/E_p) exceeding unity - SBS reflectivities can only approach unity.

These comparative properties will be discussed in the light of how they affect the practical performance of phase conjugate resonators.

FOUR-WAVE MIXING PCR's

The first category of resonators to be described is that in which phase conjugate mirror (PCM) is generated by four-wave mixing (FWM). In this class there are three generic types, starting with the simplest (1) external laser pumped; (2) self-pumped and (3) self-starting and self-pumped.

EXTERNAL LASER PUMPED PCR's

The basic configuration of this type is shown in Figure 1. This configuration is similar to conventional resonators where now a PCM pumped by an external laser replaces the normal mirror at the right hand end of the resonator. The threshold condition for such a resonator is the same as for a conventional resonator where the reflection coefficient of the PCM is the phase conjugate reflectivity determined by the four-wave mixing process. If it is assumed that the four-wave conjugate signal is produced by a 2-level saturable absorption process the output power of such a resonator can be calculated simply as¹¹

$$P_{OUT} = A I_{sc} (1-R) (R R_{PCM} G_0^2 - 1) / R G_0 \text{ Watts}$$

where I_{sc} is the conjugator saturation intensity (assumed to be much smaller than the saturation intensity of the gain medium) $G_0 = e^{g_0 L}$, R is the reflectivity of the output coupler, R_{PCM} is the reflectivity of the PCM and A is the area of a resonator mode.

This type of resonator is inherently inefficient when one considers the requirement for external pumps whose powers are typically greater than the PCR's output power. However, because of its relative simplicity the external laser-pumped configuration has been used for a number of significant experimental demonstrations of the unique properties of PCR's. A brief summary follows.

The first demonstration of a pulsed PCR was made in which stable oscillation was sustained even with a convex mirror.⁶ Lind and Steel¹¹ were the first to demonstrate a cw PCR with an intracavity gain medium. They also showed that when an aberrator was placed inside the PCR, the output through the ordinary mirror was diffraction limited, while the output through the PCM was severely aberrated. The output

frequency of the PCR was shown to be locked to that of the pump laser and independent of cavity length. Finally, they observed for the first time the paired half-axial modes separated by $c/4L$ from the central frequency.

Another oscillating structure can be obtained in which the intracavity gain medium is absent. This occurs when the PCM reflectivity is substantially in excess of unity.

This configuration has been used to demonstrate properties of PCR's¹² but, because it is an empty resonator structure, its principal appeal appears to be scientific rather than practical, especially for high power applications.

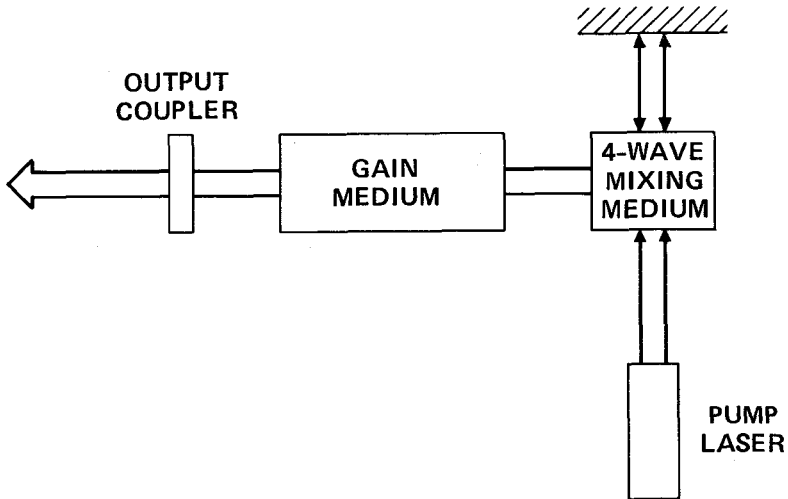

Figure 1. Schematic diagram of an external laser-pumped FWM PCR.

SELF-PUMPED PCR's

In this category the pumps for the four-wave mixer are not obtained by a separate laser but are derived from a portion of the useful output of the PCR itself. In its simplest form such a configuration is shown in Figure 2. It is assumed that an external laser is used in some fashion to start the oscillation by providing the pumps for the FWM and then switching this laser out of the system. (Schemes for self starting will be described later).

Two key issues related to such a design that come to mind immediately are the efficiency of such a system and the beam quality of the pumps. Clearly the reason for incorporating a PCM in a resonator is to improve beam quality and thus increase the far-field irradiance. But since, in a self pumped configuration, some of the energy of the PCR is required to pump the PCM the question of whether one gains in energy delivery is a key factor in PCR design. In addition, the pumps must be plane waves (or conjugates of each other) to realize the conjugate properties of such PCR's.

Other factors must be considered for such PCR designs: (1) frequency control devices - gratings, etalons, etc. -- must be included in the pump path if precise frequency control is needed to obtain efficient operation of the PCM. This would be required if a resonant nonlinear process such as saturable absorption were used to generate the PCM as in Na vapor;¹¹ (2) Pump depletion - that is in general, DFWM theory considers the probe (the intracavity beam in a PCR) intensity to be less (say a factor of 10 typically) than the pump intensity. It is clear that a PCR will not operate in this mode and in fact all beams will be of the same magnitude so that the effect of this "pump depleted" mode on the efficiency of PCR's must be carefully

evaluated; (3) pump recovery - examining the diagram in Figure 2 we see that the counterpropagating pump of the FWM is lost to the PCR lowering the efficiency of the system. However, this energy can be recovered by the use of alternate geometries. An example of such a configuration is given in Figure 3. Here the pumps are obtained by the action of the tuned Fabry-Perot that surrounds the FWM. In this case the Fabry-Perot is tuned such that very little energy is reflected back from the resonant structure. (4) Probe recovery - again referring to Figure 2 we see that

12203-2

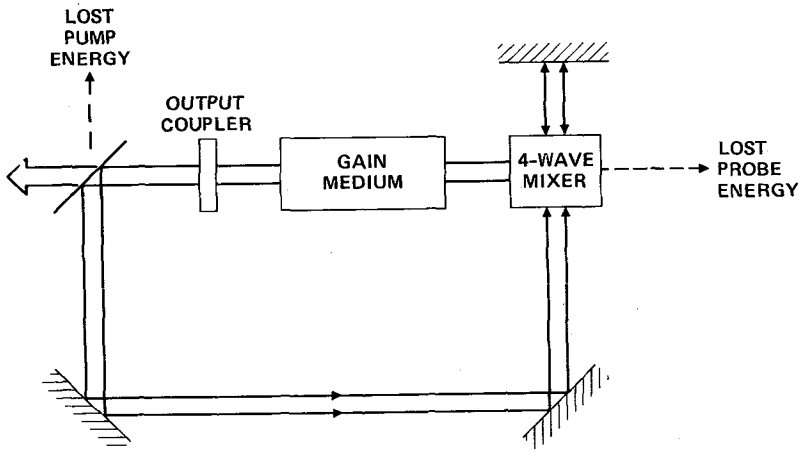

Figure 2. Schematic diagram of a self-pumped FWM PCR indicating lost pump energy and lost probe energy.

12203-3

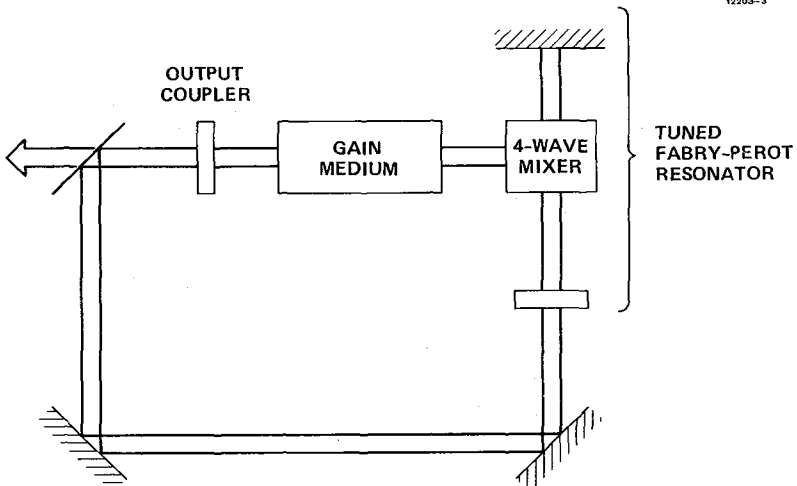

Figure 3. Self-pumped FWM PCR using tuned Fabry-Perot resonator to minimize pump losses.

probe energy is lost to the system by transmission through the PCM. Recovering this energy represents a challenge to PCR design and is a current area of research at Hughes. In principle it is easy to return this energy to the PCR cavity but it will not be the conjugate signal. Thus the resonator produced will have an output that has a mixture of non-conjugated and conjugated beams.

There are many other possible geometries and configurations which are variants on the theme shown but will not be described here. However, a somewhat different implementation is the synchronously pumped geometry described by Vanherzeele, Van Eck and Siegman.¹³ This scheme uses pulses in a cavity timed to generate the various pump and probe pulses. It is a very clever and complex scheme which shows that pulse compression can be achieved in such a configuration but offers no promise for intra-cavity aberration correction since it extracts the useful output from the conjugator end.

SELF-STARTING AND SELF-PUMPED PCR'S

In this category all the features of the self-pumped configurations described previously are retained but in addition the resonator also has the ability to reach threshold itself - that is self-starting. Again in its simplest form such a configuration is shown in Figure 4. Here we make use of the "lost" transmitted probe by inserting an E/O switch and total reflector in that path. Oscillation is then initiated between the output coupler and the total reflector as in a conventional resonator. The FWM is in general a low loss device so that threshold is easily reached in the cavity formed by the output coupler and the total reflector. Initially no pump energy is available however at some point in time sufficient output will have been obtained such that the pumps will be of a magnitude that the FWM will be generating a strong conjugate signal so that the PCR can oscillate. At that time the E/O switch is operated removing the total reflector from the optical path. This type of resonator configuration is currently under investigation at Hughes.

12203-1

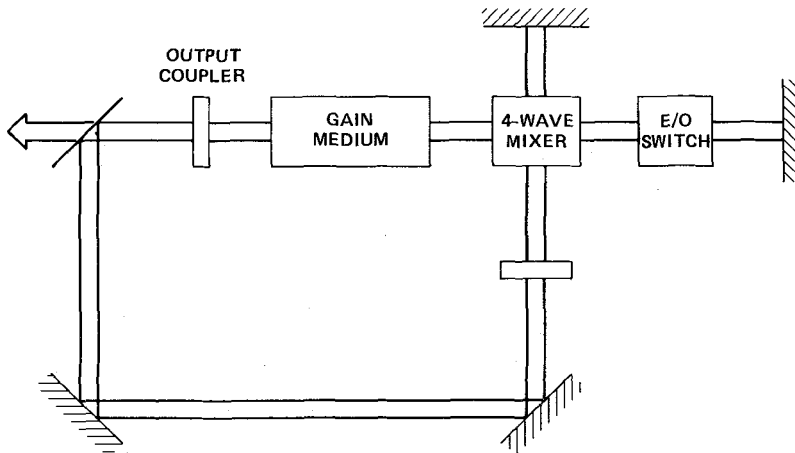

Figure 4. Self-starting self-pumped FWM PCR.

PCR'S USING STIMULATED BRILLOUIN SCATTERING

An alternate approach to PCR's is one in which the PCM is derived from SBS. This approach is conceptually simpler than the one that uses DFWM in that it does not require the use of auxiliary pumps. However, in spite of this apparent simplicity, it has certain challenges that must be met before it can be implemented in a viable way.

First, there is the problem of initiation. In contrast to DFWM, SBS will occur only after a certain threshold intensity is reached. Thus, a situation must be set up so that the intracavity flux can build up to a point at which SBS takes over. This can be realized conceptually by considering Figure 5 in which the SBS cell is situated inside an ordinary optical resonator. The idea here is that once the oscillation builds up in the ordinary resonator, the SBS mirror takes over and oscillation continues between it and the output coupler. Thus, the system starts out as an ordinary optical resonator and converts to a PCR once SBS threshold is reached inside the cavity.

More important than the initiation process is the fact that SBS occurs with a frequency down-shift equal to the frequency of the coherent acoustic wave generated in the process. This shift, equal to $2 v_s/c$, where v_s is the speed of sound in the nonlinear medium, amounts to about one part in 10^5 and gives rise to a spectral output that sweeps downward in frequency with each successive pass through the resonator. Thus, a PCR with an SBS conjugator, once initiated, will eventually die out as the successive frequency shifts cause the circulating wave to walk off the gain curve of the active medium. Operating with this constraint, the SBS PCR is best suited for pulsed operation. The duration of the pulse is determined by the width of the gain curve, the degree of output coupling, and the cavity length. Moreover, one must accept operation which gives an inverse "chirp" for an output which may or may not be tolerable depending on the application.

Note that for several types of gain media, e.g. most gas lasers, the size of the SBS shift is larger than the width of the gain line. Hence, the "oscillation" will essentially die out after one pass through the resonator and the PCR as such is not truly realizable. For lasers that have relatively broad gain profiles (e.g. Nd: glass, ruby, most dyes, and excimers) many hundreds of SBS shifts can be sustained before oscillation ceases due to the frequency walk-off.

There are several approaches to the frequency walk-off problem, some more complex than others. The simplest conceptually is to move the SBS medium towards the incident optical wave at a speed large enough to cancel the frequency shift, i.e. the speed of sound. For gaseous media Mach 1 flows are within the state-of-the-art but pose a challenge for gas pressures that work best for efficient SBS (1-10 atm). For liquids and solids the challenge is greater and may require mechanically sophisticated implementations such as high speed rotating discs or synchronized reciprocating designs. If these challenges can be met, the promise of cw or quasi-cw PCR's using SBS conjugators may be realized.

Another approach to the frequency walk-off problem is the double SBS ring resonator configuration shown in Figure 6. This approach is more complex in concept and in implementation but may have promise for some applications. It was inspired by the work of Basov and Zubarev¹⁴ and further elucidated by the work of Abrams, Giuliano and Lam.¹⁵ Here we show the SBS medium pumped by a separate pump laser. The pump laser is chosen so that its intensity exceeds SBS threshold in the nonlinear medium. The circulating fields in the ring resonator are not large enough to reach SBS threshold but nevertheless undergo phase conjugation as long as the pump waves are present. As described^{14,15} the nonlinear process that takes place is a kind of resonant-enhanced four-wave mixing in which the pump waves are the incident and SBS-scattered pumps externally imposed. Here, the counter-clockwise wave has frequency ω and the clockwise wave, $\omega - \delta$. Instead of the successive down-shift that takes place in the linear SBS resonator, here we have alternating up-and-down shifts and the walk-off problem is avoided. We also note as shown by Basov and Zubarev¹⁴ that high quality pumps are not required for this process to work. This is because, as in the general case of four-wave mixing, the counterpropagating pumps are conjugates of each other and, for this reason, the signal and probe waves are also conjugates.

PCR's USING SHIFTED GRATING CONJUGATORS

A third category of PCR's is that which makes use of the shifted grating effect which occurs in certain nonlinear materials. Here, the refractive index grating which is produced in these materials is shifted laterally from the intensity grating by a phase shift determined by the properties of the material. Under some conditions, this shift can be exactly one-half of the grating period. Such a shift has very interesting consequences for two-wave interference patterns because the shift allows preferential energy transfer from one wave to the other. Shifted grating materials used for four-wave mixing have allowed construction of novel devices¹⁶ and, in fact, a very significant demonstration of using a shifted-grating conjugator in a PCR that does not use external pumps¹⁷ has been constructed. Figure 7 shows a schematic diagram of the PCR, which work as follows.

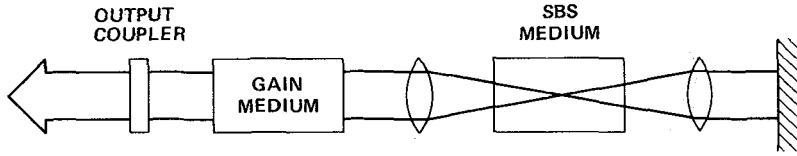

Figure 5. Schematic diagram of SRS PCR.

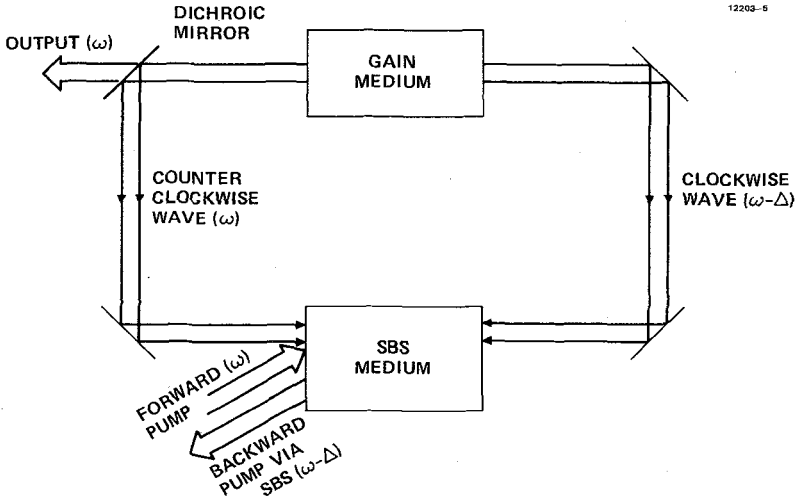

Figure 6. Pumped SRS PCR that eliminates frequency walk-off; note down-shifted clockwise wave and up-shifted counter-clockwise wave.

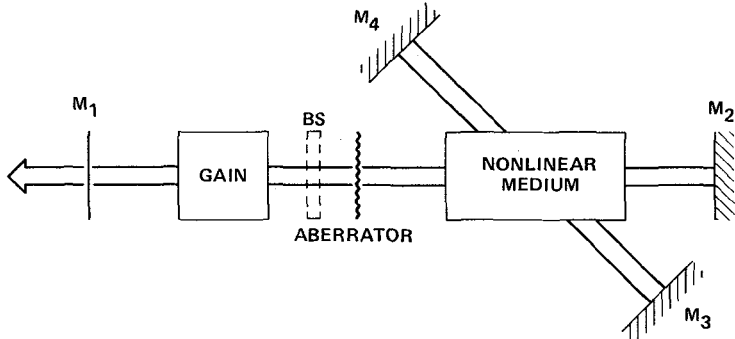

Figure 7. Schematic diagram of a PCR using a shifted grating nonlinear medium.

Lasing is initially induced between mirror M_1 and beam splitter BS. Light transmitted through the beam splitter causes oscillation in the PCR consisting of the crystal and mirrors M_3 and M_4 . This oscillation is due to the shifted grating process described above. M_2 is used to assist in the buildup of oscillation. With oscillation established between M_3 and M_4 , the beam splitter and M_2 are removed.

At the present time, only photorefractive materials have operated as shifted grating PCR's. Because of the slow time response of such materials, these PCR's have only

slowly varying aberration correction capabilities. Efficiency considerations of such PCR's have not been examined to date.

PRACTICAL ISSUES IN THE CONSTRUCTION OF PCR'S

The key attraction of a PCR is its ability to produce a nearly diffraction limited output beam with extremely large intra-cavity aberrations while providing efficient mode filling for large gain volumes. The size of the aberrations that can be corrected is limited by the finite transverse size of the laser resonator and conjugator and by nonreciprocal propagation effects such as may occur in a saturated gain medium. Aberration correction has been analyzed analytically and computationally.^{9,18-20} Numerical results from a three dimensional saturated gain calculation are shown in Figure 8. This figure shows Strehl ratio and fractional outcoupled power as a function of the standard deviation of the phase produced by an aberration screen placed at the conventional plane mirror side of a PCR. We see that for the particular resonator chosen, the fractional outcoupled power degrades by only about 25% for $\sigma_\phi = 6$ radians. The curve for the CR corresponds to a resonator that has two plane parallel mirrors having the same separation as the PCR. At zero phase error the values of P_{out}/P_{stored} for the two resonators are different because their transverse modes are not the same. The key comparison between the two curves is that the CR curve degrades substantially more rapidly than that for the PCR. In fact the dashed portion of the CR curve corresponds to a region in which there was doubt whether a converged solution has been obtained in the computer simulation.

The Strehl ratio, defined as outcoupled far-field irradiance with aberrations divided by far-field irradiance of a uniform amplitude and phase beam, also degrades by about 25% at $\sigma_\phi = 6$. Thus, one concludes that even in the face of very bad aberrations, a PCR can provide good performance. It is important to note that as the Fresnel number of the resonator (square of radius divided by wavelength times resonator length) decreases, the degradation in PCR performance increases. Computer simulations show that this degradation becomes substantial at Fresnel numbers less than about 5.

Figure 9 shows results for computer-simulated PCR's with and without the use of intracavity spatial filters. The original motivation for the use of a spatial mode selector in a PCR was based on the notion that a unique transverse mode might not be established without one. In fact it can be shown that for a PCR having infinite lateral extent any arbitrary wave is a stable solution. A PCR of finite extent however does possess unique transverse modes. This occurs because of the diffraction losses at the edges of the mirrors which, because of their finite extent, act as spatial filters.

Note the following features in the simulation results shown in Figure 9 for a PCR with a saturable gain medium. (1) The phase of the wave at the output coupler is well behaved. (2) The outcoupled irradiance is spatially smoother with the spatial filters than without. (3) The far-field Strehl ratios are comparable for all three cases. (4) The extracted power, P_{out}/P_{stored} , is appreciably increased for the case without the spatial filter.

In spite of the aberration correction capability PCR's must still provide an acceptable level of extraction from the available gain medium. The two major differences in extraction between PCR's and CR's are the transverse mode shapes or filling factors and mirror losses. PCR's may offer the opportunity to fit a transverse mode to a given gain medium but must use a phase conjugate mirror as one reflecting element, and current phase conjugate mirrors are limited in efficiency. For SBS the principal efficiency issue is a reflectivity less than unity which results in some fraction of the resonator output lost through the PCM. For FWM PCR's the need to provide pumps operating in a strongly depleted mode combined with the loss through the PCM limits the overall efficiency.

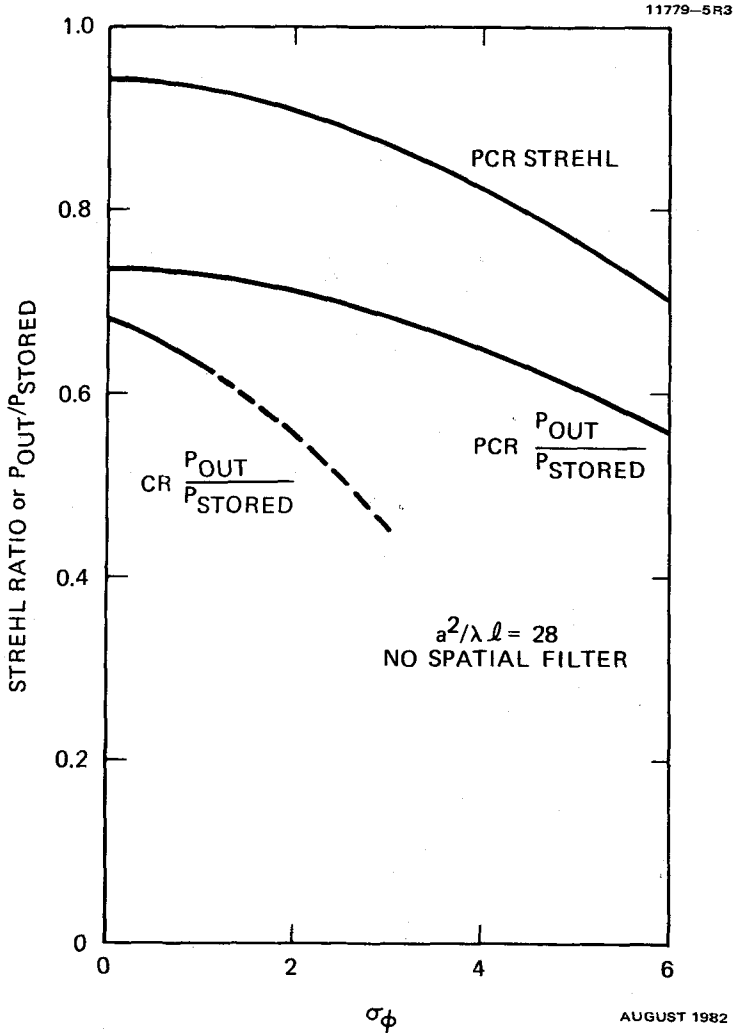

Figure 8. Results of computer simulations comparing P_{out}/P_{stored} of a PCR compared to a CR and PCR strehl ratio as a function of rms phase error.

Phase conjugate mirrors using SBS have been demonstrated with reflectivities between 50 and 70%. Efficient operation of a resonator with a mirror with such a reflectivity requires both a high gain laser medium and a very low value of feedback coupling, that is the resonator must have a very low Q . The gain requirements are quantified in Figure 10 for a 70% reflectivity mirror. The PCR system efficiency in these curves is defined as the ratio of the net output power to the power stored in the inverted population. It is a generalized extraction efficiency. The output coupling mirror reflectivity has been optimized for maximum extraction efficiency at every gain value on this curve. The predicted performance ignores transverse mode filling factor losses and spatial hole burning effects.

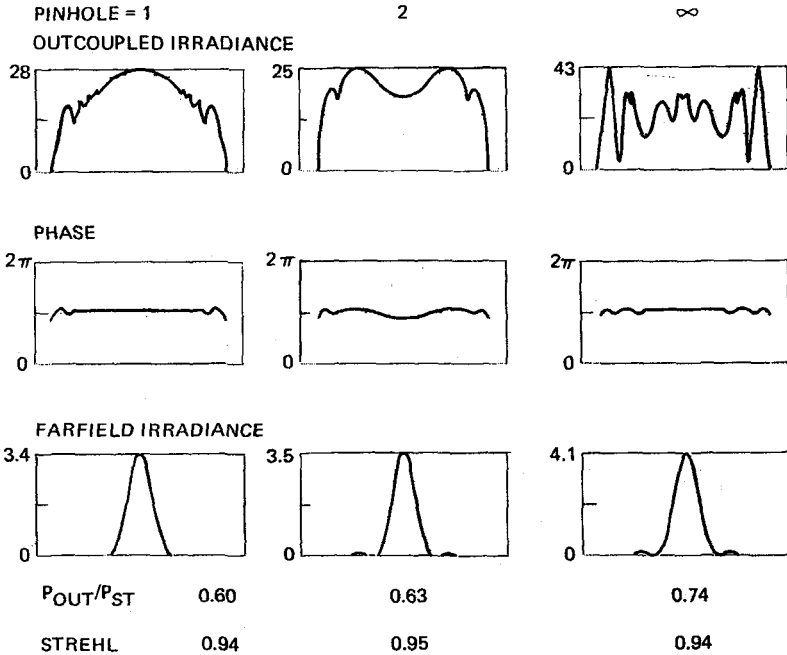

Figure 9. Computer simulation results showing outcoupled irradiance, output phase, and far-field irradiance for different intracavity spatial filters.

At first thought it might appear that four-wave mixer conjugators could minimize the lossy mirror problem since reflectivities up to and exceeding unity have been measured and reported in the literature. Unfortunately, there are major problems with the use of such conjugators in PCR's. The high reflectivities occur as a consequence of nonlinear diffraction coupling of the pump waves into the conjugated signal direction, and thus the magnitude of the required pump powers is given by the required conjugate signal power divided by the diffraction efficiency of the four-wave mixer. In typical high reflectivity experiments the pump powers have exceeded the signal powers by at least an order of magnitude. Clearly the pumps most operate at power levels which can easily exceed the PCR output power - an untenable situation.

To summarize then, the key parameters to be optimized for a PCR with a FWM PCM is the operating efficiency, not the reflectivity. This efficiency is defined as the conjugated signal output power divided by the sum of the input powers required to produce it. The FWM efficiency issues addressed in this paper are based on a 2-level saturable absorber model in which the nonlinearity is established by maintaining a substantial excited state population. The two factors which limit the efficiency (1) the power required to maintain the excited state population and (2) the power transmitted through the PCM end of the resonator.

In order to achieve high efficiency in a two-level saturable absorber FWM one must operate far off resonance with a probe wave sufficiently strong that the pumps operate in a strongly depleted mode. There are few experiments and no published analysis which describes operation under these conditions. However, W. P. Brown of our laboratories²¹ has recently analyzed and programmed computer solutions to

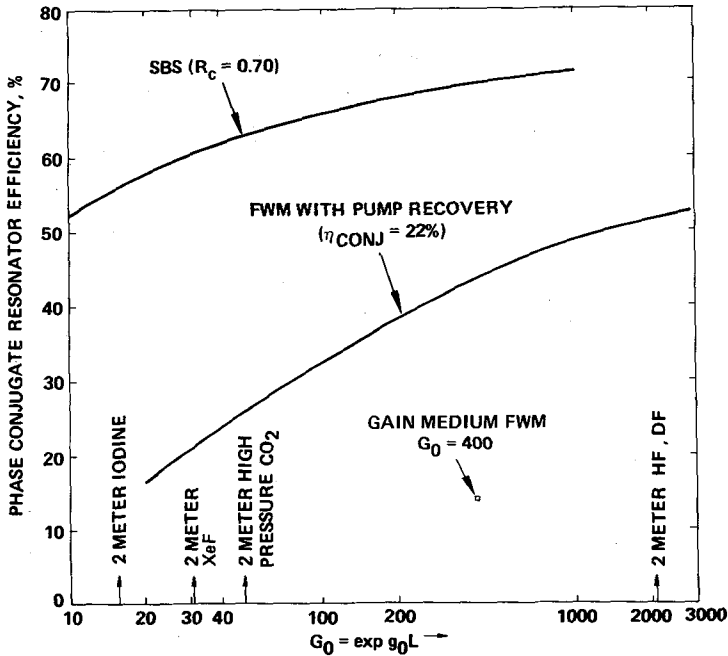

Figure 10. System efficiency as a function of gain for SBS and FWM PCR's.

mixers operating under such conditions. Using this code, the pump and probe levels have been perturbed to maximize the operating efficiency as defined above yielding a maximum efficiency of 18% without pump recovery and 22% with full pump recovery.

Figure 10 shows the results for the FWM PCR optimized as described above. Note that very much higher gains are required to realize the same system efficiency for FWM PCR's than resonators with SBS mirrors. Use of an active gain medium for a four-wave mixer avoids the external power requirement for the pumps since the pump fields are generated via a separate laser extraction of the inverted population of the mixer medium. However, one requires a very large energy investment in this inverted population, an investment that would otherwise be available to the basic laser itself. Similar calculations have been made for saturable gain FWM's (i.e. an inverted 2-level system) and one such result is shown in Figure 10. Thus, no improvement in system efficiency is achieved by using an active gain medium four-wave mixer. Because of the simplifying assumptions, these efficiencies are found to improve monotonically with increasing g_0L . In actual fact, unsaturated absorption coefficients or parasitic oscillations will provide an upper limit on the G_0L which can effectively be employed.

While PCR's can provide substantial improvement in the beam quality of a laser as shown this must be done with reasonable efficiency since little is accomplished by turning an efficient resonator with poor beam quality into a very inefficient PCR with good beam quality. A wave of poor beam quality can always be converted into a wave of good beam quality and lower power by using a spatial filter. Thus a reasonable figure of merit for comparing PCR's to conventional resonators is far-field power in a diffraction limited bucket. Given these problems a different way of comparing the performance is to use a so-called break-even beam quality factor.²²

Take two resonators with equal stored power, one a conventional resonator, CR, and the other a PCR. The power delivered to the far field in a diffraction-limited spot depends upon two factors - the beam quality β and the resonator extraction efficiency, η . It is the tradeoff between these two quantities that we will use to illustrate under what conditions one would favor a PCR over a CR. We define break-even to occur when the peak far-field irradiance of the two resonators is equal. Hence $\beta_{\text{Breakeven}}^2 = \eta_{\text{CR}}/\eta_{\text{PCR}}$ where we take $\beta = 1$ for the PCR (i.e. diffraction limited beam quality).

The curves in Figure 11 show $\beta_{\text{Breakeven}}^{\text{CR}}$ as a function of G_0 for both DFWM and SBS PCR's. Conventional resonators whose β 's lie above the curves are unfavorable compared to the PCR's. For example, suppose we had a conventional resonator with $G_0 = 100$ and $\beta = 1.4$. The curves tell us that the SBS PCR would give a higher far-field irradiance than the conventional resonator, whereas the FWM PCR would not.

12293-7

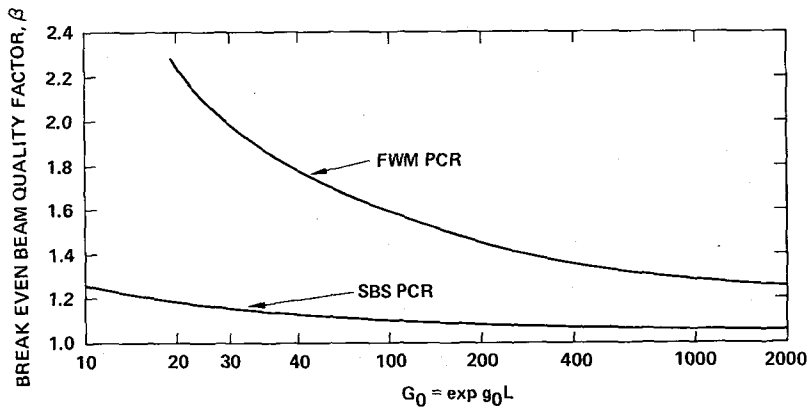

Figure 11. Breakeven beam quality factor, β , as a function of gain for FWM and SBS PCR's.

CONCLUSION

The future of phase conjugate resonators as practical devices, especially for high power applications, lies in the issues of improved efficiency. Several questions arise in this regard that only further research can answer. First, to what extent can SBS conjugators be made to operate at higher reflectivities than have been demonstrated to date (i.e. 50 to 70%)? We know that SBS as a nonlinear process has been observed with reflectivities approaching unity. This has not occurred in the geometries used in conjugation experiments in which the input beams are aberrated as well. The reasons for the differences are not known. The challenge for SBS is to understand what are the fundamental limits on conjugate reflectivity; it is clear that the attractiveness of an SBS PCR hinges strongly on this issue, especially for lasers having low to moderate gains.

A similar question can be asked for FWM PCR's or, more generally, PCR's that employ real-time holography to do the conjugation. What are the fundamental factors that determine the efficiencies of these conjugators, especially under conditions of pump depletion for FWM? Remember that the FWM model used in the results presented here were for a two-level saturable absorber FWM, the only one that has been analyzed thoroughly. Other nonlinear mechanisms such as a purely dispersive interaction or the photorefractive effect may offer more promise for higher efficiency PCR's.

Finally, we wish to emphasize that all experimental demonstrations of PCR's to date have been carried out using low power laboratory lasers. Many of the practical issues surrounding high power operation of PCR's (e.g. thermal loading in the PCM, nonlinear propagation effects) and their impact on efficiency and conjugation fidelity have yet to be addressed. We believe that these issues could be best resolved through experimental research using high power lasers.

REFERENCES

1. B. I. Stepanov, E. V. Ivakin, A. S. Rubanov, *Sov. Phys. Doklady* 16, 46 (1971).
2. B. Ya. Zel'dovich, V. I. Popovichev, V. V. Ragul'skii, F. S. Faizullov, *Sov. Phys. JETP* 15, 109 (1972); O. Yu Nosach, V. I. Popovichev, V. V. Ragul'skii, F. S. Faizullov, *Sov. Phys. JETP* 16, 435 (1972).
3. V. Wang, C. R. Giuliano, *Opt. Lett.* 2, 4 (1978).
4. C. R. Giuliano, *Physics Today* 34, 27 (1981).
5. *Optical Engineering* 21, March-April (1982), Special Issue on Nonlinear Optical Phase Conjugation.
6. J. AuYeung, D. Fakete, D. M. Pepper, A. Yariv, *IEEE J. Quantum Electron.* QE-15, 1180 (1979).
7. P. A. Belanger, A. Hardy, A. E. Siegman, *Appl. Opt.* 19, 602 (1980).
8. J. M. Bel'dyugin, M. G. Galushkin, E. M. Zemskov, *Sov. J. Quantum Electron.* 9, 20 (1979).
9. J. F. Lam, W. P. Brown, *Opt. Lett.* 5, 61 (1980).
10. P. A. Belanger, *Opt. Eng.* 21, (1982), and references therein.
11. R. C. Lind, D. G. Steel, *Opt. Lett.* 6, 519 (1980).
12. J. Feinberg, R. W. Hellwarth, *Opt. Lett.* 5, 519 (1980); 6, 257 (1981).
13. H. Vanherzeele, J. L. VanEck, A. E. Siegman, *Opt. Lett.* 6, 467 (1981); *Appl. Opt.* 20, 524 (1981).
14. N. Basov, I. G. Zubarev, *Appl. Phys.* 20, 261 (1979).
15. R. L. Abrams, C. R. Giuliano, J. F. Lam, *Opt. Lett.* 6, 131 (1981).
16. J. O. White, M. Cronin-Golomb, B. Fischer, A. Yariv, *Appl. Phys. Lett.* 40, 450 (1982).
17. M. Cronin-Golomb, B. Fischer, J. Nilsen, J. O. White, A. Yariv, *Appl. Phys. Lett.* 41, 219 (1982).
18. I. M. Bel'dyugin, A. P. Pogibel'skii, *Soviet J. Quantum Electron.* 10, 1271 (1980).
19. A. Hardy, *IEEE J. Quantum Electron.* QE-17, 1581 (1981).
20. G. C. Valley, D. Fink, to be published in *J. Opt. Soc. Am.*, April (1983).
21. W. P. Brown (Private communication).
22. T. J. Karr, H. J. Hoffman, *Proceedings of SPIE*, Volume 293 (August, 1981).