



HAL
open science

TIMEKEEPING POTENTIALS USING PASSIVE HYDROGEN MASERS

F. Walls, D. Howe

► **To cite this version:**

F. Walls, D. Howe. TIMEKEEPING POTENTIALS USING PASSIVE HYDROGEN MASERS. Journal de Physique Colloques, 1981, 42 (C8), pp.C8-151-C8-158. 10.1051/jphyscol:1981817 . jpa-00221712

HAL Id: jpa-00221712

<https://hal.science/jpa-00221712v1>

Submitted on 4 Feb 2008

HAL is a multi-disciplinary open access archive for the deposit and dissemination of scientific research documents, whether they are published or not. The documents may come from teaching and research institutions in France or abroad, or from public or private research centers.

L'archive ouverte pluridisciplinaire **HAL**, est destinée au dépôt et à la diffusion de documents scientifiques de niveau recherche, publiés ou non, émanant des établissements d'enseignement et de recherche français ou étrangers, des laboratoires publics ou privés.

TIMEKEEPING POTENTIALS USING PASSIVE HYDROGEN MASERS

F.L. Walls and D.A. Howe

*Frequency and Time Standards Group, Time and Frequency Division,
National Bureau of Standards, Boulder, Colorado 80303, U.S.A.*

Abstract. - Recent experimental data on the frequency stability of the National Bureau of Standards small passive hydrogen masers indicates that they are superior to any commercially available cesium standard for frequency comparisons or timekeeping out to periods of at least a month. Frequency drift between the small passive hydrogen maser and an ensemble of nine commercial cesium standards has been measured and is of order $1 \pm 5 \times 10^{-16}$ /day averaged over 72 days. This is substantially less than the drift in active hydrogen masers. Timekeeping to a few nanoseconds per week has been demonstrated using the small passive hydrogen maser. These small masers are expected to be available in a 30 cm high rack mount in the near future. Using full-sized passive hydrogen masers, it appears possible to achieve frequency stabilities of order 10^{-15} over days and timekeeping to about one nanosecond per week. In order to take full advantage of the improved capabilities of the passive hydrogen masers, it will be necessary to use improved time comparison techniques.

Introduction. - For many years, precision timekeeping has nearly exclusively relied on commercially available cesium beam standards. The nominal frequency stability is of order 3×10^{-14} at one day and about 1×10^{-13} at a year. This corresponds to timekeeping performance of order 25 ns per week and a few μ s per year [1].

A new precision frequency standard specifically aimed at providing excellent timekeeping has been developed at the National Bureau of Standards (NBS) [2,3, 4,5]. Recent data presented in the following pages illustrates the excellent performance of these new standards. The small passive hydrogen maser (SPHM) demonstrates a frequency stability of about 5×10^{-15} for averaging times of seven days and a frequency drift versus an ensemble of nine commercial cesium standards of $1.2 \pm 5 \times 10^{-16}$ /day over a 72 day period. The timekeeping ability is of order 5 ± 3 ns for seven days. The large passive hydrogen maser (LPHM) being developed at NBS is expected to achieve a performance about five times better than the SPHM or about 1 ns per week.

The present time comparison techniques within and between laboratories will generally have to be improved in order to take full advantage of these new developments.

Passive Hydrogen Masers - Several years ago, NBS embarked on a program to develop a frequency standard based on the hydrogen magnetic hyperfine resonance shown in figure 1 [2,3,4,5]. The basic technique for state preparation is virtually unchanged

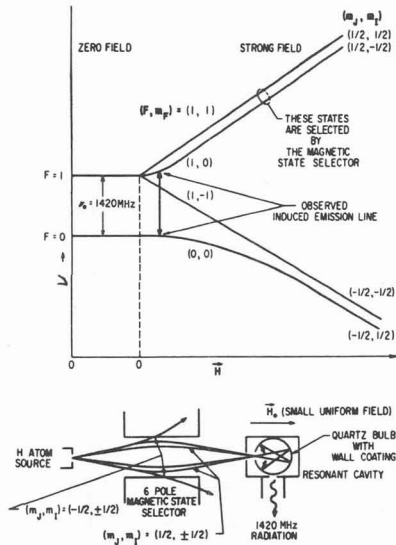

Figure 1. Upper portion shows the hyperfine separation vs. magnetic field of atomic hydrogen. Lower portion shows the traditional method of state preparation and storage.

from the earlier active hydrogen maser work [6]. The microwave cavity for shaping the interrogation field has taken two different forms in the NBS work. The first is a small dielectrically-loaded cavity, while the second is a vacuum dielectric cavity identical to that normally used by the active hydrogen masers. The basic principles are described in the literature [4,5].

Very briefly, a local probe signal ultimately derived from 5 MHz is phase modulated at two frequencies, f_1 and f_2 , and introduced into the microwave cavity containing the state-selected hydrogen atoms (see figure 2). The transmitter signal is envelope-detected and processed in two synchronous detectors, one referenced to the modulation frequency, f_1 , and the other to f_2 . f_1 corresponds to approximately the half-linewidth of the microwave cavity and f_2 corresponds to the half-linewidth of the hydrogen resonance. The output of the f_1 synchronous detector is used to actively correct the microwave cavity frequency with a time constant of about 10 seconds. The output of the f_2 synchronous detector is used to steer the probe frequency to the center of the hydrogen line with a time constant of several seconds. The unique feature of the passive hydrogen masers, as compared to the active hydrogen masers, is the ability to lock the microwave cavity frequency to the hydrogen resonance frequency without the need for an external high-stability reference. Lesage *et al.*, have theoretically examined the expected characteristics of such a system [7]. Their results, with the exception of cavity pulling, agree rather well with the experimentally observed characteristics. Figure 3, based on their work, shows the predicted short-term stability versus α , where the maser power gain is given by $G = \left(\frac{1}{1-\alpha}\right)^2$ in the limit of zero microwave power.

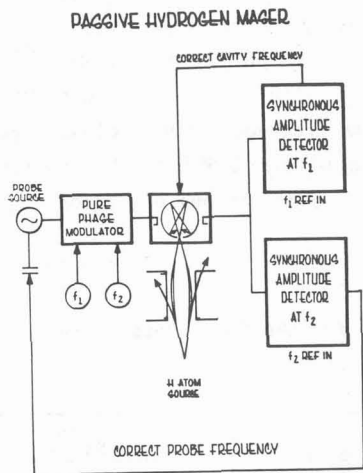

Figure 2. Simplified diagram of the passive hydrogen maser system.

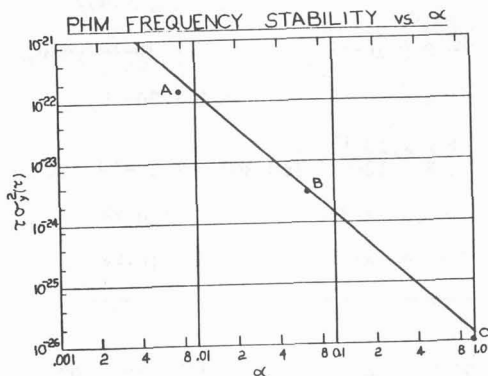

Figure 3. White frequency noise contribution to the frequency stability of passive hydrogen masers is shown versus α where maser power gain is given by $G = \left(\frac{1}{1-\alpha}\right)^2$ in the limit of zero microwave power. Noise figure $F = 2$ assumed. The straight line corresponds to $\sigma_y(\tau) = 1.1 \times 10^{-13} \sigma \tau^{-1/2}$.

Experimentally measured points, A and B, were measured with a SPHM, while point C is inferred from the hyperfine linewidth and the signal-to-noise measured on a LPHM. The agreement is excellent.

More recent calculations [Audoin, C., private communication (1981)] confirm that the cavity pulling is identical with the active masers namely:

$$\frac{\nu_0 - \nu_H}{\nu_H} = \frac{Q_c}{Q_l} \frac{\Delta \nu_c}{\nu_H} \tag{1}$$

where Q_c is the quality factor of the cavity, Q_p is the quality factor of the hydrogen line, $\Delta\nu_c$ is the detuning of the cavity, ν_H is the unperturbed hydrogen hyperfine frequency, and ν_0 is the output frequency.

Systematic effects which can perturb the output frequency are listed in table 1 with the expected effect on stability. The temperature coefficient was measured for a 9 °C temperature change. The frequency change closely followed the temperature. The frequency recovered to within $0.5 \pm 2 \times 10^{-14}$ within six hours. Frequency stability is not affected by simultaneous operation of the two servos in our system.

Table 1. Summary of Systematic Effects for the Small Passive Hydrogen Maser.

	<u>EFFECT</u>	<u>OFFSET</u>	<u>INSTABILITY</u>
1.	Second-order Doppler Changes	-4.3×10^{-11}	3×10^{-15}
2.	Temperature Coefficient		$1.3 \times 10^{-14}/K$
3.	Wall Shift	$\sim 2 \times 10^{-11}$	$\leq 10^{-13}/\text{year}$
4.	Spin Exchange	2×10^{-13}	5×10^{-15}
5.	Magnetic Field Changes	$+ 1 \times 10^{-13}$ for $\pm 3 \times 10^{-5}$ T ($\pm 0.3G$)	10^{-15}
6.	Power Dependence	$< 10^{-13}/\text{dB}$	10^{-15}
7.	Phase Drive Modulator	$< 10^{-13}/\text{dB}$	10^{-15}

Experimental Frequency Stability and Timing Results. - Four SPHM's and one LPHM have been assembled and tested at NBS over the past several years. Most of the testing has used our commercial cesium ensemble and occasionally one of our large primary cesium standards as a reference in order to avoid the uncertainty of the SPHM's moving in unison due to some unsuspected environmental parameter.

Curve a of figure 4 shows the daily average frequency of SPHM-4 relative to an experimental ensemble of nine commercial cesium standards, while curve b shows the comparison to NBS-4, one of our primary frequency standards. The outage of NBS-4 was due to a power supply failure. The frequency drift between the cesium ensemble and SPHM-4 is very small. A least squares fit yields $1.2 \pm 5 \times 10^{-16}/\text{day}$ limited by the length of the data and the 8S cesium time scale noise. The frequency excursion of curve a from 19 July to 23 July is most likely due to the commercial cesium standards because it is not apparent in the SPHM-4 versus NBS-4 data.

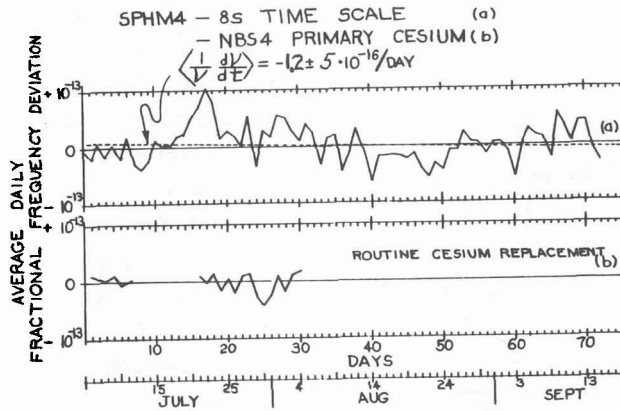

Figure 4. - The fractional frequency of SPHM-4 is shown vs. the 8S time scale composed of nine commercial cesium frequency standards and NBS-4, a large laboratory primary cesium frequency standard.

Figure 5 shows an earlier 10 day comparison taken using direct phase comparison at 5 MHz between NBS-4 and SPHM-4, where an average frequency difference has been subtracted. Note that the data from figure 5 is much more stable than the data of figure 4, which used a counter to measure the time delay (phase) between one second tic derived from the 5 MHz output of each clock. Curves a and b of figure 6 shows the fractional frequency stability as derived from the data of figures 4 and 5. This data also shows a timekeeping ability of 5 ± 3 ns for SPHM-4 vs. NBS-4 at a prediction interval of seven days. For comparison, curve c of figure 6 shows the frequency stability of our most stable commercial cesium clock over the same time period (see also Ref. 1). It should be noted that SPHM-4 was in a laboratory where the temperature variations were about 1.5 K peak-to-peak, and people were moving equipment, while the commercial cesium standards were magnetically shielded and thermally controlled to about ± 0.02 K. Tests on SPHM's 1, 2, and 3 for periods out to 30 days confirm the general features of curves a and b in figure 6.

The time dispersion of SPHM-4 versus the ensemble is shown in figure 7 using a one day prediction interval based on the previous day's frequency. This data clearly shows the superior performance of the NBS SPHM over commercially available cesium standards. The performance of SPHM-4 is the best that has been documented for a single clock other than the large primary cesium beam frequency standard. Of particular note is that the drift of $1.2 \pm 5 \times 10^{-16}/\text{day}$ is nearly 50 times smaller than that typically observed

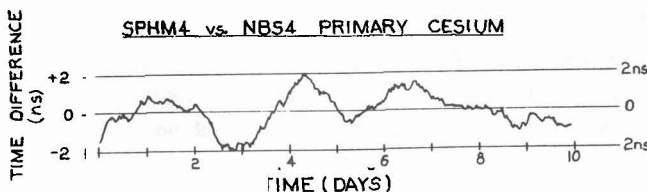

Figure 5. - The continuous time (phase) difference between SPHM-4 and NBS-4 is shown over a ten day period. A mean frequency difference has been subtracted.

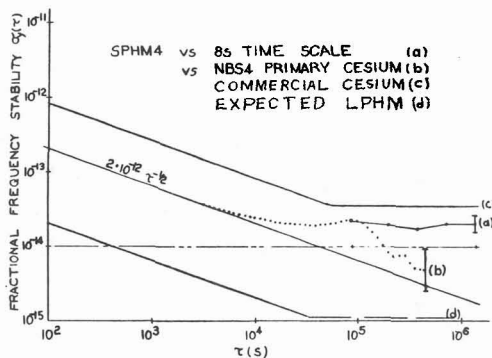

Figure 6. - Fractional frequency stability of SPHM-4 vs. the 8S time scale and NBS-4 calculated from figures 4 and 5. No drift subtracted and no adjustment for the inherent instability of the 8S time scale or NBS-4 has been made. For comparison, the performance of a single commercial standard is shown as (c). Expected performance for LPHM is shown as (d).

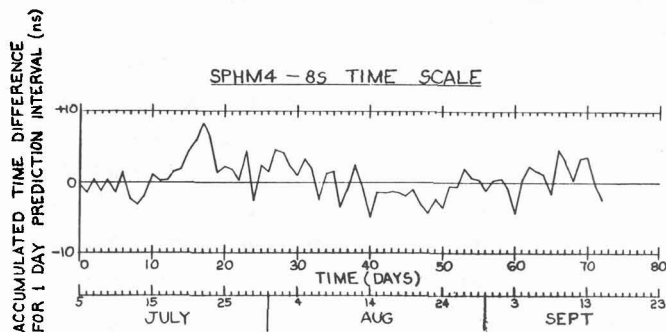

Figure 7. - Accumulated time difference of SPHM-4 vs. the 8S time scale based on a commercial frequency standards. A one day predication interval based on the previous day's average rate has been used.

with active hydrogen masers. There is no evidence to support the 1×10^{-15} /day frequency drift due to the wall effect reported by Morris [8]. This effect, if present in the SPHM, would result in a drift of order 2×10^{-15} /day due to the larger surface-to-volume ratio of the storage bulb as compared to the full-sized masers. We are in the process of repackaging the SPHM in a 48 cm wide rack-mounted package about 30 cm high by 50 cm deep, which is only slightly bigger than present commercially available cesium standards.

The LPHM design is substantially larger than the SPHM design; however, the high microwave cavity Q and longer storage times should lead to about a factor of 5 to 10 enhanced frequency stability. This prediction is based on the work of

Lesage et al. [7] and our measurements of signal-to-noise and linewidth achieved in a two liter storage bulb (i.e., point C of figure 3). Earlier measurements [5] using a linewidth of about 3 Hz demonstrated that cavity pulling could be stabilized to the 3×10^{-15} level. Using a linewidth of order 0.3 to 0.4 Hz should reduce this effect by an order of magnitude. Most other effects will also be reduced with decreased linewidth. Therefore, we anticipate that using the electronics concepts refined for the SPHM's on the LPHM should lead to fractional frequency stabilities of at least $2 \times 10^{-13} \tau^{-1/2}$ for measurement times from 1 to 10^5 s and 1×10^{-15} for weeks. This is indicated by curve d of figure 6. This would correspond to timekeeping ability of order 1 ns per week, which exceeds the stability of even the primary cesium frequency standards by nearly an order of magnitude.

Timekeeping of the present SPHM's, and particularly the future LPHM's, exceeds the stability of present time measurement systems based on 1 s time tics obtained by frequency division. Advanced systems based on heterodyne techniques at the clock rf reference frequency, such as the dual mixer scheme [9], will become imperative in order to take full advantage of these new high-precision clocks. One such system being tested at NBS exhibits a timekeeping ability of order a few picoseconds per week.

Conclusion. - It has been experimentally demonstrated that the SPHM design yields a precision clock of extraordinary performance. The timekeeping of this new design is better than 5 ± 3 ns per week. Long-term frequency stability is comparable to or better than an ensemble of nine commercial cesium standards. The frequency drift versus the ensemble is $1.2 \pm 5 \times 10^{-16}$ /day when averaged over 72 days. It is expected that the NBS SPHM design will soon be repackaged in a 30 cm high rack-mounted package. This new development should greatly advance timing capabilities at NBS and other labs.

The LPHM based on the same principles as the SPHM should yield even higher precision. Timing stabilities of order 1 ns per week are expected. Frequency stability per year could exceed that of the present primary frequency standards.

The timing stabilities of these new generation clocks exceed the timing stability of most distribution and timing equipment. This will necessitate changes throughout the timing community to take full advantage of these new capabilities. One system under test at NBS shows a timing stability of a few picoseconds per week.

Acknowledgements. - This work has been supported in part by the Naval Research Laboratory and the Jet Propulsion Laboratory. We wish to thank D. W. Allan and Dr. J. A. Barnes for assistance in data analysis and our many colleagues at NBS for fruitful discussions.

References.

1. Winkler, G.M.R, Advances in Electronics and Electron Physics Academic Press (1977) 44; also Hellwig, H., Radio Science 14 (1979) 561.
2. Walls, F. L., and Howe, D. A., Proc. 12th Annual Precise Time and Time Interval Planning Meeting (1980).
3. Howe, D. A., Walls, F. L., Bell, Howard E., and Hellwig, H., Proc. 33rd Annual Symposium on Frequency Control (1979) 554.
4. Walls, F. L., and Hellwig, H., Proc. 30th Annual Symposium on Frequency Control (1976) 473.
5. Walls, F. L., Proc. 8th Annual Precise Time and Time Interval Planning Meeting (1976) 369.
6. Kleppner, D., Goldenberg, H. M., and Ramsey, N. F., AppI. Opt. 1 (1962) 55.
7. Lesage, P., Audoin, C, and Têtu, M., Proc. 33rd Annual Symposium on Frequency Control (1979) 515.
8. Morris, D., CPEM Digest (1978) 10.
9. Allan, D. W., and Daams, H., Proc. 29th Annual Symposium on Frequency Control (1975) 404.