



HAL
open science

ELECTRONIC STRUCTURE OF BIOMOLECULES

E. Münck, P. Champion

► **To cite this version:**

E. Münck, P. Champion. ELECTRONIC STRUCTURE OF BIOMOLECULES. Journal de Physique Colloques, 1974, 35 (C6), pp.C6-33-C6-46. 10.1051/jphyscol:1974604 . jpa-00215704

HAL Id: jpa-00215704

<https://hal.science/jpa-00215704>

Submitted on 4 Feb 2008

HAL is a multi-disciplinary open access archive for the deposit and dissemination of scientific research documents, whether they are published or not. The documents may come from teaching and research institutions in France or abroad, or from public or private research centers.

L'archive ouverte pluridisciplinaire **HAL**, est destinée au dépôt et à la diffusion de documents scientifiques de niveau recherche, publiés ou non, émanant des établissements d'enseignement et de recherche français ou étrangers, des laboratoires publics ou privés.

ELECTRONIC STRUCTURE OF BIOMOLECULES

E. MÜNCK (*) and P. M. CHAMPION

Department of Physics, University of Illinois, Urbana, Illinois 61801, U. S. A.

Résumé. — L'application de la spectroscopie Mössbauer à l'étude de molécules biologiques est discutée sur l'exemple des protéines de type hème. Toutes ces protéines ont fondamentalement le même centre actif constitué par l'hème. Le fer dans l'hème est habituellement à l'état ferreux ou ferrique ; dans chaque état d'oxydation on peut trouver des configurations aussi bien de spin fort que de spin faible. Les spectres Mössbauer à basse température peuvent être décrits par un Hamiltonien de spin de la forme

$$\mathcal{H} = S \cdot \tilde{D} \cdot S + \beta S \cdot \tilde{g} \cdot H + S \cdot \tilde{A} \cdot I + \mathcal{H}_Q - g_n \beta_n H \cdot I.$$

Dans les faibles symétries — pour lesquelles la nature semble avoir une préférence dans les biomolécules — l'Hamiltonien de spin comprendra un grand nombre de coefficients inconnus et l'analyse des spectres constitue un travail d'une énorme complexité. On discute les spectres Mössbauer typiques pour les différents états de charge et de spin du fer dans l'hème à l'aide des exemples du cytochrome P450, de la chloroperoxydase et de la peroxydase du raifort. Dans le cas des protéines ferriques, l'utilisation des résultats de RPE facilite grandement l'analyse des spectres Mössbauer. Pour les protéines ferreuses à spin fort, les mesures dans des champs magnétiques externes intenses sont particulièrement utiles ; des mesures de ce type sont discutées en détail pour le cytochrome P450 à l'état réduit. En outre on présente les spectres Mössbauer d'émission d'hèmes substitués par ^{57}Co ; ce type de spectroscopie permet d'étudier des modèles de composés d'hèmes qui ne peuvent être préparés chimiquement.

Abstract. — The application of Mössbauer spectroscopy to the investigation of biomolecules is discussed for heme proteins. All heme proteins have basically the same active center, namely heme. The heme iron is usually either ferric or ferrous ; in either oxidation state both high-spin and low-spin configurations can occur. The low temperature Mössbauer spectra can be described by a spin Hamiltonian of the form

$$\mathcal{H} = S \cdot \tilde{D} \cdot S + \beta S \cdot \tilde{g} \cdot H + S \cdot \tilde{A} \cdot I + \mathcal{H}_Q - g_n \beta_n H \cdot I.$$

In low symmetries, which nature seems to prefer in biomolecules, the spin Hamiltonian will have a large number of unknown coefficients and the evaluation of the spectra is a formidable task. The Mössbauer spectra typical for the various charge and spin states of the heme iron are discussed ; cytochrome P450, chloroperoxidase and horseradish peroxidase are used as examples. For ferric heme proteins Epr results can be used to significantly facilitate the analysis of the Mössbauer spectra. For high-spin ferrous proteins Mössbauer measurements in strong applied fields are particularly useful ; such measurements on reduced cytochrome P450 are discussed in detail. In addition, Mössbauer emission experiments on ^{57}Co substituted hemes are presented ; this type of spectroscopy provides a means of studying heme model compounds which cannot be prepared chemically.

1. Introduction. — Nature abounds with a wide variety of iron containing biomolecules which challenge the talents of researchers in many fields. In addition to being involved in many of the fundamental processes that sustain life, these biomolecules offer the Mössbauer spectroscopist every degree of scientific challenge. In the past years the Mössbauer effect, which is the focus of this International Conference, has made a sizeable contribution to unveiling some unique biological structures.

In this paper we will discuss Mössbauer spectroscopy of a special class of biomolecules — the heme proteins. However, since much of the literature dealing with Mössbauer spectroscopy of biomolecules is scattered

through physical and biological journals, we would briefly like to mention some structures which we will not discuss here but which are quite interesting from a stand-point of physics.

There is the large class of so-called plant-type ferredoxins which are involved in electron transport in plant, bacterial or mammalian systems ; in addition they act as primary electron acceptors in photosynthesis. These proteins have a fascinating active site made up of two iron atoms which are spin-coupled via sulfur bridges. Mössbauer spectroscopy has played an indispensable role in revealing features of these unique structures [1, 2].

Bacterial-type ferredoxins feature spin-coupled clusters involving four iron atoms situated at alternate corners of a distorted cube. One protein, the ferredoxin from *Chlostridium pasteurianum* (a bacterium) has two such clusters ; X-ray crystallography has

(*) New address : Department of Biochemistry/Freshwater Biological Institute, University of Minnesota, St. Paul, Minnesota 55101, USA.

revealed that these clusters are spaced apart by 12 Å [3]. There is experimental evidence that the reduced form of this protein presents us with a double spin-coupling problem; each individual cluster is strongly spin-coupled to a spin $\frac{1}{2}$ system and both clusters are weakly coupled to yield a singlet and a triplet state.

The plot thickens when we consider the MoFe proteins from nitrogenase, an enzyme system capable of reducing molecular nitrogen to ammonia. These proteins contain two molybdenum and some twenty-odd iron atoms. Recently these proteins have been studied by the Mössbauer effect [4] and by Epr spectroscopy and it appears that nature utilizes yet another type of cluster, containing (probably) four iron atoms, spin-coupled to a total spin of $S = \frac{3}{2}$ (E. Münck *et al.*, submitted for publication). The MoFe protein seems to have two such clusters accounting for a total of 8 iron atoms. The other irons reside in complexes of integer electronic spin and are therefore not amenable to most of the spectroscopic methods. Thus the elucidation of structural details of the MoFe proteins falls squarely upon the shoulders of Mössbauer spectroscopy.

In this paper we shall be concerned with heme proteins. These proteins, immensely important in biological systems, serve as good examples to show what information can be obtained from Mössbauer spectroscopy. Elegant reviews about the application of Mössbauer spectroscopy to biological materials have been written by Lang [5] and Debrunner [6].

2. Cytochrome P450 : an example. — Heme proteins perform many vital functions in biological systems. Probably the best known example of this class is hemoglobin, the oxygen carrier in the blood. All heme proteins have basically the same prosthetic group, namely Fe-protoporphyrin IX (heme). As depicted in figure 1, the iron atom is incorporated into an aromatic ring and coordinated to four nitrogen atoms. In general, a fifth (axial) coordination position is occupied by an amino acid residue (like histidine in hemoglobin); the sixth position is either vacant, or occupied by another amino acid residue or by an extraneous ligand (like O_2 , CO, etc.). This multitude of possible coordinations permits the amazing diversity of biological functions that characterize the families of heme proteins (electron transport, oxygen transport, and a variety of catalytic reactions). From a standpoint of Mössbauer spectroscopy the variability in stereochemical coordination results in different electronic spin configurations which give their characteristic signature in the Mössbauer spectra.

As an example we discuss cytochrome P450, an enzyme which catalyses the hydroxylation of camphor. This protein has a molecular weight of 40 000 (393 amino acids) and has one heme group. The axial ligands to the heme iron are not known with certainty, though cysteine is suspected. In the following sections

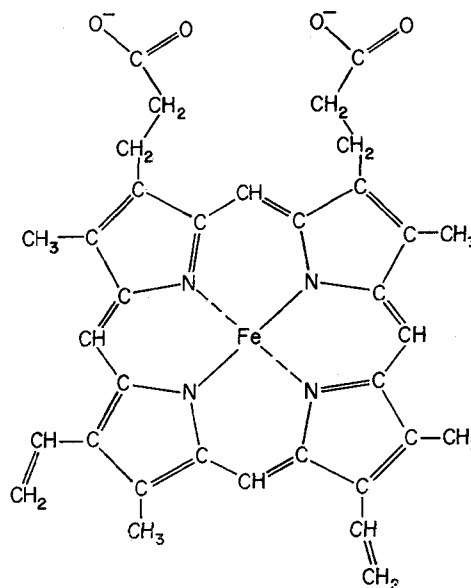

FIG. 1. — The heme group (Fe-protoporphyrin IX). Eight side chains are attached to the periphery of the porphyrin ring (4 methyl, 2 vinyl and 2 propionic acid groups).

we will discuss some of the Mössbauer data which have been obtained for this protein. Cytochrome P450 has been isolated from a bacterium, *Pseudomonas putida*, by Gunsalus and coworkers [7]. The proposed reaction mechanism is shown in figure 2. We start at the lower left in figure 2 and move clockwise around the

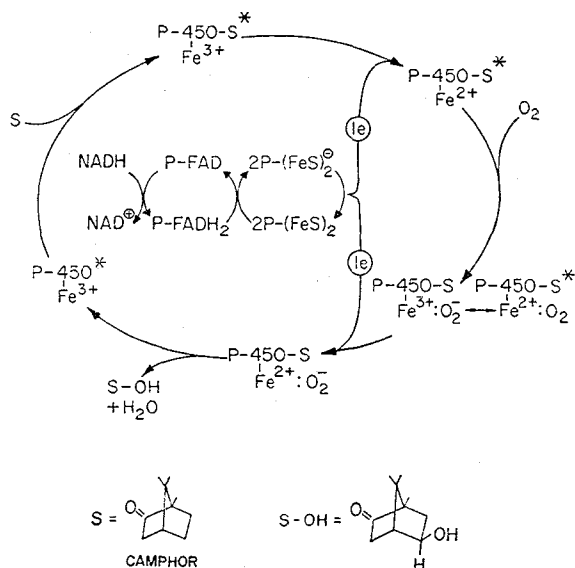

FIG. 2. — Proposed reaction mechanism for the hydroxylation of camphor in *Pseudomonas putida*. NADH (NAD⁺) is a biological reducing agent in its reduced (oxidized) state, P-FAD is a flavoprotein, P-(FeS)₂ is the 2 Fe-2S protein, putidaredoxin, S and S-OH stand for the substrate, *D*-camphor, and the product, hydroxylated camphor, respectively. Species marked with an asterisk have been studied by Mössbauer spectroscopy.

reaction cycle. In the native protein, the heme iron is in a low-spin ferric state ($S = \frac{1}{2}$). Upon binding of the substrate (camphor) the electronic configuration of the iron atom changes drastically, although the substrate does not bind directly to the iron. In the temperature range from 1.5 K to 240 K one observes a mixture of high-spin ferric and low-spin ferric material [8]. In the next step the P450-substrate complex is reduced in a one-electron transfer reaction. In the biological system the reduction is mediated by putidaredoxin, an iron-sulfur protein (putidaredoxin has been studied extensively by Mössbauer spectroscopy; its active center consists of a spin-coupled pair of iron atoms [1]). It is interesting to note that putidaredoxin cannot reduce P450 unless the substrate is bound to the latter. Substrate binding causes a dramatic change in the redox potential; thus the substrate acts like a switch controlling the flow of electrons to P450.

The heme iron of reduced P450 is in a high-spin ferrous state as witnessed by the Mössbauer data. The reduced P450-substrate complex binds to molecular oxygen to yield a diamagnetic complex. The remaining steps, addition of a second electron and product formation (hydroxylated camphor and H_2O) are mediated by putidaredoxin and proceed through an unstable intermediate, or perhaps a series of them. Cytochrome P450 has now completed a catalytic cycle and has returned to its native state.

3. Paramagnetic Mössbauer spectra. — The example in the preceding section illustrates that the heme iron can occur in a variety of charge and spin states. Most, but not all, states of the heme iron fit conveniently into four classes: high-spin ferric ($S = \frac{5}{2}$), and ferrous ($S = 2$), low-spin ferric ($S = \frac{1}{2}$) and ferrous ($S = 0$). In three of these states the iron is paramagnetic and magnetic Mössbauer spectra may be observed under the proper experimental conditions. These spectra carry a wealth of information and for this reason, most of this paper will be concerned with spectra showing paramagnetic hyperfine structure.

Ultimately, we want to use the Mössbauer parameters to obtain a detailed picture of the electronic structure which, in turn, should relate directly to biological function. Presently, we have to be humble since a quantitative theoretical description of the heme prosthetic group imposes formidable difficulties and experimental work is preceding theoretical studies. Fortunately the spin-Hamiltonian approximation works very well in describing the data. Such a description is of considerable value for various reasons: 1) one can cast the experimental data into a compact form; 2) the Mössbauer data can be related to results obtained from Epr, Endor, far-infrared spectroscopy, and magnetic susceptibility; 3) the spin Hamiltonian provides means of looking at the results for various proteins in a systematic way. Moreover, the spin Hamiltonian is a useful interface between experimental and theoretical work.

A spin Hamiltonian adequate for the description of the data obtained for heme proteins may be written as

$$\mathcal{H} = S \cdot \tilde{D} \cdot S + \beta S \cdot \tilde{g} \cdot H + S \cdot \tilde{A} \cdot I + I \cdot \tilde{P} \cdot I - g_n \beta_n H \cdot I \quad (1)$$

where the electronic spin S (real or fictitious) can assume the values $\frac{5}{2}$, 2, and $\frac{1}{2}$.

Before discussing the spin Hamiltonian for each state separately, a few general remarks might be useful for the reader not so familiar with the nature of paramagnetic Mössbauer spectra. For ferric heme proteins we can observe, at low temperatures, well developed paramagnetic Mössbauer spectra even in the absence of an applied magnetic field. However, the resulting spectra are almost unmanageably complicated since the electronic magnetic moment interacts with ligand nuclei. (The heme iron is surrounded by four ^{14}N nuclei ($I = 1$) in the porphyrin plane!) In this case ($H = 0$) terms describing transferred hyperfine interactions need to be included in the Hamiltonian. The Mössbauer spectra change drastically when the samples are measured in a weak applied magnetic field. A few hundred gauss will sufficiently decouple ligand nuclei; this simplifies the problem. For most cases the intensities of the spectra depend quite sensitively on the direction of the applied field relative to the observed γ -rays. The problem of computing a Mössbauer spectrum from eq. (1) is both facilitated and complicated when a magnetic field is included in the problem. The field in effect decouples the electronic and nuclear variables (for an applied field of 500 G the electronic Zeeman energy is about 50 times larger than the magnetic hyperfine interaction); thus the applied field determines the expectation value of the electronic spin, $\langle S \rangle$, which in turn determines the internal magnetic field,

$$H_{int} = - \langle S \rangle \cdot \tilde{A} / g_n \beta_n,$$

via the A -tensor. However, the presence of an applied field implies that eq. (1) is orientation dependent, i. e. the Mössbauer spectrum (intensities and positions) depends on the direction of the applied field relative to the molecular axes. For polycrystalline specimen (a protein in frozen solution) the computation of a Mössbauer spectrum from eq. (1) requires proper averaging of all molecular orientations. A computer program is available for this task [9].

4. High-spin ferric heme proteins. — A considerable amount of information may be obtained from Mössbauer investigations of high-spin ferric heme proteins when the samples are studied at the temperature of liquid helium. At higher temperatures, only the quadrupole splitting and the isomeric shift can be measured and it is difficult to draw detailed conclusions from the data. At low temperature, however, these spectra are rich in information and can be interpreted in terms of electronic structure. Further-

more, the hyperfine parameters obtained at low temperature can be related to the results of complementary spectroscopic techniques.

The low temperature Mössbauer spectra of heme proteins in a high-spin ferric state can be quite complex. However, evaluation of the spectra presents no particular difficulty, since the problem is considerably simplified when the results of an Epr investigation are taken into account. This will become clear when we look at the pertinent spin Hamiltonian.

For high-spin ferric heme proteins the ${}^6\text{S}$ free ion ground state is split into three Kramers doublets by the combined interactions of crystalline electric fields and spin-orbit coupling. The ground state retains a dominant ${}^6\text{S}$ character, however, and orbital contributions to the electron Zeeman interaction and the magnetic hyperfine interactions are negligible.

Before we consider the Mössbauer spectra we briefly discuss the electronic part of the spin Hamiltonian,

$$\mathcal{H}_e = D \left[S_z^2 - \frac{1}{3} S(S+1) + \frac{E}{D} (S_x^2 - S_y^2) \right] + g_0 \beta \mathbf{H} \cdot \mathbf{S}. \quad (2)$$

In eq. (2) we have assumed that the electronic Zeeman interaction is isotropic, a fact well established (to within 1 %) from Epr results. D and E are the coefficients describing the zero-field splitting of the spin sextet; the coordinate system can always be chosen such that $0 \leq \frac{E}{D} \leq \frac{1}{3}$ [10, 11]. For heme proteins the parameter D is always found to be positive and very large ($5-15 \text{ cm}^{-1}$) and E/D is usually quite small ($E/D < 0.1$). This suggests that nature, in designing heme proteins, was on the side of the Epr spectroscopist; the values for D and E yield an almost pure $M_s = \pm \frac{1}{2}$ ground doublet, which gives rise to a very intense Epr signal; the other two Kramers doublets are Epr silent. Figure 3 shows the energy level diagram resulting from eq. (2) for $E = 0$ and $\beta H \ll D$.

As long as mixing of the Kramers doublets by the applied magnetic field can be neglected, it is convenient to describe the ground doublet by an effective spin ($S' = \frac{1}{2}$) Hamiltonian

$$\mathcal{H} = \beta \mathbf{S}' \cdot \tilde{g} \cdot \mathbf{H}. \quad (3)$$

The components of the effective g -tensor associated with the ground doublet can be computed quite easily by comparing the matrix elements of the $|\frac{5}{2}, \pm \frac{1}{2}\rangle$ subspace of eq. (2) with the elements of eq. (3). For tetragonal symmetry ($E = 0$) one obtains $g_x = g_y = 6$ and $g_z = 2$. For lower symmetries the signal at $g = 6$ splits and, to first order, the splitting is directly related to the departure from tetragonality of the heme,

$$\begin{aligned} g_x &= 3g_0(1 - 4E/D) = 6 - 24E/D \\ g_y &= 3g_0(1 + 4E/D) = 6 + 24E/D. \end{aligned} \quad (4)$$

Expressions (4) show that Epr spectroscopy is a sensitive tool for the determination of E/D ; even values

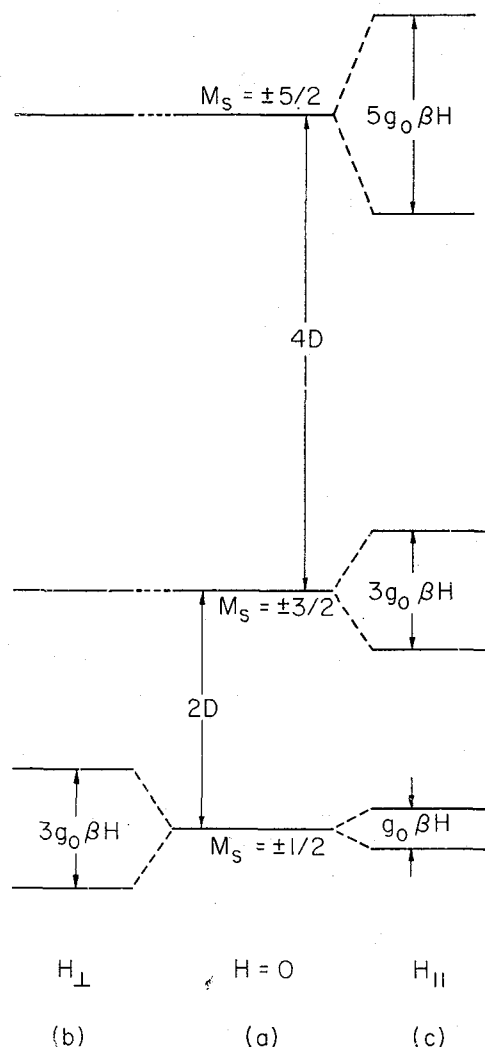

FIG. 3. — Splittings of the sextet ground state in (a) zero magnetic field, (b) in perpendicular field and (c) in parallel field. The Zeeman splittings are given for the case $D > 0$, $g_0 \beta H \ll D$ and $E = 0$.

as small as $E/D = 0.005$ can be determined from a measurement on a polycrystalline sample.

The Mössbauer spectrum measures the magnetic hyperfine interaction and the electric quadrupole interaction. Quite often the spin-lattice relaxation time is too fast to observe magnetic spectra above 10 K, so we generally cool the sample to the temperature of liquid helium to observe magnetic effects. Hence, only magnetic spectra associated with the ground doublet are observed. For high-spin ferric heme proteins we can utilize the fact that the magnetic hyperfine interaction in eq. (1) contains only the Fermi contact term ($A_0 \mathbf{S} \cdot \mathbf{I}$). We therefore can define an effective magnetic hyperfine tensor for the lowest Kramers doublet. The Mössbauer spectrum can be described by

$$\mathcal{H} = \beta \mathbf{S}' \cdot \tilde{g} \cdot \mathbf{H} + \mathbf{S}' \cdot \tilde{A} \cdot \mathbf{I} + \frac{eQV_{zz}}{12} (3I_z^2 - 15/4 + \eta(I_x^2 - I_y^2)) \quad (5)$$

where the components of the effective A -tensor are related [11] to the g -values by

$$\frac{g_x}{A_x} = \frac{g_y}{A_y} = \frac{g_z}{A_z} = \frac{g_0}{A_0} \quad (6)$$

Thus if the g -values are known (from Epr) the magnetic hyperfine tensor is known to within a scaling factor. This factor can easily be determined from the total magnetic splitting of the Mössbauer spectrum. How good is the approximation of an isotropic hyperfine interaction for heme proteins? The Mössbauer spectra of polycrystalline specimen are very sensitive to A_x and A_y in eq. (5), but quite insensitive to A_z which cannot be determined to better than 20%. Recent Endor results [12] for metmyoglobin and methemoglobin confirm that the A -tensor in eq. (1) is isotropic to within 2%; moreover, Mössbauer and Endor measurements on metmyoglobin give the same value for A_0 within the experimental errors (see Table I).

The quadrupole splitting in high-spin ferric compounds is generally independent of temperature and, in many cases, can be determined directly at higher temperatures. A characteristic feature of the low temperature magnetic spectra is that they probe the components of the field gradient in the x - y plane; the magnetic anisotropy forces the internal field into the x - y plane, and, since $\Delta E_Q \ll g_n \beta_n H_{int}$, the component of the field gradient perpendicular to H_{int} does not effect the Mössbauer spectrum.

As typical examples, the Mössbauer spectra of the fluoride complexes of two heme proteins, horseradish peroxidase and chloroperoxidase, are shown in figures 4 and 5. A difference in symmetry at the heme iron of the two proteins is apparent. For horseradish peroxidase (F^-), a tetragonal symmetry at the heme

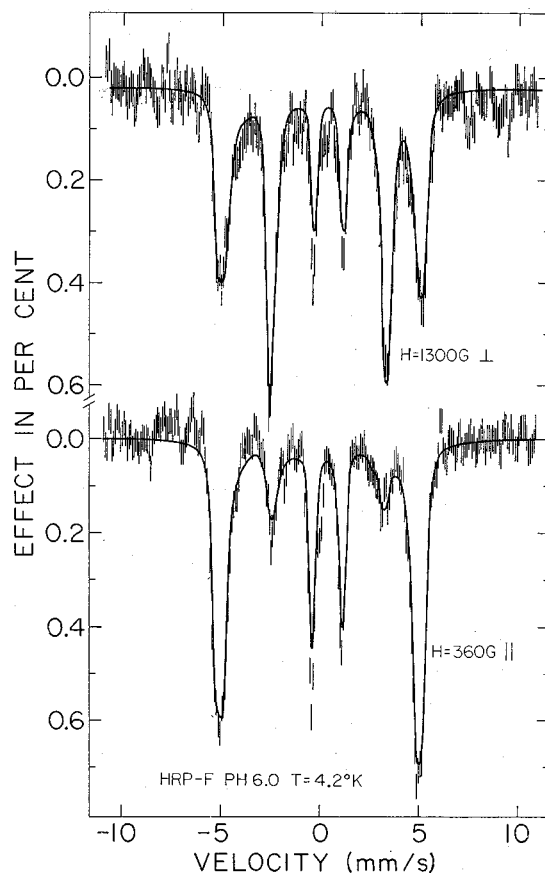

FIG. 4. — Mössbauer spectra of horseradish peroxidase fluoride at pH 6.0 taken at 4.2 K in transverse and parallel magnetic fields. The solid curves superimposed upon the experimental data are computed spectra; the parameters used are quoted in Table I.

iron gives rise to a spectrum with six fairly narrow absorption lines. The heme iron in chloroperoxidase

TABLE I

Parameters of some high-spin ferric heme proteins

	D (cm $^{-1}$)	E/D	$\frac{H_{sat}}{2 g_g \beta_n} = \frac{-5 A_0}{2 g_g \beta_n}$ (kG)	ΔE_Q (mm/s)	Method & Reference
Myoglobin (H $_2$ O)	10.0	~ 0			Susceptibility [13],
	10.0 ± 1.0	~ 0	-498 ± 4	$+1.3 \pm 0.1$	Mössbauer [5],
	9.5 ± 1.5	~ 0			far-infrared [14],
	9.14 ± 0.18	~ 0	-496 ± 2		Epr relaxation [15],
Myoglobin (F^-)	6.5	~ 0			Endor [12],
	6.3 ± 0.5	~ 0	-525 ± 3	$+0.8 \pm 0.1$	Susceptibility [13],
	5.94 ± 0.08	~ 0			Mössbauer [5],
	6.08 ± 0.08	~ 0			far-infrared [14],
Hemoglobin (F^-)	7 ± 1	~ 0.003			Epr relaxation [15],
	7.0 ± 1.5	~ 0	-529 ± 20	$+0.7 \pm 0.2$	high-frequency Epr [17],
	6.3 ± 0.12	~ 0			Mössbauer [5],
Cytochrome c peroxidase	15 ± 3		-490 ± 11	1.2 ± 0.1	far-infrared [14],
Cytochrome c peroxidase (F^-)	7.3 ± 0.3		-514 ± 6	0.84 ± 0.1	Mössbauer [5],
Chloroperoxidase (F^-)		0.05	-500 ± 10	1.00 ± 0.05	Mössbauer [5],
Chloroperoxidase (I^-)		0.07	-460 ± 10	0.65 ± 0.07	Mössbauer, Epr [18, 19],
Cytochrome P450	3.8	0.087	-448 ± 10	0.79 ± 0.05	Mössbauer, Epr [18, 19],
Horseradish peroxidase (pH $_6$)		~ 0.03	-442 ± 10	1.62 ± 0.1	Epr, Mössbauer [20, 8],
Horseradish peroxidase (F^-)		~ 0	-526 ± 10	0.8 ± 0.05	Epr, Mössbauer [21],

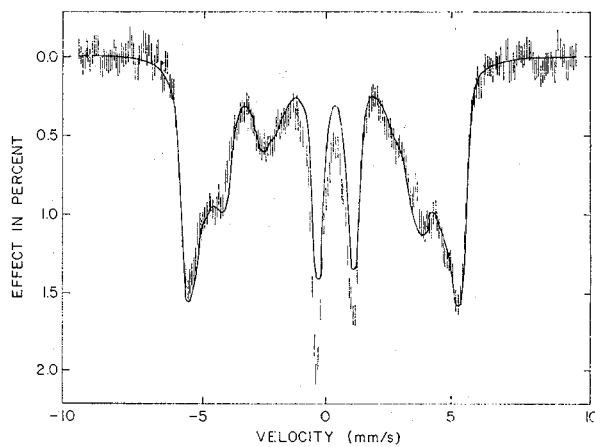

FIG. 5. — Spectrum of the fluoride complex of chloroperoxidase taken at 4.2 K in a 2 500 G field applied parallel to the Mössbauer radiation. The computed spectrum (solid line) was calculated with the parameters quoted in Table I.

(F^-) has a more rhombic environment ($E/D = 0.05$); this causes an anisotropy of the hyperfine field in the heme plane ($A_x \neq A_y$) and a spectrum with broad absorption bands results. The solid lines are theoretical spectra generated with a computer program [9]. The parameters used to calculate the spectra are listed in Table I.

As mentioned above, the parameter E/D can be determined from a measurement of the principal axes values of \tilde{g} . This parameter is a reflection of the asymmetry of the ligand field, but contains no information regarding its strength. In order to obtain a measurement of the magnitude of the zero-field splitting various methods can be used. Most common is a measurement of the magnetic susceptibility as a function of temperature [13]; however, direct measurements of the splitting can be obtained from far-infrared spectroscopy [14]. Measurement of electron spin relaxation utilizing the temperature dependence of the Orbach process can also be employed [15].

So far we have assumed that the Mössbauer sample is studied in a weak magnetic field (< 2 kG) so that mixing of the Kramers doublets by the applied field can be ignored. We can, however, use a strong magnetic field to our advantage since a large field (10-30 kG) mixes the wave functions of the Kramers doublets appreciably, causing a drastic change in the Mössbauer spectrum. The mixing depends on the strength of the magnetic field relative to the zero-field splitting. With all other parameters known from low field measurements, D can be determined with reasonable accuracy. The value $D = (6.3 \pm 0.5) \text{ cm}^{-1}$ obtained by Lang [5] for myoglobin fluoride is in good agreement with results obtained by other methods. A similar technique, mixing of the Kramers doublets by a strong applied field, has been used in Epr spectroscopy also. Epr studies using submillimeter microwaves have been employed to determine D from the field dependence of the ground state g -values [16].

A brief summary of some pertinent parameters found for various high-spin ferric heme proteins has been compiled in Table I.

5. Low-spin ferric heme proteins. — Many heme proteins in their resting state have the heme iron in the low-spin ferric configuration ($S = \frac{1}{2}$). Examples are the cytochromes c , b_5 and P450. Others, like chloroperoxidase, are high-spin ferric at physiological temperatures and undergo a transition to low spin when the temperature is lowered. P450 complexed to its substrate, camphor, is a nearly temperature independent spin mixture at temperatures below 200 K. Horseradish peroxidase can be brought into low-spin configurations at high pH values. Finally, many ferric heme proteins can be converted into low-spin forms by addition of strong binding exogenous ligand groups. Thus, with such a variety of compounds available, the low-spin ferric form of hemes offer a wide field for investigations.

The method most commonly used to evaluate Epr and Mössbauer data obtained from low-spin ferric heme proteins follow the treatment of Griffith [22]. This simple, yet illuminating theory, assumes that the cubic component of the ligand field potential is strong enough so that only the ${}^2T_{2g}(t_{2g}^5)$ ground term needs to be considered. The six-fold degeneracy of the ground state can be partially removed by non-cubic contributions to the crystal field and by spin-orbit coupling. Usually, an orthorhombic symmetry is assumed which allows the Hamiltonian perturbing the degenerate ground state to be expressed in terms of a tetragonal distortion parameter (Δ), a rhombic parameter (V), a spin-orbit coupling constant (λ) and an orbital reduction factor (k). The application of Kramers' theorem to the system and diagonalization of a 3×3 matrix involving the dimensionless parameters Δ/λ , V/λ and k yields a set of wave functions and energy levels which can be used to calculate the g -tensor, A -tensor, and EFG -tensor associated with each Kramers doublet. Details of this type of calculation and its application to low-spin ferric Mössbauer spectra have been discussed by Oosterhuis and Lang [23]. The method has been applied to Mössbauer spectra of heme proteins and reasonable theoretical fits to the data have been obtained [18, 8, 24].

An Epr experiment provides an excellent starting point for this type of analysis, since the three g -values belonging to the ground doublet can be measured and used to find the parameters Δ/λ , V/λ and k . Thus, once the ground state g -values are known, a complete set of hyperfine parameters, consistent within the theory, may be generated. The g -values of a large number of low-spin ferric compounds have been measured by Blumberg and Peisach [25] and the preceding type of analysis was used to find the tetragonality, Δ/λ , and rhombicity, V/Δ , of each compound. The results are classified in a *Truth Diagram* and display information pertaining to the axial ligands of the heme group.

We now present a few typical Mössbauer spectra and discuss how well the simple theory describes the data. Figures 6 and 7 show Mössbauer spectra taken at 4.2 K in weak magnetic fields applied transverse and parallel to the Mössbauer radiation. Figure 6 shows the spectra of native chloroperoxidase [18] and figure 7 the spectra of oxidized P450 complexed to 2-phenylimidazole [26]. The displayed spectra are typical for heme proteins in a low-spin configuration. The large quadrupole splitting (2.9 mm/s for chloroperoxidase and 2.85 mm/s for the P450 complex) in conjunction with a large and anisotropic hyperfine field gives rise to these broad and intricate magnetic spectra. The anisotropy of the A -tensor results from large orbital contributions which often exceed the (isotropic) Fermi contact interaction.

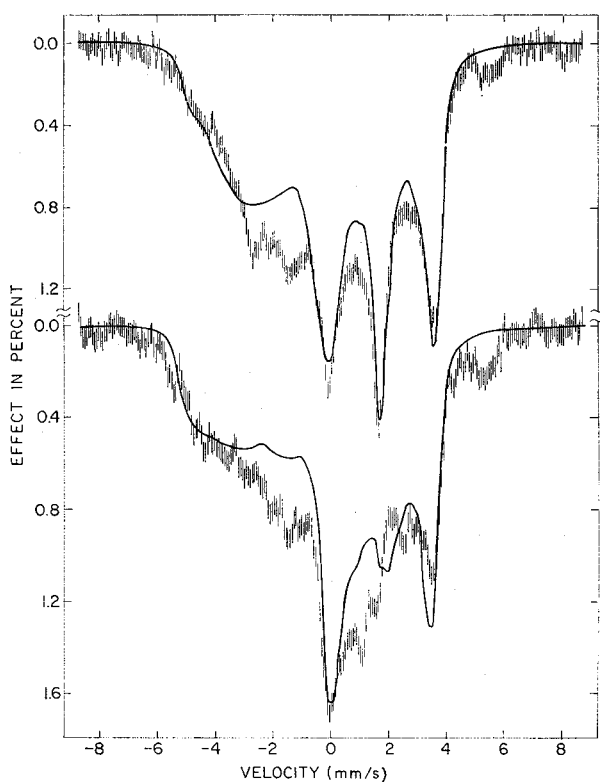

FIG. 6. — Mössbauer spectra of native chloroperoxidase, PH3. O, taken at 4.2 K in 1 300 G external magnetic fields, applied transverse (upper spectrum) and parallel (lower spectrum) to the observed γ -rays. The solid lines are computed spectra. The absorption peak at about + 5.3 mm/s shows the presence of some high-spin material (approximately 5-10 % of total Fe present).

For chloroperoxidase we have computed Mössbauer spectra predicted by the simple model described above. We have used a computer program to search for those values of Δ/λ , V/λ and k giving the correct experimental g -values. These parameters were used to compute the A -tensor and the EFG -tensor. To allow for some lattice contribution to the EFG -tensor and for the Sternheimer factor we used different scaling factors for the A -tensor and the EFG -tensor but kept the

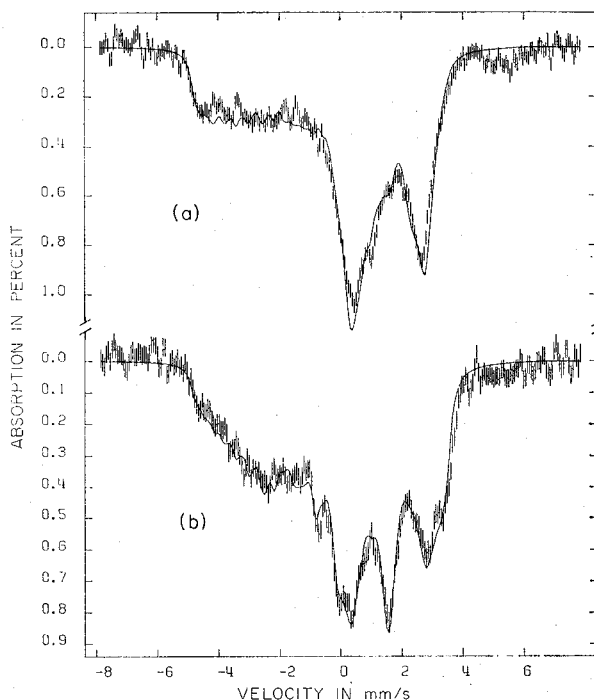

FIG. 7. — Mössbauer spectra, measured at 4.2 K, of the complex of oxidized cytochrome P450 with 2-phenylimidazole. A magnetic field of approximately 1 650 G was applied parallel to the transmitted γ -rays in (a) and perpendicularly in (b). The solid lines are simulated spectra taking into account different covalencies for different d-orbitals. For details see text and reference [26].

anisotropy of both tensors as predicted by the model. The solid lines in figure 6 are the computed spectra [18]; the overall features of the experimental spectra are described rather well by the theory. We did not try to improve the fits for two reasons. First, the resonance absorption at a velocity of + 5.3 mm/s clearly shows the presence of some high-spin material (approximately 5-10 % of total Fe present). Secondly, little is known about the symmetry of the iron environment. For symmetries lower than orthorhombic the various tensors involved will have different principal axes systems. This would introduce more unknown parameters and it is doubtful whether improved fits would give more reliable information. Endor measurements could help here greatly, since this method could give precise values for the components of the A -tensor. Moreover, it could give information about the relative orientations of the principal axes systems of the g - and A -tensors and provide crucial information about the symmetry of the heme environment. Thus, Endor results would reduce the large number of unknown parameters affecting the Mössbauer spectra.

We have found that the fits to the Mössbauer spectra can be improved substantially if the parameters predicted by the model are used as starting parameters and the value of the asymmetry parameter η is varied. Such an alteration of η can be justified if covalency effects are larger for those iron orbitals that are out

of the heme plane (d_{xz} and d_{yz}) than for that in the heme plane (d_{xy}). M. Sharrock in our laboratory obtained quite satisfactory fits for the spectra of oxidized P450 complexed to 2-phenylimidazole assuming different covalency factors for different t_{2g} orbitals ($N_{xz}^2 = N_{yz}^2 = 0.83$, and $N_{xy}^2 = 0.96$). The solid lines in figure 7 show the results [26]. A similar variation of η improves the fits to the Mössbauer spectra of oxidized cytochrome b_5 quite drastically [27].

At temperatures above 100 K the electron spin relaxation time of low-spin ferric heme proteins is short compared with the nuclear quadrupole precession frequency. The magnetic hyperfine interaction is averaged out and the Mössbauer spectra consist of fairly well resolved quadrupole doublets. Thus, at high temperatures, the quadrupole splitting and its temperature dependence can be measured. In order to further check the model described above, we can compare these measurements with the calculated temperature dependence of ΔE_Q . This is accomplished by taking a thermal average over the components of the EFG -tensor for the three Kramers doublets. In general the theory predicts a drop in ΔE_Q of only a few percent from 4.2 K to 240 K. The temperature dependences of ΔE_Q for the cytochromes c , b_5 and P450 agree quite well with the predictions of the model. However, for

the peroxidases it fails to account for the large decrease of ΔE_Q at higher temperatures. Since peroxidases under various conditions (pH, concentration, ionic strength) can undergo transitions from high-spin into low-spin configurations, considerable care has to be taken in interpreting the rapid decrease of ΔE_Q at higher temperatures.

As an example of the above consideration we discuss briefly the high temperature Mössbauer spectra of chloroperoxidase [18]. The spectra in figure 8 consist of two quadrupole doublets, a narrow one belonging to a high-spin ferric configuration and a wide doublet showing low-spin ferric material. As the temperature is raised the intensity of the narrow doublet increases with a concomitant decrease of the intensity of the wide doublet; the sample undergoes a transition from a low-spin ($S = \frac{1}{2}$) to a high-spin ($S = \frac{5}{2}$) configuration. Since the spectra are reasonably well resolved, the spin fractions can easily be quantitated by least-squares fitting the spectra. The results are plotted in the lower half of figure 9. We have also plotted in figure 9 the temperature dependence of the quadrupole splitting for the low-spin material (ΔE_Q is independent of temperature for the high-spin component).

We have also investigated the chloride complex of chloroperoxidase. At 4.2 K the Mössbauer spectra of this complex are nearly indistinguishable from

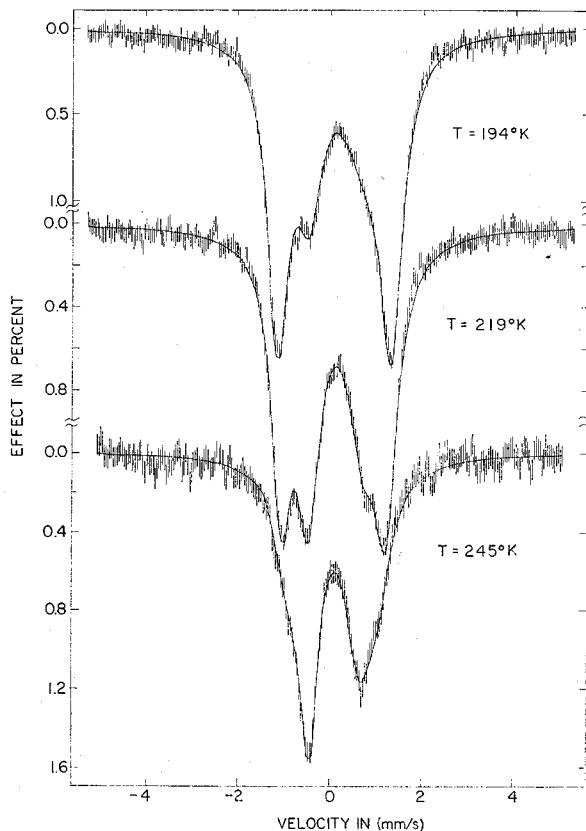

FIG. 8. — Mössbauer spectra of native chloroperoxidase taken at 194 K, 219 K and 245 K. The spectra show that native chloroperoxidase undergoes a spin transition from low spin to high spin as the temperature is raised. The solid lines are the results of fitting two quadrupole doublets to the data.

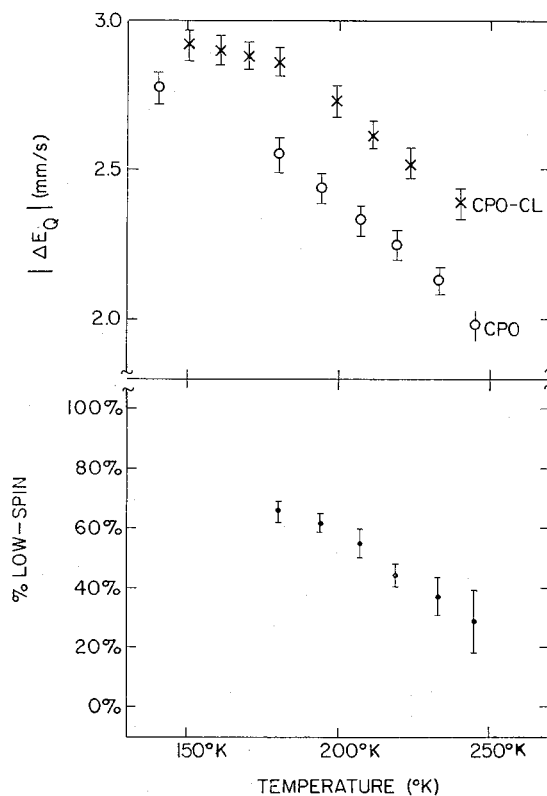

FIG. 9. — The fraction of low-spin ferric material in native chloroperoxidase is plotted as a function of temperature. The upper part of the figure shows the temperature dependence of the quadrupole splitting for the low-spin component of native chloroperoxidase (circles) and for the chloride complex (crosses).

native chloroperoxidase. However, at higher temperatures the chloride complex shows no evidence of a spin transition and the material remains low spin. As observed for the low-spin components of the native protein, the quadrupole splitting of the chloride complex decreases strongly at high-temperatures (see Fig. 9). These observations suggest that any explanation of the temperature dependence of ΔE_Q which assumes rapid transitions between a high-spin and a low-spin configuration [28] must be viewed with caution.

In summary, we must conclude that the adopted ligand field model describes the low temperature Mössbauer spectra reasonably well. At least it serves as a good starting point for evaluation of the data, although the model certainly needs some refinement. One way to improve the agreement with the experimental spectra is to allow for different covalencies for the different orbitals. Endor measurements on low-spin ferric heme proteins could help greatly, since useful information about the symmetry of the iron environment could be obtained and the usefulness of the ligand field approach could be further explored. The strong temperature dependences of ΔE_Q for the peroxidases need further studies. The difficulties in calculating the temperature dependence of ΔE_Q could be caused by neglecting contributions from excited states outside the T_{2g} configuration. Alternatively, the strong temperature dependence of ΔE_Q may indicate a change in geometry and therefore in the crystal field parameters of the heme iron as the temperature is raised.

6. High-spin ferrous heme proteins : measurements in strong magnetic fields. — Heme proteins in the high-spin ferrous state are excellent candidates for Mössbauer investigations since the Mössbauer effect is potentially the most powerful method of revealing details about the electronic structure at the heme iron. Some examples are hemoglobin and myoglobin which are high-spin ferrous in their native states. In Chapter 2 we discussed P450 which goes through this state in the catalytic cycle. For other heme proteins, such as chloroperoxidase and horseradish peroxidase, we have no evidence that the proteins become high-spin ferrous in the catalytic process, but nevertheless some of these proteins exhibit stable high-spin ferrous forms upon reduction.

The high-spin ferrous ion is a non-Kramers system and under most circumstances electron spin resonance cannot be observed. Therefore, Mössbauer measurements may be especially valuable as the only method of studying structural details of the iron atom.

In the absence of a strong magnetic field, Mössbauer spectra of heme iron in a high-spin ferrous state consist of a quadrupole doublet characterized by a large isomeric shift ($\delta \approx 0.7$ - 1.1 mm/s relative to iron metal). The quadrupole splittings of most high-spin ferrous heme proteins at 4.2 K lie in a range from 2.0 mm/s to 2.7 mm/s and show a pronounced decrease

as the temperature is increased. Two exceptions are the reduced forms of P450 and chloroperoxidase ; both display almost temperature independent quadrupole splittings up to 230 K.

Surprisingly little work has been reported concerning the paramagnetic hyperfine interactions of the ferrous ion. In 1966, Lang and Marshall [29] published the Mössbauer spectrum of reduced red blood cells measured at 4.2 K in an applied field of 30 kG. The spectrum shows the presence of paramagnetic hyperfine structure, but it is very featureless ; thus, it is very difficult to extract useful information from it.

We have recently started working in this area and have measured Mössbauer spectra of reduced cytochrome P450 in strong applied magnetic fields. Before presenting the data, we discuss briefly what parameters the spectra depend upon and how the data can be evaluated.

The ligand field of the heme iron removes the orbital degeneracy of the 5D free ion ground state and gives rise to a new ground term which is quite often an orbital singlet and a spin multiplet well separated from the next higher set of levels. The degeneracy of the spin quintet is lifted by the spin-orbit coupling interaction in conjunction with the ligand field. The resulting zero-field splitting along with the action of an applied magnetic field can be adequately and conveniently described by a spin Hamiltonian ($S = 2$),

$$\mathcal{H} = D \left[S_z^2 - \frac{1}{3} S(S+1) + \frac{E}{D} (S_x^2 - S_y^2) \right] + \beta \mathbf{S} \cdot \tilde{\mathbf{g}} \cdot \mathbf{H}, \quad (7)$$

where D and E are coefficients describing the zero-field splitting, \mathbf{H} is the applied magnetic field, and $\tilde{\mathbf{g}}$ expresses the anisotropic Zeeman interaction. The energy levels resulting from the solution of eq. (7) are shown in figure 10. For $S = 2$, the eigenstates are all singlets, except when $E = 0$. In the absence of an applied magnetic field a singlet state can have no

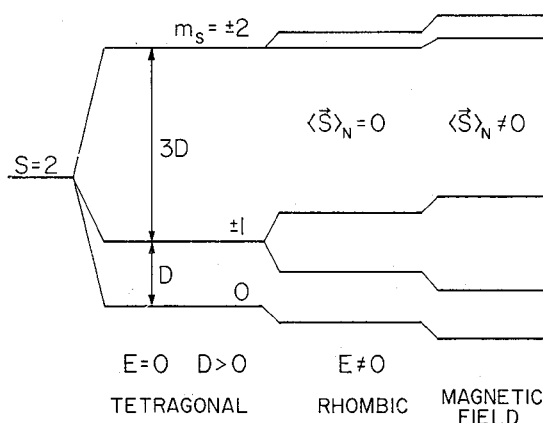

FIG. 10. — Energy eigenvalues for the spin Hamiltonian eq. (7) with $S = 2$. For $E \neq 0$ the degeneracy of the spin quintet is completely removed ; the expectation values of the spin are zero unless a magnetic field is applied.

magnetic moment and therefore no magnetic Mössbauer spectrum can be observed. An applied magnetic field mixes the states and produces a polarization, i. e. the expectation value of the spin $\langle \mathbf{S} \rangle \neq 0$, a fact which is used in magnetic susceptibility measurements.

Generally the high-spin ferrous ion has a fast relaxation time, i. e. the spin flips very rapidly from one electronic state into another. The nucleus then sees a net expectation value of the electronic spin which is a thermal average taken over the five spin states

$$\langle S_i \rangle_{av} = \frac{\sum_{N=1}^5 \langle S_i \rangle_N \exp\left(-\frac{\Delta E_N}{kT}\right)}{\sum_{N=1}^5 \exp\left(-\frac{\Delta E_N}{kT}\right)}, \quad (8)$$

where i designates the component of the electron spin and N sums over the five states; ΔE_N is the energy of the N th state relative to the lowest state. Observe that $\langle S_i \rangle_{av}$ depends on D , E , the g -tensor, and is strongly dependent on the magnitude and direction of the magnetic field. In the fast relaxation limit we may write down a nuclear Hamiltonian involving the magnetic hyperfine interaction, the nuclear Zeeman term, and the quadrupole interaction (\mathcal{H}_Q is given by eq. (5));

$$\begin{aligned} \mathcal{H} &= \langle \mathbf{S} \rangle_{av} \cdot \tilde{\mathbf{A}} \cdot \mathbf{I} - g_n \beta_n \mathbf{H} \cdot \mathbf{I} + \mathcal{H}_Q \\ &= -g_n \beta_n \left[\mathbf{H} - \frac{\langle \mathbf{S} \rangle_{av} \cdot \tilde{\mathbf{A}}}{g_n \beta_n} \right] \cdot \mathbf{I} + \mathcal{H}_Q, \end{aligned} \quad (9)$$

where $\tilde{\mathbf{A}}$ is the magnetic hyperfine tensor and $g_n \beta_n \mathbf{I}$ the nuclear magnetic moment. The quantity

$$\mathbf{H}_{int} = -\langle \mathbf{S} \rangle_{av} \cdot \tilde{\mathbf{A}} / g_n \beta_n$$

is commonly called the internal magnetic field at the nucleus. The nucleus experiences an effective magnetic field which is the vector sum $\mathbf{H}_{eff} = \mathbf{H}_{int} + \mathbf{H}$. The internal magnetic field is quite a complicated quantity, since it depends on the zero-field splitting, the g -tensor, the A -tensor, the magnitude and direction of the applied field, and, because of the thermal averaging procedure in eq. (8), on the temperature.

The task is then to measure the Mössbauer spectra at various temperatures in applied magnetic fields of different strengths and to find a consistent set of parameters describing the spectra. This requires a computer program which calculates Mössbauer spectra resulting from eq. (7), (8) and (9). Since we investigate heme proteins generally in frozen solutions rather than in the form of single crystals, the Mössbauer spectrum has to be properly averaged over all orientations of the molecule relative to the applied magnetic field. (For details see Münck *et al.* [9].)

We now turn to some experimental results obtained for reduced cytochrome P450. We have chosen this protein for several reasons. Primarily, because we have an ample supply of extremely pure ^{57}Fe enriched

material. In zero field reduced P450 exhibits a sharp and symmetrical quadrupole doublet ($\Gamma = 0.23$ mm/s); the spectra show that no detectable iron impurities are present in the sample. Furthermore the quadrupole splitting, $\Delta E_Q = 2.42$ mm/s at 4.2 K, is almost independent of temperature (unlike hemoglobin and horseradish peroxidase for example) implying that the first excited orbital state is far above the ground state. This suggests that one might be able to use a ligand field model to compute the coefficients of the spin Hamiltonian in a second order perturbation treatment [30]; such calculations might aid the search for a consistent set of parameters.

We have measured reduced P450 in strong applied fields under a variety of conditions (6.6 kG transverse field at five temperatures between 1.5 K and 15 K; 8.6, 17 and 25 kG parallel field at 1.5 K and 4.2 K; 46 kG parallel field at 180 K). Some representative spectra are shown in figures 11 and 12. During the

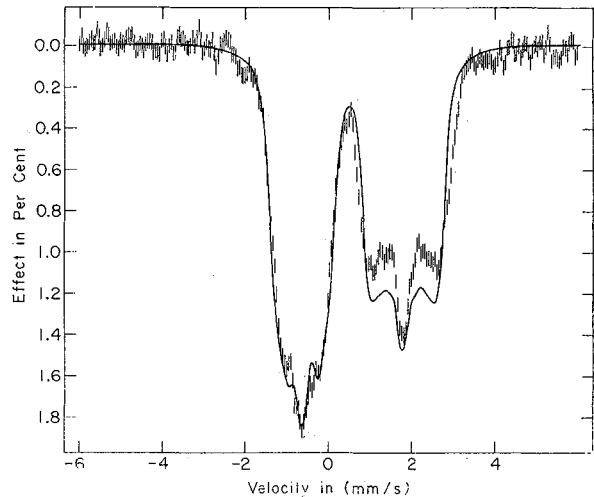

FIG. 11. — Mössbauer spectrum of reduced cytochrome P450 taken at 4.2 K in a 8.6 kG magnetic field applied parallel to the γ -radiation. The solid lines in figures 11 and 12 are computer simulated spectra using the following set of parameters: $D = 14$ cm $^{-1}$, $E/D = 0.15$, $g_x = 2.24$, $g_y = 2.32$, $g_z = 2.00$, $A_x = -180$ kG, $A_y = -125$ kG, $A_z = -150$ kG, $\Delta E_Q = +2.42$ mm/s, $\eta = 0.8$ and $\Gamma = 0.25$ mm/s. The g -tensor and the A -tensor were assumed to have the same principal axes frame as the zero-field splitting tensor. The EFG tensor is rotated relative to this frame. The Euler angles $\alpha = 60^\circ$, $\beta = 70^\circ$ and $\gamma = 0^\circ$ rotate the zero-field splitting tensor into the EFG frame.

last six months we have been working on the evaluation of these spectra using the human iteration procedure, i. e. we have computer simulated hundreds of spectra using different sets of parameters in eq. (7)-(9). After missing badly for a few months (assuming a high symmetry at the heme iron), two conditions necessary for satisfactory fits to the data emerged. First, a systematic study of the temperature dependence of the spectra revealed that the zero-field splitting parameter, D , is positive and larger than

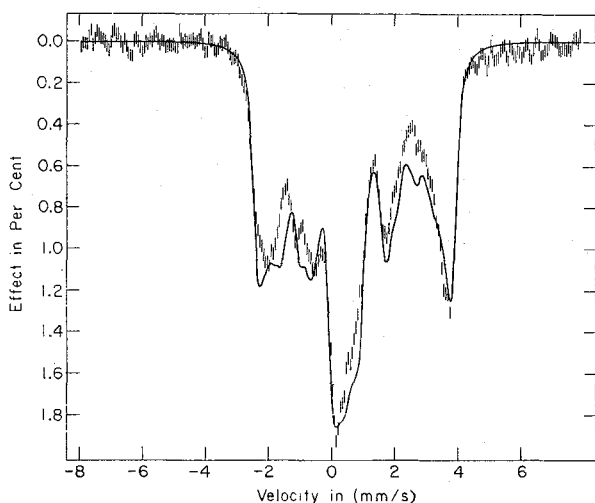

FIG. 12. — Mössbauer spectrum of reduced cytochrome P450 taken at 4.2 K in a 25 kG parallel field. The parameters used to generate the solid line are quoted in the caption of figure 11.

10 cm^{-1} (1). Second, the *EFG*-tensor has a large asymmetry parameter η , and its largest component (V_{zz}) is tilted substantially away ($\sim 70^\circ$) from the z -axis defined by the zero-field splitting tensor. A third remark, probably in order here, concerns itself with the insensitivity of the low temperature spectra to the component of the *A*-tensor along the (electronic) z -direction. When D is 10 cm^{-1} or greater, $\langle S_z \rangle_{av}$ is much smaller than either $\langle S_x \rangle_{av}$ or $\langle S_y \rangle_{av}$ for the vast majority of magnetic field orientations. This results in powder averaged Mössbauer spectra which are quite insensitive to A_z at 4.2 K.

The solid lines in figures 11 and 12 reflect our current status of finding a consistent set of parameters. The reader is advised to view the parameters quoted in the caption of figure 11 in the spirit of a progress report. These parameters are chosen such that the features of the entire set of experimental data are reproduced reasonably well. Presently, we are working on magnetic susceptibility experiments to obtain better values for D and E/D ; such data should greatly facilitate the search for better hyperfine parameters.

It might be useful here to comment on the spectrum taken at 180 K in a parallel field of 46 kG (Fig. 13). Measurements at high temperatures in strong fields can

(1) The magnetic term acts as a perturbation on \mathcal{H}_Q if H_{eff} is sufficiently small. Under these conditions one obtains spectra consisting of quadrupole split lines, each broadened by H_{eff} . The energy levels which give rise to this broadening can be calculated explicitly as a function of η and H_{eff} ; and, since H_{eff} depends on $\langle S \rangle_{av}$, a series of experiments at different temperatures can yield the temperature dependence of $\langle S \rangle_{av}$. This gives the same information which is obtained from a magnetic susceptibility measurement. The interpretation of the Mössbauer data does not rely on the sample concentration and *non-iron* spin impurities do not affect the results. This overcomes some of the crucial problems associated with protein magnetic susceptibility experiments.

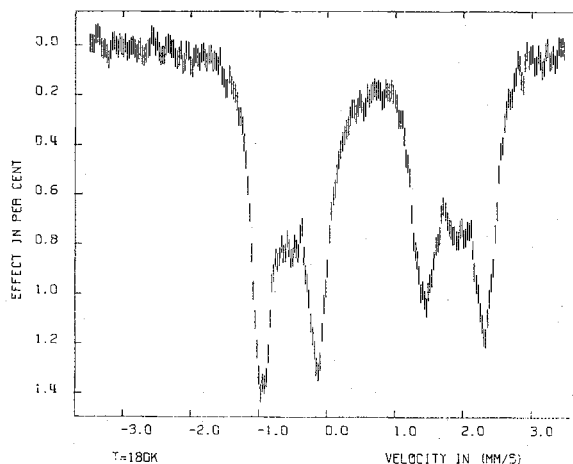

FIG. 13. — Mössbauer spectrum of reduced cytochrome P450 taken at 180 K in a parallel field of 46 kG. The triplet structure on the right would indicate that $\Delta E_Q < 0$. However, the overall intensity pattern is better reproduced for $\Delta E_Q > 0$ (see text).

often be used to determine η and the sign of ΔE_Q . As Johnson [31] and Lang [5] have pointed out, the internal magnetic field at high temperatures is proportional to the applied field and can be related to the magnetic susceptibility. Since $\langle S \rangle_{av}$ decreases with $1/T$, one can hope that the largest component of the internal field, H_{max} , is sufficiently small compared to the applied field ($H_{\text{max}} \leq H/10$), so that the Mössbauer spectrum looks like that of a diamagnetic compound. However, η can also be determined quite accurately if H_{int} is large but isotropic (H_{iso}); then the spectrum looks like that of a diamagnetic compound measured in a reduced *applied* field $H' = H - H_{\text{iso}}$. Unfortunately, neither condition holds for the spectrum shown in figure 13. The triplet structure at positive velocities would indicate $\Delta E_Q < 0$. However, a computer analysis shows that the overall intensity pattern of the spectrum is much better reproduced for $\Delta E_Q > 0$. We can use eq. (9) and the parameters obtained at low temperatures to elucidate the problem. For $T = 180 \text{ K}$ we obtain $H_{\text{int } x} = -14 \text{ kG}$ and $H_{\text{int } y} = -11 \text{ kG}$. However, $H_{\text{int } z}$ is undetermined and can be anywhere between -3 kG and -15 kG at 180 K. This unknown anisotropy makes a precise determination of η at high temperatures virtually impossible. (We can infer from figure 13, however, that η is certainly larger than 0.5.) In order to sufficiently suppress the effects of the internal fields one would like to measure the sample at 400-500 K, a temperature quite unsatisfactory to the P450 molecule.

7. Low-spin ferrous hemes. — Some heme proteins occur in the low-spin ferrous state as they function in the biological system. These molecules are mainly involved in electron transport reactions; examples are the cytochromes c and b_5 which are low-spin ferric in their oxidized state and become low-spin ferrous upon reduction. Many proteins which bind extraneous

ligands to the heme iron undergo transitions to the low-spin ferrous states; examples are the carbon monoxide complexes of hemoglobin and cytochrome P450. Oxyhemoglobin and the oxygenated P450 complex have one property in common with low-spin ferrous hemes — they are diamagnetic. However, a bulk of experimental data collected in the past few years favors a description where iron is formally ferric and the ligand is the bound superoxide anion O_2^- [32].

Since the heme iron is diamagnetic for the low-spin ferrous state we can obtain only isomeric shift and field gradient data. However, Mössbauer data are very useful since most of the other techniques discussed in previous chapters cannot be applied. In the absence of single crystal data the most useful information has been obtained from measurements in strong applied fields. Both the sign of ΔE_Q and the asymmetry parameter can be determined from such studies. As an example a Mössbauer spectrum of the reduced P450-carbonmonoxide complex is shown in figure 14; the solid line is the result of a computer simulation.

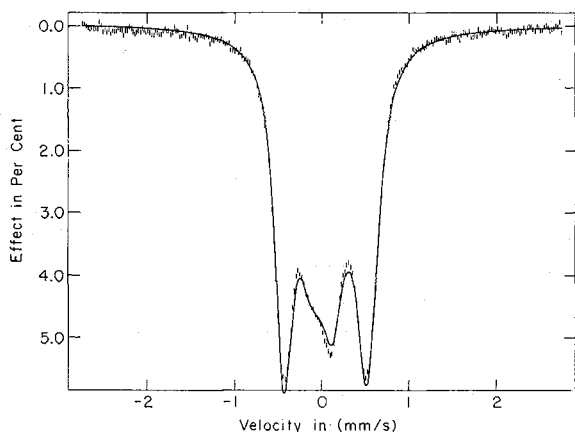

FIG. 14. — Mössbauer spectrum of reduced P450 complexed with carbonmonoxide taken at 4.2 K in a 25.5 kG parallel field. The solid line is a computer simulated spectrum using the following set of parameters: $\Delta E_Q = +0.29$ mm/s, $\eta = 0.5$ and $\Gamma = 0.25$ mm/s. The agreement between theory and experiment is not perfect; the sample contains a few percent of high-spin ferrous iron contamination and thickness broadening was not taken into account. However, η can be determined to $\eta = 0.5 \pm 0.2$.

8. Mössbauer emission spectroscopy. — One aim of the study of heme proteins is to learn the mechanisms by which a protein can modify the chemical reactivity and the electronic structure of the heme prosthetic group. Such information can be obtained by comparing the results obtained for a protein with those obtained for a model compound. Such comparisons, however, have been frustrated by two facts; either the proper ligand combination cannot be assembled or the desired heme model complex cannot be stabilized in the desired oxidation state. Fortunately, rapid progress has been made in the preparation of hemes for which the iron atom is substituted by cobalt. These developments

have offered a new approach to the study of heme model complexes — Mössbauer emission spectroscopy.

Hemoglobin and myoglobin are 5-coordinated high-spin ferrous complexes in their deoxy form. The axial heme ligand is the imidazole ring of the amino acid residue histidine. Upon oxygenation the heme iron becomes 6-coordinated, with oxygen binding in the position trans to the imidazole. Model complexes for these proteins are of considerable interest for two reasons: 1) Can a non-protein environment for iron duplicate the unique Mössbauer spectrum for oxyhemoglobin? 2) To what extent does the protein environment impose a stereochemical constraint on the binding of histidine in the deoxy forms? Neither a 5-coordinated nor an oxygenated model complex with Fe-protoporphyrin IX suitable for Mössbauer investigations has been reported in the literature⁽²⁾. Fortunately, the cobalt analogues for these compounds can be prepared.

We have prepared ^{57}Co (II) labeled protoporphyrin IX complexes with 1-methyl imidazole as axial ligand. These compounds were kept in toluene, a solvent which allows efficient oxygenation at low temperatures. The complexes ($^{59}\text{Co} : ^{57}\text{Co} \approx 500 : 1$) can be studied with optical and Epr spectroscopy to check the desired coordination. The resulting emission spectra are shown in figure 15. Figure 15a shows the spectrum of the 5-coordinated complex; the quadrupole splitting, its temperature dependence and the isomeric shift of the major spectral component (designated by the bracket) agree within the experimental error with the parameters reported for myoglobin and hemoglobin. Figure 15b shows a spectrum taken after the sample was oxygenated at -60°C ; a new component (indicated by the bracket) has appeared with parameters matching those of oxyhemoglobin. Thus a non-protein environment can reproduce the Mössbauer parameters of hemoglobin and myoglobin.

The spectra in figure 15 clearly show that more than one spectral component is present in the samples and we have to ask a crucial question associated with emission spectroscopy: Do some molecules fracture in the aftermath of the nuclear decay process? The major impurity in the spectra (with broad absorption lines at -1.5 mm/s and $+0.2$ mm/s) can be traced to a problem commonly associated with the chemistry of porphyrins: low solubility in toluene and aggregation. These impurities were present with different inten-

(2) Recently specifically designed heme model complexes, the so-called picket-fence porphyrins have opened an interesting new approach to the problem. These compounds (hemes, chemically modified at the porphyrin periphery) can be prepared as five-coordinated compounds which can be reversibly oxygenated [33]. The picket fence analog to oxyhemoglobin is diamagnetic and shows a temperature dependent quadrupole splitting like oxyhemoglobin. However, the absolute values of ΔE_Q are approximately 20% smaller for the model compound [33]. It is well established that a chemical modification of the substituents at the porphyrin periphery can influence the Mössbauer parameters profoundly [34].

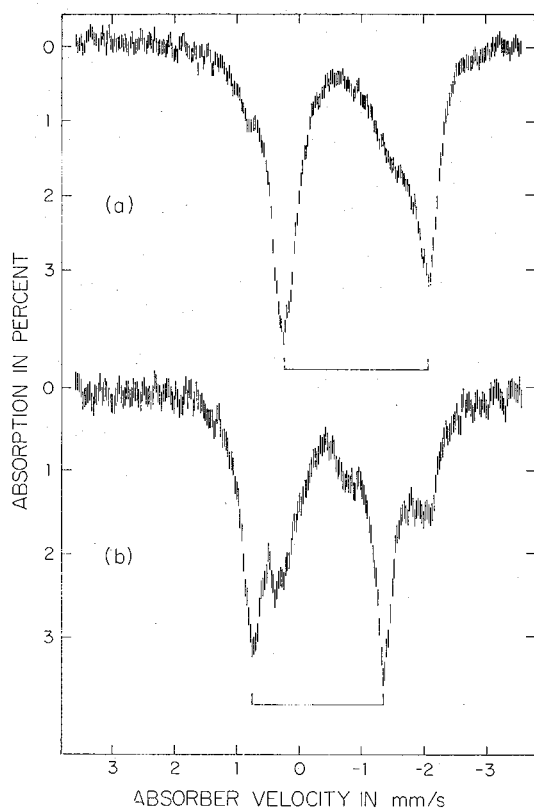

FIG. 15. — Mössbauer emission spectra obtained from complexes of 1-methyl imidazole and oxygen with ^{57}Co -labeled protoporphyrin IX dimethylester in toluene. The ^{57}Co -labeled compounds were used as the Mössbauer source. The source was immersed in liquid helium and kept stationary while a single-line absorber, $\text{K}_4\text{Fe}(\text{CN})_6 \cdot 3 \text{H}_2\text{O}$ (kept at room temperature), was moved relative to the source: (a) emission spectrum of the porphyrin complex with 1-methyl imidazole; (b) emission spectrum (taken at 4.2 K) of the same sample after oxygenation at -60 C .

sities in different preparations and a sample of ^{57}Co -protoporphyrin IX « dissolved » in toluene showed broad absorption peaks at the same velocities. At the

present time we are not able to state that no chemical bonds are disrupted after the electron capture process. However, it appears that the majority of molecules escape fragmentation and stabilize in the desired state.

We have further studied oxygenated porphyrin complexes using a variety of axial ligands (pyridine, piperidine, 1,2 dimethyl imidazole, and ethylmethyl sulfide) (E. Münck *et al.* in preparation). Surprisingly, the spectra of these compounds resemble each other quite strongly. This suggests that the Mössbauer parameters essentially reflect the nature of the iron-oxygen bond.

Although the absorption technique has received more attention, Mössbauer emission spectroscopy can offer distinct advantages for certain biological studies. It requires far less material than the absorption method if cobalt of high specific activity is used (less than 1 nmole of ^{57}Co can be sufficient). This inherently greater sensitivity could be exploited for single crystal work. If tracer free ^{57}Co -protoporphyrin IX is available, a cobomyoglobin (the cobalt analog of myoglobin) single crystal containing only 20 μg of protein could be investigated.

Acknowledgments. — A successful Mössbauer investigation depends critically on the help of biochemists. We enjoy a fruitful cooperation with various groups in the Department of Biochemistry and we wish to express our gratitude to Dr. I. C. Gunsalus, Dr. L. P. Hager, Dr. V. Marshall, Dr. P. Hollenberg, J. D. Lipscomb and D. Doubek. In the Mössbauer emission project we appreciate the cooperation with Drs. B. M. Hoffman and L. Marchant at Northwestern University. We are grateful to Dr. De Pasquali for the preparation of ^{57}Co labeled porphyrins and to Dr. M. Sharrock who worked with E. M. on the Mössbauer emission studies. Finally, we wish to thank Drs. P. Debrunner and H. Frauenfelder for their interest and support of this work.

These studies were supported by U. S. Public Health Service Grant GM 16406.

References

- [1] MÜNCK, E., DEBRUNNER, P. G., TSIBRIS, J. C. M. and GUNSALES, I. C., *Biochemistry* **11** (1972) 855.
- [2] DUNHAM, R., BEARDEN, A., SALMEEN, I., FEE, J., PETERING, D., SANDS, R. H. and ORME-JOHNSON, W., *Biochim. Biophys. Acta* **253** (1971) 134.
- [3] SEKER, L. C., ADMAN, E. and JENSEN, L. H., *Nature* (London) **235** (1972) 40.
- [4] LANG, G. and SMITH, B., *Biochemical Journal* **136** (1974).
- [5] LANG, G., *Quart. Rev. Biophys.* **3** (1970) 1.
- [6] DEBRUNNER, P. G., *Spectroscopic Approaches to Biomolecular Conformation*, ed. Urry, D. W. (American Medical Association Press, Chicago) 1969, p. 209.
- [7] HEDEGAARD, I. and GUNSALES, I. C., *J. Biol. Chemistry* **240** (1965) 4029.
- [8] SHARROCK, M., MÜNCK, E., DEBRUNNER, P. G., MARSHALL, V., LIPSCOMB, J. D. and GUNSALES, I. C., *Biochemistry* **12** (1973) 258.
- [9] MÜNCK, E., GROVES, J. L., TUMOLLILLO, T. A. and DEBRUNNER, P. G., *Computer Phys. Commun.* **5** (1973) 225-238.
- [10] WICKMAN, H. H., KLEIN, M. P. and SHIRLEY, D. A., *J. Chem. Phys.* **42** (1965) 2113.
- [11] WICKMAN, H. H., KLEIN, M. P. and SHIRLEY, D. A., *Phys. Rev.* **152** (1966) 345.
- [12] SCHOLES, C. P., ISAACSON, R. A., YONETANI, T. and FEHER, G., *Biochim. Biophys. Acta* **322** (1973) 457.
- [13] KOTANI, M., *Advances in Quantum Chemistry*, Vol. 4, ed. Lowdin, P. O. (Academic Press) 1968.
- [14] BRACKETT, G. C., RICHARDS, P. L. and CAUGHEY, W. S., *J. Chem. Phys.* **54** (1971) 4383.
- [15] SCHOLES, C. P., ISAACSON, R. A. and FEHER, G., *Biochim. Biophys. Acta* **244** (1971) 206.
- [16] ALPERT, Y., COUDER, Y., TUCHENDLER, J. and THOMÉ, H., *Biochim. Biophys. Acta* **322** (1973) 34.

- [17] SLADE, E. F. and FARROW, R. H., *Biochim. Biophys. Acta* **278** (1972) 450.
- [18] CHAMPION, P. M., MÜNCK, E., DEBRUNNER, P. G., HOLLENBERG, P. F. and HAGER, L. P., *Biochemistry* **12** (1973) 426.
- [19] PEISACH, J. and BLUMBERG, W. E., private communication.
- [20] TSAI, R., YU, C. A., GUNSALUS, I. C., PEISACH, J., BLUMBERG, W., ORME-JOHNSON, W. H. and BEINERT, H., *Proc. Nat. Acad. Sci. USA* **66** (1970) 1157.
- [21] MÜNCK, E., CHAMPION, P. M., DOUBEK, D. L. and HAGER, L. P., unpublished results.
- [22] GRIFFITH, J. S., *Nature* **180** (1957) 30.
- [23] OOSTERHUIS, W. T. and LANG, G., *Phys. Rev.* **178** (1969) 439.
- [24] LANG, G., HERBERT, D. and YONETANI, T., *J. Chem. Phys.* **49** (1968) 944.
- [25] BLUMBERG, W. E. and PEISACH, J., *Probes of Structure and Function of Macromolecules and Membranes*, Chance, B., Lee, C. P. and Yonetani, T. (Academic Press, New York) 1971, p. 215.
- [26] SHARROCK, M., Ph. D. thesis, University of Illinois (1973).
- [27] MÜNCK, E. and STRITTMATTER, P., Unpublished results.
- [28] MAEDA, Y., *J. Phys. Soc. Japan* **24** (1968) 151.
- [29] LANG, G. and MARSHALL, W., *Proc. Phys. Soc. (London)* **87** (1966) 3.
- [30] ABRAGAM, A. and BLEANEY, B., *Electron Paramagnetic Resonance of Transition Ions* (Oxford University Press) 1970, chapter 19.
- [31] JOHNSON, C. E., *Proc. Phys. Soc.* **92** (1967) 748.
- [32] WITTENBERG, J. B., WITTENBERG, B. A., PEISACH, J. and BLUMBERG, W. E., *Proc. Nat. Acad. Sci. USA* **67** (1970) 1846.
- [33] COLLMAN, J. P., GAGNE, R. R., HALBERT, T. R., MARCHON, J. and REED, C. A., *J. Am. Chem. Soc.* **95** (1973) 7861.
- [34] MOSS, T. H., BEARDEN, A. J. and CAUGHEY, W. S., *J. Chem. Phys.* **51** (1969) 2624.