



HAL
open science

HYPERFINE STRUCTURE INVESTIGATIONS IN Os I AND Eu II AND THE NUCLEAR QUADRUPOLE MOMENTS OF ^{189}Os ^{151}Eu AND ^{153}Eu

G. Guthöhrlein, G. Himmel, A. Steudel

► **To cite this version:**

G. Guthöhrlein, G. Himmel, A. Steudel. HYPERFINE STRUCTURE INVESTIGATIONS IN Os I AND Eu II AND THE NUCLEAR QUADRUPOLE MOMENTS OF ^{189}Os ^{151}Eu AND ^{153}Eu . Journal de Physique Colloques, 1969, 30 (C1), pp.C1-66-C1-73. 10.1051/jphyscol:1969122 . jpa-00213653

HAL Id: jpa-00213653

<https://hal.science/jpa-00213653v1>

Submitted on 4 Feb 2008

HAL is a multi-disciplinary open access archive for the deposit and dissemination of scientific research documents, whether they are published or not. The documents may come from teaching and research institutions in France or abroad, or from public or private research centers.

L'archive ouverte pluridisciplinaire **HAL**, est destinée au dépôt et à la diffusion de documents scientifiques de niveau recherche, publiés ou non, émanant des établissements d'enseignement et de recherche français ou étrangers, des laboratoires publics ou privés.

HYPERFINE STRUCTURE INVESTIGATIONS IN Os I AND Eu II AND THE NUCLEAR QUADRUPOLE MOMENTS OF ^{189}Os , ^{151}Eu AND ^{153}Eu

G. GUTHÖHRLEIN, G. HIMMEL (*) AND A. STEUDEL

Institut für Experimentalphysik A der Technischen Universität, Hannover, Germany.

Résumé. — On a étudié la structure hyperfine de onze raies du spectre d'arc de l'osmium et de quatre raies du spectre d'étincelle de l'euporium en utilisant des échantillons enrichis isotopiquement dans des cathodes creuses refroidies à l'air liquide et un spectromètre Fabry-Perot à sortie digitalisée. Dans le cas de l'euporium, on a utilisé un double Fabry-Perot. Comme les composantes hyperfines des deux spectres n'étaient que partiellement résolues, nous avons utilisé un ordinateur pour résoudre les spectres. L'interprétation des structures hyperfines observées mène aux résultats suivants :

1) *Osmium*. — Nous avons déterminé pour l'isotope ^{189}Os les valeurs de A et de B relatives aux niveaux $5d^6 6s^2 \ ^5D_2$, $\ ^5D_3$, $\ ^5D_4$ et $5d^7 6s \ ^5F_5$ (ou des combinaisons linéaires de ces constantes de couplage). Nous avons utilisé les valeurs mesurées de A pour contrôler les fonctions d'onde de Gluck, Bordarier, Bauche et Van Kleef, fonctions d'onde calculées en couplage intermédiaire en tenant compte de l'interaction de configuration entre $d^6 s^2$, $d^7 s$ et d^8 . L'accord entre valeurs calculées et observées de A est très satisfaisant. La valeur du moment quadrupolaire nucléaire déduit des valeurs de B observées, est :

$$Q(^{189}\text{Os}) = (0,91 \pm 0,10) \times 10^{-24} \text{ cm}^2.$$

2) *Euporium*. — Nous avons mesuré pour les isotopes ^{151}Eu et ^{153}Eu , les valeurs de A et de B pour les niveaux $4f^7 6p z \ ^9P_3$, $\ ^9P_4$ et $\ ^9P_5$. Ces valeurs de A ont été utilisées conjointement avec celles relatives aux niveaux $4f^7 6p z \ ^7P_3$ et $\ ^7P_4$, pour vérifier les fonctions d'onde de Bordarier, Judd et Klapisch qui ont été calculées en couplage intermédiaire. On n'obtient un bon accord entre valeurs de A calculées et observées que si on utilise comme paramètre ajustable la partie à symétrie sphérique de l'opérateur d'interaction magnétique hyperfine de l'électron $6p$. Suivant Judd, ce paramètre tient compte de l'interaction de configuration entre $4f^7 6p$ et $4f^6 5d 6s$. Heureusement, ce mélange n'affecte pas l'interaction quadrupolaire. Les moments quadrupolaires peuvent donc être déduits des valeurs de B en utilisant les fonctions d'onde non perturbées :

$$Q(^{151}\text{Eu}) = (1,12 \pm 0,07) \times 10^{-24} \text{ cm}^2$$

et

$$Q(^{153}\text{Eu}) = (2,85 \pm 0,18) \times 10^{-24} \text{ cm}^2.$$

Ces valeurs sont en excellent accord avec celles trouvées par Müller, Steudel et Walther (*Z. Physik*, 1965, **183**, 303) dans le spectre d'arc de l'euporium.

Abstract. — The hyperfine structure of eleven lines of the arc spectrum of osmium and of four lines of the spark spectrum of europium was investigated using enriched isotope samples in liquid air cooled hollow cathodes and a digital recording Fabry-Perot-spectrometer. With europium a double-Fabry-Perot was used. As the hyperfine components in both spectra were only partially resolved the patterns were analysed by a computer. The interpretation of the observed hyperfine structures leads to the following results :

1) *Osmium*. — The A - and B -values of the levels $5d^6 6s^2 \ ^5D_2$, $\ ^5D_3$, $\ ^5D_4$ and $5d^7 6s \ ^5F_5$ or linear combinations of these coupling constants were determined for the isotope ^{189}Os . The measured A -values were used to make a check on the eigenfunctions of Gluck, Bordarier, Bauche, and van Kleef, which have been calculated for intermediate coupling considering configuration interaction between $d^6 s^2$, $d^7 s$ and d^8 . The agreement between calculated and observed A -values turned out to be very satisfactory. The value of the nuclear quadrupole moment derived from the measured B -factors is :

$$Q(^{189}\text{Os}) = (0,91 \pm 0,10) \times 10^{-24} \text{ cm}^2.$$

2) *Euporium*. — The A - and B -values of the levels $4f^7 6p z \ ^9P_3$, $\ ^9P_4$, and $\ ^9P_5$ were evaluated for the isotopes ^{151}Eu and ^{153}Eu . Together with the experimental A -values of the levels

(*) Now at Institut für Experimentalphysik II, Ruhr-Universität, Bochum, Germany.

$4f^7 6p z {}^7P_3$ and $z {}^7P_4$ the A -values were used to check the eigenfunctions of Bordarier, Judd, and Klapisch, which have been calculated for intermediate coupling. Good agreement between the calculated and observed A -values was reached only if the spherical-symmetric part of the magnetic hyperfine interaction operator of the 6 p -electron was used as a free parameter. According to Judd this parameter takes into account the configuration interaction between $4f^7 6p$ and $4f^6 5d 6s$. Fortunately this mixing does not affect the quadrupole interaction. Therefore the quadrupole moments could be derived from the B -values using the unperturbed eigenfunctions:

$$Q(^{151}\text{Eu}) = (1.12 \pm 0.07) \times 10^{-24} \text{ cm}^2,$$

and

$$Q(^{153}\text{Eu}) = (2.85 \pm 0.18) \times 10^{-24} \text{ cm}^2.$$

The agreement of these values with the values found by Müller, Steudel, and Walther [*Z. Physik*, 1965, 183, 303] in the arc spectrum of europium is excellent.

I. Introduction. — Till now there existed only one determination of the nuclear quadrupole moment of ^{189}Os by Murakawa [1] [2]. In his work the hyperfine splitting of two Os I lines was determined by taking photographs of the Fabry-Pérot interference pattern. In order to deduce the quadrupole moment rough assumptions were made concerning the coupling of the electrons and the effects of configuration mixing were neglected. Meanwhile extensive theoretical work on the low even configurations of Os I was done by Gluck, Bordarier, Bauche and van Kleef [3]. The eigenfunctions of the levels of $5d^6 6s^2$, $5d^7 6s$ and $5d^8$ were calculated for intermediate coupling considering configuration interaction between all these configurations. This encouraged us to investigate once more the hyperfine structure of Os I using a Fabry-Perot spectrometer with digital output of the data.

With europium there exists a precise value of the

quadrupole moment for each of the two stable isotopes determined by Müller, Steudel and Walther [4] from the hyperfine structure of seven $4f^7 6s 6p$ levels of the Eu I spectrum. The stimulus for the investigation of the $4f^7 6p z {}^9P$ levels of Eu II was a discrepancy between the results in Eu I and a value given by Krebs and Winkler [5] who derived the quadrupole moments from the measured B -values of the $4f^7 6p z {}^9P_5$ level of Eu II. This discrepancy is somewhat unexpected since the quadrupole effect of a single 6 p -electron is measured in both spectra. Therefore we wanted to settle this point. The investigations in Eu II were done with two recording Fabry-Perot's in series. This arrangement has been described in detail by Kuhl, Steudel and Walther [6] [7].

II. Investigations in Os I and the nuclear quadrupole moment of ^{189}Os . — Figure 1 shows part of the fine

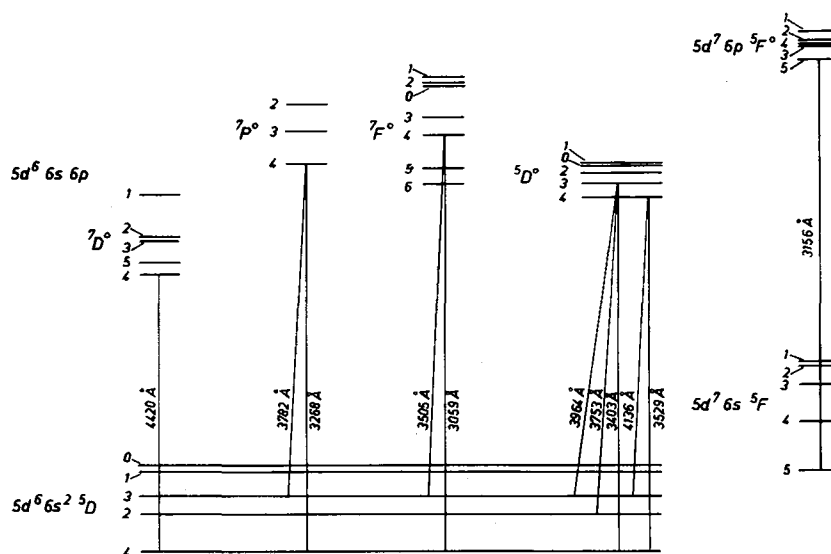

FIG. 1. — Part of the fine structure level scheme of Os I. Only the investigated transitions are shown. Designation of the levels according to van Kleef [3].

structure level scheme of Os I containing all measured transitions. The line λ 4 420 Å was recorded with a double Fabry-Perot too, in all other cases the resolution of a single Fabry-Perot was sufficient. As the calculations of Gluck, Bordarier, Bauche and van Kleef were done for the lowest even configurations, the splitting of the lower levels of all transitions in figure 1 was of interest. In the group of transitions of the type $d^6 sp - d^6 s^2$ the splitting of the lower levels is small and not resolved whereas the upper levels have a wider splitting. By measuring always two lines having a common upper level, for instance the pairs (λ 3 782, 3 268 Å), (λ 3 505, 3 059 Å) and (λ 4 136, 3 529 Å), the differences of the resulting line *A*- and line *B*-values⁽¹⁾ lead to linear combinations of the *A*- and *B*-values of the lower levels the hyperfine coupling constants of the upper levels being eliminated. In this way linear combinations of the *A*- and *B*-values of 5D_2 , 5D_4 and 5D_3 , 5D_4 were obtained. The *A*- and *B*-values of 5D_4 and 5F_5 were evaluated directly. Using the eigenfunctions of Gluck, Bordarier, Bauche and van Kleef these values were represented in the following way by three parameters :

$$A = \alpha_1 a_d(d^6 s^2) + \alpha_2 a_s(d^7 s) + \alpha_3 a_{sd}(d^6 s^2, d^7 s)$$

$$B = \beta_1 b_d(d^6 s^2) + \beta_2 b'_d(d^7 s) + \beta_3 b_{sd}(d^6 s^2, d^7 s)$$

a_d stands for the magnetic hyperfine interaction of the 5 *d*-electron in $5 d^6 6 s^2$. The influence of the different values of a_d in the configurations $d^7 s$ and d^8 is included in α_1 by use of the ratio of the different spin-orbit parameters ζ determined by the fine structure analysis. The parameter a_s stands for the magnetic hyperfine interaction of the 6 *s*-electron in $5 d^7 6 s$ and a_{sd} takes into account the configuration interaction between $d^6 s^2$ and $d^7 s$. The term including the interaction between d^8 and $d^7 s$ was neglected because its coefficient is much less than α_3 . The quadrupole interaction parameters b_d and b'_d allow for the separation of the quadrupole effects of the 5 *d*-electron in the configurations $d^6 s^2$ and $d^7 s$. $b_d(d^8)$ is included in b'_d . The error caused hereby is negligible because the coefficient of $b_d(d^8)$ is very small. Again the term concerning the interaction between d^8 and $d^7 s$ is neglected because of its smallness.

The coefficients α_i and β_i were calculated by M^{me} Bauche-Arnoult. α_1 , β_1 and β_2 were provided with relativistic corrections. First the measured *A*-values and linear combinations of *A*-values were used to check the calculated eigenfunctions. The

parameters a_d , a_s and a_{sd} were fitted to the observed *A*-values by the method of least squares. The result is shown in table I. All values are for the isotope ^{189}Os . The resulting parameters are :

$$a_d = 9.06 (42) \text{ mK},$$

$$a_s = 263.3 (2.7) \text{ mK},$$

$$a_{sd} = 14.2 (8.3) \text{ mK}.$$

The quoted errors are three times the rms error.

TABLE I. Calculated and observed A^{189} -values⁽²⁾

A^{189} /factors	A_{calc} [mK]	A_{obs} [mK]
—	—	—
$A(^5D_4)$	5.55	5.66 (33)
$A(^5D_4) - \frac{3}{4} \cdot A(^5D_3)$	2.70	2.69 (07)
$A(^5D_4) - \frac{11}{15} \cdot A(^5D_3)$	2.74	2.55 (26)
$A(^5D_4) - \frac{8}{15} \cdot A(^5D_2)$	0.67	0.66 (33)
$A(^5F_5)$	31,37	31.62 (20)

Besides the excellent agreement between observed and calculated *A*-values it is interesting to note that the value of a_s determined in this way leads to a rather reasonable value for the nuclear magnetic dipole moment of ^{189}Os by means of the Goudsmit-Fermi-Segré formula: $\mu_1 = 0.60 (6)$ n. m. The NMR-value is $\mu_1 = 0.650 655 (81)$ n. m. [9].

A similar least squares procedure with the experimental *B*-values was carried out. The result is shown in table II. The results for the parameters are

$$b_d(d^6 s^2) = 122.8 (3.5) \text{ mK}$$

$$b'_d(d^7 s) = 93.8 (9.9) \text{ mK}$$

$$b_{sd}(d^6 s^2, d^7 s) = 15 (41) \text{ mK}.$$

Taking the spin-orbit coupling constants determined from the fine structure for the configurations $5 d^6 6 s^2$ and $5 d^7 6 s$, and using $Z_i = Z - 11 = 65$ the nuclear quadrupole moment can be calculated either with b_d or b'_d . Two different values result :

$$Q(^{189}\text{Os}; 5 d^6 6 s^2) = 1.00 (03) \times 10^{-24} \text{ cm}^2,$$

and

$$Q(^{189}\text{Os}; 5 d^7 6 s) = 0.82 (09) \times 10^{-24} \text{ cm}^2.$$

(1) These quantities were first defined by Brix [8].

(2) 1 mK = 10^{-3} cm^{-1} .

TABLE II. — Calculated and observed B^{189} -values (in mK) ⁽³⁾

B^{189} -factor	B_{calc}	B_{obs}
$B(^5D_4)$	37.5	37.2 (2.7)
$B(^5D_4) - B(^5D_3)$	30.3	30.6 (1.2)
$B(^5D_4) - \frac{252}{275} \cdot B(^5D_3)$	30.9	31.5 (4.8)
$B(^5D_4) - \frac{336}{275} \cdot B(^5D_2)$	50.2	46.1 (5.9)
$B(^5F_5)$	12.9	13.0 (1.5)

This seems to indicate an influence of a different Sternheimer-effect in the two configurations. As no calculations of Sternheimer-effect exist so far in the Os spectrum we give finally a mean value

$$Q(^{189}\text{Os}) = 0.91 (10) \times 10^{-24} \text{ cm}^2$$

taking the limits of error as large as to include the results in both configurations.

III. Investigations in Eu II and the nuclear quadrupole moments of ^{151}Eu and ^{153}Eu . — The measured transitions in Eu II are shown in figure 2 as fully drawn lines. All recordings were done using enriched samples of the stable isotopes and the double Fabry-Perot spectrometer. Figure 3 shows as an example the hyperfine structure and the hfs-level-scheme of the transition $4f^7 6p z^9 P_3 - 4f^7 6s a^9 S_4^0$ (λ 4 205 Å) for the isotope ^{151}Eu . According to the selection rules there are fifteen hyperfine components for one isotope. The six strongest components of the other isotope ^{153}Eu are drawn in the negative intensity direction to simplify the picture. The intensity ratio between the two isotopes corresponds to the mixture in the sample used for the investigations. The following five distances are the most interesting ones: $b - \beta$, $c - \gamma_2$, $d - \delta_2$, $e - \varepsilon_2$, and $f - \zeta_2$. They correspond to the hyperfine intervals of the $z^9 P_3$ level. The very small components γ_1 , δ_1 , ε_1 and ζ_1 can be neglected in a first approximation. The remaining components form groups of doublets consisting of a weak and a

(3) The A - and B -values are used in the following notation :

$$W_F = W_J + A C/2 + B \frac{3/4 C(C+1) - I(I+1) J(J+1)}{2 I(2I-1) J(2J-1)}$$

with $C = F(F+1) - I(I+1) - J(J+1)$.
 W_F = energy of the hyperfine level with quantum number F ;
 W_J = energy of the fine structure level with quantum number J .

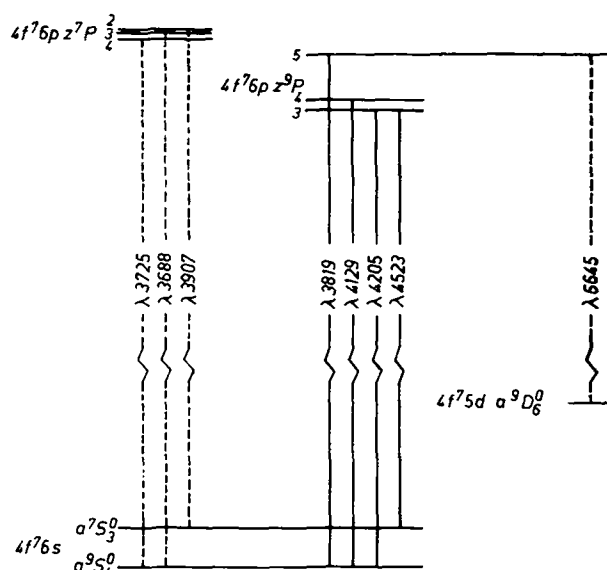

FIG. 2. — Part of the fine structure level scheme of Eu II. The investigated transitions are fully drawn.

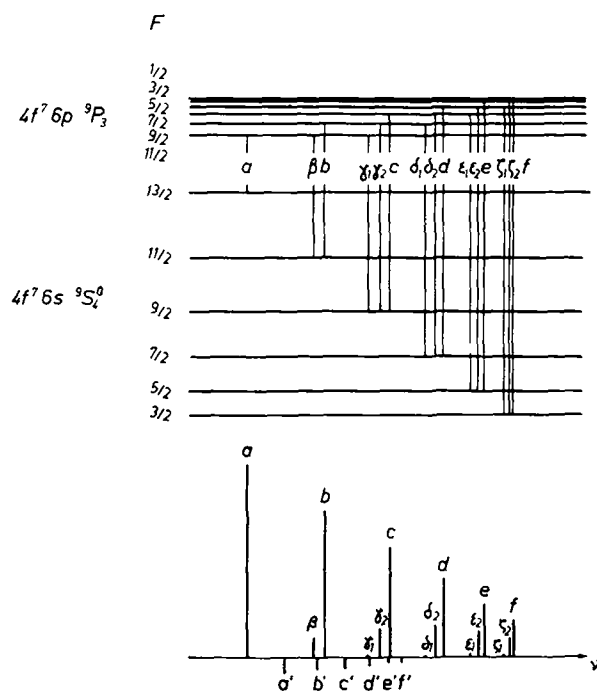

FIG. 3. — Hyperfine level scheme and hyperfine structure of the transition $4f^7 6p z^9 P_3 - 4f^7 6s a^9 S_4^0$ for the isotope ^{151}Eu . For simplicity the components of the other isotope ^{153}Eu are drawn inverted.

strong hyperfine component. Figure 4 shows part of two recordings of this line. The upper trace was made with one Fabry-Pérot. The strongest component is

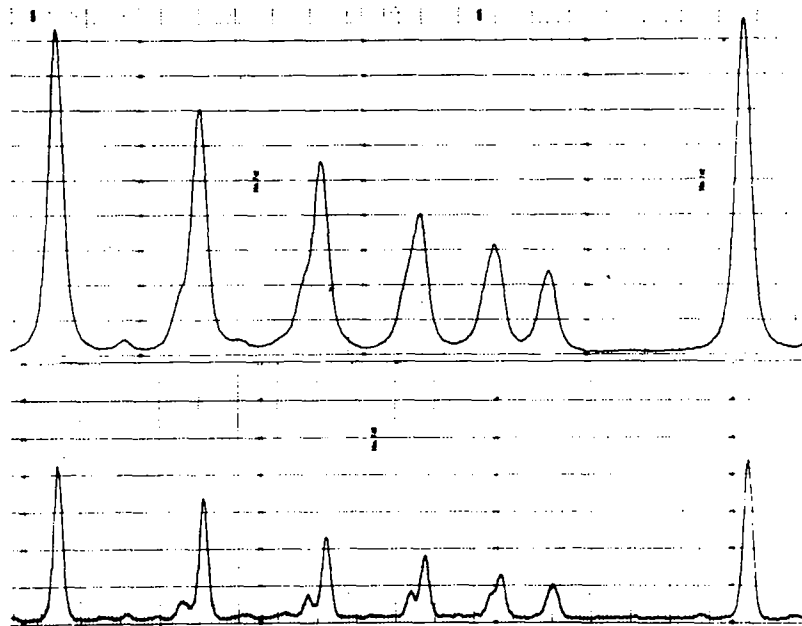

FIG. 4. — Hyperfine structure of the ^{151}Eu II line λ 4 205 Å. The wave number increases from left to right. The upper recording is made with one Fabry-Pérot (spacer : $d = 2,666$ mm). The lower recording is made with a double Fabry-Pérot (spacers : $d_1 = 2,666$ mm, $d_2 = 39,99$ mm).

repeated in the next order. The lower trace was obtained with a double Fabry-Perot. The ratio of the two spacers was 15 : 1 the smaller spacer being the same as used for the upper recording. The satellite-components β , γ_2 and δ_2 are partially resolved with the double Fabry-Perot. In addition to the hyperfine structure the ghosts [6] [7] of the double Fabry-Perot, belonging to the strongest components can be seen. The evaluation of the observed intensity distribution was done by a computer in the following way :

First the measured data points of the completely resolved strongest hyperfine component a including the first two neighbouring ghosts were fed into the computer and smoothed by a polynomial of second degree fitted to every five neighbouring data points. Figure 5 shows a smoothed curve, called the « normal line shape », and also the deviations between the measured data points and the normal line shape for one order.

Taking the normal line shape and the theoretical hyperfine intensities for each of the doublet separations an intensity-normalized superposition was calculated and fitted by a step by step least squares procedure to the corresponding data points, the doublet separation being the step-parameter. As an example figure 6 shows the variation of $\delta_2 - d$ and a distinct minimum of the sum of the residuals for a separation of about 40 mK. For this minimum situation figure 7

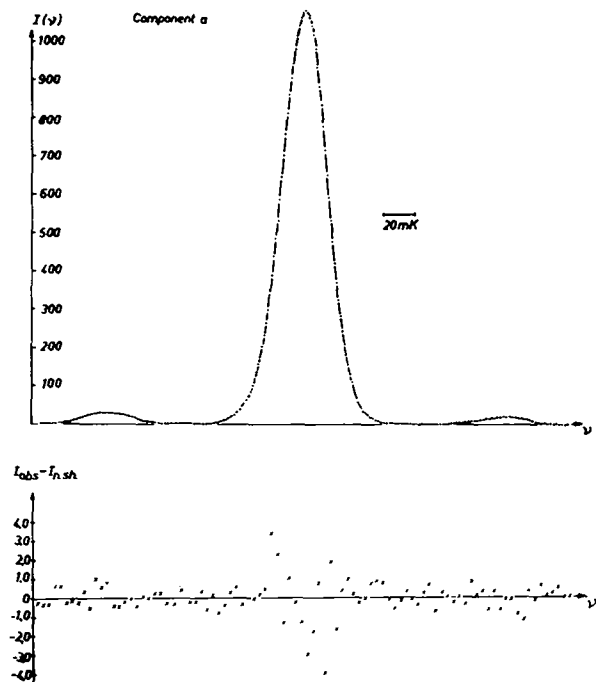

FIG. 5. — « Normal line shape » of one order of a double Fabry-Perot recording and the deviations between the data points and the normal line shape (see text).

shows the calculated profile in comparison with the measured profile. The crosses represent the data points

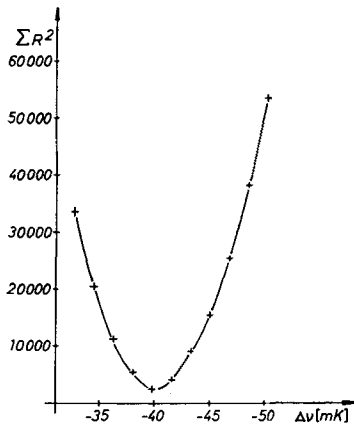

FIG. 6. — Sum of the residuals in arbitrary units as a function of the doublet separation $\Delta\nu = \delta_2 - d$.

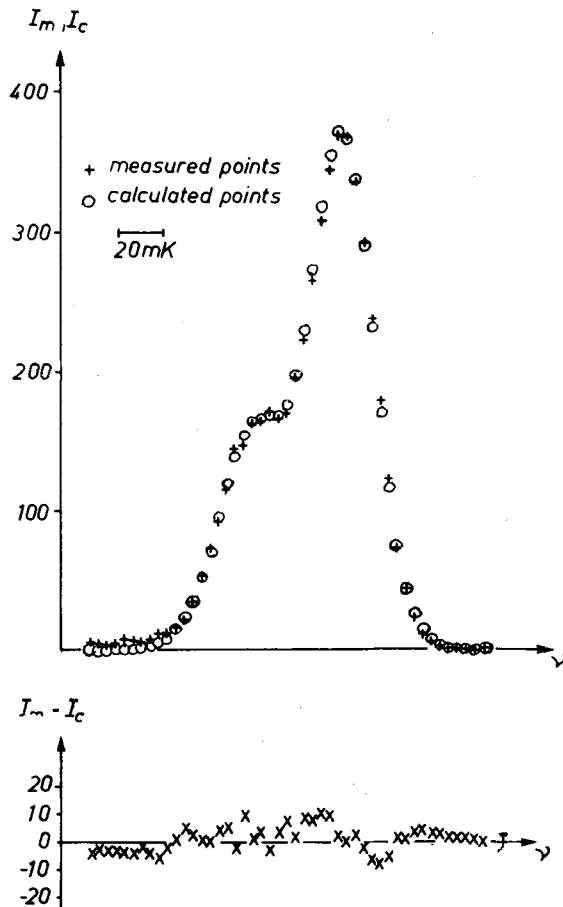

FIG. 7. — Upper part : data points (crosses) and calculated superposition values (circles) for one order of the doublet (δ_2, d) see Fig. 6). Lower part : Differences between measured and calculated points on an enlarged scale. For comparison the bar on the right indicates the rms noise amplitude for this doublet.

for one order, the circles are the calculated superposition values. The lower part of figure 7 shows on an enlarged scale the differences between the calculated and measured structure. These deviations are to be compared with the bar on the right, which gives the rms noise amplitude over the range of data points used.

For the evaluation of the exact doublet separation two corrections were made : (i) In the case of the doublets containing the components b and c the perturbing components of the other isotope have to be considered, (ii) neglect of the components $\gamma_1, \delta_1, \epsilon_1$ and ζ_1 has to be accounted for.

The mentioned procedure was repeated for each order. Taking fifty orders the final result for the separation $\delta_2 - d$ is 40.16 mK. The rms error is 0.08 mK. In this way the A - and B -values of the three 9P levels were evaluated.

Again a check was made on the eigenfunctions calculated for intermediate coupling in the $4f^7 6p$ configuration by Bordarier, Judd, and Klapisch [10]. For the description of the magnetic hyperfine interaction of this configuration the following radial parameters were used :

a_f representing the magnetic hyperfine interaction of the 4 f -core, a_{ps} the Fermi-contact interaction which is proportional to the spin operator s of the 6 p -electron, a_p the interaction between the nucleus and the magnetic field produced by the orbital motion of the 6 p -electron which is proportional to the orbital operator l of the 6 p -electron, $a_{p(sC)}$ the interaction between the magnetic dipole moments of the nucleus and the 6 p -electron which is proportional to the operator $(s^{(1)} C^{(2)})^{(1)}$.

In a first step a_{ps} and $a_{p(sC)}$ were expressed in terms of a_p assuming a common $\langle r^{-3} \rangle_{6p}$ for all parts of the hyperfine interaction. Table III shows the result

TABLE III

Calculated and observed A^{151} -values using only a_f and a_p as parameters (see text)

A^{151} -factors	A_{calc} [mK]	A_{obs} [mK]
$A(^9P_5)$	1.96	4.67 (13)
$A(^9P_4)$	7.11	6.95 (15)
$A(^9P_3)$	- 12.06	- 11.26 (07)
$A(^7P_4)$	1.43	1.76 (25)
$A(^7P_3)$	- 1.74	- 4.65 (20)

Resulting parameters

Expected values

$$a_f = - 1.97 (1.16) \text{ mK}$$

$$a_p = 24.44 (4.12) \text{ mK}$$

$$- 3.43 \text{ mK}$$

$$24.82 \text{ mK}$$

of a least squares fitting procedure of a_f and a_p to the measured A -values. The A -values of the two 7P levels have been measured by Krebs and Winkler [11].

Comparing the calculated and observed A -values listed in table III there are big discrepancies in all except the $J = 4$ levels. This causes the large rms errors of the resulting parameters and the deviation between the fitted and expected a_f . The expected a_f has been taken from the ENDOR-measurements by Baker and Williams [12] in the $4f^7$ ground state of Eu III. The expected a_p is calculated by means of the spin-orbit coupling constant ζ_{6p} and the known magnetic moment of ${}^{151}\text{Eu}$.

This unsatisfactory situation indicates a perturbation of the $4f^7 6p$ configuration. Indeed a configuration mixing between $4f^7 6p$ and $4f^6 5d 6s$ would have a considerable influence on the A -values of the levels of $4f^7 6p$ caused by the unpaired $6s$ -electron in $4f^6 5d 6s$. To take account for this possibility a second fit was carried out using the Fermi-contact part of the magnetic interaction of the $6p$ -electron as a third free parameter. Table IV shows the results of the three-parameter fit. Now good agreement between observed and calculated A -values is obtained. The big discrepancy between the fitted a_{ps} and expected a_{ps} demonstrates the configuration mixing the expected a_{ps} being calculated assuming a pure $4f^7 6p$ configuration.

TABLE IV

Calculated and observed A^{151} -values using a_f , a_p and a_{ps} as parameters (see text)

A^{151} -factors	A_{calc} [mK]	A_{obs} [mK]
$A({}^9P_5)$	4.88	4.67 (13)
$A({}^9P_4)$	6.95	6.95 (15)
$A({}^9P_3)$	- 11.31	- 11.26 (07)
$A({}^7P_4)$	1.38	1.76 (25)
$A({}^7P_3)$	- 4.43	- 4.65 (20)

Resulting parameters	Expected values
$a_f = - 3.20$ (20) mK	- 3.43 mK
$a_p = 26.4$ (6) mK	24.82 mK
$a_{ps} = 32.4$ (3.0) mK	- 2.5 mK

Fortunately a configuration mixing of this kind does not affect the radial part of the quadrupole interaction of the $6p$ -electron. Comparing a_p with the expected value there is a difference of 6 %, but a deviation in the same direction was found already

in Eu I [4]. Using the unperturbed eigenfunctions the following quadrupole moments are derived :

$$Q({}^{151}\text{Eu}) = 1.12 (07) \times 10^{-24} \text{ cm}^2,$$

$$Q({}^{153}\text{Eu}) = 2.85 (18) \times 10^{-24} \text{ cm}^2.$$

The quoted limits of error are chosen as to include the 6 % discrepancy between the fitted a_p and the a_p calculated using nuclear and fine structure data. Table V shows a comparison between the results of Müller, Steudel and Walther in the Eu I spectrum with the results in the second spectrum. Regarding the good agreement we give finally the following mean values for the quadrupole moments :

$$Q({}^{151}\text{Eu}) = 1.14 (07) \times 10^{-24} \text{ cm}^2,$$

$$Q({}^{153}\text{Eu}) = 2.88 (18) \times 10^{-24} \text{ cm}^2.$$

No Sternheimer corrections were applied to these values.

The intrinsic quadrupole moment of ${}^{153}\text{Eu}$ was determined to $Q_0({}^{153}\text{Eu}) = 7.01 (10) \times 10^{-24} \text{ cm}^2$ [13] [14]. Using the equation

$$Q = Q_0 I(2I - 1)/(I + 1) (2I + 3)$$

it follows for the spectroscopic quadrupole moment $Q({}^{153}\text{Eu}) = 2.50 (04) \times 10^{-24} \text{ cm}^2$. The discrepancy of 15 % between this value and the Q value derived from the hyperfine structure measurements is probably caused by the Sternheimer effect [15] [16] [17]. The Sternheimer atomic shielding factor $R_{6p} = - 0.15$ which is deduced from the experimental results on ${}^{153}\text{Eu}$ seems to be completely reasonable, since it is close to the values which Sternheimer has calculated for the excited np states of the alkalis [16] [18].

The support of the Deutsche Forschungsgemeinschaft is gratefully acknowledged.

TABLE V

Summary of the results in Eu I and Eu II

	Level	$Q({}^{151}\text{Eu})$ [b]	$Q({}^{153}\text{Eu})$ [b]
Eu I $4f^7({}^8S) 6s 6p$	$z {}^{10}P_{11/2}$	1.19 (07)	—
	$z {}^{10}P_{9/2}$	1.18 (05)	2.95 (10)
	$z {}^{10}P_{7/2}$	1.16 (09)	2.94 (12)
	$z {}^8P_{9/2}$	1.12 (05)	2.88 (10)
	$z {}^6P_{5/2}$	1.08 (08)	—
Eu II $4f^7({}^8S) 6p$	$z {}^9P_3$	1.02 (25)	2.91 (16)
	$z {}^9P_4$	1.24 (05)	2.98 (13)
	$z {}^9P_5$	1.12 (07)	2.65 (17)

References

- [1] MURAKAWA (K.), and KAMEI (T.), *Phys. Rev.*, 1957, **105**, 671.
- [2] MURAKAWA (K.), *J. Phys. Soc. Japan*, 1962, **17**, 991.
- [3] GLUCK (G. G.), BORDARIER (V.), BAUCHE (J.) and VAN KLEEF (Th. A. M.), *Physica*, 1964, **30**, 2068.
- [4] MÜLLER (W.), STEUDEL (A.) und WALTHER (H.), *Z. Physik*, 1965, **183**, 303.
- [5] KREBS (K.) und WINKLER (R.), *Naturwissenschaften*, 1960, **47**, 490.
- [6] KUHL (J.), STEUDEL (A.) and WALTHER (H.), *J. Physique*, 1967, **28**, C 2-308.
- [7] KUHL (J.), STEUDEL (A.) und WALTHER (H.), *Z. Physik*, 1966, **196**, 365.
- [8] BRIX (P.), *Z. Physik*, 1952, **132**, 579.
- [9] LOELIGER (H. R.) and SARLES (L. R.), *Phys. Rev.*, 1954, **95**, 291.
- [10] BORDARIER (Y.), JUDD (B. R.) and KLAPISCH (M.), Unpublished Material.
- [11] KREBS (K.) und WINKLER (R.), *Z. Physik*, 1960, **160**, 320.
- [12] BAKER (J. M.) and WILLIAMS (F. I. B.), *Proc. Roy. Soc.*, 1962, **A 267**, 283.
- [13] ELBEK (B.), Determination of Nuclear Transition Probabilities by Coulomb Excitation, Copenhagen 1963.
- [14] CARRIGAN (R. A.), Jr., GUPTA (P. D.), SUTTON (R. B.), SUZUKI (M. N.), THOMPSON (A. C.), COTÉ (R. E.), and PRESTWICH (W. V.), *Phys. Rev. Lett.*, 1968, **20**, 874.
- [15] STERNHEIMER (R. M.), *Phys. Rev.*, 1951, **84**, 244.
- [16] STERNHEIMER (R. M.), *Phys. Rev.*, 1957, **105**, 158.
- [17] STERNHEIMER (R. M.), *Phys. Rev.*, 1967, **164**, 10.
- [18] STERNHEIMER (R. M.), private communication.

PROGRESS IN AUTOMATIC MEASURING OF SPECTRAL PLATES

R. HOEKSTRA, P. J. G. KRUIVER AND R. SLOOTEN

Zeeman-Laboratorium, Amsterdam

Résumé. — Le travail qui a été exposé est la continuation de ceux qui ont été décrits par [1], [2]. Les résultats nouveaux seront prochainement publiés dans *Physica*.

Abstract. — This is a continuation of the work described in [1], [2]. The new results will be published in *Physica*.

Bibliographie

- [1] STEINHAUS (D. W.), ENGLEMAN (R. Jr.) and BRISCOE (W. L.), *Appl. Opt.*, 1965, **4**, 799.
- [2] HOEKSTRA (R.), *Appl. Opt.*, 1967, **6**, 807.