



HAL
open science

DISLOCATION DIPOLES AND DISLOCATION LOOPS

F. Kroupa

► **To cite this version:**

F. Kroupa. DISLOCATION DIPOLES AND DISLOCATION LOOPS. Journal de Physique Colloques, 1966, 27 (C3), pp.C3-154-C3-167. 10.1051/jphyscol:1966320 . jpa-00213130

HAL Id: jpa-00213130

<https://hal.science/jpa-00213130>

Submitted on 4 Feb 2008

HAL is a multi-disciplinary open access archive for the deposit and dissemination of scientific research documents, whether they are published or not. The documents may come from teaching and research institutions in France or abroad, or from public or private research centers.

L'archive ouverte pluridisciplinaire **HAL**, est destinée au dépôt et à la diffusion de documents scientifiques de niveau recherche, publiés ou non, émanant des établissements d'enseignement et de recherche français ou étrangers, des laboratoires publics ou privés.

DISLOCATION DIPOLES AND DISLOCATION LOOPS

F. KROUPA

Institute of Physics, Czechosl. Acad. Sci. Viničná 7, Prague 2

Résumé. — L'auteur présente les idées théoriques de base relatives aux propriétés de deux configurations de dislocation particulières, les dipôles de dislocation et les boucles de dislocation prismatiques. Il donne aussi ses résultats récents fondés principalement sur l'application du modèle du continuum élastique à ces défauts cristallins. Il discute l'influence des dipôles et des boucles sur diverses propriétés mécaniques.

Abstract. — Basic theoretical ideas on the properties of two special dislocation configurations, dislocation dipoles and prismatic dislocation loops, are presented. Some of the author's recent results, based mostly on the application of the model of elastic continuum on these crystalline defects, are also given. The influence of dipoles and loops on different mechanical properties is discussed.

1. Introduction. — Basic theoretical ideas on the properties of two special dislocation arrangements will be reviewed : dislocation dipoles (i. e. pairs of parallel dislocations with opposite Burgers vectors) and prismatic dislocation loops (i. e. dislocation loops with Burgers vectors that do not lie in the loop planes). These arrangements have been observed in crystalline materials by transmission electron microscopy after different kinds of treatment : the dipoles after plastic deformation, the prismatic loops after quenching, irradiation, and after plastic deformation.

The density of these defects is often very high. Therefore, they can influence considerably the mechanical as well as some other physical properties of crystalline materials.

Some properties of the dipoles and prismatic loops are rather similar : e. g. their stress field decreases more quickly with distance than that of straight individual dislocations, which leads to a much weaker mutual elastic interaction and to the possibility of formation of a very high local density of these defects ; both of them can disappear by climbing at elevated temperatures. In fact, dipoles can be described as elongated prismatic loops. Therefore, it may be useful to review both these defects simultaneously.

More attention will be given to the dipoles, and only some analogical properties of the prismatic loops will be mentioned.

Basic properties of the dipoles and their influence on the physical properties have recently been reviewed by Gilman [1]. In the present paper, some new results for dipoles, based mostly on the application of the

model of elastic continuum, will be pointed out. Recently, the elastic properties of dislocation loops have been similarly reviewed by the author [2].

2. Formation of dipoles and prismatic loops. — The actual forms of dislocations differ considerably from the idealization mostly used in the theory of dislocations — from the straight infinite dislocation.

Dislocations in as-grown or in well annealed single crystal form two-dimensional nets in the mosaic block boundaries and three-dimensional nets inside the mosaic blocks. The main part of the dislocations formed during the plastic deformation or during the different thermal treatment is in the form of loops.

By a *dislocation loop* we understand a dislocation whose dislocation line is closed inside the crystal.

The dislocation loops are usually formed in special crystallographic planes and according to the relative position of the Burgers vector and the loop plane they can be divided into two groups (Fig. 1) :

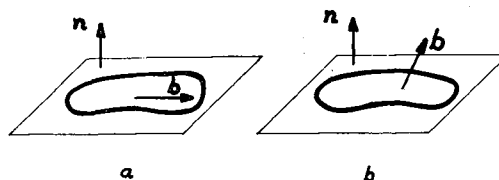

FIG. 1. — Dislocation loops : a) slip loop, b) prismatic loop.

i) *slip loops*, the Burgers vector of which lies in the loop plane,

ii) *prismatic loops*, the Burgers vector of which does not lie in the loop plane.

Slip loops are usually formed in slip planes under external shear stress, e. g. by Frank-Read source mechanism or by stress concentration on non-homogeneities. These loops can further extend by gliding and reach dimensions of a few μ up to 100μ ; in single crystals of pure metals they may be even larger.

During the expansion of loops in the slip planes, *dislocation dipoles* are formed by different processes [3]. Two of them seem to be most important :

i) When parts of two loops pass one over another in parallel slip planes close to each other (Fig. 2), they

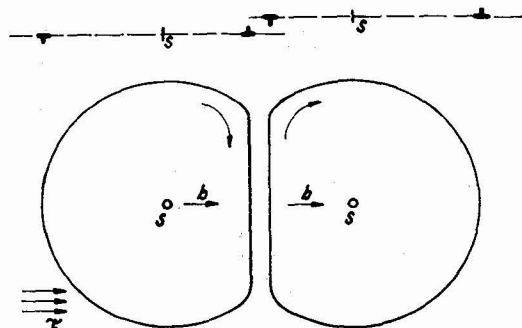

FIG. 2. — Dipole formation by dislocations gliding in parallel slip planes.

can reorientate into a parallel section and, thus, form a stable configuration. This configuration, i. e. two parallel dislocation segments with opposite Burgers vectors (in other words : two antiparallel segments with the same Burgers vectors) is called a dislocation dipole. It can be expected that the dipoles will be formed mostly by edge dislocations because two screw segments can easily annihilate by a cross slip, especially in metals with a high stacking fault energy.

This mechanism of dipole formation seems to be very frequent at the beginning of plastic deformation when a great number of dislocation loops expand in parallel slip planes.

ii) Dipoles can also be formed by the motion of screw dislocations with large jogs (Fig. 3) with a jog length of at least several Burgers vectors. Similar jogs can be formed by the cross slip of parts of the screw dislocation or by the concentration of unit jogs formed by intersection with other dislocations. The jogs have an edge orientation and cannot glide with the screw dislocation. As a result, cusps and edge dislocation dipoles are left behind the gliding screw dislocation.

Dipoles formed by these two mechanisms in Cu are shown in figure 4 adopted from [4].

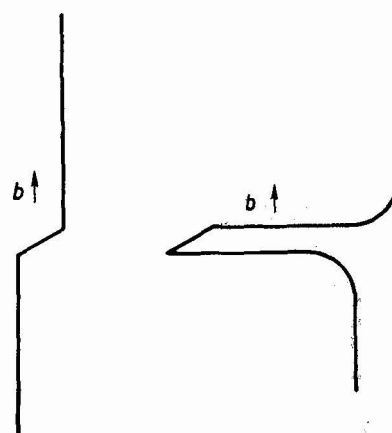

FIG. 3. — Dipole formation by motion of screw dislocations with large jogs.

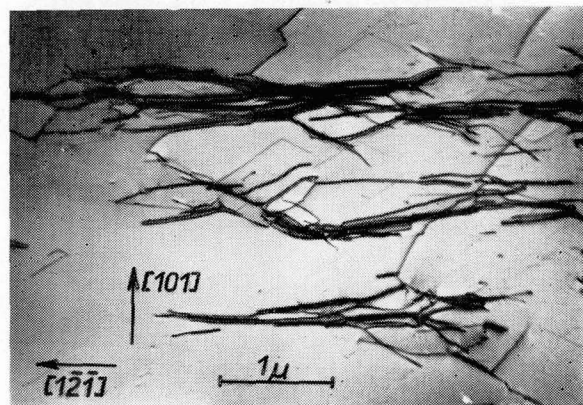

FIG. 4. — Dipoles in Cu (Z. S. Basinski [4]).

Typical heights of dipoles observed are 100 to 1 000 Å.

Dipoles formed by the first process should be originally open at both ends, those formed by the second mechanism should be originally open at one end. However, the dipoles can be terminated by different slip processes [5, 6] or by climbing [7, 8]. Shorter segments of dipoles, terminated at both ends and left behind the screw dislocations, are often called dislocation debris. Figure 5 shows an example of debris formed in deformed silicon-iron crystals [9].

They can be also called «elongated» prismatic dislocation loops because the longer dislocation segments lie in different slip planes and, therefore, the Burgers vector cannot lie in the plane of the debris.

The dipole distribution in strongly deformed metals will be complicated (Fig. 6) : bundles of dipoles formed by the meeting of dislocations from neighbouring



FIG. 5. — Dipoles in Fe-3 % Si alloy (A. Gemperle [9]).

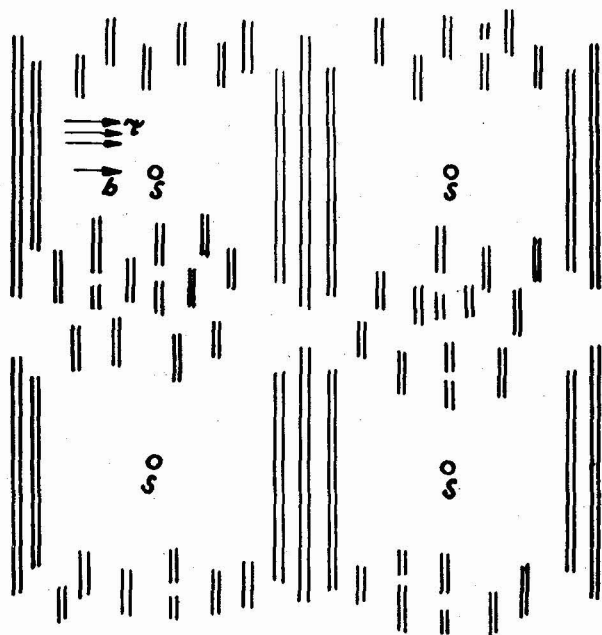

FIG. 6. — Distribution of dipoles in deformed crystals (schematically; plane parallel to the slip plane).

sources and dislocation debris left behind the moving screw dislocations; a lot of screw dislocations from neighbouring sources will annihilate. In combination with the remaining individual dislocations and different intersections and reactions with dislocations from

secondary slip systems, dipoles will begin to form complicated dislocation tangles.

Different processes of formation of *prismatic dislocation loops* will now be summarized. The most important mechanism, the precipitation of point defects, was first proposed by Nabarro in 1947 [10]. He assumed that the vacancies precipitate in special crystallographic planes and form discs. A prismatic dislocation loop can then be formed by the collapse of the vacancy disc (Fig. 7). A prismatic loop can

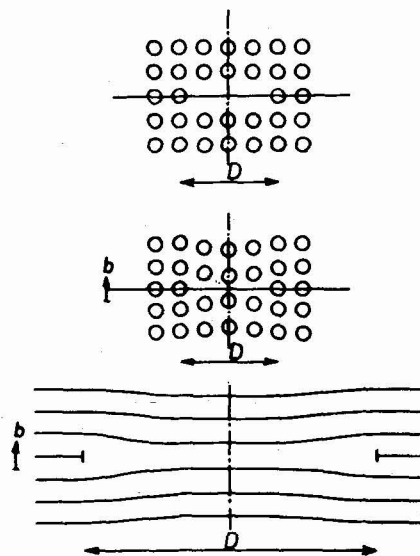

FIG. 7. — Formation of prismatic dislocation loop (schematically).

glide along its slip prism or slip cylinder. In its plane a prismatic loop can only move, expand or contract by climbing, i. e. by diffusion of point defects.

Prismatic dislocation loops have already been observed in different metals by transmission electron microscopy, first in aluminium in 1958 [11]. They are formed after quenching, which produces a high over-saturation of vacancies, and during subsequent annealing, which enables diffusion and precipitation of vacancies to take place. Typical diameters of these loops are a few hundred Å and their maximum density is 10^{15} to 10^{16} loops/cm³, which corresponds to a dislocation line density of 10^{10} to 10^{11} per cm².

Prismatic dislocation loops can also be formed by precipitation of interstitial atoms in irradiated crystal [12].

The process of point defect precipitation depends on the type of point defects, the crystal structure, the stacking fault energy, the content of impurities, the density and distribution of dislocations, the specimen

or grain size, and on different conditions, e. g. the quenching temperature, quenching rate, and ageing temperature.

For example, in f. c. c. metals the disc of vacancies formed on the most densely packed atomic plane (111) (Fig. 8) will collapse first into a prismatic dislocation

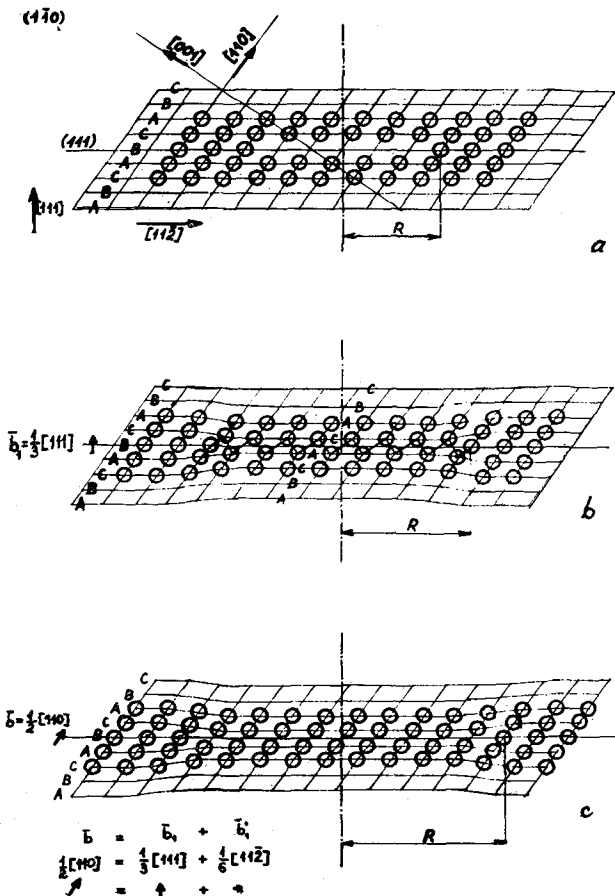

FIG. 8. — Collapse of a disc of vacancies in a f.c.c. metal (a) into a partial dislocation loop (with stacking fault) (b) and its transformation into a complete dislocation loop (without stacking fault) (c).

loop with the Burgers vector $(1/3)$ $[111]$ enclosing a stacking fault. After a further growth by precipitation of vacancies, this partial dislocation loop may change into a complete dislocation loop with the Burgers vector $(1/2)$ $[110]$ without a stacking fault and so decrease its total energy. The critical radius for this change is approximately proportional to $1/\gamma$ where γ is the stacking fault energy. Therefore, in metals with a high stacking fault energy, e. g. in Al, all loops should be without stacking faults.

In fact, in aluminium of purity up to 99.99 %, only complete prismatic loops have been observed.

Surprisingly, it has been recently found that in very pure aluminium (99.999 %) prismatic loops with stacking faults and with radii up to 1000 Å are formed after quenching [13]. This can be explained by the fact that for transforming a partial prismatic loop into a complete one, nucleation of a slip loop with the Burgers vector $(1/6)$ $[112]$ in the loop plane is necessary. In low purity metals, the non-homogeneities cause this nucleation. In very pure metals, the above simple condition for the critical radius cannot be used. The process of nucleation and growth of the additional slip loop and the energy barrier connected with this process have to be taken into account [14].

Other defects can also be formed in f. c. c. metals after quenching. In metals with a very low stacking fault energy, the tetrahedra of stacking faults on (111) planes have been observed, e. g. in gold [15]. It has been shown [16] that their energy is lower than that of the prismatic loops with stacking faults.

In quenched Al-4 % Cu alloy [17] most vacancies precipitate on dislocations and transform the screw dislocations, previously straight, into helical dislocations. This may be due to the difficult nucleation of the loops in this alloy.

Recently, also larger cavities with regular shapes have been observed in quenched aluminium [18]; their formation can be explained by the presence of gas impurities.

Of course, prismatic dislocation loops can be formed not only by point defect precipitation but also by the so-called punching effect during annealing [19] or pressurization [20] of crystals containing precipitates, and, moreover, during plastic deformation as the already mentioned dipole debris. Surprisingly, stacking fault tetrahedra have recently been also found in different plastically deformed f. c. c. metals [21] with low stacking fault energy. They are probably formed on split jogs on the moving screw dislocations and can also be called debris.

There are, therefore, some new surprising results concerning the formation of loops and precipitation of point defects in f. c. c. metals which have been so far mostly investigated, and other new results can be expected.

Much less is known about similar problems in h. c. p. and b. c. c. metals. For example, no prismatic loops have been found in quenched b. c. c. metals, but different loops have been already found in irradiated b. c. c. metals, e. g. in iron [22], which are probably formed by interstitials.

It can be concluded that the problems of precipita-

tion of point defects are far from being completely solved and that the main interest shifts from f. c. c. to h. c. p. and especially to b. c. c. metals, similarly as in the problems of plastic deformation.

3. Basic properties of dipoles.

3.1 DIPOLES WITHOUT EXTERNAL STRESS FIELD. — For the sake of simplicity, let us consider an infinitely long edge dipole in an infinite elastic isotropic continuum (Fig. 9a). Because of elastic interaction, the

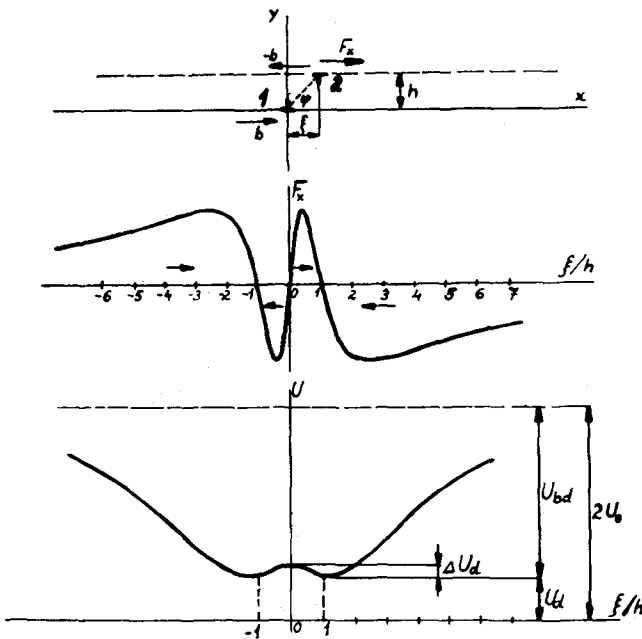

FIG. 9. — a) Edge dislocation dipole. b) Force from dislocation 1 on dislocation 2. c) Total elastic energy of a dipole.

two dislocations forming the dipole influence each other by forces given by the Peach-Koehler formula [3]; these forces have components in the slip plane as well as perpendicular to the slip plane.

3.1.1 At low temperatures, the dislocations can only move in their slip planes and the elastic interaction leads to three equilibrium configurations of the dipole. They are apparent from the dependence of the force F_x which dislocation 1 exerts on a unit length of dislocation 2 (Fig. 9b), and from the dependence of the total elastic energy per unit length of the dipole (Fig. 9c). There are two stable equilibrium positions for $\xi/h = \pm 1$ (i. e. for $\varphi = \pm 45^\circ$) and one unstable position for $\xi = 0$ (i. e. for $\varphi = 90^\circ$). Without an external stress field, the dipole will occupy one of the two stable equilibrium positions. For this

stable arrangement, the total elastic energy (per unit length) is approximately

$$U_d \approx Db \ln(h/b) \tag{1}$$

where $D = Gb/[2\pi(1-\nu)]$, G is the shear modulus and ν the Poisson ratio. The energy of two independent straight dislocations (per unit length) is

$$2U_0 \approx Db \ln(R/b) \tag{2}$$

where R is the outer radius of the body. The binding energy (per unit length) with respect to gliding is, therefore,

$$U_{bd} = 2U_0 - U_d \approx Db \ln(R/h). \tag{3}$$

When the height of the dipole h is small, e. g. between 10 to 100 b , the total energy of the dipole will be much smaller than that of two independent dislocations, and the dipole binding energy will be very high, of the order of 10 eV per atomic plane.

The two positions of stable equilibrium are separated by the unstable equilibrium position with a local energy maximum. In order to change the orientation of the dipole, e. g. from $\varphi = +45^\circ$ to $\varphi = -45^\circ$, the energy barrier (per unit length)

$$\Delta U_d = Db[(1/2) - \ln\sqrt{2}] \approx 0.154 Db \tag{4}$$

must be overcome. This energy is called the flipping energy; it does not depend on the dipole height h and is of the order of 0.1 eV per atomic plane.

The high stability of the dipole is due to the fact that the stresses of both dislocations of opposite sign practically cancel at large distances. More precisely, the dipole stress field σ_{ij} (Fig. 10) can be written as a sum of stresses of both dislocations

$$\sigma_{ij}(r) = \sigma_{ij}^{(1)}(r) + \sigma_{ij}^{(2)}(r) = \sigma_{ij}^{(1)}(r) - \sigma_{ij}^{(1)}(r - a). \tag{5}$$

For large distances, i. e. for $|r| \gg |a|$, it follows that

$$\sigma_{ij} = a \cdot \text{grad } \sigma_{ij}^{(1)} = \xi(\partial\sigma_{ij}^{(1)}/\partial x) + h(\partial\sigma_{ij}^{(1)}/\partial y). \tag{6}$$

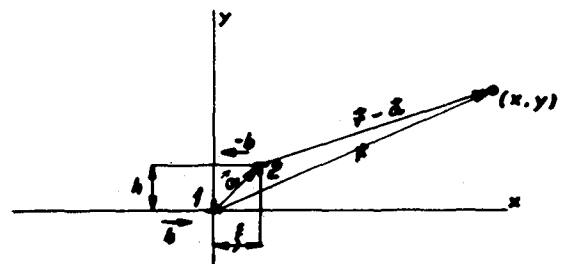

FIG. 10. — Dipole stress field as a sum of stress fields of two dislocations.

The long range dipole stress field is expressed in this equation by means of the stress gradients of one edge dislocation. Since the stress field of a dislocation decreases with the distance r as $1/r$, it simply follows that the long range stress field of a dipole decreases as $1/r^2$.

The stress field in the close neighbourhood of the dipole is complicated. Only the stress field at the centre of the dipole will be mentioned (Fig. 11). It is

$$\begin{aligned} \sigma_{xx} &= \pm \frac{G}{\pi(1-\nu)} \frac{b}{h}, \quad \sigma_{yy} = 0, \quad \sigma_{xy} = 0, \\ \sigma_{xz} = \sigma_{yz} &= 0, \quad \sigma_{zz} = \pm \frac{\nu G}{\pi(1-\nu)} \frac{b}{h}, \end{aligned} \quad (7)$$

where the + sign holds for the extensional dipoles (Fig. 11a), and the — sign for the compressional dipoles (Fig. 11b). The stress components σ_{xx} of both

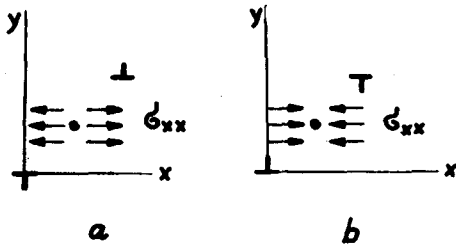

FIG. 11. — Stress field at centre of:
a) extensional dipole, b) compressional dipole.

dislocations do not cancel in the centre, on the contrary they add. Thus in the case of extensional dipoles there is a large tensile stress; for $h/b \approx 10$ to 100, $\sigma_{xx} \approx G/20$ to $G/200$. Consequently, places with a high density of extensional dipoles represent a weakening of the crystal and can become nuclei of fracture.

3.1.2 The elastic interaction also leads to non-zero force components perpendicular to the slip planes (Fig. 12). The corresponding motion of the two dislocations out of the slip plane is only possible by *climbing*, i. e. at elevated temperatures.

According to the Peach-Koehler formula, the force F_y (on unit elements) which dislocation 1 exerts on dislocation 2, is

$$F_y = b\sigma_{xx}^{(1)}. \quad (8)$$

In accordance with a recent paper by Weertman [23], the deviator stress components should be used instead of the stress components in the Peach-Koehler formula

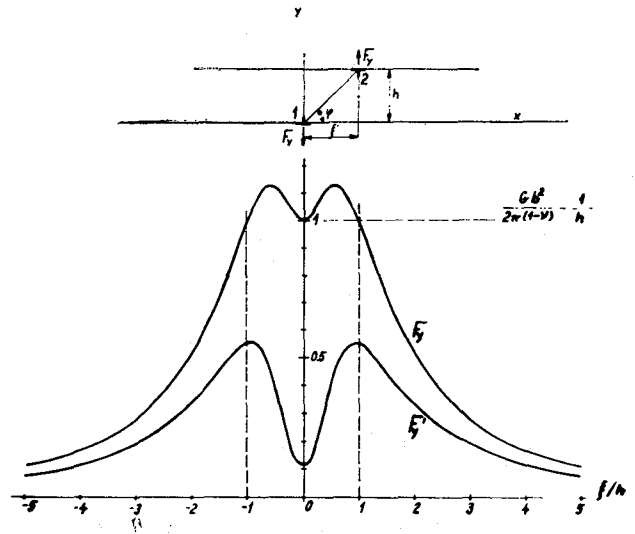

FIG. 12. — Dependence of force F_y (from Peach-Koehler equation) and of F'_y (from equation modified by Weertman) on ξ . Force is given in units

$$\frac{Gb^2}{2\pi(1-\nu)} \frac{1}{h}.$$

because the hydrostatic stress cannot make the dislocations climb; if it is so, instead of (8) we obtain for the force

$$F'_y = b[\sigma_{xx}^{(1)} - (1/3)(\sigma_{xx}^{(1)} + \sigma_{yy}^{(1)} + \sigma_{zz}^{(1)})]. \quad (8')$$

The dependence of F_y and F'_y is shown in figure 12. The two dislocations attract each other in the y direction in all mutual positions. For the equilibrium position, $\xi = \pm h$, it follows that

$$F_y = \beta \frac{Gb^2}{2\pi(1-\nu)} \frac{1}{h} \quad (9)$$

where $\beta = 1$ for the original formula, and $\beta = (2-\nu)/3$ for the modified Peach-Koehler formula.

Under this driving force, climbing is made possible by diffusion of vacancies to or from jogs on the dislocations. The compressional dipoles will absorb vacancies and the extensional dipoles will emit them.

The velocity v of the climbing of each of the two dislocations is, according to [3],

$$v = -(1/2) (dh/dt) = \alpha v_0 (b^2/L) e^{-U_D/kT} [e^{F_y b^2/kT} - 1] \quad (10)$$

where α is the atomic coordination number, v_0 an atomic frequency, L the mean distance between the jogs, U_D the activation energy of self-diffusion.

After integrating [10], the time dependence of the

dipole height h , at constant temperature T , can be found. This dependence is plotted in figure 13; the time t_0 necessary for the dipole annihilation is called the life time of the dipole.

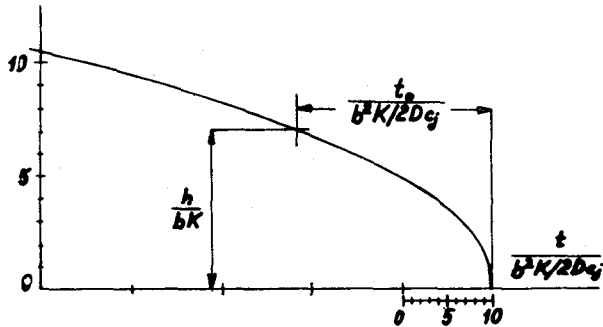

FIG. 13. — Dipole width h as a function of time t at a constant temperature T . Non-dimensional arguments are used ($K = Gb^3/[2\pi(1-\nu)kT]$, $c_j = b/L$, D is self-diffusion coefficient).

It should be stressed that the above concept of the dipole annihilation is rather a simplified one.

The process of approach of dislocations is obviously unstable along the dipole. When the jog density $c_j = b/L$ locally increases, the velocity of climbing also increases and this will lead to local annihilation of the short parts of the dipole, i. e. to the formation of the dipole *constrictions*. The decomposition of a long dipole into a shorter dipole debris can be expected in the first stage of annihilation, in the second stage, the debris will preferentially annihilate from the ends. This complicated process can be very roughly described by the gradual approach of the two straight dislocations with an effective value of the jog density c_j of the order of $1/2$.

In some metals, e. g. in Zn [7], the decomposition into shorter debris is due to the pipe-diffusion. Without doubt, the bulk diffusion is responsible for further annihilation of the debris.

The dipole annihilation may be one of the important processes in the mechanism of creep. A corresponding model has been proposed by Chang [24]: the dipole formation causes hardening, while dipole annihilation causes recovery.

3.2. DIPOLES IN A STRESS FIELD.

3.2.1 Consider the *homogeneous* external shear stress σ_{xy}^E . It exerts on the individual dislocations, composing the dipole, forces $F_x^{(1)} = -F_x^{(2)} = b\sigma_{xy}^E$ which are equal and of opposite sign: there is no net force exerted on a dipole in a homogeneous stress

field while the individual dislocations tend to move in opposite directions.

Two different cases can take place (Fig. 14), which

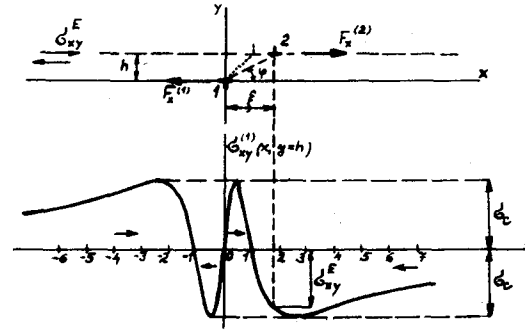

FIG. 14. — Dipole polarization or decomposition in external stress field σ_{xy}^E .

depends on whether the value of σ_{xy}^E is smaller or larger than the maximum value of the stress component $\sigma_{xy}^{(1)}$ from dislocation 1 in the slip plane of dislocation 2, which is expressed by

$$(\sigma_{xy}^{(1)})_{\max} = \sigma_c = \frac{G}{8\pi(1-\nu)} \frac{b}{h}. \quad (11)$$

When $\sigma_{xy}^E < \sigma_c$, only the equilibrium distance ξ of the dipole will change; the dipole will polarize but will keep its stable equilibrium. When $\sigma_{xy}^E > \sigma_c$, the dipole is not stable any more and the two dislocations will separate and move to infinity; the dipole will decompose. The same critical stress is necessary for flipping a perfect dipole. The binding stress σ_c is a function of the dipole height h . In a given external shear stress σ_{xy}^E only those dipoles remain stable for which

$$\frac{h}{b} < \frac{1}{8\pi(1-\nu)} \frac{G}{\sigma_{xy}^E} \approx \frac{G}{16\sigma_{xy}^E}. \quad (12)$$

3.2.2 If the applied stress field σ_{xy}^E is *non-homogeneous* (i. e. if it depends on x or y), the net force $F_x^{(d)} = F_x^{(1)} + F_x^{(2)}$ on the dipole, is generally non-zero and the dipole can also move as a whole. For small gradients of the external stress, the force $F_x^{(d)}$ can be written in the form

$$F_x^{(d)} = \pm b[(\partial\sigma_{xy}^E/\partial x)\xi + (\partial\sigma_{xy}^E/\partial y)h], \quad (13)$$

where the + sign holds for the extensional dipoles and the - sign for the compressional ones. It can be concluded that the dipoles will not move as a whole in the external stress field, which is usually homogeneous, but can move as a whole in the stress field of

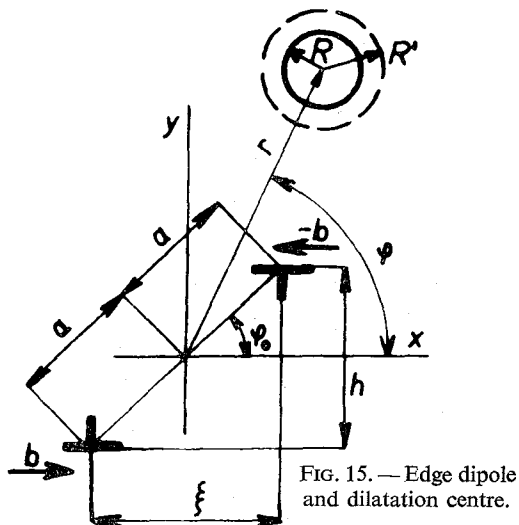

FIG. 15. — Edge dipole and dilatation centre.

other defects (especially of dislocations) which is always non-homogeneous.

4. Interaction between dipoles and other defects.

4.1. DIPOLES AND POINT DEFECTS — Let us consider the simplest possible model of a point defect, the so-called dilatation centre, i. e. a sphere with the radius R' inserted into a spherical cavity with the radius R (Fig. 15). The interaction energy between a dilatation centre and the dipole stress field, and the trajectories of the motion of a dilatation centre in the dipole stress field can be easily calculated [25]; they are shown in figure 16 for a dipole in the equilibrium position.

The time dependence of the drift of the dilatation centres to the dipoles, due to the elastic interaction,

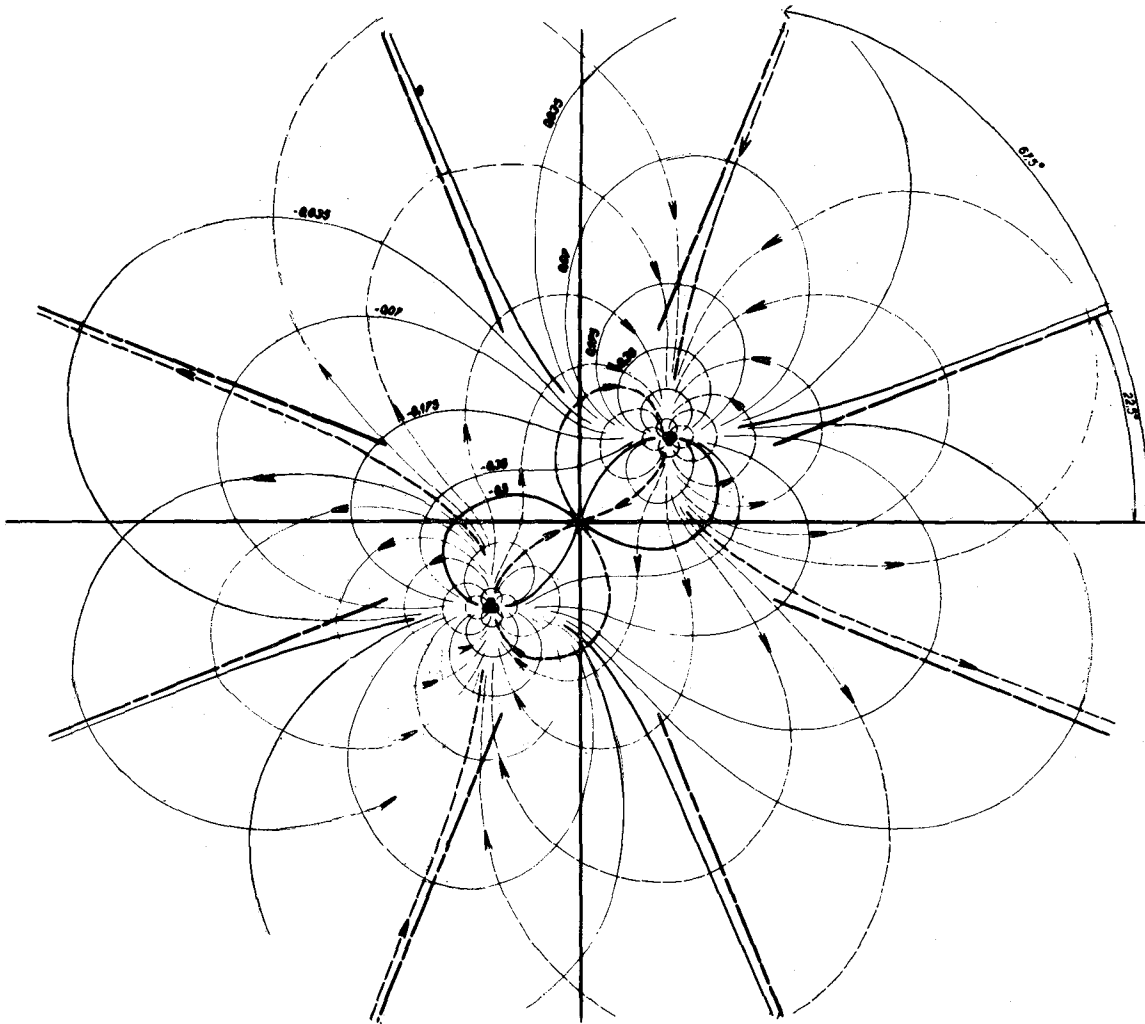

FIG. 16. — Curves of constant interaction energy E_{int} between dipole and dilatation centre (solid lines; numbers give E_{int} in non-dimensional units). Trajectories of dilatation centre (dashed lines).

can be solved in a similar way as Cottrell and Bilby [26] have done for individual dislocations. If only the long-range dipole stress field is considered, we get the law for the dipoles in the form $n \sim t^{1/2}$ (where n is the number of dilatation centres, e.g. of impurities that arrive at the dipoles between the times 0 and t) instead of the Cottrell and Bilby's law for individual dislocations, $n \sim t^{2/3}$. It should be emphasized that these calculations based on the elastic interaction only, without taking into account the diffusion due to concentration gradients, are only valid for the initial stage of diffusion.

From our results it can be concluded that the time dependence of the diffusion of impurities to the dislocations and, therefore, also the time dependence of ageing of some alloys depends, in the initial stage, on the dislocation distribution and, in the case of a high density of dipoles, the $t^{1/2}$ law can also be expected.

4.2 DIPOLES AND STRAIGHT DISLOCATIONS. — Let us discuss separately the cases when the dipoles and dislocations are parallel and non-parallel.

4.2.1 The elastic interaction between dipoles and parallel dislocations has recently been discussed in detail [27].

A dipole, together with another straight parallel dislocation, can form a stable configuration called a tripole; four possible types are shown in figure 17.

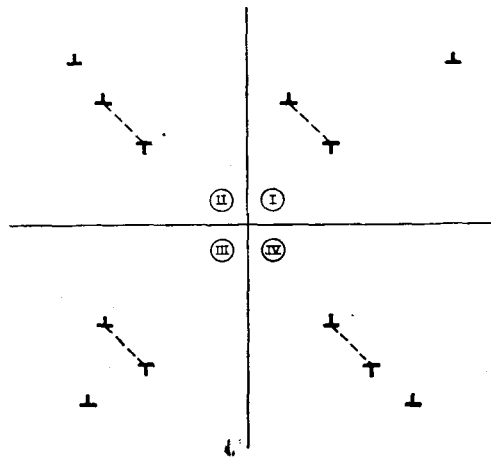

FIG. 17. — Four general types of edge dislocation dipoles (Chen, Gilman, and Head [27]).

It can be shown again that the tripoles are very stable when the distances between the slip planes of individual dislocations are small. The main difference between the properties of the dipoles and tripoles follows from the fact that a tripole has a non-zero resultant

Burgers vector equal to one b . Thus it can move as a whole also in a homogenous stress field, and its long-range stress field is practically equal to that of one dislocation.

A tripole can trap another dislocation and form a new stable configuration — a quadrupole; one example of a special, very stable quadrupole is shown in figure 18. In a similar way, higher order multipoles

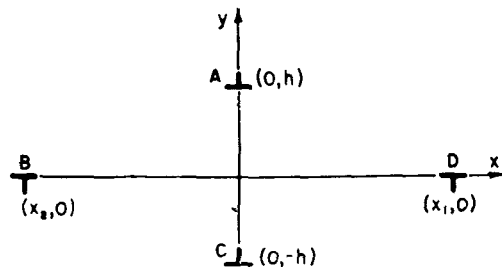

FIG. 18. — Symmetric quadrupole (Chen, Gilman, and Head [27]).

can be formed. Again, they represent a stable configuration with much lower stress field than that of n randomly distributed dislocations. The binding stress, necessary for their decomposition by gliding, is approximately equal to that for decomposition of the dipoles.

In an external stress field σ_{xy}^E , the multipoles with an average height h between the slip planes,

$$h/b < G/16 \sigma_{xy}^E,$$

remain stable. During the plastic deformation, further dislocations are trapped by multipoles and the local density of dislocations in multipoles can be expected to be extremely high.

One terminological remark can be added; an isolated dislocation could also be called a dislocation monopole. This term seems to be interesting but superfluous.

The trapping of gliding dislocations during the plastic deformation and the formation of stable configurations, and a high density of dipole debris inhibit the motion of dislocations and lead to a strain hardening. Gilman has shown [28,27] that this hardening should be linear. Of course, a detailed theory of work hardening cannot be based only on the formation of dipoles. It should also take into account the interaction with dislocations from other slip systems the influence of other dislocation configurations, e.g. dislocation pile-ups, the specific dislocation properties in special crystal structures, e.g. the splitting of dislocations, and it should explain the formation of the cell-substructure.

On the other hand, any detailed theory of work hardening should also consider the influence of dipoles because, as experiments show, their density, e.g. in plastically deformed metals, is very high and, sometimes, a majority of dislocations is in the form of dipoles and multipoles.

For instance, dipoles are considered in a recent Hirsch's theory of linear strain hardening [29] : bundles of dipoles form long obstacles which block dislocation loops emitted from sources and start the formation of cell-substructure.

4.2.2. Let us now consider a dipole and a *non-parallel* dislocation in an infinite medium (Fig. 19).

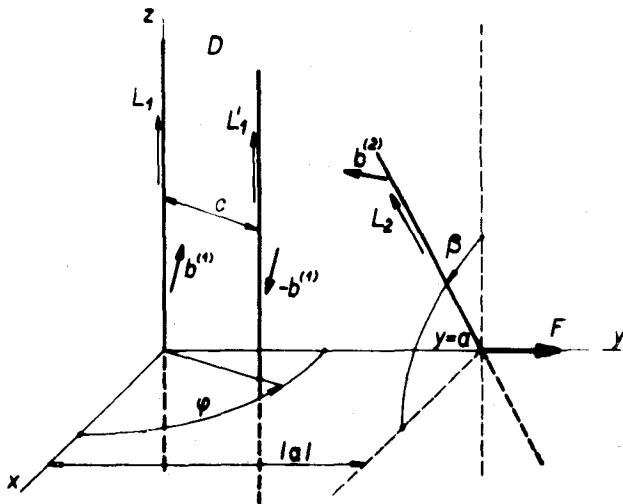

FIG. 19. — Dipole and non-parallel dislocation.

When the dislocation L_2 moves in the stress field of the dipole D , the distribution of the forces on unit elements of L_2 changes in a complicated way, but very simple conclusions can be drawn for the total force F (which is an integral of forces on elements along the whole dislocation).

When the dislocation L_2 does not intersect the ribbon between the two dislocations L_1, L_1' forming the dipole, the total force is exactly zero. When the dislocation L_2 intersects the above mentioned ribbon the total force F is generally non-zero and constant; it does not depend on the exact position « inside » the dipole. It acts in the direction of the shortest distance between L_2 and L_1 , i. e. only the F_y component is non-zero.

The following conclusion follows for the theories of hardening : the contribution to the hardening of the elastic interaction between the dipoles and non-parallel dislocations, in case that they run outside the dipoles, can very well be neglected. There remains, of course, the formation of intersection junctions and also the

short-range elastic interaction for those dislocations intersecting the dipole ribbons.

5. Further remarks on dipoles.

a) The equilibrium of edge dislocation dipoles composed of *extended dislocations* has already been considered [31]. Let us only mention one important conclusion : because of mutual elastic interaction, the width of extended dislocations in the dipoles will be lower than that of isolated dislocations.

b) The elastic solution can only be used for dipoles with a height $h \gg b$, practically $h > 3b$. Dipoles with a smaller height can be better described as *rows of point defects*, i. e. the extensional dipoles as rows of vacancies and the compressional dipoles as rows of interstitial atoms. From this it follows that the properties of these two types of dipoles for small height will differ, e. g. the compressional dipoles will have a larger energy than the extensional ones.

c) The main properties of dipoles have been derived using the model of infinitely long dipoles, but some special problems concerning the *dipole ends* have already been studied, e. g. the stress field of dipole ends [32] and their interaction with point defects [33]. Recently, the interaction between the ends of two neighbouring dipoles [34] has been discussed and it has been shown that they can join to form one longer dipole.

d) The two equilibrium positions of the dipole are equivalent and it can be expected that they will alternate along the dipole. The two types of the dipole orientation must be connected by the so-called *orientation junction* (Fig. 20).

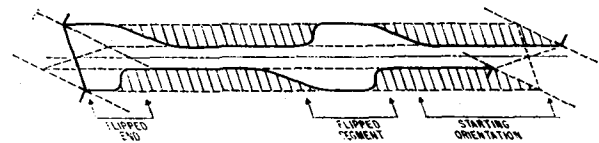

FIG. 20. — Orientation junctions (Gilman [35]).

The motion of these junctions along the dipoles in an oscillating external stress field leads to a small cyclic plastic deformation and mechanical relaxation [25].

e) The *flipping* of dipoles can be important at high stresses, e. g. in fatigued metals. The dipole debris, formed during the first few per cent of life, is probably responsible for the cyclic strain hardening because it acts as obstacles to the motion of gliding dislocations. In the later stages of life the hardening does not increase any more. This has been explained by Feltner [36] : when

the crystal is filled up with debris, the motion of the gliding dislocations practically stops and the cycles of plastic deformation are fundamentally performed by the flip-flop motion of the dislocation debris from stable equilibrium orientation to another without any further strain hardening.

f) A possible influence of the dipoles on some *mechanical properties* of the crystals has already been mentioned (strain hardening, cyclic strain hardening, internal friction, creep, nucleation of cracks).

Gilman [1] proposed that also the changes of some other properties by plastic deformation can be, at least partly, explained by the influence of the dipoles.

Some of other mechanical properties can be explained in this way: the decrease of the elastic moduli in cold-worked metals can be caused by polarization of the dipoles, and the Bauschinger effect by the line tension of the dipoles connected with the screw dislocations, which helps in their reverse motion. Also intrusions and extrusions on the surface of the fatigued specimens can be simply explained by the emergence of the extensional and compressional dipoles.

g) Most of the other *physical properties*, e. g. electrical, magnetic, and thermal, are influenced by plastic deformation and the idea to discuss this influence in terms of dipoles seems to be very attractive. The main reason for this is that the earlier theoretical treatment in terms of individual dislocations was not very successful in some cases, especially in the problems of scattering of phonons and electrons by dislocations. The calculated values are often much lower than those obtained from experiments. This may be due to the fact that individual dislocations with the stress and strain fields proportional to $1/r$, i. e. with a slowly varying field, have only a small influence on the scattering. The main part of the scattering could be due to much more concentrated stress fields of dipoles that decrease as $1/r^2$, and also to especially high dilatations in the dipoles centres.

6. Prismatic dislocation loops.

6.1. LOOPS WITHOUT EXTERNAL STRESS FIELD. —

a) The stress field of dislocation loops is complicated and must be treated as a three-dimensional problem (in contrast to dipoles, the stress field of which can be mostly treated as a two-dimensional problem because of their predominant length). Nevertheless, the stress field and the energy of loops of different shapes have already been calculated by different authors (for references see [2]). Let us only mention that the long-range stress field (at distances much greater than the dimensions of the loop) decreases as $1/r^3$, i. e. faster

than that of a dipole ($1/r^2$), and much faster than that of a straight isolated dislocation ($1/r$). The loop energy can be generally written in the form [37]

$$E = p \left(C_1 \ln \frac{p}{b} + C_2 \right) \quad (14)$$

where p is the perimeter of the loop, and the constants C_1 , C_2 depend on the elastic constants and on the detailed shape of the loop. The energy per unit length of the loop is much lower than that of a straight dislocation (similarly as in the case of the dipoles), and the core energy will already become an important part of the total energy of the small loops.

An analogy to the study of the stable equilibrium position of a dipole is the study of the minimum energy positions of a prismatic loop which is able to change its orientation by *rotation* on the glide prism (Fig. 21).

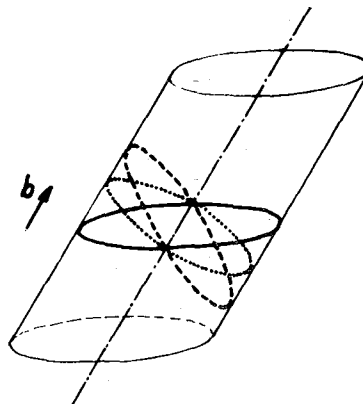

FIG. 21. — Loop rotation on the glide cylinder.

This is a more difficult problem because, during this rotation, the shape and area of the loop change. One special case was studied [38] using isotropic theory of elasticity: it was shown that the energy of rhombus shaped prismatic loops with a $(1/2) [01\bar{1}]$ Burgers vector (in f. c. c. metals) should be lower when they lie on the planes (012) instead of on (011) . However, the result can strongly depend on the elastic anisotropy of the crystal. Similar calculations for loops are also very sensitive to the conditions chosen at the dislocation core. The position of the loop plane can also be given by the original plane of the discs of point defects and by the splitting of dislocations on that plane. The rotation of the loop, even if it should lead to a decrease of energy, can be suppressed by a large critical stress on the prism faces which need not be parts of the usual slip planes.

b) A prismatic loop can change its area in the loop

plane by *climbing*, the driving force for it being the dislocation line tension and the super- or undersaturation of point defects. Under different conditions, the loops grow or disappear by climbing.

Let us only mention that the annealing-out of the loops [39] can be studied in a similar way as the annihilation of the dipoles. The main difference in the case of the loops formed after quenching follows from the fact that all the loops are made of vacancies. Shrinking of all the loops is not possible in the bulk material because it would lead to a high supersaturation of the vacancies. Thus, only the smaller loops will disappear during annealing while the larger loops will grow. In thin foils, however, all the loops will be annealed out because vacancies can migrate to the surface.

6.2 LOOPS IN A STRESS FIELD. — *a*) In an *homogeneous* stress field there are forces on elements of the dislocation line of a loop but the total force is zero (Fig. 22*a*).

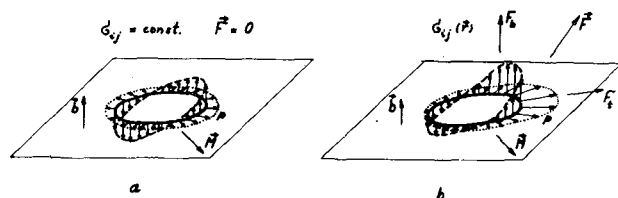

FIG. 22. — Forces on a loop in :
a) homogeneous stress field, *b*) non-homogeneous stress field.

The components of the forces perpendicular to the loop plane tend to rotate the loop, i.e. there is the total moment of forces on the loop (this is an analogy to the polarization of a dipole); the components in the loop plane tend to expand or contract the loop and this effect can be called the induced surface tension in the loop.

b) In a *non-homogeneous* stress field, there is also a non-zero total force and the loop can move as a whole (Fig. 22*b*). The component of the total force in the Burgers vector direction tends to move the loop by gliding along the glide cylinder; the component in the loop plane tends to move the loop by a special interesting type of motion called conservative climb which is due to the pipe-diffusion of vacancies (Fig. 23). Vacancies travel along the dislocation segments in one direction and, therefore, the loop moves in the same direction as a whole. The loop area is conserved during this motion and no bulk diffusion of vacancies is necessary.

This type of motion of loops due to a non-homogeneous stress field of an edge dislocation has been observed in Zn [40].

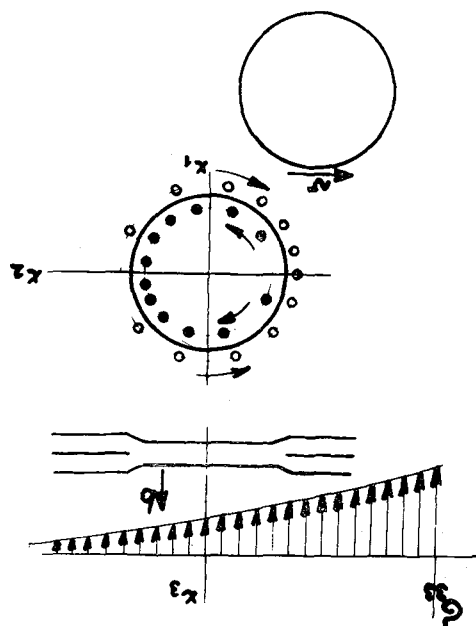

FIG. 23. — Motion of a prismatic loop in its plane by conservative climb.

6.3. INTERACTION BETWEEN LOOPS AND OTHER DEFECTS. — Elastic interaction between prismatic dislocation loops and different other defects (e. g. point defects, other loops, surface) has already been studied (for references see [2]). Let us only mention the interaction between small prismatic loops and moving dislocations which seems to be responsible for the main part of quench hardening and can also contribute to the irradiation hardening in pure metals. There are two types of theories, one based on elastic interaction between loops and moving dislocations [41], and the second based on formation of intersection junctions [42]. A rough estimation [43] of the increase of the critical resolved shear stress $\Delta\tau_0$ due to a random distribution of prismatic loops gives

$$\Delta\tau_0 \approx \frac{Gb}{8} \sqrt{2Rn} = \frac{Gb}{8\sqrt{\pi}} \sqrt{\rho'} \quad (15)$$

where R is the loop radius, n the number of loops per cm^3 , and ρ' the dislocation line density of loops ($\rho' = 2\pi Rn$). With values of R and n measured in [39] we get, e. g. for Al, $\Delta\tau_0 \approx 0.5 \text{ kg/mm}^2$, which is in good agreement with experiments.

This estimation can be also applied to the cyclic strain hardening in fatigued metals where dipole debris seems to be the main obstacle. We get, e. g. for iron (for $\rho' \approx 10^{11} \text{ cm}^{-2}$) for an increase in the yield point $\Delta\sigma_0 \approx 9 \text{ kg/mm}^2$.

6.4 A NOTE ON INFINITESIMAL LOOPS. — a) The main properties of *small dislocation loops* can be described by the concept of the so-called infinitesimal loop (Fig. 24), i. e. a loop with the Burgers vector \mathbf{b} ,

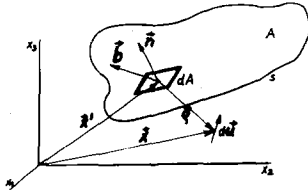

FIG. 24. — Infinitesimal loop and synthesis of infinitesimal loops.

normal \mathbf{n} , and area dA . The displacement field at the point \mathbf{x} of such a loop, situated at \mathbf{x}' , is given by [44, 45]

$$du_i = -\frac{1}{8\pi(1-\nu)} \frac{1}{\rho^2} \left[\frac{1-2\nu}{\rho} (n_i b_k \rho_k + b_i n_k \rho_k - \rho_i b_k n_k) + \frac{3\rho_i b_k \rho_k n_i \rho_l}{\rho^3} \right] dA \quad (16)$$

where $\rho = |\mathbf{x} - \mathbf{x}'|$ and $\rho_k = x_k - x'_k$; the Einstein's summation convention is employed. The stress components then follow from the Hooke's law

$$d\sigma_{ij} = \frac{1}{\rho^3} f_{ij} \left(\mathbf{n}, \mathbf{b}, \frac{\rho}{\rho}, \nu, G \right) dA. \quad (17)$$

This stress field also describes the long-range stress field of a finite loop if its (final) area δA is taken instead of dA .

From the view-point of the continuum theory of elasticity, an infinitesimal loop represents a special point singularity. Different quantities can be very simply introduced for infinitesimal loops: e. g. the interaction energy in an external stress field $\sigma_{ij}^E(\mathbf{x}')$

$$E_{\text{int}} = n_i \sigma_{ij}^E b_j \delta A,$$

the total force on the loop is

$$F_i = -\frac{\partial E_{\text{int}}}{\partial x'_i},$$

the moment of forces with respect to the loop centre

$$M_i = -\varepsilon_{ijk} n_j \sigma_{kl}^E b_l \delta A,$$

and the induced surface tension

$$p = n_i \sigma_{ij} b_j.$$

The concept of infinitesimal loops considerably simplifies the study of the interaction between small dislocation loops and other defects.

b) A *pedagogical remark* on the foundations of the theory of dislocations might be added. It is usual to start with the derivation of stresses around a straight infinite dislocation in continuum. However, dislocations in crystals are formed by nucleation and growth of loops, and there are no straight infinite dislocations.

Therefore, it seems more logical to start the theory of dislocations in continuum with infinitesimal loops. The growth of a loop and, generally, the motion of dislocations can be imagined as a gradual joining of other infinitesimal loops. The stress field of any finite dislocation loop (and also of a straight infinite dislocation) can be derived by surface integration of stresses of infinitesimal loops,

$$\sigma_{ij} = \iint_{(A)} d\sigma_{ij}. \quad (18)$$

This method was first adopted in a special case by Nabarro [46]. An infinitesimal loop can be taken for a « basic solution » (or « Green's function ») of the theory of dislocations in continuum.

The concept of dipoles of infinitesimal width can be introduced in a similar way [47]; as a matter of fact, this concept was used in this paper in Eq. (6) and (13).

A volume synthesis of infinitesimal loops differently orientated in space can describe a plastically deformed continuum with internal stresses [45]; this concept is, of course, only another interpretation of the continuum theory of dislocations.

Bibliographie

- [1] GILMAN (J. J.), *Disc. Farad. Soc.*, 1964, **38**, 123.
- [2] KROUPA (F.), *Theory of Crystal Defects*, Summer School, Hrazany 1964, Academia, Prague 1966.
- [3] FRIEDEL (J.), *Dislocations*, Pergamon Press, Oxford 1964.
- [4] BASINSKI (Z. S.), *Disc. Farad. Soc.*, 1964, **38**, 93.
- [5] LI (J. C. M.), SWAN (R. R.), *Phil. Mag.*, 1964, **10**, 617.
- [6] FOURIE (J. T.), *Phil. Mag.*, 1964, **10**, 1027.
- [7] PRICE (P. B.), *Phil. Mag.*, 1961, **6**, 449.
- [8] KROUPA (F.), *Czech. J. Phys.*, in press.
- [9] GEMPERLE (A.), 1960, not published.
- [10] NABARRO (F. R. N.), Report of a Conference on Strength of Solids, University of Bristol, 1947, The Physical Society, London 1948.
- [11] HIRSCH (P. B.), SILCOX (J.), SMALLMAN (R. E.), WESTMACOTT (K. H.), *Phil. Mag.*, 1958, **3**, 897.
- [12] SILCOX (J.), HIRSCH (P. B.), *Phil. Mag.*, 1959, **4**, 1356.
- [13] COTTERILL (R. M. J.), SEGALL (R. L.), *Phil. Mag.*, 1963, **8**, 1105.
- [14] SAADA (G.), *J. Phys. Soc. Jap.*, 1963, **18**, Suppl. III, 41.

- [15] SILCOX (J.), HIRSCH (P. B.), *Phil. Mag.*, 1959, 4, 72.
[16] YOFFE (E. H.), *Phil. Mag.*, 1960, 5, 161.
[17] THOMAS (G.), WHELAN (M. J.), *Phil. Mag.*, 1959, 4, 511.
[18] KIRITANI (M.), SHIMOMURA (Y.), YOSHIDA (S.),
J. Phys. Soc. Jap., 1964, 19, 1624.
[19] JONES (D. A.), MITCHEL (J. W.), *Phil. Mag.*, 1958,
3, 1.
[20] BULLEN (F. P.), HENDERSON (F.), HUTCHINSON (M.M.),
WAIN (H. L.), *Phil. Mag.*, 1964, 9, 285.
[21] LORETTO (M. H.), CLAREBROUGH (L. M.), SEGALL (R.
L.), *Phil. Mag.*, 1965, 11, 111.
[22] EYRE (B. L.), BARTLETT (A. F.), *Phil. Mag.*, 1965,
12, 261.
[23] WEERTMAN (J.), *Phil. Mag.*, 1965, 11, 1217.
[24] CHANG (R.), in *The Physics and Chemistry of Ceramics*,
Editor S. Klingsberg, Gordon and Breach, New York, 1963, p. 275.
[25] NOVOTNÝ (J.), KROUPA (F.), *Czech. J. Phys.*, in press.
[26] COTTRELL (A. H.), BILBY (B. A.), *Proc. Phys. Soc.*,
1949, A 62, 49.
[27] CHEN (H. S.), GILMAN (J. J.), HEAD (A. K.), *J. Appl.*
Phys., 1964, 35, 2502.
[28] GILMAN (J. J.), *J. Appl. Phys.*, 1962, 33, 2703.
[29] HIRSCH (P. B.), *Disc. Farad. Soc.*, 1964, 38, 111.
[30] KROUPA (F.), *Acta Met.*, 1966, 14, 60.
[31] CHEN (H. S.), GILMAN (J. J.), HEAD (A. K.), *Phil. Mag.*,
1964, 10, 35.
[32] KROUPA (F.), *Physica Status Solidi*, 1965, 9, 27.
[33] KROUPA (F.), NOVOTNÝ (J.), International Conference
on Electron Diffraction and Crystal Defects,
Melbourne, 1965.
[34] FONTAINE (G.), JOUFFREY (B.), in press.
[35] GILMAN (J. J.), *J. Phys. Soc. Jap.*, 1963, 18, Suppl. I,
172.
[36] FELTNER (C. E.), *Phil. Mag.*, 1965, 12, 1229.
[37] BACON (D. J.), CROCKER (A. G.), *Phil. Mag.*, 1965,
12, 195.
[38] BULLOUGH (R.), FOREMAN (A. J. E.), *Phil. Mag.*,
1964, 9, 315.
[39] SILCOX (J.), WHELAN (M. J.), *Phil. Mag.*, 1960, 5, 1.
[40] KROUPA (F.), PRICE (P. B.), *Phil. Mag.*, 1961, 6, 243.
[41] KROUPA (F.), HIRSCH (P. B.), *Disc. Farad. Soc.*, 1964,
38, 49.
[42] SAADA (G.), WASHBURN (J.), *J. Phys. Soc. Jap.*, 1963,
18, Suppl. I, 43.
[43] KROUPA (F.), *Freiberger Forschungshefte*, 1965,
B 101, 181.
[44] KROUPA (F.), *Czech. J. Phys.*, 1963, A 13, 301.
[45] KROUPA (F.), *Czech. J. Phys.*, 1964, B 12, 191.
[46] NABARRO (F. R. N.), *Phil. Mag.*, 1951, 42, 1224.
[47] KROUPA (F.), *Czech. J. Phys.*, 1965, B 15, 896.
-