



HAL
open science

Physical properties and alignment of a polymer-monomer ferroelectric liquid crystal mixture

D.S. Parmar, N.A. Clark, P. Keller, D.M. Walba, M. D. Wand

► **To cite this version:**

D.S. Parmar, N.A. Clark, P. Keller, D.M. Walba, M. D. Wand. Physical properties and alignment of a polymer-monomer ferroelectric liquid crystal mixture. *Journal de Physique*, 1990, 51 (4), pp.355-368. 10.1051/jphys:01990005104035500 . jpa-00212372

HAL Id: jpa-00212372

<https://hal.science/jpa-00212372v1>

Submitted on 4 Feb 2008

HAL is a multi-disciplinary open access archive for the deposit and dissemination of scientific research documents, whether they are published or not. The documents may come from teaching and research institutions in France or abroad, or from public or private research centers.

L'archive ouverte pluridisciplinaire **HAL**, est destinée au dépôt et à la diffusion de documents scientifiques de niveau recherche, publiés ou non, émanant des établissements d'enseignement et de recherche français ou étrangers, des laboratoires publics ou privés.

Classification
Physics Abstracts
61.30 — 64.40

Physical properties and alignment of a polymer-monomer ferroelectric liquid crystal mixture

D. S. Parmar ⁽¹⁾, N. A. Clark ⁽¹⁾, P. Keller ⁽⁴⁾, D. M. Walba ⁽²⁾ and M. D. Wand ⁽³⁾

⁽¹⁾ Department of Physics and Center for Optoelectronic Computing Systems, Boulder, Colorado 80309, U.S.A.

⁽²⁾ Department of Chemistry and Center for Optoelectronic Computing Systems, University of Colorado, Boulder, CO 80309, U.S.A.

⁽³⁾ Displaytech, Inc., 2200 Central Ave., Boulder, CO 80301, U.S.A.

⁽⁴⁾ Laboratoire Leon Brillouin (CNRS), CEN Saclay, 91191 Gif-sur-Yvette, France

(Reçu le 29 juin 1989, accepté le 5 octobre 1989)

Résumé. — Nous décrivons un nouveau polymère mésomorphe en peigne ferroélectrique appartenant à la famille des polysiloxanes qui est miscible en toutes proportions avec un composé ferroélectrique classique, le 4-décyloxybenzoate de 4'-(s)(4-méthylhexyl)oxyphényl. Le mélange présente une transition d'alignement : pour les concentrations élevées en polymère, les plans smectiques s'orientent parallèlement à la direction de frottement alors que pour des concentrations faibles en polymère, les plans smectiques s'orientent perpendiculairement à cette direction (cette dernière situation est typique des petites molécules ferroélectriques). Les échantillons orientés présentent une commutation électro-optique avec un contraste élevé, ce qui a permis d'étudier le signe et l'amplitude de la polarisation ferroélectrique et sa variation avec la température, ainsi que l'évolution de l'angle d'inclinaison des molécules avec la température et la réponse optique en fonction du champ appliqué.

Abstract. — We present a new Ferroelectric Liquid Crystal (FLC) siloxane-based polymer which exhibits complete miscibility with the low molecular weight FLC (4'[(S)-(4-methylhexyl)oxy]phenyl-4-(decyloxy)benzoate). The mixture exhibits an alignment transition, orienting with the smectic layers *along* the rubbing direction at high polymer concentrations and, typical of low molecular weight liquid crystals, *normal* to the rubbing direction at low polymer concentrations. The aligned mixture exhibits high contrast electro-optic switching and has been physically characterized with respect to the sign and magnitude of the ferroelectric polarization and its temperature dependence, temperature variation of optical tilt angle and the optical response to an applied electric field.

1. Introduction.

During the past decade, a number of liquid crystalline polymers have been synthesized and characterized with respect to their thermodynamic and physical properties. These polymer liquid crystals include mesogenic groups in the main chain [1] or as part of the side group [2] or polymers with more complex structures [3]. Recently, there has been increasing interest in polymer ferroelectric liquid crystals in which a permanent electric dipole density is obtained

by incorporation of chiral side groups to form a tilted chiral smectic phase analogous to those formed by low molecular weight liquid crystals. Of particular interest is the potential of the polymer ferroelectric liquid crystals and their mixtures with low mass ferroelectric smectic C* liquid crystals for application in the fast switching, bistable surface stabilized ferroelectric liquid crystal (SSFLC) electro-optic devices of Clark and Lagerwall [4, 5].

A variety of polymer ferroelectric liquid crystals have been synthesized to date [6-16], however, not much work has been done on mixtures with monomer homologs or on the physical characterization of polymer FLC materials and mixtures for SSFLC applications. In the present paper, we report our results on SSFLC alignment, phase characterization, electro-optic switching responses, optical tilt angles and ferroelectric polarization measurements on a new polysiloxane [17]-chiral epoxide [18] based side chain polymer ferroelectric liquid crystal W219 [19] synthesized in our laboratory, and its mixtures with the low mass FLC W82 [20].

2. Phase diagram.

The chemical structure and the phase transition temperatures for W219 and W82 are given in figure 1. The phase identification has been done using polarizing microscopy.

On cooling from isotropic liquid phase, W219 undergoes a phase transition to the C* phase at 147 °C and continues in this phase until 85 °C, below which it undergoes a glass transition which is maintained down to room temperature. We have not seen samples form the crystal phase from the glass phase even after keeping them for several weeks at room temperature.

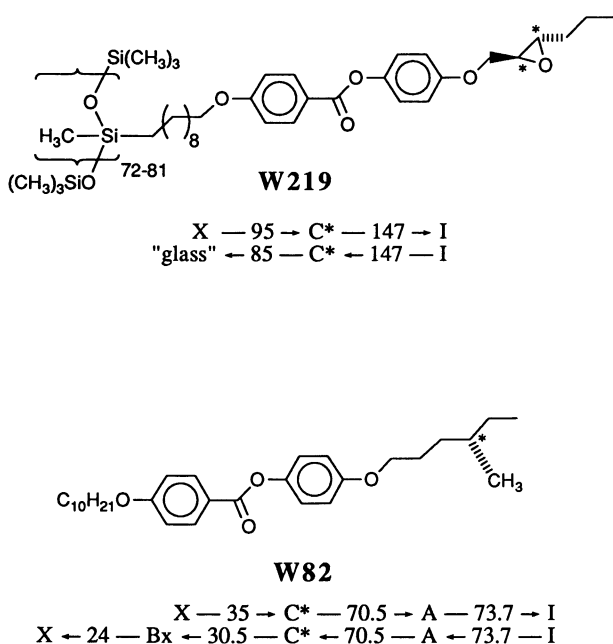

Fig. 1.

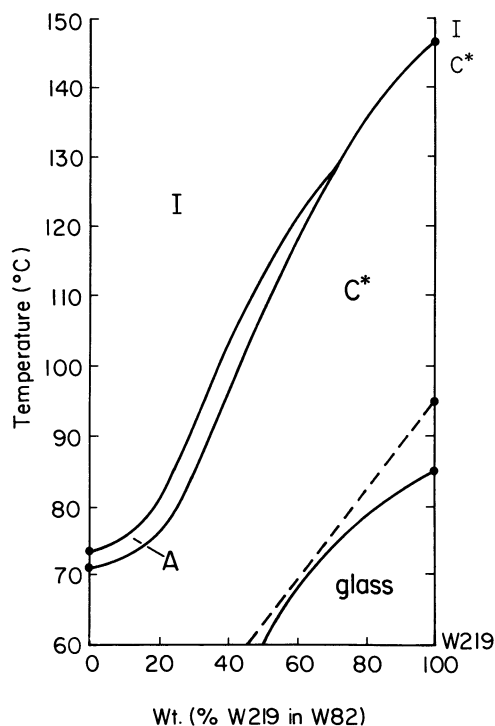

Fig. 2.

Fig. 1. — Structure and transition temperatures for W219 and W82.

Fig. 2. — Phase Diagram for W219 and W82 mixtures.

Since the starting material at room temperature is a crystalline phase, we believe the glassy state is supercooled from the C* phase.

The miscibility of the polymer ferroelectric liquid crystal W219 with the low mass ferroelectric liquid crystal W82 has been tested. These components mix very well in the entire range of polymer FLC concentrations as shown in figure 2. It may be noted that at ~ 80 % of W219, the smectic A (SmA) phase appears and continues through the entire range towards W82. The C* range is quite large in all the W219-W82 mixtures.

3. Alignment.

In smectic polymer side chain liquid crystals the side groups are organized into layers, much like the monomeric smectics, while the backbone chains are confined largely to lie in the layering planes. Thus the phase orientation produced by an anisotropic surface treatment will depend on which part of the polymer molecule is most strongly coupled to the surface anisotropy. An anisotropic surface (e.g. rubbed nylon) which orients the backbone parallel to a particular direction (\hat{z}) in the surface will induce smectic layers *parallel* to \hat{z} . If, on the other hand, the coupling is primarily to the side groups, then, as in low mass liquid crystals, the side chain molecules line up along \hat{z} forming the smectic layers *perpendicular* to \hat{z} . In our side chain polymer-monomer homolog liquid crystal mixture, we observe a transition between these two alignment modes, obtaining the former (layers $\parallel \hat{z}$) at high polymer concentration and the latter (layers $\perp \hat{z}$) at low polymer concentration. We used nylon brushed surfaces to align our polymer FLC samples. The ITO coated glass plates, one of which having polyimide spacers of $\sim 3 \mu\text{m}$, were nylon surface coated and then hair brushed in one direction and assembled in a

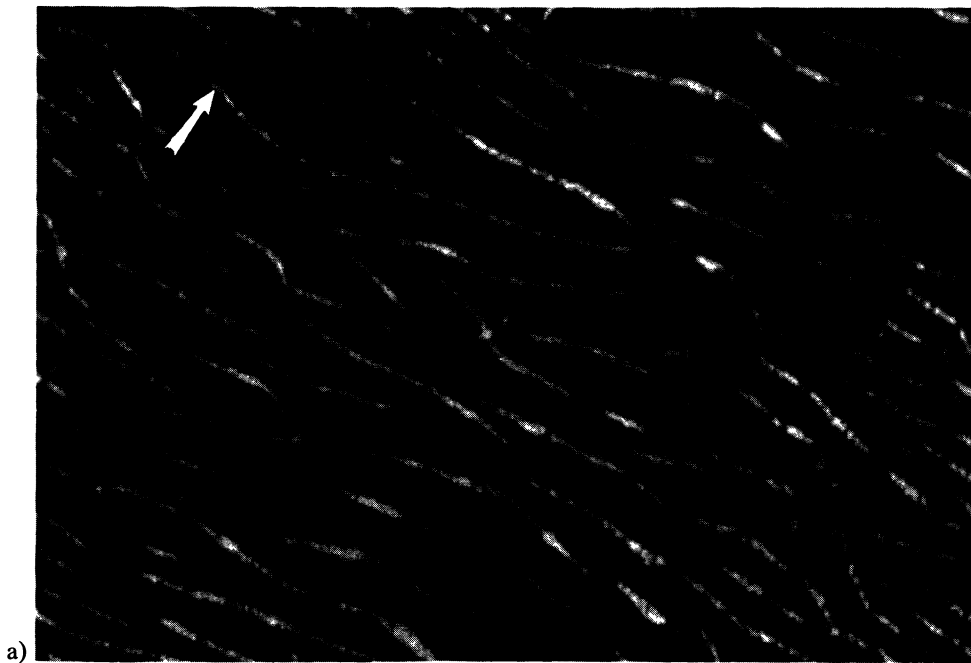

Fig. 3. — (a, b) In a cell containing pure W219 the C* focal conics grow perpendicular to the brushing direction on cooling from the isotropic liquid phase. (c) Shear along the brushing direction helps in planar orientation. The arrows indicate the rubbing, shear and the layer directions.

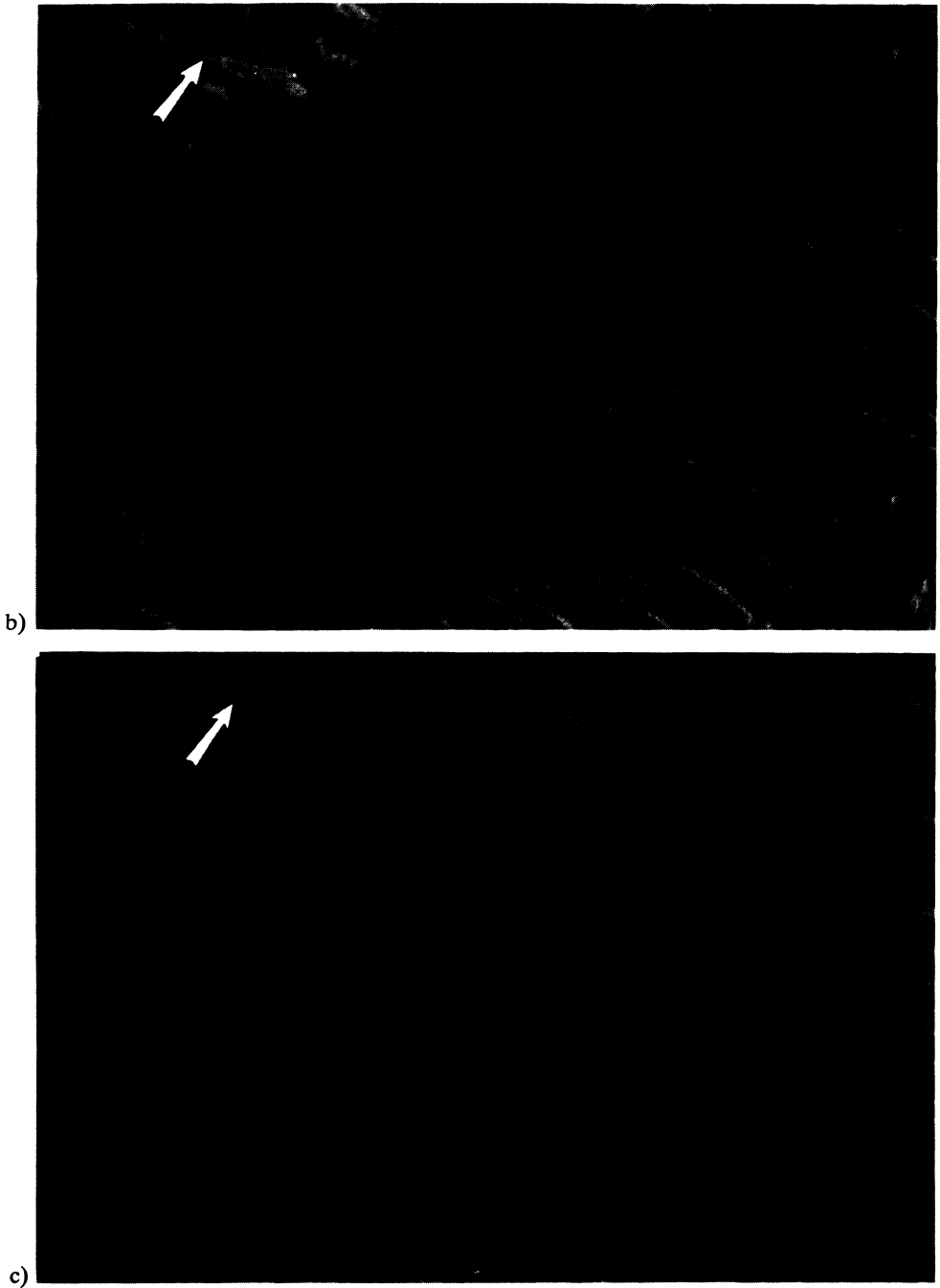

Fig. 3 (*continued*).

way such that the rubbing direction on the two surfaces sandwiching the liquid crystal was parallel. The polymer FLC was heated to the isotropic liquid phase to fill the cell. It may be noted that the sample did not completely extinguish between crossed polarizers even in the isotropic phase for the pure W219, indicating that in thin cells the polymer FLC is partially oriented by the surface.

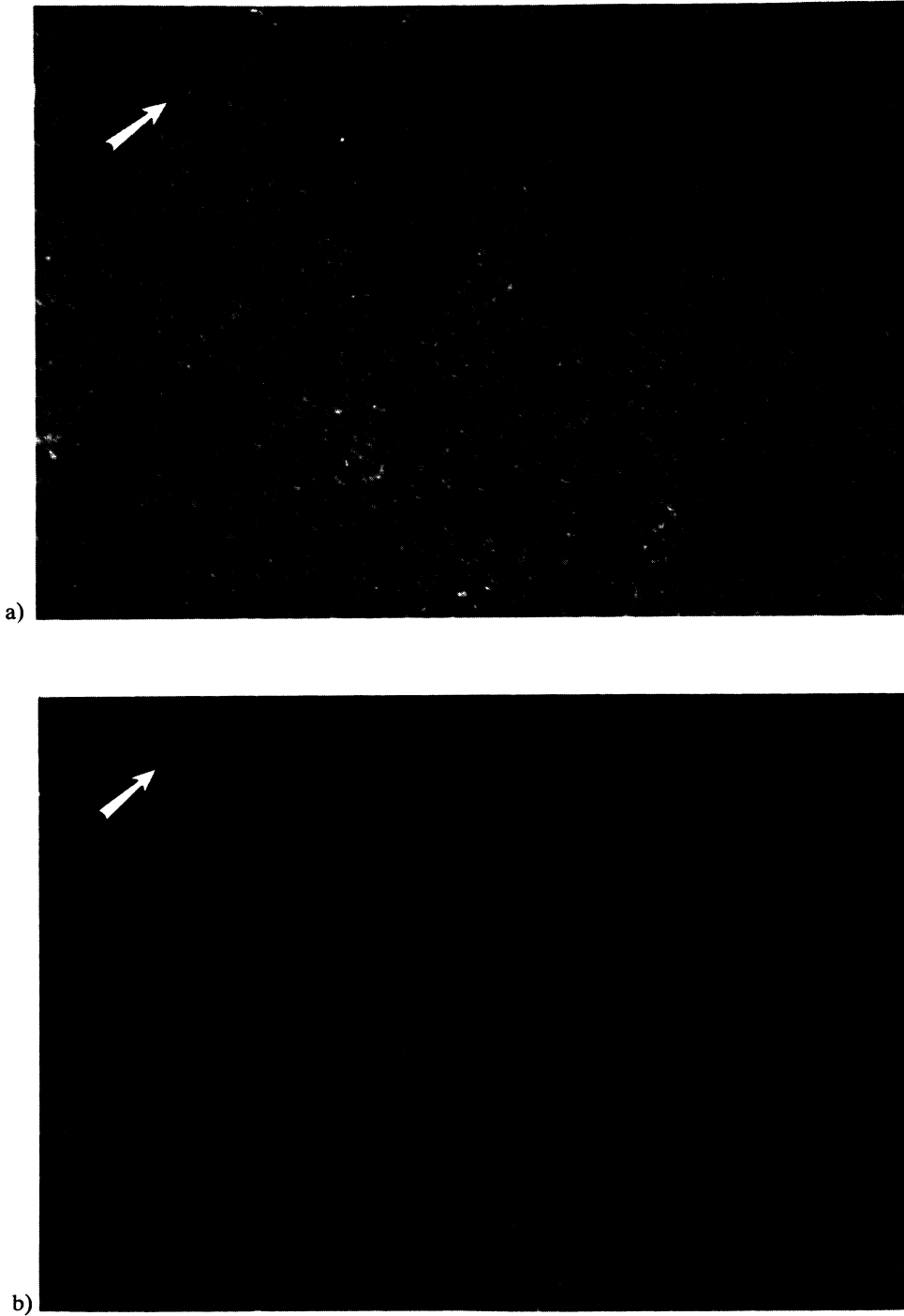
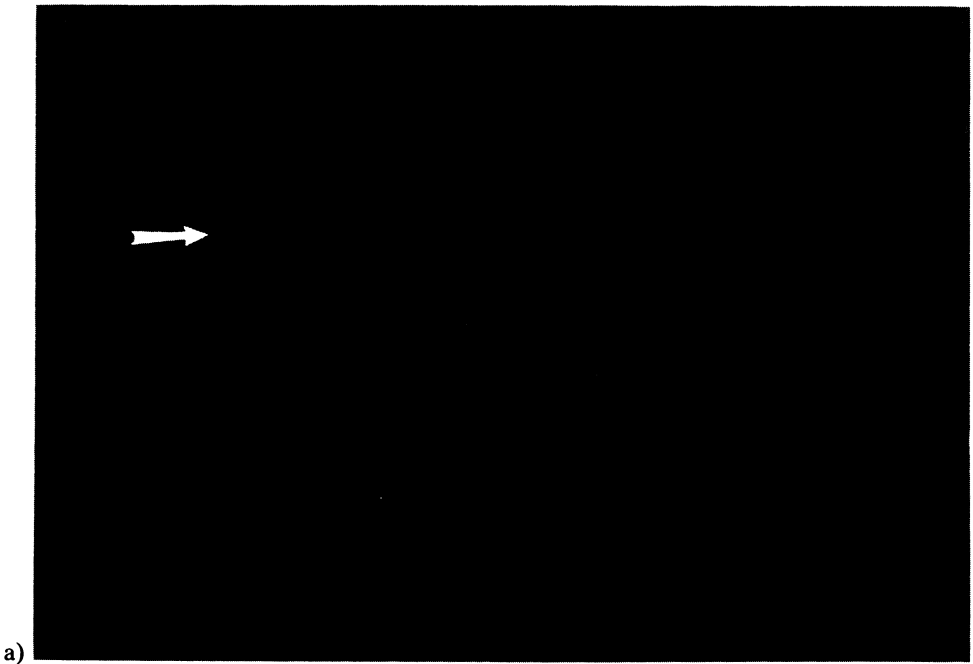

Fig. 4. — A shear aligned pure W219 cell on nylon coated and brushed ITO glass. (a) Bright state and (b) Black state with switching the field in appropriate direction. The cell is strongly bistable and the two states are surface stabilized in the entire range of temperature. The arrows indicate the rubbing, shear and the layer directions.

As the pure W219 sample is cooled from the isotropic phase, smectic C focal conics start appearing below 146 °C as shown in figure 3a. The focal conics are lined up perpendicular to the direction of rubbing indicating the layer orientation along the rubbing direction, indicated by the arrows. The focal conics grow in size as the sample is further cooled (Fig. 3b). A slight shear along the direction of rubbing makes these focal conics grow normal to the shearing direction (Fig. 3c). Simultaneous cooling and shearing leave the sample in a perfect planar orientation (layers parallel to the rubbing and shearing direction), the surface stabilized bright state of which is shown in figure 4a. Application of an electric field in appropriate direction switches the sample to the other surface stabilized state shown as black in figure 4b. The cell in figure 4 is bistable, either state remaining even when the field is removed.

It may be noted here that in pure W219, the alignment is maintained even below the glass transition (85 °C) temperature. Upon cooling the cell under a d.c. field ($\sim 10^7$ V/m) to room temperature, it was found to be poled, a voltage of ~ 0.6 V appearing measured across it upon removing the external voltage source at room temperature. A further interesting aspect of the W219 cell is the absence of zig-zag walls [21].

W219 was mixed with W82 and a 20 % by weight mixture of W219 in W82 was observed to have a phase sequence I-A-C*. the actual phase transition temperatures are shown in figure 2. Smectic A layers in this mixture are formed perpendicular to direction of rubbing and shear as is typical for low molecular weight liquid crystals on the nylon coated glass plates. The typical texture of the shear aligned cell in the C* phase has a texture as shown in figure 5a. The commonly observed zig-zag wall defects [21] are observed in this case as shown in figure 5b.



a)

Fig. 5. — C* texture in a shear aligned cell of 20 % W219 in W82. (a) The smectic layers are perpendicular to the rubbing direction which is vertical. (b) A chevron layer structure [21] is indicated by the presence of zig-zag walls. In (a) and (b) the rubbing direction (arrows) is perpendicular to the layers. (c) C* texture of a sheared cell of (1:1) mixture of W219 and W82. The arrows indicate the rubbing, shear and the layer directions.

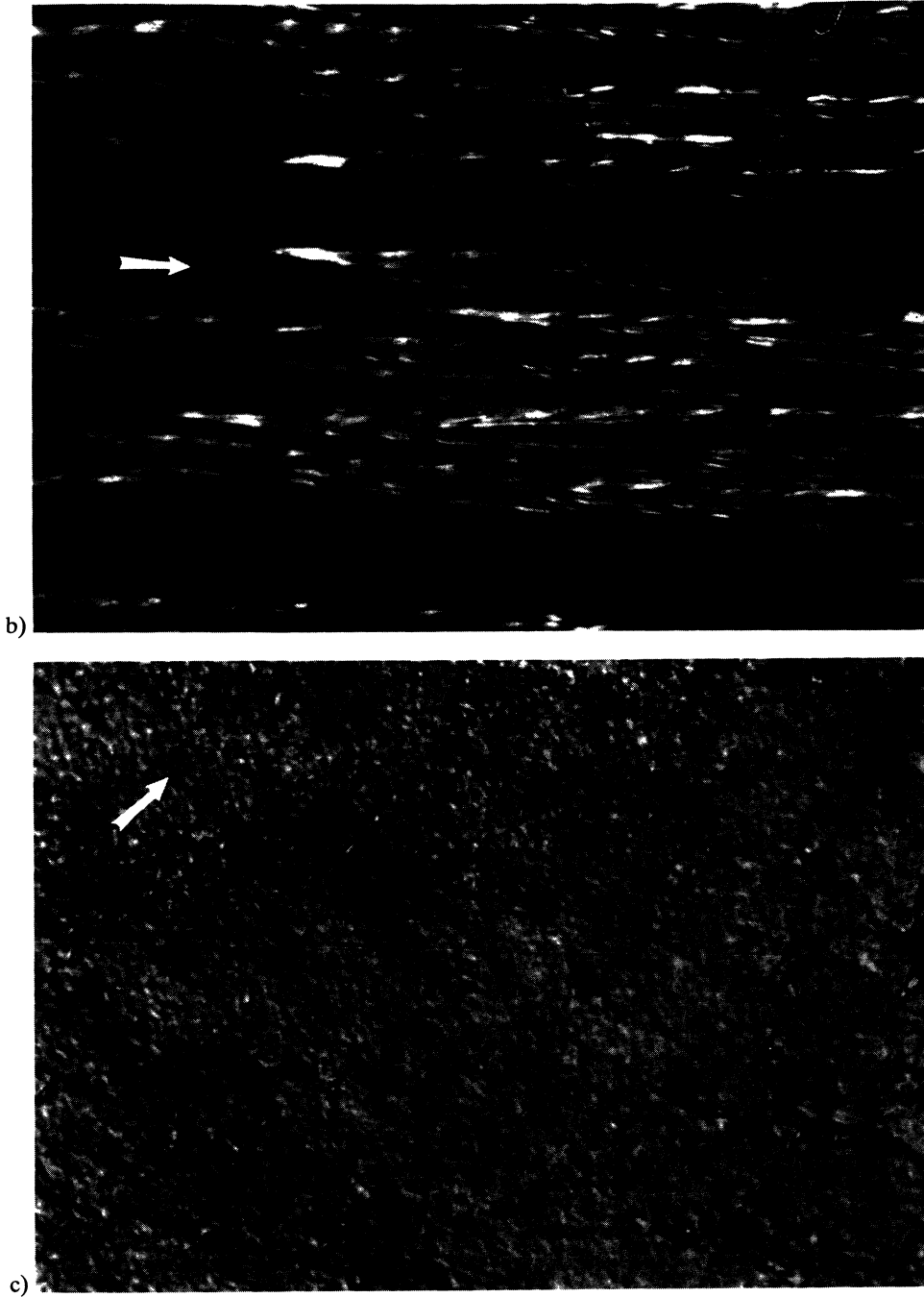

Fig. 5 (continued).

Thus as the concentration of W219 is decreased, the layer alignment shifts from layers parallel to the rubbing (polymer) to layers perpendicular to the rubbing (monomer). The crossover occurs for an approximately 1:1 mixture.

Cooling the sample of 1:1 mixture, in a nylon coated and rubbed ITO glass cell, from isotropic liquid to the A phase, two distinct focal conic orientations are observed : one

parallel to the direction of rubbing and the other perpendicular to it. There are more focal conics oriented perpendicular to the rubbing direction than along it. Thus shear alignment along the rubbing direction is easier and produces a cell with fewer defects as shown in figure 5c where the general alignment is good and planar with only a small number of defects seen in the form of black lines. No zig-zag wall defects are observed in this case. This sample is surface stabilized and bistable as for pure W219, it ending up in a glassy state upon cooling to room temperature as does W219.

4. Polarization and tilt angle measurements.

The typical sample geometry for the measurements is shown in figure 6. The C^* phase is sandwiched in between two ITO coated glass plates on which a very thin nylon film is deposited and the surfaces are brushed parallel to the plates. The plates are separated by a $\sim 3 \mu\text{m}$ thick polyimide spacer deposited on one of the plates. The area of the ITO electrode is 1.17 cm^2 . The SSFLC sample cell thus behaves like a thin birefringent slab in which the optic axis rotation can be induced by the application of a voltage [22].

Tilt angle θ has been measured as a function of temperature by measuring the angle between the two stable states of the cell with an electric field applied. For a given direction of the field, the C^* director is placed along one of the polarization directions of the crossed

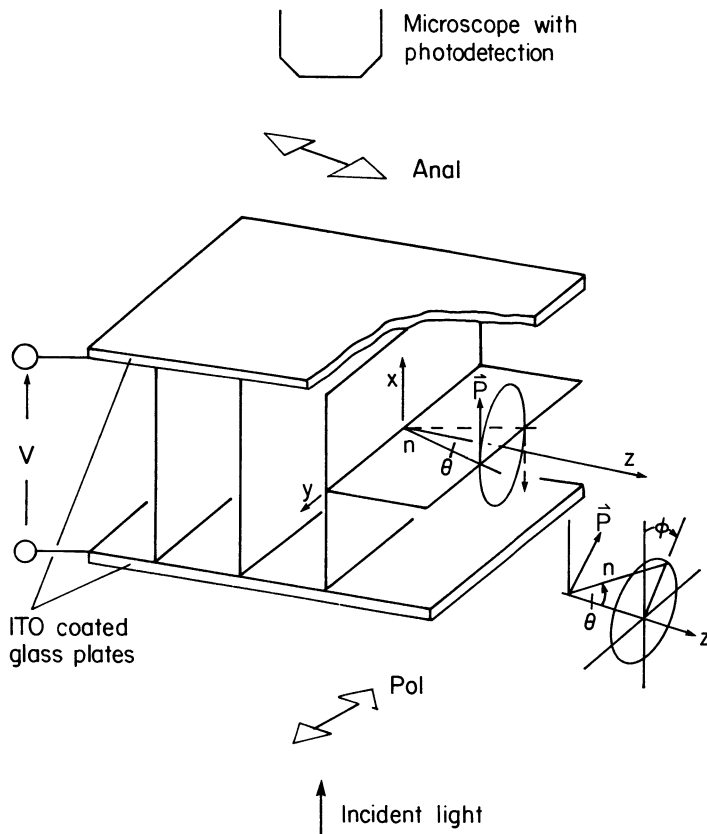

Fig. 6. — Sample geometry for tilt angle and polarization measurements.

polarizers of the optical microscope. In this situation the cell extinguishes. The electric field is reversed and depending on the sign of polarization, the sample is rotated so that the director lines up along the same polarization direction. The angle between these two director orientations is a measure of twice the tilt angle θ .

The polarization P has been measured by integration of the polarization current peak observed during the application of a triangular wave field. The typical current peak and the driving triangular wave field traces on a dual trace oscillogram are shown in figure 7. The current peak is integrated with the help of the storage oscilloscope and a computer.

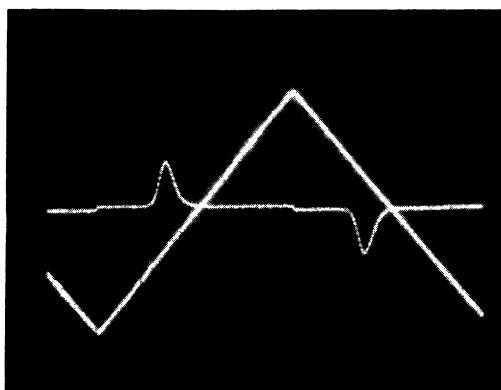

Fig. 7. — Typical oscillograms and the resulting polarization current peak with a 30 V peak to peak triangular wave driving field on W219 (200 ms/div).

Typical variation of tilt angle θ and polarization P with temperature are shown in figure 8a, b for pure W219, W82 and their mixtures given in table I. It is interesting to note that for pure W219, θ stays almost constant at $\sim 29.5^\circ$ in a large temperature range and drops only slightly near the first order I-C* transition. For W82 and its other mixtures with W219 which all show A phase above the C* phase, θ drops continuously to zero near the A-C* transition temperature (T_C) indicative of a second order A-C* transition. In figure 8, T_C for W219 is the I-C* transition temperature. There is a jump in θ even for lower concentrations of W219 (Fig. 8a). For example, at $T_C - T = 21.0^\circ\text{C}$, θ jumps from 16.5° for 100 % W82 to 26.2° for a 20 % mixture of W219 in W82. Further increase in W219 concentration does not change θ to

Table I. — *Materials used in the present investigations, their polarization P and the phase transition temperature. X is the crystal phase and B_x is hexatic smectic B phase.*

Material name	P (nC.cm ⁻²)	Phase diagram
W82	- 0.4	I 75 A 72.8 C* 32 B_x 24 X
W219 + W82(1:4)	+ 11	I 81.2 A 75.6 C* 49.3 B_x 32 X
W219 + W82(1:1)	+ 33	I 113.4 A 108.1 C* 49.5 glass
W219	+ 66	I 146.2 C* 85 glass

any considerable extent as is evident from the fact that the saturation value of θ for pure W219 is 31.0° .

The temperature variation of P for W219 and its 20 % and 50 % mixtures with W82 is shown in figure 8b. Since, W82 is very weakly ferroelectric, independent measurement of its polarization has not been possible and the saturated value of its polarization has been determined by extrapolation of polarization with various mixtures. The polarization of W82 is $P = -0.4 \text{ nC/cm}^2$. It is further noted from figure 8b that whereas P for W219-W82 mixtures falls continuously to zero at $T_C - T^* = 0^\circ\text{C}$ for pure W219, it drops only slightly near the $I-C^*$ transition temperature.

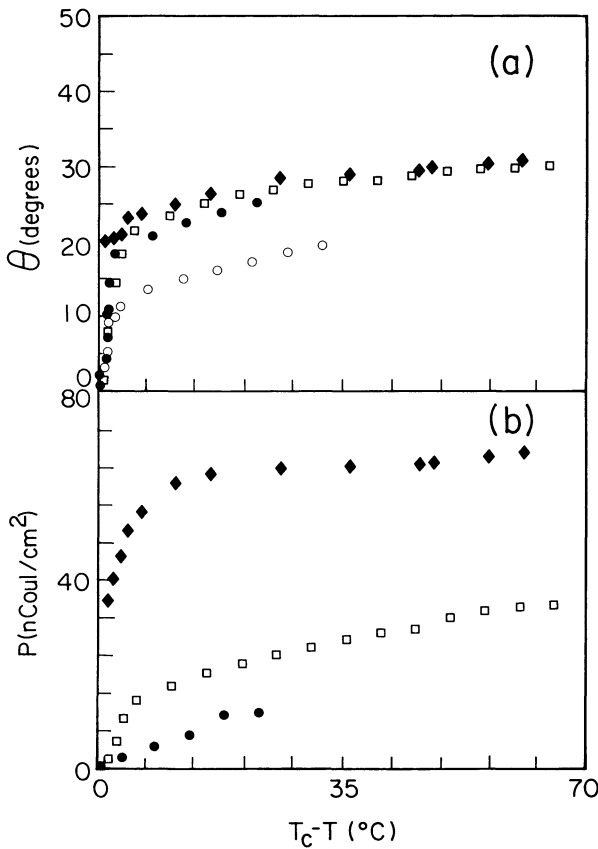

Fig. 8.

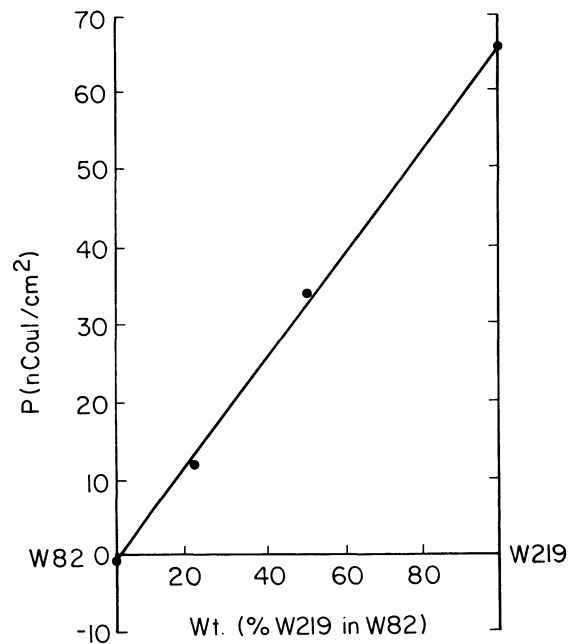

Fig. 9.

Fig. 8. — Temperature dependence of (a) θ and (b) P for W219 concentrations : \circ — 0 % ; \bullet — 20 % ; \square — 50 % ; \blacklozenge — 100 %.

Fig. 9. — The variation of the saturation value of P with W219 concentration in W82 is linear.

From the extrapolated value of P for W82 and using the saturated values of P for its mixtures with W219, a linear relationship between the W219 concentration and P is obtained as shown in figure 9.

5. Response time measurements.

Optical response to an applied step voltage has been measured using polarizing microscopy and an associated photodetector arrangement. A typical dual trace oscillogram respectively for a voltage step from -15 V to $+15\text{ V}$ and the corresponding optical response signal for W219 is shown in figure 10. Similar responses are obtained for all the materials under investigation. The symmetry in the shape of the optical response curve for both directions of the electric field suggests that the C^* layers are more or less normal to the plates [22] in W219 and no significant layer tilt can be interpreted from these observations. X-ray measurements are, however, required to confirm this preliminary observation. By changing the magnitude of the applied voltage, the time for 10 % to 90 % rise in intensity of the transmitted light (defined here as rise time τ_r) and rise time variation with applied field at different temperatures for

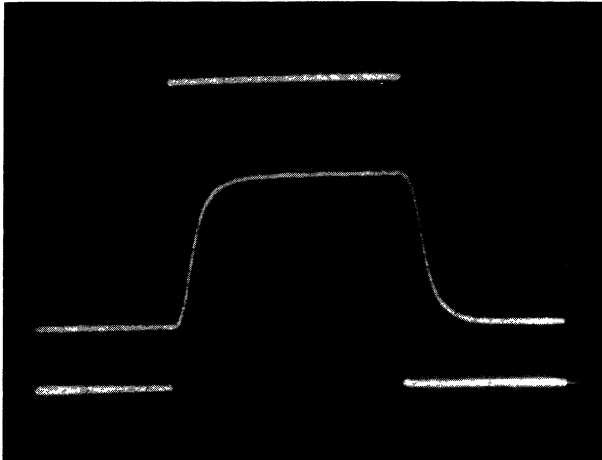

Fig. 10. — Dual trace oscillogram of a typical optical response curve with a 30 V p-p square wave applied to W219 (100 ms/div).

W219 has been measured as shown in figure 11a. The delay time τ_d defined as the time for the first 10 % rise in transmitted light intensity at the same temperatures is shown in figure 11b. In a log-log plot, the rise time vs. the applied field relationship, as shown in figure 12 is linear. Accordingly the $\tau_r = \eta/PE$ relationship holds for polymer liquid crystals too. For a fixed applied field of $\sim 1.5 \times 10^7\text{ V/m}$, we have measured the τ_r as a function of temperature for W219 and other materials under investigation. The results are shown in figure 13.

It is interesting to note that :

- 1) For W219, τ_r increases near the I- C^* transition temperature. On the other hand, mixtures with W82 demonstrate a fall near the A- C^* transition ;
- 2) For a given $T_C - T$, τ_r for a 20 % mixture of W219 in W82 is lower than that for pure W82. It is likely that this is due to the rise in polarization of the mixture in comparison to that of pure W82.

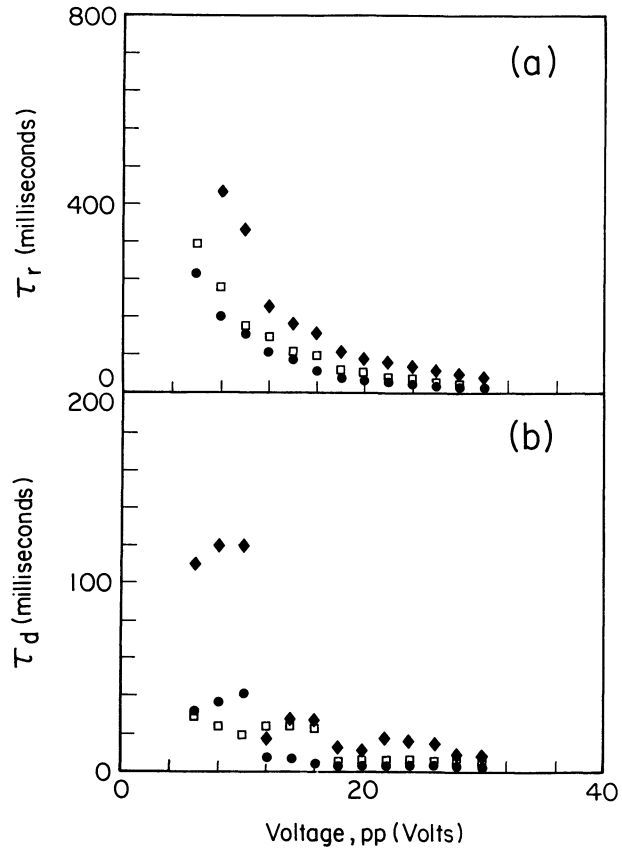

Fig. 11. — Variation of (a) rise and (b) delay times with applied voltage for a $3 \mu\text{m}$ thick sample of W219 ; ● - 135° ; □ - 130° ; ◆ - 120°C .

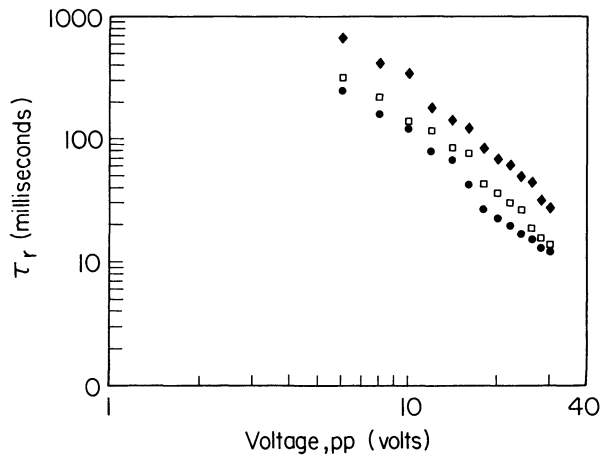

Fig. 12. — Log-log plots of rise time vs. voltage ; ● - 135°C ; □ - 130°C , ◆ - 120°C .

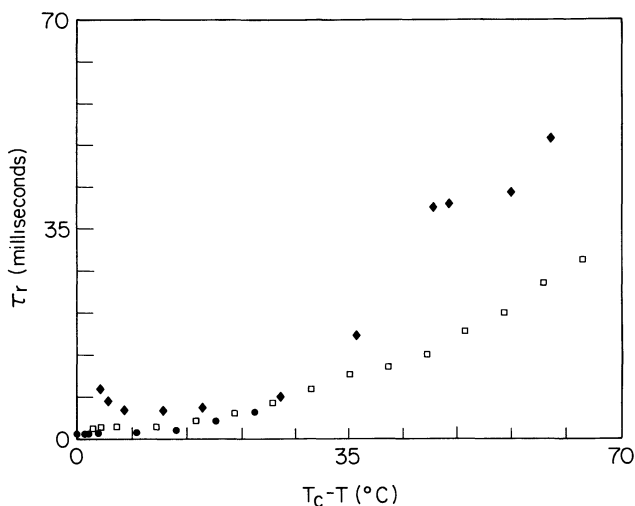

Fig. 13. — Rise time vs. $T_C - T$ for the W219 and W82 mixtures of table I. ● — 20 % ; □ — 50 % ; ◆ — 100 %.

6. Conclusions.

1. By using rubbed nylon surfaces, we have been able to align polymer liquid crystals and their mixtures with low mass ferroelectric liquid crystals. The alignment so obtained is as good as for any low mass FLC.

2. The growth of C^* focal conic domains relative to the direction of rubbing on a nylon surface indicates that the polysiloxane backbone in these side chain polymers prefers to line up along the rubbing direction resulting in smectic layer orientation in the rubbing direction. Since the extinction even in the isotropic liquid phase of the pure polymer is incomplete, we believe that the polymer backbone remains always lined up on the surface in the rubbing direction.

3. As a result of the polymer backbone lining up along the rubbing direction, for polymer concentrations of greater than 50 % the smectic layers are formed along the rubbing direction with the polymer backbone in the plane of the layers and the sample needs to be sheared in the rubbing direction in order to get almost perfect planar alignment. This may be compared to low mass FLC's where shearing normal to the rubbing direction leads to good alignment. At low polymer concentration, the usual alignment of smectic layers normal to the rubbing is obtained.

4. The absence of zig-zag walls at high polymer liquid crystal concentration indicates that the smectic layers are more or less normal to the plates and do not form chevron texture [21].

5. The tilt angle and polarization behaviour with temperature of the polymer liquid crystal is similar to that for low mass liquid crystals. Although the optical response is slow owing to very high orientational viscosity of the polymer, the switching mechanism seems to be the same as for the low mass FLC's. Also, the mixtures with low mass FLC's reveal the total polarization as a sum of the two components giving linearity to the P vs. concentration curves.

Acknowledgments.

This work was supported by NSF Contract DMR 8611192, by NSF Grant CDR 8622236 through the National Science Foundation Engineering Research Center for Opto-electronic Computing Systems, and by the Office of Naval Research.

References

- [1] Eds. M. Gordon and N. A. Platé, Liquid Crystal Polymers, *Adv. Polymer Sci.* **I-III** (1984) 59.
- [2] Eds. A. Ciferri and W. R. Krigbaum, Liquid Crystal Polymers (Academic Press) 1982.
- [3] ENGEL M., HISGEN B., KELLER R., KREUDER W., RECK B., RINGSDORF H., SCHMIDT H. W. and TSCHIRNER P., *Pure Appl. Chem.* **57** (1985) 1009.
- [4] CLARK N. A. and LAGERWALL S. T., *Appl. Phys. Lett.* **36** (1980) 899.
- [5] CLARK N. A. and LAGERWALL S. T., *Ferroelectrics* **59** (1984) 25.
- [6] SHIBAEV V. P., KOZLOVSKY M. V., BERESNEV L. A., BLINOV L. M. and PLATÉ N. A., *Polym. Bull.* **12** (1984) 299.
- [7] DECOBERT G., DUBOIS J. C., ESSELIN S. and NOEL C., *Liq. Cryst.* **1** (1986) 307.
- [8] ESSELIN S., BOSIO L., NOEL C., DECOBERT G. and DUBOIS J. C., *Liq. Cryst.* **2** (1987) 505.
- [9] DECOBERT G., SOYER F., DUBOIS J. C. and DAVIDSON P., *Polym. Bull.* **14** (1986) 549.
- [10] CHIELLINI E., GALLI G., CARROZZINO S., MELONE S. and TORQUATI G., *Mol. Cryst. Liq. Cryst.* **146** (1987) 385.
- [11] HAHN B. and PERCEC V., *Mol. Cryst. Liq. Cryst.* **157** (1988) 125.
- [12] KELLER E. N., NACHALIEL E. and DAVIDOV D., *Phys. Rev. A* **37** (1988) 2251.
- [13] ZENTEL R., *Liq. Cryst.* **3** (1988) 531.
- [14] MÜLLER U., SCHEROWSKY G., SPRINGER J., TRAPP W., UZMANN M., Presented at the Twelfth Int'l. Liq. Cryst. Conf., Freiburg (1988) p. 289.
- [15] ZENTEL R., RECKERT R., BECK B., *Liq. Cryst.* **2** (1987) 83.
- [16] BUALEK S. and ZENTEL R., *Makromol. Chem.* (in press);
KAPITZA H. and ZENTEL R., *Makromol. Chem.* (in press) 1988.
- [17] KELLER P., *Ferroelectrics* **85** (1988) 425.
- [18] WALBA D. M., VOHRA R. T., CLARK N. A., HANDSCHY M. A., XUE J., PARMAR D. S., LAGERWALL S. T. and SKARP K., *J. Am. Chem. Soc.* **108** (1986) 7424.
- [19] WALBA D. M., KELLER P., PARMAR D. S., CLARK N. A. and WAND M. D., *J. Am. Chem. Soc.* **111** (1989) 8273; W219 is shown in figure 1.
- [20] W82 is 4'[(S)-(4-methylhexyl)oxy]phenyl-4-(decyloxy)benzoate described in (KELLER P., *Ferroelectrics* **58** (1984) 3) obtained from Displaytech Inc., Boulder, Co. 80301.
- [21] RIEKER T. P., CLARK N. A., SMITH G. S., PARMAR D. S., SIROTA E. B. and SAFINYA C. R., *Phys. Rev. Lett.* **59** (1987) 2658;
CLARK N. A., RIEKER T. P. and MACLENNAN J. E., *Ferroelectrics* **85** (1988) 79.
- [22] XUE J., HANDSCHY M. A. and CLARK N. A., *Liq. Cryst.* **2** (1987) 707.