



HAL
open science

Micellar structure from comparison of X-ray and neutron small-angle scattering

Thomas Zemb, P. Charpin

► **To cite this version:**

Thomas Zemb, P. Charpin. Micellar structure from comparison of X-ray and neutron small-angle scattering. *Journal de Physique*, 1985, 46 (2), pp.249-256. 10.1051/jphys:01985004602024900 . jpa-00209964

HAL Id: jpa-00209964

<https://hal.science/jpa-00209964>

Submitted on 4 Feb 2008

HAL is a multi-disciplinary open access archive for the deposit and dissemination of scientific research documents, whether they are published or not. The documents may come from teaching and research institutions in France or abroad, or from public or private research centers.

L'archive ouverte pluridisciplinaire **HAL**, est destinée au dépôt et à la diffusion de documents scientifiques de niveau recherche, publiés ou non, émanant des établissements d'enseignement et de recherche français ou étrangers, des laboratoires publics ou privés.

Classification
Physics Abstracts
61.10F

Micellar structure from comparison of X-ray and neutron small-angle scattering

T. Zemb and P. Charpin (+)

Département de Physico-Chimie, CEN-Saclay, 91191 Gif sur Yvette Cedex, France

(+) Laboratoire de Réactivité et de Mécanismes en Chimie Inorganique (*), CEA/CEN-Saclay, 91191 Gif sur Yvette Cedex, France

(Reçu le 17 août 1984, accepté le 16 octobre 1984)

Résumé. — Les diagrammes de diffusion aux petits angles de micelles ioniques sont constitués d'interférences intramicellaires $S(q)$ et d'un terme intermicellaire $P(q)$. Une méthode originale de séparation de ces deux termes dans le cas de la diffusion de neutrons a été proposée par Hayter et Penfold. Nous montrons que cette méthode permet d'interpréter pour la première fois les diagrammes de diffusion de rayons X aux petits angles de solutions concentrées de micelles. Divers résultats de la littérature sont discutés en choisissant comme exemple des solutions de dodécylsulfate (SDS) et d'octanoate (NaC8) de sodium.

Abstract. — X-ray scattering patterns of ionic micellar solutions contain both inter- and intramicellar interferences. We show that these two terms can be separated according to the method developed by Hayter and Penfold. Both X-ray and neutron scattering signals are predicted on an absolute scale by a unique model of chain packing. Examples of results obtained through an incomplete separation of intermicellar interferences are discussed using sodium octanoate and sodium dodecylsulfate as typical examples of direct ionic micelles.

1. Introduction.

To obtain information about a micellar structure, the most direct method is the measurement of the scattering of a radiation, the wavelength of which is close to the size of the micellar aggregate.

The observed small-angle scattering by such systems shows a peak. This peak may be produced either by intermicellar or by intramicellar interferences, or by a combination of both. It has been shown recently [1, 2] that it is possible in neutron scattering studies (SANS) to separate intramicellar scattering and intermicellar interference effects. In X-ray scattering studies (SAXS), this method has not yet been used. Our aim is to give a unified interpretation of both SAXS and SANS on an absolute scale. Interpretation of absolute scaled scattering cross-sections requires the construction of a packing model for the molecules to predict the observed scattering.

The pioneering work of Reiss-Husson and Luzati [3] has demonstrated that ionic micelles are spheres or cylinders. This was the first proof of the now accepted structural model of the micelle. In some cases, as for

instance sodium dodecyl-sulfate (SDS) without added salt, these authors have observed by careful dilution studies that intermicellar interactions effects are negligible in the observed scattering [4]. However, a generalization of this observation can lead to questionable results [5]. SAXS studies of direct micelles are not very frequent in the literature since :

— The X-ray scattering is essentially due to the counter-ion layer of high electronic density and not to the hydrocarbon core. This counter-ion hollow shell could give a peak without any interference effects. Separation of intra- and interparticular scattering is therefore difficult.

— SAXS spectra are generally not recorded with point collimation. Perfect deconvolution is difficult to achieve. Systematic errors can affect the results, especially if the source is a quasi-infinite slit. If one uses a semi-punctual collimation, the uncertainties can be confined at the very low angle part of the scattering curve (typically 3 or 4 points, $q < 0.02 \text{ \AA}^{-1}$).

— Contrast variation, although sometimes used in SAXS studies [6, 7], is inapplicable on micellar systems, since the micellar structure is affected by the addition of any soluble compound.

(*) L.A. 331 du CNRS.

— One must keep in mind that isotopic effects can be important in the values of the cmc's [8].

All these problems can be overcome. SAXS and SANS spectra are interpreted with a unique model, giving a coherent view of the micellar structure. We'll see that, in most cases, SAXS studies are less relevant than SANS studies. We'll choose two typical micellar systems :

— A dilute solution (20 g/l) of sodium dodecyl-sulfate (SDS), the properties of which are well known. SANS of SDS has shown the importance of interactions [1, 2]. Though this solution can be considered as dilute for a chemical use, but in the sense of scattering, it is a concentrated one since the interactions are not negligible *a priori*.

— A concentrated solution (200 g/l) of sodium octanoate (NaC8). Micellar mass variation with concentration has been found by SANS [8] and confirmed by a light scattering study [9]. Two papers on SAXS of this system are available [10, 5], but their results are physically unrealistic and not consistent with neutron and light scattering : for instance, the radii given are much longer than the extended chain length and the volume fractions exceed unity. These results are due to an erroneous evaluation of interference effects and an inappropriate iterative minimization.

2. Experimental.

The apparatus used is a GDPA30 goniometer by C.G.R. (France). The tube is a micro-focus 600 W with a copper anticathode. Radiation used is $\text{CuK}\alpha_1$. A curved quartz crystal achieves monochromatization and focalization. The distance from the sample to the detector was 277 mm. An evacuated cylinder with beryllium windows lies between the sample and the detector. The latter is a linear multidetector (INEL-France) with a resolution of 0.3 mm half-height. The useful length of the detector is 40 mm and saturation due to dead-time occurs at 5 000 cps. The beam-stop inside the cylinder is a piece of nickel or lead of 2 mm width. The quality test of the setting of the slits and the beam-stop is given by the following quantities :

— Total flux in the beam (2×10^6 cps), obtained by integration of the beam measured with a calibrated attenuator. Calibration of the attenuator is obtained within 1 % precision through 48 h accumulation.

— Limiting factor, i.e. the count-rate at the edge of the beam-stop (0.3 cps) in the first useful channel of the analyser. The value of the momentum q ($4.\pi \sin(\theta)/\lambda$; θ is the half of the scattering angle) at this point is 0.02 \AA^{-1} .

— Flat background without sample in place was about 0.03 cps, mainly due to air scattering between the monochromator and the anti-diffusion slit. Diffusion of a water sample is about three times more. The observed scattering is of the same magnitude as water scattering, which was therefore chosen as a reference.

Two vertical slits are used to reduce parasite scattering before the sample. Two additional vertical slits achieve semi-punctual collimation : the image of the direct beam in the detector plane is then a thin vertical line of same height as the detector window (8 mm). This condition gives the best signal-to-noise ratio after deconvolution. The deconvolution procedure used was proposed by Lake [11]. A correct deconvolution is obtained in three to four iterations. It must be noted here that collimation affects only the lowest channels ($q < 0.08 \text{ \AA}^{-1}$) in our case. For an experiment on micelles with a linear detector, a quasi-linear collimation would give inaccurate results, since linear collimation produces unnecessary excess smearing of the signal. Before deconvolution, the scattering of an aqueous solution of surfactant at cmc is subtracted.

The samples were of the same origin as those used in previous studies [8, 9]. The exposure times were 24 h to 48 h for all the samples. The statistical fluctuation at the maximum of the peak given by micelles is about 1 %.

The sample thickness is 1.5 mm. The transmissions are measured with the sample in place, using a calibrated attenuator, the beam-stop being moved out. The windows are made of 26μ low density mylar, their transmission is about 0.96 for $\text{CuK}\alpha_1$. Mica windows are inadequate here since the surfactant wets the plane of the lamellar crystal. This can be checked by measuring the scattering of a dry and empty cell with mica windows previously kept in contact for two days with a SDS solution. For precise measurements of a surfactant solution, the choice of the glue is also crucial, since some glues are slightly soluble in micelles and give strong artefacts on the lower angle scattering part near the beam-stop.

3. Absolute scale of intensities.

The total number C of detected particles in a given detector (SANS) or channel (SAXS) is given by :

$$C = \varepsilon \Delta\Omega N_s \left(\frac{\partial\sigma}{\partial\Omega} \right) \Delta t T \phi_0 \quad (1)$$

where T is the transmission of the sample, Δt the measurement time, ϕ_0 the incident energy, $\Delta\Omega$ the solid-angle intercepted by the detector, N_s the concentration of scatterer, ε the efficiency of the detector and $(\partial\sigma/\partial\Omega)$ the differential cross-section of an isolated scatterer.

For an isotropic scattering, we define the absolute count-rate $I(q)$ of a given sample by the relation :

$$I(q) = \frac{C(q)}{T \Delta t \phi_0} \quad (2)$$

where $I(q)$ is the probability for a given incident photon or particle to be detected with a momentum transfer q . We use these notations instead of those introduced by Luzzati [12] since units like barns are transpo-

sable from one scattering technique to the other, as shown by Stuhmann [13]. With our experimental setting, a typical value for water is $I(q) = 5.5 \times 10^{-8}$.

If we consider now two measurements, one with the sample I_s and the other with the reference I_r , the scattering probabilities are independent of geometrical terms :

$$\frac{I_s(q)}{I_r(q)} = \frac{\left(\frac{\partial \sigma}{\partial \Omega}\right)_s n_s}{\left(\frac{\partial \sigma}{\partial \Omega}\right)_r n_r} \quad (3)$$

here the concentration of scatterers in the sample (n_s) and in the reference (n_r) can be expressed in any units. In the angular range investigated, the water scattering is constant : in SANS, the isotropic incoherent scattering of the protons is used as a reference, the effective incoherent cross-section of hydrogen being evaluated from the transmission of the sample, considering incoherent scattering as the main term of absorption [14] :

$$I_r(q) = n_r \frac{\sigma_{\text{inc}}}{4 \pi} \quad (4)$$

$$T = \exp(-n_r \sigma_{\text{inc}} t) \quad (5)$$

With this notation, for a typical transmission of 0.416 (1 mm water, used wavelength 10 \AA^{-1}), the intensity of water scattering is 0.71 cm^{-1} . The effective value obtained is slightly different from the absolute value quoted in cross-section tables due to inelastic effects, and variable from one neutron spectrometer to another [15]. These inelastic effects are tabulated for the different settings of the available diffractometers at Institut Laue-Langevin.

For X-ray scattering, we also use water as a reference : it is well suited since the intensity of scattering is about the same as the signal from a typical ionic micelle in a 2 % solution. The cross-section of water is independent of the scattering angle and has been carefully determined : a water molecule has the same scattering as $P = 6.35$ independent electrons. This is in agreement with the compressibility of water [16]. The total cross-section of an electron is well known and given by the Thomson factor $f^2 = 7.9 \times 10^{-26} \text{ cm}^2$. It is thereby very easy to evaluate the intensity of water scattering :

$$I_r(q) = n_r \left(\frac{\partial \sigma}{\partial \Omega}\right)_r = \frac{1}{4 \pi} f^2 P n_r \quad (6)$$

The absolute scale of water scattering is also $I_r = 1.33 \times 10^{-3} \text{ cm}^{-1}$. Now, we have to compute the scattering of a real sample. At the zero angle limit, one has :

$$\lim_{q \rightarrow 0} I_s(q) = n_s V^2 (\bar{B} - B_s)^2 S(0) \quad (7)$$

where n_s is the concentration (cm^{-3}) of micelles, each of volume V . $\bar{B}(B_s)$ is the mean scattering length den-

sity of the object (resp. solvent). I_s is expressed in cm^{-1} , as a density per unit volume of scattering length. It should be pointed out that it is equivalent to introduce the wet or the dry volume of the micelle : an increase of the volume goes with a decrease of the contrast. There is no way to determine the hydration of the micelle from the zero angle scattering. $S(0)$ is the inverse of the osmotic compressibility of the sample. This interference term, the structure factor, can also be verified by static light scattering measurements [9].

4. Model for the micelle.

In the general case of interacting monodisperse spheres, the observed intensity is the product of the form factor $P(q)$ and the structure factor $S(q)$ [1] :

$$I(q) = P(q) * S(q) \quad (8)$$

The more general case of slightly polydisperse spheres can be found in reference [7] but is not of interest here. The form factor $P(q)$ for a spherical object is given by the integral [18]

$$P(q) = \left| \int_0^\infty (B(r) - B_s) e^{iqR} dR \right|^2 \quad (9)$$

Since the spatial resolution of the experiment is $2 * \pi/q_{\text{max}}$, it is equivalent to use instead of the integral the sum of two terms :

$$P(q) = n_s \{ (B_2 - B_1) V_1 f(qR_1) + (B_2 - B_s) \times V_2 f(qR_2) \}^2 \quad (10)$$

where

$$f(x) = \{ 3 * \sin(x) - x * \cos(x) \} / x^3 \quad (11)$$

The inner hydrophobic core of radius R_1 has the scattering length density B_1 and the volume V_1 . The interface extends between R_1 and R_2 , and V_2 is the volume of the whole micelle (Fig. 1). This model has been used by several authors and works very well. This is not a proof of the existence of two well separated and distinct volumes in the micelle. With the resolution used, the scattering of a micelle is close to the scattering obtained for two concentric shells.

The problem is now reduced to the choice of the four quantities B_1 , B_2 , R_1 and R_2 . The worst way of doing it would be an adjustment without constraints. Indeed, in the expression of the form factor $P(q)$ (Eq. (9)), only the product of scattering length density and radius appears, so that any unphysical solution can be extracted from a fitting procedure taking B_i and R_i as independent parameters (as in [10, 20]). We have to take advantage of additional knowledge of the system : the micelle is an aggregate of molecules of known volume and chemical structure.

The simplest model we can build is the following : let us consider N molecules of surfactant and bring the hydrophobic chains (except the α -methylene)

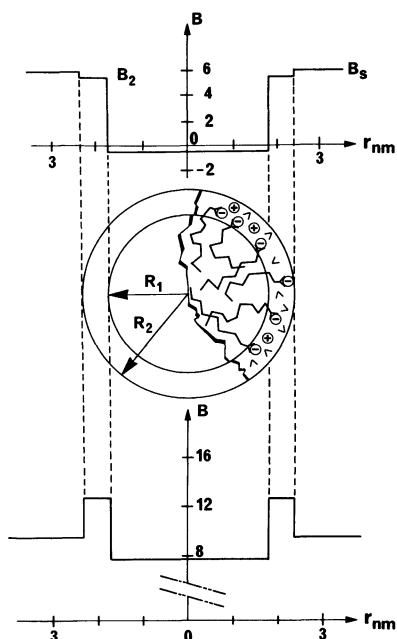

Fig. 1. — The concentric shell model of the micelle with the radial scattering length density profiles expressed in 10^{10} cm^{-2} . Upper part : SANS, lower part : SAXS for a SDS micelle.

in a sphere, the scattering length density of which is trivial to calculate. Let us build concentric shells with the volumes of α -methylenes, ionic headgroups, condensed counter-ions and bound water. In this way, a full set of radii and scattering length densities is generated from the assumption of an aggregation number N , an effective charge Z and an hydration number h . These conditions are drastic limitations for the fitting procedure. One has to notice here that a different set of radii can be obtained if one decides to locate the α -methylenes in the internal sphere : Anyway, the calculated $P(q)$ would be exactly the same in the observed q -range. The sets of radii and scattering length densities are therefore distinct but equivalent, since they are only intermediate in the calculation. A direct fitting of a set of B and R is without significance and this procedure must be avoided (as in [20]). In the same way, the $P(q)$ generated with and without hydration would be exactly identical in the q -range of observation, so long the hydration layer at the interface does not exceed the resolution π/q_{max} , i.e. 5 \AA . Hydration has only an effect on the volume fraction and on the interactions between micelles.

In a second step, the input parameters to calculate the structure factor $S(q)$ can be evaluated : the volume fraction of the micelles, including hydration water molecules and the well-known Debye screening length of the solvent κ :

$$\kappa^2 = 4 \pi L_b \sum c_i Z_i^2 \quad (12)$$

where L_b is the Bjerrum length (7.2 \AA) and c_i the concentration of ions (m^{-3}) of charge Z_i in the solvent.

In SANS the « hydration » of the micelle is the volume of bound water which is not expelled at the closest approach between micelles. Any other type of hydration, such as « fjords » or « water drops in the core », can only be detected at q -values larger than 0.5 \AA^{-1} .

The set $S(q)$, $P(q)$ can also be generated on an absolute scale both for SAXS and SANS, if the hydration number h , the net charge Z and the aggregation number N are known. The calculation is iterated until a good agreement between the calculated $I(q)$ and the observed one is obtained. The structural parameters of the micelle, N , Z and h are found and fixed. Without changing any more parameters, the scattering length used in SANS are replaced by the number of electrons of each atom. The quality of the predicted scattering is a strong argument in favour of the model of interacting spheres for the description of aqueous micelles.

In intermediate calculations, two interesting properties have to be noted : the value of the structure factor $S(q)$ at the zero angle limit gives the osmotic compressibility of the system and can be checked by separate classical light scattering experiments. A solution is dilute in the sense of a scattering experiment only if $S(0)$ is close to unity ; it occurs when the volume fraction of micellized amphiphile is less than 0.5% . Another intermediate result of interesting physical sense is the contact potential between two micelles γ in kT units.

5. Results.

Figure 1 shows the model of the micellar aggregate : a first sphere is constructed with the volume of all the hydrophobic tails (except the alpha methylenes). The radius R_1 of this sphere is deduced from the aggregation number N and the partial molar volume obtained by density measurements for the same systems in the same conditions (SDS : ref. [4] ; NaC8 ref. [21]). The scattering length densities are calculated for each technique. The interface is then constructed with the alpha methylenes, the adsorbed counter-ions and the water molecules. In the case of neutron scattering, a sharp contrast exists between the core and the two aqueous phases (interface and solvent). In the case of X-ray scattering, the core has a lower electron density than the solvent, but the interface has a very high electron density. A micelle is seen in this case as a hollow shell. The mean scattering length density of the whole micelle is very close to that of the solvent. This gives as a result a very low scattered intensity at zero angle and a peak in the $P(q)$ of the micelle, giving some confusion with interference effects.

Figure 2 shows the SAXS and SANS spectra from a dilute solution of SDS. The reference ($I = 1$) is taken as the scattering of water. The two experiments were carried out in D_2O in order to avoid any difference due to the deuteration which is necessary

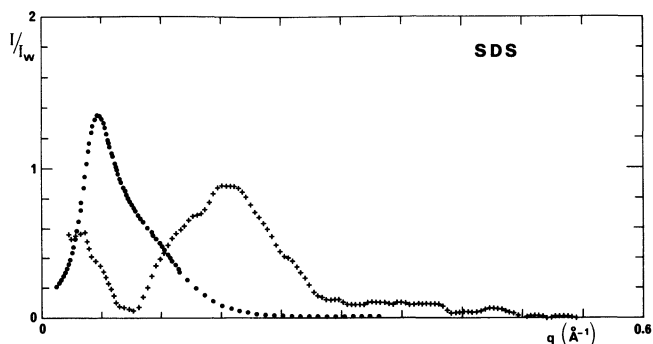

Fig. 2. — Comparison on an absolute scale of SAXS (+) and SANS (●) of 20 g/l SDS. Unity for SANS : incoherent scattering of the same thickness of water. Unity for SAXS : scattering of water.

to ensure contrast in neutron scattering. Figure 3 gives the decomposition of the scattering in $P(q)$ and $S(q)$ for neutron scattering. The contrast in SANS (Fig. 1) comes from D_2O and the protonated hydrophobic core. The SAXS on the same system occurs through the high electron density beared by the condensed counter-ions and headgroups on the surface of the micelle, so that the $P(q)$ has itself an oscillating behaviour characteristic of a shell. The structure factor $S(q)$ is identical in SAXS and SANS (dashed line in Fig. 3). The $I(q)$ predicted from figure 3-n and

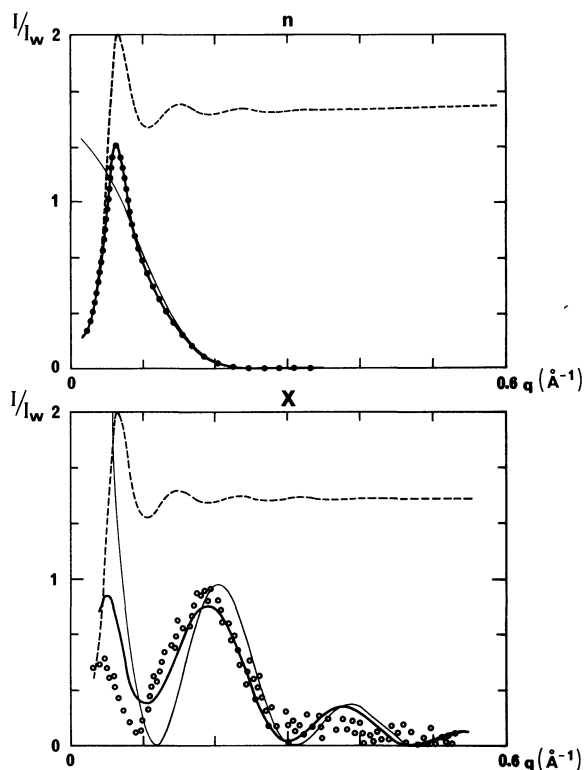

Fig. 3. — $S(q)$ and $P(q)$ decomposition of SAXS (X) and SANS (n) of SDS. $S(q)$ is the same for the two parts of the figure. Thick line in SAXS is convoluted by the smearing effect of the collimation for comparison with experimental data.

the $I_s(q)$ experimentally observed after smearing by collimation effects is shown in figure 3-X. I_s is thereby comparable to the observed scattering. Table I gives the input parameters of the calculation : aggregation number N , hydration h and net charge Z . The intermediate computations give the interference term $S(0)$, the contact potential γ in kT units and the set of radii and scattering length densities. The table also reports the values of Luzzati and Reiss-Husson. The agreement is excellent since in the limited angular range observed twenty years ago, the interference term $S(q)$ does not practically differ from unity. The fundamental assumption of Reiss-Husson and Luzzati is thus confirmed : the peak observed in SAXS is not due to interference but corresponds to the secondary maximum of the counter-ions shell. The raise of the experimental scattering at low q was not observable but was predicted by Reiss-Husson in her thesis ! A very similar conclusion on a nematic phase has been drawn in reference [22], where SAXS and SANS experiments were compared too.

This conclusion is not true for any micellar system. Figure 4 shows the SAXS and SANS spectra of a concentrated solution of sodium octanoate. Figure 5-n shows the decomposition $S(q)$ and $P(q)$. From figure 5 it is obvious that interference effects are important both for SAXS and SANS, at any concentration of sodium octanoate micelles. Previous X-ray studies [5, 10] which attempted to fit $P(q)$ to the observed scattering are completely erroneous (Table II).

Is it therefore possible to determine the aggregation number N , the charge Z and the hydration number h from the X-ray scattering alone ? The answer is yes, but with less precision than through neutron scattering. In the case of SDS, only the mass of the aggregate can be precisely obtained in this manner. To emphasize this, we have made simulations with an error of

Table I. — Parameters and intermediate values in the calculation of SDS scattering. SAXS : as predicted by SANS (1) ; as given in reference [4] (2).

	SAXS		
	SANS	(1)	(2)
R_1 (nm)	1.79	1.79	1.78
R_2 (nm)	2.20	2.20	2.40
b_1 $\left\{ \begin{array}{l} e^2/\text{Å}^3 \\ 10^{10} \text{ cm}^{-2} \end{array} \right.$	-	0.280	0.275
	0.4	7.86	7.72
b_2 $\left\{ \begin{array}{l} e^2/\text{Å}^3 \\ 10^{10} \text{ cm}^{-2} \end{array} \right.$	-	0.445	0.395
	5.3	12.5	11.1
Z	26		-
N	70		67
γ (kT)	25		-
$S(0)$	0.28		-

	SANS		SAXS	
		(1)	(2)	(3)
R_1 (nm)	9.9	9.9	5.5	5.7
R_2 (nm)	13.8	13.8	26.5	24.3
b_1	$e/\text{Å}^3$	-	0.234	0.263
	10^{10}cm^{-2}	0.5	6.57	7.38
b_2	$e/\text{Å}^3$	-	0.368	0.337
	10^{10}cm^{-2}	5.1	10.3	9.46
Z	10		-	-
N	22		-	-
γ (kT)	1.3		-	-
S(O)	0.11		-	-

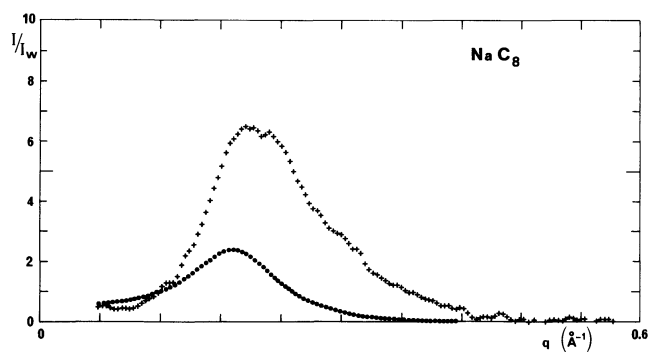

Fig. 4. — In the same representation as figure 2, SAXS and SANS data for a 200 g/l solution of sodium octanoate.

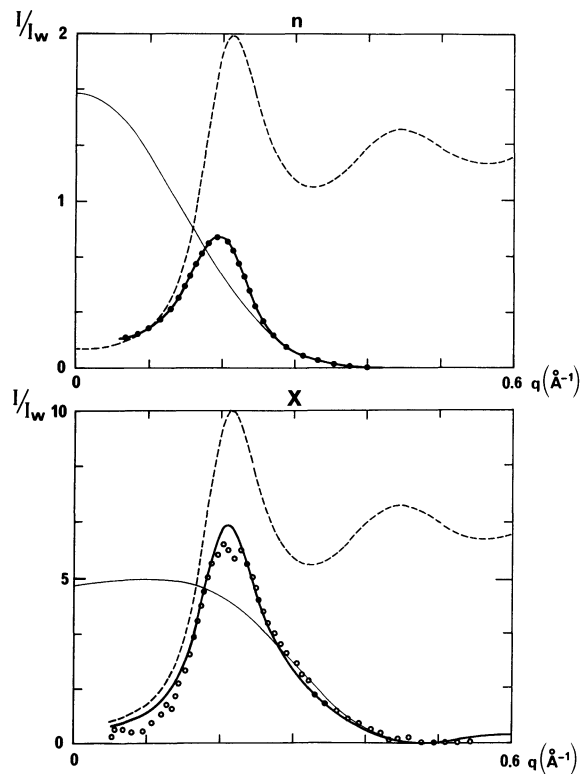

Fig. 5. — $S(q)$ and $P(q)$ decomposition of SAXS and SANS scattering of sodium octanoate.



Table II. — Parameters and intermediate values in the calculation of octanoate scattering. SAXS : as predicted by SANS (1), as given in reference [5] (2) and in reference [10] (3). Using the older notations of Luzzati et al., one would have for sodium octanoate : number of electrons per micelle $m = 1870$; $i_n c = 36$ as the value of the scattering $P(q)$ at the zero angle limit and $w = 2.57 e \text{Å}^3$.

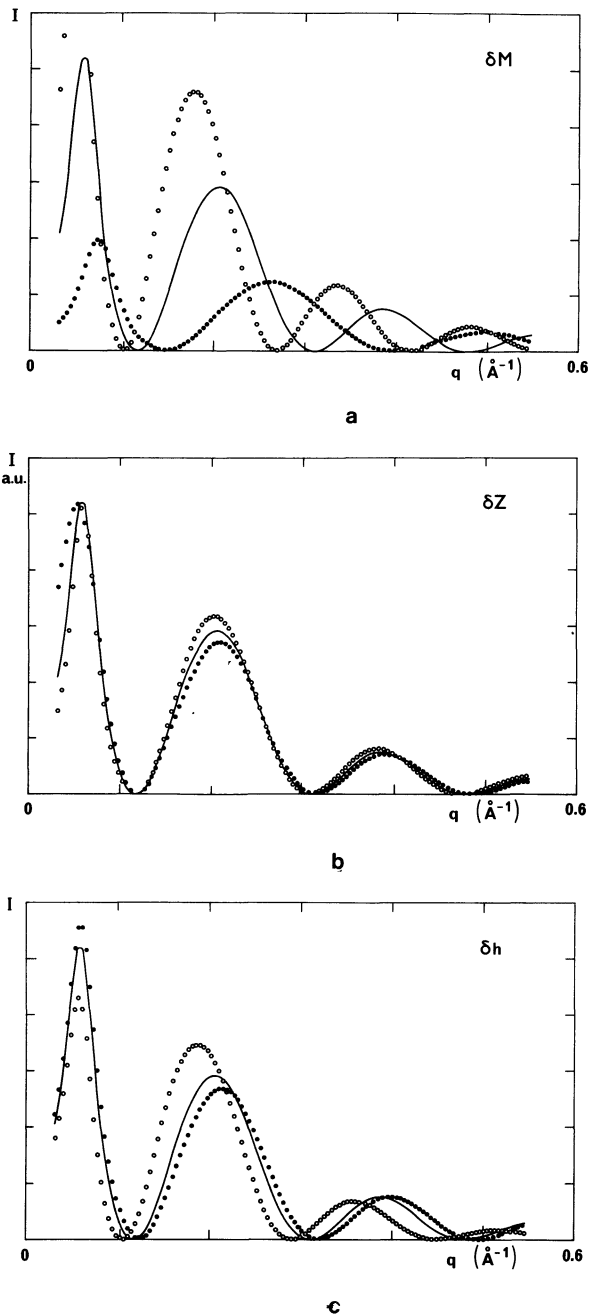

Fig. 6. — Effect of a 50% variation of the three input parameters (Z , M , h) for the model on the scattering of SDS. A mass variation is easily detected but charge and hydration variation are beyond actual resolution.

50 % more or less of the exact value for the three basic parameters of the model. Figure 6 gives the obtained scattering profiles on an absolute scale in the case of SDS. A careful examination of the figures brings the conviction that charge or hydration numbers are difficult to determine with some accuracy. Absolute scaling cannot be safely claimed with less than 10 % systematic errors. Even in neutron scattering, the values of hydration or water penetration cannot be observed on low resolution scattering ($q < 0.5 \text{ \AA}^{-1}$), although it is sometimes claimed [20]. The resolution barrier in real space is π/q_{max} . The hydration has only an indirect effect on the hard sphere volume of the micelle, which is obviously higher than the volume of N dry isolated surfactant molecules [1].

In the case of X-ray scattering, the obtained values of the micellar mass can be affected by a spurious effect due to a slight error in the partial molar volume. The mean scattering length density of the whole micelle is very dependent on the molecular volume chosen in the computation. If we choose, instead of the value accurately measured in the same conditions by volumetric measurements, the value in some widely used table [23], the error is more than 50 % on the obtained mass of the micelle. Initial values of partial molar volumes are always important in order to obtain correct values of micellar mass.

Figure 7 shows the errors which can be made by using Fourier transformation into real space without a previous separation of $S(q)$. The Patterson function or distance distribution function (Ref. [24], section 15, p. 500) can give direct qualitative information on the shape of the scatterer. Truncation effects give an indication on the resolution obtained. Before Fourier transformation, no extrapolation of the scattering curves in low- q or high- q range were made. The dots are the Patterson function of the scattered intensity $I(q)$. The continuous line is the Patterson function of the single particle scattering in the range of the measurement. It is clear from this figure that artefacts due to truncation effects in the Fourier transformation to real space are less important than perturbation of the signal due to interferences. Any attempt to deconvolute a Patterson function of $I(q)$ to an electronic density will lead to artefacts (as in Ref. [24], section 15, p. 501).

6. Conclusion.

We have shown here that a unique assumption on spherical packing of N amphiphilic molecules associat-

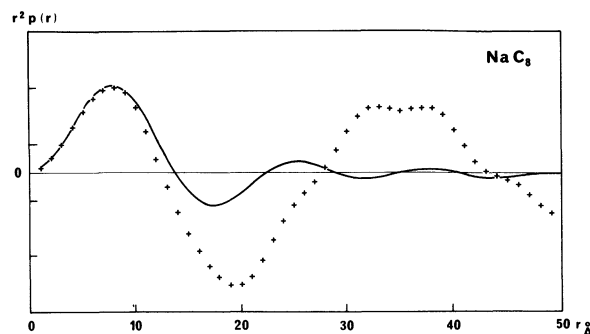

Fig. 7. — $r^2 p(r)$ versus q ; $p(r)$ is the distance distribution function for sodium octanoate (1.2 M). Dotted line : Fourier transformation of $I(q)$. Solid line : Fourier transformation of $P(q)$, after separation of the interferences.

ed with h water molecules per headgroup in a micelle of charge Z , interacting through a screened electrostatic potential is able to predict, on an absolute scale, both X-ray and neutron scattering. Any interpretation of a concentrated (i.e. more than 0.5 %) solution of ionic micelles cannot be interpreted quantitatively without separation of the interference term $S(q)$ and the intramicellar scattering $P(q)$. If the partial molar volumes are known, a good value for the aggregation number is obtained. Charge of the micelle and hard sphere effective volume are obtained with less precision than by SANS.

Lastly, the method proposed by Hayter and Penfold is operating with success in SAXS, which needs much cheaper sources than nuclear reactors. There are, however, some extra difficulties in SAXS, the observed scattering being mainly due to the ionic interface and not to the hydrophobic core. We hope that, despite this intrinsic limitation, this method will make quantitative SAXS studies in concentrated micellar systems possible.

Acknowledgments.

We wish to thank for helpful discussions and encouragements Bernard Cabane, Yves Chevalier, John B. Hayter and Annette Tardieu who also let us kindly access to her own diffractometer for useful control measurements.

References

- [1] HAYTER, J. B. and PENFOLD, J., *J. Chem. Soc. Faraday Trans. I* **77** (1981) 1851.
- [2] HAYTER, J. B. and PENFOLD, J., *Mol. Phys.* **42** (1981) 109.
- [3] REISS-HUSSON, F. and LUZZATI, V., *J. Phys. Chem.* **68** (1964) 3504.
- [4] REISS-HUSSON, F., thesis 1963 University of Strasbourg (France).
- [5] SVENS, B. and ROSENHOLM, B., *J. Colloid Interface Sci.* **44** (1973) 495.
- [6] TARDIEU, A. *et al. Biochemistry* **20** (1981) 4399.
- [7] LUZZATI, V. and TARDIEU, A., *Ann. Rev. Biophys. Bioeng.* **9** (1980) 1.
- [8] HAYTER, J. B. and ZEMB, T., *Chem. Phys. Lett.* **93** (1982) 91.
- [9] ZEMB, T., DIFFORD, M., HAYOUN, M. and JEHANNO, A., *J. Phys. Chem.* **87** (1983) 4524.
- [10] FRIMAN, R. and ROSENHOLM, J. B., *Colloid Polym. Sci.* **260** (1982) 545.
- [11] LAKE, J. A., *Acta Cryst.* **23** (1967) 191.
- [12] LUZZATI, V., *Acta Cryst.* **13** (1945) 939.
- [13] STUHRMANN, H. B. and MILLER, A., *J. Appl. Cryst.* **11** (1978) 325.
- [14] JACROT, B. and ZACCAI, G., *Biopolymers* **20** (1981) 2420.
- [15] OBERTHUER, R., Institut Laue-Langevin (Grenoble, France) personal communication.
- [16] LEVELUT, A. M., thesis, University of Paris (1968).
- [17] HAYTER, J. B., Enrico Fermi School of Physics, hold in Varenna, Italy (July 1983).
- [18] HAYTER, J. B. and PENFOLD, J., *Colloid Polym. Sci.* **261** (1983) 1022.
- [19] CABANE, B., DUPLESSIX, R. and ZEMB, T. in *Surfactants in solution*, Vol. 1, p. 373, K. L. Mittal and B. Lindman editors (Plenum Press) 1984.
- [20] TABONY, *Mol. Phys.* **51** (1984) 975.
- [21] EKWALL, P., EIKREM, H. and MANDELL, L., *Acta Chem. Scand.* **17** (1963) 111.
- [22] HENDRICKS, Y., CHARVOLIN, J., RAWISO, M., LIEBERT, L. and HOLMES, M. C., *J. Phys. Chem.* **87** (1983) 3991.
- [23] IMIRZI, A. and PERINI, B., *Acta Cryst. A* **33** (1977) 216.
- [24] *Small angle X-ray scattering* (Academic Press) 1982. Glatter, O. and KRATKY, O. editors.
-