



HAL
open science

Some polynomial classes for the acyclic orientation with parity constraint problem

Sylvain Gravier, Matthieu Petiteau, Isabelle Sivignon

► To cite this version:

Sylvain Gravier, Matthieu Petiteau, Isabelle Sivignon. Some polynomial classes for the acyclic orientation with parity constraint problem. 2026. <hal-05545067>

HAL Id: hal-05545067

<https://hal.science/hal-05545067v1>

Preprint submitted on 10 Mar 2026

HAL is a multi-disciplinary open access archive for the deposit and dissemination of scientific research documents, whether they are published or not. The documents may come from teaching and research institutions in France or abroad, or from public or private research centers.

L'archive ouverte pluridisciplinaire HAL, est destinée au dépôt et à la diffusion de documents scientifiques de niveau recherche, publiés ou non, émanant des établissements d'enseignement et de recherche français ou étrangers, des laboratoires publics ou privés.



Distributed under a Creative Commons CC BY-NC-ND 4.0 - Attribution - Non-commercial use - No Derivative Works - International License

Some polynomial classes for the acyclic orientation with parity constraint problem

Sylvain Gravier^{1,3}, Matthieu Petiteau^{1,3}, and Isabelle Sivignon^{2,3}

¹Univ. Grenoble Alpes, CNRS, Institut Fourier, 38000 Grenoble, France

²Univ. Grenoble Alpes, CNRS, Grenoble INP, GIPSA-lab, 38000 Grenoble, France

³Univ. Grenoble Alpes, Maths à Modeler, 38000 Grenoble, France

March 10, 2026

Abstract

We study the problem of finding an acyclic orientation of an undirected graph with constrained in-degree parities specified by a subset T of vertices. An orientation is called T -odd if a vertex v has odd in-degree if and only if $v \in T$. While the unconstrained parity orientation problem is polynomial (Chevalier et al. (1983)), imposing acyclicity makes it more challenging, and its complexity remains an open question. Szegedy and Szegedy (2006) proposed a randomized polynomial-time algorithm for this problem, but it is not known whether it belongs to co-NP. Furthermore, Gravier et al. (2025) showed the problem becomes NP-complete on partially directed graphs, even when restricted to planar cubic graphs.

We identify three necessary conditions for the existence of acyclic T -odd orientation: a global parity condition \mathcal{P} , and two conditions \mathcal{S} and $\bar{\mathcal{S}}$ ensuring the existence of potential sources and sinks. Following the work of Frank and Kiraly (2002), we define graph classes containing the graphs for which a given subset of the necessary conditions \mathcal{P} , \mathcal{S} and $\bar{\mathcal{S}}$ is also sufficient for the existence of an acyclic T -odd orientation. We establish the inclusion relationships between these classes.

We complete the study of these classes by a characterization of the solvable instances for Cartesian products of paths and cycles. The proofs of these results are all constructive, so that acyclic T -odd orientations can be built in polynomial time whenever they exist. We use these families, along with cliques, to demonstrate the strictness of the class inclusions in our hierarchy.

Contents

1	Introduction	2
2	Definitions and preliminaries	4
3	Classes of necessary conditions: proof of Theorem 1.1	5
3.1	Proof of (a) and (b)	6
3.2	Proof of (c)	6
3.3	Proof of (d)	7
3.4	Proof of (e)	7
4	Cartesian product of path and/or cycle	8
4.1	Proofs methods and overview	8
4.2	Basic cases	10
4.3	Grids	10
4.4	Cylinders and Tori	18
4.5	Final remarks	33
5	Proof of Corollary 1.5	35
5.1	Proof of (c'), (d') and (e')	36
5.2	Proof of (c''), (d'') and (e'')	36

1 Introduction

In this paper, we study an orientation problem with parity constraints on simple graphs. We first consider a local constraint on the parity of the in-degree of vertices. For a graph G and a subset $T \subseteq V(G)$, an orientation of G is called T -**odd** if any vertex $v \in V$ has an odd in-degree if and only if it is in T . Chevalier, Jaeger, Payan, and Xuong (1983) [1] demonstrated that finding a T -odd orientation of an undirected graph G can be solved in polynomial time. Specifically, they showed that such an orientation exists if and only if T satisfies $|E| + |T| \equiv_2 0$. In the following, we call this property \mathcal{P} .

Frank and Király (2002) [2] later considered adding a k -connectivity global constraint. They provided a characterization of undirected graphs $G = (V, E)$ for which there exists a k -arc-connected T -odd orientation if and only if $T \subset V$ satisfies \mathcal{P} . This work also raised questions about other global constraints such as acyclicity, which can be seen as another type of connectivity constraint. This leads to the following problem:

Problem 1 (Acyclic Orientation with Parity Constraints).

Instance: A pair (G, T) with G an undirected graph and $T \subseteq V(G)$ a subset of its vertex set.

Question: Does G have an acyclic T -odd orientation?

The characterization of the satisfying instances of this problem is referenced on the Egres platform¹ and is known as the "Acyclic orientation with parity constraints" problem. The complexity of this decision problem remains an open question. Szegedy (2005) [3] proposed a randomized polynomial algorithm to answer Problem 1, it is closely related to results on matroids presented also in Szegedy, Szegedy (2006) [4]; however, it is not known whether it belongs to co-NP, and the problem becomes NP-complete on partially directed graphs, even restricted to graphs being both planar and cubic [5].

Following the work of Frank and Kiraly (2002) [2], an associated problem considering acyclicity is also introduced on the Egres platform:

Problem 2.

Find a good characterization for undirected graphs $G = (V, E)$ which, for every possible $T \subsetneq V$ satisfying \mathcal{P} , have an acyclic orientation T -odd orientation.

The condition \mathcal{P} remains a necessary condition for the existence of an acyclic T -odd orientation. Note also that the acyclicity constraint gives rise to two other necessary conditions: the existence of a potential source and a potential sink. Any acyclic orientation of a finite graph G must have at least one vertex with in-degree 0 and one vertex with out-degree 0. These vertices are respectively called a **source** and a **sink**. In the context of T -odd orientations, a vertex is called a **potential source** if it belongs to $Source(T) = V \setminus T$ and a **potential sink** if it belongs to $Sink(T) = \{v \in T, d(v) \equiv_2 1\} \cup \{v \in V \setminus T, d(v) \equiv_2 0\}$. These names arise from the fact that, in any acyclic T -odd orientation of G , the sources and sinks must be potential sources and potential sinks, respectively. It is also worth noticing that if $Source(T) = Sink(T) = \{v\}$ for some vertex v , then no acyclic T -odd orientation exists unless the graph is a singleton. This last necessary condition is relatively weak; indeed, any odd degree vertex in T belongs to $Sink(T) \setminus Source(T)$ and any odd degree vertex in $V \setminus T$ belongs to $Source(T) \setminus Sink(T)$, while even degree vertices in $V \setminus T$ belong to $Source(T) \cap Sink(T)$, so $Source(T) = Sink(T)$ if and only if the graph has no odd degree vertex. Thus, we do not consider it apart from the other conditions, and for symmetry reasons, we consider it in both the **source condition** \mathcal{S} and **sink condition** $\bar{\mathcal{S}}$. This leads to the following necessary conditions for the existence of an acyclic T -odd orientation:

$$\mathcal{P}: |E| + |T| \equiv_2 0.$$

$$\mathcal{S}: Source(T) \neq \emptyset \text{ and if } |Source(T)| = 1 \text{ then either } \begin{cases} |V| = 1, \\ \text{or} \\ Source(T) \neq Sink(T). \end{cases}$$

$$\bar{\mathcal{S}}: Sink(T) \neq \emptyset \text{ and if } |Sink(T)| = 1 \text{ then either } \begin{cases} |V| = 1, \\ \text{or} \\ Sink(T) \neq Source(T). \end{cases}$$

¹https://lemon.cs.elte.hu/egres/open/Acyclic_orientation_with_parity_constraints

We now define the classes $\mathcal{C}_{\mathcal{P}}, \mathcal{C}_{\mathcal{S}}, \mathcal{C}_{\overline{\mathcal{S}}}, \mathcal{C}_{\mathcal{PS}}, \mathcal{C}_{\overline{\mathcal{PS}}}, \mathcal{C}_{\mathcal{S}\overline{\mathcal{S}}}, \mathcal{C}_{\overline{\mathcal{PS}\overline{\mathcal{S}}}}$ as the sets of graphs for which the indexed necessary conditions are also sufficient for the existence of an acyclic T -odd orientation. Specifically, a graph belongs to $\mathcal{C}_{\mathcal{N}}$ for $\mathcal{N} \subseteq \{\mathcal{PS}\overline{\mathcal{S}}\}$ if it admits an acyclic T -odd orientation for any subset T satisfying all necessary conditions in \mathcal{N} , thereby implying that all the necessary conditions in $\{\mathcal{PS}\overline{\mathcal{S}}\} \setminus \mathcal{N}$ are always satisfied for all such T . In particular, this gives straightforward inclusions between these classes: if $\mathcal{N}' \subseteq \mathcal{N} \subseteq \{\mathcal{PS}\overline{\mathcal{S}}\}$, then $\mathcal{C}_{\mathcal{N}'} \subseteq \mathcal{C}_{\mathcal{N}}$.

Our first result is the description of all the classes mentioned above. The proof of this theorem is the object of Section 3.

Theorem 1.1.

- (a) $\mathcal{C}_{\mathcal{S}} = \mathcal{C}_{\overline{\mathcal{S}}} = \{\circ, \circ \circ\}$,
- (b) $\mathcal{C}_{\mathcal{S}\overline{\mathcal{S}}} = \{\circ, \circ \circ, \circ \circ \circ\}$,
- (c) $\mathcal{C}_{\mathcal{P}} = \{\circ\} \cup \{G \in \mathcal{C}_{\overline{\mathcal{PS}\overline{\mathcal{S}}}} \mid G \text{ is connected, non-Eulerian, and } |V(G)| + |E(G)| \equiv_2 1\}$,
- (d) $\mathcal{C}_{\mathcal{PS}} \setminus \mathcal{C}_{\mathcal{P}} = \mathcal{C}_{\overline{\mathcal{PS}\overline{\mathcal{S}}}} \setminus \mathcal{C}_{\mathcal{P}} = \{\circ \circ, \circ \circ \circ\} \cup \{G \in \mathcal{C}_{\overline{\mathcal{PS}\overline{\mathcal{S}}}} \mid G \text{ is Eulerian}\}$,
- (e) $\mathcal{C}_{\overline{\mathcal{PS}\overline{\mathcal{S}}}} \setminus \mathcal{C}_{\mathcal{PS}} \subset \{\circ \circ \circ\} \cup \{G \mid G \text{ is connected, non-Eulerian, and } |V(G)| + |E(G)| \equiv_2 0\}$.

With this new formalism, Problem 2 is essentially asking if G belongs to $\mathcal{C}_{\mathcal{PS}}$. To put it in perspective, let us recall a result from Kiraly and Kisfaludi-Bak:

Theorem 1.2 (Theorem 1.8 in [6]).

Let $G = (V, E)$ be a graph.

G admits an acyclic T -odd orientation for all $T \subseteq V$ satisfying $|E(G)| + |T| \equiv_2 0$ if and only if G admits an acyclic T' -odd orientation with $T' = V \setminus \{v\}$ for some vertex $v \in V$.

Note the distinction between Theorem 1.2 and the question in Problem 2: Theorem 1.2 gives a characterization of graphs in $\mathcal{C}_{\mathcal{P}}$ while Problem 2 asks for an analogous characterization restricted to sets $T \subsetneq V$. This difference is of importance, indeed, as we shall see later, there exist graphs that are not in $\mathcal{C}_{\mathcal{P}}$ but admit acyclic T -odd orientations for every $T \subsetneq V$ satisfying \mathcal{P} .

Moreover, the constraint $T \subsetneq V$ guarantees the existence of a source but breaks the symmetry with the existence of sinks. We restore this symmetry with the study of the classes $\mathcal{C}_{\mathcal{PS}}, \mathcal{C}_{\overline{\mathcal{PS}}}$ and $\mathcal{C}_{\overline{\mathcal{PS}\overline{\mathcal{S}}}}$.

In a second section, we study classes of instances defined from the Cartesian product of cycles and/or paths. We define the **grid**, **torus**, and **cylinder** as the Cartesian product of two paths, two cycles, and a cycle and a path, respectively (see Figures 1 and 2). We then give a complete characterization of sets T satisfying all three necessary conditions $\mathcal{PS}\overline{\mathcal{S}}$ such that G admits an acyclic T -odd orientation, where G is either a grid, a torus, or a cylinder. In particular, as a second main result, we prove the following two theorems:

Theorem 1.3. Let $G = C_p \square H_q$ be a graph where C_p is a cycle on p vertices and H_q is a path or a cycle on q vertices. Let $T \subset V(G)$ be a subset that satisfies $\mathcal{PS}\overline{\mathcal{S}}$.

If H_q is a path or if $p, q \geq 4$, then G has an acyclic T -odd orientation.

Theorem 1.4. Let $G = P_p \square P_q$ be a graph where P_p and P_q are paths with vertex sets $\{v_1, \dots, v_p\}$ and $\{w_1, \dots, w_q\}$, respectively. Let $T \subset V(G)$ be a subset that satisfies \mathcal{P} .

$P_p \square P_q$ has no acyclic T -odd orientation if and only if $p, q \equiv_2 0$ and $V \setminus T$ satisfies that:

- $(v_{2k}, w_j) \in V \setminus T$ if and only if $(v_{2k+1}, w_j) \in V \setminus T$ for all $k \in \{1, \dots, \frac{p}{2} - 1\}$ and $j \in \{1, q\}$.
- $(v_i, w_{2k}) \in V \setminus T$ if and only if $(v_i, w_{2k+1}) \in V \setminus T$ for all $i \in \{1, p\}$ and $k \in \{1, \dots, \frac{q}{2} - 1\}$ symmetrically.

As a corollary of these characterizations, we show that the inclusions between the classes $\mathcal{C}_{\mathcal{P}}, \mathcal{C}_{\mathcal{PS}}$, and $\mathcal{C}_{\overline{\mathcal{PS}\overline{\mathcal{S}}}}$ are actually strict (see Figure 3):

Corollary 1.5. Let $p, q, k \geq 1$ be three integers.

- (c)' The Cylinders $C_{2p+1} \square P_{2q}$, the Grids $P_{2p+1} \square P_q$, and Trees are in $\mathcal{C}_{\mathcal{P}}$.
- (d)' The Tori $C_p \square C_q$ with $p, q \geq 4$ and Cycles are in $\mathcal{C}_{\overline{\mathcal{PS}\overline{\mathcal{S}}}} \setminus \mathcal{C}_{\mathcal{P}}$.
- (e)' The Cylinders $C_{2p} \square P_q, C_{2p+1} \square P_{2q+1}$ are in $\mathcal{C}_{\overline{\mathcal{PS}\overline{\mathcal{S}}}} \setminus \mathcal{C}_{\mathcal{PS}}$.

Moreover,

- (c)'' The Cliques $K_{4k+2} \in \{G \text{ connected and non-Eulerian} \mid |V(G)| + |E(G)| \equiv_2 1\} \setminus \mathcal{C}_{\mathcal{P}}$.

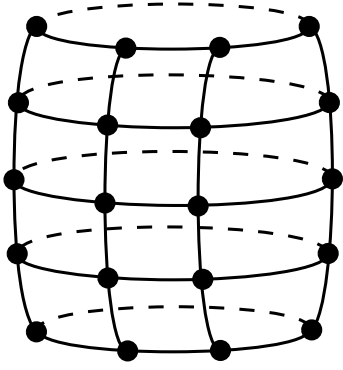

Figure 1: Cylinder graph $C_4 \times P_5$

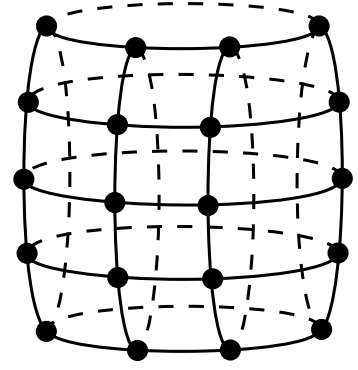

Figure 2: Torus graph $C_4 \times C_5$

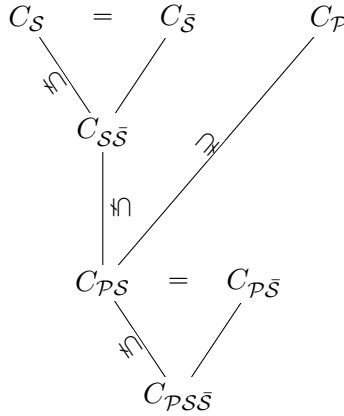

Figure 3: Theorem 1.1.

(d) The Cliques $K_{2k+1} \in \{\circ \circ\} \cup \{G \mid G \text{ is Eulerian}\} \setminus C_{PS}$.

(e) The Cliques $K_{4k} \in \{G \text{ connected and non-Eulerian} \mid |V(G)| + |E(G)| \equiv_2 0\} \setminus C_{PS\bar{S}}$.

The paper is structured in three major sections. Section 3 is dedicated to the proof of Theorem 1.1 on graph classes. In Section 4 we prove Theorem 1.3 and 1.4 on graphs obtained from the Cartesian product of paths and cycles. Finally, Section 5 is for the proof of this last corollary.

2 Definitions and preliminaries

A **graph** G is a pair $(V(G), E(G))$ where $V(G)$ is a non-empty set of vertices and $E(G)$ is a set of edges. We only consider simple graphs i.e., loopless and without multi-edges. For a subset $X \subseteq V(G)$, the **subgraph** $G[X]$ is the graph whose vertex set is X and whose edge set is $E(G[X]) = \{(u, v) \mid u \in X, v \in X, (u, v) \in E(G)\}$. For subsets $X, Y \subseteq V(G)$, the **cut set** $\delta(X, Y)$ is the set of edges with one endpoint in X and the other in Y . When $Y = V(G) \setminus X$, we simply write $\delta(X)$. The **degree** of a vertex v , denoted $d(v)$, is the number of edges incident to v , i.e. $|\delta(v)|$.

Let G and H be two graphs. The **Cartesian product** of G and H , denoted by $G \square H$, is the graph whose vertex set is $V(G \square H) = V(G) \times V(H) = \{(u, v) \mid u \in V(G), v \in V(H)\}$. Two vertices (u, v) and (u', v') in $V(G \square H)$ are adjacent if and only if $[u = u' \text{ and } (v, v') \in E(H)]$ or $[v = v' \text{ and } (u, u') \in E(G)]$.

A **directed graph** D consists of a non-empty set of vertices $V(D)$ and a set of arcs $A(D)$, where an arc is an ordered pair of vertices. An arc is denoted \vec{uv} or \overleftarrow{vu} according to the ordering. For subsets $X, Y \subseteq V(D)$, the **cut set** $\delta_D(X, Y)$ is the set of arcs with one endpoint in X and the other in Y . For a vertex $v \in V(D)$, we define the **out-degree** $d_D^+(v)$ and the **in-degree** $d_D^-(v)$.

to be the number of arcs directed outward and inward from v , respectively. The degree $d_D(v)$ is $d_D^+(v) + d_D^-(v)$. The subscript can be omitted when there is no ambiguity on the concerned graph.

Given a graph G and a set $S \subset E(G)$, an **orientation** O of S is a set of arcs such that for every edge $uv \in S$, either $\overrightarrow{uv} \in O$ or $\overleftarrow{uv} \in O$, but not both. An **orientation O of a graph G** is an orientation of $E(G)$, and we denote by $G_O = (V(G), O)$ the associated directed graph. A set of arcs A is said to be **acyclic** if the subgraph induced by A does not contain any directed cycle. By extension, a directed graph D is acyclic if its arc set $A(D)$ is acyclic.

For the figures, given (G, T) an instance of Problem 1, we refer to vertices in T as **black** vertices and vertices in $V(G) \setminus T$ as **white** vertices. The **gray** vertices symbolize vertices that can be either black or white. The **blue sets** are sets of vertices of the same color; hence, a blue set of gray vertices is a set whose vertices are either all white or all black.

3 Classes of necessary conditions: proof of Theorem 1.1

First, we prove the following useful lemma. Let $\mathcal{G}_{\leq 3}$ be the set of graphs with at most 3 vertices.

Lemma 3.1. *The following holds:*

$$\begin{aligned} \mathcal{C}_S \cap \mathcal{G}_{\leq 3} &= \mathcal{C}_{\overline{S}} \cap \mathcal{G}_{\leq 3} = \{\circ, \circ \circ\} \\ \mathcal{C}_{S\overline{S}} \cap \mathcal{G}_{\leq 3} &= \{\circ, \circ \circ, \circ-\circ\} \\ \mathcal{C}_{\mathcal{P}} \cap \mathcal{G}_{\leq 3} &= \{\circ, \circ-\circ, \circ \circ\} \\ \mathcal{C}_{\mathcal{P}S} \cap \mathcal{G}_{\leq 3} &= \mathcal{C}_{\mathcal{P}\overline{S}} \cap \mathcal{G}_{\leq 3} = \{\circ, \circ \circ, \circ-\circ, \circ \circ, \circ \circ, \circ \circ\} \\ \mathcal{C}_{\mathcal{P}S\overline{S}} \cap \mathcal{G}_{\leq 3} &= \{\circ, \circ \circ, \circ-\circ, \circ \circ, \circ \circ, \circ \circ, \circ \circ\} \end{aligned}$$

Proof.

(\circ) The one-vertex graph admits an acyclic T -odd orientation if and only if $T = \emptyset$; this is already imposed if either \mathcal{P} , \mathcal{S} , or $\overline{\mathcal{S}}$ is satisfied. Thus, it belongs to $\mathcal{C}_{\mathcal{P}}$, \mathcal{C}_S , $\mathcal{C}_{\overline{S}}$ and by inclusion, to $\mathcal{C}_{S\overline{S}}$, $\mathcal{C}_{\mathcal{P}S}$, $\mathcal{C}_{\mathcal{P}\overline{S}}$, and $\mathcal{C}_{\mathcal{P}S\overline{S}}$.

($\circ-\circ$) This graph admits an acyclic T -odd orientation if and only if $|T| = 1$. Hence, it does not belong to \mathcal{C}_S or $\mathcal{C}_{\overline{S}}$ since a set T' with $|T'| = 0$ would satisfy \mathcal{S} but not $\overline{\mathcal{S}}$, and $|T'| = 2$ would satisfy $\overline{\mathcal{S}}$ but not \mathcal{S} . But it indeed belongs to $\mathcal{C}_{S\overline{S}}$ as any set T' satisfying both \mathcal{S} and $\overline{\mathcal{S}}$ has to be of size 1. It also belongs to $\mathcal{C}_{\mathcal{P}}$ as any set T' satisfying \mathcal{P} verifies $|T'| \equiv_2 |E| \equiv_2 1$. Hence, by inclusion, it also belongs to $\mathcal{C}_{\mathcal{P}S}$, $\mathcal{C}_{\mathcal{P}\overline{S}}$, and $\mathcal{C}_{\mathcal{P}S\overline{S}}$.

($\circ \circ$) This graph admits an acyclic T -odd orientation if and only if $|T| = 0$. Hence, it does not belong to $\mathcal{C}_{\mathcal{P}}$ since a set T' with $|T'| = 2$ would satisfy \mathcal{P} but not \mathcal{S} . But it indeed belongs to \mathcal{C}_S and $\mathcal{C}_{\overline{S}}$ as $T = \emptyset$ satisfies both conditions, but the set T' where $|T'| \geq 1$ would not satisfy \mathcal{S} nor $\overline{\mathcal{S}}$ as $|V \setminus T' \cup \{v \in T', d(v) \equiv_2 1\}| > 1$ would not be satisfied. By inclusion, it also belongs to $\mathcal{C}_{S\overline{S}}$, $\mathcal{C}_{\mathcal{P}S}$, $\mathcal{C}_{\mathcal{P}\overline{S}}$, and $\mathcal{C}_{\mathcal{P}S\overline{S}}$.

($\circ \circ$) This graph admits an acyclic T -odd orientation if and only if $|T|$ is even. This graph does not belong to \mathcal{C}_S nor $\mathcal{C}_{\overline{S}}$ since a set T' containing only a vertex of degree 1 would satisfy both \mathcal{S} and $\overline{\mathcal{S}}$ but not \mathcal{P} . However, it does belong to $\mathcal{C}_{\mathcal{P}}$ as any set T' satisfying \mathcal{P} precisely satisfies $|T'| \equiv_2 |E| \equiv_2 0$. By inclusion, it also belongs to $\mathcal{C}_{\mathcal{P}S}$, $\mathcal{C}_{\mathcal{P}\overline{S}}$, and $\mathcal{C}_{\mathcal{P}S\overline{S}}$.

($\circ \circ$) This graph admits an acyclic T -odd orientation if and only if $|T| = 1$. This graph does not belong to \mathcal{C}_S nor $\mathcal{C}_{\overline{S}}$ since a set T' with $|T'| = 0$ would satisfy both \mathcal{S} and $\overline{\mathcal{S}}$. It also does not belong to $\mathcal{C}_{\mathcal{P}}$ since a set T' with $|T'| = 3$ would satisfy \mathcal{P} but not \mathcal{S} nor $\overline{\mathcal{S}}$. However, it does belong to $\mathcal{C}_{\mathcal{P}S}$ and $\mathcal{C}_{\mathcal{P}\overline{S}}$ because if a set T' satisfies \mathcal{P} , it verifies $|T'| \equiv_2 1$, and if it satisfies either \mathcal{S} or $\overline{\mathcal{S}}$, it verifies that $|V \setminus T'| > 1$. Thus, it imposes that $|T'| = 1$. By inclusion, it also belongs to $\mathcal{C}_{\mathcal{P}S\overline{S}}$.

($\circ \circ$) This graph admits an acyclic T -odd orientation if and only if $|T| = 0$. This graph does not belong to $\mathcal{C}_{S\overline{S}}$ since the set T' with $|T'| = 1$, would satisfy both \mathcal{S} and $\overline{\mathcal{S}}$. It also does not belong to $\mathcal{C}_{\mathcal{P}}$ since a set T' with $|T'| = 2$ would satisfy \mathcal{P} . However, it does belong to $\mathcal{C}_{\mathcal{P}S}$ and $\mathcal{C}_{\mathcal{P}\overline{S}}$ because if a set T' satisfies \mathcal{P} , it verifies $|T'| \equiv_2 0$, and if it satisfies either \mathcal{S} or $\overline{\mathcal{S}}$, it verifies that $|V \setminus T'| > 1$.

Thus, it imposes that $|T'| = 0$. By inclusion, it also belongs to $\mathcal{C}_{\mathcal{P}\mathcal{S}\overline{\mathcal{S}}}$.

() This graph does not belong to $\mathcal{C}_{\mathcal{S}\overline{\mathcal{S}}}$ since any set T' with $|T'| = 2$ would satisfy both \mathcal{S} and $\overline{\mathcal{S}}$ but not \mathcal{P} . It also does not belong to $\mathcal{C}_{\mathcal{P}\overline{\mathcal{S}}}$ since a set T' with $|T'| = 3$ would satisfy \mathcal{P} and $\overline{\mathcal{S}}$ but not satisfy \mathcal{S} . It does not belong to $\mathcal{C}_{\mathcal{P}\mathcal{S}}$ since the set T' composed only of the isolated vertex would satisfy both \mathcal{P} and \mathcal{S} but not $\overline{\mathcal{S}}$. However, it does belong to $\mathcal{C}_{\mathcal{P}\mathcal{S}\overline{\mathcal{S}}}$ as the only possible sets T' satisfying $\mathcal{P}\mathcal{S}\overline{\mathcal{S}}$ are the ones containing only a single vertex of degree one. Such sets always admit an acyclic T' -odd orientation. \square

Lemma 3.2. *Let $G \in \mathcal{C}_{\mathcal{P}\mathcal{S}\overline{\mathcal{S}}}$ with $|V(G)| \geq 4$. Then G is connected.*

Proof.

By way of contradiction, suppose that G is not connected.

a. Assume first that every vertex in G has even degree. Let H be the smallest connected component, either it is of size one, or it has at least 3 vertices since the graph is simple and all degrees are even. By minimality of H and because $|V(G)| \geq 4$, we have $|V \setminus H| \geq 3$. Select any $A \subset V \setminus H$ with $|A| = 2$ if $|V(G)| + |E(G)| \equiv_2 0$ else $|A| = 3$. This choice of A implies that $|A| \equiv_2 |V(G)| + |E(G)|$ and in particular that the set $T = V(G) \setminus A$ satisfies \mathcal{P} . Moreover T satisfies \mathcal{S} and $\overline{\mathcal{S}}$ since $A \subseteq \text{Source}(T) \cap \text{Sink}(T)$ and $|A| \geq 2$. Nevertheless, G has no acyclic T -odd orientation since all vertices of H are in T , hence $T(H)$ violates \mathcal{S} in $G[H]$.

b. Assume now that there exist two vertices $u, v \in V(G)$ with odd degree.

- If $|V(G)| + |E(G)|$ is odd, then choose $T = V(G) \setminus \{x\}$ for any vertex $x \neq u, v$. Now, T satisfies \mathcal{P} . It also satisfies \mathcal{S} and $\overline{\mathcal{S}}$ since $\{x\} = \text{Source}(T)$, $u, v \in \text{Sink}(T)$ and $\text{Source}(T) \neq \text{Sink}(T)$. However, there is at least one other connected component than the one containing x , and all its vertices are in T , hence it fails to satisfy \mathcal{S} , and G has no acyclic T -odd orientation.

- If $|V(G)| + |E(G)|$ is even, choose $T = V(G) \setminus \{u, x\}$ with x in the same connected component as u (x is guaranteed to exist since u has odd degree). Note that T satisfies \mathcal{P} . If x is different from v , then T also satisfies \mathcal{S} and $\overline{\mathcal{S}}$ since $\{u, x\} = \text{Source}(T)$, $\{v\} \in \text{Sink}(T)$ and $\text{Source}(T) \neq \text{Sink}(T)$. But any other connected component different from the one containing u has all its vertices in T and contains no potential source, so G has no acyclic T -odd orientation.

Otherwise, if $x = v$, then we may finally assume that u and v form by themselves a connected component of two vertices. We now take $T = V(G) \setminus \{y, z\}$ with both y, z different from u, v (they are guaranteed to exist since $|V(G)| \geq 4$). This choice of T ensures that it satisfies $\mathcal{P}\mathcal{S}\overline{\mathcal{S}}$ since $\{y, z\} \in \text{Source}(T)$, $\{u, v\} \in \text{Sink}(T)$. Nevertheless, G has no acyclic T -odd orientation since $u, v \in T$ and the connected component composed of u, v fails to satisfy \mathcal{S} . \square

The following subsections are dedicated to prove the different items of Theorem 1.1.

3.1 Proof of (a) and (b)

From Lemma 3.1, we have $\{\circ, \circ \circ\} = \mathcal{C}_{\mathcal{S}} \cap \mathcal{G}_{\leq 3} = \mathcal{C}_{\overline{\mathcal{S}}} \cap \mathcal{G}_{\leq 3}$ and $\{\circ, \circ \circ, \circ-\circ\} = \mathcal{C}_{\mathcal{S}\overline{\mathcal{S}}} \cap \mathcal{G}_{\leq 3}$. In fact, we show those are the only graphs in $\mathcal{C}_{\mathcal{S}}, \mathcal{C}_{\overline{\mathcal{S}}}, \mathcal{C}_{\mathcal{S}\overline{\mathcal{S}}}$.

Let G be any graph with $|V(G)| \geq 4$. We find T that satisfies \mathcal{S} and $\overline{\mathcal{S}}$ but not \mathcal{P} . Consider $T \subsetneq V(G)$ such that $|T| = 2$ if $|E(G)| \equiv_2 1$, and $|T| = 1$ otherwise. By construction, T does not satisfy \mathcal{P} . Since $T \neq V(G)$, and because $|V(G)| \geq 4$, we have $|\text{Source}(T)| = |V(G) \setminus T| \geq 2$, therefore T satisfies \mathcal{S} . If all vertices are of even degree, then $\text{Source}(T) = \text{Sink}(T)$ and $\overline{\mathcal{S}}$ is also satisfied. Otherwise, T can be chosen to contain a vertex of odd degree, so that $\overline{\mathcal{S}}$ is satisfied. Hence:

$$\mathcal{C}_{\mathcal{S}} = \mathcal{C}_{\overline{\mathcal{S}}} = \{\circ, \circ \circ\} \subsetneq \mathcal{C}_{\mathcal{S}\overline{\mathcal{S}}} = \{\circ, \circ \circ, \circ-\circ\}. \quad \square$$

3.2 Proof of (c)

This part of Theorem 1.1 could be proved using Theorem 1.2, instead, we give an independent proof.

We first prove:

$$\mathcal{C}_{\mathcal{P}} \subseteq \{\circ\} \cup \{G \in \mathcal{C}_{\mathcal{P}\mathcal{S}\overline{\mathcal{S}}} \mid G \text{ is connected, non-Eulerian and } |V(G)| + |E(G)| \equiv_2 1\}$$

Let $G \in \mathcal{C}_{\mathcal{P}}$. By Lemmas 3.1 and 3.2, G is connected.

4 Cartesian product of path and/or cycle

This section is dedicated to the proofs of Theorems 1.3 and 1.4. In the first subsection, we present a general method, called T -decomposition, used in all the proofs. Then, we study basic cases (namely trees and cycles), prior to addressing grids, cylinders, and finally torii.

4.1 Proofs methods and overview

We present here the main tools used in the proofs of the next section subsections. Let us first introduce an equivalent formulation of Problem 1.

Problem 3 (Game).

Instance: A pair (G, T) where $G = (V, E)$ is a graph and $T \subset V$ is a subset of vertices colored black, the other vertices are colored white.

Rules: This is a single-player game. At each turn, the player must remove a white vertex; upon doing so, the player flips the color of the vertex' neighbors: a black neighbor becomes white, and a white neighbor becomes black.

Question: Is it possible to remove all vertices of G while respecting the rules of the game?

Lemma 4.1. *Problem 3 is equivalent to Problem 1.*

Proof.

Let $G = (V, E)$ be a graph and $T \subset V$ a set of vertices.

\Rightarrow) Let $v_1 > \dots > v_n$ be an elimination order of the vertices that solves Problem 3. Define an acyclic orientation o of the edges of G as follows: for every $v_i > v_j$, orient the edge $v_i v_j$ from v_i to v_j . This orientation is clearly acyclic, and moreover, it is T -odd. Indeed, each vertex is white when it is removed; thus, a vertex initially black (resp. white) has changed color an odd (resp. even) number of times, meaning that an odd (resp. even) number of its neighbors were removed before it. That is, it has an odd (resp. even) in-degree in o . Therefore, from an elimination order of the vertices, one can construct an acyclic T -odd orientation of G in linear time.

\Leftarrow) Conversely, let o be an acyclic T -odd orientation of G . Since o is acyclic, there exists a total order $v_1 > \dots > v_n$ on the vertices such that for every $v_i > v_j$, the edge $v_i v_j$ is oriented from v_i to v_j . We consider this elimination order in Problem 3 and notice that a vertex color is flipped as many times as its in-degree in o . Hence, each vertex is white when it is removed and it is a valid elimination order for Problem 3. Thus, from an acyclic T -odd orientation of G , one can construct an elimination order of the vertices of G in linear time via a topological sort of the orientation. \square

This game understanding of Problem 1 is very useful in the proofs, mainly because it allows focusing on the structure of the graph, and on the set T without considering the orientation. It also provides a constructive way to build an acyclic T -odd orientation by giving an elimination order of the vertices. We often recognize some subgraphs that can be removed from G in the sense of Problem 3, usually thanks to an induction argument, and this leaves a smaller graph that can be handled more easily.

Now, more formally, a T -**decomposition** of a graph G with $T \subseteq V(G)$ is an ordered decomposition $\langle V_0, \dots, V_k \rangle$ of $V(G)$. To each V_i , we associate a set $T_i = Z_i \Delta T(V_i)$ where the set Z_i is defined as the set of vertices of V_i that have an odd number of neighbors in $V_0 \cup \dots \cup V_{i-1}$, and Δ denotes the **symmetric difference** between two sets (i.e. $X \Delta Y = (X \setminus Y) \cup (Y \setminus X)$ for sets X and Y).

We say that a T -decomposition **satisfies** \mathcal{P} if T_i satisfies \mathcal{P} in $G[V_i]$ for all $i \in \{0, \dots, k\}$, meaning that $|T_i| \equiv_2 |T(V_i)| - |Z_i| \equiv_2 |E(G[V_i])|$. We say that the decomposition is **good** if for each V_i the induced subgraph $G[V_i]$ admits an acyclic T_i -odd orientation. In particular, every good T -decomposition satisfies \mathcal{P} .

Good T -decompositions provide a structured way to construct acyclic T -odd orientations of G by orienting each $G[V_i]$ sequentially. In the sense of Problem 3, this decomposition corresponds to an elimination order where all vertices in V_1 are removed first, then all vertices in V_2 , and so on. More generally, we claim that:

Theorem 4.2. *G has an acyclic T -odd orientation if and only if G admits a good T -decomposition.*

Proof.

First, suppose that G admits a good T -decomposition $\langle V_0, \dots, V_k \rangle$. For all $0 \leq i \leq k$, let O_i be an acyclic T_i -odd orientation of $G[V_i]$ where $T_i = Z_i \triangle T(V_i)$. Consider the orientation O of G defined as follows. For any edge $uv \in E(G)$ with $u \in V_i, v \in V_j$ and $j \geq i$:

- if $j = i$ then $\overrightarrow{uv} \in O$ if and only if $\overrightarrow{uv} \in O_i$,
- else $\overrightarrow{uv} \in O$.

We claim that O is an acyclic T -odd orientation of G .

Combining the facts that, in the orientation O , all arcs are directed from V_i to V_j for all $i, j \in \{0, \dots, k\}$, and each O_i is acyclic, we obtain that O is acyclic. Now, let $v \in V_i$, for some $i \in \{0, \dots, k\}$. By definition of O , we have:

- if $v \in Z_i$ then $d_{G_O}^-(v) \equiv d_{G[V_i]_{O_i}}^-(v) + 1 \pmod{2}$,
- else $d_{G_O}^-(v) \equiv d_{G[V_i]_{O_i}}^-(v) \pmod{2}$.

Moreover, by definition of T_i , we have

- if $v \in Z_i$, then $v \in T_i$ if and only if $v \notin T$,
- else $v \in T_i$ if and only if $v \in T$.

From these last remarks and since each O_i is a T_i -odd orientation of $G[V_i]$, O is a T -odd orientation of G .

Second, let us show that any acyclic T -odd orientation induces a good T -decomposition. Let O be an acyclic T -odd orientation of a graph G . Since O is acyclic, there exists a total ordering of the vertices v_1, \dots, v_n such that for any edge $v_i v_j \in E(G)$, O contains the arc $\overrightarrow{v_i v_j}$ if $i < j$ and $\overrightarrow{v_j v_i}$ otherwise. Moreover, since O is a T -odd orientation, $v_i \in T$ if and only if $d_{G_O}^-(v_i)$ is odd.

We define the trivial decomposition where $V_i = \{v_i\}$ for all $i \in \{0, \dots, |V(G)| - 1\}$. For each i , note that $d_{G_O}^-(v_i) = |\{v_1, \dots, v_{i-1}\} \cap N(v_i)|$. Thus, $v_i \in T$ if and only if $v_i \in Z_i$. This implies $T_i = \emptyset$ for all i , as $T_i = (Z_i \triangle T) \cap V_i$. Since each V_i is a single vertex, it trivially admits an \emptyset -odd orientation. Therefore, the decomposition $\{V_0, \dots, V_{n-1}\}$ is a good T -decomposition. \square

In the proofs of the following sections, we will often want to prove that some chosen T -decomposition $\langle V_0, \dots, V_k \rangle$ is good. To make things easier, we will try to ensure as often as possible that, for each V_i in the decomposition, $G[V_i]$ belongs to $\mathcal{C}_{\mathcal{P}}$, $\mathcal{C}_{\mathcal{P}\mathcal{S}}$ or $\mathcal{C}_{\mathcal{P}\mathcal{S}\mathcal{S}}$. Hence, to show that a T -decomposition is good we always prove first that it satisfies \mathcal{P} and then prove that T_i satisfies $\mathcal{P}\mathcal{S}\mathcal{S}$ in $G[V_i]$ for every $i \in \{0, \dots, k\}$. The following lemma will be helpful in this task:

Lemma 4.3. *Let G be a graph and let $T \subseteq V(G)$ be a subset of vertices satisfying \mathcal{P} . Let $\mathcal{A} = \langle V_0, \dots, V_k \rangle$ be a T -decomposition of G and let i be any integer in $\{0, \dots, k\}$:*

If T_j satisfies \mathcal{P} in $G[V_j]$ for every $j \in \{0, \dots, k\} \setminus \{i\}$ then \mathcal{A} satisfies \mathcal{P} .

Proof.

Let G be a graph and let $T \subseteq V(G)$ be a subset of vertices satisfying \mathcal{P} . Let $\mathcal{A} = \langle V_0, \dots, V_k \rangle$ be a T -decomposition of G and let i be any integer $\{0, \dots, k\}$. Assume T_j satisfies \mathcal{P} in $G[V_j]$ for every $j \in \{0, \dots, k\} \setminus \{i\}$, then:

$$\begin{aligned}
|T_i| &\equiv_2 |T(V_i)| - |Z_i| && \text{(by definition)} \\
&\equiv_2 \left(|T| - \sum_{j \in S_i} |T(V_j)| \right) - |Z_i| \\
&\equiv_2 \left(|E(G)| - \sum_{j \in S_i} (|E(G[V_j])| + |Z_j|) \right) - |Z_i| && \text{(by } \mathcal{P} \text{)} \\
&\equiv_2 |E(G)| - \sum_{j \in S_i} |E(G[V_j])| - \sum_{j=0}^k |Z_j| \\
&\equiv_2 |E(G[V_i])| + \sum_{j=0}^k |\delta(V_0 \cup \dots \cup V_{j-1}, V_j)| - \sum_{j=0}^k |Z_j| \\
&\equiv_2 |E(G[V_i])| + \sum_{j=0}^k (|\delta(V_0 \cup \dots \cup V_{j-1}, V_j)| - |Z_j|) && \text{(by definition of } Z_j \text{)} \\
&\equiv_2 |E(G[V_i])|.
\end{aligned}$$

Therefore, T_i satisfies \mathcal{P} in $G[V_i]$, thus T_j satisfies \mathcal{P} in $G[V_j]$ for every $j \in \{0, \dots, k\}$ and \mathcal{A} satisfies \mathcal{P} . \square

4.2 Basic cases

Lemma 4.4. *Trees belong to $\mathcal{C}_{\mathcal{P}}$.*

Proof.

From [1], we know that a tree admits a T -odd orientation for a subset $T \subseteq V(G)$ if and only if $|E(G)| + |T| \equiv_2 0$. \square

Remark. Because trees (and in particular paths) verify $|V(G)| + |E(G)| \equiv_2 1$, the condition $|E(G)| + |T| \equiv_2 0$ is equivalent to $|V(G) \setminus T| \equiv_2 1$, which is consequently also necessary and sufficient for the existence of an acyclic T -odd orientation.

Lemma 4.5. *Cycles belong to $\mathcal{C}_{\mathcal{P}\mathcal{S}} \setminus \mathcal{C}_{\mathcal{P}}$.*

Proof.

Let C be a cycle. Since $|V(C)| = |E(C)|$, then, by point (c) of Theorem 1.1, $C \notin \mathcal{C}_{\mathcal{P}}$.

Let T be a subset of $V(C)$ satisfying \mathcal{P} and \mathcal{S} . By \mathcal{S} , there exists a vertex $u \in V(C) \setminus T$. Let v be a neighbor of u in C . The graph $P = C - uv$ is a path with $d(u) = 1$. Let $T' = \{v\} \Delta T$, and note that T' satisfies \mathcal{P} in P . Moreover P is a tree, then, by Lemma 4.4, P admits an acyclic T' -odd orientation O . Observe that $d_{P_O}(u) = 0$, since $u \in V(P) - T'$ and $d_P(u) = 1$. One can get an acyclic T -odd orientation of C by completing O with the arc \overrightarrow{uv} . \square

Remark. In fact, this proves that for any vertex $v \notin T$, there exists an acyclic T -odd orientation of C where v is a source.

4.3 Grids

In this section, we provide a characterization of the instances $I = (G, T)$ of Problem 1, where G is a grid, for which G admits an acyclic T -odd orientation.

We prove Theorem 1.4 recalled here:

Theorem 1.4:

Let $G = P_p \square P_q$ be a graph where P_p and P_q are paths with vertex set $\{u_0, \dots, u_{p-1}\}$ and $\{v_0, \dots, v_{q-1}\}$ respectively. Let be a subset $T \subset V(P_p \square P_q)$ that satisfies $\mathcal{P}\mathcal{S}\mathcal{S}$.

$P_p \square P_q$ has no acyclic T -odd orientation if and only if $p, q \equiv_2 0$ and $V \setminus T$ satisfies that:

- $(u_{2k-1}, v_j) \in V \setminus T$ if and only if $(u_{2k}, v_j) \in V \setminus T$ for all $k \in \{1, \dots, \frac{p-2}{2}\}$ and $j \in \{0, q-1\}$.
- $(u_i, v_{2k-1}) \in V \setminus T$ if and only if $(u_i, v_{2k}) \in V \setminus T$ for all $i \in \{0, p-1\}$ and $k \in \{1, \dots, \frac{q-2}{2}\}$ symmetrically.

Preliminaries

A **path** H of length h is a graph with vertex set $V(H) = \{w_0, \dots, w_{h-1}\}$ and edge set $E(H) = \{(w_i, w_{i+1}) \mid 0 \leq i < h-1\}$. We define for any path H , the set $Pairs(H) = \{(w_{2k-1}, w_{2k}) \subset V(H) \mid k = 1, \dots, \frac{p-2}{2}\}$. Let $H^{[\geq k]}$ and $H^{[\leq k]}$ be the graph induced by $\{w_k, \dots, w_{h-1}\}$ and $\{w_0, \dots, w_k\}$ respectively.

A **bad path instance** of Problem 1 is an instance (H, T) where H is a path of even length h , and $T \subseteq V(H)$ satisfies the following conditions: first, both endpoints of the path, w_0 and w_{h-1} , belong to T ; and second, for any pair of vertices $[w, w'] \in Pairs(H)$, $w \in T$ if and only if $w' \in T$. An example of this construction is illustrated in Figure 4.

A notable property of path instances is that, as long as it is not a bad path instance, it is always possible to find a subpath of odd length including one of the endpoints such that it has an even number of T 's vertices.

In particular we claim:

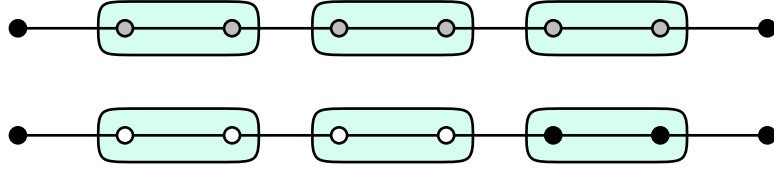

Figure 4: (Top) Generic bad path instance, along with an example (bottom)

Claim 4.6. *Let (H, T) be an instance of Problem 1 such that H is a path of even length h .*

If (H, T) is not a bad path instance of Problem 1, then there exists $k \in \{0, \dots, \frac{h-2}{2}\}$ and $L \in \{H^{[\leq 2k]}, H^{[\geq 2k+1]}\}$ such that $|T(L)|$ is even.

Proof.

Let (H, T) be an instance of Problem 1 where H is a path.

Suppose (H, T) is not a bad path instance. If $w_0 \notin T$ or $w_{h-1} \notin T$, choose $L = H[w_0]$ or $L = H[w_{p-1}]$ respectively. In either case, $|T(L)|$ is even.

Otherwise, if $w_0, w_{p-1} \in T$, then since (H, T) is not a bad path instance, there exists a pair of vertices $(w_{2k-1}, w_{2k}) \in \text{Pairs}(V(H))$ of smallest index $k \in \{1, \dots, \frac{h-2}{2}\}$ such that $w_{2k-1} \in T$ if and only if $w_{2k} \notin T$. Then, $|T(H^{[\leq 2k]})|$ is even. \square

Note in fact that the equivalence holds. Indeed, for any bad path instance (H, T) , we have that for all $k \in \{0, \dots, \frac{h-2}{2}\}$, both $|T(H^{[\leq 2k]})|$ and $|T(H^{[\geq 2k+1]})|$ are odd.

We now focus on **grids** $G = P_p \square P_q$, where P_p and P_q are paths of length p and q , respectively, with vertex sets $V(P_p) = \{u_0, \dots, u_{p-1}\}$ and $V(P_q) = \{v_0, \dots, v_{q-1}\}$. Define also $X_j = \{(u_i, v_j) \mid i = 1, \dots, p-1\}$ for all $j \in \{0, \dots, q-1\}$, and $Y_i = \{(u_i, v_j) \mid j = 1, \dots, q-1\}$ for all $i \in \{0, \dots, p-1\}$. Additionally, we note $X_{\leq k} = \bigcup_{j=0}^k X_j$ and $X_{\geq k} = \bigcup_{j=k}^{q-1} X_j$ and similarly for Y . A **grid instance** is an instance (G, T) of Problem 1 where G is a grid. It is worth noticing that for any grid:

$$|V(G)| \equiv_2 p \times q, \quad |E(G)| \equiv_2 p + q \quad (\text{G0})$$

For any grid G , we note $\text{Pairs}(G) = \text{Pairs}(G[X_0]) \cup \text{Pairs}(G[X_{q-1}]) \cup \text{Pairs}(G[Y_0]) \cup \text{Pairs}(G[Y_{p-1}])$. A **bad grid instance** of Problem 1 is an instance (G, T) where $G = P_p \square P_q$ is a grid with $p \equiv_2 q \equiv_2 0$, and T satisfies the following conditions:

1. $(G[U], T(U))$ is a bad path instance of Problem 1 for all $U \in \{X_0, X_{q-1}, Y_0, Y_{p-1}\}$.
2. For all $i \in \{1, \dots, p-2\}$ and $j \in \{1, \dots, q-2\}$ we have that $(u_i, v_j) \in T$.

Note that condition 1. is equivalent to say that for any pair $[(u, v), (u', v')] \in \text{Pairs}(G)$, we have that $(u, v) \in T$ if and only if $(u', v') \in T$. So in essence, Theorem 1.4 states that for any grid instance (G, T) with T satisfying the parity condition \mathcal{P} , G admits an acyclic T -odd orientation if and only if (G, T) is not a bad grid instance.

It is also worth noticing the following:

Claim 4.7. *Let (G, T) be a grid instance of Problem 1 such that T satisfies the parity condition \mathcal{P} .*

If (G, T) is not a bad grid instance of Problem 1, then T also satisfies \mathcal{S} and $\overline{\mathcal{S}}$.

Proof.

Let (G, T) be a grid instance of Problem 1 such that T satisfies the parity condition \mathcal{P} .

If G has an odd dimension, then, by (a), $|V(G) \setminus T| \equiv_2 |V(G) \setminus E(G)| \equiv_2 1$. Furthermore, any grid with an odd dimension admits at least two vertices of odd degree. Hence, T does satisfy the conditions \mathcal{S} and $\overline{\mathcal{S}}$.

Suppose now that both p and q are even. If T does not satisfy condition \mathcal{S} , then $T = V(G)$. And if it does not satisfy condition $\overline{\mathcal{S}}$, then $V(G) \setminus T = \{v \in V(G) \mid d(v) \equiv_2 1\}$. In both cases, (G, T) is a bad grid instance of Problem 1. \square

Thanks to this claim, when considering grid instances, we can focus on the parity condition \mathcal{P} and on checking if the instance is a bad grid instance or not. Hence, we drop further reference to the

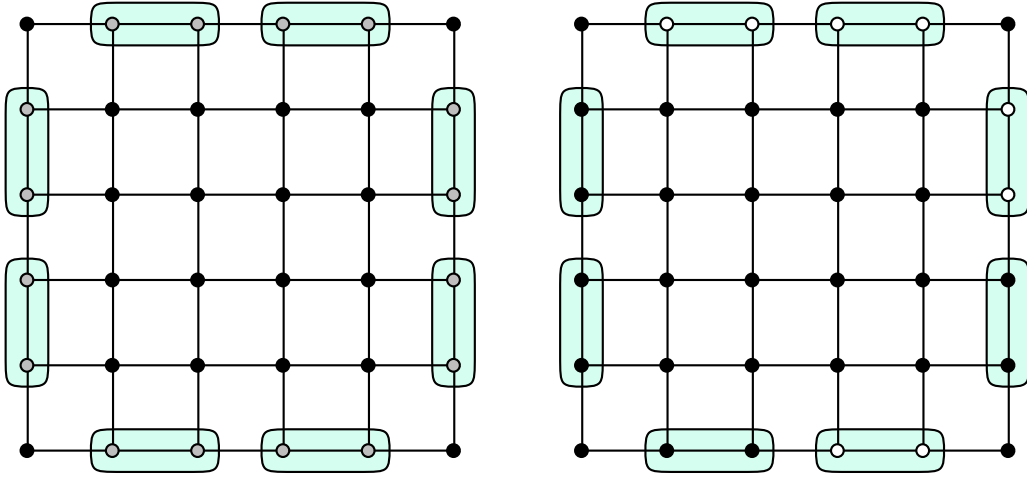

Figure 5: Generic bad grid instances along with an example

conditions \mathcal{S} and $\bar{\mathcal{S}}$ in this section.

In the next proofs, we use multiple T -decompositions of a grid instance (G, T) that we shall describe carefully here. We always assume that T satisfies condition \mathcal{P} .

(i,j)-corner T-decomposition $\langle V_0, V_1, V_2 \rangle$ is defined as follows (see figure 6a):

$$\begin{aligned} V_0 &= \{(u_a, v_b) \mid 0 \leq a < i, 0 \leq b < j\} = \bigcup_{k=0}^{i-1} Y_k^{[<j]} \neq \emptyset \\ V_1 &= \{(u_a, v_b) \mid i \leq a < p, 0 \leq b < q\} = Y_{\geq i} \\ V_2 &= \{(u_a, v_b) \mid 0 \leq a < i, j \leq b < q\} = \bigcup_{k=0}^{i-1} Y_k^{[\geq j]} \end{aligned}$$

By Lemma 4.3, this T -decomposition satisfies \mathcal{P} if and only if: (G1)

$$\begin{aligned} |T_0| &\equiv_2 |E(G[V_0])| \text{ i.e. } |T(V_0)| \equiv_2 |E(G[V_0])| \equiv_2 i + j \\ |T_1| &\equiv_2 |E(G[V_1])| \text{ i.e. } |T(V_1)| \equiv_2 |E(G[V_1])| - |Z_1| \equiv_2 (p - i + q) - j \end{aligned}$$

Inner-grid T-decompositions: We define here two different T -decompositions $\langle V_{out}, V_{in} \rangle$ and $\langle V_{in}, V_{out} \rangle$ of a grid instance (G, T) (see figure 6b), where V_{out}, V_{in} are as follows:

$$\begin{aligned} V_{out} &= X_0 \cup Y_0 \cup X_{q-1} \cup Y_{p-1} \\ V_{in} &= V \setminus V_{out} \end{aligned}$$

By Lemma 4.3, $\langle V_{out}, V_{in} \rangle$ satisfies \mathcal{P} if and only if $|T_0| \equiv_2 |E(G[V_{out}])|$ i.e. $|T(V_{out})| \equiv_2 0$.

And by Lemma 4.3, $\langle V_{in}, V_{out} \rangle$ satisfies \mathcal{P} if and only if $|T_1| \equiv_2 |E(G[V_{out}])|$ i.e. $|T(V_{out})| \equiv_2 |E(G[V_{out}])| - |Z_1| \equiv_2 0$.

Hence, for both inner-grid T -decompositions we only have to check whether $|T(V_{out})| \equiv_2 0$ to check if the decomposition satisfies \mathcal{P} . (G2)

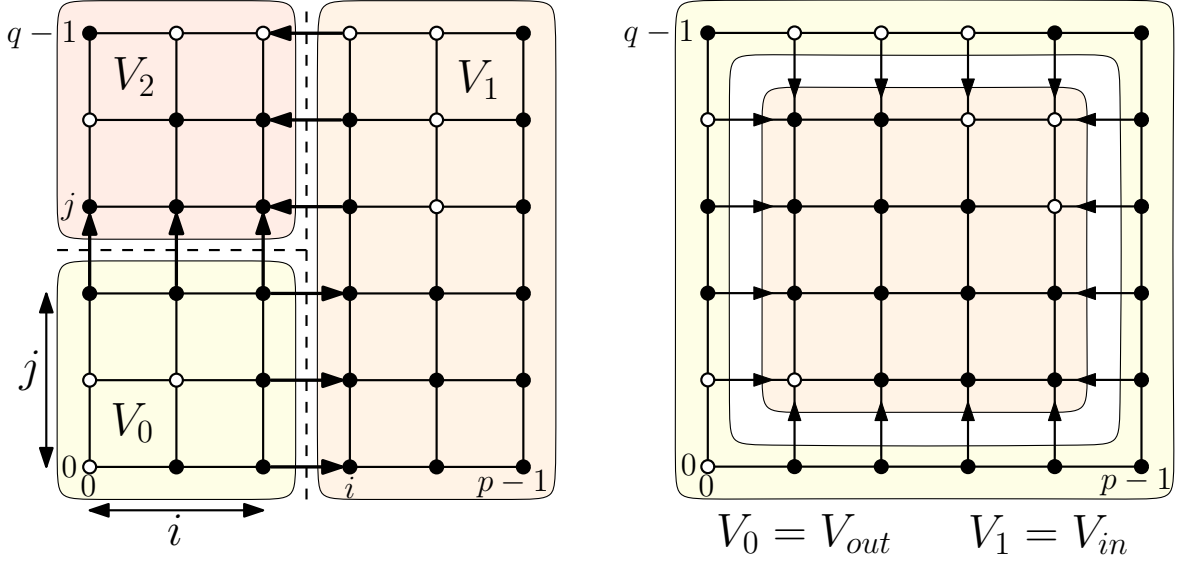

(a) (i, j) -corner T -decomposition satisfying \mathcal{P}

(b) An inner-grid T -decomposition satisfying \mathcal{P}

Figure 6

Proof of Theorem 1.4

The proof is split in three lemmas, the first two (Lemma 4.8 and Lemma 4.9) proving the sufficient condition, and the last one (Lemma 4.10) the necessary condition.

Lemma 4.8. *Let (G, T) be a grid instance of Problem 1 such that T satisfies the parity condition \mathcal{P} .*

If there exists $U \in \{X_0, X_{q-1}, Y_0, Y_{p-1}\}$ such that $(G[U], T(U))$ is not a bad path instance of Problem 1 then G admits an acyclic T -odd orientation.

Proof.

Let (G, T) be a grid instance of Problem 1 such that T satisfies the parity condition \mathcal{P} .

a. Suppose G has an odd dimension, say $q \equiv_2 1$. In this case, both $(G[Y_0], T(Y_0))$ and $(G[Y_{p-1}], T(Y_{p-1}))$ are not bad path instances. We proceed by induction on p . For $p = 1$, G is a path and the result follows from Lemma 4.4. For $p > 1$, since T satisfies \mathcal{P} and $|E(G)| \equiv_2 p + 1$, we have $|T| \equiv_2 p + 1$. Thus, $|V(G) \setminus T| = pq - (p + 1)$ is odd, so there exists $k \in \{0, \dots, p - 1\}$ such that $|Y_k \setminus T(Y_k)|$ is odd. Let k be the smallest such index and up to symmetry, we can suppose $k < p - 1$. We now consider the $(k + 1, q)$ -corner T -decomposition $\langle V_0, V_1, \emptyset \rangle = \langle Y_{<k+1}, Y_{\geq k+1}, \emptyset \rangle$ (see Figure 7a). We prove that this decomposition satisfies \mathcal{P} . Thanks to Lemma 4.3 we only get to check whether $|T_0| = |T(V_0)| \equiv_2 |E(G[V_0])|$. Recalling that $q \equiv_2 1$, we have:

$$|T(V_0)| = \sum_{0 \leq i < k+1} |T(Y_i)| \equiv_2 qk + q + 1 \equiv_2 k + 1 + q$$

Moreover, each V_i induces a grid with an odd dimension, so by induction, each $G[V_i]$ admits an acyclic T_i -odd orientation. Therefore, $\langle V_0, V_1, \emptyset \rangle$ is a good T -decomposition and G admits an acyclic T -odd orientation by Theorem 4.2.

b. Suppose both p and q are even, and there exists $U \in \{X_0, X_{q-1}, Y_0, Y_{p-1}\}$ such that $(G[U], T(U))$ is not a bad path instance. Without loss of generality, let $U = Y_0$. Since T satisfies \mathcal{P} , $|T|$ is even.

b.1. If $|T(Y_0)|$ is odd, consider the $(1, q)$ -corner T -decomposition $\langle V_0, V_1, \emptyset \rangle = \langle Y_0, Y_{\geq 1}, \emptyset \rangle$ (see Figure 7b).

We prove that this decomposition satisfies \mathcal{P} and thanks to Lemma 4.3 we only get to check whether $|T_0| = |T(V_0)| \equiv_2 |E(G[V_0])|$. But by hypothesis:

$$|T(V_0)| = |T(Y_0)| \equiv_2 1 + q$$

b.2. If $|T(Y_0)|$ is even, because $(Y_0, T(Y_0))$ is not a bad path instance of problem 1, by Claim 4.6, there exists $k \in \{0, \dots, \frac{q-2}{2}\}$ such that $|T(Y_0^{[\leq 2k]})|$ is even. In this case, consider the $(1, 2k+1)$ -corner T -decomposition $\langle V_0, V_1, V_2 \rangle = \langle Y_0^{[< 2k+1]}, Y_{\geq 1}, Y_0^{[\geq 2k+1]} \rangle$ (see Figure 7c). To prove that this decomposition satisfies \mathcal{P} we refer to (G1):

$$\begin{aligned} |T(V_0)| &= |T(Y_0^{[< 2k+1]})| \equiv_2 1 + 2k + 1 \\ |T(V_1)| &= |T(Y_{\geq 1})| \equiv_2 |T| - |T(Y_0)| \equiv_2 p + q - 0 \equiv_2 p - 1 + q - (2k + 1) \quad (\text{by (G0)}) \end{aligned}$$

In both cases, each V_i induces a grid with an odd dimension, so by Case 1, each $G[V_i]$ admits an acyclic T_i -odd orientation. Thus, $\langle V_0, V_1, V_2 \rangle$ is a good T -decomposition and G admits an acyclic T -odd orientation by Theorem 4.2. □

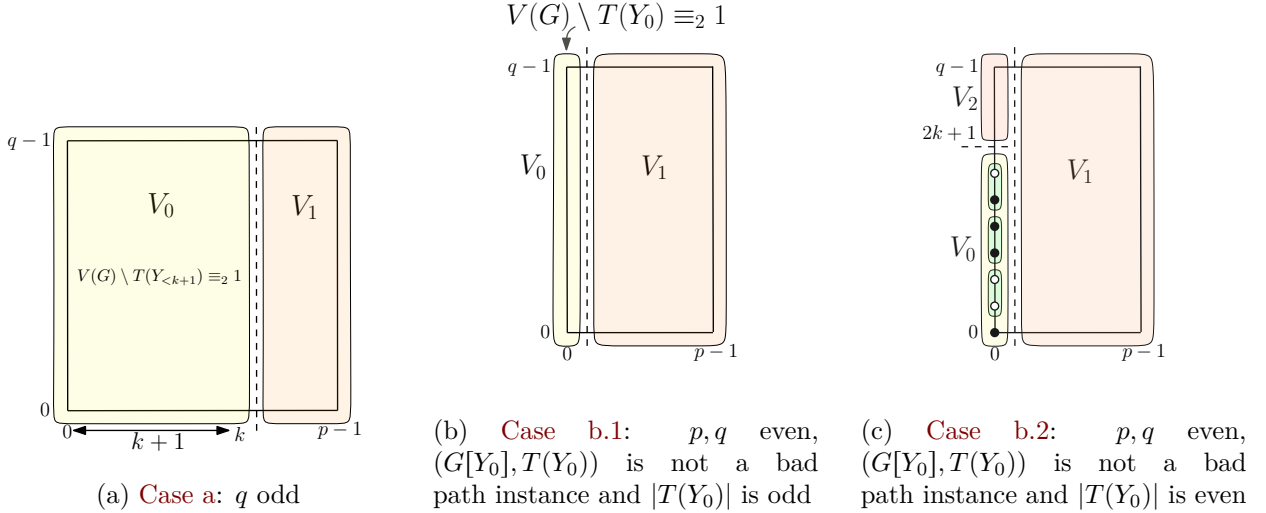

Figure 7: Illustration of the three decompositions used in the proof of Lemma 4.8.

Lemma 4.9. Let (G, T) be a grid instance of Problem 1 such that T satisfies the parity condition \mathcal{P} .

If (G, T) is not a bad grid instance of Problem 1, then G admits an acyclic T -odd orientation.

Proof.

Let (G, T) be a grid instance of Problem 1 such that T satisfies the parity condition \mathcal{P} . Lemma 4.8 covers the cases where G has an odd dimension, thus we assume $p, q \equiv_2 0$ and since T satisfies \mathcal{P} , we have that $|T| \equiv_2 0$.

We proceed by induction on the size of the grid.

Init case: $p = 2$ and $q \geq 2$. If (G, T) is not a bad grid instance, then there exists $i \in \{0, 1\}$ such that $(G[Y_i], T(Y_i))$ is not a bad path instance. Thus, Lemma 4.8 applies and G admits an acyclic T -odd orientation. We take care of the case $p \geq 2$ and $q = 2$ by symmetry.

Induction: We suppose $p \geq 4$ and $q \geq 4$ and every non-bad grid instance $(G' = P_{p'} \square P_{q'}, T')$ of Problem 1 such that $p' < p$ or $q' < q$ and T' satisfies \mathcal{P} in G' admits an acyclic T' -odd orientation. From Lemma 4.8, if there exists $U \in \{X_0, X_{q-1}, Y_0, Y_{p-1}\}$ such that $(G[U], T(U))$ is not a bad path instance of Problem 1, then G admits an acyclic T -odd orientation. So, in what follows, we can assume such a U does not exist. Note that this implies $|T(U)| \equiv_2 0$ for all $U \in \{X_0, X_{q-1}, Y_0, Y_{p-1}\}$.

Define $V_{out} = X_0 \cup Y_0 \cup X_{q-1} \cup Y_{p-1}$ and $V_{in} = V(G) \setminus V_{out}$. The rest of the proof is split into two parts in which we prove that G admits an acyclic T -odd orientation. In the first part, we suppose $(G[V_{in}], T(V_{in}))$ is not a bad grid instance of Problem 1. In the second part, we suppose $(G[V_{in}], T(V_{in}))$ is a bad grid instance of Problem 1 such that $T(V_{in}) \neq V_{in}$. The only remaining case not considered here corresponds to $T(V_{in}) = V_{in}$, which is precisely the case where (G, T) is a bad grid instance.

Part a. We suppose here that $(G[V_{in}], T(V_{in}))$ is not a bad grid instance of Problem 1. Recall that, in a T -decomposition, $T_i = Z_i \triangle T(V_i)$ where Z_i is the set of vertices of V_i that have an odd number of neighbors in $V_0 \cup \dots \cup V_{i-1}$.

We distinguish two cases illustrated in Figures 8a, 8b and 8c.

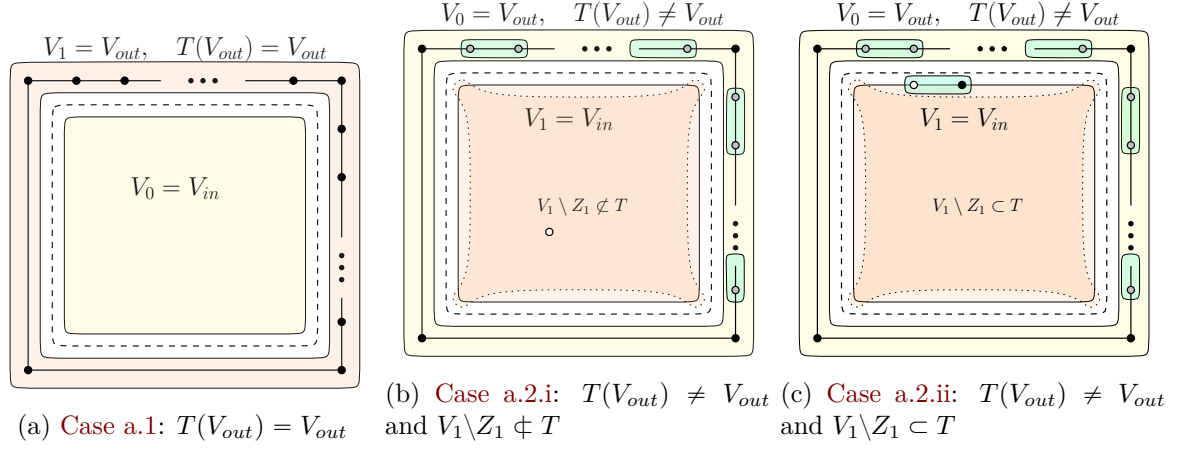

Figure 8: Illustration of the three decompositions used in the proof of Lemma 4.9 Part a.

a.1. If $T(V_{out}) = V_{out}$, we prove that the inner-grid T -decomposition $\langle V_0, V_1 \rangle = \langle V_{in}, V_{out} \rangle$ is good (see figure 8a) and apply Theorem 4.2. Since $|T(V_{out})| = |V_{out}| \equiv_2 0$, the decomposition satisfies \mathcal{P} by (G2). By hypothesis $(G[V_0], T_0)$ is not a bad grid instance of Problem 1, so $G[V_0]$ admits an acyclic T_0 -odd orientation by induction. And $G[V_1]$ is a cycle with $T_1 = V_{out} \triangle Z_1 \neq V_{out}$ since $Z_1 \neq \emptyset$. So T_1 also satisfies \mathcal{S} in $G[V_1]$ and $G[V_1]$ admits an acyclic T_1 -odd orientation by Lemma 4.5.

a.2. Otherwise, we prove that the inner-grid T -decomposition $\langle V_0, V_1 \rangle = \langle V_{out}, V_{in} \rangle$ is good (see figure 8b and 8c) and then apply Theorem 4.2. First, the decomposition satisfies \mathcal{P} : indeed, since $(G[U], T(U))$ is a bad path instance of Problem 1 for all $U \in \{X_0, X_{q-1}, Y_0, Y_{p-1}\}$, we have $|T(V_{out})| \equiv_2 0$ and (G2) ensures that \mathcal{P} is thus satisfied. Moreover, $G[V_0]$ is a cycle with $T_0 = T(V_{out}) \neq V_{out}$, so $G[V_0]$ admits an acyclic T_0 -odd orientation by Lemma 4.5. It remains to check that $(G[V_1], T_1)$ is not a bad grid instance of Problem 1, so that it admits an acyclic T_1 -odd orientation by induction. Recall $V_1 = V_{in}$ and $T_1 = T(V_{in}) \triangle Z_1$.

a.2.i If there exists a vertex $(u, v) \in V_1 \setminus T$ that is not in Z_1 , then (u, v) is not in T_1 , which ensures that $(G[V_1], T_1)$ is not a bad grid instance (see Figure 8b).

a.2.ii Else, since $(G[V_{in}], T(V_{in}))$ is not a bad grid instance, there must exist $[(u, v), (u', v')] \in Pairs(G[V_{in}])$ such that $(u, v) \in T(V_{in})$ if and only if $(u', v') \notin T(V_{in})$ (see Figure 8c). But since both (u, v) and (u', v') belong to Z_1 , they also satisfy $(u, v) \in T_1$ if and only if $(u', v') \notin T_1$. Thus, $(G[V_1], T_1)$ is not a bad grid instance.

Part b. Suppose now that $(G[V_{in}], T(V_{in}))$ is a bad grid instance of Problem 1 such that $T(V_{in}) \neq V_{in}$. Note that it implies that $p \geq 6$ or $q \geq 6$ and that it must exist $[x, x'] \in Pairs(G[V_{in}])$ such that $x, x' \notin T(V_{in})$. Up to symmetry, we can assume that $q \geq 6$ and $[x, x'] = [(u_1, v_{2k}), (u_1, v_{2k+1})]$ for some $k \in \{1, \dots, \frac{q-4}{2}\}$.

We distinguish three cases illustrated in Figures 9a, 9b and 9c (gray vertices in the same green set are either all black or all white).

b.1. Assume that the pair $[y, y'] = [(u_{p-2}, v_{2k}), (u_{p-2}, v_{2k+1})]$ is such that $y, y' \in T$. We prove that the $(p, 2k+1)$ -corner T -decomposition $\langle V_0, \emptyset, V_2 \rangle = \langle X_{<2k+1}, \emptyset, X_{\geq 2k+1} \rangle$ is good (see figure 9a) to apply Theorem 4.2. From the current hypothesis and (G1), the decomposition satisfies \mathcal{P} : indeed, $T(V_0) \equiv_2 1 \equiv_2 p + 2k + 1$. Moreover, V_0 and V_2 induce grids with an odd dimension, so Lemma 4.8 ensures that $G[V_0]$ and $G[V_2]$ admit an acyclic T_0 -odd and T_2 -odd orientation respectively.

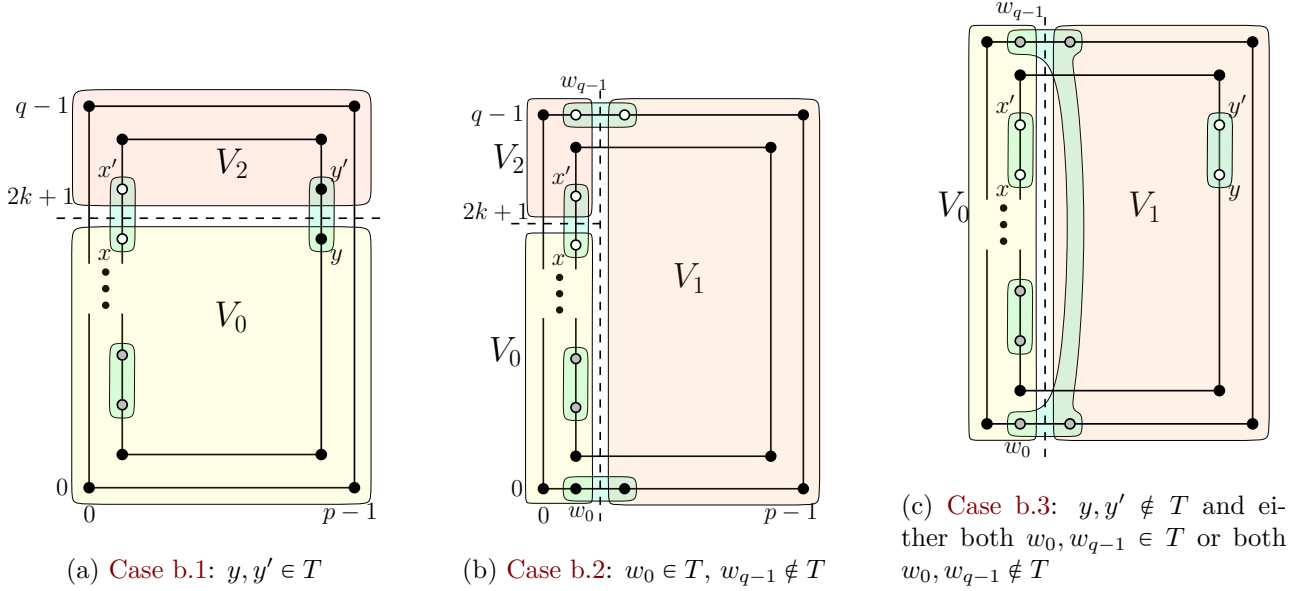

Figure 9: Illustration of the three decompositions used in the proof of Lemma 4.9 Part b.

b.2. Assume that $w_0 = (u_1, v_0) \in T$ and $w_{q-1} = (u_1, v_{q-1}) \notin T$.

We now prove that the $(2, 2k+1)$ -corner T -decomposition $\langle V_0, V_1, V_2 \rangle = \langle Y_0^{[<2k+1]} \cup Y_1^{[<2k+1]}, Y_{\geq 2}, Y_0^{[\geq 2k+1]} \cup Y_1^{[\geq 2k+1]} \rangle$ of G is good (see Figure 9b). Similarly, our current hypothesis and (G1) certify that the decomposition satisfies \mathcal{P} :

$$\begin{aligned} T(V_0) &\equiv_2 1 \equiv_2 2 + 2k + 1 \\ T(V_1) &\equiv_2 |T(Y_{\geq 2})| \equiv_2 1 \equiv_2 p - 2 + q - (2k + 1) \end{aligned}$$

Notice also that $G[V_0]$ and $G[V_2]$ are grids with an odd dimension. Hence, by Lemma 4.8 they admit an acyclic T_0 -odd and T_2 -odd orientation respectively. To show that the T -decomposition is good, it is now enough to check that $G[V_1]$ is not a bad grid instance of Problem 1 and apply induction. Since $(u_1, v_0) \in T$ and $[(u_1, v_0), (u_2, v_0)] \in Pairs(G[V_1])$, we deduce that $(u_2, v_0) \in T$. Notice also that $(u_2, v_0) \in Z_2$. Hence, $(u_2, v_0) \notin T_2$, which implies that $(G[V_1], T_1)$ is not a bad grid instance of Problem 1. So by Theorem 4.2, G admits an acyclic T -odd orientation.

The case where $(u_1, v_{q-1}) \in T$ and $(u_1, v_0) \notin T$ is symmetrical.

b.3. Finally, assume that y, y' are not in T and either both $w_0, w_{q-1} \in T$ or both $w_0, w_{q-1} \notin T$. We prove that the $(2, q)$ -corner T -decomposition $\langle V_0, V_1, \emptyset \rangle = \langle Y_{< 2}, Y_{\geq 2}, \emptyset \rangle$ of G is good (see figure 9c) and conclude by applying Theorem 4.2. To show that the decomposition satisfies \mathcal{P} , we only need to check that $|T(V_0)| \equiv_2 |E(G[V_0])|$ thanks to Lemma 4.3:

$$T(V_0) \equiv_2 0 \equiv_2 2 + q \equiv_2 |E(G[V_0])| \quad \text{by (G0)}$$

Now, to show that the T -decomposition is good, it is enough to check that $(G[V_0], T_0)$ and $(G[V_1], T_1)$ are not bad grid instances of Problem 1 and apply induction:

- Let us show that $(G[V_0], T_0)$ (with $V_0 = Y_{< 2}$) is not a bad grid instance.

Since $(G[V_{in}], T(V_{in}))$ is a bad grid instance of Problem 1, note that $(u_1, v_1) \in T$ and $[(u_1, v_{2j}), (u_2, v_{2j+1})] \in Pairs(G[V_{in}])$ for all $j \in \{1, \dots, \frac{q-4}{2}\}$. However, since $(u_1, v_{2k}) \notin T$, there must exist $1 \leq k' \leq k$ such that $(u_1, v_{2k'-1}) \in T$ if and only if $(u_1, v_{2k'}) \notin T$. Thus, $(G[Y_1], T(Y_1))$ is not a bad path instance and by Lemma 4.8, $G[V_0]$ admits an acyclic T_0 -odd orientation.

- Let us show that $(G[V_1], T_1)$ (with $V_1 = Y_{\geq 2}$) is not a bad grid instance. We distinguish two cases:

If $p = 4$, since $Z_1 = Y_2$, we deduce that $(u_2, v_1) \notin T_1$ and $(u_{p-2}, v_{2k-1}), (u_{p-2}, v_{2k}) = (u_2, v_{2k}), (u_2, v_{2k+1}) \in T_1$. Moreover, since $(G[V_{in}], T(V_{in}))$ is a bad grid instance of Problem 1, we have that $[(u_2, v_{2j}), (u_2, v_{2j+1})] \in Pairs(G[Y_{\geq 2}])$ for all $1 \leq j \leq \frac{q-4}{2}$. Hence, there must exist $1 \leq k' \leq k$ such that $(u_2, v_{2k'-1}) \in T_1$ if and only if $(u_2, v_{2k'}) \notin T_1$. Thus, $(G[Y_2], T_1(Y_2))$ is not a bad path instance of Problem 1 and by Lemma 4.8, $G[V_1]$ admits an acyclic T_1 -odd orientation.

If $p \geq 6$, note that $(u_{p-2}, v_{2k-1}), (u_{p-2}, v_{2k}) \notin T_1$, so $(G[V_1], T_1)$ is not a bad grid instance of Problem 1 and by induction, $G[V_1]$ admits an acyclic T_1 -odd orientation.

Combining parts 1 and 2 concludes the induction. Thus, if (G, T) is not a bad grid instance of Problem 1 such that T satisfies the parity condition \mathcal{P} , then it admits an acyclic T -odd orientation. \square

Lemma 4.10. *If (G, T) is a bad grid instance of Problem 1, then G does not admit an acyclic T -odd orientation.*

Proof.

Let (G, T) be a bad grid instance of Problem 1 with $G = P_p \square P_q$. We show that G does not admit any acyclic T -odd orientation.

The proof proceeds as follows. We construct a new instance $(\mathcal{G}, \mathcal{T})$, where $|\mathcal{T}| = |V(\mathcal{G})| - 1$, and we show that any acyclic T -odd orientation of G would imply the existence of an acyclic \mathcal{T} -odd orientation of \mathcal{G} . Next, we recall the following theorem of Kiraly and Kisfaludi-Bak (Theorem 1.40 in [6]). It provides a key characterization for acyclic T -odd orientations in planar graphs. To cite this theorem, we give some quick intuitive definitions; for formal ones, we refer to [7]. A **planar embedding** is a drawing of a graph in the plane such that no edges cross each other. A graph that admits a planar embedding is called **planar**. The **dual** of a planar embedding of G is the graph where the faces of this embedding are its vertex set, and two faces are adjacent whenever they share an edge of G . A graph is **factor-critical** if, after removing any vertex, the remaining graph has a perfect matching.

(Theorem 1.40 in [6]) The dual of a planar graph $G = (V, E)$ having an acyclic $V \setminus \{v\}$ -odd orientation for some vertex $v \in V$ is always factor-critical. (So if there are multiple dual graphs depending on the planar embedding of G , then all of them are factor-critical.)

From the contrapositive of this theorem, to show that G does not admit any acyclic T -odd orientation, it is enough to show that the dual of some planar embedding of \mathcal{G} is not factor-critical. To do so, we show that some planar embedding $\phi(\mathcal{G})$ of \mathcal{G} contains $\lfloor \frac{f}{2} \rfloor$ pairwise independent faces, where f is the number of faces in $\phi(\mathcal{G})$ and two faces are independent if they do not share an edge. Indeed, this implies that the dual of $\phi(\mathcal{G})$ contains an independent set of size $\lfloor \frac{n}{2} \rfloor$ and hence that it is not factor-critical.

Construction of $(\mathcal{G}, \mathcal{T})$:

Define \mathcal{G} from G by adding a vertex s connected to every vertex in $V \setminus T$ as follows:

- $V(\mathcal{G}) = V(G) \cup \{s_{root}\}$
- $E(\mathcal{G}) = E(G) \cup \{ws_{root} \mid w \in V(G) \setminus T\}$

Set $\mathcal{T} = V(\mathcal{G}) \setminus \{s_{root}\}$.

Correctness of $(\mathcal{G}, \mathcal{T})$:

Suppose that G admits an acyclic T -odd orientation O . We construct an orientation O' of \mathcal{G} as follows:

- $a \in O'$ for all arcs $a \in O$.
- For each $w \in V(G) \setminus T$, $\overrightarrow{s_{root}w} \in O'$.

By construction, O' is a \mathcal{T} -odd orientation of \mathcal{G} . Furthermore, O' remains acyclic s_{root} is a source in $\mathcal{G}_{O'}$. Hence, any acyclic T -odd orientation of G implies an acyclic \mathcal{T} -odd orientation of \mathcal{G} .

Planar Embedding $\phi(\mathcal{G})$:

We now describe a planar embedding $\phi(\mathcal{G})$ of \mathcal{G} . We first map the vertex $(u_i, v_j) \in V(G)$ to the point $(i, j) \in \mathbb{Z}^2$ for all $i \in \{0, \dots, p-1\}$ and $j \in \{0, \dots, q-1\}$. Each edge is drawn as a straight line segment between its endpoints. We say that a vertex (v_i, v_j) is on the border of the grid if $i \in \{0, p-1\}$ or $j \in \{0, q-1\}$. The additional vertex s_{root} is adjacent only to vertices of $V(G) \setminus T$. Because (G, T) is a bad grid instance, all those vertices lie on the border of the grid. Hence, we embed s_{root} in the external face of the grid, at the point (p, q) , and for each vertex $w \in V(G) \setminus T$, we draw a curve from s_{root} to w . These curves can be chosen so that they do not cross each other, nor any edge of G , except at their endpoints (see Figure 10).

Independent faces of $\phi(\mathcal{G})$:

First, note that $|V(\mathcal{G})| = pq + 1$ and $|E(\mathcal{G})| = q(p-1) + p(q-1) + |V(G)\setminus T|$, so by Euler's formula, $\phi(\mathcal{G})$ contains $f = (p-1)(q-1) + |V(G)\setminus T|$ faces.

We select the following faces of $\phi(\mathcal{G})$ defined by the cycles:

1. $(u_{2i}, v_{2j})(u_{2i}, v_{2j+1})(u_{2i+1}, v_{2j+1})(u_{2i+1}, v_{2j})$ for all $i \in \{0, \dots, \frac{p-2}{2}\}$ and $j \in \{0, \dots, \frac{q-2}{2}\}$
2. $(u, v)(u', v')s_{root}$ for all $[(u, v), (u', v')] \in \text{Pairs}(G)$ such that $(u, v), (u', v') \in V(G)\setminus T$.

Note that all selected faces of $\phi(\mathcal{G})$ are independent. Also, we selected precisely $\lceil \frac{(p-1)(q-1)}{2} \rceil$ faces in **1.** and $\frac{|V(G)\setminus T|}{2}$ faces in **2.**. This makes a total of $\lceil \frac{(p-1)(q-1)}{2} \rceil + \frac{|V(G)\setminus T|}{2} = \lceil \frac{f}{2} \rceil$ independent faces (see Figure 10).

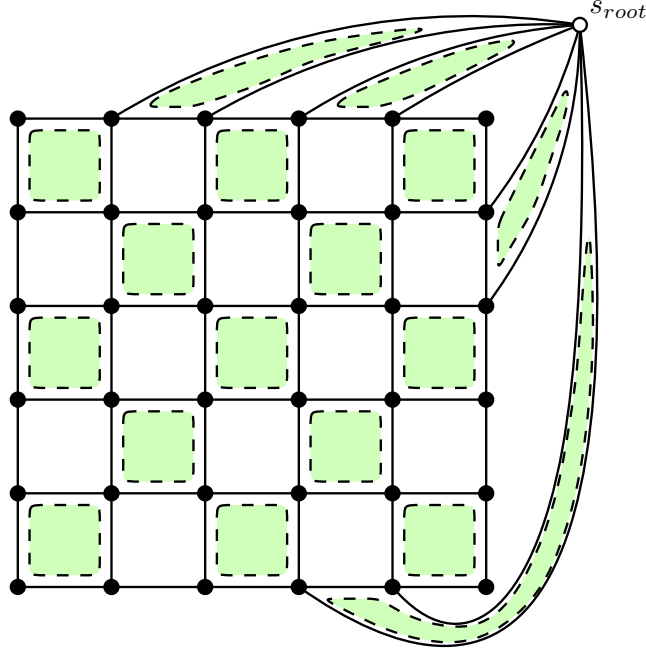

Figure 10: Chosen faces on the planar embedding of \mathcal{G} associated with the bad grid instance of Figure 5.

□

Combining Lemma 4.9 and Lemma 4.10, we obtain the following theorem:

Theorem 4.11. *Let (G, T) be a grid instance of Problem 1 such that T satisfies the parity condition \mathcal{P} .*

G admits an acyclic T -odd orientation if and only if (G, T) is not a bad grid instance of Problem 1. □

4.4 Cylinders and Tori

In this section, we prove Theorem 1.3 which solves Problem 1 for graphs $G \square H$ when G and H are a path or a cycle. Let us recall this second result on cylinders and tori:

Theorem (1.3). *Let $G = C_p \square H_q$ be a graph where C_p is a cycle on p vertices and H_q is either a path or a cycle on q vertices. Let $T \subseteq V(G)$ be a subset that satisfies \mathcal{PSS} .*

If H_q is a path, or if $p, q \geq 4$, then G has an acyclic T -odd orientation.

As for grids, the proof of Theorem 1.3 works by construction and induction. We decompose the proof into three lemmas (Lemmas 4.12, 4.13 on cylinders and 4.15 on tori) from which this theorem is a direct consequence. We now give some preliminary results and definitions.

Preliminaries

Let $p \geq 3$ and $q \geq 1$. Let G be $C_p \square H_q$ with $H_q \in \{P_q, C_q\}$. If $H_q = C_q$, then $q \geq 3$.

We denote the vertex sets by $V(C_p) = \{u_0, \dots, u_{p-1}\}$ and $V(H_q) = \{v_0, \dots, v_{q-1}\}$. We fix the edge sets as follows: $E(C_p) = \{u_i u_{i+1 \bmod p} \mid i = 0, \dots, p-1\}$ and $E(H_q) = \{v_j v_{j+1} \mid j = 0, \dots, q-2\}$ if H_q is a path; else $E(H_q) = \{v_j v_{j+1 \bmod q} \mid j = 0, \dots, q-1\}$.

For every $j \in \{0, \dots, q-1\}$, let $X_j^{[\geq i]} = \{(u_k, v_j) \mid k = i, \dots, p-1\}$ and $X_j^{[\leq i]} = \{(u_k, v_j) \mid k = 0, \dots, i\}$. We drop the superscript $[\geq i]$ and $[\leq i]$ when $i = 0$ or $p-1$ respectively, and in those cases, the graph induced by X_j is C_p ; we call X_j a **row**. By extension, we denote $X_{\leq j} = \cup_{k=0}^j X_k$, $X_{< j} = X_{\leq j} \setminus X_j$ and $X_{\geq j} = \cup_{k=j}^q X_k$, $X_{> j} = X_{\geq j} \setminus X_j$. In particular, the graph induced by $X_{\leq j}$ is a cylinder.

For every $i \in \{0, \dots, p-1\}$, let $Y_i^{[\geq j]} = \{(u_i, v_k) \mid j \leq k \leq q-1\}$ and $Y_i^{[\leq j]} = \{(u_i, v_k) \mid 0 \leq k \leq j\}$. We drop the superscript $[\geq j]$ and $[\leq j]$ when $j = 0$ or $q-1$ respectively, and in those cases, the graph induced by Y_i is H_q ; we call Y_i a **column**. We also denote similarly $Y_{\leq i} = \cup_{k=0}^i Y_k$, $Y_{< i} = Y_{\leq i} \setminus Y_i$ and $Y_{\geq i} = \cup_{k=i}^p Y_k$, $Y_{> i} = Y_{\geq i} \setminus Y_i$. In particular, the graph induced by $Y_{\leq i}$ is a grid whenever $H_q = P_q$ but a cylinder whenever $H_q = C_q$.

Cylinders

This part is dedicated to the proof of Theorem 1.3 for cylinders. For any cylinder $G = C_p \square P_q$, it is useful to remind that:

$$|V(G)| \equiv_2 p \times q, \quad |E(G)| \equiv_2 p \quad (\text{C0})$$

Let be a subset $T \subseteq V(G)$. Recall that $Source(T) = V(G) \setminus T$ and $Sink(T)$ is the set of vertices in T that have an odd degree and vertices in $V(G) \setminus T$ that have an even degree. Hence, in cylinders, $Source(T) \neq \emptyset$ if and only if $T \neq V(G)$ and $Sink(T) \neq \emptyset$ if and only if $T \neq V(G) \setminus \{X_0, X_{q-1}\}$. Moreover there is no need to check whether $Source(T) \neq Sink(T)$ as it is always the case for non Eulerian graphs.

Note that T does not satisfy \mathcal{S} if and only if $T = V(G)$ and does not satisfy $\bar{\mathcal{S}}$ if and only if $T = V(G) \setminus \{X_0, X_{q-1}\}$ (see Figure 11). In the proof, to show that a cylinder instance (G, T) satisfies \mathcal{S} or $\bar{\mathcal{S}}$ we show that $Source(T)$ and $Sink(T)$ are non empty.

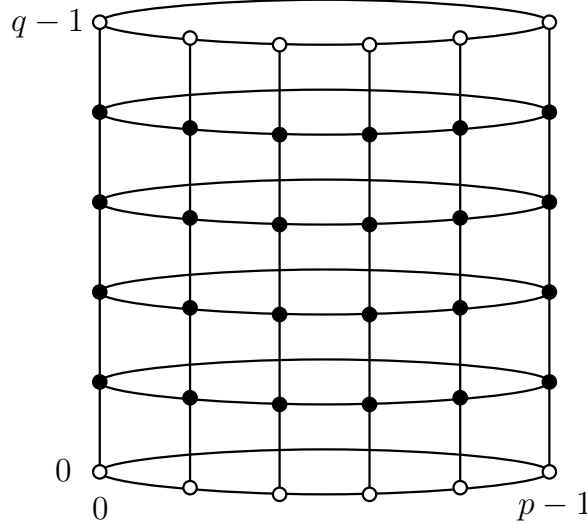

Figure 11: A cylinder with T satisfying \mathcal{P} and \mathcal{S} , but violating $\bar{\mathcal{S}}$

In the next proofs, we use multiple T -decompositions of a cylinder instance (G, T) that we shall describe carefully here. Using Lemma 4.3, we give the necessary and sufficient conditions we use to prove that these T -decompositions satisfy the parity condition \mathcal{P} .

first-row T-decompositions. We define here two different T -decompositions $\langle V_0, V_1 \rangle = \langle X_0, X_{\geq 1} \rangle$ or $\langle X_{\geq 1}, X_0 \rangle$ of (G, T) (see Figure 12a). By Lemma 4.3, these two T -decompositions satisfy \mathcal{P} if

and only if:

$$|T(V_0)| \equiv_2 |E(X_0)| \equiv_2 |E(X_{\geq 1})| \equiv_2 p \quad (\text{C1})$$

i^{th} -column T -decomposition. It is defined as $\langle V_0, V_1 \rangle = \langle Y_i, V(G) \setminus Y_i \rangle$ for $i \in \{0 \dots p-1\}$ (see Figure 12b):

$$V_0 = Y_i, \quad V_1 = V(G) \setminus Y_i$$

By Lemma 4.3, this T -decomposition satisfies \mathcal{P} if and only if:

$$|T_0| \equiv_2 |E(G[V_0])| \text{ i.e. } |T(V_0)| \equiv_2 |E(Y_i)| \equiv_2 q-1 \quad (\text{C2})$$

i^{th} -column & first-row T -decompositions. We define here two different T -decompositions (see Figure 12c).

The first one is $\langle V_0, V_1, V_2 \rangle = \langle Y_i^{[\geq 1]}, X_0, V(G) \setminus (Y_i^{[\geq 1]} \cup X_0) \rangle$. By Lemma 4.3, it satisfies \mathcal{P} if and only if:

$$\begin{aligned} |T_0| \equiv_2 |E(G[V_0])| \text{ i.e. } |T(V_0)| \equiv_2 |E(Y_i^{[\geq 1]})| \equiv_2 q \\ |T_1| \equiv_2 |E(G[V_1])| \text{ i.e. } |T(V_1)| \equiv_2 |E(X_0)| - |Z_1| \equiv_2 p-1 \end{aligned} \quad (\text{C3a})$$

The second one is $\langle V_0, V_1, V_2 \rangle = \langle V \setminus (Y_i^{[\geq 1]} \cup X_0), X_0, Y_i^{[\geq 1]} \rangle$. By Lemma 4.3, it satisfies \mathcal{P} if and only if:

$$\begin{aligned} |T_1| \equiv_2 |E(G[V_1])| \text{ i.e. } |T(V_1)| \equiv_2 |E(X_0)| - |Z_1| \equiv_2 p - (p-1) \equiv_2 1 \\ |T_2| \equiv_2 |E(G[V_2])| \text{ i.e. } |T(V_2)| \equiv_2 |E(Y_i^{[\geq 1]})| - |Z_2| \equiv_2 q-1 \end{aligned} \quad (\text{C3b})$$

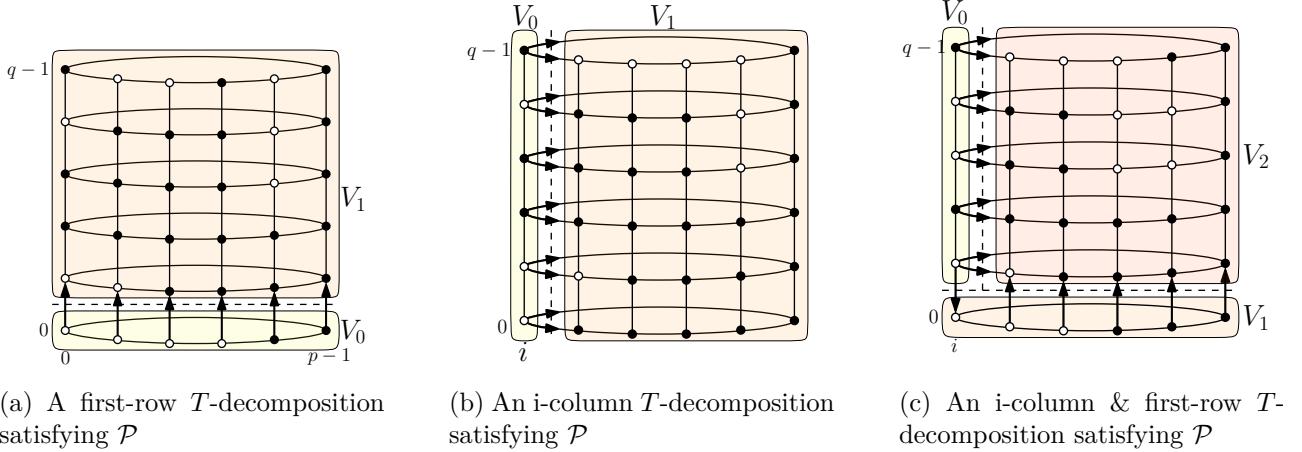

Figure 12: T -decompositions used in the proofs of Lemmas 4.13 and 4.12.

Lemma 4.12. Let G be a cylinder $C_p \square P_q$ with $p \geq 3$ odd and $q \geq 1$. The graph G admits an acyclic T -odd orientation for any subset $T \subseteq V(G)$ satisfying:

- \mathcal{P} if q is even.
- $\mathcal{P}\overline{\mathcal{S}}$ if q is odd.

Proof.

Let $G = C_p \square P_q$ with $p \geq 3$ odd and $q > 1$ (for $q = 1$, refer to Lemma 4.5).

a. Suppose that $q \equiv_2 0$, so that $|V(G)| \equiv_2 0$. Let T be a subset of $V(G)$ satisfying \mathcal{P} and recall we suppose p odd. By (C0), this implies $|T| \equiv_2 1$ and $|V(G) \setminus T| \equiv_2 1$. This implies that T also satisfies \mathcal{S} and $\overline{\mathcal{S}}$ ($T \neq V(G)$ and $T \neq V(G) \setminus \{X_0, X_{q-1}\}$ since $|V(G) \setminus \{X_0, X_{q-1}\}| \equiv_2 0$). By (C0), we have that $|V(G)| + |E(G)| \equiv_2 1$ so T must verify whether $|V(G) \setminus T| \equiv_2 1$ and hence satisfies \mathcal{S} and $\overline{\mathcal{S}}$ as well. Also, since $|V(G) \setminus T| \equiv_2 1$, there must exist $i \in \{1, \dots, p\}$ such that $|Y_i \cap T| \equiv_2 1$. Let us consider the i^{th} -column T -decomposition $\mathcal{A}_1 = \langle V_0, V_1 \rangle = \langle Y_i, V(G) \setminus Y_i \rangle$ (see Figure 13a). It satisfies \mathcal{P} (see (C2)):

$$|T(V_0)| \equiv_2 q-1 \equiv_2 |E(G[V_0])|$$

Now, $G[V_0]$ is a path and has an acyclic T_0 -odd orientation by Lemma 4.4. $G[V_1]$ is a grid with even dimensions, hence, if $(G[V_1], T_1)$ is not a bad grid instance, it has an acyclic T_1 -odd orientation by Lemma 4.9 and \mathcal{A}_1 is good.

Otherwise, if $(G[V_1], T_1)$ is a bad grid instance in \mathcal{A}_1 , we have in particular that (u_{i+1}, v_0) and (u_{i+1}, v_{q-1}) are not in T . In this case, we define $\mathcal{A}_2 = \langle V_0, V_1 \rangle = \langle V(G) \setminus Y_i, Y_i \rangle$. To show it satisfies \mathcal{P} it is enough by Lemma 4.3 to check that $|T_1| \equiv_2 |E(G[V_1])|$ or equivalently that $|T(V_1)| \equiv_2 |E(G[V_1])| - |Z_1|$. But $|Z_1| \equiv_2 0$ hence:

$$|T(V_1)| \equiv_2 |T(Y_i)| \equiv_2 q - 1 \equiv_2 |E(G[V_1])| - |Z_1|$$

Now, the subgraph induced by V_0 in \mathcal{A}_2 is a grid with even dimensions but in this case $(G[V_0], T_0)$ is guaranteed to not be a bad grid instance in \mathcal{A}_2 as its corner vertices (u_{i+1}, v_0) and (u_{i+1}, v_{q-1}) are not in T_0 . Hence, $G[V_0]$ has an acyclic T_0 -odd orientation by Lemma 4.9. Furthermore, $G[V_1]$ is a path and has an acyclic T_1 -odd orientation by Lemma 4.4, achieving to prove that \mathcal{A}_2 is good.

b. From now on, suppose that $q \equiv_2 1$ and let T be a subset of $V(G)$ satisfying $\mathcal{P}\overline{\mathcal{S}\mathcal{S}}$.

b.1. Suppose that there is a column Y_i such that $T(Y_i)$ satisfies \mathcal{P} in $G[Y_i]$ for some $i \in \{0, \dots, p-1\}$. Then the i^{th} -column T -decomposition $\mathcal{B} = \langle V_0, V_1 \rangle = \langle Y_i, V(G) \setminus Y_i \rangle$ satisfies \mathcal{P} (refer to (C2) and Figure 13b):

$$|T(V_0)| \equiv_2 |T(Y_i)| \equiv_2 q - 1$$

We now show it is a good decomposition. The subgraph $G[V_0]$ is a path and has an acyclic T_0 -odd orientation by Lemma 4.4. The subgraph $G[V_1]$ is a grid with an odd dimension, hence it has an acyclic T_1 -odd orientation by Lemma 4.8.

b.2. Assume that for all $i \in \{0, \dots, p-1\}$, $T(Y_i)$ does not satisfy \mathcal{P} in $G[Y_i]$, i.e. $|T(Y_i)| \equiv_2 1$.

b.2.i. Suppose that $T(X_0) \neq X_0$ and $T(X_0) \neq \emptyset$. If $T(X_0)$ satisfies \mathcal{P} in $G[X_0]$, we consider the first-row T -decomposition $\mathcal{C}_1 = \langle V_0, V_1 \rangle = \langle X_0, X_{\geq 1} \rangle$; otherwise if $T(X_0)$ does not satisfy \mathcal{P} in $G[X_0]$, then $T(X_{\geq 1})$ satisfies \mathcal{P} in $G[X_{\geq 1}]$. Indeed :

$$\begin{aligned} |T| &= |T(X_0)| + |T(X_{\geq 1})| \\ &\equiv_2 |E(G[X_0])| + |E(G[X_{\geq 1}])| + |\delta(X_0, X_{\geq 1})| \\ &\equiv_2 |E(G[X_0])| + |E(G[X_{\geq 1}])| + 1 \end{aligned}$$

where $\delta(X_0, X_{\geq 1})$ denotes the set of edges with one endpoint in X_0 and the other in $X_{\geq 1}$.

In this case, we consider the first-row T -decomposition $\mathcal{C}_2 = \langle V_0, V_1 \rangle = \langle X_{\geq 1}, X_0 \rangle$ (see Figure 13c) and either \mathcal{C}_1 or \mathcal{C}_2 satisfies \mathcal{P} by Lemma 4.3.

For $i \in \{0, 1\}$, if the subgraph $G[V_i]$ is either a cylinder with p odd and q even or a cycle (with T_i verifying \mathcal{S} since $T_i \neq V_i$), then it has an acyclic T_i -odd orientation by case **a.** or Lemma 4.5, respectively. Hence, either \mathcal{C}_1 or \mathcal{C}_2 is good. We take care of the case where $T(X_{q-1}) \neq X_{q-1}$ and $T(X_{q-1}) \neq \emptyset$ by symmetry.

b.2.ii. Suppose that $T(X_0) = X_0$ and $T(X_{q-1}) = X_{q-1}$. We consider an i^{th} -column & first-row T -decomposition $\mathcal{D}_1 = \langle V_0, V_1, V_2 \rangle = \langle V \setminus (Y_i^{[\geq 1]} \cup X_0), X_0, Y_i^{[\geq 1]} \rangle$ for some $i \in \{0, \dots, p-1\}$ such that $T(V \setminus (Y_i^{[\geq 1]} \cup X_0)) \neq V \setminus (Y_i^{[\geq 1]} \cup X_0)$ (see Figure 13d). This decomposition satisfies \mathcal{P} (refer to (C3b)):

$$|T(V_1)| \equiv_2 |T(X_0)| \equiv_2 p, \quad |T(V_2)| \equiv_2 |T(Y_i^{[\geq 1]})| \equiv_2 0 \equiv_2 q - 1$$

The subgraph $G[V_0]$ is a grid with even dimensions. If $(G[V_0], T_0)$ is a bad grid instance of Problem 1, we consider symmetrically the i^{th} -column & first-row T -decomposition $\mathcal{D}_2 = \langle V_0, V_1, V_2 \rangle = \langle V \setminus (Y_i^{[\leq q-2]} \cup X_{q-2}), X_{q-1}, Y_i^{[\leq q-2]} \rangle$ (see Figure 13d) which satisfies \mathcal{P} as well. Now, $(G[V_0], T_0)$ cannot be a bad grid instance in both \mathcal{D}_1 and \mathcal{D}_2 . Indeed, this would imply that $T(V \setminus Y_i) = V \setminus Y_i$, which is not possible because $V \setminus Y_i \supset V \setminus (Y_i^{[\geq 1]} \cup X_0)$ and we supposed $T(V \setminus (Y_i^{[\geq 1]} \cup X_0)) \neq V \setminus (Y_i^{[\geq 1]} \cup X_0)$. By Lemma 4.9, $G[V_0]$ has an acyclic T_0 -odd orientation. The subgraph $G[V_1]$ is a cycle with T_1 satisfying \mathcal{P} and \mathcal{S} since $T_1 \neq V_1$, so it has an acyclic T_1 -odd orientation by Lemma 4.5. The subgraph $G[V_2]$ is a path and has an acyclic T_2 -odd orientation by Lemma 4.4. We deduce that at least one decomposition among \mathcal{D}_1 or \mathcal{D}_2 is good.

b.2.iii. Suppose that $T(X_0) = \emptyset$ and $T(X_{q-1}) = X_{q-1}$. We consider the i^{th} -column & first-row T -decomposition $\mathcal{E} = \langle V_0, V_1, V_2 \rangle = \langle Y_i^{[\geq 1]}, X_0, V \setminus (Y_i^{[\geq 1]} \cup X_0) \rangle$ for some $i \in \{0, \dots, p-1\}$ (see Figure 13e). This decomposition satisfies \mathcal{P} (refer to (C3a)):

$$|T(V_0)| \equiv_2 |T(Y_i^{[\geq 1]})| \equiv_2 1 \equiv_2 q, \quad |T(V_1)| \equiv_2 |T(X_0)| \equiv_2 0 \equiv_2 p-1$$

We now show that \mathcal{E} is good. The subgraph $G[V_0]$ is a path and has an acyclic T_0 -odd orientation by Lemma 4.4. The subgraph $G[V_1]$ is a cycle and T_1 satisfies \mathcal{S} since $T_1 \neq V_1$ from the hypothesis, so it has an acyclic T_1 -odd orientation by Lemma 4.5. The subgraph $G[V_2]$ is a grid with even dimensions, but $(G[V_2], T_2)$ is not a bad grid instance of Problem 1 as the corner vertex $(u_{i+1}, v_{q-1}) \in T_2$, so we are done using Lemma 4.9.

b.2.iv. Suppose that $T(X_0) = \emptyset$ and $T(X_{q-1}) = \emptyset$, so that all vertices of odd degree are not in T . Thus, since T satisfies $\overline{\mathcal{S}}$, we have $T \neq V(G) \setminus \{X_0, X_{q-1}\}$ and there exists a vertex $u \in V(G) \setminus \{X_0, X_{q-1}\}$ that does not belong to T (otherwise it would precisely be the instance described in Figure 11). But because T satisfies \mathcal{P} we also have that $|V(G) \setminus T| \equiv_2 p \times q - |E(G)| \equiv_2 0$. Thus, there exist in fact two distinct vertices $u, v \in V(G) \setminus \{X_0, X_{q-1}\}$ such that $u, v \notin T$. Moreover, because we assumed that for all $i \in \{0, \dots, p-1\}$, $|T(Y_i)| \equiv_2 p$, there must exist a $k \in \{0, \dots, p-1\}$ such that $|Y_k \setminus T(Y_k)| \geq 4$. We now consider an i^{th} -column & first-row T -decomposition $\mathcal{F}_1 = \langle V_0, V_1, V_2 \rangle = \langle Y_i^{[\geq 1]}, X_0, V \setminus (Y_i^{[\geq 1]} \cup X_0) \rangle$ for some $i \in \{0, \dots, p-1\} \setminus \{k\}$ (see Figure 13f). It is essentially the same decomposition as in case **b.2.iii.** and it satisfies \mathcal{P} for the same reason. The subgraph $G[V_2]$ is a grid with even dimensions and T_2 verifies both \mathcal{S} and $\overline{\mathcal{S}}$ in $G[V_2]$: indeed, since $Y_i \neq Y_k$ it is enough to look at vertices in Y_k , to find either two vertices of degree 4 not in T_2 (i.e. in $Source(T_2) \cap Sink(T_2)$ of $G[V_2]$) whenever $k \neq i-1$ and $k \neq i+1$, or two vertices of degree 3 in T_2 (i.e. in $Sink(T_2) \setminus Source(T_2)$ of $G[V_2]$) and a vertex of degree 3 not in T_2 (i.e. in $Source(T_2) \setminus Sink(T_2)$ of $G[V_2]$) whenever $k = i-1$ or $k = i+1$. Now, if $(G[V_2], T_2)$ is a bad grid instance, we consider symmetrically the decomposition $\mathcal{F}_2 = \langle V_0, V_1, V_2 \rangle = \langle Y_i^{[\leq q-2]}, X_{q-1}, V \setminus (Y_i^{[\leq q-2]} \cup X_{q-1}) \rangle$ which satisfies \mathcal{P} as well (see Figure 13f).

We now show that either \mathcal{F}_1 or \mathcal{F}_2 is good. The subgraph $G[V_0]$ is a path and has an acyclic T_0 -odd orientation by Lemma 4.4. The subgraph $G[V_1]$ is a cycle and T_1 satisfies \mathcal{S} since $T_1 \neq V_1$ from the hypothesis, so it has an acyclic T_1 -odd orientation by Lemma 4.5.

We now notice that $(G[V_2], T_2)$ cannot be a bad grid instance in both \mathcal{F}_1 and \mathcal{F}_2 . Indeed, this would imply that $Y_j \setminus T(Y_j) = \{(u_j, v_0), (u_j, v_{q-1})\}$ for all $j \in \{0, \dots, p-1\} \setminus \{i\}$, which is a contradiction as $|Y_k \setminus T(Y_k)| \geq 4$ with $k \in \{0, \dots, p-1\}$ and $i \neq k$ by hypothesis. From this observation, we deduce that $G[V_2]$ has an acyclic T_2 -odd orientation by Lemma 4.9 in either \mathcal{F}_1 or \mathcal{F}_2 . Consequently, either \mathcal{F}_1 or \mathcal{F}_2 is good which ends the proof. \square

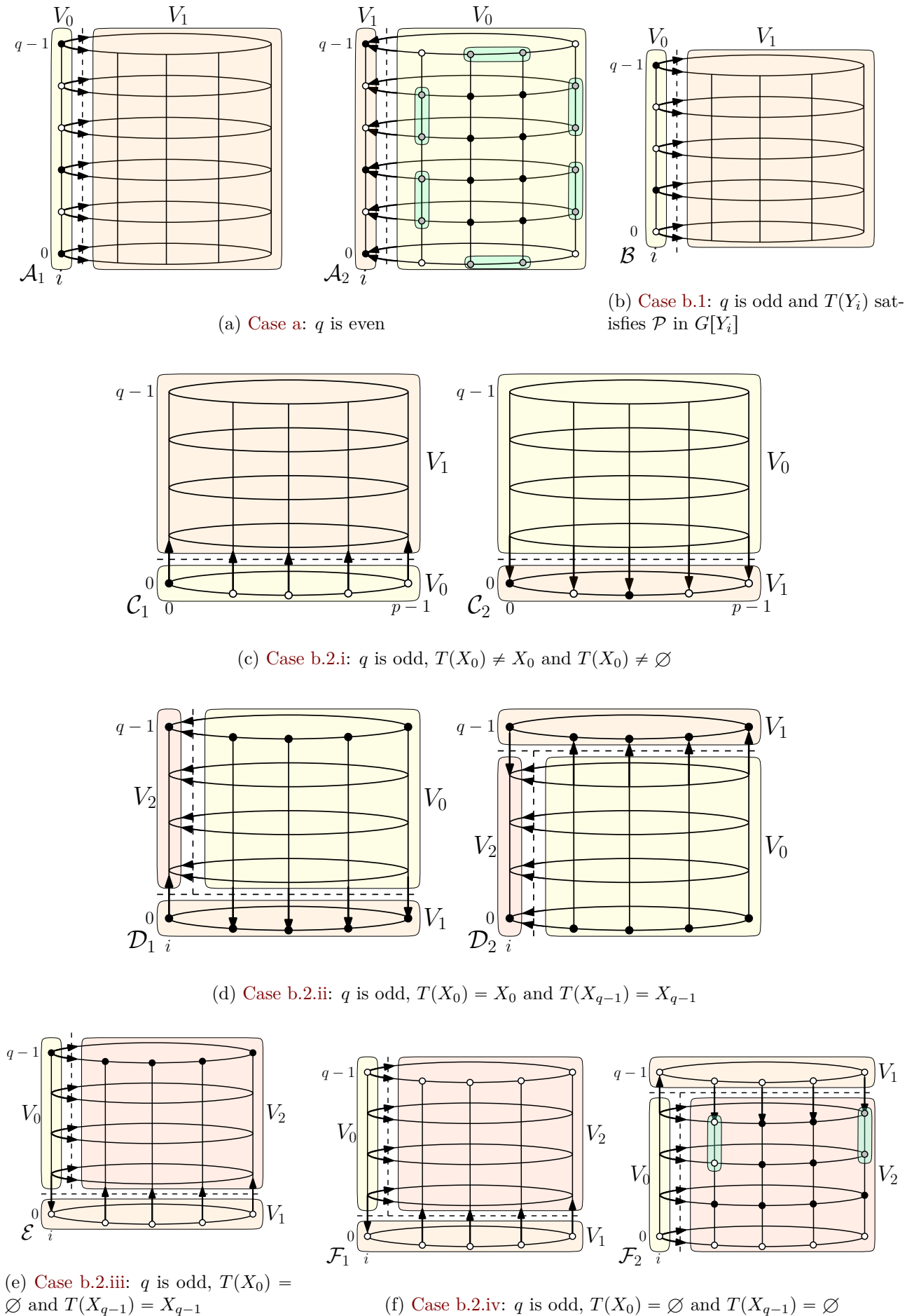

Figure 13: T -decompositions used for the proof of Lemma 4.12 in which p is odd by hypothesis.

Lemma 4.13. *Let G be a cylinder $C_p \square P_q$ with $p \geq 4$ even and $q \geq 1$. Then G admits an acyclic T -odd orientation for any subset $T \subseteq V(G)$ satisfying $\mathcal{P}\overline{\mathcal{S}}$.*

Proof.

Let G be a cylinder $C_p \square P_q$ with $p \geq 4$ even and $q > 1$ (for $q = 1$, refer to Lemma 4.5) and let $T \subseteq V(G)$ such that it satisfies $\mathcal{P}\overline{\mathcal{S}}$. We go through multiple cases:

a. Suppose that $T(X_0)$ does not satisfy \mathcal{P} in $G[X_0]$ i.e. $|T(X_0)| \equiv_2 1 \not\equiv_2 |E(G)|$ by (C0). Then there must exist a subpath of 3 adjacent vertices w_1, w_2, w_3 in X_0 such that $|T(\{w_1, w_2, w_3\})| \equiv_2 0$. Indeed, suppose it is not the case, then:

$$3|T(X_0)| = \sum_{i=0}^{p-1} |T(\{(u_i, v_0), (u_{i+1}, v_0), (u_{i+2}, v_0)\})| \equiv_2 p$$

But p is even, so $|T(X_0)| \equiv_2 0$ and it satisfies \mathcal{P} in $G[X_0]$, a contradiction. Let $w \in \{w_1, w_2, w_3\}$ such that $w \notin T$. We consider the decomposition $\mathcal{A}_1 = \langle V_0, V_1, V_2 \rangle = \langle \{w\}, X_{\geq 1}, X_0 \setminus \{w\} \rangle$ (see Figure 14a). $T(V_0)$ trivially satisfies \mathcal{P} in $G[V_0]$, and we have $|T_1| = |T(V_1)| + 1 = |T| - |T(V_0)| + 1 \equiv_2 0 \equiv_2 |E(G[V_1])|$, so using Lemma 4.3 it shows that \mathcal{A}_1 satisfies \mathcal{P} . If T_1 does not satisfy either \mathcal{S} or $\overline{\mathcal{S}}$ in $G[V_1]$, then, instead of \mathcal{A}_1 , we consider the decomposition $\mathcal{A}_2 = \langle V_0, V_1, V_2 \rangle = \langle \{w_1, w_2, w_3\}, X_{\geq 1}, X_0 \setminus \{w_1, w_2, w_3\} \rangle$ (see Figure 14a) which also satisfies \mathcal{P} . Indeed, by Lemma 4.3, it is enough to check the following:

$$\begin{aligned} |T_0| &\equiv_2 |T(V_0)| \equiv_2 0 \equiv_2 |E(G[V_0])| \\ |T_2| &\equiv_2 |T(V_2)| - |Z_2| \equiv_2 1 - 1 \equiv_2 0 \equiv_2 |E(G[V_2])| \end{aligned}$$

Now, in both partitions, V_0 and V_2 are paths and admit an acyclic T_0 -odd and T_2 -odd orientation respectively by Lemma 4.4. Moreover, V_1 induces a non empty cylinder (as $q > 1$) and we show that it admits an acyclic T_1 -odd orientation by induction on Lemma 4.13 in at least one of the partitions. First, if we consider \mathcal{A}_1 then T_1 satisfies both \mathcal{S} or $\overline{\mathcal{S}}$ in $G[V_1]$ by hypothesis. Second, if we consider \mathcal{A}_2 , then we define $w'_1, w'_2, w'_3 \in V_1$ as the three neighbors of w_1, w_2, w_3 in V_1 , and we denote $w' \in \{w'_1, w'_2, w'_3\}$ the neighbor of w . By hypothesis, $T(V_1) \triangle \{w'\}$ does not satisfy either \mathcal{S} or $\overline{\mathcal{S}}$ in $G[V_1]$ i.e. $T(V_1) \triangle \{w'\} = V_1$ or $T(V_1) \triangle \{w'\} = V_1 \setminus (X_1 \cup X_{q-1})$. But then $T(V_1) \triangle \{w'_1, w'_2, w'_3\} = T_1$ is different from both V_1 and $V_1 \setminus (X_1 \cup X_{q-1})$ and as such satisfies \mathcal{S} and $\overline{\mathcal{S}}$ in $G[V_1]$ (see Figure 11). Hence, either \mathcal{A}_1 or \mathcal{A}_2 is good.

b. From now on, we assume that $T(X_0)$ satisfies \mathcal{P} in $G[X_0]$. This implies that $|T(X_{\geq 1})| \equiv_2 p$, so that $T(X_{\geq 1})$ also satisfies \mathcal{P} in $G[X_{\geq 1}]$. And up to symmetry, we can assume that $T(X_{q-1})$ and $T(X_{\leq q-2})$ satisfy \mathcal{P} as well in $G[X_{q-1}]$ and $G[X_{\leq q-2}]$ respectively.

b.1. Suppose that neither $T(X_{\geq 1})$ nor $T(X_{\leq q-2})$ satisfies both \mathcal{S} and $\overline{\mathcal{S}}$ in $G[X_{\geq 1}]$ and $G[X_{\leq q-2}]$ respectively. Then either $T = V(G)$ in which case T does not satisfy \mathcal{S} which is a contradiction, or $q = 3$ and $T = \emptyset$. In this case, we define the i^{th} -column T -decomposition $\mathcal{B} = \langle V_0, V_1 \rangle = \langle Y_i, V(G) \setminus Y_i \rangle$. It satisfies \mathcal{P} for any $0 \leq i \leq p-1$ (see Figure 14b): indeed, we refer to (C1), and remark that $|T(V_0)| \equiv_2 |T(Y_i)| \equiv_2 p$. We now show that the decomposition is good. V_0 induces a path so it has an acyclic T_0 -odd orientation by Lemma 4.4. The graph $G[V_1]$ is a grid with an odd dimension, hence it has an acyclic T_1 -odd orientation by Lemma 4.8.

b.2. Assume without loss of generality that $T(X_{\geq 1})$ satisfies both \mathcal{S} and $\overline{\mathcal{S}}$ in $G[X_{\geq 1}]$.

b.2.i. Suppose that $T(X_0) \neq \emptyset$. We consider the first-row T -decomposition $\mathcal{C} = \langle V_0, V_1 \rangle = \langle X_{\geq 1}, X_0 \rangle$ (see Figure 14c). This decomposition satisfies \mathcal{P} as $T(X_0)$ satisfies \mathcal{P} in $G[X_0]$ by hypothesis and T_1 satisfies \mathcal{P} in $G[V_1]$ by Lemma 4.3.

Furthermore, it is good. Indeed, $G[V_0]$ is a cylinder with an even dimension and has an acyclic T_0 -odd orientation by induction, and $G[V_1]$ is a cycle in which T_1 satisfies \mathcal{S} since $T_1 = X_0 \triangle T(X_0) \neq X_0 = V_1$ from the hypothesis, so it has an acyclic T_1 -odd orientation by Lemma 4.5.

b.2.ii. Suppose that $T(X_0) = \emptyset$. We consider the first-row T -decomposition $\mathcal{D}_1 = \langle V_0, V_1 \rangle = \langle X_0, X_{\geq 1} \rangle$ (see Figure 14d). The decomposition \mathcal{D}_1 satisfies \mathcal{P} : indeed, we refer to (C1) and remark that $|T(V_0)| \equiv_2 |T(X_0)| \equiv_2 p$. Note also that $G[V_0]$ has an acyclic T_0 -odd orientation by Lemma 4.5. We now have three cases to consider:

- If T_1 satisfies both \mathcal{S} and $\overline{\mathcal{S}}$ in $G[V_1]$ then $G[V_1]$ has an acyclic T_1 -odd orientation by induction and \mathcal{D}_1 is good.
- If T_1 does not satisfy $\overline{\mathcal{S}}$ in $G[V_1]$, then $T_1 = X_{\geq 1} \setminus \{X_1, X_{q-1}\}$ and $T = V(G) \setminus \{X_0, X_{q-1}\}$,

which is precisely saying that T does not satisfy $\overline{\mathcal{S}}$ (see Figure 11), a contradiction.

- Finally, if T_1 does not satisfy \mathcal{S} in $G[V_1]$, then $T_1 = X_{\geq 1}$, which implies that $T = V(G) \setminus \{X_0, X_1\}$.

If $q = 2$ then T does not satisfy $\overline{\mathcal{S}}$ as every vertex of G would be of degree 3 but none of them would belong to T . Hence, we can assume that $q \geq 3$. We define $C_4 = \{(u_0, v_0), (u_0, v_1), (u_1, v_0), (u_1, v_1)\}$ and consider the T -decomposition $\mathcal{D}_2 = \langle V_0, V_1, V_2 \rangle = \langle C_4, X_{\geq 2}, X_{< 2} \setminus C_4 \rangle$ (see Figure 14d). By Lemma 4.3, it satisfies \mathcal{P} . Indeed, we have:

$$\begin{aligned} |T_0| &\equiv_2 |T(V_0)| \equiv_2 0 \equiv_2 |E(G[V_0])| \\ |T_2| &\equiv_2 |T(V_2)| - |Z_2| \equiv_2 0 - 0 \equiv_2 |E(G[V_2])| \quad \text{by (G0)} \end{aligned}$$

We now show that it is good. $G[V_0]$ is a cycle and admits an acyclic T_0 -odd orientation by Lemma 4.5. $G[V_1]$ is a cylinder with T_1 satisfying $\mathcal{P}\overline{\mathcal{S}}$ since $(u_0, v_2), (u_1, v_2) \notin T_1$ (i.e. in $Source(T_1)$ of $G[V_1]$), $(u_2, v_2) \in T_1$ is of degree 3 in $G[V_1]$ (i.e. in $Sink(T_1) \setminus Source(T_1)$ of $G[V_1]$). So $G[V_1]$ has an acyclic T_1 -odd orientation by induction. Finally, $(G[V_2], T_2)$ is not a bad grid instance since both corner vertices (u_3, v_1) and (u_{p-1}, v_1) are not in T_2 . Hence it has an acyclic T_2 -odd orientation by Lemma 4.8.

□

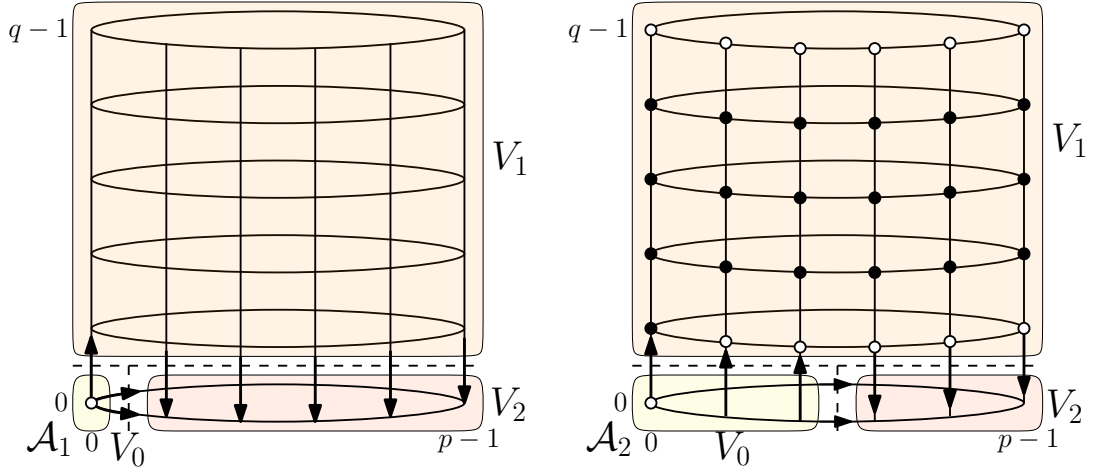

(a) **Case a:** $T(X_0)$ does not satisfy \mathcal{P} in $G[X_0]$.

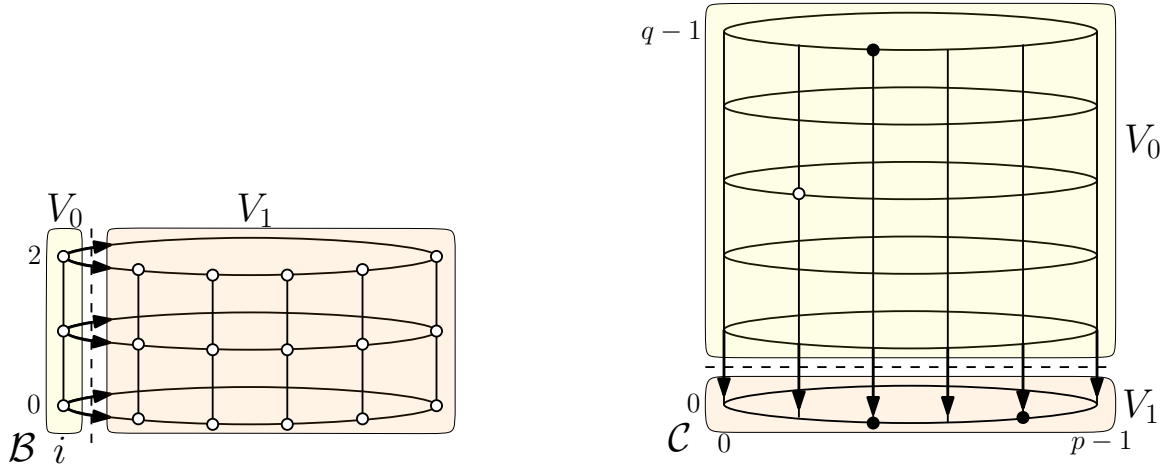

(b) **Case b.1:** neither $T(X_{\geq 1})$ nor $T(X_{\leq q-2})$ satisfies both \mathcal{S} and $\bar{\mathcal{S}}$.

(c) **Case b.2.i:** $T(X_{\geq 1})$ satisfies both \mathcal{S} and $\bar{\mathcal{S}}$ and $T(X_0) \neq \emptyset$.

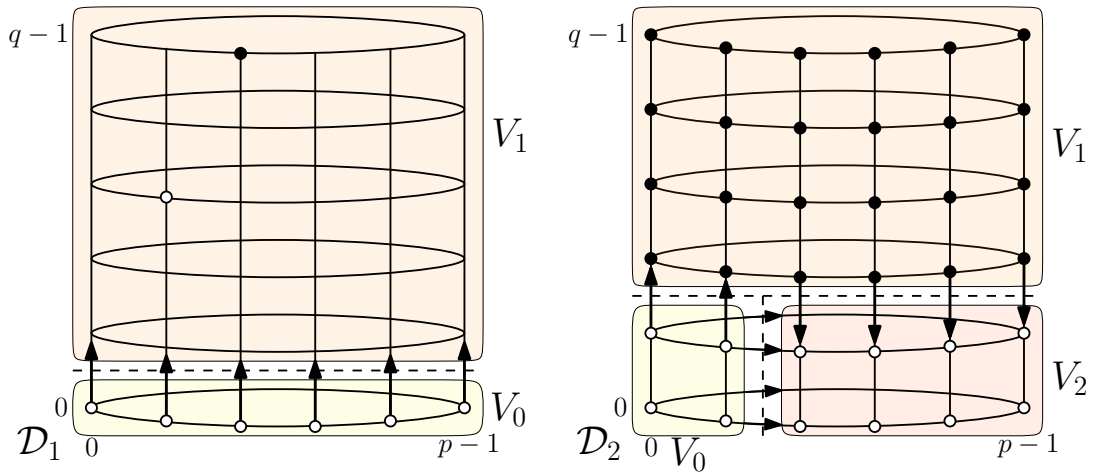

(d) **Case b.2.ii:** $T(X_{\geq 1})$ satisfies both \mathcal{S} and $\bar{\mathcal{S}}$ and $T(X_0) = \emptyset$

Figure 14: T -decompositions used for the proof of Lemma 4.13 in which p is even by hypothesis.

Furthermore, it is good since for all $k \in \{0, 1, 2\}$, the path $G[V_k]$ admits an acyclic T_k -odd orientations by Lemma 4.4.

- Suppose now that $T(X_0) = \emptyset$. We consider the T -decomposition $\mathcal{B}_2 = \langle V_0, V_1, V_2 \rangle = \langle \{(u_0, v_1)\}, X_0, X_1 \setminus \{(u_0, v_1)\} \rangle$ (see Figure 16b). By Lemma 4.3, it satisfies \mathcal{P} since:

$$\begin{aligned} |T_0| &= |T(V_0)| \equiv_2 0 \equiv_2 |E(G[V_0])| \\ |T_1| &= |T(X_0)| - |Z_1| \equiv_2 0 - 1 \equiv_2 |E(G[X_0])| \end{aligned}$$

Furthermore, it is good since for all $k \in \{0, 1, 2\}$, the path $G[V_k]$ admits an acyclic T_k -odd orientations by Lemma 4.4.

b. Suppose that $p \equiv_2 0$, so in particular $|X_0| \equiv_2 0$ and $|X_1| \equiv_2 1$. Let $T \subseteq V(G)$ be a subset satisfying \mathcal{PSS} . Then by (QC) we have that $|T| \equiv_2 |E(G)| \equiv_2 1$ and $|V(G) \setminus T| \equiv_2 0$.

b.1. Suppose first that $T(X_0)$ satisfies \mathcal{PSS} in $G[X_0]$. We consider the decomposition $\mathcal{C} = \langle V_0, V_1 \rangle = \langle X_0, X_1 \rangle$ (see Figure 16c). Since $T_0 = T(X_0)$ satisfies \mathcal{P} and \mathcal{S} in $G[V_0]$ by hypothesis, using Lemma 4.3 is enough to show that \mathcal{C} satisfies \mathcal{P} . Furthermore, it is good since the cycle $G[V_0]$ admits an acyclic T_0 -odd orientation by Lemma 4.5 and the path $G[V_1]$ admits an acyclic T_1 -odd orientation by Lemma 4.4.

b.2. Suppose now that $T(X_0)$ satisfies \mathcal{P} but does not satisfy \mathcal{S} (or equivalently $\overline{\mathcal{S}}$) in X_0 , then $T(X_0) = X_0$ and $|T(X_1)| \equiv_2 1$. In this case, we claim that we can split X_1 into two paths such that one of them, say P , is of even length and $T(P)$ satisfies \mathcal{P} in $G[P]$. More precisely, we claim that there exists $l \in [1, \frac{p-2}{2}]$ such that either $|T(X_1^{[\leq 2l]})| \equiv_2 1$ or $|T(X_1^{[\geq 2l]})| \equiv_2 1$. Suppose by contradiction that it is not the case, then for all $k \in [1, \frac{p-2}{2}]$, we have $|T(X_1^{[\leq 2k]})| \equiv_2 |T(X_1^{[\geq 2k]})| \equiv_2 0$ and:

$$0 \equiv_2 |T(X_1^{[\leq 2k]})| + |T(X_1^{[\geq 2k]})| \equiv_2 |T(X_1)| + |T(\{(u_{2k}, v_1)\})| \equiv_2 1 + |T(\{(u_{2k}, v_1)\})|$$

So for all $k \in [1, \frac{p-2}{2}]$, we get that $(u_{2k}, v_1) \in T(X_1)$. But we also have for all $k \in [1, \frac{p-2}{2}]$, that $|T(X_1^{[\leq 2k]})| \equiv_2 0$ by hypothesis, so we deduce inductively that $(u_{2k-1}, v_1) \in T(X_1)$ for all $k \in [1, \frac{p-2}{2}]$. This implies that $|T(X_1)| = |X_1|$ and thus that $T = V(G)$ and does not satisfy \mathcal{S} , which contradicts our assumptions.

Thus, let l be such that, up to symmetry, $|T(X_1^{[\geq 2l]})| \equiv_2 1$. We define the decomposition $\mathcal{D} = \langle V_0, V_1, V_2 \rangle = \langle X_1^{[\geq 2l]}, X_0, X_1^{[< 2l]} \rangle$ (see Figure 16d). By Lemma 4.3, it satisfies \mathcal{P} since:

$$\begin{aligned} |T_0| &= |T(X_1^{[\geq 2l]})| \equiv_2 1 \equiv_2 |E(G[X_0])| \\ |T_2| &= |T(X_1^{[< 2l]})| - |Z_2| \equiv_2 |T(X_1)| - |T(X_1^{[\geq 2l]})| - 0 \equiv_2 1 - 1 \equiv_2 |E(G[X_1^{[< 2l]}])| \end{aligned}$$

Note that $|Z_2| \equiv_2 0$ because $|Z_2| \equiv_2 |\delta(V_0 \cup V_1, V_2)| \equiv_2 |\delta(V_0, V_2)| + |\delta(V_1, V_2)| \equiv_2 1 + 1 \equiv_2 0$. We now show that the decomposition is good. $G[V_0]$ and $G[V_2]$ are paths and admit an acyclic T_0 -odd and T_2 -odd orientation respectively by Lemma 4.4. $G[V_1]$ is a cycle and T_1 satisfies \mathcal{S} in $G[V_1]$ since $T_1 = T(V_1) \triangle Z_1 = X_0 \triangle X_0^{[\geq 2l]} \neq X_0$ (i.e. $Source(T_1) \neq \emptyset$ in $G[V_1]$), so $G[V_1]$ admits an acyclic T_1 -odd orientation by Lemma 4.5.

b.3. Suppose now that $T(X_0)$ does not satisfy \mathcal{P} , i.e., $|T(X_0)| \equiv_2 1$ and $|T(X_1)| \equiv_2 0$.

b.3.i. Suppose first that $T(X_0) \neq \{(u_0, v_0)\}$. We consider the decomposition $\mathcal{E} = \langle V_0, V_1 \rangle = \langle X_1, X_0 \rangle$ (see Figure 16e). By Lemma 4.3 it satisfies \mathcal{P} since $|T_0| = |T(X_1)| \equiv_2 |T| - |T(X_0)| \equiv_2 1 - 1 \equiv_2 |E(G[X_1])|$. We now show it is good. The path $G[V_0]$ admits an acyclic T_0 -odd orientation by Lemma 4.4. In order to show that the cycle $G[V_1]$ admits an acyclic T_1 -odd orientation using Lemma 4.5, we have to show that $T_1 \neq V_1$. By contradiction, we have:

$$\begin{aligned} T_1 = V_1 &\iff T(V_1) \triangle Z_1 = V_1 \\ &\iff T(X_0) \triangle X_0^{[\geq 1]} = X_0 \\ &\iff T(X_0) = X_0 \triangle X_0^{[\geq 1]} \\ &\iff T(X_0) = \{(u_0, v_0)\} \quad \text{a contradiction} \end{aligned}$$

b.3.ii. Now suppose that $T(X_0) = \{(u_0, v_0)\}$. In this case, we claim that we can split X_1 into two paths such that one of them, say P , is of even length and $T(P)$ does not satisfy \mathcal{P} in

$G[P]$. More precisely, we claim that there exists $l \in [1, \frac{p-2}{2}]$ such that either $|T(X_1^{[\leq 2l]})| \equiv_2 0$ or $|T(X_1^{[\geq 2l]})| \equiv_2 0$. Suppose it is not the case, then for all $k \in [1, \frac{p-2}{2}]$, we have $|T(X_1^{[\leq 2k]})| \equiv_2 |T(X_1^{[\geq 2k]})| \equiv_2 1$ and:

$$0 \equiv_2 |T(X_1^{[\leq 2k]})| + |T(X_1^{[\geq 2k]})| \equiv_2 |T(X_1)| + |T(\{(u_{2k}, v_1)\})| \equiv_2 |T(\{(u_{2k}, v_1)\})|$$

So for all $k \in [1, \frac{p-2}{2}]$, we get that $(u_{2k}, v_1) \notin T(X_1)$. Using that $|T(X_1^{[\leq 2]})| = |T(\{(u_1, v_1), (u_2, v_1)\})| \equiv_2 0$, we deduce that $(u_1, v_1) \in T(X_1)$. Similarly, because $|T(X_1^{[\geq p-2]})| = |T(\{(u_{p-2}, v_1), (u_{p-1}, v_1)\})| \equiv_2 0$ we deduce that $(u_{p-1}, v_1) \in T(X_1)$. Then using $|T(X_1^{[\leq 2k]})| \equiv_2 0$ for all $k \in [2, \frac{p-2}{2}]$ we further deduce inductively that no other vertex belongs to $T(X_1)$ and that $T(X_1) = \{(u_1, v_1), (u_{p-1}, v_1)\}$. This implies that $T = \{(u_0, v_0), (u_1, v_1), (u_{p-1}, v_1)\}$ and does not satisfy \bar{S} as it contains precisely every vertex of even degree (see Figure 15), which contradicts our initial assumptions.

Thus, let be such an l and assume up to symmetry that $|T(X_1^{[\geq 2l]})| \equiv_2 0$. We define the decomposition $\mathcal{F} = \langle V_0, V_1, V_2 \rangle = \langle Y_{\geq 2l}, Y_0, Y_{< 2l} \setminus Y_0 \rangle$ (see Figure 16f). By Lemma 4.3, it satisfies \mathcal{P} since:

$$\begin{aligned} |T_0| &= |T(Y_{\geq 2l})| = |T(X_1^{[\geq 2l]})| + |T(X_0^{[\geq 2l]})| \equiv_2 0 + 0 \equiv_2 |E(G[X_1^{[\geq 2l]})| \\ |T_1| &= |T(V_1)| - |Z_1| \equiv_2 1 - 1 \equiv_2 |E(G[V_1])| \end{aligned}$$

We now prove that the decomposition is good. The graphs $G[V_0]$ and $G[V_2]$ are grids and admit an acyclic T_0 -odd and T_2 -odd orientation respectively by Theorem 4.11. Indeed, $(G[V_0], T_0)$ is not a bad grid instance since the corner vertex $(u_{p-1}, v_0) \notin T_0$ and $(G[V_2], T_2)$ is not a bad grid instance either since $G[V_2]$ is a grid with an odd dimension. □

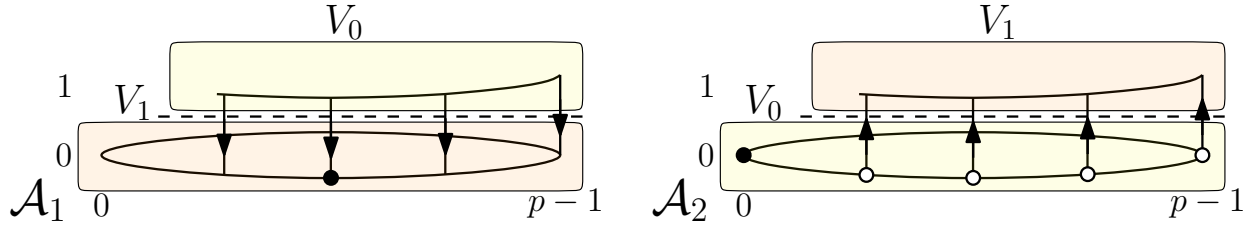

(a) **Case a.1:** $p \equiv_2 1$ and $T(X_0)$ satisfies \mathcal{P} in $G[X_0]$

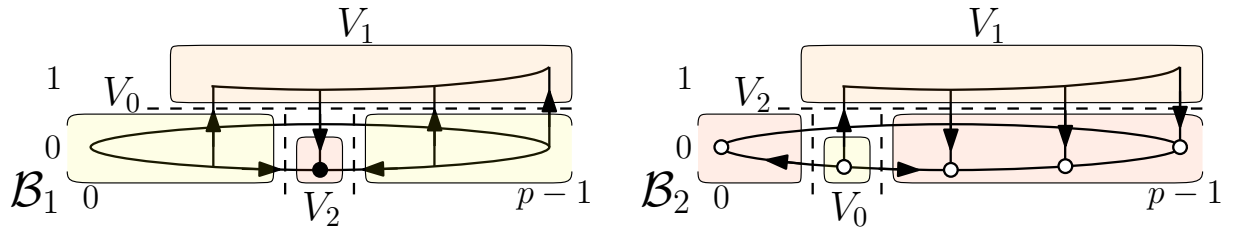

(b) **Case a.2:** $p \equiv_2 1$ and $T(X_0)$ does not satisfy \mathcal{P} in $G[X_0]$

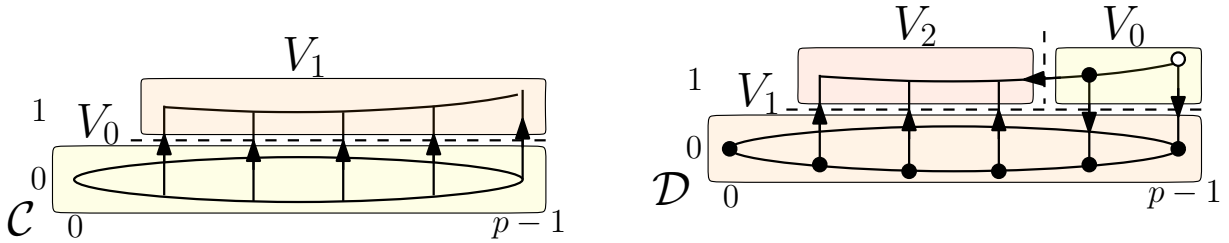

(c) **Case b.1:** $p \equiv_2 0$ and $T(X_0)$ satisfies $\mathcal{P}\overline{\mathcal{S}}$ in $G[X_0]$

(d) **Case b.2:** $p \equiv_2 0$ and $T(X_0)$ satisfies \mathcal{P} but not \mathcal{S} and $\overline{\mathcal{S}}$ in $G[X_0]$

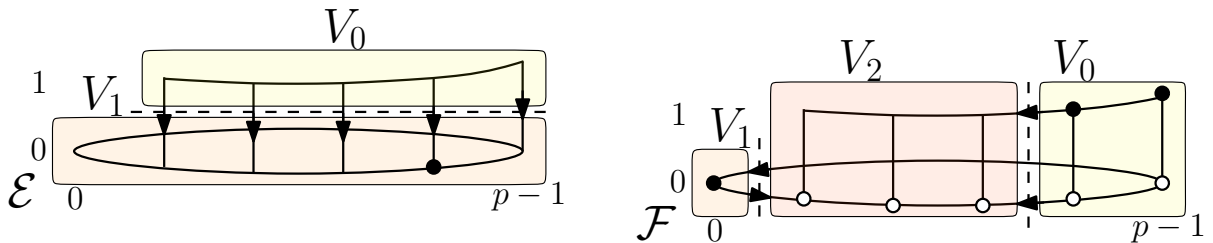

(e) **Case b.3.i:** $p \equiv_2 0$, $T(X_0)$ does not satisfy \mathcal{P} in $G[X_0]$ and $T(X_0) \neq \{(u_0, v_0)\}$

(f) **Case b.3.ii:** $p \equiv_2 0$ and $T(X_0) = \{(u_0, v_0)\}$ in $G[X_0]$

Figure 16: T -decompositions used for the proof of Lemma 4.14.

Torus

This part is dedicated to proving Theorem 1.3 for tori. As before, the proof works by construction and induction. For any torus $G = C_p \square C_q$, it is useful to remind that:

$$|V(G)| \equiv_2 p \times q, |E(G)| \equiv_2 0 \quad (\text{T})$$

Lemma 4.15. *Let $p, q \geq 4$. The Torus $G = C_p \square C_q$ admits an acyclic T -odd orientation for any subset $T \subseteq V(G)$ satisfying \mathcal{PSS} .*

Proof.

Let $p, q \geq 4$ and $G = C_p \square C_q$. Let $T \subseteq V(G)$ be a subset which satisfies \mathcal{PSS} . By (T) we have that $|T|$ is even.

a. First, suppose that $T(X_0)$ satisfies \mathcal{P} and \mathcal{S} , that is, $|T(X_0)| \equiv_2 p$, $X_0 \setminus T \neq \emptyset$, and consequently that $|T(X_{\geq 1})| \equiv_2 p$. By Lemma 4.5, we already have that $G[X_0]$ admits an acyclic $T(X_0)$ -odd orientation. We distinguish two cases depending on the set $T(X_{\geq 1})$.

- Suppose that $T(X_{\geq 1}) \neq X_{\geq 1}$ and $T(X_{\geq 1}) \neq X_{>1} \setminus X_{q-1}$ (this last set is well defined since $q \geq 4$) and let us consider the decomposition $\mathcal{A}_1 = \langle V_0, V_1 \rangle = \langle X_0, X_{\geq 1} \rangle$ (see Figure 17a). By Lemma 4.3, this decomposition satisfies \mathcal{P} , indeed $|T_0| = |T(X_0)|$ satisfies \mathcal{P} in $G[X_0]$ by hypothesis. In order to prove that $G[V_1]$ admits an acyclic T_1 -odd orientation, and thus that \mathcal{A}_1 is good, we use Theorem 1.3 on cylinders. To do so, we have to prove that T_1 satisfies \mathcal{S} and $\overline{\mathcal{S}}$. Equivalently, we prove by contradiction that $T_1 \neq X_{\geq 1}$ (i.e. $Source(T_1) \neq \emptyset$ in $G[V_1]$) and $T_1 \neq X_{>1} \setminus X_{q-1}$ (i.e. $Sink(T_1) \neq \emptyset$ in $G[V_1]$):

$$\begin{aligned} T_1 = (X_{\geq 1} \text{ or } X_{>1} \setminus X_{q-1}) &\iff T(V_1) \triangle Z_1 = (X_{\geq 1} \text{ or } X_{>1} \setminus X_{q-1}) \\ &\iff T(X_{\geq 1}) \triangle (X_1 \cup X_{q-1}) = (X_{\geq 1} \text{ or } X_{>1} \setminus X_{q-1}) \\ &\iff T(X_{\geq 1}) = (X_{\geq 1} \triangle (X_1 \cup X_{q-1}) \text{ or } (X_{>1} \setminus X_{q-1}) \triangle (X_1 \cup X_{q-1})) \\ &\iff T(X_{\geq 1}) = (X_{>1} \setminus X_{q-1} \text{ or } X_{\geq 1}) \quad \text{a contradiction} \end{aligned}$$

- Now, suppose that $T(X_{\geq 1})$ is either $X_{\geq 1}$ or $X_{>1} \setminus X_{q-1}$. Let O be an acyclic $T(X_0)$ -odd orientation of $G[X_0]$. Let w_1 and w_2 be vertices of X_0 such that $d_{G[X_0]_O}^-(w_1) = d_{G[X_0 \setminus \{w_1\}]_O}^-(w_2) = 0$. Note that this directly implies that $T(\{w_1, w_2\})$ satisfies \mathcal{P} in $G[\{w_1, w_2\}]$. We define the decomposition $\mathcal{A}_2 = \langle V_0, V_1, V_2 \rangle = \langle \{w_1, w_2\}, X_{\geq 1}, X_0 \setminus \{w_1, w_2\} \rangle$ (see Figure 17a). By Lemma 4.3 this decomposition satisfies \mathcal{P} : indeed, $T_0 = T(\{w_1, w_2\})$ satisfies \mathcal{P} in $G[V_0]$ and:

$$\begin{aligned} |T_1| &= |T(X_{\geq 1})| - |Z_1| \\ &\equiv_2 |T| - |T(X_0)| - 2 \\ &\equiv_2 |E(G)| - |E(G[X_0])| \\ &\equiv_2 |E(G[X_{\geq 1}])| + |\delta(X_0, X_{\geq 1})| \\ &\equiv_2 |E(G[X_{\geq 1}])| \end{aligned}$$

proving that T_1 satisfies \mathcal{P} in $G[V_1]$. Furthermore, \mathcal{A}_2 is good. Indeed, by construction, $G[V_0]$ and $G[V_2]$ admit acyclic T_0 -odd and T_2 -odd orientations respectively. Finally, we use 1.3 on cylinders to prove that $G[V_1]$ admits an acyclic T_1 -orientation. To do so, we have to show that T_1 satisfies \mathcal{S} and $\overline{\mathcal{S}}$: call w'_1, w''_1 and w'_2, w''_2 the four neighbors of w_1 and w_2 in V_1 . Then $T_1 = T(V_1) \triangle Z_1 = T(X_{\geq 1}) \triangle \{w'_1, w'_2, w''_1, w''_2\} \neq X_{\geq 1}$ (i.e. $Source(T_1) \neq \emptyset$ in $G[V_1]$) and $T_1 \neq X_{>1} \setminus X_{q-1}$ (i.e. $Sink(T_1) \neq \emptyset$ in $G[V_1]$) as $T(X_{\geq 1})$ is either $X_{\geq 1}$ or $X_{>1} \setminus X_{q-1}$ by hypothesis. Thus $(G[V_1], T_1)$ cannot be one of the instances on which T_1 fails \mathcal{S} or $\overline{\mathcal{S}}$ in the cylinder $G[V_1]$ (see Figure 11).

b. One may assume now that for all $i \in \{0, \dots, p-1\}$, either $T(X_i)$ does not verify \mathcal{S} in $G[X_i]$ (i.e., $X_i \subseteq T$) or does not verify \mathcal{P} in $G[X_i]$ (i.e., $|T(X_i)| \equiv_2 p-1$). Equivalently, for all $i \in \{0, \dots, p-1\}$, $|X_i \setminus T(X_i)|$ is either 0 or odd. By symmetry, assume also that for all $j \in \{0, \dots, q-1\}$, $|T(Y_j)| \equiv_2 q$ if and only if $Y_j \subseteq T$ (i.e., $|Y_j \setminus T(Y_j)|$ is either 0 or odd). Furthermore, since T verifies \mathcal{S} , we may suppose $T(X_0)$ satisfies \mathcal{S} , which implies $|T(X_0)| \equiv_2 p-1$ and $X_0 \setminus T \neq \emptyset$. As a consequence, and since $|T|$ is even by (T), we have $|T(X_{\geq 1})| \equiv_2 p-1$. Let $x \in X_0 \setminus T$ and by symmetry, suppose that $x = (u_0, v_0)$.

b.1. If p is even then $|T(X_0)| \equiv_2 1$, so we can assume up to rotation that $(u_{p-1}, v_0) \in T$. Also, it implies $|T(X_{\geq 1})| \equiv_2 1$, so there is $0 < i \leq q-1$ such that $|T(X_i)| \equiv_2 1$. Let k be the smallest

such index. Since $p \geq 3$, up to symmetry, we may assume that $k < q - 1$. By definition of k , we have that $X_j \subseteq T$ for all $0 < j < k$. We now consider two cases:

- Suppose there exists $j \in \{k + 1, \dots, q - 1\}$ such that $X_j \not\subseteq T$. We consider the decomposition $\mathcal{B}_1 = \langle V_0, V_1 \rangle = \langle X_{<k+1}, X_{\geq k+1} \rangle$ (see Figure 17b). By Lemma 4.3, it satisfies \mathcal{P} as $|T_0| = |T(X_{<k+1})| \equiv_2 |T(X_0)| + |T(X_k)| \equiv_2 1 + 1 \equiv_2 0$. Also, \mathcal{B}_1 is good. Indeed, T_0 satisfies \mathcal{S} and $\overline{\mathcal{S}}$ in $G[V_0]$ as $x \in \text{Source}(T_0)$ in the cylinder $G[V_0]$ and $(u_{p-1}, v_0) \in \text{Sink}(T_0)$ in $G[V_0]$. Thus, $G[X_0]$ admits an acyclic T_0 -odd orientation by Lemma 4.13. Furthermore, T_1 satisfies \mathcal{S} in the cylinder $G[V_1]$ since $T(X_j) \neq X_j$ by hypothesis (i.e. $\text{Source}(T_1) \neq \emptyset$ in $G[V_1]$) and it satisfies $\overline{\mathcal{S}}$ in $G[V_1]$ indeed: by hypothesis $T(X_{\geq k+1}) \neq X_{\geq k+1}$ and $T_1 = T(V_1) \triangle Z_1 = T(X_{\geq k+1}) \triangle (X_{k+1} \cup X_{q-1}) \neq X_{>k+1} \setminus X_{q-1}$ (i.e. $\text{Sink}(T_1) \neq \emptyset$ in $G[V_1]$). Thus $(G[V_1], T_1)$ is not an instance for which T_1 fails $\overline{\mathcal{S}}$ in $G[V_1]$ (see Figure 11). So, by Lemma 4.13, the cylinder $G[V_1]$ admits an acyclic T_1 -odd orientation.

- Suppose now that $T(X_j) = X_j$ for all $j \in \{k + 1, \dots, q - 1\}$. We consider the decomposition $\mathcal{B}_2 = \langle V_0, V_1, V_2 \rangle = \langle Y_0^{[<q-1]}, X_{q-1} \cup X_0 \setminus \{x\}, V \setminus (V_0 \cup V_1) \rangle$ (see Figure 17b). By Lemma 4.3, it satisfies \mathcal{P} since:

$$\begin{aligned} |T_0| &= |T(Y_0^{[<q-1]})| \equiv_2 |T(Y_0)| - 1 \equiv_2 q \equiv_2 |E(G[Y_0])| \equiv_2 |E(G[Y_0^{[<q-1]}])| \\ |T_1| &= |T(X_{q-1} \cup X_0 \setminus \{x\})| - |Z_1| \\ &\equiv_2 |T(X_{q-1})| + |T(X_0)| - 4 \\ &\equiv_2 0 + 1 - 4 \\ &\equiv_2 |E(G[X_{q-1} \cup X_0 \setminus \{x\}])| \quad \text{by (QC)} \end{aligned}$$

Furthermore, \mathcal{B}_2 is good. By Lemma 4.4, the path $G[V_0]$ admits an acyclic T_0 -odd orientation. By Lemma 4.14, the quasi-cylinder $G[V_1]$ admits an acyclic T_1 -odd orientation. Indeed, T_1 verifies $\overline{\mathcal{S}}$ because $T_1(X_{q-1}) = X_{q-1} \subset \text{Sink}(T_1)$ in $G[V_1]$ and it verifies \mathcal{S} since $(u_{p-1}, v_0) \in \text{Source}(T_1)$ in $G[V_1]$. Furthermore, V_2 induces a grid with an odd dimension so Lemma 4.8 ensures that $G[V_2]$ admits an acyclic T_2 -odd orientation.

b.2. Suppose now that p and q are odd. Recall that we supposed in **b.** that for all $i \in \{0, \dots, p-1\}$ either $T(X_i) = X_i$ or $|T(X_i)|$ is even, and for all $j \in \{0, \dots, q-1\}$ either $T(Y_j) = Y_j$ or $|T(Y_j)|$ is even.

b.2.i Assume that $X_1 \subseteq T$. Then, $T(X_{<2})$ and $T(X_{\geq 2})$ verify \mathcal{P} in $G[X_{<2}]$ and $G[X_{\geq 2}]$ respectively. Indeed:

$$\begin{aligned} |T(X_{<2})| &= |T(X_0)| + |T(X_1)| \equiv_2 0 + 1 \equiv_2 |E(G[X_{<2}])| && \text{by (C0)} \\ |T(X_{\geq 2})| &= |T| - |T(X_{<2})| \equiv_2 0 - 1 \equiv_2 |E(G[X_{\geq 2}])| && \text{by (C0)} \end{aligned}$$

We rely on Figure 17c to illustrate the following cases.

- If $T(X_{\geq 2})$ verifies \mathcal{S} and $\overline{\mathcal{S}}$ in $G[X_{\geq 2}]$ then the decomposition $\mathcal{C}_1 = \langle V_0, V_1 \rangle = \langle X_{\geq 2}, X_{<2} \rangle$ is good by Lemma 4.12.

- If $T(X_{\geq 2})$ does not verify $\overline{\mathcal{S}}$ in $G[X_{\geq 2}]$ then $T(X_2) = T(X_{q-1}) = \emptyset$ and $X_i \subseteq T$ for all $2 < i < q - 1$ (see Figure 11). In this case, since $p \geq 5$ and by Lemma 4.3, the decomposition $\mathcal{C}_2 = \langle V_0, V_1 \rangle = \langle X_1 \cup X_2, X_0 \cup X_{\geq 3} \rangle$ satisfies \mathcal{P} as $|T(X_1 \cup X_2)| = |T(X_1)| + |T(X_2)| \equiv_2 1 + 0 \equiv_2 |E(G[X_1 \cup X_2])|$. Furthermore, the decomposition is good by Lemma 4.12. Indeed, T_0 satisfies \mathcal{S} and $\overline{\mathcal{S}}$ in $G[V_0]$ as $X_1 \in \text{Sink}(T_0)$ in $G[V_0]$ and $X_2 \in \text{Source}(T_0)$ in $G[V_0]$, and T_1 satisfies both \mathcal{S} and $\overline{\mathcal{S}}$ in $G[V_1]$ as $X_{q-1} \in \text{Source}(T_1) \cap \text{Sink}(T_1)$ in $G[V_1]$. Note also that because we supposed that for all $i \in \{0, \dots, p-1\}$ either $T(X_i) = X_i$ or $|T(X_i)|$ is even, it imposes that $T(X_0) = \emptyset$.

- If $T(X_{\geq 2})$ does not verify \mathcal{S} in $G[X_{\geq 2}]$ then $X_i \subseteq T$ for all $1 \leq i \leq p - 1$. Suppose first that $T(X_0) \neq \emptyset$ and up to symmetry we can assume that $(u_1, v_0) \in T$. Also, since T satisfies \mathcal{S} , i.e., $V \setminus T \neq \emptyset$ and $|V \setminus T \cup \{v \in T, d(v) \equiv_2 1\}| > 1$, we know $|V \setminus T| > 1$. Hence, there exists $y \neq (u_0, v_0)$ with $y \in X_0 \setminus T$. Let us now consider the decomposition $\mathcal{C}_3 = \langle V_0, V_1 \rangle = \langle Y_{<2}, Y_{\geq 2} \rangle$. By Lemma 4.3 it satisfies \mathcal{P} as $|T_0| = |T(Y_{<2})| = |T(Y_0)| + |T(Y_1)| \equiv_2 0 + 1 \equiv_2 |E(G[Y_{<2}])|$. Furthermore, the decomposition is good by Lemma 4.12. Indeed, T_0 satisfies \mathcal{S} and $\overline{\mathcal{S}}$ in the cylinder $G[V_0]$ as $x \in \text{Source}(T_0)$ in $G[V_0]$ and $(u_1, v_0) \in \text{Sink}(T_0)$ in $G[V_0]$. Furthermore, T_1 satisfies \mathcal{S} in the cylinder $G[V_1]$ as $Y_2^{[\geq 1]} \in \text{Source}(T_1)$ in $G[V_1]$ and also satisfies $\overline{\mathcal{S}}$ in $G[V_1]$ as y either belongs to Y_2 or Y_{q-1} , in which case it belongs to T_1 and is of degree 3 in $G[V_1]$, or it does not belong to Y_2 nor Y_{q-1} , in which case it does not belong to T_1 and is of degree 4 in

$G[V_1]$. In both cases, $y \in \text{Sink}(T_1)$ in $G[V_1]$.

Finally, assume that $T(X_0) = \emptyset$. In this case, we consider the decomposition $\mathcal{C}_4 = \langle V_0, V_1, V_2 \rangle = \langle \{x\}, Y_{\geq 2}, Y_{<2} \setminus \{x\} \rangle$. By Lemma 4.3, the decomposition satisfies \mathcal{P} :

$$\begin{aligned} |T_0| &= |T(\{x\})| \equiv_2 0 \\ |T_1| &= |T(Y_{\geq 2})| - |Z_1| \equiv_2 1 - 1 \equiv_2 |E(G[Y_{\geq 2}])| \end{aligned}$$

Furthermore, the decomposition is good. Indeed, the cylinder $G[V_1]$ admits an acyclic T_1 -odd orientation by Lemma 4.12 since T_1 satisfies both \mathcal{S} and $\overline{\mathcal{S}}$ in $G[V_1]$ as the vertex $(u_3, v_0) \in \text{Sink}(T_1)$ in $G[V_1]$ because $q \geq 4$ and $(u_2, v_0) \in \text{Source}(T_1)$ in $G[V_1]$. Also the quasi-cylinder $G[V_2]$ admits an acyclic T_2 -orientation by Lemma 4.14 since q is odd.

b.2.ii Suppose now that for all $i \in \{0, \dots, p-1\}$ and $j \in \{0, \dots, q-1\}$, we have $|T(X_i)| \equiv_2 |T(Y_j)| \equiv_2 0$. We consider the decomposition $\mathcal{D} = \langle \{x\}, X_{\geq 2}, X_{<2} \setminus \{x\} \rangle$ (see Figure 18). By Lemma 4.3, it satisfies \mathcal{P} :

$$\begin{aligned} |T_0| &= |T(\{x\})| \equiv_2 0 \\ |T_1| &= |T(X_{\geq 2})| - |Z_1| \equiv_2 (q-2) \times (p-1) - 1 \equiv_2 p \equiv_2 |E(G[X_{\geq 2}])| \quad \text{by (C0)} \end{aligned}$$

We now show the decomposition is good. From the hypothesis, $|T(X_2)| \equiv_2 p-1$ and by construction of the decomposition $Z_1 = X_2 \cup X_{q-1}$. This implies that X_2 contains both vertices that are and are not in $T_1 = T(V_1) \triangle Z_1$. In particular, $T_1(X_2) \subset \text{Sink}(T_1)$ in $G[V_1]$ as those are vertices of degree 3, and $X_2 \setminus T_1(X_2) \subset \text{Source}(T_1)$ in $G[V_1]$. Therefore T_1 satisfies both \mathcal{S} and $\overline{\mathcal{S}}$ in $G[V_1]$ and the cylinder $G[V_1]$ admits an acyclic T_1 -odd orientation by Lemma 4.12. Also the quasi-cylinder $G[V_2]$ admits an acyclic T_2 -orientation by Lemma 4.14 since q is odd.

In all cases, we get a good T -decomposition and one can conclude by applying Theorem 4.2. \square

4.5 Final remarks

It seems that Lemma 4.15 works when $p = 3$ and $q > 3$. Nevertheless, the proof would be even more technical to settle this case. Moreover, the configuration illustrated in Figure 19 shows that with $p = q = 3$ the result fails.

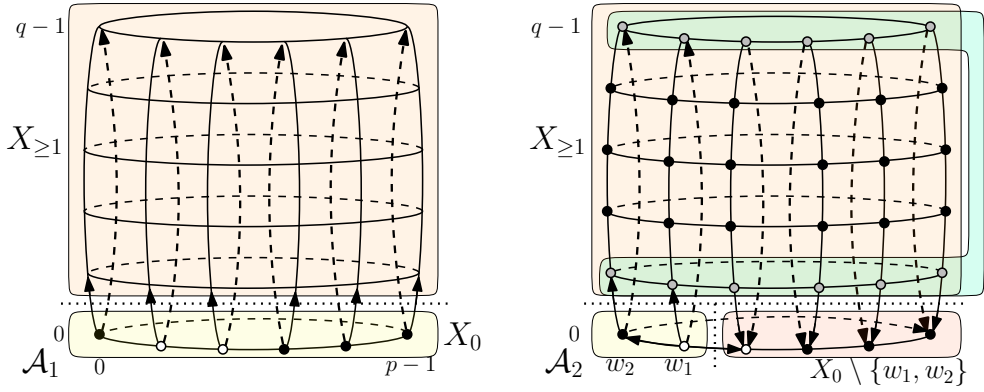

(a) **Case a:** $T(X_0)$ satisfies \mathcal{S} and \mathcal{P} in $G[X_0]$

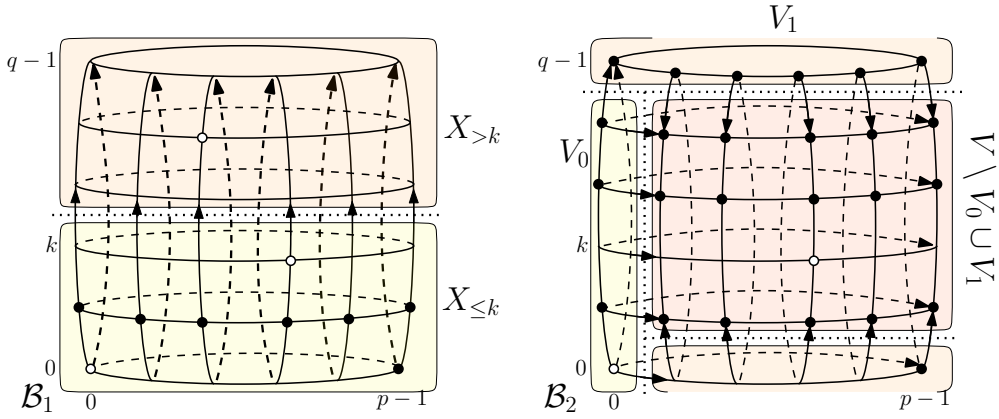

(b) **Case b.1:** p is even, $|X_i \setminus T(X_i)|$ and $|Y_j \setminus T(Y_j)|$ are 0 or odd for all i, j

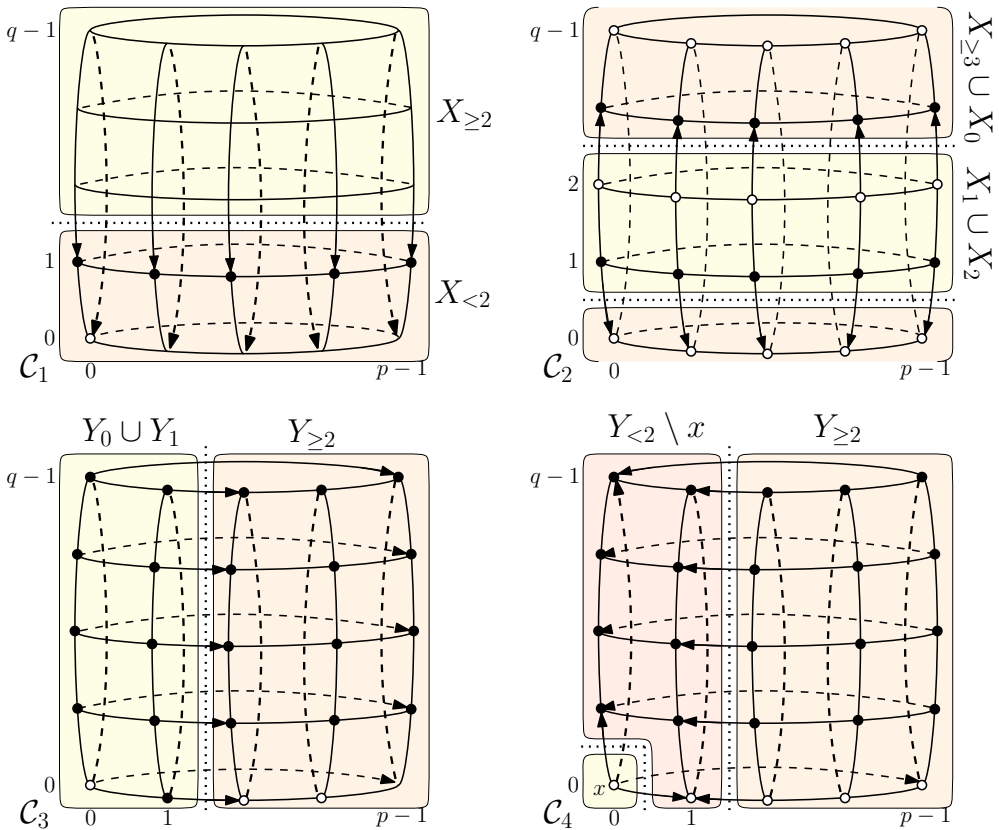

(c) **Case b.2.i:** p, q are odd, $|X_i \setminus T(X_i)|$ and $|Y_j \setminus T(Y_j)|$ are 0 or odd for all i, j and $X_1 \subseteq T$

Figure 17: T -decompositions used for the proof of Lemma 4.15

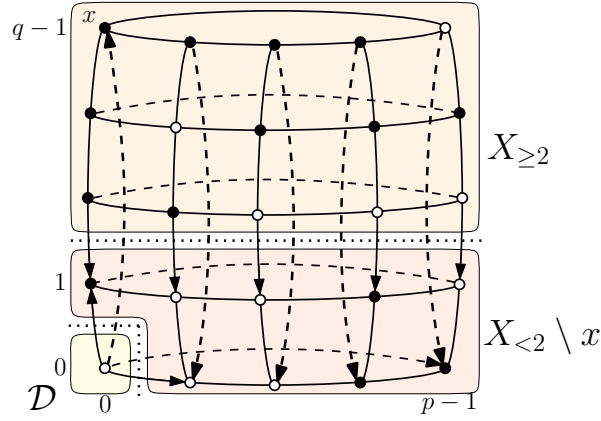

Figure 18: **Case b.2.ii:** p, q are odd, $|X_i \setminus T(X_i)| \equiv_2 |Y_j \setminus T(Y_j)| \equiv_2 1$ for all i and j

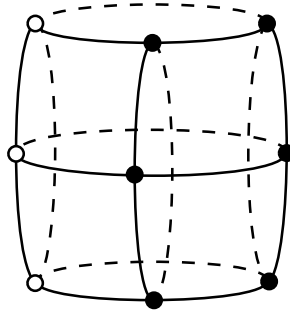

Figure 19: The Torus $C_3 \times C_3$ with a bad T .

5 Proof of Corollary 1.5

This section is dedicated to the proof of Corollary 1.5. For readability, we recall Theorem 1.1 and Corollary 1.5 here :

Theorem (1.1).

- (a) $\mathcal{C}_S = \mathcal{C}_{\bar{S}} = \{\circ, \circ \circ\}$,
- (b) $\mathcal{C}_{S\bar{S}} = \{\circ, \circ \circ, \circ \circ \circ\}$,
- (c) $\mathcal{C}_P = \{\circ\} \cup \{G \in \mathcal{C}_{P\bar{S}\bar{S}} \mid G \text{ is connected, non-Eulerian, and } |V(G)| + |E(G)| \equiv_2 1\}$,
- (d) $\mathcal{C}_{P\bar{S}} \setminus \mathcal{C}_P = \mathcal{C}_{P\bar{S}} \setminus \mathcal{C}_P = \{\circ \circ, \circ \circ \circ\} \cup \{G \in \mathcal{C}_{P\bar{S}\bar{S}} \mid G \text{ is Eulerian}\}$,
- (e) $\mathcal{C}_{P\bar{S}\bar{S}} \setminus \mathcal{C}_{P\bar{S}} \subset \{\circ \circ \circ\} \cup \{G \mid G \text{ is connected, non-Eulerian, and } |V(G)| + |E(G)| \equiv_2 0\}$.

Corollary (1.5). *Let $p, q, k \geq 1$ be three integers.*

- (c)' *The Cylinders $C_{2p+1} \square P_{2q}$, the Grids $P_{2p+1} \square P_q$, and Trees are in \mathcal{C}_P .*
- (d)' *The Tori $C_p \square C_q$ with $p, q \geq 4$ and Cycles are in $\mathcal{C}_{P\bar{S}} \setminus \mathcal{C}_P$.*
- (e)' *The Cylinders $C_{2p} \square P_q, C_{2p+1} \square P_{2q+1}$ are in $\mathcal{C}_{P\bar{S}\bar{S}} \setminus \mathcal{C}_{P\bar{S}}$.*

Moreover,

- (c)" *The Cliques $K_{4k+2} \in \{G \text{ connected and non-Eulerian} \mid |V(G)| + |E(G)| \equiv_2 1\} \setminus \mathcal{C}_P$.*
- (d)" *The Cliques $K_{2k+1} \in \{\circ \circ\} \cup \{G \mid G \text{ is Eulerian}\} \setminus \mathcal{C}_{P\bar{S}}$.*
- (e)" *The Cliques $K_{4k} \in \{G \text{ connected and non-Eulerian} \mid |V(G)| + |E(G)| \equiv_2 0\} \setminus \mathcal{C}_{P\bar{S}\bar{S}}$.*

5.1 Proof of (c'), (d') and (e')

Proof of (c)': By Lemma 4.4, all trees belong to $\mathcal{C}_{\mathcal{P}}$. Furthermore, by Lemma 4.8 on grids, if $G = P_p \square P_q$ with p or q odd, then $G \in \mathcal{C}_{\mathcal{P}\mathcal{S}\overline{\mathcal{S}}}$. Similarly, by Lemma 4.12 on cylinders, if $G = C_p \square P_q$ with p odd and q even, then $G \in \mathcal{C}_{\mathcal{P}\mathcal{S}\overline{\mathcal{S}}}$. In both cases, the graph G is connected, non-Eulerian and the condition $|V(G)| + |E(G)| \equiv_2 1$ is satisfied. So, by (c) of Theorem 1.2, we have $G \in \mathcal{C}_{\mathcal{P}}$. \square

Proof of (d)': By Lemma 4.5, all cycles belong to $\mathcal{C}_{\mathcal{P}\mathcal{S}} \setminus \mathcal{C}_{\mathcal{P}}$. Furthermore, by Lemma 4.15, any tori $C_p \square C_q$ with $p > 3$ or $q > 3$ is in $\mathcal{C}_{\mathcal{P}\mathcal{S}\overline{\mathcal{S}}}$. In these cases, those graphs are Eulerian and hence belong to $\mathcal{C}_{\mathcal{P}\mathcal{S}} \setminus \mathcal{C}_{\mathcal{P}}$ from (d) of Theorem 1.2. \square

Proof of (e)': Theorem 1.3 states that all cylinders belongs to $\mathcal{C}_{\mathcal{P}\mathcal{S}\overline{\mathcal{S}}}$. Furthermore, $C_{2p+1} \square P_{2q+1}$ and $C_{2p} \square P_q$ are non Eulerian and verify $|V(G)| + |E(G)| \equiv_2 0$, thus $C_{2p+1} \square P_{2q+1}, C_{2p} \square P_q$ are in $\mathcal{C}_{\mathcal{P}\mathcal{S}\overline{\mathcal{S}}} \setminus \mathcal{C}_{\mathcal{P}\mathcal{S}}$ from (c) and (d) of Theorem 1.2. \square

5.2 Proof of (c''), (d'') and (e'')

We first prove the following lemma on cliques:

Lemma 5.1. *Let $p > 1$ be an integer, and T be any subset of $p - 2$ vertices of a complete graph K_n on $n \in \{2p + 1, 2p + 2\}$ vertices. We have:*

- $K_{2p+1} \in \{G \mid |V(G)| + |E(G)| \equiv_2 p + 1\} \cap \{G \mid G \text{ is Eulerian}\}$.
- $K_{2p} \in \{G \mid |V(G)| + |E(G)| \equiv_2 p\} \cap \{G \mid G \text{ is connected and not Eulerian}\}$.
- T verifies $\mathcal{P}\mathcal{S}\overline{\mathcal{S}}$ in K_n .
- If $n \geq 5$ then K_n has no acyclic T -odd orientation.

Proof.

The first two parts come from the facts that for $n \in \{2p, 2p + 1\}$, we have $|V(K_n)| = n$, $|E(K_n)| = \frac{n(n-1)}{2} \equiv_2 p$ and $d(v) \equiv_2 n - 1$ for every vertex v . For the third part, \mathcal{P} follows from $|T| \equiv_2 p$ and \mathcal{S} from $|V(K_n) \setminus T| \geq 2$, since $p > 1$. Moreover, $\overline{\mathcal{S}}$ follows from $d(v) \equiv_2 n - 1$ for all v in $V(K_n)$: indeed, vertices in $V(G) \setminus T$ are potential sinks whenever p is odd and vertices in T are potential sinks whenever p is even.

The last assertion is a direct consequence of the claim asserting that the complete graph on n vertices admits an acyclic T -odd orientation if and only if $|T| = \lfloor \frac{n}{2} \rfloor$. This claim can be easily proved by induction on n . \square

Now, we know from Lemma 5.1, that $K_n \notin \mathcal{C}_{\mathcal{P}\mathcal{S}\overline{\mathcal{S}}}$ for any $n \geq 5$. And we also know that:

- For any odd $p \geq 1$, we have that $K_{2p} \in \{G \mid |V(G)| + |E(G)| \equiv_2 1\} \setminus \mathcal{C}_{\mathcal{P}\mathcal{S}\overline{\mathcal{S}}}$ and is non-Eulerian. Thus, (c'') of Theorem 1.5 is a direct consequence of this last observation.
- For any $p \geq 1$, we have $K_{2p+1} \in \{G \mid G \text{ is Eulerian}\}$. Thus, (d'') of Theorem 1.5 is a direct consequence of this last observation.
- For any even $p \geq 1$, we have that $K_{2p} \in \{G \mid |V(G)| + |E(G)| \equiv_2 0\} \setminus \mathcal{C}_{\mathcal{P}\mathcal{S}\overline{\mathcal{S}}}$ and is non-Eulerian. Thus, (e'') of Theorem 1.5 is a direct consequence of this last observation. \square

6 Conclusion

This paper advances our understanding of the acyclic orientation problem with parity constraints. We introduced new necessary conditions, the first one, \mathcal{S} ensures the existence of a source which would not be the unique sink, and symmetrically $\overline{\mathcal{S}}$ ensures the existence of a sink which would not be the unique source. From those necessary condition, we established a hierarchy of graph classes, $\mathcal{C}_{\mathcal{N}}$ for $\mathcal{N} \subseteq \{\mathcal{P}, \mathcal{S}, \overline{\mathcal{S}}\}$, which characterize when those conditions are also sufficient. Our preliminary characterization of these classes in Theorem 1.1 reveals strict inclusions and highlights the special role of Eulerian graphs (see Figure 20).

In fact, we could take apart a condition $\mathcal{S} \cap \overline{\mathcal{S}}$ that is currently included in \mathcal{S} and $\overline{\mathcal{S}}$. That is, if $Source(T) = Sink(T) = \{v\}$ for some vertex v , then no acyclic T -odd orientation exists unless the graph is a singleton. We would like to discuss some properties of this condition. Remind that $Source(T) = Sink(T)$ if and only if the graph has no odd degree vertices. Now, in graphs satisfying $|E| + |V| \equiv_2 0$ the condition \mathcal{P} already imposes that $|V \setminus T| \equiv_2 0$ so in particular $\mathcal{S} \cap \overline{\mathcal{S}}$ is always satisfied. Hence, the condition $\mathcal{S} \cap \overline{\mathcal{S}}$, for graphs with at least 4 vertices, finds its real meaning for

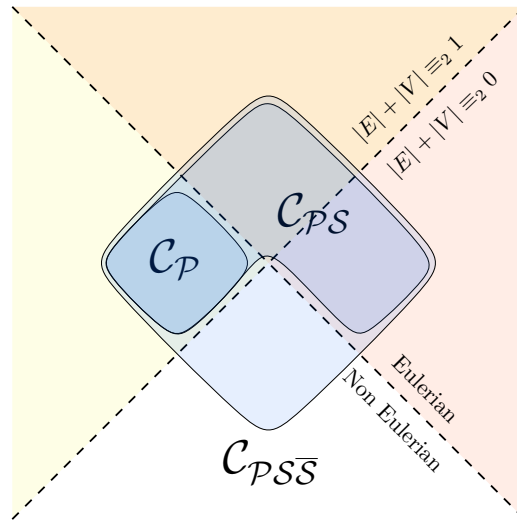

Figure 20: Hierarchy of classes $\mathcal{C}_{\mathcal{N}}$ for $\mathcal{N} \subseteq \{\mathcal{P}, \mathcal{S}, \overline{\mathcal{S}}\}$.

Eulerian graphs verifying $|E| + |V| \equiv_2 1$ and taking it apart would allow only to refine the class $\mathcal{C}_{\mathcal{P}\mathcal{S}} \setminus \mathcal{C}_{\mathcal{P}}$ into two subclasses depending of whether the graphs verify $|E| + |V| \equiv_2 1$ or $|E| + |V| \equiv_2 0$.

A central contribution of this work is the complete characterization of solvable instances for grids, cylinders, and large tori. These results not only solve the problem for significant graph families but also serve to demonstrate the strictness of the inclusions within our proposed hierarchy. Methodologically, we introduced T -decompositions, a powerful constructive tool that provides a pathway to polynomial-time algorithms for these specific graph classes.

Our findings open several avenues for future research. A primary open question is the computational complexity of recognizing graphs in the class $\mathcal{C}_{\mathcal{P}\mathcal{S}\overline{\mathcal{S}}}$. A polynomial-time algorithm for this problem would significantly clarify the landscape of tractable instances especially since it would directly provide from our results a polynomial-time algorithm for recognizing instances in $\mathcal{C}_{\mathcal{P}\mathcal{S}}$ and $\mathcal{C}_{\mathcal{P}}$. Further investigation is also needed to fully characterize the graphs within this class, for which we have provided initial insights and counterexamples using cliques. We thus pose the following open problem:

Problem 4. *Given a graph G , does there exists a polynomial time algorithm to decide whether $G \in \mathcal{C}_{\mathcal{P}\mathcal{S}\overline{\mathcal{S}}}$?*

Finally, extending our results on Cartesian products presents a natural next step. Indeed, a consequence of Theorem 1.8 in [6] gives that, given two graphs $G, H \in \mathcal{C}_{\mathcal{P}}$ such that $|V(G)| \equiv_2 1$, we have $G \square H \in \mathcal{C}_{\mathcal{P}}$. More generally, determining the conditions on factors G and H such that $G \square H$ belongs to one of our classes remains a challenging problem. The case of small tori, such as $C_3 \square C_q$, which our current methods do not cover, stands as an intriguing open problem as well.

References

- [1] O. Chevalier et al. “Odd Rooted Orientations and Upper-Embeddable Graphs”. In: *North-Holland Mathematics Studies*. Vol. 75. Elsevier, 1983, pp. 177–181.
- [2] A. Frank and Z. Király. “Graph Orientations with Edge-connection and Parity Constraints”. *Combinatorica* 22.1 (2002), pp. 47–70.
- [3] C. Szegedy. “Some Applications of the Weighted Combinatorial Laplacian”. PhD thesis. Rheinische Friedrich-Wilhelms-Universität Bonn, 2005.
- [4] B. Szegedy and C. Szegedy. “Symplectic Spaces And Ear-Decomposition Of Matroids”. *Combinatorica* 26.3 (2006), pp. 353–377.
- [5] S. Gravier, M. Petiteau, and I. Sivignon. *Note about the complexity of the acyclic orientation with parity constraint problem*. 2025.

- [6] Z. Kiraly and S. Kisfaludi-Bak. “Dual-Critical Graphs – Notes on Parity Constrained Acyclic Orientations”. 2012.
- [7] R. Diestel. *Graph Theory*. Vol. 173. Graduate Texts in Mathematics. Berlin, Heidelberg: Springer Berlin Heidelberg, 2017.