



HAL
open science

Integrated product relationships management: a model to enable concurrent product design and assembly sequence planning

Frédéric Demoly, Xiu-Tian Yan, Benoît Eynard, Samuel Gomes, Dimitris Kiritsis

► **To cite this version:**

Frédéric Demoly, Xiu-Tian Yan, Benoît Eynard, Samuel Gomes, Dimitris Kiritsis. Integrated product relationships management: a model to enable concurrent product design and assembly sequence planning. *Journal of Engineering Design*, 2012, 23 (7), pp.544-561. <10.1080/09544828.2011.629317>. <hal-05455053>

HAL Id: hal-05455053

<https://hal.science/hal-05455053v1>

Submitted on 12 Jan 2026

HAL is a multi-disciplinary open access archive for the deposit and dissemination of scientific research documents, whether they are published or not. The documents may come from teaching and research institutions in France or abroad, or from public or private research centers.

L'archive ouverte pluridisciplinaire **HAL**, est destinée au dépôt et à la diffusion de documents scientifiques de niveau recherche, publiés ou non, émanant des établissements d'enseignement et de recherche français ou étrangers, des laboratoires publics ou privés.



Distributed under a Creative Commons CC BY 4.0 - Attribution - International License



A theoretical framework for product relationships description over space and time in integrated design

Journal:	<i>Journal of Engineering Design</i>
Manuscript ID	CJEN-2015-0157.R1
Manuscript Type:	Article
Keywords:	design representations < Product and Systems Modelling, Design Theory and Research Methodology, information representation < Knowledge and Information Management, design understanding < Knowledge and Information Management, mechanical product design < Engineering Design in Industry

SCHOLARONE™
Manuscripts

ORIGINAL ARTICLE

A theoretical framework for product relationships description over space and time in integrated design

(Received 10 June 2015; revised version received 20 September 2015)

This paper presents a novel qualitative description theory in the context of **integrated design**, which **here incorporates** assembly sequence planning in the early product design stages (also called **assembly-oriented design - AOD**). Based on a literature review of current **AOD approaches**, **product models** and mereotopology-based theories, the authors introduces a promising mereotopological theory which enables the formal product relationships description in **integrated design by introducing an emerging framework**, **four dimensionalism** (i.e. **perdurantism in philosophy**). The proposed efforts aim at providing a concrete basis for describing **the evolution** of spatial entities (i.e. product parts) and their relationships over time and space **during the design phases by considering their related assembly processes**. In product design, the interpretation of engineering reality from a **perdurantist point of view** leads to a seamless consideration of relationships between spatial, temporal and spatiotemporal dimensions. Indeed, with such a mereotopological theory, formal product design description is enabled by **proactively considering its assembly sequence from a temporal point of view in the early stages of the product development process**, and ensures information and knowledge consistency over space and time. Finally, an ontological implementation is presented within Protégé through a mechanical assembly as a case study, so as to illustrate the **applicability and the relevance** of the theory.

Keywords: Mereotopology; Qualitative description ; Product design ; Assembly sequence planning ; Design formalism ; Product-process description

1. Introduction

The current industrial context is faced to severe competition and leads companies to make numerous tradeoffs in terms of internal and external development strategies and constraints. Industry is at a turning point where production strategy (i.e. global versus local), product strategy (e.g. short versus long-life cycle), information/knowledge capture/accessibility strategy (e.g. ontology-based, cloud-based, etc.), to name a few, need to be addressed in a well-balanced manner. From an internal point of view, engineering processes **become more and more knowledge-intensive and then require** adapted intelligent environment, especially in product design and manufacturing. **Indeed during the**

1
2
3
4
5 product development process, product architects and designers decisions have a major
6 impact on downstream processes and then demand better understanding and awareness
7 in their activities. Currently, the knowledge-intensive and scattered information systems
8 covering the beginning of product lifecycle also requires advanced interaction, informa-
9 tion flows consistency and interpretable description, especially in the early design phases
10 where proactive integration of knowledge from downstream processes and qualitative
11 specification are needed (Demoly et al. 2013). This can be done through the fact of de-
12 livering product models in line with realistic situations over time. Such stake opens new
13 research challenges in engineering design, which covers different research areas, such as
14 philosophical investigations, mathematics, artificial intelligence and engineering to name
15 a few. In general, products models are considered as a representation of our percep-
16 tion of the reality from a three-dimensionalism (i.e. endurantism in philosophy) point of
17 view. Literature has proved that researchers have built product models regarding their
18 functionalities and their extension in space. Endurantism actually supports that objects
19 have three spatial dimensions and move through time. In others words, this conception
20 argue that material objects are persisting things wholly present at every moment of their
21 existence.
22

23
24 Nowadays this kind of framework is widely accepted in industry and conditions cur-
25 rent engineering applications related to 3D product definition. At first glance, this trend
26 is understandable since it does not exist yet ubiquitous system able to represent infor-
27 mation of all things at all times. This has provided real advances in engineering and
28 manufacturing but also causes difficulties in engineering definitions and wrong design
29 interpretations. By following three-dimensionalism, design activity is mainly dedicated
30 on the development of the spatial aspect of the product without considering intrinsically
31 its evolution over time. A possible reason is due to the functional, geometric, physical
32 complexity and multiple temporal configurations inferred in the design process, and also
33 when the product information passes from design to manufacturing engineering and later
34 stages (Chandrasegaran et al. 2013). This recurring issue denotes a lack of association be-
35 tween product and process models at various abstraction levels, particularly at a logical
36 and semantical point of view (Demoly et al. 2012, 2013).
37

38 These aforementioned stakes fall within a broader research challenge which consists
39 in the knowledge integration of products lifecycle phases (i.e. process planning, assembly
40 planning, etc.) in an appropriate manner at the earliest product design stages (Demoly
41 et al. 2012). To tackle this challenge, Demoly et al. (Demoly et al. 2012) have highlighted
42 the current stakes in engineering design and emerging needs in proactive engineering
43 based on qualitative description of lifecycle knowledge, so as to improve designers' aware-
44 ness and understanding. This statement has also been claimed by Kusiak and Salustri
45 (Kusiak and Salustri 2007), who have stated that design engineering is currently chang-
46 ing from an informal approach based on experience to a science-based approach (Zeng
47 and Gu 1999).
48

49 Furthermore the dynamic aspect of the product definition has not been yet described
50 in a seamless fashion (Zeng and Gu 1999). Indeed, current CAD applications are mainly
51 dedicated the spatial and geometric definition and does not capture the design story
52 (that is quite different from a CSG tree for example) from a temporal point of view. Such
53 design practices actually lead to static product definition and time-consuming efforts from
54 manufacturing side in order to interpret assembly intents for example. A similar issue can
55 be identified in engineering change management, where changes are represented through
56 objects' effectiveness. This results in the capture of multiple product configurations and
57 increase complexity in the management of product design information. But evolution
58
59
60

1
2
3
4
5 and changes ((i.e. related to part, assembly, relationship, etc.) that may occur during
6 the product definition are not adequately described, captured and represented. Hence, it
7 is needed to refer to philosophical concepts which aid to identify things to be described
8 here. A promising one is about four dimensionalism or perdurantism, on which an object
9 has distinct temporal parts throughout its existence.

10 Based on these research stakes, new research efforts have to be addressed on formalism
11 and theory in engineering design in order to represent product information and knowledge
12 in a qualitative and machine-interpretable manner. The main objective is therefore to
13 propose and describe a region-based theory (called mereotopology) for assembly-oriented
14 design (AOD), which is built on four dimensionalism. The paper firstly presents, in
15 section 2, a comprehensive literature review on AOD approaches and mereotopology-
16 based theories so as to highlight the research issue to be tackled. Then section 3 describes
17 the proposed theory, which provides product-process associations through semantics and
18 logics. Section 4 introduces an ontological implementation within Protégé, in which a
19 mechanical assembly is defined in order to illustrate the relevance and the application
20 of the proposed theory. In section 5 the limits and the advantages of such a theory are
21 discussed. Finally, in section 6, conclusions and future work are given.

26 2. Literature review

27 2.1. *Assembly-Oriented Design and related product models*

28
29
30 The concept of integrating assembly sequence planning (ASP) in product design was
31 introduced at the beginning of the previous decade in order to overcome the current
32 limitations of design for assembly (DFA) and ASP approaches. Based on detailed prod-
33 uct geometry, and a part-to-part oriented evaluation, DFA approaches generally lead
34 to a redesign. In such a context, the issue of concurrent product design and ASP (Zha
35 and Du 2002), also called assembly-oriented design (AOD) (Mantripragada 1998), has
36 received much attention in research work during the last decade (Wang et al. 2008).
37 Product design and assembly sequence planning phases are normally undertaken sepa-
38 rately and sequentially, which results in missing an efficient integration between both
39 phases. Here, the assembly-oriented practice of product development can be considered
40 as a top-down approach by proactively considering the assembly related product design
41 and its relationship issues in the early phases of the product development process.

42
43 Among the models and ontology in the literature, relevant work has been done by
44 focusing on assembly formalisms and semantics, in a collaborative product development
45 context (Kim et al. 2008). In addition, NIST has proposed generic models, such as Core
46 Product Model (CPM) (Fenves et al. 2008b), CPM2 (Fenves et al. 2008a) and Open As-
47 sembly Model (OAM) (Sudarsan et al. 2005) that are particularly relevant to represent
48 the product in an integrated manner, including assembly features and so on. Indeed,
49 Swain et al. (Swain et al. 2014) has extended OAM model by using extended liaison so
50 as to associate assembly and design processes. Here liaison supports technological no-
51 tions such as riveting, welding and so on. As a result of these efforts, the introduction
52 of semantics and knowledge in assembly models has enabled a better understanding and
53 interpretation of the product architects' and assembly planners' intents. These represen-
54 tations facilitate reasoning about assembly relationships for assembly process planning
55 and assembly line balancing issues as well as, in a more efficient manner, at a high abstrac-
56 tion level of the product definition. More close to the product relationships description
57 issue, Horvath and van der Vegte (Horvath and van Der Vegte 2003) have proposed a
58
59
60

nucleus-based modelling theory, in which three groups of reflexive relations have been defined (i.e. existence, reference, substance) and eight kinds of binary relations are also defined (i.e. connectivity, positioning, morphological, kinematical, deformation, kinetic, physical phenomenon nad physical field).

Although these research efforts have provided strong foundation and support for designers to understand physical effects in product design, it remains a need to provide a unified foundation which enables the entire understanding of the establishment of product relationships over time in order to bridge product with process models.

2.2. Mereotopology-based theories

Lesniewski (Lesniewski 1929b) was the first to describe a mereology-based theory including theorems and axioms, in order to develop the parthood relationship in a formal manner (Demoly et al. 2012). This initial effort has provided an interesting basis and also led to limits and basic problems in mereology (Varzi 1998, Salustri 2002). As an automotive example, the speedometer is *Part of* the dashboard, the dashboard is *Part of* the car and the car is *Part of* the fleet. This seems to be logical sentences, but in no case the speedometer is *Part of* the fleet. The problem encountered here is that parthood relationship is transitive (i.e. parthood means only one thing at once) in the first two statements and intransitive (i.e. parthood means something else) in the last one (Salustri and Lockledge 1999).

To overcome this paradox, the notion of topology has been incorporated and considered together with mereology so as to initiate mereotopology. This theory enables the qualitative formalisation of two fundamental predicates: parthood (i.e. one entity is *Part of* another) and connection (i.e., an entity is *connected to* another, denoted *C*) (Salustri 2002). By developing such a mereotopological theory, two main notions have to be introduced, so as to describe product evolution, such as regions (e.g. a spatial region is a portion of space occupied by some entities such as a physical part (Salustri 2002)) and primitives (i.e. used to describe region-to-region relationships). The current challenge of the mereotopology-based theory in engineering design is to consider the product as it is perceived in the real world (Demoly et al. 2012). In other words, mereotopology describes relationships between parts with an “engineering sense”. Here, the engineering sense requires a more accurate and more structured prospect (Salustri 2002) needed in AOD.

Relevant existing theories in product design is presented in Table 1 according to authors, their first spatial primitives on which theories are based, related primitives in spatial, temporal and even spatiotemporal dimensions and their application domain (Gruhier et al. 2014). Based on this primitives inventory, missing parts can be highlighted to fully cover the dynamic aspect of the product design domain. Besides, it seems that most of the listed theories does not cover entirely spatial and temporal dimensions, but rather provide an accurate description of spatial dimension for a specific area.

A novel dimension in mereotopological theory is needed, insofar as objects evolution has to be described over space and time. Moreover, temporal description is not applied to product design information, which means that evolution in product definition assembly cannot be considered. Table 1 enables the identification of primitives used in the mechanical engineering domain. It seems that primitives such as *Part of*, *InteriorPart of*, *Overlap*, *Tangent* or their equivalents are used by every author in the research area.

By focusing on mechanical engineering application, few research efforts have been done, especially at different abstraction levels (i.e. functional, kinematic, technological, etc.).

Table 1. Relevant region-based theories

Author	Dimension			Application domain	
	Spatial		Temporal		Spatio-temporal
	First primitive	Developed primitive			
Allen (1983)			< ; =	Artificial intelligence	
Asher and Vieu (1995)	<i>C</i>	<i>P; PP; O; EC; TP; NTP</i>		Artificial intelligence	
Bennett et al. (2000)	<i>P; S</i>	<i>PP; D; O; PO; B; COB; EQD; MID; NEARER</i>		Artificial intelligence	
Borgo et al. (1996)	<i>P; SR; CG</i>			Knowledge representation and reasoning	
Clarke (1981)	<i>C</i>		<	Mathematics	
De Laguna (1922)	<i>C</i>			Philosophy	
Demoly et al. (2012)	<i>P</i>	<i>O; IP; D; Point; X; St; B; T; IB</i>	<	<i>Ot; ⊆t; *</i>	Mechanical assembly
Duntsch et al. (2001)	<i>C</i>	<i>P; PP; O; PO; TPP; NTPP; EC; DC</i>			Computer Science
Eschenbach (1999)	<i>P; DC</i>	<i>PP; O; PO; D; C; EC; TPP; NTPP; component</i>			Cognitive science
Galton (1997)	<i>C</i>	<i>DC; P; O; D; C; EC; PO; EQ; PP; TPP; NTPP</i>	< ; =		Knowledge representation and reasoning
Goodman (1951)	<i>D</i>	<i>P; O</i>			Mathematics
Kim et al. (2008)	<i>P; IP</i>	<i>O; D; Point; X; St; B; T</i>			Mechanical assembly joint
Lemon and Pratt (1998)	<i>C</i>				Visual languages and computing
Lesniewski (1929a)	<i>I</i>				Mathematics
Muller (2002)	<i>C</i>	<i>P; PP; O; PO; EC; TP; NTP; TPP; NTPP; TPPI; NTPPI</i>	<	<i>TS; ⊆t; *; MO-TION</i>	Knowledge representation and reasoning
Randell and Cohn (1989)	<i>C</i>	<i>DC; P; O; PP; D; EC; TP; NTP; TPP; NTPP; TPI; NTPI; PO</i>	<i>B</i>		Knowledge representation and reasoning
Salustri (2002)	<i>P; C</i>	<i>PP; O; EC; TPP; NTPP; SC; E</i>			Mechanical engineering
Smith (1996)	<i>P; IP</i>	<i>O; D; Point; X; St; B</i>			Mechanical engineering
Stell and West (2004)	<i>C</i>	<i>P; PP; O; EC; NTPP</i>	<	<i>Pt; GAL; Hc</i>	Information system
Tarski (1956)	<i>P; S</i>				Mathematics
Varzi (1996)	<i>P; C</i>	<i>PP; O; U; OX; UX; PO; PU; EC; TP; IP; E; IE; TE; SU; SX; PS</i>			Philosophy
Whitehead (1929)	<i>R; C</i>				Mathematics and philosophy

< (*Precedence*), $\subseteq t$ (*temporal inclusion*), * (*temporal connection*), *B* (*Wholly before*), *C* (*Connected*), *D* (*Discrete*), *E* (*Enclosure*), *EC* (*Externally Connected*), *IB* (*Internal Boundary*), *IP* (*InteriorPart*), *NTPP* (*Non Tangential Proper Part*), *O* (*Overlap*), *Ot* (*temporal overlap*), *P* (*Part of*), *Point*, *X* (*Cross*), *PP* (*Proper Part*), *SC* (*Self-Connection*), *St* (*Straddle*), *T* (*Tangent*), *TPP* (*Tangential Proper Part*).

More precisely Demoly et al. (Demoly et al. 2012) have described product relationships by mainly focusing on kinematic pairs. Kim et al. (Kim et al. 2008) have proposed a region-based theory to differentiate assembly joints obtained by welding or adhesive bonding. They both used Smith's mereotopological primitives (Smith 1996). In addition, Salustri (Salustri 2002) has also introduced similar primitives which have the same properties but not the same names (e.g. *InteriorPart IP* is equivalent to *Non Tangential Proper Part NTPP* or *Tangential Proper Part TPP*), so as to cover product modelling issue. Moreover he did not use the *Crosse X* primitive, which seems to be relevant in the above mentioned context, and which is intensively used during assembly sequence planning. Finally, Randell and Cohn (Randell and Cohn 1989) research works have enabled the representation of relationships between fluid and solid objects at different states.

2.3. Motivation

The outcome of the above literature review highlights need for a new qualitative description theory in the context of integrated design, so as to extend current engineering capabilities and overcome current philosophical framework (i.e. endurantism) in design systems. Indeed, most of the research works have been based upon an endurantist point of view in product design so far, by only considering product definition in the spatial dimension. Such engineering practices led to understand design changes in terms of things, that is not enough suitable to be aware of design and assembly evolution. The fact of considering assembly sequence planning issue in product design in a proactive fashion requires a novel description able to associate product and process models from a logical and semantical point of view. This therefore causes a revision of the commonly used philosophical foundation. The whole thing is to describe the entire evolution of the product definition over space and time. Such issue introduces a promising philosophy, perdurantism, in order to represent spatial, temporal and spatiotemporal objectifs in a unified framework (Al-Debei et al. 2012). In this way, engineering practices will interpret things in terms of changes.

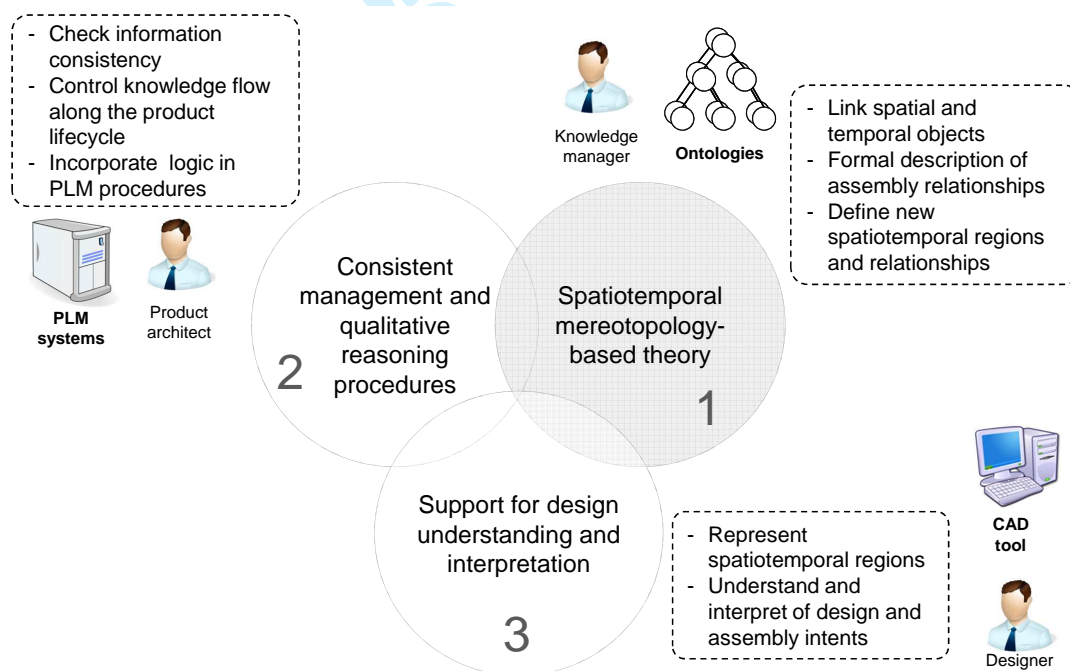

Figure 1. Proposed vision of the research

As a consequence, the main objective of the paper is to describe product-process relationships in a formal manner by considering a perdurantist philosophy. The development of a first-order logic mereotopological theory is addressed to cover three dimensions (i.e. spatial, temporal and spatiotemporal). The theory enables to reason and provides a complete awareness and understanding of product evolution (i.e. design changes and assembly plan) to product architects and designers. Built on this, Figure 1 presents the overall research vision, in which only Step 1 (gray disc of Figure 1) is addressed in this article. Compared to recent research works (Demoly et al. 2012, Kim et al. 2008), the

1
2
3
4
5
6
7
8
9
10
11
12
13
14
15
16
17
18
19
20
21
22
23
24
25
26
27
28
29
30
31
32
33
34
35
36
37
38
39
40
41
42
43
44
45
46
47
48
49
50
51
52
53
54
55
56
57
58
59
60

current efforts are focused on the description of product evolution in the context of AOD. As such, this paper extends existing spatial mereotopology-based theories in the temporal and spatiotemporal dimensions in order to describe persistent objects over time and space. In addition, this step requires an ontological implementation of the theory by using OWL-DL (Ontology Web Language - Description Logic) and SWRL (Semantic Web Rule Language)(Gruhier et al. 2015). Therefore, its machine interpretation and usage within PLM (Product Lifecycle Management) systems (Step 2 of Figure 1) and CAD (Computer-Aided Design) application (Step 3 of Figure 1) are supported. Ontology also enables having a common semantic between all stakeholders (i.e. product architect, assembly planner and designer) and improves understanding with its reasoning capabilities.

The second step of Figure 1 will set up complex rules to reason, check information consistency and understand designer's intents within Product Data Management (PDM) and Manufacturing Process Management (MPM) systems. Thus, information related to the product evolution will be available to product architects and designers. In addition, top-down design approach will be considered so as to facilitate the designer's understanding and awareness. The third step of Figure 1 will introduce a spatiotemporal layer in CAD systems by supporting the swept volumes visualisation related to design changes and assembly process. The understanding of the product architect and the designer and their awareness about their decisions will be then facilitated with such spatiotemporal descriptions. Steps 2 and 3 of Figure 1 will be approached in a future paper.

3. Spatiotemporal mereotopology for product-process design description

The current section describes the developed theory, called JANUS (Joined AwareNess and Understanding in assembly-oriented deSign with mereotopology), in the field of AOD (Gruhier et al. 2014). The theory foundation is based on regions and primitives covering spatial, temporal and spatiotemporal dimensions.

3.1. Overall description of JANUS theory

3.1.1. General philosophy

Figure 2 introduces the main objective of JANUS theory. Indeed, the formal representation of the relational information of the product with its parts and its lifecycle operations (i.e. here assembly operations) at various abstraction levels, is a critical point in the product design process. At this stage, an additional layer is needed so as to ensure a seamless integration of assembly sequence planning in product design with semantics and logics. In this article, spatial objects as well as temporal objects are introduced in order to formally describe product-process relationships in a machine-interpretable manner. The fact of introducing spatiotemporal objects (such as swept volumes) and spatiotemporal relationships enables the appropriate understanding of spatial objects evolution (i.e. over time) and then their associations. By introducing such a formal representation, AOD tackles current engineering issues related to the integration of product lifecycle constraints and knowledge in a proactive manner. The perdurantist paradigm leads product architects and designers to play a role through spatial, temporal and spatiotemporal dimensions (also considered as four-dimensionalism) (Sider 2001).

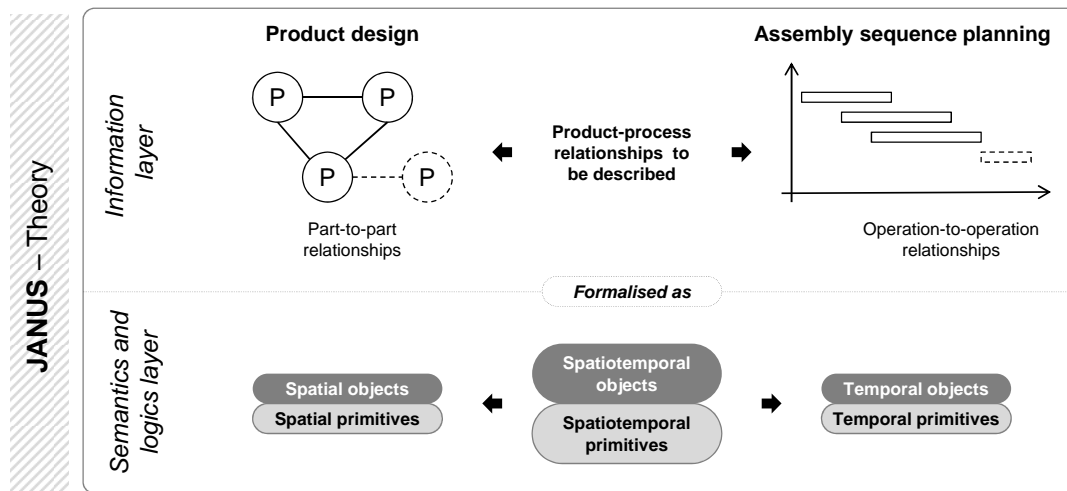

Figure 2. Introduction of a semantics and logics layer for ensuring product-process integration

Moreover, the JANUS theory is derived from ISO 159262 Standard (Standard 2003) – used in oil and gas industry – to describe a foundation based on industrial needs for the support of information changes over time (Demoly et al. 2012). This standard is based on four-dimensionality, which means that object can be extended over space and time (Batres et al. 2007). In such a context, the object can be described in four dimensions so as to enable the existence of the past, present and future. The object is then considered as being perdurant over time and is defined according to its relationships with others. In this approach change is expressed using mereotopology through the object lifecycle (Sider 2001).

3.1.2. Object change definition

The theory frame, is based on Le Moigne’s framework (Le Moigne 1994). By stating that product is composed of spatial parts assembled over time, the author has considered that objects differ from others according to:

- Their position in space;
- Their position in time;
- Their form (i.e. the object structure).

As soon as an attribute (i.e. time, space and form) is modified, a change during the assembly design occurs. This implies that time can be considered with spatial coordinates. This point is related to the concept of spatialised time or spatial time. As such, Bergson (Bergson 1923) stated “I simultaneously get that I think in duration and that I am in duration”. This means that “I am defining the product and I am aware of its evolution (assembly sequence and design changes)” in the AOD context. The definition of spatial time from Heidegger (Heidegger 1962) can be adapted to the moving process in assembly, which starts from the object initial position and finishes as soon as the object reaches its final destination (and changes its spatial primitives). By adding temporal part, it enables the description of the object changes during product design stages. The object description – *when* (defined by the assembly planner), *where* (defined by the product architect), *what* form (defined by the designer) – can be considered as complete with such kind of modelling technique (i.e. theory frame). Afterwards, the stakeholders can

Table 2. Fundamental mereotopological operators (Demoly et al. 2012)

Symbol	Name
\wedge	Logical conjunction
\vee	Logical Disjonction
$:=$	Definition
\rightarrow	Logical implication
\exists	Existential quantifier
\neg	Logical negation
\forall	Universal quantifier
\emptyset	Empty region
A	Overall assembly
ϕ	Condition
σ	Sum (fusion or join)
\equiv	Equivalence
ι	Definite descriptor

understand the transformation process (*how* and *why* questions) (Rodier et al. 2010). As such, the object adaptation is seen as understandable (e.g. why a planar pair has been used ?). Indeed, the product lifecycle is a series of adaptations and decisions that the designer has to make. Since an object is related to numerous other objects, decisions will impact the entire assembly (and not only the object itself).

3.2. Description of the spatial dimension of JANUS

The spatial dimension of the theory describes the spatial mereotopological relationships between spatial objects (e.g. mechanical parts) at a specific instant (e.g. at a particular brief moment where a part touches another part) of the assembly process. Each spatial object is considered, as a spatial region at a specific instant. Here a discrete space is considered as the description of the spatial position of an object according to others, which depends on their spatial mereotopological primitives. An empty region (denoted \emptyset), where no object is located, is also considered as a spatial region. The overall assembly (denoted A) is the region considering all regions forming the final product. Spatial relationships capture the way of which objects are related at a certain time (Del Mondo et al. 2010). So the relative position of objects compared to others can be fully described (Rodier et al. 2010). Each region is in relation with at least another region. If there is no contact between two objects, then the *Discrete D* primitive is used. From that moment on, the relationship is valid for every spatial primitive (except discrete primitive) and the letter **R**, which means *Relationship*, is used. Consider that at time 't' there are two different parts: x and y (see Equation (1)).

$$\forall t \forall x \exists y / x_t \mathbf{R} y_t \quad (1)$$

Here spatial primitives are introduced to formally describe part-to-part relationships. They are based on Smith's mereotopological primitives (Smith 1996), and have already been addressed and adapted in Demoly et al. (Demoly et al. 2012) and Kim et al. (Kim et al. 2008), who have both focused their research efforts in assembly design and sequence planning. As for Salustri (Salustri 2002), similar primitives – same properties but not the

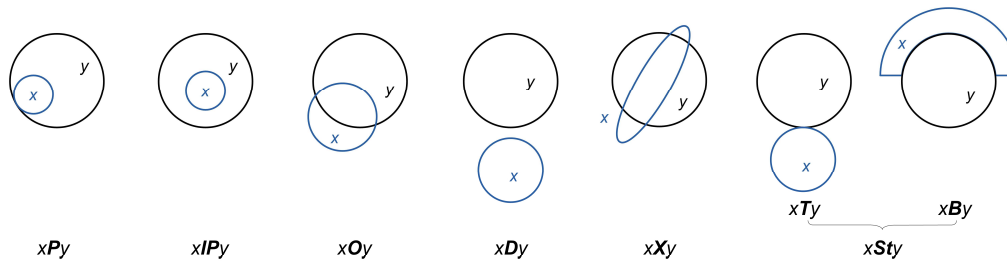

Figure 3. Spatial mereotopological primitives representation (Demoly et al. 2012)

Table 3. Spatial mereotopological primitives description (Demoly et al. 2012)

Name	Mereotopological description
<i>x is Part of y</i>	$x\mathbf{P}y := \forall z(z\mathbf{O}x \rightarrow z\mathbf{P}y)$
<i>x is InteriorPart of y</i>	$x\mathbf{I}P y := x\mathbf{P}y \wedge \neg x\mathbf{T}y$
<i>x Overlaps y</i>	$x\mathbf{O}y := \exists z(z\mathbf{P}x \wedge z\mathbf{P}y)$
<i>x is Discrete from y</i>	$x\mathbf{D}y := \neg x\mathbf{O}y$
<i>x Crosses y</i>	$x\mathbf{X}y := \neg x\mathbf{P}y \wedge \neg x\mathbf{D}y$
<i>x Tangent y</i>	$x\mathbf{T}y := \exists z(z\mathbf{P}x \wedge z\mathbf{B}y)$
<i>x is Boundary of y</i>	$x\mathbf{B}y := \forall z(z\mathbf{P}x \rightarrow z\mathbf{S}t y)$
<i>x Straddles y</i>	$x\mathbf{S}t y := \forall z(x\mathbf{I}P z \rightarrow z\mathbf{X}y)$
<i>Sum of ϕ ers</i>	$\sigma x(\phi x) := \iota y(\forall w(w\mathbf{O}y \equiv \exists v(\phi v \wedge w\mathbf{O}v)))$

same names (e.g. *InteriorPart IP* is equivalent to *NonTangentialProperPart NTPP* or *TangentialProperPart TPP*) – have been introduced. Besides the same author did not use the *Crosse X* primitive, which seems to be relevant in the above mentioned context and is intensively employed in ASP. By using mereotopological operators (see Table 2), eight spatial primitives have been represented in Figure 3 and described in Table 3. Here z is considered as a spatial region. In addition, “not x ” is a logical negation and an operation that can be interpreted as being true when its operand (i.e. quantity on which a mathematical operation is performed) is false, and false when its operand is true.

At the beginning of the design phase, part-to-part relationships are considered as critical input for AOD. This information is then described into geometric skeletons in order to control geometric assembly models in a central manner (Demoly et al. 2011). At a more detailed level, the condition ϕ is used and states that a condition ϕ in a single variable x is satisfied if and only if the sentence ϕx is true for at least one value of x . Based on this assumption, it is possible to introduce and define two entities (Figure 4 and Figure 5), on which the object form depends (Demoly et al. 2012):

- *Assembly skeleton*, which ensures assembly positioning, is represented by k (e.g. straight line representing the rotation and/or translation axis): $k := \sigma z(\phi z \rightarrow \forall z(\phi z \rightarrow (z\mathbf{T}x \wedge z\mathbf{T}y) \wedge (z\mathbf{P}x \wedge z\mathbf{P}y)))$ (See Figure 4);
- *Interface skeleton*, which describes geometric boundaries (e.g. circle, square) used to build a functional surface and supported by an assembly skeleton, is represented by f : $f := \sigma z(\phi z \rightarrow \forall z(\phi z \rightarrow z\mathbf{B}x \wedge z\mathbf{B}y))$ (See Figure 4).

Multiple assembly or interface skeletons on the same assembly, are respectively denoted

k_1 and k_2 or f_1 and f_2 . Moreover, the interface skeleton type depends on the shape of the parts on which a physical contact exist.

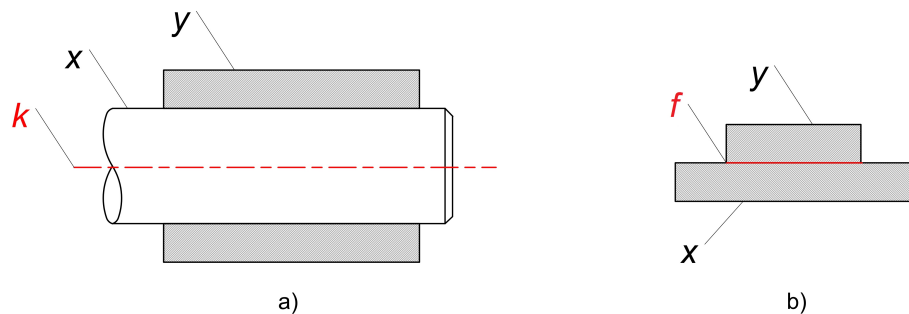

Figure 4. Geometric representation of k and f entities (Demoly et al. 2012)

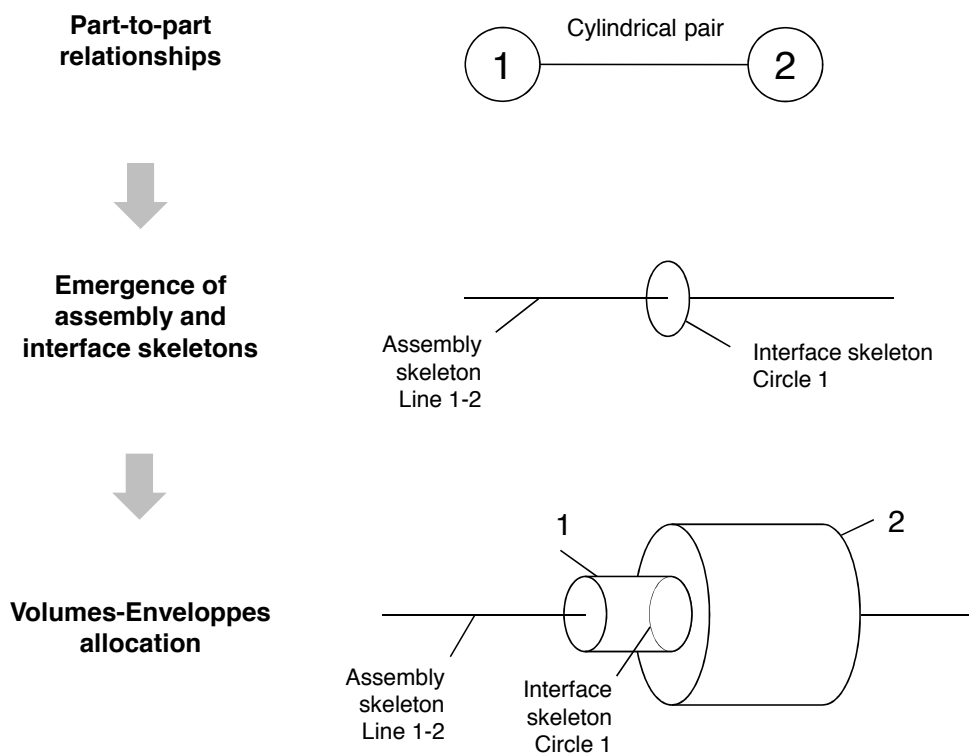

Figure 5. Example of cylindrical pair assembly and related skeletons (i.e. assembly and interface skeletons)

3.3. Description of the temporal dimension of JANUS

Based on the spatial part of JANUS, the temporal aspect is then defined with temporal relationships and temporal objects. The lifetime of an object is broken down into several smaller temporal objects (Hadjieleftheriou et al. 2002), which are created each time a part change occurs (Rodier et al. 2010). The object change is generally associated to an

1
2
3
4
5 event or a process. The purpose here is to describe changes that affect objects during
6 design and assembly process. As soon as an event occurs, changes occur at time ' t '.
7 An event indicates a discontinuity in a stable referential. There is a break between the
8 "before" and the "after" of the event. In that sense, Sider (Sider 2001) provides the
9 following definition: x is an *InstantaneousTemporalPart of y* if, at instant t , x exists at,
10 but only at, t . Therefore, the region is only spatial and there is no swept volume (i.e. no
11 spatiotemporal region). On the other hand swept volumes, which are generated during
12 assembly process, are used to understand and represent product evolution over time. So
13 process expresses a change during the intern evolution of the object and is composed of
14 an initial event, a duration between both events and a final one.

15
16 Here each temporal object is considered as a Temporal Region (TR). To understand
17 the notion of temporal region, mechanical assembly design history has to be considered
18 as a story. It describes when the base part (i.e. first part to be assembled) is placed, how
19 the second is assembled to the previous one and so on. As commonly admitted, this story
20 has temporal regions created at each new assembled spatial region. Temporal regions can
21 be either intervals or instants (Sider 2001). Assembly operations are a kind of temporal
22 regions. Thus there exist two types of temporality, such as the temporality of the object
23 itself (i.e. how it evolves over time) and the temporality of the object regarding to the
24 others (i.e. which is shown with spatial primitives).

25
26 The relative chronology between assembly operations can be understood by using tem-
27 poral relationships (Rodier et al. 2010). Table 4 shows the temporal relationships between
28 two intervals (third column), one interval and one instant (fourth column), and two in-
29 stants (with **Bt** the temporal boundary primitive) (fifth column). The proposed descrip-
30 tion is similar to Allen's intervals (Allen 1983), who formalized topological relationships
31 between temporal intervals. Here, a , b and c are used to describe three temporal regions.
32 Since the dimensions of the regions and primitives in the section 3.3 (i.e. temporal di-
33 mension) are different from the **ones** in section 3.2 (i.e. spatial dimension), the authors
34 have decided to use other letters for variables in order to remove any ambiguity.

35
36 Temporal primitives are inspired from spatial primitives and adapted to represent every
37 temporal phenomenon that may be identified during an assembly process. Phenomena
38 have been classified according to the type of mechanical assemblies. Just two of them
39 can describe all types of assembly **presented** in Table 5: *TemporallyPrecede* (denoted **tp**)
40 and *TemporallyTangent* (denoted **Tt**). The different types of assembly are considered as
41 follows (Demoly et al. 2011): interconnected serial, serial, constrained serial and parallel
42 (see Table 5). Both "interconnected serial" and "constrained" are constraint dependency
43 relationships. The only difference is that in the latter, some parts can be temporally
44 constrained by other parts without being in physical contact with them (i.e. precedence
45 constraint). For instance, in the "constrained" assembly type, *Part 2* must be assembled
46 before *Part 3* and there is no contact between both parts. As a consequence, time is
47 considered as linear (Renolen 1999) and discrete.

51 3.4. Description of the spatiotemporal dimension of JANUS

52 3.4.1. Basic problem with spatiotemporal visualisation

53
54
55 The description of assembly design over space and time (evolution) requires an addi-
56 tional dimension, **the** spatiotemporal dimension. Each spatiotemporal object is consid-
57 ered as a spatiotemporal region such as swept volume during deformation, modification
58 or transformation. The latter notion is the spatial region occupied by an object during
59
60

Table 4. Temporal mereotopological primitives description and representation

Name	Mereotopological description	Repres. with two intervals	Repres. with one interval and one instant	Repres. with two instants
<i>b</i> is TemporallyPart of <i>a</i>	$bPta := \forall c(cOtb \rightarrow cPta)$			
<i>b</i> is StartTemporallyPart of <i>a</i>	$bPtsa := \exists c(bPta \wedge cTtb \wedge ctpa)$			
<i>b</i> is FinishTemporallyPart of <i>a</i>	$bPfta := \exists c(bPta \wedge bTtc \wedge atpc)$			
<i>b</i> is TemporallyInteriorPart of <i>a</i>	$bIPta := bPta \wedge \neg bPta \vee \neg bPfta$			
<i>b</i> TemporallyOverlaps <i>a</i>	$bOta := \exists c(cPtb \wedge cPta)$			
<i>a</i> TemporallyPrecedes <i>b</i>	$atpb := \exists c(aTtc \wedge bPftc)$			
<i>b</i> is TemporallyTangent of <i>a</i>	$bTta := \exists c(cPta \wedge cBtb)$			
<i>b</i> is TemporallyEqual to <i>a</i>	$btea := bIPta \wedge aIPtb$			

Table 5. Assembly types of three components (*Part 1*, *Part 2* and *Part 3*) (Demoly et al. 2011)

Assembly type	Interconnected serial	Serial	Parallel	Constrained
Directed graph				
Example				

a specific duration. By considering swept volume, the past coexists with the present. In our context, geometric skeletons do not have spatiotemporal parts, since spatiotemporal regions consist of spatial and temporal components (Bittner et al. 2004). For instance, it is possible to see during a change (e.g. Move of Part 5 in Figure 6) the path of an object and the related needed space to reach its final position.

Several problems concerning spatiotemporal visualisation can be encountered by human. Actually human can only see the initial spatial region and the final spatial region

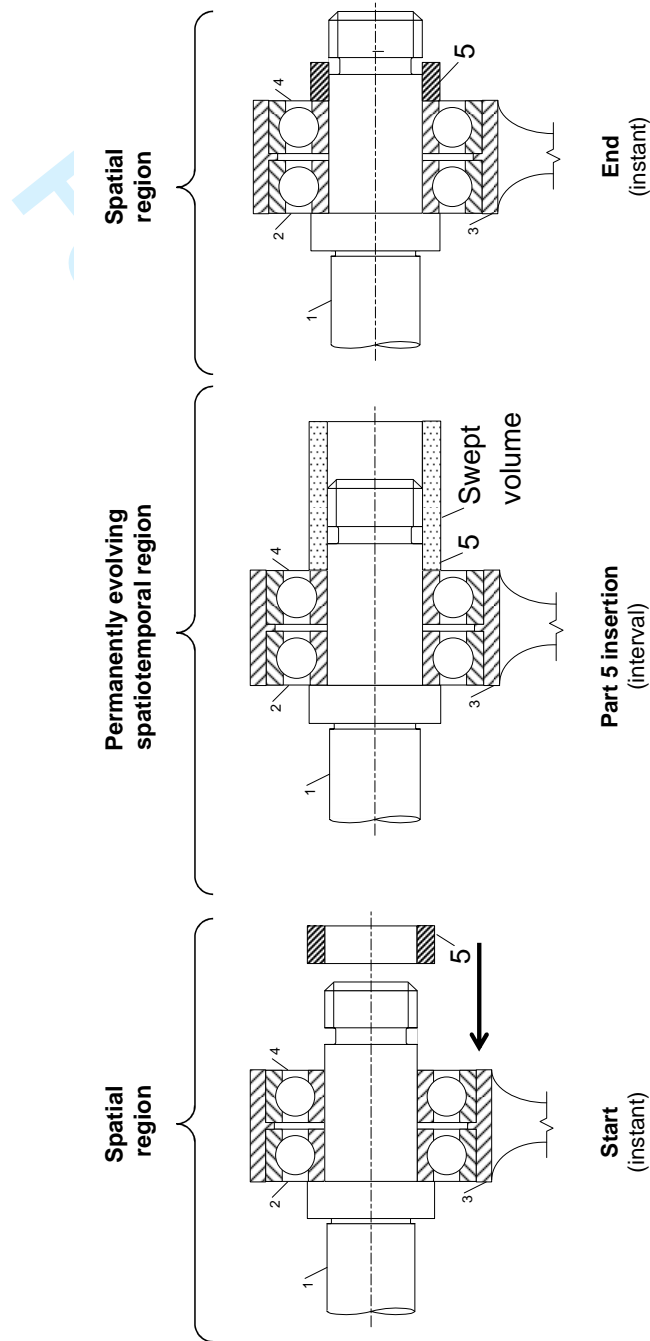

Figure 6. Decomposition of Part 5 insertion

Only

1
2
3
4
5
6
7
8
9
10
11
12
13
14
15
16
17
18
19
20
21
22
23
24
25
26
27
28
29
30
31
32
33
34
35
36
37
38
39
40
41
42
43
44
45
46
47
48
49
50
51
52
53
54
55
56
57
58
59
60

1
2
3
4
5 during a move. The actor cannot percept the swept volume. For instance, during an
6 assembly sequence, if a part is being moved in order to cross the shaft, the designer will
7 not be able to see generated spatiotemporal part. Indeed the move need to be broken
8 down into several instants. This is due to human intelligence which is only able to see
9 motionless object and fixes the time. Humans cannot think in terms of continuous evolu-
10 tion (Bergson 1923). As a consequence, the spatiotemporal dimension of the theory has
11 been defined as a sequence of pictures.

12 If an object must undergo two consecutive changes, then the final spatial region of
13 the first change corresponds to the first spatial region of the second change. This kind
14 of description does not provide all information about what happens during intervals. A
15 quantitative study has to be carried out with specific laws to know what happens in the
16 interior of an interval.

17 3.4.2. Filiation relationships

18
19
20 Descartes (Descartes 1996) made an experiment with wax. When he saw it, the wax
21 was solid. But when he put it near fire, it melts. His conclusion is that with human
22 understanding, the wax is wax and will always be wax whatever happens to it (e.g.
23 transformation). Moreover, Sider (Sider 2001) and Hawley (Hawley 2004) describes the
24 object as persisting over time. As soon as an object is modified, its properties change (but
25 not the object itself). The object will have attributes showing for instance if the object
26 is deformed or not. For few changes (e.g. union or split), a new object is created from
27 the “initial” one. The same identity basis is described with filiation relationships. It is a
28 dependence relationship where the kinship is transmitted from the parent (i.e. assembly)
29 to the child (i.e. part). It therefore enables the identification of every object and its
30 uniqueness. Based on the identity concept, it is possible to distinguish an object from
31 others. Two types of filiation relationships can be found during AOD phase (Del Mondo
32 et al. 2010), such as:

- 33 • Continuation relationship, denoted γ (i.e. exactly the same object but at two different
34 times);
- 35 • Derivation relationship, denoted δ (i.e. a part of the identity from the original object
36 is present in the changed object).

37
38
39 In the JANUS theory, the continuation relationship is considered as implicit. The latter
40 always occurs between two objects with the same name at different instants. Derivation
41 relationships exist if two objects are in relation with spatiotemporal primitives and do
42 not have the same name.

43 3.4.3. Spatiotemporal primitives classification

44
45
46 Changes have spatiotemporal aspects and need spatiotemporal relationships to link
47 spatial objects over time. The latter, which are introduced to link spatial and temporal
48 dimensions (Del Mondo et al. 2010), can be described as follow:

- 49 • Between two spatial regions at two different instants (e.g. *Move*);
- 50 • From a spatial to an empty spatial region at two different instants (e.g. *Deletion*);
- 51 • From an empty spatial to a spatial region at two different instants (e.g. *Addition*).

52
53
54
55 As a consequence, spatiotemporal primitives express the change over space and time
56 (Haddad 2009), which provides an effective mechanism to visualise and communicate
57 design and assembly intents (McKinney et al. 1996). In that case, the evolution of an
58 object can be seen as a succession of events and processes. Let us consider two different
59
60

Table 6. Part-to-part relationships definition for spatiotemporal primitives (Demoly et al. 2012)

Relationship type	Definition
Contact	Physical contact relationship between two parts
Kinematic pair	Additional information on contact relationship which enables the description of constrained degrees of freedom (rotation and translation) for each part
Technological pair	Additional information on contact relationship which enables the definition of the assemblability of the product, and therefore on the joining relationship between two parts

times t_i and t_j and two different parts x and y (see Equation (2)):

$$\forall t_i \neq t_j \forall x \exists y / x_{t_i} \mathbf{R}y_{t_j} \quad (2)$$

In rigid **mechanical** assembly, two parts during the assembly **process** cannot physically *overlap*, on the contrary two spatiotemporal regions can *overlap* themselves at two different instants. For instance, several parts can be positioned on a shaft in a serial **process** manner and so their spatiotemporal regions are overlapping but are assembled at different times in order to have no physical overlap of their spatial regions. That is the reason why spatiotemporal primitives are needed to model the actual world. By describing new spatiotemporal primitives such as kinematic and technological pairs positioning (as described in Table 6), **evolution information in product design can be managed and understood**. In Table 7, all spatiotemporal primitives are described and classified in terms of their changes over time, space and form (Haddad 2009). For growing and move, the change occurs during the process: SpatioTemporal Region (**denoted** STR) form changes, but also during the instant just after, i.e. change of Spatial Region Final (**denoted** SRF). Here, STR simply represents spatiotemporal region and SRF as final spatial region. On the contrary for **Union**, changes in form just occur at the final spatial region. For instance, kinematic pairs undergo spatial and spatiotemporal changes, but part number **remains** identical. Moreover, the form of the part, which is moving/progressing, is not the same during the move (i.e. swept volume) and at the final stage of the evolution (i.e. part).

3.4.4. Kinematic pairs positioning and design changes description

Each spatiotemporal primitive is described in details using spatial and temporal mereotopological primitives (see Table 2 and Table 4). This kind of spatiotemporal primitives has been developed in order to enable the description of the product evolution over time in the context of AOD. The spatiotemporal primitive called **CylindricalOP** (here OP stands for operation) is described in details in a specific graph (Figure 7) with its related legend (Table 8). The definition says that at the beginning **Part 1** and **Part 5** are **Discrete** and that **1 is Overlapped by** its assembly skeleton k_1 , which **is Discrete** with 5. After that, **5 Moves** and k_1 **Overlaps** 1 and 5. As such, both 1 and 5 are aligned. At the end of the **assembly** positioning, **5 Moves** again, **Crosses** 1 and **are Tangent to** the interface skeleton f_5 . Processes are considered continuous, non-instantaneous (e.g. object cannot move from one point to another in one instant) and linear. **5 CylindricalOP 1** means that 1 is the base part and 5 is moving to be positioned in a cylindrical manner. For next descriptions, TR_i always precedes TR_{i+1} . The mereotopological descriptions of kinematic pairs positioning and design changes (such as

Table 7. Classification of changes and associated spatiotemporal primitives

Changes types	Spatiotemporal primitives	Temporal change	Spatial change	Form change	Parts number change	Exemple of Event (E) or Process (P)
Move	Kinematic pairs	•	•	STR+SRF	○	P: Place an object
	<i>Rotation</i>	•	•	STR+SRF	○	P: Orient an object
Replacement process	<i>Permutation</i>	•	•	STR+SRF	○	P: Designer oversight
Basic change	<i>Addition</i>	•	○	SRF	•	E: Missing object
	<i>Deletion</i>	•	○	SRF	•	E: Useless object
Restructuring Processes	<i>Split</i>	•	○	SRF	•	E: Complex assembly
	<i>Union</i>	•	○	SRF	•	E: Subassembly creation
	<i>Growing</i>	•	○	STR+SRF	○	P: Object too small
Transformation	<i>Decrease</i>	•	○	STR+SRF	○	P: Object too large
	<i>ChangeOfForm</i>	•	○	STR+SRF	○	P: Change of idea
	<i>Deformation</i>	•	○	STR+SRF	○	P: Rivet positioning
	Permanent with added part	•	•	STR+SRF	○	P: Place permanently an object
Technological pairs	Non-permanent with added part	•	•	STR+SRF	○	P: Place non-permanently an object
	Non-permanent without added part	•	•	STR+SRF	○	P: Place non-permanently an object

Addition, Growing and so on) are defined in Appendix (cf. Table A1 and Table B1).

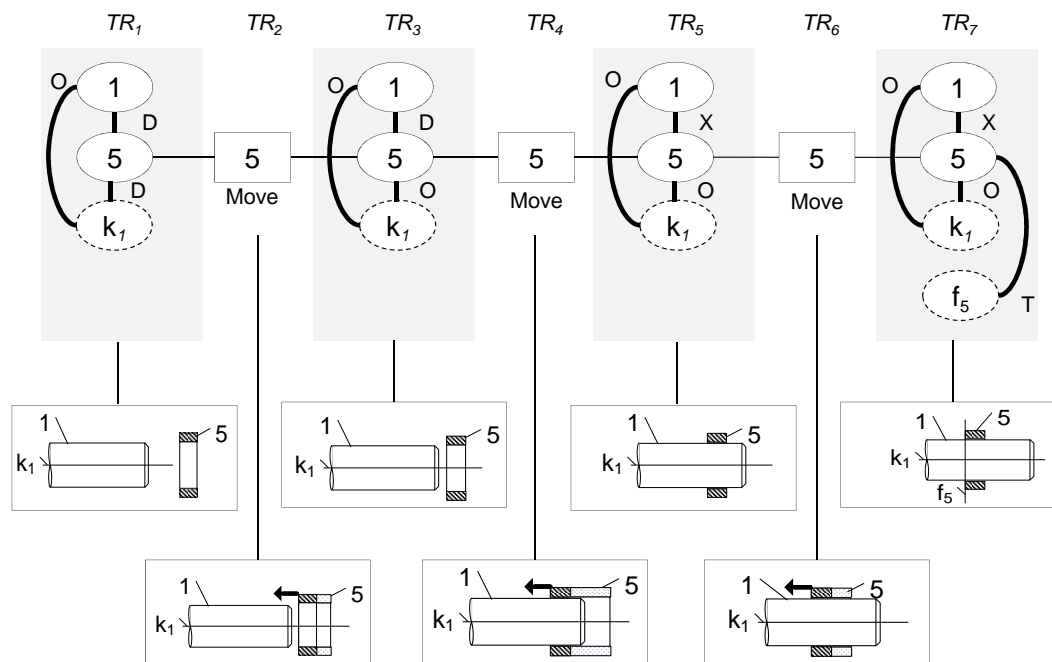

Figure 7. Representation of *CylindricalOP* in a spatiotemporal graph

3.4.5. Technological pairs positioning description

At a lower granularity, several technological pairs can be used when the product architect decides to design a rigid assembly (e.g. adhesive bonding, welding and so on). These

Table 8. Legend of the spatiotemporal graph

Representation	Meaning
\top	Spatial relationship (e.g. <i>Tangent</i>)
$\dashrightarrow \pi$	Temporal relationship (e.g. <i>TemporallyTangent</i>)
Move	Spatiotemporal relationship (e.g. <i>Move</i>)
TR_i	Temporal region number i
5	Spatial region (e.g. <i>Part 5</i>)
5	Spatiotemporal region (e.g. <i>Swept volume 5</i>)
k	Assembly skeleton (e.g. k)
f	Interface skeleton (e.g. f)

Table 9. Classification of technological assembly operations

Assembly Type		With added part	Without added part
Non-permanent		Mechanical Fastening	None
Permanent	Parts destruction	Gas Welding Brazing Adhesive Bonding	Arc Welding Spot Welding Clinching Crimping Interference Fit
	Fastening destruction	Nail Assembly Simple Rivet Double Rivet Blind Rivet Snap In Metal Stitching	None

relationships have been classified (see Table 9) into four groups according to different criteria (e.g. added entity needed, non-permanent assembly, etc.). Thus it is not possible to have a non-permanent technological pair without added entities. Some rules have been set up, such as:

- p and s denote tools;
- u and v denote added entities;
- x and y denote both entities to be assembled.

According to the classification in Table 9, technological pairs positioning are described in Appendix (cf. Table C1, Table D1, Table D2, Table D3 and Table E1). Spatiotemporal descriptions expressed at TR_i are not written again at TR_{i+1} in order to lighten the equations and to facilitate understanding. Here, the authors have considered Kim et al.'s propositions related to the technological relationships description (Kim et al. 2008). With such descriptions, the aim is to trace the objects being assembled and also their tools. Hence, spatial and temporal primitives are needed.

4. Ontological implementation with a case study

This section introduces an ontological implementation of the JANUS theory with an illustrative case study, so as to highlight the applicability of the proposal.

4.1. Case study and its mereotopological description

For this case study, the eBOM (engineering Bill Of Material) is composed of six parts (Table 10) and the part-to-part relationships have been defined in a directed graph (Figure 8) by the product architect. Based on such information, the ASDA algorithm (Assembly Sequence Definition Algorithm) (Demoly et al. 2012) has generated a relevant assembly sequence that is expressed as follows [1, [3, 2, 4], 5, 6]. So the spatial regions (i.e. product parts) 2, 3 and 4 are embedded in a Sub-Assembly (denoted SA). The assembly sequence is then refined by the assembly planner.

Table 10. Parts list of the case study

No.	Part name	No.	Part name
1	Shaft	4	Bearing 2
2	Bearing 1	5	Spacer
3	Hub	6	Nut

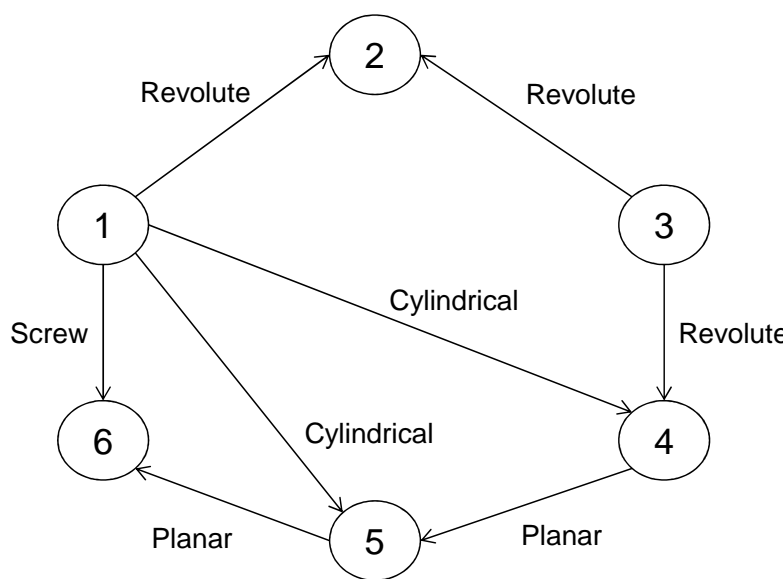

Figure 8. Graph of part-to-part relationships

Based on the previous directed graph, the temporal information (see Table 11) and the kinematic pairs positioning can be converted into mereotopological descriptions with

Table 11. Temporal information: assembly operations and their associated primitives

Operations description (Boothroyd et al. 2002)	Temporal relationships between operations
OP10: Insertion of 2 on 3	OP10 Ot OP20
OP20: Insertion of 4 on 3	OP20 Tt OP30
OP30: Insertion of SA on 1	OP10 tp OP30
OP40: Insertion of 5 on 1 and 4	OP30 Tt OP40
OP50: Insertion of 6 on 1 and 5	OP40 Tt OP50

1
2
3
4
5 the JANUS theory (see Table 12). All information is then gathered to describe product
6 evolution (See Figure 9) (Gruhier et al. 2014). Hence, spatial (i.e. mechanical part),
7 temporal (i.e. assembly operation) and spatiotemporal (i.e. swept volume in the context
8 of AOD) regions are represented and linked with primitives. Only regions, which undergo
9 a change at OP_i , are presented at OP_i in order to facilitate understanding of the reader.
10 Changes are here considered **once** novel spatiotemporal relationships appear. As such,
11 product architect and designer can **really** understand what happens **to** each operation,
12 especially where a part is situated and linked regarding to others, and which part is
13 moving or evolving and so on. For instance, **Theses actors** can **assess** that at OP_{50} ,
14 *Swept volume 6* is moving to be **positioned** in a **ScrewOP** manner on *Part 1* and in
15 a **PlanarOP** manner on *Part 5*. **Therefore, this representation provides an overview of**
16 **the product evolution along its assembly sequence and so a suitable design support to**
17 **the product architect and designer before starting the product modelling phase in CAD.**
18
19
20
21
22
23
24
25
26
27
28
29
30
31
32
33
34
35
36
37
38
39
40
41
42
43
44
45
46
47
48
49
50
51
52
53
54
55
56
57
58
59
60

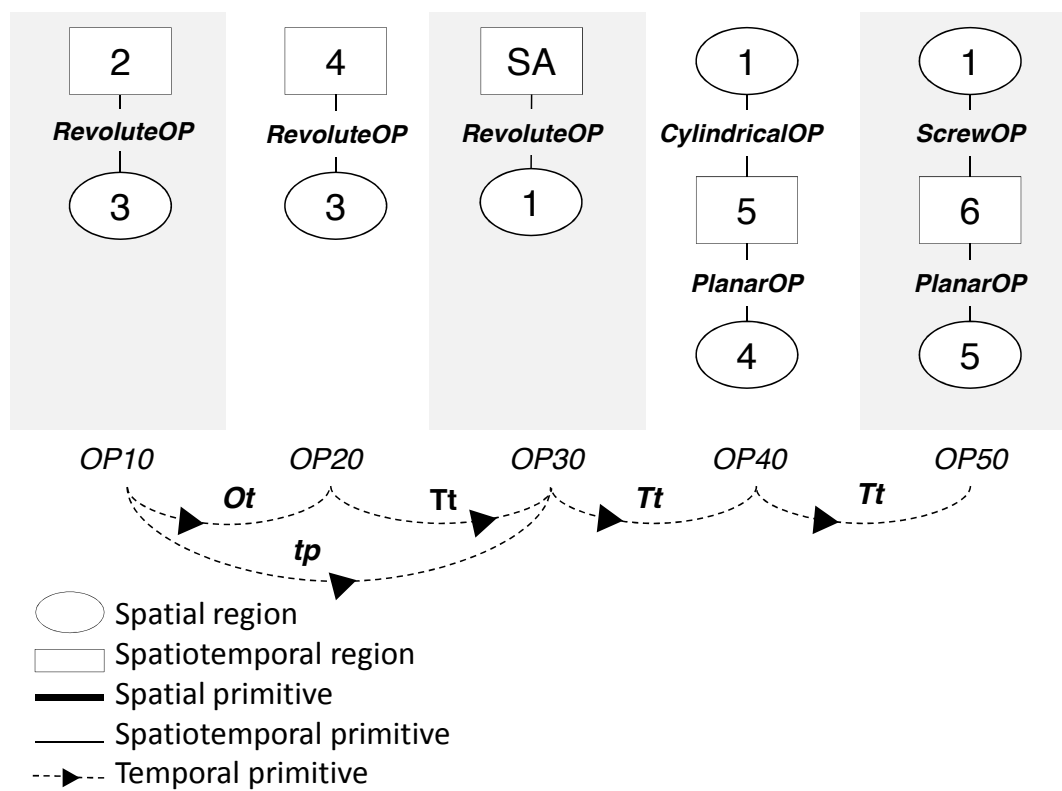

Figure 9. Representation of the whole assembly process in a spatiotemporal graph

Based on Figure 8, the final stage of the assembly design process is represented in Figure 10. Kinematic pairs are expressed with mereotopological primitives. For instance *PlanarOP* is equivalent to *Tangent* primitive at the end of the process, as well as *RevoluteOP* is equivalent to *Cross* and *Tangent* primitives. This kind of representation allows the designer to fully understand the relationships between parts at the end of the assembly process. For example, such graph informs that *Part 2* and *Part 6* are never in contact and that all parts are linked to *Part 1*. This information will aid the designer during the CAD modelling phase.

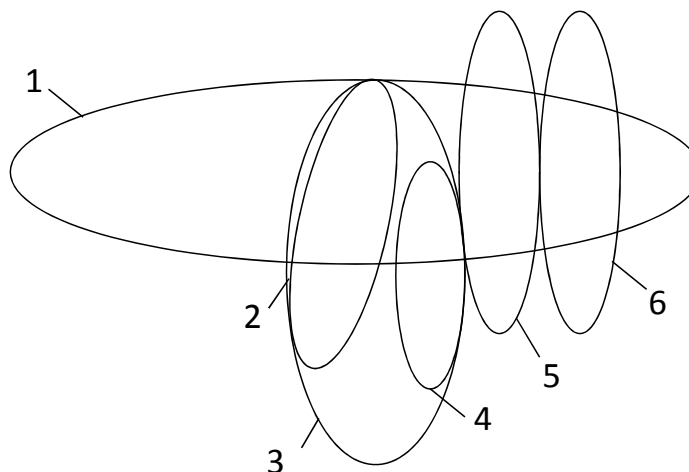

Figure 10. Spatial representation of the whole assembly process

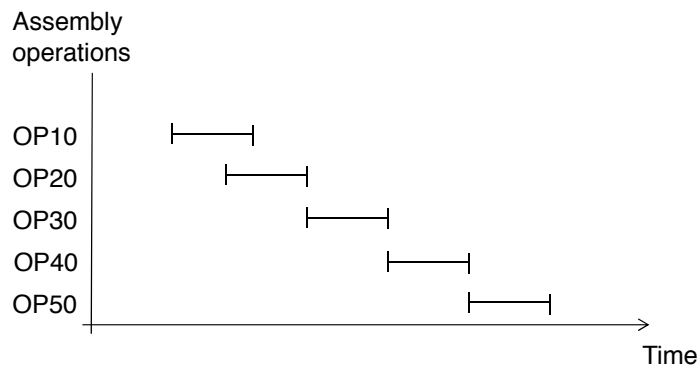

Figure 11. Assembly sequence planning of the case study

Since JANUS theory is used at the early design stages, qualitative information is favored (i.e. detailed geometry does not exist yet). Build on part-to-part relationships, the assembly sequence can be defined and represented such as in Figure 11. Moreover spatial and temporal relationships are simultaneously represented in Figure 12 within a space-time graph in order to understand product relationships design over time. This graph is obtained with the previous information on spatial, temporal and spatiotemporal dimensions. The horizontal axis represents temporal connections between regions, and the vertical axis shows spatial relationships. For instance if two objects are touching and if the tangency between them can be projected in the horizontal axis, it means that they are *TemporallyTangent* (and vice versa for the vertical axis and the *Tangent* relationship). Figure 10 and Figure 12 enable the introduction of a complementary vision to the current 3D definition of the product. By considering such a description, product architects and designers will know how and when parts are related via the early-defined assembly sequence. Therefore, the entire understanding about the assembly process and product design evolution in the early design phase is ensured.

4.2. System execution

Built on this formal description, the JANUS theory has been implemented in an ontology called PRONOIA2 (i.e. PROduct relatiONships description based On mereotopologIcAl theory 2) in Protégé in order to be machine-interpretable by product lifecycle management (PLM) systems. PRONOIA2 is based on PRONOIA (Demoly et al. 2012) and extends it in the temporal and spatiotemporal dimensions. The OWL language has been used to formalise the ontology. The terms from JANUS have been reused, especially the two top-level classes, Region and Primitive (See Figure 13). In addition, description logic restrictions and SWRL rules have been incorporated to be able to reason on information and check its consistency from a logical and semantical point of view. The ontology in its current shape proposes some available queries to designers so as to display and represent evolutions and changes in product design stages.

For this case study, PRONOIA 2 has been populated with previous information. The individuals are shown in Figure 14, in which on the right individuals have been linked together with properties, and on the left part the caption of properties. This figure is composed of five states represented in the middle. Each state is composed of spatial, temporal and/or spatiotemporal regions and primitives. The different states allow visualising what happens in the context of AOD and show the product evolution over time

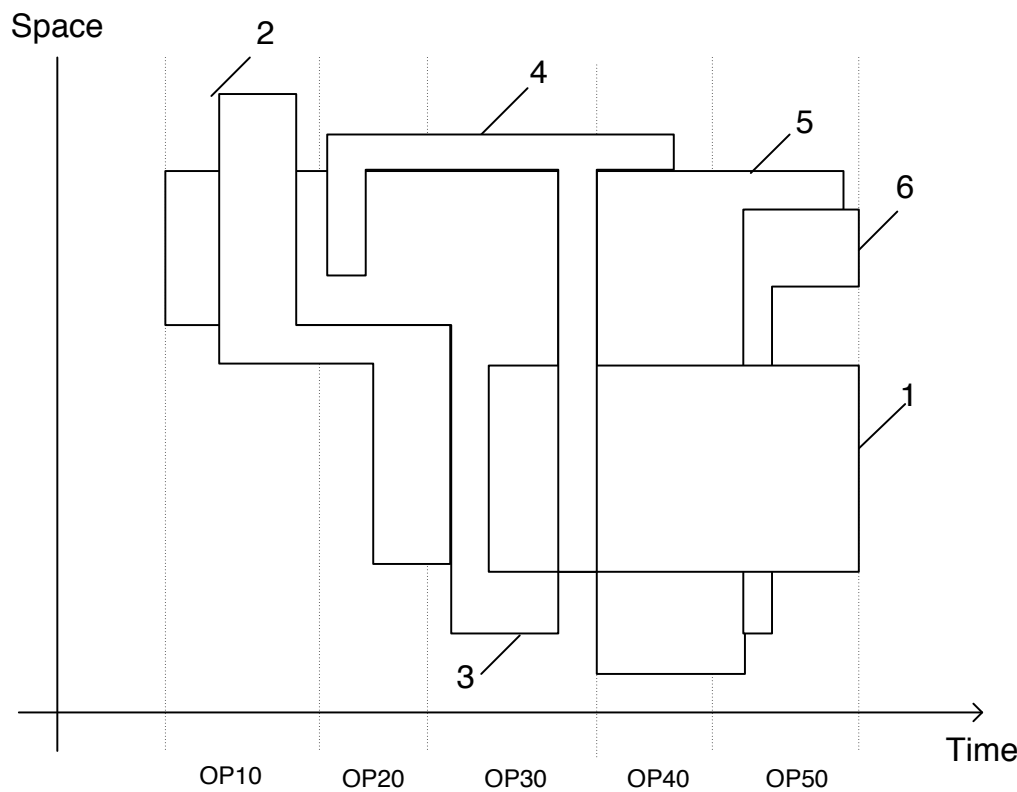

Figure 12. Representation of the product relationships over space and time

and space.

After checking information consistency related to product architect' and the assembly planner's intents (Gruhier et al. 2015), the designer has a suitable design support based on a perdurantist vision to define consistent mechanical assemblies (See Figure 15). Indeed, designer is aware of product architect's and assembly planner's knowledge and can take into consideration lifecycle constraints at the early design stages so as to enable concurrent and proactive engineering. This mechanical assembly case can then be visualised within a CAD application (e.g. CATIA v5) as illustrated in Figure 16. This last step of the framework – regarding the awareness and understanding support in design – will be addressed in detailed in Step 3 of Figure 1.

5. Discussions

The proposed JANUS theory enables the description of product-process relationships by introducing spatial, temporal and spatiotemporal regions and related primitives in the context of perdurantism. Thus, the relationships between parts of the product along the assembly process are fully described and exploitable as well as their design changes, whatever the part number and the product complexity. Product evolution over time is therefore captured at each change, enabling a better understanding of the product. As a result, the first step (Step 1 of Figure 1) has been fully covered in this article, by describing new temporal and spatiotemporal mereotopological primitives. This research

1
2
3
4
5
6
7
8
9
10
11
12
13
14
15
16
17
18
19
20
21
22
23
24
25
26
27
28
29
30
31
32
33
34
35
36
37
38
39
40
41
42
43
44
45
46
47
48
49
50
51
52
53
54
55
56
57
58
59
60

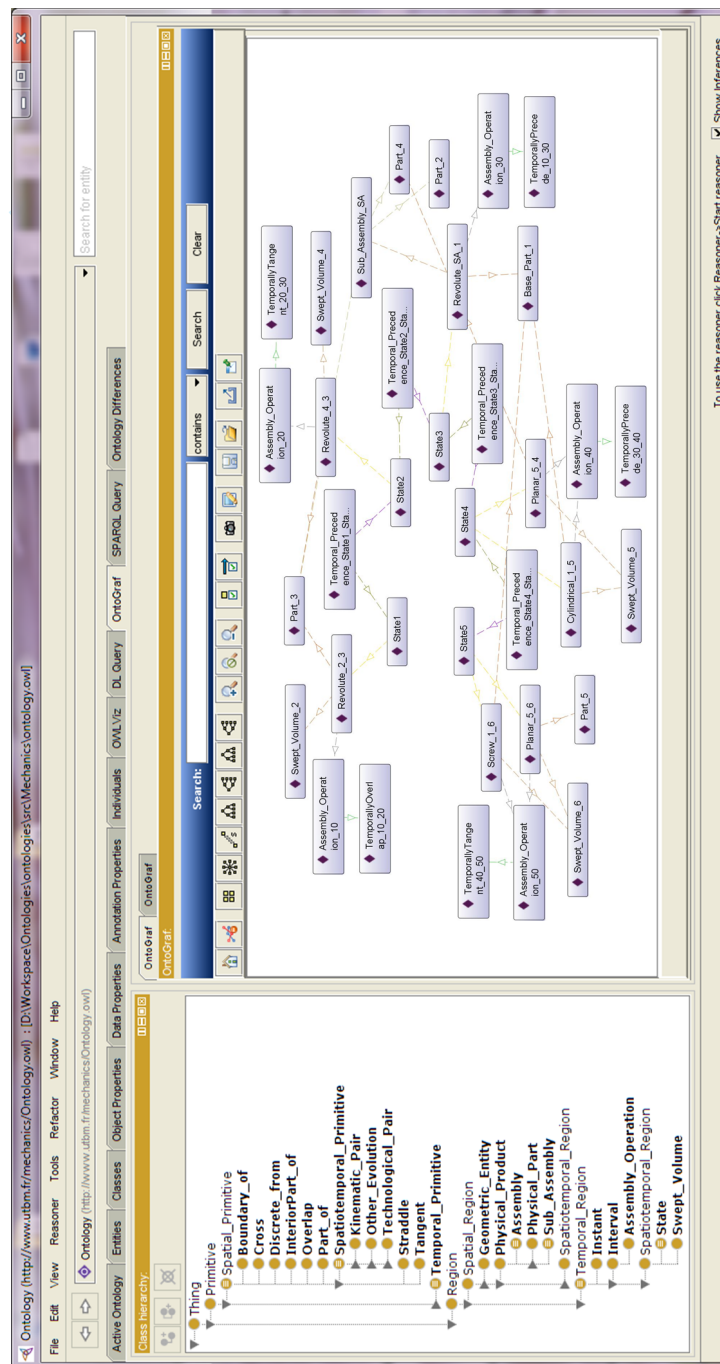

Figure 14. Instances of the ontology for the presented case study

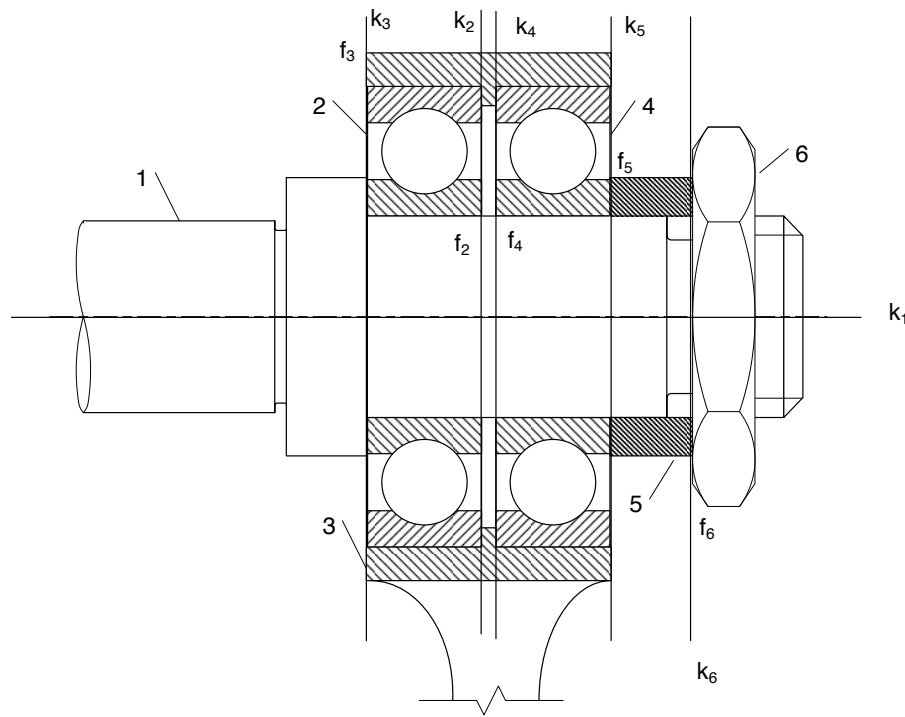

Figure 15. Cross-section view of the considered mechanical assembly

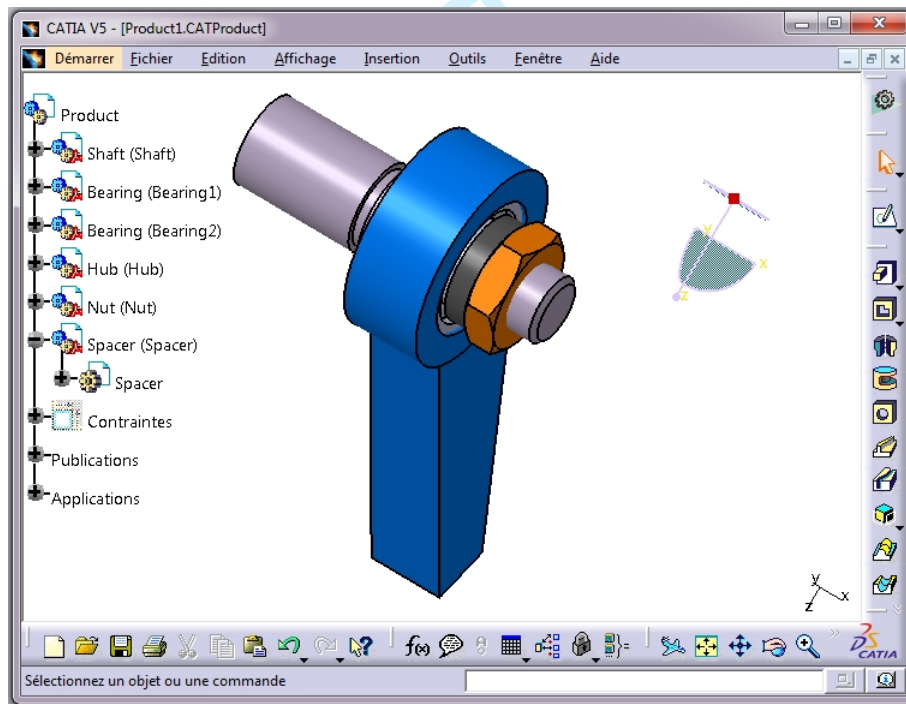

Figure 16. Implementation of the case study within CATIA v5 (CAD application).

effort is considered here as the basis for future studies where additional spatiotemporal layers will be specified to assist designers in the detailed design stage.

1
2
3
4
5
6
7
8
9
10
11
12
13
14
15
16
17
18
19
20
21
22
23
24
25
26
27
28
29
30
31
32
33
34
35
36
37
38
39
40
41
42
43
44
45
46
47
48
49
50
51
52
53
54
55
56
57
58
59
60

Actually information is not always available or understandable by designers. Since only one assembly sequence has been considered in the case study, only one product evolution has been carried out. In the case where another one is integrated, the product evolution will be slightly different. However the proposed theory has some limitations since it does not describe the exact shape, position (e.g. within a coordinates system) and orientation of spatial objects. At this stage, the purpose is to develop a qualitative theory, which could be applied to any kind of **mechanical** assembly (i.e. independent of shape and size), insofar the 3D model is not yet well-defined in the early design stages. In its current shape, JANUS does not describe all types of evolution that can **exist** during the product design process, but **enables** the description of the most important and **recurrent** ones.

In addition JANUS could be extended to describe not only assembly **process** knowledge, but also knowledge from manufacturing process (e.g. additive manufacturing, tapping, etc.). **In such a case**, new spatiotemporal regions will be described by considering material flow as well as new specific primitives. **As a consequence, the theory seems to be enough extensible could cover all the lifecycle stages in product design.** Moreover, such a theory could be applied to any domain where description of relationships between objects is needed. **If the theory is planned to be adapted to another domain (e.g. geographical information system - GIS), the basis will remain the same but new regions (e.g. city) and related primitives will have to be developed.**

6. Conclusions and future work

The article has introduced a literature review on AOD approaches and related product models, and mereotopology-based theories, on which a research problem formulation has been highlighted. **Built on this, a novel mereotopological theory (called JANUS) following a four dimensionalism philosophy has been presented.** Such a theory covers **three dimensions (i.e. spatial, temporal and spatiotemporal) so as to describe product-process relationships over space and time.** Spatial and temporal objects and primitives have been defined, as well as their associations between both dimensions. Indeed, new spatiotemporal objects and primitives have been introduced in order to describe product-process knowledge and information. By considering the spatiotemporal dimension and the associated mereotopology-based theory, information has been added to **design** objects **in order to** express their history in a consistent and understandable manner. This description aids to understand phenomena during AOD process. The actual stake is to get a long term dynamic vision of the space over time in order to facilitate the understanding of assembly and design changes.

Moreover, the JANUS theory has been implemented into an ontology by using OWL-DL and SWRL languages. As such, by considering these novel rules, a reasoning layer has been implemented so as to reason on spatiotemporal associations. Such efforts enable the introduction of novel procedures for consistency checking of product-process information and knowledge in PLM, and create a robust epistemological and methodological platform.

In future work, the PRONOA2 ontology model will be linked to information systems covering product design and assembly planning phases such as planned in Figure 1. As such, PDM and MPM systems will be associated through an ontology, which will bring a novel semantic layer in PLM. **Hence, designers will be supported to design a consistent product over space and time.** Next research efforts will also address the representation of spatiotemporal information within CAD application, so as to support concurrent and proactive engineering by defining product evolution at the early design stages.

References

- Al-Debei, M. M., M. M. Al Asswad, S. De Cesar, and M. Lycett (2012). Conceptual modelling and the quality of ontologies : endurantism vs perdurantism. *International Journal of Database Management Systems* 4(3), 1–19.
- Allen, J. F. (1983). Maintaining knowledge about temporal intervals. *Communications of the ACM* 26(11), 832–843.
- Asher, N. and L. Vieu (1995). Toward a geometry of common sense: A semantics and a complete axiomatization of mereotopology. In *International Joint Conference on Artificial Intelligence*, Volume 14, pp. 846–852.
- Batres, R., M. West, D. Leal, D. Price, and Y. Naka (2007). An upper ontology based on ISO 15926. *Computers and Chemical Engineering* 31, 519–534.
- Bennett, B., A. G. Cohn, P. Torrini, and S. Hazarika (2000). Describing rigid body motions in a qualitative theory of spatial regions. In *Proceedings of the National Conference on Artificial Intelligence*, pp. 503–509.
- Bergson, H. (1923). *Creative evolution*. H. Holt and Company.
- Bittner, T., M. Donnelly, and B. Smith (2004). Endurants and perdurants in directly depicting ontologies. *Artificial Intelligence Communications* 17(4), 247–258.
- Boothroyd, G., P. Dewhurst, and W. Knight (2002). *Product design for manufacture and assembly* (second edition ed.). Taylor and Francis.
- Borgo, S., N. Guarino, and C. Masolo (1996). A pointless theory of space based on strong connection and congruence. In *Principles of Knowledge Representation and Reasoning-International Conference*, pp. 220–229.
- Chandrasegaran, S., K. Ramani, R. D. Sriram, I. Horváth, A. Bernard, R. F. Harik, and W. Gao (2013). The evolution, challenges, and future of knowledge representation in product design systems. *Computer-Aided Design* 45(2), 204–228.
- Clarke, B. (1981). A calculus of individuals based on connection. *Notre Dame Journal of Formal Logic* 22(3), 204–218.
- De Laguna, T. (1922). Point, line, and surface, as sets of solids. *The Journal of Philosophy* 19(17), 449–461.
- Del Mondo, G., J. G. Stell, C. Claramunt, and R. Thibaud (2010). A graph model for spatiotemporal evolution. *Journal of universal computer science* 16(11), 1452–1477.
- Demoly, F., S. Deniaud, and S. Gomes (2012). Towards an harmonious and integrated management approach for lifecycle planning. In *International Conference on Advanced Production Management Systems*, Volume 398, Greece, pp. 208–215.
- Demoly, F., O. Dutartre, X.-T. Yan, B. Eynard, D. Kiritsis, and S. Gomes (2013). Product relationships management enabler for concurrent engineering and product lifecycle management. *Computers in Industry* 64(7), 833–848.
- Demoly, F., A. Matsokis, and D. Kiritsis (2012). A mereotopological product relationship description approach for assembly oriented design. *Robotics and Computer-Integrated Manufacturing* 28(6), 681–693.
- Demoly, F., H. J. Pels, and S. Gomes (2013). Proactive Engineering and PLM: Current Status and Research Challenges. In *Product Lifecycle Management for Society*, pp. 170–181. Springer.
- Demoly, F., L. Toussaint, B. Eynard, D. Kiritsis, and S. Gomes (2011). Geometric skeleton computation enabling concurrent product engineering and assembly sequence planning. *Computer-Aided Design* 43(12), 1654–1673.
- Demoly, F., X.-T. Yan, B. Eynard, S. Gomes, and D. Kiritsis (2012). Integrated product relationships management: a model to enable concurrent product design and

- 1
2
3
4
5 assembly sequence planning. *Journal of Engineering Design* 23(7), 544–561.
- 6 Demoly, F., X. T. Yan, B. Eynard, L. Rivest, and S. Gomes (2011). An assembly oriented
7 design framework for product structure engineering and assembly sequence planning.
8 *Robotics and Computer-Integrated Manufacturing* 27(1), 33–46.
- 9 Descartes, R. (1996). *Meditations on First Philosophy With Selections from the Objec-*
10 *tions and Replies* (Cambridge University Press ed.). John Cottingham.
- 11 Duntsch, I., H. Wang, and S. McCloskey (2001). A relation-algebraic approach to the
12 region connection calculus. *Theoretical Computer Science* 255, 63–83.
- 13 Eschenbach, C. (1999). A predication calculus for qualitative spatial representations.
14 In *Spatial Information Theory. Cognitive and Computational Foundations of Geo-*
15 *graphic Information Science*, Berlin, pp. 749–749. Springer.
- 16 Fenves, S., S. Foufou, C. Bock, and R. Sriram (2008a). CPM2: a core model for product
17 data. *Journal of Computing and Information Science in Engineering* 8(1), 14501.
- 18 Fenves, S. J., S. Foufou, C. Bock, and R. D. Sriram (2008b). CPM: A core model for
19 product data. *Journal of computing and information science in engineering* 5, 238–
20 246.
- 21 Galton, A. (1997). *Spatial and temporal reasoning* (Oliviero Stock ed.). Springer Neth.
- 22 Goodman, N. (1951). *The structure of appearance*. Harvard University Press.
- 23 Gruhier, E., F. Demoly, O. Dutartre, S. Abboudi, and S. Gomes (2015). A formal
24 ontology-based spatiotemporal mereotopology for integrated product design and as-
25 sembly sequence planning. *Advanced Engineering Informatics* 29, 495–512.
- 26 Gruhier, E., F. Demoly, and S. Gomes (2014). A spatiotemporal mereotopology-based
27 theory for qualitative description in assembly design and sequence planning. United
28 Kingdom, pp. 57–77. J.S. Gero.
- 29 Gruhier, E., F. Demoly, K. Y. Kim, and S. Gomes (2014). Mereotopology and product
30 design: state of the art and research challenges. Hungary, pp. 1099–1110. I. Horvath
31 and Z. Rusak.
- 32 Haddad, H. (2009). *Une approche pour supporter l'analyse qualitative des suites d'actions*
33 *dans un environnement géographique virtuel et dynamique*. Ph. D. thesis, Universite
34 Laval, Departement d'informatique.
- 35 Hadjieleftheriou, M., G. Kollios, V. Tsotras, and D. Gunopulos (2002). Efficient index-
36 ing of spatiotemporal objects. In *Advances in Database Technology*, pp. 251–268.
37 Springer.
- 38 Hawley, K. (2004). Temporal parts. *The Stanford of Encyclopedia Philosophy*.
- 39 Heidegger, M. (1962). *Being and time*. Harper and Row.
- 40 Horvath, I. and W. F. van Der Vegte (2003). Nucleus-Based Product Conceptualization-
41 Part 1: Principles and Formalization. In *International Conference on Engineering*
42 *Design*.
- 43 Kim, K. Y., H. Yang, and D. W. Kim (2008). Mereotopological assembly joint information
44 representation for collaborative product design. *Robotics and Computer-Integrated*
45 *Manufacturing* 24(6), 744–754.
- 46 Kusiak, A. and F. A. Salustri (2007). Computational intelligence in product design
47 engineering: review and trends. *IEEE Transactions on Systems Man and Cybernetics*
48 *Part C Applications and Reviews* 37(5), 766–778.
- 49 Le Moigne, J.-L. (1994). *La theorie du systeme general : theorie de la modelisation*.
50 Presses universitaires de France.
- 51 Lemon, O. and I. Pratt (1998). Complete logics for QSR: a guide to plane mereotopology.
52 *Journal of Visual Languages and Computing* 9, 5–21.
- 53 Lesniewski, S. (1929a). Fundamentals of a new system of the foundations of mathematics.
54
55
56
57
58
59
60

- 1
2
3
4
5 *Fundamenta Mathematicae* 14, 1–81.
- 6 Lesniewski, S. (1929b). On the foundations of ontology. *Comptes rendus des seances de*
7 *la societe des sciences et des lettres de Varsovie* 22, 111–132.
- 8 Mantripragada, R. (1998). *Assembly oriented design: concepts algorithms and compu-*
9 *tational tools*. Ph. D. thesis, Massachusetts Institute of Technology, Department of
10 mechanical engineering.
- 11 McKinney, K., J. Kim, M. Fischer, and C. Howard (1996). Interactive 4d-CAD. In
12 *Proceedings of the third Congress on Computing in Civil Engineering*, pp. 383–389.
- 13 Muller, P. (2002). Topological spatio-temporal reasoning and representation. *Computa-*
14 *tional Intelligence* 18(3), 420–450.
- 15 Randell, D. A. and A. G. Cohn (1989). Exploring naive topology: Modelling the force
16 pump. In *Proceedings of the Third International Qualitative Physics Workshop*.
- 17 Renolen, A. (1999). Concepts and methods for modelling temporal and spatiotemporal
18 information. Technical report, NTNU.
- 19 Rodier, X., L. Saligny, B. Lefebvre, and J. Pouliot (2010). ToToPI a GIS for understand-
20 ing urban dynamics based on the OH FET model. Virginia, USA, pp. 337–349.
- 21 Fricher B., Crawford J., Koler D.
- 22 Salustri, F. A. (2002). Mereotopology for product modeling. A new framework for prod-
23 uct modeling based on logic. *The Journal of Design Research* 2.
- 24 Salustri, F. A. and J. C. Lockledge (1999). Towards a formal theory of products including
25 mereology. In *Proceeding of 12th International Conference on Engineering Design*,
26 pp. 1125–1130.
- 27 Sider, T. (2001). *Four dimensionalism: an ontology of persistence and time*. Oxford,
28 Clarendon Press.
- 29 Smith, B. (1996). Mereotopology: a theory of parts and boundaries. *Data and Knowledge*
30 *Engineering* 20(3), 287–303.
- 31 Standard, I. . (2003). *Integration of lifecycle data for process plant including oil and gas*
32 *production facilities*. ISO.
- 33 Stell, J. G. and M. West (2004). A four-dimensionalist mereotopology. In *Formal On-*
34 *tology in Information Systems*, pp. 261–272.
- 35 Sudarsan, R., S. Fenves, R. Sriram, and F. Wang (2005). A product information modeling
36 framework for product lifecycle management. *Computer-Aided Design* 37(13), 1399–
37 1411.
- 38 Swain, A., D. Sen, and B. Gurumoorthy (2014). Extended liaison as an interface be-
39 tween product and process model in assembly. *Robotics and Computer-Integrated*
40 *Manufacturing* 30(5), 527–545.
- 41 Tarski, A. (1956). *Foundations of the geometry of solids* (Woodger, J., Corcoran, J. ed.).
42 Trans. Hackett.
- 43 Varzi, A. C. (1996). Parts, wholes, and part-whole relations: The prospects of mereotopol-
44 ogy. *Data and Knowledge Engineering* 20(3), 259–286.
- 45 Varzi, A. C. (1998). Basic problems of mereotopology. In *Formal Ontology in Information*
46 *Systems*. IOS Press, Italy, pp. 29–38. IOS Press.
- 47 Wang, L., S. Keshavarzmanesh, H.-Y. Feng, and R. Buchal (2008). Assembly process
48 planning and its future in collaborative manufacturing: a review. *The International*
49 *Journal of Advanced Manufacturing Technology* 41(1-2), 132–144.
- 50 Whitehead, A. N. (1929). *Process and reality an essay in cosmology*. New York: Macmil-
51 lan.
- 52 Zeng, Y. and P. Gu (1999). A science-based approach to product design theory Part II:
53 Formulation of design requirements and products. *Robotics and Computer Integrated*
54
55
56
57
58
59
60

1
2
3
4
5 *Manufacturing 15(4)*, 341–352.

6 Zha, X. F. and H. Du (2002). A PDES/STEP-based model and system for concurrent
7 integrated design and assembly planning. *Computer-Aided Design 34(14)*, 1087–
8 1110.
9

10
11
12 **Appendix A. Mereotopological description of the “kinematic pairs
13 positioning” primitives**

14
15
16 **Appendix B. Mereotopological description of the “design changes”
17 primitives**

18
19 **Appendix C. Mereotopological description of non-permanent assembly
20 with added entities**

21
22 **Appendix D. Mereotopological description of permanent assembly
23 with added entities**

24
25
26 **Appendix E. Mereotopological description of permanent assembly
27 without added entities**
28
29
30
31
32
33
34
35
36
37
38
39
40
41
42
43
44
45
46
47
48
49
50
51
52
53
54
55
56
57
58
59
60

Table 12. Mereotopological description of the mechanical case study

OP No.	Spatiotemporal primitive	Mereotopological description	Skeleton
10	2 RevoluteOP 3	$((3D2) \wedge (3Ok_1) \wedge (2Dk_1))_{TR1} \wedge (2Move3)_{TR2} \wedge ((3D2) \wedge (3Ok_1) \wedge (2Ok_1))_{TR3} \wedge (2Move3)_{TR4} \wedge ((3X2) \wedge (3Ok_1) \wedge (2Ok_1))_{TR5} \wedge (2Move3)_{TR6} \wedge ((3T2) \wedge (3X2) \wedge (3Ok_1) \wedge (3Tk_2) \wedge (3Tf_2) \wedge (2Ok_1) \wedge (2Tk_2) \wedge (2Tf_2))_{TR7}$	k_1 line, k_2 plane, f_2 surface
20	4 RevoluteOP 3	$((3D4) \wedge (3Ok_1) \wedge (4Dk_1))_{TR1} \wedge (4Move3)_{TR2} \wedge ((3D4) \wedge (3Ok_1) \wedge (4Ok_1))_{TR3} \wedge (4Move3)_{TR4} \wedge ((3X4) \wedge (3Ok_1) \wedge (4Ok_1))_{TR5} \wedge (4Move3)_{TR6} \wedge ((3T4) \wedge (3X4) \wedge (3Ok_1) \wedge (3Tk_4) \wedge (3Tf_4) \wedge (4Ok_1) \wedge (4Tk_4) \wedge (4Tf_4))_{TR7}$	k_1 line, k_4 plane, f_4 surface
30	SA RevoluteOP 1	$((1DSA) \wedge (1Ok_1) \wedge (SADk_1))_{TR1} \wedge (SAMove1)_{TR2} \wedge ((1DSA) \wedge (1Ok_1) \wedge (SAOk_1))_{TR3} \wedge (SAMove1)_{TR4} \wedge ((1XSA) \wedge (1Ok_1) \wedge (SAOk_1))_{TR5} \wedge (SAMove1)_{TR6} \wedge ((1TSA) \wedge (1XSA) \wedge (1Ok_1) \wedge (1Tk_3) \wedge (1Tf_3) \wedge (SAOk_1) \wedge (4Tk_3) \wedge (4Tf_3))_{TR7}$	k_1 line, k_3 plane, f_3 surface
40	5 CylindricalOP 1 and 5 PlanarOP 4	$((1D5) \wedge (1Ok_1) \wedge (5Dk_1))_{TR1} \wedge (5Movex)_{TR2} \wedge ((1D5) \wedge (1Ok_1) \wedge (5Ok_1))_{TR3} \wedge (5Move1)_{TR4} \wedge ((1X5) \wedge (1Ok_1) \wedge (5Ok_1))_{TR5} \wedge (5Move4)_{TR6} \wedge ((4T5) \wedge (4Tf_5) \wedge (5Tk_5) \wedge (k_5Tf_5))_{TR7}$	k_1 line, k_5 plane, f_5 surface
50	6 ScrewOP 1 and 6 PlanarOP 5	$((1D6) \wedge (1Ok_1) \wedge (6Dk_1))_{TR1} \wedge (6Move1)_{TR2} \wedge ((1D6) \wedge (1Ok_1) \wedge (6Ok_1))_{TR3} \wedge (6Move1)_{TR4} \wedge ((1X6) \wedge (1Ok_1) \wedge (6Ok_1))_{TR5} \wedge (6Move5)_{TR6} \wedge ((5T6) \wedge (5Tf_6) \wedge (6Tk_6) \wedge (f_6Tk_6))_{TR7}$	k_1 line, k_6 plane, f_6 surface

Table A1. Mereotopological description of the "kinematic pairs positioning" primitives



Name	Mereotopological description	Representation	Comment
Moves	$(x\mathbf{T}k_1)_{TR1} \wedge (x\mathbf{T}k_2)_{TR2}$		k_1 and k_2 point, line or surface
CylindricalOP	$((x\mathbf{D}y) \wedge (x\mathbf{O}k) \wedge (y\mathbf{D}k))_{TR1} \wedge (y\mathbf{M}ove\mathbf{x})_{TR2} \wedge ((x\mathbf{D}y) \wedge (x\mathbf{O}k) \wedge (y\mathbf{O}k))_{TR3} \wedge (y\mathbf{M}ove\mathbf{x})_{TR4} \wedge ((x\mathbf{X}y) \wedge (x\mathbf{O}k) \wedge (y\mathbf{O}k))_{TR5} \wedge (y\mathbf{M}ove\mathbf{x})_{TR6} \wedge ((x\mathbf{X}y) \wedge (x\mathbf{O}k) \wedge (y\mathbf{T}f))_{TR7}$		k line, f surface
PrismaticOP	$((x\mathbf{D}y)_{TR1} \wedge (y\mathbf{M}ove\mathbf{x})_{TR2} \wedge ((x\mathbf{S}t\mathbf{y}) \wedge (x\mathbf{I}P\mathbf{y}) \wedge (x\mathbf{T}f) \wedge (y\mathbf{T}f) \wedge (x\mathbf{O}k) \wedge (y\mathbf{O}k))_{TR3}$		k point, f surface
SphericalOP	$((x\mathbf{D}y) \wedge (x\mathbf{O}k_1) \wedge (y\mathbf{D}k_1))_{TR1} \wedge (y\mathbf{M}ove\mathbf{x})_{TR2} \wedge ((x\mathbf{D}y) \wedge (x\mathbf{O}k_1) \wedge (y\mathbf{O}k_1))_{TR3} \wedge (y\mathbf{M}ove\mathbf{x})_{TR4} \wedge ((x\mathbf{X}y) \wedge (x\mathbf{O}k_1) \wedge (y\mathbf{O}k_1))_{TR5} \wedge (y\mathbf{M}ove\mathbf{x})_{TR6} \wedge ((x\mathbf{T}y) \wedge (x\mathbf{X}y) \wedge (x\mathbf{O}k_1) \wedge (x\mathbf{T}k_2) \wedge (x\mathbf{T}f) \wedge (y\mathbf{O}k_1) \wedge (y\mathbf{T}k_2) \wedge (y\mathbf{T}f))_{TR7}$		k_1 line and k_2 plane, f surface
PlanarOP	$((x\mathbf{D}y) \wedge (x\mathbf{T}k))_{TR1} \wedge (y\mathbf{M}ove\mathbf{x})_{TR2}$		k plane, f surface
PointContactOP	$((x\mathbf{T}y) \wedge (x\mathbf{T}f) \wedge (y\mathbf{T}k) \wedge (f\mathbf{T}k))_{TR3}$		k point, f point
LineContactOP			k line, f segment
ScrewOP	$((x\mathbf{D}y) \wedge (x\mathbf{O}k_1) \wedge (y\mathbf{D}k_1))_{TR1} \wedge (y\mathbf{M}ove\mathbf{x})_{TR2} \wedge ((x\mathbf{D}y) \wedge (x\mathbf{O}k_1) \wedge (y\mathbf{O}k_1))_{TR3} \wedge (y\mathbf{M}ove\mathbf{x})_{TR4} \wedge ((x\mathbf{X}y) \wedge (x\mathbf{O}k_1) \wedge (y\mathbf{O}k_1))_{TR5} \wedge (y\mathbf{M}ove\mathbf{x})_{TR6} \wedge ((x\mathbf{X}y) \wedge (x\mathbf{O}k_1) \wedge (y\mathbf{O}k_1) \wedge (y\mathbf{T}f_1) \wedge (f_2\mathbf{O}f_3) \wedge (y\mathbf{T}f_2) \wedge (x\mathbf{T}f_3))_{TR7}$		k_1 line, f_1 area, f_2 and f_3 elliptical curve
Rotation	$((x\mathbf{O}k_2) \wedge (k_1\mathbf{O}k_2) \wedge (k_1\mathbf{O}k_3) \wedge (k_2\mathbf{D}k_3))_{TR1} \wedge (x\mathbf{M}ove\mathbf{k}_1)_{TR2} \wedge ((x\mathbf{O}k_2) \wedge (k_1\mathbf{O}k_2) \wedge (k_1\mathbf{O}k_3) \wedge (k_2\mathbf{O}k_3) \wedge (x\mathbf{O}k_3))_{TR3}$		k_1 point, k_2 and k_3 line

Table B1. Mereotopological description of the “design changes” primitives

Name	Mereotopological description	Representation	Comment
Serial-Permutation	$((xRz) \wedge (yRz) \wedge (xRy) \wedge (xTf) \wedge (xRk) \wedge (zTf_1) \wedge (zTf_2) \wedge (yTf_2))_{TR1} \wedge (yRk)_{TR1} \wedge (xMovez)_{TR2} \wedge ((xDz) \wedge (yRz) \wedge (xDy) \wedge (zTf_2) \wedge (yTf_2) \wedge (yRk)_{TR3} \wedge (yMovez)_{TR4} \wedge ((xDz) \wedge (yDz) \wedge (xDy))_{TR5} \wedge (yMovez)_{TR6} \wedge ((xDz) \wedge (yDz) \wedge (yTf_1) \wedge (yRk) \wedge (zTf_1))_{TR7} \wedge (xMovez)_{TR8} \wedge ((xRz) \wedge (yRz) \wedge (xRy) \wedge (xTf_2) \wedge (xRk) \wedge (zTf_1) \wedge (zTf_2) \wedge (yTf_1) \wedge (yRk))_{TR9}$		k line, f_1 and f_2 surface
Parallel-Permutation	$((xRz) \wedge (yRz) \wedge (xDy) \wedge (xTf_1) \wedge (xRk_1) \wedge (zTf_1) \wedge (zTf_2) \wedge (yTf_2) \wedge (yRk_2) \wedge (f_1Df_2) \wedge (k_1Dk_2))_{TR1} \wedge (xMovez) \wedge (yMovez)_{TR2} \wedge ((xDz) \wedge (yDz) \wedge (xDy))_{TR3} \wedge ((xMovez) \wedge (yMovez)_{TR4} \wedge ((xRz) \wedge (yRz) \wedge (xDy) \wedge (xTf_2) \wedge (xRk_2) \wedge (zTf_1) \wedge (zTf_2) \wedge (yTf_1) \wedge (yRk_1) \wedge (f_1Df_2) \wedge (k_1Dk_2))_{TR5}$		k_1 and k_2 line, f_1 and f_2 surface
Addition	$(xP\emptyset)_{TR1} \wedge ((xPA) \wedge (xTf))_{TR2}$		f surface
Deletion	$((xPA) \wedge (xTf))_{TR1} \wedge (xP\emptyset)_{TR2}$		f surface
Split	$((\emptyset Additiony) \wedge (\emptyset Additionz) \wedge (x\delta y) \wedge (x\delta z) \wedge (xTf_1))_{TR1} \wedge ((yPx) \wedge (zPx) \wedge (zTf_1) \wedge (yTf_2))_{TR2} \wedge ((xDeletion\emptyset) \wedge (zTf_1) \wedge (yTf_2))_{TR3}$		f_1 and f_2 surface
Union	$((xAddition\emptyset) \wedge (zTf_1) \wedge (yTf_2))_{TR1} \wedge ((yPx) \wedge (zPx) \wedge (zTf_1) \wedge (yTf_2))_{TR2} \wedge ((\emptyset Deletiony) \wedge (\emptyset Deletionz) \wedge (x\delta y) \wedge (x\delta z) \wedge (xTf_1))_{TR3}$		f_1 and f_2 surface
ChangeOfForm			
Deformation			
Growing	$(xTf_1)_{TR1} \wedge (xTf_2)_{TR2}$		f_1 and f_2 surface
Decrease			

Table C1. Mereotopological description of non-permanent assembly with added entities

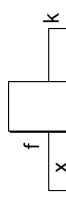
Name	Mereotopological description	Representation	Comment
	$((x\mathbf{T}y) \wedge (u\mathbf{D}x) \wedge (p\mathbf{T}u) \wedge (p\mathbf{T}f_2) \wedge$		
	$(u\mathbf{T}f_2) \wedge (p\mathbf{T}k_4) \wedge (u\mathbf{T}k_4) \wedge$		
	$(x\mathbf{T}k_3) \wedge (y\mathbf{T}k_3) \wedge (x\mathbf{O}k_1) \wedge$		
	$(y\mathbf{O}k_1) \wedge (u\mathbf{O}k_1) \wedge (p\mathbf{O}k_1))_{TR1} \wedge$		
	$((p\mathbf{CylindricalOP}x)$		
Mechanical-	$(u\mathbf{ScrewOP}x))_{TR2} \wedge (u\mathbf{X}x)_{TR3} \wedge$	<p>(k_1 line, k_2, k_3 and k_4 plane, f_1 and f_2 surface)</p>	
Fastening-	$((p\mathbf{CylindricalOP}x)$		
ByThreaded-	$(u\mathbf{ScrewOP}x))_{TR4} \wedge (u\mathbf{X}y)_{TR5} \wedge$		
Fasteners	$((p\mathbf{CylindricalOP}x)$		
	$(u\mathbf{ScrewOP}x))_{TR6}$		
	$((u\mathbf{T}x) \wedge (u\mathbf{T}f_1) \wedge (x\mathbf{T}f_1) \wedge$		
	$(u\mathbf{T}k_2) \wedge (x\mathbf{T}k_2))_{TR7} \wedge$		
	$(p\mathbf{PrismaticOP}x)_{TR8}$		
	$(p\mathbf{Deletion}\emptyset)_{TR9}$		

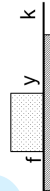
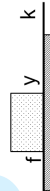
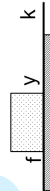
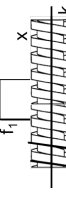
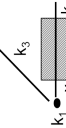
Peer Review Only

Table D1. Mereotopological description of permanent assembly with added entities (1)

Name	Mereotopological description	Representation	Comment
Gas Welding	$((x\mathbf{T}y) \wedge (x\mathbf{T}k) \wedge (y\mathbf{T}k))_{TR1} \wedge$ $((x\mathbf{Deformation}p) \wedge (y\mathbf{Deformation}p) \wedge$ $(u\mathbf{Deformation}p) \wedge (u\mathbf{Move}x) \wedge$ $(p\mathbf{Move}x))_{TR2} \wedge ((x\mathbf{St}y) \wedge (u\mathbf{St}x) \wedge$ $(u\mathbf{St}y) \wedge (u\mathbf{D}p) \wedge (x\mathbf{D}p) \wedge (u\mathbf{T}f) \wedge (x\mathbf{T}f) \wedge$ $(y\mathbf{T}f) \wedge (y\mathbf{D}p))_{TR3} \wedge (p\mathbf{Deletion}\emptyset)_{TR4}$		<i>k</i> line and <i>f</i> segment
Soldering	$((x\mathbf{T}y) \wedge (x\mathbf{T}k) \wedge (y\mathbf{T}k))_{TR1} \wedge ((u\mathbf{Move}x) \wedge$ $(u\mathbf{Deformation}p) \wedge (p\mathbf{Move}x))_{TR2} \wedge$ $((u\mathbf{St}x) \wedge (u\mathbf{St}y) \wedge (u\mathbf{D}p) \wedge (x\mathbf{D}p) \wedge$ $(u\mathbf{T}f) \wedge (x\mathbf{T}f) \wedge (y\mathbf{T}f) \wedge (y\mathbf{D}p))_{TR3} \wedge$ $(p\mathbf{Deletion}\emptyset)_{TR4}$		<i>k</i> line and <i>f</i> segment
Brazing	$((x\mathbf{T}u) \wedge (x\mathbf{T}k_1) \wedge (u\mathbf{T}k_1) \wedge (u\mathbf{T}f_1) \wedge$ $(x\mathbf{T}f_1))_{TR1} \wedge (y\mathbf{PrismaticOP}x)_{TR2} \wedge$ $((y\mathbf{T}k_2) \wedge (y\mathbf{T}u) \wedge (u\mathbf{T}k_2) \wedge (u\mathbf{T}f_2) \wedge$ $(y\mathbf{T}f_2))_{TR3} \wedge ((p\mathbf{PrismaticOP}y) \wedge$ $(u\mathbf{Deformation}p))_{TR4} \wedge ((p\mathbf{T}y) \wedge (u\mathbf{St}x) \wedge$ $(u\mathbf{St}y) \wedge (y\mathbf{T}k_3) \wedge (p\mathbf{T}k_3) \wedge (p\mathbf{T}f_3) \wedge$ $(y\mathbf{T}f_3))_{TR5} \wedge (p\mathbf{PrismaticOP}y)_{TR6} \wedge$ $(p\mathbf{Deletion}\emptyset)_{TR7}$		<i>k</i> line and <i>f</i> segment
Adhesive-Bonding	$((x\mathbf{D}u) \wedge (u\mathbf{O}k_1) \wedge (x\mathbf{O}k_1))_{TR1} \wedge$ $((u\mathbf{PrismaticOP}x) \wedge$ $(u\mathbf{Deformation}x))_{TR2} \wedge ((u\mathbf{T}x) \wedge$ $(u\mathbf{X}x) \wedge (u\mathbf{T}k_3) \wedge (x\mathbf{T}k_3) \wedge (u\mathbf{T}k_2) \wedge$ $(x\mathbf{T}k_2))_{TR3} \wedge (u\mathbf{PrismaticOP}x) \wedge$ $(u\mathbf{Deformation}x))_{TR4} \wedge (u\mathbf{St}x)_{TR5}$		<i>k</i> line and <i>f</i> segment
SnapIn	$((x\mathbf{D}u) \wedge (u\mathbf{O}k_1) \wedge (x\mathbf{O}k_1))_{TR1} \wedge$ $((u\mathbf{PrismaticOP}x) \wedge$ $(u\mathbf{Deformation}x))_{TR2} \wedge ((u\mathbf{T}x) \wedge$ $(u\mathbf{X}x) \wedge (u\mathbf{T}k_3) \wedge (x\mathbf{T}k_3) \wedge (u\mathbf{T}k_2) \wedge$ $(x\mathbf{T}k_2))_{TR3} \wedge (u\mathbf{PrismaticOP}x) \wedge$ $(u\mathbf{Deformation}x))_{TR4} \wedge (u\mathbf{St}x)_{TR5}$		<i>k</i> line and <i>f</i> segment

Table D2. Mereotopological description of permanent assembly with added entities (2)

Name	Mereotopological description	Representation	Comment
Nail-Assembly	$ \begin{aligned} & ((x\mathbf{T}y) \wedge (p\mathbf{T}u) \wedge (u\mathbf{D}x) \wedge (x\mathbf{O}k_1) \wedge (y\mathbf{O}k_1) \wedge \\ & (x\mathbf{T}k_2) \wedge (y\mathbf{T}k_2) \wedge (u\mathbf{O}k_1) \wedge (p\mathbf{O}k_1) \wedge (p\mathbf{T}k_4) \wedge \\ & (u\mathbf{T}k_4) \wedge (p\mathbf{T}f_2) \wedge (u\mathbf{T}f_2))_{TR1} \wedge ((p\mathbf{PrismaticOP}x) \wedge \\ & (u\mathbf{PrismaticOP}x) \wedge (x\mathbf{Deformation}u))_{TR2} \wedge \\ & (u\mathbf{X}x)_{TR3} \wedge ((p\mathbf{PrismaticOP}x) \wedge (u\mathbf{PrismaticOP}x) \wedge \\ & (x\mathbf{Deformation}u) \wedge (y\mathbf{Deformation}u))_{TR4} \wedge ((u\mathbf{X}x) \wedge \\ & (u\mathbf{X}y))_{TR5} \wedge ((p\mathbf{PrismaticOP}x) \wedge (u\mathbf{PrismaticOP}x) \wedge \\ & (x\mathbf{Deformation}u) \wedge (y\mathbf{Deformation}u))_{TR6} \wedge ((u\mathbf{X}x) \wedge \\ & (u\mathbf{X}y) \wedge (u\mathbf{T}x) \wedge (u\mathbf{T}k_3) \wedge (x\mathbf{T}k_3) \wedge (u\mathbf{T}f_1) \wedge \\ & (x\mathbf{T}f_1))_{TR7} \wedge (p\mathbf{PrismaticOP}x)_{TR8} \wedge (p\mathbf{D}u)_{TR9} \wedge \\ & (p\mathbf{PrismaticOP}x)_{TR10} \wedge (p\mathbf{Deletion}\emptyset)_{TR11} \\ & ((x\mathbf{T}y) \wedge (p\mathbf{X}x) \wedge (p\mathbf{X}y) \wedge (u\mathbf{I}p) \wedge (x\mathbf{T}k_2) \wedge (y\mathbf{T}k_2))_{TR1} \wedge \\ & ((p\mathbf{PrismaticOP}x) \wedge (u\mathbf{PrismaticOP}x))_{TR2} \wedge ((p\mathbf{X}x) \wedge \\ & (p\mathbf{X}y) \wedge (p\mathbf{T}x) \wedge (p\mathbf{T}y))_{TR3} \wedge ((u\mathbf{PrismaticOP}x) \wedge \\ & (x\mathbf{Deformation}u))_{TR4} \wedge (u\mathbf{X}x)_{TR5} \wedge \\ & ((u\mathbf{PrismaticOP}x) \wedge (y\mathbf{Deformation}u))_{TR6} \wedge ((u\mathbf{T}p) \wedge \\ & (u\mathbf{X}y))_{TR7} \wedge (u\mathbf{Deformation}x)_{TR8} \wedge ((u\mathbf{X}y) \wedge (u\mathbf{X}y) \wedge \\ & (u\mathbf{T}x) \wedge (p\mathbf{X}x) \wedge (p\mathbf{X}y) \wedge (u\mathbf{T}f) \wedge (x\mathbf{T}f) \wedge (x\mathbf{T}k_1) \wedge \\ & (u\mathbf{T}k_1))_{TR9} \wedge (u\mathbf{Deformation}p)_{TR10} \wedge ((u\mathbf{T}y) \wedge \\ & (u\mathbf{T}k_3) \wedge (y\mathbf{T}k_3))_{TR11} \wedge (p\mathbf{PrismaticOP}x)_{TR12} \wedge \\ & (p\mathbf{Deletion}\emptyset)_{TR13} \end{aligned} $	<p>k_4, k_1 line, k_2, k_3 and k_4 plane, f_1 and f_2 surface</p>	
Metal-Stitching	$ \begin{aligned} & ((x\mathbf{T}y) \wedge (p\mathbf{T}u) \wedge (u\mathbf{D}x) \wedge (x\mathbf{O}k_1) \wedge (y\mathbf{O}k_1) \wedge \\ & (x\mathbf{T}k_2) \wedge (y\mathbf{T}k_2) \wedge (u\mathbf{O}k_1) \wedge (p\mathbf{O}k_1) \wedge (p\mathbf{T}k_4) \wedge \\ & (u\mathbf{T}k_4) \wedge (p\mathbf{T}f_2) \wedge (u\mathbf{T}f_2))_{TR1} \wedge ((p\mathbf{PrismaticOP}x) \wedge \\ & (u\mathbf{PrismaticOP}x) \wedge (x\mathbf{Deformation}u))_{TR2} \wedge \\ & (u\mathbf{X}x)_{TR3} \wedge ((p\mathbf{PrismaticOP}x) \wedge (u\mathbf{PrismaticOP}x) \wedge \\ & (x\mathbf{Deformation}u) \wedge (y\mathbf{Deformation}u))_{TR4} \wedge ((u\mathbf{X}x) \wedge \\ & (u\mathbf{X}y))_{TR5} \wedge ((p\mathbf{PrismaticOP}x) \wedge (u\mathbf{PrismaticOP}x) \wedge \\ & (x\mathbf{Deformation}u) \wedge (y\mathbf{Deformation}u))_{TR6} \wedge ((u\mathbf{X}x) \wedge \\ & (u\mathbf{X}y) \wedge (u\mathbf{T}x) \wedge (u\mathbf{T}k_3) \wedge (x\mathbf{T}k_3) \wedge (u\mathbf{T}f_1) \wedge \\ & (x\mathbf{T}f_1))_{TR7} \wedge (p\mathbf{PrismaticOP}x)_{TR8} \wedge (p\mathbf{D}u)_{TR9} \wedge \\ & (p\mathbf{PrismaticOP}x)_{TR10} \wedge (p\mathbf{Deletion}\emptyset)_{TR11} \\ & ((x\mathbf{T}y) \wedge (p\mathbf{X}x) \wedge (p\mathbf{X}y) \wedge (u\mathbf{I}p) \wedge (x\mathbf{T}k_2) \wedge (y\mathbf{T}k_2))_{TR1} \wedge \\ & ((p\mathbf{PrismaticOP}x) \wedge (u\mathbf{PrismaticOP}x))_{TR2} \wedge ((p\mathbf{X}x) \wedge \\ & (p\mathbf{X}y) \wedge (p\mathbf{T}x) \wedge (p\mathbf{T}y))_{TR3} \wedge ((u\mathbf{PrismaticOP}x) \wedge \\ & (x\mathbf{Deformation}u))_{TR4} \wedge (u\mathbf{X}x)_{TR5} \wedge \\ & ((u\mathbf{PrismaticOP}x) \wedge (y\mathbf{Deformation}u))_{TR6} \wedge ((u\mathbf{T}p) \wedge \\ & (u\mathbf{X}y))_{TR7} \wedge (u\mathbf{Deformation}x)_{TR8} \wedge ((u\mathbf{X}y) \wedge (u\mathbf{X}y) \wedge \\ & (u\mathbf{T}x) \wedge (p\mathbf{X}x) \wedge (p\mathbf{X}y) \wedge (u\mathbf{T}f) \wedge (x\mathbf{T}f) \wedge (x\mathbf{T}k_1) \wedge \\ & (u\mathbf{T}k_1))_{TR9} \wedge (u\mathbf{Deformation}p)_{TR10} \wedge ((u\mathbf{T}y) \wedge \\ & (u\mathbf{T}k_3) \wedge (y\mathbf{T}k_3))_{TR11} \wedge (p\mathbf{PrismaticOP}x)_{TR12} \wedge \\ & (p\mathbf{Deletion}\emptyset)_{TR13} \end{aligned} $	<p>k_1, k_2 and k_3 X plane and f surface and f face</p>	

Table D3. Mereotopological description of permanent assembly with added entities (3)

Name	Mereotopological description	Representation	Comment
SimpleRivet	$ \begin{aligned} & ((uBs) \wedge (\emptyset \text{Addition}y) \wedge (uBf_2) \wedge (uOk_1) \wedge (sOk_1))_{TR1} \wedge \\ & (y\text{PrismaticOP}x)_{TR2} \wedge ((uTy) \wedge (uXy) \wedge (\emptyset \text{Addition}x) \wedge \\ & (uTk_2) \wedge (yTk_2) \wedge (yOk_1))_{TR3} \wedge (x\text{PrismaticOP}y)_{TR4} \wedge \\ & ((uTy) \wedge (uXx) \wedge (\emptyset \text{Addition}p) \wedge (xOk_1) \wedge (xTk_3) \wedge x \\ & (yTk_3))_{TR5} \wedge (p\text{PrismaticOP}x)_{TR6} \wedge ((pBu) \wedge y \\ & (pOk_1) \wedge (uBf_1) \wedge (pBf_1))_{TR7} \wedge ((p\text{PrismaticOP}x) \wedge \\ & (u\text{Deformation}p))_{TR8} \wedge ((uTx) \wedge (pTx) \wedge (uTk_4) \wedge \\ & (pTk_4))_{TR9} \wedge (p\text{PrismaticOP}x)_{TR10} \wedge (p\text{Deletion}\emptyset)_{TR11} \end{aligned} $		k_1 line, k_2 , k_3 and k_4 plane, f_1 and f_2 surface
DoubleRivet	$ \begin{aligned} & ((vTs) \wedge (\emptyset \text{Addition}y) \wedge (vOk_1) \wedge (vTk_5) \wedge (sOk_1))_{TR1} \wedge \\ & (y\text{PrismaticOP}x)_{TR2} \wedge ((\emptyset \text{Addition}x) \wedge (vTk_2) \wedge \\ & (yTk_2) \wedge (vXy) \wedge (yOk_1))_{TR3} \wedge (x\text{PrismaticOP}y)_{TR4} \wedge \\ & ((\emptyset \text{Addition}u) \wedge (xOk_1) \wedge (xTk_3) \wedge (yTk_3) \wedge (vXx))_{TR5} \wedge \\ & (u\text{PrismaticOP}x)_{TR6} \wedge ((\emptyset \text{Addition}p) \wedge (uTk_5) \wedge (uStv) \wedge \\ & (uXx) \wedge (uXy))_{TR7} \wedge (p\text{PrismaticOP}x)_{TR8} \wedge ((pBu) \wedge \\ & (pOk_1) \wedge (uBf_1) \wedge (pBf_1))_{TR9} \wedge ((p\text{PrismaticOP}x) \wedge \\ & (u\text{Deformation}p) \wedge (v\text{Deformation}x))_{TR10} \wedge ((uTx) \wedge \\ & (pTx) \wedge (uTk_4) \wedge (pTk_4) \wedge (vBf_2) \wedge (vTy) \wedge (vBs))_{TR11} \wedge \\ & (p\text{PrismaticOP}x)_{TR12} \wedge (p\text{Deletion}\emptyset)_{TR13} \end{aligned} $		k_1 line, k_2 , k_3 , k_4 and k_5 plane, f_1 and f_2 surface
Compression	$ \begin{aligned} & ((xTy) \wedge (pXv) \wedge (pTu) \wedge (uDx) \wedge (uXv) \wedge \\ & (xTk_2) \wedge (yTk_2) \wedge (xOk_1) \wedge (yOk_1) \wedge (vOk_1) \wedge \\ & (uOk_1) \wedge (pOk_1))_{TR1} \wedge (p\text{PrismaticOP}x)_{TR2} \wedge \\ & (uXx)_{TR3} \wedge (p\text{PrismaticOP}x)_{TR4} \wedge (uTk_3) \wedge (uTf) \wedge \\ & (p\text{PrismaticOP}x)_{TR6} \wedge ((uTx) \wedge (uTk_3) \wedge (uTf) \wedge \\ & (xTf) \wedge (xTk_3))_{TR7} \wedge ((v\text{PrismaticOP}x) \wedge \\ & (u\text{Deformation}p))_{TR8} \wedge (uTy)_{TR9} \wedge ((v\text{Split}a) \wedge (v\text{Split}b)) \wedge \\ & (p\text{PrismaticOP}x)_{TR10} \wedge ((pDx) \wedge (uIPu) \wedge (bIPp) \wedge \\ & (p\text{Deletion}\emptyset) \wedge (b\text{Deletion}\emptyset))_{TR11} \end{aligned} $		k_1 line, k_2 and k_3 plane, f surface

Table E1. Mereotopological description of permanent assembly without added entities

Name	Mereotopological description	Representation	Comment
ArcWelding	$((xTy) \wedge (pDx) \wedge (pDy) \wedge (xTk) \wedge (yTk))_{TR1} \wedge ((xDeformationp) \wedge (yDeformationp))_{TR2} \wedge ((xSty) \wedge (xStk) \wedge yStk) \wedge (pDeletion\emptyset)_{TR3}$		k plane
SpotWelding	$((xTy) \wedge (pDx) \wedge (sTy) \wedge (pOk_1) \wedge (sOk_1) \wedge (xOk_1) \wedge (yOk_1) \wedge (sTf_2) \wedge (sTk_2) \wedge (yTk_2) \wedge (yTf_2) \wedge (xTk_3) \wedge (yTk_3))_{TR1} \wedge (pPrismaticOPx)_{TR2} \wedge ((pTx) \wedge (pTf_1) \wedge (xTk_4) \wedge (pTk_4))_{TR3} \wedge ((xDeformationp) \wedge (yDeformationp))_{TR4} \wedge ((xSty) \wedge (xStk_3) \wedge (yStk_3))_{TR5} \wedge ((pPrismaticOPx) \wedge (sPrismaticOPx))_{TR6} \wedge ((pDeletion\emptyset) \wedge (sDeletion\emptyset))_{TR7}$		k1 line, k2, k3 and k4 plane, f1 and f2 surface
Clinching	$((xTs) \wedge (xTk_2) \wedge (xTk_1) \wedge (xTf_1) \wedge (pTk_2) \wedge (pTf_2) \wedge (sTk_1) \wedge (sTf_1) \wedge (xTy) \wedge (yTp) \wedge (yTk_4) \wedge (yTk_2) \wedge (yTf_2))_{TR1} \wedge ((pPrismaticOPx) \wedge (xDeformationp) \wedge (yDeformationp))_{TR2} \wedge ((sBx) \wedge (pBy) \wedge (xSty) \wedge (xStk_4) \wedge (yStk_4))_{TR3} \wedge (pPrismaticOPx)_{TR4} \wedge ((pDeletion\emptyset) \wedge (sDeletion\emptyset))_{TR5}$		k3 line, k1, k2 and k4 plane, f1 and f2 surface
Crimping	$((xXy) \wedge (xTk_3) \wedge (yTk_3) \wedge (pTy) \wedge (pXy) \wedge (xOk_1) \wedge (yOk_1) \wedge (yTk_2) \wedge (pTk_2))_{TR1} \wedge ((pDecreasex) \wedge (yDeformationp) \wedge (xDeformationy))_{TR2} \wedge ((pBy) \wedge (yStx) \wedge (xStk_3) \wedge (yStk_3))_{TR3} \wedge (pPrismaticOPx)_{TR4} \wedge (pDeletion\emptyset)_{TR5}$		k1 line and k2, k3 plane
Interference-Fit	$((xDy) \wedge (xOk_1) \wedge (yOk))_{TR1} \wedge ((yGrowingx) \wedge (yPrismaticOPx))_{TR2} \wedge (xXy)_{TR3} \wedge (yDecreasex)_{TR4} \wedge ((xStk_2) \wedge (yStk_2) \wedge (xSty))_{TR5}$		k1 line and k2 plane

Dear Editor-in-Chief and Reviewers,

We would like to thank reviewers for their valuable comments on the proposal. We have considered their comments carefully. As a consequence substantial changes have been made. Please find the list of changes related to each point raised by the reviewers below. We have divided reviewers' comments into the following table. For each point, we have provided a response and given justification and the place in the text where the changes have been made. All these comments have been taken into account. As a result, the paper has been improved from a scientific point of view, and English language has been verified by a native speaker. Further details have been provided in the paper in order to improve understanding.

Comment number	Reviewer's comment	Response	Changes made in the manuscript
R1.1	<p>This paper deals with formal relations that can exist between a product design and its assembly process planning. This is a very significant problem targeting the « ultimate goal » : provide a product design to a computer and ask the computer to provide you its assembly process...</p> <p>The good points of the paper:</p> <p>1 - Serious study and writing.</p> <p>The authors really try to introduce in details all the elements that support the Janus theory.</p> <p>2 - Large scope from conceptual contributions to software proofs (also a weak points)</p> <p>Once theory is described, they suggest a software implementation and a case study.</p> <p>3 - Results that clearly sound interesting and that deserve to be published.</p>	<p>The authors would like to thank this positive comment about the general vision of the article. Indeed, the authors have decided to introduce an implementation and a case study to demonstrate the operational side of the described theory.</p>	/
R1.2	<p>1 - Paper presentation and readability.</p> <p>For a reader not familiar with this subject the paper is really hard to follow. Of course a theory presentation is always delicate to achieve. And many times, the style looks a little too much like "blabla". In some cases, the references used to justify concepts are not strong and rather old.</p>	<p>The authors have made some efforts to increase clarity in the description of the theory. Nevertheless, since this theory has a mathematical and philosophical foundation, it has been necessary to keep some explanations. In addition, few references (i.e. Bittner et al, Huang & Gu and Muller) have been replaced by more recent ones. However, some references (i.e. Goodman, Heidegger, Lesniewski and so on) have been retained since being</p>	References

1
2
3
4
5
6
7
8
9
10
11
12
13
14
15
16
17
18
19
20
21
22
23
24
25
26
27
28
29
30
31
32
33
34
35
36
37
38
39
40
41
42
43
44
45
46
47
48
49

		strongly associated to the basis of the theory.	
R1.3	2 – Paper ambition. This was also a good point (!) but... Of course gathering: (i) a theory proposition (ii) a software implementation (iii) a case study in a single paper, is a very good idea. But the result is a very dense paper too hard to follow. I would suggest dividing this paper in two papers, 1: theory + example, 2 : Implementation + case study.	Sure, the fact of incorporating a theory, an ontological implementation with a case study gives the article quite dense but the authors think that without such parts, the article risks to be too theoretical. The authors would like to have the indulgence of the reviewer on this aspect. For your information, the implementation part of the theory has already been described in detailed and published in another article with the following reference: Gruhier E., Demoly F. Dutartre O., Abboudi S., Gomes S. “A formal ontology-based spatiotemporal mereotopology for integrated product design and assembly sequence planning”. <i>Advanced Engineering Informatics</i> , Vol. 29, No. 3, 2015, pp. 495-512.	/
R1.4	3 – Paper goal. The paper goal or the clear interests of the JANUS theory should also clearly more highlighted in the beginning of the paper. Can’t you : (i) describe a small example (ii) explain the problem that cannot be solved with existing theories (iii) deduce the goal of Janus.	The authors have well understood this comment. As a consequence, the introduction has been improved so as to highlight current problem of existing theories and the objectives/interests of JANUS theory.	Introduction section
R1.5	More in details about weak points 2 and 3 “In general, products models are considered as a representation of our perception of the reality from an endurantist point of view” Very quickly, reader not familiar with the subject can be lost.	The authors agree that a definition of endurantism is missing. As such, a specific explanation has been introduced in order to facilitate understanding of the reader.	Introduction section
R1.6	“This research challenge emphasizes a lack of awareness and understanding of product lifecycle information and knowledge flows.” An example of style which sounds too much general or “blabla”	True. This sentence has been removed by an appropriate explanation.	Introduction section
R1.7	“A remaining challenge consists in integrating knowledge of products lifecycle”	This issue has been removed from the paper since it does not fit appropriately with the scope of the paper.	Introduction section

	Why ??		
R1.8	“the dynamic aspect of the design process has not been yet taken into account in an appropriate manner” Style : meaning of appropriate manner ? thanks to explain.	This sentence has been improved and justified.	Introduction section
R1.9	“Based on these research stakes, new research efforts have to be addressed on formalism...” “Based on this literature review on AOD approaches and mereotopology-based theories, the authors propose to develop their own theory....” Too weak justifications – Theory need unclear - Paper goal too fuzzy The simple example (weak point 3) in section 2.3 (motivation) is necessary.	The introduction has been improved so as to highlight current problem of existing theories and the objectives/interests of JANUS theory. A simple example has also been incorporated.	Introduction section. Section 2.3
R1.10	Globally a serious and detailed work but a paper with a too large scope. A resulting paper too hard to follow. I suggest reconsidering the global architecture of your contribution.	The paper has been reinforced and improved in each section in order to facilitate understanding. The structure of the paper has been slightly changed but not globally. The authors would like to have the indulgence of the reviewer on this aspect.	All sections.
R2.1	There are many unclear sentences in the paper, practically in every section. For instance, the title of the paper may be interpreted so that the intension is to use spatiotemporal mereotopology to describe the relationships between product design engineering and assembly planning in a formal manner, rather than mereotopological relationships among the components of a complex artefact. Then, in the Abstract: “a promising mereotopological theory which enables the formal relationships description of product-process design information and knowledge”. (What is product-process design information and knowledge?) Or, still in the Abstract: “This region-based theory links together spatial, temporal and spatiotemporal dimensions, therefore leading to a perdurantist philosophy in product	True. The paper has been enhanced in each section in order to increase clarify. The title of the article has also been changed in order to fit better with the research efforts. The authors agree with the comment related to perdurantism. As a consequence, the introduction section has been changed and improved from a clearness point of view, by introducing specific definitions of endurantism and perdurantism and how these philosophical concepts have been considered in the context of information modelling in integrated design. Finally, a native speaker has checked the whole article.	Title. Introduction section. All section.

1
2
3
4
5
6
7
8
9
10
11
12
13
14
15
16
17
18
19
20
21
22
23
24
25
26
27
28
29
30
31
32
33
34
35
36
37
38
39
40
41
42
43
44
45
46
47
48
49

	design". (How does a spatiotemporal mereotopological theory lead to a perdurantist philosophy – actually, what it is and why it is needed in product design?) Or, in the Introduction: "In general, products models are considered as a representation of our perception of the reality from an endurantist point of view. This paradigm often leads to misunderstanding in engineering definitions and causes wrong design interpretations." (What is an endurantist point of view in the context of the paper, and what paradigm the authors talk about?) This question stands even after considering what is discussed in 2.3. These, as well as the other ambiguous sentences should be fixed. The whole of the text needs a careful brush up before the manuscript can be considered for publication.		
R2.2	The Introduction is somewhat general (not structured and focused enough). It does not explain why the proposed spatiotemporal mereotopological theory is needed. Is it just an opportunity to adopt the results of recent mereotopological studies, or are there specific bottlenecks in the current early product development and assembly modelling practice that could be eliminated by applying them?	True. The introduction section was not enough structured in its current shape. As a consequence, the authors have enhanced this section. As such, needs of such a theory have been better addressed.	Introduction section.
R2.3	Table 1 provides an overview of the research efforts to develop region-based mereological/mereotopological theories, involving an overview of the proposed formal relationships between regions. The caption of the Table says that it is a classification of the relevant region-based theories, but I cannot understand in which sense it is classification. It seems to be an inventory of the theories and the introduced (primitive) relationships.	Right. This is actually a list of relevant mereotopology-based theories. Caption of the table has been changed.	Table 1
R2.4	Mereotopological relationships can be conceptualized on multiple abstraction levels. The issue of specifying and using spatiotemporal mereotopological relations (both containment and associative relations) on multiple	Right. The state-of-the-art section has been improved by introducing reference ([Horvath and van der Vegte, 2003]) related to nucleus-based modeling in product modelling.	Sections 2.1. and 2.2. References section

	architectural abstraction levels (system, subsystem, module, unit, component, etc.) and on different conceptualization levels (functional, structural, behavioural, technological, etc.) is not sufficiently addressed in the literature review, and in the rest of the text. The findings of subsections 2.1 and 2.2 are not blended and concluded.	Brief conclusions have been included.	
R2.5	The authors wrote: "As such, this paper extends existing spatial mereotopology-based theories in the temporal and spatiotemporal dimensions in order to describe persistent objects over time and space." The literature shows that there have been efforts to include time aspects in mereotopology before this work of the authors.	Indeed, the authors have highlighted existing research effort towards the integration of temporal dimension in mereotopology, but although few temporal primitives have been defined, none of them fully covers all possibilities (related to intervals and instants) addressed by the authors. Besides, primitives are generally described to a specific domain, and in mechanical engineering, new ones have been introduced to represent mechanical pairs over time.	Section 2.3
R2.6	The authors wrote: "In addition, this step requires an ontological implementation of the theory by using OWL-DL (Ontology Web Language - Description Logic) and SWRL (Semantic Web Rule Language) (Gruhier et al. 2015), therefore enabling its machine interpretation and usage within PLM (Product Lifecycle Management) systems (Step 2 of Figure 1) and CAD (Computer-Aided Design) application (Step 3 of Figure 1)." Why is an ontological implementation of the proposed theory indeed needed (the theory could be used in an implicit form too to underpin an artefact and process inclusive assembly sequence planning methodology), and why OWL-DL and SWRL are specifically needed (used) for the development of the ontology based on the JANUS theory?	The authors have decided to implement this theoretical framework in a formal ontology. Such ontology requires a strong mathematical basis and the consideration of a philosophical trend in order to have a fully independent construction from technological constraints and oriented towards the understanding of the reality even if it remains simple. The use of OWL-DL and SWRL languages have been needed, given that they are the most common restrictions / rules languages used in Protégé Editor. Such kind of language depends on the authors' purpose as well as the rules complexity to be described.	Introduction section and Section 4.2.
R2.7	Related to 3.1.2: In principle, the state of an object can also change in the spatiotemporal domain. For instance, an object can become deformed (or should be deformed for assembly), or ice melt and water evaporated. Should these	Here the JANUS theory only considers physical objects, which are defined in the design of mechanical assemblies. Nevertheless, deformed objects can be represented with such one. Actually, the authors did not focus their	

1
2
3
4
5
6
7
8
9
10
11
12
13
14
15
16
17
18
19
20
21
22
23
24
25
26
27
28
29
30
31
32
33
34
35
36
37
38
39
40
41
42
43
44
45
46
47
48
49

	state changes be considered together with spatial and temporal positions and form?	research work on physical phenomenon but rather on is based on contact/relationships between physical objects. As such, if the change of states of an object implies a change of relationships or the move of an object, then object like ice melt and water evaporated can be described. Inner change (at a very low granularity) of an object cannot be directly described here. This description should consider the atoms composing the objects and the relationships between atoms.	
R2.8	Subsection 3.2 repeats what has been presented in (Demoly et al. 2012). The description of forms considers only rigid objects, but not deformed (deformable) of flexible objects. Furthermore, the need for combining the spatial and the temporal dimensions in assembly process planning is obvious. But assembly also needs a compositional logic. How has it been considered in the Janus theory? How can multistate objects (e.g., snap-fits) be represented? How are possible collisions handled?	JANUS is enough suitable to represent deformed or flexible objects over time, as soon as the interface with another object is deformed. Since the theory is adapted to the early design stages, i.e. before the product geometry is committed, such a description can be only based on spatial and temporal position as well as form. In addition, multistate object is always considered as the same object from the perdurantist framework. Such objects (e.g. snap-fits) have been defined in Table D1 in Appendix Section, where each state is described with spatial, temporal and spatiotemporal mereotopological primitives. Regarding the last question, the authors do not focus their theory on the feasibility checking of the assembly and the collision between parts that the product can undergo.	
R2.9	In Section 4, the proposed theory is transferred to an ontological implementation using Protégé, “to illustrate the relevance of the proposed theory”. Talking about ‘relevance’ only is not enough, the authors should show how it helps integrating assembly sequence planning into early product design and the benefits too. More importantly, this section discusses a process of assembly sequence planning, rather than the representation of the specification of the spatiotemporal mereotopology theory (4.1. Case study and its mereotopological description). Neither the next subsection (4.2. System execution) does present a formal specification of the content of the	Right actually the proposed ontological implementation has enabled the development of a formal ontology (called PRONOIA 2). This ontology makes explicit and machine-interpretable the JANUS theory from a logical and semantical manner. The authors have introduced such implementation to prove that the theory works. For more information, a detailed development of PRONIA2 has already been published. Gruhier E., Demoly F. Dutartre O., Abboudi S., Gomes S. “A formal ontology-based spatiotemporal mereotopology for integrated	Section 4 Section 4.2

	PRONOA2 ontology – instead, a prototype system. The use of this ontology in the assembly sequence planning remained is not explained with sufficient details.	product design and assembly sequence planning”. Advanced Engineering Informatics, Vol. 29, No. 3, 2015, pp. 495-512. Since the content of the paper seems quite dense, the authors have preferred to not explain all the details associated to the ontology. However, the authors have understood this comment and then have incorporated addition explanations in the appropriate section.	
R2.10	The section Conclusions and future work provides a summary of the work and some findings, but fails to offer explicitly tested propositions. The specification of the referenced papers should be made complete and uniform. At least a spellchecker should be used to eliminate the grammatical errors and typos.	Right. This section has been improved so as to highlight the added value of the research efforts. Grammatical errors and typos have been eliminated with the aid of a native speaker. The specifications of the references papers have also been checked.	Conclusions section. All sections. References section.
R3.1	This is a very good paper on the topic of the application of the mereotopological theory in Assembly Design and Process Planning. It provides a rigorous and robust presentation of the theoretical background with appropriate examples and a case study. The presentation is overall correct but it requires a serious revision of the writing style by a native English spoken person.	The authors kindly accept this positive comment. A native English spoken person has made a serious revision of the writing style.	All sections.