



HAL
open science

Phase Equilibrium Study of Hexafluoropropylene Oxide and Propane System at (283.05, 303.05, 323.05) K: Experimental Measurements and Thermodynamic Modeling

Marc Mulamba Tshibangu, Christophe Coquelet, Deresh Ramjugernath

► To cite this version:

Marc Mulamba Tshibangu, Christophe Coquelet, Deresh Ramjugernath. Phase Equilibrium Study of Hexafluoropropylene Oxide and Propane System at (283.05, 303.05, 323.05) K: Experimental Measurements and Thermodynamic Modeling. *Journal of Chemical and Engineering Data*, 2025, 70 (6), pp.2415-2421. <10.1021/acs.jced.5c00251>. <hal-05071396>

HAL Id: hal-05071396

<https://hal.science/hal-05071396v1>

Submitted on 16 May 2025

HAL is a multi-disciplinary open access archive for the deposit and dissemination of scientific research documents, whether they are published or not. The documents may come from teaching and research institutions in France or abroad, or from public or private research centers.

L'archive ouverte pluridisciplinaire **HAL**, est destinée au dépôt et à la diffusion de documents scientifiques de niveau recherche, publiés ou non, émanant des établissements d'enseignement et de recherche français ou étrangers, des laboratoires publics ou privés.



HAL Authorization

Phase Equilibrium Study of Hexafluoropropylene Oxide and Propane system at (283.05, 303.05, 323.05) K: Experimental Measurements and Thermodynamic Modelling

Marc Mulamba Tshibangu^{†, ‡, *}, **Christophe Coquelet**^{□, □} and **Deresh Ramjugernath**^{‡, □}

*Email: tshibangu.marc@mut.ac.za

[†]Department of Chemical Engineering, Mangosuthu University of Technology, Jacobs, Durban, 4026, South Africa

[‡]Thermodynamics Research Unit, School of Engineering, University of KwaZulu-Natal, Howard College Campus, Durban, 4041, South Africa

[□]Mines Paris PSL University, Centre for Energy Environment Processes (CEEP), 35 Rue Saint Honoré, 77305 Fontainebleau, France

[□]Université de Toulouse, IMT Mines Albi, CNRS UMR 5302, Centre Rapsodee Campus Jarlard, 81013 Albi CT Cedex 9, France

[□]Department of Chemical Engineering, Faculty of Engineering, Stellenbosch University, Stellenbosch, 7600, South Africa

ABSTRACT

This study presents the vapour-liquid equilibrium data of two fluorinated systems: R116 + propane, as a test system to validate both the experimental setup and the procedure, and hexafluoropropylene oxide + propane, as a novel system. Measurements of vapour-liquid equilibrium data were achieved via a static-analytical setup equipped with the ROLSI device for phase sampling and gas chromatography for composition analysis. The expanded uncertainties for temperature, pressure, and composition measurements were estimated at 0.02 K, 0.008 MPa, and 0.006, respectively. Thermodynamic modelling of the experimental VLE data was via the direct method, using the Peng-Robinson equation of state with the Mathias-Copeman alpha function and the Wong-Sandler mixing rule, incorporating the nonrandom two-liquid activity coefficient model. The deviations AAD_{xy} and $Bias_{xy}$ between the measured and the computed data were determined to be less than 2%, indicating a good agreement between the model and the measurements. The successful correlation of the experimental data demonstrates the reliability of the experimental approach used and provides valuable insights into the thermodynamic behaviour of the investigated fluorinated systems. The hexafluoropropylene oxide + propane system was found to exhibit azeotropic behaviour across the investigated isotherms, with azeotropic compositions not varying significantly with temperature.

INTRODUCTION

South Africa is endowed with a rich diversity of mineral resources, including fluorspar, bauxite and platinum. Among these minerals, the country boasts significant fluorspar reserves, positioning it as a leading global supplier¹. To capitalize on this resource, South Africa has initiated the Fluorochemical Expansion Initiative (FEI), aimed at fully beneficiating fluorspar ore, and advancing its applications.

In line with the objectives of the FEI, extensive research has been undertaken on the thermodynamic properties of fluorochemicals. This research includes phase equilibrium studies of fluorinated systems, which hold potential as substitutes for energy-intensive and environmentally harmful solvents²⁻⁵. Such systems also offer promising alternatives to chlorine-based refrigerants⁶⁻⁸, aligning with global efforts to promote sustainable and environmentally friendly chemical processes.

This study focuses on the phase equilibrium of the HFPO (hexafluoropropylene oxide) + propane system at three isotherms below the critical temperature of propane. The experiment was performed using a static-analytical setup featuring online sampling of equilibrium phases through the capillary sampler ROLSI, with phase composition analysis via gas chromatography. The measured data are considered novel, as a comprehensive literature review confirms their absence in existing publications. The VLE data were thermodynamically modelled using the direct method. The Peng-Robinson equation of state⁹ with the Mathias-Copeman alpha function¹⁰ and the Wong-Sandler mixing rule¹¹ was employed for this purpose. The Wong-Sandler mixing rule incorporates the nonrandom two-liquid (NRTL) activity coefficient model¹² to account for non-ideal behaviour in the liquid phase. Model parameters were optimized by minimizing a flash calculation objective function. This modelling approach has demonstrated its reliability and accuracy in describing similar systems, as evidenced in previous studies¹³⁻¹⁵. The propane (1) + HFPO (2) system is classified as a Type I system with a positive azeotrope, based on the van Konynenburg and Scott¹⁶ classification scheme.

Experimental and/or Computational Methods

Materials

The binary systems investigated in this study consisted of R116, propane, and hexafluoropropylene oxide as the primary chemical components. These materials were used without further purification, as gas chromatography (GC) analysis confirmed their compositions aligned with the purities specified by the suppliers. Table 1 summarizes their critical properties, acentric factor, and supplier specifications.

Table 1. Summary of critical properties, acentric factor, and supplier specifications of R116, ethane and HFPO^a

component	CAS number	supplier	volume fraction	T _c /K	P _c /MPa	ω
Propane	74-98-6	Afrox	0.9950	369.95	4.246	0.152
R116	76-16-4	Messer Griesheim	0.9999	293.04	3.042	0.229
HFPO	428-59-1	NECSA	0.9999	358.93	3.136	0.353

^aProperty values taken from ref. 17

Experimental Apparatus

The experimental apparatus used in this study was based on the static-analytical method, previously described by Tshibangu¹⁸ and Tshibangu et al.¹⁹. The centrepiece of this setup, shown in Figure 1, is a 60 cm³ cylindrical equilibrium cell equipped with two 22 mm sapphire windows on the front and back to allow visual observation of the contents. Critical sealing was achieved using “O” rings between the cell body and the sapphire windows to prevent leaks. The cell’s bottom was designed with a thinner section to enhance stirring efficiency. A cap on the cell accommodated the mobile ROLSI capillary sampler for online phase sampling.

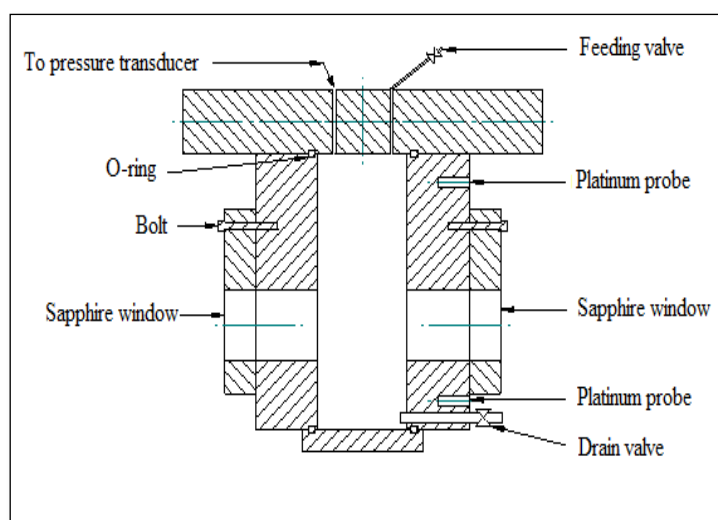

Figure 1. A cross-sectional view of the equilibrium cell. Reproduced from reference [18].

Copyright [2011] [University of KwaZulu-Natal].

The cell was submerged in a temperature-controlled liquid bath equipped with a Grant Optima GR150 immersion circulator and a Polychem Supplies immersion circulator to ensure isothermal conditions. Temperature measurements were performed using two WIKA Class A platinum resistance thermometers (Pt-100s) positioned to correspond with the liquid and vapour phases, as depicted in Figure 1. The thermometers were regularly calibrated against a standard $100\ \Omega$ platinum resistance thermometer using a WIKA CPH6000 processor calibrator with a certified accuracy of $\pm 0.03\ \text{K}$. During calibration, the sensors were immersed in a vigorously stirred liquid bath to ensure uniform temperature distribution. The uncertainty in temperature measurements (243.15–323.15 K) was estimated at $\pm 0.02\ \text{K}$.

Pressure measurements were carried out using a WIKA P-10 pressure transducer mounted in a heated block above the equilibrium cell. The transducer was periodically calibrated against a WIKA CPT6000 standard pressure transducer using an HD250 test pump, with the standard transducer certified accurate to within 0.025%. Calibration involved applying identical pressure to both transducers and comparing readings to verify accuracy. The uncertainty in pressure measurements (0.3–6.1 MPa) was estimated at $\pm 0.008\ \text{MPa}$.

Pressure and temperature data were acquired using an Agilent 34970A data acquisition unit connected to a personal computer.

Equilibrium phase compositions were analyzed using a Shimadzu GC-17A gas chromatograph configured with a flame ionization detector (FID) and a thermal conductivity

detector (TCD). The TCD was operated at 473 K, with Porapak Q packed column selected as the analytical column. Calibration of the GC detector for all components was periodically performed via the direct injection method using SGE-type gastight syringes. The uncertainty in phase equilibrium compositions for both liquid and vapor phases of the investigated systems was estimated to be less than 0.006.

Experimental Procedure

The procedure adopted in this study follows the methodology previously described by Tshibangu¹⁸ and Tshibangu et al.¹⁹. While the experimental setup has been utilized in earlier studies, verifying the reliability of both the apparatus and the procedure is essential to ensure the reproducibility of published phase equilibrium data. To this end, vapour pressure measurements of propane¹⁶ and VLE data for the R116 + propane system¹⁷ were conducted. The accurate reproduction of propane's vapour pressure, which is well-documented in the open literature, serves as a strong indicator of the apparatus' reliability. The procedure adopted for this study can be summarized as follows. The equilibrium cell and its auxiliary lines were pressurized with propane to 2 MPa, the maximum operating pressure of the system under investigation, for 24 hours. The setup was deemed leak-free and ready for use if the pressure drop observed the following day was within the expanded uncertainty of the pressure measurement. To eliminate trace impurities, the sampling lines conveying samples to the GC were heated to 423.15 K, 50 K above the operating conditions. The transfer lines were thereafter flushed thoroughly with helium. Gas chromatograph traces of the sample were monitored to confirm the absence of residual impurities. Before starting VLE data measurements, the equilibrium cell and associated lines were flushed multiple times with the propane and evacuated to a pressure of -0.015 MPa for at least 30 minutes. The cell was then immersed in a bath filled with ethanol, and the chilling unit was activated to achieve the desired cooling. Propane was introduced into the cell from its cylinder after the bath reached the set temperature. For vapour pressure measurements, the bath temperature was set to 253.30 K, and the cell was stirred intensively until equilibrium was attained. Subsequent vapour pressure data points were obtained by incrementally increasing the bath temperature within (253.30 to 323.05) K. For the R116 + propane test system, the bath temperature was set to 263.15 K, a value corresponding to the first isothermal run. R116 was added stepwise to the equilibrium cell, leading to equilibrium mixtures while increasing the concentration of R116. Equilibrium was deemed achieved when both the temperature and pressure remained unchanged for at least 10 minutes under vigorous stirring. The HFPO + propane system

followed the same procedure. Once a full compositional range was completed for an isotherm, the cell was emptied, and the process was repeated. At each equilibrium state, online sampling of both liquid and vapour phases was performed using the ROLSI capillary sampler and conveyed to the GC for composition analysis. No fewer than five samples were taken for each equilibrium phase to ensure repeatability within a 1% error margin.

DATA REDUCTION

Phase equilibrium data reduction was achieved via Thermopack, a software developed at Mines Paris, PSL University in France. The measured vapour pressure data were modelled using the Peng-Robinson equation of state (EoS) coupled with the Mathias-Copeman alpha function for improved temperature dependency.

The experimental VLE data were modelled using the direct method, also known as the “ Φ - Φ ” approach. This method computes both liquid and gas phase fugacities using an equation of state enhanced by an alpha function and an EoS/ G^E mixing rule. Specifically, the Peng-Robinson EoS, incorporating the Mathias-Copeman alpha function and the Wong-Sandler mixing rule, was employed in this study.

The Wong-Sandler mixing rule integrates a Gibbs excess energy (g^E) model, such as the nonrandom two-liquid (NRTL) activity coefficient model, into the Peng-Robinson EoS. This approach enables accurate representation of phase equilibrium data for polar compounds under high-pressure conditions. The PR-MC-WS-NRTL model has demonstrated satisfactory performance in representing experimental VLE data for systems like the HFPO (1) + propane (2) system. The parameter set for this model includes three NRTL parameters (g_{12} - g_{22} , g_{21} - g_{11} , α_{ij}) and one binary interaction parameter (k_{ij}). The NRTL non-randomness parameter (α_{ij}) is fixed at 0.3, as suggested by Sandler²⁰. The model parameters are adjusted using the flash calculation objective function, defined as:

$$FC = \frac{100}{N} \left[\sum_1^N \left(\frac{x_{exp} - x_{cal}}{x_{exp}} \right)^2 + \sum_1^N \left(\frac{y_{exp} - y_{cal}}{y_{exp}} \right)^2 \right] \quad (1)$$

where FC represents the objective function to be minimized during data reduction, N denotes the number of data points, x_{exp} and x_{cal} denote the experimental and calculated liquid mole fractions, respectively, while y_{exp} and, y_{cal} refer to the experimental and calculated vapour mole fractions, respectively.

Statistical analysis is typically performed using metrics such as the absolute average deviation (AAD), bias, and relative mean deviation (RMD) to evaluate how well a model represents the experimental data. In this study, the AAD and bias were employed and are defined as follows:

$$\text{AAD}(\%) = (100/N) \sum |U_{\text{cal}} - U_{\text{exp}}| \quad (2)$$

$$\text{Bias}(\%) = (100/N) \sum \left((U_{\text{exp}} - U_{\text{cal}}) / U_{\text{exp}} \right) \quad (3)$$

where N represents the number of data points and $U = x_1$ or y_1

Relative volatility (α_{ij}) values for the HFPO (1) + propane (2) system were computed as follows.

$$\alpha_{ij} = \frac{K_i}{K_j} = \frac{y_i / x_i}{y_j / x_j} = \frac{y_i / x_i}{(1 - y_i) / (1 - x_i)} \quad (4)$$

where subscripts i and j represents the binary components; K represents the equilibrium ratio; y denotes the mole fractions of the binary components in the vapour phase and x the mole fractions of the binary components in the liquid phase.

RESULTS AND DISCUSSION

Test system: R116 (1) + propane (2) system

Experimental vapour pressure data for propane are provided in Table 2.

Table 2. Measured vapour pressure data for propane^a

T / K	P /MPa
253.30	0.239
258.07	0.287
263.05	0.346
266.06	0.382
270.05	0.434
273.07	0.475
277.96	0.55
283.03	0.636
287.95	0.729
292.9	0.833
293.04	0.832
297.86	0.946
302.84	1.069
303.05	1.070
323.05	1.703

^aExpanded uncertainty $U(T) = 0.02 \text{ K}$ ($k = 2$); $U(P) = 8.0 \text{ kPa}$ ($k = 2$).

The measured vapour pressure data were modelled using the PR EoS with the MC alpha function to obtain parameters reported in Table 3. These data are further graphically compared with both the model and the data reported by Rips²¹ and Coquelet et al.²² in Figure 2.

Table 3. MC alpha function parameters adjusted on the experimental data

Coefficient	Propane
C_1	0.795
C_2	-3.106
C_3	11.944

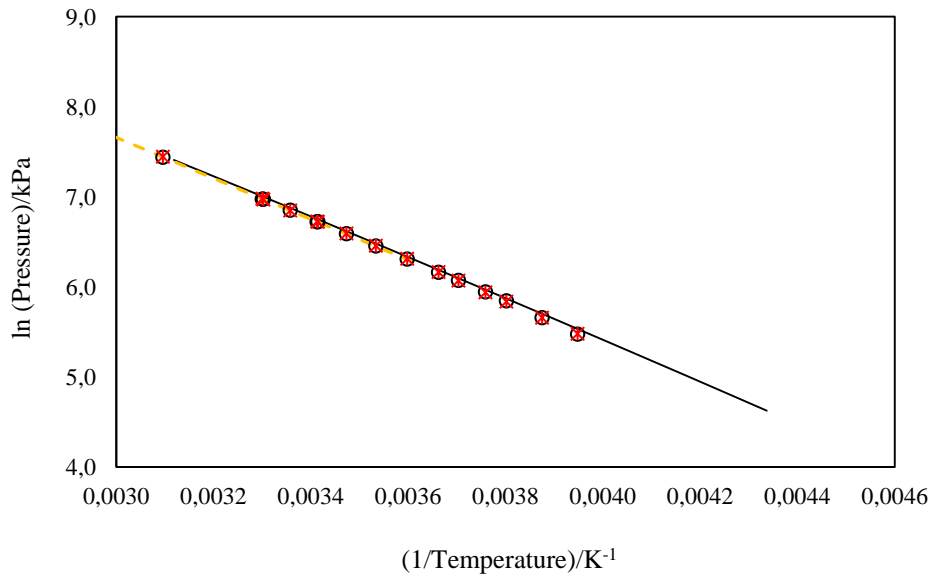

Figure 2. Graphical representation of vapour pressure data for propane. This study: \circ ; PR-MC: $*$; Rips²¹: —; Coquelet et al.²²: - - - -.

The experimental vapour pressure data exhibit strong agreement with the model and the data reported by Rips²¹ and Coquelet et al.²² The computed deviations, including absolute average deviation (AAD) and bias, were found to be less than 0.2%, indicating that the model provides a good representation of the measured data.

The VLE data measurement for the R116 + propane system was subsequently undertaken at 263.15 K to assess the reliability of the experimental setup to reproduce VLE data. The experimental VLE data are reported in Table 4 and graphically compared with the calculated ones in Figure 3.

Table 4. VLE data for the R116 (1) + propane (2) at 263.15 K^a

pressure (MPa)	x_1	y_1
0.328	0.000	0.000
0.477	0.023	0.267
0.653	0.060	0.450
0.860	0.131	0.575
1.044	0.271	0.659
1.180	0.435	0.718

^a x_1, y_1 : liquid and vapour mole fractions. Expanded uncertainty: $U(T) = 0.02$ K ($k = 2$); $U(P) = 0.008$ MPa ($k = 2$) and $U(y_1, x_1) = 0.006$ ($k = 2$).

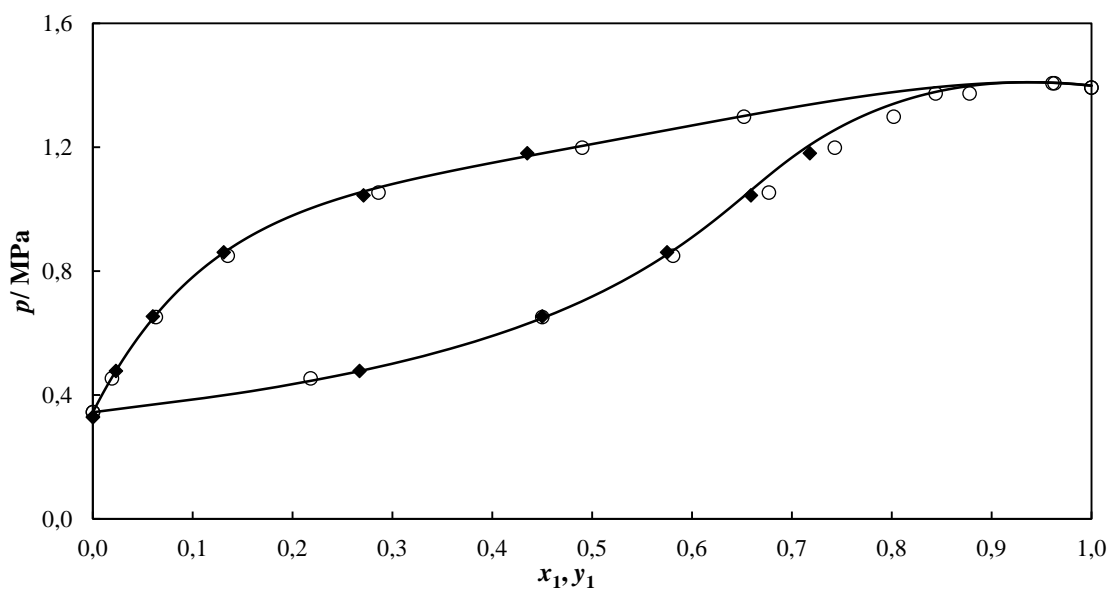

Figure 3. Graphical representation of VLE data (P - x - y) for the system R116 (1) + propane (2) at 263.15 K. This study: \blacklozenge , PR-MC-WS-NRTL model: —; Ramjugernath et al.²³: \circ . A part of the graph has been reproduced from Ramjugernath et al.²³. Copyright [2009] [American Chemical Society].

As shown in Figure 3, the PR-MC-WS-NRTL model accurately represents the measured VLE data, which aligns favourably well with the data reported by Ramjugernath et al.²³. This agreement indicates the reliability of the apparatus in reproducing accurate VLE data.

Novel system: propane (1) + HFPO (2) system

Experimental VLE data for the propane (1) + HFPO (2) system at three isotherms (283.05, 303.05, 323.05) K are provided in Table 5. The VLE data were modelled via the “ Φ - Φ ” approach using the PR-MC-WS-NRTL model. The MC alpha function parameters for HFPO are available in Subramoney et al.²⁴. The calculated data are graphically compared with the measured data in figures 4 – 7. The PR-MC-WS-NRTL model parameters are provided in tabular and graphical formats in Table 6 and figures 8 and 9, respectively.

Table 5. Experimental VLE data for the propane (1) + HFPO (2) system^a

pressure (MPa)	x_1	y_1
T/K = 283.05		
0.437	0.000	0.000
0.528	0.074	0.223
0.6	0.166	0.361
0.643	0.235	0.433
0.691	0.343	0.514
0.723	0.434	0.566
0.736	0.477	0.591
0.742	0.502	0.600
0.748	0.540	0.618
0.748	0.696	0.692
0.685	0.95	0.897
0.629	1.000	1.000
T/K = 303.05		
0.787	0.000	0.000
0.915	0.081	0.185
1.009	0.164	0.303
1.072	0.222	0.369
1.157	0.333	0.464
1.225	0.476	0.558
1.26	0.646	0.657
1.256	0.778	0.743
1.233	0.853	0.799
1.159	0.953	0.914
1.07	1.000	1.000

T/K = 323.05

1.324	0.000	0.000
1.511	0.091	0.154
1.684	0.193	0.284
1.79	0.277	0.368
1.885	0.374	0.447
1.959	0.488	0.524
1.987	0.556	0.577
2.000	0.622	0.629
1.956	0.827	0.796
1.909	0.887	0.841
1.817	0.956	0.928
1.703	1.000	1.000

^a x_1, y_1 : liquid and vapour mole fractions. Expanded uncertainty: $U(T) = 0.02$ K ($k = 2$); $U(P) = 0.008$ MPa ($k = 2$) and $U(y_1, x_1) = 0.006$ ($k = 2$).

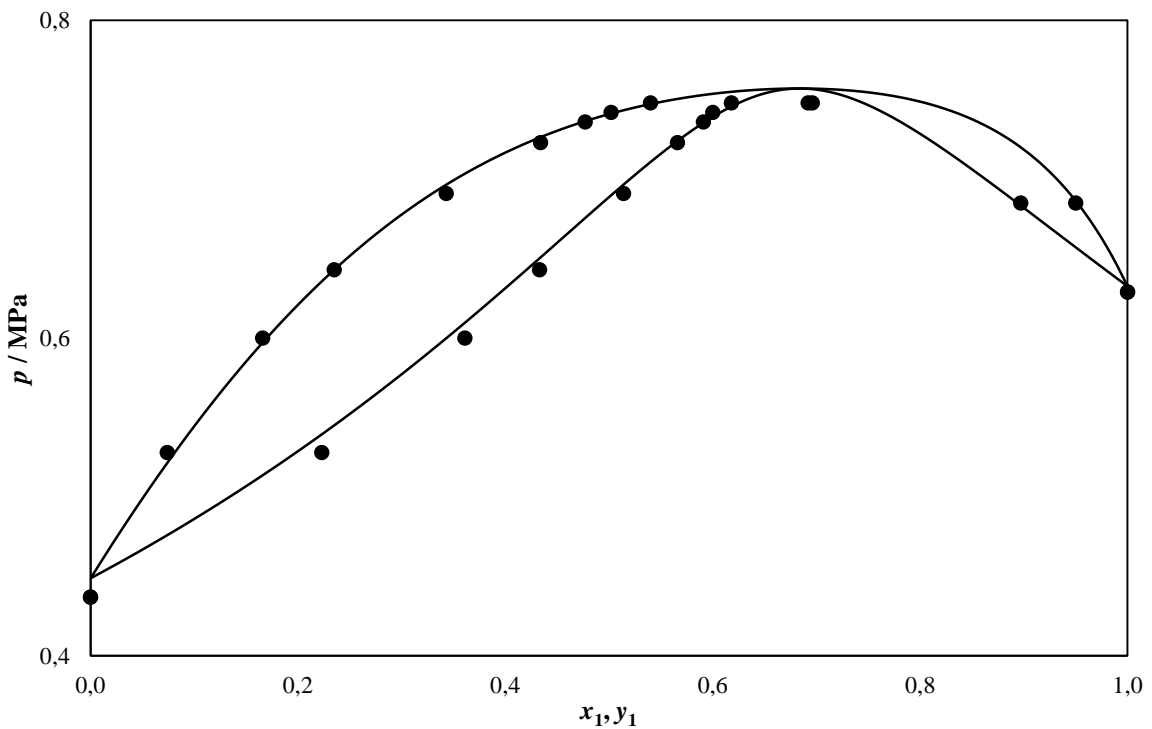

Figure 4. Graphical representation of VLE data (P - x - y) for the propane (1) + HFPO (2) system. Experimental: ●, 283.05 K; —, PR-MC-WS-NRTL model.

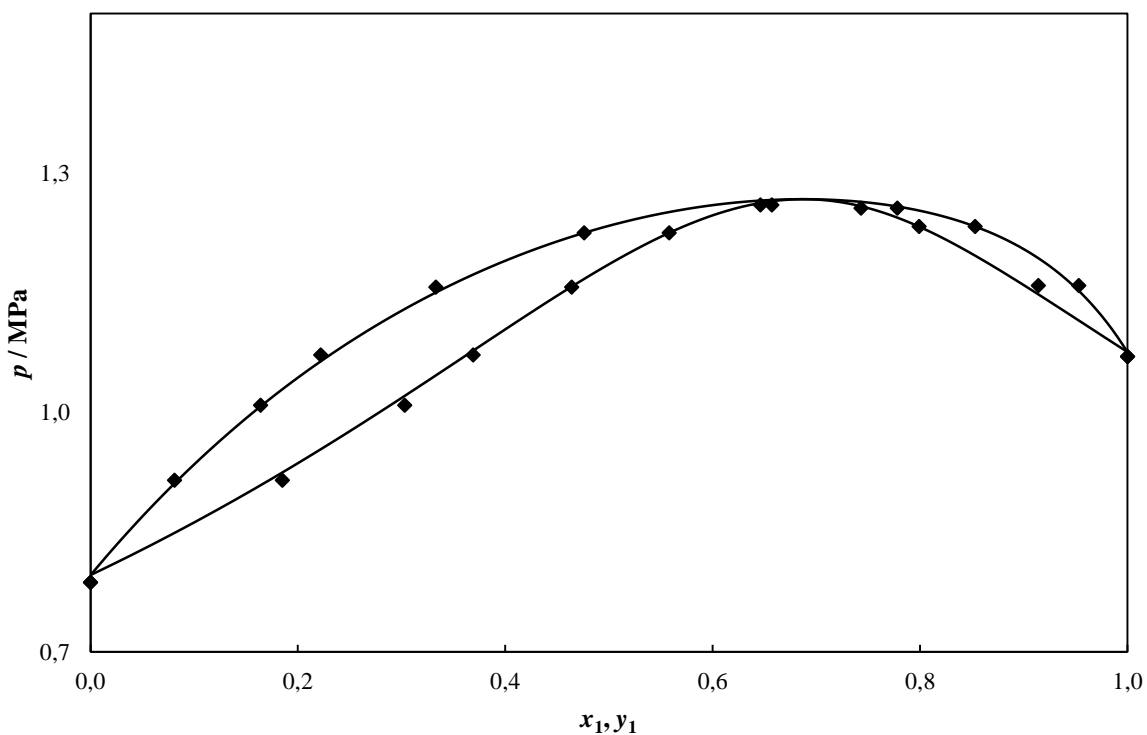

Figure 5. Graphical representation of VLE data (P - x - y) for the propane (1) + HFPO (2) system. Experimental: ◆, 303.05 K; —, PR-MC-WS-NRTL model.

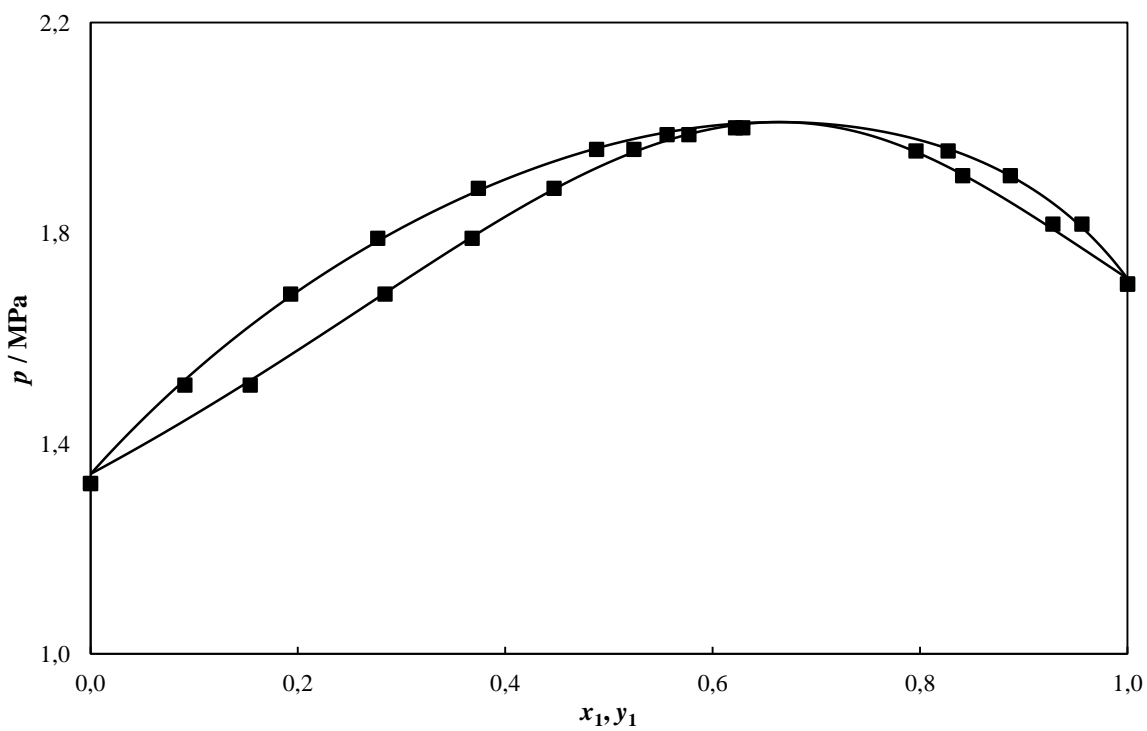

Figure 6. Graphical representation of VLE data (P - x - y) for the propane (1) + HFPO (2) system. Experimental: ■, 323.05 K; —, PR-MC-WS-NRTL model.

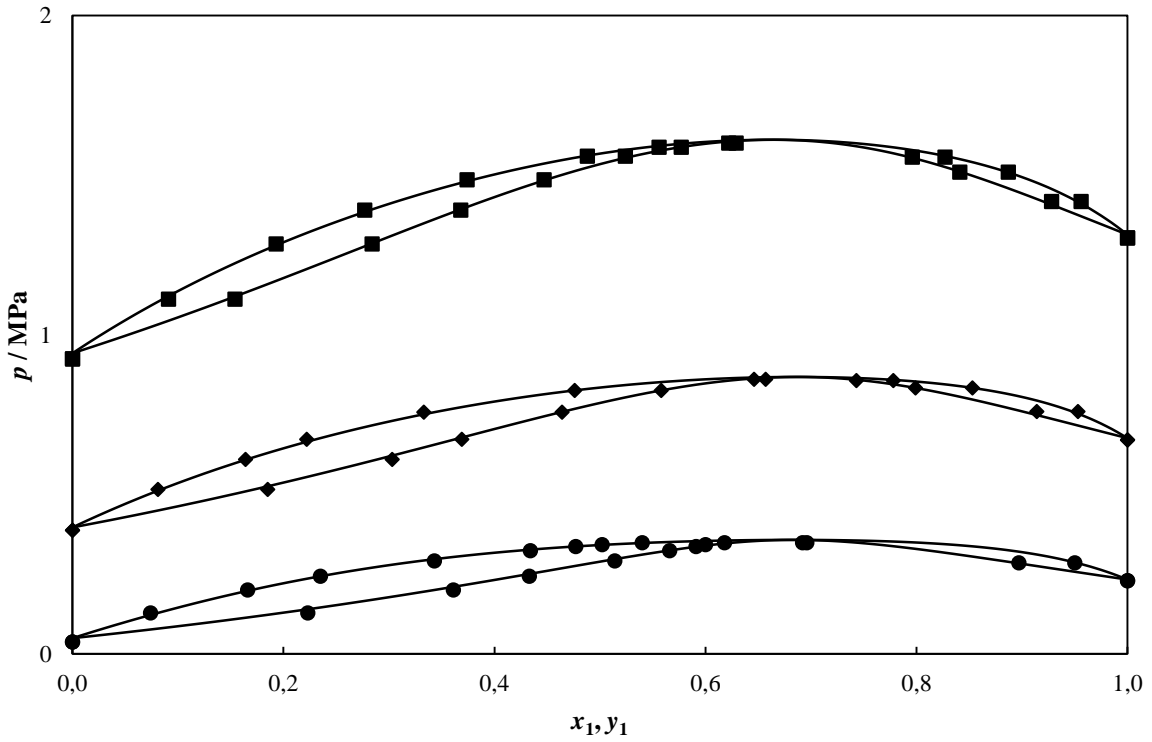

Figure 7. Graphical representation of VLE data (P - x - y) for the propane (1) + HFPO (2) system. Experimental: ●, 283.05 K; ◆, 303.05 K; ■, 323.05 K; —, PR-MC-WS-NRTL model.

Table 6. PR-MS-WS-NRTL model parameters for the propane (1) + HFPO (2) system

T/K	$(g_{12}-g_{22}) / \text{J.mol}^{-1}$	$(g_{21}-g_{22}) / \text{J.mol}^{-1}$	k_{12}
283.05	4328	-625	0.264
303.05	5154	641	0.039
323.05	4885	1089	0.004

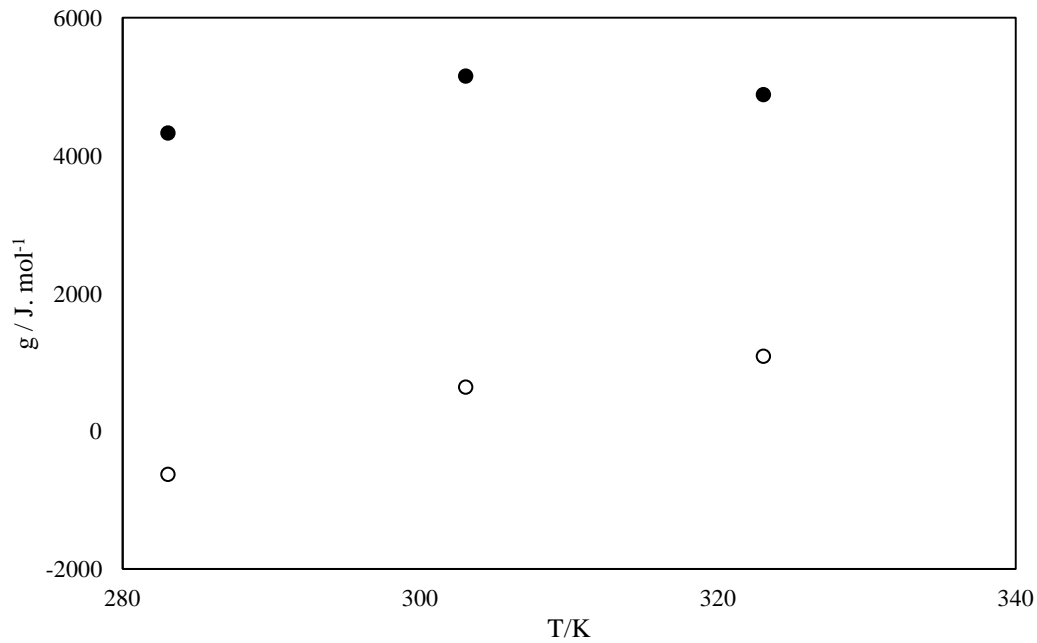

Figure 8. NRTL binary parameter across (283.05, 303.05 and 323.05) K. ●, ($g_{12}-g_{22}$); ○, ($g_{21}-g_{11}$).

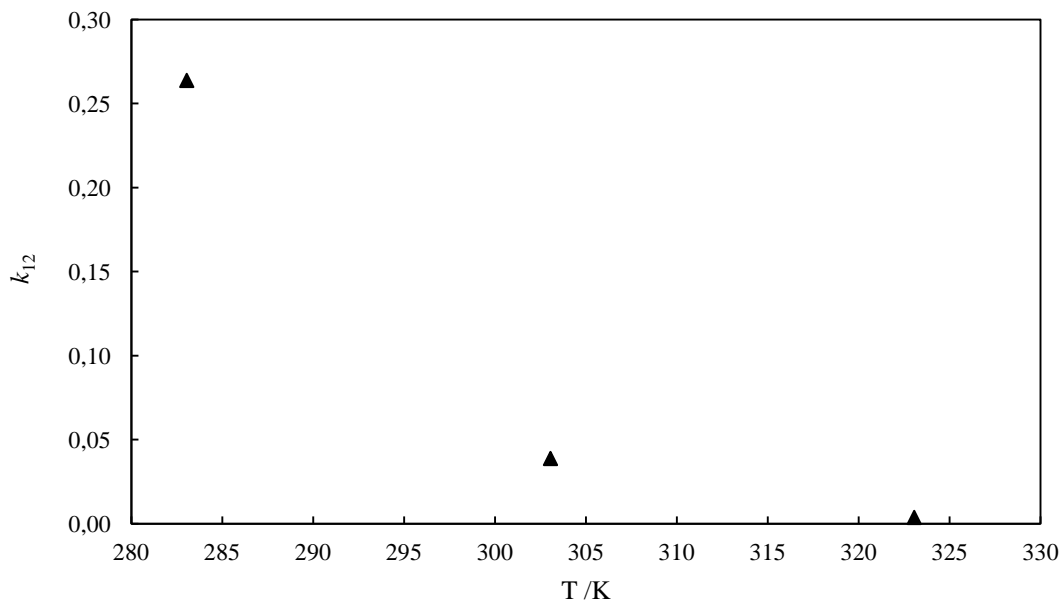

Figure 9. EoS binary interaction parameter across (283.05, 303.05 and 323.05) K.

As illustrated in Figures 4–7, the PR-MC-WS-NRTL model demonstrates a strong ability to represent the measured data accurately. However, some discrepancies are observed, particularly for a few data points in the vapour phase at 283.05 K, especially near the azeotropic region. This deviation is likely due to the inherent challenges of measuring data in this region, where the liquid and vapour phases of the binary mixture exhibit identical

compositions. Such conditions make it difficult to distinguish between the phases, which can lead to experimental uncertainties or modelling limitations. The NRTL model parameters, depicted in Figure 8, increase with temperature, while the EoS binary interaction parameter, shown in Figure 9, decreases with temperature across the studied range.

The deviations, including the absolute average deviation (AAD) and bias, between the experimental and calculated mole fractions for both the liquid and vapor phases were computed and are summarized in Table 7.

Table 7. Deviation values, Bias and AAD from fitting the experimental VLE data with the PR-MC-WS-NRTL model

T/K	bias x (%)	bias y (%)	AAD x (%)	AAD y (%)
283.05	0.38	0.95	1.51	1.53
303.05	-1.03	1.63	1.86	1.84
323.05	0.56	0.53	1.66	0.93

The deviation values reported in Table 7 for both liquid and vapour compositions are generally below 2%, indicating good agreement between the model and experimental data. The overall deviation value of 2% excludes the data first VLE data point measured at 283.05 K. However, the discrepancy clearly shown in Figure 4 can be attributed, at least in part, to the data point measured in the azeotropic region. To better understand the source of this disparity and to validate the model's performance, repeating measurements for other VLE data points under similar conditions would be beneficial. This approach could help identify whether the observed bias is due to measurement errors, model limitations, or a combination of both.

The relative volatility values derived from the experimental data are compared with the calculated values in Figure 10. This comparison further evaluates the model's effectiveness in representing the measured data.

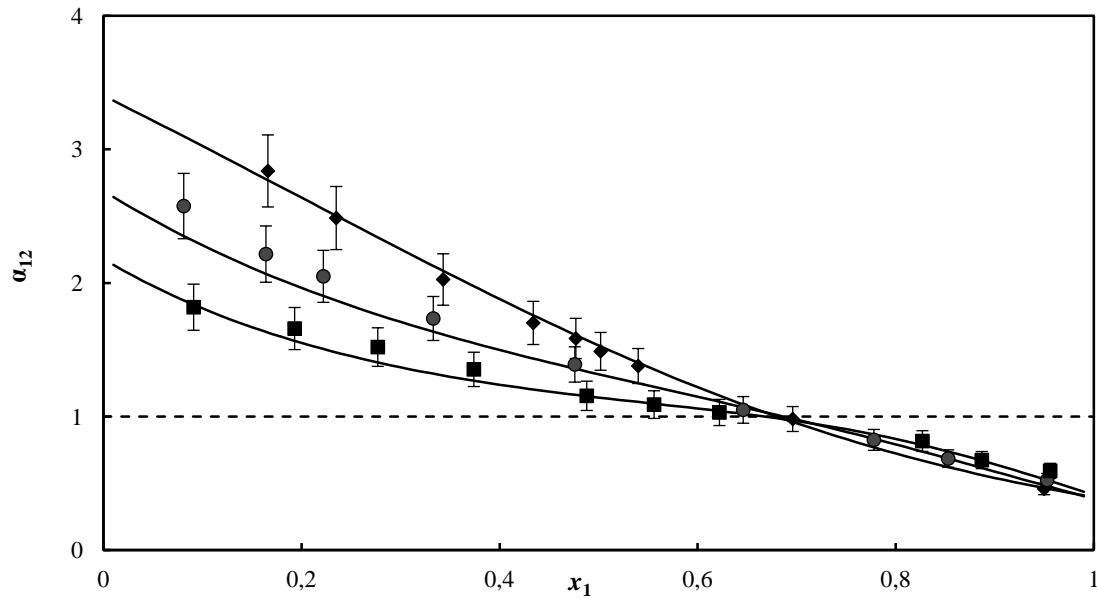

Figure 10. Graph of the relative volatility versus x_1 for the system propane (1) + HFPO (2). \blacklozenge , 283.05 K; \bullet , 303.05 K; \blacksquare , 323.05 K; —, PR-MC-WS-NRTL model.

Figures 4-7 show that the propane (1) + HFPO (2) system exhibits azeotropic behaviour across all measured isotherms. The azeotropic points are provided in Table 8 and are graphically shown in Figure 11 alongside the complete set of VLE data for the system.

Table 8. Azeotropic points for the measured VLE data

T/K	P/MPa	x
283.05	0.757	0.684
303.05	1.267	0.687
323.05	2.011	0.664

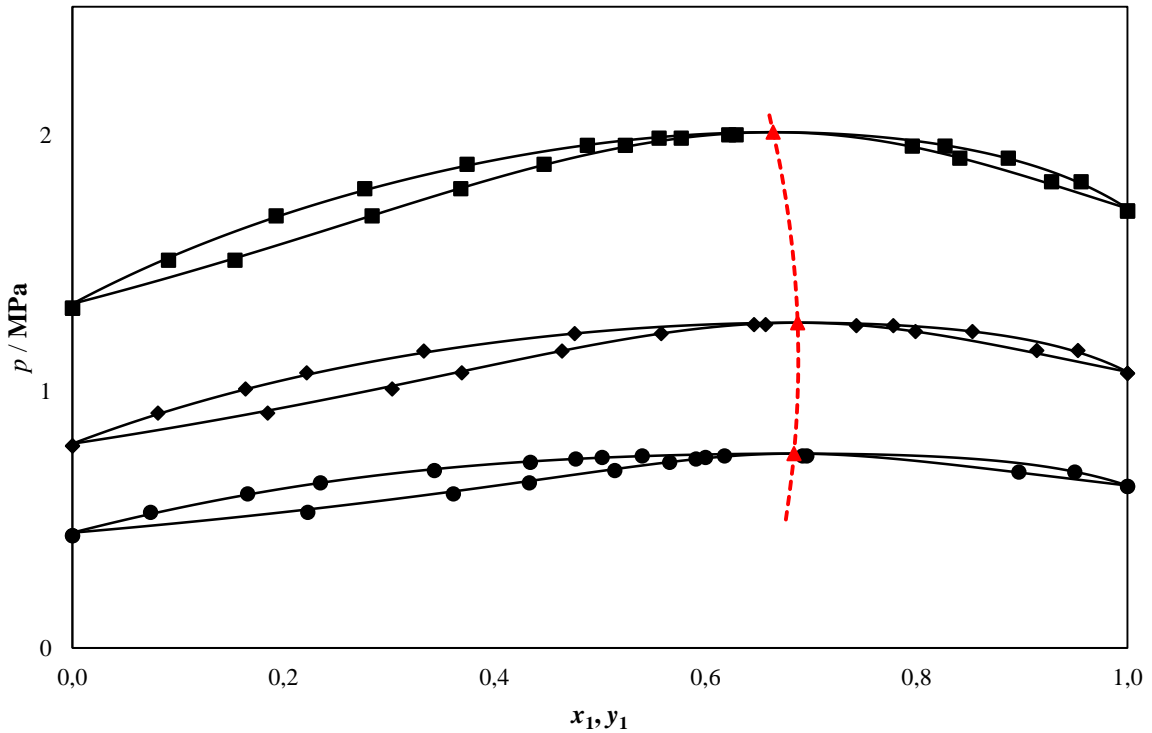

Figure 11. Graphical representation of VLE data for the propane (1) + HFPO (2) system. Experimental: ●, 283.05 K; ◆, 303.05 K; ■, 323.05 K; —, PR-MC-WS-NRTL model; ▲; Azeotropic point; - - -: Azeotrope line.

This azeotropic behaviour highlights the inherent complexity of phase equilibria in the propane (1) + HFPO (2) system, where both the liquid and vapour phases exhibit identical compositions at specific temperatures and pressures. This phenomenon renders conventional distillation ineffective for separating such mixtures, as it relies on differences in volatility between components. To overcome these challenges, separation processes, such as azeotropic, pressure-swing or extractive distillation are recommended. However, the presence of an azeotrope is not always disadvantageous. In certain applications, such as wastewater stripping or solvent dehydration, heterogeneous azeotropic points can be advantageous²⁵. For instance, they facilitate the removal of trace impurities, which is critical for achieving high-purity products.

CONCLUSIONS

In this study, novel isothermal VLE data for the propane (1) + HFPO (2) system were measured at three temperatures (283.05, 303.05, and 323.05 K) using a static-analytical setup. Phase equilibrium sampling was via the ROLSI capillary sampler, and composition analysis via gas chromatography. The experimental setup was validated by successfully reproducing the vapour pressure of propane and the isothermal VLE data for the R116 + propane system. For the propane (1) + HFPO (2) system, the expanded uncertainties in pressure, temperature, and phase composition measurements were determined to be within 0.008 MPa, 0.02 K, and 0.006, respectively. The isothermal VLE data were thermodynamically modelled via the direct method, utilizing the Peng-Robinson equation of state together with the Mathias-Copeman alpha function, and the Wong-Sandler mixing rule using the nonrandom two-liquid activity coefficient model. This approach yielded successful correlations of the measured data. The propane (1) + HFPO (2) system was found to exhibit azeotropic behaviour across the investigated isotherms, with azeotropic compositions not varying significantly with temperature. This behaviour highlights the complexity of separating this mixture within the studied range. Conventional distillation is ineffective for such system, consequently, azeotropic distillation or pressure-swing distillation are recommended for achieving separation.

AUTHOR INFORMATION

Corresponding Author

Marc Mulamba Tshibangu – Department of Chemical Engineering, Mangosuthu University of Technology, Jacobs, Durban, 4026, South Africa; Thermodynamics Research Unit, School of Engineering, University of KwaZulu-Natal, Howard College Campus, Durban, 4041, South Africa; <https://orcid.org/0009-0007-6248-7706>; Email: tshibangu.marc@mut.ac.za

Authors

Christophe Coquelet – Université de Toulouse, IMT Mines Albi, CNRS UMR 5302, Centre Rapsodee Campus Jarlard, 81013 Albi CT Cedex 9, France; Mines Paris PSL University, Centre for Energy Environment Processes (CEEP), 35 Rue Saint Honoré, 77305 Fontainebleau, France; <https://orcid.org/0000-0001-6382-673X>

Deresh Ramjugernath – Department of Chemical Engineering, Faculty of Engineering, Stellenbosch University, Stellenbosch, 7600, South Africa; Thermodynamics Research Unit, School of Engineering, University of KwaZulu-Natal, Howard College Campus, Durban, 4041, South Africa; <https://orcid.org/0000-0003-3447-7846>

Author contributions

The manuscript was written through contributions of all authors.

Marc Mulamba Tshibangu: Measurement and modelling of phase equilibrium data; write up of the original draft; contribution to the review and the editing process.

Christophe Coquelet: Provision of feedback and contribution to the review and editing of the original draft.

Deresh Ramjugernath: Conceptualisation of the project, contribution to the review and editing of the original draft.

Notes

The authors declare that there are no competing financial interests.

ACKNOWLEDGEMENTS

This research was funded by the South African Research Chairs Initiative under the Department of Science and Technology and the National Research Foundation of South Africa. Additionally, it is supported by the National Research Foundation of South Africa (Grant Number: 80063).

REFERENCES

- (1) Meshri, D. T. Book Chapter: Industrial Applications of Inorganic Fluorides. *Advanced Inorganic Fluorides: Synthesis, Characterization and Applications*. **2000**, Elsevier Science S.A.
- (2) Heintz, Y. H., Sehabiague, L., Morsi, B. I., Jones, K. L., and Pennline, H. W. Novel Physical Solvents for Selective CO₂ Capture from Fuel Gas Streams at Elevated Pressures and Temperatures. *Energy & Fuels* **2008**, Vol. 22, pp. 3824-3837.
- (3) Williams-Wynn, M. D.; Naidoo, P.; Ramjugernath, D. Isothermal Bubble Pressure Data for the Binary System of C₂F₆ and n-Octane. *J. Chem. Eng. Data* **2018**, 63, 12, 4795-4800.
- (4) Tshibangu, M. M., Valtz, A., Narasigadu, C. Coquelet, C. and Ramjugernath, D. Vapor-Liquid Equilibrium (VLE) Data and Thermodynamic Modeling for Binary Systems Containing Perfluorobutane (R610) with Carbon Monoxide or Nitric Oxide at (293, 313 and 333) K. *J. Chem. Eng. Data* **2014a**, Vol. 59(2), pp. 346-354.
- (5) Tshibangu, M. M.; Valtz, A.; Narasigadu, C.; Coquelet, C.; Ramjugernath, D. Isothermal Vapor-Liquid Equilibrium (VLE) and Vapor-Liquid-Liquid equilibrium (VLLE) Data for Two Binary Systems Containing Perfluorohexane with Carbon Monoxide or Hydrogen sulfide at (293, 313, and 333) K. *J. chem. Eng. Data* **2015**, Vol. 60, 2461 – 2468.
- (6) El Ahmar, E., Valtz, A., Naidoo, P., Coquelet, C., and Ramjugernath, D. Isothermal Vapour-Liquid Equilibrium Data for the Perfluorobutane (R610) + Ethane System at Temperatures from (263 to 353) K. *J. Chem. Eng. Data* **2010**, Vol. (56), pp. 1918-1924.
- (7) Subramoney, C. S.; Valtz, A.; Coquelet, C.; Richon, D.; Naidoo, P.; Ramjugernath, D. Vapor-Liquid Equilibrium Measurements and Modeling for the Ethane (R-170) + 1,1,2,3,3,3-Hexafluoro-1-propene (R-1216) Binary System. *J. Chem. Eng. Data* **2012**, 57, 2947–2955.
- (8) Coquelet, C.; Ramjugernath, D.; Madani, H.; Valtz, A.; Naidoo, P.; Meniai, A. H. Experimental Measurement of Vapor Pressures and Densities of Pure Hexafluoropropylene. *J. Chem. Eng. Data* **2010**, 55, 2093-2099.
- (9) Peng, D. Y.; Robinson, D. B. A New Two Constant Equation of State. *Ind. Eng. Chem. Fundam.* **1976**, 15, 59–64.

- (10) Mathias, P. M.; Copeman, T. W. Extension of the Peng-Robinson Equation of State to Complex mixtures: Evaluation of Various Forms of the Local Composition Concept. *Fluid Phase Equilib.* **1983**, 13, 91–108.
- (11) Wong, D. S. H.; Sandler, S. I. A Theoretically Correct Mixing Rule for Cubic Equation of State. *AIChE J.* **1992**, 38, 671–680.
- (12) Renon, H.; Prausnitz, J. M. Local Compositions in Thermodynamic Excess Functions for Liquid Mixtures. *AIChE. J.* **1968**, 14 (1), 135–144.
- (13) Coquelet, C.; Valtz, A.; Naidoo, P.; Ramjugernath, D.; Richon, D. Isothermal Vapor-Liquid Equilibrium Data for the Hexafluoropropylene (R1216) + Propylene System at Temperatures from (263.17 to 353.14) K. *J. Chem. Eng. Data* **2010**, 55, 1636-1639.
- (14) Tshibangu, M. M., Valtz, A., Narasigadu, C. Coquelet, C. and Ramjugernath, D. Isothermal Vapor-Liquid equilibrium Data and Thermodynamic Modeling for Binary Systems of Perfluorobutane (R610) + (Methane or Hydrogen Sulfide) at (293, 313, and 333) K. *J. Chem. Eng. Data* **2014**, 59, 2865-2871.
- (15) Dicko, M.; Coquelet, C.; Theveneau, P.; Mougin, P. Phase Equilibria of H₂S-Hydrocarbons (Propane, *n*-Butane, and *n*-Pentane) Binary Systems at Low Temperatures. *J. Chem. Eng. Data* **2012**, 57, 1534-1543.
- (16) van Konynenburg, P. H.; Scott, R. L. Critical Lines and Phase Equilibria in Binary Van Der Waals Mixtures. *Philos. Trans. R. Soc. London* **1980**, 298, 495–539.
- (17) Reid, R. C.; Prausnitz, J. M.; Poling, B. E. The properties of gases and liquids, 4th ed.; McGraw-Hill Book Company: New York, USA, **1987**.
- (18) Tshibangu, M. M. High Pressure Vapour-Liquid Equilibrium Data of Fluorochemical systems for Various Temperatures Using a New Static Apparatus. MSc dissertation, University of KwaZulu-Natal, Durban, South Africa (**2011**).
- (19) Tshibangu, M. M.; Courtial, X.; Coquelet, C.; Naidoo, P.; Ramjugernath, D. Isothermal Vapor-Liquid Equilibrium Data and Modeling for the Ethane (R170) + Perfluoropropane (R218) system at Temperatures from (264 to 308) K.
- (20) Sandler, S. I. *Chemical and Engineering Thermodynamics*, 3rd ed.; John Wiley & Sons, Inc.: New York, **1997**.

- (21) Rips, S. M. On a Feasible Level of Filling in of Reservoirs by Liquid Hydrocarbons, *Khim. Prom. (Moscow)*, **1963**, 8, 610-613.
- (22) Coquelet, C.; Chareton, A.; Valtz, A.; Baba-Ahmed, A.; Dominique Richon. Vapor–Liquid Equilibrium Data for the Azeotropic Difluoromethane + Propane System at Temperatures from 294.83 to 343.26 K and Pressures up to 5.4 MPa. *J. Chem. Eng. Data* **2003**, 48 (2), 317–323.
- (23) Ramjugernath, D.; Valtz, A.; Coquelet, C.; and Richon, D. Isothermal Vapor-Liquid Equilibrium Data for the Hexafluoroethane (R116) + Propane System at Temperatures from (263 to 323) K. *J. Chem. Eng. Data* **2009**, 54, 1292–1296.
- (24) Subramoney, S. C.; Nelson, W. M.; Valtz, A.; Coquelet, C.; Richon, D.; Naidoo, P.; and Ramjugernath, D. Pure Component and Binary Vapor-Liquid Equilibrium + Modeling for Hexafluoropropylene and Hexafluoropropylene Oxide with Toluene and Hexafluoroethane. *J. Chem. Eng. Data* **2010**, 55, 411–418.
- (25) Gmehling, J.; Bölts, R. Azeotropic Data for Binary and Ternary Systems at Moderate Pressures. *J. Chem. Eng. Data* **1996**, 41, 202-209.

Table of Contents

VLE DATA: Propane (1) + HFPO (2) System

