



**HAL**  
open science

## **Territorial blueprint in the hippocampal system**

Sylvia Wirth, Amelie Soumier, Marina Eliava, Dori Derdikman, Shlomo Wagner,  
Valery Grinevich, Angela Sirigu

► **To cite this version:**

Sylvia Wirth, Amelie Soumier, Marina Eliava, Dori Derdikman, Shlomo Wagner, et al.. Territorial blueprint in the hippocampal system. Trends in Cognitive Sciences, 2021, 25 (10), pp.831-842. <10.1016/j.tics.2021.06.005>. <hal-04973127>

**HAL Id: hal-04973127**

**<https://hal.science/hal-04973127v1>**

Submitted on 31 Mar 2025

**HAL** is a multi-disciplinary open access archive for the deposit and dissemination of scientific research documents, whether they are published or not. The documents may come from teaching and research institutions in France or abroad, or from public or private research centers.

L'archive ouverte pluridisciplinaire **HAL**, est destinée au dépôt et à la diffusion de documents scientifiques de niveau recherche, publiés ou non, émanant des établissements d'enseignement et de recherche français ou étrangers, des laboratoires publics ou privés.



Distributed under a Creative Commons CC BY-NC 4.0 - Attribution - Non-commercial use - International License

## **Territorial blueprint in the hippocampal system**

Sylvia Wirth<sup>1</sup>, Amelie Soumier<sup>2</sup>, Marina Eliava<sup>3</sup>, Dori Derdikman<sup>4</sup>, Shlomo Wagner<sup>5</sup>, Valery Grinevich<sup>\*3</sup>, Angela Sirigu<sup>\*1,2</sup>

<sup>1</sup>Institute of Cognitive Science Marc Jeannerod, CNRS and University of Lyon, Etablissement  
1, Bron, France

<sup>2</sup>iMIND Center of Excellence for Autism, le Vinatier Hospital, Bron, France

<sup>3</sup>Department of Neuropeptide Research in Psychiatry, Central Institute of Mental Health,  
University of Heidelberg, Mannheim, Germany

<sup>4</sup>Neuroscience Department, Technion - Israel Institute of Technology, Haifa, Israel

<sup>5</sup>Sagol Department of Neurobiology, the Integrated Brain and Behavior Research Center,  
Faculty of Natural Sciences, University of Haifa, Haifa, Israel.

Correspondence to: [sirigu@isc.cnrs.fr](mailto:sirigu@isc.cnrs.fr) or [swirth@isc.cnrs.fr](mailto:swirth@isc.cnrs.fr)

*\* equal contribution*

## **ABSTRACT**

As we skillfully navigate through familiar places, neural computations of distances and coordinates escape our attention. However, we perceive clearly the division of space into socially meaningful territories. “My space” vs. “your space” is a distinction familiar to all of us. Spatial frontiers are social in nature since they regulate individuals’ access to utilities in space depending on hierarchy and affiliation. How does the brain integrate spatial geometry with social territory? We propose that the action of oxytocin (OT) within the entorhinal-hippocampal regions supports this process. Grounded on the functional role of the hypothalamic neuropeptide in the hippocampal system, we show how OT induced plasticity may bias the geometrical coding of place and grid cells to represent social territories.

**Keywords:** space, social competition, resource protection, hippocampus, oxytocin, territorial behavior.

## **Origins of Territoriality in Humans: The Social Contract for Land Partition**

The human diaspora, which began *circa* 70,000 years ago as *Homo Sapiens* expanded out of Africa, was probably stimulated by massive local ecological changes [1]. The scarcity of resources such as food and shelter pushed humans to conquer new territories offering better prospects [2]. This adaptation is hypothesized to result from a genetically based proclivity for social group cooperation, coupled with the tendency to exploit dense and predictable nutritional sources [3]. Much later, the emergence of agriculture and animal domestication in Levant Natufian communities about 10,000 years ago was likely fostered by a rising sedentary lifestyle [4]. **Philopatry** (see Glossary) was in turn increased by the investments made in territory needed for farming. Humans transitioned from hunter-gatherer habitats to settlements, thereby providing the foundations of today's territorial landscape with villages or towns [5] with massive reorganization in workloads and division of labor. Even more consequential was the subsequent establishment of communal and private property, with increasing territorial control through societal organization, politics and sometimes war enforcement [4].

It is striking that territorial behavior has not declined over recent human evolution, and still strongly shapes individuals' views of space in terms of private, public, or neutral (no man's land). The scope of the phenomenon extends from the individual to society, with land use regulated between families, groups, cities, and countries, as embodied by legal and political agreements. Indeed, humans follow social contracts that govern the territorial use of land and its frontiers, depending on hierarchy and kinship [6]. Traditional and modern cultural agreements of land sharing include filiation, marriages, and between-group alliances [7]. Thus, space in the territorial format is essentially social.

We propose that this **territoriality** is underpinned by adaptive neural substrates linking the memory of resources via orienting and navigation to those controlling group interactions leading to land partition. In support of this idea, we adopt a neuro-ethological perspective and synthesize findings in several disciplines to explore the relationships between spatial and social cognition as a basis of the expression of territorial behavior (Figure 1). We propose possible brain mechanisms of territorial implementation driven by **oxytocin** (OT) input into the hippocampal-entorhinal complex. We suggest that space as a territory is a novel domain in cognitive neuroscience that should be further investigated using a read out of spatial metrics in terms of ownership, utilities, attachment, and social hierarchies.

## **Territorial Behavior is at the Crossroads Between Spatial and Social Representations**

Territorial behavior is not unique to humans. Limited resources such as food, shelter and mates have led many species, including birds, carnivorans, rodents, and primates, to exclude conspecifics from regions of space, granting them continuous access to resources [8]. Thus, a portion of space becomes a territory when an animal maintains a presence in a fixed limited area (philopatry) and defends it against intruders. This operational definition puts the concept of territory at the interface between physical attributes of space and the social interactions relating to acceptance or rejection of conspecifics in that space (Figure 1). That a territory possesses stable contours makes its definition parallel with that of “**home-range**”, which, for many species, consists of recurrent visits to specific feeding, caching, or sleeping sites [9], [10]. **Spatial cognition** is therefore a common capacity that enables exploitation of home-range resources in species subject to a wide variety of evolutionary pressures [11], [12], and can be adapted to manage the economics of important resources in a social competitive context. For example, in the monogamous territorial prairie vole, the expression of territorial behavior can be directly linked to spatial cognition: animals submitted to a high sexual competition, which increases territorial behavior, display better performance in laboratory spatial memory tests [13][14].

Space becomes a territory only when ownership is claimed by an individual or group and is challenged by others [15]. In gregarious species, the capacity of the home range to fulfill the increased nutritional needs of a thriving group often results in territorial defensiveness and conflict with other conspecific groups [15]. Male chimpanzees (*Pan troglodytes*) patrol and actively defend their borders through the formation of coalitions during intergroup aggression [16]. In fact, this aggressive strategy results in territorial home-range expansion for the victorious chimpanzees following a lethal conflict [17], improving the feeding success of individuals in their own community [18]. Male bonding play an important role when raids involve coalitions [19], a pattern that parallels human behavior in belligerent contexts [20]. Even in macaque species not known to exhibit strong territorial defense, such agonistic behavior between groups can emerge when animals are confronted with a lower food supply and higher population density [21]. Within the group, to reconcile possessive behaviors with the need to thrive, many mammalian species, including humans, compromise on the use of territory, according to social status and group affiliation [6]. The presence of marked levels of hierarchies and systems of dominance inherited through affiliation and kinship [22], strongly influence access to food, mates [23] and individual position within the group [24]. The overall intricacy of spatial distribution as a function of social determinant led us to hypothesize that common neural substrate is responsible for territorial behavior.

## **From Spatial Cognition to Space Ownership**

To navigate between locations in space, humans and other animals rely on a range of spatial information. Knowledge about self-position and heading direction, distance with respect to geographical landmarks or goals greatly enhances the exploitation of a home range. The past four decades of neuroscience research have confirmed that many of the building blocks essential to support an internal cognitive map of space [25] are present in the hippocampal formation (broadly defined as the hippocampus, the subiculum and the entorhinal cortex). The cognitive spatial map is now believed to be embodied by neurons with unique functional properties, such as place cells and grid cells (Figure 2A,B) in the hippocampus and the entorhinal cortex [25]. Such cells, first demonstrated in rodents, display a selective neuronal activity for a place that depends on the animal occupying that place. Other notable functional cell types identified in species evolving under various ecological settings (rats, bats and macaques), include cells encoding a particular direction in space with respect to an object, a goal or a reward [26]–[29] (Figure 2C), and cells that are active when animals roam along the physical limits of a place [27] (Figure 2D). Thus, the hippocampal formation harbors the essential building blocks to encode the physical attributes and resources available in a territory.

An important issue is how territorial behavior relates to the mechanisms underlying a sense of ownership associated with one's own territory. While other animals may not have the same concept of ownership as humans do, it is plausible that territorial defense may be a form of rudimentary ownership expression. A prerequisite for territorial behavior is that a partition of land is recognized as one's own. Such sense of ownership might arise from (a) long-term familiarity, which may help in recognizing what is one's own, and (b) a bias to return to rewarding places. These processes may be mediated by the hippocampal formation's ability to learn about rewards within a home-range and to bias future exploitation of rewards within a known place [30], [31]. In this respect, the hippocampus might contribute to territorial cognition before that territory is shared with or protected from others.

## **Mapping Social Information in the Hippocampal Regions**

Recent evidence indicates that the hippocampus displays complexity along social dimensions comparable to that described above for spatial dimensions. In humans, macaque monkeys and rodents, hippocampal neurons carry information related to other individuals' identity [32]–[34], a requirement for territorial representation. Notably, in humans, these neurons respond selectively to a specific person's visual image, spoken name, or when the person's identity

is recalled from memory [35]. In rodents, several findings support the involvement of all regions of the hippocampus in encoding and maintenance of **social memory**, the ability of an animal to remember a conspecific. Recent attention has been drawn specifically to **CA2**, the region interposed between CA3, the input region, and CA1, the output region of the hippocampus. Silencing neuronal activity in CA2, [36] and its projection to CA1 impacts encoding, consolidation and recall of social memory [37] and induces specific changes in CA1 neural dynamics [38]. Conversely, optogenetic activation of CA2 enhanced social memory if applied during encoding [39]. Beyond CA2, direct optogenetic manipulation of ventral hippocampal CA1 neurons in mice shows that this output region possibly stores social memory [37], [40], [41]. Specific alterations of the input region of the hippocampus, in ventral CA3, via blockage of glutamate (NMDA) receptor plasticity also produces deficits in social memory [42].

Recent neurophysiological findings reveal the convergence of social and spatial signals in the hippocampus. Specifically, rodent pyramidal cells in CA2 [37], [43] and CA1 [34] exhibit spatial firing rates that change or “remap” depending on the presence of conspecifics. Further, **social place cells** found in CA1 in rats and bats (Figures 2E and 2G,) encode the observed position of conspecifics in turn-taking tasks in which the other’s position in place was monitored [44], [45]. These cells fire distinctively (in different locations) or jointly (in same locations) for self or observed other’s position in space, and even can acquire spatial selectivity through observation prior to actual self-exploration [46]. Recent intracranial recordings in human patients during actual ambulation show that hippocampal oscillatory activity is modified by the presence of another individual, indicating a boundary anchoring effect [47]. Thus, the hippocampus possesses the functional cells types that may support the computation of self and other’s place most suitable to define self and other’s territory. Finally, functional neuroimaging studies in humans show that hippocampal activity encodes social distances along axes representing dominance and affiliation [48] and tracks dynamic social behavior, such as hierarchical status [49]. The social factors in these studies are relevant to territorial compromises with others in one’s group, or with out-groups. Hence, the hippocampus could provide an important contribution to territorial representation. Next, we explore how this role may be linked to OT actions.

Although the role of canonical neurotransmitters, such as glutamate, glycine and GABA, within the hippocampal formation has been studied for decades, the impact of non-conventional neurotransmitters, such as neuropeptides, remains poorly explored. OT and arginine vasopressin, both synthesized in the hypothalamic paraventricular and supraoptic nuclei of mammals, are of interest to territoriality because they are both released in the hippocampus [50]. However, direct

OT-ergic projections to the hippocampal regions are best documented [50]–[52]. Therefore, basing this opinion on evidence from the literature and our own results, we focus on oxytocin and propose that by virtue of its role in processing social information this neuropeptide influences territorial representation *via* the hippocampal-entorhinal circuit.

### **Linking Oxytocin to Territorial Behavior**

OT is released into the blood stream as a hormone controlling various physiological processes, such as parturition, lactation, energetic metabolism, and cardiovascular functions[53]. In conjunction, OT acts centrally in the brain as a non-canonical neurotransmitter or neuromodulator, regulating a number of behaviors ranging from pain to social behaviors [50], [54]. Indeed, many actions of OT are key to territorial behavior because they influence emotions and reactions to others, such as attachment and affiliation, or distancing and aggression[53], [55], [56]. For example, a key difference between the monogamous territorial prairie vole and the polygamous non-territorial montane vole lies in the way the OT system controls their behavior, which stems from distinct patterns of OT receptor expression [57]–[59]. Direct OT infusion into the cerebral ventricles of the monogamous prairie vole’s brain alters not only pair bonding, but also tolerance towards competitors [60], a behavior that subserves territoriality in this monogamous species [58]. Specifically, in monogamous males, OT receptor expression was greater in individuals that exhibited high reproductive success and expressed high territoriality [58]. In contrast, in polygamous mammalian species, OT increases social affiliation and contact [61], which may enhance tolerance of others, and contribute to the regulation of the peri-personal space defining the territory of self. In line with this possibility, firing of OT neurons in the paraventricular nucleus increases gradually when female rats approach each other [62]. Thus, OT may regulate territoriality in rodents by acting on variables controlling social tolerance and affiliation by species, sex and reproductive strategies.

In both human and non-human primates, intranasally administered OT which crosses the blood-brain barrier [63]–[65] globally increases attention to the eyes region [66], [67], gaze following in monkeys [68], [69] and facilitates the reading of emotions in humans [70]. Within a group of macaques, OT reduces the normally hierarchized gazing behavior between dominant and subordinate monkeys [71], [72] suggesting that OT increases tolerance across levels of the hierarchy within a group. Similarly, in chimpanzees plasma OT levels assessed from urine are correlated to the strength of social bonding among individuals in a group [73]. In humans,

intranasal OT administration increases trust in other individuals [74], [75] and alters social distance in personal space [76]. Overall, these results suggest that OT increases the saliency of social elements [77] which, in a context of spatial competition, could reinforce individual and collective territoriality. Indeed, OT promotes in-group favoritism by increasing biases in a test of stereotypes [78] and increases in-group cooperation when attacking out-group competitors [79]. This fits with results supporting OT involvement in chimpanzee intergroup conflict [80]. Altogether, these findings support a role of the neuropeptide in **ethnocentrism**, important for the expression of territorial behavior when confronted with a resource limitation of space. This is not a direct evidence for an involvement of OT in territorial behavior, but it indicates that OT acts on the social variables that modulate tolerance to other individuals and group cohesion, which in turn influences territorial defense.

### **The central Action of Oxytocin in the Hippocampal Formation**

Although peripherally circulating, OT does not cross the blood brain barrier in behaviorally relevant amounts [81], [82], and local concentrations of the hypothalamic neuropeptide in the brain are surprisingly much higher than in the blood [83]. Indeed, beyond its classic peripheral targets, (such as the uterus and mammary glands) [84], the central action of OT, supports a wide range of physiological and behavioral effects mediated by its actions on its receptors (OTRs), which are distributed in many regions such as the basal forebrain and the amygdala (for review see [52], [54]). Here we will focus on OT signaling in the hippocampal-entorhinal regions specifically relevant to the processing of spatial and social information linked to territoriality (Figure 3). In rodents, OTRs have been found in all fields of the hippocampus (but most abundantly in CA2 and CA3) and entorhinal cortex, [53], [85], [86] despite the fact that mice, rats and voles have their own peculiarities in the OTR distribution patterns in other brain regions. Interestingly, in the prairie voles, the pattern of hippocampal OTR expression predicted the animal's territorial profile (i.e. maintaining and defending a portion of space) in the context of sexual competition [58].

Evidence for hippocampal OTR expression has also been reported in primates. More specifically, OTR binding was found in the entorhinal cortex of the rhesus macaque [87], and in the whole hippocampal regions in the Titi monkey [87], [88]. In the latter species, OTR hippocampal binding was increased depending on parental experience, suggesting a direct role of OTR in affiliative behavior [88]. Using a highly sensitive RNA sequencing technique, OTR gene expression has been found in human hippocampus [89]. However, this latter finding awaits confirmation for functional OTRs by advanced techniques with cellular and molecular resolutions, such as precise *in*

*situ* hybridization (RNAscope) and region-specific real time PCR. Nevertheless, intranasal administration of OT in humans modulates fMRI signals in the hippocampus when subjects perceive faces having a social value [90]. Further, central OT infusion into the lateral ventricle of rhesus macaques affects hippocampal binding of serotonin, a neurotransmitter, known to regulate emotional responses and approach-avoidance behaviors [91].

How does OT reach its target within the hippocampal formation? Although long-standing theory proposes a passive diffusion of the neuropeptide from dendrites of hypothalamic neurons (in the paraventricular and supraoptic nuclei) through the entire brain [92], such passive diffusion would have a limited ability to elicit temporally-locked and brain-region specific behaviors. An alternative concept, supported by a numerous circuit-intervened manipulations [51], [93]–[96] argues for precise release of OT from axon terminals of OT neuronal projections terminating in distant brain regions. Although both mechanisms of OT transmission can be considered, it is crucial for our hypothesis that long-range oxytocinergic axonal projections have been found in all fields of the hippocampus and in subdivisions of the entorhinal cortex of rats [51], [52], [97]–[99].

There is ample evidence for the functional significance of evoked endogenous release of OT in the hippocampal-entorhinal system in rodents [97]. Direct activation or inactivation of OTRs via optogenetic, chemogenetic, or pharmacological approaches reveals three important cellular effects of OT signaling. First, their activation increases bursting firing in CA2 pyramidal cells as well as in fast-spiking CA2 interneurons [100], [101] thereby enhancing spike transmission and tuning of CA1 neurons output. Second, it promotes long term-potential of synaptic activity in CA1 pyramidal neurons [102] and depression in the dentate gyrus [103]. Third, their inactivation reduces synaptic transmission from pyramidal CA2 neurons to CA1 [98] or to the entorhinal cortex [104].

At the behavioral level, chemical or genetic silencing of OTR in CA2/CA3 and/or dentate gyrus reveals that they are essential for social memory [98], [104]. Further, during the processing of a social stimulus, the activation of OT receptors in CA2/CA3 neurons results in the recruitment of population-based coding mechanisms through ensembles of neurons [98]. The connectivity of this CA2/CA3 population may be maintained by OT because deletion of OT receptors reduces the complexity of basal dendritic arbors of CA2 pyramidal neurons [98], [104]. This suggests that OT controls the neural signal strength of social stimuli in the hippocampus. These effects set the stage for a specific role of OT signaling by means of information selection and plasticity within the hippocampus prior to the output to other regions. We suggest that in addition to social memory, OT might enable defining own and other's space, depending on the ecological context.

## **A Neural Implementation of Territorial Behavior: a Role of Oxytocin Inputs in the Hippocampal Networks**

How might OT inputs affect territorial representations? An elementary implementation of a territory can be based on the hallmark of the hippocampal function: its multi-modal associative ability supported by extensive **CA3 recurrent collateral connections** [105], [106] (Figure 3). Given input from the entorhinal cortex and dentate gyrus through the trisynaptic circuit, neurons in any part of CA3 can form connections with neurons in CA3, CA2 and CA1 and can, by associative learning, create cell assemblies linking neurons with different representations [107] (Figures 3 and 4). A parsimonious expression of territory might be encoded by links (in green on Figure 4) between spatial representations (carried by CA3 or CA1 place cells) and social representations (carried by social cells and identity cells in CA2 and CA1); and further embodied by neurons coding the learned association between a set of locations and an individual. Being formed only in a competitive context, we term any such neurons “territory” cells. These cells could encode locations within a territorial boundary in a position invariant manner (in green in Figure 4) reduced to personal or other property dimensions and support memory of territorial interactions similar to place cells representing familiar locations. Given this associative scheme, and in a manner consistent with the cellular and behavioral effects of OT in the hippocampus described above, OT may directly modulate synaptic weights to facilitate learning between spatial and social representations. In addition, OT might influence territorial representation by its inputs to layers II and III of the entorhinal cortex. Within this region, signals carried by grid cells and border cells could provide socially biased input to the hippocampal CA1 via the trisynaptic pathways depending on OT release in the entorhinal cortex during a social encounter (Figure 3). We speculate that entorhinal object vector cells [108] could anchor on social stimulus instead of physical objects. In this framework, as shown in Figure 4, a representation of the geometric space may co-exist in conjunction with a representation of the same space in a territorial format when social context is gated by entorhinal input. Switching between these representations could depend on the presence or absence of other individuals, and be facilitated by the increase in signal to noise ratio provided by OT actions in hippocampus [97], [104]. In addition to the well documented trisynaptic pathway, EC cortex also provides a more sparse monosynaptic input to CA1[109] whose role is less understood, but is hypothesized to relate to novelty detection. By modulating entorhinal cortex neurons *via* this dual input, OT actions can occur during territorial initiation, recall and updating of the existing territorial map.

These hypotheses could be directly tested by measuring the effects of activating or suppressing OTR actions (via chemo- or optogenetic tools) in the hippocampus while animals navigate in or out a social territory (see Figure 4). The effects of direct stimulation of OT neurons innervating the entorhinal cortex should also be tested on behavior and on hippocampal neural activity. For example, behavioral measures (exploration, avoidance) and neural activity (via spatial selectivity measures) should be compared before and after an animal's territory has been restricted by a partition of the environment creating a neighboring territory. Territory and border cells could be identified while animals access each other's territory or observe another conspecific in their own territory. We predict that silencing or increasing OT action would modulate the signal carried in the hippocampal regions and the expression of territorial behavior.

Territorial behavior is likely to involve other brain regions in conjunction with the hippocampal system to guide behaviors such as acceptance or rejections of intruders within a territory depending on their subordinate or dominance status or affiliation. The two key regions, which are strongly connected with the hippocampus and control behavior relevant to territoriality such as defensive fight-flight responses, are the amygdala [110], [111] and the medial septum [112]. Depending on the nature of the social encounter, modulation of the behavior can take place through the output projections from the hippocampus to the amygdala [113] or to the septal regions [114]. Thus, based on the memory of previous interactions formed by the hippocampus, these circuits likely are important players to guide specific behavior (submission, approach, attack, and defense) depending on the presence or absence of a threat in a territorial space.

### **Concluding remarks**

Territoriality, often associated more generally with property (i.e., owned objects and land), is an evolutionarily rooted behavior that has a pervasive influence on human individuals and societies. We propose a model based on two evolutionary conserved systems, the hippocampal formation and the OT neuropeptide, fitting the enduring adaptive relevance of territorial behavior. Although the role of hippocampus in spatial cognition and more recently in social cognition [49], [115], is widely corroborated, it is never formulated in terms of territoriality. Our model proposes a new view of space in which spatial metrics integrate social demands to generate territorial behavior, either as territorial aggression or as a compromise of spatial resources. Exactly how territorial behavior, stems from OT action needs to be unraveled and many other questions should be prospectively addressed (see also Outstanding Questions). In particular, the well-known interaction between OT and its sister peptide, arginine vasopressin, both originating from hypothalamic nuclei, may reveal

networks with functions complementary to those discussed here [116]. Indeed, OT, released massively during dramatic behavioral and homeostatic challenges, can bind to arginine vasopressin receptors [116], [117]. This is particularly relevant to arginine vasopressin signaling in aggression and individual territory defense [118]. Altogether, exploring the neural mechanisms of territorial behavior is likely to be of significant utility in understanding modern human society, in which territorial boundaries, whether private or national, are the origin of most conflicts and wars. Therefore, advances on the neural underpinning of territoriality could thus support prospects for translational applications.

### **Acknowledgements**

ASir, ASou and SW are supported by CNRS, ANR (16-CE37-0017-01, 17-CE37-0015-01) and by Labex Cortex (ANR-11-LABEX-0042) grant from the University of Lyon I within the program “*Investissement d’Avenir*”. VG is supported by German Research Foundation (DFG) Collaborative Research Center (SFB) 1158-2, DFG-RSF grant GR 3619/15-1, DFG grant GR 3619/10-1, DFG grant GR 3619/13-1, and DFG-SNSF grant GR 3619/8-1. We thank Dr. Thomas Spletstoeser (SciStyle; [www.scistyle.com](http://www.scistyle.com)) for his help with the preparation of figures and Alessandro Treves for exciting discussion.

**Authors contribution:** SWir, VG and ASir proposed the original concept framework. All authors contributed to the elaboration of the proposed model. SWir wrote a first draft and ASir and Vg provided ongoing review. All authors contributed and approved the final version of the document.

**The authors declare no conflict of interest.**

## Figure Legends

**Figure 1. Conceptual framework of territorial coding interfacing spatial and social domains.** Oxytocin inputs (red) on brain areas dedicated to spatial processing (blue) yields a territorial representation where space is mapped within the social domain. This process merges 1) the ability to know a terrain such as a home-range, through its resources and borders, and 2) the ability to identify others allowed in that terrain (self, mate, kin, affiliated) and excluded (any other conspecific, any non-kin). Thereby, territoriality results from the controlled access to spatial resources by social determinants between and within groups.

**Figure 2. Spatial and social codes in the hippocampus and entorhinal cortex of rodents and bats.** **A**, Place cells in rodent CA1 adapted from [119]. **B**, Grid cells in rodent medial entorhinal cortex (MEC) adapted from [120]. **C**, Object vector cells in rodent MEC adapted from [108], **D**, Border cells in rodent MEC adapted from [27]. **E**, A social place cell in the rodent hippocampus adapted from [121]. The left panel: the turn-taking task in which the correct reward location for one rat depended on the observed trajectory of the other rat. The right panel: example cell's activity (bottom) and firing rate map (top) for self and other's trajectory. **F**, social place cell in the hippocampus of the bat adapted from [44]. Left panel: a bat (with a red mark) observes a demonstrator during successive flights between two goal positions A and B. Right panel: Neural activity (top) and firing rate map (bottom) for self or other's trajectories.

**Figure 3. The Oxytocin action in the hippocampal system.** Schematic representation of the sites of OT action in the hippocampal system in the CA regions. OT-induced plasticity may promote the combination of spatial and social inputs within the hippocampal circuit via CA3 recurrent collaterals or by its action in the entorhinal cortex. The outputs of this circuit convey territorial information to the cortex, the amygdala and to septal regions. Abbreviations: paraventricular nucleus of hypothalamus (PVN), entorhinal cortex (EC).

**Figure 4. Theoretical territorial neural representation implementing putative oxytocin action sites to modulate diverse cell types within the hippocampus and entorhinal cortex of rodents.** In the hippocampus, promoted by OT action on synaptic plasticity, territory might be encoded by synaptic links (green cells) between cells representing space (in blue) and social stimuli (in red). These converging inputs might lead to the appearance of "territory cells" displaying large place fields encompassing all positions within a territory. In the entorhinal cortex, cells might encode the social border between self and other territory (green territory border cells), or one's bearing with respect to others in space (social object vector cell in red). OT may modulate activity of social place cells and territory cells in the hippocampus and entorhinal cortex via its axonal projections originating from paraventricular nucleus of the hypothalamus (in purple) (see Figure 3). The cells encoding territory may co-exist with other cells encoding physical attributes of the environment (in blue) or social stimuli (in red).

## REFERENCES

- 1 Eriksson, A. *et al.* (2012) Late Pleistocene climate change and the global expansion of anatomically modern humans. *Proceedings of the National Academy of Sciences* 109, 16089–16094
- 2 Mellars, P. (2006) Why did modern human populations disperse from Africa ca. 60,000 years ago? A new model. *Proc. Natl. Acad. Sci. U.S.A.* 103, 9381–9386
- 3 Marean, C.W. (2015) An Evolutionary Anthropological Perspective on Modern Human Origins. *Annu. Rev. Anthropol.* 44, 533–556
- 4 Bar-Joseph, O. (2001) From Sedentary Foragers to Village Hierarchies: The Emergence of Social Institutions. 101,
- 5 Bowles, S. and Choi, J.-K. (2013) Coevolution of farming and private property during the early Holocene. *Proceedings of the National Academy of Sciences* 110, 8830–8835
- 6 King, G.E. (1976) Society and territory in human evolution. *Journal of Human Evolution* 5, 323–331
- 7 Taylor, R. (1988) *HUMAN TERRITORIAL FUNCTIONING, An empirical, evolutionary perspective on individual and small group territorial cognitions, behaviors, and consequences*, DANIEL STOKOLS, IRWIN ALTMAN. CAMBRIDGE UNIVERSITY PRESS.
- 8 Burt, W.H. (1943) Territoriality and Home Range Concepts as Applied to Mammals. *Journal of Mammalogy* 24, 346
- 9 Börger, L. *et al.* (2008) Are there general mechanisms of animal home range behaviour? A review and prospects for future research: Home range modelling. *Ecology Letters* 11, 637–650
- 10 Gould, K.L. *et al.* (2010) What scatter-hoarding animals have taught us about small-scale navigation. *Philos. Trans. R. Soc. Lond., B, Biol. Sci.* 365, 901–914
- 11 Fagan, W.F. *et al.* (2013) Spatial memory and animal movement. *Ecol. Lett.* 16, 1316–1329
- 12 Spencer, W.D. (2012) Home ranges and the value of spatial information. *J Mammal* 93, 929–947
- 13 Rice, M.A. *et al.* (2019) Social context alters spatial memory performance in free-living male prairie voles. *R. Soc. open sci.* 6, 190743
- 14 Ophir, A.G. (2017) Navigating Monogamy: Nonapeptide Sensitivity in a Memory Neural Circuit May Shape Social Behavior and Mating Decisions. *Front. Neurosci.* 11, 397
- 15 Hinsch, M. and Komdeur, J. (2017) What do territory owners defend against? *Proc. R. Soc. B* 284, 20162356
- 16 Watts, D.P. *et al.* (2006) Lethal intergroup aggression by chimpanzees in Kibale National Park, Uganda. *Am. J. Primatol.* 68, 161–180
- 17 Mitani, J.C. *et al.* (2010) Lethal intergroup aggression leads to territorial expansion in wild chimpanzees. *Current Biology* 20, R507–R508
- 18 Langergraber, K.E. *et al.* (2017) Group augmentation, collective action, and territorial boundary patrols by male chimpanzees. *Proc Natl Acad Sci USA* 114, 7337–7342
- 19 Wilson, M.L. and Wrangham, R.W. (2003) Intergroup Relations in Chimpanzees. *Annu. Rev. Anthropol.* 32, 363–392

- 20 Wrangham, R.W. and Glowacki, L. (2012) Intergroup Aggression in Chimpanzees and War  
in Nomadic Hunter-Gatherers: Evaluating the Chimpanzee Model. *Hum Nat* 23, 5–29
- 21 José-Domínguez, J.M. *et al.* (2015) Non-territorial Macaques Can Range Like Territorial  
Gibbons When Partially Provisioned With Food. *Biotropica* 47, 733–744
- 22 Chapais, B. (2004) How kinship generates dominance structures: A comparative  
perspective. In : *How societies arise: the macaque model* B. Thierry, M. Singh & W.  
Kaumanns. Cambridge University Press
- 23 Silk, J.B. (2009) Nepotistic cooperation in non-human primate groups. *Philos. Trans. R. Soc.  
Lond., B, Biol. Sci.* 364, 3243–3254
- 24 Farine, D.R. *et al.* (2017) Individual variation in local interaction rules can explain emergent  
patterns of spatial organization in wild baboons. *Proc. R. Soc. B* 284, 20162243
- 25 Grieves, R.M. and Jeffery, K.J. (2017) The representation of space in the brain. *Behavioural  
Processes* 135, 113–131
- 26 Sarel, A. *et al.* (2017) Vectorial representation of spatial goals in the hippocampus of bats.  
*Science* 355, 176–180
- 27 Solstad, T. *et al.* (2008) Representation of geometric borders in the entorhinal cortex.  
*Science* 322, 1865–1868
- 28 Wang, C. *et al.* (2018) Egocentric coding of external items in the lateral entorhinal cortex.  
*Science* 362, 945–949
- 29 Wirth, S. *et al.* (2017) Gaze-informed, task-situated representation of space in primate  
hippocampus during virtual navigation. *PLoS Biol.* 15, e2001045
- 30 Boccara, C.N. *et al.* (2019) The entorhinal cognitive map is attracted to goals. *Science* 363,  
1443–1447
- 31 Butler, W.N. *et al.* (2019) Remembered reward locations restructure entorhinal spatial  
maps. *Science* 363, 1447–1452
- 32 Quiroga, R.Q. *et al.* (2005) Invariant visual representation by single neurons in the human  
brain. *Nature* 435, 1102–1107
- 33 Sliwa, J. *et al.* (2016) Independent Neuronal Representation of Facial and Vocal Identity in  
the Monkey Hippocampus and Inferotemporal Cortex. *Cereb. Cortex* 26, 950–966
- 34 Rao, R.P. *et al.* (2019) Neuronal Responses to Conspecifics in the Ventral CA1. *Cell Reports*  
27, 3460–3472.e3
- 35 Rey, H.G. *et al.* (2020) Single Neuron Coding of Identity in the Human Hippocampal  
Formation. *Current Biology* 30, 1152–1159.e3
- 36 Hitti, F.L. and Siegelbaum, S.A. (2014) The hippocampal CA2 region is essential for social  
memory. *Nature* 508, 88–92
- 37 Meira, T. *et al.* (2018) A hippocampal circuit linking dorsal CA2 to ventral CA1 critical for  
social memory dynamics. *Nat Commun* 9, 4163
- 38 Brown, L.Y. *et al.* (2020) Hippocampal CA2 Organizes CA1 Slow and Fast  $\gamma$  Oscillations  
during Novel Social and Object Interaction. *eNeuro* 7, ENEURO.0084-20.2020
- 39 Smith, A.S. *et al.* (2016) Targeted activation of the hippocampal CA2 area strongly enhances  
social memory. *Mol Psychiatry* 21, 1137–1144
- 40 Okuyama, T. *et al.* (2016) Ventral CA1 neurons store social memory. *Science* 353, 1536–1541
- 41 Okuyama, T. (2018) Social memory engram in the hippocampus. *Neuroscience Research* 129,  
17–23
- 42 Chiang, M.-C. *et al.* (2018) A role for CA3 in social recognition memory. *Behav. Brain Res.*  
354, 22–30
- 43 Alexander, G.M. *et al.* (2016) Social and novel contexts modify hippocampal CA2  
representations of space. *Nat Commun* 7, 10300
- 44 Omer, D.B. *et al.* (2018) Social place-cells in the bat hippocampus. *Science* 359, 218–224

- 45 Danjo, T. *et al.* (2018) Spatial representations of self and other in the hippocampus. *Science* 359, 213–218
- 46 Mou, X. and Ji, D. (2016) Social observation enhances cross-environment activation of hippocampal place cell patterns. *eLife* 5, e18022
- 47 Stangl, M. *et al.* (2021) Boundary-anchored neural mechanisms of location-encoding for self and others. *Nature* 589, 420–425
- 48 Tavares, R.M. *et al.* (2015) A Map for Social Navigation in the Human Brain. *Neuron* 87, 231–243
- 49 Montagrin, A. *et al.* (2018) The social hippocampus. *Hippocampus* 28, 672–679
- 50 Cilz, N.I. *et al.* (2018) Oxytocin and vasopressin in the rodent hippocampus. *Genes, Brain and Behavior* DOI: 10.1111/gbb.12535
- 51 Knobloch, H.S. *et al.* (2012) Evoked axonal oxytocin release in the central amygdala attenuates fear response. *Neuron* 73, 553–566
- 52 Grinevich, V. *et al.* (2016) Assembling the Puzzle: Pathways of Oxytocin Signaling in the Brain. *Biological Psychiatry* 79, 155–164
- 53 Jurek, B. and Neumann, I.D. (2018) The Oxytocin Receptor: From Intracellular Signaling to Behavior. *Physiological Reviews* 98, 1805–1908
- 54 Grinevich, V. and Neumann, I.D. (2020) Brain oxytocin: how puzzle stones from animal studies translate into psychiatry. *Mol Psychiatry* DOI: 10.1038/s41380-020-0802-9
- 55 Lee, H.-J. *et al.* (2009) Oxytocin: The Great Facilitator of Life. *Progress in Neurobiology* DOI: 10.1016/j.pneurobio.2009.04.001
- 56 Donaldson, Z.R. and Young, L.J. (2008) Oxytocin, vasopressin, and the neurogenetics of sociality. *Science* 322, 900–904
- 57 Beery, A.K. (2019) Frank Beach award winner: Neuroendocrinology of group living. *Hormones and Behavior* 107, 67–75
- 58 Ophir, A.G. *et al.* (2012) Oxytocin receptor density is associated with male mating tactics and social monogamy. *Hormones and Behavior* 61, 445–453
- 59 Young, L.J. and Wang, Z. (2004) The neurobiology of pair bonding. *Nat Neurosci* 7, 1048–1054
- 60 Carter, C.S. *et al.* (1992) Oxytocin and Social Bonding. *Annals of the New York Academy of Sciences* 652, 204–211
- 61 Lim, M.M. and Young, L.J. (2006) Neuropeptidergic regulation of affiliative behavior and social bonding in animals. *Horm Behav* 50, 506–517
- 62 Tang, Y. *et al.* (2020) Social touch promotes interfemale communication via activation of parvocellular oxytocin neurons. *Nat Neurosci* 23, 1125–1137
- 63 Lee, M.R. *et al.* (2018) Oxytocin by intranasal and intravenous routes reaches the cerebrospinal fluid in rhesus macaques: determination using a novel oxytocin assay. *Mol Psychiatry* 23, 115–122
- 64 Lee, M.R. *et al.* (2020) Labeled oxytocin administered via the intranasal route reaches the brain in rhesus macaques. *Nat Commun* 11, 2783
- 65 Striepens, N. *et al.* (2013) Elevated cerebrospinal fluid and blood concentrations of oxytocin following its intranasal administration in humans. *Sci Rep* 3, 3440
- 66 Chang, S.W.C. and Platt, M.L. (2014) Oxytocin and social cognition in rhesus macaques: Implications for understanding and treating human psychopathology. *Brain Research* 1580, 57–68
- 67 Lefevre, A. and Sirigu, A. (2016) The two fold role of oxytocin in social developmental disorders: A cause and a remedy? *Neuroscience & Biobehavioral Reviews* 63, 168–176
- 68 Parr, L.A. *et al.* (2013) Intranasal oxytocin selectively attenuates rhesus monkeys' attention to negative facial expressions. *Psychoneuroendocrinology* 38, 1748–1756

- 69 Putnam, P.T. *et al.* (2016) Oxytocin enhances gaze-following responses to videos of natural  
social behavior in adult male rhesus monkeys. *Psychoneuroendocrinology* 72, 47–53
- 70 Domes, G. *et al.* (2007) Oxytocin Improves “Mind-Reading” in Humans. *Biological  
Psychiatry* 61, 731–733
- 71 Jiang, Y. and Platt, M.L. (2018) Oxytocin and vasopressin flatten dominance hierarchy and  
enhance behavioral synchrony in part via anterior cingulate cortex. *Sci Rep* 8, 8201
- 72 Ebitz, R.B. *et al.* (2013) Oxytocin blunts social vigilance in the rhesus macaque. *Proceedings  
of the National Academy of Sciences* 110, 11630–11635
- 73 Crockford, C. *et al.* (2013) Urinary oxytocin and social bonding in related and unrelated wild  
chimpanzees. *Proc. R. Soc. B* 280, 20122765
- 74 Kosfeld, M. *et al.* (2005) Oxytocin increases trust in humans. *Nature* 435, 673–676
- 75 Declerck, C.H. *et al.* (2020) A registered replication study on oxytocin and trust. *Nat Hum  
Behav* 4, 646–655
- 76 Cohen, D. *et al.* (2017) The role of oxytocin in modulating interpersonal space: A  
pharmacological fMRI study. *Psychoneuroendocrinology* 76, 77–83
- 77 Shamay-Tsoory, S.G. and Abu-Akel, A. (2016) The Social Salience Hypothesis of Oxytocin.  
*Biological Psychiatry* 79, 194–202
- 78 De Dreu, C.K.W. *et al.* (2011) Oxytocin promotes human ethnocentrism. *Proceedings of the  
National Academy of Sciences* 108, 1262–1266
- 79 Zhang, H. *et al.* (2019) Oxytocin promotes coordinated out-group attack during intergroup  
conflict in humans. *eLife* 8, e40698
- 80 Samuni, L. *et al.* (2017) Oxytocin reactivity during intergroup conflict in wild chimpanzees.  
*Proc Natl Acad Sci USA* 114, 268–273
- 81 Kagerbauer, S.M. *et al.* (2013) Plasma oxytocin and vasopressin do not predict neuropeptide  
concentrations in human cerebrospinal fluid. *J. Neuroendocrinol.* 25, 668–673
- 82 Leng, G. and Sabatier, N. (2016) Measuring Oxytocin and Vasopressin: Bioassays,  
Immunoassays and Random Numbers. *J. Neuroendocrinol.* 28,
- 83 Neumann, I.D. and Landgraf, R. (2012) Balance of brain oxytocin and vasopressin:  
implications for anxiety, depression, and social behaviors. *Trends Neurosci.* 35, 649–659
- 84 Dale, H.H. (1906) On some physiological actions of ergot. *J. Physiol. (Lond.)* 34, 163–206
- 85 Mitre, M. *et al.* (2016) A Distributed Network for Social Cognition Enriched for Oxytocin  
Receptors. *J. Neurosci.* 36, 2517–2535
- 86 Young, L.J. *et al.* (1997) Species differences in V1a receptor gene expression in monogamous  
and nonmonogamous voles: behavioral consequences. *Behav. Neurosci.* 111, 599–605
- 87 Freeman, S.M. *et al.* (2014) Neuroanatomical distribution of oxytocin and vasopressin 1a  
receptors in the socially monogamous coppery titi monkey (*Callicebus cupreus*).  
*Neuroscience* 273, 12–23
- 88 Baxter, A. *et al.* (2020) Oxytocin receptor binding in the titi monkey hippocampal formation  
is associated with parental status and partner affiliation. *Sci Rep* 10, 17301
- 89 Bethlehem, R.A.I. *et al.* (2017) Intranasal oxytocin enhances intrinsic corticostriatal  
functional connectivity in women. *Transl Psychiatry* 7, e1099–e1099
- 90 Andari, E. *et al.* (2016) Adaptive coding of the value of social cues with oxytocin, an fMRI  
study in autism spectrum disorder. *Cortex* 76, 79–88
- 91 Lefevre, A. *et al.* (2017) Oxytocin and Serotonin Brain Mechanisms in the Nonhuman  
Primate. *J. Neurosci.* 37, 6741–6750
- 92 Ludwig, M. (2014) Dendritic Release of the Neuropeptides Vasopressin and Oxytocin. In  
*Neurophysiology of Neuroendocrine Neurons* (Armstrong, W. E. and Tasker, J. G., eds), pp.  
207–223, John Wiley & Sons, Ltd
- 93 Hasan, M.T. *et al.* (2019) A Fear Memory Engram and Its Plasticity in the Hypothalamic  
Oxytocin System. *Neuron* 103, 133–146.e8

- 94 Ross, H.E. *et al.* (2009) Characterization of the oxytocin system regulating affiliative behavior in female prairie voles. *Neuroscience* 162, 892–903
- 95 Ferretti, V. *et al.* (2019) Oxytocin Signaling in the Central Amygdala Modulates Emotion Discrimination in Mice. *Current Biology* 29, 1938–1953.e6
- 96 Eliava, M. *et al.* (2016) A New Population of Parvocellular Oxytocin Neurons Controlling Magnocellular Neuron Activity and Inflammatory Pain Processing. *Neuron* 89, 1291–1304
- 97 Lin, Y.-T. and Hsu, K.-S. (2018) Oxytocin receptor signaling in the hippocampus: Role in regulating neuronal excitability, network oscillatory activity, synaptic plasticity and social memory. *Progress in Neurobiology* 171, 1–14
- 98 Raam, T. *et al.* (2017) Hippocampal oxytocin receptors are necessary for discrimination of social stimuli. *Nat Commun* 8, 2001
- 99 Lin, Y.-T. *et al.* (2017) Oxytocin stimulates hippocampal neurogenesis via oxytocin receptor expressed in CA3 pyramidal neurons. *Nat Commun* 8, 537
- 100 Owen, S.F. *et al.* (2013) Oxytocin enhances hippocampal spike transmission by modulating fast-spiking interneurons. *Nature* 500, 458–462
- 101 Tirko, N.N. *et al.* (2018) Oxytocin Transforms Firing Mode of CA2 Hippocampal Neurons. *Neuron* 100, 593–608.e3
- 102 Lin, Y.-T. *et al.* (2012) Oxytocin Promotes Long-Term Potentiation by Enhancing Epidermal Growth Factor Receptor-Mediated Local Translation of Protein Kinase M. *Journal of Neuroscience* 32, 15476–15488
- 103 Dubrovsky, B. *et al.* (2002) Oxytocin induces long-term depression on the rat dentate gyrus: Possible ATPase and ectoprotein kinase mediation. *Brain Research Bulletin* 58, 141–147
- 104 Lin, Y.-T. *et al.* (2018) Conditional Deletion of Hippocampal CA2/CA3a Oxytocin Receptors Impairs the Persistence of Long-Term Social Recognition Memory in Mice. *J. Neurosci.* 38, 1218–1231
- 105 Amaral, D.G. and Witter, M.P. (1989) The three-dimensional organization of the hippocampal formation: a review of anatomical data. *Neuroscience* 31, 571–591
- 106 Wittner, L. *et al.* (2007) Three-dimensional reconstruction of the axon arbor of a CA3 pyramidal cell recorded and filled in vivo. *Brain Struct Funct* 212, 75–83
- 107 Treves, A. and Rolls, E.T. (1994) Computational analysis of the role of the hippocampus in memory. *Hippocampus* 4, 374–391
- 108 Høydal, Ø.A. *et al.* (2019) Object-vector coding in the medial entorhinal cortex. *Nature* 568, 400–404
- 109 Gluck, M.A. *et al.* (2003) Computational models of the hippocampal region: linking incremental learning and episodic memory. *Trends in Cognitive Sciences* 7, 269–276
- 110 Saunders, R.C. *et al.* (1988) Comparison of the efferents of the amygdala and the hippocampal formation in the rhesus monkey: II. Reciprocal and non-reciprocal connections: RECIPROCAL CONNECTIONS OF AMYGDALA AND HIPPOCAMPUS. *J. Comp. Neurol.* 271, 185–207
- 111 LeDoux, J.E. (2000) Emotion Circuits in the Brain. *Annu. Rev. Neurosci.* 23, 155–184
- 112 Risold, P.Y. and Swanson, L.W. (1997) Connections of the rat lateral septal complex 1Published on the World Wide Web on 2 June 1997. 1. *Brain Research Reviews* 24, 115–195
- 113 Chaaya, N. *et al.* (2018) An update on contextual fear memory mechanisms: Transition between Amygdala and Hippocampus. *Neurosci Biobehav Rev* 92, 43–54
- 114 Besnard, A. *et al.* (2020) Distinct Dorsal and Ventral Hippocampal CA3 Outputs Govern Contextual Fear Discrimination. *Cell Reports* 30, 2360–2373.e5
- 115 Dorfman, A. *et al.* (2021) Social spatial cognition. *Neuroscience & Biobehavioral Reviews* 121, 277–290
- 116 Stoop, R. (2012) Neuromodulation by Oxytocin and Vasopressin. *Neuron* 76, 142–159

- 117 Grinevich, V. and Stoop, R. (2018) Interplay between Oxytocin and Sensory Systems in the  
Orchestration of Socio-Emotional Behaviors. *Neuron* 99, 887–904
- 118 Gobrogge, K.L. *et al.* (2009) Anterior hypothalamic vasopressin regulates pair-bonding and  
drug-induced aggression in a monogamous rodent. *PNAS* 106, 19144–19149
- 119 Koenig, J. *et al.* (2011) The Spatial Periodicity of Grid Cells Is Not Sustained During Reduced  
Theta Oscillations. *Science* 332, 592–595
- 120 Hafting, T. *et al.* (2005) Microstructure of a spatial map in the entorhinal cortex. *Nature*  
436, 801–806
- 121 Danjo, T. *et al.* (2018) Spatial representations of self and other in the hippocampus. *Science*  
359, 213–218

## **Glossary (450 words)**

### **Ethnocentrism**

Ethnocentrism is to the tendency of human to favor own ethnicity in their judgment, and by extension display kin or own group preference.

### **Hippocampal CA2**

Hippocampal CA2 is a small region composed of large pyramidal cells between CA3 and CA1 sub fields, specifically important for processing of social stimuli. Lesion of CA2 or blocking neurotransmission in CA2 disrupts social memory.

### **Hippocampal recurrent collaterals CA3**

In the hippocampus CA3, the axons of pyramidal cells ramify to reach other pyramidal cells throughout all hippocampus, enabling each neuron in CA3 to make contact with any other cell within the hippocampus. The recurrent collaterals autoassociative network, present in rodents and primates, provides a scaffolding to link memories about places with memories about social stimuli.

### **Home-range**

The home-range is the living area of animal containing primary resources such as shelter, mates and food. Its maintenance and exploitation benefits from spatial cognition mapping the location of utilities in space.

### **Oxytocin**

The neuropeptide oxytocin (OT) is secreted by the paraventricular and the supraoptic nuclei of the hypothalamus. In addition to its peripheral actions linked to sexual reproduction and labor, central action of oxytocin modulates attachment and prosocial behavior. The hormone also plays a role in anxiety management. The central actions of OT result from diffusion of OT in the brain or local release through the activation of long-range oxytocinergic axons. OT action results from its effects on the OT receptors (OTR).

### **Philopatry**

Philopatry originally refers to the tendency of animals to return to their birthplace to breed. By expansion, this term refers to a manifest attachment to a land in animals or human.

**Social memory**

Social memory defines the ability to discriminate between a previously known individual (familiar) and a new one. Such memory is measured in rodents via the animal's natural tendency to explore a new conspecific more than a familiar one, which demonstrates that rats can recognize others. Such individual recognition is essential to many social interactions guided by kinship and dominance hierarchies supported by the history of interaction with individuals.

**Social place cells**

In rats and bats, social place cells in the hippocampus, exhibit a spatially selective activity during own movement in a place and also while observing another conspecific moving in that place. Thus, the cells enable to represent other's presence in a place.

**Spatial cognition**

Spatial cognition refers to the cognitive abilities enabling learning the layout of elements within a place and navigate between them in a goal directed and flexible manner. Spatial cognition depends mainly on the integrity of hippocampal formation.

**Territoriality**

Territoriality defines the defensiveness expressed by an individual to exclude others from its home range. In humans, territoriality refers to the social contract regulating land ownership and access.

Landmark  
Navigation  
Spatial cognition  
Foraging strategies  
Resource economics  
Home range  
Philopatry



Kinship  
Dominance hierarchy  
Resource protection  
Coalition alliances  
Intergroup competition  
Ethnocentrism

Hippocampal regions



Self Place



Self Place

Territorial Border

Oxytocin

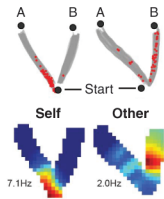
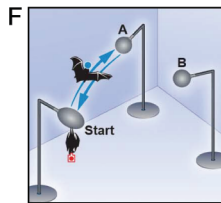
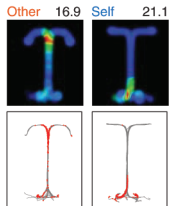
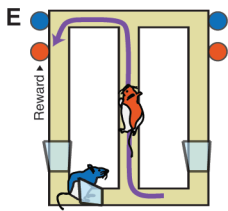
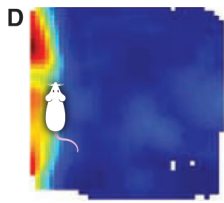
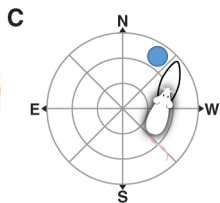
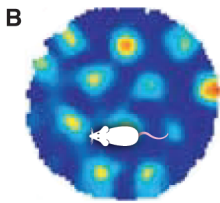
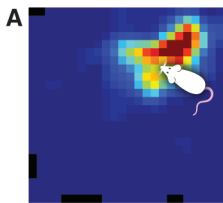

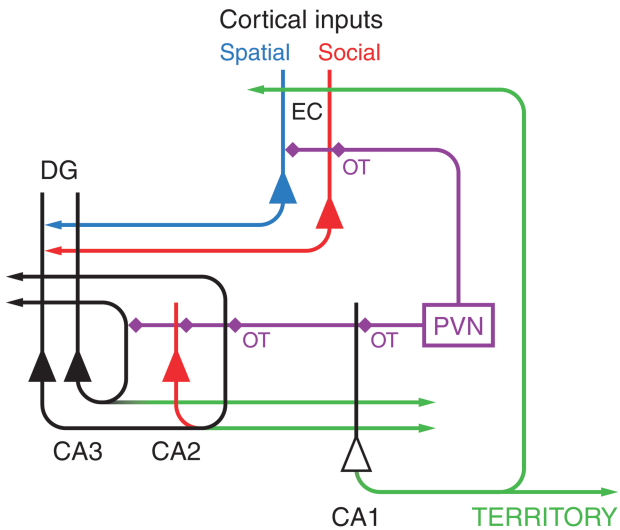

Spatial Coding



Territory

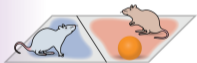

Social Coding

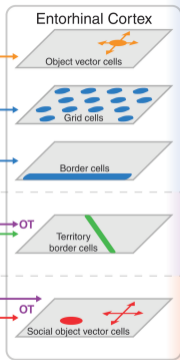
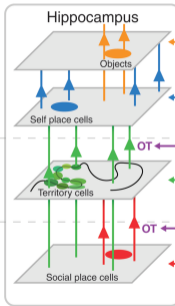

Hypothalamus