



HAL
open science

Observability and sliding mode observer design for Multi-cell Series Converter

Mariem Jday, Paul-Etienne Vidal, Joseph Haggege, Frederic Rotella

► To cite this version:

Mariem Jday, Paul-Etienne Vidal, Joseph Haggege, Frederic Rotella. Observability and sliding mode observer design for Multi-cell Series Converter. 2019 6th International Conference on Control, Decision and Information Technologies (CoDIT), Apr 2019, Paris, France. pp.1486-1491, <10.1109/CoDIT.2019.8820642>. <hal-04935989>

HAL Id: hal-04935989

<https://hal.science/hal-04935989v1>

Submitted on 10 Feb 2025

HAL is a multi-disciplinary open access archive for the deposit and dissemination of scientific research documents, whether they are published or not. The documents may come from teaching and research institutions in France or abroad, or from public or private research centers.

L'archive ouverte pluridisciplinaire HAL, est destinée au dépôt et à la diffusion de documents scientifiques de niveau recherche, publiés ou non, émanant des établissements d'enseignement et de recherche français ou étrangers, des laboratoires publics ou privés.



HAL Authorization

Observability and sliding mode observer design for Multi-cell Series Converter

Mariam Jday¹, Paul-Etienne Vidal², Joseph Haggège¹, Frédéric Rotella²

Abstract—The aim of this paper is to design a super twisting observer for a multi-cell series converter. First of all, the hybrid model of the multi-cell series converter is introduced. In order to check the observability of the floating capacitors voltages from the load current measurement, an observability analysis based on the hybrid approach of dynamic systems is given. Thereafter, super twisting observer are presented in order to observe the converter's floating capacitors. Simulations of three cells multi-cell converter highlight the efficiency of the proposed hybrid model and the performance of the observer in terms of floating voltages estimation.

I. INTRODUCTION

CURRENT industrial applications such as energy conversion systems, require high voltages-power levels. A structures of power converter so called a multi-level converter prove to be a solution to meet requirements of those applications [1][2]. Multilevel present more than two levels of voltages. Among these structures, the multicellular series converter that appeared at the beginning of the 90's is the the Flying Capacitor (FC) topology. This converter is an association of switching cells series-connected with inner capacitors. The number of output voltage level is dependent of the number of inner capacitors and switching cells. To benefit as much as possible from the advantages of multilevel converter structures, it is necessary to have an appropriate distribution of every cell voltages. These voltages take specific reference values according to the applied input constant value when a suitable control strategy is applied. For reliability as control reason, it is important to know at each time the voltages capacitors values. This knowledge will ease the imbalance monitoring. Indeed the use of extra sensors to measure such voltages increases the cost and the complexity of the converter, especially when the number of cells is important. The use of the observer to estimate the voltage can be an economic and attractive solution. Different observers based methods have been developed to estimate the voltage capacitors. The observation strategy proposed by Gateau and all in [3] is given using the average model which enables to highlight the non linear form of the converter [4]. Other works developed observers based on an instantaneous hybrid model [5][6]. Then, with such a model, multi-cell converters are classified as an hybrid system. The instantaneous model can be used for any purpose such as control, observation. It is noted that the study of the

balancing phenomena of flying capacitor is not described by average models. This is the reason why most of the literature concerning the observation of flying-capacitors voltages are based on the instantaneous hybrid model.

Indeed, a finite time observer was proposed by Defoort and all in [5]. Adaptive linear observers are given in [7] [8]. In [9] [10] a sliding mode observer are given.

This paper describes the procedure to design a super twisting sliding modes observer applied on the instantaneous model of the multi-cell series converter. It uses the fact that it belongs to a particular class of hybrid system. More precisely the estimation of voltages capacitors is studied. To fullfil possible control law to compensate unbalanced voltages [11], the observer is based on an instantaneous model.

The paper is arranged as follow. In section 2 the hybrid model of the multi-cell series converter is proposed. Section 3 discusses the problem of the observability of the voltage capacitors. Section 4 is dedicated to the design of the super twisting observer for this system. Finally, an application to a three-cells converter is provided.

II. DEFINITON AND MATHEMATICAL MODEL OF MULTI-CELL SERIES THREE PHASES INVERTER

The multi-cell DC-AC converter shown in the figure 1 consists of a series association of p elementary switching cells (one cell composed of two complementary switchers). It is equipped with secondary sources made by floating capacitors. It is a system with variable structure that changes during its operation[12][2].

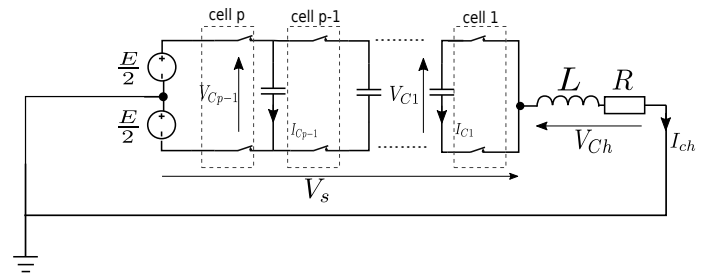

Fig. 1. Structure of multi-cell series DC-AC converter

The load voltage is defined as:

$$V_{Ch} = V_s - \frac{E}{2} = L_{Ch} \frac{dI_{Ch}}{dt} + R_{Ch} I_{Ch} \quad (1)$$

The load current I_{Ch} is expressed as follow:

¹Research Laboratory L.A.R.A in Automatic control, National Engineering School of Tunis (ENI-Tunis), University of Tunis El Manar, BP 37, Le Belvédère, 1002 Tunis, Tunisia

²Laboratoire Génie de Production, LGP, Toulouse University, INP-ENIT, 47 avenue d'Azereix, 65000 Tarbes, France

$$\dot{I}_{Ch} = \frac{V_s}{L_{Ch}} - \frac{R_{Ch}}{L_{Ch}} I_{Ch} - \frac{E}{2L_{Ch}} \quad (2) \quad A_{\sigma(t)} = \begin{bmatrix} 0 & \cdots & 0 & \frac{S_2 - S_1}{c_1} \\ \vdots & \ddots & \vdots & \vdots \\ 0 & \cdots & 0 & \frac{S_p - S_{p-1}}{c_{(p-1)}} \\ -\frac{S_2 - S_1}{L} & \cdots & -\frac{S_p - S_{p-1}}{L} & -\frac{R_{Ch}}{L_{Ch}} \end{bmatrix},$$

The output voltage is :

$$V_s = E S_p + \sum_{j=1}^{p-1} V_{c_j} (S_j - S_{(j+1)}) \quad (3)$$

Where:

$S_j \in \{0, 1\}, j = 1, \dots, p$ are the continuous input sent to the complementary switchers of the j cells.

If $S_j = 1$ the upper switcher of cell is closed and the lower one is open. If $S_j = 0$ the lower switcher of cell is open and the upper one is closed. Consequently, the new differential equation of the load current is expressed::

$$\dot{I}_{Ch} = -\frac{R_{Ch}}{L_{Ch}} I_{Ch} + \frac{S_p E}{L_{Ch}} - \frac{E}{2L_{Ch}} - \sum_{j=1}^{p-1} \frac{V_{c_j}}{L_{Ch}} (S_j - S_{(j+1)}) \quad (4)$$

The capacitor current I_{c_j} is expressed as:

$$I_{c_j} = I_{Ch} \times (S_j - S_{(j+1)}) \quad (5)$$

Thus the flying capacitor voltage V_{c_j} is defined in equation 6:

$$\dot{V}_{c_j} = I_{Ch} \frac{1}{C_j} (S_j - S_{(j+1)}) \quad (6)$$

Two following formulas describes the dynamic model for a multi-cell series converter with p cells. They express the load current I_{Ch} following the state of every switch, and the flying capacitor voltage V_{c_j} given for every cell numbered p :

$$\begin{cases} \dot{I}_{Ch} = -\frac{R_{Ch}}{L_{Ch}} I_{Ch} + \frac{S_p E}{L_{Ch}} - \frac{E}{2L_{Ch}} - \sum_{j=1}^{p-1} \frac{V_{c_j}}{L_{Ch}} (S_j - S_{(j+1)}) \\ \dot{V}_{c_j} = I_{Ch} \frac{1}{C_j} (S_j - S_{(j+1)}) \end{cases} \quad (7)$$

The previous equations lead to this converter's instantaneous hybrid model [13]:

$$\begin{cases} \dot{x}(t) = A_{\sigma(t),a} x(t) + B_{\sigma(t),a} E \\ y = C_{\sigma(t),a} x(t) \end{cases} \quad (8)$$

where:

$$B_{\sigma(t)} = \begin{bmatrix} 0 & \cdots & 0 & \frac{S_p}{L_{Ch}} - \frac{1}{2L_{Ch}} \end{bmatrix}^T$$

$$C_{\sigma(t)} = \begin{bmatrix} 0 & \cdots & 0 & 1 \end{bmatrix}$$

The switching signal $\sigma : \mathbb{R} \rightarrow \mathbb{N}$ (set of natural numbers) is a piece wise constant and right-continuous function that changes its value at switching times $t_n, n \in \mathbb{N}$. Thus $\sigma(t)$ is the operation mode and is considered as a discrete state variable of this system which depends on the input signals. S_j .

Let us define q_j and q_p such as:

$$q_j = S_{j+1} - S_j \text{ and } q_p = S_p.$$

Subsequently it is noticed that this model merges continuous variables (I, V_{C_j}) and discrete variables (S_1, S_2, \dots, S_p). Consequently, the multicell converter is an hybrid system and more precisely switched system.

The operation mode value m is defined according the number of cells. For p cells it exists 2^p operation mode values. Table I summarizes the output voltage value V_s , following the mode m considered. The values are computed for a three-cells converter.

TABLE I
MODES OF OPERATIONS

Mode (m_i)	S_3	S_2	S_1	V_s
1	0	0	0	0
2	0	0	1	V_{C1}
3	0	1	0	$V_{C2} - V_{C1}$
4	0	1	1	V_{C2}
5	1	0	0	$E - V_{C2}$
6	1	0	1	$E + V_{C1} - V_{C2}$
7	1	1	0	$E - V_{C1}$
8	1	1	1	E

To simulate the multi-cell converter with the hybrid approach every matrices A and B have to be computed. As stated in figure 2 the Pulse Width Modulation scheme, [14] provides the input order allowing to specify the operation mode m . According to this mode, the system switches to the appropriate matrices A and B

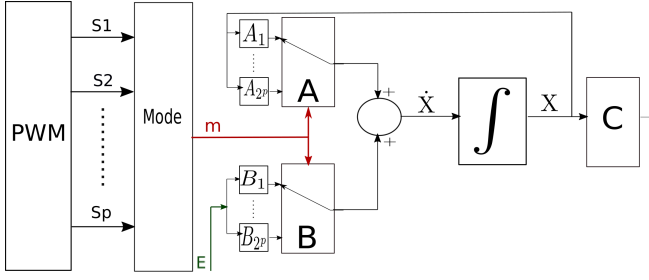

Fig. 2. Modeling steps of the multi-cell converter

The observability analysis is performed on the instantaneous model described.

III. OBSERVABILITY ANALYSIS

For most hybrid system, the observability is not obvious. The observability analysis is a challenge hybrid system models. Let's consider the multi-cell converter hybrid model given by the equation 8. Using the theory of linear observability, it can be easily checked that for all operating modes, the flying voltages can not be observed with the measurement of the current I_{ch} and the knowledge of the control input sequence. To study the observability of switching system, another criteria are used. The hybrid observability [15][16][17] is considered as the model defined is related to switched system class [6].

A. Hybrid observability ($Z(TN)$ observability)

In order to work with the hybrid observability denoted also as ' $Z(TN)$ observability' the hybrid time trajectory is defined.

Definition1: $Z(TN)$ observability

A hybrid time trajectory is a finite or infinite interval sequence $T_n = \{I_i\}_{i=0,N}$ such as :

- $I_i = [t_{i,0}, t_{i,1}]$, for all $0 \leq i \leq N$
- For all $0 \leq i \leq N$, $t_{i,1} = t_{i+1,0}$
- $t_{0,0} = t_{init}$ and $t_{N,1} = t_{end}$.

In addition, we define $\langle T_N \rangle$: the ordered list of the discrete input q associated to the trajectory T_N . In other words it means the ordered modes $\{\dots m_i \dots\}$ with m_i the current mode during the interval I_i .

Let's us define $Z(t, x)$, such as is the state vector containing the observed state which are the voltage capacitors $V_{c1}, V_{c2}, \dots, V_{cp-1}$. $P_i Z(t, x)$ is a state variable of the state vector $Z(t, x)$.

Theorem1: As stated in [15], the system is $Z(TN)$ -observable if it verifies the following assumption. Consider a hybrid system, the hybrid time trajectory T_N and the ordered list $\langle T_N \rangle$. Suppose that $z = Z(t, x)$ is always continuous under any admissible control input. If there is a sequence of linear projections $\{P_i\}_{i=0,N}$ such as:

- for all $0 \leq i \leq N$, $P_i Z(t, x)$ is Z -observable for all $t \in I_i$,
- $\text{Rank}([P_0^T, \dots, P_N^T]) = \dim(Z)$,

• $\frac{dP_i Z(t, x)}{dt} = 0$ for $t \in I_i$ where $\{P_i^T, P_i^T\}$ has a full rank in $\mathbb{R}^{\dim(z) \times \dim(z)}$.

Then, z is Z -observable with respect to the hybrid time trajectory T_N and $\langle T_N \rangle$.

The first condition means that each element of the state vector is Z -observable within at least one time interval. The second condition means that for an hybrid trajectory T_N including time intervals I_i , all the components of the Z are observable within it.

The last condition means that the not observable component of the state vector in a time interval I_i , must remain constant during this interval of time when another one is observable.

B. Application of $Z(TN)$ observability to the multi-cell converter

The application of the theorem 1 to the multicell converter [5],[18],[19] yields to the following results. Expression 9 is expressed as:

$$\dot{V}_{cj} = I_{Ch} \frac{1}{c_j} q_j. \quad (9)$$

Consequently, from current measurement I_{ch} , V_{cj} can be observed on the time interval I_i associated to q_j . So the first condition is verified.

Let us consider equation 10 which describes the dynamic of the load current:

$$\dot{I}_{Ch} = -\frac{R_{Ch}}{L_{Ch}} I_{Ch} + \frac{q_p E}{L_{Ch}} - \frac{E}{2L_{Ch}} - \frac{V_{c1}}{L_{Ch}} q_1 - \dots - \frac{V_{cp-1}}{L_{Ch}} q_{p-1}. \quad (10)$$

According to this equation, $p - 1$ input sequence $\langle T_N \rangle$ associated to $p - 1$ time intervals I_i , the load current measurement provides a set of equations which are linearly independent of the capacitor voltages $V_{c1} \dots V_{cp-1}$. Thus we can affirm that after $p - 1$ input sequences, it's possible to generate all the state variable $P_i Z(t, x)$ which are the $p - 1$ voltages floating capacitors. Based on this result, the second observability was verified. Finally, for the multi-cell converter the third condition is verified which is not the case for the another type of multilevel converter.

Consequently, the system considered is $Z(TN)$ -observable. So it is possible to use an observer for capacitor voltage.

IV. DESCRIPTION OF A SUPER-TWISTING OBSERVER

The following assumption is proposed in order to guarantee the existence of a hybrid time trajectory T_N in which the observability of the voltages V_{Ck} is possible whence the existence of the observer.

Hypothesis: the switch sequence $\{q_p \dots q_N\}$ generates the space \mathbb{R}^{p-1} .

In order to observe the flying capacitors voltage $V_{cj}, j \in \{1 \dots p - 1\}$, a super twisting observer (STO) is designed. The discrete state $\sigma(t)$ is known.

The sliding mode observer is one of the most well-known robust observers against parametric uncertainties and modeling errors. These observers are also know reduce the oscillations and the chattering phenomena that we are recovered in one order sliding mode observer [20].

For a dynamic system, the Super-Twisting Observer (STO) is given by the following equations [19] [21]:

$$\begin{cases} \dot{\hat{x}}_1 = \hat{x}_2 + \lambda_1 \text{sign}(x_1 - \hat{x}_1) \\ \dot{\hat{x}}_2 = \hat{x}_3 + \lambda_2 \alpha_1 \text{sign}(\tilde{x}_2 - \hat{x}_2) \\ \vdots \\ \dot{\hat{x}}_{n-1} = \hat{x}_n + \lambda_{n-1} \alpha_{n-2} \text{sign}(\tilde{x}_{n-1} - \hat{x}_{n-1}) \\ \dot{\hat{x}}_n = f(\tilde{x}_1, \tilde{x}_2, \dots, \tilde{x}_n) + \lambda_n \alpha_{n-1} \text{sign}(\tilde{x}_n - \hat{x}_n) \end{cases} \quad (11)$$

where:

$[\hat{x}_1, \dots, \hat{x}_n]$ are the observed states of $[x_1, \dots, x_n]$, $\lambda_k > 0$, $\alpha_k > 0$, $k = \{1 \dots n\}$,

$\tilde{x}_j = \hat{x}_j + (\lambda_{j-1} \text{sign}(\tilde{x}_{j-1} - \hat{x}_{j-1}))$, $j = \{2 \dots n\}$,
 $\text{sign}(x)$ is the sign function.

Dedicated to the studied system, $[x_1, x_2, x_3, x_4] = [I_{ch}, V_{c1}, V_{c2}, V_{c3}]$. So the STO is given in equation 12:

$$\begin{cases} \dot{\hat{I}}_{ch} = -\frac{R_{ch}}{L_{ch}} I_{ch} + \frac{q_p E}{L_{ch}} - \frac{E}{2L_{ch}} - \sum_{j=1}^{p-1} \frac{\hat{V}_{Cj}}{L_{ch}} q_j \\ + \sum_{j=1}^{p-1} \lambda |q_j| |I_{ch} - \hat{I}_{ch}|^{1/2} \text{sign}(I_{ch} - \hat{I}_{ch}) \\ \dot{\hat{V}}_{c1} = I_{ch} \frac{q_1}{C_1} + \alpha_1 q_1 \text{sign}(I_{ch} - \hat{I}_{ch}) \\ \vdots \\ \dot{\hat{V}}_{cp-1} = I_{ch} \frac{q_{p-1}}{C_{p-1}} + \alpha_{p-1} q_{p-1} \text{sign}(I_{ch} - \hat{I}_{ch}) \end{cases} \quad (12)$$

where α_k and λ_k must satisfy the following condition which is demonstrated in [19]. Consequently, λ_k and α_k are constant and satisfy this inequality:

$$\alpha > 0, \lambda > \frac{1 + \theta}{1 - \theta} \sqrt{\frac{2\alpha}{L}}, 0 < \theta < 1 \quad (13)$$

with θ constant. A diagram that details the application of the STO on the multi-cell converter is presented in figure 3.

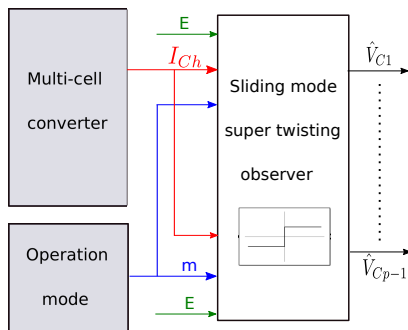

Fig. 3. Super Twisting observer design for multi-cell converter

The observation errors are expressed in equation 14.

$$\begin{cases} e_1 = I_{ch} - \hat{I}_{ch} \\ e_{cj} = V_{cj} - \hat{V}_{cj} \\ j = 1, \dots, p-1 \end{cases} \quad (14)$$

The error dynamics are expressed in equation 15:

$$\begin{cases} \dot{e}_1 = -\sum_{k=1}^{p-1} \frac{e_{ck}}{L_{ch}} q_k + \sum_{k=1}^{p-1} \lambda |q_k| |e_1|^{1/2} \text{sign}(e_1) \\ \dot{e}_{cj} = -\alpha_j q_j \text{sign}(e_1) \\ j = 1, \dots, p-1 \end{cases} \quad (15)$$

For q_j constant, α_k and λ_k satisfying condition 13, there exists $t_{i,0} < T_i < t_{i,1}$ ($t_{i,1}$ is end time of switching i and $t_{i,0}$ is the start time of switching i) such as $e_1(t) = 0$, $\dot{e}_1(t) = 0$. Therefore, since q_j is constant on $t \in [t_{i,0}, t_{i,1}]$, it must be ensured that T_i is smaller than $t_{i,1}$. So the time convergence of the sliding mode observer is obtained:

$$T_i - t_{i,0} \leq \frac{1 + \theta}{2\theta\alpha} \sum_{j=1}^{p-1} |V_{cj(0)} - \hat{V}_{cj(0)}| \quad (16)$$

α has to be enough big enough big in order to have $T_i - t_{i,0} < \tau$ with the length $(t_{i,1} - t_{i,0})$ is greater then τ for any time interval I_i .

Hence $T_i < t_{i,1}$, so expression 15 allows deducing that $\dot{e}_{cj} = 0$

It is concluded that the observation errors are theoretically null.

V. APPLICATION TO A THREE-CELLS MULTI-CELL SERIES CONVERTER

1) *Observer design:* The following section illustrates the design of STO for a three multi-cell DC-AC series converter which is defined as follow:

$$\begin{cases} \dot{\hat{I}}_{ch} = -\frac{R_{ch}}{L_{ch}} I_{ch} + \frac{q_p E}{L_{ch}} - \frac{E}{2L_{ch}} - \frac{\hat{V}_{C1}}{L_{ch}} q_1 - \frac{\hat{V}_{C2}}{L_{ch}} q_2 \\ + \lambda (|q_1| + |q_2|) |I_{ch} - \hat{I}_{ch}|^{1/2} \text{sign}(I_{ch} - \hat{I}_{ch}) \\ \dot{\hat{V}}_{C1} = I_{ch} \frac{q_1}{C_1} + \alpha q_1 \text{sign}(I_{ch} - \hat{I}_{ch}) \\ \dot{\hat{V}}_{C2} = I_{ch} \frac{q_2}{C_2} + \alpha q_2 \text{sign}(I_{ch} - \hat{I}_{ch}) \end{cases} \quad (17)$$

To overcome the chattering problem, the sign function is replaced with a smoother one such as the sigmoid function.

2) *simulation results:* The performance of this observer is depicted by a simulation on Matlab/Simulink. The table II presents the simulation parameters.

TABLE II
SIMULATION PARAMETERS

E	f_{PWM}	L_{ch}	C	R_{ch}	λ	α
300V	1kHz	1mH	$4 \times 10^{-4} F$	10Ω	4050	100

In order to test the performance of this observer, the input voltage is switched at $t=5s$ to 400 V. The results are shown in figures 4, 5, 6, and 7 .

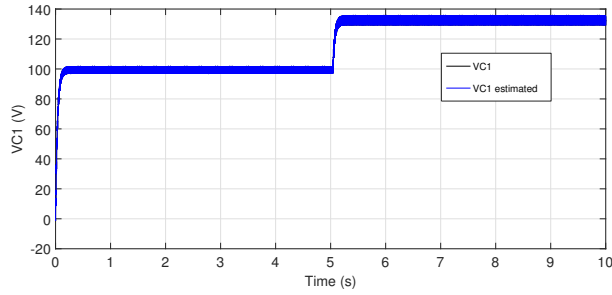

Fig. 4. Estimated VC1

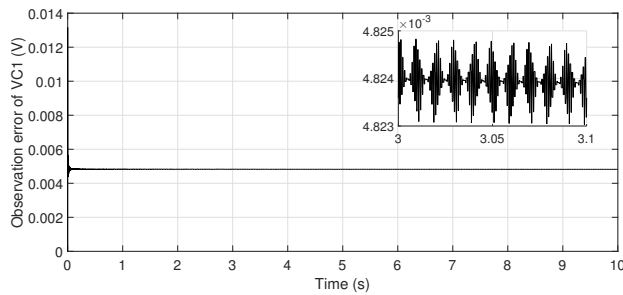

Fig. 5. VC1 observation error

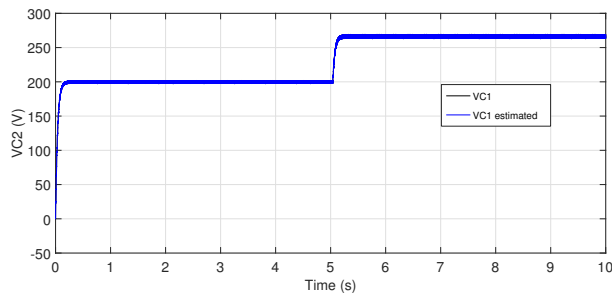

Fig. 6. Estimated VC2

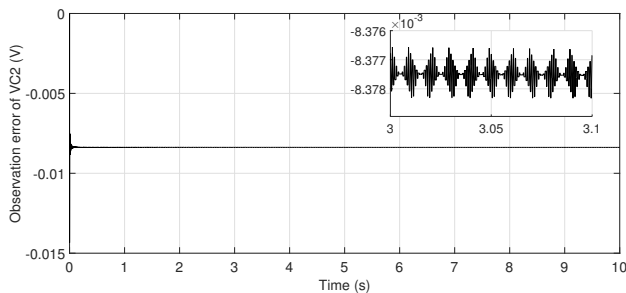

Fig. 7. VC2 observation error

This results highlight the high dynamics of this observer. Also, the estimated voltages values respond to the abrupt

change of the input signal. In fact, after a transient regime, the voltages of the estimated floating capacitors are equal to the reference values which are in our case $V_{C1ref} = 100V$ and $V_{C2ref} = 200V$ for $E = 300V$, so we have a very low observation error on the order of $e = 0.004V$ which indicated the performance and the robustness of this observer.

VI. CONCLUSION

This paper presents the instantaneous model of the multi-cell series converter which are belongs to the hybrid dynamic system class. After that the observability of this converter is studied. Then the super twisting observer to estimate the flying capacitor voltages of the multi-cell converters is proposed. So the problem of the capacitor voltages estimation is solved. Some simulations results of three cells converters illustrates the performance of such observer. This observer is characterized by its high dynamic and robustness. Also it can be used for the detection and the faults diagnostic of multilevel converter.

REFERENCES

- [1] S. Kouro, M. Malinowski, K. Gopakumar, J. Pou, L. G. Franquelo, B. Wu, J. Rodriguez, M. A. Pérez, and J. I. Leon, "Recent advances and industrial applications of multilevel converters," *IEEE Transactions on industrial electronics*, vol. 57, no. 8, pp. 2553–2580, 2010.
- [2] J. Rodriguez, J.-S. Lai, and F. Z. Peng, "Multilevel inverters: a survey of topologies, controls, and applications," *IEEE Transactions on industrial electronics*, vol. 49, no. 4, pp. 724–738, 2002.
- [3] G. Gateau, M. Fadel, P. Maussion, R. Bensaid, and T. A. Meynard, "Multicell converters: active control and observation of flying-capacitor voltages," *IEEE Transactions on Industrial Electronics*, vol. 49, pp. 998–1008, Oct 2002.
- [4] S. B. Said, K. B. Saad, and M. Benrejeb, "Hil simulation approach for a multicellular converter controlled by sliding mode," *International journal of hydrogen energy*, vol. 42, no. 17, pp. 12790–12796, 2017.
- [5] M. Defoort, M. Djemai, T. Floquet, and W. Perruquetti, "Robust finite time observer design for multicellular converters," *International Journal of Systems Science*, vol. 42, no. 11, pp. 1859–1868, 2011.
- [6] M. Djemai and M. Defoort, "Hybrid dynamical systems," *Lecture notes in Control and information sciences*, vol. 457, 2015.
- [7] K. Benmansour, J. De Leon, and M. Djemai, "Adaptive observer for multi-cell chopper," in *Second International Symposium on Communications, Control and Signal Processing ISCCSP, Marrakech, Maroc*, 2006.
- [8] M. Ghanes, F. Bejarano, and J.-P. Barbot, "On sliding mode and adaptive observers design for multi-cell converter," in *2009 American Control Conference*, pp. 2134–2139, IEEE, 2009.
- [9] J. Van Gorp, M. Defoort, M. Djemai, and K. C. Veluvolu, "Fault detection based on higher-order sliding

- mode observer for a class of switched linear systems,” *IET Control Theory & Applications*, vol. 9, no. 15, pp. 2249–2256, 2015.
- [10] M. Ghanes, M. Trabelsi, H. Abu-Rub, and L. Ben-Brahim, “Robust adaptive observer-based model predictive control for multilevel flying capacitors inverter,” *IEEE Transactions on Industrial Electronics*, vol. 63, pp. 7876–7886, Dec 2016.
- [11] A. Bouarfa, M. Bodson, and M. Fadel, “A fast active-balancing method for the 3-phase multilevel flying capacitor inverter derived from control allocation theory,” *IFAC-PapersOnLine*, vol. 50, no. 1, pp. 2113–2118, 2017.
- [12] K. Berkoune, P.-e. Vidal, and F. Rotella, “Modélisation générique pour les stratégies de modulation des onduleurs multiniveaux: application aux onduleurs à capacités flottantes,” in *Symposium de Genie Electrique*, 2016.
- [13] N. Gazzam and A. Benalia, “Observability analysis and observer design of multicellular converters,” in *2016 8th International Conference on Modelling, Identification and Control (ICMIC)*, pp. 763–767, Nov 2016.
- [14] J. I. Leon, S. Vazquez, and L. G. Franquelo, “Multilevel converters: Control and modulation techniques for their operation and industrial applications,” *Proceedings of the IEEE*, vol. 105, pp. 2066–2081, Nov 2017.
- [15] W. Kang and J.-P. Barbot, “Discussions on observability and invertibility,” *IFAC Proceedings Volumes*, vol. 40, no. 12, pp. 426–431, 2007.
- [16] W. Kang, J.-P. Barbot, and L. Xu, “On the observability of nonlinear and switched systems,” in *Emergent problems in nonlinear systems and control*, pp. 199–216, Springer, 2009.
- [17] A. Smati, W. Chagra, and M. Kssouri, “Fault-tolerant model predictive control for a $z(tn)$ -observable linear switching systems,” *International Journal Of Advanced Computer Science And Applications*, vol. 8, no. 6, pp. 365–374, 2017.
- [18] B. Amghar, A. Darcherif, and J.-P. Barbot, “ $Z(tn)$ -observability and control of parallel multicell chopper using petri nets,” *IET Power Electronics*, vol. 6, no. 4, pp. 710–720, 2013.
- [19] Bejarano, F. Javier, Ghanes, Malek, and J.-P. Barbot, “Observability and observer design for hybrid multicell choppers,” *International Journal of Control*, vol. 83, no. 3, pp. 617–632, 2010.
- [20] H. Meziane, C. Labarre, S. Lefteriu, M. Defoort, and M. Djemai, “Fault detection and isolation for a multicellular converter based on sliding mode observer,” *IFAC-PapersOnLine*, vol. 48, pp. 164–170, 12 2015.
- [21] M. Djemai, N. Manamanni, and J. P. Barbot, “Sliding mode observer for triangular input hybrid system,” *IFAC Proceedings Volumes*, vol. 38, no. 1, pp. 181–186, 2005.