



HAL
open science

A review on the use of sorption materials in solar dryers

Rock Aymar Dake, Kokouvi Edem N'tsoukpoe, Frédéric Kuznik, Babacar Lèye,
Igor W.K. Ouédraogo

► **To cite this version:**

Rock Aymar Dake, Kokouvi Edem N'tsoukpoe, Frédéric Kuznik, Babacar Lèye, Igor W.K. Ouédraogo. A review on the use of sorption materials in solar dryers. *Renewable Energy*, 2021, 175, pp.965-979. <10.1016/j.renene.2021.05.071>. <hal-04918193>

HAL Id: hal-04918193

<https://hal.science/hal-04918193v1>

Submitted on 31 Mar 2025

HAL is a multi-disciplinary open access archive for the deposit and dissemination of scientific research documents, whether they are published or not. The documents may come from teaching and research institutions in France or abroad, or from public or private research centers.

L'archive ouverte pluridisciplinaire **HAL**, est destinée au dépôt et à la diffusion de documents scientifiques de niveau recherche, publiés ou non, émanant des établissements d'enseignement et de recherche français ou étrangers, des laboratoires publics ou privés.



Distributed under a Creative Commons CC0 1.0 - Universal - International License

1 A review on the use of sorption materials in solar dryers

2 Rock Aymar Dake^a, Kokouvi Edem N'Tsoukpoe^a (*), Frédéric Kuznik^b, Babacar Lèye^c, Igor
3 W. K. Ouédraogo^a

4 ^aLaboratoire Énergies Renouvelables et Efficacité Énergétique (LabEREE), Département Génie Électrique,
5 Énergétique et Industriel, Institut International d'Ingénierie de l'Eau et de l'Environnement (2iE), 01 BP 594
6 Ouagadougou 01, Burkina Faso

7 ^bUniversité de Lyon, INSA de Lyon, CETHIL UMR5008, F-69622, Villeurbanne, France

8 ^cLaboratoire Eaux Hydro-Systèmes et Agriculture (LEHSA), Département Sciences et Techniques de
9 l'Ingénieur, Institut International d'Ingénierie de l'Eau et de l'Environnement (2iE), 01 BP 594 Ouagadougou
10 01, Burkina Faso

11 **Abstract**

12 Solar drying has received great interest as a viable alternative solution to fossil fuel dryers.
13 However, due to the intermittency of the solar resource, solar dryers suffer from discontinued
14 drying and thus, long drying time. In this paper, the use of sorption materials to enhance the
15 performance of solar dryers is reviewed. The main aspects regarding their use as thermal energy
16 storage or dehumidification materials are highlighted. The paper shows that solid adsorbents,
17 especially silica gel, are the most used materials. The use of composite materials, for instance
18 the mixture of bentonite, CaCl₂, vermiculite, and cement proved to be promising. The
19 incorporation of a sorption dehumidifier in a solar dryer, usually at the solar collector inlet,
20 generally leads to a reduction of the drying time of 15 to 30%, although values up to 50% and
21 even 64% have been reported. On the other hand, introducing sorption materials as thermal
22 storage in a solar dryer, mostly integrated at the top in the drying chamber, usually leads to a
23 reduction of the drying time in a range of 30 to 45%. There are still various aspects to be
24 investigated in depth before a large-scale utilization of these techniques in solar drying
25 technology.

26 **Keywords:** solar energy; solar dryer; sorption thermal storage; dehumidifier; desiccants;
27 adsorbents.

28 *Corresponding author:

29 E-mail address: edem.ntsoukpoe@2ie-edu.org ; alternative e-mail: n_christedem@yahoo.fr
30 (K.E. N'Tsoukpoe)

31 **1. Introduction**

32 In a portion of food with high moisture content, the presence of water can be observed in both
 33 bound and unbound forms. In contrast to bound water, which is an integral part of the molecular
 34 structure of the food [1], unbound water is involved in biological reactions and natural processes
 35 that lead to a decrease in food quality [2]. The ratio of the partial pressure of water vapor just
 36 above the product to the partial pressure of pure water at the same temperature gives the water
 37 activity, usually denoted a_w [3,4]. This coefficient evaluates the amount of unbound water
 38 available in a product that can participate in chemical reactions and thus accelerate its
 39 deterioration. Therefore, high-moisture food materials are very sensitive to spoilage due to their
 40 high water activity. Figure 1 shows how microorganisms such as bacteria, yeasts, etc. develop
 41 according to the water activity in common food. For food with a water activity below 0.6, there
 42 is no proliferation of microorganisms. Thus, those products are less sensitive to spoilage.

a_w	0.6	0.65	0.75	0.80	0.87	0.91	0.95	1
No microbial proliferation	Osmophilic yeasts (<i>S. rouxii</i>), few moulds	Xerophilic moulds (<i>A. chevalieri</i>), <i>S. bisporus</i>	Most halophilic bacteria	Most moulds, most saccharomyces, <i>staphylococcus</i>	Most yeasts (<i>condida, torulopsis</i>), <i>micrococcus</i>	<i>Salmonella, vibrio parahaemolyticus, lactobacillus</i> moulds, yeasts	<i>Pseudomonas, bacillus escherichia,</i> some yeasts	
Pasta, food with about 10 % moisture	Dried fruits containing 25–20 % moisture, honey, caramel	Jelly, nuts, molasses. Raw cane, sugar, some dried fruits	Jam, marmalade, fruits	Most fruit juice concentrates, maple, chocolate and fruit syrups, flour, rice, fruit cake	Fermed sausage (salami), dry cheeses, margarine	Some cheeses, cured meat, some fruit juice concentrates	Fresh and canned fruits, vegetables, meat, fish and other perishable foods	

43
 44 *Figure 1: Microorganisms growth as a function of water activity in common foods. Data from [5]*

45 Among the various ways to control water activity in foods, reduction of water content is widely
 46 used. In this context, thermal drying remains the most common drying method, especially for
 47 agricultural products [5]. Many industrial and agricultural processes make use of thermal
 48 drying. For example, fruits, crops, and vegetables such as mint, mangoes, apples, rice, oilseeds,
 49 and carrots are dried with hot air [6]. Unfortunately, because they are highly energy-intensive
 50 (for example 65.45 MJ/kg of water evaporated for hybrid convective electric-gas dryer while
 51 drying some onion slices at 50 °C [7]), conventional industrial thermal drying methods increase
 52 final product cost. Consequently, solar drying has appeared to be a good alternative to sun

53 drying and all those expensive industrial drying methods [8]. It provides solutions to most of
54 their drawbacks, namely [9]:

- 55 - For sun drying: (i) damage to the products by rodents, birds and animals. (ii)
56 degradation through exposure to rain, storm and dew as well as wind. (iii)
57 contamination by dirt, dust, wind-blown debris and environmental pollution. (iv)
58 splitting of the grain, bleaching and loss of germination capability due to overdrying.
59 (v) insect infestation. (vi) growth of micro-organisms, and (vii) additional losses during
60 storage due to insufficient or non-uniform drying for sun drying.
- 61 - For industrial dryers (i) high initial investment and high energy costs. (ii) lack of
62 available skilled personnel for operation and maintenance, and (iii) lack of availability.

63 Convective thermal drying, which is commonly encountered in solar dryers, is governed by a
64 simultaneous heat and mass transfer in the product, accompanied by various physico-
65 biochemical transformations (shrinkage, changes in color, texture, odor, etc.) [10]. As heat is
66 supplied to the product at its surface, it diffuses into the solid essentially by conduction. This
67 heat supply causes the liquid or moisture in the product to move outward toward the product
68 surface and to vaporize before it is removed away by the carrier or surrounding gas [10]. Drying
69 is a very complex process and the dynamic of the heat and mass transfer may change a lot
70 during the process.

71 Since the solar resource is intermittent, conventional solar dryers suffer from discontinued
72 drying due to sunshine and non-sunshine hour cycles. Some studies have therefore introduced
73 hybrid solar drying. In hybrid solar dryers, in addition to solar energy, auxiliary energy sources
74 are also used to heat the drying air. For example, the auxiliary source may be an electric heater
75 [11] or a biomass back-up heater [12–14]. Besides auxiliary sources, thermal storage in solar
76 dryers has also been widely investigated.

77 The researches on thermal storage for solar dryers have been mostly oriented toward the use of
78 latent and sensible heat storage. Many authors [15–21] dealt with the use of rock as sensible
79 thermal storage in solar dryers. Also, because of its good sensible heat storage characteristics
80 (affordable, good thermal stability, and high specific heat), the use of sand has sometimes been
81 considered in some solar dryers [20,22]. Water has also been used as sensible thermal storage
82 in solar dryers [20]. Potdukhe and Thombre [23] used thermal oil as thermal storage material
83 in an agricultural solar dryer for drying products such as chili peppers and fenugreek leaves.
84 Phase change materials are also discussed in the literature as latent heat storage in solar dryers

85 [24–46]. However, although sensible heat storage is widely used, it faces major challenges such
86 as low energy density and heat losses. Fortunately, phase-change materials greatly improve
87 energy storage density but do not solve the problem of heat losses. Increasing the thickness of
88 insulation would be helpful, but it also increases the size and cost of the system [47]. On the
89 other hand, sorption materials used as thermal storage could be an interesting alternative to
90 sensible heat storage and phase change materials. Moreover, they theoretically exhibit three
91 times higher volume energy storage density than sensible heat storage materials and twice as
92 high as latent heat storage materials [47]. They also have the advantage of reducing heat loss
93 and allow seasonal storage [47]. Apart from their use as a thermal storage medium, sorption
94 materials are also used in solar dryers as dehumidifiers. In this configuration, the sorption
95 material lowers the relative humidity of the drying air before it enters the drying chamber. This
96 enhances the overall drying performance of the dryer.

97 This review paper focuses on the use of sorption materials as thermal storage or dehumidifier
98 in solar dryers. It covers forty years of the field and aims to point out what advantages have
99 already been taken into account in the use of sorption materials in such dryers. Authors also
100 identify gaps and challenges in the current research towards improving the performances of
101 solar dryers and ensuring their continuous operation. First, a brief insight on some terminologies
102 related to the concept of sorption and that of solar dryers is given, and then studies related to
103 the use of sorption materials as thermal storage or dehumidifier, or even both in solar dryers are
104 presented. Then, the findings are synthesized for critical analysis and to clearly show the gaps
105 and rooms for improvement of the use of sorption materials as thermal storage and dehumidifier
106 in solar dryers

107 **2. Principles and terminology**

108 **2.1. Typology of solar dryers**

109 Worldwide, there are different types of solar dryers. They fall into two main categories [5,48]
110 : (i) passive solar dryers where the drying air circulates by natural convection and (ii) active
111 solar dryers, often called forced convection solar dryers, where the circulation of the drying air
112 is ensured by a blower. For Ekechukwu et al. [49], because of the system components that differ
113 from one solar dryer to another as well as the way solar heat is used, three sub- categories of
114 active and passive solar dryers can be listed: integral-type, distributed-type, and mixed-mode
115 type (Figure 2). In integral or direct solar dryers, the product is directly exposed to solar
116 radiation [50]. Direct solar dryers are simple and cheap to be constructed. They prevent the

117 product from contamination due to dust, rain, debris, etc. [51]. On the other hand, due to direct
 118 exposure to solar radiation, the product may become discolored, overheated, and hence, lose
 119 some qualities [52]. The drying capacity in such dryers may also be limited [51]. In indirect
 120 solar dryers, solar energy is first collected by a solar collector and is then passed onto the drying
 121 chamber, where the drying occurs. This offers better temperatures and air flow rate control,
 122 leading to better moisture removal and product drying [53,54].

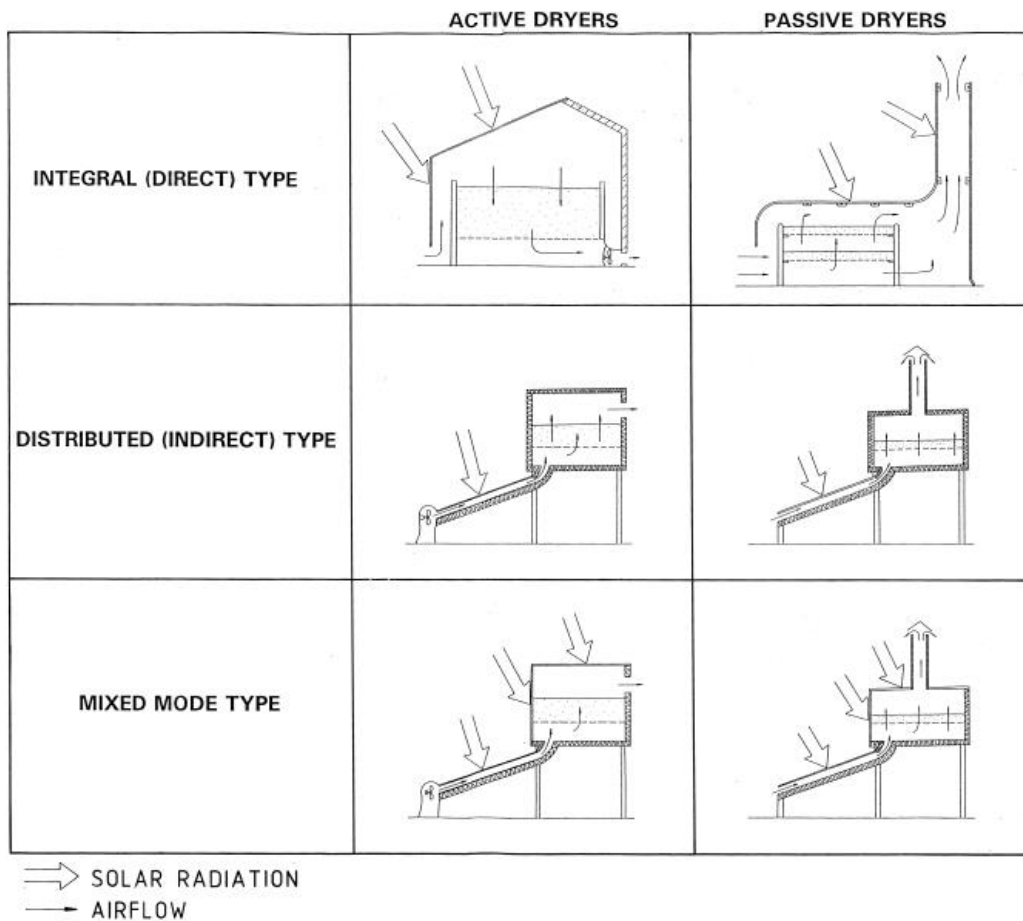

123

124 *Figure 2: Sub-categories of solar drying systems as classified by Ekechukwu et al. [49]. Reprinted from Energy Conversion &*
 125 *Management 40 (1999), O.V. Ekechukwu, B. Norton, Review of solar-energy drying systems II: an overview of solar drying*
 126 *technology, Pages 615–655, Copyright (1998), with permission from Elsevier.*

127 **2.2. Definitions related to sorption storage**

128 Concepts related to heat storage such as "sorption storage", "chemical storage" and
 129 "thermochemical storage" are generally misused in literature. In a study [55], the authors
 130 discussed the ambiguity associated with the use of these three expressions. It comes out from
 131 their study that when reversible chemical reactions are used to store heat in the limit of chemical
 132 bonds, the proper expression to use is that of "chemical storage". In that case, "thermochemical

133 reactions”, “photosynthesis” and “photochemical reactions” can provide the required energy
 134 for the storage (Figure 3).

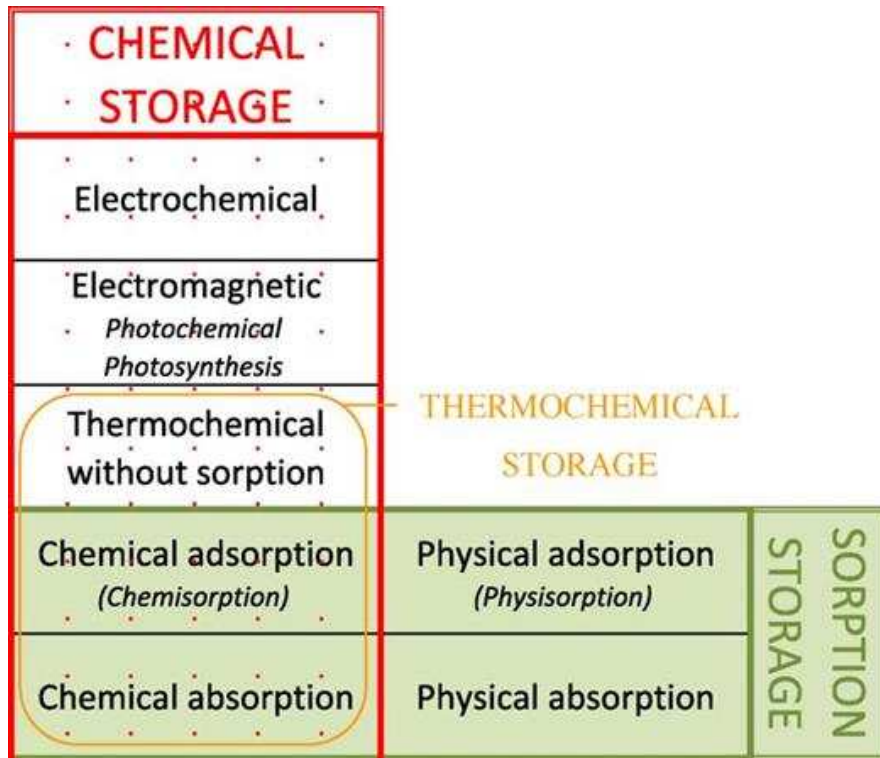

135
 136 *Figure 3: Different types of sorption storage and chemical storage as described by N'Tsoukpoe et al. [55]. Reprinted from*
 137 *Renewable and Sustainable Energy Reviews 13 (2009), K. Edem N'Tsoukpoe, Hui Liu, Nolwenn Le Pierres, Lingai Luo, A*
 138 *review on long-term sorption solar energy storage, Pages 2385–2396, Copyright (2009), with permission from Elsevier.*

139 On the other side, when during the heat storage, a gas or a vapor is captured by a solid or a
 140 liquid the authors talk about “sorption storage”. The gas being captured is called “sorbate” and
 141 the host is referred to as “sorbent”. It is important to notice that when the sorbate integrates the
 142 molecular structure of the sorbent, the type of “sorption storage” is “absorption”. But if the gas
 143 remains at the surface of the host, then it is an “adsorption”. There are two types of adsorption.
 144 The first type is known as physisorption [56], and the second type, as chemisorption.
 145 Physisorption is a physical adsorption that mostly involves weak van der Waals forces and is
 146 reversible, while solid chemisorption is a chemical adsorption where valence forces are
 147 involved. Similarly, there are two types of absorption processes: physical absorption and
 148 chemical absorption, depending on whether there is any chemical reaction between the
 149 absorbate and the absorbent (chemical) or not (physical) [57].

150 In this paper, sorption storage covers both absorption and adsorption and encompasses chemical
 151 and physical phenomenon. Sorption materials signify both liquid and solid materials but also

152 composites materials, which are usually a combination of two of the previous type to overcome
153 some limitations and improve some technical performances.

154 2.3. Basic principles of heat storage with sorption materials

155 The operating principle of sorption or thermochemical heat storage is based on reversible
156 physico-chemical phenomena, which are used to store energy [58].

157 During the charging period, heat is supplied (1) to the material AB (solid or liquid), which
158 absorbs the heat and decomposes into two products A (solid or liquid) and B (gas): this is an
159 endothermic reaction. For the heat recovery in discharging period, the compounds A and B are
160 put in contact; the reverse phenomenon occurs and AB is formed with a heat release (exothermic
161 reaction).



162 Figure 4 shows the principle of thermal storage with solid sorption material (adsorbent).

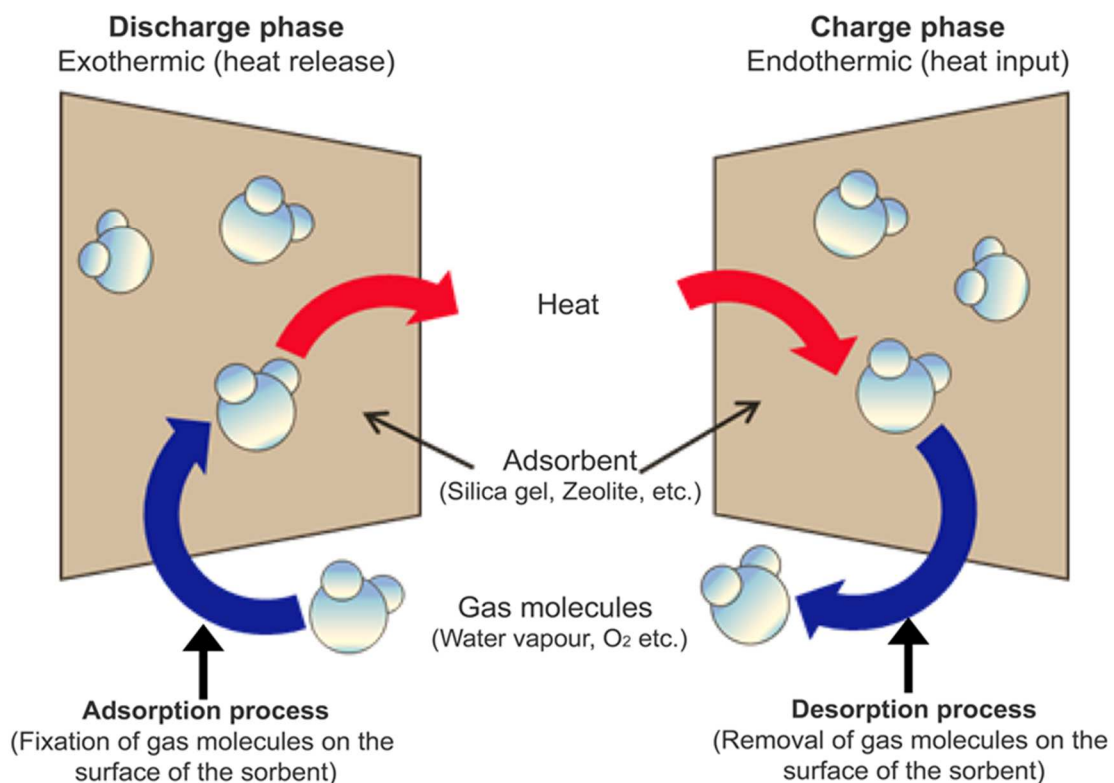

163

164

Figure 4: Principle of energy storage by adsorption/desorption. Adapted from [59]

165 2.4. Principles of the use of sorption materials as dehumidifier and thermal storage in 166 solar dryers

167 Sorption materials can be used for two main purposes in solar dryers [60]: dehumidification
168 and heat storage. The purpose of using sorption materials as dehumidifier is to lower the relative
169 humidity of the drying air before it enters the drying chamber. In practice, a bed of a sorption
170 material is provided in the path of the drying air, usually, at the entrance of the solar collector.
171 As the drying air flows through the dehumidification bed towards the solar collector, the
172 sorption materials ab/adsorb (depending on the type of material used) water molecules in the
173 air, in order to reduce its relative humidity. This ad/absorption process which is exothermic,
174 will also increase the drying air temperature and then enhance its overall drying potential. As
175 for heat storage in solar dryers, the desorption process usually takes place during the day, by
176 solar heat supply. This regenerates the sorption potential of the drying material. At night, the
177 dried sorbent is introduced into the solar dryer, together with the wet product to be dried. The
178 admission of air in the dryer is stopped so that the confined air can be recirculated between the
179 bed of sorbent material and the product to be dried by the mean of a fan that can be powered by
180 either a battery or another source of electricity. At that moment, adsorption process starts and
181 the water molecules contained in the air are adsorbed by the sorbent. Since the process is
182 exothermic, heat is released. This heat is transferred to the product to be dried, which releases
183 water back into the air. These water molecules are again adsorbed by the sorption material and
184 heat is again released. Thus, through this cycle, the drying of the product continues.

185 **3. Review of the use of sorption materials in solar dryers**

186 The use of sorption materials in solar dryers is subject to several conditions. First of all, since
187 solar dryers are mostly used in agro-food applications [61], a crucial aspect to consider is
188 toxicity. The ideal sorption material for an application in a solar dryer should therefore meet
189 this first criterion which is that of non-toxicity, especially regarding human health hazards. It is
190 very important because, in most applications, the drying air is in contact with both the sorption
191 material and the product to be dried. Therefore, the transfer of toxic particles from the material
192 to the product should be avoided. In this same line of maintaining product quality, one property
193 to be considered in the selection is the handling of the material. Indeed, the material must allow
194 good handling without risk of direct contact with the product to be dried, so that it does not alter
195 its taste. Another property to be considered, which is not the least important, is the regeneration
196 temperature of the material. It is important to ensure that the regeneration temperature of the
197 material to be selected is in line with the temperatures achievable by the solar collector(s)
198 integrated into the solar dryer. All these properties of the ideal sorption material for application
199 in a solar dryer must be combined with the criterion of cost-effectiveness. More broadly, the

200 main parameters to be considered for an optimal choice of the sorption material for a solar dryer
201 application are as follows [62–64]:

- 202 ▪ high water uptake [kg(water)/kg(sorbent)];
- 203 ▪ high energy storage density under the operating conditions ;
- 204 ▪ regeneration at a relatively low temperature that is reachable by the solar thermal
205 collectors of the dryer;
- 206 ▪ short regeneration time;
- 207 ▪ appropriate heat and mass transfer properties;
- 208 ▪ easy to handle i.e. nonpoisonous;
- 209 ▪ low investment cost;
- 210 ▪ thermal stability;
- 211 ▪ low environmental or lifecycle impact including disposal at the end of the lifetime.

212 These criteria are often in conflict with each other, which means that a good compromise for
213 an optimum must be made for the final choice.

214 **3.1. Review of applications of sorption materials as dehumidifier**

215 Silica gel is the most known [65,66] and used sorption material for physical adsorption of water
216 vapor especially due to its hydrophilic properties [47]. By far, it is also the material that has
217 been considered for dehumidification in solar dryers, both in direct and indirect forced
218 convection solar dryers [67–72]. Indeed, standard white silica gel is non-toxic and inert. It is
219 only when it is impregnated with a moisture indicator, such as cobalt chloride, which is
220 carcinogenic, that silica gel may become hazardous [73]. It is non-corrosive, odorless, thermally
221 stable, and requires a relatively low regeneration temperature. A combination of characteristics
222 that makes silica gel the preferred choice by most authors (Table 1). Calcium chloride aqueous
223 solution has also been considered for dehumidification in solar drying as it is also an abundant,
224 cheap, and non-toxic material. However, as a liquid material, it offers less handling possibility
225 compared to solids, namely silica gel. The regeneration of these materials used as dehumidifiers
226 in solar dryers is usually done with solar resource (Table 1).

227 Considering the works reported in the literature, most of the performances recorded in a solar
228 dryer integrated with a dehumidifier unit based on sorption material, ranged from 15 to 30%
229 reduction in drying time compared to operation without the sorption material integrated into the
230 dryer. Exceptional reduction in drying time of 50% and 64% were also reported by Punlek et
231 al. [68] and Misha et al. [71], respectively. In all these applications, forced convection solar

232 dryers have been of great interest for authors because the presence of the sorption bed creates
233 resistance (pressure drop) that is not favorable to natural convection [74,75].

Table 1: Key data and main results of some studies on the use of sorption materials for dehumidification in solar dryers. (wb=wet basis, db=dry basis.)

Reference	Hodali and Bougard [67]	Punlek et al. [68]	Chramsard et al. [69]	Misha et al. [70]	Misha et al. [71]	Dorouzi et al. [76]
Country	Morocco	Thailand	Thailand	Malaysia	Malaysia	Iran
Type of work	Simulation	Experiment	Experiment	Experiment	Experiment	Experiment
Product	Apricots	Ginger slices	Chili	Kenaf core fiber	Crushed oil palm fronds	Tomato slices
Mass of product	300 kg	–	–	155 kg	231 kg	500 g
Initial moisture content of the product	5.2 g/kg (db)	–	82 % (wb)	55 % (wb)	69 %	93.6% (wb)
Final moisture content	0.25 g/g(db)	–	13 % (wb)	< 18% (wb)	29% (wb)	9.2 %
Drying time	44 h	4 h	19 h	15.75 h	10 h 55 min	5.5 h
Time saved	8 h / 15.4% (compared to without sorption material)	4 h / 50% (compared to without sorption material)	5 h / 20.8% (compared to without sorption material)	24 % compared to direct sun drying	64 % compared to direct sun drying	27 % (compared to without sorption material)
Electricity consumption saving	–	–	21.5 kWh	–	–	–
Type of dryer	Indirect	Indirect	Indirect	Indirect	Indirect	Indirect
Convection	Forced	Forced	Forced	Forced	Forced	Forced
Collector	Flat plate	Flat plate	Flat plate	Evacuated tubes	Evacuated tubes	Flat plate
	20 m ²	0.8125 m ²	2.5 m ²	31.5 m ²	31.5 m ²	1.1 m ²
Drying chamber	2 m ³	0.112 m ³	–	10.2 m ³	10.2 m ³	–

235

Sorption material	Silica gel	Silica gel	Silica gel	Silica gel	Silica gel	Solution of CaCl ₂
Regeneration	Solar	Solar	Solar	Solar	Solar	Solar

236 **3.2.Review of applications of sorption materials as thermal storage**

237 If authors working on dehumidifiers integrated to solar dryers has shown a very high interest
238 for silica gel, this does not seem to be the case while considering thermal sorption storage
239 integrated to solar dryers since achieving a high energy storage density and a sufficient
240 temperature level during the discharging is a target (Table 2). To meet these requirements, some
241 authors [77,78] proposed the development of composite materials. These researches are
242 focusing on materials that have high porosity, a low cost, and a low regeneration temperature
243 suitable to be integrated into solar dryers. Existing composite materials have already been
244 identified to be capable of exhibiting excellent humidity adsorbing ability and attain deep
245 dehumidification of moist air [79]. They are obtained by impregnating hygroscopic salt into the
246 pores of porous desiccant host materials. Calcium chloride appears to be one of the most favored
247 hygroscopic salts in this regard (Table 2), probably because of several advantages that it
248 exhibits as sorption and thermochemical heat storage material [80]. It is easily available, cheap
249 (maybe the cheapest salt hydrate), thermally and chemically more stable than several other salt
250 hydrates, non-toxic, and offers a high hygroscopic desiccating and sorption capacity while it
251 can be easily regenerated at relatively low temperature [81–83].

252 Thoruwa et al. [77,78,84,85] used, for example, a solid composite material consisting of
253 calcium chloride impregnated on bentonite in an indirect forced-convection solar dryer in
254 Nairobi (subtropical highland climate, Kenya). The authors reported that this desiccant is
255 capable of regeneration at 45 °C and has a high sorption capacity of 45% of its mass. They add
256 that this mixture was suitable for the work, first, because it significantly extends the drying
257 process at night and reduces aflatoxin contamination of the grain, and second, because it is a
258 low-cost solid desiccant. During the experiments in Kenya, the authors used the material as
259 thermal storage for drying 90 kg of maize. The dryer performed well, under crop harvesting
260 conditions in Nairobi, drying maize from 38% (db) to 15% (db) within 24 h of harvest. One
261 very important finding of their work that can be useful when one is about to make a thermal
262 storage application of this composite material is that throughout the drying operation, 70% of
263 the moisture content of the product was removed during the day while the remaining 30% was
264 removed by thermal storage at night. Other authors, especially Patil et al. [86], who observed a
265 load distribution of 68% for daytime drying and 32% for thermal storage, have confirmed these
266 values.

Reference	Shanmugam and Natarajan [87]	Shanmugam and Natarajan [88]	Thoruwa et al. [78]	Dina et al. [89]	Dina et al. [89]	Phadke et al. [90]
Country	India	India	Kenya	Indonesia	Indonesia	India
Type of work	Experiment	Experiment	Experiment	Experiment	Experiment	Experiment
Product	Green peas	Green peas	Maize	Cocoa bean	Cocoa bean	Grapes
Mass of product	20 kg	20 kg	90 kg	1 kg	1 kg	1.2 kg
Initial moisture content of the product	80 % (wb)	80 % (wb)	38 % (wb)	59.1%–60.4%	59.1%–60.4%	
Final moisture content of the product	5 % (wb)	5 % (wb)	15 % (wb)	–	–	20 % (wb)
Drying time	21 h	19 h with reflective mirrors on sorption bed	Within 24 h	41 h	30 h/	57 h
Time saved	10 h (32.2%)	12 h (38.7%) – compared to without sorption material	–	25.45% compared to direct sun drying	45.45% compared to direct sun drying	47 h / 45% compared to direct sun drying

	– compared to without sorption material.					
Type of solar dryer	Indirect	Indirect	Indirect	Indirect	Indirect	Indirect
Convection	Forced	Forced	Forced	Natural	Natural	Forced
Collector	Flat plate	Flat plate	Flat plate	Flat plate	Flat plate	Flat plate
	2.88 m ²	2.88 m ²	–	0.1 m ²	0.1 m ²	1.4 m ²
Drying chamber	1.44 m ³	1.44 m ³	–	0.125 m ³	0.125 m ³	0.512 m ³
Sorption material	Bentonite + CaCl ₂ , vermiculite, and cement in a mass ratio of 6:1:2:1	Bentonite + CaCl ₂ , vermiculite, and cement in a mass ratio of 6:1:2:1	Bentonite + CaCl ₂ , vermiculite, and cement in a mass ratio of 6:1:2:1	Zeolite X	Solid CaCl ₂	Silica gel
Form of the sorption material	Solid	Solid	Solid	Solid	Solid	Solid
Regeneration	Solar	Solar	Solar	Solar	Solar	Solar

268

269

270 Because of this good performance of the mixture of bentonite, CaCl_2 , vermiculite, and cement
271 in a mass ratio of 6:1:2:1, Shanmugam et al. [87,88] also used it for thermal storage in an
272 indirect forced convection solar dryer in the hot and humid climatic conditions of Chennai in
273 India. Experiments have shown that for the drying of 20 kg of green peas, the moisture content
274 declined from 80% to 5% in 21 h. With the inclusion of a set of two reflective mirrors on the
275 sorption bed, the drying time was reduced to 19 h. Similar results were recorded for the drying
276 of 20 kg of pineapple. The safe moisture content was reached in 32 h with the thermal storage
277 without the set of mirrors. With the two mirrors on the sorption bed, the drying time was reduced
278 by 4 h leading to a drying time of 28 h.

279 Dina et al. [89] studied the performance of zeolite X compared to that of solid calcium chloride
280 when each of them is separately used as thermal storage in the same natural convection indirect
281 solar dryer. In general, zeolites are more hydrophilic than silica gels with a rate of water uptake
282 of 0.3 kg per kg of materials [47]. However, for solar-driven systems, zeolites have a major
283 drawback because of their high regeneration temperature which typically could reach more than
284 200 °C [47]. A fact that limits their use in solar dryers. Drying experiments were performed
285 between April and June 2013 in Medan city (tropical rainforest climate, Indonesia) and have
286 been classified into three groups. The first group is continuous solar drying integrated with
287 zeolite X, the second group is continuous solar drying integrated with solid CaCl_2 , and the third
288 group is intermittent direct sun drying. Experiments showed that while the traditional direct sun
289 drying required 55 h of intermittent drying, the use of zeolite X and that of solid CaCl_2 , reduce
290 the drying time to 41 h and 30 h, respectively. Besides, the authors pointed out the specific
291 energy consumptions for direct sun drying, solar dryer integrated with solid CaCl_2 , and solar
292 dryer integrated with zeolite X. Their values were 60.4 MJ/kg of water, 18.94 MJ/kg of water,
293 and 13.29 MJ/kg of water, respectively. Therefore, the authors concluded that a solar dryer
294 integrated with sorption thermal storage makes drying using solar energy more effective not
295 only in terms of drying time but also in terms of specific energy consumption. Zeolite X, with
296 a 25.45% reduction in drying time, was, therefore, less efficient than solid calcium chloride
297 (45.45%).

298 A 45% reduction in drying time was also reported by Phadke et al. [90] who used indicating
299 silica gel as thermal storage in an indirect solar dryer. Indicating silica gels are silica gels that
300 are capable of changing color depending on their state of charge (full of adsorbate or dry). This
301 makes the monitoring of the state of a desiccant bed easier. Phadke et al. [90] used an indicating

302 silica gel which becomes pink when it absorbs moisture and blue when it is dry (Figure 5). In
303 the study and for a constant air flow rate of 0.026 kg/s, the desiccant bed was regenerated in
304 about 5 h during a normal day with solar energy. According to the authors, the quality of the
305 grapes obtained from the solar dryer was excellent with good colors and taste in comparison to
306 those dried directly under the sun.



307

308 *Figure 5: Indicating silica gel bed used as thermal storage in a forced convection solar dryer in India [90].*

309 Overall, and compared to dehumidification, thermal storage seems to bring a slight advantage
310 in reducing the drying time of solar dryers. A range of 30 to 45% reduction in drying time has
311 been reported by the different studies.

312 Apart from the nature of the material used for either dehumidification or thermal storage, the
313 arrangement of the material within the dryer and sometimes even its conditioning or design
314 innovations have often been influencing factors in the performance mentioned in this section.
315 A review of these different configurations is made in the following section.

316 **4. Design aspects of the use of sorption materials in solar dryers**

317 **4.1. Use of sorption materials as dehumidifier**

318 In solar dryers where sorption materials are used as a dehumidifier, sorption beds are mostly
319 located outside the drying chamber, in the path of the drying air. Figure 6 summarizes some
320 configurations of this type encountered in experimental studies that have been reported in the
321 literature.

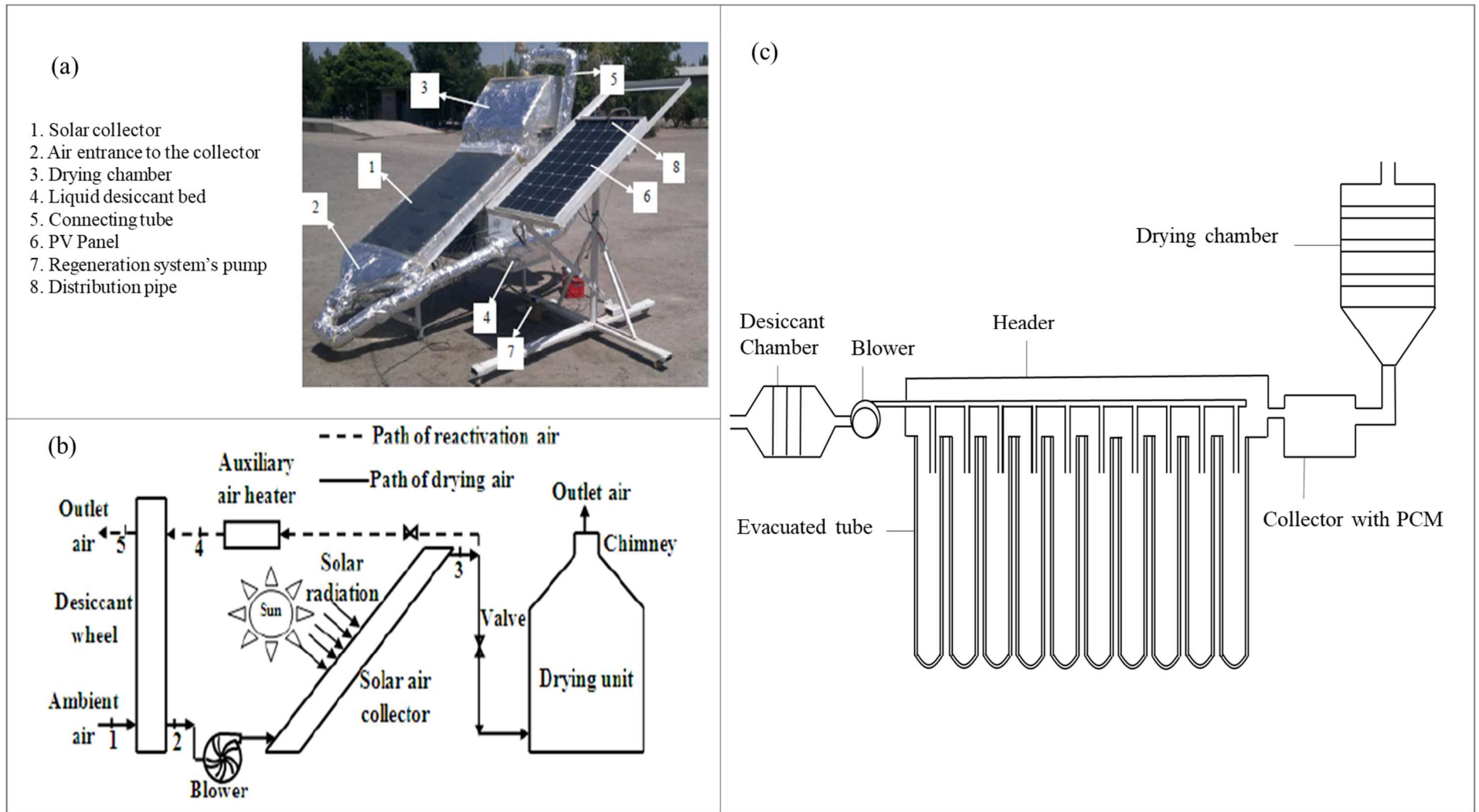

322

323

Figure 6: Some configurations of sorption beds located outside the drying chamber for air dehumidification (a) [76] (b) [91] (c) [92]

324 Let's take for example the dryer experimented by Misha et al. [70,71] (Figure 7). The material,
 325 silica gel, is packed in a rotating wheel with a diameter of 550 cm and a thickness of 20 cm. A
 326 special feature of this dryer is that it uses both water and air as heat transfer fluids. The desiccant
 327 wheel is regenerated with hot air produced through a heat exchanger between hot water coming
 328 from the evacuated tubes solar collector and the ambient air. No-loads experiment showed that
 329 the desiccant wheel performed poorly.

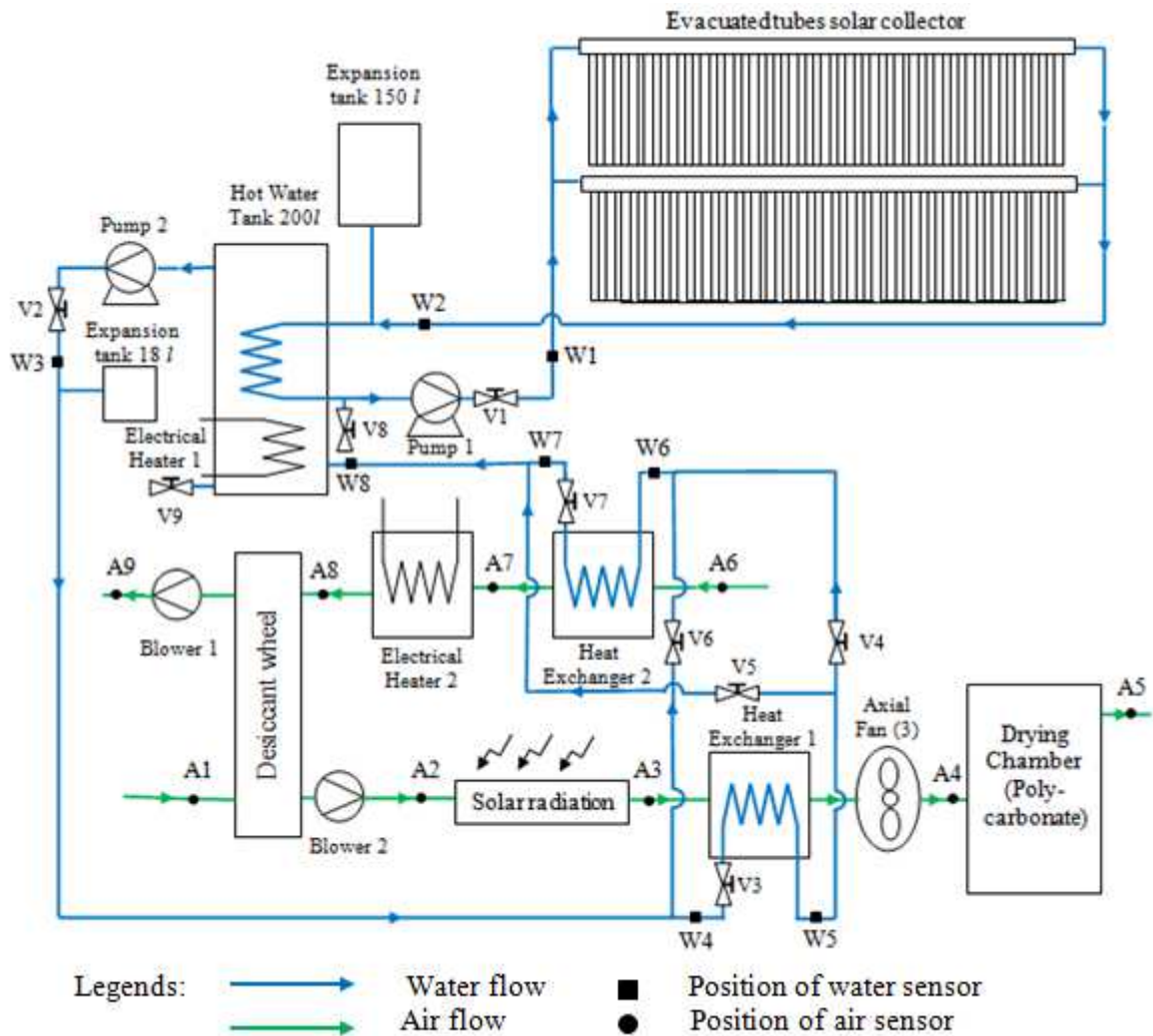

330
 331 *Figure 7: Set up of an experimental indirect solar dryer equipped with silica gel wheel as dehumidifier and using both*
 332 *water and air as heat transfer fluids [70,71].*

333 Its thermal, regeneration and dehumidification effectiveness was 48%, 29%, and 6%,
 334 respectively. The authors noticed that the poor performance of the desiccant wheel might be
 335 improved by increasing the regeneration temperature above 65 °C, since the regeneration
 336 temperature appeared to range from 49 °C to 54 °C throughout the experiment, whereas the
 337 minimum regeneration temperature for better performance is 65 °C according to the
 338 manufacturer. Furthermore, the collector had an efficiency of 70%, and the heat transfer through
 339 the copper coil between the hot water from the solar collector and the water in the storage tank

340 was poor. In fact, despite the average temperature of the hot water from the tube solar collector
341 was around 84 °C, the temperature of water in the tank reached approximately 65 °C. When
342 used to dry 155 kg of kenaf fibers [70] the dryer exhibits a 24% gain in drying time compared
343 to the performance of sun drying. However, this same dryer when used to dry 231 kg of crushed
344 oil palm leaves [71] shows a 64% reduction in drying time. It highlights the influence of the
345 product on the performance of a given dryer incorporating sorption materials.

346 In Figure 6a, Dorouzi et al. [76] used a bed of calcium chloride solution (concentration of 30%
347 by mass) as a liquid desiccant. The desiccant bed was a 0.2 × 0.3 × 0.5 m galvanized iron
348 chamber. The exhaust air from the drying chamber passes over the desiccant bed where part of
349 its moisture is absorbed by the desiccant material. The desiccant regeneration process, when
350 needed, was carried out by a PV-T solar collector which was of the free-flow type. It allowed
351 the liquid to flow over the surface of the PV panel. A distribution pipe feeds the liquid desiccant
352 uniformly over the surface of the solar panel so that it flows freely downwards and is
353 regenerated by absorbing the accumulated heat from the panel. The concentrated solution is
354 then fed to the desiccant chamber through the return pipe. During operation, when the relative
355 humidity of the drying air raised above a given value, a relative humidity control unit activated
356 the regeneration pump to re-concentrate the diluted solution. This increased the moisture
357 absorption potential of the drying bed and caused the relative humidity of the drying air to drop
358 back below the set point. The tests were carried out at three levels of drying air temperature
359 (60, 65, and 70 °C) and at three levels of regeneration system pump relative humidity activation
360 (18, 23, and 28%), which were selected based on the literature and the tests, respectively. For
361 the drying of 500 g of tomato slices, the authors reported that the drying time was 27% shorter
362 when applying the activation relative humidity of 18% instead of 28%. Besides, the increase of
363 the drying air temperature from 60 to 70 °C leads to a reduction (about 10%) of the drying time.

364 Elsewhere, Kabeel and Abdelgaied [91] used a rotating silica gel wheel in a solar dryer as a
365 dehumidifier. In their work, the cross-section of the wheel is divided into two parts (Figure 6 b).
366 The first part has a central angle of 240° and is for air-drying. The second one with a central
367 angle of 120° is dedicated to air regeneration. Therefore, the solar drying unit consists of two
368 air paths, the air-drying path (1–3) and the air regeneration path (3–5). The drying air follows
369 the path giving as follows: from state 1, it passes through the desiccant wheel, where its
370 moisture is removed and the temperature is increased since the process is exothermic. Then
371 through the solar collector, this hot and dry air is significantly heated from state point 2 to state
372 point 3. A part of the drying air leaving the solar air collector is heated in an auxiliary air heater

373 from state 3 to state 4 for regeneration purposes. Finally, this warm air flows through the
 374 desiccant wheel to desorb the water vapor and regenerate the desiccant wheel and leaves at state
 375 5. It appears from this work that the use of part of the hot air from the solar collector for the
 376 regeneration of the desiccant wheel results in a reduction of the operating cost of the dryer.

377 Punlek et al. [68] played on the geometric shape of the sorption bed. More precisely, the shape
 378 of the horizontal silica gel used in their study was optimized by simulation, and a V-shape bed
 379 was found more suitable from a technical point of view for the dryer (Figure 8).

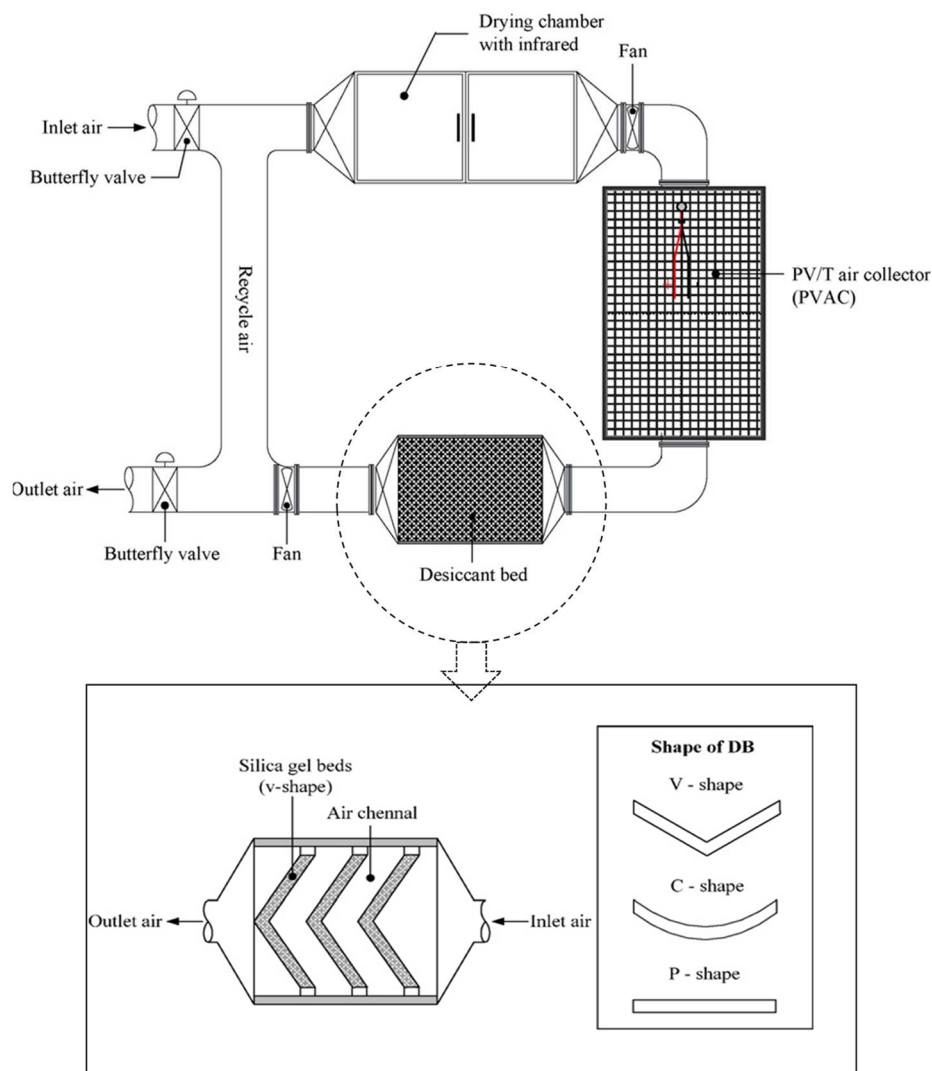

380

381 *Figure 8: V-Shaped silica gel bed integrated as a dehumidifier in a hybrid solar dryer designed to dry ginger slices in Thailand*
 382 *[68]. Adapted from food and bioproducts processing 87 (2009), Chantana Punlek, Rattanachai Pairintra, Sirinuch*
 383 *Chindaraksa, Somchai Maneewan, Simulation design and evaluation of hybrid PV/T assisted desiccant integrated HA-IR*
 384 *drying system (HPIRD), Pages 77–86, Copyright (2009), with permission from Elsevier.*

385 With these optimization works, they were able to dry ginger slices to their safe moisture content
 386 after 4 h in an indirect solar dryer, which resulted in a 50% reduction in drying time (4 h).

387 But although the general trend in the literature regarding the use as dehumidifier of sorption
 388 materials is to locate the sorption bed before the drying chamber, Padmanaban et al. [93] in
 389 their work, reported a configuration in which the dehumidifier bed is located at the outlet of the
 390 solar collector (Figure 9). In their study, and unlike the other works where the dehumidification
 391 beds are used, and where the air intake into the dryer after sunset is stopped, the air intake is
 392 maintained at sunset. Here, a thermal storage based on phase-change materials located below
 393 the flat plate solar collector heats the air during the night and then the dehumidifier bed reduces
 394 its relative humidity. From an initial moisture content of about 52% (wb), the authors were
 395 capable of drying the samples of copra to a final moisture content (wb) of about 8% in 62 h.
 396 This represents a gain of 42 h compared to conventional solar dryers, which have a drying time
 397 of about 104 h.

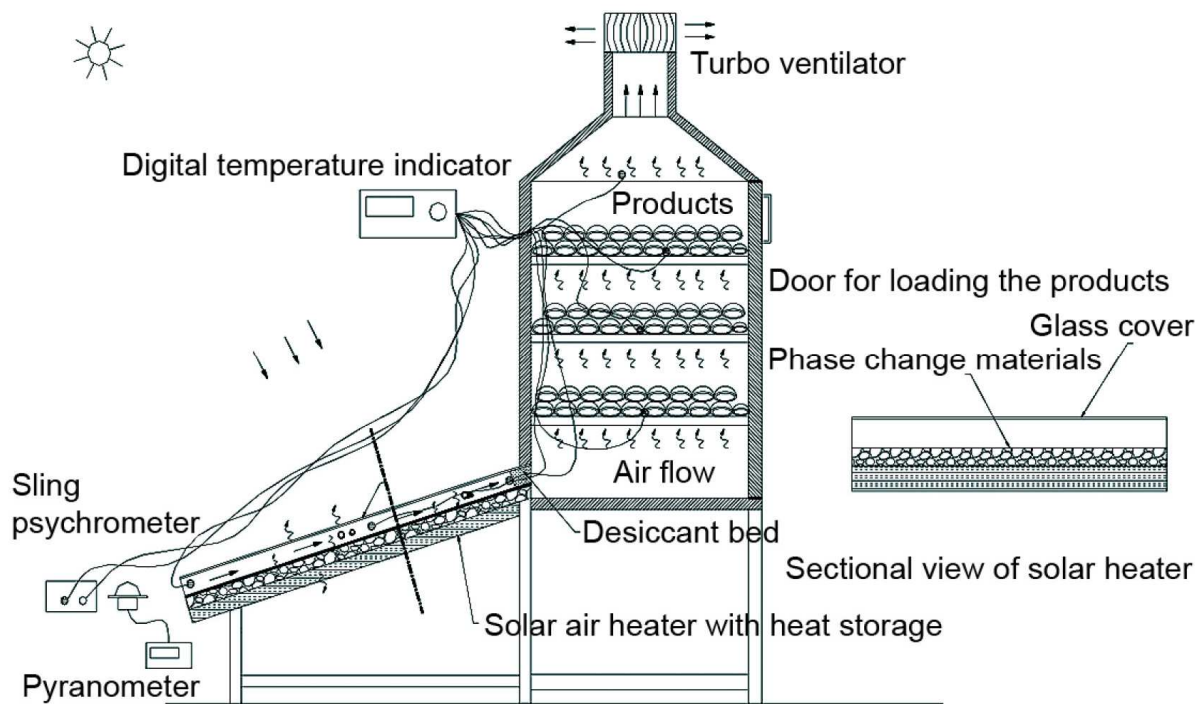

398

399 *Figure 9: Sorption bed placed at the inlet of the drying chamber – Desiccant assisted packed bed solar dryer for copra*
 400 *processing: use as a dehumidifier in the study of Padmanaban et al. [93].*

401 **4.2. Use of sorption materials as thermal storage**

402 Most studies using sorption materials for thermal storage have the sorption bed above the drying
 403 chamber. The typical configuration encountered in these case studies is shown in Figure 10. In
 404 this configuration, the sorption material is often packaged in small spherical bags and arranged
 405 on a tray perforated at several locations at the bottom. The perforated tray is covered with glass
 406 so that the solar radiations come in direct contact with the material. It is placed above the drying

407 chamber at a tilting angle close to that of the flat plate collector used. During daytime operation,
408 while the hot air from the flat plate collector is used to dry the products stored in the drying
409 chamber, the sorption bed is regenerated at the same time, with the incident solar radiation.
410 During this phase of operation, the drying chamber is isolated from the tray containing the
411 sorption material with e.g. plywood as done by Shanmugam et al. [87,88]. The moisture
412 removed from the material is usually extracted and discharged to the surrounding through a
413 valve (Figure 10b). At nightfall, the admission of fresh air in the dryer is stopped and the
414 insulation inserted between the sorption bed and the drying chamber is removed. At this stage,
415 a fan powered by a battery previously charged with a solar panel during the day is used to
416 recirculate the air confined in the drying chamber on the sorption bed. Exchanges between the
417 air and the material occur through the perforated holes at the bottom of the tray containing the
418 material, and thus, the drying process continues. A limitation of this configuration is that it
419 usually involves additional electricity consumption at night for the recirculation of the confined
420 air. Batteries for the storage of electricity are therefore required for a proper operation of the
421 dryer.

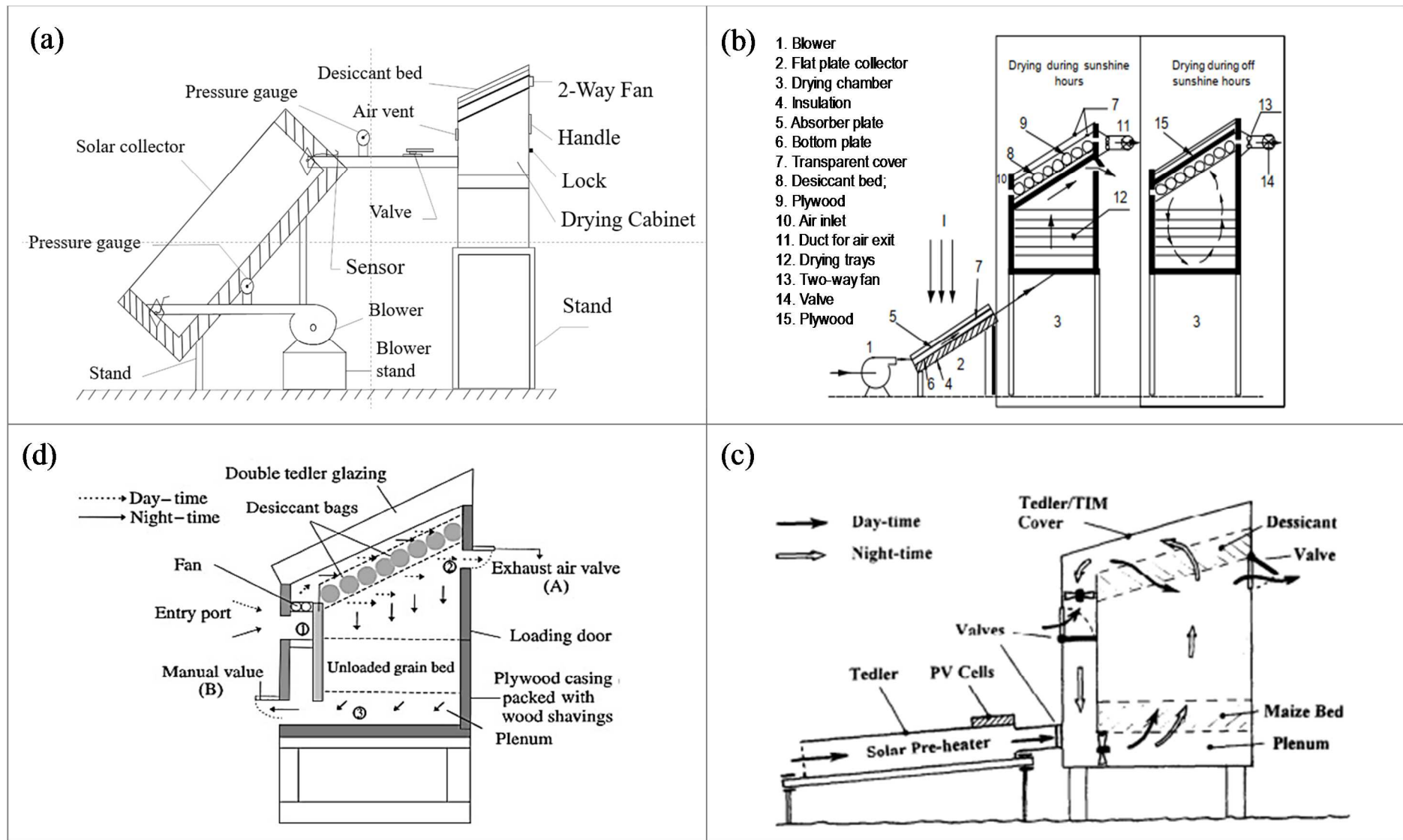
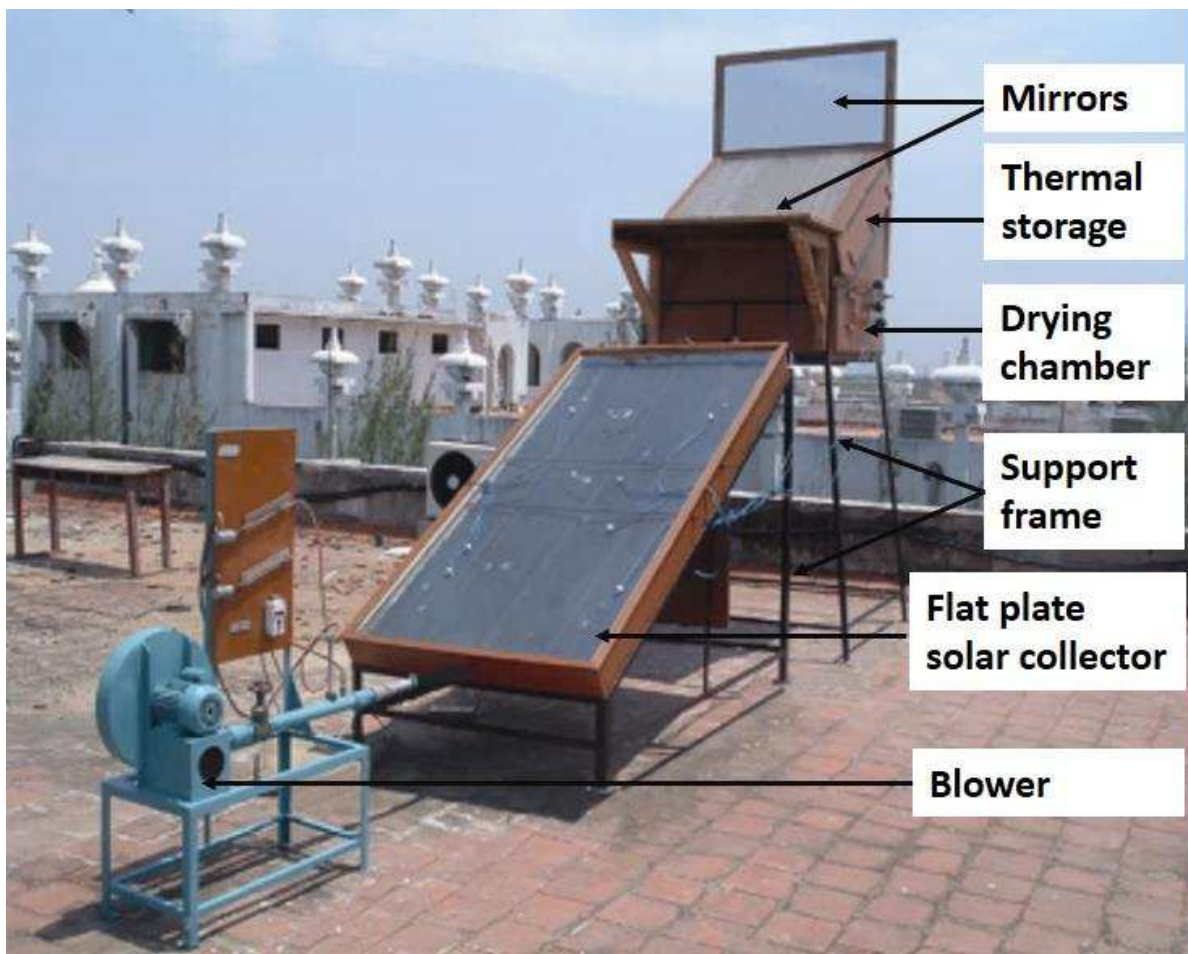

Figure 10: Examples of sorption beds positioned on the top of the drying chamber of a solar dryer. (a) [90], (b) [87], (c) [78], (d) [77].

422

423

424 Another challenge to consider is the position of the sun during the day. It can be seen that in
425 the systems that have been listed, the bed is fixed in a given orientation and tilting. Depending
426 on the position of the sun during the day, the bed receives less or more radiation. This influences
427 the dynamics of regeneration in the bed. To mitigate this problem, Shanmugam et al. [87]
428 integrated a system of reflecting mirrors in their prototype (Figure 11). Two reflective mirrors
429 have been placed on the two sides of the sorption bed that are in the same orientation as the
430 solar collector. These two mirrors reflect and concentrate solar radiation onto the bed to
431 accelerate the regeneration process.



432

433 *Figure 11: System of two reflective mirrors integrated on a sorption bed to improve the regeneration of the material [87].*
434 *Adapted from Applied Thermal Engineering 27 (2007), V. Shanmugam, E. Natarajan, Experimental study of regenerative*
435 *desiccant integrated solar dryer with and without reflective mirror, Pages 1543–1551, Copyright (2006), with permission from*
436 *Elsevier.*

437 The sorption bed average temperature with the reflective mirror reached 86 °C at noon. This
438 temperature is about 10 °C higher than the temperature without a reflecting mirror.
439 Consequently, a higher drying potential of the sorption material is achieved and the temperature
440 of the sorption bed is kept above the ambient temperature even the next morning. The mirrors

441 of Shanmugam et al. [87] are fixed in 90° positions, a tilt angle that might not be suitable with
442 all the sun positions during the day.

443 Dina et al. [89] tested another configuration for thermal storage. In their design, the thermal
444 storage was placed in an open steel container whose dimension is 30 cm×30 cm×5 cm (Figure
445 12) and placed just below the drying tray containing the product to be dried.



446

447 *Figure 12: Sorption bed located inside the drying chamber - Application of adsorbent (zeolite X) as thermal storage in a natural*
448 *convection indirect dryer for cocoa beans drying [89]. Adapted from Case Studies in Thermal Engineering 5 (2015), Sari*
449 *Farah Dina, Himsar Ambarita, Farel H. Napitupulu, Hideki Kawai, Study on effectiveness of continuous solar dryer integrated*
450 *with desiccant thermal storage for drying cocoa beans, Pages 32–40, Copyright (2014), with permission from Elsevier.*

451 The sorption bed is removable, which offers several advantages, especially concerning the
452 regeneration of the material. Indeed, during the day, the bed can be removed from the drying
453 chamber and exposed anywhere to maximize the solar radiation in case the regeneration takes
454 place in the course of the sun. If this is not the case, regardless of the means of regeneration,
455 the bed removability is still an advantage for controlling the bed's regeneration conditions
456 outside the drying chamber, particularly the temperature, the humidity, and the regeneration air
457 flow rate. In this case, Dina et al. [89] removed the sorption bed from the drying chamber during
458 the day and allowed it to regenerate just by exposing it to sunlight. For small installations, this
459 configuration may be feasible; even more so when there is a need to experiment several
460 materials on the same dryer as Dina et al. [89]. However, an issue here is the heat losses
461 resulting from the opening and closing of the drying chamber during the operations related to
462 the replacement of the sorption bed. This could influence the efficiency of the dryer. A solution
463 would be to opt for a non-removable bed, which would not require the opening and closing of
464 the drying chamber as proposed by Phadke et al. [90]. On a prototype of an indirect solar dryer

465 with forced convection, the authors integrated into the drying chamber, beds of indicating silica
466 gel to serve as thermal storage (Figure 13).

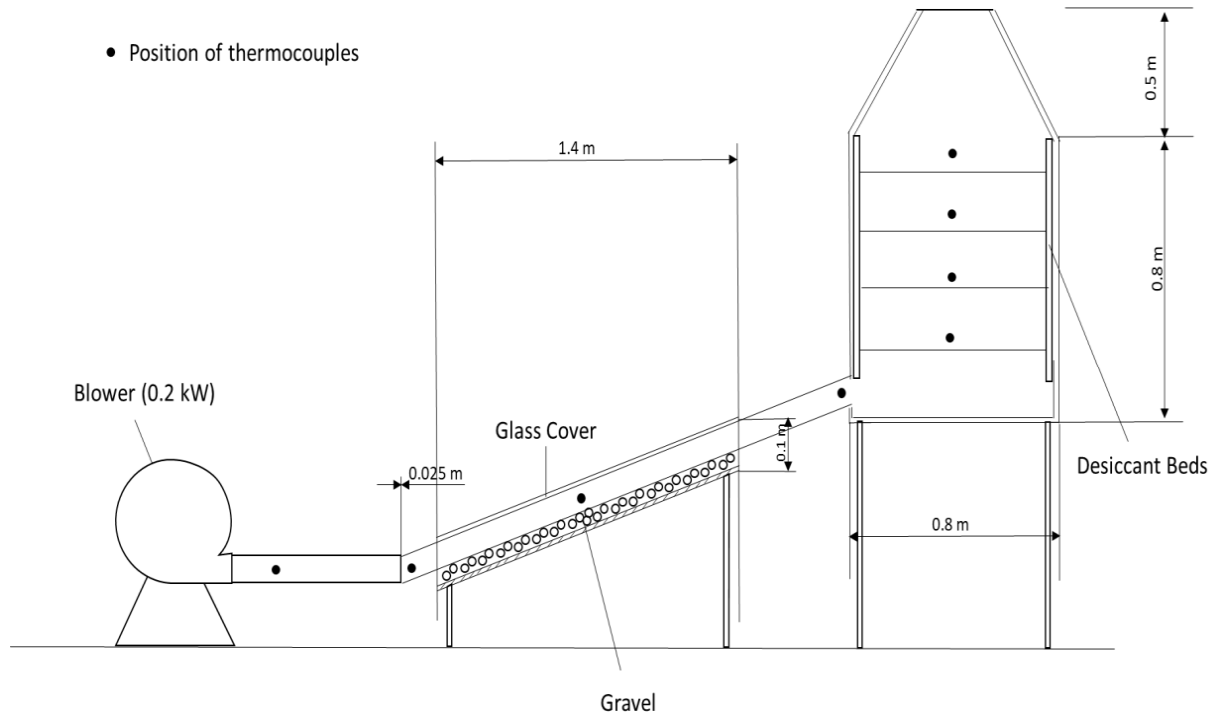

467

468 *Figure 13: Sorption bed attached to the walls of the drying chamber –: Forced convection solar dryer integrated with*
469 *thermal energy storage units based on gravel and rectangular indicating silica gel beds in India [90]*

470 The rectangular silica gel beds are attached on three sides inside the drying chamber with an
471 industrial adhesive, so that during sunny hours, while the temperature inside the dryer rises,
472 they also get rid of their moisture together with the products in the drying chamber. In the non-
473 sunny times, as the ambient air is still being admitted in the dryer, when the temperature of the
474 drying air decreases, the heat from the gravels is recovered and the air re-heated. After the
475 blower is stopped at night, and there is no more admission of ambient air in the drying chamber,
476 moisture from the products is now removed by the silica gel bed, which then acts as thermal
477 storage. From the experiment, it came out that for a constant air flow rate of 0.026 kg/s, the
478 desiccant beds were regenerated in about 5 h during a normal day.

479 **5. Discussion and recommendation for future work**

480 In this paper, many investigations on the use of sorption materials in solar dryers for
481 performance improvement have been reviewed. These solar dryers have been proved
482 technically more beneficial than classical solar dryers, specifically from the point of view of
483 drying time and energy efficiency. With reference to these investigations, the following points
484 can be highlighted (Figure 14):

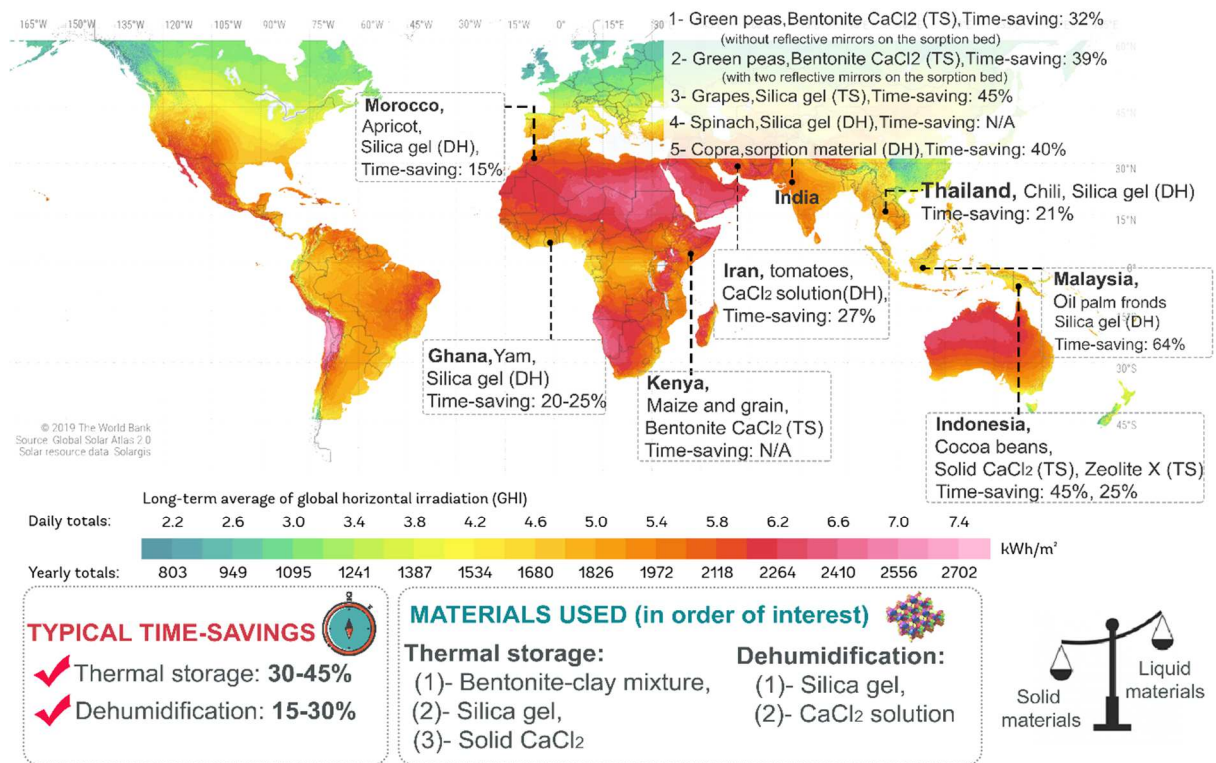

485

486

487

Figure 14: Worldwide distribution of studies reported in the literature regarding the use of sorption materials in solar dryers as thermal storage (TS) or dehumidifier (DH)

488

1. As for the use of sorption materials for dehumidification in solar dryers:

489

- Silica gel is by far the most used sorption material even though some applications of calcium chloride aqueous solution [76] have been found;

490

- Sorption beds are all located outside the drying chamber with a predominance for the location before the solar collector, except in a case where thermal storage is integrated into the solar collector and the air intake was not stopped at night.

491

- The incorporation of a dehumidification unit based on sorption material in a solar dryer usually leads to a reduction of the drying time of 15 to 30% compared to operation without the sorption material in the dryer, though values up to 50% [68] and even 64% [71] have been reported;

492

- The reduction of the drying time is highly affected by the product to be dried;

493

- For the regeneration of the regeneration material, solar energy is the preferred resource. For a continuous regeneration, some authors proposed a rotating desiccant wheel [91], with the use of a part of the hot air from the solar collector for the regeneration;

494

495

496

497

498

499

500

501

502

503 ▪ Forced convection solar dryers have been of great interest for authors since the
504 presence of the sorption bed creates resistance (pressure drop) that is not
505 favorable to natural convection [74,75];

506 2. *As for the use of sorption materials for thermal storage in solar dryers:*

507 ▪ Composite materials have been of great interest. More precisely, the mixture of
508 bentonite, CaCl₂, vermiculite, and cement in a mass ratio of 6:1:2:1 was used
509 several times. Authors [78], reported that the material was capable of
510 regeneration at 45°C and could adsorb 45% of its mass. Besides composite
511 materials, some applications of indicating silica gel [90], zeolite X [89], and
512 solid CaCl₂ [89] were also found;

513 ▪ Sorption beds are most of the time located at the top of the drying chamber. This
514 makes it possible to naturally recirculate the air confined in the drying chamber
515 across the sorption bed and thus perpetuate the drying process after sunset and
516 also absorbed maximum solar energy for regeneration. However, some authors
517 [90] preferred to attach the sorption beds to the sidewalls of the drying chamber
518 to take advantage of the hot air from the solar collector during the day and use
519 it for regeneration purposes. Others [89] have used removable sorption beds,
520 which offers several advantages, especially with regard to the regeneration of
521 the material. Indeed, during the day, the bed can be removed from the drying
522 chamber and exposed anywhere to maximize the solar radiation;

523 ▪ The integration of thermal storage based on sorption materials in a solar dryer
524 usually leads to a reduction of the drying time in a range of 30 to 45% compared
525 to the operation without thermal storage;

526 ▪ Some innovations regarding the regeneration procedure by solar energy were
527 found in the literature, namely the inclusion of a set of two mirrors on the
528 sorption bed placed at the top of the drying chamber. The inclusion of reflective
529 mirrors increases the drying potential of the desiccant material by 20% and
530 therefore reduces the drying time of the dryer [88].

531 In both cases:

532 ▪ Little place for liquid desiccant has been found in the works reported in the literature.
533 Instead, solid materials have been of great interest because they offer better handling, a
534 property which is very important for use in solar dryers [62–64];

- 535 ▪ Only one numerical work was found, namely that of Hodali et al. [67] who numerically
536 studied the optimized coupling between the collector, the sorption bed and the drying
537 chamber for a dehumidification use;
- 538 ▪ Since silica gel is expensive, composite materials could be of great interest. In this
539 regard, recent advances in materials for thermochemical and sorption storage which
540 mostly focused on long-term heat storage but with several limitations could find here a
541 field of application. The mixture of bentonite, CaCl₂, vermiculite, and cement in a mass
542 ratio of 6:1:2:1 is promising. However, there is a need for further studies in order to
543 better understand the material and to evaluate economic aspects, which were barely
544 discussed in the literature.

545 Finally, the most important challenges on the use of sorption materials in solar dryers systems
546 include:

- 547 ▪ The elaboration of a comprehensive methodology for sizing the quantity of sorption
548 material to be used according to the use (thermal storage or dehumidification), the
549 climatic conditions of dryer operation, the targeted drying air conditions, and the
550 product to be dried ;
- 551 ▪ The identification or the development of cost-effective pure or composite sorption
552 materials, for instance naturally and locally available materials.

553

554 **6. Conclusion**

555 The objectives of this review were to identify the current status of the research on the use of
556 sorption materials in solar dryers and to provide future perspectives for better applications of
557 such materials in solar dryers. From the literature review, the most commonly used materials for
558 dehumidification and thermal storage were identified (as silica gel and CaCl₂-based material
559 respectively), and the main conclusions and results regarding the various applications of
560 sorption materials in solar dryers were highlighted. Although, further studies are needed to
561 better understand influence of sorption materials on solar dryers' performances, typical drying
562 time reductions compared to operations without sorption storage and dehumidification unit are
563 30–45% and 15–30%, respectively. This review has revealed the need to develop a
564 comprehensive methodology to size the amount of sorption material to be used depending on
565 the application (thermal storage or dehumidification), the operating climatic conditions of the
566 dryer, the targeted drying air properties, and the product to be dried. Considering that composite
567 materials have exhibited good results in various experiments in the literature, it appears

568 important to work on identifying or developing cost-effective pure or composite sorption
569 materials naturally and locally available.

570 **Acknowledgement**

571 This work was supported by the German Academic Exchange Service (DAAD) [grant numbers
572 57506852, 2019].

573

575

- 576 [1] Caurie M. Bound water: its definition, estimation and characteristics. *Int J Food Sci*
577 *Technol* 2011;46:930–4.
- 578 [2] Available Moisture in Foods: What Is It Anyway? | College of Agriculture, Forestry and
579 Life Sciences | Clemson University, South Carolina n.d.
580 <https://www.clemson.edu/extension/food/canning/canning-tips/39available-moisture.html>
581 (accessed March 22, 2021).
- 582 [3] Barbosa-Cánovas GV, Fontana Jr AJ, Schmidt SJ, Labuza TP. *Water activity in foods:*
583 *fundamentals and applications.* John Wiley & Sons; 2020.
- 584 [4] Zhang L, Sun D-W, Zhang Z. Methods for measuring water activity (A_w) of foods and
585 its applications to moisture sorption isotherm studies. *Crit Rev Food Sci Nutr*
586 2017;57:1052–8. <https://doi.org/10.1080/10408398.2015.1108282>.
- 587 [5] Prakash O, Kumar A. *Solar Drying Technology: Concept, Design, Testing, Modeling,*
588 *Economics, and Environment.* Springer; 2017.
- 589 [6] Pirasteh G, Saidur R, Rahman SMA, Rahim NA. A review on development of solar
590 drying applications. *Renew Sustain Energy Rev* 2014;31:133–48.
591 <https://doi.org/10.1016/j.rser.2013.11.052>.
- 592 [7] Nwakuba N, Asoegwu S, Nwaigwe K. Energy consumption of agricultural dryers: An
593 overview 2017;18.
- 594 [8] VijayaVenkataRaman S, Iniyan S, Goic R. A review of solar drying technologies. *Renew*
595 *Sustain Energy Rev* 2012;16:2652–70. <https://doi.org/10.1016/j.rser.2012.01.007>.
- 596 [9] Tiris C, Ozbalta N, Tiris M, Dincer I. Thermal performance of a new solar air heater. *Int*
597 *Commun Heat Mass Transf* 1995;22:411–23. [https://doi.org/10.1016/0735-](https://doi.org/10.1016/0735-1933(95)00021-P)
598 [1933\(95\)00021-P](https://doi.org/10.1016/0735-1933(95)00021-P).
- 599 [10] Mujumdar AS, Devahastin S. *Fundamental principles of drying.* Exergex Brossard
600 Can 2000;1:1–22.
- 601 [11] Komilov OS, Astanov SKh, Safarov OF, Sharipov MZ, Faizullaev AR, Tillaev L.
602 Combined solar drying unit. *Appl Sol Energy* 2009;45:262–5.
603 <https://doi.org/10.3103/S0003701X09040082>.
- 604 [12] Madhlopa A, Ngwalo G. Solar dryer with thermal storage and biomass-backup heater.
605 *Sol Energy* 2007;81:449–62. <https://doi.org/10.1016/j.solener.2006.08.008>.
- 606 [13] Dhanushkodi S, Wilson VH, Sudhakar K. Mathematical modeling of drying behavior
607 of cashew in a solar biomass hybrid dryer. *Resour-Effic Technol* 2017;3:359–64.
608 <https://doi.org/10.1016/j.refit.2016.12.002>.
- 609 [14] Sonthikun S, Chairat P, Fardsin K, Kirirat P, Kumar A, Tekasakul P. Computational
610 fluid dynamic analysis of innovative design of solar-biomass hybrid dryer: An
611 experimental validation. *Renew Energy* 2016;92:185–91.
612 <https://doi.org/10.1016/j.renene.2016.01.095>.
- 613 [15] Fagunwa AO, Koya OA, Faborode MO. Development of an intermittent solar dryer
614 for cocoa beans. *Agric Eng Int CIGR J* 2009.
- 615 [16] Berinyuy JE, Tangka JK, Fotso GMW. Enhancing natural convection solar drying of
616 high moisture vegetables with heat storage. *Agric Eng Int CIGR J* 2012;14:141–8.
- 617 [17] Abdel-Galil HS. Solar system with energy storage for drying poultry manure. *Misr J*
618 *Agric Eng* 2007;24:978–1003.
- 619 [18] Abubakar S, Umaru S, Kaisan MU, Umar UA, Ashok B, Nanthagopal K.
620 Development and performance comparison of mixed-mode solar crop dryers with and
621 without thermal storage. *Renew Energy* 2018;128:285–98.
622 <https://doi.org/10.1016/j.renene.2018.05.049>.

- 623 [19] Jain D. Modeling the performance of greenhouse with packed bed thermal storage on
624 crop drying application. *J Food Eng* 2005;71:170–8.
625 <https://doi.org/10.1016/j.jfoodeng.2004.10.031>.
- 626 [20] Natarajan K, Thokchom SS, Verma TN, Nashine P. Convective solar drying of *Vitis*
627 *vinifera* & *Momordica charantia* using thermal storage materials. *Renew Energy*
628 2017;113:1193–200. <https://doi.org/10.1016/j.renene.2017.06.096>.
- 629 [21] Aboul-Enein S, El-Sebaei AA, Ramadan MRI, El-Gohary HG. Parametric study of a
630 solar air heater with and without thermal storage for solar drying applications. *Renew*
631 *Energy* 2000;21:505–22.
- 632 [22] El-Sebaei AA, Aboul-Enein S, Ramadan MRI, El-Gohary HG. Experimental
633 investigation of an indirect type natural convection solar dryer. *Energy Convers Manag*
634 2002;43:2251–66. [https://doi.org/10.1016/S0196-8904\(01\)00152-2](https://doi.org/10.1016/S0196-8904(01)00152-2).
- 635 [23] Potdukhe PA, Thombre SB. Development of a new type of solar dryer: its
636 mathematical modelling and experimental evaluation. *Int J Energy Res* 2008;32:765–82.
- 637 [24] Agarwal A, Sarviya RM. An experimental investigation of shell and tube latent heat
638 storage for solar dryer using paraffin wax as heat storage material. *Eng Sci Technol Int J*
639 2016;19:619–31. <https://doi.org/10.1016/j.jestch.2015.09.014>.
- 640 [25] Agarwal A, Sarviya RM. Characterization of Commercial Grade Paraffin wax as
641 Latent Heat Storage material for Solar dryers. *Mater Today Proc* 2017;4:779–89.
642 <https://doi.org/10.1016/j.matpr.2017.01.086>.
- 643 [26] Arun KR, Srinivas M, Saleel CA, Jayaraj S. Active drying of unripened bananas
644 (*Musa Nendra*) in a multi-tray mixed-mode solar cabinet dryer with backup energy
645 storage. *Sol Energy* 2019;188:1002–12. <https://doi.org/10.1016/j.solener.2019.07.001>.
- 646 [27] Arun KR, Srinivas M, Saleel CA, Jayaraj S. Influence of the location of discrete
647 macro-encapsulated thermal energy storage on the performance of a double pass solar
648 plate collector system. *Renew Energy* 2020;146:675–86.
649 <https://doi.org/10.1016/j.renene.2019.07.036>.
- 650 [28] Azaizia Z, Kooli S, Hamdi I, Elkhali W, Guizani AA. Experimental study of a new
651 mixed mode solar greenhouse drying system with and without thermal energy storage for
652 pepper. *Renew Energy* 2020;145:1972–84. <https://doi.org/10.1016/j.renene.2019.07.055>.
- 653 [29] Baddadi S, Bouadila S, Guizani A. Beneficial use of two packed beds of latent storage
654 energy for the heating of a hydroponic greenhouse. *Energy Procedia* 2019;162:156–63.
655 <https://doi.org/10.1016/j.egypro.2019.04.017>.
- 656 [30] Bal LM, Satya S, Naik SN, Meda V. Review of solar dryers with latent heat storage
657 systems for agricultural products. *Renew Sustain Energy Rev* 2011;15:876–80.
658 <https://doi.org/10.1016/j.rser.2010.09.006>.
- 659 [31] Baniyadi E, Ranjbar S, Boostanipour O. Experimental investigation of the
660 performance of a mixed-mode solar dryer with thermal energy storage. *Renew Energy*
661 2017;112:143–50. <https://doi.org/10.1016/j.renene.2017.05.043>.
- 662 [32] Bhardwaj AK, Chauhan R, Kumar R, Sethi M, Rana A. Experimental investigation of
663 an indirect solar dryer integrated with phase change material for drying valeriana
664 *jatamansi* (medicinal herb). *Case Stud Therm Eng* 2017;10:302–14.
665 <https://doi.org/10.1016/j.csite.2017.07.009>.
- 666 [33] Devahastin S, Pitaksuriyarat S. Use of latent heat storage to conserve energy during
667 drying and its effect on drying kinetics of a food product. *Appl Therm Eng*
668 2006;26:1705–13. <https://doi.org/10.1016/j.applthermaleng.2005.11.007>.
- 669 [34] Khadraoui AE, Bouadila S, Kooli S, Farhat A, Guizani A. Thermal behavior of
670 indirect solar dryer: Nocturnal usage of solar air collector with PCM. *J Clean Prod*
671 2017;148:37–48. <https://doi.org/10.1016/j.jclepro.2017.01.149>.

- 672 [35] Jain D, Tewari P. Performance of indirect through pass natural convective solar crop
673 dryer with phase change thermal energy storage. *Renew Energy* 2015;80:244–50.
674 <https://doi.org/10.1016/j.renene.2015.02.012>.
- 675 [36] Khadraoui AE, Bouadila S, Kooli S, Guizani A, Farhat A. Solar air heater with phase
676 change material: An energy analysis and a comparative study. *Appl Therm Eng*
677 2016;107:1057–64. <https://doi.org/10.1016/j.applthermaleng.2016.07.004>.
- 678 [37] Khouya A, Draoui A. Computational drying model for solar kiln with latent heat
679 energy storage: Case studies of thermal application. *Renew Energy* 2019;130:796–813.
680 <https://doi.org/10.1016/j.renene.2018.06.090>.
- 681 [38] Lakshmi DVN, Muthukumar P, Layek A, Nayak PK. Drying kinetics and quality
682 analysis of black turmeric (*Curcuma caesia*) drying in a mixed mode forced convection
683 solar dryer integrated with thermal energy storage. *Renew Energy* 2018;120:23–34.
684 <https://doi.org/10.1016/j.renene.2017.12.053>.
- 685 [39] Lamidi RO, Jiang L, Pathare PB, Wang YD, Roskilly AP. Recent advances in
686 sustainable drying of agricultural produce: A review. *Appl Energy* 2019;233–234:367–85.
687 <https://doi.org/10.1016/j.apenergy.2018.10.044>.
- 688 [40] Rabha DK, Muthukumar P. Performance studies on a forced convection solar dryer
689 integrated with a paraffin wax–based latent heat storage system. *Sol Energy*
690 2017;149:214–26. <https://doi.org/10.1016/j.solener.2017.04.012>.
- 691 [41] Raj AK, Srinivas M, Jayaraj S. A cost-effective method to improve the performance of
692 solar air heaters using discrete macro-encapsulated PCM capsules for drying applications.
693 *Appl Therm Eng* 2019;146:910–20.
694 <https://doi.org/10.1016/j.applthermaleng.2018.10.055>.
- 695 [42] Reyes A, Mahn A, Vásquez F. Mushrooms dehydration in a hybrid-solar dryer, using
696 a phase change material. *Energy Convers Manag* 2014;83:241–8.
697 <https://doi.org/10.1016/j.enconman.2014.03.077>.
- 698 [43] Reyes A, Pailahueque N, Henríquez-Vargas L, Vásquez J, Sepúlveda F. Analysis of a
699 multistage solar thermal energy accumulator. *Renew Energy* 2019;136:621–31.
700 <https://doi.org/10.1016/j.renene.2018.12.103>.
- 701 [44] Shalaby SM, Bek MA. Experimental investigation of a novel indirect solar dryer
702 implementing PCM as energy storage medium. *Energy Convers Manag* 2014;83:1–8.
703 <https://doi.org/10.1016/j.enconman.2014.03.043>.
- 704 [45] Swami VM, Autee AT, T r A. Experimental analysis of solar fish dryer using phase
705 change material. *J Energy Storage* 2018;20:310–5.
706 <https://doi.org/10.1016/j.est.2018.09.016>.
- 707 [46] Wadhawan A, Dhoble AS, Gawande VB. Analysis of the effects of use of thermal
708 energy storage device (TESD) in solar air heater. *Alex Eng J* 2018;57:1173–83.
709 <https://doi.org/10.1016/j.aej.2017.03.016>.
- 710 [47] Jarimi H, Aydin D, Yanan Z, Ozankaya G, Chen X, Riffat S. Review on the recent
711 progress of thermochemical materials and processes for solar thermal energy storage and
712 industrial waste heat recovery. *Int J Low-Carbon Technol* 2018;14:44–69.
713 <https://doi.org/10.1093/ijlct/cty052>.
- 714 [48] Visavale GL. Principles, classification and selection of solar dryers. *Sol Dry Fundam*
715 *Appl Innov Ed Hii CL Ong SP Jangam SV Mujumdar Publ Singap* 2012:1–50.
- 716 [49] Ekechukwu OV, Norton B. Review of solar-energy drying systems II: an overview of
717 solar drying technology. *Energy Convers Manag* 1999;40:615–55.
718 [https://doi.org/10.1016/S0196-8904\(98\)00093-4](https://doi.org/10.1016/S0196-8904(98)00093-4).
- 719 [50] Jairaj KS, Singh SP, Srikant K. A review of solar dryers developed for grape drying.
720 *Sol Energy* 2009;83:1698–712. <https://doi.org/10.1016/j.solener.2009.06.008>.

- 721 [51] Kumar M, Sansaniwal SK, Khatak P. Progress in solar dryers for drying various
722 commodities. *Renew Sustain Energy Rev* 2016;55:346–60.
723 <https://doi.org/10.1016/j.rser.2015.10.158>.
- 724 [52] Fudholi A, Sopian K, Ruslan MH, Alghoul MA, Sulaiman MY. Review of solar dryers
725 for agricultural and marine products. *Renew Sustain Energy Rev* 2010;14:1–30.
726 <https://doi.org/10.1016/j.rser.2009.07.032>.
- 727 [53] Lingayat AB, Chandramohan VP, Raju VRK, Meda V. A review on indirect type solar
728 dryers for agricultural crops–Dryer setup, its performance, energy storage and important
729 highlights. *Appl Energy* 2020;258:114005.
- 730 [54] Simate IN. Optimization of mixed-mode and indirect-mode natural convection solar
731 dryers. *Renew Energy* 2003;28:435–53. [https://doi.org/10.1016/S0960-1481\(02\)00041-1](https://doi.org/10.1016/S0960-1481(02)00041-1).
- 732 [55] N'Tsoukpoe KE, Liu H, Le Pierrès N, Luo L. A review on long-term sorption solar
733 energy storage. *Renew Sustain Energy Rev* 2009;13:2385–96.
734 <https://doi.org/10.1016/j.rser.2009.05.008>.
- 735 [56] Kreuzer HJ, Gortel ZW. *Physisorption kinetics*. vol. 1. Springer Science & Business
736 Media; 2012.
- 737 [57] Nagwa El-Mansy. Absorption n.d. <https://slideplayer.com/slide/5979061/> (accessed
738 March 25, 2021).
- 739 [58] N'Tsoukpoe KE, Mazet N, Neveu P. The concept of cascade thermochemical storage
740 based on multimaterial system for household applications. *Energy Build* 2016;129:138–
741 49.
- 742 [59] Stockage thermochimique n.d. [http://www.recuperation-chaleur.fr/stockage-](http://www.recuperation-chaleur.fr/stockage-thermochimique)
743 [thermochimique](http://www.recuperation-chaleur.fr/stockage-thermochimique) (accessed April 17, 2021).
- 744 [60] Misha S, Mat S, Ruslan MH, Sopian K. Review of solid/liquid desiccant in the drying
745 applications and its regeneration methods. *Renew Sustain Energy Rev* 2012;16:4686–707.
746 <https://doi.org/10.1016/j.rser.2012.04.041>.
- 747 [61] Mohana Y, Mohanapriya R, Anukiruthika T, Yoha KS, Moses JA,
748 Anandharamakrishnan C. Solar dryers for food applications: Concepts, designs, and
749 recent advances. *Sol Energy* 2020;208:321–44.
- 750 [62] Yu N, Wang RZ, Wang LW. Sorption thermal storage for solar energy. *Prog Energy*
751 *Combust Sci* 2013;39:489–514.
- 752 [63] Weber R, Dorer V. Long-term heat storage with NaOH. *Vacuum* 2008;82:708–16.
753 <https://doi.org/10.1016/j.vacuum.2007.10.018>.
- 754 [64] Wongsuwan W, Kumar S, Neveu P, Meunier F. A review of chemical heat pump
755 technology and applications. *Appl Therm Eng* 2001;21:1489–519.
756 [https://doi.org/10.1016/S1359-4311\(01\)00022-9](https://doi.org/10.1016/S1359-4311(01)00022-9).
- 757 [65] Chang K-S, Chen M-T, Chung T-W. Effects of the thickness and particle size of silica
758 gel on the heat and mass transfer performance of a silica gel-coated bed for air-
759 conditioning adsorption systems. *Appl Therm Eng* 2005;25:2330–40.
- 760 [66] Srivastava NC, Eames IW. A review of adsorbents and adsorbates in solid–vapour
761 adsorption heat pump systems. *Appl Therm Eng* 1998;18:707–14.
- 762 [67] Hodali R, Bougard J. Integration of a desiccant unit in crops solar drying installation:
763 optimization by numerical simulation. *Energy Convers Manag* 2001;42:1543–58.
764 [https://doi.org/10.1016/S0196-8904\(00\)00159-X](https://doi.org/10.1016/S0196-8904(00)00159-X).
- 765 [68] Punlek C, Pairintra R, Chindaraksa S, Maneewan S. Simulation design and evaluation
766 of hybrid PV/T assisted desiccant integrated HA-IR drying system (HPIRD). *Food*
767 *Bioprod Process* 2009;87:77–86.
- 768 [69] Chramsard W, Jindaruksa S, Sirisumpunwong C, Sonsaree S. Performance
769 Evaluation of the Desiccant Bed Solar Dryer. *Energy Procedia* 2013;34:189–97.
770 <https://doi.org/10.1016/j.egypro.2013.06.747>.

- 771 [70] Misha S, Mat S, Ruslan MH, Salleh E, Sopian K. Performance of a solar assisted solid
 772 desiccant dryer for kenaf core fiber drying under low solar radiation. *Sol Energy*
 773 2015;112:194–204.
- 774 [71] Misha S, Mat S, Ruslan MH, Salleh E, Sopian K. Performance of a solar-assisted solid
 775 desiccant dryer for oil palm fronds drying. *Sol Energy* 2016;132:415–29.
 776 <https://doi.org/10.1016/j.solener.2016.03.041>.
- 777 [72] Amankwah EYA. Drying of yam with solar adsorption system. PhD Thesis.
 778 Wageningen University, 2019. <https://doi.org/10.18174/471677>.
- 779 [73] Rao NK, Hanson J, Dulloo ME, Ghosh K, Nowell A. Manual of seed handling in
 780 genebanks. Bioersivity International; 2006.
- 781 [74] Ghaffari A, Mehdipour R. Modeling and improving the performance of cabinet solar
 782 dryer using computational fluid dynamics. *Int J Food Eng* 2015;11:157–72.
- 783 [75] Yuan G, Hong L, Li X, Xu L, Tang W, Wang Z. Experimental investigation of a solar
 784 dryer system for drying carpet. *Energy Procedia* 2015;70:626–33.
- 785 [76] Dorouzi M, Mortezapour H, Akhavan H-R, Moghaddam AG. Tomato slices drying in
 786 a liquid desiccant-assisted solar dryer coupled with a photovoltaic-thermal regeneration
 787 system. *Sol Energy* 2018;162:364–71. <https://doi.org/10.1016/j.solener.2018.01.025>.
- 788 [77] Thoruwa TFN, Grant AD, Smith JE, Johnstone CM. A Solar-regenerated Desiccant
 789 Dehumidifier for the Aeration of Stored Grain in the Humid Tropics. *J Agric Eng Res*
 790 1998;71:257–62. <https://doi.org/10.1006/jaer.1998.0321>.
- 791 [78] Thoruwa TFN, Smith JE, Grant AD, Johnstone CM. Developments in solar drying
 792 using forced ventilation and solar regenerated desiccant materials. *Renew Energy*
 793 1996;9:686–9. [https://doi.org/10.1016/0960-1481\(96\)88378-9](https://doi.org/10.1016/0960-1481(96)88378-9).
- 794 [79] Chua KJ. Heat and mass transfer of composite desiccants for energy efficient air
 795 dehumidification: Modelling and experiment. *Appl Therm Eng* 2015;89:703–16.
- 796 [80] N'Tsoukpoe KE, Rammelberg HU, Lele AF, Korhammer K, Watts BA, Schmidt T, et
 797 al. A review on the use of calcium chloride in applied thermal engineering. *Appl Therm*
 798 *Eng* 2015;75:513–31.
- 799 [81] Audah N, Ghaddar N, Ghali K. Optimized solar-powered liquid desiccant system to
 800 supply building fresh water and cooling needs. *Appl Energy* 2011;88:3726–36.
- 801 [82] Lowenstein A, Slayzak S, Kozubal E. A zero carryover liquid-desiccant air
 802 conditioner for solar applications. *Int. Sol. Energy Conf.*, vol. 47454, 2006, p. 397–407.
- 803 [83] Lowenstein A. Review of liquid desiccant technology for HVAC applications. *HvacR*
 804 *Res* 2008;14:819–39.
- 805 [84] Thoruwa TFN, Johnstone CM, Grant AD, Smith JE. Novel, low cost CaCl₂ based
 806 desiccants for solar crop drying applications. *Renew Energy* 2000;19:513–20.
- 807 [85] Thoruwa TFN. Physical and microbiology investigations of day and night
 808 photovoltaic-desiccant solar crop dryer for village use in Kenya. *Univ Strathclyde Glasg*
 809 1996.
- 810 [86] Patil KS, Mahajan SD, S.R.Burkul. Experimentation of solar dryer with desiccant
 811 material for agricultural products. *Int J Multidiscip Res Dev* 2015;2:01–7.
- 812 [87] Shanmugam V, Natarajan E. Experimental study of regenerative desiccant integrated
 813 solar dryer with and without reflective mirror. *Appl Therm Eng* 2007;27:1543–51.
 814 <https://doi.org/10.1016/j.applthermaleng.2006.09.018>.
- 815 [88] Shanmugam V, Natarajan E. Experimental investigation of forced convection and
 816 desiccant integrated solar dryer. *Renew Energy* 2006;31:1239–51.
 817 <https://doi.org/10.1016/j.renene.2005.05.019>.
- 818 [89] Dina SF, Ambarita H, Napitupulu FH, Kawai H. Study on effectiveness of continuous
 819 solar dryer integrated with desiccant thermal storage for drying cocoa beans. *Case Stud*
 820 *Therm Eng* 2015;5:32–40. <https://doi.org/10.1016/j.csite.2014.11.003>.

- 821 [90] Phadke P. Performance evaluation of forced convection desiccant bed solar dryer
822 integrated with sensible heat storage material. *Int J Anal Exp Finite Elem Anal IJAEFEA*
823 2018;5. <https://doi.org/10.26706/IJAEFEA.2.5.20180501>.
- 824 [91] Kabeel AE, Abdelgaied M. Performance of novel solar dryer. *Process Saf Environ*
825 *Prot* 2016;102:183–9. <https://doi.org/10.1016/j.psep.2016.03.009>.
- 826 [92] Chopade A, Ranade SM. Performance Analysis of Evacuated Tube Solar Dryer with
827 Desiccant Dehumidifier and PCM as Thermal Storage Material. 2019.
- 828 [93] Padmanaban G, Kumaraswamy P, Mohanraj M. Performance of a desiccant assisted
829 packed bed passive solar dryer for copra processing. *Therm Sci* 2017;21:419–26.
830 <https://doi.org/10.2298/TSCI17S2419P>.
- 831

Worldwide distribution of studies reported in the literature regarding the use of sorption materials in solar dryers as thermal storage (TS) or dehumidifier (DH)

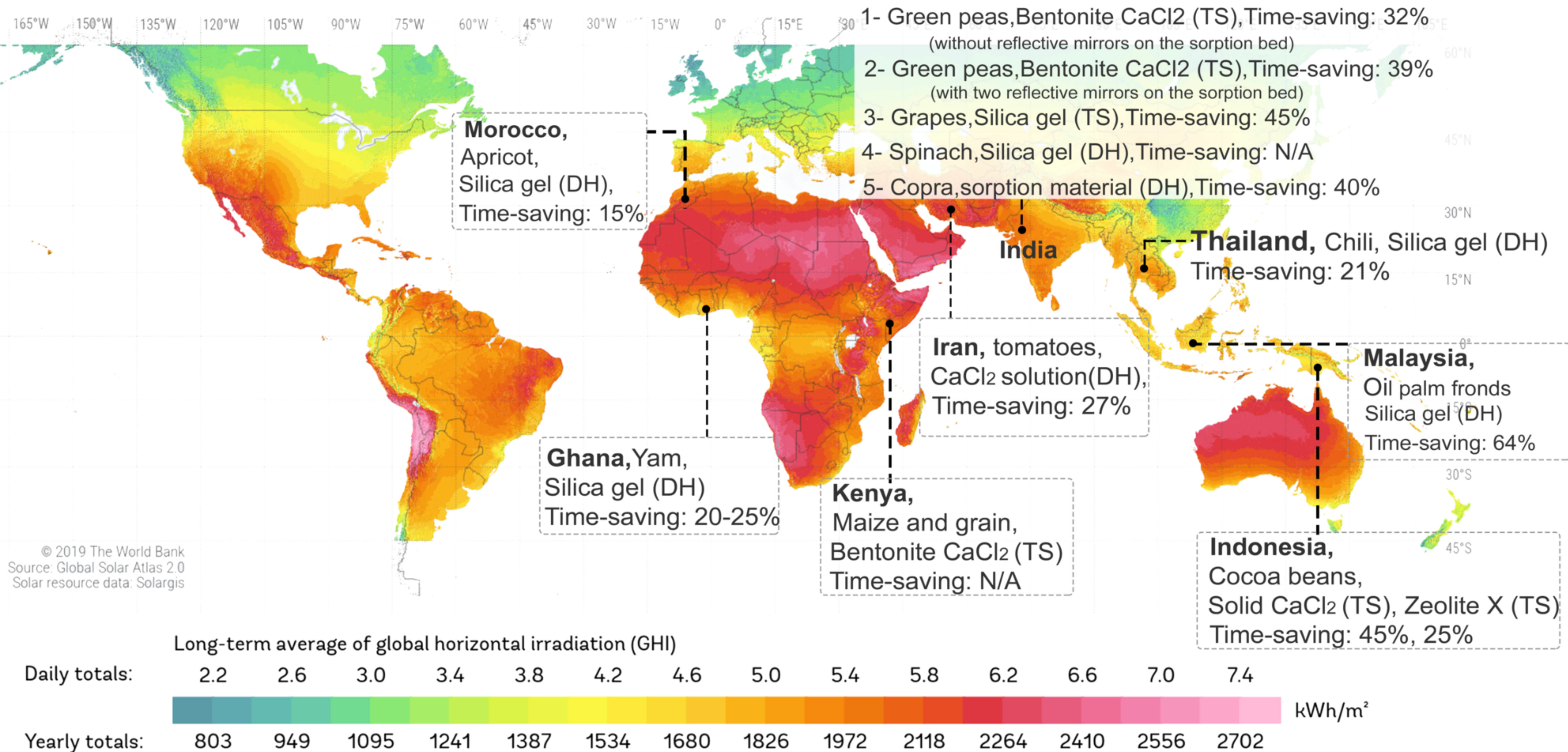

TYPICAL TIME-SAVINGS

- ✓ Thermal storage: **30-45%**
- ✓ Dehumidification: **15-30%**

MATERIALS USED (in order of interest)

Thermal storage:

- (1)- Bentonite-clay mixture,
- (2)- Silica gel,
- (3)- Solid CaCl₂

Dehumidification:

- (1)- Silica gel,
- (2)- CaCl₂ solution

