



HAL
open science

Energy management solution of the future dual-mode electric train

Fawzia Amokrane, Mohammed Ilyas Elbachir, Clement Depature Lançon, Danilo Crispiani, Gilles Petitet, Nada Zouzou, Smail Ziani

► To cite this version:

Fawzia Amokrane, Mohammed Ilyas Elbachir, Clement Depature Lançon, Danilo Crispiani, Gilles Petitet, et al.. Energy management solution of the future dual-mode electric train. IEEE Electrical Systems for Aircraft, Railway, Ship Propulsion and Road Vehicles (ESARS) and International Transportation Electrification Conference, Nov 2024, Naples, Italy. hal-04886305

HAL Id: hal-04886305

<https://hal.science/hal-04886305v1>

Submitted on 14 Jan 2025

HAL is a multi-disciplinary open access archive for the deposit and dissemination of scientific research documents, whether they are published or not. The documents may come from teaching and research institutions in France or abroad, or from public or private research centers.

L'archive ouverte pluridisciplinaire **HAL**, est destinée au dépôt et à la diffusion de documents scientifiques de niveau recherche, publiés ou non, émanant des établissements d'enseignement et de recherche français ou étrangers, des laboratoires publics ou privés.



Distributed under a Creative Commons Attribution - NonCommercial - NoDerivatives 4.0 International License

Energy management solution of the future dual-mode electric train

AMOKRANE Fawzia
IRT
Railenium
Valenciennes, France
fawzia.amokrane@railenium.eu

Elabachir Mohammed Ilyas
IRT
Railenium
Valenciennes, France
mohammed.elbachir@railenium.eu

Depature Lançon Clément
SNCF Direction Technologies,
Innovation et Projets Groupe
Paris, France
clement.depature@sncf.fr

CRISPIANI Danilo
SNCF Direction Technologies,
Innovation et Projets Groupe
Paris, France
danilo.crispiani@sncf.fr

PETITET Gilles
SNCF Direction Technologies,
Innovation et Projets Groupe
Paris, France
gilles.petitet@sncf.fr

ZOUZOU Nada
IRT
Railenium
Valenciennes, France
nada.zouzou@railenium.eu

ZIANI Smail
IRT
Railenium
Valenciennes, France
smail.ziani@railenium.eu

Abstract—As part of the agreements signed by the French government to guarantee the future of the country’s secondary rail network, the regional transport authorities are looking for ways to reduce overall costs (purchase of equipment, operating and maintenance costs, etc.) while maintaining and even developing the transport offer on these lines. In this context, a new project called TELLi has been proposed. TELLi’s ambition is to provide the regions with a solution that reduces the total costs of the railway system over its entire lifecycle. It proposes an innovative solution to replace the diesel rolling stock X73500 and X72500 currently used in this secondary rail network by autonomous electrical trains, which will be powered by catenary and modular energy sources: batteries and fuel cell. Consequently, this dual-mode approach improves flexibility and efficiency in various railway operations, while simultaneously promoting energy efficiency and emission reduction. This paper develops a modelling and an innovative method for energy management to minimize the energy consumption of this novel train within the health conscious of the energy sources. Finally, simulation results of real train mission in French railway network will be presented to test and validate the energy management system.

Index Terms—Dual-mode train, Energy management system, Fuel cell, Battery, Energy.

I. INTRODUCTION

In France, the secondary rail network represents the lines that serve the whole area. These lines are classified as ‘UIC 7 to 9 SV’ by the International Union of Railways, which indicates the lines with the least traffic on the network. They are generally associated with daily commuter lines. They represent railway axes with low traffic but are essential in terms of territorial planning and are currently facing an investment barrier. Restoring these lines to normal operating conditions would require an additional 675 M€ per year. As these lines are regularly called into question, it is urgent to implement solutions that guarantee continuity of mobility services for

citizens in sparsely populated areas. In this context, the French National Railway Company (SNCF) has formed a consortium to bring together the best of the French rail industry around a shared goal: we need to innovate to revitalise these lines. The consortium is made up of 11 partners, including Railenium, with complementary roles. The consortium proposes an innovative project named TELLi.

TELLi proposes an inventive solution to replace the diesel rolling stock X73500 and X72500 currently used in this secondary rail network by autonomous electrical trains, which will be powered by catenary and modular energy sources: batteries and fuel cell. Therefore, this dual mode solution allows for greater flexibility and efficiency in various railway operations while offering energy efficiency and emissions reduction [1].

For the proposed train, a robust method is needed to manage the energy flows of the system while respecting the physical constraints of each source. An innovative energy management system (EMS) is proposed to split the power between the battery and the catenary or between the battery and the fuel cell (FC). Several EMS methods can be implemented in this case, such as optimization-based methods, for example, the Pontryagin minimum principle (PMP) [2] and Equivalent Consumption Minimization Strategy (ECMS) [3], Dynamic Programming [4], Particle Swarm Optimization [5], Genetic Algorithm [6], etc. Rule-based methods, like fuzzy logic [7], deterministic rules based [8], etc. Machine learning based methods, like: reinforcement learning [9], multi-agent system [10], etc. The ECMS method has proven to be highly effective for energy management in the railway systems. By optimizing energy consumption in real-time, ECMS ensures a balanced trade-off between fuel efficiency and performance, making it a reliable approach for reducing overall energy costs while

maintaining operational efficiency. This method has been successfully applied to various rail systems, demonstrating its adaptability and significant potential for improving sustainability in railway operations. In [11], an energy management system based on ECMS is applied to minimize the hydrogen consumption to improve the characteristics of the rolling stock, saving 3.5% hydrogen consumption. In [12], ECMS is used to reduce the total equivalent hydrogen consumption of the system, reduces the volume and weight of the hydrogen storage device, and improve the economy. In [13], the authors implemented an algorithm to optimize the standard equivalent consumption minimization strategy (ECMS) for an FC-B-SC tram. An analysis is conducted and the strategy designed is compared with other algorithms, based on operative mode control, achieving operating cost and fuel consumption saving (more than 13.81% and 20.75%) and FC efficiency improvements (more than 0.5%).

Fuel Cells are well-known candidates for the second energy sources in dual-mode train, but they are subject to some degradations. The main operating modes leading to degradation and premature failure in automotive applications have been detailed in [14] and [15]. Degradation caused by load changes (56.5%) and start/stop of the FC (33%) account for more than 89% of the overall degradation, while the degradations caused by high power (5.8%) and idling operation (4.7%) are minor.

Batteries are characterized by many parameters: power density, energy density and life cycle. The common definition of end of life of the battery is based on losing 20% of its nominal capacity. The life of a battery depends on many parameters. Temperature, the number of life cycles and the state of charge (SOC) are the most important factors to consider when determining the battery life [16]. Thus, it is important to limit the start/stop cycles of the FC, the depth of discharge of the battery, and the current of the battery when designing the EMS. This paper develops an innovative method for energy management to minimize the energy consumption of this novel train, avoiding operating zones that accelerate the ageing of the fuel cell and battery. Following the introduction of the power-train model, an energy management system is developed to split the power between the battery, fuel cell and catenary within the health conscious of the fuel cell and the batteries.

The rest of this paper is organized as follows: section II details the proposed train versions and its modelling. Section III introduces the energy management strategy that is used. Section IV represents the simulation results followed by conclusion in section V.

II. PROPOSED TRAIN IN TELLI PROJECT

The proposed train in TELLI is characterized by its mass of about 48t, and its maximum speed of 120 km/h. In the electrified zones, this innovative train can be powered by either a 1.5 kV DC overhead line or a 25 kV AC line. This dual-power configuration allows to obtain two versions of TELLI: the Battery Electrical Multiple Units (BEMU) 1.5 kV DC and 25kV AC. This power can be used directly for the train

traction and to recharge its batteries. In non-electrified zones, it is equipped with the lithium batteries that power the train. For greater autonomy on non-electrified rail lines, a hybrid solution has been proposed, it is named hydrogen (H2) version, it consists of coupling the batteries with a fuel cell (FC), see figure1. The Hybrid hydrogen traction provides greater autonomy than the previous version, without emitting any local carbon emissions or pollutants.

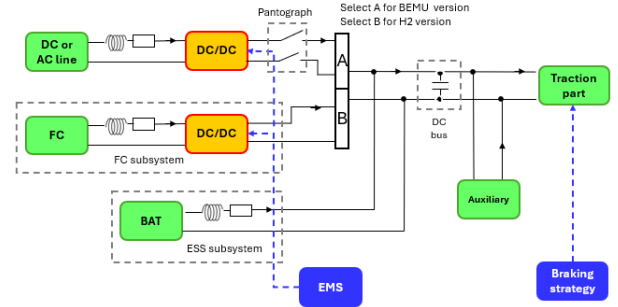

Fig. 1. Architecture of the proposed train in TELLI

A. Energetic Representation Macroscopy (EMR)

EMR is a graphical description tool that organizes the system into interconnected basic elements (see Figure 2). Source element (green oval), accumulation element (orange crossed rectangle), monophysical (orange square) or multiphysical conversion (orange circle), and distribution element (double orange square). This organization is based on the physical interactions (action/reaction principles) and causality between each component, which can illustrate the power exchanged within the system [17]. Additionally, a control scheme is defined from the EMR of the system using inversion rules, with all control pictograms are presented by blue parallelograms.

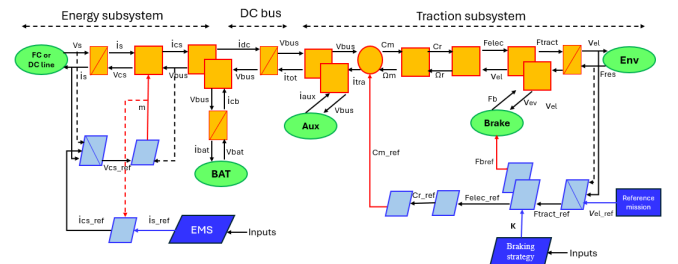

Fig. 2. EMR and inversion-based control of BEMU and H2 versions

B. Modelling

The fuel cell system includes a FC stack and auxiliary components, such as: hydrogen recirculation pump, cooling pumps, air compressor and humidifiers. A complete FC dynamic model will consider thermal, fluid, electrochemical and electrical models. In this paper, the FC is modeled as a current-controlled voltage source. A polarization curve is considered like in previous works [18]. The model used for the battery is

a linear simple model, more detailed information are available in [19]. The battery voltage V_{bat} is given by:

$$V_{bat} = V_{oc}(SoC) - R_{int}(SoC) \times I_{bat} \quad (1)$$

where I_{bat} is the battery current. V_{oc} the battery open circuit voltage and internal resistance R_{int} depend on the battery state of charge (SoC). The battery SOC is calculated using :

$$SOC(t) = Q_{bat}(t)/Q_{nom} \quad (2)$$

where Q_{bat} and Q_{nom} are respectively the battery capacity at time t and the battery nominal capacity.

The environment is considered as source of resistive forces includes the gravity force F_{gra} and resistance forces F_{RA} , it is given by:

$$F_{res} = F_{RA} + F_{gra} = A + B \times V_{el} + C \times V_{el}^2 + M_s \times g \times i \quad (3)$$

Where A , B , C are the coefficient of the resistive forces, g is gravity, M_s is the static mass, i is the slope. The energy variables, including source (DC line or FC) currents, DC bus voltage, and train velocity, are imposed by accumulation elements, represented by orange crossed rectangles.

$$V_s - V_{sc} = L_i \frac{di_s}{dt} + R_i di_s \quad (4)$$

$$F_{tract} - F_{res} = M_d a = M_d \frac{dV_{el}}{dt} \quad (5)$$

$$I_{tot} - I_{dc} = C_{bus} \frac{dV_{bus}}{dt} \quad (6)$$

where M_d is the dynamical mass, C_{bus} represents the capacity of DC bus and L_i inductance of the filter source. V_s is the voltage source, V_{sc} is the voltage of the converter, V_{bus} is the voltage bus, F_{tract} is the total force of traction, F_{res} is the resistive force, I_{tot} is the load current and I_{dc} is the DC bus current.

The monophysical conversion units (orange squares), represents the DC/DC which alter both current and voltage in accordance with the modulation ratio m . Additionally, the gear box and the wheel are represented by the same bloc.

$$\begin{aligned} V_{cs} &= V_{bus} \times m \\ I_{cs} &= i_s \times m \end{aligned} \quad (7)$$

where V_{cs} , I_{cs} , V_{bus} , and i_s represent respectively the DC/DC converter voltage of the source, its current, DC bus voltage and the current source.

The inverter and machine are considered as multiphysical conversion that converts the electrical variables to mechanical variables.

$$i_{tract} = \frac{C_{m_ref} \times \omega_m}{\eta^k \times V_{bus}} \quad (8)$$

where i_{tract} is the traction current, C_{m_ref} is the total torque reference, ω_m rotational speed, η^k is the motor efficiency, k is a coefficient ($k = -1$ i.e. traction, $k = 1$ i.e. braking).

C. Control

The control scheme represented by the lower blue part in figure 2, it is deduced from the EMR using inversion-based rules [17]. Assumed that all variables can be measured.

The inversion of the filter is used to calculate the converter voltage reference given by 9.

$$V_{cs_ref} = -C_i(t)(i_{s_ref} - i_s) + V_s \quad (9)$$

where $C_i(t)$ is a PI controller. The parameters of the PI controller are calculated using the pole placement method.

The modulation ratio m is then calculated using the following equation :

$$m = \frac{V_{cs_ref}}{V_{bus}} \quad (10)$$

To ensure the desired train velocity, the tuning variable F_{tract_ref} is linked to the variable to be controlled. From F_{res} , the measured train velocity V_{el} and the desired train velocity V_{el_ref} , the reference traction force F_{tract_ref} is calculating by:

$$F_{tract_ref} = C_v(t) \times (V_{el_ref} - V_{el}) + F_{res} \quad (11)$$

where C_v is a PI controller. Its parameters are calculated using the pole placement method. In addition, a limits of traction force is respected in order to limit the current demand that can degrade the ESS or the traction system. This control saturation is finally taken into account by the velocity regulator using an anti-windup control loop.

The torque reference of the machine is determined by a direct inversion of the wheel and the gearbox.

III. ENERGY MANAGEMENT SYSTEM DESIGN

Depending on the reference mission profile of the train, the traction subsystem presented by the green block named "env" in figure 2 will impose a current i_{tot} on the DC bus. This current is the sum of the auxiliaries current and the traction current (obtained according to the mechanical braking strategy, the vehicle characteristics and the corresponding control). The DC bus current will be managed by the energy management system presented by the dark blue block in figure 2. The energy performance of the train will then depend on the developed energy management strategy.

In this paper, the DC bus current will be optimally distributed among the following energy sources in the best way to minimize the hydrogen consumption within the health conscious of the fell cell and the energy storage system by avoiding operating zones that accelerate their ageing. An Equivalent Consumption Minimization Strategy (ECMS) is used to achieve these objectives.

A. Health conscious ECMS

ECMS is an optimal control based energy management method. It is widely used in the field mobility for the energy management for dual mode trains and vehicles [20]. It is developed from the Pontryagin Minimum Principle to find the optimal solution for continuous or discontinuous control

systems. Specifically, ECMS can determine the optimal control inputs that satisfy the minimum cost function given a set of boundary conditions, with the goal of minimizing the Hamiltonian. A controlled system can be expressed as follows:

$$\dot{x} = f(x, u, t) \quad (12)$$

where x represents the state variables and u represents the control inputs. In addition, the cost function of the controlled system is:

$$J(t) = \int_0^{t_f} C(x(t), u(t), t) dt \quad (13)$$

where $C(x(t), u(t), t)$ is the instantaneous cost. In this paper, this cost function refers to the electricity consumption for the BEMU version and the hydrogen consumption for the H2 version. To minimize this cost function of the controlled system, the corresponding Hamilton equation can be written as follows:

$$H(x(t), u(t), k(t), t) = C(x(t), u(t), t) + k^T(t) f(x, u, t) \quad (14)$$

where $k(t)$ is the co-state variable. In this paper, its initial value is determined offline using the Pontryagin Minimum Principle with iterative calculations. During operation, it is subsequently adjusted online using a PID control mechanism.

Under certain constraints, the optimal solution can be found by minimizing the Hamiltonian function within a finite set, which can be expressed as follows:

$$u^*(t) = \arg \min_u [H(x(t), u(t), k(t), t)] \quad (15)$$

where $u^*(t)$ is the optimal control action obtained by ECMS. For both versions of the train, the control problem is subject to the following constraints:

$$\begin{aligned} P_{load}(t) &= P_{es}(t) + P_{bat}(t) \\ \dot{x} &= -\frac{P_{bat}(x(t), u(t))}{Q_{bat} V_{bat}(x(t))} \\ SOC_{min} &\leq x \leq SOC_{max} \\ P_{bat\ min} &\leq x \leq P_{bat\ max} \\ U_{min} &\leq u \leq U_{max} \end{aligned} \quad (16)$$

where $P_{load}(t)$, $P_{bat}(t)$ and $P_{es}(t)$ represent respectively the load power, the battery power and the energy source power. It represents the DC line power in the BEMU 1.5 kV DC version and the FC power in the H2 version.

As discussed in the introduction, it is important to design a health conscious EMS by avoiding operational conditions that accelerate aging. This EMS should be capable of dealing with the following requirements:

- Minimizing the energy consumption,
- Maintaining the battery SOC inside the boundary values,
- Minimizing the number of FC start/stop,
- Maintaining the battery power inside the boundary values,
- Maintaining the FC power inside the boundary values,
- Maintaining the battery current inside the boundary values

IV. SIMULATION RESULTS

In this section, the train model and the energy management system are simulated using one specified mission of 135 km from origin to destination which is adapted to the train equipped by the batteries and the fuel cell. The aims of this simulation is to compare the hydrogen consumption between two energy management strategies for this specified mission.

The train parameters and the constraint values are listed in Table I.

TABLE I
PARAMETERS

Parameter	Hydrogen version
P_{aux}	35 kW
M_s	33717 kg
M_d	35317 kg
Maximal speed	120 km/h
DC bus capacity	40 mF
Catenary voltage	/
Batteries energy	295 kWh
SOC max	80%
SOC min	15%
Pfc max	100 kW

The ECMS is designed to minimise the hydrogen consumption. The first part in the Hamiltonian in equation (14) is presented by the H2 consumption W_{H2} calculated by:

$$W_{H2}(P_{fc}) = \frac{P_{fc}}{\eta_{fc}(P_{fc}) \times LHV_{H2}} \quad (17)$$

where P_{fc} , LHV_{H2} and η_{fc} represent respectively the fuel cell power, the hydrogen lower heating value (120 MJ/kg or 33.3 kWh/kg) and fuel cell system efficiency in figure 3.

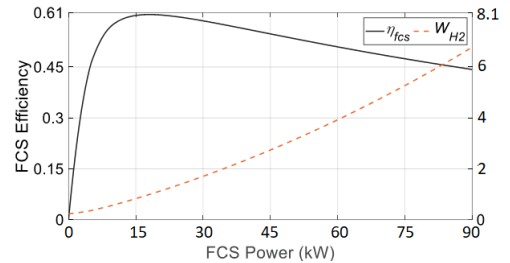

Fig. 3. Fuel cell system efficiency and fuel consumption

The second part of this Hamiltonian represents the equivalent consumption of the battery.

To illustrate the effectiveness of ECMS-based energy management, it was compared with a rule-based energy management method. These rules are:

- Fuel cell works with its maximum power when $SOC < 40\%$ or when the train is stop,
- Fuel cell works with the power corresponding to its maximum efficiency in the other cases.

Both energy management strategies were tested on the same mission under identical conditions: the initial SOC was set at

80%, and the final SOC was kept the same 38%. The results of these two energy management strategies are shown in the figures 4, 5, 6 and 7.

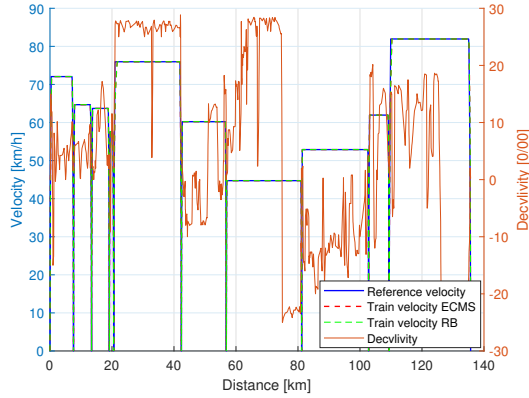

Fig. 4. Evolution of train velocity and decivity

Figure 4 illustrates the evolution of the train’s reference velocity and its actual velocity relative to distance, as well as the decivity with respect to distance. In both cases of EMS, we observe that the train’s velocity follows the reference velocity.

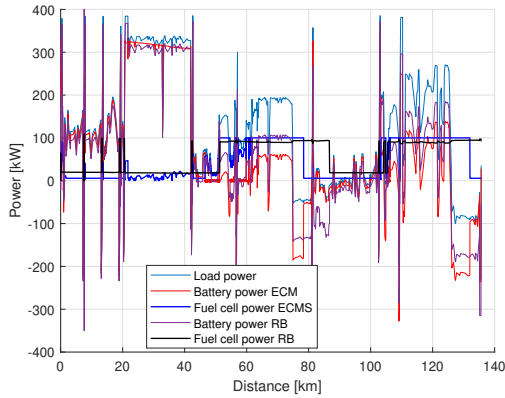

Fig. 5. Evolution of powers

Figure 5 illustrates the evolution of the battery power, load power and the fuel cell power with respect to distance.

Figure 6 illustrates the evolution of the energies: traction energy, auxiliaries energy, battery energy and fuel cell energy for the two energy management methods. We notice that the energies of the battery at the end of the mission are the same in both cases to ensure a meaningful comparison. We notice that in the case of ECMS, to minimize H2 consumption, the battery is used much more in the begining of the mission compared to the cased of rule based. On the other hand, the opposite is true for the fuel cell. In this specific use case, we can summarize that utilizing the same amount of battery energy in different ways can significantly reduce overall hydrogen consumption.

Figure 7 depicts the evolution of the battery state of charge and hydrogen consumption for the two energy management tests. The SoCs at the end of the mission are the same in both cases to ensure a meaningful comparison. We observe

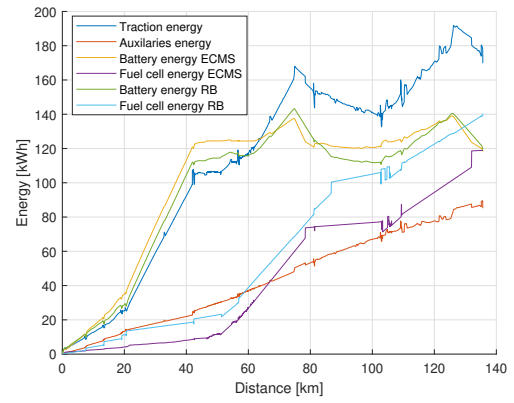

Fig. 6. Evolution of energies

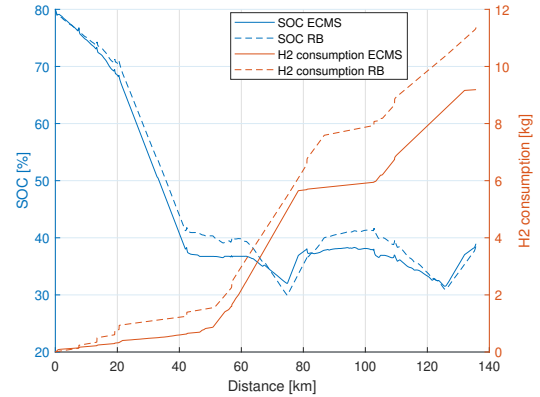

Fig. 7. Evolution of SOC and H2 consumption

that for identical initial and final state of charge values, the hydrogen consumption at the end of the mission is lower in the case of ECMS. Table II represents the hydrogen consumption (CH2) for 100 km in the case of the two energy management strategies.

TABLE II
H2 CONSUMPTION

CH2 ECMS [kg/100 km]	CH2 RB [kg/100 km]	Gain [%]
6.77	8.38	19.21

The implementation of ECMS has resulted in a significant reduction in hydrogen consumption. By optimizing the energy usage and distribution, ECMS has demonstrated a remarkable efficiency improvement over RB EMS which a reduction of 19.21% of the hydrogen consumption. This gain in hydrogen efficiency not only reduces operational costs but also enhances the overall sustainability of the train energy system. Such improvements highlight the critical role of energy management in achieving more efficient and eco-friendly transportation solutions. The reduction in hydrogen consumption directly translates to extended operational range and reduced environmental impact, making energy management an essential aspect of modern train design and performance optimization.

However, this hydrogen consumption gain value is specific to this case study, where the battery is not completely discharged and the two sources are sufficient to cover the entire journey. In future studies, it would be judicious to carry out a study of the autonomy that this train can cover over several destination origins, without any battery recharging stations, in order to be able to quantify this gain in hydrogen consumption in a more general way for this new train.

V. CONCLUSION

This paper proposed a modelling and energy management system for new train proposed within the framework of the TELLi project. TELLi proposes an inventive solution to replace the diesel rolling stock X73500 and X72500 currently used in this secondary rail network by autonomous electrical trains, which are powered by catenary and modular energy sources: batteries and fuel cell. In fact, the choice of dual-mode was motivated by the need to make the most of the existing infrastructure: no new facilities are needed to recharge the batteries of the BEMU version, which will have a range of 200km. The H2 version will be used on lines where the BEMU version does not have enough autonomy.

The first part of this paper detailed the modelling of dual-mode BEMU 1.5 kV DC and hydrogen versions using EMR. This method allows various elements of the drive train to be represented according to the action/reaction and causality principles. Such representation facilitates the control structure employing direct and indirect inversion techniques. The second part of this paper elaborates on a health-conscious energy management strategy aimed at minimizing hydrogen consumption while considering the health impact of energy sources. This energy management strategy is the equivalent consumption minimization strategy. The efficiency of this method is illustrated with its comparison with a rule based energy management strategy through simulation results.

In future work, we plan to analyze both the autonomy and the SOC conditions at the end of the mission, along with a more comprehensive use case involving longer missions over greater distances. This will allow for higher H2 consumption and enable a more thorough evaluation of the two optimization approaches. In addition to this, for the final version (BEMU) of the train, in the future, we plan to conduct simulations in order to minimize the energy bill.

ACKNOWLEDGMENT

This work received funding from ADEME, specifically for the TELLi project.

REFERENCES

- [1] C. Depature Lançon, M. Renault, D. Crispiani, I. Abdallah, M. Juston, C. Foncin, G. Petitot, S. Ziani, "Hydrogen and Battery Trains, Which Technologies for Future Light Trains?", Transport Research Arena, Dublin, 2024
- [2] P. Hujun, L. Feifei, C. Zhu, D. Kai, J. Sebina, H. Kay, "Adaptive Pontryagin's Minimum Principle-Inspired Supervised- Learning-based Energy Management for Hybrid Trains Powered by Fuel Cells and Batteries", 2022.

- [3] R. Chang, Y. Liu, Y. Cao, J. Liu, "An Optimal Energy Management Strategy for a Hybrid Train". In: Sun, H., Pei, W., Dong, Y., Yu, H., You, S. (eds) Proceedings of the 10th Hydrogen Technology Convention, Volume 1. WHTC 2023.
- [4] S. Tao, W. Chen, R. Gan, L. Li, G. Zhang, Y. Han, Q. Li, "Energy management strategy based on dynamic programming with durability extension for fuel cell hybrid tramway", Rail. Eng. Science, 2021.
- [5] U. Sarma, S. Ganguly, "Determination of the component sizing for the PEM fuel cell-battery hybrid energy system for locomotive application using particle swarm optimization", Journal of Energy Storage, Volume 19, 2018.
- [6] V. I. Herrera, H. Gaztañaga, A. Milo, A. Saez-de-Ibarra, I. Etxeberria-Otadui and T. Nieva, "Optimal Energy Management and Sizing of a Battery–Supercapacitor-Based Light Rail Vehicle With a Multiobjective Approach.", IEEE Trans. on Industry Applications, vol. 52, no. 4, pp. 3367-3377, 2016.
- [7] A. Mirabadi, M. Najafi, "Energy management system in hybrid trains using fuzzy control: A comparative study", Proc. of the Institution of Mechanical Engineers, Part F: Journal of Rail and Rapid Transit, 2011.
- [8] W. Shabbir and S.A. Evangelou, "Exclusive operation strategy for the supervisory control of series hybrid electric vehicles," IEEE Trans. Control Syst. Technol., vol. 24, no. 6, pp. 2190–2198, 2016.
- [9] K. Deng, Y. Liu, D. Hai, H. Peng, L. Löwenstein, S. Pischinger, K. Hameyer, "Deep reinforcement learning based energy management strategy of fuel cell hybrid railway vehicles considering fuel cell aging", Energy Conversion and Management, Volume 251, 2022.
- [10] B. Soukaina, O. Mohammed, M. Mohamed, "Multi agent system in a distributed energy management of a multi sources system with a hybrid storage". 1-6, 2015.
- [11] Zhang, W.; Jianqiu, L.; Liangfei, X.; Minggao, O. "Optimization for a fuel cell/battery/capacity tram with equivalent consumption minimization strategy". Energy Conversion and Management, 2017, V134, 59-69.
- [12] Shang, W, Yu, Shuang, Z, Guorui, Li, Chen, W, "Fuel cell hybrid locomotive system based on equivalent consumption minimization strategy". 2457-2461, CAC, 2017.
- [13] Zhang, H.; Yang, J.; Zhang, J.; Song, P.; Xu, X. "A Firefly Algorithm Optimization-Based Equivalent Consumption Minimization Strategy for Fuel Cell Hybrid Light Rail Vehicle". Energies 2019, 12, 2665.
- [14] Jiale, L, Tao, C, Fei, X and Yulin, P, 'Remaining useful life prediction of PEMFC based on CNN-Birnn model'. International Journal of Green Energy, pages 1-12, 2023.
- [15] Chen, H, Pei, P, Song, M, 'Lifetime prediction and the economic lifetime of Proton Exchange Membrane fuel cells'. Applied Energy, 2015.
- [16] Marchegiani, E, Ferracuti, F, Monteriu, A, Jin, L, Rossi, M, Comodi, G and Ciabattini, L, 'Li-ion battery aging model robustness: An analysis using univariate and multivariate techniques', Journal of Energy Storage, 72, 2023.
- [17] A. Bouscayrol, J.-P. Hautier, B Lemaire-Semail, "Graphic Formalisms for the Control of Multi-Physical Energetic Systems: COG and EMR", Systemic Design Methodologies for Electrical Energy Systems, 2019
- [18] J. Solano; D. Jimenez, A. Ilinca, "A Modular Simulation Testbed for Energy Man-agement in AC/DC Microgrids", Energies, 2020.
- [19] S. Gaizka, M. José, Z. Inmaculada, A. Francisco, O. Oier, "Analysis of the Current Electric Battery Models for Electric Vehicle Simulation", Energies. 12. 2750, 2019.
- [20] Hongwen, H, Yiwen, S, Jian, S, 'An improved A-ECMS energy management for plug-in hybrid electric vehicles considering transient characteristics of engine', Energy Reports, Volume 10, Pages 2006-2016, 2023.