



HAL
open science

Analysis of GaN-HEMT switching current overshoot in a half-bridge circuit

Ke Li, Cyril Buttay, Angel Pena Quintal, Paul Evans

► **To cite this version:**

Ke Li, Cyril Buttay, Angel Pena Quintal, Paul Evans. Analysis of GaN-HEMT switching current overshoot in a half-bridge circuit. 2024 IEEE 9th Southern Power Electronics Conference (SPEC), IEEE, Dec 2024, Brisbane, Australia. hal-04885644

HAL Id: hal-04885644

<https://hal.science/hal-04885644v1>

Submitted on 14 Jan 2025

HAL is a multi-disciplinary open access archive for the deposit and dissemination of scientific research documents, whether they are published or not. The documents may come from teaching and research institutions in France or abroad, or from public or private research centers.

L'archive ouverte pluridisciplinaire **HAL**, est destinée au dépôt et à la diffusion de documents scientifiques de niveau recherche, publiés ou non, émanant des établissements d'enseignement et de recherche français ou étrangers, des laboratoires publics ou privés.

Analysis of GaN-HEMT switching current overshoot in a half-bridge circuit

1st Ke Li

PEMC Research Institute
University of Nottingham
Nottingham, UK

ke.li2@nottingham.ac.uk

2nd Cyril Buttay

Ampere Laboratory
INSA Lyon
Lyon, France

cyril.buttay@insa-lyon.fr

3rd Angel Pena Quintal

PEMC Research Institute
University of Nottingham
Nottingham, UK

angel.penaquintal2@nottingham.ac.uk

4th Paul Evans

PEMC Research Institute
University of Nottingham
Nottingham, UK

paul.evans@nottingham.ac.uk

Abstract—Crosstalk is an issue in wide bandgap power electronics circuit design due to fast switching. The outcomes such as instability and additional power losses have been well studied and analysed in literature. However, the bridge-leg shoot-through due to crosstalk, especially the switching current overshoot of GaN-HEMT has been little studied. Therefore, in this paper, the origin of the switching current overshoot of a GaN-HEMT half-bridge circuit due to both switching speed and circuit shoot-through are analysed. The influence of the parameters such as turn-ON gate resistance, turn-OFF gate resistance, device threshold voltage and circuit parasitic inductance on switching current overshoot are analysed and verified by simulation. Experimental measurement further confirms the simulation results of the influence of turn-OFF gate resistance on switching current overshoot. It is shown that in order to mitigate the shoot-through issue and reduce the switching losses, an optimised L_S is needed rather than a small value.

Index Terms—GaN-HEMT, switching, half-bridge, simulation, parasitic inductance.

I. INTRODUCTION

With low power losses and high switching frequency, gallium nitride (GaN) high electron mobility transistors (HEMTs) have received increased research interest for their applications in power electronics converters to achieve high efficiency and power density [1], [2].

However, voltage and current switching transients ($\frac{dv}{dt}$ and $\frac{di}{dt}$) of GaN are fast. As a result, there are several issues such as switching voltage and current overshoot and sustained oscillation, that are usually challenging power electronics engineers when designing GaN power electronics converters.

Voltage overshoots are the most obvious consequence of these fast switching transients, and a large corpus of research has addressed their origin and mitigation solutions [3]. By contrast, there is little research reported to investigate the switching current overshoot. Unlike switching voltage overshoot, a high switching current spike may not break down power semiconductor devices immediately, but it will still impact devices power losses [4] and long-term reliability due to current stress [5].

Sustained oscillation, which leads to bridge-leg crosstalk and shoot-through, is another challenge to prevent the wide

adoption of wide bandgap power semiconductor devices. Power electronics circuits instability and additional losses due to bridge-leg crosstalk has been studied and analysed in [6]–[8]. To detect and model crosstalk issue, gate voltage is usually analysed and its amplitude and oscillation are used as an indicator to detect shoot-through [9], [10]. Thus, several approaches have been found in literature to tackle the challenge. For example, Zhou et al. proposed a circuit design to reduce the mutual coupling effect between gate and power loops, which helps to alleviate the crosstalk [11]. Zhang et al. proposed an intelligent gate driver to actively control gate voltage and gate loop impedance to suppress crosstalk [12].

In this paper, other than sustained oscillation, it is found that bridge-leg crosstalk and shoot-through also contributes to GaN power converter switching current overshoot, which is less studied in literature. Furthermore, the existing methods to analyse crosstalk from the above literature mainly focus on circuit parasitic inductance [6] or device non-linear junction capacitance [10]. As GaN power transistors suffer from threshold voltage V_{th} instability issue due to current collapse [13], V_{th} instability will also contribute to bridge-leg crosstalk during device switching. Therefore, the paper will analyse the relation between switching current overshoot and V_{th} instability, which offers a more comprehensive understanding of the phenomenon than existing literature.

The paper is organized as follows: Section II analyses the switching transients of GaN-HEMT in a half-bridge layout. Afterwards, Section III validates the theoretical analysis by circuit simulation. Following that, Section IV presents the experimental measurements to verify the simulation. Finally, the paper will be concluded.

II. CURRENT OVERSHOOT ANALYSIS

A. Due to switching speed

Fig. 1(a) shows a typical GaN-HEMT half-bridge circuit, which is mainly formed by two GaN-HEMTs (T_1 and T_2) and their gate driver circuits. Different external gate resistors ($R_{G,on}$ and $R_{G,off}$) are used to control turn-ON and turn-OFF switching speed separately. An inductive load is connected in parallel with the high-side transistor T_1 . Parasitic inductances L_D , L_{G1} , L_{G2} , L_{S1} and L_{S2} represent the lumped values of the power loop, high-side gate driver loop, low-side gate

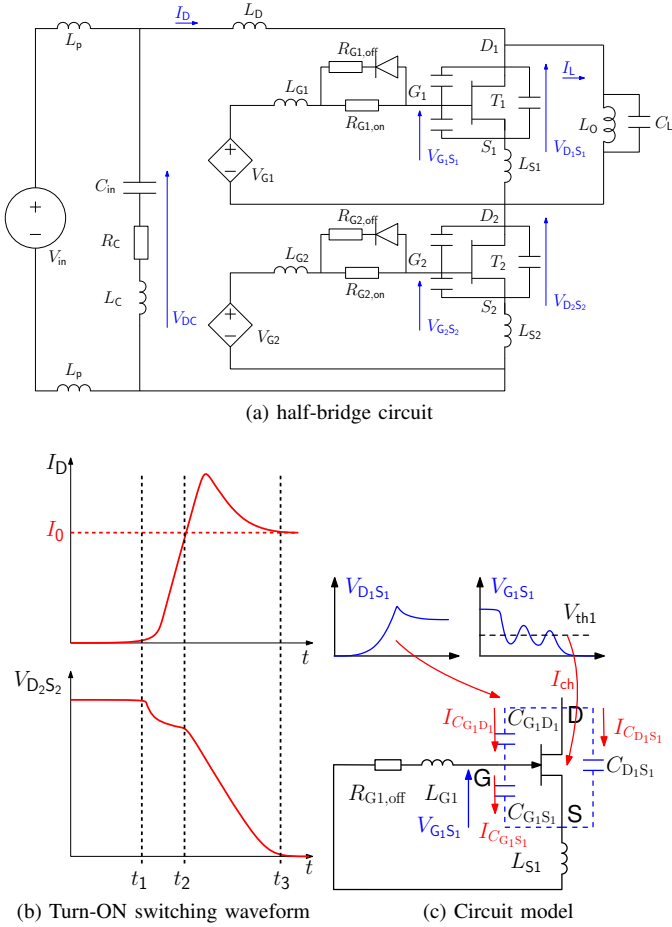

Fig. 1: GaN-HEMT half-bridge circuit and T_2 turn-ON switching waveform

driver loop and the common source inductance between power loop and two gate driver loops respectively. I_D and $V_{D_2S_2}$ turn-ON switching waveforms of the transistor T_2 are shown in Fig. 1(b), where I_D rises first to reach the load current value I_0 between t_1 - t_2 and then $V_{D_2S_2}$ falls from t_2 - t_3 . During the falling stage of $V_{D_2S_2}$, an overshoot of I_D is presented. As GaN-HEMTs have no body-diode, there is no reverse recovery charge [14], therefore the existing research knowledge point that current overshoot is mainly due to the C_{oss} charging current of the high-side transistor T_1 and the parasitic capacitance C_L of the load. Their contribution to the current overshoot can be described by:

$$I_D - I_0 = (C_{oss} + C_L) \frac{dV_{D_2S_2}}{dt} \quad (1)$$

Eq. 1 reveals that the current overshoot will be determined primarily by turn-ON switching speed $\frac{dV_{D_2S_2}}{dt}$, which is further influenced by the external gate resistor $R_{G2,on}$. Circuit parasitic inductance such as L_D and L_{S_2} will also play a role on turn-ON switching speed, and there are already a number of publications from the literature to quantify their influence [9], [15], so the analysis will not be repeated here.

B. Due to shoot-through

Fig. 1(c) illustrates the circuit model of T_1 switching transients when T_2 is switching ON. During the falling of $V_{D_2S_2}$, $V_{D_1S_1}$ is rising ($V_{D_1S_1} \approx V_{DC} - V_{D_2S_2}$). Therefore, the charging current of capacitor $C_{G_1D_1}$ may flow to $C_{G_1S_1}$, increasing $V_{G_1S_1}$ which may exceed the threshold voltage V_{th1} of T_1 , and therefore cause a shoot-through of the half-bridge circuit during the switching. Although half-bridge shoot-through (crosstalk) has been extensively studied in literature [6]–[10], the reported results are mainly focused to understand the root cause of circuit instability. Indeed, Videt et al. revealed a gate source boundary voltage V_{GS}^{lim} during T_1 switching [13]. When $V_{G_1S_1}$ surpasses V_{GS}^{lim} during switching, sustained oscillation happens which causes instability issue. It should be noted that V_{GS}^{lim} is not simply the value of V_{th1} , and we need to combine the circuit impedance and transistor non-linear capacitances to determine its value. When $V_{G_1S_1}$ is smaller than V_{GS}^{lim} during switching, the oscillation dampens, but $V_{G_1S_1}$ may still surpass V_{th1} , and therefore causes a shoot-through of the half-bridge circuit. The shoot-through will no doubt impact on the switching current overshoot, which is not well reported in literature, but will be extensively studied in the paper.

Following equations (2)-(5) are applied to analyse the increase of $V_{G_1S_1}$ during T_2 turn-ON switching.

$$I_{C_{G_1D_1}} = C_{G_1D_1} \frac{dV_{D_1S_1}}{dt} \quad (2)$$

$$I_{C_{D_1S_1}} = C_{D_1S_1} \frac{dV_{D_1S_1}}{dt} \quad (3)$$

$$I_{C_{G_1S_1}} = C_{G_1S_1} \frac{dV_{G_1S_1}}{dt} \quad (4)$$

$$V_{G_1S_1} + L_{S_1} \frac{dI_{C_{D_1S_1}} + dI_{C_{G_1S_1}}}{dt} = L_{G_1} \frac{dI_{C_{G_1D_1}} - dI_{C_{G_1S_1}}}{dt} + R_{G1,off}(I_{C_{G_1D_1}} - I_{C_{G_1S_1}}) \quad (5)$$

By combining the above equations together and applying the condition that $I_{C_{D_1S_1}} \gg I_{C_{G_1S_1}}$, eq.(5) can be further transferred into eq.(6) using Laplace transform:

$$V_{G_1S_1} = I_{C_{G_1D_1}} \frac{R_{G1,off} + S \left(L_{G_1} - L_{S_1} \frac{C_{D_1S_1}}{C_{G_1D_1}} \right)}{1 + SR_{G1,off}C_{G_1S_1} + S^2L_{G_1}C_{G_1S_1}} \quad (6)$$

It implies that gate driver circuit impedance ($R_{G1,off}$, L_{G_1} and L_{S_1}) can all influence on $V_{G_1S_1}$. Furthermore, as GaN-HEMT has threshold voltage instability issue due to trapped charge [16], V_{th1} will also impact on circuit shoot-through together with the gate driver circuit impedance.

To summarise, the switching current overshoot of the GaN-HEMT is due to both the device switching speed and the shoot-through of the half-bridge circuit. Therefore, the influence of all of the above discussed parameters ($R_{G2,on}$, $R_{G1,off}$, V_{th1} , L_{S_1} and L_{G_1}) on switching current overshoot will be comprehensively studied and verified by simulation in the next section.

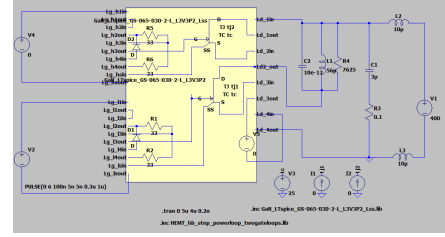
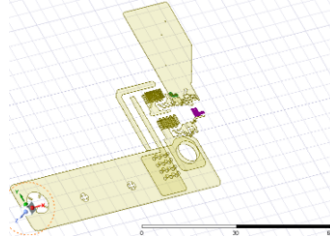
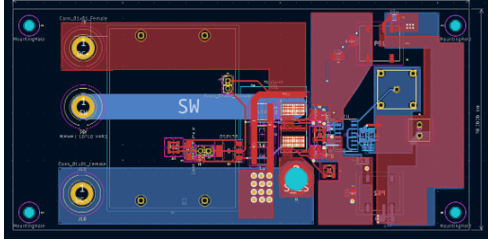
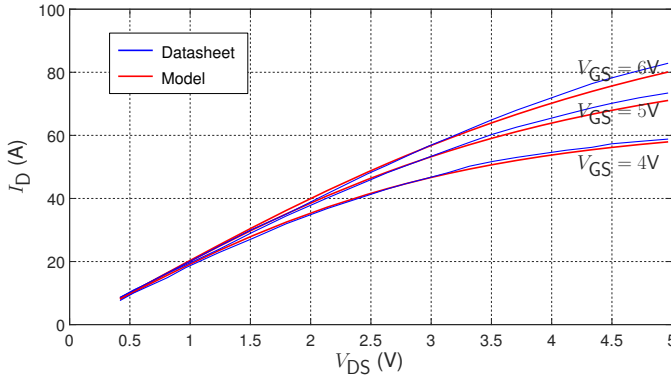
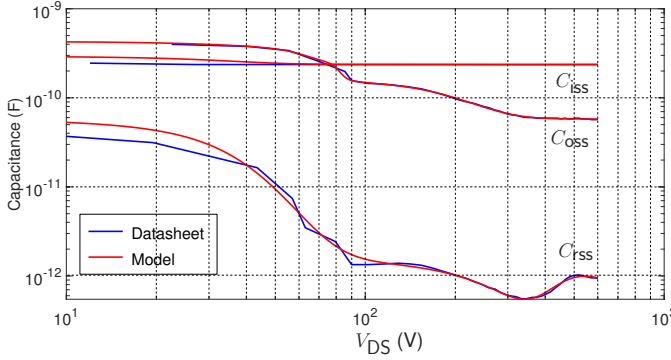

Fig. 2: Different steps to simulate GaN-HEMT switching transients of a half-bridge circuit



(a) Output characteristics



(b) Inter-electrode capacitance

Fig. 3: Comparison between the model and datasheet value for GaN-HEMT (GS-065-030-2-L)

III. SIMULATION VERIFICATION

A. GaN-HEMT transistor and circuit model

A GaN-HEMT (GS-065-030-2-L, 650V/30A) compact model based on behavioural equations [17] was built in LTSpice to verify the variation of each parameter on switching current overshoot. The comparison between the model and datasheet values are shown in Fig. 3, where the output characteristics, and inter-electrode capacitance are all modelled accurately.

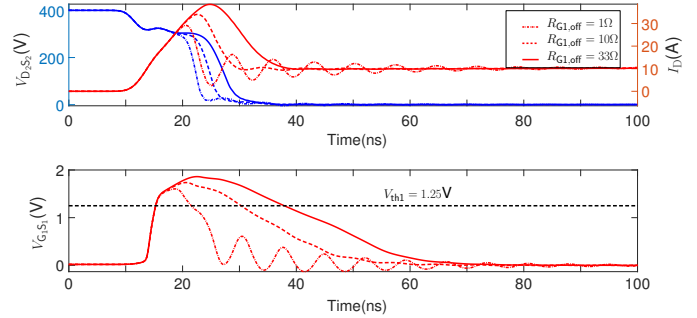

Fig. 4: Investigation of $R_{G1,off}$ on switching current overshoot in simulation

A half-bridge circuit was also built and different steps to simulate GaN-HEMT switching waveforms are illustrated in Fig. 2. First, the PCB was imported into Ansys Q3D, which generated an equivalent circuit. Then, by using the proposed GaN-HEMT compact model, device switching transients can be obtained in LTSpice. The circuit lumped parasitic inductance values (including both self and mutual inductance) are: $L_D=18.9$ nH, $L_{G1}=6.4$ nH, $L_{G2}=7.5$ nH, $L_{S1}=0.1$ nH and $L_{S2}=0.47$ nH.

The initial simulation conditions are: $V_{in} = 400$ V, $I_L = 12$ A, $R_{G1,on} = R_{G1,off} = R_{G2,on} = R_{G2,off} = 33 \Omega$, $V_{th1} = 1.25$ V, and $V_{th2} = 1.5$ V. Because T_1 and T_2 have different trapping effect in a half-bridge layout [16], which results in different V_{th} values, and we consider this difference in the simulation.

We will then vary the discussed parameters in the simulation and demonstrate their influence on switching current overshoot.

B. $R_{G1,off}$

It is illustrated in Fig. 4 the switching waveforms under different $R_{G1,off}$. The increase of $R_{G1,off}$ does not impact on $\frac{di}{dt}$. However, I_D current overshoot amplitude largely increases when $R_{G1,off}$ increases. As shown in V_{G1S1} , the peak V_{G1S1} voltage increases above the transistor T_1 threshold voltage ($V_{th1}=1.25$ V), which indicates that there is a shoot-through of

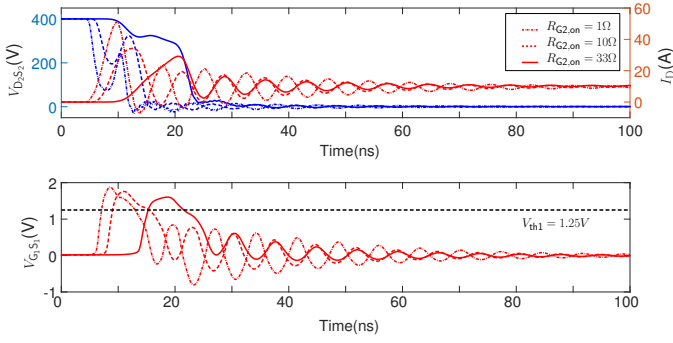

Fig. 5: Investigation of $R_{G2,on}$ on switching current overshoot in simulation

the circuit during turn-ON switching. The peak $V_{G1,S1}$ voltage decreases from 1.86 V to 1.6 V when $R_{G1,off}$ changes from 33 Ω to 1 Ω , which explains the decreases of I_D current overshoot amplitude.

The charge Q_C due to T_1 C_{oss} and C_L of load is 63 nC when the switching voltage is 400 V. The current overshoot charge Q_{I_D} obtained in the simulation are 108 nC, 206 nC and 360 nC when $R_{G1,off}$ is 1 Ω , 10 Ω and 33 Ω . Therefore, by comparing Q_{I_D} with Q_C , we can determine whether there is a shoot-through of the bridge-leg during switching.

C. $R_{G2,on}$

When $R_{G1,off}$ is 1 Ω , the relation between $R_{G2,on}$ on I_D current overshoot is further investigated and the result is presented in Fig. 5.

The decrease of $R_{G2,on}$ increases the $\frac{di}{dt}$ and thus increases I_D switching current overshoot amplitude. With regards to the Q_{I_D} , it increases slightly to 122 nC and 139 nC when $R_{G2,on}$ is 10 Ω and 1 Ω . By comparing with previous result, it is found that the change of $R_{G2,on}$ is less sensitive than $R_{G1,off}$ to influence on Q_{I_D} .

D. V_{th1}

It is illustrated in Fig. 6 the switching waveforms under different V_{th1} . V_{th1} needs to be considered here as it is likely to shift due to accumulated stress of $V_{D1,S1}$ in power converter. As $R_{G1,off}$, the increase of V_{th1} does not impact on $\frac{di}{dt}$, but reduces the amplitude of I_D current overshoot.

With regards to the Q_{I_D} , it decreases to 237 nC and 177 nC when V_{th1} is 1.4 V and 1.5 V. It implies that a higher V_{th} value (due to GaN-HEMT trapping) helps to mitigate the issue of shoot-through of the circuit during turn-ON switching.

E. L_{S1}

It is illustrated in Fig. 7 the switching waveforms under different L_{S1} . The increase of L_{S1} does not impact on $\frac{di}{dt}$, but reduces the amplitude of the I_D current overshoot. As a result, Q_{I_D} decreases to 245 nC and 178 nC when L_{S1} is 0.5 nH and 0.8 nH.

A higher L_{S1} value results in a higher voltage drop across it due to C_{DS} charging current, which further prevents the flowing of C_{GD} charging current through C_{GS} , and reduces the

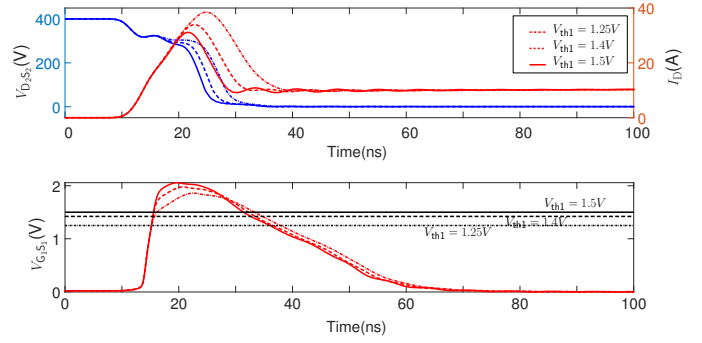

Fig. 6: Investigation of the variation of V_{th1} on switching current overshoot in simulation

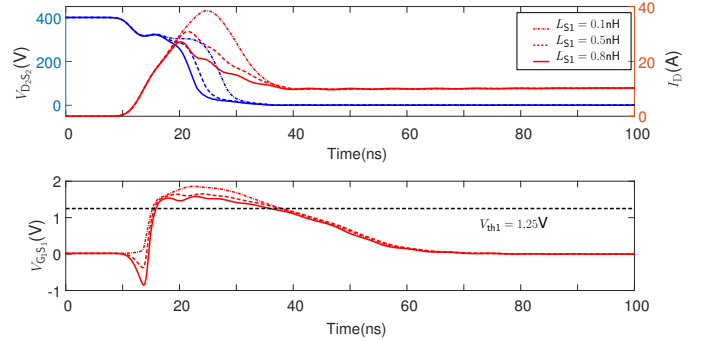

Fig. 7: Investigation of the variation of L_{S1} on switching current overshoot in simulation

increase of V_{GS} during turn-ON switching. It is worth noting that I_D current overshoot is very sensitive to L_{S1} value, as each 100pH increase of L_{S1} results in a reduction of 2A peak current value. It is also shown in the result that it exists an optimised value of L_{S1} to prevent bridge-leg shoot-through, so the common sense that L_{S1} should be minimised cannot help to mitigate the issue in this case.

F. L_{G1}

As shown in the result of Fig. 8, there is little influence of L_{G1} on switching current overshoot amplitude. This is because as presented in eq.(6), the change of L_{G1} appears in both nominator and denominator, which counteracts the overall action on $V_{G1,S1}$ voltage. As a result, Q_{I_D} varies only 2 nC when L_{G1} changes 2 nH.

G. Shoot-through mitigation

Based on the above analysis, it is found that a small $R_{G1,off}$ and an optimised L_{S1} tends to decrease Q_{I_D} and therefore prevents the bridge-leg shoot-through. It is illustrated in Fig. 9 the switching waveforms under different L_{S1} when $R_{G1,off}=1 \Omega$.

As shown in $V_{G1,S1}$, the peak $V_{G1,S1}$ voltage is below transistor T_1 threshold voltage ($V_{th1}=1.25$ V) when L_{S1} is 0.7 nH and 1 nH. As a result, I_D switching waveforms are identical under the two L_{S1} values, and therefore same Q_{I_D} value of 61 nC is obtained, which is approximately equal to the charge

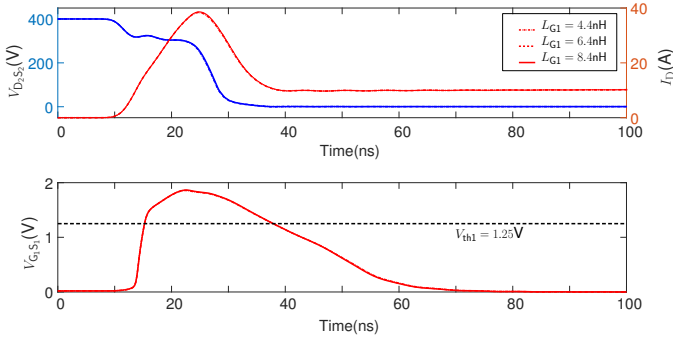

Fig. 8: Investigation of the variation of L_{G1} on switching current overshoot in simulation

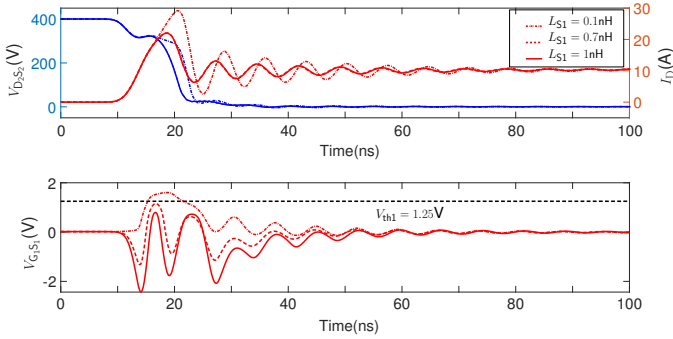

Fig. 9: Investigation of the variation of L_{S1} to mitigate bridge-leg shoot-through in simulation

of C_{oss} and C_L ($Q_C=63$ nC). It confirms that the bridge-leg shoot-through is mitigated.

It should be noted that even though a big L_{S1} helps to mitigate bridge-leg shoot-through, however, it increases the V_{G1S1} resonance negative amplitude, which may worsen the gate reliability of the transistor. For this reason, L_{S1} should be optimised rather than blindly selected in the design.

In the next section, the above analysis and simulation results of $R_{G1,off}$ on I_D switching current overshoot will be experimentally validated.

IV. EXPERIMENTAL VALIDATION

A. Experimental setup

The half-bridge circuit illustrated in Fig. 1 was built to measure both the V_{DS} and I_D switching waveforms via double pulse test. The experimental setup of the GaN-HEMT half-bridge circuit is shown in Fig. 10. A co-axial 1.2GHz current shunt (SSDN-414-025) is used to measure I_D switching current and a 200MHz differential voltage probe (THDP0200) is used to measure V_{DS} switching voltage. Here, a differential voltage probe is preferred because it avoids the issue of ground connection, even though it has less bandwidth and longer leads than a passive voltage probe. Finally, A 1GHz oscilloscope (MSO58B) is used to record the measurement waveform.

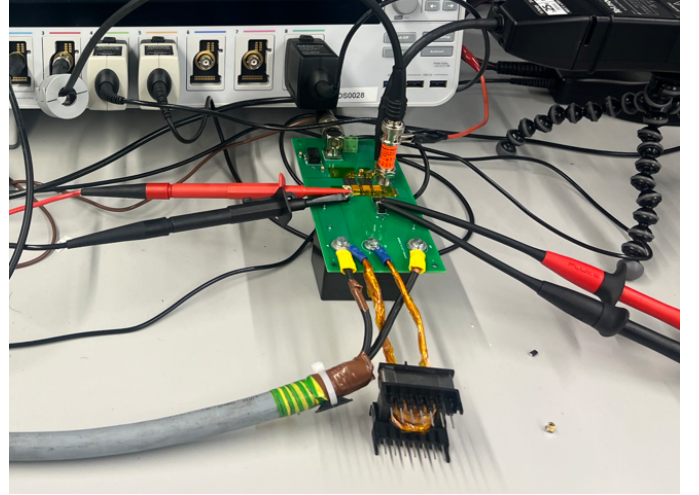

Fig. 10: Experimental setup of GaN-HEMT half bridge circuit

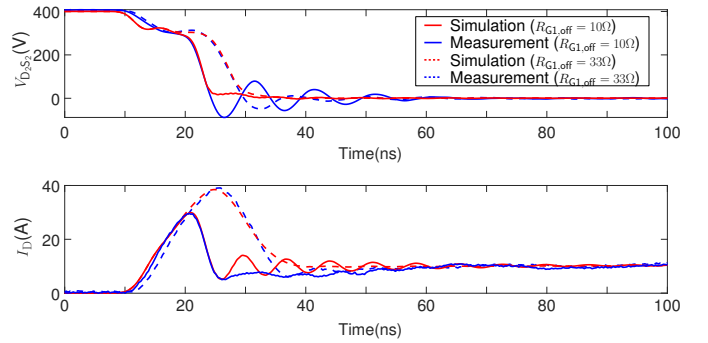

Fig. 11: Comparison between the simulation and measurement on I_D switching current overshoot

TABLE I: Comparison of Q_{I_D} between simulation and experiment measurement

Test condition	Simulation	Experimental measurement
$R_{G1,on} = R_{G1,off}=33\Omega$	360 nC	334 nC
$R_{G1,on} = R_{G1,off}=10\Omega$	123 nC	118 nC

B. Experimental results

The experimental measurement was carried out when both $R_{G1,on}$ and $R_{G1,off}$ are 10Ω and 33Ω , in which the comparison between the measurement and simulation is presented in Fig. 11.

It is clearly shown in the experimental results that the increase of $R_{G1,off}$ does not impact on $\frac{di}{dt}$, but largely increases the amplitude and charge of the I_D current overshoot, which confirms the above analysis. The simulation of the I_D switching waveform accurately matches the experimental measurement results. The comparison of Q_{I_D} between simulation and experiment measurement is presented in TABLE I, where the charge of the current overshoot is accurately modelled and it verifies the above simulation results of a half-bridge circuit shoot-through during turn-ON switching of the GaN-HEMT.

V. CONCLUSIONS

In this paper, GaN-HEMT switching current overshoot has been thoroughly investigated in a half-bridge circuit layout. Two origins due to the switching speed and shoot-through are identified, and the influence of the parameters such as turn-ON gate resistance $R_{G,on}$, turn-OFF gate resistance $R_{G,off}$, device threshold voltage V_{th} , common source inductance L_S and gate loop inductance L_G on switching current overshoot are analysed and verified by simulation. It is shown that shoot-through can be mitigated by using a small $R_{G,off}$ and an optimised L_S . Experimental measurement further confirms the simulation results of the influence of $R_{G,off}$ on switching current overshoot.

The proposed work can help designers to better analyse switching waveforms and optimise the circuit design of GaN power transistors. It should be noted that one common sense to design GaN switching circuit is to minimise L_S . However, this is not true in the case of switching current overshoot, as it is shown that a small L_S indeed increases the overshoot amplitude and charge. In order to mitigate the issue, an optimised L_S is needed rather than a small value.

REFERENCES

- [1] T. V. Do, K. Li, J. P. Trovão, and L. Boulon, "Reviewing of using wide-bandgap power semiconductor devices in electric vehicle systems: from component to system," in *2020 IEEE Vehicle Power and Propulsion Conference (VPPC)*, pp. 1–6, 2020.
- [2] Z. Liu, Z. Lin, J. Wang, K. Ma, D. Disney, and F. Meng, "A Fully Integrated Heterogenous Si-CMOS/GaN 500 MHz 6 V-to-18 V Boost Converter Chip," *IEEE Transactions on Power Electronics*, vol. 38, no. 5, pp. 5615–5618, 2023.
- [3] H. C. P. Dymond, J. Wang, D. Liu, J. J. O. Dalton, N. McNeill, D. Pamunuwa, S. J. Hollis, and B. H. Stark, "A 6.7-GHz Active Gate Driver for GaN FETs to Combat Overshoot, Ringing, and EMI," *IEEE Transactions on Power Electronics*, vol. 33, no. 1, pp. 581–594, 2018.
- [4] X. Long, Z. Jun, B. Zhang, D. Chen, and W. Liang, "A Unified Electrothermal Behavior Modeling Method for Both SiC MOSFET and GaN HEMT," *IEEE Transactions on Industrial Electronics*, vol. 68, no. 10, pp. 9366–9375, 2021.
- [5] J. P. Kozak, R. Zhang, M. Porter, Q. Song, J. Liu, B. Wang, R. Wang, W. Saito, and Y. Zhang, "Stability, Reliability, and Robustness of GaN Power Devices: A Review," *IEEE Transactions on Power Electronics*, vol. 38, no. 7, pp. 8442–8471, 2023.
- [6] X. Li, X. Liu, J. Cao, Y. Liu, H. Yuan, and Y. Xue, "Modeling and Analysis of Bridge-Leg Crosstalk of GaN HEMT Considering Staged Effect of Common-Source Inductance," in *2022 IEEE Energy Conversion Congress and Exposition (ECCE)*, pp. 01–08, 2022.
- [7] L. Salvo, M. Pulvirenti, A. G. Sciacca, G. Scelba, and M. Cacciato, "Gate-source voltage analysis for switching crosstalk evaluation in sic mosfets half-bridge converters," *IEEE Power Electronics Magazine*, vol. 9, no. 4, pp. 54–60, 2022.
- [8] Z. Zhang, B. Guo, and F. Wang, "Evaluation of switching loss contributed by parasitic ringing for fast switching wide band-gap devices," *IEEE Transactions on Power Electronics*, vol. 34, pp. 9082–9094, Sep. 2019.
- [9] Y. Liu, X. Liu, X. Li, and H. Yuan, "Analytical Model and Safe-Operation-Area Analysis of Bridge-Leg Crosstalk of GaN E-HEMT Considering Correlation Effect of Multi-Parameters," *IEEE Transactions on Power Electronics*, vol. 39, no. 7, pp. 8146–8161, 2024.
- [10] B. Li, G. Wang, S. Liu, N. Zhao, G. Zhang, X. Zhang, and D. Xu, "Modeling and Analysis of Bridge-Leg Crosstalk of GaN HEMT Considering Nonlinear Junction Capacitances," *IEEE Transactions on Power Electronics*, vol. 36, no. 4, pp. 4429–4439, 2021.
- [11] Y. Zhou, A. Zhu, Y. Jin, C. Li, H. Luo, W. Li, and X. He, "Cancellation of power-gate mutual inductance for crosstalk voltage alleviation in sic mosfet multi-chip power modules," in *2021 IEEE 1st International Power Electronics and Application Symposium (PEAS)*, pp. 1–4, 2021.
- [12] Z. Zhang, J. Dix, F. F. Wang, B. J. Blalock, D. Costinett, and L. M. Tolbert, "Intelligent gate drive for fast switching and crosstalk suppression of sic devices," *IEEE Transactions on Power Electronics*, vol. 32, pp. 9319–9332, Dec 2017.
- [13] A. Videt, K. Li, N. Idir, P. Evans, and M. Johnson, "Analysis of GaN Converter Circuit Stability Influenced by Current Collapse Effect," in *2020 IEEE Applied Power Electronics Conference and Exposition (APEC)*, pp. 2570–2576, 2020.
- [14] C.-L. Radu, K. Li, P. Igetic, S. Shepherd, A. Wörndle, C. H. van der Broeck, and S. Faramehr, "An improved SiC-MOSFET model with focus on internal stray inductance and body diode stored charge for switching transients," in *2022 IEEE Workshop on Wide Bandgap Power Devices and Applications in Europe (WiPDA Europe)*, pp. 1–6, 2022.
- [15] K. Li, P. Evans, and M. Johnson, "Developing Power Semiconductor Device Model for Virtual Prototyping of Power Electronics Systems," in *2016 IEEE Vehicle Power and Propulsion Conference (VPPC)*, pp. 1–6, Oct 2016.
- [16] X. Lu, A. Videt, S. Faramehr, K. Li, V. Marsic, P. Igetic, and N. Idir, "Impact of V_{th} Instability of Schottky-type p-GaN Gate HEMTs on Switching Behaviors," *IEEE Transactions on Power Electronics*, pp. 1–11, 2024.
- [17] K. Li and S. Sen, "A Fast and Accurate GaN Power Transistor Model and Its Application for Electric Vehicle," *IEEE Transactions on Vehicular Technology*, vol. 73, no. 4, pp. 4541–4553, 2024.