



HAL
open science

Development of Miniaturized Autonomous and Versatile Gas Chromatograph for Volatile Organic Compounds monitoring using Nano-Gravimetric-Detector.

Malak Rizk-Bigourd, Cécile Gaimoz, Eric Colinet, Jean-Pierre Pineau, Vincent Guerrini, Vivien Tranier, Fabrice Bertrand, David Coscia, Anaïs Feron, Michel Cabane, et al.

► To cite this version:

Malak Rizk-Bigourd, Cécile Gaimoz, Eric Colinet, Jean-Pierre Pineau, Vincent Guerrini, et al.. Development of Miniaturized Autonomous and Versatile Gas Chromatograph for Volatile Organic Compounds monitoring using Nano-Gravimetric-Detector.. Journal of Chromatography Open, In press, 10.1016/j.jcoa.2024.100202 . hal-04868522

HAL Id: hal-04868522

<https://hal.science/hal-04868522v1>

Submitted on 6 Jan 2025

HAL is a multi-disciplinary open access archive for the deposit and dissemination of scientific research documents, whether they are published or not. The documents may come from teaching and research institutions in France or abroad, or from public or private research centers.

L'archive ouverte pluridisciplinaire **HAL**, est destinée au dépôt et à la diffusion de documents scientifiques de niveau recherche, publiés ou non, émanant des établissements d'enseignement et de recherche français ou étrangers, des laboratoires publics ou privés.



Distributed under a Creative Commons Attribution - NonCommercial - NoDerivatives 4.0 International License

Journal Pre-proof

Development of Miniaturized Autonomous and Versatile Gas Chromatograph for Volatile Organic Compounds monitoring using Nano-Gravimetric-Detector.



Malak RIZK-BIGOURD , Cécile GAIMOZ , Eric COLINET ,
Jean-Pierre PINEAU , Vincent GUERRENI , Vivien TRANIER ,
Fabrice BERTRAND , David COSCIA , Anaïs FERON ,
Michel CABANE , Cyril SZOPA , Patrice COLL , Agnès BORBON ,
François RAVETTA

PII: S2772-3917(24)00089-6
DOI: <https://doi.org/10.1016/j.jcoa.2024.100202>
Reference: JCO 100202

To appear in: *Journal of Chromatography Open*

Received date: 9 October 2024
Revised date: 20 December 2024
Accepted date: 22 December 2024

Please cite this article as: Malak RIZK-BIGOURD , Cécile GAIMOZ , Eric COLINET , Jean-Pierre PINEAU , Vincent GUERRENI , Vivien TRANIER , Fabrice BERTRAND , David COSCIA , Anaïs FERON , Michel CABANE , Cyril SZOPA , Patrice COLL , Agnès BORBON , François RAVETTA , Development of Miniaturized Autonomous and Versatile Gas Chromatograph for Volatile Organic Compounds monitoring using Nano-Gravimetric-Detector., *Journal of Chromatography Open* (2024), doi: <https://doi.org/10.1016/j.jcoa.2024.100202>

This is a PDF file of an article that has undergone enhancements after acceptance, such as the addition of a cover page and metadata, and formatting for readability, but it is not yet the definitive version of record. This version will undergo additional copyediting, typesetting and review before it is published in its final form, but we are providing this version to give early visibility of the article. Please note that, during the production process, errors may be discovered which could affect the content, and all legal disclaimers that apply to the journal pertain.

© 2024 Published by Elsevier B.V.
This is an open access article under the CC BY-NC-ND license
(<http://creativecommons.org/licenses/by-nc-nd/4.0/>)

Highlights

- *Proof of concept of miniaturized gas chromatograph*
- *First coupling of preconcentrator to Nano Gravimetric Detector*
- *Monitoring and long-survey of air quality pollutants using autonomous system*
- *Volatile Organic Compounds monitoring in extreme environments*

Journal Pre-proof

Development of Miniaturized Autonomous and Versatile Gas Chromatograph for Volatile Organic Compounds monitoring using Nano-Gravimetric-Detector.

Malak RIZK-BIGOURD^{1*}, Cécile GAIMOZ², Eric COLINET³, Jean-Pierre PINEAU¹, Vincent GUERRENI¹, Vivien TRANIER¹, Fabrice BERTRAND¹, David COSCIA¹, Anaïs FERON⁴, Michel CABANE¹, Cyril SZOPA¹, Patrice COLL⁴, Agnès BORBON⁵, François RAVETTA¹

¹LATMOS/IPSL, UVSQ Université Paris-Saclay, Sorbonne Université, CNRS, 11bd d'Alembert, 78280 Guyancourt, France.

²Univ Paris Est Creteil and Université Paris Cité, CNRS, LISA, F-94010 Créteil, France

³Apix Analytics, Miniparc Polytec, Immeuble Tramontane, 60 rue des Berges, 38000 Grenoble, France

⁴Université Paris Cité and Univ Paris Est Creteil, CNRS, LISA, F-75013 Paris, France

⁵Université Clermont Auvergne, Laboratoire de Météorologie Physique, OPGC/CNRS UMR 6016, 63000, Clermont-Ferrand, France

*Corresponding author: malak.bigourd@latmos.ipsl.fr

Abstract

Environmental monitoring and air quality survey during long-term field campaign tests, especially in low-accessibility or extreme environments, requires robust, standalone and autonomous analyzer with low gas consumption and minimal human intervention. The current states of art emphasize the need to develop miniaturized GC based on novel detectors that offers the best compromise between carrier gas consumption, detection limits and panel of measured VOCs. This work presents the development and optimization of MAVERIC, a miniaturized and autonomous Gas Chromatograph system coupled to an innovative *Nano Gravimetric Detector* (NGD) based on NEMS (nano-electromechanical-system) resonator. A homemade software is developed to control the instrument as well as the electronics modules. The system operates at low flow rate (2 mL.min⁻¹) of helium used as carrier gas, and allows the measurements of VOCs from C₆ to C₁₀ in less than 30 minutes. A mixture of isoprene, benzene, toluene and α -pinene is used to optimize experimental conditions. Under optimal conditions, the detection limit, the stability, the repeatability and the linearity of the analytical system are assessed. A detection limit of sub-ppb to few ppt level was determined for C₉ and C₆ compounds, respectively. The lowest detection limit corresponds to the highest molecular weight compounds due to NGD sensitivity at ambient temperature. The system is standalone, portable, robust and equipped with 4G connection that allows remote control of the instrument and easy data export. It is very adapted for a long period field campaign test, environmental monitoring and air quality survey outdoors and in low-accessibility or extreme environments.

Key Words: *Miniaturized Gas Chromatograph, Volatile Organic Compounds, Nano Gravimetric Detector NGD.*

1. Introduction

Volatile Organic Compounds (VOCs) are ubiquitous pollutants with well-known impacts on air quality, human health, and climate change. Outdoors, the atmospheric mixing ratios of VOCs and their nature is a crucial information for estimating, anticipating and mitigating their impacts. VOCs are emitted in the atmosphere by biogenic and anthropogenic sources [1, 2]. Indoors, monitoring VOCs and determining the emissions sources (*e.g.* materials, human activities) and sorption processes on surfaces could help to improve indoor air quality [3]. In both environments, *in situ* observations provide very useful information on VOCs composition, sources, physical and chemical processes controlling

their concentration and thus the population exposure. However, VOCs show high spatial and temporal heterogeneity and a networking deployment would be the most appropriate observational strategy to consider VOC heterogeneity, using sensitive and specific techniques allowing accurate estimation of VOC at sub-ppb levels. Several kinds of portable sensors have been investigated because they have fast response and good portability to support a networking deployment. However, these sensors present high detection limits (hundreds of ppb to ppm), are not specific to individual VOCs and have an important drift over long measurement period [4]. Accurate monitoring of VOC at sub-ppb level has been presented in literature using online and offline measurements techniques. Offline techniques are approved and usually based on active or passive sampling on sorbent tubes [5] or sampling in canister and tedlar bags [6], followed by analysis in the laboratory using commercial Gas Chromatograph (GC) coupled to various types of detectors (e.g. Flame Ionization Detector FID, Photo Ionization Detector PID, Mass Spectrometer MS) [7]. The advantages of offline methods are their low detection limit (ppt level), cost-effectiveness, easy implementation of sampling units and their compact volume relevant to spatial heterogeneity issues. However, their main disadvantages are their poor time resolution, logistics and the necessary delay to get results. Online techniques, such as online-GC and Proton-Transfer Reaction Mass Spectrometer (PTR-MS) [8], allow real-time measurements with a high temporal resolution (several seconds for PTR-MS to few minutes for GC) and a low detection limit (ppt). However, these instruments are expensive, very heavy (120 to 280 kg) and bulky. Then, their deployment on the field needs human resources and a good quality power supply that limit the deployment capabilities in many extreme environments.

To overcome these disadvantages of sensors, offline and online measurements, there have been many investigations to develop laboratory miniaturized GC or commercial GC systems that have been presented and reviewed in different works (e.g. [9-14]). The commercial analyzers are usually equipped with conventional detectors as PID or FID which provide very low detection limits (ppt levels for benzene), for a cycle time of 10 to 15 minutes. However, they present a relatively high consumption of carrier gas (15 - 51 mL.min⁻¹) for a weight varying between 6.6 and 13.6 kg [14]. For instance, the miniaturized laboratory GC-PID developed in previous works [14, 15] present a lower consumption of carrier gas (i.e. between 2 and 3.5 mL.min⁻¹ for helium, dinitrogen or dihydrogen) and low detection limit between 0.14 ppt [15] and 1 ppb for BTEX compounds and for a cycle time of 10 minutes [14]. PID-based systems suffer from selectivity issues and require filtering at the source, which makes them ineffective and expensive for multi-compounds analysis [16]. On the other hand, FID detector requires gas supply for the flame which is restrictive for field applications. Trying to bypass the drawbacks of conventional detectors, other miniaturized and micro GC systems (with a maximum reported weight of 3 kg) have been developed using other detectors such as sensors with polymer coating [17], micro fabricated quartz crystal tuning forks [18, 19] and micro-TCD based on MEMS technology [20, 21]. They present lower consumption of carrier gas (2 - 15 mL.min⁻¹) for a cycle time of a few minutes (3 - 4 minutes), but they have relatively higher detection limits (30 – 10000 ppb). Only miniaturized GC with a MOX array sensors [22] was reported to have a lower limit of detection (0.1 ppb) but for a higher cycle time (i.e. 60 minutes), with relatively high consumption of carrier gas (15 mL.min⁻¹). Considering the literature state of art, *in situ* measurements requires developing miniaturized GC using novel detectors that offers the best compromise between carrier gas consumption, detection limits and panel of measured VOCs. Moreover, long-term field campaigns especially in low accessibility or extreme environments [23, 24] requires robust analyzer with low resource needs in terms of gas consumption and human intervention for operation or maintenance. Consequently, this work aims to

develop robust, autonomous, miniaturized and versatile GC analyzer based on a novel NEMS detector allowing measurements of a large panel of VOCs with a ppb detection level, low carrier gas consumption ($2 \text{ mL}\cdot\text{min}^{-1}$) and with reasonable time resolution for field observations ($\sim 30 \text{ min}$). This work presents the development of an instrument, called MAVERIC (Miniaturized Autonomous and VERsatlle gas Chromatograph), using a patented NGD detector (Nano-Gravimetric-Detector) based on a nanoelectromechanical array of adsorbent-coated resonating double clamped beams [25, 26]. An easily removable homemade preconcentrator is used which allows changing of used sorbent and then extend or change the panel of target compounds. MAVERIC is mechanically robust and relies on a technology transfer by adapting SAM-GC technology successfully developed and embedded on MSL science lander (mass 900kg, science payload 80 kg) for Mars exploration [27]. SAM-GC has demonstrated the reliability of its technological concept in an extremely constrained environment. The main objective of this paper is to present the instrument conception and design based on a novel detector, and its basic performances established in the laboratory using synthetic gas mixtures.

2. Material and Methods

2.1. General description of the system

MAVERIC instrument operates using three sub-modules responding to three specific tasks for the analysis: (i) sampling and preconcentration, (ii) separation, and (iii) detection. More details on each analytical component will be given in the following sections. The carrier gas used is helium (Air Liquid, Alphagaz 2, purity $> 99.9999 \%$) and its flow rate inside the analytical system is regulated by a pressure regulator (Bronkhorst) placed at the column inlet and operating in the range 0 - 6 bar relative to the atmospheric pressure (with 0.05% uncertainty on full scale and a 0.4% accuracy according to the manufacturer). A solenoid 3-ports valve (Lee Company) is placed upstream the column to flush it either with the carrier gas during sampling, or with the sample during analysis. Two similar valves are used at the trap inlet and outlet in order to ensure the air sampling and the back-flush of the trap during analysis. Sampled air is preconcentrated on the trap at a stable air flow controlled manually using a needle valve (Swagelok) located before a mini-diaphragm air pump (KNF). The flow of sampled air is monitored using a digital mass flowmeter (Bronkhorst). The fluidic connections between the different sub-units are made using inert tubes in PTFE and inox with an external diameter of $1/32''$. A picture of the full system is shown on Figure 1. It fits inside a metal case which dimensions are $43 \text{ (l)} \times 34 \text{ (w)} \times 17 \text{ (h)} \text{ cm}$, and weighs about 10 kg. It is worth noting that the dimensions of this first prototype can be reduced by optimizing the space and the arrangement of the different parts.

MAVERIC operates under two modes, (a) sampling and (b) analysis as presented on figure 2 through a schematic drawing of the instrument.

During the sampling step, the 3-ports valves are switched on the position called "NO". The ambient air or the standard mixture is sampled into the trap using a micro pump at a constant flow rate controlled with a needle valve and digital flowmeter. At the same time, the carrier gas is continuously passing through the column and the NGD detector at a constant flow rate. Indeed, the carrier gas pressure at the column inlet is controlled using a pressure flow control and the system is set at isothermal temperature of 35°C maintaining a constant air flow through the system (Figure 2). Once the sampling step is completed, the 3-ports valves are switched to position called "NC" and then the carrier gas (flow rate of $1 \text{ to } 2 \text{ mL}\cdot\text{min}^{-1}$) passes through the trap in a back-flush mode to carry the sampled gas into the capillary column where VOC are separated before being detected by the NGD detector (Figure 2). The transition between the two positions is automatically controlled by MAVERIC's software.

2.2. Preconcentration unit (adsorption trap)

A homemade thermal-desorption trap was made using a glass tube (ID: 2 mm; length: 60 mm) filled with 50 mg of Carbopack B 60-80 mesh (*Sigma-Aldrich*). The trap can be heated-up using an electrical wire resistor equipped with a temperature platin probe PT100. A thermally conductive potting of the wire is used to ensure a uniform heat diffusion throughout the trap external wall. Air sample is preconcentrated on the trap at ambient temperature. Once the sampling carried out, the trap is heated up to $\sim 300^{\circ}\text{C}$ in a flash mode in ~ 6 sec to ensure a fast desorption of the analytes. The trap temperature is then stabilized for 60 to 70 sec in order to ensure a full desorption and injection of the VOCs into the analytic column.

2.3. Separation module (chromatographic column)

A 26-m long capillary column (Rxi-1, ID: 0.25 mm, $1.0\ \mu\text{m}$ of PDMS stationary phase, *Restek*) is used in this prototype. The column is coiled on a stainless-steel cylinder of small diameter (6 cm) and is heated-up with an electrical resistor equipped with a temperature probe PT100. The column is embedded in a thermally conductive potting ensuring a uniform temperature throughout it. A miniature box fan was used for cooling the column faster after each analysis. The column was designed to be heated up to 300°C and using different ramp temperature. The column initial temperature is stabilized at 35°C during the sampling phase, then heated up to 150°C - 170°C following a temperature gradient of 3 to $4^{\circ}\text{C}\cdot\text{min}^{-1}$ depending on the analyzed mixture (*i.e.* a higher temperature gradient is used to achieve faster analysis). The best efficiency of this type of column was already tested under isothermal conditions at 100°C and 150°C in our laboratory for other study [28] and was found to be optimal using a helium flow rate between 1 and $2\ \text{mL}\cdot\text{min}^{-1}$.

2.4. Detection module (NGD detector)

A commercial and patented NGD detector manufactured, assembled and tested by *APIX Analytics*, is used. This detector is based on a nanoelectromechanical array of adsorbent-coated resonating double clamped beams [25, 26]. NGD is a concentration-sensitive detector and its sensitivity is analyte-dependent based on the affinity of the analyte with the porous layer coated on the beams surface. An adsorption-desorption model was set up by *APIX Analytics* to characterize the NGD response on a large set of n-alkanes [25]. This affinity is also strongly related to the NGD temperature. The first generation of NGD used in this paper for the instrument validation, operates under ambient laboratory temperature, when the signal of NGD is measured in Hz unit. A second generation of NGD is developed using an electronic card called "Salsa" that allows a thermal control of the NGD between 30 to 220°C and then enhancing its sensitivity. Moreover, it is also possible to make a cleaning cycle of the detector between two injections to regenerate the porous layer coated on the beams surface of NGD. The detector performances were characterized and compared to Flame Ionization Detector (FID)[29]. This second generation of NGD is tested at the end of this work to determine the best performance of the detector. For this, all measurements are done with the NGD detector set at 50°C . A cleaning cycle is also performed between 2 successive analysis by heating the detector during 2 minutes at 50°C then up to 150°C following a ramp temperature of $20^{\circ}\text{C}\cdot\text{min}^{-1}$ before stabilizing at 150°C during 3 minutes. A new acquisition is then performed at 50°C after NGD cooling. This cleaning cycle of 10 minutes is performed during the sampling phase on the preconcentrator.

2.5. System integration and instrument operation

The instrument is controlled by a homemade software (based on a Python script) running under a windows operating system. The software called "MAVERIC Soft" controls the GC parameter settings (sampling time, analysis time, temperature, TCD detector), and creates different analysis method using open scripts. NGD detector is operating using a software ownershiped by Apix Analytics, and can be controlled through "MAVERIC Soft" which allows synchronization between the GC operations and detector acquisition. The acquisition frequency is around 100 Hz. The signals treatment is performed using a commercial software called *Azur*. MAVERIC instrument is also equipped with 4G connection for simple connection to internet on site during field campaign without any infrastructure needed (ethernet/wifi). This connection allows remote control of the instrument and easy data export.

2.6. Experimental calibration setup

Different anthropogenic VOCs concentration are generated using a certified gas mixture purchased from *Air Liquide* (called in the following AL-Mix11) (Supplementary Material, Table S1). The initial concentration for each compound is between 2 and 2.5 ppm (except m,p-xylene at 5 ppb) with an average uncertainty of 2%. The concentrations used for calibration curves are obtained after dilution with dinitrogen (99.999% purity) using Zephyr dilution system (AlyTech). Zephyr consists of 2 mass flow controllers (MFC) with a dynamic range of 0.917 – 49.908 mL.min⁻¹ for dinitrogen and 20.131 – 1001.878 mL.min⁻¹ for VOCs mixture, which allow generating different concentrations in the range 20 - 300 ppb (Supplementary Material, Table S2) at a total flow rate of 1008 -1064 mL.min⁻¹. These MFCs present an uncertainty of 0.5% full scale. Only a part of generated gas flow is pumped through the trap using an outlet split regulated using a needle valve. Using the same experimental calibration setup, the system's accuracy in ppb level is evaluated with 9 different concentrations and using three different gas mixtures.

2.7. Other chemical mixtures

For the optimization of MAVERIC operating conditions, we used a simple mixture of isoprene, benzene, toluene and α -pinene at 10 ppb diluted in dinitrogen and purchased from Air Liquid (called AL-Mix4). This mixture is used because such VOCs are commonly measured in literature using different GC methods. Moreover, they are representative of VOCs found in ambient air and are characteristic of both anthropogenic and natural sources. Besides, a standard mixture of 36 VOCs from C₂ to C₁₀ (called NPL-Mix36) diluted in dinitrogen and provided by the NPL (National Physical Laboratory, UK) is used to test the instrument performance at sub-ppb level around 4 ppb (Supplementary Material, Table S3).

3. Results and discussion

3.1. Optimization of MAVERIC operating conditions

First of all, MAVERIC operating conditions are optimized. The experiments presented in the following are performed in order to determine the most appropriated flow sampling and duration, the breakthrough volume of the adsorption trap and the column performance for different carrier gas flow rates.

- **Sampling conditions**

In order to get the lowest limit of detection, we determined the most appropriate volume of air and the duration of air sampling through the trap. A first set of experiments are carried out by sampling a

simple mixture of VOCs at different flow rates from 10 to 80 mL.min⁻¹ during 10 minutes. The carrier gas flow rate (helium) is set to 1.2 mL.min⁻¹ and the column ramp temperature is 4°C.min⁻¹. The standard mixture AL-Mix4 containing isoprene, benzene, toluene and α -pinene at 10 ppb each is used. The choice of the best sampling flow rate is based on the detection limit obtained for each compound. The LOD_i for a VOC_i is calculated using the signal over noise method (S/N=3) as presented in the following equation (Eq. 1):

$$LOD_i(\text{ppb}) = 3 \frac{h_n}{h_{si}} C_i \quad \text{Eq. 1}$$

where: h_n is the average height of noise (mm), h_{si} is the peak height for VOC_i (mm) and C_i is the concentration of a VOC_i in the gas mixture (ppb).

Each experiment is repeated 3 times with blank tests performed before and after each single test to ensure the absence of any contamination or memory effect. The compounds elute in the order of their boiling point, *i.e.* isoprene (34.1°C), benzene (80.1°C), toluene (110.6°C) and α -pinene (156°C). Average LOD are presented in Table 1 with 1 standard deviation. The isoprene is detected with a S/N >3 only at 80 mL.min⁻¹ with a LOD of 14 ± 1.8 ppb. Therefore, isoprene is not presented in the following section (3.2.) to assess breakthrough volume of the used trap. Indeed, isoprene is a 5 carbon atoms molecule, while NGD has only validated performance for compounds having at least 6 atoms of carbon.

As expected, the limit of detection decreases when the sampling flow rate increases. The relative uncertainty obtained is around 4 - 5% for 60 mL.min⁻¹ and 70 mL.min⁻¹ flow rates. For 80 mL.min⁻¹ the variation coefficient is around 7%. Therefore, the optimum sampling flow rate is between 60 - 70 mL.min⁻¹ for 10 min of sampling time, which is equivalent to 600-700 mL of total volume sampled.

Table 1 : Average limit of detection LOD obtained for benzene, toluene and α -pinene using different sampling flow rates and a constant sampling time of 10 minutes. The average LOD and the standard deviation σ are calculated over three repetitive tests.

Sampling flow rate (mL.min ⁻¹)		10	20	30	40	50	60	70	80
Average	Benzene	24 ± 7.1	11 ± 1.3	6.3 ± 1.3	6.9 ± 0.73	4.5 ± 0.64	2.8 ± 0.14	2.5 ± 0.1	2.3 ± 0.16
LOD ± 1 σ	Toluene	13 ± 1.9	5.1 ± 0.43	2.8 ± 0.55	2.9 ± 0.1	1.9 ± 0.19	1.2 ± 0.06	1.1 ± 0.05	0.92 ± 0.07
(ppb)	α -Pinene	24 ± 7.9	7.7 ± 0.67	4.1 ± 1.1	3.4 ± 0.2	1.9 ± 0.33	1.4 ± 0.06	1.3 ± 0.06	1.1 ± 0.07

A second set of experiments is conducted using an average sampling flow rate of 65 mL.min⁻¹ and 3 different sampling durations of 5, 10 and 15 minutes, corresponding to a total air volume of 325, 650 and 975 mL, respectively. This set of experiments allows determining the effect of sampling duration and also the effect of total sampling volume. Obtained LOD values decrease when the total sampling volume increases (Supplementary Material – Table S4). For 10 minutes of sampling (650 mL of sample volume) an example of obtained chromatogram is presented in Supplementary Material (Figure S1) and LOD results are consistent with those previously obtained in Table 1 with LOD values of 2.4 ± 0.08 for benzene, 1.02 ± 0.05 for toluene and 1.3 ± 0.07 for α -pinene. However, in the case of the 15 minutes sampling time, a memory effect is observed on the blank test performed after the analysis. This indicates a limitation due to the trap desorption. These experiments show that the total sampled volume is an important parameter to perform sampling. Therefore, the trap breakthrough volume will be investigated in the following section using these data in order to determine the safe sampling volume for the trap.

3.2. Trap breakthrough volume

In order to estimate the breakthrough volume of the used trap, the peak area obtained for each VOC from previous experiments is plotted as a function of total volume of sampled air which varies between 100 mL and 975 mL (Figure 3). A linear relationship with a correlation coefficient varying between 0.97 and 0.98 is observed between the peak area and the total volume sampled between 100 and 929 mL. The breakthrough volume is estimated to be reached for an air volume between 929 and 975 mL since we estimate that a loss of linearity for the volume of 975 mL is detected (empty point on Figure 3) especially for the α -pinene. Unfortunately, the exploration of higher sampling volume is not possible with the current pump due to its limited maximal pumping speed. Consequently, we estimate that the breakthrough volume is greater than 929 mL. The safe sampling volume (SSV) is defined as 70% of the breakthrough volume (*i.e.* taking two-thirds of the breakthrough volume using a direct method calculation already reported in the state of art [30]). Under these conditions, 650 mL can be considered as the SSV volume, and it corresponds to a sampling flow of 65 mL.min⁻¹ during 10 minutes.

3.3. Calibration and analysis of different gas mixtures

MAVERIC calibration curves are performed with different gaseous concentrations varying between 16 and 300 ppb using a 11-alkanes (C₅-C₁₀) mixture diluted in dinitrogen. The dilution of AL-Mix11 is achieved using a dilution system as described above (see section 2.6.) and seven analyses are conducted in triplicates under the optimal conditions determined above (*i.e.* sampling flow rate of 65 mL.min⁻¹ for 10 min). Helium flow rate is set at 2 mL.min⁻¹ to reduce the analysis time given the analyzed mixture. The temperature ramp of the column is set to 3°C.min⁻¹ to allow the separation of analyzed components within the minimum duration and preventing components co-elution. The retention time (*t_r*), the peak area, height and width at half height (*w*_{1/2}) are calculated for every compound from the chromatograms generated by the NGD. The resolution (*R_s*) is defined in Eq.4 as:

$$R_s = 2 \left(\frac{t_{rB} - t_{rA}}{W_A + W_B} \right) = 1.18 \left(\frac{t_{rB} - t_{rA}}{w_{1/2A} + w_{1/2B}} \right) \quad \text{Eq. 1}$$

Where: *T_r* is the time resolution of a peak, *W* is the peak width at the base and *w*_{1/2} is the peak width at half height for the two compounds, A and B.

The chromatogram on Figure 4 shows the successful identification of eleven compounds within 19.3 min. The compounds are eluted in order of increasing boiling point (Supplementary Material, Table S1). The resolution between compounds is higher than 1.5 showing a correct separation excepted for the last pair of compounds for which the resolution varied between 1.3 and 1.4. The peak integration of the last two peaks is done even their low recovering at the base. Calibration curves will be presented and discussed in the section below.

Once the calibration of MAVERIC instrument is performed, an analysis of a synthetic mixture similar to an outdoor air composition is conducted. This experiment allows proving the instrument performance under conditions similar to outdoor air composition and for lower concentration at sub-ppb level. A standard mixture (NPL-Mix36) including alkanes, alkenes and aromatic VOCs (C₂ to C₁₀) at 4 ppb ±2% diluted in dinitrogen and supplied by the NPL (National Physical Laboratory, UK) is used (Supplementary Material – Table S3). Two injections are performed using directly the gas cylinder without any dilution system. Figure 5 reports an example of obtained chromatogram and Table 2 presents the main detected compounds with a signal to noise ratio (S/N) greater than 3 that allows identifying detected compounds, as well as the values related to chromatographic peaks and LODs. The LODs determined for benzene and toluene using this mixture are slightly lower than those already

determined in the beginning of this paper. Theoretically, the LOD is independent of the VOC injected concentration but highly dependent on the average amplitude of background noise used for the calculation and the peak height. For the AL-Mix4, the peaks are slightly broader (Table S4 – Supplementary material) than those obtained with NPL-Mix36 because of a lower temperature gradient but the peak heights (normalized to the injected concentration) are lower (*i.e.* the proportionality ratio for peak height between the two gas mixtures is lower than for peak area). Besides, the amplitude of background noise is higher for the analysis done with NPL-Mix36 and is probably related to the different purity of the dinitrogen used in the two gaseous Air Liquid and NPL standards, and the available adsorption sites on the NGD detector after several tests. It is worth to note that the LOD values determined here present an estimation of LODs in laboratory conditions and should be confirmed during field campaigns under realistic test conditions. In this analysis, isoprene is detected with a S/N of 3 and an average LOD values of 4.29 ppb. For the other compounds bearing more than 6 carbon atoms, we observe that LODs are in the range 0.48 to 0.74 ppb. The LOD decreases with the number of carbon atoms, which is consistent with the NGD detector sensitivity as already observed during the instrument calibration.

Table 2: Chromatographic results obtained for the analysis of the NPL standard mixture.

Compounds	Tr (min)	A (a.u.)	$\omega_{1/2}$ (sec)	H (Hz)	S/N	R	LOD (ppb)
n-Hexane	4.3	2726	3.4	602	2.8	91	4.57 ± 0.10
Isoprene	4.9	2902	3.8	638	3.0	5.8	4.29 ± 0.09
Benzene	6.3	5521	4.4	1146	5.3	12	2.27 ± 0.05
2-Methylpentane	7.3	3407	3.6	668	3.1	9.2	3.88 ± 0.08
n-Heptane	7.6	6207	3.9	1391	6.4	3.0	1.98 ± 0.04
Toluene	9.7	21131	5.4	3409	16	16	0.74 ± 0.02
n-Octane	11	16547	5.1	2771	13	10	0.94 ± 0.02
Ethylbenzene	13	46341	7.7	5209	24	12	0.53 ± 0.01
m,p-Xylene	14	84560	9.5	7880	36	1.6	0.68 ± 0.01
o-Xylene	15	49569	9.0	4816	22	3.7	0.54 ± 0.03
1,3,5-Trimethylbenzene	18	91383	15	5212	24	10	0.48 ± 0.01
1,2,4- Trimethylbenzene	19	101173	18	5161	24	2.5	0.51 ± 0.01
1,2,3- Trimethylbenzene	21	111137	20	4786	22	2.6	0.52 ± 0.01

A= Peak Area, $\omega_{1/2}$ =Width at half height, H= Peak height, S/N= Signal to noise ratio and R= Peak resolution

3.4. Linearity, stability and repeatability of the measurements

MAVERIC linearity response is investigated by plotting the mean peak area as a function of the concentration of tested compounds using three different gas mixture (AL-Mix4, AL-Mix11 and NPL-Mix 36) prepared independently and purchased from two different suppliers. The tests performed to optimize the instrument (AL-Mix4), the calibration tests (AL-Mix11) and the analysis performed using the NPL-Mix36 (section 3.4) are used to have a representative panel of concentrations ranging between 4 and 300 ppb. Used concentrations with standard deviation values are given in Supplementary Material (Table S2). Peak area is integrated over the peak width at the base and all results are reported in Table 3. The system repeatability is determined using three consecutive injections of the gas mixture used for the calibration procedure with seven different concentrations. Over the 21 replicates, the retention times for all compounds are very stable and varied by an average RSD of 0.14 %. The peak width at half height and the peak height presents a good repeatability as well with an average RSD of 5.0 and 4.5 % respectively. Peak areas determined for each compound show

also good repeatability with an average RSD of 5.1 % (except for three tests where higher RSD are observed for 1,2,4-trimethylbenzene with one tested concentration and n-decane with two tested concentrations).

The comparison of the results obtained using different concentrations for the same compound with three different gas mixtures shows also a high repeatability with an average RSD of 2.7 %. We can conclude that the determination of peak areas using MAVERIC shows a high precision and accuracy.

In order to evaluate the linearity of MAVERIC instrument, Figure 6 shows the linear correlation ($y=a*x$) between the peak area (y) and compound concentration (x). Obtained parameters of the best fit are listed in

Table 4 and a high correlation coefficients $R (> 0.9)$ is always observed.

The range of tested concentrations is representative of those observed in ambient air at sub-ppb for trace measurements to ppb levels as observed in megacities worldwide, downwind industrial areas and in near-traffic areas [31-33] allowing precise quantification of pollutants concentration using MAVERIC instrument. In comparison with reference GC instruments used during offline and online analysis and having LOD levels of few ppts, MAVERIC shows relatively higher detection limits for medium molecular weight compounds, but offers an easier deployment with lower needed resources (lower weight and lower gas consumption). Likewise, MAVERIC LODs for BTEX are higher than those of portable commercial analyzers based on PID or FID as already presented in the introduction section [14]. However, MAVERIC is able to measure more extended range of VOCs using NGD. MAVERIC is considered practical with a BAGI score [34] of 65 (Supplementary Materiel – Figure S3) obtained using BAGI software to assess the methods' workability and functionality.

Finally, among all VOCs, air quality guidelines in France and Europe [35, 36] recommend a limit value of $5 \mu\text{g.m}^{-3}$ for only benzene (calculated as annual calendar average) which corresponds to 1.54 ppb. Using a NGD of 1st generation, MAVERIC LODs are higher than the air quality guidelines but the NGD of 2nd generation (Table 4 and section 3.5) will allow the measurement of such levels for benzene.

In conclusion, MAVERIC performances allow its deployment in different environments (except in low emission zones for medium molecular weight survey) and would be very useful for VOCs measurements in low-accessibility environments or extreme ones. NGD detector is a plug and play component and it does not need any heavy maintenance (internal calibration is automatically done by the software) and requires only helium as a gas supply which is very useful for field applications.

Table 3: Results obtained with MAVERIC for repeatability and linearity tests performed using different gas mixtures and different concentrations. Average peak area is calculated over 3 replicates and RSD is random standard deviation calculated using the standard deviation 1σ (n=3) except for NPL-Mix36 (n=1). 1,2,4-TMB is 1,2,4-Trimethylbenzene.

	Compo unds	n- Penta ne	n- Hexa ne	Benz ene	Tolu ene	N- Octan e	Ethylben zene	m,p- Xylene	O- Xylen e	n- Nona ne	1,2,4- TMB	n- Deca ne
Average peak area (a.u.) (n=3)												
NPL- Mix36	No dilution		2726	5521	1	16547	46341	84560	4956		10117	
AL- Mix4	No dilution			1200	5020							
AL- Mix11	Dilution 1		7942	1844	7434	61416	122132	229904	1480	13227	21844	25206
	Dilution 2		10791	2853	9558	93798	186401	351587	2324	20686	34620	39323
	Dilution 3	8178	18346	4388	1433	14033	282025	522911	3412	30716	50037	54024
	Dilution 4	17423	30001	7056	2306	22792	442930	810537	5591	50771	82534	93647
	Dilution 5	21273	38942	9186	2745	28900	561438	100222	6995	63896	10583	11802
	Dilution 6	27580	52218	1195	3649	38214	718974	127766	9388	85548	14145	16345
	Dilution 7	38475	66128	1497	4399	45912	849392	147458	1107	10147	16537	19202
Standard deviation (1σ) (n=3)												
AL- Mix4	No dilution			960	475							
AL- Mix11	Dilution 1		302	197	2263	1267	1650	4649	3225	1599	11422	13106
	Dilution 2		370	1404	560	204	2417	7855	6647	6608	29947	44615
	Dilution 3	1106	217	776	2799	1232	3814	8535	6121	4883	23490	31854
	Dilution 4	849	1389	2415	1617	7985	13240	31511	2286	29200	11330	14314
	Dilution 5	599	1803	3613	1114	12707	19503	31130	2799	23085	65875	75989
	Dilution 6	1094	1134	1637	4981	7077	11405	21339	1763	23893	69022	93669
	Dilution 7	660	680	2725	7126	8649	11168	20481	2160	19987	93024	14698
RSD (%) (n=3)												
AL- Mix4	No dilution			8.0	0.9							
AL- Mix11	Dilution 1		3.8	1.1	3.0	2.1	1.4	2.0	2.2	1.2	5.2	5.2
	Dilution 2		3.4	4.9	0.6	0.2	1.3	2.2	2.9	3.2	8.6	11
	Dilution 3	14	1.2	1.8	2.0	0.9	1.4	1.6	1.8	1.6	4.7	5.9

Dilution 4	4.9	4.6	3.4	0.7	3.5	3.0	3.9	4.1	5.8	14	15
Dilution 5	2.8	4.6	3.9	4.1	4.4	3.5	3.1	4.0	3.6	6.2	6.4
Dilution 6	4.0	2.2	1.4	1.4	1.9	1.6	1.7	1.9	2.8	4.9	5.7
Dilution 7	1.7	1.0	1.8	1.6	1.9	1.3	1.4	2.0	2.0	5.6	7.7

Table 4: Linear correlation parameters between the peak area and the sampled air volume for toluene, benzene and α -pinene (Peak Area = $a \times \text{concentration}$). Three calibration standards were used and nine different concentrations were tested (three time each). R is the correlation coefficient determined for the best fit using the least squares method. ASTM recommendation: Correlation coefficient $R > 0.9$; values outside of the recommendation are underlined.

No.	Compounds	NGD 1 st generation		NGD 2 nd Generation		Sensitivity Ratio between NGD 1 st and 2 nd generation
		a	R	a	R	
1	n-Pentane	235 ± 35	0.9922	518 ± 42	0.9956	2.2
2	n-Hexane	413 ± 26	0.9951	1484 ± 107	0.9986	3.6
3	Benzene	977 ± 42	0.9965	1657 ± 86	0.9991	1.7
4	Toluene	2949 ± 148	0.9971	7077 ± 206	0.9992	2.4
5	n-Octane	3051 ± 125	0.9977	19382 ± 1490	0.9939	6.4
6	Ethylbenzene	5777 ± 200	0.9984	20295 ± 1270	0.9959	3.5
7	m,p-Xylene	5124 ± 243	0.9977	21643 ± 1670	0.9934	4.2
8	o-Xylene	7419 ± 315	0.9968	22870 ± 1520	0.9952	3.1
9	n-Nonane	7050 ± 325	0.9964	54063 ± 7690	<u>0.9772</u>	7.7
10	1,2,4-Trimethylbenzene	13883 ± 637	0.9963	63785 ± 4990	0.9941	4.6
11	n-Decane	12722 ± 797	0.9937	155580 ± 22900	<u>0.9754</u>	12

3.5. Optimization of NGD signal

Using the second generation of NGD, supplementary tests are performed to determine the sensitivity and the response linearity of MAVERIC instrument. For this, MAVERIC calibration curves are performed with the NGD 2nd generation detector heated at 50°C and using different gaseous concentrations varying between 16 and 300 ppb for a 13-alkanes (C₅-C₁₀) mixture diluted in dinitrogen. Peak areas are integrated over the peak width at the base. Obtained results (Supplementary Material – Figure S2) show a linear correlation ($y = a \times x$) between the peak area (y) and compound concentration (x) with a high correlation coefficients R as reported in Table 4. However, for n-nonane and n-decane, correlation coefficients of 0.9772 and 0.9754 are obtained respectively, which is higher than the acceptable value given by the ASTM recommendation. This result highlights a loss of linearity between determined peak area and tested concentration from 200 ppb level for compounds bearing 9 and 10 carbon atoms. A similar behavior was already observed in a qualification study of the NGD performances and it is related to the tested conditions (NGD temperature) and molecular weight of measured compounds as well as their concentration [25]. However, for VOCs monitoring in ambient air, a concentration of 200 ppb for n-nonane and n-decane is very high and it will not be probably measured.

Nevertheless, the comparison of the results obtained previously with the first generation of NGD used at ambient temperature, shows a gain of sensitivity by a factor of 1.7 to 12 depending on the measured compounds with a general trend to have better sensitivity for compounds having higher molecular weight excepting 1,2,4-trimethylbenzene. This difference may be explained by a lower adsorption between the compound and the layer coated on the beams surface of NGD. Due to this gain of sensitivity, the LOD of MAVERIC instrument will be significantly enhanced and are estimated on average at 1 ppb for benzene and 84 ppt for 1,2,4-trimethylbenzene for instance.

4. Conclusions

We presented in this work the development of a new miniaturized autonomous and versatile gas chromatograph for VOC monitoring using an innovative nano-gravimetric detector NGD based on NEMS resonator array. The GC system has a robust design and operates using only helium as carrier gas with a consumption of $2.0 \text{ mL}\cdot\text{min}^{-1}$ allowing the total analysis time to remain shorter than 20 minutes, this for compounds bearing from 5 to 10 carbon atoms. The system is standalone, portable and is fully controlled by homemade software with an automatic synchronize with NGD detector software. It can be connected to internet to be remotely controlled and is very adapted for a long period field campaign test or environmental monitoring and air quality survey. Optimal experimental conditions of MAVERIC are successfully determined at sub-ppb to few ppt level and the instrument allows reliable detection of complex mixtures of compounds. Comparing to other instruments, MAVERIC presents a good compromise between portability, gas consumption, time analysis and LOD. Nevertheless, MAVERIC instrument should be validated in comparison with other online analytical instruments during laboratory tests and then during field campaign measurements. Further works will be conducted to validate MAVERIC performances using real sample analysis and *in situ* conditions. The main application perspectives are to use MAVERIC for outdoor air monitoring and during field campaigns in extreme environments. For this, a nafion system could be added on the sample inlet to avoid the effect of humidity present in outdoor samples. Besides, a fine calibration of the instrument is required for all tested compounds to perform quantitative measurements because NGD response is analyte-dependent. It would be also interesting to use NGD under temperature ramp to have the same sensitivity for the compounds having growing number of carbon atoms to avoid calibration of all compounds. We also plan to rearrange the different parts to have a more compact system.

5. Acknowledgements

The development of MAVERIC was partly funded by the Defi – Instrumentation aux limites (AMI2013-INSTRUM) from CNRS and Institut Pierre Simon Laplace in Paris.

6. References

- [1] R. Koppmann, Volatile organic compounds in the atmosphere, Wiley Online Library (2007).
- [2] G. Huang, R. Brook, M. Crippa, G. Janssens-Maenhout, C. Schieberle, C. Dore, D. Guizzardi, M. Muntean, E. Schaaf, R. Friedrich, Speciation of anthropogenic emissions of non-methane volatile organic compounds: a global gridded data set for 1970–2012, *Atmos. Chem. Phys.* 17 (12) (2017) 7683.

- [3] M. Rizk, F. Guo, M. Verrielle, M. Ward, S. Dusanter, N. Blond, N. Locoge, C. Schoemaeker, Impact of material emissions and sorption of volatile organic compounds on indoor air quality in a low energy building: Field measurements and modeling, *Indoor Air* 28 (6) (2018) 924-935, <https://doi.org/10.1111/ina.12493>.
- [4] A.C. Lewis, J.D. Lee, P.M. Edwards, M.D. Shaw, M.J. Evans, S.J. Moller, K.R. Smith, J.W. Buckley, M. Ellis, S.R. Gillot, A. White, Evaluating the performance of low cost chemical sensors for air pollution research, *Faraday Discuss.* 189 (0) (2016) 85-103, <https://doi.org/10.1039/C5FD00201J>.
- [5] E. Woolfenden, Monitoring VOCs in Air Using Sorbent Tubes Followed by Thermal Desorption-Capillary GC Analysis: Summary of Data and Practical Guidelines, *J. Air Waste Manag. Assoc.* 47 (1) (1997) 20-36, <https://doi.org/10.1080/10473289.1997.10464411>.
- [6] W.A. McGlenny, J.D. Pleil, G.F. Evans, K.D. Oliver, M.W. Holdren, W.T. Winberry, Canister-Based Method for Monitoring Toxic VOCs in Ambient Air, *J. Air Waste Manag. Assoc.* 41 (10) (1991) 1308-1318, <https://doi.org/10.1080/10473289.1991.10466924>.
- [7] F.J. Santos, M.T. Galceran, The application of gas chromatography to environmental analysis, *TrAC, Trends Anal. Chem.* 21 (9) (2002) 672-685, [https://doi.org/https://doi.org/10.1016/S0165-9936\(02\)00813-0](https://doi.org/https://doi.org/10.1016/S0165-9936(02)00813-0).
- [8] W. Lindinger, A. Jordan, Proton-transfer-reaction mass spectrometry (PTR-MS): on-line monitoring of volatile organic compounds at pptv levels, *Chem. Soc. Rev.* 27 (5) (1998) 347-375, <https://doi.org/10.1039/A827347Z>.
- [9] Y.I. Yashin, A.Y. Yashin, Miniaturization of Gas-Chromatographic Instruments, *J. Anal. Chem.* 56 (9) (2001) 794-805, <https://doi.org/10.1023/A:1016795926329>.
- [10] A. Gałuszka, Z.M. Migaszewski, J. Namieśnik, Moving your laboratories to the field – Advantages and limitations of the use of field portable instruments in environmental sample analysis, *Environ. Res.* 140 (2015) 593-603, <https://doi.org/https://doi.org/10.1016/j.envres.2015.05.017>.
- [11] J. A. Contreras, J. A. Murray, S. E. Tolley, J. L. Oliphant, D. H. Tolley, S. A. Lammert, E. D. Lee, D. W. Later, M. L. Lee, Hand-portable gas chromatograph-toroidal ion trap mass spectrometer (GC-TMS) for detection of hazardous compounds, *J. Am. Soc. Mass Spectrom.* 19 (10) (2008) 1425-1434, <https://doi.org/10.1016/j.jasms.2008.06.022>.
- [12] J.T. Kelly, A. Qualley, G.T. Hughes, M.H. Rubenstein, T.A. Malloy, T. Piatkowski, Improving Quantification of tabun, sarin, soman, cyclosarin, and sulfur mustard by focusing agents: A field portable gas chromatography-mass spectrometry study, *J. Chromatogr. A.* 1636 (2021) 461784, <https://doi.org/https://doi.org/10.1016/j.chroma.2020.461784>.
- [13] M. Marć, B. Zabiegała, J. Namieśnik, Mobile Systems (Portable, Handheld, Transportable) for Monitoring Air Pollution, *Crit. Rev. Anal. Chem.* 42 (1) (2012) 2-15, <https://doi.org/10.1080/10408347.2011.607079>.
- [14] R. Nasreddine, V. Person, C.A. Serra, S. Le Calvé, Development of a novel portable miniaturized GC for near real-time low level detection of BTEX, *Sens. Actuators B: Chem.* 224 (2016) 159-169, <https://doi.org/https://doi.org/10.1016/j.snb.2015.09.077>.
- [15] M. Wei-Hao Li, A. Ghosh, A. Venkatasubramanian, R. Sharma, X. Huang, X. Fan, High-Sensitivity Micro-Gas Chromatograph-Photoionization Detector for Trace Vapor Detection, *ACS Sensors* 6 (6) (2021) 2348-2355, <https://doi.org/10.1021/acssensors.1c00482>.
- [16] A. Garg, M. Akbar, E. Vejerano, S. Narayanan, L. Nazhandali, L.C. Marr, M. Agah, Zebra GC: A mini gas chromatography system for trace-level determination of hazardous air pollutants, *Sensors and Actuators B: Chemical* 212 (2015) 145-154, <https://doi.org/https://doi.org/10.1016/j.snb.2014.12.136>.
- [17] C.J. Lu, J. Whiting, R.D. Sacks, E.T. Zellers, Portable gas chromatograph with tunable retention and sensor array detection for determination of complex vapor mixtures, *J. Anal. Chem.* 75 (6) (2003) 1400-9, <https://doi.org/10.1021/ac026092n>.
- [18] R.A. Iglesias, F. Tsow, R. Wang, E.S. Forzani, N. Tao, Hybrid Separation and Detection Device for Analysis of Benzene, Toluene, Ethylbenzene, and Xylenes in Complex Samples, *J. Anal. Chem.* 81 (21) (2009) 8930-8935, <https://doi.org/10.1021/ac9015769>.

- [19] C. Chen, F. Tsow, K.D. Campbell, R. Iglesias, E. Forzani, N. Tao, A Wireless Hybrid Chemical Sensor for Detection of Environmental Volatile Organic Compounds, *IEEE Sens. J.* 13 (5) (2013) 1748-1755, <https://doi.org/10.1109/JSEN.2013.2239472>.
- [20] A. Garg, M. Akbar, E. Vejerano, S. Narayanan, L. Nazhandali, L.C. Marr, M. Agah, Zebra GC: A mini gas chromatography system for trace-level determination of hazardous air pollutants, *Sens. Actuators B: Chem.* 212 (2015) 145-154, <https://doi.org/10.1016/j.snb.2014.12.136>.
- [21] J.H. Sun, D.F. Cui, X. Chen, L.L. Zhang, H.Y. Cai, H. Li, A micro gas chromatography column with a micro thermal conductivity detector for volatile organic compound analysis, *Rev. Sci. Instrum.* 84 (2) (2013) 025001, <https://doi.org/10.1063/1.4789526>.
- [22] S. Zampolli, I. Elmi, F. Mancarella, P. Betti, E. Dalcanale, G.C. Cardinali, M. Severi, Real-time monitoring of sub-ppb concentrations of aromatic volatiles with a MEMS-enabled miniaturized gas-chromatograph, *Sens. Actuators B: Chem.* 141 (1) (2009) 322-328, <https://doi.org/10.1016/j.snb.2009.06.021>.
- [23] V. Selimovic, D. Ketcherside, S. Chaliyakunnel, C. Wielgasz, W. Permar, H. Angot, D.B. Millet, A. Fried, D. Helmig, L. Hu, Atmospheric biogenic volatile organic compounds in the Alaskan Arctic tundra: constraints from measurements at Toolik Field Station, *Atmos. Chem. Phys.* 22 (21) (2022) 14037-14058, <https://doi.org/10.5194/acp-22-14037-2022>.
- [24] P. Van Overmeiren, K. Demeestere, A. Mangold, A. Delcloo, H. Van Langenhove, C. Walgraeve, Year-round measurement of atmospheric volatile organic compounds using sequential sampling in Dronning Maud Land, East-Antarctica, *Atmos. Environ.* 314 (2023) 120074, <https://doi.org/10.1016/j.atmosenv.2023.120074>.
- [25] L. Alonso Sobrado, M. Loriau, S. Junca, C. Tremaudant, P. Puget, E. Colinet, J. Randon, Characterization of Nano-Gravimetric-Detector Response and Application to Petroleum Fluids up to C34, *Analytical Chemistry* (2020), <https://doi.org/10.1021/acs.analchem.0c03157>.
- [26] M. Li, E.B. Myers, H.X. Tang, S.J. Aldridge, H.C. McCaig, J.J. Whiting, R.J. Simonson, N.S. Lewis, M.L. Roukes, Nanoelectromechanical Resonator Arrays for Ultrafast, Gas-Phase Chromatographic Chemical Analysis, *Nano Lett.* 10 (10) (2010) 3899-3903, <https://doi.org/10.1021/nl101586s>.
- [27] P.R. Mahaffy, C.R. Webster, M. Cabane, P.G. Conrad, P. Coll, S.K. Atreya, R. Arvey, M. Barciniak, M. Benna, L. Bleacher, W.B. Brinckerhoff, J.L. Eigenbrode, D. Carignan, M. Cascia, R.A. Chalmers, J.P. Dworkin, T. Errigo, P. Everson, H. Franz, R. Farley, S. Feng, G. Frazier, C. Freissinet, D.P. Glavin, D.N. Harpold, D. Hawk, V. Holmes, C.S. Johnson, A. Jones, P. Jordan, J. Kellogg, J. Lewis, E. Lyness, C.A. Malespin, D.K. Martin, J. Maurer, A.C. McAdam, D. McLennan, T.J. Nolan, M. Noriega, A.A. Pavlov, B. Prats, E. Raaen, O. Sheinman, D. Sheppard, J. Smith, J.C. Stern, F. Tan, M. Trainer, D.W. Ming, R.V. Morris, J. Jones, C. Gundersen, A. Steele, J. Wray, O. Botta, L.A. Leshin, T. Owen, S. Battel, B.M. Jakosky, H. Manning, S. Squyres, R. Navarro-González, C.P. McKay, F. Raulin, R. Sternberg, A. Buch, P. Sorensen, R. Kline-Schoder, D. Coscia, C. Szopa, S. Teinturier, C. Baffes, J. Feldman, G. Flesch, S. Forouhar, R. Garcia, D. Keymeulen, S. Woodward, B.P. Block, K. Arnett, R. Miller, C. Edmonson, S. Gorevan, E. Mumm, The Sample Analysis at Mars Investigation and Instrument Suite, *Space Sci. Rev.* 170 (1) (2012) 401-478, <https://doi.org/10.1007/s11214-012-9879-z>.
- [28] V. Moulay, C. Freissinet, M. Bigourd, A. Buch, M. Ancelin, E. Couturier, C. Breton, M.G. Trainer, C. Szopa, Selection and Analytical Performances of the Dragonfly Mass Spectrometer Gas Chromatographic Columns to Support the Search for Organic Molecules of Astrobiological Interest on Titan, *Astrobiology* 23 (2) (2023) 213-229, <https://doi.org/10.1089/ast.2022.0038>.
- [29] M. Rachkidi, L. Alonso-Sobrado, G. Raffin, E. Colinet, J. Randon, Dual detection chromatographic method for fast characterization of nano-gravimetric detector, *Talanta* 257 (2023) 124359, <https://doi.org/10.1016/j.talanta.2023.124359>.
- [30] EPA, Compendium of Methods for the Determination of Toxic Organic Compounds in Ambient Air, Determination of Volatile Organic Compounds in Ambient Air Using Active Sampling Onto Sorbent Tubes, Compendium Method TO-17, in: O. U.S. Environmental Protection Agency Cincinnati (Ed.) Center for Environmental Research Information Office of Research and Development, January 1999.

- [31] A. Borbon, P. Dominutti, A. Panopoulou, V. Gros, S. Sauvage, M. Farhat, C. Afif, N. Elguindi, A. Fornaro, C. Granier, J. R. Hopkins, E. Liakakou, T. Nogueira, T. Corrêa dos Santos, T. Salameh, A. Armangaud, D. Piga, O. Perrussel, Ubiquity of Anthropogenic Terpenoids in Cities Worldwide: Emission Ratios, Emission Quantification and Implications for Urban Atmospheric Chemistry, *J. Geophys. Res. Atmos.* 128 (7) (2023) e2022JD037566, <https://doi.org/https://doi.org/10.1029/2022JD037566>.
- [32] P. A. Dominutti, T. Nogueira, A. Borbon, M. Andrade, A. Fornaro, One-year of NMHCs hourly observations in São Paulo megacity: meteorological and traffic emissions effects in a large ethanol burning context, *Atmos. Environ.* 142 (2016) 371-382, <https://doi.org/https://doi.org/10.1016/j.atmosenv.2016.08.008>.
- [33] M. Farhat, C. Afif, S. Zhang, S. Dusanter, H. Delbarre, V. Riffault, S. Sauvage, A. Borbon, Investigating the industrial origin of terpenoids in a coastal city in northern France: A source apportionment combining anthropogenic, biogenic, and oxygenated VOC, *Sci. Total Environ.* 928 (2024) 172098, <https://doi.org/https://doi.org/10.1016/j.scitotenv.2024.172098>.
- [34] N. Manousi, W. Wojnowski, J. Płotka-Wasyłka, V.F. Samanidou, Blue applicability grade index (BAGI) and software: a new tool for the evaluation of method practicality, *GREEN CHEMISTRY* (2023).
- [35] K. Kuklinska, L. Wolska, J. Namiesnik, Air quality policy in the U.S. and the EU – a review, *Atmos. Pollut. Res.* 6 (1) (2015) 129-137, <https://doi.org/https://doi.org/10.5094/APR.2015.015>.
- [36] Directive 2008/50/CE du Parlement européen et du Conseil du 21 mai 2008 concernant la qualité de l'air ambiant et un air pur pour l'Europe

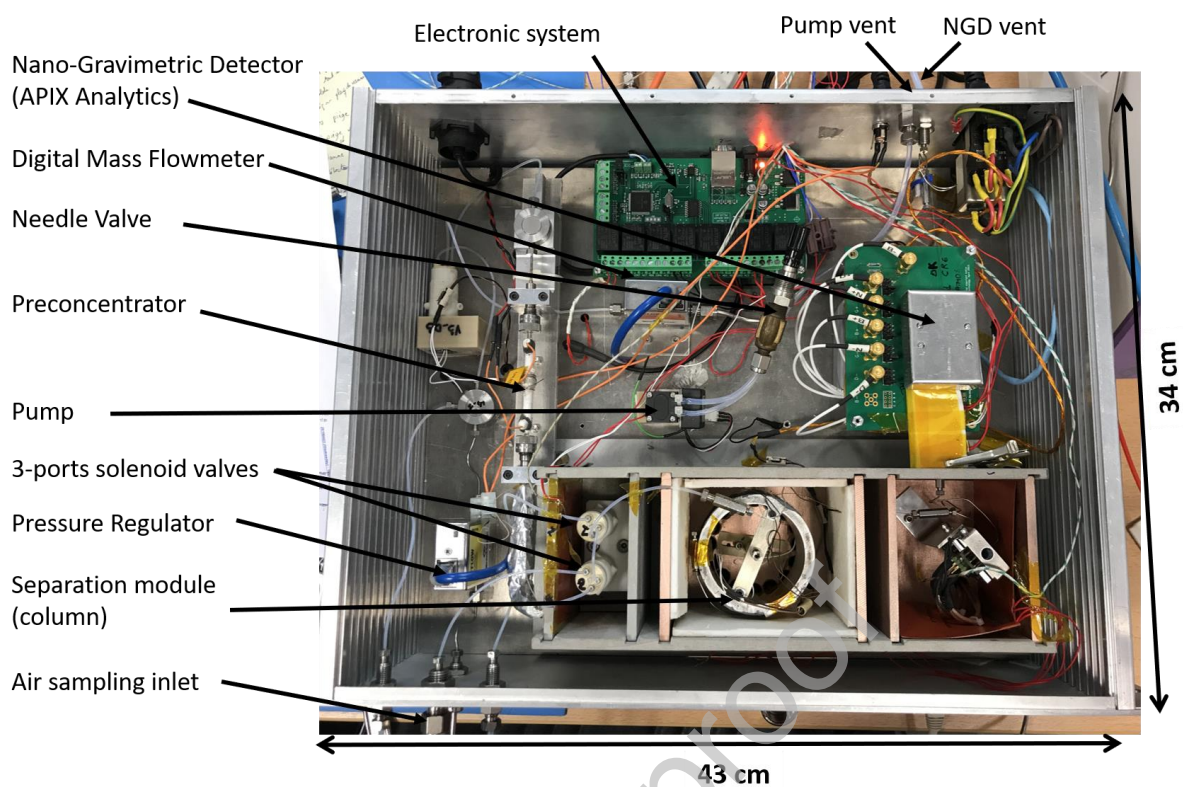

Figure 1: Photograph of MAVERIC portable GC prototype seen from the top.

Journal Pre-proof

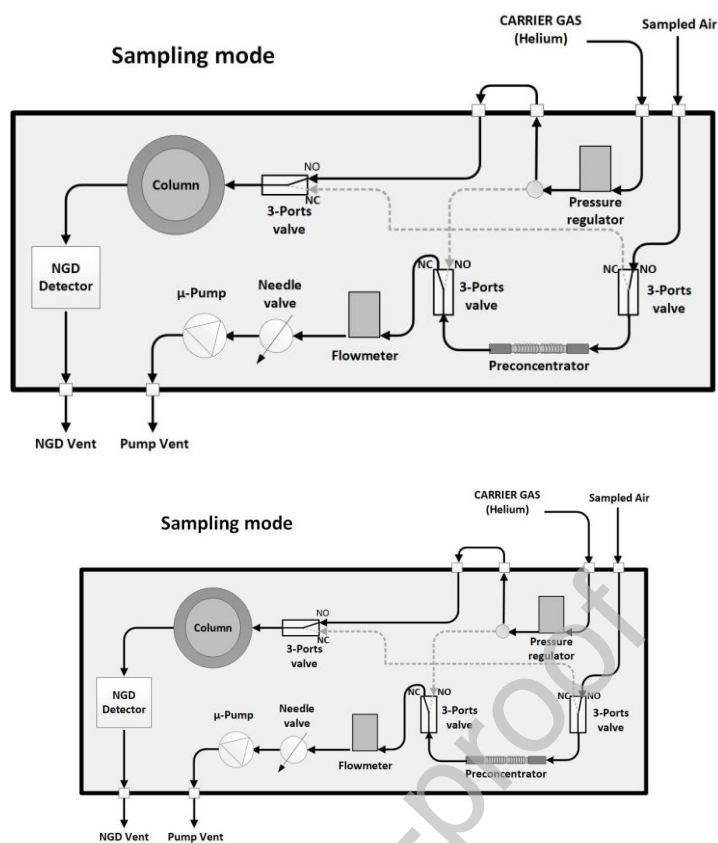

Figure 2: Schematic drawing of the MAVERIC instrument in the sampling and analysis modes. Plain and black lines indicate the used fluidic paths while the grey discontinuous lines presents the unused ones during each mode.

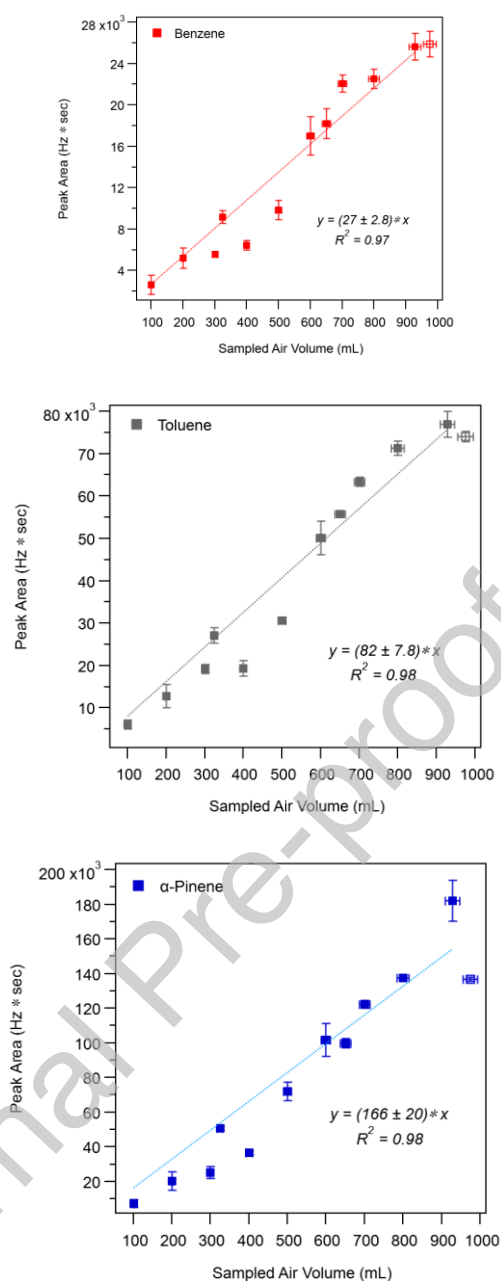

Figure 3 : Peak area correlation with the sampled air volume (sampled volume) tested for benzene, toluene and α -pinene. A standard mixture (AL-Mix4) of isoprene, benzene, toluene and α -pinene at 10 ppb each is used. Each point is an average value obtained after 3 repetitive tests. Vertical error bars represent the standard deviation of the triplicates of peak areas, while the horizontal ones represent the uncertainty evaluated on the volume of sampled air. Only the plain points are considered for the best fit (forced zero Y-intercept) and R² is the correlation coefficient determined using the least squares method. Empty points represent the estimated breakthrough volume reached experimentally.

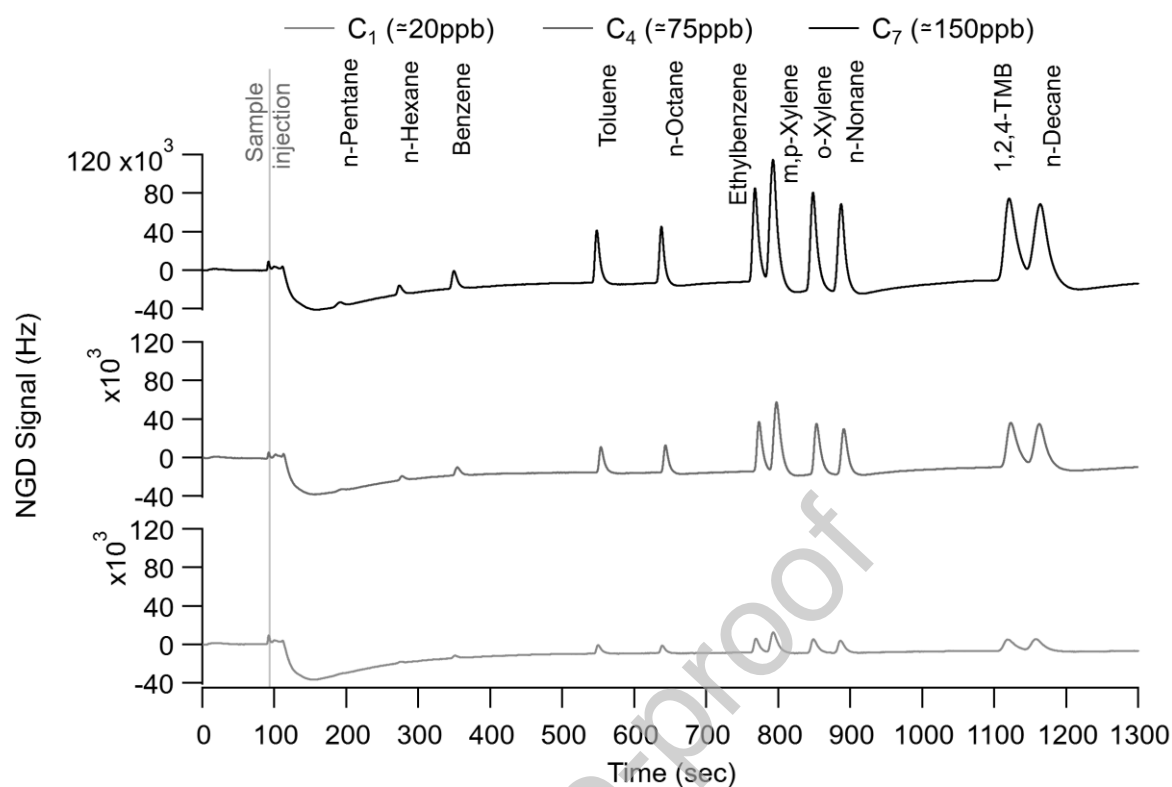

Figure 4: Chromatograms obtained for 3 different concentrations labeled C₁, C₃ and C₇ (among 7 tested diluted mixture) of the test compounds mixture. The mentioned concentration gives an order of magnitude because the precise concentration of each compound is calculated considering the initial concentration and the different uncertainties related to the gas mixture and the dilution process. Gray vertical line corresponds to the injection of sample after flash desorption of the trap.

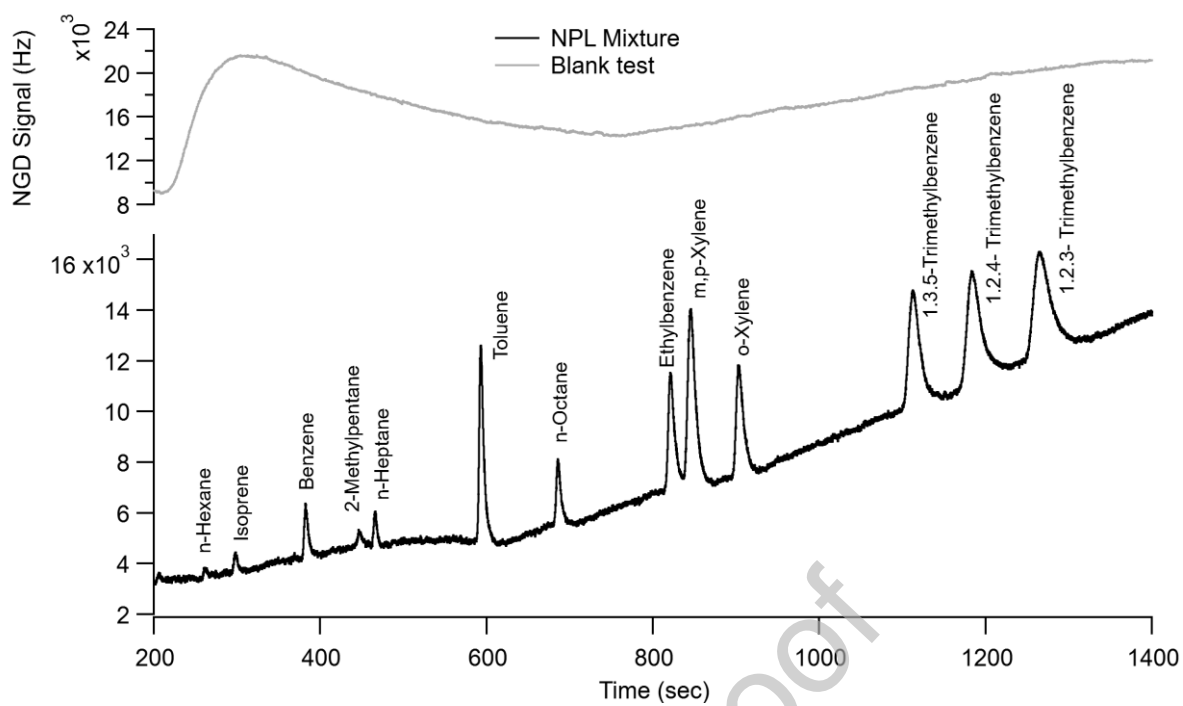

Figure 5: Chromatograms obtained with (NPL-Mix36) in comparison with blank tests.

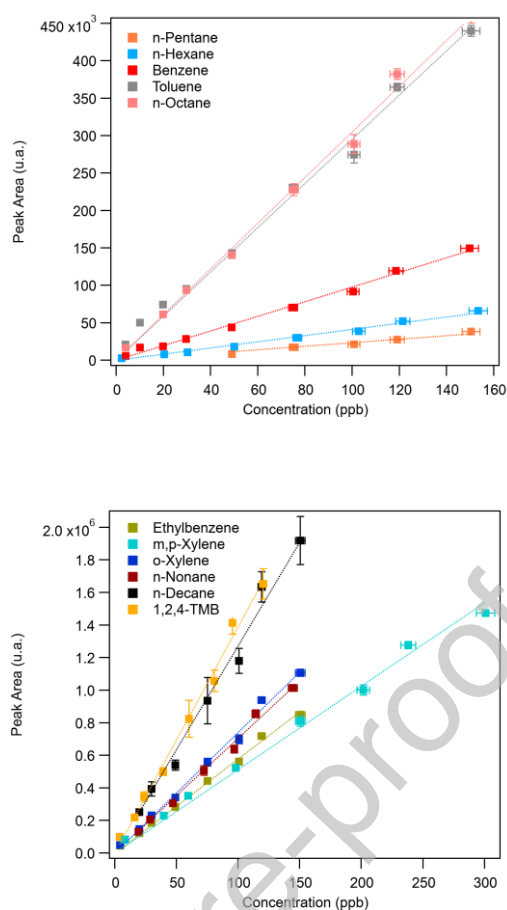
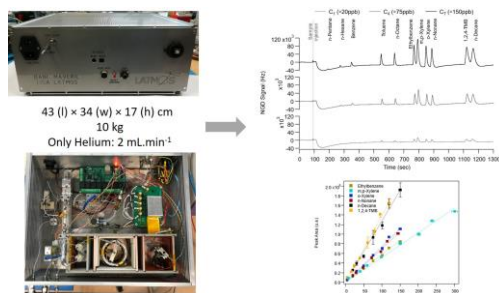

Figure 6 : Calibration curves obtained for MAVERIC by injecting different concentration of AL-Mix11 and calculating the analyzer response (peak area). Each point represents an average value over 3 replicates. Vertical error bars represent 1 σ variation on peak areas while the horizontal ones represent the uncertainty evaluated on the generated concentration (depending on the uncertainty of initial gas concentration used and the accuracy of the mass flow controllers used for dilution).

Graphical Abstract



Credit authorship contribution statement

Malak RIZK-BIGOURD: Methodology, Project Administration, Supervision, Validation, Writing original draft, Writing review & editing. **Cécile GAIMOZ:** Methodology, Writing, review & editing. **Eric COLINET:** Conceptualization, Software, Visualization, Writing, original draft. **Jean-Pierre PINEAU:** Conceptualization, Methodology, Visualization, Writing original draft. **Vincent GUERRENI:** Methodology, Visualization, Writing, original draft. **Vivien TRANIER:** Software, Writing original draft. **Fabrice BERTRAND:** Software, Writing original draft. **David COSCIA:** Supervision, Writing review & editing. **Anaïs FERON:** Methodology, Writing review & editing. **Michel CABANE:** Conceptualization, Writing review & editing. **Cyril SZOPA:** Conceptualization, Validation, Writing review & editing. **Patrice COLL:** Conceptualization, Writing review & editing. **Agnès BORBON:** Conceptualization, Methodology, Funding acquisition, Writing review & editing. **François RAVETTA:** Conceptualization, Funding acquisition, Writing review & editing.

Declaration of interests

The authors declare that they have no known competing financial interests or personal relationships that could have appeared to influence the work reported in this paper.

The authors declare the following financial interests/personal relationships which may be considered as potential competing interests:

Journal Pre-proof