



**HAL**  
open science

## Accessible techniques for digital building surveying

Bernd Dahlgrün, Till Rudolph, Laurent Lescop

► **To cite this version:**

Bernd Dahlgrün, Till Rudolph, Laurent Lescop. Accessible techniques for digital building surveying. Ing. Bernd Dahlgrün; Till Rudolph. HafenCity University Hamburg, 2024. hal-04844758

**HAL Id: hal-04844758**

**<https://hal.science/hal-04844758v1>**

Submitted on 19 Dec 2024

**HAL** is a multi-disciplinary open access archive for the deposit and dissemination of scientific research documents, whether they are published or not. The documents may come from teaching and research institutions in France or abroad, or from public or private research centers.

L'archive ouverte pluridisciplinaire **HAL**, est destinée au dépôt et à la diffusion de documents scientifiques de niveau recherche, publiés ou non, émanant des établissements d'enseignement et de recherche français ou étrangers, des laboratoires publics ou privés.

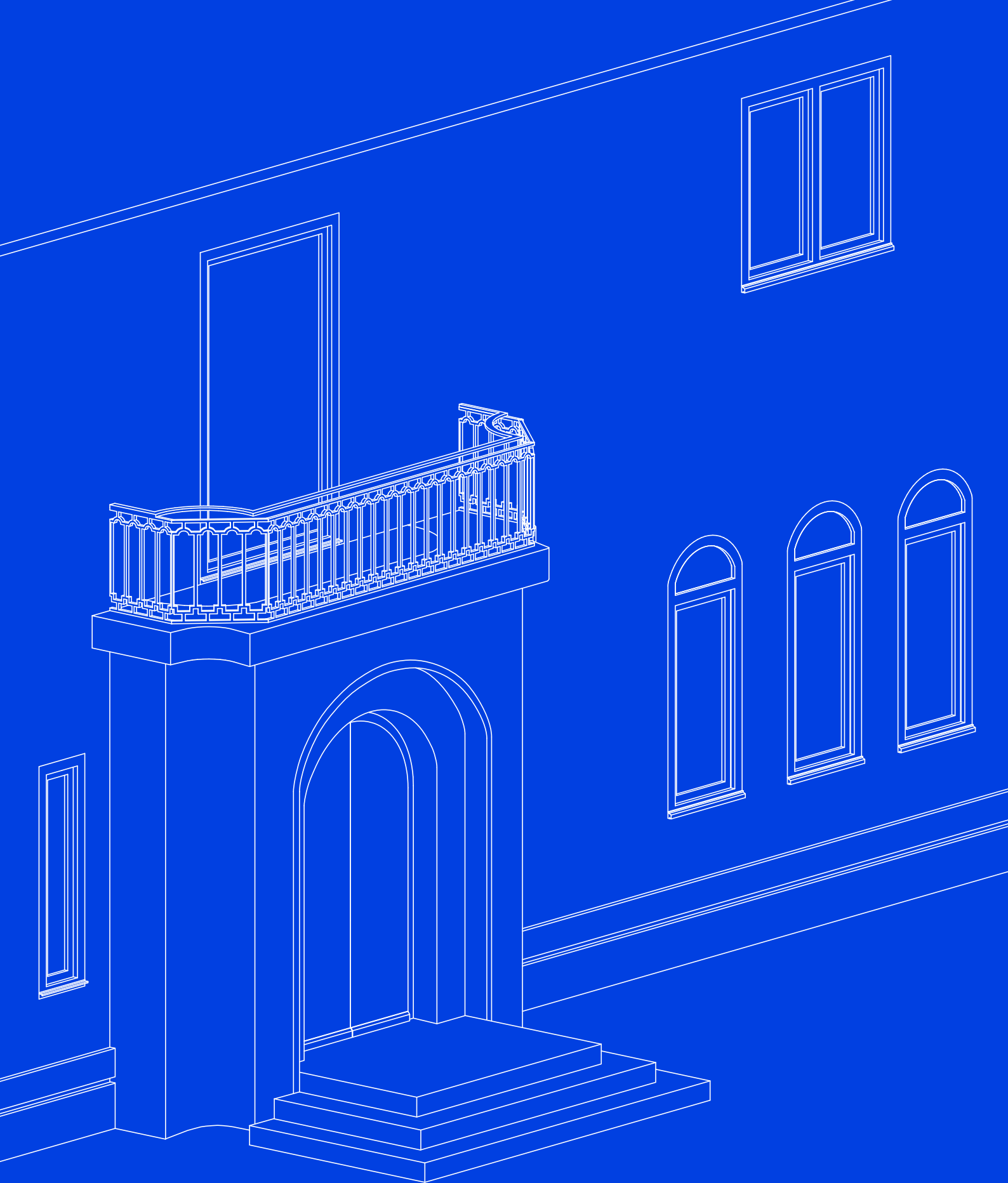

# ACCESSIBLE TECHNIQUES FOR DIGITAL BUILDING SURVEYING

M. Sc. Architecture - HafenCity University Hamburg



# ACCESSIBLE TECHNIQUES FOR DIGITAL BUILDING SURVEYING

## SUPERVISORS/EDITORS

Prof. Dr.-Ing. Bernd Dahlgrün

Till Rudolph

## STUDENTS/AUTHORS

Elmira Akbarzada

María Albert Enguádanos

Sedanur Albustanli

Michèle Armbrecht

Fritz Baader

Hendrick Behringer

Tabea Bläse

Lena Böttcher

Wladislav Gert

Barbora Hajicova

Myriam Herder

Gina Hommola

Alina Ivanova

Enver Can Kabaran

Emma Kelly

Katharina Koch

Marianela Lopez

Moritz Mahr

Timo Margaritidis

Marisa Martin Pelegrina

Mostafa Nasri

Anna Plate

Viktoria Probst

Sina Richter

Henri Sebgo

Jakob Thon

Anika Wallbrecher

Benedikt Wigro

Hermann Zepp

Cover: Close-up of the entrance portal, CAD model of the Ohlendorff Villa

This course was supported by FRANK Beteiligungsgesellschaft mbH, providing access to the Ohlendorff Villa. Additionally, the publication was made possible through their generous financial support. We would like to express our heartfelt thanks to our sponsor.

# CONTENT

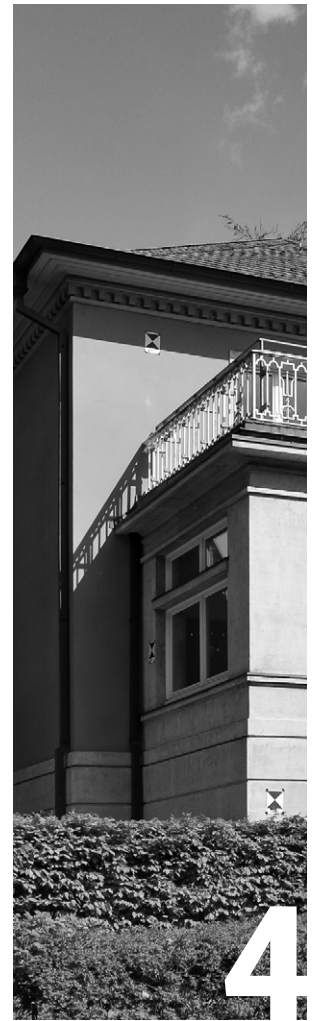
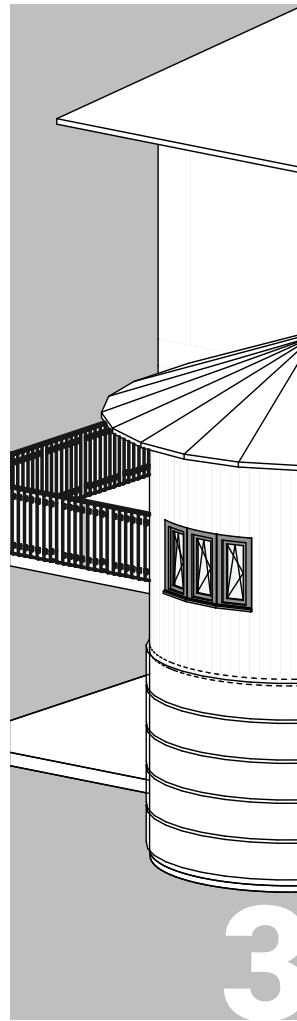

<b>INTRODUCTION</b>	<b>6</b>	<b>METHODS</b>	<b>34</b>	<b>OUTCOME</b>	<b>268</b>	<b>APPENDIX</b>	<b>282</b>
Preface	8	Laser		Analysis	270	Bibliography	284
- Bernd Dahlgrün	8	- Faro	36	- Costs	271	List of figures	290
- Laurent Lescop	12	Laser		- Time	273	Imprint	298
- Thomas Kersten	26	- Matterport	62	- Precision	275		
Presentation Villa	30	Photo		- Basic Requirements	277		
		- outside	92	Conclusion	278		
		Photo					
		- inside	114				
		Photo					
		- Theta 360°	146				
		Lidar					
		- Apps	176				
		Manual					
		- Distometer	226				
		Manual					
		- Disto/Apps	248				

# INTRODUCTION





# PREFACE



If we are to meet climate goals in the construction sector, we must significantly increase the renovation and repurposing of buildings beyond our current efforts. In the future, architects will plan the majority of their projects within the existing building stock, as we will need to make greater use of, and extend the life of, existing resources. Building digitization, specifically the representation of existing structures in a BIM model, is the foundation for planning in this context.

In an elective course within the Master's program in Architecture at HafenCity University (HCU), we addressed two research questions in light of this challenge: 'What methods and processes can we use today to digitize existing buildings?' Our focus was on the overall processes, rather than on evaluating specific methods and tools. Such evaluations—regarding precision, applicability, and susceptibility to error—are rooted in geodesy and geoinformatics, and have already been partially published in those fields. As architects, we are more interested in the entire process, from building surveying to the creation of a BIM-ready 3D model. This includes data preparation and modeling in CAD programs. The primary goal of this semester project was not to create a precise 3D model, but to identify the hurdles, challenges, errors, and inaccuracies encountered along the way, using different methods and tools by students with the architectural background of a Master's

program. All surveying methods were applied to the same building, the Ohlendorff Villa in Hamburg-Volksdorf, evaluated based on the same criteria and patterns, and ultimately compared with each other.

The second research question that followed was: 'Which of the methods are accessible to architects and can be effectively used by them?' The range of surveying methods used spanned from highly precise laser scanners available through the Geodesy and Geoinformatics program at HCU to mobile phone applications, which can be downloaded by anyone from the respective app stores. The building surveys using the systems established in geoinformatics were conducted concurrently by Prof. Dr. Thomas Kersten, head of the Geoinformatics Laboratory at HCU, and geoinformatics students. The architecture students were introduced to these systems (Faro laser scanner and Matterport) by the geoinformatics students and were able to operate these complex instruments themselves to some extent. Throughout the surveying process, the architecture students meticulously documented each step and the time involved. Other architecture students measured the Ohlendorff Villa using photogrammetry systems, conventional cameras, mobile phone applications, and surveying tools from Bosch and Leica, supported by Prof. Laurent Lescop from ENSA Nantes in France. Prof. Lescop, who researches the digi-

tization of spaces and uses cost-effective tools in his work, provided valuable tutorials on his blog and supported the students in preparing and processing the data via Zoom. We sought to determine how these low-cost systems compare to the highly precise and expensive systems of geoinformatics. As a reference for time, cost, and susceptibility to error, we also conducted manual surveys using a folding rule, measuring tape, and laser pointer.

These numerous surveying methods unfold across two seemingly opposing systems: space documentation and component surveying. Laser-, image-, and lidar-based systems document spaces, capturing the void between structural components, including furnishings and fixtures. This spatial documentation is then converted into point clouds or meshes using specific software, which are subsequently imported into CAD programs, where they serve as a template for the CAD model. In the CAD program, the 'voids' of the point clouds are filled with digital components. This process is comparable to a concrete formwork (spatial template) being filled with concrete (structural components). The unique potential of these systems lies in the ability to capture a space at a specific point in time, which can be preserved in the 3D model. Ultimately, it is the spaces and their architectural qualities that largely define the value of real estate, rather than the structural components alone. These documented spatial qualities can be maintained in the 3D models created by these systems.

In component surveying, such as with manual measurements and the surveying systems from Bosch and Leica, the dimensions and distances between components are measured. These serve as the numerical foundation for creating 3D CAD models. While the first system conceptualizes spaces being filled with components, in the second system, components are directly dimensioned and positioned numerically within CAD programs, based on

documented distances.

This documentation was produced as part of a 'Zukunftslabor' (Future-Lab) in the Master's program in Architecture at HCU. The Architecture program has incorporated this unique teaching format into its curriculum as a standard format for Master's students. In these Future-Labs, research questions are initially posed and students then develop their insights independently. The role of the instructor shifts from a knowledge conveyor to that of an organizer, methods advisor, and quality monitor.

In this Future-Lab, 30 Master's students were divided into eight groups, each focusing on one surveying instrument, namely: the Faro laser scanner, the Matterport laser scanner, photogrammetry using cameras and drones, photogrammetry with a Theta 360° camera, lidar-based mobile applications such as Scaniverse and Polycam, systems from Bosch and Leica, and, of course, the reference method of manual measurement. All systems were applied to the same building on the same day, documented using the same templates, and evaluated based on the same criteria—time, cost, precision, and error susceptibility. In the end, the results were compared, and conclusions were drawn about the applicability of these systems for architects.

This course would not have been possible without the support of FRANK Beteiligungsgesellschaft mbH, which granted us access to the Ohlendorff Villa and generously provided financial support, allowing us to publish this work. I would like to extend my heartfelt thanks to them on behalf of all participants.

Bernd Dahlgrün







## SURVEYING IN AN OCCUPIED BUILDING

### DIGITAL SURVEYING: A WELL-ESTABLISHED BUT COMPLEX TECHNIQUE

Digital surveying of an inhabited building presents specific challenges, particularly due to the presence of furniture, decorative objects, and other temporary elements that complicate the installation, data acquisition, and post-processing stages. These objects often obstruct and obscure the walls and key architectural

features, making it difficult to capture accurate architectural data. In 3D surveys, this partial occlusion of architectural surfaces by interior elements introduces anomalies in the digital models, which then require extensive data cleaning. This post-processing phase, often time-consuming and labour-intensive, aims to eliminate visual interferences and produce a model that accurately reflects the true architectural form.

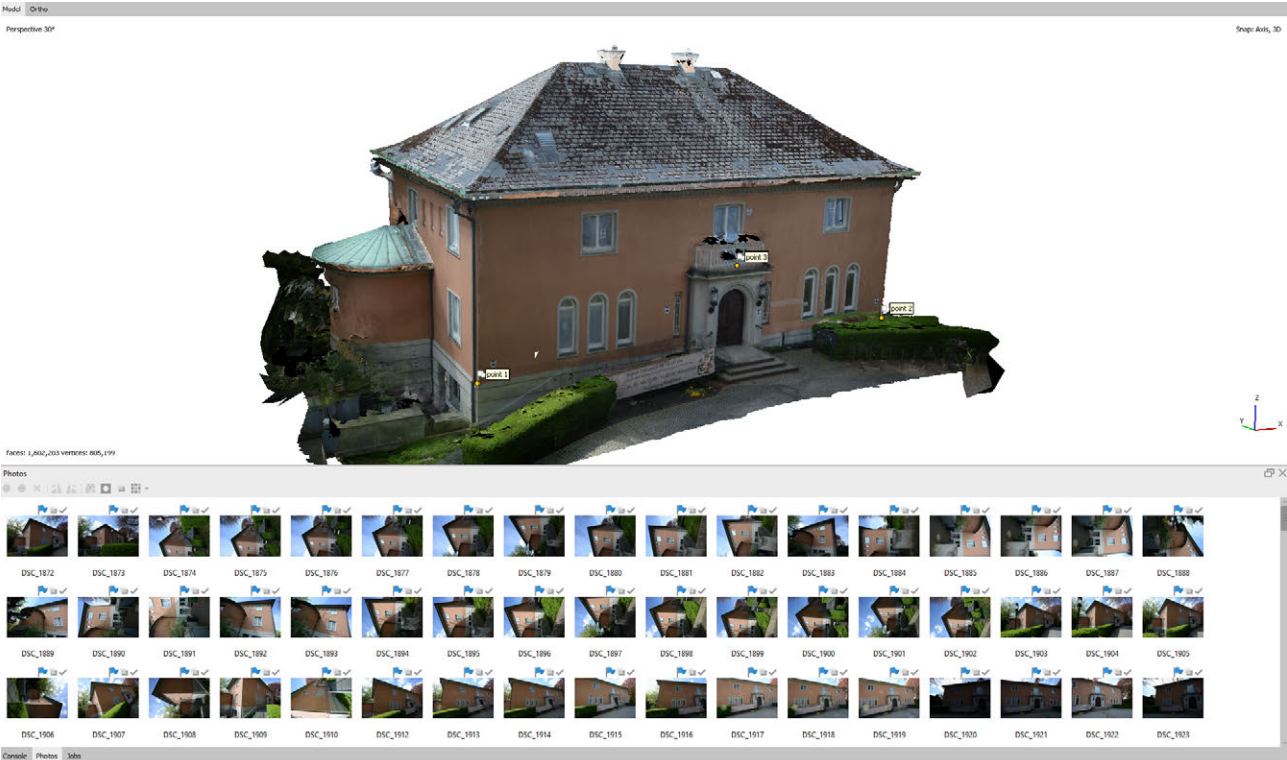

Fig. 1.1.1: Metashape interface

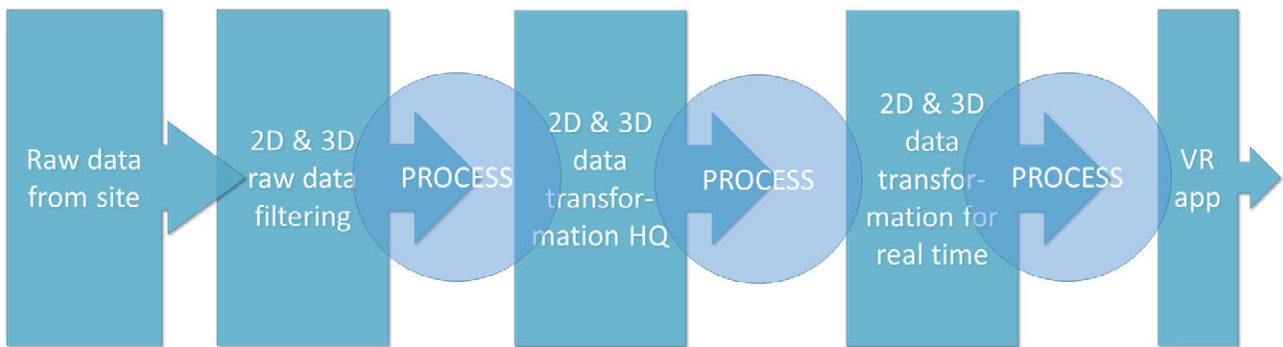

Fig. 1.1.2: Survey process overview

The definition of a technical workflow for the digital survey of an inhabited building is a critical issue due to the numerous constraints inherent to the environment. The workflow encompasses the entire sequence of operations, including the choice of equipment, software, personnel, and the specific local challenges. It is essential to establish a tailored process that considers several key factors: the setup and data acquisition time, the required precision for the survey, and the specific characteristics of the materials present, such as glass and reflective surfaces, which often introduce errors into the digital models. This process involves a combination of technical expertise and the appropriate equipment.

Complex architectural forms pose additional challenges, requiring specialized solutions to ensure accurate representation. Limited access to certain areas may also necessitate adjustments in the deployment of equipment. Furthermore, lighting conditions play a crucial role in the quality of the survey data. Excessive brightness, strong contrasts, or, conversely, significant dimness can affect the accuracy of the collected data. Therefore, a comprehensive survey strategy must account for these variables to minimize errors and optimize the efficiency of capturing architectural information.

## TECHNICAL OVERVIEW

In the projects presented here, three different techniques were tested: two of them are well-established, while the third remains experimental.

The first method, laser scanning, uses a sensor that emits a 360° laser beam around the scanner and measures the time it takes for each pulse to return after being reflected by a surface. The sensor records both the position and colour of each identified point. The precision is millimetric, and thousands of points are captured at each station, which corresponds to the sensor's position. Depending on the complexity of the site, multiple stations may be required, and specialized software correlates the data points to create a unified point cloud. A point cloud is the complete set of points recorded. The range of the laser scanner depends on the model, varying from 60 meters to a kilometre, but it is important to note that the quality and density of the data are linked to distance—the closer the object, the denser and more precise the information. From the point cloud, a coloured mesh is created, which can later be textured.

The second technique, photogrammetry, uses photographs to measure distances and generate 3D models. It involves capturing multiple images of an object or scene from various angles, then analysing the similarities between

the images to reconstruct a 3D model. Once the photographs are taken, software analyses them to determine the camera positions and, by comparing two views, identifies the spatial location of key points through triangulation. This process generates thousands of points that are placed in space, which are then meshed and textured. The advantage of photogrammetry is its cost-effectiveness, as it mainly depends on the price of the camera used. Different types of cameras can be utilized, including DSLRs, compact cameras, smartphones, or 360° cameras. The final quality—both in precision and density—depends on the quality of the camera used. A variation of photogrammetry is now available in the latest Apple devices equipped with a LiDAR sensor. These devices continuously record images and point positions, enabling rapid output but with lower density and precision. The third technique, which is still emerging, leverages artificial intelligence through Neural Radiance Fields (NeRF). The core concept of NeRF is based on the radiance field, which describes the light emitted in all directions from every point in a 3D scene. NeRF's goal is to model this radiance field for a given scene. The image rendering process with NeRF uses a technique called volumetric rendering. For each pixel in a generated image, a ray is cast from a virtual camera through the scene. NeRF samples a large number of points along this ray in 3D space and predicts the color and density of each point using a neural network. This recent technique allows for the real-time exploitation of dense point clouds, which is already achievable with engines like Unreal Engine.

## THE CHALLENGE: REAL-TIME PROCESSING WITHOUT QUALITY LOSS

While the complexity of digital surveying is well understood and mastered, the process itself has become a highly reliable technique. The methods are now proven, and when handled by a skilled professional, the results are guaranteed. However, in an educational context, several factors must be considered, such as identifying technical and conceptual prerequisites, the time required to train students, and the availability of equipment. The real challenge, though, lies in exploiting laser or photogrammetric survey data in real-time and within virtual reality (VR) environments, such as in a metaverse or using a VR headset.

Why is this challenging? Laser scanning and photogrammetry generate not just thousands, but millions of data points. Once the data is meshed, the result consists of millions of polygons, which future applications must process in real-time. While powerful engines like Unreal can manage this on high-performance computers, real-time rendering for online dissemination in a metaverse or via a VR headset poses a much greater challenge.

The key issue is data reduction—simplifying the data without compromising visual quality. This is a significant technical challenge that requires strong expertise in post-production processes following data capture, as well as in the functioning of real-time applications. In the context of the demonstration presented here, this aspect is still in the research phase and is the subject of ongoing experimentation.



## GENERAL PROCESS WORKFLOW

To visualize the general workflow, we can describe it as a five-step process, whether capturing data with a laser scanner or using photogrammetry.

The first step is data acquisition on site. This includes laser scanner point clouds and photos, photogrammetry images, control measurements taken on-site, additional reference photos, geolocation data, and any other information that will inform the subsequent stages. These raw data are then sorted, filtered, and organized. The second step involves processing the data to generate 3D geometries at full scale, complete with high-resolution textures that capture all the details. Any missing parts or errors are corrected at this stage. The third step involves simplifying the data for real-time use. Achieving this requires balancing the mesh

density with the texture quality. Dense meshes are more accurate but computationally expensive, while textures preserve visual detail at the cost of less precise geometry. Adjusting the size and number of textures is also crucial, as these parameters are fine-tuned during the final step—implementation for real-time use—depending on the subject, the viewing distance, and any potential interactions with the environment.

The detailed steps are as follows:

1. Data Acquisition: Collection of raw data, including point clouds (laser scanning), photos (photogrammetry), control measurements, and additional reference materials.
2. Data Organization and Filtering: Sorting and cleaning the data.

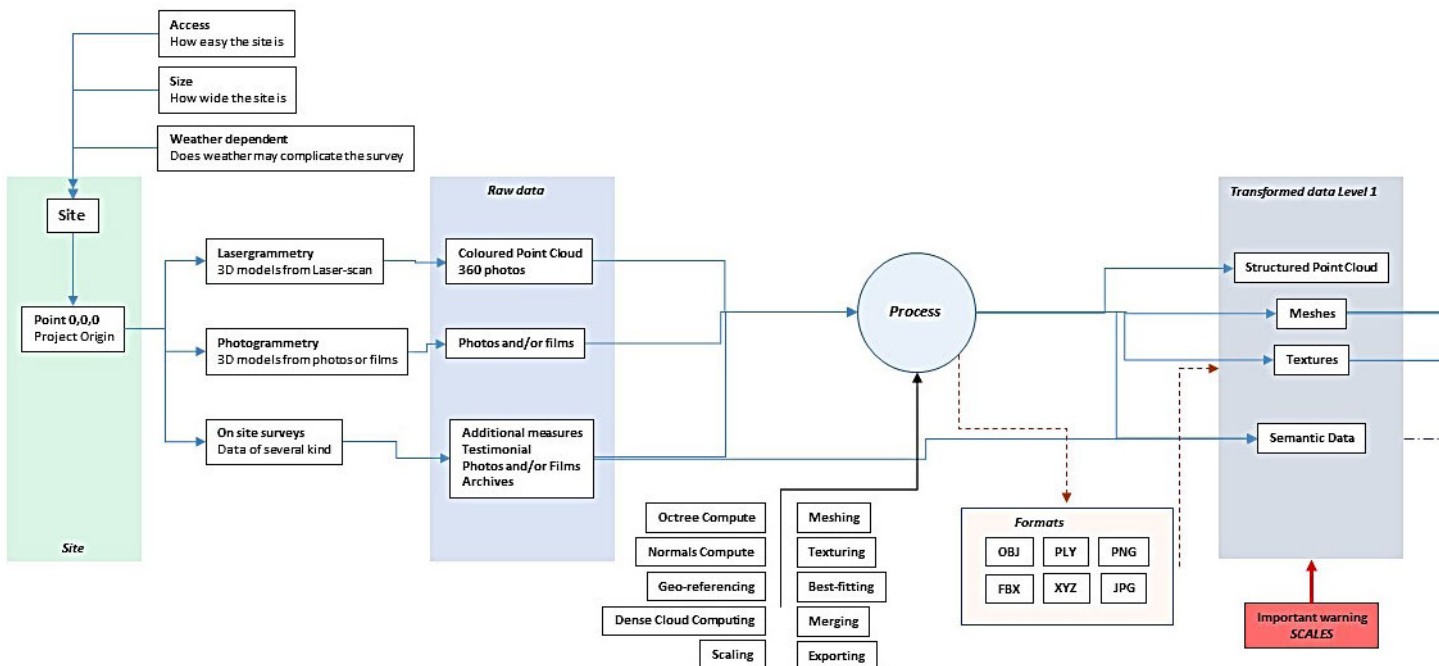

Fig. 1.1.3: Synoptic view of the data workflow

3. High-Resolution 3D Model Creation: Generating full-scale, detailed 3D models with high-resolution textures, correcting any errors or missing elements.

4. Data Simplification for Real-Time: Simplifying the geometry and textures to balance visual quality with computational efficiency.

5. Real-Time Implementation: Final adjustments for real-time display based on the specific context, viewing distance, and interaction needs.

Both techniques, laser scanning and photogrammetry, offer similar precision, but each has its own strengths. Laser scanning produces a georeferenced point cloud at scale, while photogrammetry allows for working at multiple resolutions. However, both methods struggle with reflective or transparent surfaces, uniform

blacks or whites, and very thin volumes, requiring manual modeling of certain elements in these cases.

The choice of file formats is critical, as these formats serve as bridges between different partners and workflow stages. For this project, we used the following 3D formats: XYZ, PLY, OBJ, and FBX, depending on the complexity of the models. XYZ and PLY are typically used for point clouds, while OBJ and FBX can include both mesh and texture, and FBX even supports animation. For images, we used JPG and PNG formats—JPG being a compressed, lossy format, and PNG being a compressed, lossless one.

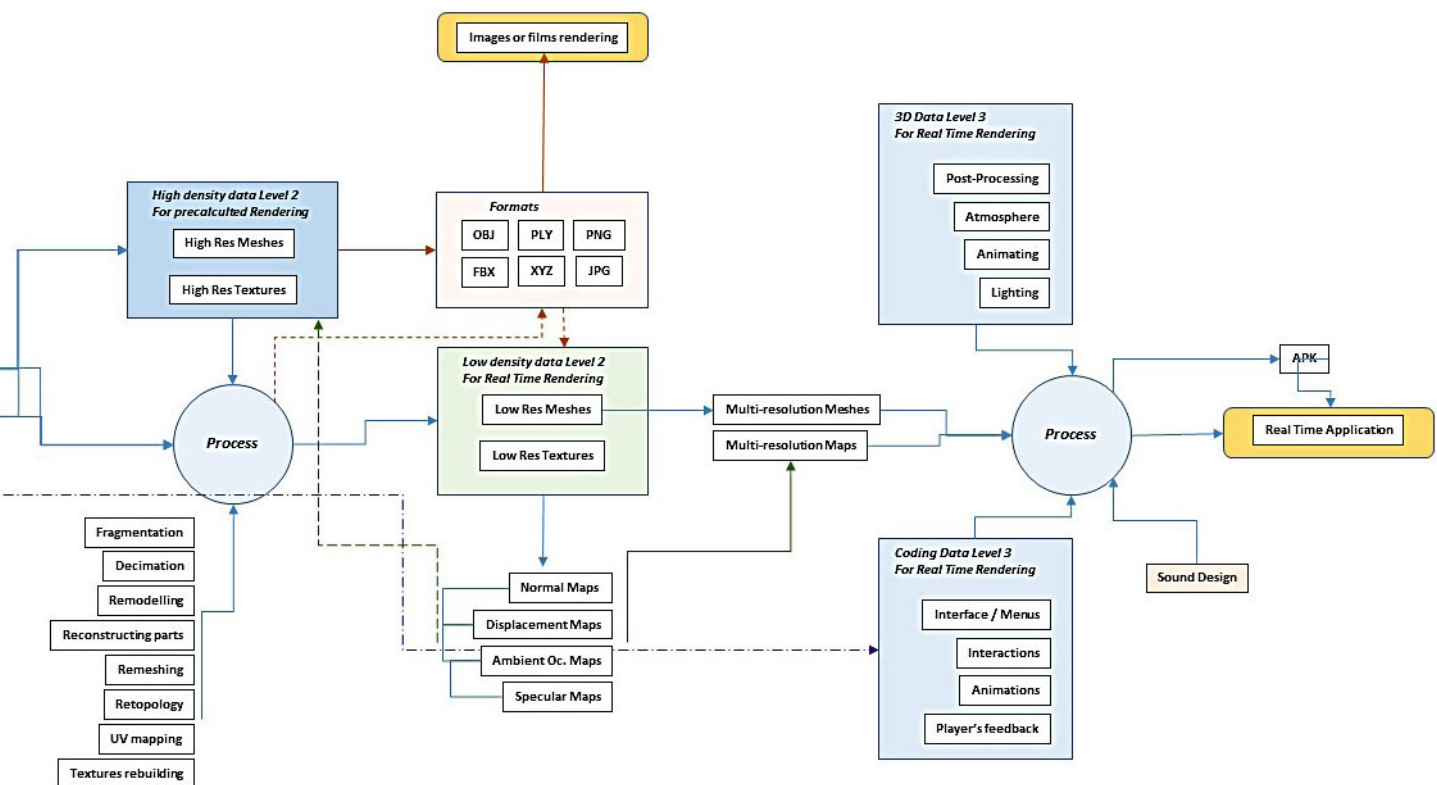

## DEVELOPING THE VIRTUAL APPLICATION

The final step involves building a virtual application compatible with the Oculus Quest headset, chosen for its processing power and the freedom of movement it provides.

To create the immersive experience for the headset, we selected the Unity software, although Unreal Engine was also a viable option (Anahid et al., 2021). Both platforms are free for academic development, but Unity is particularly well-suited for lightweight devices like the Quest. However, given the large size of the site and the complexity of the models, we had to implement visual strategies to maintain the quality of the experience while optimizing performance.

The global model is displayed in low resolution when viewed from a distance, which is acceptable given that users are positioned primarily

in front of the main façade. This allowed us to simplify the other façades, thereby improving rendering performance. By focusing user interest on a few controlled points, we minimized the likelihood that users would explore areas outside the primary focal zone. Additionally, we used the site's vegetation to create invisible barriers, subtly guiding user movement.

The vegetation itself posed significant challenges. Abundant throughout the campus, it is essential for visual quality and spatial orientation, but it comes with a high polygon cost. Fewer polygons make the vegetation look unrealistic, while more polygons drastically reduce the frame rate. Ultimately, we opted for a point cloud display for the vegetation, which provided a compromise between visual fidelity and performance. The pointillistic appearance of the vegetation created by the point cloud achieves the desired visual effect, and the point cloud's density increases as the user moves farther away, enhancing the illusion.

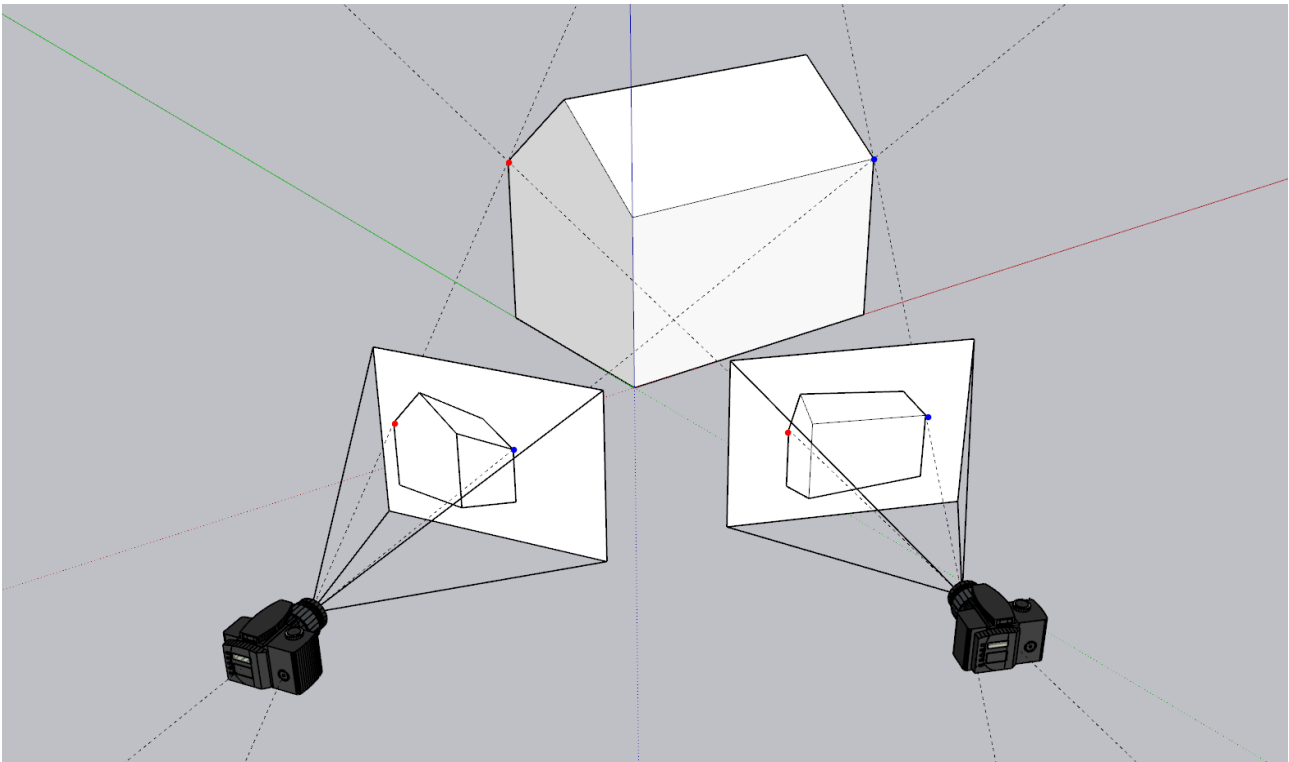

Fig. 1.1.4: The photogrammetry principle, finding the third dimension from a couple of images

## PERSPECTIVES OF DEVELOPMENT

### HISTORICAL MILESTONES IN PHOTOGRAMMETRY

Dr. Albrecht Meydenbauer is regarded as a pioneering figure in the field of photogrammetry. Born in 1834 and passing away in 1921, this German engineer is celebrated for developing precise measurement techniques using photography, laying the groundwork for modern photogrammetry. In 1893, he was one of the first to explicitly define the term \*photogrammetry\*, even though his work had started long before that. Photogrammetry involves using photographs to make precise measurements, mainly for mapping and 3D reconstruction of objects or landscapes.

It is said that Meydenbauer's interest in the discipline was sparked by a near-fall in 1858 while attempting to measure a historical building by hand. This incident led him to seek safer and more efficient methods, turning to photography as a solution. He began using photography to capture images of buildings and developed methods to obtain accurate measurements from these images. Meydenbauer created a stereoscopic photography system to measure and document historic monuments, eventually founding the Königlich Preußische Messbildanstalt (Royal Prussian Photogrammetry Institute) in 1885, dedicated to monument preservation through photogrammetry.

His work played a crucial role in the preservation of Europe's architectural heritage, establishing a standardized method for documenting and measuring historical monuments using photography.

### Meydenbauer's Plane Table Principle in Photogrammetry

The plane table principle, developed by Albrecht Meydenbauer, is based on projecting points from a photograph onto a plane to determine the dimensions and geometry of an object or structure. Here's a detailed explanation based on his original drawings and designs:

1. Photography from Two Angles: Meydenbauer's method involved taking photographs from multiple viewpoints (typically two), at different angles. These photographs captured precise reference points on the object (like building corners or marked points).
2. Projection onto a Plane Table: The photographs were then projected onto a plane table, representing a fixed horizontal plane. The goal was to simulate that these points existed on the same plane, although in reality, they were three-dimensional.
3. Intersection of Sightlines: Using the angles at which the photos were taken, Meydenbauer drew sightlines from each point on the photograph to the object. These sightlines were projected onto the plane table, and where they intersected marked the exact position of the measured point on the real object.
4. Reconstructing Distances: By analyzing where the sightlines intersected on the plane, Meydenbauer could reconstruct the distances between various points in three dimensions.

This method simplified calculations by avoiding complex 3D geometry formulas and was especially useful for historic monuments, where safety and preservation were paramount. It allowed for precise measurements without having to physically access the structures.



Fig. 1.1.5: Photogrammetry: Light point cloud



Fig. 1.1.6: Photogrammetry: meshing and texturing

## GAUSSIAN SPLATTING: AN EMERGING TECHNIQUE IN 3D RECONSTRUCTION

Gaussian Splatting is an innovative technique in computer graphics, particularly useful for reconstructing and rendering 3D scenes from 2D data, such as images or point clouds. Introduced recently, it is known for its speed and efficiency in creating realistic 3D renderings.

1. Point Cloud Representation: Initially, the 3D scene is represented as a point cloud, with each point corresponding to a specific location in 3D space.
2. Splatting: Each point in the cloud is converted into a Gaussian, a small bell-shaped distribution that spreads across space. Instead of representing a point as a single pixel, Gaussian Splatting assigns a "splat" zone for each point, creating a smoother and more continuous representation of the scene.
3. Gaussian Accumulation: When multiple Gaussians overlap, they accumulate, producing a denser and smoother distribution of information. This effect helps create realistic surface and texture rendering.
4. Final Rendering: The Gaussians are projected into the final image during rendering. Gaussian Splatting combines the Gaussians to create an image based on the observer's viewpoint, adapting to the specific perspective.



Fig. 1.1.7: Point cloud using NERF technology



Fig. 1.1.8: Full 3D model using NERF technology



Fig. 1.1.9: Full 3D model using NERF technology - view from an uncovered side



Fig. 1.1.10: Full 3D model using NERF technology - top view



## WRAPPING UP

Digital surveying in an occupied building presents specific challenges that go beyond the simple technical aspects of data capture. The context of an occupied space imposes constraints related to the daily lives of the occupants, necessitating an adapted approach in terms of planning, methodology, and tools used.

In an occupied building, technicians face several constraints. First, human Presence: Occupants come and go, interacting with their space, and these movements must be considered to avoid interference with the surveys. This requires planning capture sessions at times when human activity is minimal. Then, interior Layout: Furniture, decorative objects, and other elements can obstruct certain areas or alter the perception of volumes, requiring surveying teams to be flexible and adapt their techniques. We can also face restricted Access: Certain rooms or areas in an occupied building may be inaccessible at certain times (bedrooms, personal spaces, etc.), reducing the possibility of capturing complete data in a single session.

It is essential to schedule surveys at times when the building is least occupied. This may include interventions during off-peak hours, holiday periods, or even at night. Coordination with residents is crucial to minimize disruptions and ensure smooth operations. In occupied spaces, surveys may need to be conducted in several phases. For example, an initial series of captures might focus on main areas (lobby, corridors, common spaces), while a second phase will target private spaces at more opportune moments. Utilizing technologies that minimize intrusion, such as indoor drones or compact portable scanners, can allow data capture without overly disturbing the environment. Additionally, photogrammetric surveys using simple photographs can be an interesting alternative when the installation of bulky equip-

ment is not feasible. In occupied buildings, the density of captured elements is often higher due to details related to decoration, furniture, and personal items. This generates denser and more challenging point clouds to process, requiring a meticulous post-processing phase to isolate relevant structural information from ephemeral objects.

Using portable laser scanners allows for quick and flexible interventions in occupied environments. These devices are lightweight, easy to handle, and precise enough to capture the architectural details of a space. We also saw that photogrammetry techniques can be implemented with lightweight equipment (cameras or smartphones), facilitating data capture without disturbing the space at a very low price.

Drones are valuable to capture exterior and big volumes, it could also be used indoor.

Surveying in an occupied building, as practiced in a project like HCU, requires a combination of advanced techniques, rigorous planning, and careful interaction with occupants. Mastery of tools and the ability to adapt to human and material constraints are essential to ensure accurate results while respecting the living environment of those who inhabit the spaces.

Prof. Dr.-Arch. Laurent Lescop  
(Nantes' Superior School of Architecture)





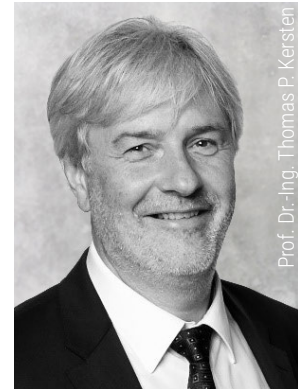

## OHLENDORFF'SCHE VILLA IN THE FOCUS OF 3D SURVEYING

Since 2001, students enrolled in the Bachelor of Science in Geodesy and Geoinformatics (formerly Geomatics) programme at HafenCity University Hamburg (formerly Hamburg University of Applied Sciences) have utilized digital photogrammetry and terrestrial laser scanning techniques in the Architectural Photogrammetry module (6th semester) to survey historic edifices in Hamburg, Schleswig-Holstein, and Lower Saxony, subsequently creating a 3D CAD model from the acquired data. The objective of this three-dimensional survey is twofold: firstly, to demonstrate to students the progression of a project from initial survey to the creation of a three-dimensional model; secondly, to produce a comprehensive record of the building, thereby contributing to the preservation of our cultural heritage.

On 29 April 2024, the Ohlendorff'sche Villa in Hamburg-Volksdorf was subjected to a comprehensive external and internal surveying utilising a range of measurement techniques by a team of 14 students enrolled in the Bachelor of Science in Geodesy and Geoinformatics programme (Fig. 1.2.1), in collaboration with architecture students. The surveying of the building was conducted with the assistance of the Hamburg State Office for Geoinformation and Surveying, which provided two measuring systems. Furthermore, the surveying office Dr Hesse und Partner Ingenieure (dhp:i) from Hamburg-Harburg supplied an additional measuring system for use.

The 3D surveying was carried out using the following instruments and measuring systems:

- 3D laser scanner IMAGER 5016 from Zoller + Fröhlich for the outdoor surveying



Fig. 1.2.1: Student Group Geodesy and Geoinformatics



Fig. 1.2.2: Part of the surveying equipment geodesy



Fig. 1.2.3: IMAGER 5010 on tripod



Fig. 1.2.4: DJI Phantom 4 Pro



Fig. 1.2.5: DJI Mavic 3



Fig. 1.2.6: Matterport Pro 3



Fig. 1.2.7: Segmented point cloud from photogrammetric image data



Fig. 1.2.8: Coloured partly segmented point cloud from NavVis VLX 2.0

- 3D laser scanner IMAGER 5010 from Zoller + Fröhlich for the outdoor surveying (Fig. 1.2.3)
- 3D laser scanner Faro Focus3D X330 for indoor surveying
- DJI Phantom 4 Pro drone for outdoor surveying (Fig. 1.2.4)
- Nikon D800 DSLR camera (with Nikkor 18 mm and 20 mm lens) for outdoor surveying
- Mobile portable system NavVis VLX 2.0 from Hamburg State Office for Geoinformation and Surveying for outdoor and indoor surveying
- DJI Mavic 3 drone from Hamburg State Office for Geoinformation and Surveying for outdoor surveying (Fig. 1.2.5)
- Matterport Pro 3 from the surveying office Dr Hesse und Partner Ingenieure (dhp:i) (Fig. 1.2.6) for indoor surveying

A local 3D network was established with the

objective of enabling the processing, combination and even merging of all measurement data within the same coordinate system during the subsequent analysis. In order to achieve this, black and white targets were affixed to and around the building, which were then measured with two Leica TS16 geodetic total stations. Subsequently, the 3D coordinates of the targets were determined through an adjustment calculation, with an accuracy of better than 5 mm for the coordinates. As the targets could be identified and measured in both the photogrammetric image data and the laser scans, all measurement data was registered in the same coordinate system. Furthermore, additional target signs were placed in the interior rooms, which were captured by the Faro Focus3D X330 laser scanner. This enabled the linking of these target signs in the interior area to the local coordinate system by scanning in front of the entrance door and on the balcony.

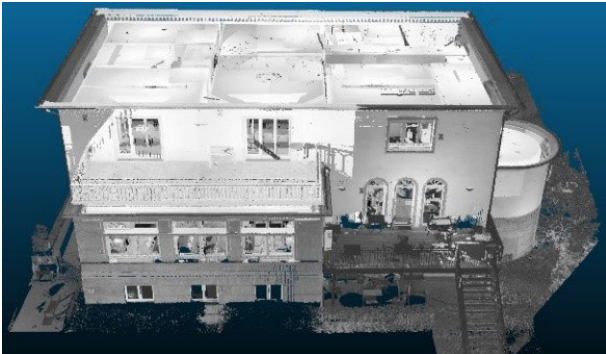

Fig. 1.2.9: Segmented point cloud from terrestrial laser scanning



Fig. 1.2.10: Coloured point cloud from the Matterport System

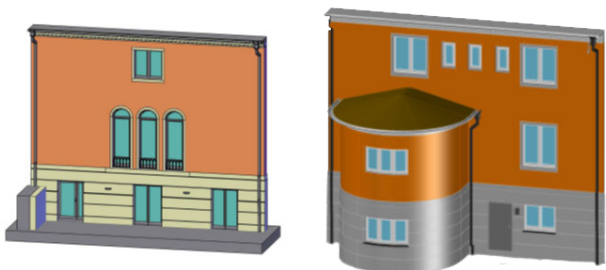
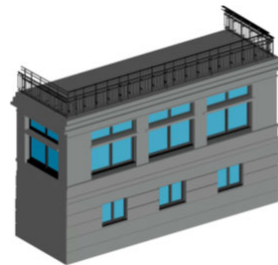

Fig. 1.2.11: Exemplary CAD models of parts of the Ohlendorff'sche Villa



The following data sets were created:

- Coloured segmented point cloud from 294 photogrammetric photos with 63 million points and an accuracy of better than 9 mm for the target coordinates (control points) for the outdoor area (data volume 1.4 GB) (Fig. 1.2.7)
- Colour partially segmented point cloud from the NavVis mobile system with 168 million points for outdoor and indoor areas (data volume 3.8 GB) (Fig. 1.2.8)
- Point cloud from terrestrial laser scanning with 97 million points from a total of 76 scans and with a registration accuracy of approx. 1.2 cm for the target coordinates (control points) and a point spacing of 5 mm for the outdoor and indoor areas (data volume 1.4 GB) (Fig. 1.2.9)
- Coloured point cloud from the Matterport system with 584 million points from a total of 95 stations for indoor areas (data volume 13.6 GB) (Fig. 1.2.10)

The point clouds were employed by the students for the purpose of modelling selected components of the building in three-dimensional space using the AutoCAD software (Fig. 1.2.11). Due to time limitations, it was not feasible for the students to model the entire building in three dimensions.

The advent of disparate measuring systems has rendered it feasible to analyse and evaluate the measurements of the edifice and the modelling with the underlying point clouds, in comparison with the measuring techniques employed by the architecture students, in terms of efficiency, precision and suitability.

Prof. Dr.-Ing. Thomas P. Kersten  
(HafenCity University Hamburg)

# **PRESENTATION VILLA**



## HISTORY

The Ohlendorff'sche Villa, located in the northern part of Germany in Hamburg-Volksdorf, was constructed between 1928 and 1929 by German architect Erich Elingius. Originally designed as a single-family home, the building was built in a neoclassical style and is now a listed heritage site. The original owner, Hans von Ohlendorff, had a previously existing manor house in the "Swiss style" demolished to make way for the villa. In 1953, he sold the property to the city of Hamburg, which used it as the local administrative office for Volksdorf until 2006. A public initiative led to the decision to preserve the villa for community use. As a result, in 2013, the FRANK Group purchased the property and undertook extensive renovations. Since September 1, 2014, the villa has served as a cultural and community center, housing the Viennese-style café "Die Villa," the children's daycare center of Kindergarten Volksdorf e.V., and several conference rooms on the upper floor.

## ARCHITECTURE

The Ohlendorff'sche Villa occupies a prominent location in Volksdorf and is accessed via a broad driveway. The two-story building is constructed of masonry with a hipped roof, featuring two symmetrically placed chimneys. The facade is plastered and painted a subtle pink above the perimeter base. Entry is through a formal portal at the front of the building. The rear side, with its attached conservatory and terrace, has a more asymmetrical design. The ground-floor windows at the front differ from the others, being designed as arched windows. On the eastern side, a semicircular apse extends from the basement to the ground floor. Both the rectangular and arched windows are framed with stonework, while the balconies and French doors feature wrought-iron railings for safety. Additional ornamentation is found on the wooden cornice, which is adorned with a dentil frieze. However, decorative elements are used sparingly throughout the design. Due to the sloping terrain, the basement opens directly to the rear garden and forms a high base along the garden side, though without direct access to the outdoor space. Windows in the basement allow natural light to illuminate the lower level.

Inside, the rooms retain their original layout from the time when the building was a private residence. Upon entering, one is greeted by



an oval foyer, leading through a stair hall to the reception room. Unlike the other rooms, this space features chamfered corners. The enfilade design offers an unobstructed view from the entrance through to the garden.

The adjacent library, once used as a music room, was built with higher ceilings, creating a height difference between the ground and upper floors. Apart from the library, the ground floor now operates as a café. The upper floor houses offices and meeting rooms, while the basement accommodates the café's bakery and a daycare center.

A particular challenge in the building's survey was measuring the curved elements, such as the arched windows, the stucco details, and the apse in the café, as well as the walls that were integrated with shelving, kitchen units, and wood paneling.



Fig. 1.3.1: Photo Ohlendorff Villa - front



Fig. 1.3.2: Photo Ohlendorff Villa - back

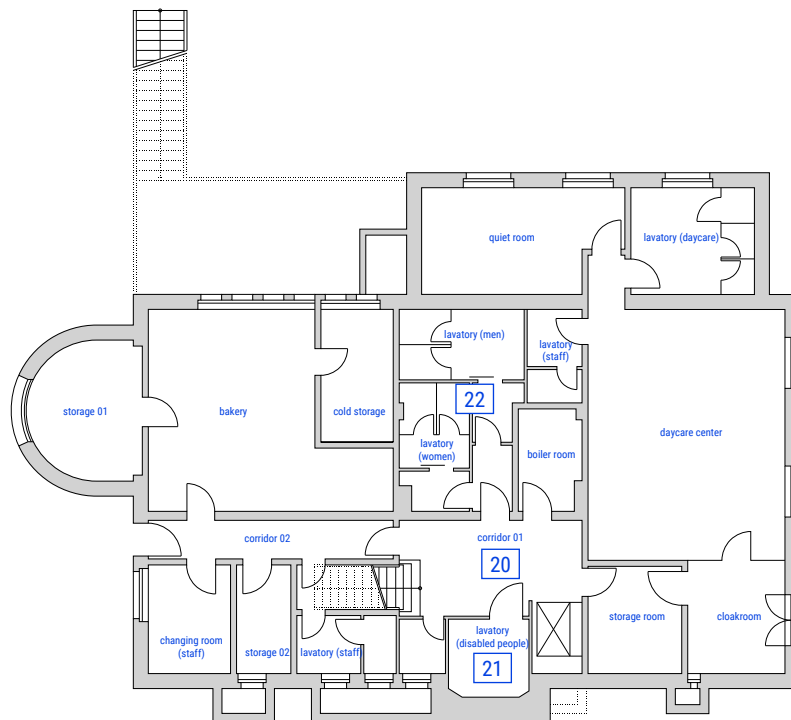

Fig. 1.3.3: Ohlendorff Villa floor plan basement

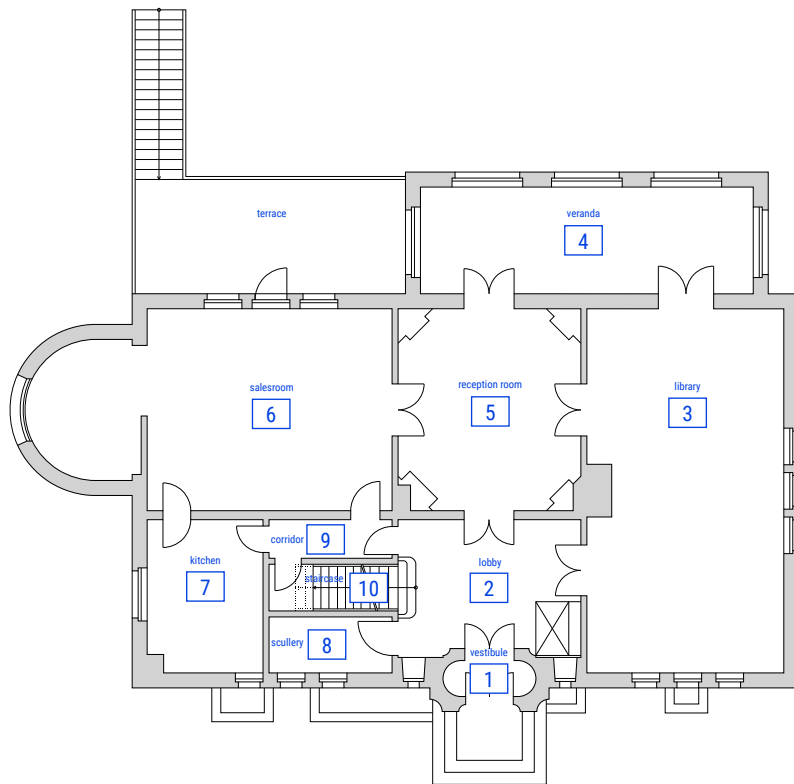

Fig. 1.3.4: Ohlendorff Villa floor plan ground floor

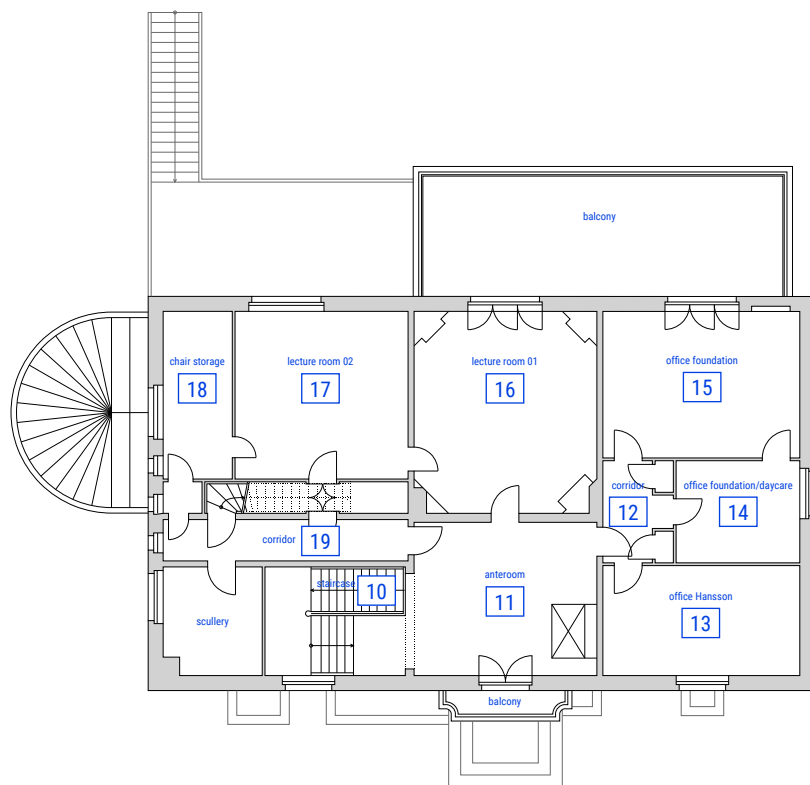
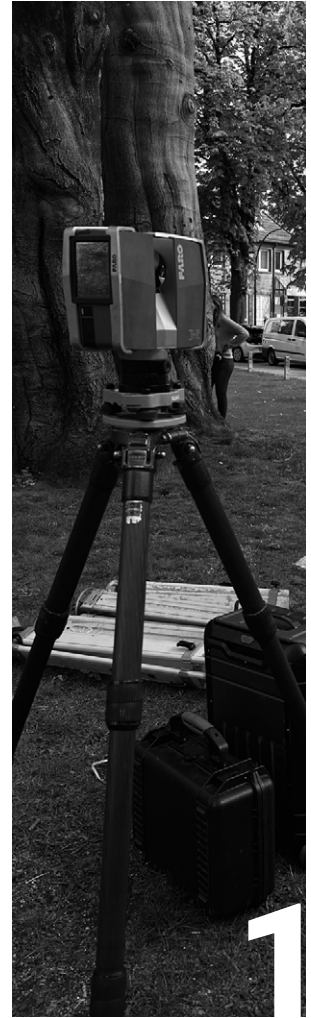

Fig. 1.3.5: Ohlendorff Villa floor plan upper floor

# METHODS



# LASER - FARO



## INTRODUCTION

Team	38
Description	38
Requirements	39



**PREPARATION**

Preparation	42
Costs	44
Usability	46
Cost Faro Scene Software	47

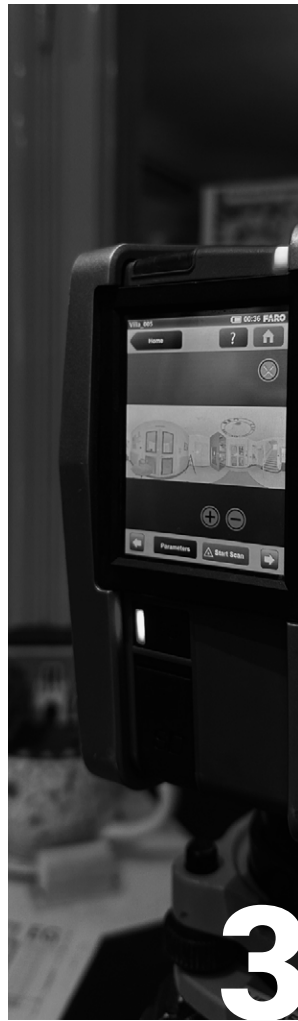

**SITE MEASUREMENT**

Site Measurement	50
------------------	----



**DATA PROCESSING**

Data Editing	54
Instruction for importing the point cloud in to Archicad	57

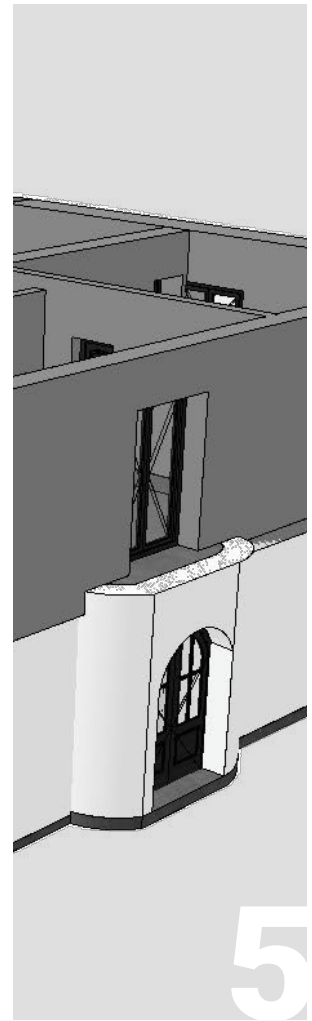

**EVALUATION**

Evaluation	58
------------	----

# 1 INTRODUCTION



## DESCRIPTION

The precise capture and documentation of historical buildings is a demanding and labor-intensive process that requires cutting-edge technology and meticulous planning. A central aim of this scientific work is the comparison of different surveying methods, with our methodology, the surveying of existing structures using a 3D laser scanner, being examined and evaluated.

At the start of the project, two architecture students in their second master's semester worked closely with two geodesy students in their sixth bachelor's semester. This interdisciplinary collaboration was crucial for efficiently and accurately managing the various stages of surveying, creating the point cloud, and finally modeling a BIM-capable 3D model. The geodesy students contributed their expertise in handling the laser scanner and generating the point clouds, which was pivotal for the examination and evaluation of our methodology.

On the day of the survey, we formed two teams: the geodesy students conducted the scans and saved them, while the architecture students on-site made detailed documentations and filled out protocols. To better understand the laser scan methodology, the architecture students were also allowed to perform some scans independently. The geodesy students answered all the questions posed by the architecture students, leading to a productive exchange.

Following the survey, there were intensive weeks of data processing, during which the geodesy students continuously informed us about their progress. Throughout the data processing phase, the geodesy students maintained constant contact with the architecture students. This transparent working method allowed us to track the creation process of the



Fig. 2.1.1: Laserscanner Faro Fokus X30

final point cloud at any time. After we received the point cloud, the main task of the geodesy students was completed. However, they remained available for any questions that arose during the subsequent work.

Based on the point cloud, we, the architecture students, created a BIM-capable 3D model and evaluated and examined the applied methodology. This investigation was based on our practical experiences, internet research, reports, facts, and the answers provided by the geodesy students.

The FARO® Focus3D X 30 is a portable laser scanner that externally resembles a camera but is equipped with advanced laser technology. It consists of a housing containing optical components and electronics, and is typically combined with a tripod or mounting system to remain stable during data capture. Weighing only 5.2 kg and with compact dimensions (24 x 20 x 10 cm), the scanner is highly portable and mobile. Integrated controls and a touch display allow the user to control the scanning process and check the captured data in real-time, while the collected data can be stored on SD, SDHC, and SDXC cards.

The FARO Focus3D X30 is a 3D laser scanner specifically designed for close-range use. It captures up to one million points per second and offers a maximum range of 30 meters, making it particularly suitable for small and confined work areas. Due to these properties, it is excellent for surveying interiors, small facades, complex structures, and production and utility facilities. Its high point density and precision enable detailed recordings in confined spaces, which is essential for the accurate documentation and analysis of such areas.

The FARO Focus X30 operates on laser scanning technology, where the scanner emits laser beams that hit the surface of the object being scanned. Highly sensitive sensors measure the reflected laser beams and capture the distances to various points on the surface. The battery life of 4.5 hours ensures flexibility and endurance in application. Therefore, the laser scanner is a versatile tool for applications such as accident reconstruction, architecture, civil engineering, forensics, and industrial manufacturing.<sup>1</sup>

## REQUIREMENTS

The preparation of a survey using the FARO 3D laser scanner X30 requires meticulous planning and precise execution to ensure accurate and reliable results. The first step involves detailed planning, which includes identifying the areas to be scanned and setting the objectives of the survey. Before the site visit, we reviewed the floor plans of the Ohlendorf Villa and considered potential challenges that might arise on the day of the survey. We asked ourselves questions like: Are all rooms accessible? Are the rooms cluttered and likely to cause issues during the scan? Does the survey need a specific sequence, determining which room to scan first? How many entrances and windows do these rooms have, and what is the function of each room? Are there only rectangular rooms or other shapes as well?

These considerations led us to thoroughly familiarize ourselves with the layout of the villa and visualize the spaces. Special attention was given to hard-to-reach areas and complex structures. Additionally, we familiarized ourselves with the specific requirements of the project. Our goal was to produce flawless

---

<sup>1</sup> cf. Faro. „FARO Laser Scanner Focus3D X 30 - The Smart Entry-Level X Series Laser Scanner“. From: Laserscanning Europe. Accessed 08.07.2024. [https://www.laserscanning-europe.com/sites/default/files/redakteur\\_images/Datasheet\\_FARO\\_Focus3D\\_X\\_30.pdf](https://www.laserscanning-europe.com/sites/default/files/redakteur_images/Datasheet_FARO_Focus3D_X_30.pdf)



scans that would serve as the foundation for building a BIM-capable model. Since we could not rescan the villa under the given conditions, it was crucial that the scans on the survey day be perfect. At the time of the scans, the villa was reserved exclusively for the students, and no other visitors were allowed to enter, minimizing disturbances.

Before using the FARO Focus3D X30, the device must be carefully set up and calibrated. A thorough check of all device functions is performed before starting the scan to ensure that the scanner is operating correctly. The calibration of the scanner is critical for measurement accuracy. This includes adjusting the optical components and setting the scan parameters such as resolution and scan mode (black-and-white or color). Additionally, the battery power must be checked to ensure continuous power supply throughout the scan. For longer surveys, additional batteries should be kept ready.

During the scan, it is important to continuously monitor and document the progress. This documentation can be in the form of notes or a log to track anomalies later. The logs and floor plans were printed and brought to the survey, allowing changes and problem areas to be directly marked and described in detail in the log. In preparation, we thoroughly informed ourselves about the device and reviewed the FARO Scene software to ensure we could process the data efficiently. Additionally, we took the opportunity to engage with the professors – recognized experts in this field – and the geodesy students on-site, asking them specific questions. This exchange not only allowed us to gain valuable expertise but also to develop a deeper understanding of FARO's functionality and the execution of precise surveys. The discussions and practical demonstrations on-site helped us better understand the complex processes of surveying technology and expand

our knowledge in this field. Thus, we were able to ideally combine theory and practice.



# 2 PREPARATION

Certain preconditions and preliminary work are essential for successful laser scans with the FARO X30. Before the scan, thorough setup and calibration of the FARO Focus X30 were required to ensure that all relevant architectural elements of the villa were precisely captured. This phase included precise adjustment and preparation of the device by the geodesy students. The appropriate scan settings had to be chosen for the specific application, including scan resolution, scan mode, and scan range.

For scanning the interiors of the Ohlendorf Villa in daylight, the FARO laser scanner X30 was set up as follows: The scanner was configured to medium to high resolution to capture enough details of the villa, with a point density of about 1/4. The standard mode was chosen to ensure a good balance between speed and detail accuracy. The scan range was set to 360° horizontal and 300° vertical to ensure comprehensive coverage of the interior. We opted for a simple black-and-white scan as additional color information in the point cloud was not necessary and would have otherwise increased the data volume significantly.

Calibration before starting the scan ensures precise results and a smooth process throughout the scanning day. When setting up the scanner, it is also crucial to mount it on a stable tripod or other supports to ensure uniform movement during the scan.

Efficiency was important as we could conduct the scans at the villa only on one day. Additionally, each room was documented in detail to ensure that the entire villa was comprehensively scanned. Sufficient personnel during the scan is essential. Also, the battery level should be checked, and additional batteries should

be ready for longer surveys. It is important to regularly check and update the firmware and software of the scanner to ensure optimal performance.

“Without the correct firmware, your FARO® Focus Laser Scanner may not function properly. When FARO releases new firmware or FARO SCENE software, you should update the firmware installed on your scanner. Firmware updates provide new operational features, fix various issues, and improve the overall performance of your device. This article includes instructions on how to download and install the latest firmware version.”<sup>2</sup>

The historic architecture of the Ohlendorf Villa posed particular challenges to the laser scanner. It was configured and operated to precisely capture all architectural details, including stucco decorations, narrow corridors, and hard-to-reach areas such as cluttered rooms or arched windows.

The positioning of the scanner in the room was crucial. The placement of the scanner within the scan area plays a significant role in ensuring complete coverage. Strategic positions such as the center of the room and door thresholds are particularly advantageous to maximize the accuracy of the scans and create overlaps between adjacent room necessary for precise data acquisition. Additionally, the scan range can vary and consolidate more information in the point cloud.

An example of this is the kitchen (room 7) on the ground floor (Fig. 2.1.2).

The kitchen was fully occupied with kitchen furniture, providing little room to maneuver. Ad-

---

2 Faro Knowledge Base. „Firmware Installation für den Focus Laser Scanner“ (14.11.2023). Accessed 10.07.2024. [https://de-knowledge.faro.com/Hardware/Focus/Focus/Firmware\\_Installation\\_for\\_the\\_Focus\\_Laser\\_Scanner](https://de-knowledge.faro.com/Hardware/Focus/Focus/Firmware_Installation_for_the_Focus_Laser_Scanner)



Fig. 2.1.2: Narrow and fully furnished kitchen

ditionally, the ceilings were fitted with extractor hoods and more cabinets. The laser scanner captured all these elements in the kitchen, even though some objects were close to the scanner, limiting the range.

The preparation of the scanning area was also crucial. A suitable environment played a key role in this. It was important to ensure clear lines of sight by removing all potential obstacles that could block the scanner's view. All movable objects such as furniture, equipment, or people were removed from the area before scanning to ensure untainted data capture.

Optimal weather conditions, especially inside the villa, were crucial for high-quality scans. A cloudy sky was advantageous as it provided enough daylight for good interior illumination; it should be sufficient without casting strong shadows to avoid impairing the scan quality. A

cloudy sky minimizes the chance of reflections on reflective surfaces from sunlight. Too much direct sunlight could negatively affect the results. Reflective surfaces such as glass or shiny materials had to be minimized to reduce unwanted reflections in the scans. Additionally, a clean lens on the laser scanner is essential to produce high-quality scans.

The georeferencing of the scans is important: By strategically placing reference markers within the scan area, such as control points or reference points, the precise assignment of the captured data to real geographic coordinates is ensured. These markers allow for the precise connection of the various scans and the correct positioning of the entire point cloud on a geographic or topographic basis (Fig. 2.1.3).

A documented record of the condition of the scan area before scanning through photos or



Fig. 2.1.3: Process in which we place the control points



Fig. 2.1.4: FARO 3D laser scanner X30

notes serves as a reference for later analyses and the identification of changes or special features.

To ensure thorough documentation and simplify post-processing, the scan area should be documented, and reference points established before scanning. Floor plans and point markers proved to be extremely helpful in correctly registering the data and facilitating later analysis.

By adhering to these preconditions and preliminary work, the foundation for successful scans with the FARO X30 was laid, ensuring high-quality results and efficient data capture and modeling.



Fig. 2.1.5: FARO Focus Core

## COSTS

The costs for FARO laser scanners vary depending on the model and specific features. The discontinued FARO 3D laser scanner X30 (Fig. 2.1.4) was designed to precisely capture architectural details and document complex structures and fine details, which was confirmed in our use. Due to its high point density and accuracy, it was particularly suitable for the precise surveying and documentation in demanding and complex environments, such as the Ohlen-dorf Villa.

After the production of the FARO Focus X30 was discontinued, it became necessary to look for suitable alternatives. Two models were considered. The Faro Core model<sup>3</sup>, recommen-

3 see Laserscanning Europe Shop. „Faro Focus Core“. Accessed 10.07.2024. <https://shop.laserscanning-europe.com/FARO-Focus-Core>



Fig. 2.1.6: FARO Focus Premium Core

ded as a more cost-effective option, has a suggested purchase price of 33,104 euros (Fig. 2.1.5). This model offers comparable performance for various building surveying applications and is designed to perform basic surveying tasks without the advanced features of the more expensive models.

In comparison, the Faro Premium<sup>4</sup> model is designed for highly complex building surveys and has a suggested purchase price of 40,200 euros (Fig. 2.1.6). It offers advanced features and even higher accuracy, making it particularly suitable for projects with high demands for precision and detail. This model is tailored for demanding applications where extremely precise measurements are required.

Additionally, an offer from a private seller was considered, who offered the FARO X30<sup>5</sup> in unused condition along with the necessary software for a total of 43,000 euros net. This offer proved to be particularly suitable for the project as it met the required needs for capturing long distances within the rooms. The FARO Focus X30 could accurately capture the extensive distances and provide detailed scans, which was crucial for the comprehensive documentation and analysis of the rooms.

---

4 see Laserscanning Europe Shop. „Faro Focus Premium“. Accessed 10.07.2024. <https://shop.laserscanning-europe.com/FARO-Focus-Premium>

5 see Bunzel Bauvermessungstechnik. „Faro Focus Core 3D-Laserscanner (Komplettpaket)“. Accessed 27.06.2024. [https://www.bauvermessungstechnik.info/epages/64219339.mobile/de\\_DE/?ObjectPath=/Shops/64219339/Products/LS9-L-Parcel](https://www.bauvermessungstechnik.info/epages/64219339.mobile/de_DE/?ObjectPath=/Shops/64219339/Products/LS9-L-Parcel)

## USABILITY

The FARO X30 laser scanner and the accompanying FARO Scene software are widely used in the construction and architecture industries, as well as in manufacturing and engineering. These technologies are employed for the precise measurement and documentation of construction projects, creating 3D models, and ensuring quality in manufacturing. In architecture, they aid in the detailed capture and analysis of historic buildings. Additionally, they are used in the manufacturing industry to verify dimensional accuracy and manufacturing tolerances.

At HafenCity University, students gained access to the FARO X30 laser scanner and its accompanying software. The scanner is characterized by its robust design and ease of use, making it suitable for various environments, including construction sites and industrial settings. The device's portability allows for flexible positioning on different surfaces, supported by stable and adjustable legs (Fig. 2.1.7). Its lightweight design makes transportation easy. The integrated screen immediately displays scan results, enabling early detection and correction of errors.

The FARO Scene software provides a user-friendly interface that allows for quick and effective data capture, processing, and analysis. It supports automatic registration, point cloud visualization, and precise measurements, facilitating the creation of high-quality 3D models and detailed analyses. Additionally, FARO Scene is compatible with various file formats, including .e57, .ptx, .pts, .las, .laz, .xyz, and .csv. This compatibility eases data exchange between different platforms and integration into existing workflows.<sup>6</sup>



Fig. 2.1.7: FARO 3D laser scanner X30

Operating the scanner and software does not require extensive expertise, as they are easy to understand and use. Before scanning, the geodesy students gave us a brief introduction to the scanner. Once the presets are established, starting the scan requires only a single button press. This enabled us, the architecture students, to use the scanner without specific expertise in 3D scanning and point cloud processing.

The FARO Scene software is designed to provide a clear and well-structured user interface. This allows for efficient data capture, processing, and analysis. The software is user-friendly, offering simple, clearly named functions and tools that are easily accessible. The layout of options and menus is logical, enabling intuitive

---

<sup>6</sup> cf. Faro. „Faro Scene Software“. Accessed 30.06.2024.  
[https://de-knowledge.faro.com/Software/FARO\\_SCENE/SCENE/Computer\\_System\\_Requirements\\_for\\_SCENE](https://de-knowledge.faro.com/Software/FARO_SCENE/SCENE/Computer_System_Requirements_for_SCENE)

navigation. This reduces the need for extensive training and facilitates ease of use for new users. These insights into the aforementioned features were derived from the observations of the geodesy students who regularly worked with the software.

Overall, the FARO X30 scanner and FARO Scene software are reliable tools for 3D data capture and point cloud processing, usable by both experienced professionals and newcomers.

### **COSTS FARO SCENE SOFTWARE**

FARO Scene is a specialized software for processing and managing 3D laser scan data captured with FARO laser scanners. The software aims to generate, edit, and visualize point clouds, offering a variety of features that support the entire workflow from data acquisition to the creation of detailed 3D models.

The process begins with on-site data acquisition using a FARO laser scanner to capture 3D data of an object or environment. After the scan is completed, FARO Scene software allows for the direct import of the collected data. This process typically involves transferring the data from the laser scanner to a computer. In our case, this import occurs on the computer at HafenCity University. The transfer is done via an SD card, where the data from the scanner is stored. After transferring, the data is loaded into FARO Scene, where it can be further processed and analyzed. The software is installed on the university's computer, enabling further editing and visualization of the data to create a point cloud.

The software registers the individual scans by aligning them to produce a complete and coherent point cloud. This registration can be

done automatically by recognizing and aligning overlapping areas of the scans. Alternatively, scans can be manually registered if the automatic method does not yield the desired results.

After registration, the point clouds in FARO Scene are cleaned and edited. This includes removing unwanted data such as noise or moving objects that were in the way during the scan. Additionally, specific areas can be highlighted or segmented to focus on particular parts of the point cloud.

FARO Scene offers tools for visualizing and editing point clouds, including filtering and segmentation tools to remove unwanted data and highlight relevant areas. The integrated tools in FARO Scene allow for precise measurements of the point cloud, including distances, areas, and volumes, which are useful for various applications such as construction surveying or architectural analysis.

The software supports the creation of detailed reports and documentation based on the point cloud data. The finished point cloud can be exported in various file formats, including .E57, .LAS, and .PTS, for further processing in other software solutions. This facilitates the creation of detailed 3D models or construction plans in CAD or BIM software, such as Archicad, with the E57 export format specifically used for our further processing.

The costs for FARO Scene software can vary depending on the version and licensing model. FARO offers different packages and options for the software, depending on the specific requirements and features needed by the user. According to online research, FARO Scene can be purchased for a one-time payment of about



6,900 euros (including VAT) or through a monthly subscription.<sup>7</sup>

For processing point clouds in FARO Scene and Archicad, a powerful computer is essential to ensure smooth and efficient processing. The recommended specifications for both applications are as follows:

For FARO Scene, the recommended hardware requirements are<sup>8</sup>: an Intel Core i7 or i9 processor or an AMD Ryzen 7 or 9 with at least 6-8 cores. A memory (RAM) of 32 GB or more is recommended to efficiently process large amounts of data. For the graphics card (GPU), an NVIDIA GeForce RTX 2070 or higher, or a comparable professional graphics card like the NVIDIA Quadro series, is recommended. An SSD with at least 1 TB storage capacity is necessary for fast loading times and storage access. The operating system should be Windows 10 or newer to ensure optimal performance.

Comparing the hardware requirements for FARO Scene with the performance of the HP ENVY (Model: TE02-1701ng), it proves to be a suitable choice for efficient work with FARO Scene, as it has a powerful configuration particularly suitable for processing point clouds and demanding 3D applications.<sup>9</sup> Equipped with a 12th generation Intel Core i7-12700F processor and 32 GB RAM, this computer offers sufficient performance and memory for processing large datasets and complex applications. The NVIDIA GeForce RTX 3060 graphics card ensures excellent graphic performance, which is particularly important for point cloud processing and 3D modeling.

The 1 TB SSD of the HP ENVY Desktop enables fast loading times and offers enough storage space for extensive projects. The Windows 11 operating system ensures optimal compatibility and performance, which is especially important for professional applications like FARO Scene. This configuration meets all recommended specifications for using FARO Scene and provides a robust foundation for other demanding applications.

The HP ENVY (TE02-1701ng) is suitable not only for professional point cloud processing but also for general office tasks, multimedia applications, and gaming. Currently, the computer is available for 2,898.99 euros on the HP website, though the price may vary depending on the provider.

---

7 cf. utb. „Faro Scene Software“. Accessed 27.06.2024. <https://www.utb.at/shop/software/produktdetail/faro-scene-software>

8 cf. Faro Knowledge Base. „Computersystemanforderungen für Scene“ (23.01.2024). Accessed 11.07.2024. [https://de-knowledge.faro.com/Software/FARO\\_SCENE/SCENE/Computer\\_System\\_Requirements\\_for\\_SCENE](https://de-knowledge.faro.com/Software/FARO_SCENE/SCENE/Computer_System_Requirements_for_SCENE)

9 cf. HP. „HP ENVY - TE02-1701ng (2023)“. Accessed 11.07.2024. <https://www.hp.com/de-de/shop/product.aspx?id=7N9Q9EA&opt=ABD&sel=DTP>



# 3 SITE MEASUREMENT

Before the commencement of the surveying, preparatory measures were undertaken in accordance with the guidelines described in the „Requirements“ chapter. The surveying process began in the Ohlendorf Villa on April 29, 2024, at 9:30 AM with initial preparations and a walkthrough. During this time, we were briefed on specific guidelines for handling the premises, particularly concerning the listed and fragile walls and wallpapers, which required especially careful handling.

Following the introduction to the villa, reference markers were placed on the walls, with 2-3 markers per room at different heights. These reference markers serve as georeferenced points for the later integration of the scans. By assigning these markers to georeferenced coordinates, the individual scans can be precisely linked and integrated into a unified coordinate system. This is crucial for accurately creating a comprehensive 3D model of the villa. The placement of these reference markers was carried out by the surveying students, facilitating the first interaction between the architects and the surveying students. Subsequently, the FARO laser scanner was jointly set up and powered on. It was ensured that the device was properly calibrated and met all technical requirements. The prior calibration outside the deployment site allowed for quick on-site preparation, which only involved powering up the device. Both the main battery and a spare battery were fully charged.

The subsequent procedure was agreed upon in consultation, and process documentation began using the prepared protocol and printed floor plans. Before the actual scanning process, it was ensured that no people were present in the room, not even the individuals responsible for the scan, to avoid any movements that could affect the accuracy of the scans. This proved challenging due to the pre-

sence of a large group of students who wanted to conduct various surveying methods. Additionally, in each room, it was individually checked whether furniture could be moved or removed to ensure optimal scanning conditions. For instance, chairs and tables were moved aside in the library (room 3) (Fig. 2.1.8) to create an open area in the center of the room for the scan.



Fig. 2.1.8: Library with the unblocked tables and chairs and the FARO X30

Subsequently, scans were conducted at strategic positions such as each doorway and the center of the room, covering areas from the ground floor to the first floor. Each scan took approximately 1.5 to 2 minutes and was performed in black and white, as previously set during the laser scanner’s calibration. This decision was made because color scans would have significantly extended the scanning time, which was unnecessary for point cloud pro-

cesscessing. After each scan, the results were reviewed on the scanner's touch screen to ensure the data was correctly and completely captured (Fig. 2.1.9). If errors were detected, such as unexpected people appearing in the scan image, the scan was immediately repeated. The total duration of the interior survey with the scanner for both floors and each room was 4 hours.



Fig. 2.1.9: Touch screen with scan of the corridor-ground floor

Additionally, we spent 45 minutes on the placement of reference markers and the walk-through of the villa. Extensive notes were taken during the surveying process, including the documentation of the survey duration per room, encountered difficulties, system limitations, and specific challenges during the scans.

Notably, the presence of stucco work on the ceilings and special moldings in almost every

room of the villa posed a challenge. Built-in fixtures like wall cabinets and lights were also captured and presented structural challenges for the scan. Large glass surfaces such as windows, glass doors, a glass platform lift, and pictures proved problematic due to reflections under sunlight. The weather conditions on the day of the survey were good but not optimal due to strong shadows and reflections in the corners of the rooms.

The laser scanner accurately captured the arched windows, all decorations, and furniture in the room. For furniture pieces like tables and chairs, the areas beneath them were not scanned and thus did not appear in the point cloud, highlighting the need to scan in rooms with minimal furniture to achieve more precise results. In some rooms, the scanner's tripod legs were adjusted to avoid obstructive furniture and ensure complete room coverage.



Fig. 2.1.10: Lecture room (room 15)

In the lecture room on the first floor (room 16), a circle of tables obstructed the scan, making the floor unrecognizable to the laser scanner. Therefore, the scanner had to be elevated on the tripod to partially capture the rear floor areas (Fig. 2.1.10).

A consistent initial height of the scanner was aimed for to ensure uniform scans and facilitate integration into a point cloud. In other intermediate rooms (Fig. 2.1.11) and corridors (Fig. 2.1.12), good captures were also achieved due to the scanner's wide-angle capability.

The reference points were particularly helpful for the georeferencing of these tight spaces, enabling precise alignment and integration of the scans.



Fig. 2.1.12: Narrow corridor on the ground floor



Fig. 2.1.11: The 3D laser scanner at the doorway of a narrow passage.

During the process, the two geodesy students and we, the architecture students, received on-site insights into the FARO Scene software. We were introduced to the representation of an unfinished and trial point cloud using scans from the ground floor and some rooms from the upper floor (Fig. 2.1.13).

After importing the scans into the FARO Scene software, we reviewed the merging of the captured scans and found that the software had difficulty accurately locating the stairs to the first floor. Due to inadequate automatic linking, all reference markers had to be manually connected floor by floor.

To further improve accuracy, the scans were subsequently recalculated based on the point clouds, enhancing the alignment of individual reference markers with the scans.

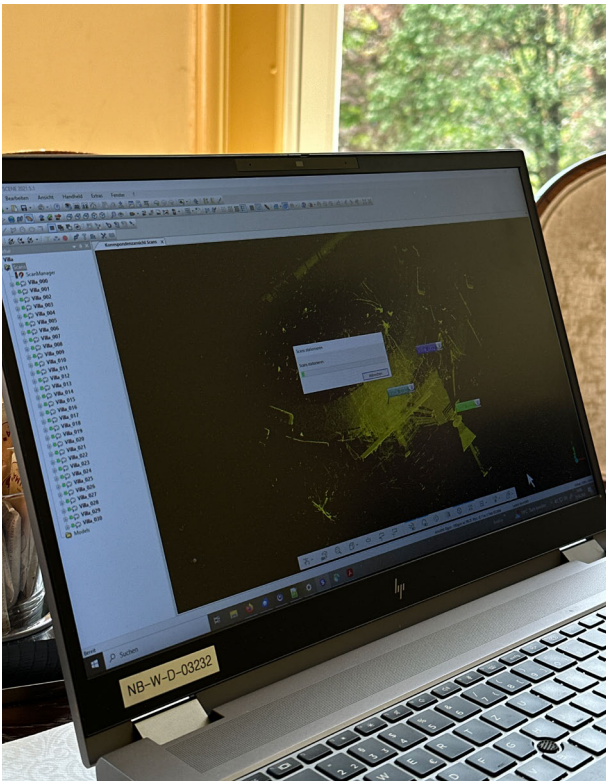

Fig. 2.1.13: First encounter with the FARO Scene software at the site

After completing this step, all floors and the staircase were merged into a single cluster. The calculation of the dense point clouds followed, but due to the time required, this was not performed on-site. For better orientation and to aid in the further processing of the data, digital photos of the rooms were taken and deviations from the floor plans were documented. These photos are intended to help interpret and process the scanned data more precisely later on.

The aim of the survey was to export the collected data from FARO Scene upon completion of the scans and convert it into a BIM-capable CAD model. This includes the precise reconstruction of the scanned rooms and architectural details in CAD software to create a detailed and to-scale 3D model that can be used for further planning and analysis.

# 4 DATA PROCESSING

## DATA EDITING

On May 6, 2024, data processing began at 8:15 AM and continued until 12:00 PM. First, the final scans from the ground and upper floors were exported from the laser scanner's memory card to the university computer and imported into FARO Scene. There, the alignment and accuracy of the scans were reassessed to ensure they were correctly integrated. It was found that the software struggled with correctly aligning the stairs—a problem that had been manually addressed on-site during the measurement process and needed to be corrected again manually, as the point cloud was incomplete at that time and only a demonstration file was available. Additionally, the measured coordinates from the entrance area and balcony needed to be integrated, which was not yet fully completed (Fig. 2.1.14).



Fig. 2.1.14: First generated point cloud with all scans

On May 13, 2024, from 8:15 AM to 11:15 AM, the point cloud was further processed by the surveying students to enhance accuracy. This included aligning the point clouds with reference marks and performing error analysis. From May 13 to May 15, 2024, the scans were georeferenced. A comprehensive scan taken in front of the building served as a reference, and all subsequent scans were aligned to it. This reference scan was created concurrently on the day of the survey by a different person using another 3D scanning method. The interior scans were merged with some exterior scans, which were also created by a different group, to form a comprehensive point cloud. This integration provided the software with information about the facade's dimensions and allowed for a more precise definition of the facade's wall thickness in relation to the interior (Fig. 2.1.15).

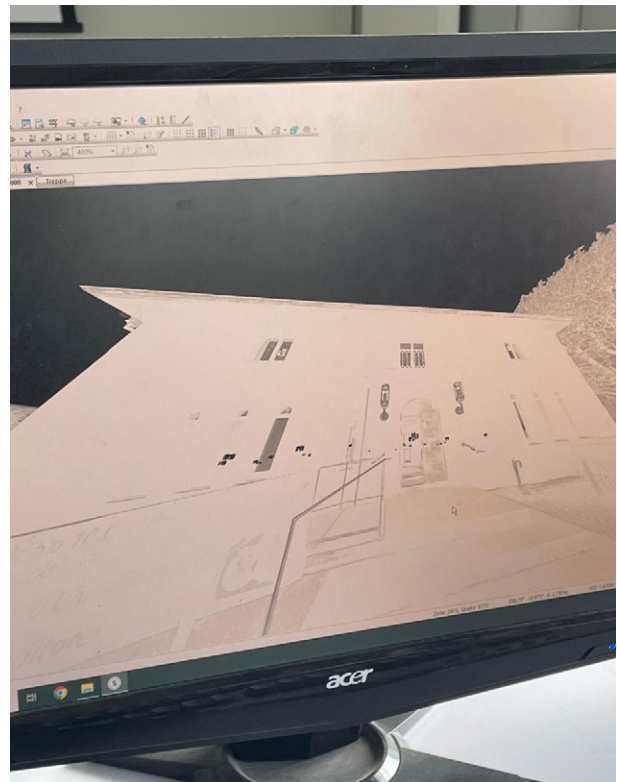

Fig. 2.1.15: Point cloud with the exterior area on the computer

Errors caused by reflective windows necessitated manual correction. The corrected scans were subsequently merged into a point cloud and exported in .e57 format. The format provided by the geodesy students had a size of approximately 4 GB. Throughout the investigation period, we processed the point cloud in Archicad. To edit a point cloud from FARO Scene in Archicad, it had to be converted into the supported e57 format. However, the file could not be opened on our laptops, prompting us to downsize the point clouds due to their size being excessive for Archicad and containing too many points.

On May 26, 2024, from 2:30 PM to 3:58 PM, the point cloud was re-imported and the file was resized smaller. Consideration was given to whether the outdoor area should also be represented in the point cloud. ArchiCAD displayed an error message during the initial attempt to import the 4 GB point cloud, stating that it must not exceed 280 million points. We ensured that the laptops we used had sufficient storage space. After consulting with the geodesy students, we opted to clean and reduce the point cloud again.

Data cleaning of point clouds in FARO Scene involves minimizing them by removing irrelevant data to enable precise and efficient analysis. This process often includes noise removal, filtering unwanted objects, or smoothing surfaces to enhance data quality. An added advantage is that this data cleaning process is feasible in cloud registration. By leveraging cloud registration features in FARO Scene, users can access powerful cloud computing resources to clean and process their point clouds, facilitating fas-

ter processing of large data volumes and offering a flexible data preparation solution not limited by local computer processing capacity.

On May 27, 2024, from 12:03 PM to 1:42 PM, the file was reduced to 1.4 GB, initially including the outdoor area. Although the file could be opened, it ran very slowly on a Microsoft Surface Book 2 (2019 model).<sup>10</sup> This laptop features an Nvidia GeForce GTX 1050 graphics card, 16 GB RAM, and an Intel Core i7 processor clocked at 4.2 GHz. The laptop's performance was deemed inadequate, and we were recommended from the geodesy students to use a more powerful computer. The HP ENVY TE02-1701ng<sup>11</sup>, previously mentioned, is suitable for editing point clouds in Archicad. It is equipped with an Intel Core i7-12700F 12th generation processor, 32 GB RAM, and an NVIDIA GeForce RTX 3060 graphics card, exceeding both the minimum and recommended specifications for Archicad. Its 1 TB SSD provides ample storage space and fast loading times, further enhancing its suitability for handling point clouds and other demanding tasks in Archicad.

The point cloud resolution was now 3 mm, meaning the points in the point cloud were spaced 3 mm apart, resulting in a dense point cloud (Fig. 2.1.16).

---

10 cf. Amazon. „Microsoft Surface Book 2 34,29 cm (13,5 Zoll) Laptop (Intel Core i7 der 8. Generation, 16GB RAM, 512GB SSD, Intel HD Graphics 620, Win 10) silber (Generalüberholt)“ Accessed 09.07.2024. [https://www.amazon.de/Microsoft-Surface-Generation-Graphics-Generalüberholt/dp/B088187BMY?source=ps-sl-shoppingads-lpcontext&ref\\_=fplfs&psc=1&smid=A2QBPT2NRCMPLN](https://www.amazon.de/Microsoft-Surface-Generation-Graphics-Generalüberholt/dp/B088187BMY?source=ps-sl-shoppingads-lpcontext&ref_=fplfs&psc=1&smid=A2QBPT2NRCMPLN)

11 cf. HP. „HP ENVY - TE02-1701ng (2023)“. Accessed 11.07.2024. <https://www.hp.com/de-de/shop/product.aspx?id=7N9Q9EA&opt=ABD&sel=DTP>





Fig. 2.1.16: Point cloud of the library with a resolution of 3mm

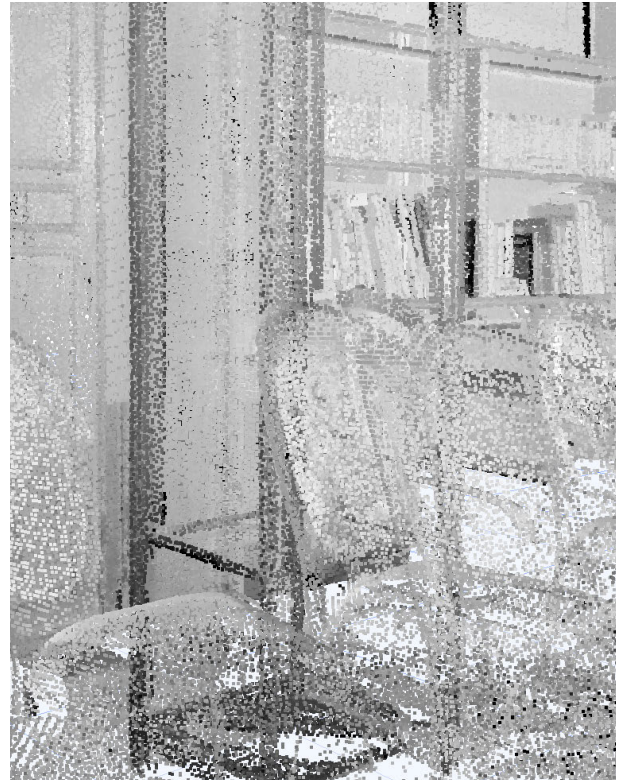

Fig. 2.1.18: Point cloud of the library 10mm resolution

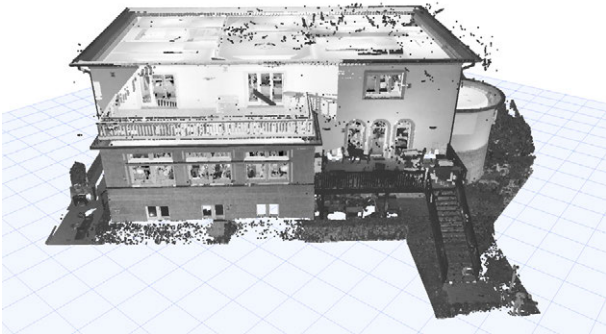
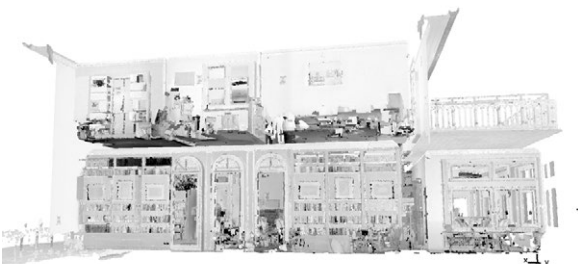

Fig. 2.1.17: Point cloud 3mm upsite + point cloud without exterior down

On May 28, 2024, from 11:45 AM to 2:20 PM, the point cloud was further reduced and limited to the interior area. The exterior area was no longer displayed (Fig. 2.1.17).

Additionally, the level of detail was significantly reduced, enabling the file to be processed in Archicad. The point cloud resolution was now 10 mm (Fig. 2.1.18). The total time spent up to this point for the entire process was 18.45 hours.



## **INSTRUCTIONS FOR IMPORTING THE POINT CLOUD INTO ARCHICAD**

For importing the point cloud, proceed as follows: Go to File and select „Interoperability“. Import the point cloud in the format (Point Cloud File (\*.e57; \*.xyz)) and then create it using the appropriate command in Archicad.

The point cloud will be uploaded as a single object in the object list and must be manually placed in the selected story. In the general 3D perspective, the object should be visible.

If the point cloud is not visible in the stories, please select the point cloud in the general perspective and adjust the object settings. Go to „Floor Plan and Section“ and set „Show on Stories“ to all stories.

After importing, you can use the point cloud for your planning and modeling tasks. You can create sections and views to use the point cloud as a reference for your 3D modeling. Use the ArchiCAD tools to create the model based on the point cloud.

# 5 EVALUATION

At the outset, we encountered no issues during the object scanning process. The device was user-friendly, and despite obstacles such as furniture or inadvertently scanned individuals in the image, we obtained an accurate point cloud. However, the scanning process took longer compared to other groups due to strategically placing scans in every room center and doorway, which was time-intensive.



Fig. 2.1.19: Scanned person in the outdoor area

Additionally, repeated scans due to image blur or people in the frame added extra time (Fig. 2.1.19).

Generating a color point cloud, as previously mentioned, would require additional time. In tighter spaces like the kitchen or hallways, we conducted multiple scans to ensure higher accuracy. Despite these challenges, the method facilitated a detailed capture of the object, proving highly beneficial for our analysis.

Early challenges arose in processing the point cloud in Archicad, as detailed in the „Data processing“ chapter. Processing proved challenging due to the need to reduce file size for efficient handling on a less powerful computer, resulting in reduced detail and loss of information. We also recommended a more powerful computer in the „Data processing“ chapter. Adjustments to the point cloud file included reducing resolution and limiting displayed areas to ensure smooth processing in Archicad.

We invested several days in making the project viable, utilizing the point cloud as a basis to reconstruct walls, ceilings, and floors. The point cloud served merely as a template, with a dense and detailed one advantageous for precise modeling (Fig. 2.1.20).



Fig. 2.1.20: Point cloud with the model and the model without point cloud

The figure depicts the reconstruction of the library (room 3) on the ground floor, visible alongside necessary views and sections (Fig. 2.1.21) to ensure precise alignment with the point cloud in the 3D view.

Figure 22 displays numerous views created to refine the point cloud for usability. The depicted floor plan had already undergone modeling, utilizing the point cloud as a base.

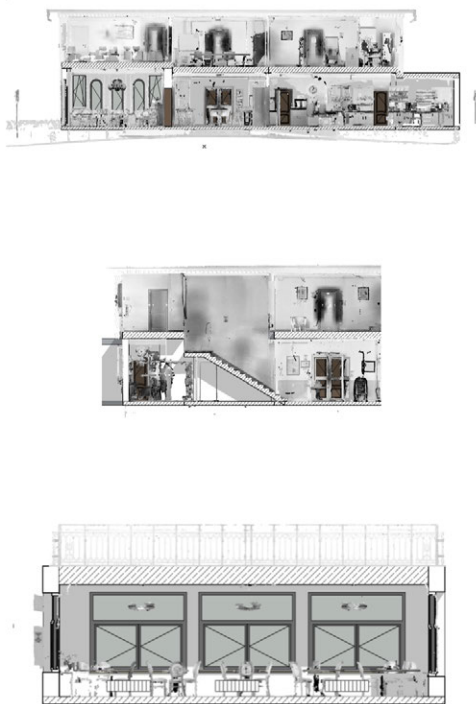

Fig. 2.1.21: Reconstructed point cloud sections and views

Creating views and sections, along with room modeling, averaged about an hour per room. Duration varied based on wall count; simpler rooms like Room 15 („Office Foundation“) modeled faster than geometrically complex spaces like room 5 („Reception Room“), partly due to Archicad’s slow response and performance issues on the Microsoft Surface Book 2, occasionally crashing during modeling.

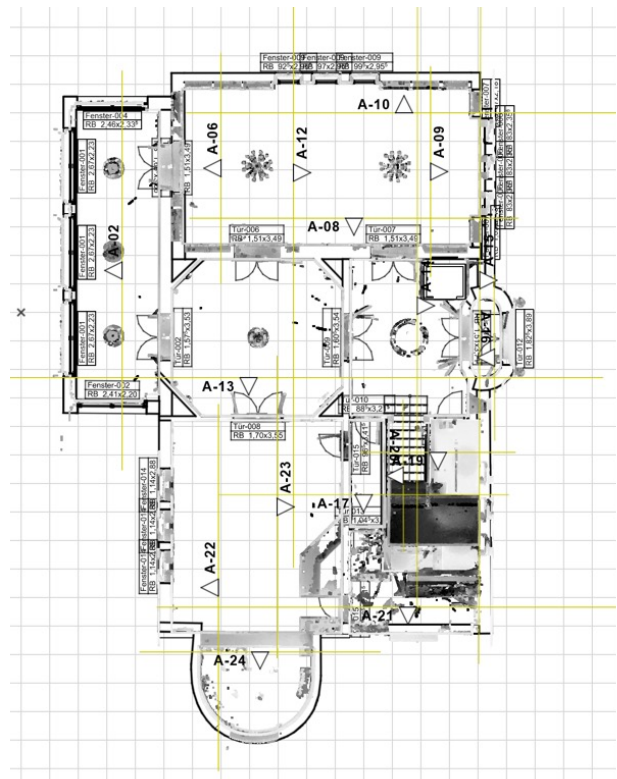

Fig. 2.1.22: Reconstructed floor plan with point cloud in the background

The point cloud presented floor-specific details (rooms, wall thicknesses, openings, etc.) at varying levels of detail. Surprisingly, ground floor detail was significantly higher than that of the first floor (Fig. 2.1.24), with the floor plan shifted right to clarify our given point cloud template.

Reducing point cloud file size seemed to have led to information loss in the first floor, resulting in uneven detail levels between floors. Possible reasons may lie in settings or parameters used during data reduction, alongside potential software or hardware limitations. Future projects would benefit from reviewing and adjusting processing steps and settings to ensure even and accurate representation of both floors in the point cloud.

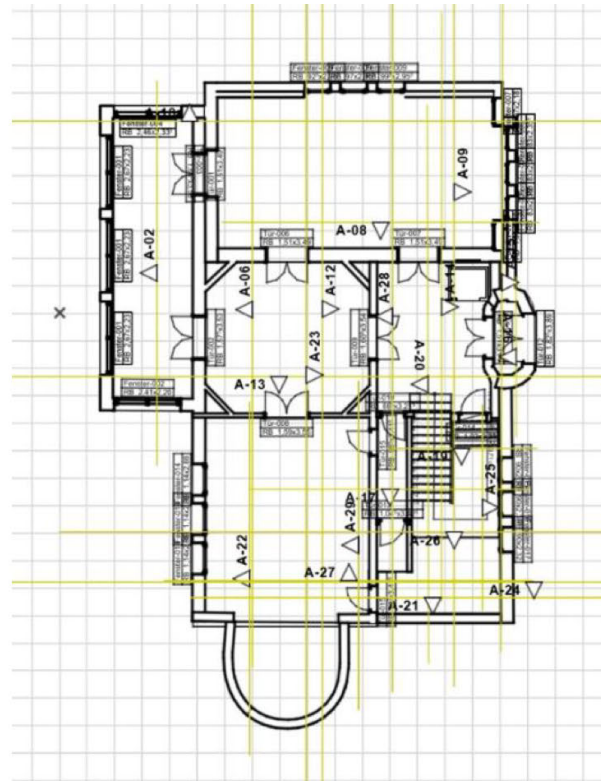
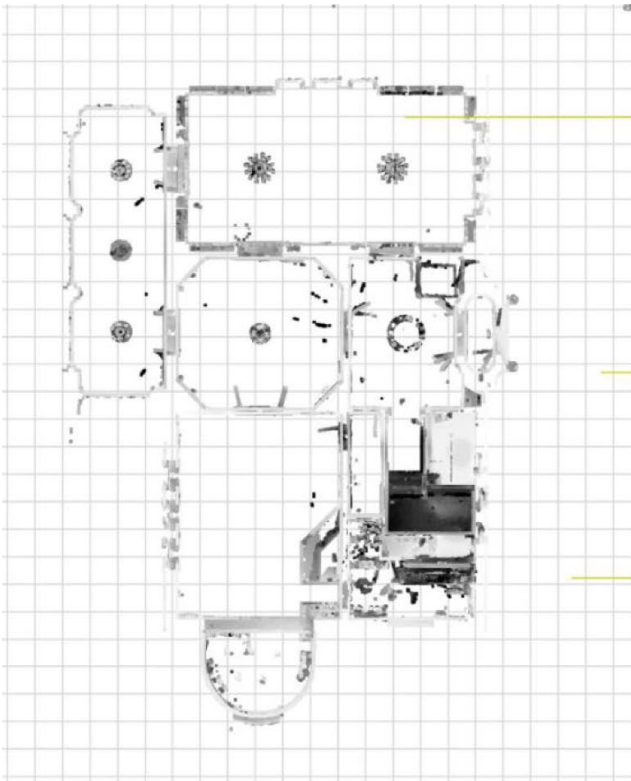

Fig. 2.1.23: Ground floor

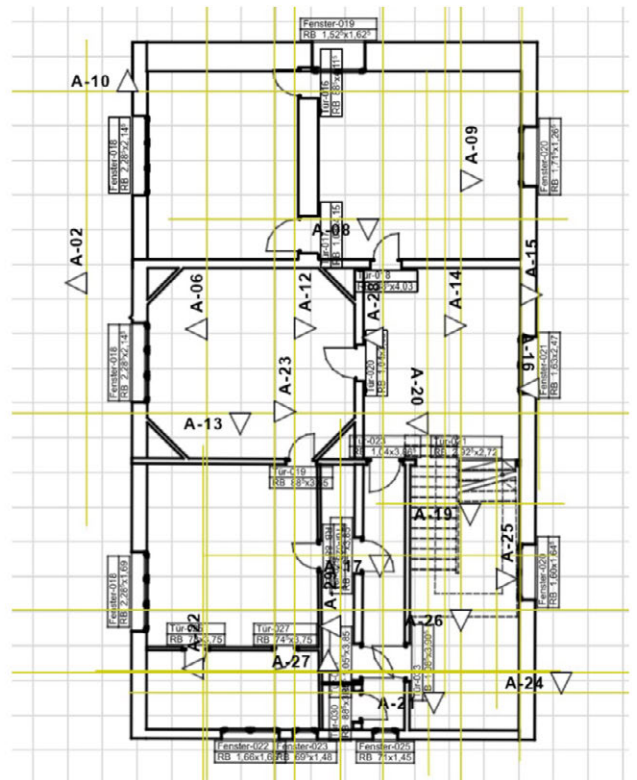
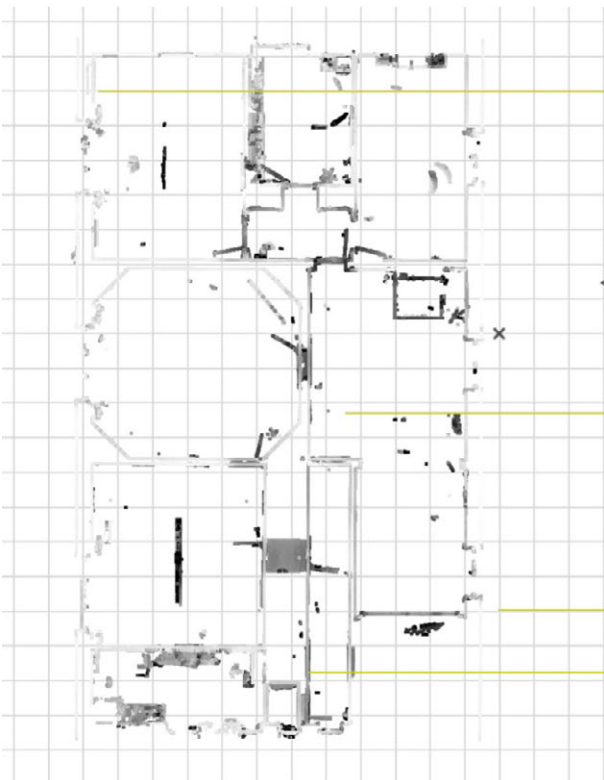

Fig. 2.1.24: First floor

- not scanned
- systemic weakness - compensable
- systemic weakness - not compensable
- own mistakes
- adopted from other groups (transparent)

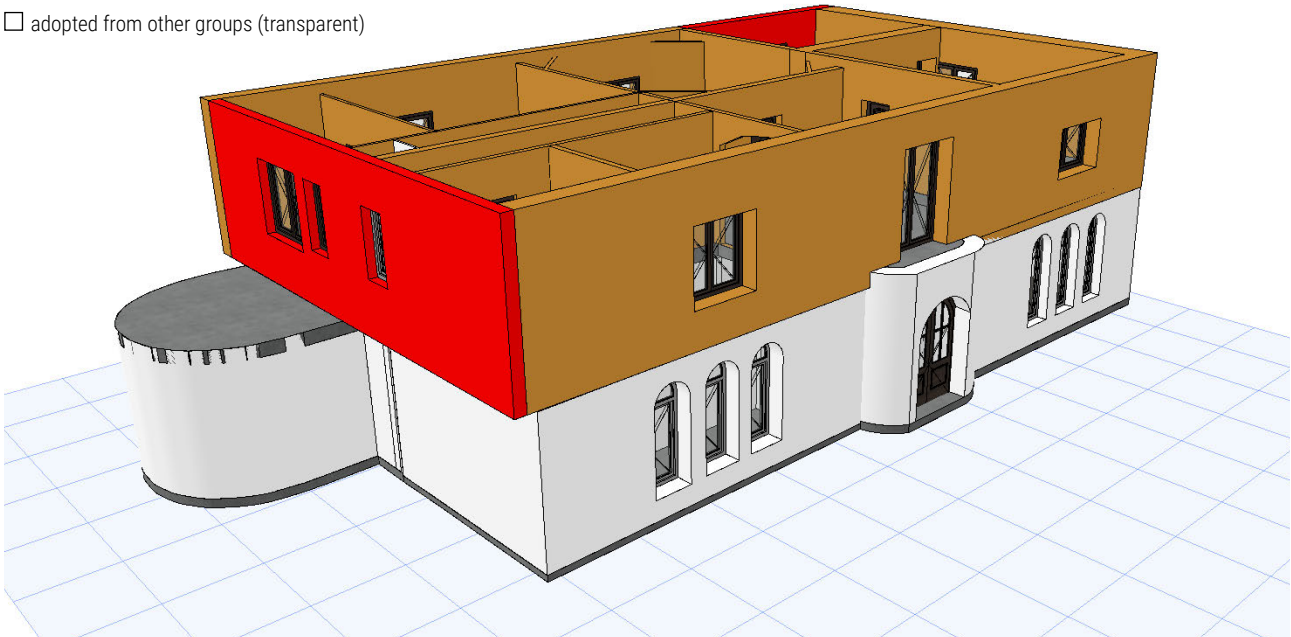

Fig. 2.1.25: Archicad model with color coding

Due to missing information, we speculated and intuitively modeled some walls, color-coding them in the 3D model (Fig. 2.1.25).

Red walls represent those barely discernible or absent due to system limitations, modeled speculatively. Orange walls indicate those identified by point clouds but with low detail. Small wall segments were occasionally missing in the floor plan, requiring information from views for modeling them.

Based on our experience, we recommend evaluating computational needs early for similar projects. A powerful computer can significantly enhance modeling efficiency and accuracy by reducing processing times and improving object representation. This optimization not only streamlines workflows but also minimizes potential data processing issues.

# LASER - MATTERPORT



## INTRODUCTION

Team	64
Description	64
Requirements	67



**PREPARATION**

Preparation 70

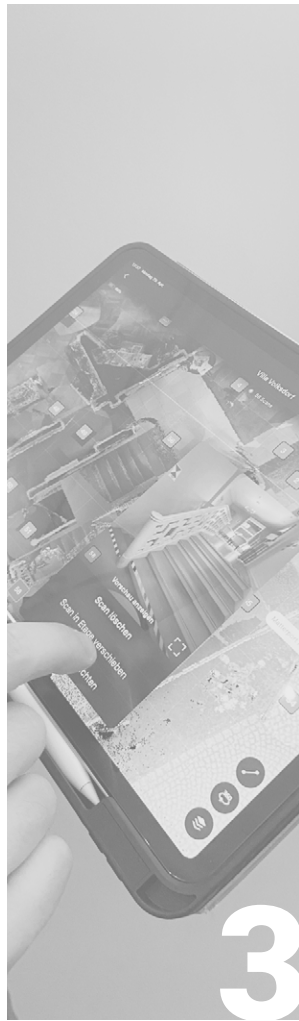

**SITE MEASUREMENT**

Site Measurement 72



**DATA PROCESSING**

Data Editing 80  
3D Model 84

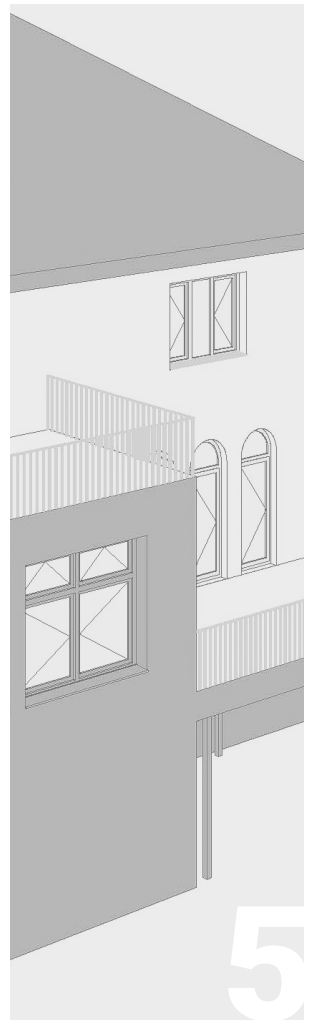

**EVALUATION**

Evaluation 90



# 1 INTRODUCTION



Fig. 2.2.1: Matterport: Matterport Pro3

## DESCRIPTION

This section deals with the measurement process using the scanning device named „Matterport Pro3“ (Fig. 2.2.1) made by the company Matterport. The Matterport Pro 3 combines the methods of lidar technology and photogrammetry, which can be used to generate high-precision 3D models of interior and exterior spaces. Matterport named those models „digital twins“.<sup>12</sup>

These „digital twins“ of the surveyed rooms are provided cloud-based by Matterport for virtual walk-throughs (Figs. 2.2.2 - 2.2.4). The „digital twin“ is the company’s unique selling point. To have this „digital twin“ publicly accessible an account and subscription is needed - further details will be given later on.

The „digital twins“ are a virtual copy of the scanned building that can be walked through digitally. It is a cloud-based file that can be accessed via a link using standard browsers and mobile devices. In this virtual model, measurements can be taken<sup>13</sup>, schematic floor plans can be displayed and squaremetres can be shown. The „digital twin“ can also be viewed in VR.<sup>14</sup>

Matterport’s scanning device is based on a combination of lidar technology, which records high-precision surveying data, and photogrammetry, which provides visual 360 degree images of the rooms. These form the basis for the virtual walk-through of the „digital twin“.<sup>15</sup>

12 cf. Matterport. "Cameras." Accessed 07.07.2024. <https://matterport.com/de/cameras>

13 cf. Matterport. "Introducing Measurement Mode: Now Everyone Can Measure." Accessed 08.07.2024. [https://support.matterport.com/s/article/Introducing-Measurement-Mode-Now-Everyone-Can-Measure?language=en\\_US&ardId=ka05d000001DWyH](https://support.matterport.com/s/article/Introducing-Measurement-Mode-Now-Everyone-Can-Measure?language=en_US&ardId=ka05d000001DWyH)

14 cf. Matterport. „Exploring Matterport Spaces in VR.“ Accessed 08.07.24. <https://support.matterport.com/s/article/Exploring-Matterport-Spaces-in-VR?language=de>

15 cf. Matterport. "Pro3 Technical Specifications." Accessed 08.07.2024. <https://support.matterport.com/s/article/Pro3-Technical-Specifications?language=de>

Matterport offers diverse services. One of which is the on-site recording of the „digital twin“. Other services include the construction of BIM-models, based on the „digital twin“. Part of the cloud based services of matterport are necessary subscriptions.

These range from €10.99 to €300 per month by 2024 (Fig. 2.2.6). Companies can negotiate separate contracts. The subscriptions differentiate between the number of publicly available „digital twins“ or the express processing of schematic floor plans and technical files, automatic facial blurring, access to survey data of the scanned objects and other services. A complete list of current costs and services can be found on the matterport website.<sup>16</sup>

The actual survey data, various data sets, like BIM models and point clouds of the scanned buildings must be purchased from Matterport separately.<sup>17</sup>

Prices for these datapacks are calculated individually according to the size of the project.<sup>18</sup>



Fig. 2.2.2: Example digital twin: Villa - doll house mode



Fig. 2.2.3: Example digital twin: Villa - schematic floorplan



Fig. 2.2.4: Example digital twin: Villa - 360 degree tour image

16 cf. Matterport. "Plans." Accessed 07.07.2024.  
<https://buy.matterport.com/de/plans>

17 cf. Matterport. "Digital Twin Features." Accessed 07.07.2024.  
<https://matterport.com/de/digital-twin-features>

18 cf. Matterport. "Matterport BIM-Datei." Accessed 07.07.2024.  
<https://support.matterport.com/s/article/Scan-to-BIM?language=de>

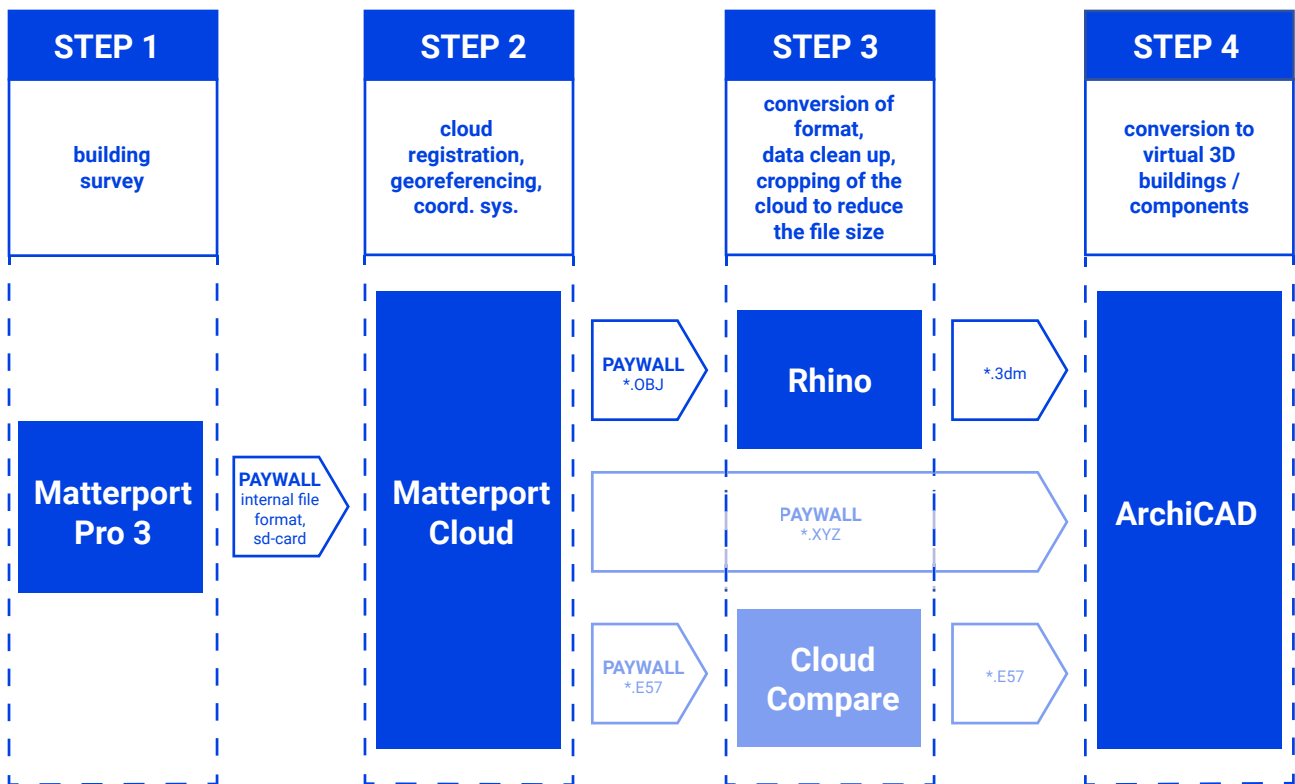

Fig. 2.2.5: Schematic diagram of procedure

## SUBSCRIPTIONS

**active space** = up to 200 scan points (spaces with more scan points count as multiple active spaces)

Free	Starter	Professional	Business	Enterprise
free	10,99 €/ month	61 €/ month	300 €/ month	price on request
1 active space 2 users	5-20 active spaces 3 users	20-150 active spaces 10 users	100-300 active spaces 50 users	custom active spaces custom users

Fig. 2.2.6: Matterport subscription options

## REQUIREMENTS

The entire process of measuring and documenting a building with Matterport (Fig. 2.2.5) can be divided into 4 steps:

- step 1: building survey
- step 2: cloud registration
- step 3: preparation of data
- step 4: development of BIM-ready 3D model

To ensure that everything runs smoothly, a few requirements should be considered (Fig. 2.2.7).

### Hard- & Software

- First of all a scanning device is needed. Matterport offers different cameras which can be used for this.<sup>19</sup> The following survey was carried out with the current flagship Matterport Pro3 lidar. The cost of the device starts at 5.695 €.<sup>20</sup>
- An additional tripod is needed to mount the camera. In the Matterport Pro 3 Performance Kit which was used in this case, a tripod as well as a tripod mount are included.
- Furthermore, an iOS or Android device are required to operate the scanner. On 21 June 2024, the manufacturer states that a device with iOS 16 or higher or Android 8 with more than 3 GB RAM memory is required, ideally with 128 GB storage capacity.<sup>21</sup> It is advisable to check for sufficient storage capacity and battery charge of the device prior to scanning. Depending on the

size of the project, a data volume of 2-3 GB should be expected.<sup>22</sup>

- On the mobile device, the Matterport app should be installed. It can be downloaded for free in the iOS App store or Google Play Store. The App is necessary for operating the scanner and for processing and uploading the scans in the end.
- To further process the scan data and use the services of Matterport, a subscription is required. The company offers five different subscription options. The individual CAD/BIM/Pointcloud/etc. data files must be purchased separately in addition to the subscription price. The free subscription does not offer the possibility to purchase further data in addition to the digital twin. With the "Starter" subscription Matter Pak and schematic floorplans can be purchased. For all other data (e.g. e57/BIM) "professional", "business" or "enterprise" subscriptions are required (Fig. 2.2.6).<sup>23</sup>
- Lastly, a PC/laptop with CAD/BIM software is required for implementing the scan data into the planning and design process. BIM data can be purchased from Matterport in a compatible format for Revit.<sup>24</sup> However, other file formats are also available and can be imported into a wide variety of software. The compatibility of file formats with the desired software and the system requirements of the PC should be checked in advance.

---

19 cf. Matterport. "Cameras." Accessed 07.07.2024. <https://matterport.com/de/cameras>

20 cf. ibid.

21 cf. Matterport. „Scan a Space: Matterport Pro Camera and Matterport Capture“ (04.04.2023). Accessed 19.06.2024. [https://support.matterport.com/s/article/Scan-a-Space-Matterport-Pro-Camera-and-Matterport-Capture?language=en\\_US&catfilter=Get\\_Started\\_Camera\\_Operators&parentCategoryLabel=Get\\_Started\\_Camera\\_Operators](https://support.matterport.com/s/article/Scan-a-Space-Matterport-Pro-Camera-and-Matterport-Capture?language=en_US&catfilter=Get_Started_Camera_Operators&parentCategoryLabel=Get_Started_Camera_Operators)

22 cf. ibid.

23 cf. Matterport. "Plans." Accessed 07.07.2024. <https://buy.matterport.com/de/plans>

24 cf. Matterport. „BIM.“ Accessed 07.07.2024. <https://matterport.com/de/bim>

## Onsite

- To ensure that the individual scans can be successfully linked together, it is important that there are no dynamic changes in the room between scans. It should therefore be considered in advance which rooms will be scanned and in which sequence this is to be done. All doors along the chosen route through the building should be opened in advance and fixed with stoppers.
- Furthermore, people or animals must not interfere with the scanning process. It is advisable to block off the room while scanning and to stay in a neighbouring room outside the camera's field of view. Objects should also not be moved or altered between scans.<sup>25</sup>

## Lightning

- To ensure high image quality, all light sources should be switched on in advance so that the room and adjacent areas are fully illuminated. In case of strong sunlight, Matterport advises to darken the windows. If possible, outdoor shots should not be taken in direct sunlight. It is recommended to take these at dusk approx. 30 minutes before sunrise or 30 minutes after sunset.<sup>26</sup>

## Scan positions

- The individual scans should be taken at intervals of 1.5 m to 2.5 m.<sup>27</sup> The tripod should be set at approximately eye level in order to create a realistic experience later

in the walk through of the digital twin.<sup>28</sup> It is important that the next scan position is within the field of view of the previous scan position. Scanning should take place centrally in the room and a minimum distance of approx. 50 cm from walls and objects should be maintained to avoid image distortion. In addition, scanning should not take place within door frames, but in the rooms in front of and behind them. It is advisable to position the camera as neatly as possible in a grid. At least two scans should be made per room, even if it is very small, to avoid blind spots. The individual scan positions correspond to the later viewpoints during the 3D tour, so special points of interest should be scanned from several positions so that they can be viewed in detail later.<sup>29</sup>

## Level of detail

- The more scans you take, the more detailed and accurate the result will be. Please note that projects with many scans will take longer to upload and will lead to large data files. A project is considered an „Active Space“ from 200 scans upwards. The number of Active Spaces that can be recorded may be limited depending on the subscription.<sup>30</sup>

---

25 cf. Matterport. „Scan a Space: Matterport Pro Camera and Matterport Capture“ (04.04.2023). Accessed 19.06.2024. [https://support.matterport.com/s/article/Scan-a-Space-Matterport-Pro-Camera-and-Matterport-Capture?language=en\\_US&catfilter=Get\\_Started\\_Camera\\_Operators&parentCategoryLabel=Get\\_Started\\_Camera\\_Operators](https://support.matterport.com/s/article/Scan-a-Space-Matterport-Pro-Camera-and-Matterport-Capture?language=en_US&catfilter=Get_Started_Camera_Operators&parentCategoryLabel=Get_Started_Camera_Operators)

26 cf. ibid.

27 cf. ibid.

28 cf. Matterport. "Scanning for 2D Snapshots While On-Site". Accessed 06.08.2024. [https://support.matterport.com/s/article/Scanning-for-2D-Snapshots-While-On-Site?language=en\\_US](https://support.matterport.com/s/article/Scanning-for-2D-Snapshots-While-On-Site?language=en_US)

29 cf. Matterport. „Scan a Space: Matterport Pro Camera and Matterport Capture“ (04.04.2023). Accessed 19.06.2024. [https://support.matterport.com/s/article/Scan-a-Space-Matterport-Pro-Camera-and-Matterport-Capture?language=en\\_US&catfilter=Get\\_Started\\_Camera\\_Operators&parentCategoryLabel=Get\\_Started\\_Camera\\_Operators](https://support.matterport.com/s/article/Scan-a-Space-Matterport-Pro-Camera-and-Matterport-Capture?language=en_US&catfilter=Get_Started_Camera_Operators&parentCategoryLabel=Get_Started_Camera_Operators)

30 cf. ibid.

No	Type	Requirement	Notes
1	Hardware	Matterport Pro 3 Performance Kit	Lidar camera, tripod, tripod mount, 2x battery, charging cable, transport case
2		iOS/ Android device	to operate the scanner, e.g. iPad Pro, check for sufficient storage capacity and battery charge
3		PC/ Laptop	for further processing of the scan data, hardware requirements depend on CAD software requirements
4	Software	Matterport Subscription	different options available
5		Matterport App	to operate the scanner, download from iOS App Store or Play Store
6		CAD/ BIM Software	for further processing of the scan data, e.g. Rhinoceros 3D, Archicad, Revit
7	Onsite	Static and clear environment, continuous route	no dynamic changes between scans, minimal obstructing objects/ people, open doors to link scans successfully
8	Lightning	good illumination, no direct sunlight	switch on all light sources, darken windows, scan at dusk or dawn
9	Scan positions	regular intervals, scan in grid	intervals of 1.5-2.5 m, keep distance to walls, scan centrally in the room, at least 2 scans per room
10	Level of detail	Active Spaces	the more scans, the higher the accuracy, more data + subscription limits

1. 
2. 
3. 
4. 
5. 
6. 
7. 
8. 
9. 
10. 

Fig. 2.2.7: Requirements

# 2 PREPARATION

## PREPARATION

We familiarised in advance with the functionality of the Matterport system. As the camera was provided by the engineering firm „dhp:i“ on the day of the measurement, it was not possible to carry out a test run in advance.

This also meant that no other aids had to be brought along. Information material was available on the Matterport website and YouTube account to research and prepare for the measurement. The video „Getting Started with Pro3“<sup>31</sup> in particular provides important information on how the camera works and how to carry out the building survey.

This theoretical approach to the functionality of the Matterport Pro3 was used to make assumptions for the upcoming shooting date. The focus here was on whether it is possible to successfully carry out the building survey without prior knowledge. During the survey, it will then be decided how easy it is to work with the Matterport Pro3. The following assumptions were made about the Matterport system:

- The implementation and handling is very simple
- The survey time required is low
- Few utensils are required (scanner, device + applicaiton, doorstops)

After appropriate preparation and research, the system is considered promising in terms of implementation, time required and results. This assumption will also be reviewed and re-evaluated in the further course of the project. In consultation with the engineering firm „dhp:i“, it was explained that the battery status

of the devices must be checked in preparation for the measurement. This concerns the batteries of the camera as well as the battery of the tablet, which is used for local project recording and for checking the individual scans. This means, above all, that the charging cable of the technical devices must also be taken to the measurement site. Secondly, it must be ensured that the Matterport app is installed on the corresponding tablet and that the connection between the camera and the tablet is working properly. Once these parameters have been checked and confirmed, nothing stands in the way of the technology running smoothly on the day of the measurement.

A few things should also be taken into account when preparing the rooms to be measured, e.g. if the images are to be aesthetically pleasing for marketing purposes, they should be tidied and cleaned. The room should look as it is intended for the subsequent 3D tour in the digital twin. Personal items such as photos, bank cards, confidential documents, etc. should be removed from the recording area if necessary.

Objects within the room that obstruct the scans should be removed in advance. If this cannot be done, it is advisable to take additional scans from several directions around the obstructing objects. It may help to adjust the height of the tripod to scan below/above the obstructions.<sup>32</sup>

As soon as the preparation of the technology and the rooms to be measured has been completed (see Checklist in Fig. 2.2.8), the recording can then begin.

31 cf. Matterport. „Getting Started w/Pro3 for Marketing your properties.“ Accessed 08.07.2024. <https://www.youtube.com/watch?v=hGRh2TRxcEw>

32 cf. Matterport. „Scan a Space: Matterport Pro Camera and Matterport Capture“ (04.04.2023). Accessed 19.06.2024. [https://support.matterport.com/s/article/Scan-a-Space-Matterport-Pro-Camera-and-Matterport-Capture?language=en\\_US&catfilter=Get\\_Started\\_Camera\\_Operators&parentCategoryLabel=Get\\_Started\\_Camera\\_Operators](https://support.matterport.com/s/article/Scan-a-Space-Matterport-Pro-Camera-and-Matterport-Capture?language=en_US&catfilter=Get_Started_Camera_Operators&parentCategoryLabel=Get_Started_Camera_Operators)

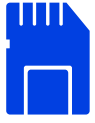

**1. CHECK STORAGE CAPACITY**



**2. OPEN ALL DOORS**



**3. ADJUST LIGHTNING**



**4. REMOVE OBSTACLES**

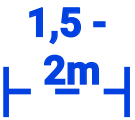

**5. SCAN IN REGULAR INTERVALS**

Fig. 2.2.8: Checklist Preparation



# 3 SITE MEASUREMENT

## SITE MEASUREMENT

In the specific case of the recording of the Ohlendorff'sche Villa, the Matterport Pro3-LiDar device was provided by the engineering firm dhp:i Dr Hesse und Partner Ingenieure. The scanner, tripod with tripod attachment for the scanner, spare batteries and a tablet with the Matterport app were provided (Fig. 2.2.9). The project was created locally on the tablet in the app and uploaded to the Matterport cloud after the scan.

In our recording of the Ohlendorff'sche Villa, we worked with the Matterport Pro3, which is why we want to focus on this device and the corresponding results in the following discussion.

A brief introduction to the operation of the scanner was given on site. After a 10-minute briefing, the scanning could begin. The intro-

duction to working with the scanner and app was low-threshold and self-explanatory. There were a few points to bear in mind when preparing the environment to be scanned, which will be explained in more detail later on.

On the day of the measurement, all of our working group got into touch with a device from the company Matterport for the first time. A Matterport Pro3 Performance Kit was provided for us, which includes the Matterport Pro 3 device, a tripod, spare batteries and a charger.

The camera was paired with an iPad, on which the app was pre-installed. In order to carry out the measurement, the Matterport Pro 3 must be removed from the case and mounted on the tripod (Fig. 2.2.12). The device and the iPad then have to be switched on and the app must be started.

A new project must now be created in the app.



Fig. 2.2.9: Matterport Pro 3 Performance Kit



Fig. 2.2.10: Resulting 3D Scan + 360° camera image the Matterport app

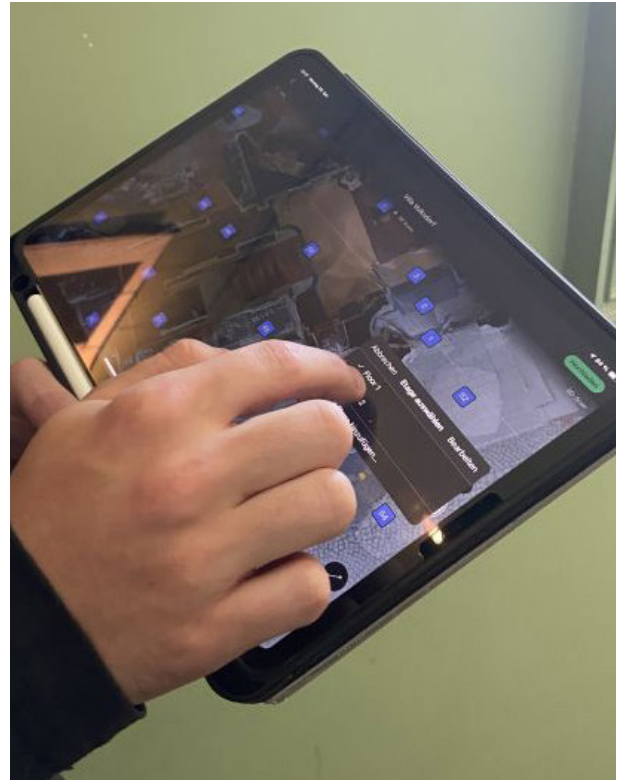

Fig. 2.2.11: Selecting 1F in the Storey Selection Tool the Matterport app

After a few minutes, the 3D capture can start. To scan a room, the tripod with the scanner mounted is placed in a free position in the room. The start button on the iPad can now be triggered from a position outside the scanner's line of sight (Fig. 2.2.13) and the scan started. During a scan process, the Matterport Pro3 rotates once through 360 degrees. As already described in section 1 Introduction: Requirements, it should be ensured that doors to rooms, terraces or open spaces that are to be scanned in the further course are opened and detected so that the device can later find the connection to the data from the previous scan. In the first room that we scanned, the doors to the neighbouring room were not yet open. After scanning the next room, an error message was displayed in the app. The scan had to be repeated with the door open so that there was sufficient overlap and the device could connect to the previous room.

The scanning process itself only takes around 15 seconds. In addition, there is a processing time of around 20 seconds until the scan data is displayed in the app. The resulting 3D scan is then displayed directly in the app and can be checked. In addition to the 3D scan of the lidar process, a 360° camera image is also created, which can also be found immediately in the app (Fig. 2.2.10). The room becomes visible in the app and the camera image can be displayed via an icon in the centre of the room. Depending on the room geometry and furnishings, the camera should be positioned at one or more other locations in the same room in order to capture any concealed areas, thereby increasing accuracy. In this way, one room at a time can be scanned, taking into account the necessary overlapping areas mentioned above. When changing floors, a new floor must be created in the app. Matterport recommends



Fig. 2.2.12: Matterport Pro 3 mounted on a tripod



Fig. 2.2.13: Operation from outside the scanning area

organising floors and areas in advance.<sup>33</sup> This is even possible during the measurement, but takes a few seconds. Depending on the length and shape of the staircase, further scans are made on the steps. The tripod may need to be readjusted for this. If you do so, the line of sight should match the previous scans. When you reach the end of the staircase on the upper floor, click on the storey selection tool in the preview window of the app and select the relevant storey on which the measurement will now be continued (Fig. 2.2.11). Split-level storeys belong to the storey below.<sup>34</sup> To improve the quality of the scan result and

avoid errors, Matterport recommends finalising the scan in the app after recording is complete.<sup>35</sup> To do this, click on the mark feature icon in the preview view. Windows can now be marked using the window tool. A pink distance line and an icon indicating the inside of the room will appear. The mirror tool can be used to mark mirrors and other reflective surfaces (e.g. televisions, stainless steel surfaces). The trim tool is used to cut off excess areas (e.g. depth points outside the building).<sup>36</sup> However, we were not yet aware of these options during our measurement and therefore did not use them.

33 cf. Thiele, Eike. Scanner 2 GO. „01b So scannen Sie richtig mit der Matterport Pro 3“. Accessed 04.07.2024. <https://support.scanner2go.de/hc/de/articles/25920709865489-01b-So-scannen-Sie-richtig-mit-der-Matterport-Pro-3>

34 cf. Matterport. „Scan a Space: Matterport Pro Camera and Matterport Capture“ (04.04.2023). Accessed 19.06.2024. [https://support.matterport.com/s/article/Scan-a-Space-Matterport-Pro-Camera-and-Matterport-Capture?language=en\\_US&catfilter=Get\\_Started\\_Camera\\_Operators&parentCategoryLabel=Get\\_Started\\_Camera\\_Operators](https://support.matterport.com/s/article/Scan-a-Space-Matterport-Pro-Camera-and-Matterport-Capture?language=en_US&catfilter=Get_Started_Camera_Operators&parentCategoryLabel=Get_Started_Camera_Operators)

35 cf. *ibid.*

36 cf. *ibid.*



Fig. 2.2.14: Floor plan with m<sup>2</sup> after upload to the matterport cloud

The quality of the measurement should then be checked again in the preview window. If possible, there should be no black areas within the project. Areas that have not been recorded are shown in black. This allows you to see directly in the app where the scan still has gaps. If this is the case, scans can be made up at the relevant points.<sup>37</sup>

The measurement can easily be executed by just one person. It is easy to use and no previous experience is necessary. Due to the very short time required for a single scan, as already mentioned above, around 15 seconds for a 360° movement of the Matterport Pro 3 and the 20 seconds processing time until the images are visible in the app, the general time required for a measurement with Matterport is very short.

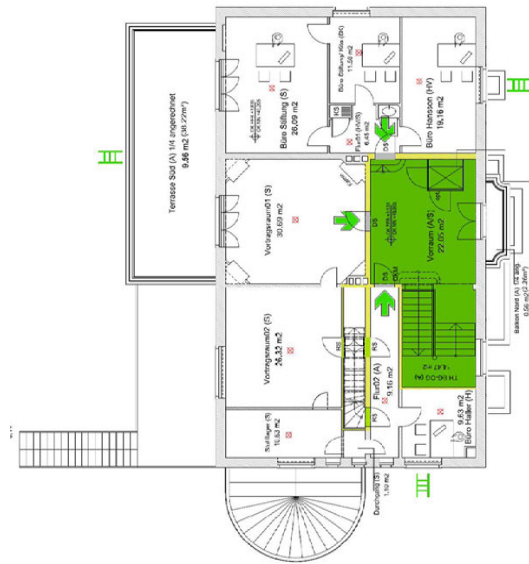

Fig. 2.2.15: Original floor plan

A total of around 2 hours and 10 minutes were needed for the entire building (start at around 12:20, end at around 14:30). The recording time for a room varied between 3 and 10 minutes, depending on its size, furniture and the resulting scanning positions. If there were obstructive objects or furniture in the room, several different locations and scans were necessary to increase the accuracy of the model. This increased the processing time accordingly. To pick out a few rooms as examples, we only needed 3 minutes each for „Büro Hansson“ (room 13) and „Flur“ (room 12) on the upper floor, 4 minutes for „Büro Stiftung/ Kita“ (room 14) and 5 minutes for „Vortragssaal01“ (room 16). For „Verkauf“ (room 6) on the ground floor, on the other hand, around 13 minutes, due to the complicated room layout caused by the furnishings. To save time, the

37 cf. *ibid.*



Fig. 2.2.16: Autom. generated floor plan with corner instead of rounding

Matterport Pro 3 can already be moved to the new position during the automatic linking of a scan with the overall model within the app. Initially, we were still unfamiliar with the system and had to repeat runs due to a lack of coverage or closed doors. The more practised the handling of the device became, the less time was needed to record the rooms. In general, it is recommended that as few people as possible are present for the recording to keep the process running smoothly. In our case, some scans had to be repeated because people walked into the room during the scan. These scans can be easily deleted from the app and restarted immediately.

Initially, we were still unfamiliar with the system and had to repeat runs due to a lack of coverage or closed doors. The more practised the handling of the device became, the less time was needed to record the rooms.

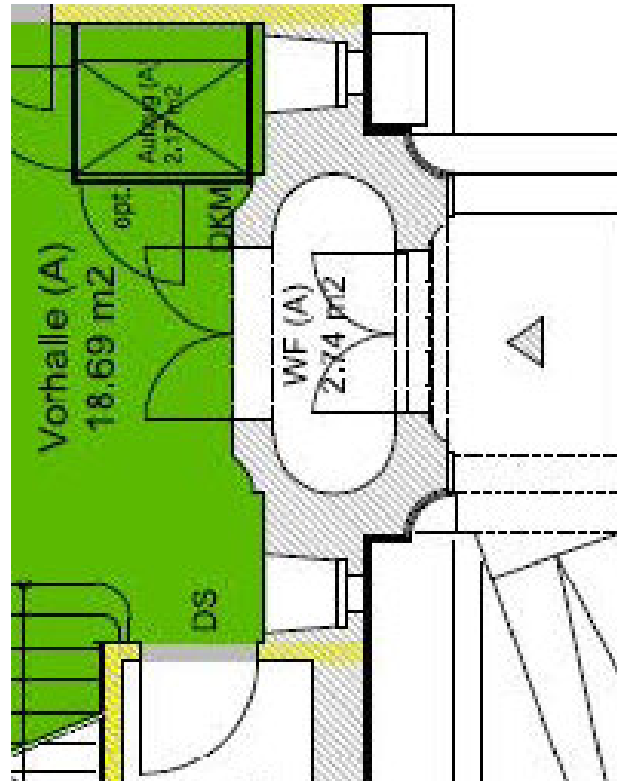

Fig. 2.2.17: Original floor plan

In general, it is recommended that as few people as possible are present for the recording, to keep the process running smoothly. In our case, some scans had to be repeated because people walked into the room during the scan. These scans can be easily deleted from the app and restarted immediately.

After each individual scan, the images are immediately visible as a coloured floor plan in the app. A 360° camera image is linked to each individual room. Each new scan is linked to the previous one and the device automatically recognises where it is when doors are open and locations are close together. The measurement is therefore immediately visible, a digital twin is generated and a 360° view of the room is also immediately available. This real-time feedback allows the result to be checked directly and, if necessary, improved with additional images.



Fig. 2.2.18: View from library in 360° tour: person on stairs



Fig. 2.2.19: Next position in 360° tour: person on stairs is gone

Once all rooms have been captured, the data can be uploaded directly to the Matterport Cloud and a link to the model can be created. The recorded model, i.e. the digital twin of the building, is available via this link. In the digital twin you can zoom into individual rooms. Recorded rooms can be viewed from all sides, including a virtual tour. The floor plans are displayed floor by floor, are provided with square metre figures (Fig. 2.2.14). The floor plan created by Matterport Pro 3 is very similar to the original plan (Fig. 2.2.15). It is particularly noteworthy that measurements can already be taken there. The 360° tour is also available via the link.

We made a few small mistakes during our measurements. For example, there must be no changes inbetween the different scans of one room at the different positions. As already explained, doors must not be opened or closed

and furniture must not be moved, otherwise an error message will appear. The app cannot stitch the scans correctly due to the errors in overlap. The failed scan has to be repeated. As mentioned, this happened several times at the beginning. To repeat a scan, the position of the scan can be selected in the app. The scan can be deleted here and then repeated by positioning the scanner in the same place again.

Also no persons should move through the room during the scans. Attention should also be paid to ensure that nobody is in the neighbouring rooms. People have sometimes been scanned in neighbouring rooms through open doors. They suddenly appear during the 360° tour through the building and are no longer visible in the next position or vice versa (Figs. 2.2.18 - 2.2.21).



Fig. 2.2.20: View from lecture room in 360° tour: person at table

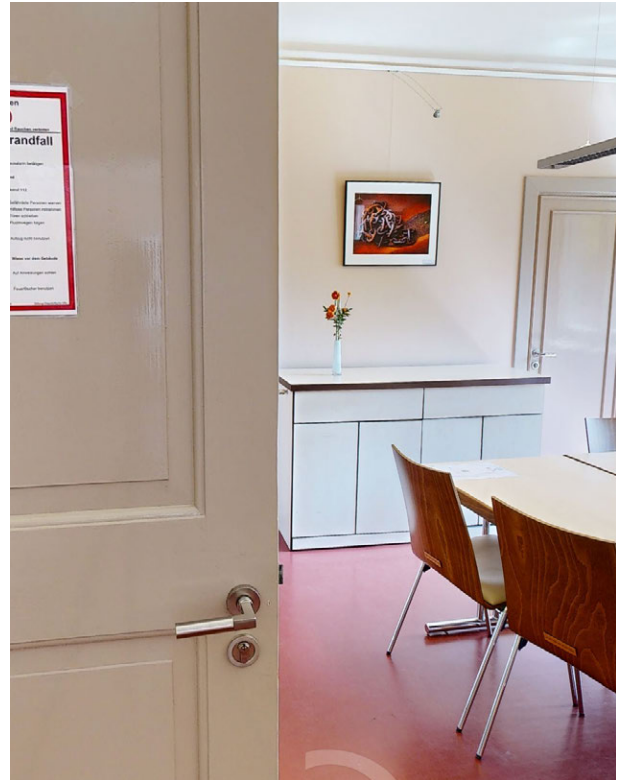

Fig. 2.2.21: Next position in 360° tour: person at table is gone

In addition, furniture and fixtures sometimes obstructed the scan. Objects in the background cannot be captured by the Matterport Pro 3. In order to capture hidden areas, the camera must be set up in another position. This sometimes occurred behind the open doors.

Walls with curves are not recognised as curves in the automatically generated floor plan (Figs. 2.2.16 and 2.2.17), which can be accessed later via the link, and doors that have been set up are sometimes interpreted as solid walls.





# 4 DATA PROCESSING

## DATA EDITING

As the scanned data was uploaded from the Matterport App to the Matterport Cloud the post-processing could start. In this step the data is given to Matterport. They corrected the position of any displacements or incorrectly positioned walls and doors.

This step is particularly important to ensure that the subsequent files are displayed correctly. The errors discussed at the end of the „Site measurement“ chapter are corrected.

After post-processing, the Matterport Cloud provides you with various file formats at different prices that can be used for further processing of the building. You can only access these files via the Matterport Cloud for a fee. The following file formats are available for our project at the specified conditions (prices provided by dhp:i as seen in their Matterport Cloud):

Matterpak (.XYZ & .OBJ; 54€)

E57 (99€)

BIM (.RVT, .IFC, .DWG; approx. 675€ - 6.000€; depending on the level of detail)

CAD file (.DWG; 350€ - 630€; depending on the level of detail)

Schematic floor plan (.PNG, .PDF, .SVG; 15€)

TruePlan for Xactimate (.SKX; approx. 401€)

The prices for the files vary depending on the size of the project and, in some cases, the desired level of detail. In addition, the prices for the BIM (Fig. 2.2.23) and CAD files are displayed as estimated prices, as these are project-dependent. An exact cost estimate can be requested in every case. It should also be noted that there are different levels of detail to be determined for the two file formats.

The screenshot displays a grid of nine service cards in the Matterport Cloud interface. Each card includes an icon, a title, a status (e.g., 'Aktualisiert' or 'Neu'), a description, and a 'Herunterladen' (Download) button. The services listed are:

- Schematischer Grundriss** (Aktualisiert): Professionelle schematische Grundrisse für die Vermarktung von Wohnräumen und gewerblichen Büros.
- CAD-Datei** (Neu): Transformieren Sie Ihren Matterport Space in eine 2D-CAD-Datei, die während des gesamten Gebäude-Lebenszyklus verwendet werden können, einschließlich Planung, Bau und Gebäudeverwaltung.
- BIM-Datei**: Transformieren Sie Ihren Matterport Space in ein 3D-Revit-Modell und eine 2D-CAD-Datei, die während des gesamten Gebäude-Lebenszyklus verwendet werden können, einschließlich Planung, Bau und Gebäudeverwaltung.
- MatterPak™**: Benutzer: Christian Hesse, Neueste Aktualisierung: May 26, 2024, Bereit.
- Inhaltsverteilung für Immobilien** (von Verschiedene Partner): Der Standardwert für das Konto: Entfernen. Erhöhen Sie die Sichtbarkeit Ihrer Matterport Bereiche, indem Sie sie automatisch an führende Partner im Internet weiterleiten.
- Veröffentlichen: Vrbo & HomeAway 360** (von Vrbo und HomeAway 360): Veröffentlichen Sie die Panoramabilder in Ihren Spaces auf den eigenen 360-Touren von Vrbo und HomeAway.
- E57-Datei**: Benutzer: Christian Hesse, Neueste Aktualisierung: May 26, 2024, Bereit.
- TruePlan™ for Xactimate®**: TruePlan™ sind SKX-Dateien, die Sie mühelos in Xactimate® importieren können. Mit diesen Dateien müssen Sie Verluste nicht mehr manuell messen und skizzieren.
- Google Street View**: Setzen Sie Ihr Unternehmen auf die Landkarte mit der Google Street View Integration von Matterport.

Fig. 2.2.22: Files offered in the Matterport Cloud



Nutzen Sie die Leistungsfähigkeit von Matterport-Modellen. Wandeln Sie Ihre Geodaten in ein LOD-200-Gebäudeinformationsmodell (BIM) im .RVT- und .DWG-Format um.

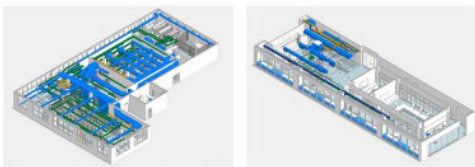

#### Schätzungen zur Preisgestaltung

Sie haben die Möglichkeit, einen oder alle der folgenden Produktbereiche einzubeziehen:

- Zur Architektur gehören sichtbare Wände, Fußböden, Türen, Säulen, Decken, Fenster, Badezimmerarmaturen, Treppen und Dächer.
- Zu den Innenmöbeln gehören sichtbare Schreibtische, Tische, Schränke, Regale, Stühle, Sitzgelegenheiten, Haushaltsgeräte, Küchenelemente und einige Wandhalterungen.
- Zu den mechanischen, elektrischen und sanitären Anlagen gehören sichtbare Klimageräte, Sanitärarmaturen, Rohre, Strom-/Datenanschlüsse und einige Kabelkanäle.
- **MEP für Architektur und komplexe Industrie** muss ausgewählt werden, wenn ihr Space einer der folgenden ist:
  - Mechanischer Raum (Kessel, Kühler, Anlage)
  - Elektrischer Raum (Hauptgeräteräume, Verteilerräume und lokale/Nebengeräteräume, Computerräume)
  - Fulfillment-Zentren
  - Fertigungseinrichtungen
  - Lagereinrichtungen (mit schweren Maschinen)
  - Rechenzentrum

Unser Standardangebot ist für Spaces bis zu 4,645 m<sup>2</sup> (50,000 ft<sup>2</sup>) verfügbar. Konten auf Unternehmensebene können bis zu 32,500 m<sup>2</sup> (350,000 ft<sup>2</sup>) bestellen. Bitte beachten Sie, dass sich der Kostenvorschlag ändern kann, sobald die endgültige Quadratmeterzahl während der Erstellung der BIM-Datei berechnet wurde.

Bei Modellen, die als „Sonderauftrag“ eingestuft sind, können Preis Anpassungen erforderlich sein.

Basierend auf der geschätzten Größe der 4.604 Quadratfuß für diesen Space ist die geschätzte Bearbeitungszeit und der Preis wie folgt:

Format	Bearbeitungszeiten Werktag	Geschätzter Preis
Grundlegende Architektur (Standard)	3-11	675,00 €
Architektur und Inneneinrichtung	3-11	945,00 €
Architektur und MEP	3-11	1.350,00 €
Architektur, MEP und Inneneinrichtung	3-11	1.650,00 €
Architektur und komplexe industrielle MEP	13-28	6.000,00 €

[Weitere Details zu BIM anzeigen](#)

#### Enthaltene Dateien

- RVT-Datei (kompatibel mit Revit 2020 und höher)
- DWG-Datei (pro Stockwerk)
- IFC-Datei (plattformneutral und lesbar/bearbeitbar mit jeder BIM-Software)
- RCS-Datei (ReCap-Punktwolke)

#### In dem RVT-Modell enthalten:

- Innenbereich: Alles, was in der Punktwolke für den angeforderten Geltungsbereich sichtbar ist, wird nach LOD 200 modelliert. Beachten Sie, dass Wandständerelemente (Rahmen) als generische Wände modelliert werden.
- Außenbereich: Außenbereiche fallen nicht in den Geltungsbereich einer BIM-Datei. Die folgenden Elemente werden nicht einbezogen: Pflanzen (einschließlich Bäume), Fahrzeuge, Außenansicht des Gebäudes. Die folgenden Elemente können einbezogen werden, wenn sie in der Punktwolke sichtbar sind: Wiege, Geländer, Treppen zur Veranda und Swimmingpool.
- Dach: Wenn das Dach in der Punktwolke sichtbar ist, wird die einfache Geometrie nach LOD 200 modelliert. Die Geometrie des Dachs lässt sich am besten modellieren, wenn Punkte von außen so gescannt werden, dass das Dach in der Punktwolke sichtbar ist.

Dies sind die **Baulemente**, die im Add-on „An BIM scannen“ von Matterport enthalten sind, entsprechend den Optionen, die Sie beim Kauf auswählen.

Fig. 2.2.23: Exemplary offer for the BIM file from the Matterport Cloud

These are divided into

- Basic architecture
- Architecture and Interior Design
- Architecture and HVAC
- Architecture, HVAC and Interior Design
- Architecture and Complex Industrial HVAC

„Basic architecture“ captures the basic components of the building’s interior structure, including walls, doors, stairs and windows. In comparison, the „Architecture and Interior Design“ option allows you to add non-architectural objects such as tables, seating, cabinets, appliances and wall fittings to the model. Furthermore, with „Architecture and HVAC“ there is the option to display visible HVAC systems, including but not limited to mechanical equipment, piping, plumbing and sockets.

The processing time for the BIM and CAD file varies between three and eleven days, while the other file formats are available after one to 24 hours.

As we did not have access to the Matterport account ourselves, we had to rely on dhp:i to relay the scan data towards us. We have been provided with the MatterPak bundle. Included in the MatterPak were different files, including .XYZ and .OBJ. The Matterpak is defined as follows: „The MatterPak Bundle is a set of assets that you can download as a .ZIP file and import into a 3D third-party program like 3ds Max, ReCap, Revit, or AutoCAD. It includes a colored point cloud, a reflected ceiling plan image and a high-resolution floor plan image and a 3D mesh file, including the necessary texture map image files.“<sup>38</sup>

38 cf. Matterport. „Available Add-Ons.“ Accessed 08.07.2024. [https://support.matterport.com/s/article/Available-Add-Ons?language=en\\_US&catfilter=&parentCategoryLabel=](https://support.matterport.com/s/article/Available-Add-Ons?language=en_US&catfilter=&parentCategoryLabel=)

After receiving the files, we first familiarized ourselves with the file formats.

For the process in CAD, the .OBJ file, the .xyz point cloud of the MatterPak, as well as the high-resolution point cloud in E57 format<sup>39</sup> (Figs. 2.2.25 and 2.2.26) would be the basis for creating the 3D model.

As the E57 format was due to its size slowing down our laptops, we developed the 3D model based on the MatterPak's contents.

In order to decide between the .OBJ model and the .XYZ point cloud, we opened both files with ArchiCad. On the following page you can see the point cloud, the .OBJ model and the photogrammetric 3D image (Figs. 2.2.27 - 2.2.29) of the same perspective to make the differences in resolution comparable. The point cloud with 86,826,928 points led to slight stuttering in the program. The .OBJ file could not be opened with ArchiCad, but could be opened with Rhino7.

The complete mesh of the recorded room opened in Rhino7 could be used as the basis for 3D modeling. Its file size is 37mb - further reduction by deleting the interior, especially the trees, reduced the file to 12mb. Deleting the loose furnishings reduced the file size to 10mb. The manual deletion of the surroundings and the loose furniture each took 5 minutes. Since the relatively larger effect is the reduction of the exterior space, we used this basis with 12mb for further work in ArchiCad.

The mesh was saved as in the .3dm fileformat from Rhino7. This format can be accessed and used as a mask for 3D modeling in ArchiCad.



Fig. 2.2.24: .XYZ pointcloud with lower point density



Fig. 2.2.25: .E57 pointcloud with higher point density

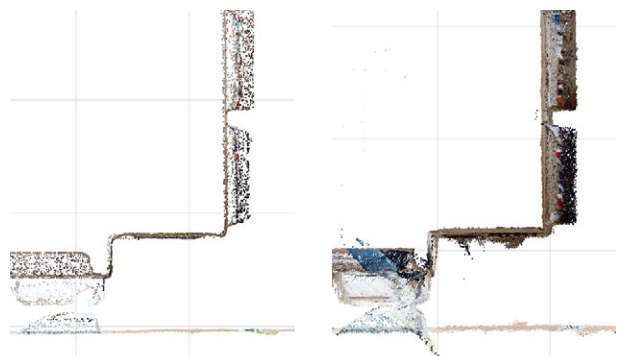

Fig. 2.2.26: Detail comparing the point densities and accuracy of the pointclouds (left .XYZ, right .E57)

39 cf. Matterport. „Overview of Matterport E57 File“ (10.05.2024). Accessed 08.07.2024. <https://support.matterport.com/s/article/Overview-of-Matterport-E57-File?language=de>



Fig. 2.2.27: photogrammetric 3D showcase of Villa Volkdorf



Fig. 2.2.28: .XYZ pointcloud example



Fig. 2.2.29: .OBJ mesh example

### 3D MODEL

Then we uploaded the .3DM file to Archicad to start the 3D modeling of the building in the next step. The .3DM file is imported into Archicad as an object in which all edges and points can be selected and therefore measured. This makes it possible to carry out a relatively precise measurement of the wall thicknesses. This is only limited by the fact that there are usually several lines next to each other so that the center point must be assumed. The file also has a clear structure in the individual storeys, which can be displayed in the floor plan. Sections and views as well as the 3D perspective can also be viewed directly and do not require any preliminary work in the sense of overlaying different elements. The structure of the building is created directly by the Matterport Pro3 camera during the scan. This means that we can start directly with the 3D modeling of the building

and no further preparatory work is necessary for the following process.

We started on the first floor with the long side of the building to the north (Fig. 2.2.30, Nr. 1). Here we scanned the interior of the individual rooms and also completed a few scans of the exterior. This shows that the thickness of the exterior wall, the windows, the window stop, as well as the doors and the door stop can be clearly read and defined. To determine the height of the individual structural elements (walls, doors, etc.), we display the view. This works without any problems so that we can model the first outer wall including windows and doors. On the eastern transverse side, we have only scanned the building from the inside and notice that the thickness of the outer wall is not specified, only the inside of the wall (Fig. 2.2.30, Nr. 2). This suggests that a scan must be made from both sides of the wall in order to

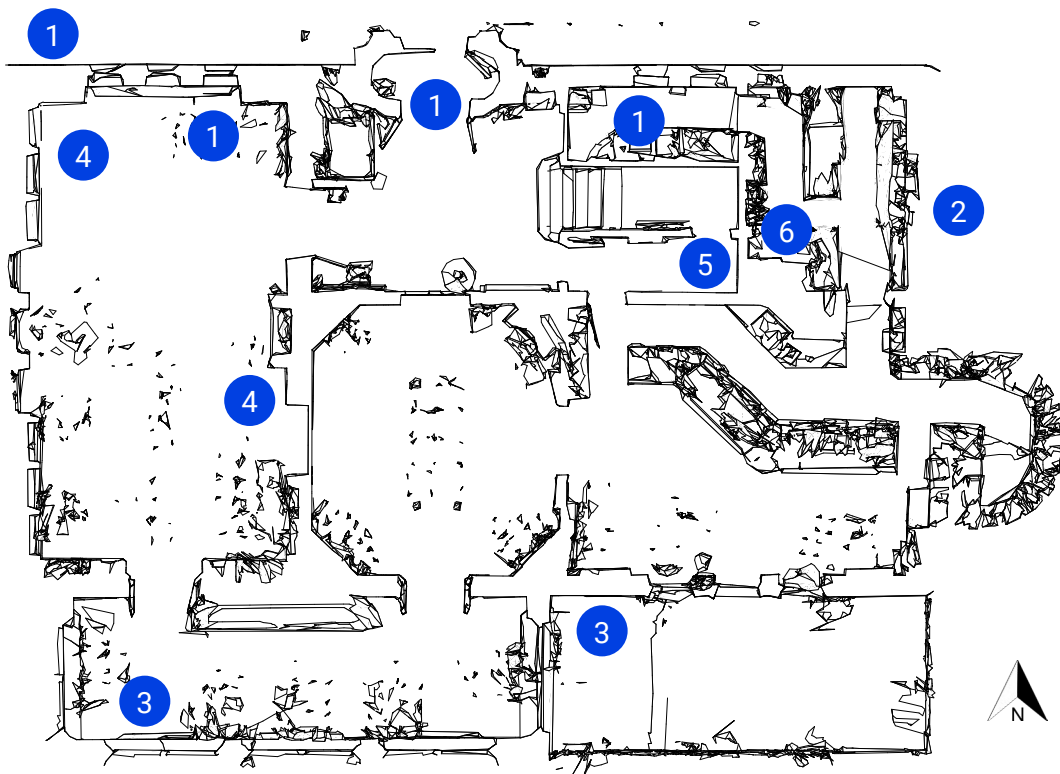

Fig. 2.2.30: Ground floor plan of the .3DM file in Archicad

be able to represent the full wall thickness. For further modeling, we use the dimension of the long side to the north. On the long side to the south, we can read the outer wall in the area of the terrace, but not in the area of the extension (Fig. 2.2.30, Nr. 3). This is again due to the fact that we did not take an external scan there. The same applies to the transverse side to the west. Here it is also noticeable that the floor-to-ceiling wall shelves are recorded by the Matterport Pro3 as a complete wall and therefore give an incorrect measurement (Figs. 2.2.30, Nr. 4 and 2.2.31). This applies to the entire library room. In the outdoor areas where we did not carry out a scan, it is still possible to determine the windows, the window stop, the doors and the door stop. This shows that the positions can be read more clearly if the indoor and outdoor scans are available, but they can also be determined without the outdoor area. We also notice that the level of detail in the .3DM

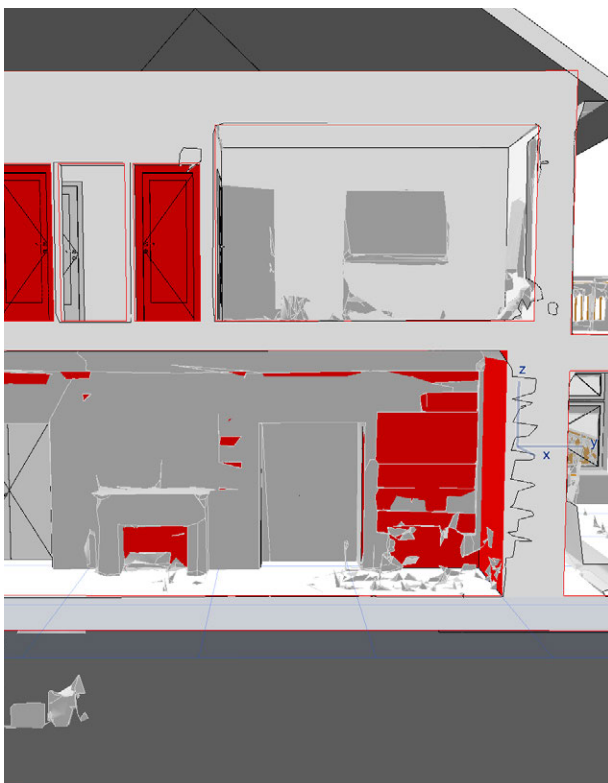

Fig. 2.2.31: Inaccuracies of the wall geometry of the .3dm mesh

file is not sufficient to display the window sills (Fig. 2.2.33). The same applies to the railings on the ramp in the north and on the terrace in the south. These deficits can be largely compensated by displaying the 3D tour. The interior walls and doors on the first floor are almost all clearly recognizable. There is only one exception in the area of the corridor leading to the kitchen. As the door was bricked up from the kitchen side, it is not shown as a door on the corridor side (Fig. 2.2.30, Nr. 5). There is also another cupboard directly in front of the same wall in the kitchen, which is why the wall thickness is also incorrect here (Figs. 2.2.30, Nr. 6 and 2.2.32).

We proceed in the same way on the upper floor as on the first floor. With regard to the exterior walls, the same problems occur here in the places where we did not scan from the outside. The same problems also occur with the

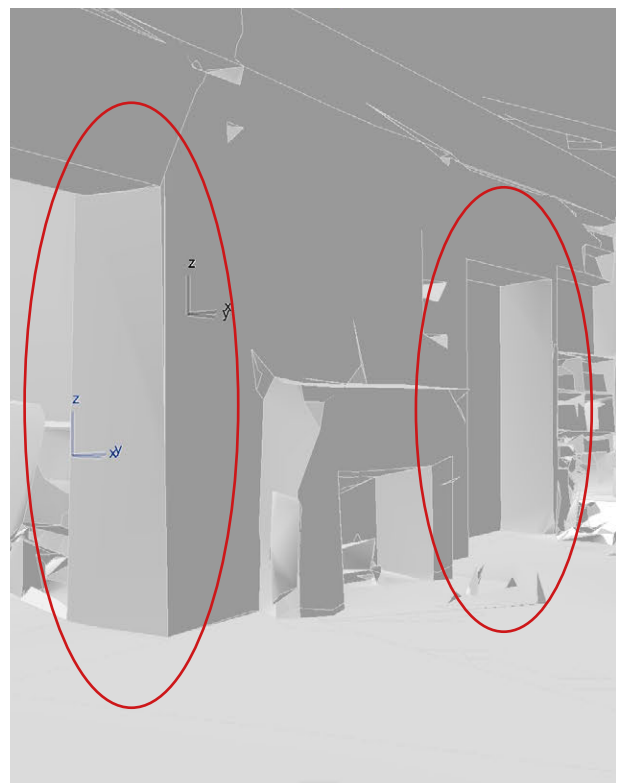

Fig. 2.2.32: Inaccuracies of the wall thickness of the .3dm mesh

window sills and railings, which can again be largely compensated by the 3D tour. Otherwise, we only had problems in the hallway in the area where we couldn't walk into the rooms. If doors and walls are flush and the door is closed and is only scanned from one side, the doors are not recognized but are displayed as walls. The problem can still be compensated for doors whose stop is further back. With the interior walls, problems also only occur in the area where we had no access to the rooms, as the interior wall thickness cannot then be recognized.

We particularly noticed that the plasterwork in the rooms is shown as a curve and could therefore be modeled schematically, but not in detail. Furthermore, curves such as the wall in the bar area (Fig. 2.2.34) or the archway above the staircase on the first floor and second floor (Fig. 2.2.35) are easily recognized and displayed. When taking measurements again, you

should only make sure that all exterior walls are scanned from both sides to ensure that the model is complete. This also applies to the interior walls. If the external wall thickness is not relevant for the purpose of the project, this step can be skipped.



Fig. 2.2.33: Missing window sills of the .3dm mesh

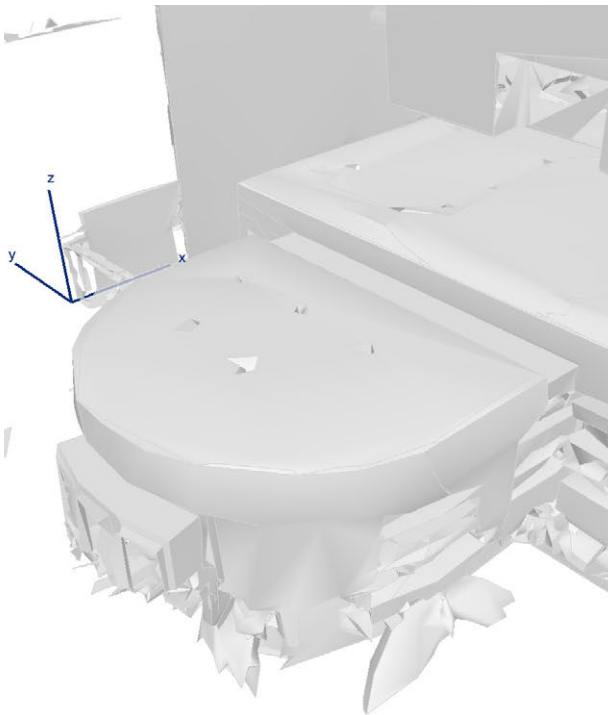

Fig. 2.2.34: Display of the round wall in the bar area of the .3dm mesh

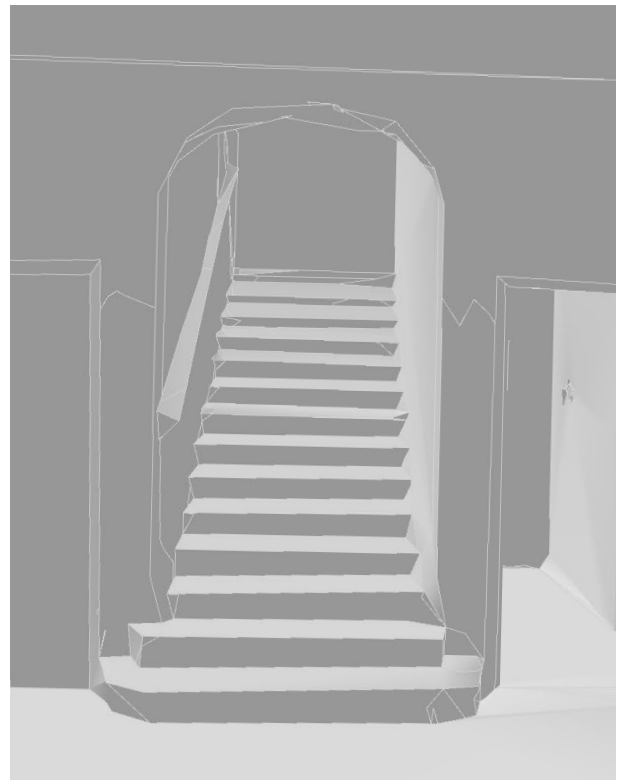

Fig. 2.2.35: Display of the archway above the staircase of the .3dm mesh

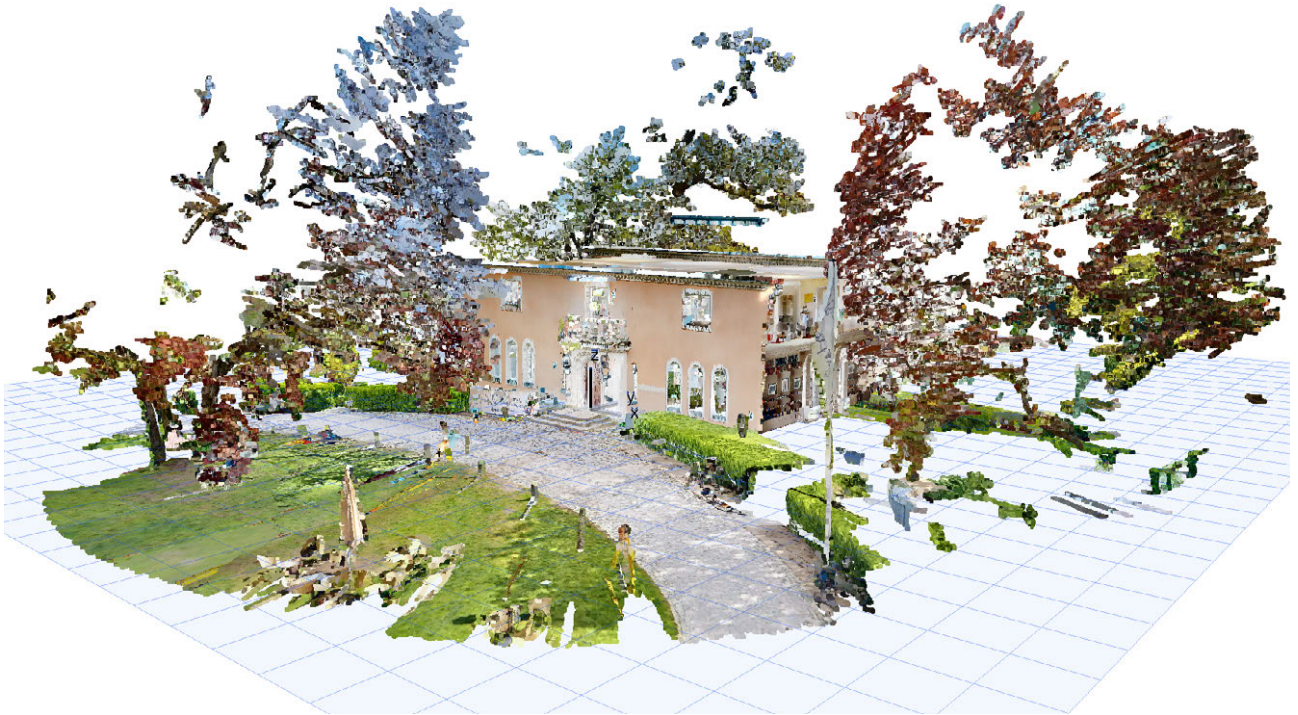

Fig. 2.2.36: 3D-View of .XYZ pointcloud in Archicad

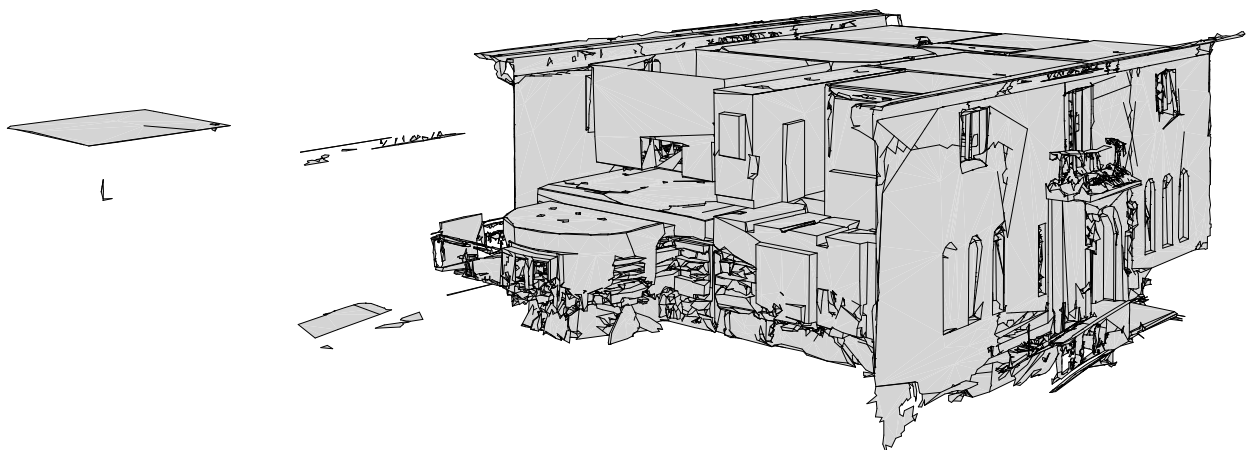

Fig. 2.2.37: 3D-View of .3dm mesh in Archicad (after original .obj was converted using Rhino)



- not scanned
- systemic weakness - compensable
- systemic weakness - not compensable
- own mistakes
- adopted from other groups (transparent)

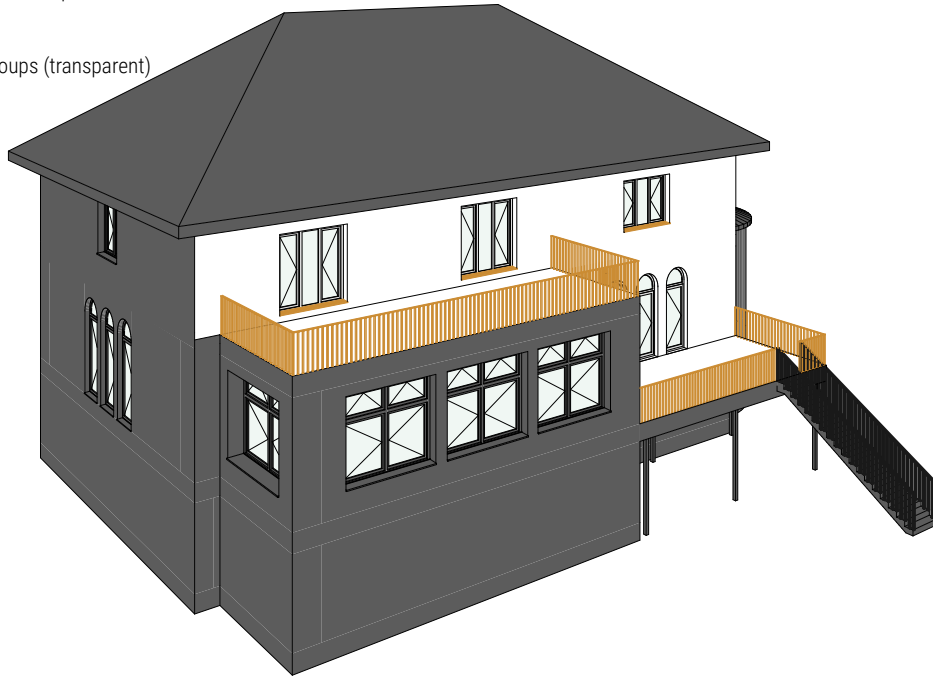

Fig. 2.2.38: Final 3D-Model in Archicad, perspective 1

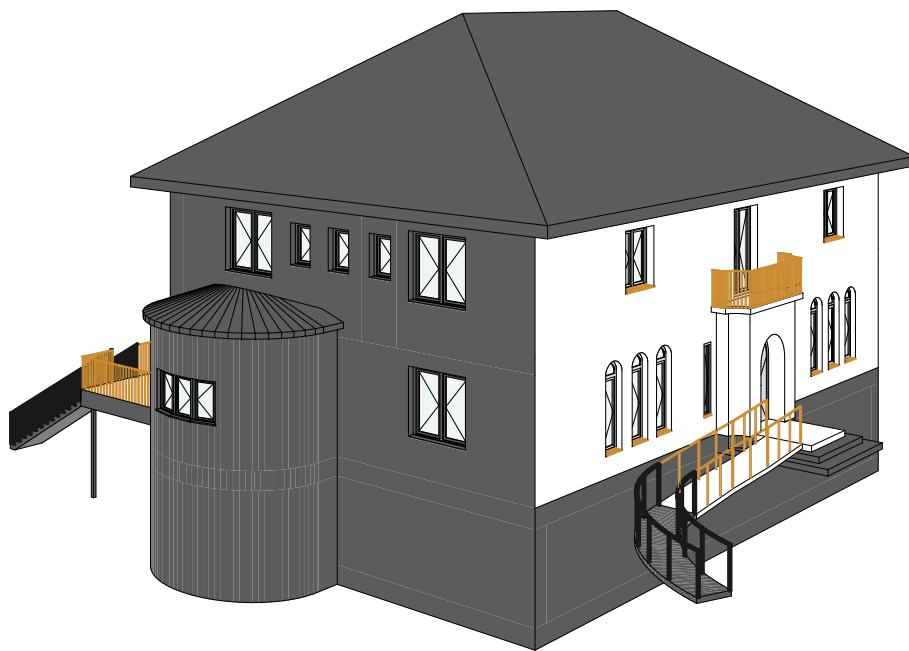

Fig. 2.2.39: Final 3D-Model in Archicad, perspective 2



# 5 EVALUATION

## ACCESSIBILITY

In our opinion, a major advantage of Matterport is its ease of use. No prior knowledge is required and the simplicity of the system means that almost anyone should be able to operate the device. Furthermore, the measurement can be carried out by one person alone. Which makes the measurement process highly efficient.

Even if the cost factor of the Matterport Pro3 is significantly lower compared to other laser scanners, the purchase price of around 6000€ is still quite high. In addition, the system is subscription-based, which means that there are further ongoing costs every month. Ultimately, the individual data sets of the scans also have to be purchased again for each project, which further increases the costs. In relation to this, the extent to which personnel and labour costs can be saved by the system should be weighed up individually to determine whether the price is justified.

## USE IN ARCHITECTURE

In general, we find that the Matterport system presented here is very suitable for measuring and modeling existing buildings in the field of architecture. Above all, we can positively evaluate the quick and easy handling, which helped us to quickly record the building in approx. 2 hours on the measurement day. After inspecting the materials, we realized that we would have had to take a few more scans of the outside area in order to obtain a complete point cloud, which would have slightly extended the time needed to capture the building. Nevertheless, we achieved good results that day with very little effort. For example, the largest tolerance for the dimensions of walls, doors etc. in the 3D model is 0.065m (see „window inside - arc height“ precision evaluation). The smallest tolerance is 0.011m (see „west side GF - length“ precision evaluation). This shows that the dimensions were recorded as accurately as possible using the Matterport Pro 3.

With the .xyz (Fig. 2.2.36) and .obj file (Fig. 2.2.37), simple basic structures such as exterior and interior walls as well as windows and doors are recognizable and can be transferred to a 3D model. Our time expenditure for modeling the 3D model using the .obj file was around 25 hours at a cost of 54 euros for the Matterpak from Matterport. If you compare these values with the BIM model that can be purchased directly from Matterport at a price of 675 euros, the independent modeling at a lower price seems to be worthwhile at first. However, if we also assume an hourly wage of 80€/h for an architect in an office, then he should not need more than 8.43h to create the 3D model (Figs. 2.2.38 and 2.2.39). Since it took us about three times as long, we believe that the effort required for independent modeling is too high, which is why Matterport's BIM Model Service is a good and fast option for recording an exis-

ting building and getting the corresponding files ready. For larger and more complex buildings in particular, the question arises as to whether the costs, time and benefits of creating the model independently are in proportion to each other.

However, as we were not provided with a finished BIM model by Matterport, we cannot conclusively assess what this model would look like and whether it contains the content that was relevant for the inventory of our building. In conclusion, we assume that the creation of the 3D model for a fee is worthwhile in terms of costs, time and benefits in general, but especially when it comes to larger and more complex buildings. With regard to our building, the paid option would have saved us a significant amount of time.

## **FIELD OF APPLICATION**

A potential area of application for the Matterport system lies in the field of property marketing. The 3D tour in the digital twin is particularly suitable for presenting a property to potential buyers or tenants in an attractive way.

It could also be used for marketing purposes in the hospitality sector. Customers of hotels, restaurants, or museums can for example check out an event location online in advance to determine whether it meets their expectations.

Furthermore, Matterport could be used in facility management to document different conditions of a building over time and compare them directly with each other. In this way, defects can be precisely documented.

Lastly, Matterport could also be used during construction. Individual construction phases can be documented and comments and additional documents such as architectural plans can be stored in the digital twin, which can facilitate communication between construction companies and architects.

Matterport offers with its services a great way to document the current state of a building or site in a customer friendly, easy accessible manner.

# PHOTO - OUTSIDE



## INTRODUCTION

Team	94
Description	94
Requirements	95

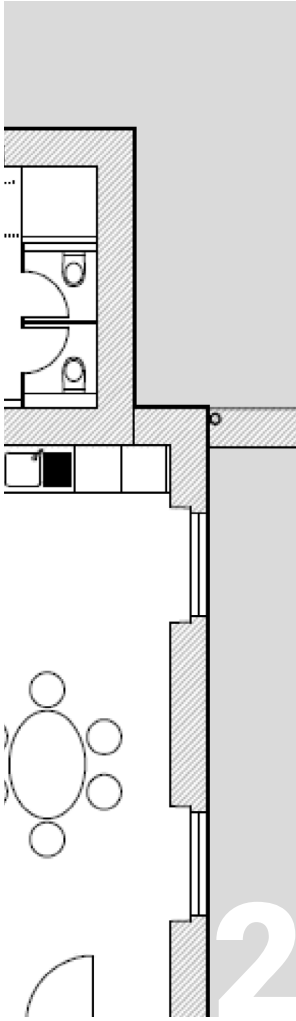

**PREPARATION**

Preparation 98



**SITE MEASUREMENT**

Site Measurement 100



**DATA PROCESSING**

Data Editing 104  
3D Model 107

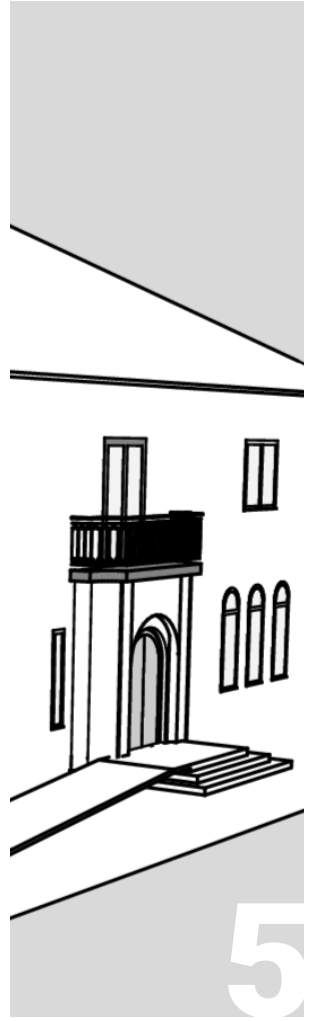

**EVALUATION**

Evaluation 112

# 1 INTRODUCTION

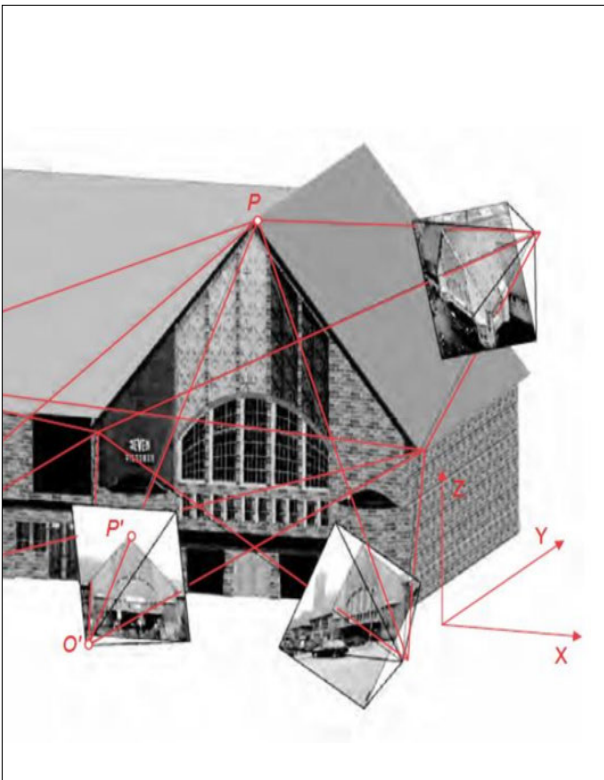

Fig. 2.3.1: Principle of Photogrammetric Measurement

## DESCRIPTION

Photogrammetry is a technology used to create three-dimensional (3D) models from two-dimensional (2D) photographic images (Fig. 2.3.1). This method is utilized in fields such as cartography, architecture, and heritage conservation, transforming conventional photographs into detailed 3D spatial representations. The core of photogrammetry lies in its ability to convert photographic data into quantitative and visual information, enabling accurate spatial analysis and modeling.<sup>40</sup>

The process begins with the systematic acquisition of photographs. Digital cameras or drones capture a series of overlapping images from multiple viewpoints. For instance, when documenting a structure like a building, images are taken from various angles, including frontal, lateral, and aerial perspectives. This comprehensive image capture is essential for ensuring that the entire object or scene is covered, facilitating the extraction of detailed spatial information.

After image acquisition, the photographs are processed using specialized photogrammetry software. This software analyzes the geometric relationships between the images by identifying common reference points and features across them. By doing so, it constructs an accurate 3D model that reflects the precise spatial characteristics of the photographed subject. This method allows for the creation of detailed and accurate 3D representations that are useful for various applications in surveying, mapping, and 3D modeling.<sup>41</sup>

40 cf. Luhman, Thomas; Robson, Stuart; Kyle, Stephen and Boehm, Jan. „Close-Range Photogrammetry and 3D Imaging“ (De Gruyter, 2013), 2.

41 cf. *ibid.*

## REQUIREMENTS

To achieve high-quality images suitable for photogrammetry, it is essential to use a digital camera with a resolution of at least 5 megapixels (MP) or higher, capturing images at the maximum possible resolution. The optimal lens choice is one with a 50 mm focal length (35 mm film equivalent), although lenses with focal lengths ranging from 20 to 80 mm in 35 mm equivalent are also suitable. Ultra-wide-angle and fisheye lenses should be avoided due to their distortion, which is not well-simulated by standard photogrammetry software models.<sup>42</sup>

Due to the stability of fixed lenses, it is important not to change the zoom and focal length during measurement. If using zoom lenses, set the focal length to either its maximum or minimum value for the entire shooting session to achieve more stable results. For intermediate focal lengths, create separate camera calibration groups. The ISO setting should be at its lowest value to minimize noise. High ISO settings introduce additional noise to images, degrading their quality.<sup>43</sup>

The aperture should be set high enough to provide sufficient depth of field, ensuring that the captured images are sharp and not blurred. Shutter speed should be fast enough to prevent blur caused by slight movements. Using RAW data, which is then losslessly converted to TIFF files, is preferred over JPEG because JPEG compression can introduce unwanted noise and artifacts into the images.<sup>44</sup>

In our work, we used a Nikon D5100 camera and a DJI Phantom 4 drone. The Nikon D5100 is a digital single-lens reflex (DSLR) camera with a 16.2 MP sensor. We used a AF-S DX NIKKOR 18-55mm f/3.5-5.6G VR II lens. This lens provides a versatile zoom range that covers wide-angle to short telephoto perspectives, making it suitable for various types of photography. The lens also includes Vibration Reduction (VR) technology, which helps to minimize camera shake and produce sharper images.<sup>45</sup> To avoid alterations and keep the settings equal for all pictures we turned this feature off.

Furthermore, we used the DJI Phantom 4 drone, equipped with a 12.4 MP camera and advanced stabilization features, enabling it to capture clear and stable aerial images.<sup>46</sup>

To convert images into detailed 3D models, photogrammetry software is essential. We used Agisoft Metashape, a software that processes large datasets of images to create accurate 3D models. However, handling the heavy computing tasks involved in photogrammetry requires computers with robust specifications. The basic configuration for such tasks includes RAM within the range of 16 - 32 GB, either in a laptop or desktop. The CPU should be a 4 - 12 core Intel, AMD, or Apple M1/M2 processor, running at 2.0+ GHz. The GPU should be an NVIDIA or AMD model with 1024+ unified shaders, such as the GeForce RTX 2060 or Radeon RX 5600M. These specifications ensure that the images can be processed efficiently and effectively.<sup>47</sup> For further creation of a 3D model suitable for BIM in a program such as Archi-

---

42 cf. Agisoft LLC. „Metashape User Manual: Professional Edition, Version 2.1“. Accessed 12.07.2024. [https://www.agisoft.com/pdf/metashape-pro\\_2\\_1\\_en.pdf](https://www.agisoft.com/pdf/metashape-pro_2_1_en.pdf)

43 cf. *ibid.*

44 cf. *ibid.*

45 cf. Nikon USA. „Nikon D5100 Camera User's Manual“. Accessed 12.07.2024. [https://cdn-10.nikon-cdn.com/pdf/manuals/dslr/D5100\\_EN.pdf](https://cdn-10.nikon-cdn.com/pdf/manuals/dslr/D5100_EN.pdf)

46 cf. DJI. „DJI Phantom 4 Specifications“. Accessed 12.07.2024. <https://www.dji.com/de/support/product/phantom-4>

47 cf. Agisoft LLC. „System Requirements“. Accessed 12.07.2024. <https://www.agisoft.com/downloads/system-requirements>



CAD, the same configurations are suitable.<sup>48</sup>

Additionally, environmental conditions significantly impact the success of photogrammetry. Effective photogrammetry requires specific environmental conditions to ensure the quality and accuracy of the captured data. Optimal lighting conditions are essential because they minimize shadows and reflections that can obscure details in the images. Optimal lighting conditions are characterized by: diffuse light (overcast skies or light diffused through translucent materials help distribute light evenly, reducing harsh shadows and bright spots); consistent illumination (lighting that remains steady throughout the session, avoiding fluctuations that can lead to inconsistent image quality); soft light (light that reduces glare and reflections, often found during early morning or late afternoon when the sun is low in the sky); balanced exposure (conditions that avoid extreme contrasts between light and dark areas, ensuring the subject is neither overexposed or underexposed); true color representation (lighting that accurately captures the true colors and textures of the subject, essential for realistic and detailed photogrammetric models). Even natural light, such as that found on cloudy days or during the evening sun, provides consistent illumination across the subject, which is crucial for producing clear and detailed photographs. These lighting conditions help prevent overexposure and underexposure, ensuring that the images accurately represent the subject's true colors and textures.<sup>49</sup>

Minimal wind conditions are necessary for drone stability. Drones are often used to capture aerial images, and strong winds can cause

them to shake or drift, resulting in blurry or misaligned photos. For optimal stability and image quality, wind speeds should not exceed 15 km/h. Stable flight conditions are vital to capturing sharp and accurate images from multiple angles, which are essential for creating precise 3D models. Wind can also affect the positioning and orientation of the drone, leading to inconsistencies in the data collected.<sup>50</sup>

Moisture from rain or snow can damage sensitive camera equipment and interfere with the electronic components of drones. Wet conditions can also cause lens fogging, reducing image clarity and quality. Ensuring that the equipment remains dry and functional is essential for reliable data capture. Furthermore, dry weather conditions help maintain consistent ground and surface conditions, which are important for accurately referencing and scaling the captured images.

---

48 cf. Graphisoft. „Recommended Configuration“. Accessed 12.07.2024. <https://graphisoft.com/de/service-support/systemanforderungen>

49 cf. Agisoft LLC. „Metashape User Manual: Professional Edition, Version 2.1“. Accessed 12.07.2024. [https://www.agisoft.com/pdf/metashape-pro\\_2\\_1\\_en.pdf](https://www.agisoft.com/pdf/metashape-pro_2_1_en.pdf)

50 cf. *ibid.*



# 2 PREPARATION

Thorough preparation is essential for accurate photogrammetry models. Effective project planning involves determining the scope and scale of the project, including the area to be covered and the desired level of detail, which dictates the number and type of images required. It is important to assign clear roles and responsibilities to team members to ensure everyone understands their tasks and the workflow.

Preliminary tests help identify potential issues and refine the process. Test shots should be taken to assess camera settings, lighting conditions, and equipment performance. Adjust the settings as needed to achieve the desired image quality. Calibrating cameras and lenses minimizes optical distortions, ensuring precise spatial data. It is also important to secure the lens to prevent movement during shooting, the reasons for this were described above in the Requirements chapter (see chapter 1, p. 95). In our case, we used masking tape to secure the lens during shooting (Fig. 2.3.2). Consistency in settings, such as shutter speed, across all photos is essential. For our project, we used the following settings: aperture F4, ISO 400, and focal length 18mm for interior shots; aperture F8, ISO 200, and focal length 18mm for exterior shots.

During the image capture phase, a systematic approach ensures comprehensive coverage and reliable data. Photos should have sufficient overlap, with at least 60-70% horizontal and 40-60% vertical overlap, to allow the software to accurately stitch them into a coherent 3D model. Capture images from various angles and distances to provide a complete dataset for 3D reconstruction, including close-up shots for detailed features and wider shots for overall context.<sup>51</sup>



Fig. 2.3.2: Fixed lens with masking tape

51 cf. Lescop, Laurent. ENSA Nantes. Photogrammetry Lecture. 26.04.2024.



# 3 SITE MEASUREMENT

For the survey of the „Ohlendorff’sche Villa“, we set the settings on the Nikon D5100 as mentioned above (see chapter 2, p. 98) and taped the automatically-adjusting lens fix at 18mm.

The weather has a significant influence on the usability of the images in photogrammetry. On the 29th of April 2024, the day of the survey, the weather at the Ohlendorff’sche Villa was sunny with a few clouds in the sky. The survey took place from 9 AM to 2 PM and was divided into the following three tasks: photographing the exterior, photographing the interior, and documenting the procedure.

In a lecture by Laurent Lescop, which took place on 26th April 2024, we received the following advice on capturing the Ohlendorff’sche Villa using photogrammetry: Move methodically around the object or area, following a planned path to ensure no part is missed. For aerial



Fig. 2.3.3: Partially hidden East Facade of the Ohlendorff'sche Villa

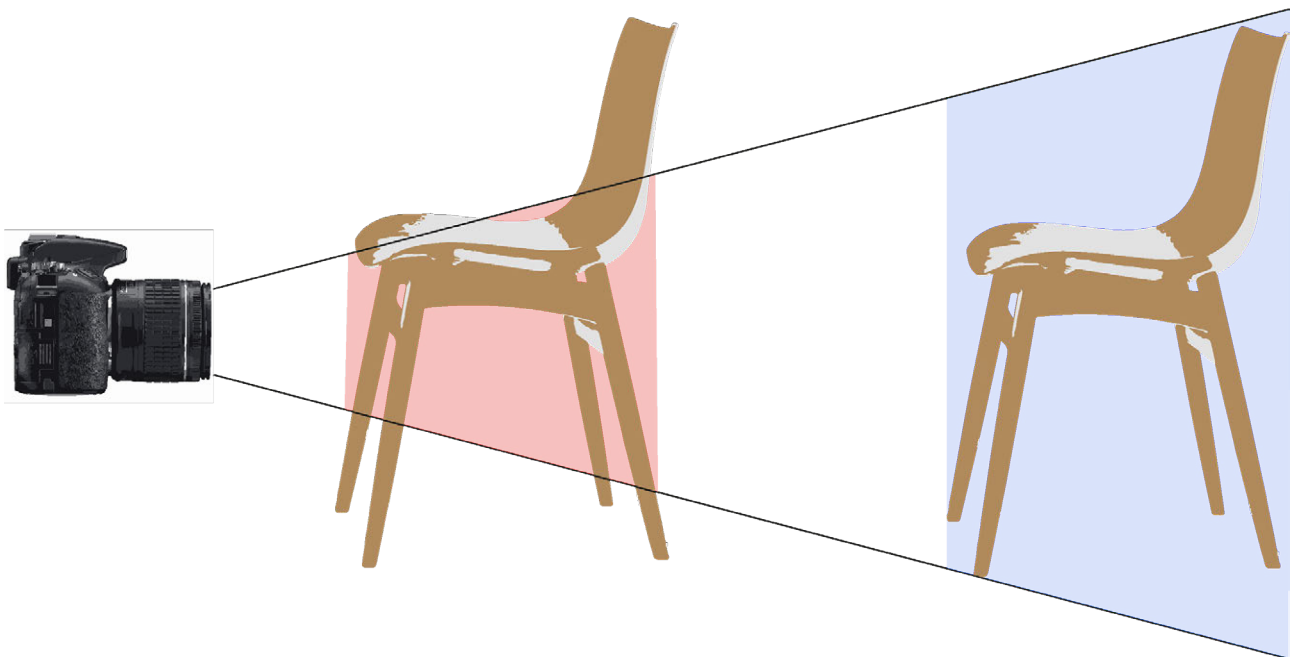

Fig. 2.3.4: Issue with the Camera Angle in Low-Distance Shots

photography, plan flight paths that cover the entire area with consistent overlap<sup>7</sup>.

To photograph the building, we tried to follow the advice, so we continuously walked around the house and took overlapping pictures of the outer shell. On the east side, dense planting (e.g. shrubs and trees) obscured the view of parts of the outer shell of the building, so that taking pictures was restricted (Fig. 2.3.3). During our survey of the exterior we took 332 images of the Ohlendorff'sche Villa.

The camera had to be adjusted again for the photoshoot of the interior, as the lighting conditions were different. As described in the previous chapter (see chapter 2, p. 98), a different aperture and ISO were set. The building has 3 floors with a total of 39 rooms, of which we only had access to 22 rooms. The toilets are located in the basement (Fig. 2.3.7). On the ground floor is the café area, consisting of a kitchen, sales, reception, a library, and a conservatory (Fig. 2.3.8). On the first floor there are storage rooms, lecture halls and offices (Fig. 2.3.9).

The images of the interior also had to be taken in an overlapping manner. This involved taking photos of the walls from the center of the room and from the opposite corner of the room (Fig. 2.3.6). Narrow room structures posed a challenge here, resulting in small sections of the walls on the images (Fig. 2.3.4) and making it difficult to focus the camera (Fig. 2.3.5). We recorded every room accessible in a structured manner whilst simultaneously documenting the process to avoid duplication and to recall all the details.



Fig. 2.3.5: Blurred Image of the Staircase to the Basement

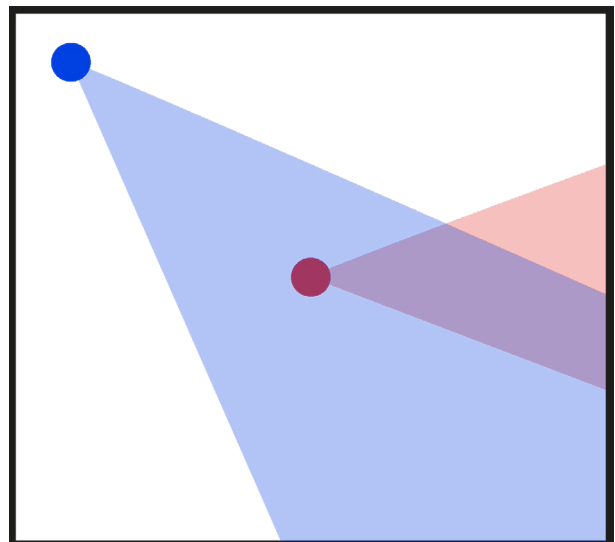

Fig. 2.3.6: Shooting Positions in a Room

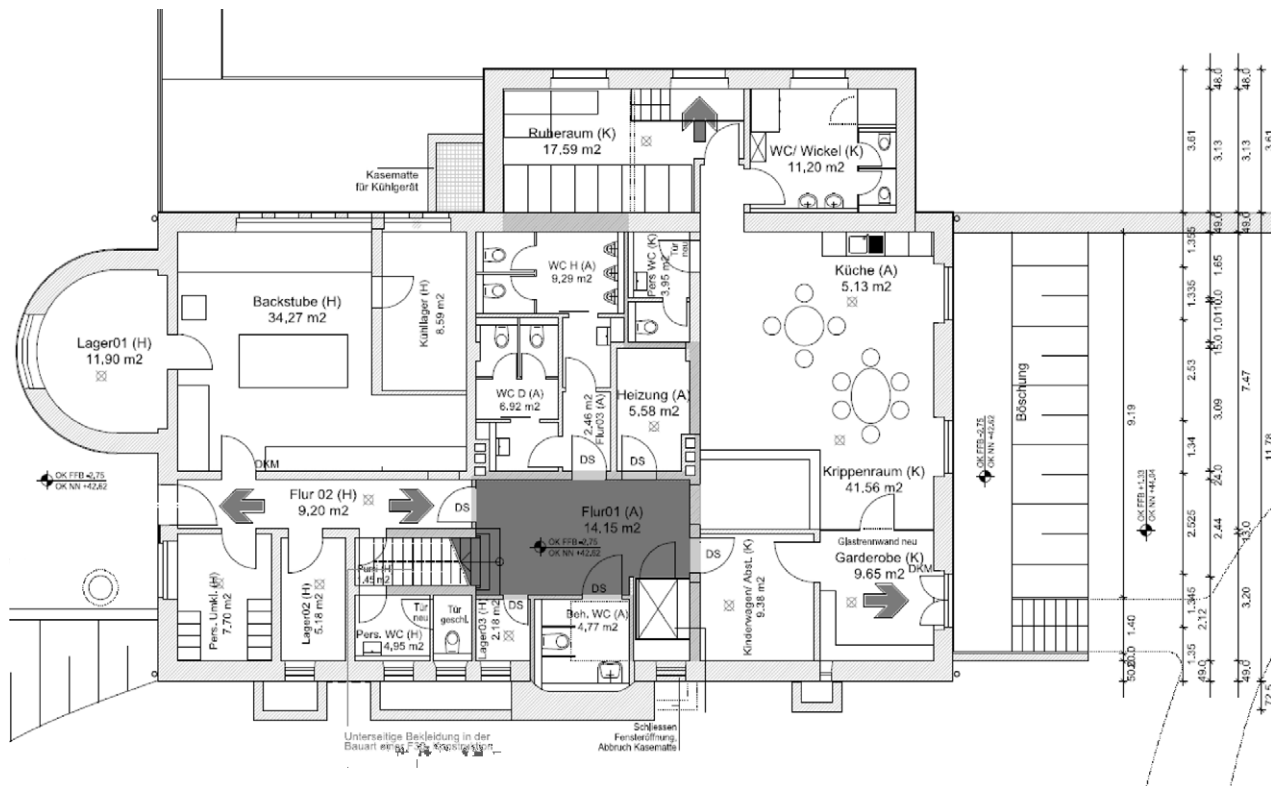

Fig. 2.3.7: Ohlendorff'sche Villa Basement

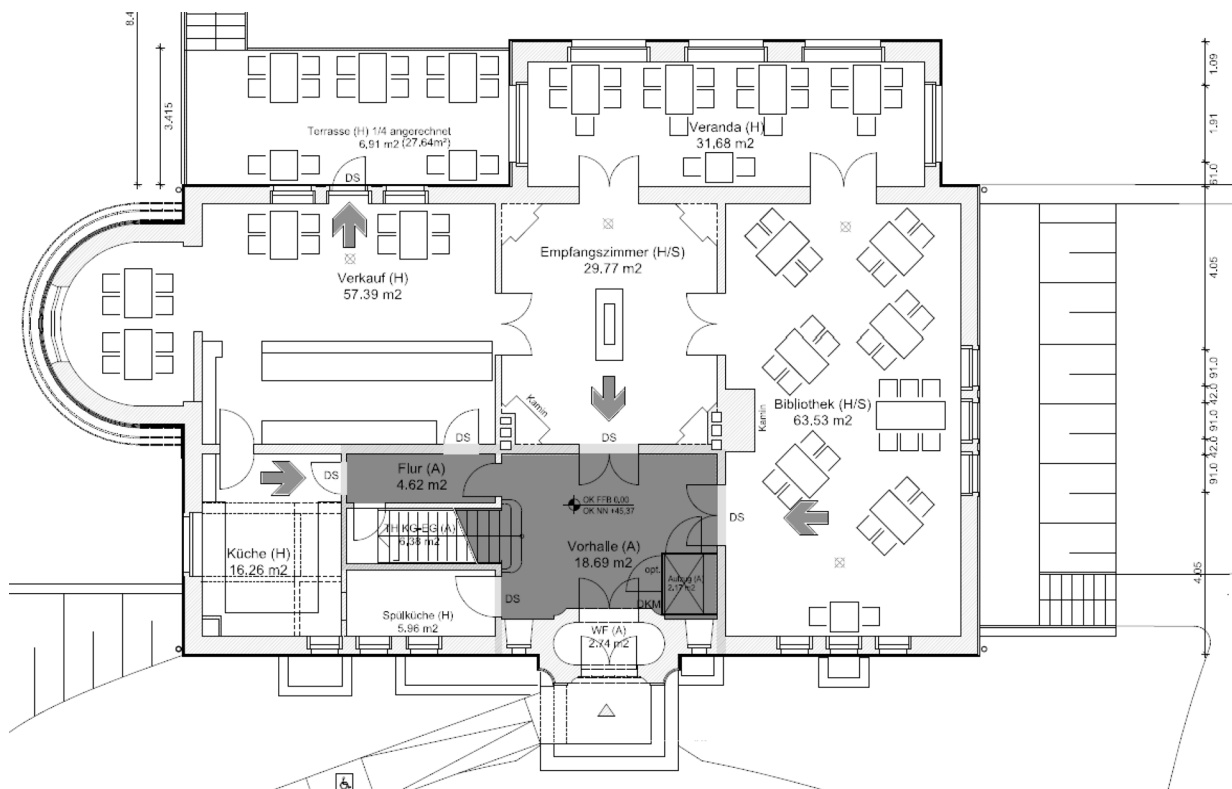

Fig. 2.3.8: Ohlendorff'sche Villa Ground Floor

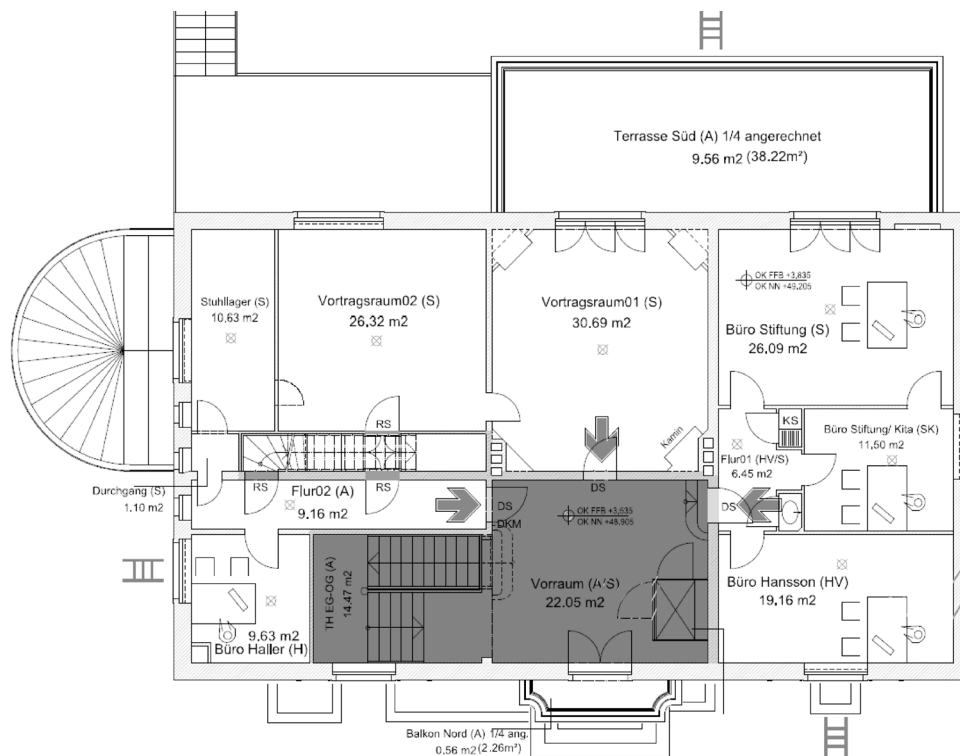

Fig. 2.3.9: Ohlendorff'sche Villa First Floor



Fig. 2.3.10: Top View Photo taken by a Drone



# 4 DATA PROCESSING

## DATA EDITING

After installing and activating Metashape, you can begin a new project by opening the software and either selecting File > New or clicking on the New Project icon. For image importation, go to Workflow > Add Photos, navigate to the folder containing your images, select the desired files, and click Open. The selected images will then appear in Metashape's workspace.

## IMAGE ALIGNMENT

Aligning the photos is the next critical step. Select Workflow > Align Photos. In the Align Photos dialog box, you can adjust settings such as Accuracy, Pair Preselection, and Key Point Limit. Click OK to start the alignment process. After the alignment, a sparse point cloud representing camera positions and the approximate scene structure will be displayed.

For example, in our project, we uploaded 382 photos taken with a professional camera and a drone. However, an error occurred where not all photos were accepted, only those from the drone (50 photos), likely because they had coordinates. Consequently, we decided to upload the photos in two stages, starting with the 332 camera photos again.

## DENSE POINT CLOUD CREATION

To create a dense point cloud, select Workflow > Build Dense Cloud. Adjust settings such as Quality and Depth Filtering, then click OK. The dense point cloud, offering a more detailed representation of the scene, will be displayed in the workspace (Fig. 2.3.11).

## 3D MESH GENERATION

Following the creation of the dense point cloud, the next step is to generate a 3D mesh. Select

Workflow > Build Mesh. In the Build Mesh dialog box, adjust settings such as the source (e.g., Dense Cloud) and Surface Type, then click OK to create the mesh. The resulting 3D mesh will appear in the workspace, representing the surface structure of the object or scene.

## TEXTURING THE MESH

Texturing the mesh enhances the realism of the 3D model. Select Workflow > Build Texture, adjust settings such as Mapping Mode and Blending Mode, and click OK. The texture will be applied to the mesh, resulting in a more lifelike 3D model (Fig. 2.3.12). Repeat steps two through five with the drone photos.

## EXPORTING RESULTS

To export the 3D model from Metashape, select File > Export > Export Model. Choose the desired file format, such as .stl, and the appropriate export options, then click OK. Open this .stl file in ArchiCAD.

We encountered an error in ArchiCAD: the creation of the morph was complex and involved many polygons, potentially affecting ArchiCAD's performance. Therefore, we decided to try exporting the file in a different format.

We exported the 3D model again from Metashape, this time choosing the .e57 format. After selecting File > Export > Export Model, choosing the .e57 file format, and clicking OK, we opened the .e57 file in ArchiCAD via File > Interoperability > Import Point Cloud. However, in ArchiCAD, the point cloud exported as an .e57 file did not display correctly within the coordinate system. Consequently, it was necessary to correct the model's position in Metashape and reload it into ArchiCAD.

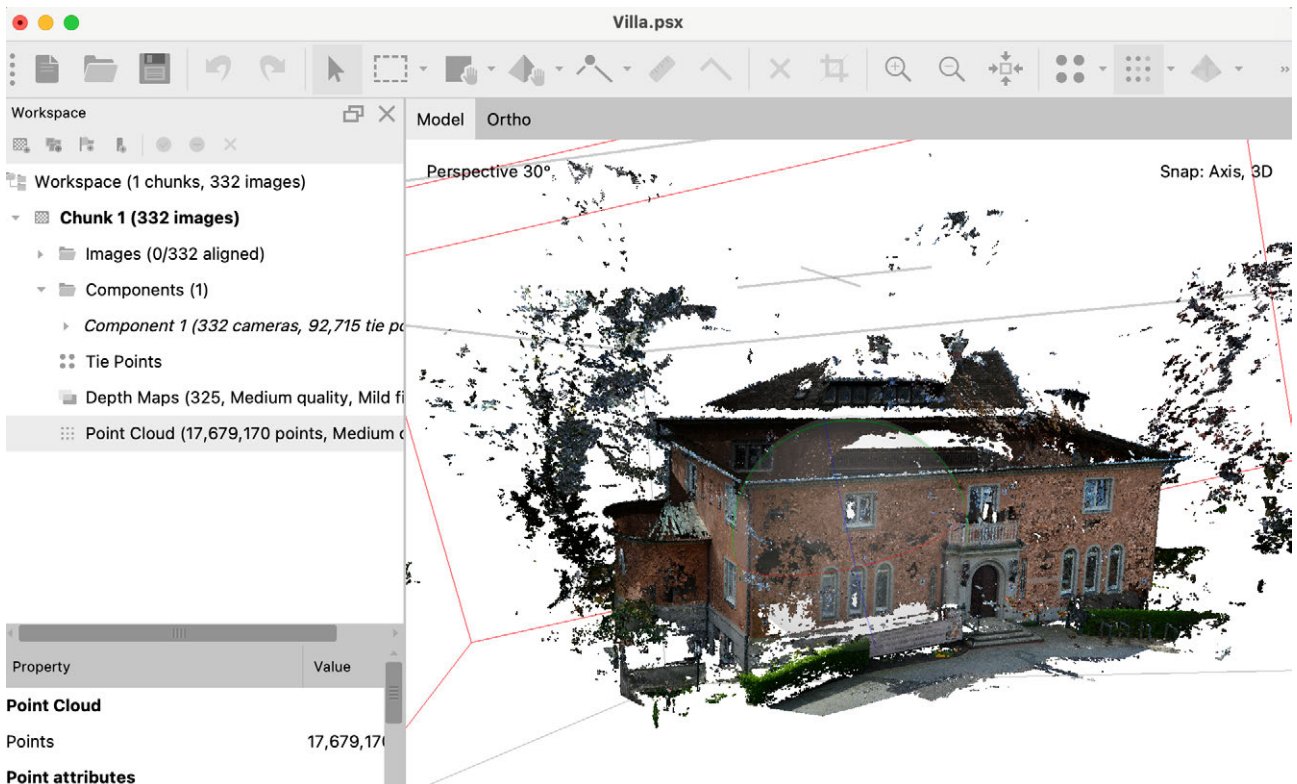

Fig. 2.3.11: Point Cloud from Agisoft Metashape

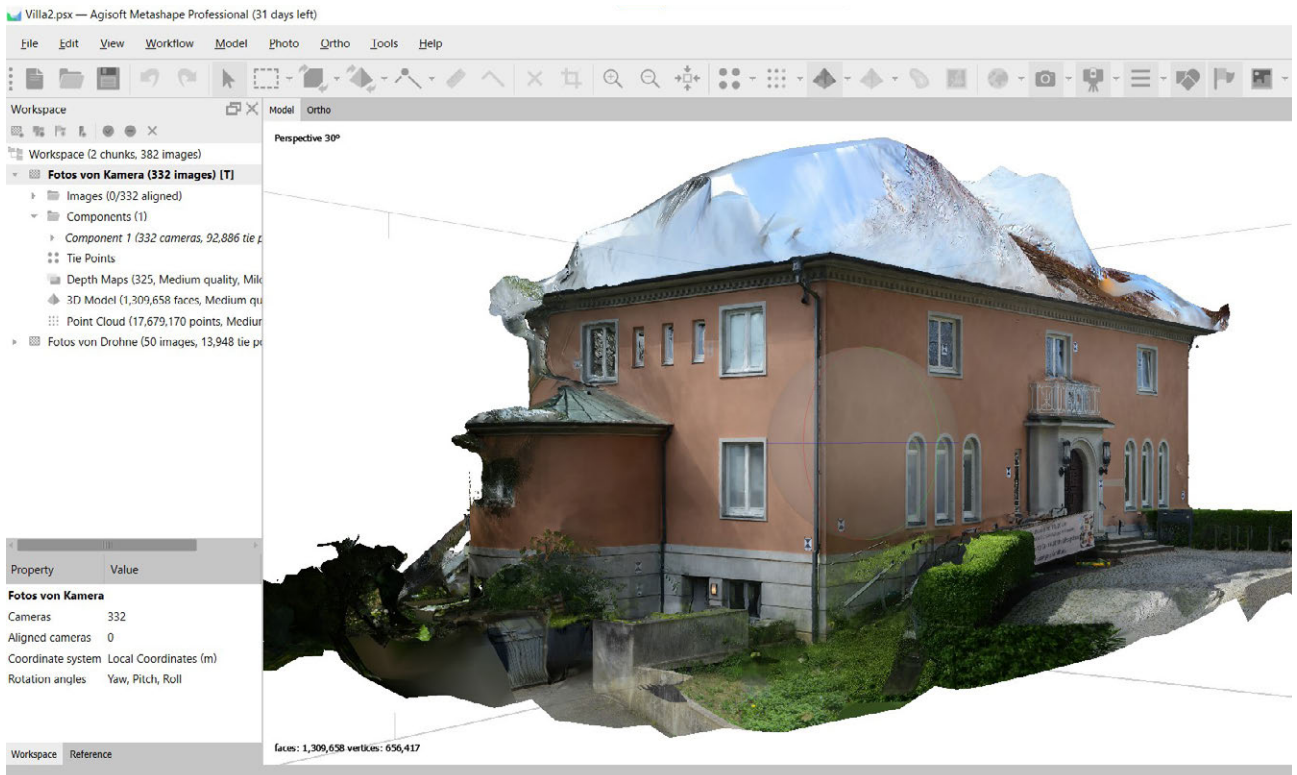

Fig. 2.3.12: Mesh Model from Agisoft Metashape

## INTERIOR IMAGING AND ADDITIONAL OBSERVATIONS

In addition to the exterior facade photos, we also captured images of all accessible rooms inside the building. The process of creating a point cloud for the interiors is identical to that of the building facade. Each room constitutes a separate model.

During this work, we found that most interior photos were rejected by Metashape, suggesting that a more detailed photography approach is needed for better results. Below, we provide examples of rooms that cannot be used for further CAD model creation (Figs. 2.3.13 and 2.3.14).



Fig. 2.3.13: Café Mesh Model from Agisoft Metashape



Fig. 2.3.14: Library Mesh Model from Agisoft Metashape

### 3D MODEL

After successfully importing the point cloud in .e57 format, we first created a suitable basis for transferring the information from the point cloud to the 3D model. We created views and used them to determine the floor heights based on the terraces and windows.

For the point clouds to be displayed on each floor in the floor plan level, they needed to be inserted on each floor and set at a specific height so that they are located at the same point (only one point cloud is visible in 3D, as they were placed at the same point for each floor).

We then began to recreate the outside area with the information from Point Cloud 1 (camera - house). We used the footage from Point Cloud 2 (drone - roof) later, only for the construction of the roof areas which were not displayed in

Point Cloud 1. Due to a tilt of Point Cloud 1, we set the floor plan cutting plane at the height of 10 cm (instead of the usual 1 m) above the floor so that the field of view and thus the scatter were smaller. When comparing the floors, we found an offset of around 25 cm on the north side of the villa (Fig. 2.3.15).

For poorly displayed areas or parapet heights behind railings in Point Cloud 1, we repeatedly compared them with the photos. We also placed a copy of Point Cloud 1 a little in front of the drawn 3D exterior wall so that the solid white wall would not cover the point cloud in the views.

When importing Point Cloud 1 into ArchiCAD, the dimensions initially seemed plausible to us without any concrete testing and we constructed the 3D model accordingly. However, when we later checked the dimensions, it be-

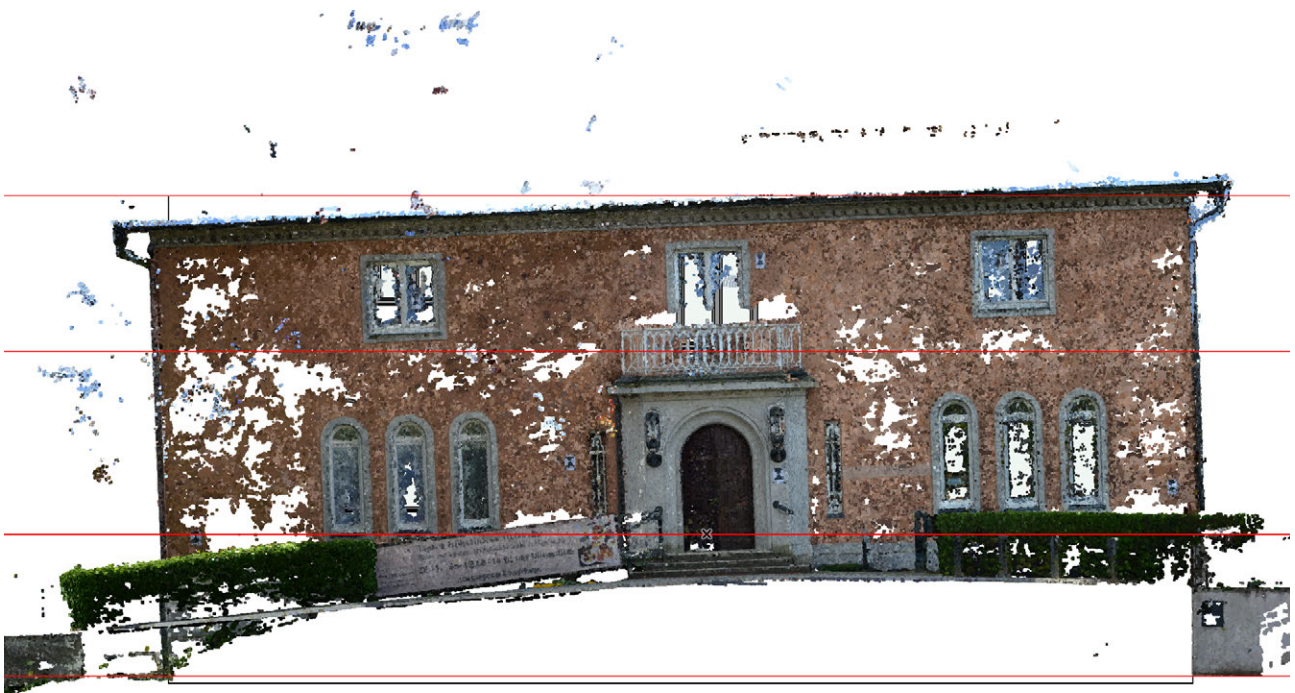

Fig. 2.3.15: Tilt of the North Facade in Point Cloud 1

came apparent that Point Cloud 1 did not show the correct scale without using anchor points (when created in Metashape). We had to scale Point Cloud 1 using a reference dimension (from the manual measurement group). The scaling of point clouds in ArchiCAD cannot be determined graphically but must be specified in the object settings using dimensions (enter the value in the object settings, and test until it is roughly on top of each other). However, when scaling the already-built 3D model, ArchiCAD applied the resizing only at the floor plan level. All heights (e.g. wall, window, parapet, and door heights) remained unchanged because the floor heights had to be set separately. We then had to adjust these selectively and did this using the point cloud in the views, as with the first construction.

We also tried to rotate Point Cloud 1 along the x and y axes to deal with the tilt of the north side.

This was possible by re-programming the point cloud library element, but it did not help because the value still had to be entered in the object settings and could not be set graphically in 2D (e.g. floor plan/front view) or 3D. When we imported Point Cloud 2 to work on the roof of the villa, we noticed that it was also not displayed at the correct scale. Since graphically scaling the point cloud was still impossible for us, we decided to construct the roof first and scale it later (Fig. 2.3.16).

For the modeling of the interiors of the Ohlen-dorff'sche Villa, the point clouds deemed usable in Metashape were added to the ArchiCAD project as well. Due to the limited number of images of the interior spaces and hindering conditions for interior photogrammetry in general, the generated point clouds were incomplete. Additionally, the point clouds for the interiors were rotated incorrectly when inserted

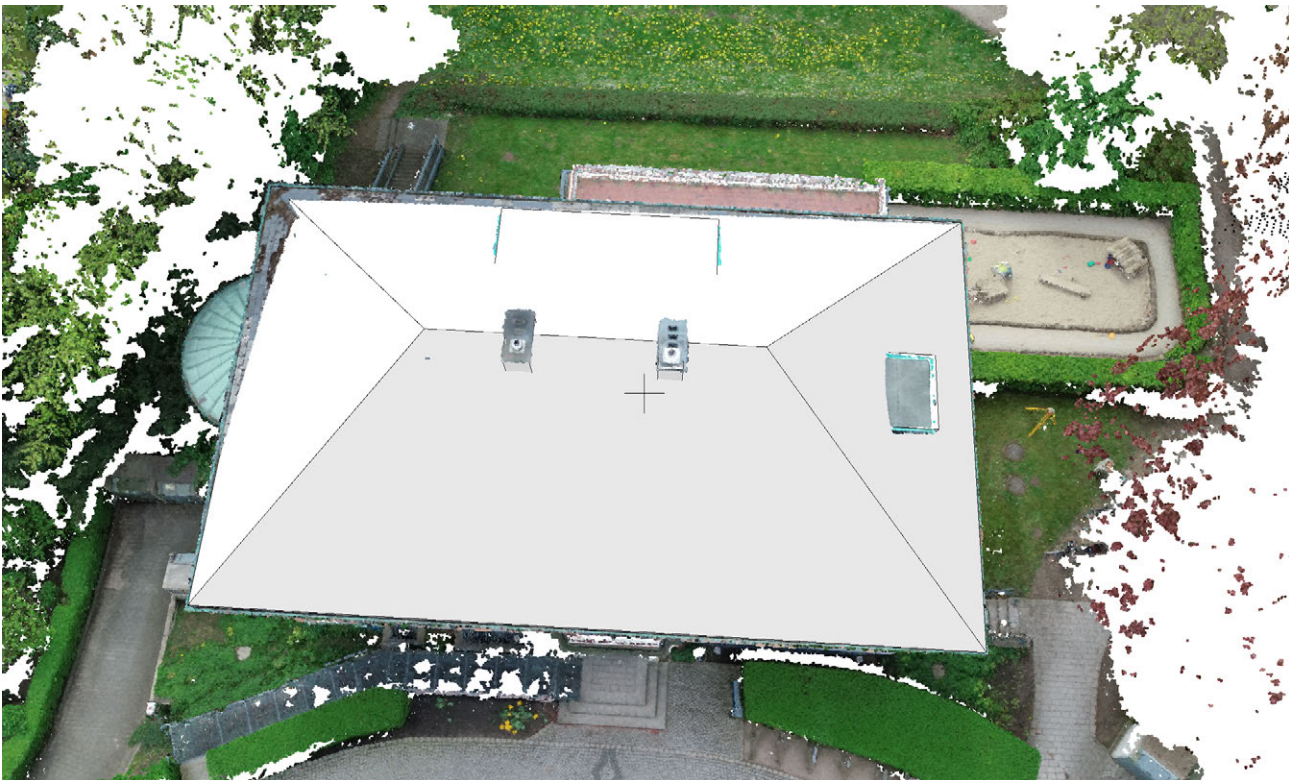

Fig. 2.3.16: 3D Model of the Roof in Point Cloud 2

to the ArchiCAD project. Due to the point cloud being incomplete, we were unable to determine in which direction the point cloud needed to be rotated to align properly within the ArchiCAD project. As an example, Figure 2.3.17 shows the point cloud of the small office on the upper floor of the villa and Figure 2.3.18 shows the Café on the ground floor.

Consequently, the point clouds could not be used for further data processing and we resorted to constructing the interior of the villa based on the manual (hand) measurements of the other team.

As information such as wall thickness was missing from the hand measurement, we traced the interior geometries with polygons as a basis for further 3D modeling. We arranged these within the outer shell of the building using logical thinking, assumptions, and photographs to create realistic wall thicknesses.

Due to the specific shape of the staircase from the ground floor to the upper floor, the flights could not be modeled with the ArchiCAD stairs tool. We instead used the morph function. To draw the handrails, we distorted one of our photographs using the Photoshop program so that the railing in the photo approximately matched the expected dimensions of the original. We imported the photo to ArchiCAD and traced the outer edge of the railing with a polygon to further create a solid from it. We then recreated the pattern of the railing so it could be seen in the 3D model. Afterward, we merged the two and created cut-outs in the shape of the pattern using boolean operations (Fig. 2.3.19).



Fig. 2.3.17: Point Cloud of the small Office



Fig. 2.3.18: Point Cloud of the Café

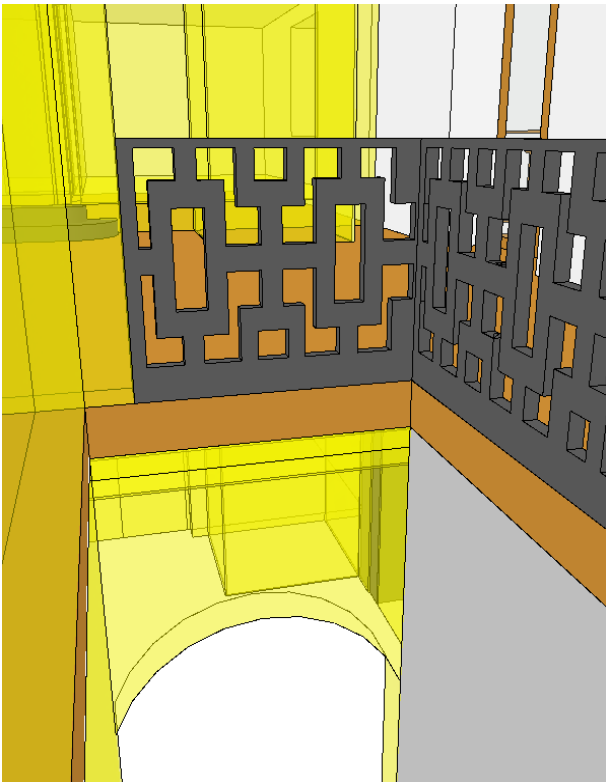

Fig. 2.3.19: Staircase Railing

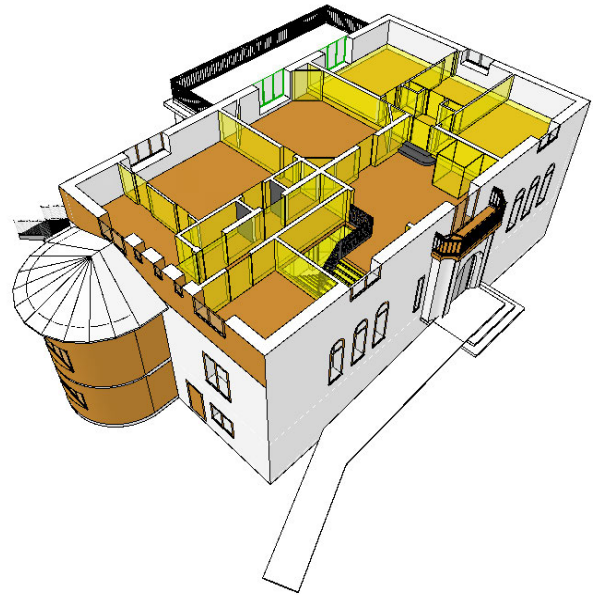

Fig. 2.3.20: Upper Floor 3D Model

- not scanned
- systemic weakness - compensable
- systemic weakness - not compensable
- own mistakes
- adopted from other groups (transparent)

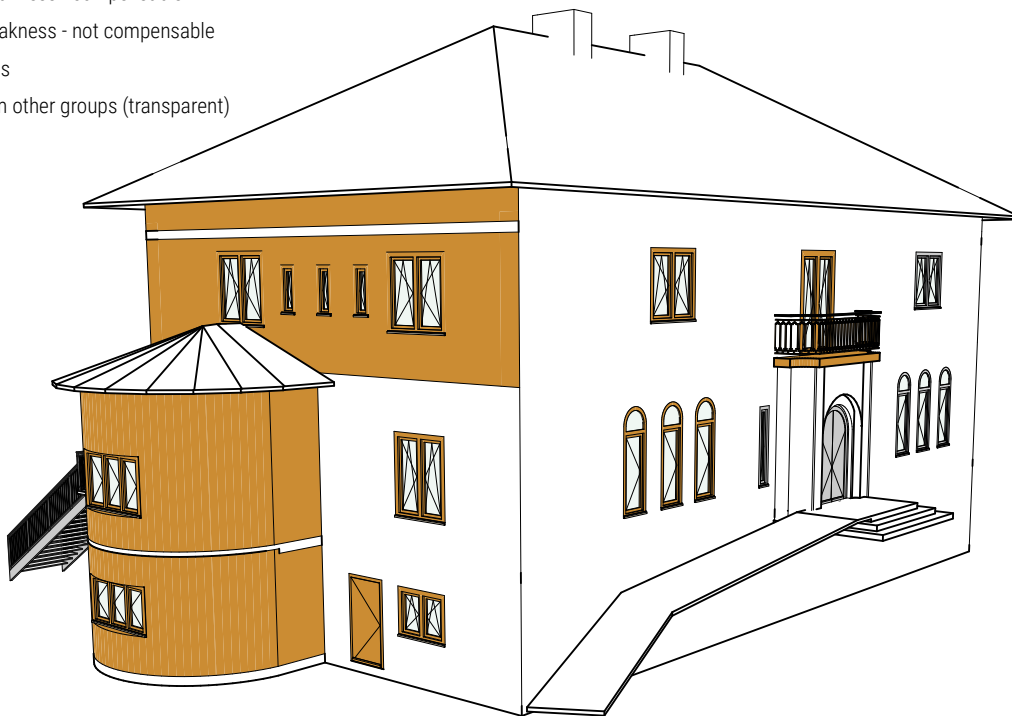

Fig. 2.3.21: Ohlendorff'sche Villa 3D Model





# 5 EVALUATION

During the process of measuring the building using photogrammetry, we identified advantages and disadvantages at each stage of the process. During the material collection phase (photos), we encountered difficulties as the surrounding environment and landscaping obstructed a clear capture of the building's facade. Weather conditions and lighting also affected the results. When creating the model in Agisoft Metashape, the results were poorer with high-contrast photos compared to photos taken under cloudy conditions. Capturing interior images was particularly challenging due to the presence of people and narrow and cluttered spaces, which led to deficient results. This highlighted the need for detailed photography approaches in confined spaces. We also realized that photogrammetry is more effective for capturing large open spaces without excessive furniture and other objects. Overall, the process took more than 1.5 hours, not including the preparation and on-site postprocessing.

While working with Agisoft Metashape, we did not encounter significant difficulties. The program's interface is accessible and understandable, even for beginners. In addition to the user manual, there are many videos on YouTube that clearly and comprehensively explain how to use the software. However, to achieve high-quality results, we lacked in-depth knowledge and experience. For example, when uploading photos from the camera and drone, we encountered an issue where not all photos were accepted by the program. We resolved this by uploading them separately, but this resulted in two models of different scales, complicating further work in ArchiCAD. Despite these challenges, the resulting mesh model was quite detailed, providing sufficient data on the dimensions of individual parts of the building. However, working with interior photos, as mentioned earlier, was the most challenging aspect. Ultimately, we did not achieve the ex-

pected results that could be used for further interior measurements in ArchiCAD. In total, the work in Metashape took almost 8.5 hours, including the installation of the program, working on the point cloud for the building's exterior facade and interior spaces, as well as subsequent exporting for further work in ArchiCAD.

Depending on the export method, the fairly true to the original model of the villa (in Metashape) was translated to a grey mesh (.stl) or colored measurement points in a point cloud (.e57). The coloring made the model fairly recognizable, but with non-colored models, it was much more difficult to assign details to the original. That is why we decided to use the colored point cloud in ArchiCAD. Importing the point cloud to ArchiCAD was also much easier than the polygon file, which was much too large to be used in ArchiCAD (from 30 million points complications can be expected).

By compressing the Metashape mesh into a point cloud, ArchiCAD showed a rather simplified model. Nevertheless, the colored measuring points still made it quite photorealistic and legible. On closer inspection, difficulties became apparent with detailed elements such as a balcony railing with a pattern. This initially seemed very easy to reconstruct due to the photograph-like representation, but the implementation was more difficult than initially assumed. If you zoomed in, to a distance suitable for an accurate transfer (on the cm or mm scale) in the 2D view or the 3D model, the points were a few cm apart and hard to identify, as they could no longer be easily differentiated by color from close up (Fig. 22). Despite the poor visibility of the points, we determined which measurements would be appropriate and were able to build a balcony railing that was visually very true to the original in the point cloud.

A major disadvantage was omitting anchor points. The model drifted apart, especially in areas that were hard to catch with the camera. But also the north facade, of which we had taken numerous pictures, was consistent in itself, but was heavily tilted (Fig. 15). With our level of knowledge in dealing with Metashape, we were unable to correct this. In addition, the omission of anchor points led to the incorrect scaling of the Metashape model and thus of the subsequent point clouds. The point clouds were also not consistent with each other, which forced us to scale both, the point clouds and the 3D model, several times, and ultimately not only led to additional processing time (a total of 30 hours on the 3D model) but also inaccuracies and possible negligence. Creating the BIM-capable 3D model was only possible by using the data from the manual measurements.

Despite working with a computer with powerful RAM (16 GB) and processor (Apple M1 Pro Chip), there were delays in work performance, especially when handling the point cloud in the 3D workspace of ArchiCAD. Setting and editing facade elements (e.g. windows) in 3D or the views took significantly longer with the point cloud switched on. In summary, the user-friendliness and handling of Agisoft Metashape are very positive. This program is also very easy to use for beginners; after a short research, you can already master the basic features. The export options are numerous and well-compatible with common CAD programs such as ArchiCAD. Metashape is suitable for recording outdoor spaces. Our results for the exterior were good with few defects mainly on the north and east facade and in hidden areas. Nonetheless, photogrammetry with Metashape did not provide promising results for interiors of this type. Metashapes' output for the interiors was so deficient, that we simply could not use it for the build of the 3D model. To create a convincing and usable result for an interior, a

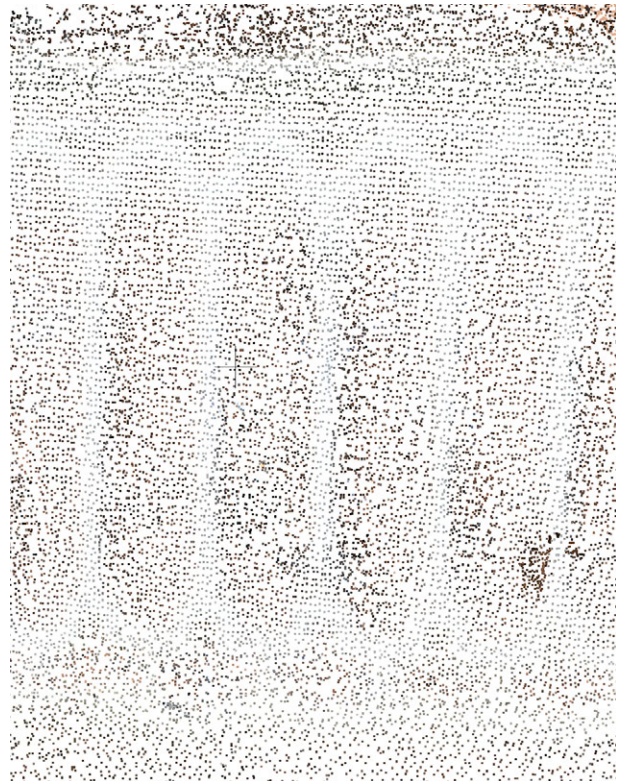
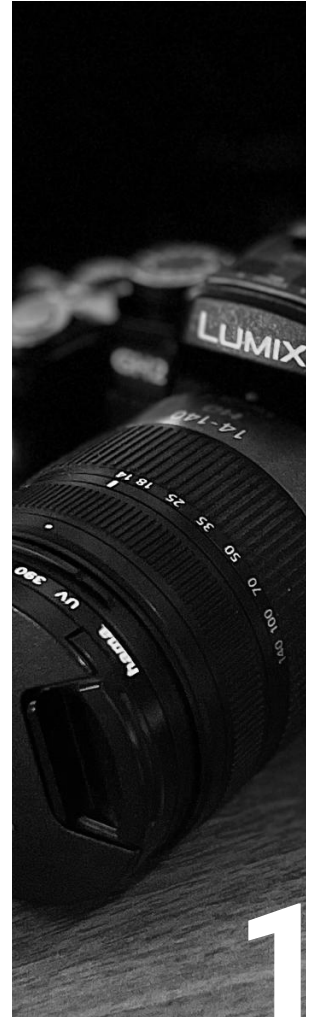

Fig. 2.3.22: Close-Up of the Railing in Point Cloud 1

lot of preparation and follow-up would have to be invested, which is why creating interiors is rather uneconomical. And even then, it would only work for some spaces. During processing, it also became clear that ArchiCAD is not optimally designed for subsequent editing of point clouds (e.g. scaling and rotating) or dealing with errors in the point cloud (e.g. deleting areas). ArchiCAD imports the point cloud as a library element. Although this allows individual points to be addressed and caught, it is still a fixed and closed group of points.

Looking back, we believe that the use of anchor points in Metashape would have significantly benefited the photogrammetry results. The scaling would have been consistent and drifting of the facade sides could have been prevented. Nevertheless, we are surprised by how good the result of the exterior turned out, even without using any anchor points.

# PHOTO - INSIDE



## INTRODUCTION

Team	116
Description	116
Requirements	117

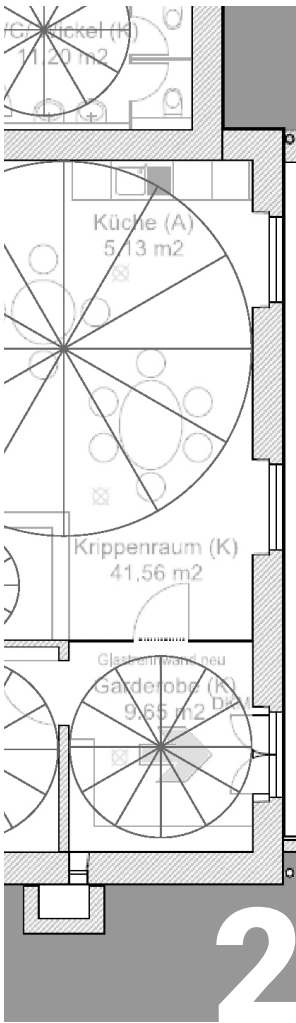

**PREPARATION**

Preparation 120



**SITE MEASUREMENT**

Site Measurement 122

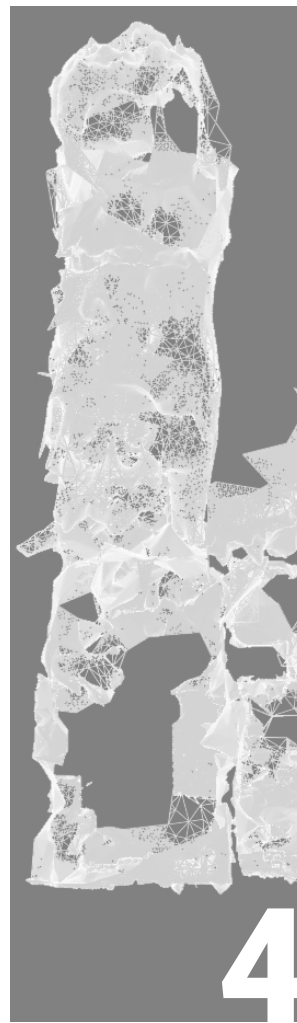

**DATA PROCESSING**

Data processing 126  
Softwares 128  
System Evaluation 132

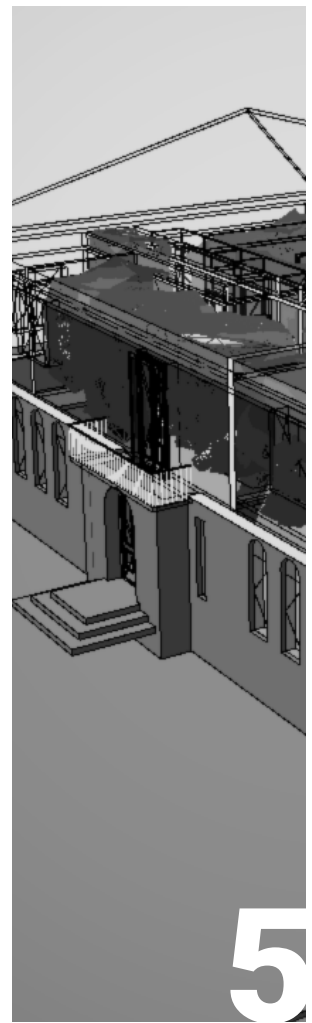

**EVALUATION**

Evaluation 142

# 1 INTRODUCTION

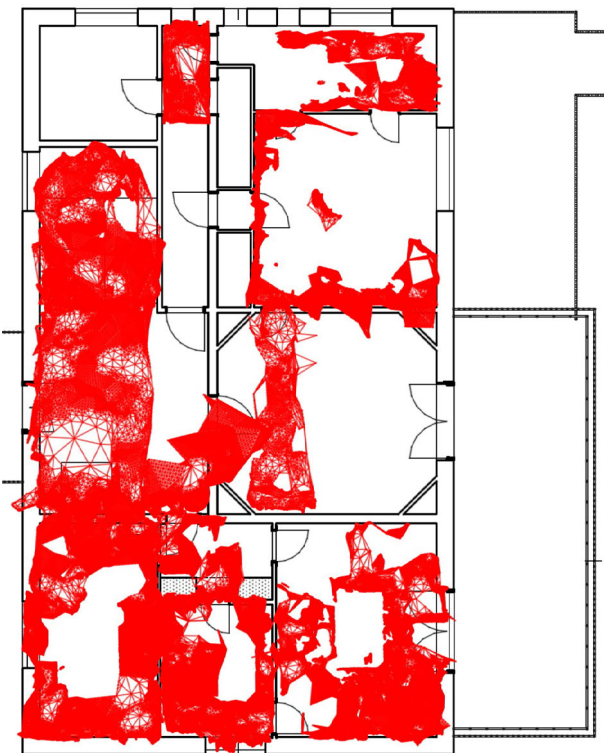

Fig. 2.4.1: Generated mesh in the floor plan

## DESCRIPTION

The German civil engineer Albrecht Meydenbauer 1893 is considered the founder of photogrammetry. This method is based on the measurement of corresponding pixels in overlapping images, which determines the spatial directions.<sup>52</sup>

Photogrammetry, also known as the science of measuring in photos, comprises a group of non-contact measuring methods and evaluation procedures. The aim is to indirectly determine the position and shape of an object and to describe its content through image interpretation, which is carried out in single image evaluation devices by rectification or in stereoscopic double image evaluation devices in three dimensions as in Figure 2.4.2, model of the pinhole camera.<sup>53</sup>

„The spatial position of the projection center in a camera-fixed reference system (image coordinate system) as well as deviations from the ideal central perspective image are described by the internal orientation.“<sup>54</sup>

“The primary aim of a photogrammetric measurement is the exact three-dimensional geometric reconstruction of the object, whereby the object is modeled in digital (coordinates, derived geometric elements) or graphic form (images, plans, maps).”<sup>55</sup> In addition, the image serves as an information store that can be accessed at any time, including for content interpretation.

52 cf. Lescop, Laurent. ENSA Nantes. Photogrammetry Lecture. 26.04.2024.

53 cf. Luhman, Thomas. „Nahbereichsphotogrammetrie - Grundlagen, Methoden und Anwendungen“ (Wichmann, 2010), 4.

54 Luhman, Thomas. „Nahbereichsphotogrammetrie - Grundlagen, Methoden und Anwendungen“ (Wichmann, 2010), 2.

55 Luhman, Thomas. „Nahbereichsphotogrammetrie - Grundlagen, Methoden und Anwendungen“ (Wichmann, 2010), 8.

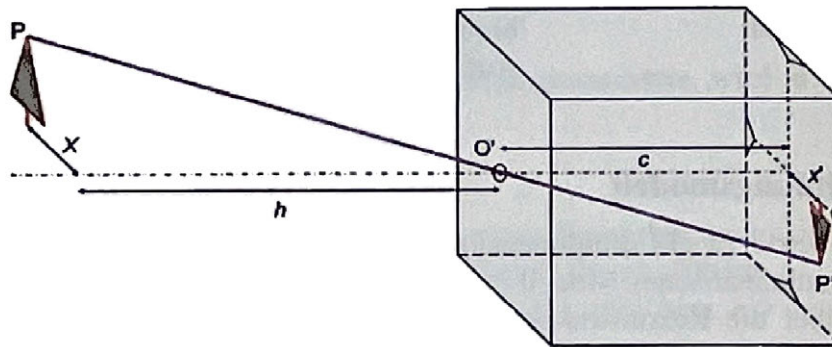

Fig. 2.4.2: Model of the pinhole camera <sup>2</sup>

In order to fulfill the objective, a few prerequisites must be taken into account, which are explained in the requirements chapter. All components involved in this process, such as light sources, properties of the object surface, media passed through, sensor and camera technology, image signal processing, object reconstruction and further processing, play a role. Finally, the object can be reconstructed and modeled from the image measurements taken by determining a transformation between image and object space based on mathematical models. This transformation describes the above-mentioned processes of image acquisition and image measurement.

## REQUIREMENTS

The successful application of photogrammetry requires careful coordination of three essential systems: “Acquisition system, measurement system and evaluation system”.<sup>2</sup> Image acquisition, as the basis of photogrammetric measurement, requires special considerations with regard to camera and accessories.

- A lens with a focal length of 15 to 35 mm is recommended, as this allows the camera to capture the object to be photographed at a wider angle, which in turn favors the overlapping of individual images.
- In addition, a tripod with a spirit level is required to adjust the tripod vertically. The tripod ensures blur-free images.
- For the application of photogrammetry, suitable software is also required to process the captured images and develop them into a 3D model at a later stage.

The choice of processing software determines the required operating system and the requirements for the processor (CPU), RAM, graphics card (GPU) and hard disc space.<sup>56</sup>

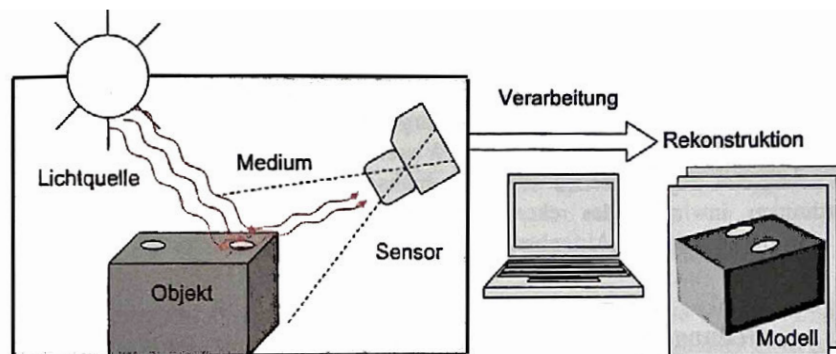

Fig. 2.4.3: From object to result <sup>4</sup>

Image measurement is usually carried out by the software used and requires precise calibration of the camera and pre-selection of the control points. Object reconstruction requires hardware and suitable software, the choice of which depends on the desired results and the user's level of experience (Fig. 2.4.3).

In order to achieve optimum results, certain conditions must be met or created at the shooting location. Uniform illumination and light contrasts of the object is crucial, whereby direct sunlight, strong shadows and reflections from shiny surfaces should be avoided, as room edges and surfaces as well as textures cannot be recognised by the processing software. The surfaces of the room should have sufficient texture and contrast to enable precise reconstruction.<sup>57</sup>

Photogrammetry software creates 3D models by geometrically recognising the same points on several photos and calculating their position in space.

- Uneven lighting leads to different shadows and brightness on the object, making the same points harder to recognise.

- White, black or shiny surfaces can lead to problems due to insufficient or even extreme contrasts.
- When using smartphone cameras, it makes sense to focus the autofocus on an object at a medium distance before deactivating it or leaving it activated if there is sufficient lighting.<sup>58</sup>

<sup>57</sup> cf. Lescop, Laurent. ENSA Nantes. Photogrammetry Lecture. 26.04.2024.

<sup>58</sup> cf. Luhman, Thomas. „Nahbereichsphotogrammetrie - Grundlagen, Methoden und Anwendungen“ (Wichmann, 2010), 4.





# 2 PREPARATION

## REQUIREMENTS

A successful workflow begins with the creation of a to-do list and the procurement of all the necessary materials, which include a camera with tripod for taking photos.

In practical implementation, it is advisable to organize the work steps logically, ideally using a prepared list with all relevant parameters, such as the camera settings like ISO, aperture, white balance and shutter speed.

Floor plans of the object are prepared and the camera distance is selected so that the images overlap sufficiently (approx. 60-80%), whereby a movement radius of 30 degrees provides an orientation value. The red circles on the floor plans in Figure 4 show the recommended camera orientation at the respective rooms.<sup>59</sup>

## PREREQUISITES

The overlapping of the images is absolutely mandatory so that the photogrammetry software can identify the same points in the different images. These same points are then used to calculate the 3D position of each point in space and create the model. During the capture, as many images as possible are taken from different perspectives and heights, while maintaining a constant zoom and avoiding blurring.

A constant zoom value is mandatory so that all images have the same focal length, which facilitates subsequent processing. Camera shake leads to blurred images, which can affect the accuracy of the 3D model. The images are analyzed later in the selected software, if necessary with the help of tutorials.<sup>60</sup>

The process records the distance to the wall, the overlap of the images, the reference points and their position, the number of shots or measured distances between the images, which merge the edges of the room using a movement system.

When using a camera, it is advisable to deactivate the autofocus to ensure better precision. The autofocus can make unwanted changes during the recording, which can lead to inconsistencies in the images. As photogrammetry software often does not have an integrated scale, at least two reference points with a known distance to the scale are also measured in each room. These reference points serve as a scale for the software and enable precise scaling of the 3D model.

Finally, a protocol is created with all relevant information such as room name, room numbering, floor, participants, duration, special features, difficulties, comments, camera settings, reference measurements.

By taking these prerequisites and steps into account, users can ensure that their photogrammetric measurements are successful and lead to precise results in the model. The consideration of reference measurements in space to determine the scale is crucial. It is better to take too many images than too few in order to achieve a complete reconstruction of the object.

---

59 cf. Lescop, Laurent. ENSA Nantes. Photogrammetry Lecture. 26.04.2024.

60 cf. Kersten, Thomas. HCU Hamburg. Photogrammetry and Laserscanning Lecture. 22.04.2024.



# 3 SITE MEASUREMENT

Once the preparations have been completed, the photogrammetric data acquisition now takes place directly on site. First of all, the required materials and basic principles are compiled, which we have already mentioned in the previous chapter. A detailed log should be prepared and printed out to record all relevant information during the survey. Relevant information includes all details that could be important for the later evaluation and reconstruction of the 3D model.

This includes the date and time to document when the recordings were made and to track possible changes over time, the exact description of the recording location so that the recordings can be clearly assigned later, the lighting and weather conditions that influence the image quality, the camera settings to ensure consistency and make adjustments if necessary, the positions and measured distances of the reference points in each room, which are crucial for the correct scaling of the model, as well as special events that could influence the recordings. For example, changes in lighting conditions, interruptions, accidental adjustments to the camera.

A typical on-location process starts with a meeting at the location, followed by a briefing and an initial walk-through of the premises to determine a suitable strategy. Once the tripod has been set up and the camera adjusted, the to-do list is checked to ensure that no important steps have been forgotten. The lighting conditions are analyzed and the camera's autofocus is deactivated.

The systematic recording of the rooms, for example on the first floor, begins with the selection of a starting room, which is marked on the floor plan. The camera is placed on the tripod in a position from which as much of the room as possible can be captured.

A first series of images is then taken by rotating the camera around its own axis and tilting it slightly up and down to capture different angles. It is important that the individual images overlap as (Fig. 2.4.6).

After the first series of images, the tripod is moved to a new position in the room and the recording process is repeated. Care is taken to ensure that the new images overlap (approx. 60-80%) with the previous ones and that the entire room is covered. This process is repeated until the entire room is covered.

Important information is documented in the log (Fig. 2.4.5) during the recordings. This includes the room name, the number of photos taken, the camera positions and angles as well as special features of the room such as stucco, arched windows, fireplaces, sloping floors or room heights. The tools used, such as camera, lens, tripod and laser rangefinder, are also noted.

Once the recordings in the first room have been completed, the same procedure is repeated for all other rooms. This systematic approach and careful documentation ensures that all rooms are recorded completely and precisely, which forms the basis for a successful photogrammetric reconstruction.

The standard operating procedure for image acquisition and documentation involved a per-room time allocation of 15 minutes. This timeframe encompassed the photography of the space, meticulous notation of all salient characteristics or anomalies observed within the room, and the recording of both the commencement and conclusion times of the process. Additionally, the total quantity of photographs captured during this session was also documented.

When capturing photogrammetric data in interiors, various challenges can arise that affect the quality of the resulting 3D models. The lighting conditions, such as underexposure or overexposure, as well as strong shadows, can impair automatic feature recognition and lead to inaccurate reconstructions.

Surfaces with low contrast or lack of texture make it difficult for the photogrammetry software to identify and track points, which can lead to errors such as missing or distorted surfaces in the model. Height differences within the room pose a challenge for camera positioning and can lead to perspective distortions in the final model. Dense furnishings can restrict the view of relevant areas and cause unwanted reflections, which can lead to gaps in the 3D model.

To overcome these challenges, meticulous documentation as part of the photogrammetric workflow is essential. Not only are the difficulties encountered recorded in detail, but also comments on specific challenges or areas that could not be captured. This information forms a valuable basis for subsequent data analysis and interpretation, enables targeted troubleshooting and contributes significantly to the quality assurance of the final result.

In addition, a comprehensive protocol serves as a reference for future projects and supports the optimisation of the photogrammetric process.

The consideration of these potential difficulties and their systematic documentation ensure that the photogrammetric reconstruction is successful and results in an accurate and complete 3D model of the captured interior.

The photogrammetric data acquisition of the interiors revealed recurring challenges. Sub-

optimal lighting conditions were observed in numerous rooms, ranging from uneven illumination due to sunlight to insufficient lighting in certain areas. These variations led to overexposure or underexposure in the images, which made feature recognition difficult.

In addition, the furniture in some rooms posed an obstacle as it made it difficult to capture the edges and corners of the room.

A further challenge was posed by the change in lighting conditions over the course of the recordings, particularly due to the influence of sunlight and shadows. This led to inconsistencies in the image data and made subsequent processing more difficult. Reflections and mirroring, particularly in the area of windows and mirrored surfaces, presented an additional difficulty that required the camera settings to be adjusted.

<b>Room designation</b> (tip: number the rooms in the order of the measurements on the floor plans -> room no.) see floor plan  Office/daycare centre foundation (SK)		<b>Floor</b>  1ST FLOOR	<b>Room no.</b>  03
<b>Persons</b> (Namens oder Number) Benedikt: Spiegelreflex Lumix Anna: Protocol	<b>Duration</b> (possibly shorter than end-start, as there may be pauses due to obstacles)  7 min	<b>Start</b>  12:57	<b>End</b>  13:04
<b>Special features of the room</b> (e.g. stucco, arched windows, fireplaces, sloping floor, etc.)  <ul style="list-style-type: none"> <li>- Small room with lots of furniture and strong contrasts of light/dark/colours</li> <li>- red linoleum floor that reflects</li> <li>- light yellow walls</li> <li>- one window opposite the door, more to the left</li> <li>- green painted door with window</li> <li>- Large bookshelf on the left wall</li> <li>- stucco mouldings on the ceiling; larger on the right than on the other edges</li> <li>- deep window sill, radiator underneath</li> <li>- Some pictures on the wall</li> <li>- Room height: 2.63m</li> </ul>			
<b>Tools / instruments used</b> (e.g. "3x hand laser, 5 x measuring tape") Form of documentation (e.g. number of photos)  <ul style="list-style-type: none"> <li>- Disto for measuring the room height</li> <li>- Panasonic Lumix GH2, 14-105mm lens, ISO 320, f/8 aperture</li> <li>- with tripod, 33 photos</li> </ul>			
<b>Obstacles / difficulties</b> (What were the difficulties or obstacles to fully measuring this room? What delayed the measurement? E.g.: "Room too small", "Room blocked", ...)  <ul style="list-style-type: none"> <li>- Little contrast between ceiling and walls</li> <li>- Sun/bright light, shadows: Photos glare against windows</li> <li>- Too small to capture everything with camera settings</li> <li>- Difficult to capture room surfaces and edges due to furnishings</li> <li>- Many objects in the room/added</li> <li>- Door paintwork reflects/shines, floor reflects/shines</li> </ul>			
<b>Notes</b> (here are the things you were unable to record or omitted. What was special/worth mentioning during the measurement in the room?)  <ul style="list-style-type: none"> <li>- Seating and tables in the way</li> <li>- "Snail" must be broken open to capture skirting board and stucco mouldings</li> <li>- 30° angle of the pictures not correctly maintained</li> <li>- We still worked very "correctly" here, but this cost us a lot of time</li> </ul>			

Fig. 2.4.5: Detailed protocol of the Office Room



Fig. 2.4.6: Picture sequence, Office Room

# 4 DATA PROCESSING

After planning and carrying out the on-site measurements, during which a large number of photographs are taken with sufficient overlap from different perspectives to ensure complete coverage of the building, the central step of the photogrammetric data processing follows the methodical recording of the building through a large number of overlapping photographs from different perspectives to generate a precise and detailed 3D model.

Our process begins with the import of the captured photographs into the selected photogrammetry software (pp. 128-131). Stringent labelling and sorting of the images by location and angle ensures an efficient workflow. Relevant meta- data such as camera model, focal length and, if necessary, GPS coordinates are checked and corrected.

In the next step, feature extraction, the software analyses each image and extracts distinctive points, so-called „features“ or „keypoints“. These characteristic structures serve as the basis for calculating the camera positions and the 3D structure of the building.

The extracted features are then used for image alignment to determine the relative position and orientation of the camera for each image. Precise alignment is essential for the accuracy of the resulting 3D model.

Based on the image alignment, the software creates a dense point cloud by calculating the 3D position in space for each image point through triangulation. The density of the point cloud depends on the number of images, the overlap and the resolution of the images.

A 3D mesh is generated from the dense point cloud, which visualises the geometry of the building in detail. The mesh is a continuous surface consisting of triangles formed by connecting the points of the point cloud.

To create a photorealistic appearance, the 3D mesh is provided with the texture information from the photos. The software projects the colours and patterns of the photos onto the mesh, taking into account the orientation of the images. (Fig. 2.4.7)

The 3D model can be further optimised by removing superfluous points or filling in gaps. Manual corrections can further increase the accuracy and quality of the model, although additions to the model itself are not possible and must be made in a later step.

Finally, the finished 3D model is exported to a suitable file format (e.g. OBJ, FBX, PLY, STL) to make it usable for further applications, analysis or 3D printing. A detailed 3D model enables a precise and comprehensive visualisation of the building and serves as the basis for a wide range of applications.

In this thesis, the resulting 3D model was used to create a CAD model. The generated mesh is used as a mask to extract precise dimensions that enable the exact digital reproduction of the rooms. To identify deviations and potential errors, the mesh is coloured red and integrated into a CAD model created. The direct comparison allows discrepancies to be identified and corrected to ensure the accuracy of the digital building model.



Fig. 2.4.7: Mesh texture of the Office Room



The selection of suitable software for photogrammetric mapping was based on various factors, including free availability, user-friendliness, range of functions, quality and establishment on the market. These are factors that we considered useful for our group as users.

### **AGISOFT METASHAPE**

Agisoft Metashape was selected due to the availability of a complimentary 30-day trial, its intuitive user interface, reliable data processing capabilities, rapid model generation, and the high accuracy of the resulting models. The software's extensive post-processing options and regular updates, owing to its established presence in the market, were additional factors influencing its selection.<sup>61</sup>

In Agisoft Metashape, a chunk is initially created, providing a digital workspace for processing an assigned dataset. Following the import and quality assessment of photographs, the software calculates camera positions and generates a dense point cloud. From this, a mesh is constructed, which is initially textured and subsequently refined with detailed texturing. The fully textured mesh can then be exported in various file formats (Figs. 2.4.8 - 2.4.9).

In principle, four different pieces of software were used in order to determine and demonstrate differences in data processing and the quality of the results with the same data basis.

### **AUTO-DESK RECAP**

Autodesk ReCap was selected due to its free availability for students. Like Agisoft Metashape, it features an intuitive user interface and offers the advantage of directly transferring the calculated point cloud into the manufacturer's own software. The software enables reliable data processing and rapid model generation.<sup>62</sup>

The photogrammetry software analyses the imported images and determines their suitability for further processing (as in Metashape), based on the detected overlap between images. Subsequently, the software calculates camera positions based on image content and generates a dense point cloud representing the object's surface. From this point cloud, a mesh, a polygonal surface network, is computed, depicting the object's geometric structure. This mesh is initially textured and then refined with detailed texturing to create a realistic appearance. The fully textured mesh can be exported in various file formats, including OBJ files and 3D PDFs (Figs. 2.4.10 - 2.4.11).

---

61 cf. Agisoft. „About“. Accessed 29.06.2024. <https://www.agisoft.com/about>

62 cf. 3DFLOW. „3DF Zephyr Free - Photogrammetry for everyone“. Accessed 29.06.2024. <https://www.3dflow.net/3df-zephyr-free/>

## LUMA AI

Luma AI was selected due to its permanently free availability and web-based platform, which enables the utilization of cloud computing for image processing, thereby reducing the load on local computer storage. The software is characterized by its ease of use.<sup>63</sup>

The images of a room are uploaded into the software, and the automatic processing by the AI is awaited. Once a result is visible, it is possible to download the provided OBJ file to refine the calculated mesh in another program and prepare it for further use (Figs. 2.4.12 - 2.4.13).

## 3DF ZEPHYR

3DF Zephyr was selected due to the availability of a complimentary 30-day trial, its user-friendly interface, reliable data processing capabilities, rapid model generation, and the high accuracy of the model representation.

The ability to further edit the generated 3D models was an additional factor in our choice of this software.<sup>64</sup>

The photogrammetry software analyses the imported images and assesses their suitability for further processing, based on the detected overlap between images. Subsequently, the software calculates camera positions using image content and generates a sparse point cloud that can reveal the object's surface. Based on the sparse point cloud and the imported images, a denser point cloud with more individual points is interpolated. From this dense point cloud, a mesh is calculated, intended to represent the geometric structure of the captured object. This mesh is also initially textured and can be subsequently refined with detailed texturing to create a realistic appearance. The fully textured mesh can be exported in various file formats, such as OBJ files and 3D PDFs, for further data processing (Figs. 2.4.14 - 2.4.15).

---

63 cf. Lumalabs. „Dream Machine“. Accessed 29.06.2024. <https://lumalabs.ai/dream-machine>

64 cf. Arnold IT Systems. „Autodesk ReCap Pro“. Accessed 29.06.2024. <https://www.arnold-it.com/produkte/3d-bestandserfassungssoftware/autodesk-recap-pro>

## AGISOFT METASHAPE



Fig. 2.4.8: Mesh and Texture with Metashape of the Office Room

## AUTO-DESK RECAP



Fig. 2.4.10: Mesh and Texture with Autodesk Recap of the Office Room

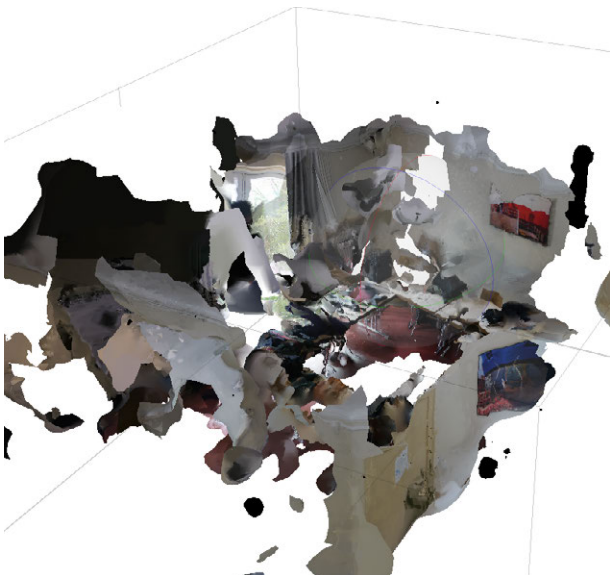

Fig. 2.4.9: Mesh and Texture with Metashape of the Office Room



Fig. 2.4.11: Mesh and Texture with Autodesk Recap of the Office Room

## LUMA AI



Fig. 2.4.12: Mesh and Texture with Luma AI of the Office Room



Fig. 2.4.13: Mesh and Texture with Luma AI of the Office Room

## 3DF ZEPHYR

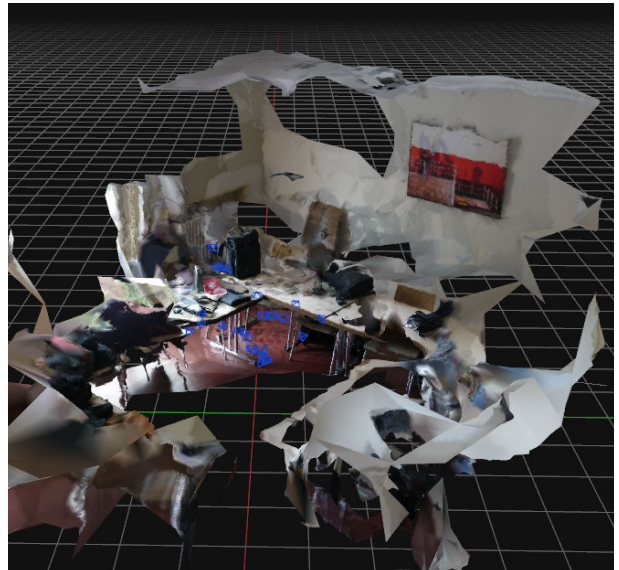

Fig. 2.4.14: Mesh and Texture with Zephyr of the Office Room

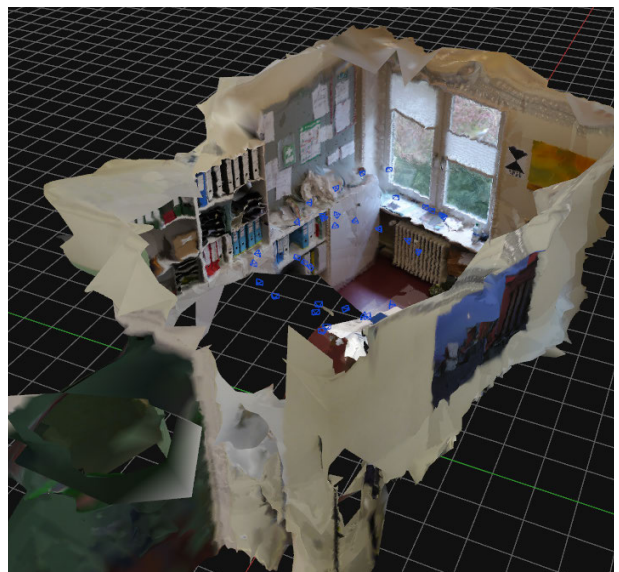

Fig. 2.4.15: Mesh and Texture with Zephyr of the Office Room

## EVALUATION OF SYSTEM LIMITATIONS

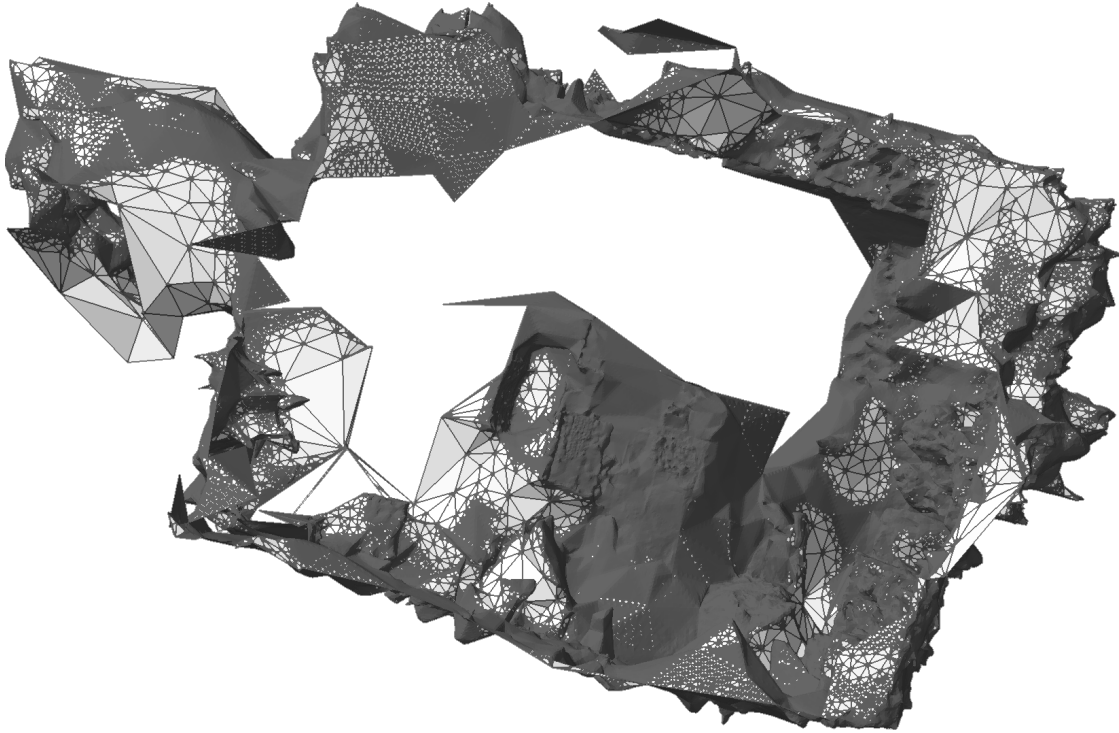

Fig. 2.4.16: 3D Meshes with 3DF Zephyr of the Office Room

The comparative analysis of photogrammetry software within the office space revealed that 3DF Zephyr produced the most favorable results among the four tested software applications. The model generated by 3DF Zephyr exhibited superior detail and sharpness, even under uneven lighting conditions and strong shadows (Figs. 2.4.16 - 2.4.18).

Other software applications demonstrated weaknesses in these aspects, potentially due to variations in algorithms.

On the day of image acquisition at the Ohlen-dorf'sche Villa, the fundamental conditions for optimal image capture were not met.

- Direct solar illumination led to high-contrast lighting conditions, increasing the probability of capturing out-of-focus images due to the fixed focal length of the lens.

- The rooms were densely furnished, this impeding free movement within the space and hindering the ability to capture comprehensive images of the rooms' interiors.
- Furthermore, certain rooms presented spatial constraints due to their narrow dimensions, further complicating the acquisition of satisfactory images.
- The high reflectivity of surfaces within the rooms, such as polished floors and metal fixtures, exacerbated the unfavorable lighting conditions. These reflective surfaces caused unwanted glare and reflections, leading to a loss of detail and overexposure in the images.

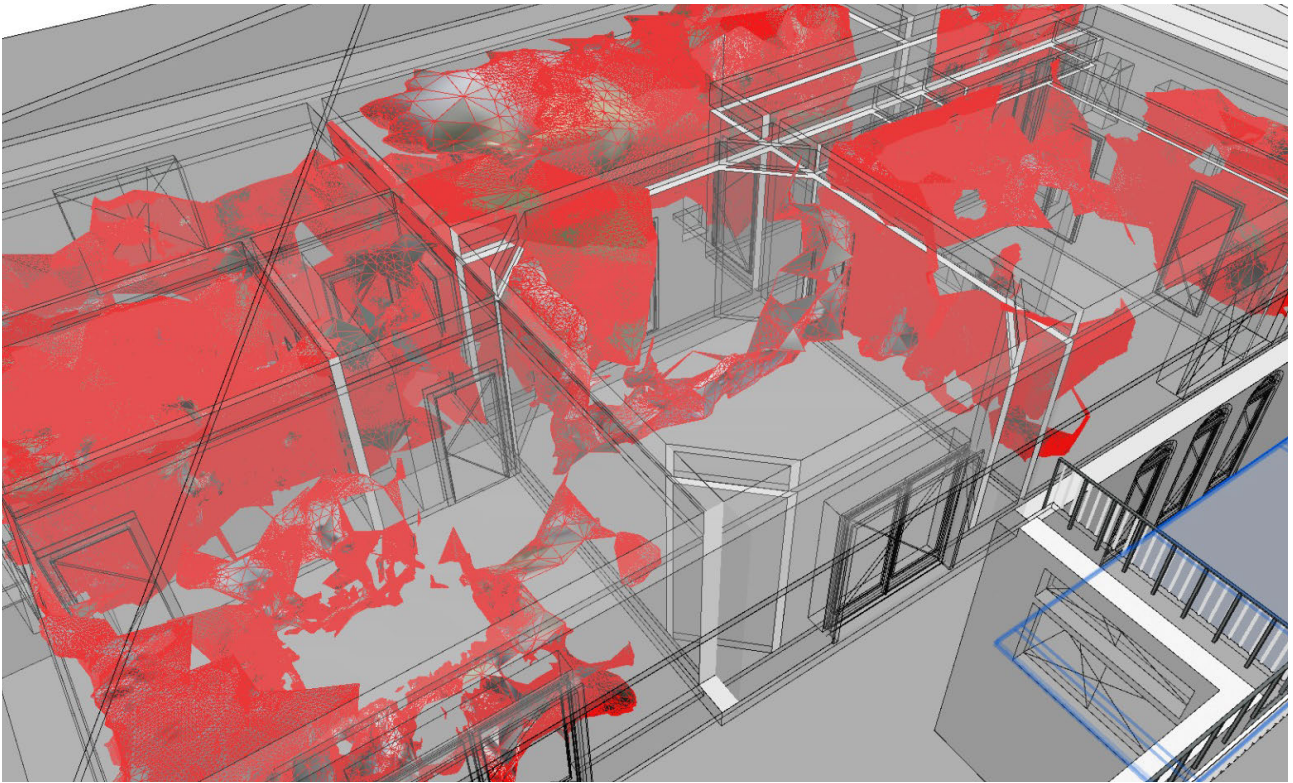

Fig. 2.4.17: 3D Meshes in CAD Model

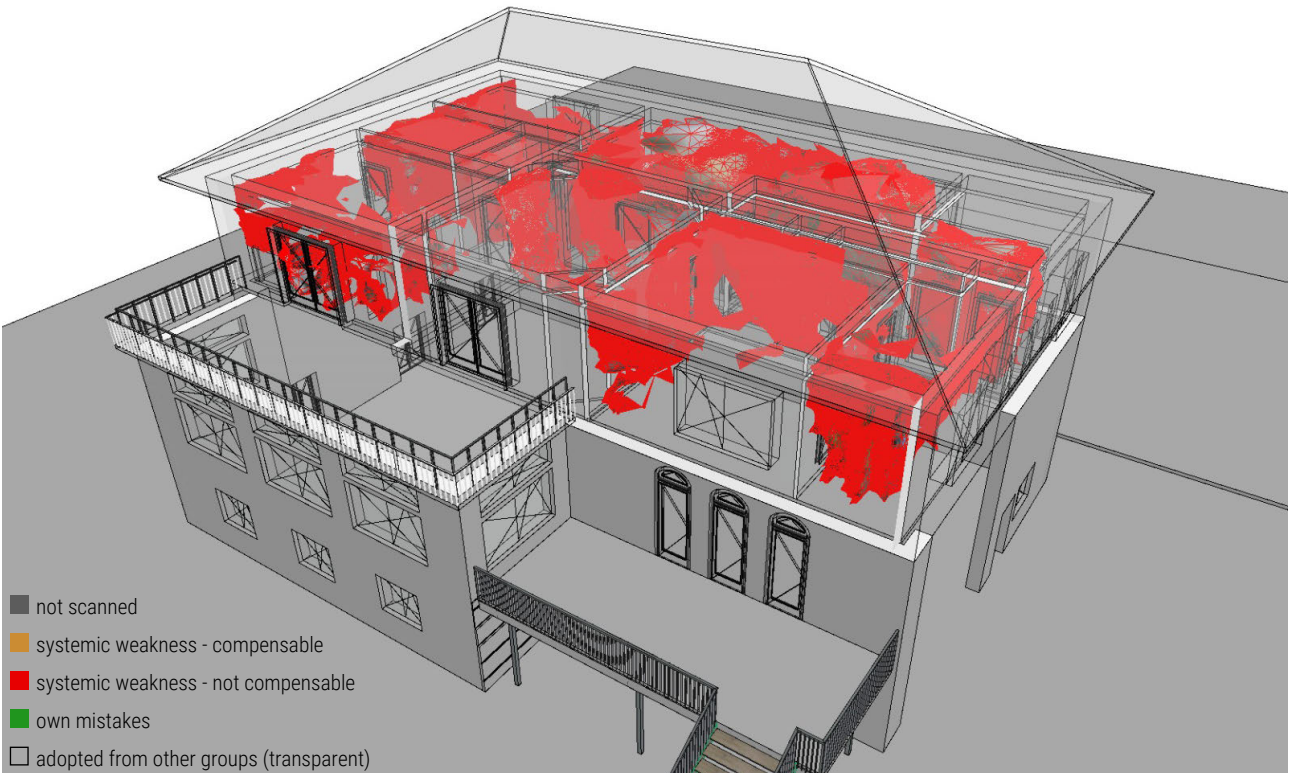

Fig. 2.4.18: 3D Meshes in CAD Model

<b>Room designation</b> (tip: number the rooms in the order of the measurements on the floor plans -> room no.) see floor plan  Basement		<b>Floor</b>  bsmt.	<b>Room no.</b>  01
<b>Persons</b> (Namens oder Number) Benedikt: Spiegelreflex Lumix Moritz: Protocol	<b>Duration</b> (possibly shorter than end-start, as there may be pauses due to obstacles)  32 min	<b>Start</b>  13:48	<b>End</b>  14:20
<b>Special features of the room</b> (e.g. stucco, arched windows, fireplaces, sloping floor, etc.)  <ul style="list-style-type: none"> <li>- The room is naturally lit only by two basement windows. Additionally, the room is illuminated solely by a ceiling light, which casts a diffused light throughout the space. The room is painted entirely white, which may cause the software to have difficulty accurately identifying overlaps in the calculation. In terms of furnishings, the room is equipped with a small sofa, a TV stand, and a table football in the middle of the room, as well as a dartboard on the wall with a carpet attachment. Small candle lights hang above the sofa, and there is a wall bar on one wall. In summary, the room is sparsely furnished, making it easier for the software to define the room edges.</li> <li>- The floor in the room is painted grey, creating a colour contrast with the walls - a positive aspect for the software and its image recognition.</li> <li>- Grey carpets under the table football and in front of the sofa define the space and enhance the colour contrast within the room, which is expected to be beneficial for subsequent processing in the software.</li> <li>- The room measures 2.16 m in height.</li> </ul>			
<b>Tools / instruments used</b> (e.g. "3x hand laser, 5 x measuring tape") Form of documentation (e.g. number of photos)  <ul style="list-style-type: none"> <li>- For the survey, a camera (Panasonic LUMIX GH2) with manual focus capability was used. This is necessary for the subsequent software application. The aperture and ISO value were adjusted automatically for each room exposure.</li> <li>- In total, 464 images with 1.03 GB of data storage were produced for the room survey</li> </ul>			
<b>Obstacles / difficulties</b> (What were the difficulties or obstacles to fully measuring this room? What delayed the measurement? E.g.: "Room too small", "Room blocked", ...)  <ul style="list-style-type: none"> <li>- Difficulties arose due to the low-contrast variety of the walls. Since all four walls are painted white, we anticipate the software may struggle to detect overlaps.</li> <li>- Regarding the light source, varying levels of exposure were observed within the room. The closer one is to the light source, the more brightly lit the room is. However, well-exposed images were still produced through the automatic ISO value adjustment and automatic shutter speed.</li> <li>- In terms of room furnishings, difficulties may arise with the geometric shape of the candle lights. The small geometric forms suggest potential problems in the software application, necessitating the production of numerous images for this small area. In rooms with many such small geometries, an increased capture time on-site should be expected.</li> </ul>			

Fig. 2.4.19: Detailed protocol of the basement



Fig. 2.4.20: Mesh and Texture of the Basement from 3DF Zephyr



Fig. 2.4.21: Photogrammetry Results of the Basement from 3DF Zephyr

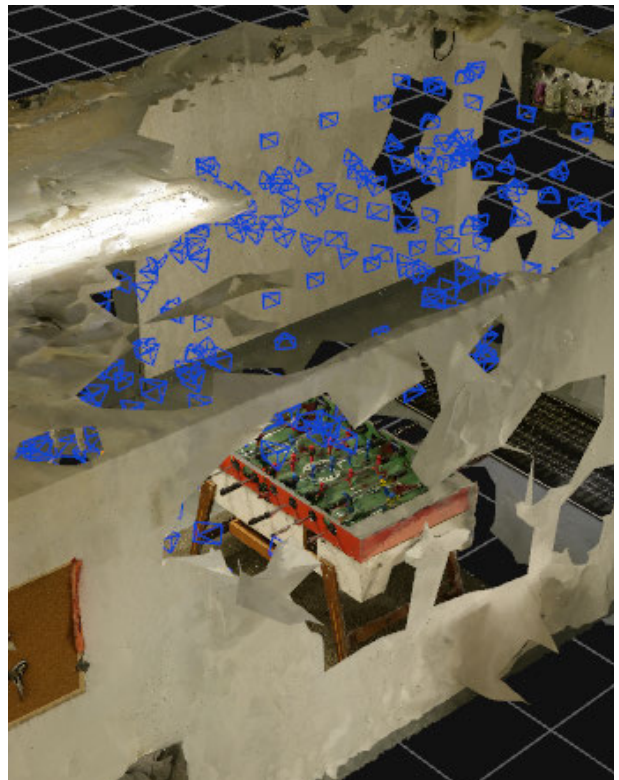

Fig. 2.4.22: Photogrammetry Results of the Basement from 3DF Zephyr



## OFFICE ROOM



Fig. 2.4.23: Blender results of the Office Room

## BASEMENT



Fig. 2.4. 24: Blender results of the Basement

## OFFICE ROOM



Fig. 2.4.25: Plan view of the Office Room



Fig. 2.4.26: Section of the Office Room

**BASEMENT**

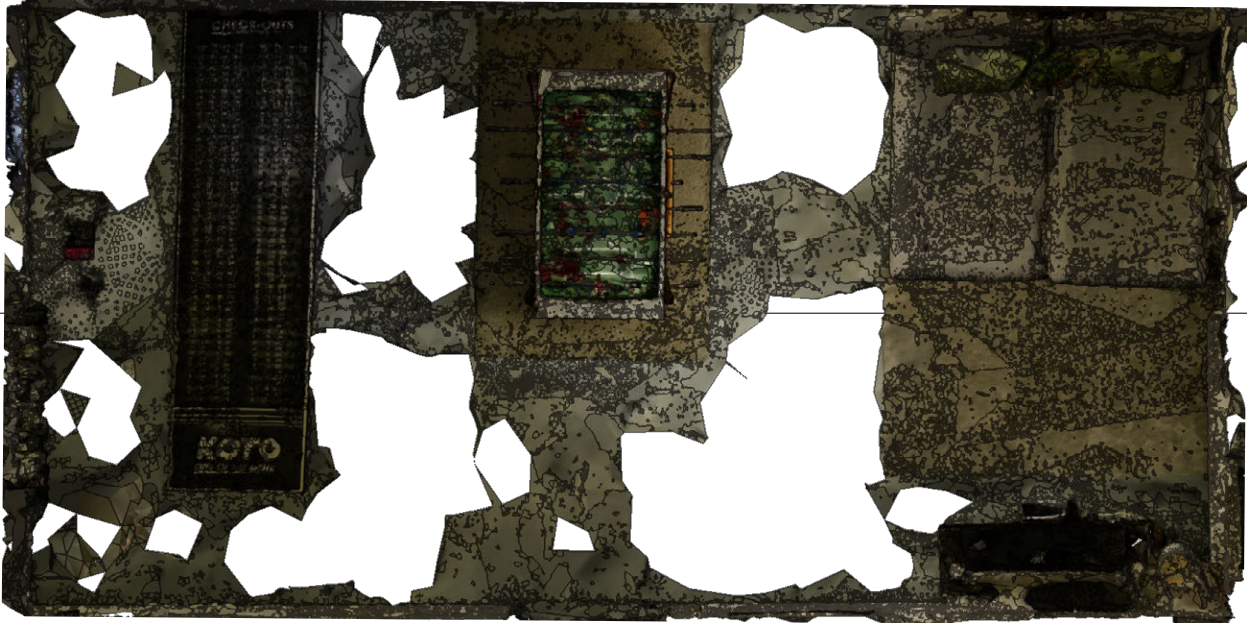

Fig. 2.4.27: Plan view of the Basement



Fig. 2.4.28: Section of the Basement



# BASEMENT

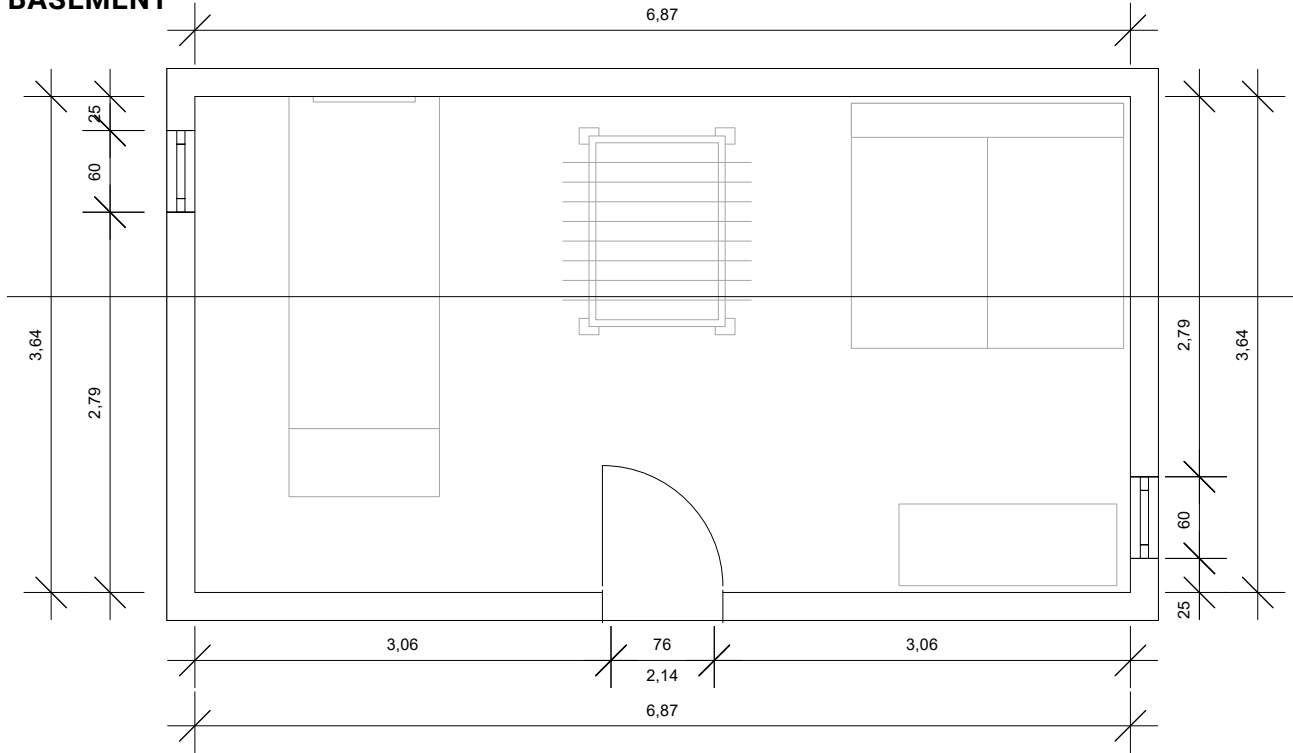

Fig. 2.4.29: CAD Plan view of the Basement

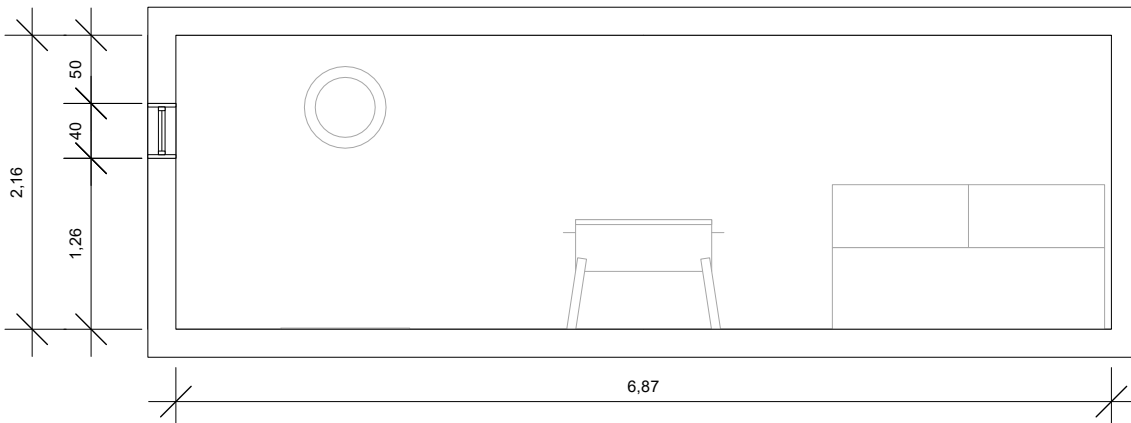

Fig. 2.4.30: CAD Section of the Basement

# 5 EVALUATION

The photogrammetric survey of the Ohlen-dorff'sche Villa revealed limitations in the methodological approach and data collection, leading to suboptimal results.

The survey aimed to create a precise 3D model of the villa for transfer into a CAD model, documenting the building's current state.

However, the generated 3D models lacked precision due to insufficient point cloud density and incomplete meshes (Fig. 2.4.1), evident when compared to the CAD model created by other research groups. This evaluation pertains solely to the survey of the architectural interiors (Figs. 2.4.23, 2.4.25 and 2.4.26).

A targeted test measurement in the separate basement room, using over 400 photographs, resulted in a detailed mesh deviating only 1% from the exact, manually measured room geometry (Fig. 2.4.19 - 2.4.22).

This accuracy was illustrated by comparing the manually measured wall length with the length derived from the generated mesh in a 2D drawing (Figs. 2.4.29 - 2.4.30). This finding highlights the direct correlation between input data quantity and quality and the resulting model accuracy.

Initial insufficient preparation and data collection, particularly the low number of images per room (under 100) and the lack of a systematic recording method, were major error sources.

A comprehensive examination of the building and photogrammetric methods beforehand would have enabled better camera positioning and room illumination. Brightly lit rooms, especially due to sunlight, can cause overexposure and image capture errors.

Applying a systematic recording method like

the „snail principle,“ where the room is photographed spirally from outside in, would have significantly improved point cloud quality.

This ensures even image distribution and sufficient overlap of approx. 60-80%, essential for precise 3D model calculation. More images per room would have further increased model detail. Similar structures, like same-colored walls, can hinder software from recognizing overlap, leading to model gaps.

Photogrammetric data processing is complex, requiring precision, computing power, and expertise. Choosing the „right“ software means selecting one meeting project-specific requirements, like processing large datasets, ensuring high accuracy, and offering a user-friendly interface. Careful execution of steps like image alignment, point cloud creation, mesh modeling, and texturing is crucial for the resulting 3D model's quality. Optimal software parameter adjustment and result checks/corrections are necessary for the best outcomes.

Evaluated meshes may have scattered points, causing inaccuracies. For example, the room corner depiction in the basement (Figs. 2.4.24, 2.4.27 and 2.4.28) shows how polygon choice for modeling affects accuracy.

These insights underscore the complexity of photogrammetric surveys and the need for careful planning, execution, and data collection. Sufficient high-quality photos, thorough preparation (including a site visit for camera planning and potential furniture adjustment), and a sound understanding of the software are essential for accurate, reliable 3D models (Figs. 2.4.31 - 2.4.33).

Despite these challenges, photogrammetry offers advantages. It's relatively easy, requiring 1-2 people on-site. Numerous tutorials exist for

various software, facilitating entry. With preparation and time investment, visually appealing models can be created.

Equipment and software costs are manageable. Images secure precise construction conditions for comparison with later reports. Geometrically complex elements, difficult to capture traditionally, can be recorded.

Photogrammetry remains valuable for documenting and analyzing buildings despite challenges. It allows facility managers to compare actual and target building states, document/analyze structural changes over time, and plan/monitor restorations or conversions. Future projects will benefit from these insights, applying an optimized methodology for improved results.

### MINUTES SPENT PER SOFTWARE

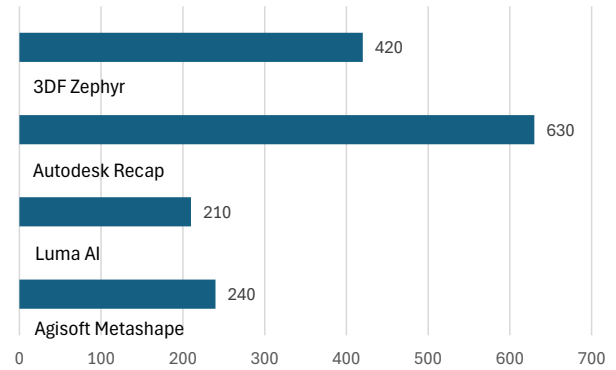

Fig. 2.4.31: Diagram time set per Software

### NUMBER OF SHOTS

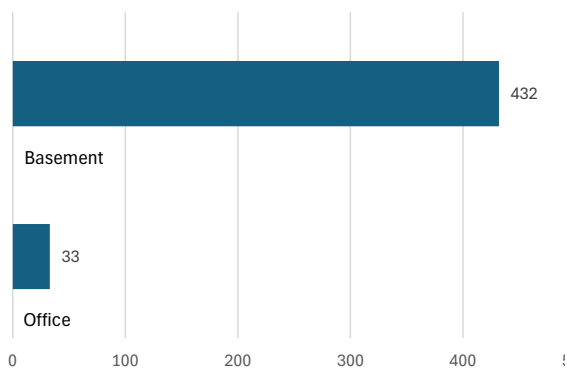

Fig. 2.4.32: Diagram Number of shots

### TIME EXPENDITURE

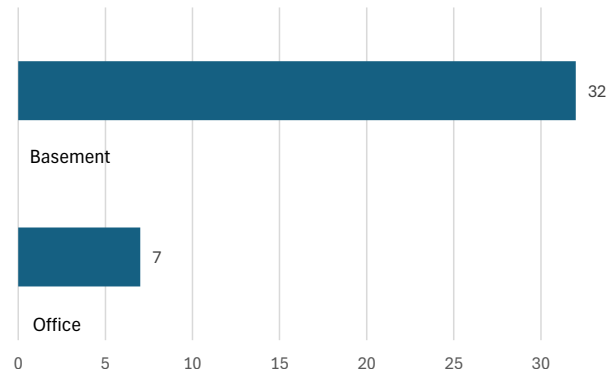

Fig. 2.4.33: Diagram Time Expenditure

OFFICE 33 PICTURES  
 BASEMENT 432 PICTURES

OFFICE 7 MINUTES  
 BASEMENT 32 MINUTES



## AGISOFT METASHAPE

### Advantages

Free download usable for 30 days

Many helpful tutorials were quickly found online

Easy handling in the user interface

Further model editing possible through various export file types

Models are visually appealing

Models can be downloaded after the calculation process

Very accurate model representation based on images

Pioneer in the market, so updates and tutorials are regularly renewed

### Disadvantages

Processing speed is highly dependent on RAM and graphics card quality

Agisoft Metashape is available for free for 30 days and offers many helpful tutorials and a simple user interface. The software processes data reliably, generates models quickly, and delivers visually appealing and accurate results. The models can be further processed, and Agisoft Metashape is considered a pioneer in the market, so updates and tutorials are released regularly. A disadvantage is that the processing speed depends on the hardware.

## AUTO-DESK RECAP

### Advantages

Models are visually appealing

Free download for students

Easy handling in the user interface

Helpful tutorials were quickly found online

Reliable data processing

Models are generated quickly

### Disadvantages

Processing speed is highly dependent on RAM and graphics card quality.

Somewhat cumbersome download process requiring several intermediate steps.

Models are visually appealing, but ambiguities in the calculation are distorted/simplified, resulting in potential errors

Autodesk ReCap is free for students and offers easy handling and helpful tutorials. The software delivers reliable results and quickly creates visually appealing models. Disadvantages include the cumbersome download process, potential errors in the models due to ambiguities in the input data, and the dependence of processing speed on the hardware.

## LUMA AI

### Advantages

Free access for the application

Usable via website

Images are uploaded to a cloud and do not initially burden the computer's storage

Very easy handling in the workflow

### Disadvantages

Processing speed is highly dependent on RAM and graphics card quality

Comparatively long calculation time für model creation

Models are visually appealing, but ambiguities in the calculation are greatly distorted/simplified, resulting in potential errors

Downloaded models differ significantly from the preview on the website, making the model unusable

Luma AI is very user-friendly and freely accessible. It is used via a website, and images are uploaded to a cloud, which does not burden the storage space of your own computer. The software creates visually appealing models that can be downloaded after calculation. However, the processing speed depends on the hardware, and the calculation time can be comparatively long. In addition, ambiguities in the input data can lead to errors in the model, and

## 3DF ZEPHYR

### Advantages

Free download permanently possible, but only for a 30-day license

Easy handling in the user interface

Helpful tutorials were quickly found online

Reliable data processing

Models are generated quickly

Further model editing possible through various export file types

very accurate model representation based on images

### Disadvantages

Processing speed is highly dependent on RAM and graphics card quality

Exported 3D files are often very large

Models are visually appealing, but ambiguities in the calculation are distorted/simplified, resulting in potential errors

the downloaded models may differ from the preview.

3DF Zephyr is available for free for 30 days and offers easy handling and helpful tutorials. The software processes data reliably, generates models quickly, and delivers visually appealing and accurate results. The models can be further processed. Disadvantages include the dependence of processing speed on the hardware and the size of the exported 3D files.

# PHOTO - THETA 360°



## INTRODUCTION

Team	148
Description	148
Requirements	149

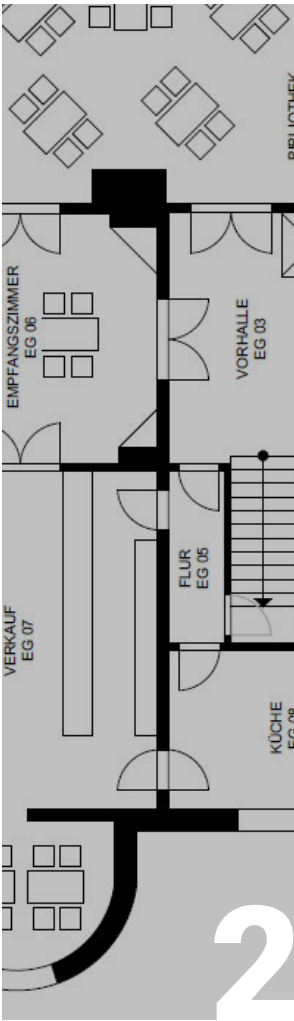

**PREPARATION**

Preparation 150



**SITE MEASUREMENT**

Site Measurement 152



**DATA PROCESSING**

Data Editing 160

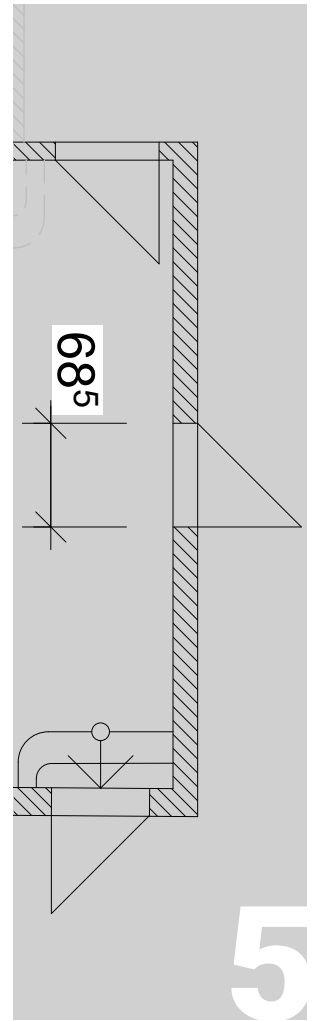

**EVALUATION**

Evaluation 174

# 1 INTRODUCTION



Fig. 2.5.1: Ricoh Theta V

## DESCRIPTION

We used the photogrammetry method to record the existing building. This method deals with the recording and evaluation of images and describes the technology of obtaining information about physical objects or landscapes from photographs.<sup>65</sup>

In this way, essential features of the room under consideration can be determined without having to touch it directly. Measurements are therefore not taken directly, but indirectly on images of the object.<sup>66</sup>

We made our first attempt to record the Ohlendorff'sche Villa with both an SLR camera and the Rico Theta V 360° camera (Fig. 2.5.1) Depending on the size and complexity of the room, we took between 25 and 70 images per room with the SLR camera and between 10 and 15 images with the 360° camera. During the further process, however, we realized that the number of images taken was not sufficient to create detailed 3D models from the photos. We then tried again and took a significantly higher number of photos of two rooms in the villa as examples.

We concentrated exclusively on using the 360° camera and took at least 30 photos per room from two different camera heights. We then evaluated these with the Agisoft Metashape program and created a 3D model from the images.

65 cf. Schindler, Konrad and Förstner, Wolfgang. „Photogrammetry“. In: Ikeuchi, Katsushi (ed.), „Computer Vision - A Reference Guide“ (Springer, 2014). 579-599.

66 cf. Konecny, Gootfried. „Mapping from space: The metric camera experiment“. Science, 225 (1984). 167-169.

## REQUIREMENTS

The aim of photogrammetry is to depict a physical object as a 3D model using photos. The first phase involves taking the photos, and the second phase involves analyzing the photos using photogrammetry software. In our case, Agisoft Metashape. We opted for this program because it supports the analysis of 360° photos and offers a free full version. 360° cameras have a fisheye lens. These special lenses are characterized by their strongly curved, outwardly curved lens, which can capture a very large image section. This lens geometry leads to a significant distortion of the image, so that straight lines appear curved at the edge of the image. This allows the entire surroundings to be captured in a complete panoramic view.<sup>67</sup>

In addition to the Ricoh Theta V used, the camera and accessories required include a tripod with a bubble level to align the camera and position it at different heights. In order to be able to determine reference lengths on site, which are later compared with the dimensions in the 3D model, a distometer or folding ruler is also required. During the second phase, the evaluation of the recordings using the 3DF Zephyr and Agisoft Metashape programs, the operating system, memory, graphics card and processor of the computer used are important. As the maximum project size is usually limited by the available memory, sufficient RAM is recommended. In addition, complex geometries within the photogrammetry programs require a considerable amount of computing resources for data processing, which results in GPU and CPU requirements.

Agisoft recommends the following minimum requirements for using the Metashape program: 16-32 GB RAM memory, a 4-12 core Intel or Apple M1/M2 processor, 2.0+ GHz and an NVIDIA or AMD graphics card with more than 1024 uniform shaders.<sup>68</sup>

For the evaluation of the photos with the corresponding programs, we used a PC with the following system characteristics: Intel(R) Core(TM) i7-8700 CPU @ 3.20GHz 3.19 GHz 32.0 GB RAM 64-bit operating system, x64-based processor. These requirements are at least equal to the performance specified by Agisoft.

---

67 cf. Staschen, Björn. „360 Grad–Rundherum unterwegs“. In: Staschen, Björn (ed.), „Mobiler Journalismus“ (Springer, 2017). 239–257

68 cf. Agisoft. „System Requirements“. Accessed 01.07.2024. <https://www.agisoft.com/downloads/system-requirements/>

# 2 PREPARATION

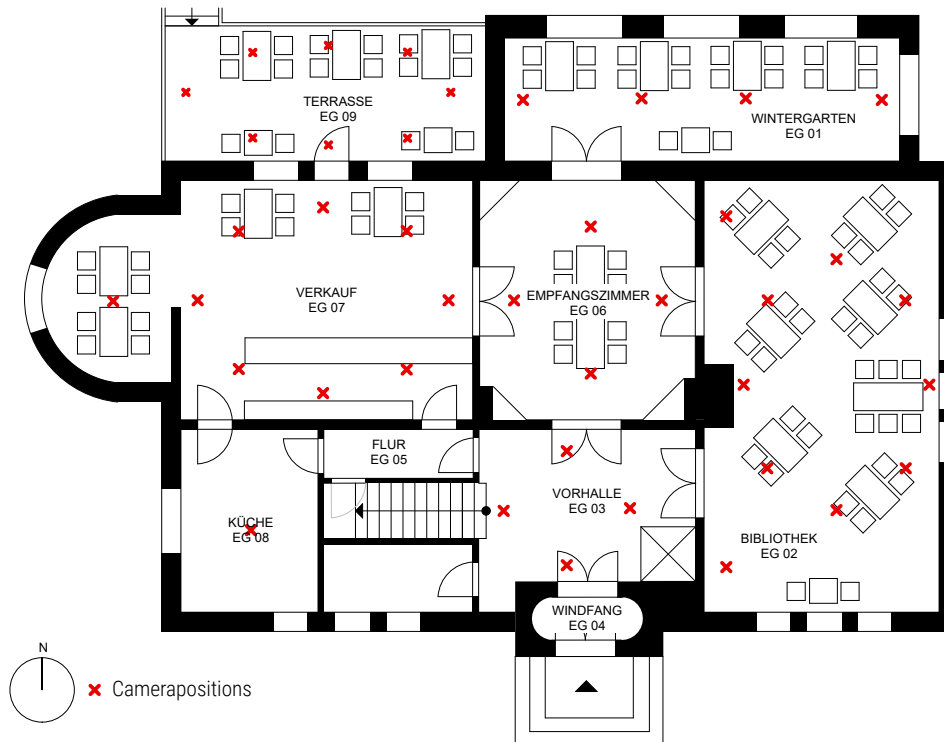

Fig. 2.5.2: Floorplan groundfloor

For reflection and follow-up, but also for the traceability of the results, it helps to prepare a measurement protocol. Important data that should be recorded are:

- Location
- Time and date
- Duration of the recording process
- Weather conditions- Room names
- People involved- Special features of the room/difficulties during the recording
- Tools/instruments used

In addition, printed floor plans are essential for orientation in the building and preparation for the recording. You should consider in advance which camera positions should be chosen in the room so that sufficient photos are taken on location and all areas of the room are captured, and thorough preparation of the room is also important.

This includes, for example, clearing the room of furniture. If furnishings obstruct parts of the room, these areas are not recorded and cannot be reconstructed afterwards. Depending on the situation, it is also important to remove personal objects or photos before the recording begins in order to protect the privacy of the users, as the transfer of a physical room or object into the model inevitably results in a loss of information.

To minimise this, it is important to determine possible camera positions in the room before the photo is taken. In rooms, the camera follows the walls (Fig. 2.5.2).

It is also important to avoid photos of windows and reflective surfaces, as these may not be captured correctly in the further process.

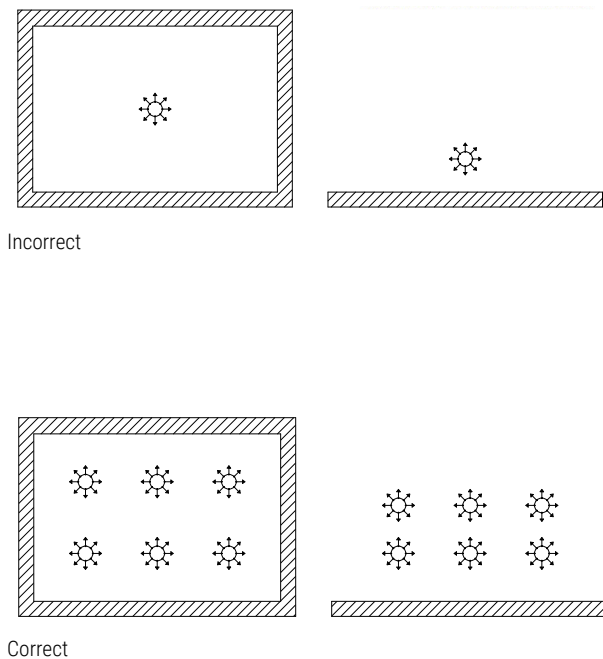

Fig. 2.5.3: Camera positioning, interior

Unevenly lit parts of the room, such as bright window areas, low-contrast or reflective surfaces, will be poorly recognised by the programmes later on. In addition, all lights should be switched on to ensure sufficient lighting. It is also important that the camera is always positioned at an angle of 90 degrees to strong light sources or direct sunlight.

When positioning the camera, it is important to use a tripod to keep the camera stable and at various uniform heights. It is necessary to move the camera to several positions in order to capture the entire room (Fig. 2.5.3).

Before each shot, all people must step out of the frame to avoid appearing in the picture themselves.

The Ricoh Theta V has a WLAN function so that the camera can be operated remotely via a mobile phone app. This allows you to take pictures without being in the camera's field of vision.

It is therefore important to remember to have a smartphone and internet access ready when preparing for the shoot and to consider the weather conditions beforehand: Bad weather is good weather, at least for photogrammetry.

Cloudy conditions provide indirect and diffuse lighting so that there are no disturbing shadows on the texture of the 3D model later on.<sup>69</sup>

The preparation took about three hours. This included the creation and printing of protocols and floor plans, the installation and testing of the Ricoh Theta V mobile phone app, as well as considerations about the recording process. In addition, we started the first test recordings before the inventory and analysed them using the photogrammetry programmes 3DF-Zephyr and Agisoft Metashape.

69 cf. Teammediadock. Hochschule Luzern - Design Film Kunst. „3D Scan (Photogrammetrie) Metashape“. Accessed 01.07.2024. <https://sites.hslu.ch/werkstatt/3d-scan-photogrammetrie/>



# 3 SITE MEASUREMENT

On the first day of shooting, we took a total of twelve to 16 photos per room at two different heights (0.8 meters and 1.50 meters)

To do this, we mounted the 360° camera (Ricoh Theta V) on the tripod and aligned it horizontally and vertically so that the camera was leveled. A series consisted of six to eight shots, evenly distributed around the room. As already mentioned in the „Preparation“ chapter, we connected an Android smartphone to the Rico Theta V camera via the mobile app installed in advance. This app can be used to start recording as well as to view the photos already taken and download them to the smartphone or send them to a computer. After the recording has been started via the app, the camera confirms the completion of the photo recording with an acoustic signal. For a clear, unfurnished room, we needed around 20 minutes for an average number of 14 photos. In rooms with a lot of furniture or other furnishings, however, the time required to capture the room photogrammetrically was significantly longer. The size of the room and the associated number of different camera positions also plays a decisive role in the assessment of the time required per room.

In the library, we first had to move some tables and chairs so that the camera could capture every part of the room. The process was also delayed because there were a lot of people in the room at the time of shooting. In total, we spent about 45 minutes in this room to take 16 photos.

After loading and analyzing the photos in Metashape, we noticed that the number of images was clearly too low to compare the model with the recorded room or to derive measurements from the model (Fig. 2.5.4). To make matters worse, images taken against the light or low-contrast bright surfaces in the room were sometimes not recognized by the programs, so that the number of images evaluated was

reduced even further. The weather conditions on the first day of recording were sunny. Some of the southern rooms in particular were too brightly lit.

We then made a second attempt in slightly cloudier weather and again took two rooms with twice the number of photos. When selecting the rooms, we took care to choose evenly lit rooms with no reflective surfaces or significant sources of backlighting. In addition, this time we paid more attention to capturing room transitions better by not only photographing the threshold area, but also the widely adjacent parts of the neighboring room. The duration of the recordings was between 20 and 30 minutes per room. As can be seen in Figure 2.5.5, the increase in the number of photos shows a clear change in the model. More detailed explanations on the evaluation of the photos and the digitization process follow in the chapter „Data Processing“. This comparison of the model representations is only intended to illustrate the differences in the results with a different number of images.

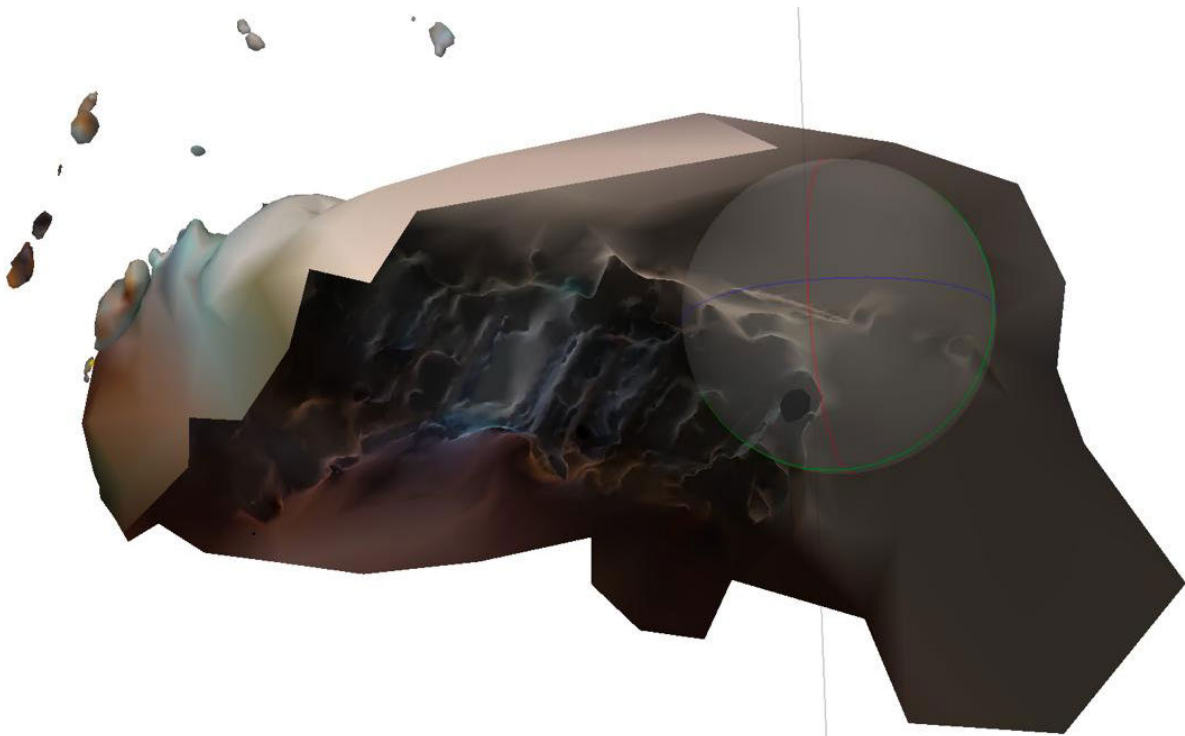

Fig. 2.5.4: Representation of the vestibule, ground floor in Metashape with 15 photos; Attempt 1



Fig 2.5.5: Representation of the vestibule, ground floor in Metashape with 30 photos; Attempt 2

Gruppe: 5.) Photogrammetrie 2					
Untergruppe:					
Studierende: Mostafa Nasri, Jakob Thon, Henri Sebgo, Hermann Zepp					
Bearbeiter/in:					
Rechner: (Acer Nitro 5: 16GB RAM, AMD RYZEN 7, GEFORCE GTX 3080) & (32GB RAM, Intel Core 7, GEFORCE RTX 2070 SUPER)					
Software: Agisoft Metashape Professional Free Trial					
Start	Ende	Dauer	Stadium	Arbeitsschritte / Beschreibung	Bemerkungen
10/5/24 14:42	10/5/24 14:43	0,02	Vorbereitung	Dateivorbereitung eines Chunks / Raumbildung	Benennung Datei, Raumunterscheidung
10/5/24 14:43	10/5/24 14:44	0,02	Datenbearbeitung	Einlesen der Bilder eines Raumes OG 05	Ohne Rechenzeit möglich
10/5/24 14:44	10/5/24 14:59	0,25	Datenbearbeitung	Bildausrichtung: 22 Bilder	Rechenprozess je nach Rechnerstärke/Fotoanzahl - 6 Sekunden
10/5/24 14:59	10/5/24 15:03	0,07	Datenbearbeitung	Erstellung Punktwolkenmodell	Rechenprozess je nach Rechnerstärke/Fotoanzahl - 21 Sekunden
10/5/24 15:03	10/5/24 15:06	0,05	Datenbearbeitung	Erstellung Mesh-Modell / Build Model	Rechenprozess je nach Rechnerstärke/Fotoanzahl - 28 Sekunden
10/5/24 16:03	10/5/24 16:11	0,13	korrektur / Fehlerbehebung	Erstellung Textur auf Modell / Texturing	Rechenprozess je nach Rechnerstärke/Fotoanzahl - 3 Minuten
10/5/24 16:11	10/5/24 16:13	0,03	Vorbereitung	Dateivorbereitung eines Chunks / Raumbildung	Benennung Datei, Raumunterscheidung
10/5/24 16:13	10/5/24 16:16	0,05	Datenbearbeitung	Einlesen der Bilder eines Raumes EG 03	Ohne Rechenzeit möglich
10/5/24 16:16	10/5/24 16:29	0,22	Datenbearbeitung	Bildausrichtung: 31 Bilder	Rechenprozess je nach Rechnerstärke/Fotoanzahl - 4 Sekunden
10/5/24 16:29	10/5/24 16:37	0,13	Datenbearbeitung	Erstellung Punktwolkenmodell	Rechenprozess je nach Rechnerstärke/Fotoanzahl - 13 Sekunden
10/5/24 16:37	10/5/24 16:40	0,05	Datenbearbeitung	Erstellung Mesh-Modell / Build Model	Rechenprozess je nach Rechnerstärke/Fotoanzahl - 26 Sekunden
10/5/24 14:55	10/5/24 14:59	0,07	korrektur / Fehlerbehebung	Erstellung Textur auf Modell / Texturing	Rechenprozess je nach Rechnerstärke/Fotoanzahl - 4 Minuten
		1,08	Stunden		

Fig. 2.5.6: Timesheets

With a number of approximately 30 images per room, the entire processing of a room took about half an hour. Most of the computing time was required to merge the images into a model. After the point cloud was exported, however, some drawing post-processing had to be carried out, so that the entire time from importing the photos to a true-to-scale floor plan took a total of one and a half hours (Fig. 2.5.6).

Raumbezeichnung Vorhalle		Geschoß EG	Raum.Nr. 03
Personen Mostafa, Jakob, Henri, Hermann	Dauer 30 min.	Start 11:30	Ende 12:00.
<b>Besonderheiten des Raumes</b> <ul style="list-style-type: none"> <li>- Raumhöhe: 3,15m</li> <li>- Treppenaufgang zum OG</li> <li>- Einige spiegelnde Glasflächen</li> <li>- Einige Türen</li> <li>- In dem Raum befindet sich ein Fahrstuhl</li> <li>- Stuck</li> </ul>			
<b>Eingesetzte Werkzeuge / Instrumente</b> <ul style="list-style-type: none"> <li>- Geschossene Fotos: 31</li> <li>- Zollstock/Disto für die Messung von Referenzgrößen (Raumhöhe)</li> <li>- RICOH THETA V 360*Kamera</li> <li>- Stativ</li> </ul>			
<b>Hindernisse / Schwierigkeiten</b> <ul style="list-style-type: none"> <li>..Lichteinfall bei geöffneter Tür</li> <li>..Der verglaste Fahrstuhl, stellt spiegelnde Flächen dar</li> <li>..In dem Raum befindet sich ein Treppenaufgang zum OG. Der Übergang war schwierig zu erfassen</li> <li>..Es befanden sich einige Menschen zur Zeit der Aufnahme im Raum</li> </ul>			
<b>Anmerkungen</b> <ul style="list-style-type: none"> <li>.. Bei geschlossener Tür war der Raum, gleichmäßig beleuchtet, jedoch kamen immer wieder Menschen in das Gebäude, wodurch sich die Lichtquellen teilweise änderten</li> </ul>			
26.06.2024			

Fig. 2.5.7: Protocols, second day of recording, groundfloor

Raumbezeichnung Vorraum		Geschoß OG	Raum.Nr. 05
Personen Mostafa, Jakob, Henri, Hermann	Dauer 20 min.	Start 11:10	Ende 11:30
Besonderheiten des Raumes  <ul style="list-style-type: none"> <li>- Anliegendes Treppenhaus</li> <li>- Sruck</li> <li>- Stufen</li> <li>- Oberlichter</li> <li>- Möbliert</li> </ul>			
Eingesetzte Werkzeuge / Instrumente  <ul style="list-style-type: none"> <li>- Geschossene Fotos: 22</li> <li>- Zollstock/Disto für die Messung von Referenzgrößen (Raumhöhe)</li> <li>- RICOH THETA V 360*Kamera</li> <li>- Stativ</li> </ul>			
Hindernisse / Schwierigkeiten  <ul style="list-style-type: none"> <li>- Wenig Kontraste</li> <li>- Große helle Flächen</li> <li>- Der Raum war durch Stühle und Tische verstellt</li> </ul>			
Anmerkungen  <ul style="list-style-type: none"> <li>- Trotz ausreichender Überlappung wurden einige Bilder im späteren Prozess von den Programmen nicht erkannt</li> <li>- Teilweise sind aufgrund der Beleuchtung sehr helle und sehr dunkle Fotos entstanden</li> <li>- Möblierung des Raumes war hinderlich, um alle Bereiche zu erfassen</li> </ul> <p style="text-align: right;">26.06.2024</p>			

Fig. 2.5.8: Protocols, second day of recording, upperfloor

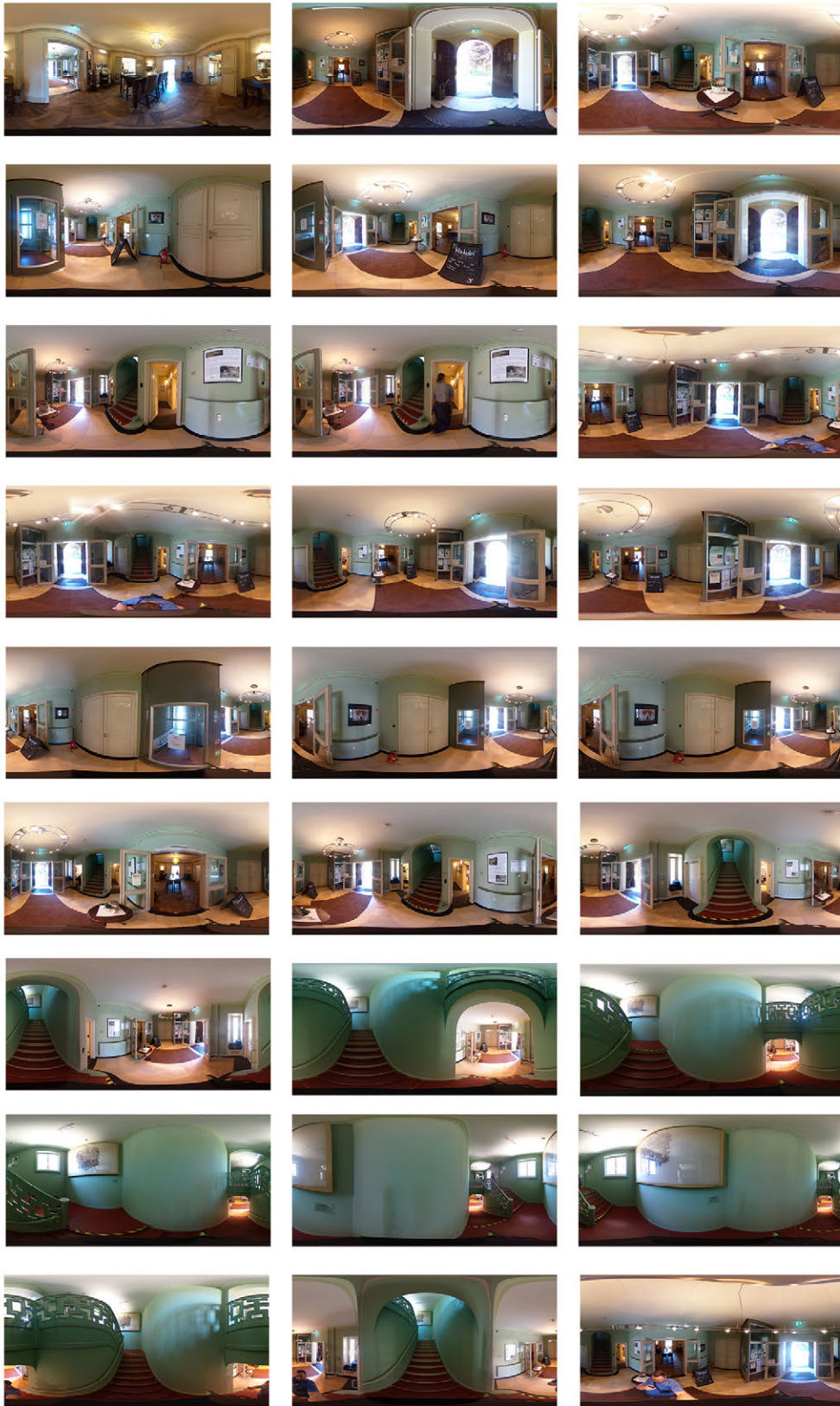

Fig. 2.5.9: Photoseries vestibule, groundfloor



Fig. 2.5.10: Photoseries anteroom, upper floor





# 4 DATA PROCESSING

Once the inventory has been recorded and the photos transferred from the mobile app of the Ricoh Theta V 360° camera to the computer, the second step is to analyze the photos with Agisoft Metashape. This photogrammetry software offers a free full version for educational institutions and can convert digital images into textured 3D models or point clouds. The photos can be loaded into the software via drag and drop. This captures metadata of the photos such as camera model or GPS data and recognizes key data such as structures, textures or characteristic shapes in the various photos and can thus determine the camera positions and merge the photos into a point cloud. Each point in the model corresponds to a point in the physical space that has been reconstructed from the photos.

constructed from the images. In the next step, the program creates a mesh from the point cloud and adds texture and color to it. Manual optimizations, such as deleting superfluous points or adjusting the textures, can then be carried out.

Metashape offers cloud-based processing options so that models can be saved in Autodesk Drive. This requires the desktop application Desktop Connector for Autodesk Drive. After downloading the app, the projects can be saved in the cloud.

The finished models can be exported to various file types such as Wavefront OBJ (\*.obj), 3DS models (\*.3ds), STL models (\*.stl), Autodesk DXF (\*.dxf), ASTM E57 (\*.e57) or Adobe 3D PDF (\*.pdf).<sup>70</sup>

After we exported a point cloud with the file type (\*.e57), it was loaded into the CAD program Archicad 27 using the „Import point cloud“ function. Some difficulties arose during this step. A comparison with the reference dimensions determined for the Ohlendorff'sche Villa revealed that the imported model did not correspond to the original dimensions. However, as point clouds cannot be scaled in Archicad, we first had to draw a two-dimensional floor plan over the point cloud and then scale it according to our manually recorded reference dimensions. To do this, we cut the point cloud at a height of about one meter, resulting in a floor plan view, and drew walls, door and window openings on top of it. This is described in the following sections.

1. Photo import to Metashape (Fig. 2.5.11)
2. Camera calibration (Fig. 2.5.12)
3. Image alignment (Fig. 2.5.13)
4. Model build and export (Fig. 2.5.14)
5. Model import ArchiCad (Fig. 2.5.19)
6. Model cutting (Fig. 2.5.20)
7. Scaling and drawing (Fig. 2.5.22)

---

70 cf. Agisoft LLC. „Agisoft PhotoScan User Manual - Professional Edition, Version 1.3“ (2017)

# WORKFLOW in MetashapePro

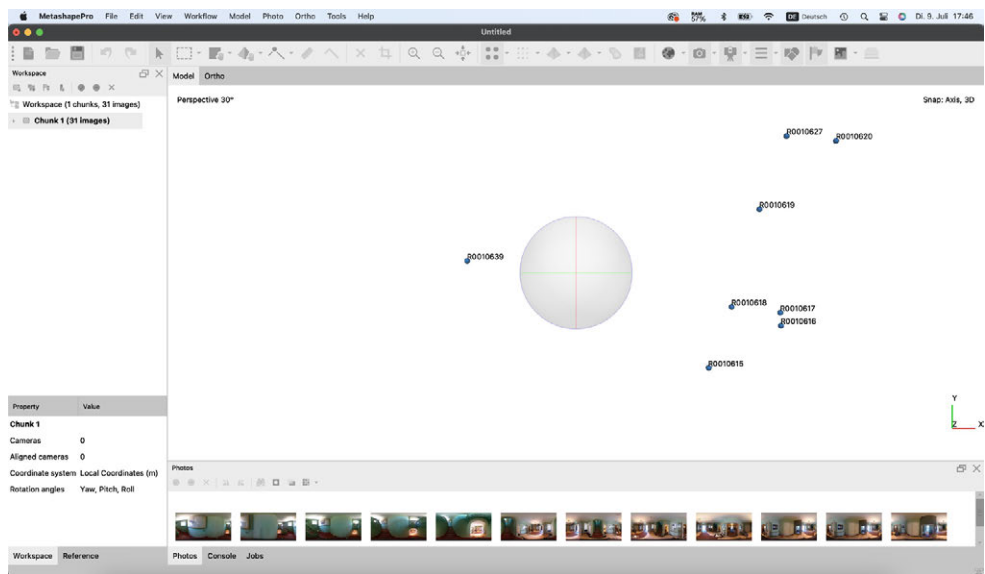
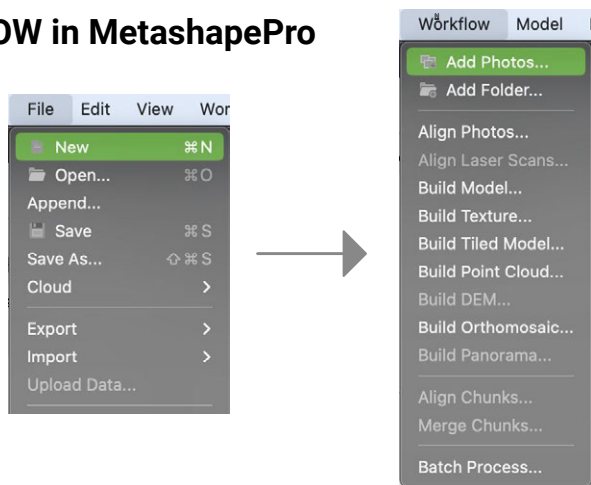

Fig. 2.5.11: Screenshots MetashapePRO

## 1. Create a new file and import the photos

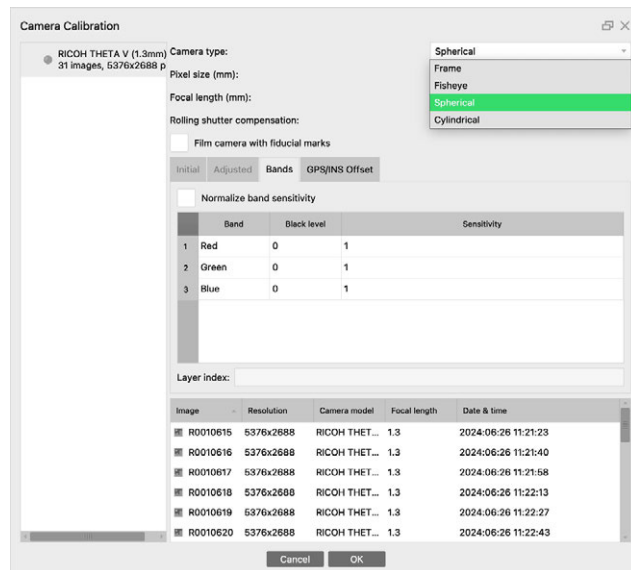
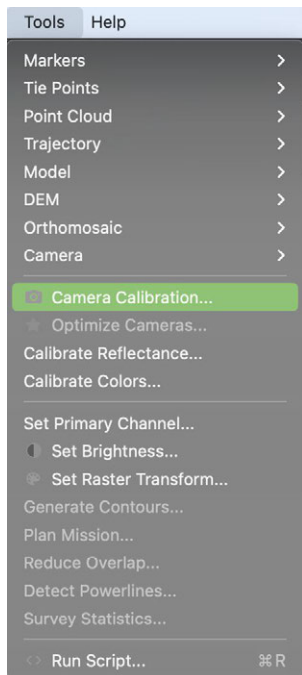

Fig. 2.5. 12: Screenshots MetashapePRO

2. Since the Rico Theta V is a 360° camera, some adjustments have to be made in the program. Due to the distortion of the photo by the special lens, the image setting must be set to “spherical”.

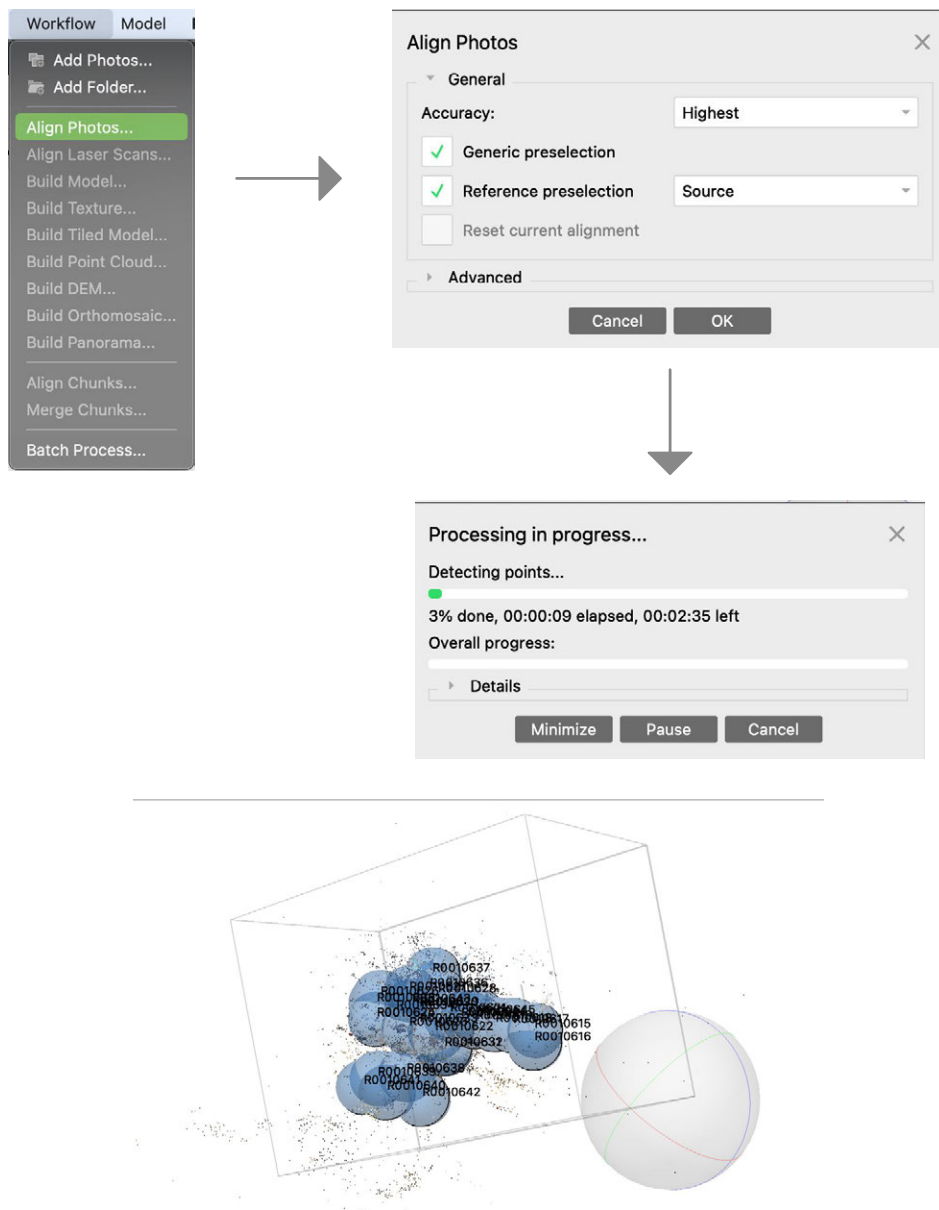

Fig. 2.5.13: Screenshots MetashapePRO

3. In this step, the program aligns the images according to their recording points in space and merges them together to form a point cloud model. The accuracy of this process can be adjusted via the “Accuracy” tab. The “Highest” setting requires the most computing power, but is particularly recommended for less complex models.

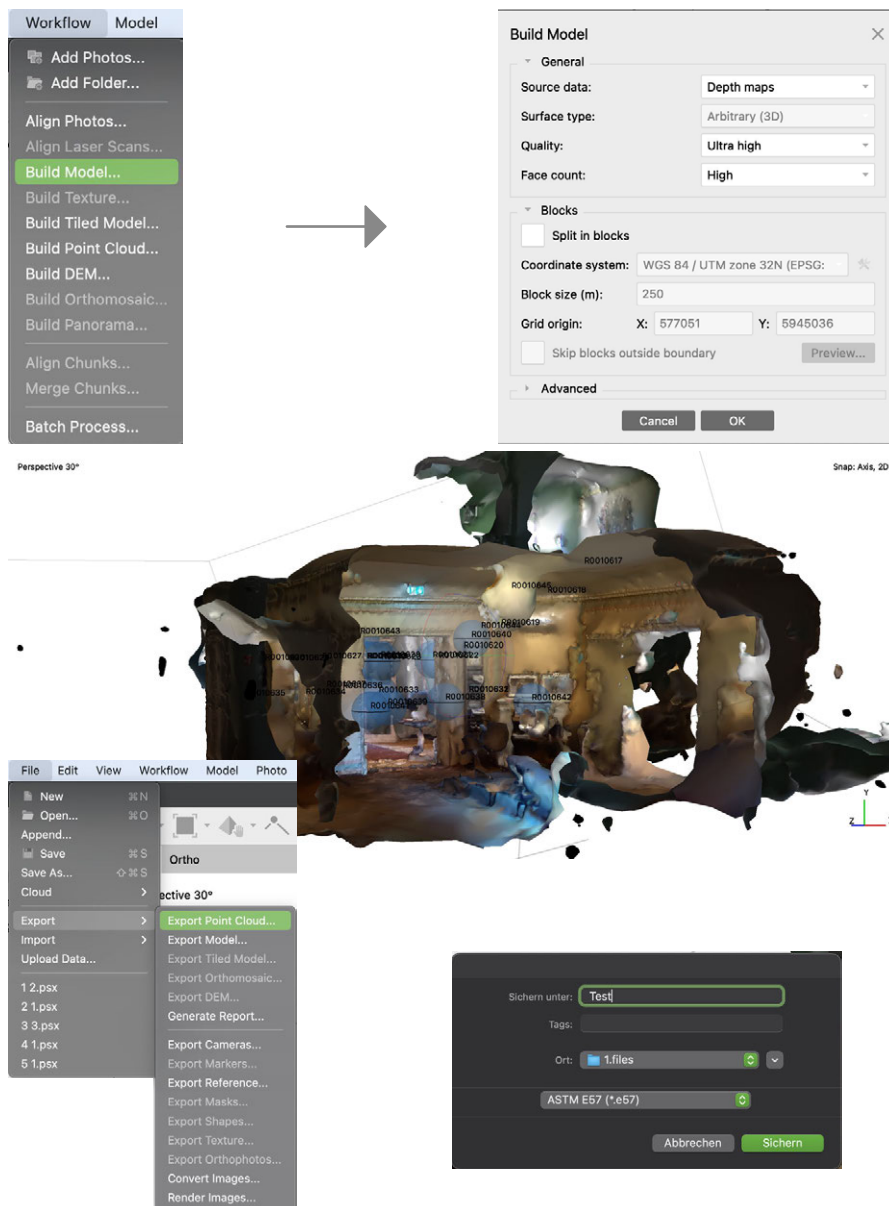

Fig. 2.5.14: Screenshots MetashapePRO

4. Now a mesh is created from the point cloud and textures are added. Metashape offers the option to select different densities of the mesh. Here too, it is advisable to select the highest density for models that are not too complex. The model can then be exported in any file format and the working environment can be saved to the Autodesk cloud.

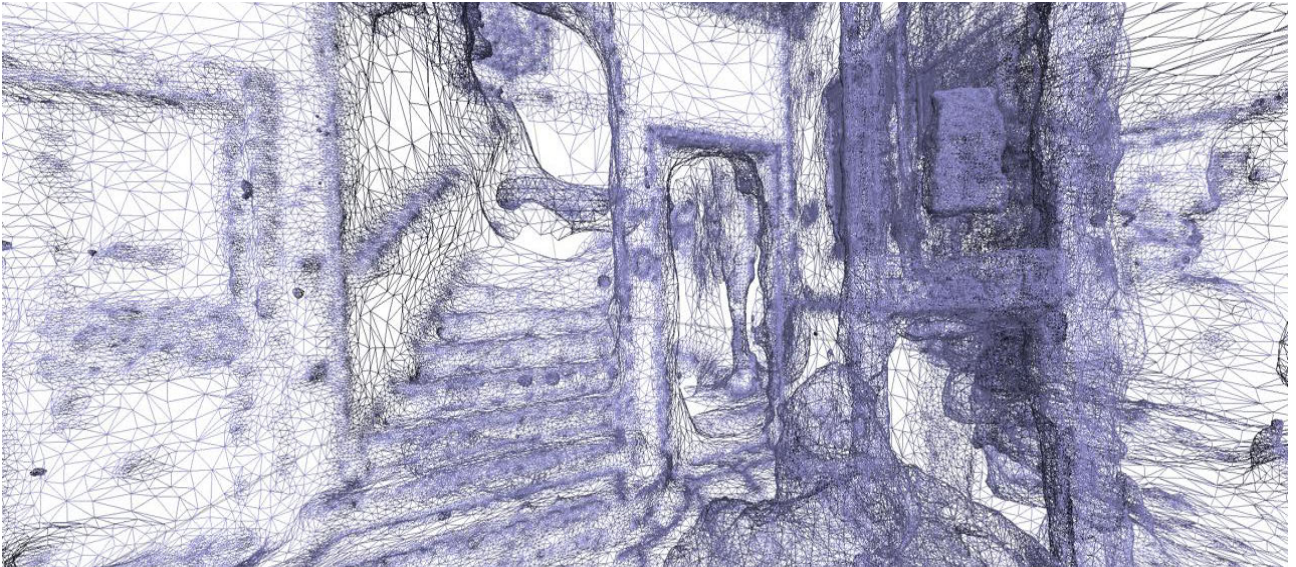

Fig. 2.5.15: Gridmodel MetashapePRO

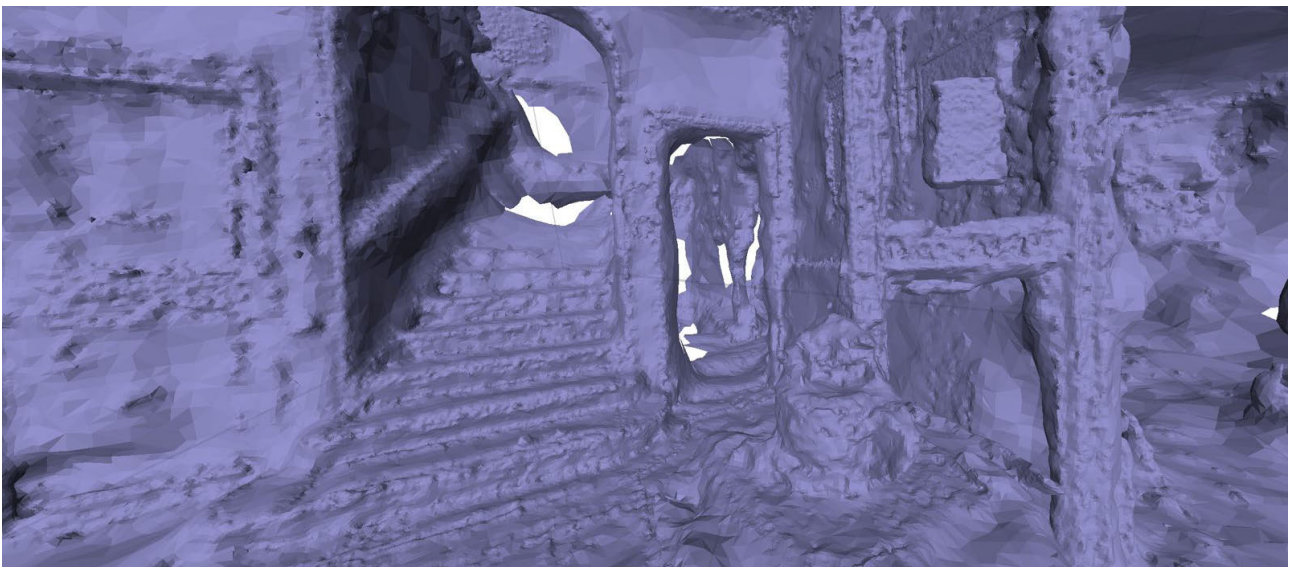

Fig. 2.5.16: Meshmodel MetashapePRO



Fig. 2.5.17: Finished model vestibule, MetashapePRO



Fig. 2.5.18: Finished Model anteroom, MetashapePRO

The model can be displayed by Metashape as a Grid, a Mesh or the finished coloured Meshmodel.

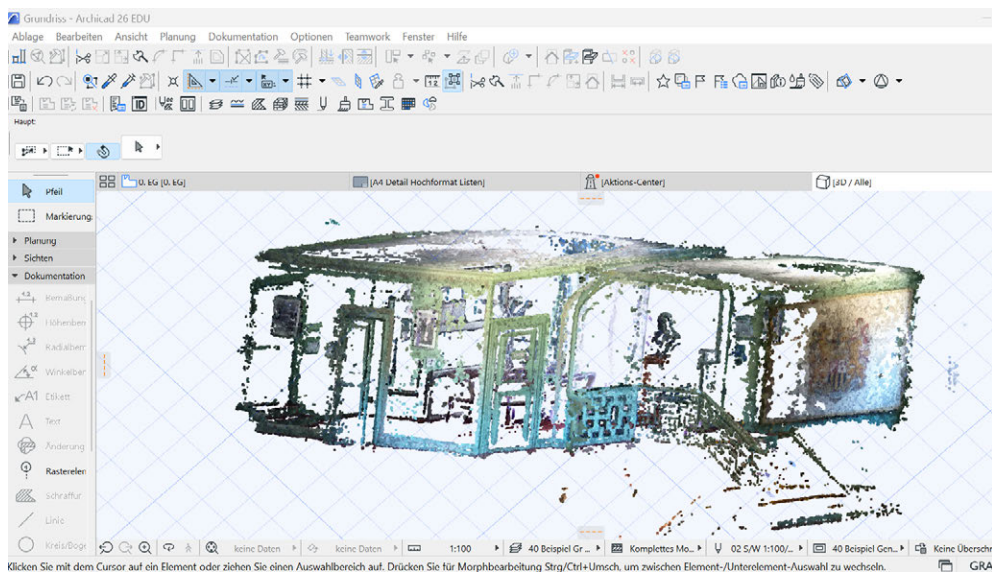
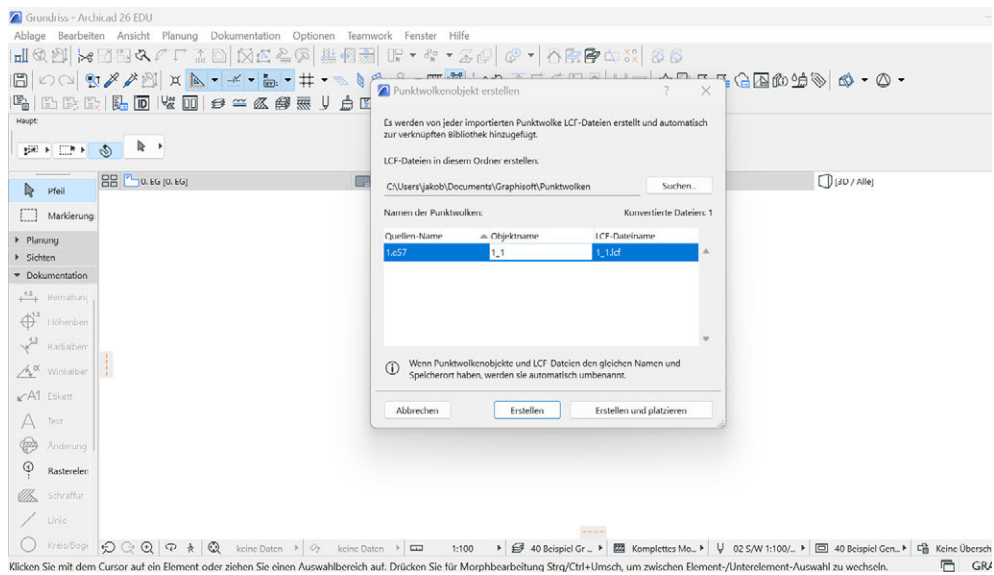

Fig. 2.5.19: Import Model to ArchiCad, 3D Mode

5. Now the point cloud of the anteroom at the upper floor is imported into Archicad to create a floor plan. The file is displayed in 3D mode.



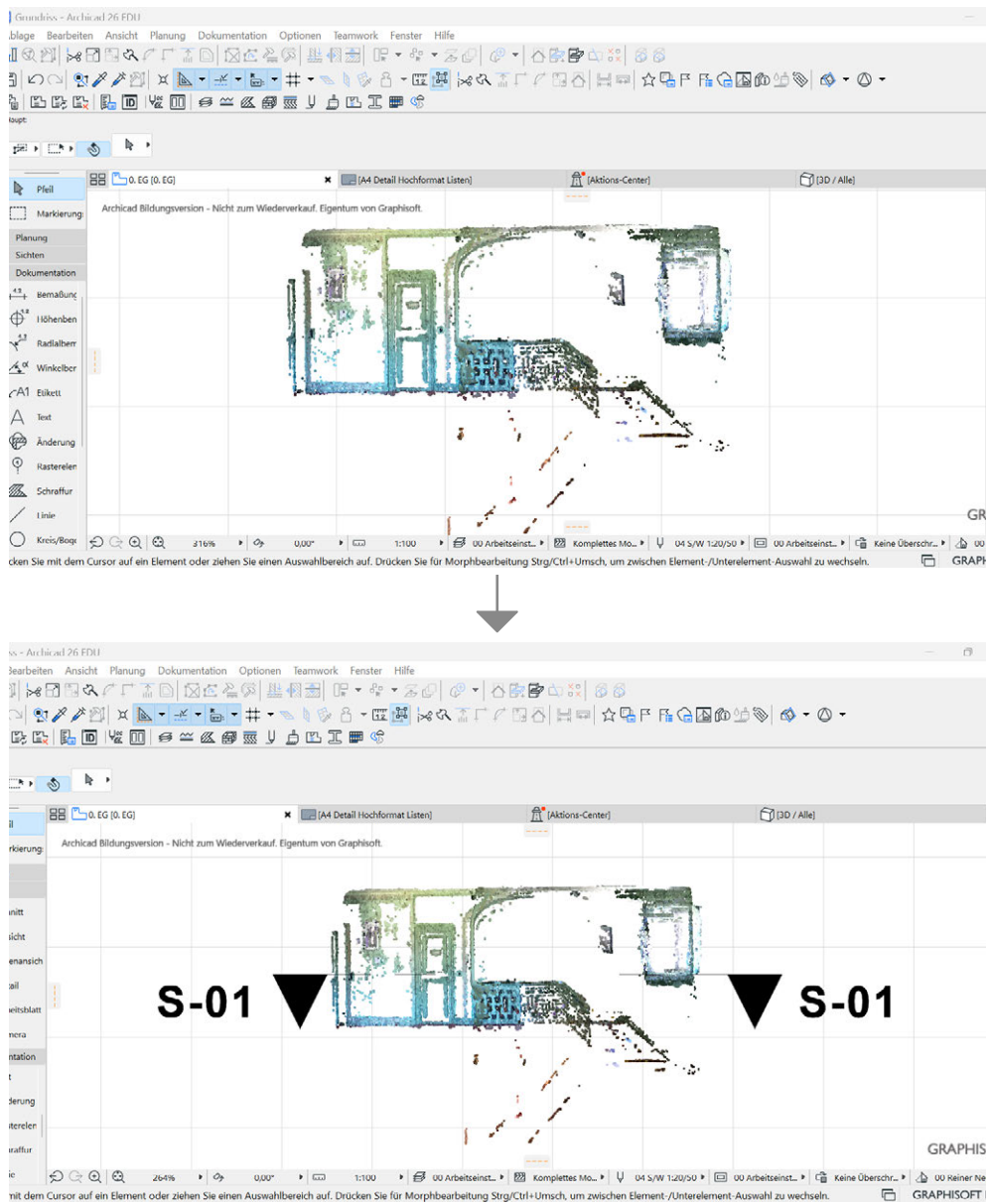

Fig. 2.5.20: Import Model to ArchiCad, Side view

6. In the side view, the point cloud is cut at a height of one meter to create the floorplan.

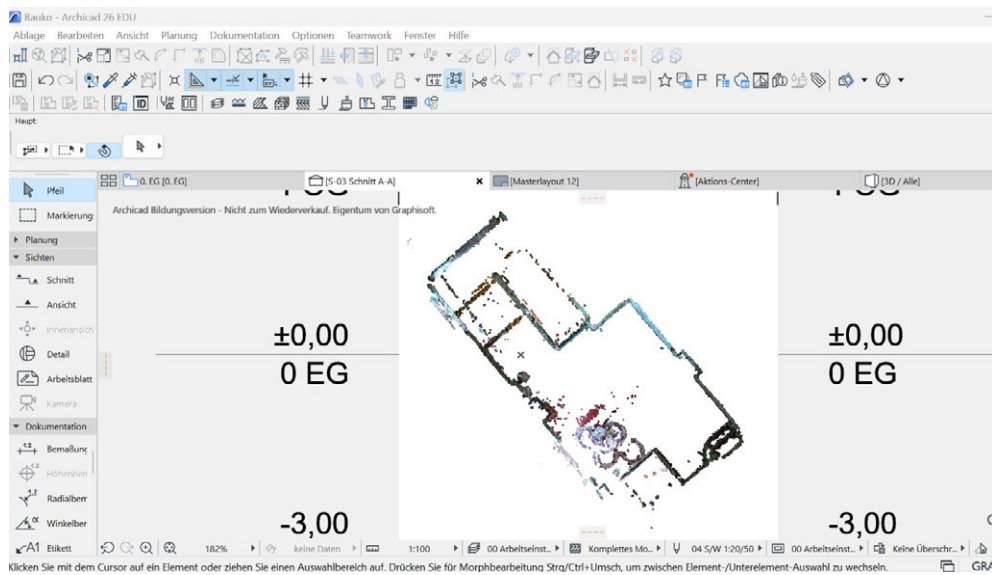

Fig. 2.5.21: Floorplan, anteroom upper floor

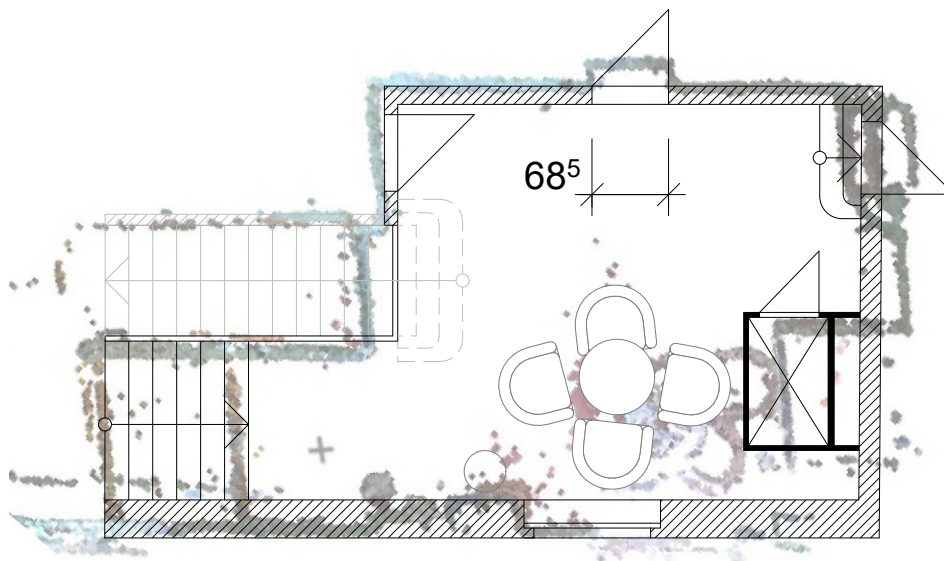

Fig. 2.5.22: Floorplan overlapping

7. After comparing the reference dimensions of the door reveal taken on site, we discovered that the point cloud was not imported into the CAD program at its original scale. Since the file is not scalable, we first drew a floor plan over the point cloud and then scaled the drawing according to the reference dimensions so that we could derive a true-to-scale floor plan from the photogrammetrical image of the villa.

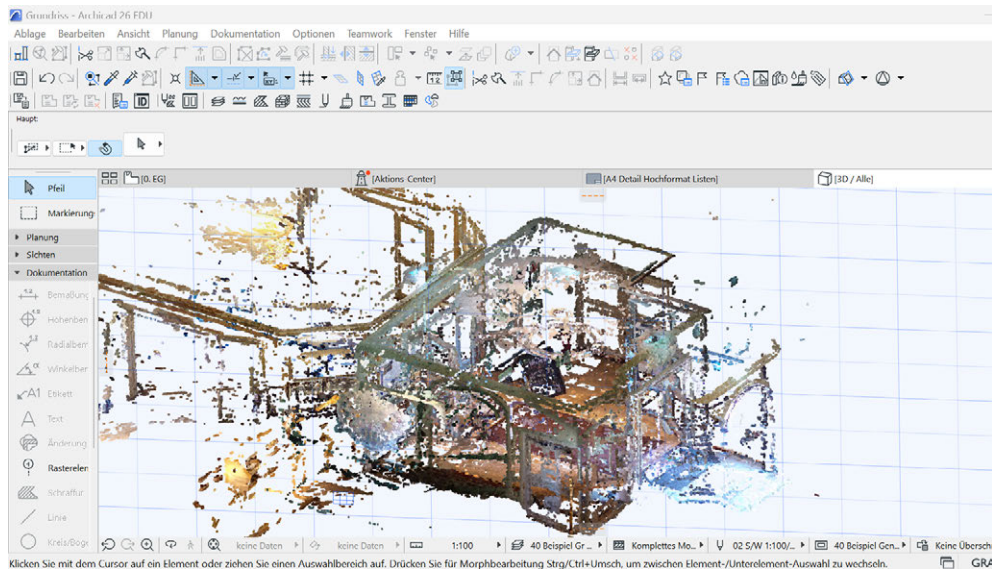

Fig. 2.5.23: Import Model to ArchiCad, 3D Mode

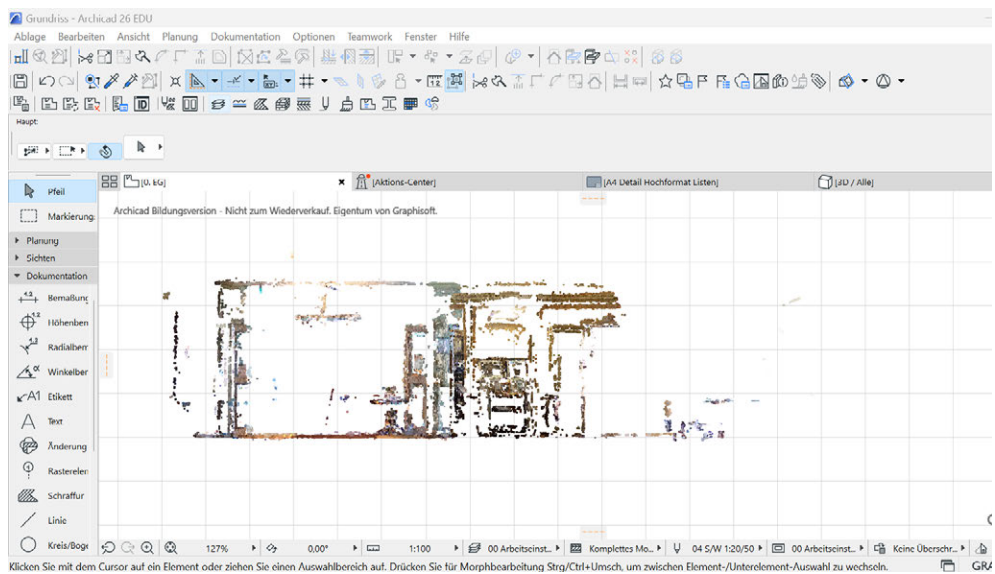

Fig. 2.5.24: Floorplan, vestibule groundfloor

8. We carried out the same steps for the second room shown as an example (vestibule, ground floor).

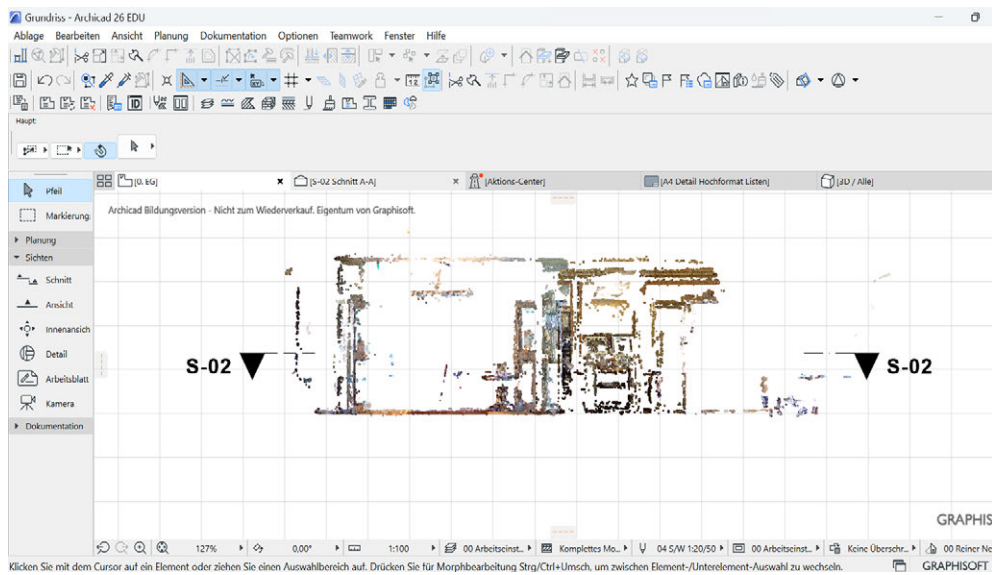

Fig. 2.5.25: Import Model to ArchiCad, Side view

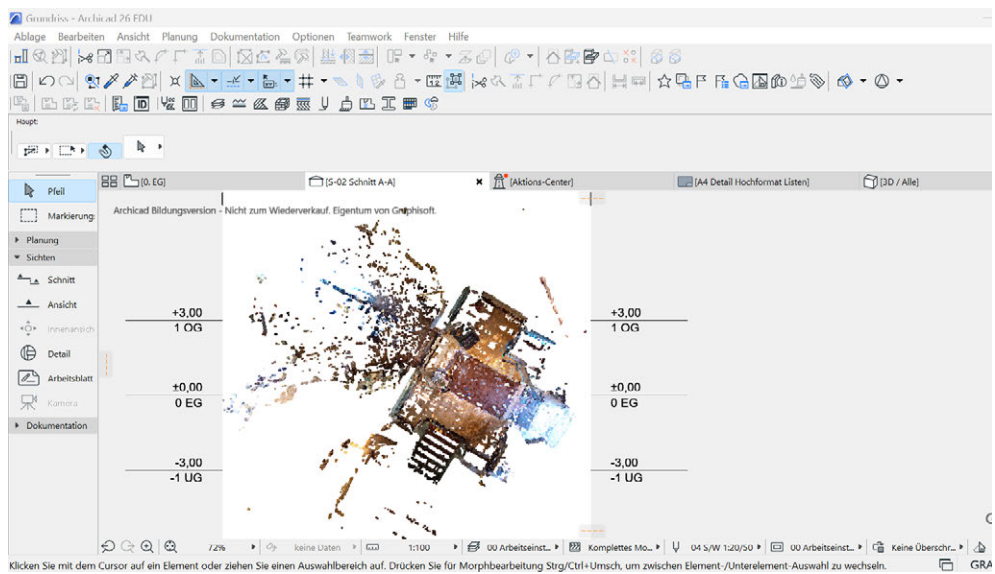

Fig. 2.5.26: Floorplan, vestibule groundfloor

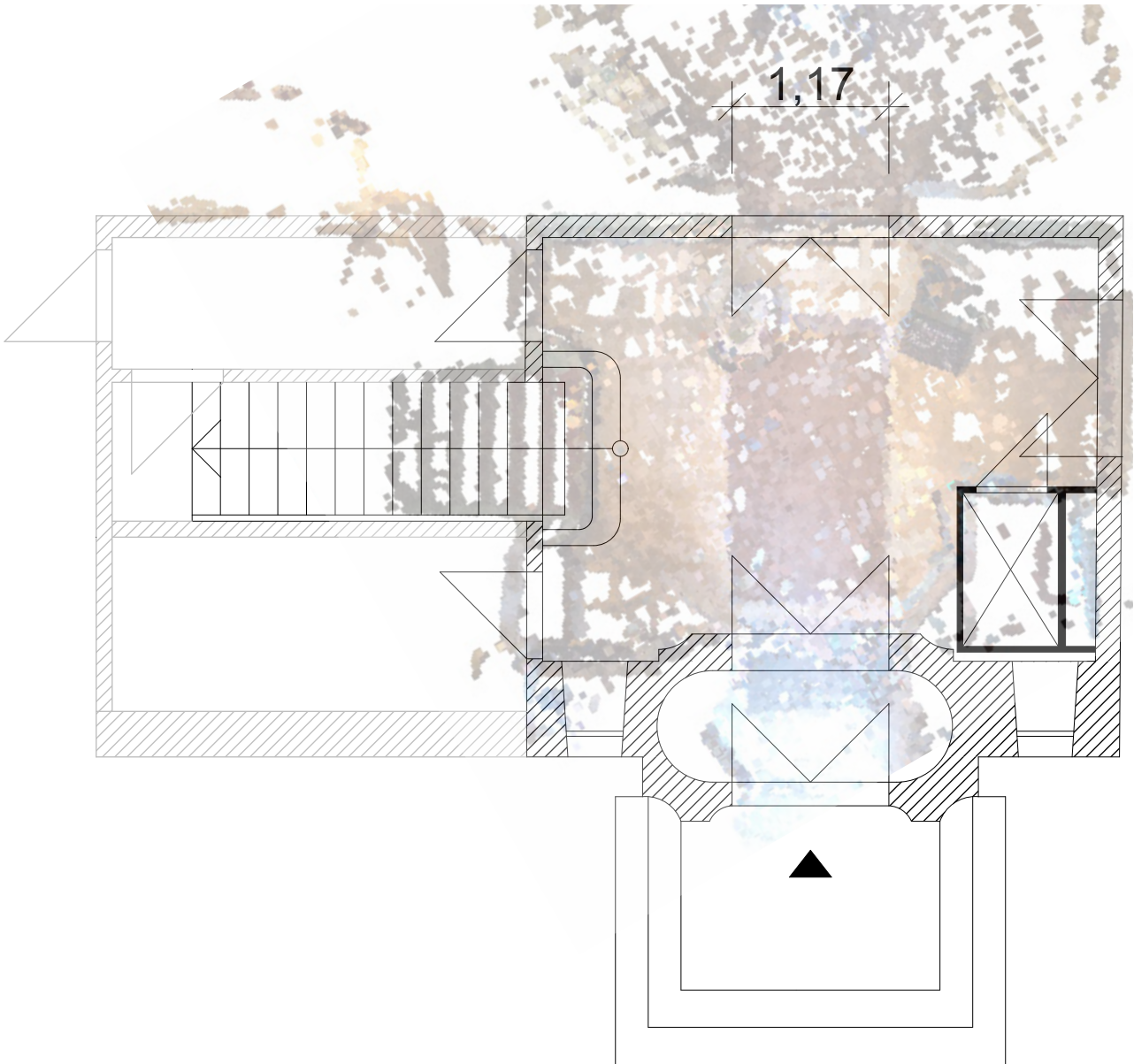

Fig. 2.5.27: Floorplan overlapping



# 5 EVALUATION

The most striking aspect in the overall process of photogrammetric recording of the villa is that too few photos lead to unusable data. Photogrammetry is based on taking enough overlapping photos from different angles to create a detailed and accurate 3D model. When the number of photos is too low, important information is missing, leading to gaps in the model and inaccuracies in the reconstruction.

Another important aspect is the photo quality. Blurry or poorly lit images can also render the data unusable. Therefore, it is essential that the photos are taken under optimal conditions to achieve the best results.

Additionally, the coverage of the entire villa plays a crucial role. All areas must be sufficiently photographed to ensure that the model is complete. Particularly complex structures and fine details require additional attention and possibly more photos to ensure that all aspects of the villa are accurately captured.

Overall, it is evident that careful planning and execution of the photo documentation is of central importance for the success of the photogrammetric recording. Only through a sufficient number of high-quality photos can a detailed and accurate 3D model of the villa be created.

For the photogrammetric recording of a room, we needed an average of about one hour, including the evaluation. This shows that while the process is time-consuming, it is still more efficient and often more accurate than traditional methods such as manual measurement. While manual measurement requires each detail to be manually measured and documented, photogrammetry allows for faster capture of large amounts of

data and a detailed visual representation of the space.

However, it should be noted that photogrammetric data is more suitable for visual representations and less for creating construction plans. The accuracy and detail required for building plans are not always achieved by photogrammetric models, as they often do not provide the precision and technical specifications necessary for such applications.

The future of photogrammetry looks promising. With the advancing development of hardware and software, the technology is becoming increasingly accessible and powerful. It can be used by architects, conservationists, real estate developers, video game and film producers, as well as scientists in various disciplines. Particularly in the field of heritage conservation and architecture, photogrammetry enables detailed documentation and preservation of historic buildings without the need for physical interventions.

A significant problem that emerged during the project was the poor data processing between Metashape and ArchiCAD. The 3D models created by Metashape could not be seamlessly imported and further processed in ArchiCAD. This led to difficulties in integrating the photogrammetric data into the architectural workflow.

The point clouds and meshes from Metashape often had to be extensively adapted or redrawn to be usable in ArchiCAD. Moreover, important detail information was often lost during the conversion between formats. These compatibility issues highlight the need for improved interfaces between photogrammetric software and CAD programs for more efficient use of the technology in architectural practice.

The use of FARO technology, particularly the FARO Orbis Mobile Laser Scanner, offers significant advantages over conventional photogrammetric methods. FARO systems enable faster and more precise data capture. The FARO Orbis can perform stationary scans in just 15 seconds and provides highly precise 3D representations. This technology reduces human error and significantly increases the overall efficiency of the scanning process. Of course, this solution is very cost-intensive.

Based on our experiences, it appears to us that photogrammetry is a powerful tool for visual documentation and analysis of structures. It offers many advantages over traditional methods, but also has its limitations, especially when it comes to creating precise technical plans. However, with advancing technological developments, the applications and precision of this method will continue to improve. Camera recordings are becoming increasingly information-rich, computer performance is continuously increasing, making the entire process more efficient and precise.



# LIDAR - APPS

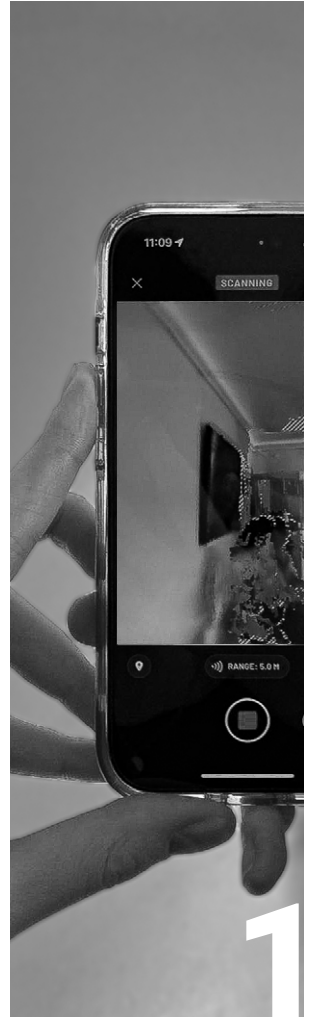

## INTRODUCTION

Team	178
Description	178
Requirements	179

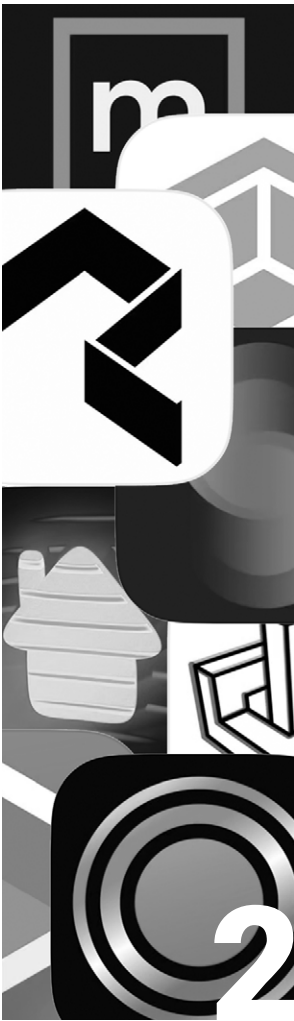

**PREPARATION**

Preparation 180



**SITE MEASUREMENT**

Scaniverse:  
Site Measurement 188

PolyCam:  
Site Measurement 210

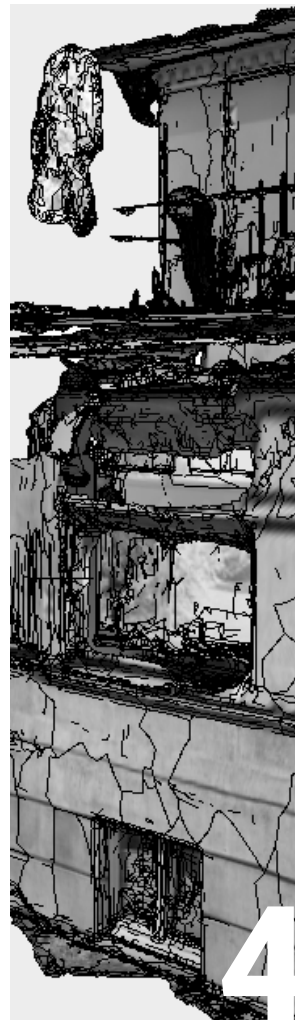

**DATA PROCESSING**

Scaniverse:  
Data Editing 196  
Format Selection 196  
Scan Merging 198  
Scan Editing 200  
3D Model 202

PolyCam:  
Data Editing 216  
3D Model 219

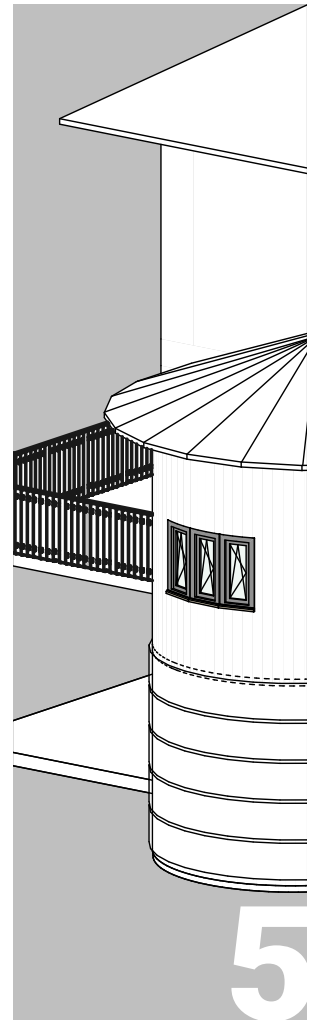

**EVALUATION**

Scaniverse:  
Evaluation 208

PolyCam:  
Evaluation 224

# 1 INTRODUCTION



Enver Can Kabaran



Michèle Armbrrecht



Anika Wallbrecher



Viktoria Probst



Maria Albert Engulidanos



Barbara Hajcova

## DESCRIPTION

LIDAR, short for „Light Detection and Ranging“, is a kind of three dimensional laserscanning. Laser beams are emitted and objects in the path of the laser reflect parts of the beam back to the scanner which provide its sensors with information about the distance and geometry of the object via the runtime of the light signals. This information is stored as 3D data points. All the data points together result in a point cloud that defines the object in detail.<sup>71</sup>

3D scanning apps are used to digitise the 3D data points and provide the scanned information using various methods. Depending on the application-specific mode, the data is made available as a point cloud or as a mesh, in some cases with a textured surface.<sup>72</sup>

Meshes are three-dimensional surface models consisting of triangular structured polygonal surfaces.<sup>73</sup>

The generated point clouds and meshes can be imported into a CAD programme and used there as a transparent trace for creating a BIM-capable 3D model. It is important to consider the importable file formats for this.

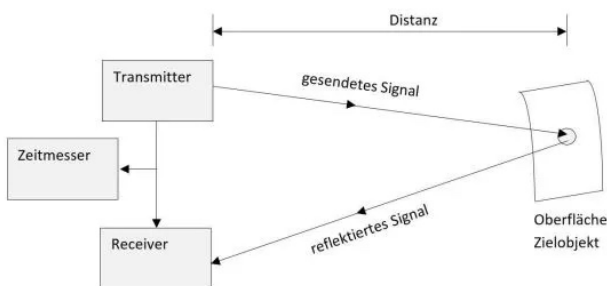

Fig. 2.6.1: Systematic of LiDAR measurement technology

71 cf. Askar, Cigdem and Sternberg, Harald. „Use of Smartphone Lidar Technology for Low-Cost 3D Building Documentation with iPhone 13 Pro: A Comparative Analysis of Mobile Scanning Applications“ (Department of Geomatics, HCU, 2023). 3, no. 4, 563-579. <https://doi.org/10.3390/geomatics3040030>

72 cf. Apple Inc. „App Store - Apple (DE)“. Accessed 04.07.2024. <https://www.apple.com/de/app-store/>

73 cf. Niantic Inc. „Support | Scaniverse - 3D Scanner + LiDAR + Gaussian Splatting for iOS and Android“. Accessed 28.06.2024. <https://scaniverse.com/support>

## REQUIREMENTS

LIDAR sensors have been installed in Apple's Pro Series smartphones and tablets since 2020. These are optimised through cooperation with the cameras and motion sensors built into the hardware and can measure distances to objects within a radius of up to five metres.<sup>74</sup>

In order to use the LIDAR sensor to scan indoor spaces, an app is required that can utilise the collected information. This was not developed by Apple itself. Instead, Apple provided a software development kit (SDK) that is used by many developers for the development of 3D scanning apps.<sup>75</sup>

Based on defined evaluation criteria (Fig 2.6.2), we decided to test the 3D scanner apps Scaniverse and PolyCam. iPhones and iPads that use a LIDAR sensor were used for this purpose.

Scaniverse is a free 3D scanner app that is available for iOS and Android users. It supports iPhones from 2018, iPads from the A12 processor and Android devices from version 7.0 with ARCore with Depth API.<sup>76</sup>

PolyCam is a paid 3D scanner app that is available for iOS, Android and web users. Most IOS16-capable devices are supported, as well as Android devices with 3.5GB RAM and 64-bit architecture.<sup>77</sup>

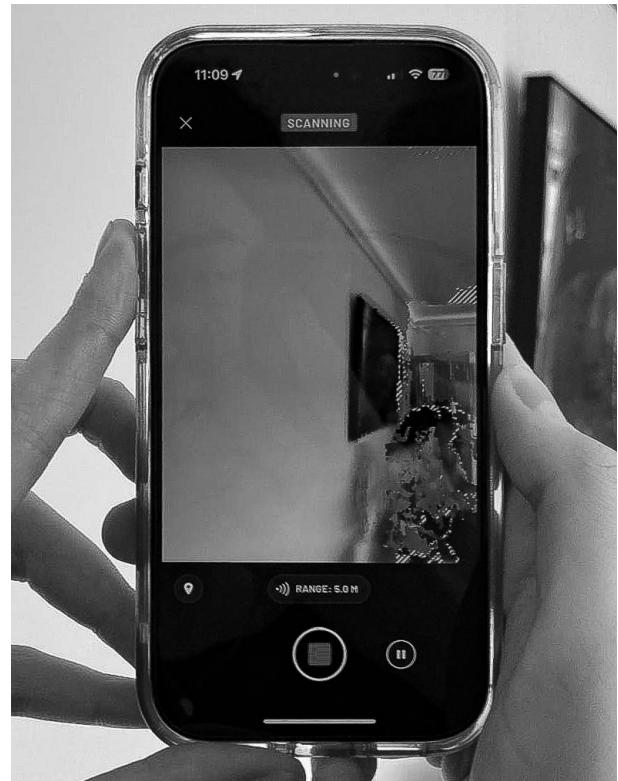

Fig. 2.6.2: Site measurement with Scaniverse

For further processing of the scan data, a CAD-capable computer and the associated CAD software are required, which in this case should be able to generate a BIM-capable 3D model. Due to individual levels of knowledge of the programmes and the associated expected better work performance, the decision was made to use Archicad and Revit, both of which have BIM capabilities.

74 cf. Apple Inc. „Apple stellt neues iPad Pro mit fortschrittlichem LiDAR Scanner vor und bringt Trackpad-Unterstützung für iPadOS - Apple (DE)“. Accessed 04.08.2024. <https://www.apple.com/de/newsroom/2020/03/apple-unveils-new-ipad-pro-with-lidar-scanner-and-trackpad-support-in-ipados/>

75 cf. Askar, C.; Sternberg, H. 563–579.

76 cf. Niantic Inc. „Support | Scaniverse - 3D Scanner + LiDAR + Gaussian Splatting for iOS and Android“. Accessed 28.06.2024. <https://scaniverse.com/support>

77 cf. Polycam Inc. „What Devices is polycam available on? - Polycam Help Center“. Accessed 28.06.2024. <https://learn.poly.cam/product-faqs/what-devices-is-polycam-available-on>

# 2 PREPARATION

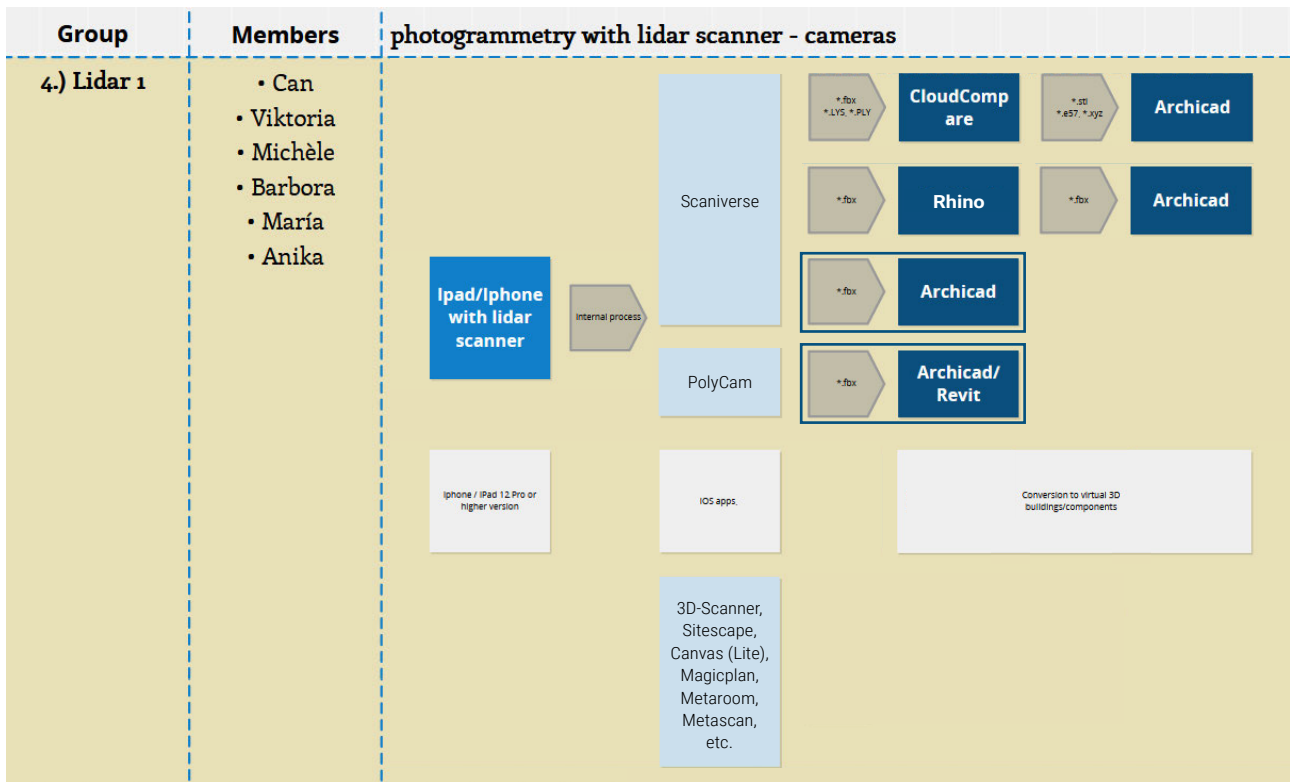

Fig. 2.6.3: Workflow LIDAR

As there are now a large number of apps on the market, the first step in this series of tests was to select suitable apps.<sup>78</sup>

After a first discussion with Laurent Lescop, the first pre-selection was PolyCam, 3D-Scanner, Sitescape, Scaniverse, Canvas Lite, Magicplan, Metaroom and Metascan.

These apps were then evaluated on the basis of various parameters:

Costs, rating (appstore), storage space (app), battery, internet connection (for scanning/processing), kind of model/data, export options, overall quality, user-friendliness and others. Findings from initial test scans with the previously listed apps were incorporated into the assessment of user-friendliness and quality, among other things.

To ensure comparability, the same space was used for the test scan when determining the battery power and file size.

It should also be mentioned that some apps are still young or are continuously being developed further, the Metaroom app, for example, received a major new update during the course of our test series, which gave it new features that were not part of our first test series.<sup>79</sup>

The comparison we carried out between the individual apps (Fig. 2.6.4) led to the selection of the Scaniverse and PolyCam apps for our test series. The Scaniverse app was the only app to receive 5 points in the comparison. It stands out in the app store rating with the highest sco-

78 cf. Apple Inc. „App Store - Apple (DE)“. Accessed 04.07.2024. <https://www.apple.com/de/app-store/>

79 cf. Apple Inc. „Metaroom - 3D Raum Scanner im App Store“. Accessed 04.06.2024. <https://apps.apple.com/at/app/metaroom-3d-raum-scanner/id163707716>

re. Furthermore, it is completely free to use, is rated as intuitive to use and offers a large selection of export formats. The first test scans also look promising.

The Magicplan and PolyCam apps have by far the most ratings in the app store. The decision was made in favour of the Polycam app, which received 4 points compared to the other apps, as it offers the option of floor plan translation in addition to intuitive use, a wide range of export formats and promising test scans. This option promises more straightforward scanning results than the Mesh and Point Cloud versions of the other apps. Compared to the other paid apps, it is in the lower price range and should therefore serve as a direct comparison to the free Scaniverse application.

Scaniverse (Fig 2.6.5) is a 3D scanning app developed by Toolbox AI Inc., which was launched in 2020 and has been continuously developed ever since. It joined Niantic Inc. in 2024. The app can generate textured 3D models or pixel clouds using a reconstruction algorithm.<sup>80</sup> Version 3.02 of Scaniverse, which requires 67 MB of memory, was used for this test series. The operating language is English.<sup>81</sup>

When carrying out the building survey, it was established that the scanning process can take place in the form of individual room scans or the scan of a room structure. After exporting the scans, they can be merged into a large overall scan within a CAD programme and transferred into a CAD model, as chapter 4 (pp. 196-207) shows in more detail.

The app offers two different modes for the scan: „Splash“ is a mode based on Gaussian splatting technology. This involves photorealistic, AI-supported scans that go beyond the 5 metre radius and therefore also include the surroundings and sky.

„Mesh“ is a mode that generates images with precise dimensions based on LIDAR, which can also be used with other 3D software. When recording in „Mesh“ mode, it is also possible to choose between three different sizes in advance in order to adapt the range of the recording to the size of the object and avoid recording any superfluous data in the surroundings. The scanned object is mapped either as a mesh or as a point cloud. The results are not interpreted by the app. By texturing the meshes, the scan gains depth of detail. This mode requires the device to be equipped with a Lidar sensor.<sup>82</sup>

As the selected hardware has a LIDAR sensor, the mesh mode was chosen for this test series, which promises greater dimensional accuracy.

The scanning process is supported by a coloured marking of the outstanding area. In addition, a preliminary result is already visible in the scan window, which enables the direct improvement of unsatisfactory results. The final result of the scan can only be viewed in the app after processing. Various modes can be selected here. The „Speed“ option as the fastest, but correspondingly less accurate processing option, „Area“ for scans of rooms with higher accuracy and „Detail“ especially for smaller and textured objects. The latter works via photogrammetry, whereas the first two options work with lidar technology. An accuracy is also specified here for both modes, which varies with

---

80 cf. Askar, C.; Sternberg, H. 563–579.

81 cf. Niantic Inc. „Support | Scaniverse - 3D Scanner + LiDAR + Gaussian Splatting for iOS and Android“. Accessed 28.06.2024. <https://scaniverse.com/support>

82 cf. *ibid.*

criteria \ apps	PolyCam	Scaniverse	3D Scanner App	Sitescape
<b>developer</b>	Polycam Inc.	Toolbox AI	Laan Labs	FARO
<b>costs</b>	7,49 €/mo	free	free	free
<b>App Store rating</b>	4,6 (6.193)	4,7 (2.350)	4,5 (2.545)	4,3 (138)
<b>app size</b>	135 MB	67 MB	198 MB	29 MB
<b>file size</b>	OBJ 825 KB / PLY 8 MB	OBJ 17 MB / PLY 10 MB	OBJ 25 MB / PLY 64 MB	PLY 180 MB
<b>battery</b>	2 %/4 min/25 m <sup>2</sup>	5 %/10 min/25 m <sup>2</sup>	2 %/4 min/25 m <sup>2</sup>	8 %/10 min/25 m <sup>2</sup>
<b>online/offline</b>	offline	offline	offline	offline
<b>kind of model</b>	3D model, point cloud, mesh, floor plan	point cloud, mesh	point cloud, mesh	point cloud
<b>export options</b>	CSV, DAE, DXF, FBX, GLTF, JPG, LAS, MP4, OBJ, PDF, PLY, PNG, PTS, STL, SVG, USDZ, XYZ	FBX, GLB, LAS, MP4, OBJ, PLY, STL, USDZ	DAE, DXF, E57, FBX, GLB, GLTF, JPG, LAS, OBJ, PCD, PDF, PLY, PNG, PTS, STL, SVG, USDZ, XYZ	E57, PLY
<b>first impression of scan quality</b>	not all elements captured, overall okay	some mistakes, partially very accurate, overall good	some mistakes, overall okay	some mistakes, not always accurate, overall okay
<b>user-friendliness</b>	good, easy to understand	good, intuitive, shows very well where to scan	good, intuitive, shows very well where to scan	good, intuitive
<b>others</b>	photogrammetry + lidar mode	additional AI mode; detailed scanning to improve quality possible; different scanning modes	detailed settings for processing available	settings for point density and size; hard to immediately evaluate scan quality due to preview as point cloud
<b>overall rating</b>	●●●●○	●●●●●	●●●●○	●●●○○

Fig. 2.6.4: Comparison of eight different scanner apps

criteria \ apps	Canvas Lite	Magicplan	Metaroom	Metascan
<b>developer</b>	Occipital	Sensopia	AMRAX Synthetic Dimension	Abound Labs
<b>costs</b>	free / scan to CAD 0,14-0,20 \$/sqft	10,83-75,00 €/mo	app free / web app. 79-139 €/mo	free version / pro 4,24 €/mo
<b>App Store rating</b>	2,3 (27)	4,6 (11.512)	4,5 (54)	4,5 (115)
<b>app size</b>	66 MB	350 MB	30 MB	117 MB
<b>file size</b>	OBJ 11 MB	OBJ 10 KB	OBJ 15 KB	OBJ 9 MB / PLY 19 MB
<b>battery</b>	3 %/7 min/25 m <sup>2</sup>	2 %/5 min/25 m <sup>2</sup>	2 %/5 min/25 m <sup>2</sup>	3 %/5 min/25 m <sup>2</sup>
<b>online/offline</b>	upload needed	offline	upload needed	offline
<b>kind of model</b>	mesh	3D model, floor plan	3D model	point cloud, mesh
<b>export options</b>	OBJ	CSV, DXF, IFC, JPG, OBJ, PDF, PNG, SVG, USDZ	ABC, DAE, DXF, FBX, GLB, GLTF, IFC, OBJ, RDF, STL, USD	FBX, GLTF, LAS, OBJ, PLY, STL, USDZ, XYZ
<b>first impression of scan quality</b>	many small mistakes, seems not accurate, overall unsatisfactory	not all elements captured, measures inaccurate, overall unsatisfactory	not all elements captured, overall unsatisfactory	many inaccuracies, overall okay
<b>user-friendliness</b>	good, easy to understand	auto mode okay, manual mode difficult	okay, easy to understand	good, intuitive, shows very well where to scan
<b>others</b>	no immediate quality control (scan processing needed, takes several hours); app for professionals also available		editing and export only in „meta-room studio“ (web app.); promised accuracy of +/- 3 cm; compliant to GDPR	preview is very blurred
<b>overall rating</b>	● ○ ○ ○ ○ ○	● ○ ○ ○ ○ ○	● ● ○ ○ ○ ○	● ● ○ ○ ○ ○

cf. Apple Inc. „App Store - Apple (DE)\* for the mentioned apps. Accessed 04.07.2024. <https://www.apple.com/de/app-store/>; mentioned apps themselves



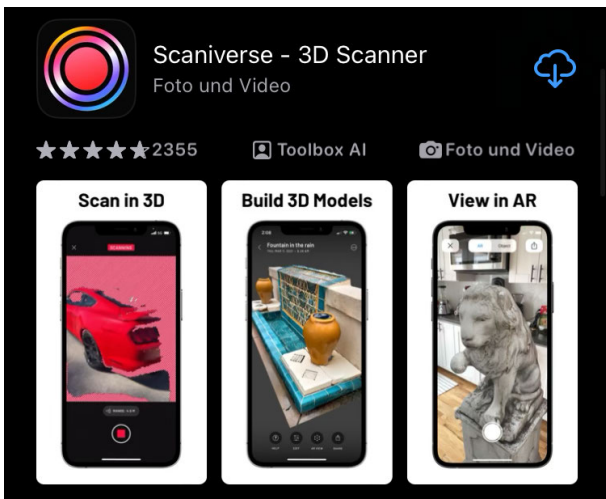

Fig. 2.6.5: Scaniverse - Apple App Store

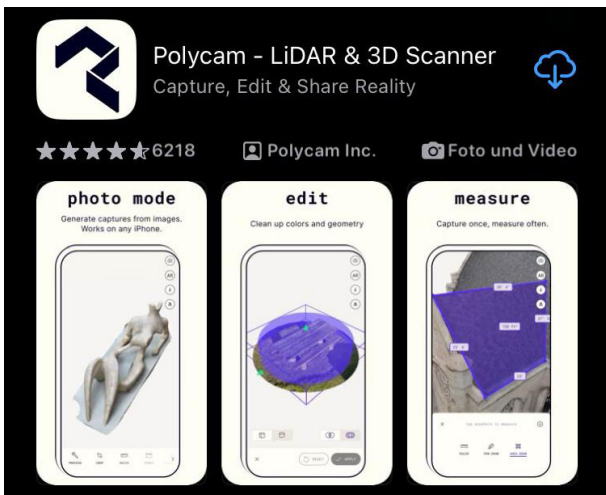

Fig. 2.6.6: Polycam - Apple App Store

the size of the area to be scanned (Figs. 2.6.18 and 2.6.19, p. 192).<sup>83</sup>

The use of the app has shown that, if the raw data of a scan has been saved in the app, it is possible to repeat the processing of a scan and thus also save the file as a splash.

Once a scan has been processed, it is no longer possible to extend it.

The scans can then be post-processed in the app. Options such as cropping the scans and common image post-processing functions such as adjusting brightness, contrast, etc. are available here. Automated videos can also be created using various options. In addition, the scans can be posted privately and publicly in Scaniverse itself and distributed as a link. Posting to the Sketchfab platform is also possible directly from the app, as is direct sharing via message, email, etc. There is also an AR view in which distances can be measured directly in the app. The dimensional accuracy depends on the measuring points selected with fingers in the screen display.<sup>84</sup>

The scans can be exported in various file formats for further processing. As meshes in .FBX, .OBJ, .GLB, .USDZ and .STL format or as point clouds in .PLY and .LAS format. E57 is planned as an additional file export format in the future.<sup>85</sup>

The app also has a community that supports the exchange of information and support in the event of problems.<sup>86</sup>

Polycam (Fig 2.6.6) is an app developed by Polycam Inc. that was launched in 2020 and has been continuously developed ever since.<sup>87</sup>

We used it in version 3.4.5. The app requires 134.4 MB of memory.

It is a 3D scanning app specially developed for architecture, engineering and construction and is available for iOS, Android and web

83 cf. Niantic Inc. „Support | Scaniverse - 3D Scanner + LiDAR + Gaussian Splatting for iOS and Android“. Accessed 28.06.2024. <https://scaniverse.com/support>

84 cf. *ibid.*

85 cf. *ibid.*

86 cf. Sketchfab Inc. „Scaniverse - Sketchfab“. Accessed 28.06.2024. <https://sketchfab.com/scaniverse>; Medium. „Scaniverse Blog“. Accessed 28.06.2024. <https://blog.scaniverse.com/>

87 cf. Polycam Inc. „Getting started with Polycam- User Guide“. Accessed 30.06.2024. <https://learn.poly.cam/about>

users. As the scans can only be used within the app without a subscription, it is necessary to take out a subscription. This allows the scans to be exported for further processing. The application creates 3D models from photos with any iPhone or iPad (from model year 2020), creates scans of rooms with the LiDAR sensor and can take 360° photos. The 3D images can be edited directly on the device and exported in various file formats such as point clouds, meshes or 2D plans (Fig. 2.6.7).

You can choose between a monthly subscription of €17.99 and an annual subscription of €89.99.<sup>88</sup>

The app offers various scan modes that you can choose from directly after opening the app: Photo Mode, Lidar Mode, Room Mode and 360 Mode.

With the Photo Mode and 360 Mode, it is possible to use the app without a LIDAR sensor by taking photos, and the Photo Mode allows you to take photos and convert them into 3D models using photogrammetry. It is suitable for scanning detailed objects and scenes and creates 3D assets that can be used immediately in any computer graphics application. With LiDAR mode, you can create true-to-scale 3D scans that are suitable for scanning rooms and large objects. As a user, you can create unlimited scans for free directly on your device without having to be connected to the internet. With the room mode, models of interior spaces can be created in real time and floor plans can be overlaid with a LiDAR survey to obtain more detailed information about the surroundings. The floor plans can then be exported in .dxf, .svg and .png formats, among others, so that



Fig. 2.6.7: PolyCam, types of data processing

they can be imported into common software such as AutoCAD, Adobe Illustrator and others and used as the basis for ongoing editing.<sup>89</sup> With the 360° mode, 360° panoramic images can be created and shared. These 360 photos can be exported as equirectangular images or shared with a link, for example to create virtual environments for games or VR tours.<sup>90</sup>

We decided to test the room mode, which has been available since 2022, as it will provide clearer edges for post-modelling than the imaging LIDAR mode.

The framework conditions for a successful scan of the interior of a building are presented below. As only the mobile phone needs to be opera-

88 cf. Polycam Inc. „Pricing | Polycam“. Accessed 30.06.2024. <https://poly.cam/pricing>

89 cf. Polycam Inc. „Getting started with Polycam- User Guide“. Accessed 30.06.2024. <https://learn.poly.cam/about>

90 cf. *ibid.*

ted, only a single user is required for both methods. This person should have familiarised themselves with the app in advance in order to achieve optimum results (see chapter 3, pp. 188-194).

Before starting the scan, it makes sense to think about a precise route that has as few obstacles as possible to ensure that the scan runs as smoothly as possible. This should be planned in an S-shape. The start point and end point should not overlap, as this can lead to distortions in the scan result (Fig. 2.6.8).

The Polycam app works more robustly than the Scaniverse method. This means that, unlike Scaniverse, the route does not have to be planned precisely as a loop, as the app does not adjust the scan further in the event of overlaps. This means that objects that have already been recognised can be scanned over without affecting the result. An important parameter of the measurement method is the range to the respective measurement object that can still be detected by the sensor. The range depends, among other things, on the type of laser and its power, on the external environmental influences and on the properties of the measurement object.<sup>91</sup> Our own experience has shown that a distance of 2-3 metres is suitable for spatial detection, and a closer range for detecting details.

The reflectivity of the measurement objects plays an important role. Diffuse or reflective surfaces can lead to errors in the reflection of the light pulses, resulting in incorrect data acquisition. The light pulses can also be affected

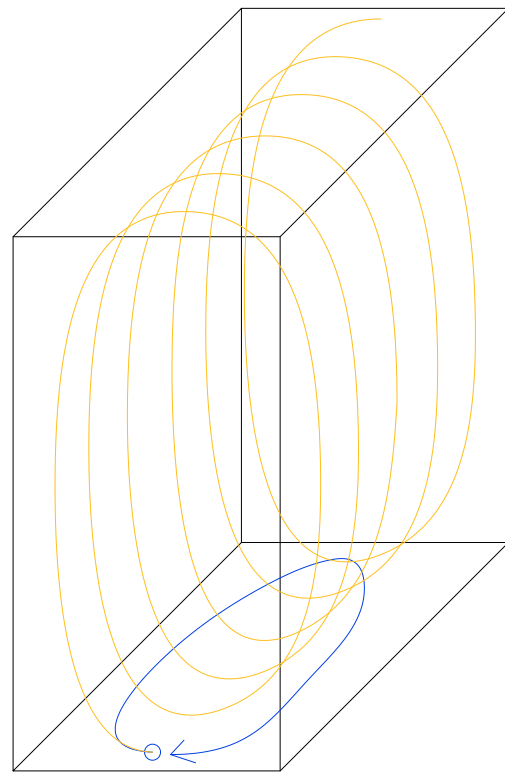

Fig. 2.6.8: Scanning process of a room

by particles in the air (e.g. fog, smoke, dust).<sup>92</sup> It should also be noted that LiDAR scanners pointing at each other can have a negative impact on each other.<sup>93</sup> As several people scanned the rooms at the same time, this had to be taken into account.

The group composition is described below. The Lidar team is made up of 6 students who are evenly distributed between the two selected apps. During the digital recording on site, two students created independent scans with Polycam and two students created independent scans with Scaniverse. Two other students were entrusted with the documentation.

91 cf. Blickfeld GmbH. „Die Wichtigsten LIDAR-Parameter im Überblick“. Accessed 12.07.2024. <https://www.blickfeld.com/de/blog/lidar-parameter-verstehen/>

92 cf. Large, Martin. all-electronics. „Lidar: Was es ist, wie es funktioniert und was es kann“. Accessed 27.06.2024. <https://www.all-electronics.de/automotive-transportation/lidar-sensoren-automotive-575.html>

93 cf. Blickfeld GmbH. „Blickfeld LiDAR für eine sichere & effiziente digitale Welt“. Accessed 12.07.2024. <https://www.blickfeld.com/de/blog/lidar-parameter-verstehen/>

During the building survey, the Scaniverse app group consisted of Michèle Armbrrecht, Enver Can Kabaran and Anika Wallbrecher as follows: Michèle tests the Scaniverse app on the iPhone 14 Pro. Enver tests the Scaniverse app on the iPhone 15 Pro. Anika documents the process.

The Polycam group consists of Viktoria Probst, Barbora Hajicova and María Albert Enguídanos. Viktoria tests the app on the iPhone 14 Pro, Barbora on the iPad Pro 12 and Maria documents the process.

Due to the limited time frame, extensive preparation was required for the recording using Scaniverse.

The apps were assigned to specific people and they carried out test scans in advance on their own premises in order to familiarise themselves with the apps and become more efficient in their use.

The apps were assigned to specific people and they carried out test scans in advance on their own premises in order to familiarise themselves with the apps and become more efficient in their use. In the course of the building survey, the following criteria proved to be essential for an efficient and successful survey process:

- The appropriate mobile device should have been obtained and the selected scanner app installed on the device.
- When using the Polycam app, it is also important that the subscription is completed before the scan, as the data is not available for export in various export formats via a subscription that is completed later.
- The LiDAR system consumes a lot of energy due to the laser pulses emitted and the

data to be processed<sup>94</sup>, which significantly reduces the battery life of the mobile phone. A power bank was therefore essential for the on-site measurement. So it is important to check that both, the mobile phone and a power bank, are charged and packed together with the connection cable (see chapter 3, p. 194).

- In addition, LiDAR systems rely on a clear line of sight between the sensor and the object.<sup>95</sup> Objects that significantly obscure the edges of the room to be measured should therefore be repositioned. It would therefore be advantageous if the owners of the property to be surveyed could tidy up before the day of the survey.
- The camera lenses and sensors should be cleaned again in advance to achieve the best possible results.
- In order to gain a better overview on site and achieve the most efficient recording possible, the floor plans of the rooms were also numbered and taken along.
- It is also a good idea to take an arm extension with you, e.g. in the form of a selfie stick, to simplify the scanning process of corners or hard-to-reach areas. A leg extension using a ladder or stilts would also be conceivable.
- To simplify the scanning process on site, especially if there are other people on site, it is recommended to pack door wedges to be able to lock the door positions during a scan (see chapter 3, p. 192).
- It is also a good idea to pack a blanket to cover reflective surfaces, as these can cause irritation to the scans (see chapter 3, p. 192).

---

94 cf. *ibid.*

95 cf. *ibid.*

# 3 SITE MEASUREMENT - SCANIVERSE

Initially, the two lidar groups split into two groups of three as described in chapter 2 (pp. 10-11). Group 1 started on the upper floor of the villa, while group 2 began on the ground floor. This approach of working separately resulted in two almost complete and independent sets of scans of the villa for each app. A second set of scans is not absolutely necessary, but advisable if errors are only detected while post-processing the scans or remodeling the building. In addition, a scan of the entire facade (within the 5 metre radius) was taken with Scaniverse at the end.

The two Scaniverse sets differ insofar as that in one set each room was recorded individually and only the transition area to the neighbouring rooms was included (Fig. 2.6.9). The scanning of all room transitions was done with the intention to simplify the subsequent merging and at the same time make it more accurate. In the other set, several rooms were scanned at a time (Fig. 2.6.10). This was expected to reduce the inaccuracies caused by the subsequent manual merging. It should also be pointed out in advance that it was not the goal to produce good scans of the furnishings. So on the contrary, the furniture was rather avoided, as it was not considered to be of great relevance for this project and the file sizes could therefore be kept smaller.

Scaniverse is characterised by the fact that the real conditions are converted into a digital image exactly as they are found. There is no interpretation of the data by the app itself. This mode of operation means that basically anything can be recorded without any problems, including for example stucco, round room edges and window and door arches. However, if something is obstructed, for example by a large number of pieces of furniture, objects or even people, these objects are also recorded, but the room edges behind them are



Fig. 2.6.9: Screenshot Scaniverse, single room with room transitions

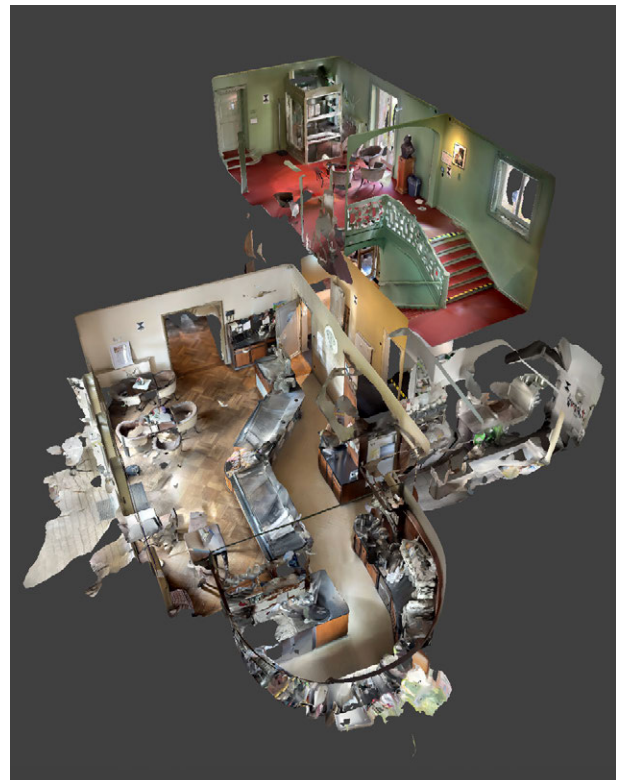

Fig. 2.6.10: Screenshot Scaniverse, multiple rooms in one scan

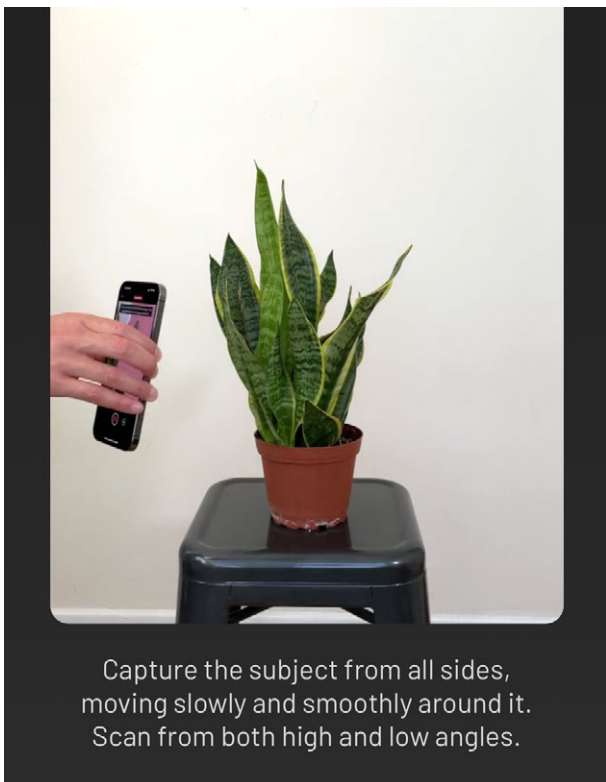

Fig. 2.6.11: Screenshot Scaniverse, illustrated instruction

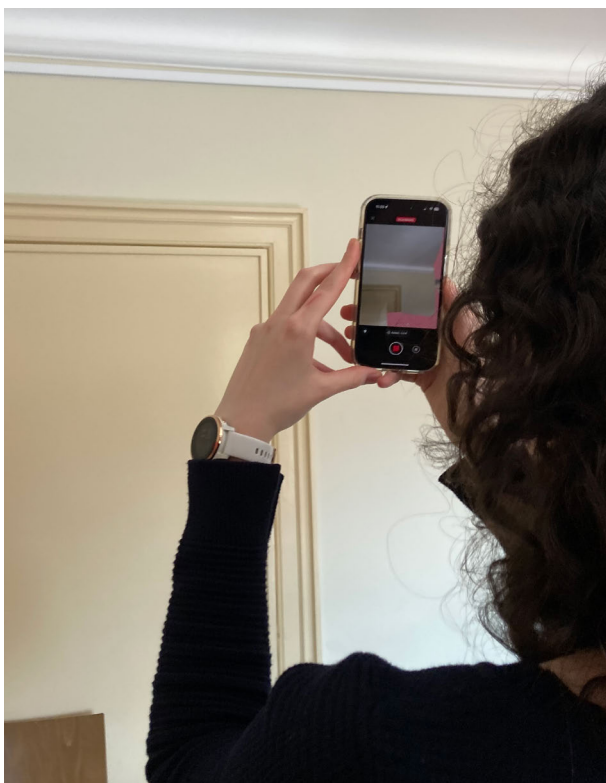

Fig. 2.6.12: Scanning process

not automatically continued and connected. The way the app works reminds therefore of a classic laser scanner and differs significantly from some other measurement apps and modes such as PolyCam. The time required for a medium-sized room of about 15 m<sup>2</sup> is approximately five minutes, depending on the size of the room, the difficulty or level of detail and the number of doors to other rooms where the transition area has to be scanned. After each scan, a short period of time of about one minute is necessary for processing before the next scan can be started.

Scaniverse is very intuitive to use and the app itself contains a number of illustrated instructions (Fig. 2.6.11). In addition, as already explained in chapter 2 (p. 181), there are various scan modes to choose from, which can be selected to suit the case of application. During the scan, the app directly displays which areas have already been scanned, as a kind of preliminary result is immediately visible and areas that have not yet been scanned are marked with red and white stripes (Figs. 2.6.12 and 2.6.13). Unsatisfactory results can thus be improved during the scan. During the scanning process, it is important to scan the room slowly without fast and abrupt movements. If one has moved too quickly, a warning appears in the app.

It has also been found that scanning from as many different angles as possible over a longer period of time improves the scan quality. The improved quality is also displayed immediately, but only up to a certain amount of data. After this point is reached, the preview initially looks much blurrier. However, the result after the subsequent processing of the scan is not related to the blurred preview during the scanning process; it is still of better quality with more visible details than with correspondingly shorter and less accurate scans.



Fig. 2.6.13: Screenshot Scaniverse, scanning process

It should be noted that when scanning again, for example after the end of the first tour of a room, it is highly likely that more additional inaccuracies will occur. For example, it has happened that a recording was started and ended at the same door, but the door was half-open at the beginning but closed at the end because other people had entered or left the room in the meantime. Changing spatial situations like this can lead to misalignments within the scans.

The subsequent attempt to rescan areas that were blocked by other people beforehand within the same scan also proved to be prone to errors.

In general, it seems to work better not to scan long rooms in a circle, but to scan them piece by piece (see chapter 2, p. 186). The longer the distance between two scan points, the greater the inaccuracy seems to be, recognisable as an offset between the start and end of the scan. This was particularly noticeable in the exterior scan. The scanning process has been started at the entrance, then continued around the entire building in an anti-clockwise direction and ended at the entrance again. This resulted in an offset of approximately 1.20 metres at the entrance door (Fig. 2.6.14). It should be taken into account that there was a fence in the way at one corner of the building, which had to be bypassed over a relatively large area, which is why the scan was paused. The pause already led to slight deviations in height at the corner (Fig. 2.6.15). In addition, the angle between the two outer walls that meet at this corner has changed significantly (Fig. 2.6.16). In the later post-processing of the scan, the correction of this angle to an assumed, approximately right-angled dimension already leads to a significantly smaller deviation of about 30 cm in the area of the entrance portal (see chapter 4, pp. 200-201).

When recording the corridor on the upper floor (room 19), pausing due to some people trying to pass through the corridor also led to the bending of the corridor (Fig. 2.6.17). In addition to changes in the spatial situation and the circular movement of rooms, pausing scans also appears to lead to inaccuracies and misalignments.

The final result can only be viewed after the scans have been processed. Three different modes can be selected here, two of which work with LiDAR technology and the third



Fig. 2.6.14: Screenshot Scaniverse, misalignment of the entrance portal



Fig. 2.6.15: Screenshot Scaniverse, misalignment of the heights



Fig. 2.6.16: Screenshot Scaniverse, incorrect angles of the exterior walls

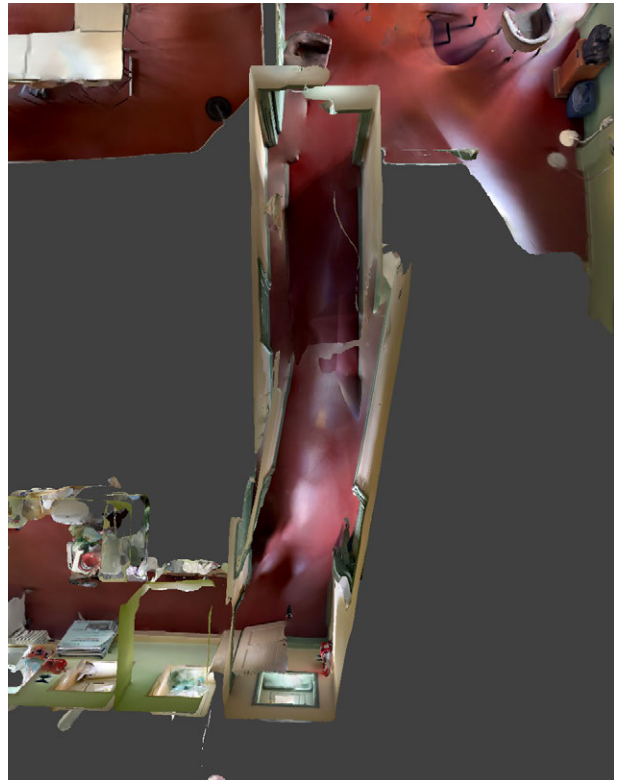

Fig. 2.6.17: Screenshot Scaniverse, crooked hallway



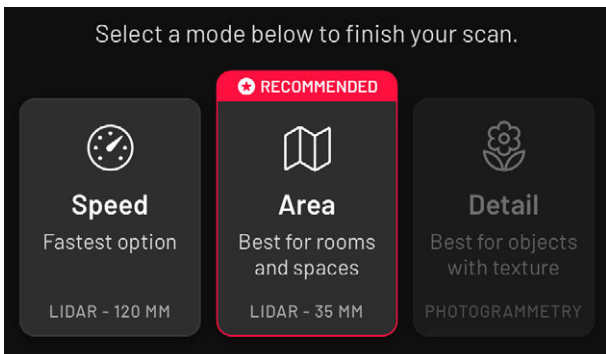

Fig. 2.6.18: Screenshot Scaniverse, processing options for exterior scan

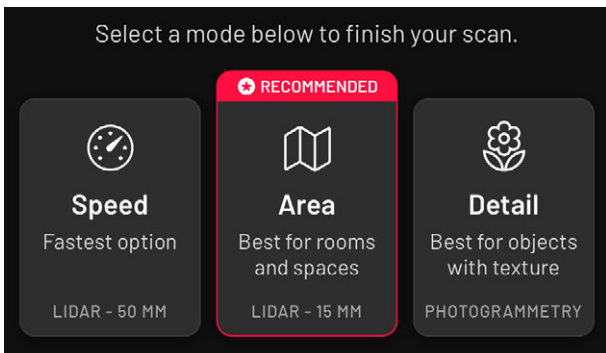

Fig. 2.6.19: Screenshot Scaniverse, processing options for room 13

works with photogrammetry (see chapter 2, pp. 181-184). The accuracy for the two LiDAR modes is also specified at this point (Figs. 2.6.18 and 2.6.19). It can be observed that the larger the scanned areas, the greater the specified tolerance.

As previously mentioned, problems are caused in particular by changing spatial situations during the scans. Here it might be beneficial to fix all doors with door wedges before starting the site measurement so that they remain the same in all scans. This is also important for the subsequent merging of the scans, as this is done on the basis of the scanned room transitions or generally on the basis of overlapping areas in several scans and can be all the more accurate the more identical the scans are.

Although moving people are recognised and not scanned if they are fast enough, in practice some part of the body is usually captured and



Fig. 2.6.20: Screenshot Scaniverse, holes in scan of window

interferes with the scan. In general, however, it is possible for other people to be in the same room during the scan, as it is possible to bypass them or coordinate with each other.

Another obstacle is window glass and other reflective surfaces, as these are not recognised. In their place holes are created (Fig. 2.6.20) or even another room behind a mirror is recognised and displayed due to the reflection. However, window frames and the outermost edge of the glass panes are generally recognised without any problems.

Corners and edges are not completely sharp-edged, but slightly rounded (Fig. 2.6.21). The further away the mobile phone was from the corresponding edge, the less accurate the scan of the edge will be. It therefore makes sense to get really close, especially for stairs. This is more difficult for ceilings and stucco edges.

Here it may be advisable to work with a selfie stick or similar tools to bridge the distance. This was not tested, which is why an offset in the stucco mouldings below the ceiling can often be seen in the scans (Fig. 2.6.22).

Flat surfaces are not scanned as completely flat surfaces, but are uneven in the scan. There are therefore always slight deviations within the surfaces.

Furthermore, it was found that due to the higher speed and the subsequent merging of all scans, it initially appears favourable to record several rooms in one scan, but this leads to other new problems. In the case of multiple rooms scanned at a time, the angles at which the rooms are positioned in relation to each other were recorded incorrectly in several scans (Fig. 2.6.23). This is already visible in the app, but requires special attention and the actual extent of the rotation cannot always be easily assessed.

However, these errors mean a lot more work in post-processing, especially the correct angles of the rooms are unknown. This can be simplified by actually scanning all rooms individually, including all room transitions. In this case, there is also a high probability that at least one of the room transitions has been recorded correctly and that the scans can be merged well.

Due to the 5 metre radius, outdoor rooms can only be scanned to a limited extent. The main difficulties here are obstacles that have to be bypassed and that the scan must always be performed in a circle around the entire building, so there is a high probability of an offset at the start and end points. Bushes and similar obstacles can be avoided relatively easily, even if they grow close to the building, because it is still possible to record a scan of the facade at close range. However, this close-up may have an impact on the

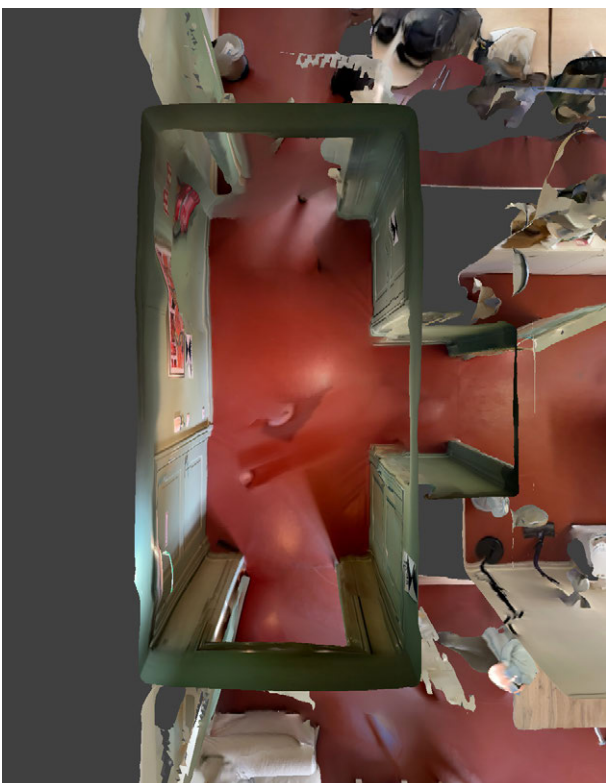

Fig. 2.6.21: Screenshot Scaniverse, round corners and edges

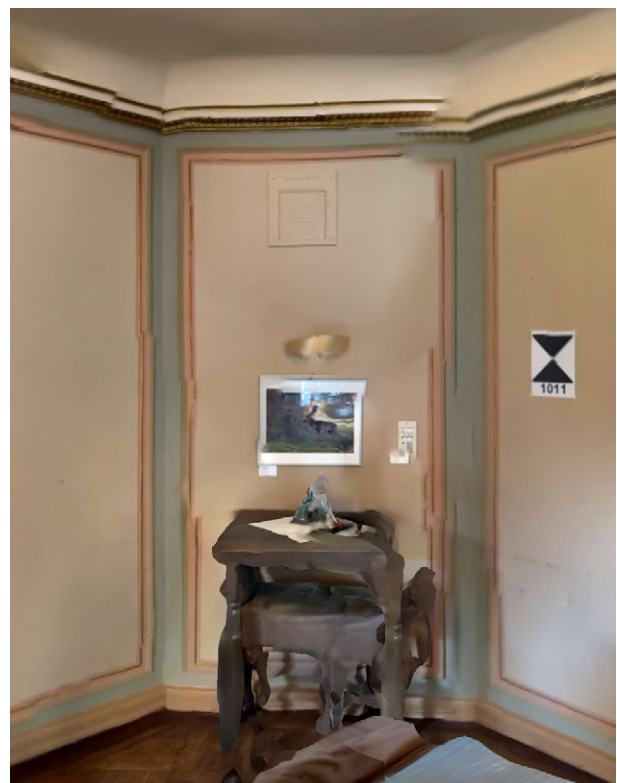

Fig. 2.6.22: Screenshot Scaniverse, misalignment of stucco mouldings

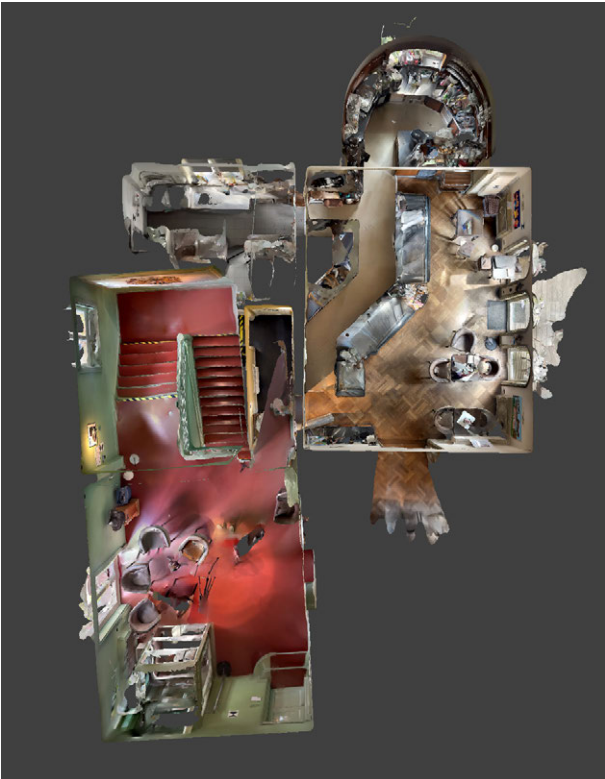

Fig. 2.6.23: Screenshot Scaniverse, contorted rooms



Fig. 2.6.24: Screenshot Scaniverse, detailed scan with high quality

scan quality, but this issue could not be tested sufficiently during the site measurement.

Using Scaniverse also significantly reduces the usual battery life of the mobile phone. Even for a building the size of the villa, a charging option, for example in the form of a power bank, is necessary. In total, around one and a half battery charges were required per mobile phone for a whole set of scans. As power banks were used, the scans did not have to be interrupted to charge the mobile phones.

As described beforehand a solution can be found for most of the difficulties with good preparation and a little practice. Nevertheless, as can be seen in the adjacent figure, the scans are already of high quality and show a high level of detail in many areas (Fig. 2.6.24).



# 4 DATA PROCESSING - SCANIVERSE

## DATA EDITING - FORMAT SELECTION

It is possible to edit scans already within the app. Options such as cropping the scans and common image editing functions are available. Before the data can be further processed in other programs, they must first be exported from Scaniverse. This can be done as meshes or point clouds in a total of seven file formats (FBX, OBJ, GLB, USDZ, STL, PLY, LAS). The duration of the export depends on the file size, but it usually only takes a few seconds.

During the first phase of work, it was found that importing formats such as PLY, LAS, and OBJ into Archicad is not possible. Therefore, the FBX format, which can be imported into Archicad, was used in the following process.

To expedite the tests, only the scan of a single room was used. During importing the scan in FBX format, the entire scan appears as a single connected polygon mesh including textures in Archicad (Fig. 2.6.25). This means that, in addition to the shape, a lot can also be interpreted from the textures when combining the scans and later modeling the 3D model.

Nevertheless, a mesh cannot be edited in Archicad. For this reason, it was tried to convert the object into morphs using Archicad, but during this process, the texture was damaged (Fig. 2.6.26). However, it was found that the meshes can be scaled.

After this negative result, an alternative method was sought to create morph objects from the scans. It is also possible to import point clouds in the XYZ or E57 format into Archicad, but these formats cannot be exported from the Scaniverse app. This is why the program Cloud-Compare was used to convert the PLY format to the XYZ format, with the „PTS“ option selected during the conversion process.

With the XYZ format, a colored representation



Fig. 2.6.25: Screenshot Archicad, textured scans imported in Archicad

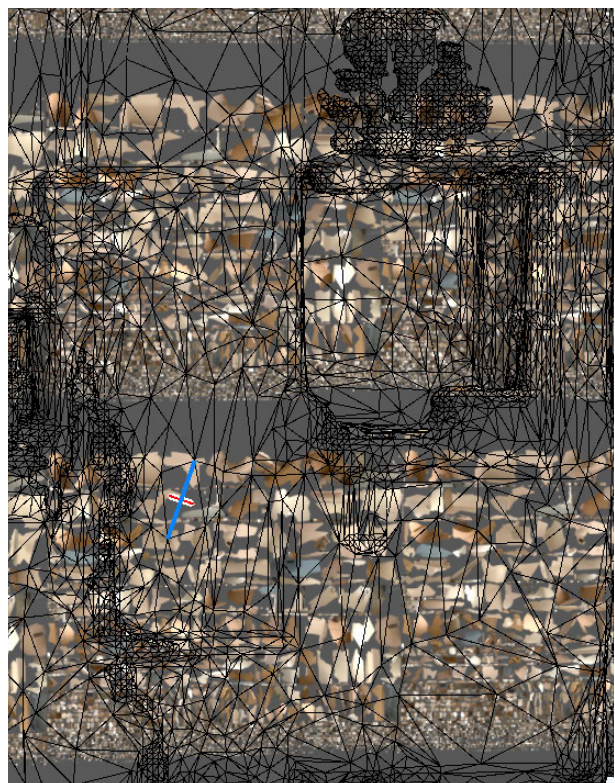

Fig. 2.6.26: Screenshot Archicad, problem during converting Morphs

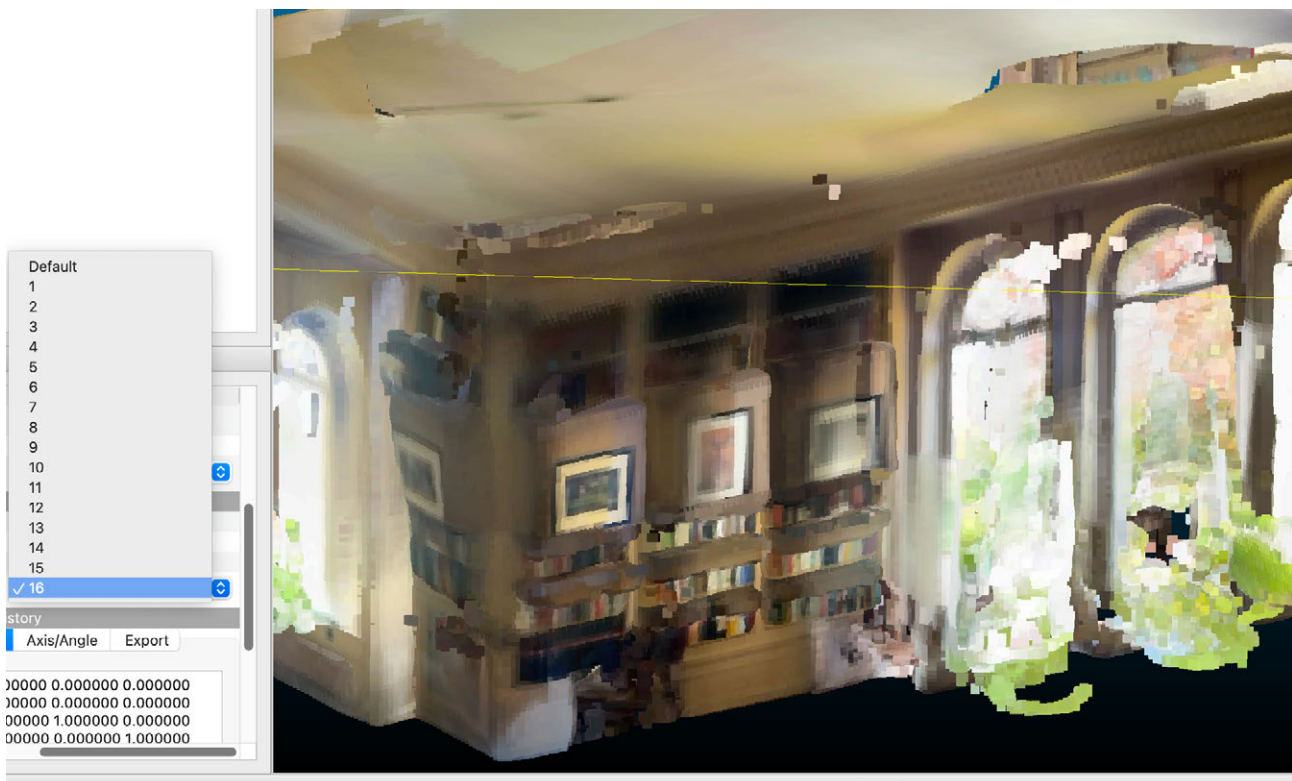

Fig. 2.6.27: Screenshot CloudCompare, converting PLY format to DXF format

consisting solely of points was obtained. In the XYZ format, the scan data could not be converted into morphs and instead remained as one large object. Since meshes better suit our purposes, this format does not provide a suitable foundation for later work processes.

It was also attempted to convert the LAS format to the XYZ format, but with the same result as with the PLY format. Later, the program CloudCompare was used to convert the PLY format to the DXF format. The „maximum point size“ option was selected during the conversion, as this was intended for a more detailed model that should be better suited for zooming (Fig. 2.6.27). However, in the DXF format, only 2D points were obtained.

Ultimately, it was decided to proceed with the scan obtained from the FBX format in Archicad as this seemed to deliver the best results without unnecessary work.

## DATA EDITING - SCAN MERGING

In the next step, the task was to merge the scans in Archicad. In an initial attempt, the set of scans from several interconnected rooms was used as the basis for this process. For this purpose, each scan was imported one by one, aligned in the floor plan view, and then the height was adjusted in the 3D view. However, it was found that the scans were crooked or rotated internally (Figs. 2.6.28, 2.6.29, and 2.6.30), and post-processing of the scans would be intensive. Therefore, a second attempt was made using the second set of scans, which included recordings of individual rooms. This time, all scans were first imported, then assigned to the correct floor, aligned in the floor plan view, and finally adjusted for vertical alignment. Due to this approach, the alignment of the scans was very slow from the beginning, whereas with the previous method, at least the first scans could

be aligned much more smoothly. Since some scans from the first set had better quality than those in the second, now successfully assembled set, these should also be integrated into the second set (Fig. 2.6.31).

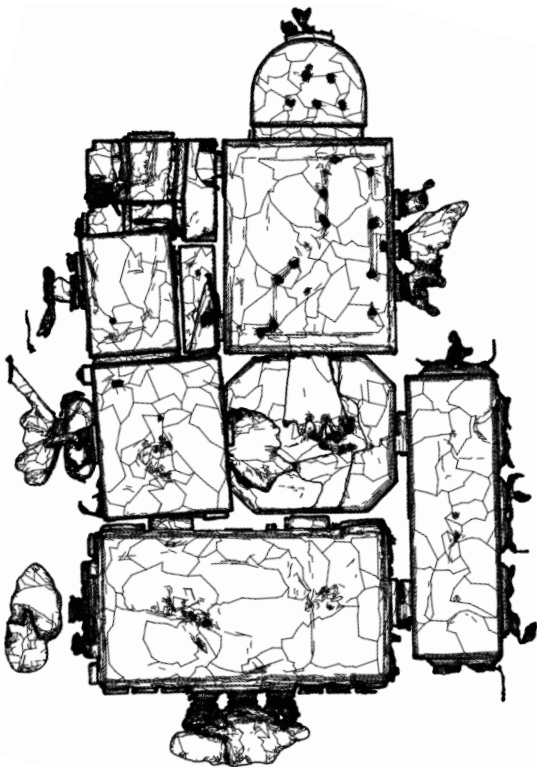

Fig. 2.6.28: Screenshot Archicad, GF of first scan set with wrong angles



Fig. 2.6.29: Screenshot Archicad, 1F of first scan set with wrong angles



Fig. 2.6.30: Screenshot Archicad, assembled first set of scans



Fig. 2.6.31: Screenshot Archicad, final version of assembled scans



## DATA EDITING - SCAN EDITING

To integrate only individual rooms and not several interconnected rooms from the first set of scans, two scans had to be edited before importing them in Archicad.

As previously explained, Archicad does not allow to convert meshes into morphs and it is not possible to edit the meshes in another way, so the 3D modeling programme Rhino has been used.

Within this programme it was possible to remove all unnecessary rooms from individual scans.

In general, this would also have been possible directly in Scaniverse, but the range of functions of the cropping tool is much smaller here, as only one cuboid can be adjusted in size and everything outside this cuboid is cut off. As the edited scan contained the stairs (room 10), this would not have led to the desired result of having only

the scan of the stairs without any other rooms. After the editing, the scan was exported again as an FBX file from Rhino and then imported into Archicad and aligned with the other scans. In this way, the textures were also preserved, which helps with the subsequent creation of the 3D model.

Furthermore, an attempt was made to correct the exterior scan in Rhino. To do so, the scan was split at the corner where the scan was paused, resulting in an incorrect angle between the two neighbouring exterior walls (see chapter 3, p. 190), and at the entrance portal. One part of the scan was now rotated (Fig. 2.6.32, blue part) around the corner with the incorrect angle until the two previously offset parts of the entrance portal were exactly in front of each other. However, one part was now still about 30 cm in front of the other, and the heights were also slightly offset.



Fig. 2.6.32: Screenshot Rhino, editing of exterior scan

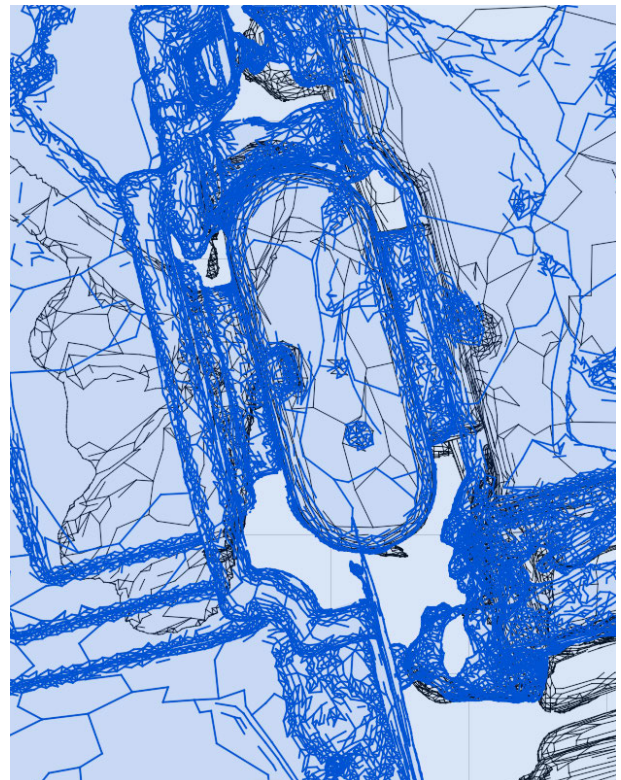

Fig. 2.6.33: Screenshot Archicad, vestibules in both scans match

The latter can presumably be explained by the pausing at the corner, which also caused the now the remaining offset. Nevertheless, it remains unclear whether this could have been prevented by a continuous scan of the facade. In addition, the scan is still slightly crooked. But due to the 5 metre radius of the lidar sensor, no meaningful scans of the outside area were even expected in advance.

For test purposes, the processed exterior scan was first inserted into the file with the scans from the first set. The vestibule (room 1) included in the exterior scan (blue) matched exactly with the interior scan (black) and was also aligned with it (Fig. 2.6.33). It was noticed that the scans of the interior and exterior areas were very similar in the areas that were comparable at all due to the rotation, which can be recognised above all by the lefthand windows on the ground floor, which overlap almost exactly (Fig.

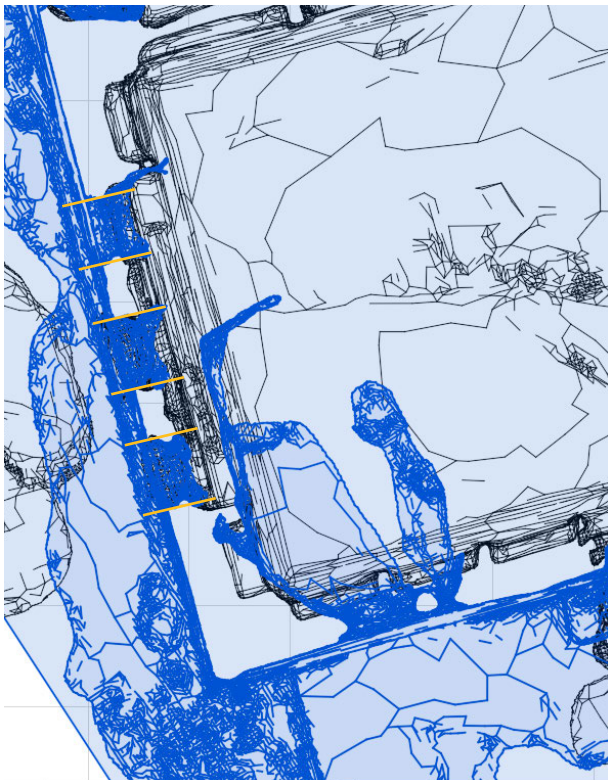

Fig. 2.6.34: Screenshot Archicad, windows in both scans match

2.6.34, exterior scan blue, interior scan black). The fact that several scans taken separately from each other generally match has also been proven for other rooms such as room 12 on the first floor (Fig. 2.6.35). Here it is visible from the slightly different colour shading that in some areas one scan is always slightly ahead of the other scan, but that this balances out over the entire room. With a little practice, even more precise results can certainly be achieved.

The subsequent editing of the scans in Rhino was of course mainly needed because of mistakes made during the site measurement. With a little more experience these mistakes could probably have been avoided and the merging of the scans in Archicad would have been sufficient.



Fig. 2.6.35: Screenshot Archicad, two overlapping scans

### 3D MODEL

Once all the scans were merged, the next step was to create a BIM-capable 3D model based on the scans in Archicad.

It was found that due to the file size, further processing was challenging and time-consuming because of the slow performance. Therefore, new methods were sought.

First, a hotlink was to be created. Hotlink modules allow to integrate external Archicad files into the currently opened project.<sup>96</sup> Therefore, the plan was to create a hotlink to start modeling in a separate file while keeping the main file with all the scans as a separate file, visible through the hotlink in the modeling file. However, the file size made this method unsuitable, and the work remained slow.

As a second method, a separate file was opened, and only the scan of the room that was currently being modeled was copied from the main file into this separate file. Modeling of 3D elements such as walls, ceilings, and so on began in this separate file.

By inserting the scans into their original positions, the risk of shifts or incorrect placement was avoided.

To progress more quickly, the scan of the room to be modeled was copied to the floor above and modeled with transparency (Fig. 2.6.36). This approach was taken because working with the scans on the modeled floor was more challenging, with the risk of unintentionally altering the scan positions, which could lead to errors.

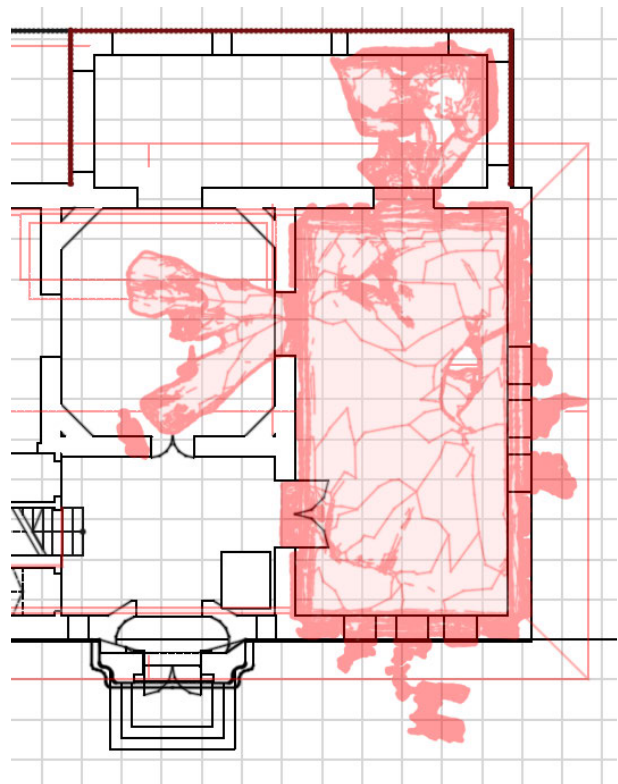

Fig. 2.6.36: Screenshot Archicad, chosen method with overlapping

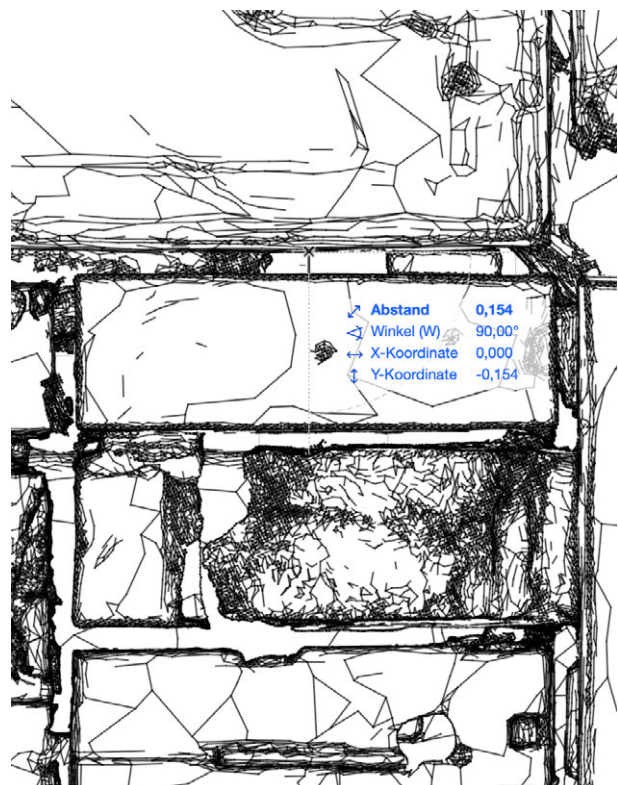

Fig. 2.6.37: Screenshot Archicad, measuring the wall thickness

<sup>96</sup> cf. GRAPHISOFT SE. „Über Hotlink-Module“. Accessed 02.08.2024. [https://help.graphisoft.com/AC/18/GER/AC18Help/05\\_Collaboration/05\\_Collaboration-64.htm](https://help.graphisoft.com/AC/18/GER/AC18Help/05_Collaboration/05_Collaboration-64.htm)

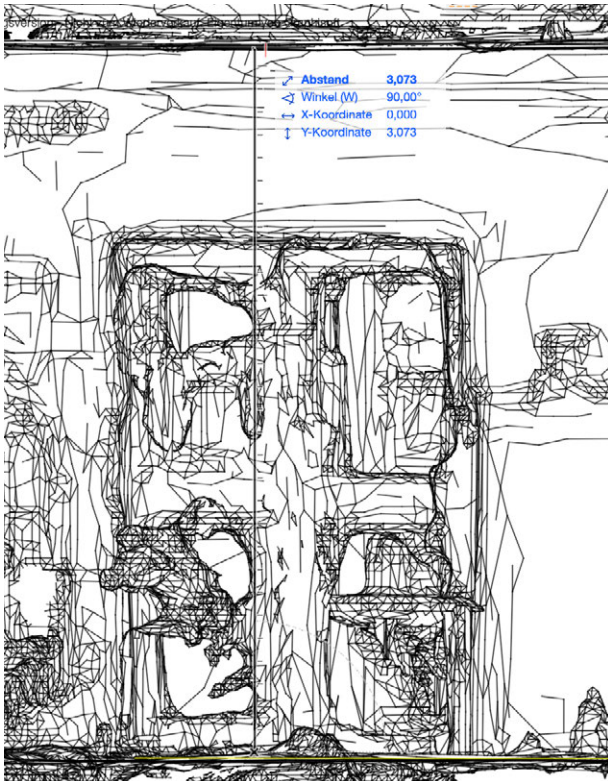

Fig. 2.6.38: Screenshot Archicad, measuring the wall height

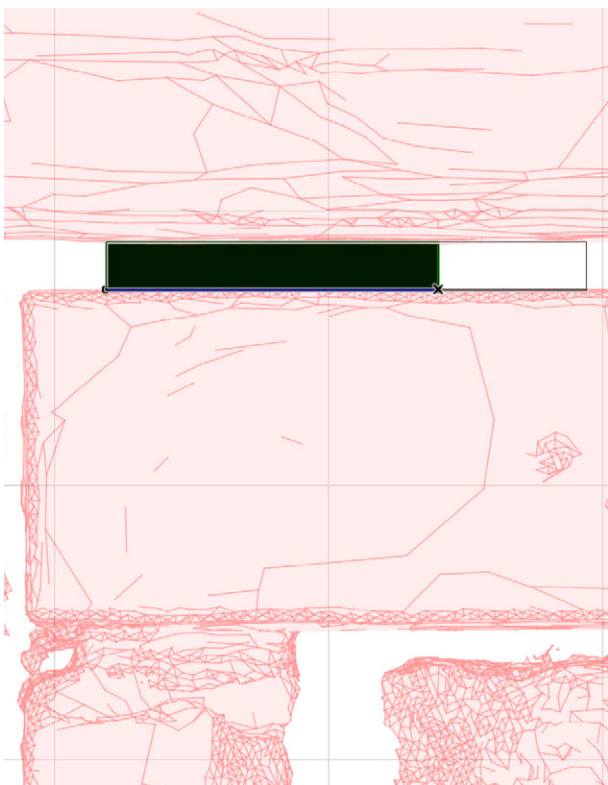

Fig. 3.6.39: Screenshot Archicad, drawing walls based on scan

It was observed that activating the „trace reference“ function slows down the program’s response time. However, this method proved to be more useful and faster in the modeling process, so it was decided to continue with this approach.

Modeling began with the walls. Since the scans were taken sequentially from the interior spaces, the thickness of the interior walls could be tracked in the overall model, where all the scans were merged, as the rooms were placed next to each other (Fig. 2.6.37).

The height of the walls, or the room height, was determined based on sections through the scan. When reading these data, the last straight line below the ceiling in the cross-section was considered as the boundary, and the wall height or room height was adjusted accordingly (Fig. 2.6.38).

On the floor plans of the scans, areas with the most straight lines were clearly visible, so these areas were considered as room delimitations. Accordingly, the interior walls were modeled along these lines (Fig. 2.6.39).

At this point, the shortcomings of the exterior scans led to a lack of information and errors in the exterior wall thicknesses. Since the modeling was based on the interior spaces, an offset occurred in the exterior walls in part of the model (Fig. 2.6.40).

The walls were placed in this manner sequentially, room by room, for each floor.

In the next step, the ceilings were modeled by again reading the thicknesses from the sections. Similarly, the area with the most straight lines was considered as the boundary and used as the realistic value. Due to the limitations of the exterior scans, the roof could not be modeled at this part.

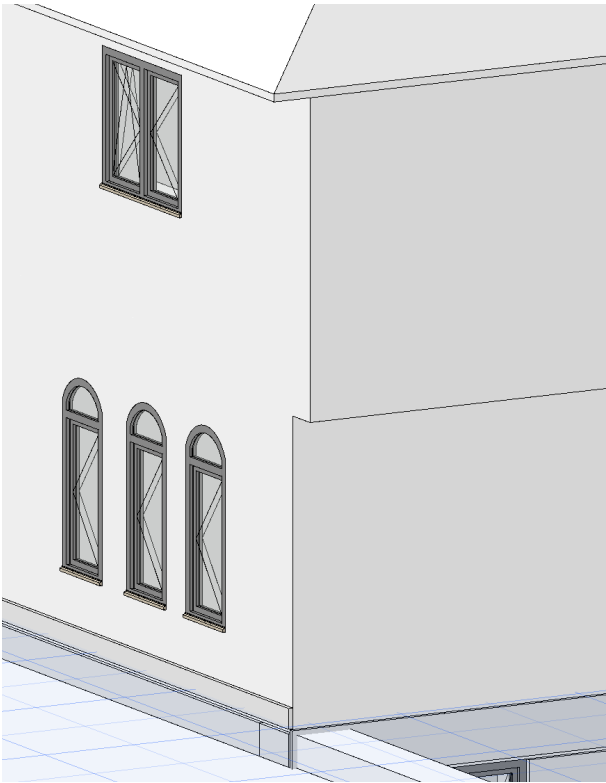

Fig. 2.6.40: Screenshot Archicad, misalignment of the exterior walls

For modeling the staircase, the number of steps was taken from the scans, and the floor height was divided by this number to determine the rise of the steps. The tread dimensions of the steps were also read from the cross-sections.

Next, the door and window openings in the walls were created. In the floor plans, the positions of the windows were clearly visible due to the protruding scans, and the outermost areas were used as boundaries to measure the width of the openings (Fig. 2.6.41). The height of the windows was measured from the 3D view of the scan, as the sections made of the windows were not sufficient to read the height.

The positions of the door openings were observed in the floor plans as clear gaps in the walls between two adjacent room scans. The width of the openings was read from the straight lines on both sides of the gap.

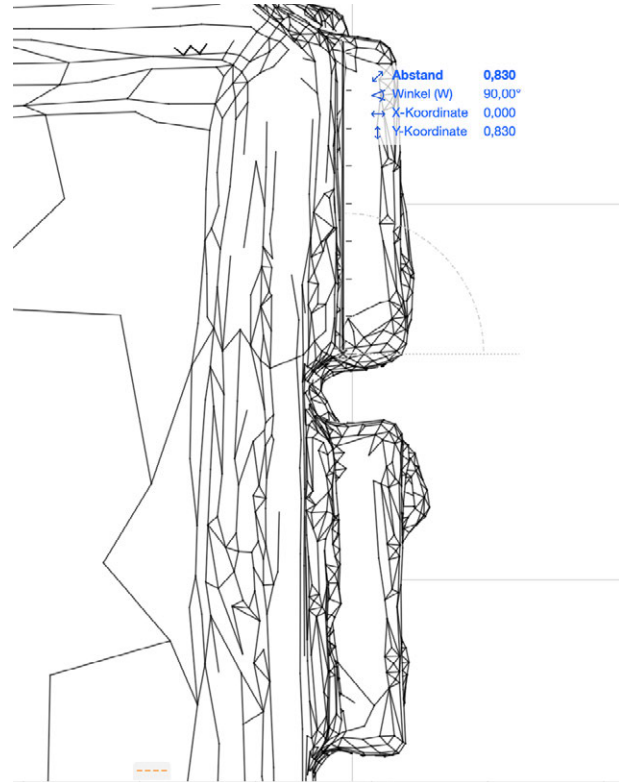

Fig. 2.6.41: Screenshot Archicad, measuring the window width

In contrast to the windows, the height of the doors was derived from the cross-sections. In these sections, the door openings were clearly visible. The straightest areas above and below the opening were identified, and the door height was measured from these points (Fig. 2.6.42).

As the final step, the entrance area, exterior walls, and associated ornaments were modeled.

While the dimensions of the entrance steps and the exterior walls were read from the floor plans of the entrance area, the details in the upper part of the entrance facade had to be taken from the 3D view (Figs. 2.6.43 and 2.6.44).

The required dimensions were measured individually and modeled accordingly. Similarly, the ornaments on the facade were read from the 3D view and modeled.

During modeling the windows on the rear of the building, the distances of these windows from

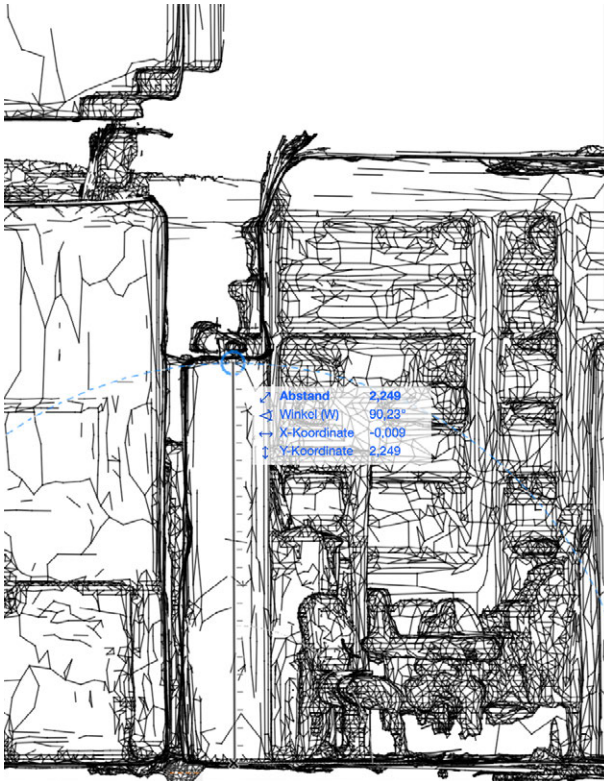

Fig. 2.6.42: Screenshot Archicad, measuring the window height

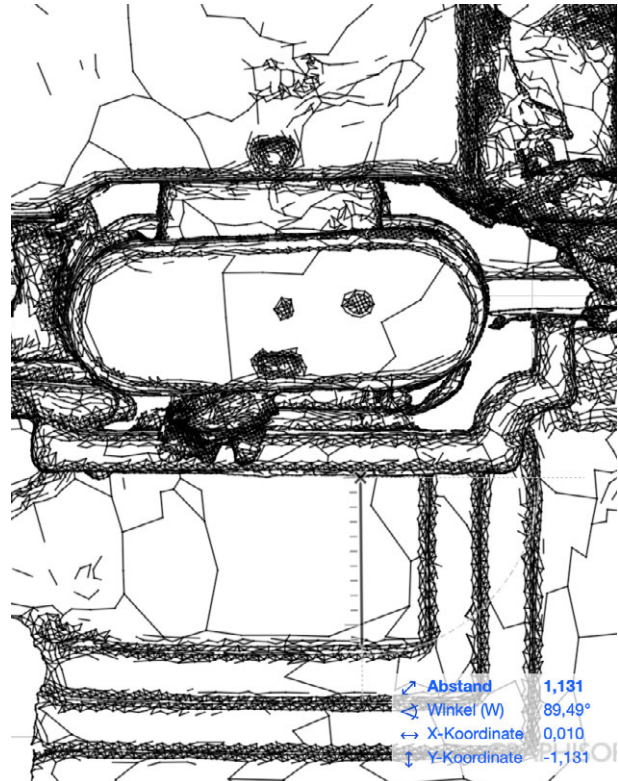

Fig. 2.6.43: Screenshot Archicad, measuring the outdoor entrance

the corner of the wall, their lengths, heights, and sill heights were read from the 3D view and modeled in accordance with it. Since there was no access to these rooms, they were modeled solely using the exterior scan.

Problems during the modeling process were only faced in room 6 in the area of the semi-circular walls. Here were many objects placed on the countertops and shelves during the site measurement which hide major parts of the walls. Nevertheless, it was possible to assume the curvature of the walls with the help of the upper parts of the walls that were still visible in the scan. Additionally, the roof and the upper half of the facade could not be captured and therefore modeled based on the scans, although it is possible to make assumptions about the whole facade based on the scans of the lower part (Fig. 2.6.45).



Fig. 2.6.44: Screenshot Archicad, measuring the entrance facade

- not scanned
- systemic weakness - compensable
- systemic weakness - not compensable
- own mistakes
- adopted from other groups (transparent)

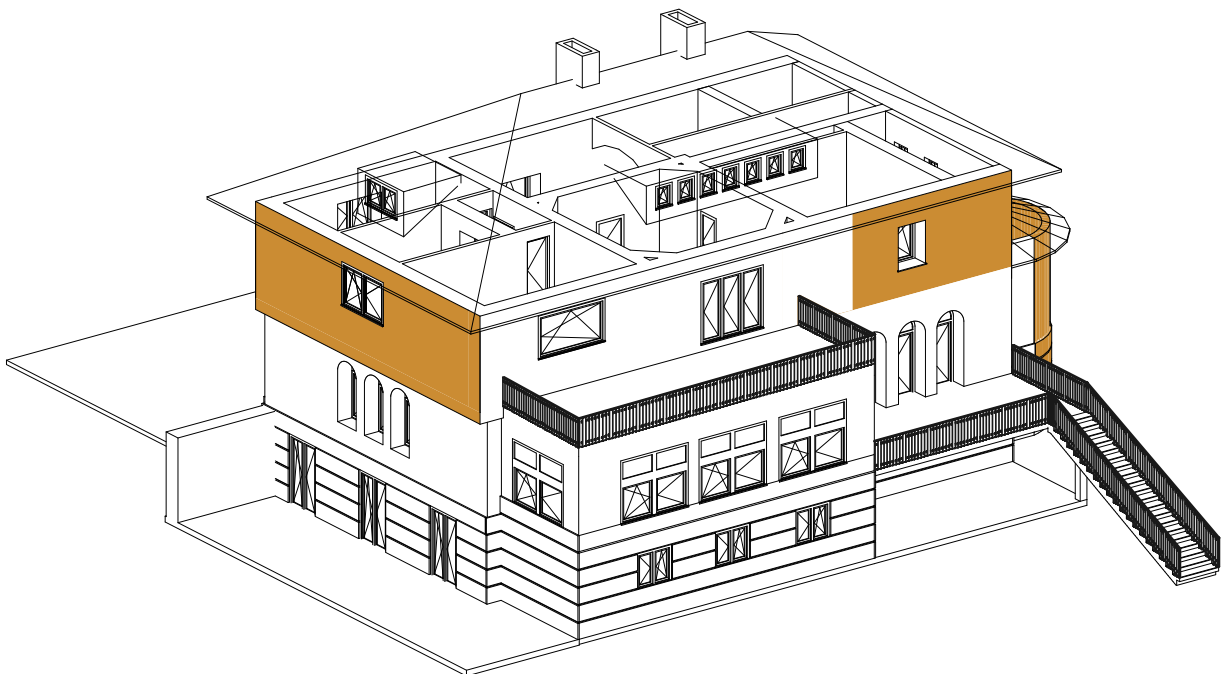
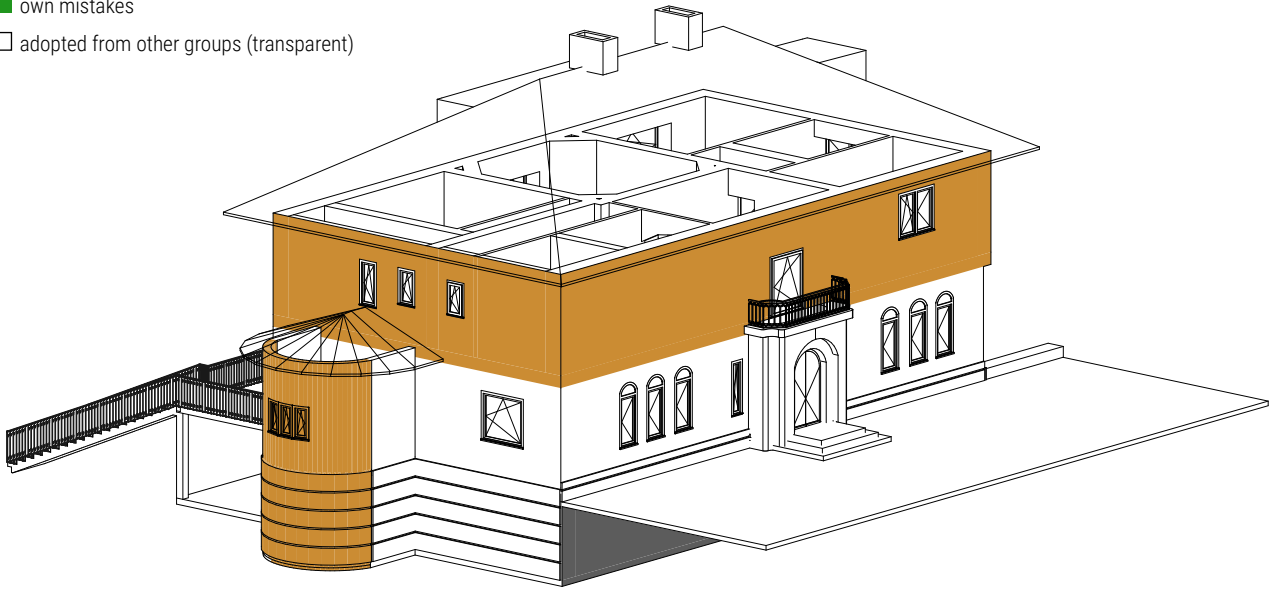

Fig. 2.6.45: Screenshot Archicad, 3D model





# 5 EVALUATION - SCANIVERSE

The measurement process is simple and only requires a mobile device with a LiDAR scanner. One person on site is sufficient for the application. If necessary, it is also possible for several people to scan with several devices at the same time and thus either be faster or, as described in chapter 3 (p. 188), several scans can be made per room. The app is very intuitive to use and even with little practice it is possible to achieve good results. With increasing experience in using the app, even higher quality results can be expected.

At around 5 minutes, the scanning process itself is not time-consuming for a medium-sized room (approx. 15 m<sup>2</sup>). All details can be captured and transferred to a point cloud or mesh. It is particularly worth mentioning that Scaniverse also captures elements such as curved room edges, window and door arches and stucco mouldings, which for example cannot be measured exactly even when taking measurements by hand. People and furniture that cover parts of the room are also recorded. The edges of the room behind them are not continued with the help of artificial intelligence or similar, as is the case with PolyCam, for example. There is therefore no automatic interpretation of the data. The exported mesh in combination with the textures and the level of knowledge after the site inspection at the site measurement appointment also allows a large number of conclusions to be drawn later when transferring the data to a 3D model.

Furthermore, it is possible to differentiate between the level of detail of the measurement depending on the intended use of the scans and the relevance of the scanned areas. Firstly, this can be controlled by the accuracy of the scan itself. By scanning an object from more different angles, the scan also becomes more accurate and detailed. Secondly, it is possible to choose between va-

rious options during processing. Even the options that are not designed to optimise speed are very fast, with a processing time of around one minute per medium-sized room. This means that processing is usually completed before the next scan in the next room can even be started, so that details do not have to be sacrificed in favour of speed.

A clear advantage is that the application is completely free of charge. The only costs incurred are for the mobile phone or tablet used for the site measurement and for the hardware and software for further processing of the scans. Depending on the case of application, this can of course be more or less extensive. Usually, no more than a powerful PC and a CAD programme should be necessary. If LiDAR-capable devices, powerful PCs and CAD software are already available, no further costs are incurred.

As the export is possible in seven different file formats (FBX, OBJ, GLB, USDZ, STL, PLY, LAS), this should be suitable for any standard CAD programme without the need for further intermediate steps. Depending on the case of application, a further export is not always necessary, as individual customisations are already possible in the app and a wide range of functions such as measuring, cropping, etc. are also offered. Publishing via various platforms and sharing via a link are also possible.

The app's weaknesses include errors in case of transparent and reflective surfaces, which are at best shown as holes (windows) or as another room (mirrors). However, as the scans also contain the textures, it is still easy to recognise whether the rooms are mirrored. In addition, these are usually only fragmentary, making it easy to differentiate between real rooms and mistakes due to mirrors. Another problem with the app is the high batte-

ry consumption, which makes it necessary to take along a power bank or to take breaks to recharge the mobile device. However, the initial comparison of eight available scanner apps in the course of the preparations (chapter 2, pp. 182-183) showed that this applies to all apps at varying degrees. Nevertheless, Scaniverse had the second-highest battery consumption in the first test.

The limitation to a scan radius of 5 metres is due to the hardware and therefore applies equally to all scanner apps. However, for buildings with more than one storey, this impedes a complete scan of the exterior facade and can also lead to problems in buildings with high room heights, such as churches. Furthermore, it is important to follow a structured and continuous scanning procedure in order to avoid errors in the scan due to double-scanned areas.

It is advisable to create the scans room by room and only include the room transitions to all neighbouring rooms instead of multiple rooms. Although this means more work afterwards to merge the scans, it is far less prone to errors. In addition, individual scans can be repeated more quickly if inaccuracies or errors are already discovered in the app after scanning.

With regard to post-processing, it must be mentioned that the amount of data significantly slowed down the process of merging and remodeling the scans. A powerful computer is therefore indispensable.

The scans can only be used as a reference and cannot be directly converted into a BIM-capable 3D model. Therefore, the entire model must be rebuilt from scratch. Nevertheless, it is possible to resort to the scans at any time in case of minor insecurities, and the textured meshes help a lot while modeling.

The accuracy of the modeling process is up to

the operator, but this also has the advantage that minor errors in the scans can be compensated and are not aggravated e. g. by artificial intelligence.

The app itself specifies the accuracy of the scans based on LiDAR technology at approx. 15 to 35 mm. The scatter measured at various sample points in the scans imported into Archicad is also roughly in this range at 6 to 33 mm. A comparison with the other methods for checking dimensional tolerance follows in the chapter „analysis“ (pp. 274-275).

The method is therefore fundamentally suitable for the quick and cost-effective measurement of a building. Even highly ornamented, detailed buildings present no problem to the technology. However, buildings with room heights over 5 metres are unsuitable due to the technically limited radius. Depending on the project, a model or plan can be created on the basis of the scans. However, for projects that require particularly accurate measurements with a high degree of precision, this method is currently hardly an option.

Apart from this, the method is particularly suitable for recording the current state of a building and using this as a comparison for changes to the building over a certain period of time. The method is also well suited for presentation purposes, for creating estate agent floor plans and for other applications in which exact dimensions are less important than a three-dimensional textured representation. Scaniverse is also suitable in early planning phases, for example in the context of acquisition or feasibility studies, due to its quick and easy handling and relatively low costs.

Significant further development can be expected in the future, as LiDAR technology is still relatively new and therefore still has a lot of potential for development.

# 3 SITE MEASUREMENT - POLYCAM

The process of room measurement with the PolyCam app can be outlined as follows. Divided into two groups, the villa was captured using an iPhone 14 Pro and an iPad Pro 12.9. This approach was intended to result in two independent sets of recordings, from which the best scans could be selected for further processing.

At the beginning, the rooms on the first floor of the villa were measured. Two approaches were followed. On the one hand, the rooms were recorded individually (Fig. 2.6.46), and on the other hand, connected room structures were combined into a single scan (Fig. 2.6.47). Each of these methods has advantages and disadvantages, which will be explained later in the chapter on data editing. At the start of each scan, a prompt appears on the display instructing that the upper and lower edges of the room should be targeted (Fig. 2.6.57). This initiates the calibration of the measurement points. Subsequently, the room edges can be captured by moving the phone camera up and down. It is important to maintain a sufficient distance from the object being measured and to avoid scanning too quickly. The edges already recognized by the sensor are marked with white lines on the display. Simultaneously, a 3D model of the room is constructed through specific algorithms, which can be seen at the bottom of the screen (Fig. 2.6.48).

On average, each scan took between two and five minutes, depending on the size of the room and the complexity of the furniture present. Room 15 (Fig. 2.6.46), with a floor area of 26 square meters, simple geometry, and minimal furniture, took 2 minutes to scan. Due to the relatively low time required for the scans, the results in the model are correspondingly simplified and abstracted into basic geometric shapes. In this process, the edges of the profiled baseboards and the arched, stucco-decorated ceiling transitions are abstracted and

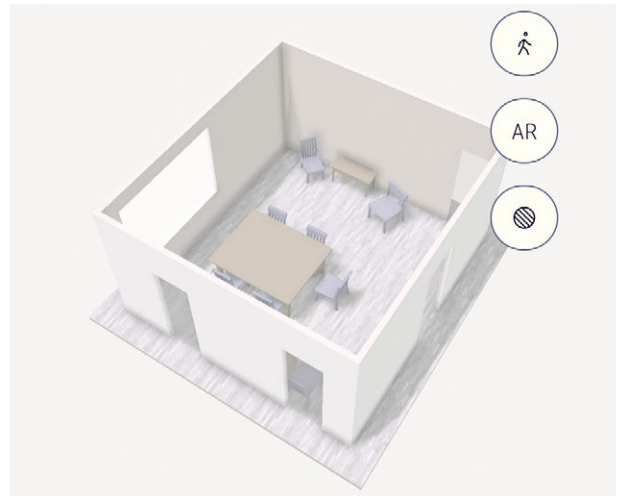

Fig. 2.6.46: Screenshot PolyCam, individual scan of room 15



Fig. 2.6.47: Screenshot PolyCam, room configuration of rooms 1, 2, 4, 5

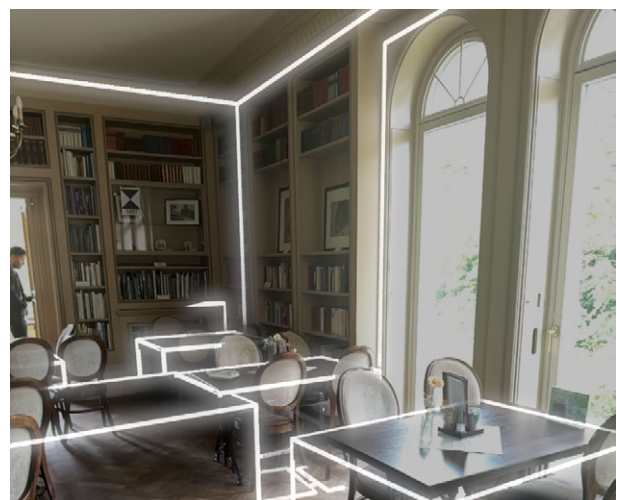

Fig. 2.6.48: Screenshot PolyCam, scanning of room 3

translated into the model using an averaged value, resulting in a loss of information about the existing structure at these points (Fig. 2.6.49). Additionally, the dimensions of the doors were recognized differently depending on whether they were open or closed. When open, the edges of the jamb were translated into the model as an opening. When the doors were closed, however, the door frame was adopted as the opening (Fig. 2.6.51), leading to different door dimensions in the model. Therefore, when modeling later, care must be taken to determine whether the width of the door frame needs to be added to or subtracted from the scanned opening.

Furthermore, windows were also represented in a highly abstracted manner. They are translated as simple openings without frames or muntin divisions. The wall thicknesses are not differentiated, resulting in all walls having the



Fig. 2.6.49: Screenshot PolyCam, scanning of stucco moldings



Fig. 2.6.50: Screenshot PolyCam, scanning of the windows



Fig. 2.6.51: Screenshot PolyCam, scanning the open and closed doors

same thickness of 10 cm and all windows having the same jamb depth, even though there are sometimes radiators under the windows, which would require a significantly greater jamb depth (Fig. 2.6.50).

Moreover, features such as translucent railings on balconies cannot be recognized, resulting in an inability to define a closed space and, consequently, no model being generated (Fig. 2.6.52). The key parameters to consider with this method are the visibility of the environment being scanned. Reflective or highly mirrored surfaces can cause errors in the model representation. This was the case with the partially glass elevator, large mirror surfaces in the basement sanitary rooms, and the windows. Another critical factor in this sensor measurement method is maintaining an appropriate distance from the object being measured. A distance that is too close to room edges or window/door openings can result in unrecognized edges or translation errors. Therefore, narrow and confined spaces such as hallways or bathrooms do not provide optimal conditions. Regarding the optimal distance from the object, it can also be noted that a maximum scan range of five meters can be achieved. As a result, higher facades cannot be scanned, confirming the app's applicability is limited to interior spaces only.

Further application of the app on the ground floor revealed that curved features are often translated into angular geometries. Arched windows (Fig. 2.6.53) and doors (Fig. 2.6.54) are represented as rectangular openings in the model (Fig. 2.6.55). Additionally, curved walls are sometimes translated into straight, tangential wall segments (Fig. 2.6.56), which can lead to erroneous intersections. Since each model is only bounded by a base plate and the room heights are only discernible through wall heights – because no ceiling plates are mode-



Fig. 2.6.52: Screenshot PolyCam, scanning the balcony



Fig. 2.6.53: Screenshot PolyCam, scanning the arched windows

led – attempting to capture the upper and lower floors in a single scan using the staircase resulted in an inaccurate scan. This suggests that elements connecting different heights, like staircases, should be scanned separately from different floors.

An advantage of directly translating measurement data into a model is the immediate error detection and the ability to optimize the scan. However, it should be noted that prolonging the scan duration does not significantly improve the scan quality. Therefore, re-scanning to better capture edges is the more promising approach. Additionally, this function of the app is highly resistant to obstructive objects. The system does not capture people, and the scan can continue even if furniture hides the room edges. The scan cannot be paused in general. You can hold the scanner in one position or swivel back to an already scanned area without causing overlaps of the measurement points.



Fig. 2.6.54: Screenshot PolyCam, scanning the entrance door



Fig. 2.6.55: Screenshot PolyCam, round kitchen area (rooms 6, 7 and 8)



Fig. 2.6.56: Screenshot PolyCam, scanning of the round vestibule

The usability of the application is particularly user-friendly. Through tutorials and on-screen instructions during the scan (Figs. 2.6.57, 2.6.58), it is immediately clear what needs to be considered for a successful scan. Additionally, the ability to read FAQs about specific functions or ask questions to the community ensures low-threshold accessibility for people with varying levels of technical knowledge.



Fig. 2.6.57: Screenshot PolyCam, tutorial and screen during the usage



Fig. 2.6.58: Screenshot PolyCam, screen during the usage

Moreover, the app allows for the easy creation of individual measurements of lengths and areas, enabling immediate verification of dimensions. However, these measurements are placed manually and can only guarantee rough estimates. For more precise information about the dimensions, floor plans with dimension chains and furniture can be directly displayed (Fig. 2.6.59).

Furthermore, there is an option to navigate the model within the app and view rooms at eye level.

Another feature is the AR (Augmented Reality) mode, which allows the digital model to be closely experienced in your current surrounding (Fig. 2.6.60).

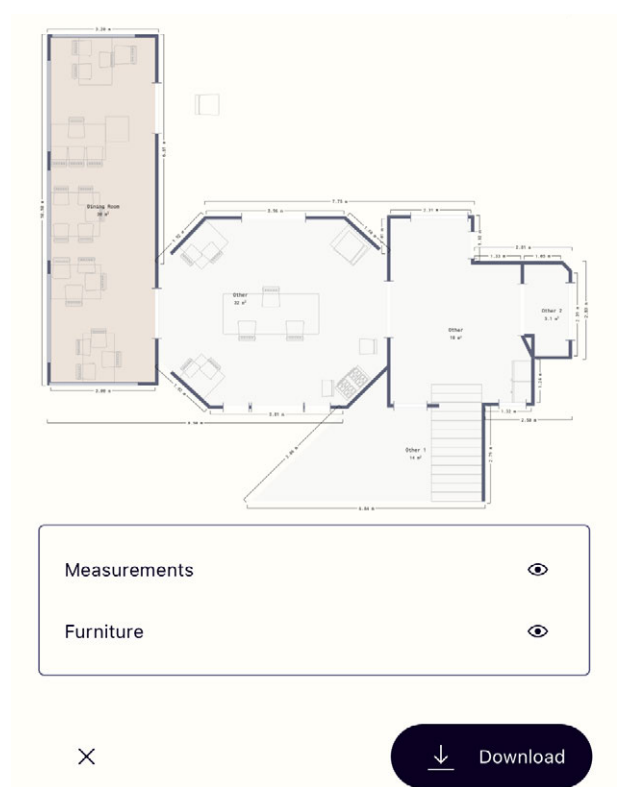

Fig. 2.6.59: Screenshot PolyCam, output of dimensioned floor plans



Fig. 2.6.60: Screenshot PolyCam, AR mode

Additionally, image captures of the 3D model can be made and edited with various drawing tools (Fig. 2.6.61), enabling notes or sketches to be added to the model.

Another post-processing option is converting the scans into textured meshes, comparable to the results from Scaniverse. The level of detail of the quality can be determined by settings such as the number of polygons in per cent and the resolution of the texture (Fig. 2.6.62). This means you don't have to decide at the beginning what level of detail is ultimately needed. Instead, the created scans can be converted to provide more detailed photo captures. This process took about four minutes for the three rooms shown. However, it should be noted that due to the short scan duration, the meshes are not captured with the same level of detail as with Scaniverse.

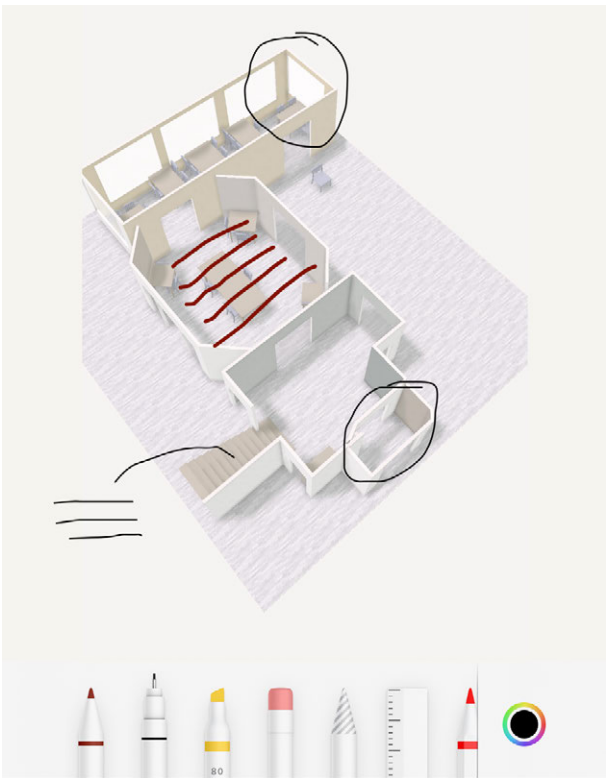

Fig. 2.6.61: Screenshot PolyCam, editing mode

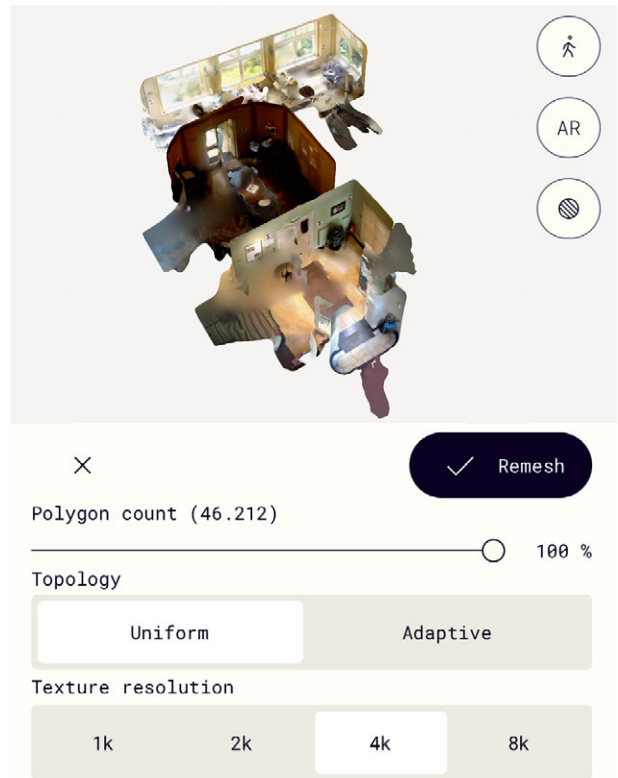

Fig. 2.6.62: Screenshot PolyCam, conversion to textured mesh



# 4 DATA PROCESSING - POLYCAM

## DATA EDITING

In the following step, the data transfer for further processing in a CAD program is explained, ultimately aiming to create a BIM-capable-model. The hardware used is a MacBook Pro (2019). The CAD software applied is Archicad 27, as experience with this program has led to a better workflow. First, the scans were exported from the app. A total of 18 file formats are available (DAE, DXF, DXF point cloud, FBX, GLB, GLTF, LAS, OBJ, PDF, PLY, PNG, PTS, RAW images, STL, SVG, USDZ, XYZ, and blueprint measurements). An album was created in the app for all 27 scans taken of the villa's rooms so that the entire album could always be exported as a single folder. This ensures that exporting a relatively large number of scans requires minimal time. The following 3D file formats can be imported into Archicad 27: DAE, FBX, STL, XYZ point cloud (Figs. 2.6.63, 2.6.64). To enable comparability with the alternatively tested app Scaniverse, the smallest file format, FBX, was chosen for further processing. The FBX file format supports the file transfer of 3D models and is therefore suitable for various 3D modelling programs and 3D rendering software packages.

The individual scans could be imported into Archicad 27 in FBX file format via drag and drop. The scaling of the respective room models had to be adjusted first, so they needed to be enlarged by a factor of 10,000. A reference measurement was required to determine this enlargement factor.

During the import of the files, the Z-coordinates were not initially determined, resulting in the models being displayed in a flat plane. It is possible to manually enter the heights of the objects so that the room height can also be adjusted later. By attempting another import, the captured room heights were represented in 3D. Alternatively, the height data of the rooms

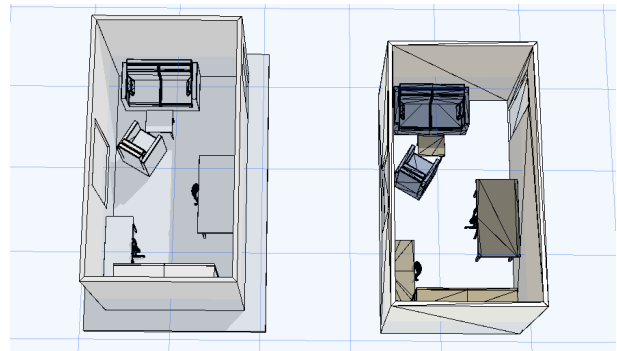

Fig. 2.6.63: Screenshot Archicad, STL and XYZ-pointcloud (from the left)

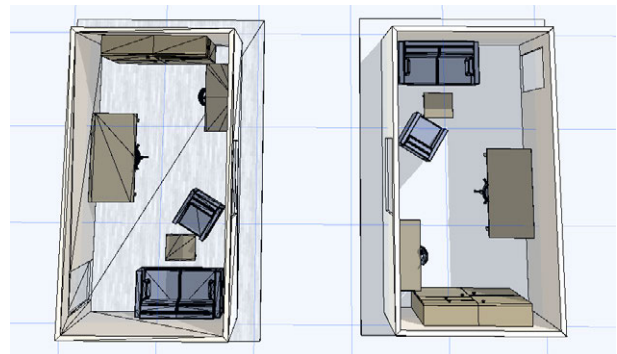

Fig. 2.6.64: Screenshot Archicad, FBX and DAE (from the left)

could have been contained in the remaining file formats, measured, and used for further processing.

To arrange the rooms correctly, the existing floor plans were used as a reference. Regarding the precision of the method, it should be noted that there is no scattering of the measurement points. However, due to the consistently uniform wall thickness of 10 cm, the rooms could not be seamlessly joined together. Using the existing floor plans as a basis, the rooms were arranged accurately, allowing for the precise reconstruction of the villa's layout.

Using the existing floor plans (Figs. 1.1.3, 1.1.4 and 1.1.5 on pp. 33-32) as transparent overlays, the interior corners could be positioned correctly (Fig. 2.6.65). It was noted that the scans sometimes deviated in their proportions from the floor plans and did not fit exactly onto

the 2D plans. Additionally, there were no snap points for the transparent overlays, so positioning the interior corners could not be done precisely.

The previously mentioned advantages and disadvantages of individual scans and scans of entire room configurations are already apparent at this point. With room configurations, the individual rooms do not need to be manually assembled. Moreover, even though the walls are still represented in a standardized manner, the wall thicknesses can be read as air spaces between the rooms. However, if a room in a room configuration was not successfully scanned, it had to be replaced with an individual scan.

Cutting out this room from the overall configuration and precisely inserting the new scan was, therefore, time-consuming. When individual scans are immediately placed next to each other, they can be more flexibly and quickly replaced. Each model can be selected as a single object, which is a single mesh consisting of polygons, but not the individual components. To work on them further, they needed to be translated into freeform shapes using the „Convert to Morphs“ function. This made the individual components such as surfaces and edges of the models selectable and deformable. Furthermore, both the protruding base plates and faulty elements such as wall segments or furniture could be removed from each model. This cleanup of the models took about 1.5 hours in total.

The resulting room configurations of the three floors (Figs. 2.6.66, 2.6.67) serve as transparent overlays for the next step in creating a BIM-capable model, with the resulting floor plans from the scans (Figs. 2.6.68, 2.6.69, 2.6.70) being used as drawing templates.

With the sharply defined edges and right angles, the creation of a BIM-capable model could begin without further post-processing effort.

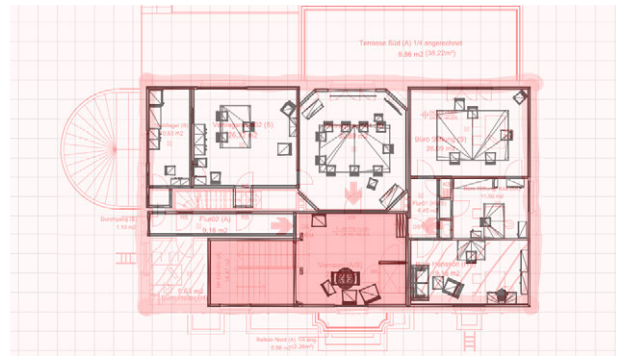

Fig. 2.6.65: Screenshot Archicad, overlaying scans and floor plans

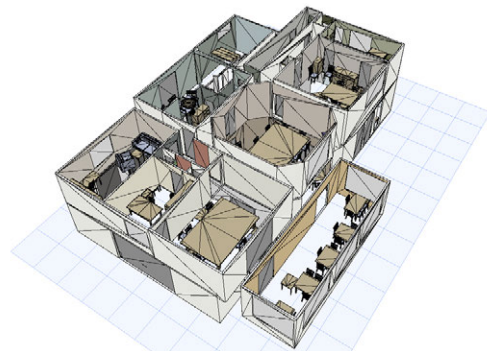

Fig. 2.6.66: Screenshot Archicad, result of the combined rooms

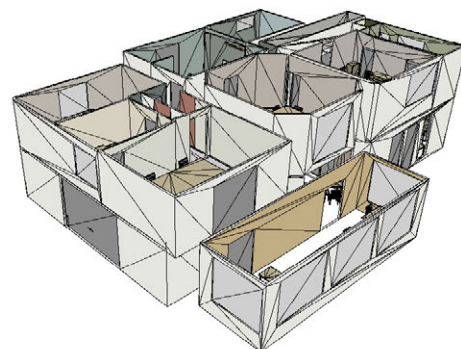

Fig. 2.6.67: Screenshot Archicad, result of the combined rooms

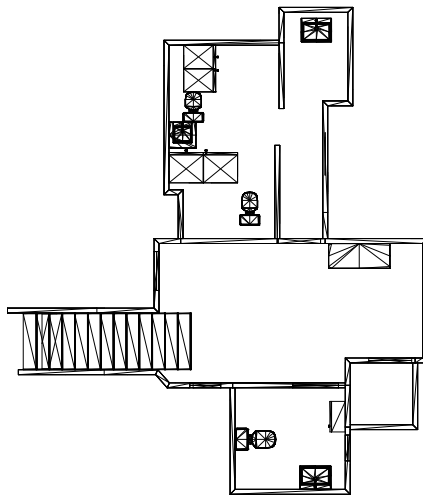

Fig. 2.6.68: Screenshot Archicad, basement floor

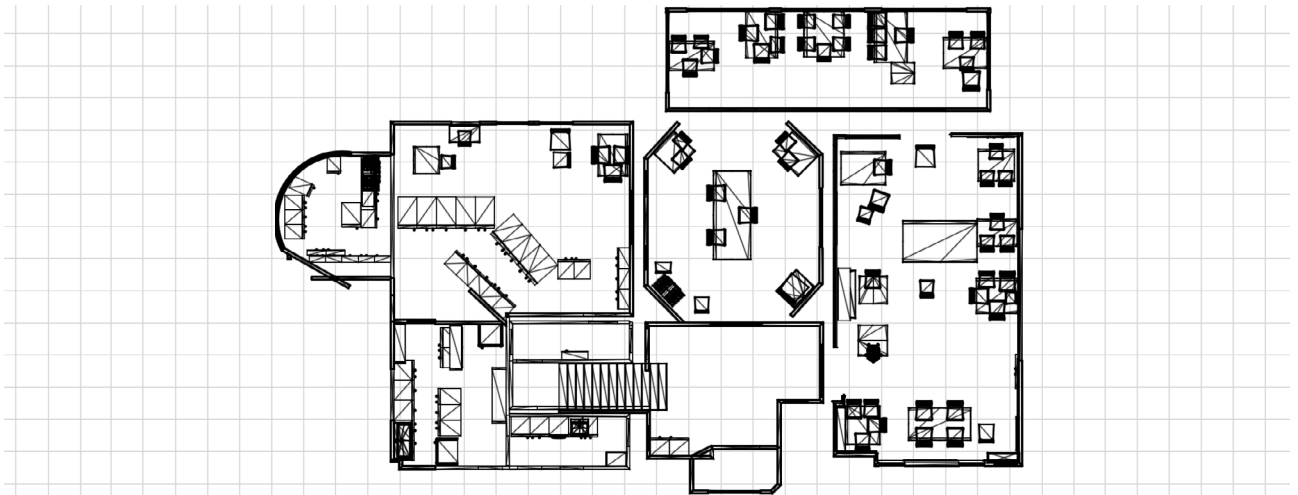

Fig. 2.6.69: Screenshot Archicad, ground floor

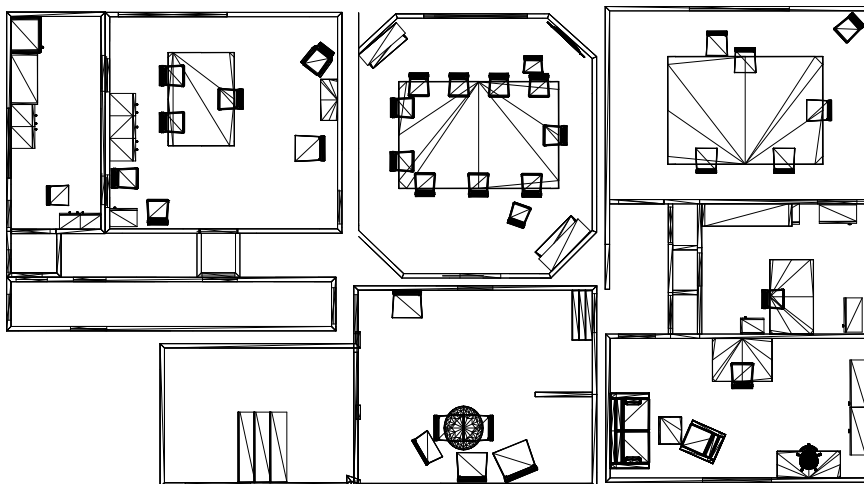

Fig. 2.6.70: Screenshot Archicad, first floor

### 3D MODEL

The following explains the process of creating a BIM-capable model using the described model from morphs. Morphs are free-form shapes that can be embedded with information, but do not represent specific building components, which are essential for a coherent BIM-capable model. Consequently, the model had to be re-modeled from scratch. Additionally, due to task distribution and the optimal workflow within the group, different hardware and CAD software were used for further processing. The hardware includes the following laptops: Dell XPS 15 and ASUS TUF F15, and the software used is Revit 23.

First, the DXF file from Archicad was converted to an IFC format for import into Revit. For this, a plugin developed by Graphisoft was added, enabling the Archicad application to convert a file into the IFC format compatible with Revit.

Due to the lack of representation of the actual wall thicknesses, this information had to be extracted from the Archicad file (Fig. 2.6.71). The spaces between the rooms, which were placed based on the existing floor plans, were measured and used accordingly for creating the walls (Fig. 2.6.72). The walls for the interior spaces were placed in this manner. To obtain and construct the actual thickness of the exterior walls, the transparent overlay was used once again.

At the entrance area, crucial information about the rounded room was missing (Fig. 2.6.73). Polycam translated the curved walls into a straight rectangular geometry. The apex of the semicircle was defined, but not its endpoints. Therefore, the model could not be easily reconstructed at this point. For this reason, the original plans had to be used as a transparent overlay (Fig. 2.6.74).

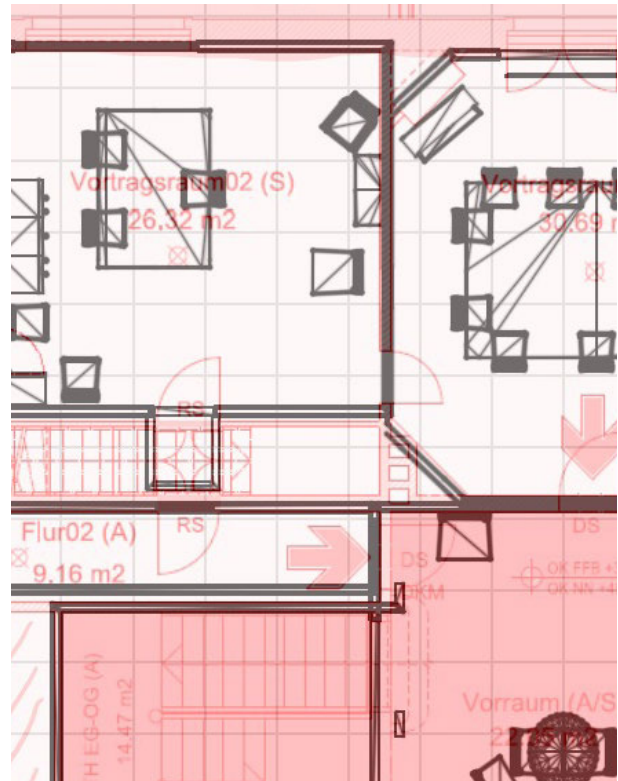

Fig. 2.6.71: Screenshot Archicad, inner corners with transparent layer

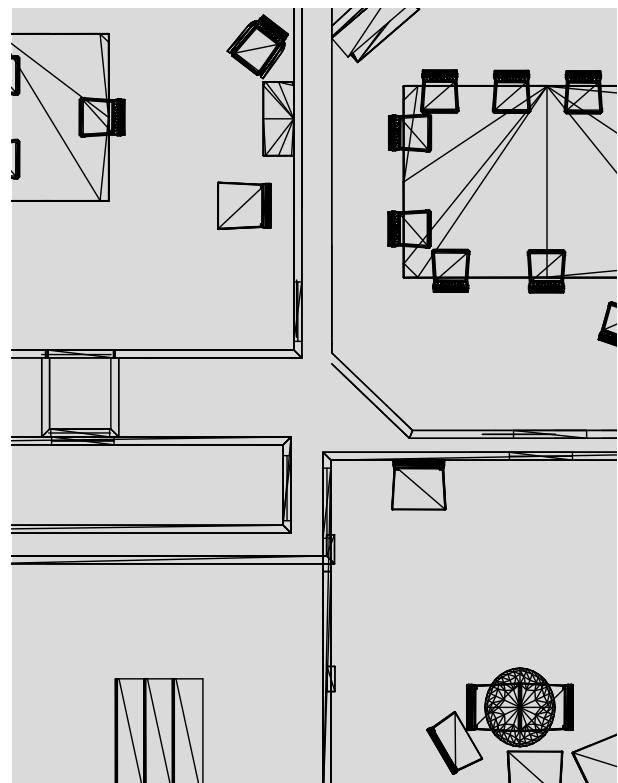

Fig. 2.6.72: Screenshot Revit, space between the scanned walls

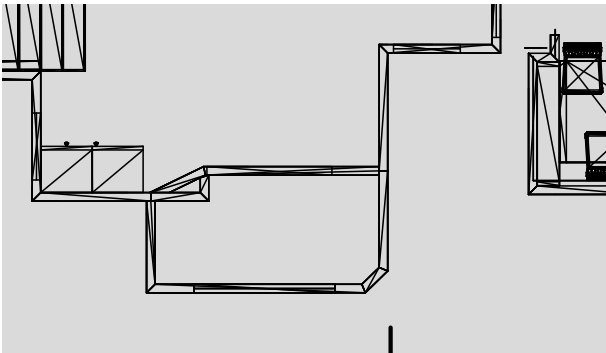

Fig. 2.6.73: Screenshot Archicad, scanned entrance

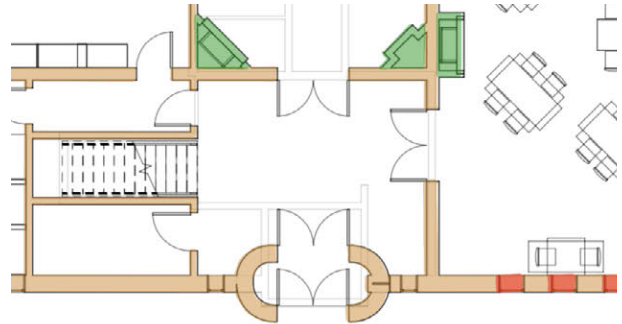

Fig. 2.6.74: Screenshot Revit, modelled entrance

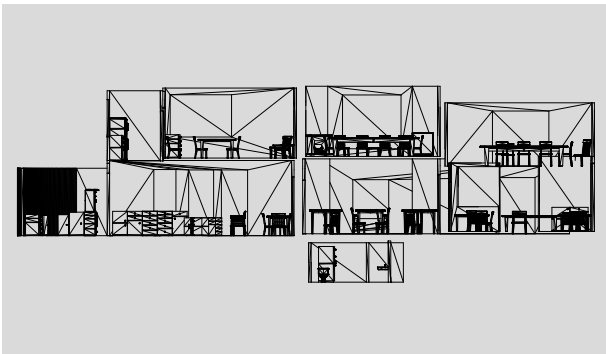

Fig. 2.6.75: Screenshot Archicad, scanned section

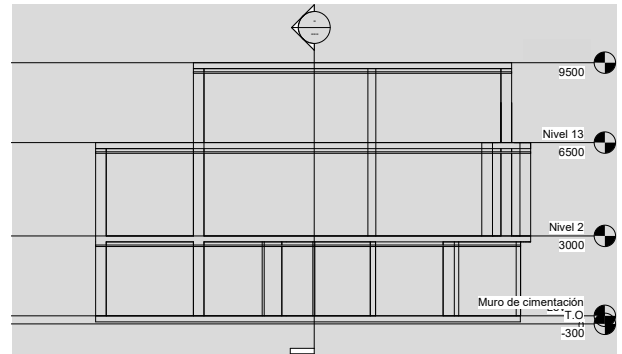

Fig. 2.6.76: Screenshot Revit, modelled section

After all the walls were placed, the next step was to determine the heights of the ceilings. It is important to note that a different height was recorded for each room (Fig. 2.6.75). Since there was no original section plan available for comparison, the heights in the various rooms were assumed to be the actual heights. To compare how the heights varied across different rooms, all rooms were set to the same floor level. It was found that the ceiling heights varied even within the same floor.

Finally, a ceiling was placed 30 cm above the highest ceiling, and the gaps between this ceiling and the lower ceilings in the other rooms were filled with an additional ceiling layer. The height differences between the rooms were not significant. If a difference of 5 cm or less was measured between the rooms, it was attributed to human error rather than inaccuracy in the building's construction and was disregarded.

The walls were then connected to the newly created ceilings. This created a complete mass of walls and ceilings without gaps (Fig. 2.6.76).

In the following step, door and window openings were created. This information was extracted from the scans, as the openings were clearly visible. To accommodate the different recorded door openings, the door dimensions were assumed to be those measured in the open state. Otherwise, it would have been necessary to measure the door frames and subtract them from the previously mentioned door openings (due to the closed state) to determine the clear door opening.

The openings also served to verify whether our scans accurately represented the correct proportions, as the door openings between one room and the adjacent room should match.

Conversely, the windows were modeled using a different method. Since the windows were visible in the scans (Fig. 2.6.77), their positions could subsequently be determined. The height of the windows was then established based on the sections from the scans. Since the scanner could only be used on the inside, we did not have information about the external ornamentation of the windows, so we could only model the frames.

A difficulty encountered during the modeling of the ground floor was presented by the walls and elements in the kitchen area. This room not only had many elements distributed on the surfaces but also featured a curved wall. The original scan could not provide accurate information about the curved wall, as it identified only part of the wall as curved and the rest as straight, which was due to interference from the furniture (Fig. 2.6.78). To address this, the transparent original floor plans had to be reactivated as a reference. Some of the furniture was out of place due to the various students scanning the rooms simultaneously, so we had to reposition some chairs and other items. When we did this, we found that the furniture was all in a block, so new furniture had to be downloaded to replace some of these misplaced elements. This process had to be done in every room, but in the end, everything was organised and there were not chairs out of place (Fig. 2.6.79).

Next, the staircase was modeled. The application did not successfully scan the staircase (Fig. 2.6.80), as it failed to interpret it correctly after the first steps due to the high ceilings and the openness of the space, resulting in the ceiling being set to the height of the adjacent room.

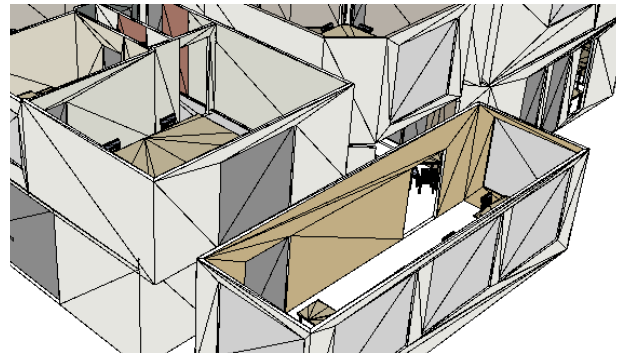

Fig. 2.6.77: Screenshot Archicad, window height

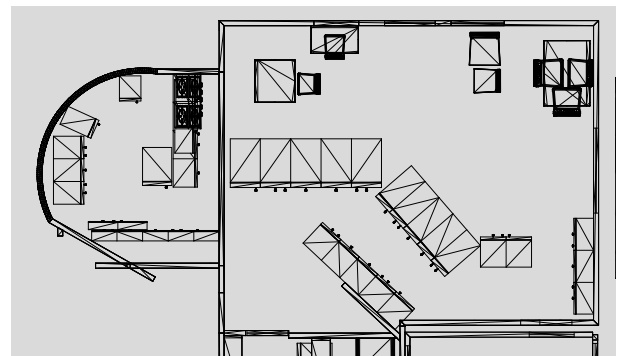

Fig. 2.6.78: Screenshot Archicad, kitchen rearrangement



Fig. 2.6.79: Screenshot Revit, ground floor

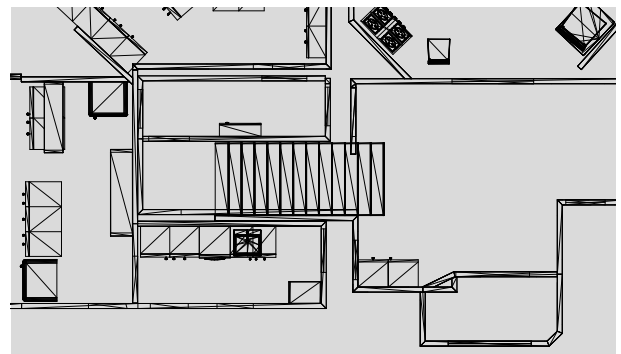

Fig. 2.6.80: Screenshot Archicad, scanning of the stairs

Therefore, the steps had to be remodeled, taking into account the first steps that were successfully scanned in terms of both height and width (Fig. 2.6.81).

Since the app is specialized in recognizing interior spaces, no successful scans of the exterior were generated. Consequently, the roof could not be modeled based on our scans but was instead taken over by the group that conducted the drone recordings and is therefore represented transparently (Fig. 2.6.82).

With all of this, finally the model was completed (Fig. 2.6.82), including the information taken out of the original plans (marked in orange), the information that we could find through other sources like pictures (marked in red), the areas that were not scanned (marked in grey) and those that are due to own errors (marked in green).

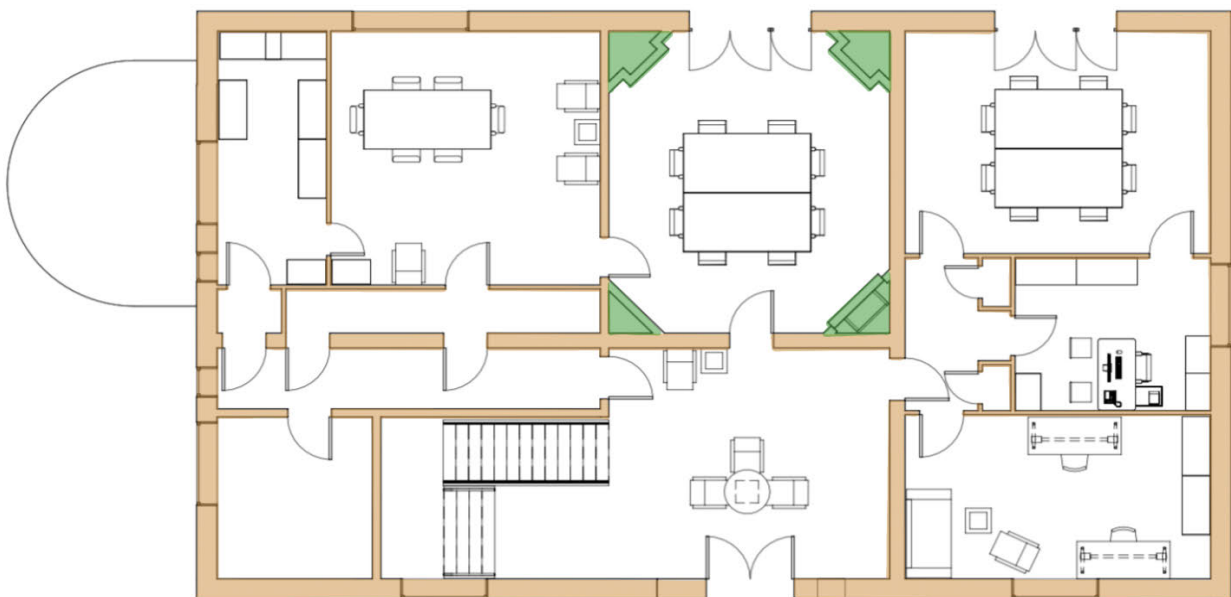

Fig. 2.6.81: Screenshot Revit, first floor

- not scanned
- systemic weakness - compensable
- systemic weakness - not compensable
- own mistakes
- adopted from other groups (transparent)

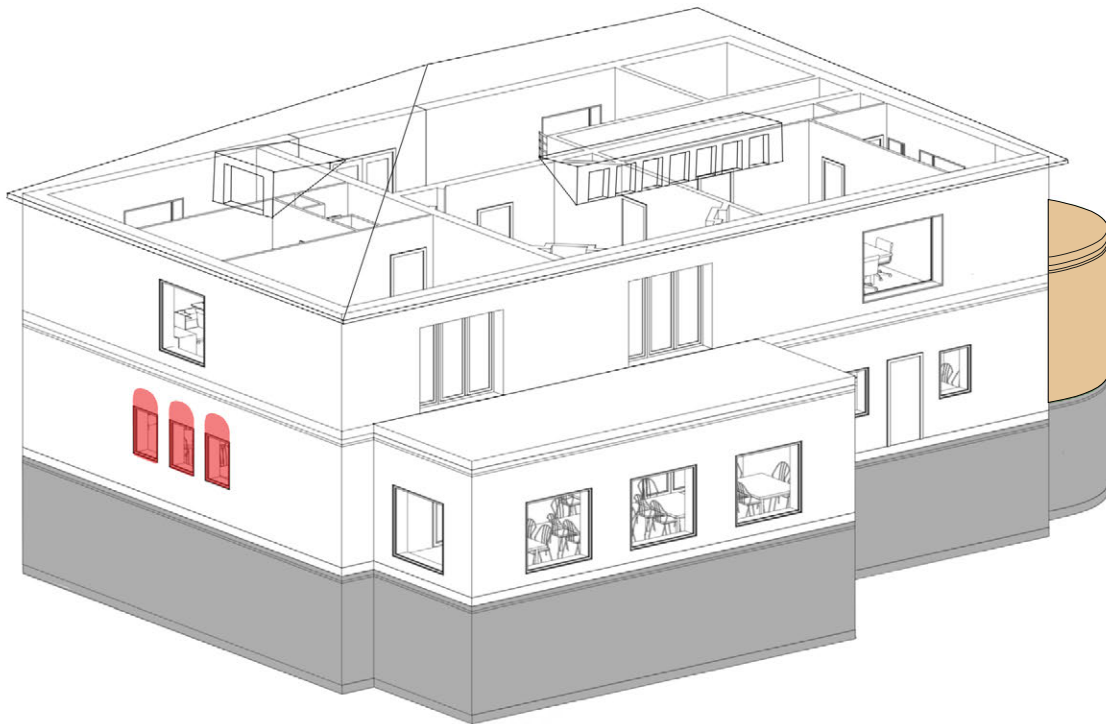
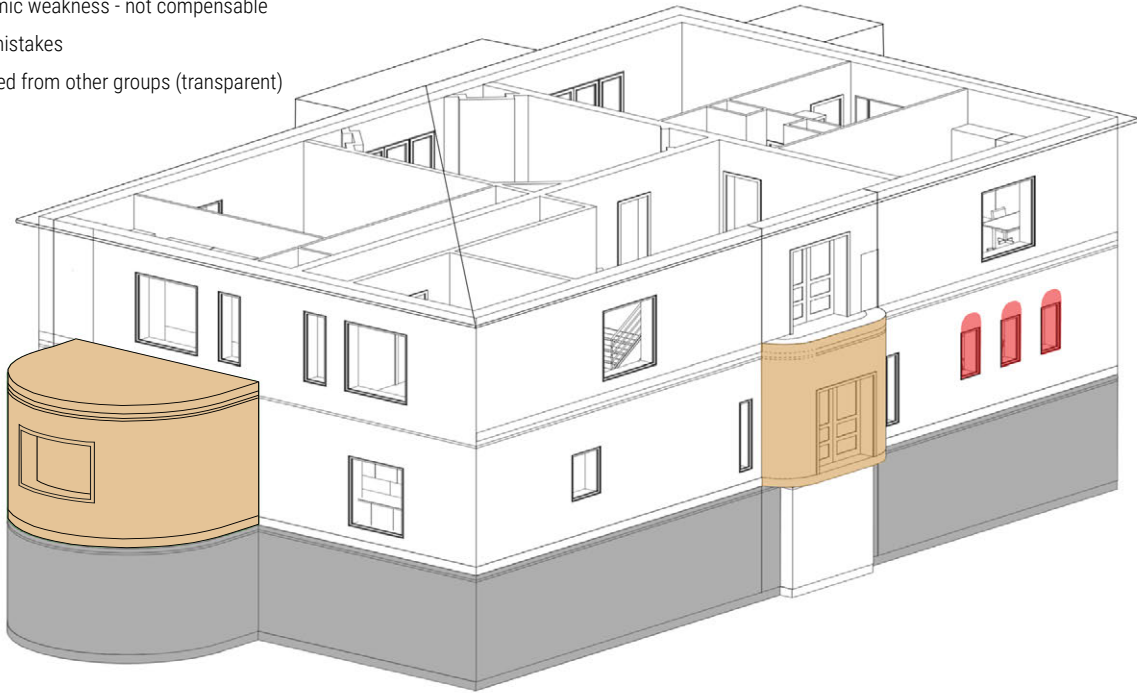

Fig. 2.6.82: Screenshot Revit, BIM-capable 3D model



# 5 EVALUATION - POLYCAM

In summary, the PolyCam app is a practical application for the LiDAR measurement method, particularly in the field of building surveying. With a little practice, the app is easy and user-friendly to operate. Thanks to real-time instructions and helpful tutorials within the app, even non-experts can achieve quality results in a relatively short time. On the technical side, it should be noted that the emission of light pulses during the entire measurement process involves high energy consumption, requiring the device to be recharged multiple times in between.

The practical application is supported by the fact that this method can be carried out with a simple smartphone and by a single person. In the context of commercial use, which is also possible according to Polycam, for example, in an architectural office, resources such as time, costs, and labor can be saved. Another advantage of the app is that the many different export options like 2D plans, 3D meshes or pointclouds allow for further post-processing in a wide range of programs. It should be noted, however, that the app is not free but requires a paid subscription of 89.99€ per year.

Due to the high level of abstraction of the 3D Room Scanner function, it is very fast to use and shows relatively high resilience to disruptive environmental influences such as changing light conditions or people in the vicinity. Difficulties were encountered with surfaces that were too reflective and curved. It is therefore sufficient for an overview of the most important room dimensions. However, crucial information about the existing building is lost throughout the data processing. Important information includes slanted walls, irregularities in floors and wall coverings, and decorations such as stucco and baseboards. For this reason, the 3D Room function is not particularly suitable for documenting existing buildings

where irregularities in the building substance are to be expected, nor for creating as-built plans where a high degree of measurement accuracy is required. Since there is no scattering of the measurement results, as is the case with point clouds, the measurements are unambiguous. However, it is essential to question and verify whether the precision of the measurements corresponds to reality.

Since the method used is not an imaging process, surface damage cannot be recorded. Additionally, due to the limited measurement range of five meters, neither high exterior facades nor high interior spaces of buildings, such as churches or industrial buildings, can be captured. However, various other functions within the app can achieve high levels of detail in surveying, so this limitation only applies to the function used.

Based on the many other functions available within the app, tasks such as documentation for surveys or quick visualizations for client meetings can be supported. With individual editing options, notes can be immediately located in the respective rooms so that, for example, in different phases (shell, expansion, in operation) and for various trades or users, remarks, instructions, and inconsistencies can be directly linked to a quickly created 3D visualization on site.

Another use case would be recording existing rooms that can be navigated within the app or experienced using the AR mode. For initial client meetings or in an early acquisition phase, initial ideas for the new concept could be presented more quickly, as it would otherwise be more time-consuming to manually survey on-site to build a 3D model to clearly present the first renovation measures and ideas to the client.

Additionally, the area of existing buildings can be measured relatively quickly, making it easier to create a land-use plan for repurposing at an earlier stage of planning.

In conclusion, the app is convincing with its abstracting function but also due to its rapid processing and visualization of spaces. Even in further use in the planning process, the scans can serve as a helpful basis for BIM-capable models. However, it should be noted that spot-checking the scanned measurements and determining comparison measurements, for example, for proper scaling or reconstructing in the modeling process, are indispensable measures.

# MANUAL - DISTOMETER



## INTRODUCTION

Team	228
Description	228
Requirements	229

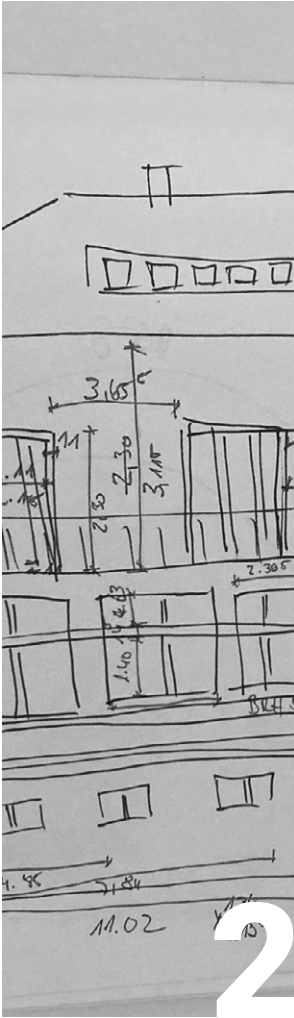

2

**PREPARATION**

Preparation 230

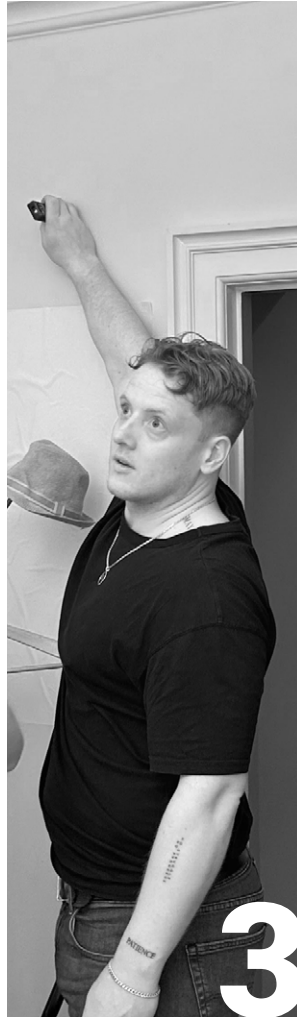

3

**SITE MEASUREMENT**

Site Measurement 234

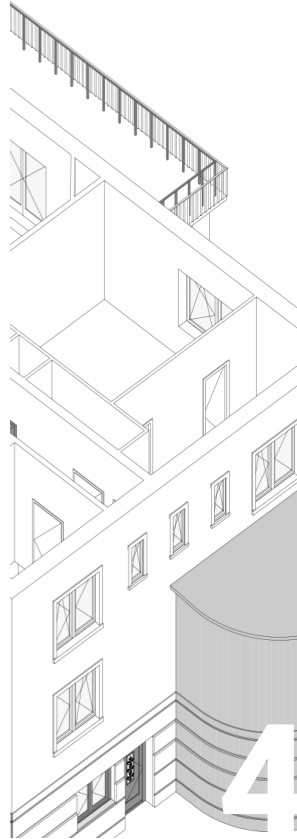

4

**DATA PROCESSING**

Data Editing and 3D Model 240

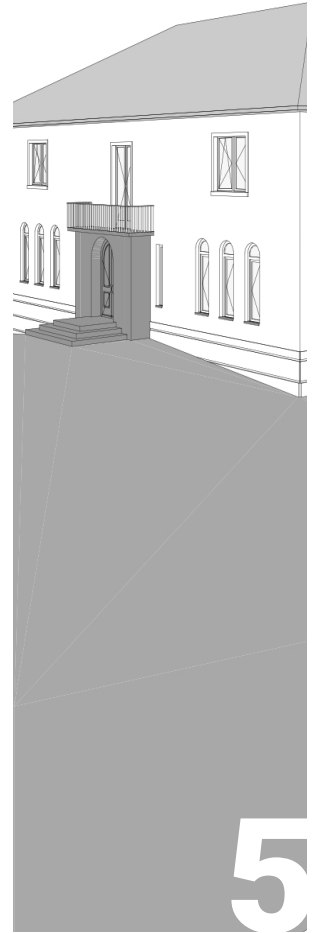

5

**EVALUATION**

Evaluation 244

# 1 INTRODUCTION



## DESCRIPTION

Manual measurement, a method that has been employed for centuries, remains an invaluable skill for architects.<sup>97</sup> This time-honored technique, which predates digital tools, involves accurate hand measurements, detailed sketches, and keen observational skills. It not only provides accurate dimensional data but also fosters an intimate understanding of the building's structure, materials, and craftsmanship.

Our project aimed to dive deep into this traditional approach, applying it to the Ohlendorffsche Villa. By utilizing tape measures, Laser distance meter and inch rule (Fig. 2.7.1), we set out to create a comprehensive documentation of the building, pointing out the differences between historical and modern methods.

This documentation serves as a record of our journey through the process of manual measurement, highlighting its enduring relevance in the digital age.



Fig. 2.7.1: Inch rule and laser distance meter

97 cf. Donath, Dirk and Thurow, Torsten. „Integrated Architectural Surveying And Planning“. *Automation in Construction* 16, Nr. 1 (January 2007). 19-27.  
<https://doi.org/10.1016/j.autcon.2005.10.012>

## REQUIREMENTS

The manual measurement process, is a traditional method of architectural documentation. This technique involves at least two people working together to measure and record the dimensions of a building or structure.<sup>98</sup> We used different tools distance measurements, such as a folding rule and laser measuring device. A levelling device could be added for height differences. For the documentation we used pencils, paper, clipboard and the printed planning materials.

The tape measure is a versatile instrument, particularly effective for measuring shorter distances and curved surfaces. Its flexibility allows surveyors to contour it along non-linear elements, providing accurate measurements of complex shapes. However, when dealing with distances over two meters, maintaining the tape measure's tension becomes challenging, which can introduce minor inaccuracies into the measurements. This is where the collaboration of two people becomes crucial: one person held the tape measure at one end, ensuring it remains taut and properly aligned, while the other held the other end and took the reading and records the measurement. This teamwork not only improved accuracy but also significantly increased efficiency in the process.

Another indispensable tool in the manual measurement is the folding rule. This tool excels in measuring smaller dimensions and accessing hard-to-reach areas due to its compact and foldable design. The rigidity of its segments allows for precise measurements in confined spaces, making it ideal for detailed work. However, the folding ruler's usefulness is limited

by its length of two meters, typically restricting its application to smaller-scale measurements.

For longer distances, the laser distance meter has become an asset in modern manual measurement. This device offers rapid and highly accurate measurements up to ten meters but still useful for distances up to 60 meters with increasing inaccuracy. Its precision and ease of use make it particularly useful for measuring building heights and long interior spaces. However, the laser distance meter is not without its limitations. In conditions of bright sunlight or when measuring highly reflective surfaces, the device may struggle to provide accurate readings, requiring us to rely on alternative methods or adjust our timing to more favorable conditions.<sup>99</sup> Our human error should also be mentioned, as the 100 per cent right angle cannot be achieved.

---

98 cf. Komzet Bau Bühl. Kompetenzzentrum der Bauwirtschaft. „Aufmaßsysteme“. Accessed 12.07.2024. <https://wiki.bubiza.de/lib/exe/fetch.php?media=massivbau:7-checklisten:aufmasssysteme.pdf>

99 cf. Streit Datentechnik GmbH. „Aufmaß – Definition, wichtige Infos & Tipps für Handwerker!“. Accessed 12.07.2024. <https://www.streit-software.de/wissen/aufmass>

# 2 PREPARATION

When we prepared for the manual measurement project, our first step was to gather all the necessary tools and equipment. A comprehensive toolkit for architectural surveying typically includes a variety of measuring instruments such as tape measures of different lengths, folding rulers, and laser distance meters. These tools are essential for capturing accurate dimensions of various building elements.

In addition to measuring devices, it was important to bring along materials for recording and documenting the measurements. This includes notebooks or sketchpads for drawing rough plans and writing down measurements (Fig. 2.7.2), as well as pencils and erasers for making and correcting notes. A camera is also an tool for visual documentation, allowing surveyors to capture images of the building's features and overall structure for later reference.

Before setting out for the site, it was crucial to inspect all equipment thoroughly. We checked each device to ensure it's in good working condition. For electronic devices like laser distance meters, it was essential to verify that they have fresh batteries installed. If possible, carrying spare batteries is advisable to avoid interruptions during the measurement process.

As a precautionary measure, it's wise to bring backup tools. This might include extra tape measures, additional pencils, even a spare laser distance meter if available or at least some batteries for exchange. Having redundant equipment can be invaluable in case of unexpected malfunctions or accidents on site, ensuring that the survey can continue without significant delays or compromises in accuracy.

## SITE PREPARATION

Before arriving at the site, it was important to obtain and study any existing documentation related to the building. This documentation may cover a variety of resources, such as old floor plans, historical records, or previous survey

data. Inventory plans can offer a detailed layout of the building's structure, including room dimensions, wall placements, and architectural features, which served as a valuable reference during the manual measurement process.

## MANUAL MEASUREMENT

Developing a systematic measurement plan was our first step in preparing for manual measurement of the building. We began by dividing the building into distinct sections, such as floors, rooms, or exterior facades. Then, established a clear order for measuring these sections, typically starting from a fixed point and moving methodically through the structure.

As part of this plan, it was important to create a consistent notation system for recording measurements. This system should be clear, unambiguous, and easily understood by all team members. In our case it included standardized abbreviations, symbols, or color-coding to differentiate between various types of measurements or building elements like in our hand sketch (Fig. 2.7.2). For instance, we could use specific symbols for doors, windows, and wall thicknesses, ensuring that all team members interpret the notations uniformly.

Additionally, the measurement plan should include guidelines for handling complex or irregular features of the building. Decide in advance how to approach elements like curved walls (Figs. 2.7.3, 2.7.4), sloped ceilings, or ornate architectural details.

This foresight will help maintain consistency in measurement techniques across different team members and throughout the entire surveying process.

By implementing such a systematic approach, we reduced the risk of overlooking important elements or duplicating efforts. It ensures that every part of the building receives thorough attention and that the resulting data is compre-

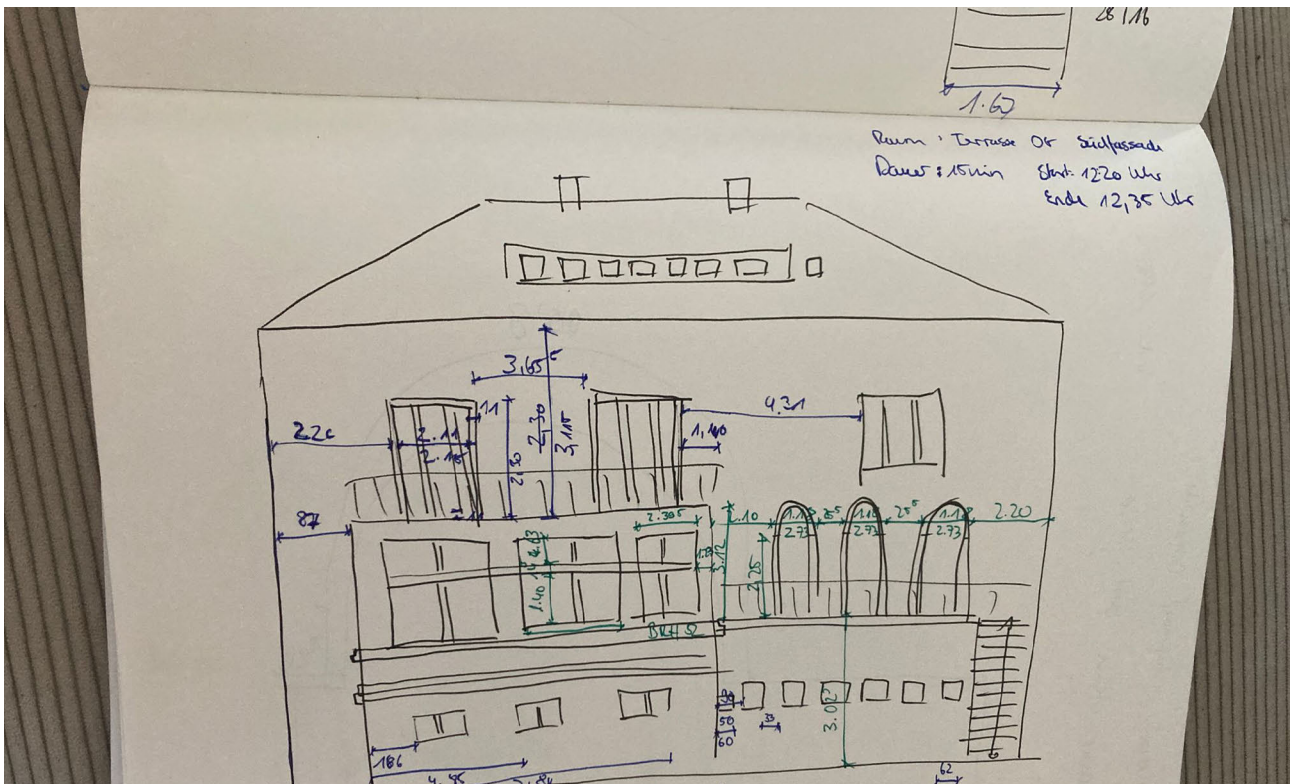

Fig. 2.7.2: Hand sketch

hensive and well-organized. This methodical strategy not only improves the accuracy and completeness of the survey but also facilitates easier data compilation and analysis in the later stages of the project.

We prepared a checklist of all the measurements we needed to take. This checklist encompassed a comprehensive range of dimensions to ensure no detail is overlooked. We started with the main dimensions, such as the overall length, width, and height of the building. These primary measurements provide the foundational data for the structure.

In addition to the main dimensions, we included detailed measurements of all windows, noting their sizes and positions. Accurate window measurements are essential for understanding the building's facade and for any future renovation or restoration work.

Similarly, document the heights and widths of all doors, as these are important for both functional and aesthetic considerations.

Wall thicknesses should also be measured and recorded, as they can vary throughout the building and impact structural assessments and interior space planning.<sup>100</sup> Pay special attention to any unique architectural features, such as decorative moldings, columns, or arches. These elements often define the character of a building and must be precisely documented to preserve its historical integrity.

By creating a detailed checklist that includes these specific measurements, we ensured a thorough and accurate survey of the building, capturing all essential data for future reference and analysis.

100 cf. Gruha Pravesh. "Interior & Exterior Wall Thickness (Residential Standards in 2023)". Accessed 26.06.2024. <https://gruhapraveshinteriors.com/interior-exterior-wall-thickness/>





Fig. 2.7.3: Curved wall on eastfacade Ohlendorfsche Villa



Fig. 2.7.4: Curved wall on eastfacade Ohlendorfsche Villa



# 3 SITE MEASUREMENT

## OUTSIDE

A typical on-site manual measurement process commences with a comprehensive exterior survey of the building. We began by carefully measuring the overall dimensions of the structure, focusing on the length and height of each exterior wall. This initial step is crucial as it establishes the basic footprint and scale of the building, providing a foundational framework for all subsequent measurements.

Once the general dimensions were recorded, we then turned our attention to the detailed features of the facade. We carefully measured and documented the position, width, and height of all openings, including doors and windows. This process involves precise measurements from fixed reference points, usually corners of the building, to ensure accurate positioning of these elements.

The recording of these openings is not merely a matter of noting their sizes. We also documented the depth of window recesses, the thickness of door frames, and any decorative elements surrounding these features. This level of detail is essential for creating a comprehensive understanding of the building's exterior composition.

These measurements serve multiple purposes in architectural documentation. Firstly, they are indispensable for creating accurate elevation drawings, which provide a true-to-scale representation of the building's exterior appearance. Secondly, they contribute vital information for the development of precise floor plans, ensuring that the interior layout aligns correctly with the exterior structure.<sup>101</sup>

Moreover, the detailed documentation of exterior features allows for the identification of any irregularities or unique architectural elements that may not be immediately apparent. This

can include variations in wall thickness.

In situations where we had a lack of access to detailed architectural drawings, we had to rely on our skills to create quick, hand-drawn sketches of the building's facades. These rapid sketches, while not exhaustive in their detail, play a role in the documentation process. They serve as visual references that complement the numerical measurements, providing a comprehensive overview of the building's exterior (Figs. 2.7.2, 2.7.5, 2.7.6). In addition we took photos for a second visual proof.

We focused on capturing the essential elements of the facade, such as the overall shape, major architectural features, and the positioning of doors and windows. While these sketches did not include fine ornamental details, they accurately represented the building's general structure and proportions.

To enhance the clarity and usefulness of these hand-drawn sketches, we often employed a color-coding system. This technique involves using different colors to distinguish various elements of the drawing. For instance, the main outline of the facade was drawn in black, providing a clear boundary for the structure. Measurement chains, which indicate the specific dimensions of different parts of the building, were added in blue, making them easily distinguishable from the main sketch. Additional notes or annotations were written in different colours, allowing for quick identification of important details or areas requiring further attention like shown in Picture (Fig 2.7.2).

This color-coding approach not only improves the readability of the sketch but also aids in the organization of information. It allowed us to quickly reference specific aspects of the building during the measurement process and

---

101 cf. McLine Studios. „What are Architectural Elevation Drawings and Its Importance?“ (24.11.2023). Accessed 12.07.2024. <https://mclinestudios.com/architectural-elevation-drawings/>

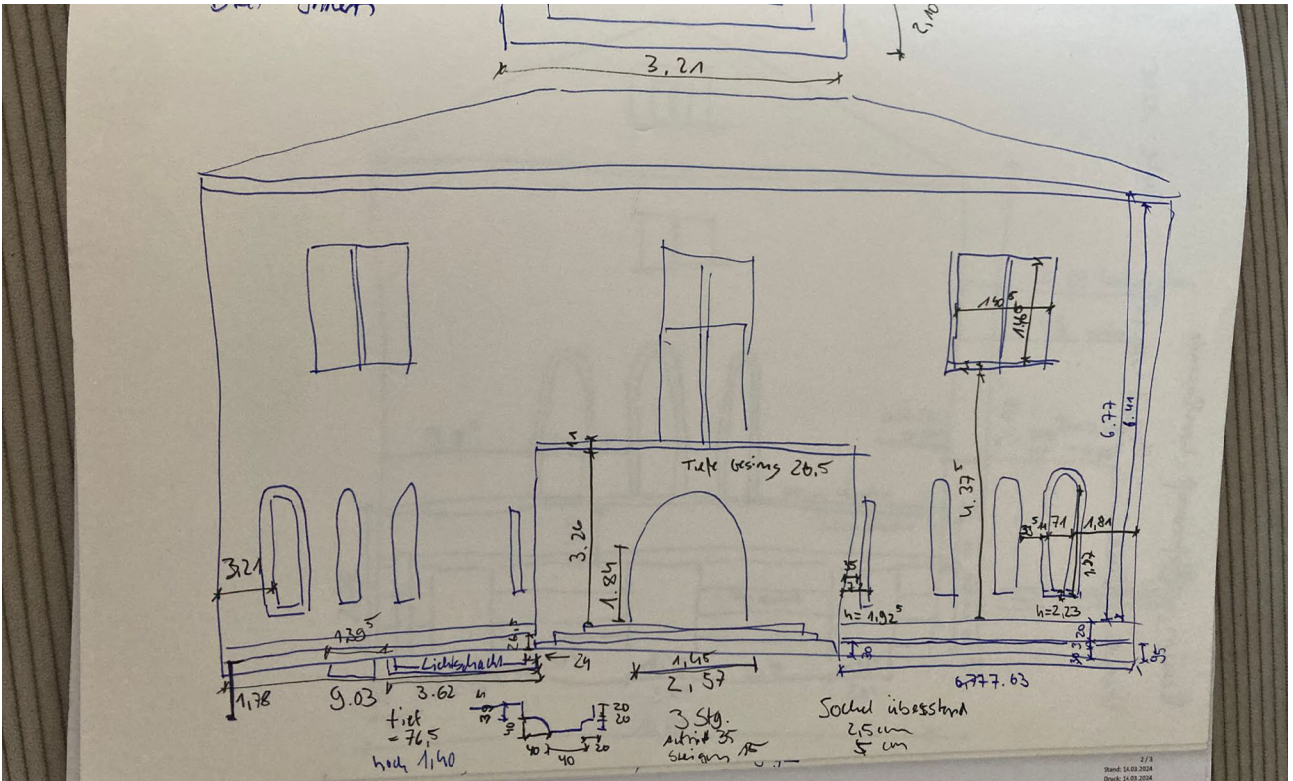

Fig. 2.7.5: Hand sketch, entrance Northfacade

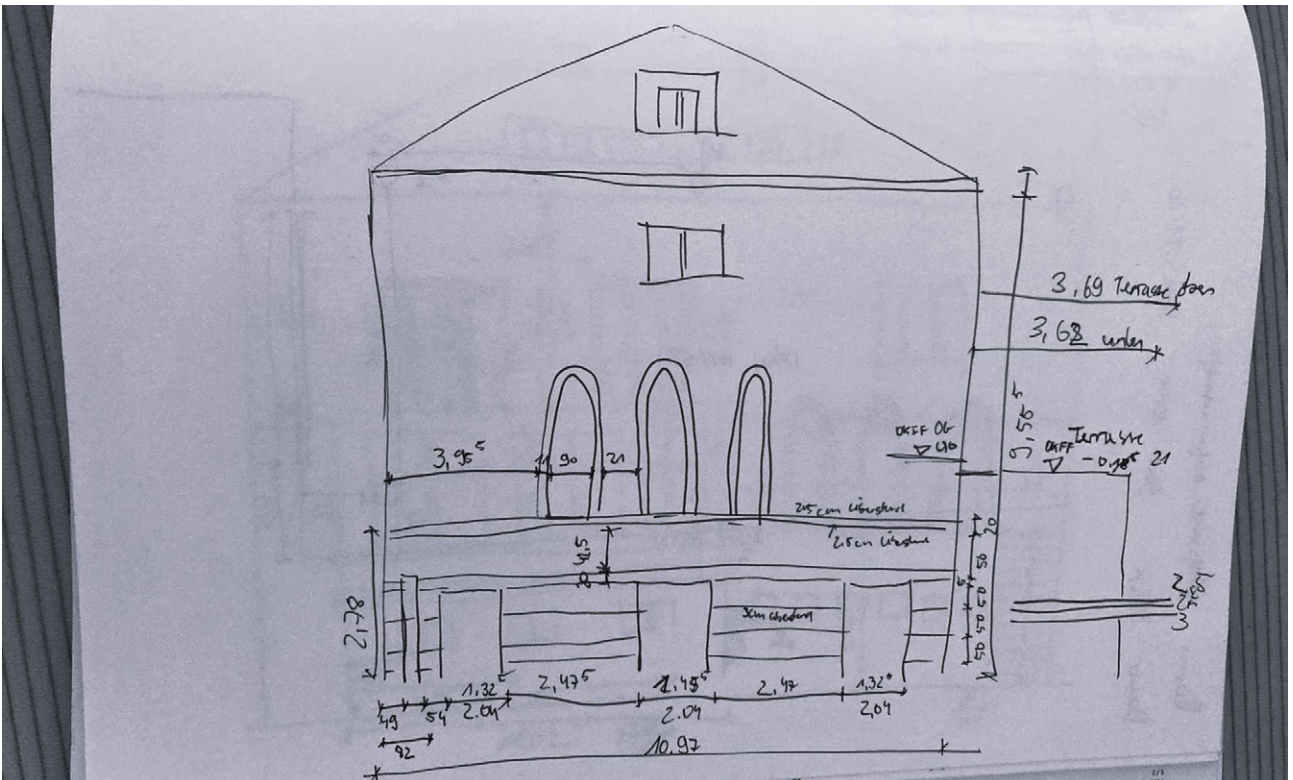

Fig. 2.7.6: Hand sketch, Westfacade

facilitates easier interpretation of the sketches when we created more detailed drawings or 3D models back in the office. The use of colors transforms these quick sketches from simple outlines into information-rich documents that form a part of the architectural documentation process.

## INSIDE

After completing the exterior measurements, we went inside to the interior of the building to conduct a detailed assessment of individual rooms. This interior survey process is comprehensive and methodical. We began by measuring the length and width of each room, using folding rule or laser distance meters (Fig. 2.7.7) to capture accurate dimensions. Afterwards we focused on doorways, recording both the width and height of each opening.

Ceiling heights are another critical aspect of the interior survey. We measured the distance from the floor to the ceiling in multiple locations within each room, noting any variations that might indicate sloped ceilings or other architectural features. Window positions are carefully documented, including their distance from adjacent walls and their dimensions (Fig. 2.7.8).

Throughout this process, we remained focused for any unique architectural features or irregularities that could impact the overall layout. We also paid attention to any signs of alterations or additions to the original structure, such as changes in flooring materials, variations in wall thickness, or differences in architectural styles between rooms, even noting the height of interior stairs (Fig. 2.7.9).



Fig. 2.7.7: Manual Measurement inside, second floor



Fig. 2.7.8: Documenting windows details



Fig. 2.7.9: Manual Measurement inside, interior stairs

In the specific case of the Ohlendorffsche Villa in Hamburg, the manual measurement process followed the general structure of architectural surveying but encountered some unique challenges. We began the work by measuring all four exterior walls of the villa, carefully recording the lengths and heights of each wall. This provided the basic outline and scale of the building. Following this, we documented the position, width, and height of the main entrance door and all windows on the facade. This detailed recording of openings was crucial for creating accurate elevations and understanding the architectural composition of the villa.

Due to the absence of existing elevation plans for the Ohlendorffsche Villa, our team was required to create quick hand-drawn sketches of the facades on site (Fig. 2.7.2, 2.7.5, 2.7.6). These sketches, while necessarily lacking in fine detail due to time constraints, served as a

visual references for our documentation process. To enhance the clarity and usefulness of these rapid drawings, we implemented a color-coding system. This approach allowed us to efficiently differentiate between various architectural elements and measurement data. For instance, we used one color to outline the general facade structure, another to denote measurement chains, and additional colors to highlight other important features or notations. By employing this color-coded method, we were able to maintain a high level of organization and clarity in our sketches, despite the speed at which we needed to work. This systematic use of color not only aided in the immediate recording of information but also proved invaluable during the later stages of our documentation process, allowing for easier interpretation and translation of our field notes into more detailed architectural drawings.

The oval annex on the ground floor of the Ohlendorff Villa (Fig. 2.7.3, 2.7.4) was a bit more complex. To determine the exact location, we calculated the distances between the extension and the edges of the building. We then measured the circumference with a tape measure to precisely define the round extension.

After completing the time-consuming exterior measurements, we proceeded to the first floor of the Ohlendorff Villa. Here, we systematically measured each room individually, employing a meticulous approach to capture all relevant details. We recorded the dimensions of door openings, carefully measuring both width and height to ensure accuracy including the door frame. We also documented the ceiling heights in each room, noting any variations that might exist. Window positions were precisely measured and recorded, including their dimensions and placement within the walls.

Throughout this interior survey, the team paid particular attention to any architectural pecu-

liarities or notable features that distinguished the Ohlendorffsche Villa from more conventional structures. This included documenting unique moldings, intricate ceiling designs, unusual room layouts, or any historical elements that contributed to the villa's character. By focusing on these distinctive aspects, we aimed to capture not just the basic dimensions of the space, but also the architectural elements that make the Ohlendorffsche Villa a unique and historically significant building.

The comprehensive approach to manual measurement employed at the Ohlendorffsche Villa, though demanding in terms of time and effort, proved invaluable in providing us with more understanding of the building's architectural composition. By physically engaging with every aspect of the structure, from its overall dimensions to its smallest details, we gained insights that go beyond mere numerical data. This hands-on process allowed us to literally feel the textures of materials, observe the subtle variations in construction techniques, and experience the spatial relationships between different elements of the building firsthand.

Throughout the manual measurement process of the Ohlendorffsche Villa, comprehensive photographic documentation played a role in complementing the physical measurements and hand-drawn sketches. One team member captured numerous images of all aspects of the building, ensuring a thorough visual record to accompany the dimensional data.

Exterior photography focused on capturing clear, well-lit images of all four facades. These photographs were taken from various angles to document the overall architectural composition, as well as close-up shots to record intricate details of ornamental features, building materials, and the condition of the structure (Fig. 2.7.10, 2.7.11) . Special attention was paid to capturing the unique oval annex, ensuring its

distinctive shape was well-documented from multiple perspectives.

For the interior, each room was systematically photographed. Wide-angle shots were taken to capture the entire space, while more focused images documented specific elements such as doorways, windows, ceiling details, and flooring. Any notable architectural features, such as decorative moldings, fireplaces, or built-in furnishings, were given particular attention, with multiple shots taken to ensure all details were clearly visible.

We also made sure to photograph any unusual or particularly significant aspects of the villa. In addition to standard shots, one team member took context images showing the relationship between different spaces and how they connected. This was particularly useful for understanding the flow and layout of the building, especially in areas where the floor plan might be complex or unusual.

All photographs were carefully labeled and organized to correspond with the measurements and sketches, creating a comprehensive visual reference that could be easily cross-referenced with the numerical data. This approach to photographic documentation not only supported the accuracy of the manual measurements but also provided a valuable resource for future reference, analysis, and potential restoration work.

The extensive photographic record serves multiple purposes: it aids in the verification of measurements, provides visual context for the written and numerical data, and preserves a detailed snapshot of the building's condition at the time of the survey.



Fig. 2.7.10: Photo documentation, entrance



Fig. 2.7.11: Photo documentation, Texture + Material of the westfacade



# 4 DATA PROCESSING

## DATA EDITING

The process of translating manual measurements into a digital format begins with the creation of a basic 2D floor plan using Archicad 27 software. This step is important as it lays the groundwork for the entire 3D modeling process. We started by inputting the exterior measurements of the building, carefully transcribing the lengths and widths recorded during the on-site survey. This established the overall footprint of the structure, providing a precise outline that serves as the foundation for all subsequent modeling work.

Once the exterior boundaries are set, we proceeded to add interior elements to the 2D plan. We placed interior walls according to the measurements taken on-site, ensuring that room dimensions accurately reflect the physical space. Doors are then inserted into the plan, with their positions and sizes carefully aligned with the recorded data. Similarly, windows are added, their locations and dimensions precisely mapped based on the manual survey notes. Throughout this process, the hand-drawn sketches created during the on-site measurement serve as valuable references, helping us to visualize the layout and cross-check the digital representation against their firsthand observations of the building's structure.

As the 2D plan takes shape in the CAD software, we began the process of transforming it into a three-dimensional representation. This transformation starts with the extrusion of walls, a technique that involves extending the 2D wall lines vertically to create solid, three-dimensional structures. The height information collected during the manual measurement process is applied to each wall, ensuring that they accurately reflect the actual dimensions of the building (Fig. 2.7.12).

Simultaneously, ceiling heights are incorporated into the model. These measurements, ca-

refully recorded during the on-site survey, are used to define the vertical spaces within the structure. The team pays close attention to any variations in ceiling height throughout the building, as these can significantly impact the overall spatial representation.

Each wall, floor, and ceiling element must be placed with precision, adhering strictly to the measurements obtained during the manual survey. We constantly refer back to our field notes and sketches, cross-checking dimensions to ensure that every component of the 3D model accurately represents its real-world counterpart.

The accuracy of this stage is paramount, as it forms the foundation upon which all subsequent detailing will be based. Any discrepancies or inaccuracies introduced at this point could propagate through the entire model, potentially compromising its overall reliability. Therefore, we verified each measurement and placement, often double-checking their work to maintain the highest level of accuracy possible in translating the manual measurements into the digital 3D environment.

Windows and doors are inserted into the 3D model using the precise dimensions and positions that were recorded during the on-site manual survey. This involves carefully placing each opening at its exact location on the walls, ensuring the width, height, and sill heights match the measurements taken on-site. For unique architectural features, such as the oval annex in the Ohlendorffsche Villa, standard modeling tools may be insufficient. These elements often require specialized modeling techniques or custom-built geometric shapes to accurately capture their distinctive forms in the 3D environment. This process may involve using advanced CAD functions like lofting, sweeping, or creating custom parametric objects to faithfully represent the curved surfaces and non-standard geometries of such architectural elements.

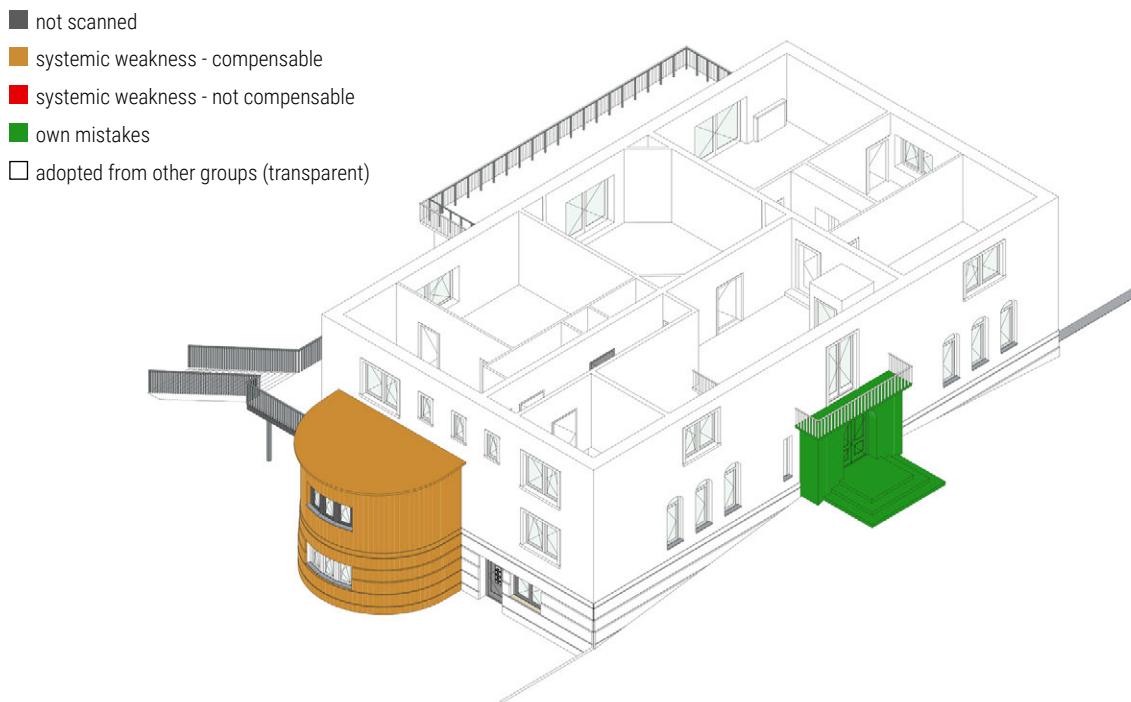

Fig. 2.7.12: 3D Modell, extruded facades and interior walls, North-east

Throughout the process of creating a 3D CAD model, the hand-drawn sketches produced during the manual measurement serve as invaluable references. These sketches, although not drawn to scale, provide information about the relative positions of architectural elements within the building. They offer a visual guide that helps surveyors and modelers understand the spatial relationships between different components of the structure. This visual information is particularly useful when translating the two-dimensional measurements into a three-dimensional digital environment, as it aids in visualizing the overall layout and composition of the building.<sup>102</sup>

Moreover, the photographic documentation taken during the on-site survey proves to be an essential complement to these sketches. Pho-

tographs capture details that might be missed in hand drawings and provide a realistic representation of textures, colors, and intricate architectural features. They serve as a crucial reference point for accurately placing elements within the 3D model and help in verifying the accuracy of measurements and sketches. The combination of hand-drawn sketches and photographic evidence ensures a more comprehensive and accurate translation of the physical building into its digital counterpart, bridging the gap between manual observation and digital representation.

One of the significant challenges in translating manual measurements into a digital 3D CAD model lies in the interpretation of hand-measu-

102 cf. Heine, Katja; Rheidt, Klaus; Henze, Frank and Riedel, Alexandra. „Erfassen, Modellieren, Visualisieren. Von Handaufmass bis High Tech III. 3D in der historischen Bauforschung“ (Verlag Philipp von Zabern, 2011). [https://publik.tuwien.ac.at/files/PubDat\\_204526.pdf](https://publik.tuwien.ac.at/files/PubDat_204526.pdf)

red data within a precise digital environment. Manual measurements, despite the surveyor's best efforts, often contain slight inaccuracies or inconsistencies. These can arise from various factors such as human error, limitations of measuring tools, or the inherent complexities of measuring irregular architectural features.<sup>103</sup> When inputting these measurements into a CAD system, these small discrepancies become more apparent. For instance, walls that should be parallel might not align perfectly, or the sum of individual room measurements might not exactly match the overall building dimensions. These inconsistencies need to be carefully reconciled to create a coherent and accurate 3D representation.

### INDIVIDUAL ADJUSTMENT

Addressing these discrepancies requires careful judgment from the CAD modeler. They must decide whether to strictly adhere to each individual measurement or to make slight adjustments for overall coherence. In some cases, this might involve calculating averages of multiple measurements for a single element or making informed estimations based on the surveyor's notes and sketches.

The goal is to create a 3D model that best represents the actual building while maintaining the integrity of the manual survey data. This process often involves a delicate balance between preserving the nuances captured by hand measurements and ensuring the geometric consistency required in a digital 3D model. It's a task that combines technical skill with architectural understanding, as the modeler must make decisions that respect both the physical reality of the building and the principles of digital modeling.

As the 3D CAD model of the Ohlendorffsche Villa progresses, the team incorporates increasingly detailed elements based on the meticulous notes and observations recorded during the manual survey, like outside terrace and details such as handrails (Fig. 2.7.13, 2.7.14). These additions bring the digital representation closer to the actual building's appearance and character. For instance, the unique structure on the outside wall of the basement, a distinctive feature of the villa, is carefully modeled based on the hand-drawn sketches and measurements taken on-site. This process involves translating the surveyors' notes on architectural details, such as ornate moldings, window trims, or the specific texture of the exterior walls, into the digital environment.

The final step we compared the 3D Modell to the measurement notes. It helps to identify any discrepancies between the digital representation and the actual building measurements. These discrepancies might arise from data input errors, misinterpretations of hand-written notes, or limitations in the CAD software's ability to represent certain architectural features accurately. Moreover, this final review serves as a quality control measure, ensuring that the digital model is as faithful as possible to the physical structure. It provides an opportunity to make final adjustments, refine details, and ensure that the 3D model serves as an accurate and reliable digital documentation of the building.

By translating the manual measurement data into a 3D CAD model, we created a detailed digital representation of the Ohlendorffsche Villa. It highlights the strengths and limitations of manual surveying, showing where this traditional method excels in capturing architectural details and where it might fall short compared to more advanced technological approaches.

---

103 cf. Bauprofessor-Redaktion. Bauprofessor Lexikon. "Bauberechnung Aufmaß" (15.09.2023). Accessed 01.07.2024. <https://www.bauprofessor.de/aufmass/>

- not scanned
- systemic weakness - compensable
- systemic weakness - not compensable
- own mistakes
- adopted from other groups (transparent)

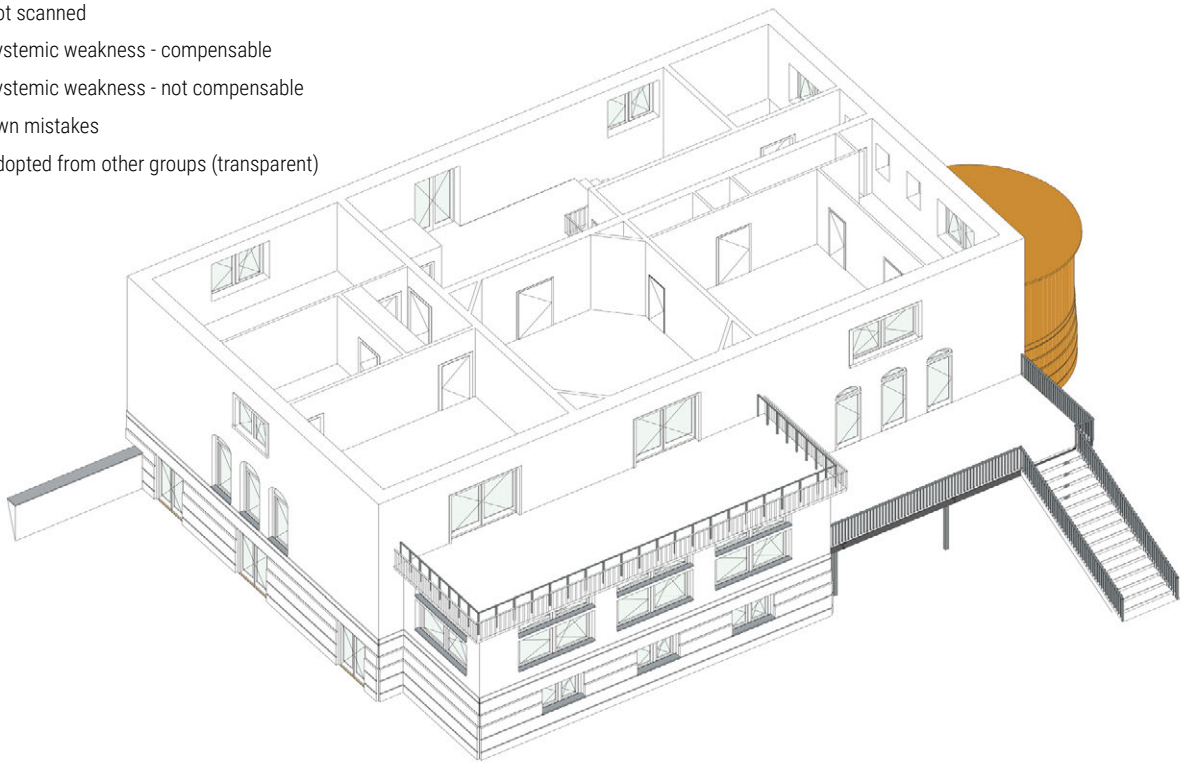

Fig. 2.7.13: 3D Modell, extruded facades and interior walls, south-west

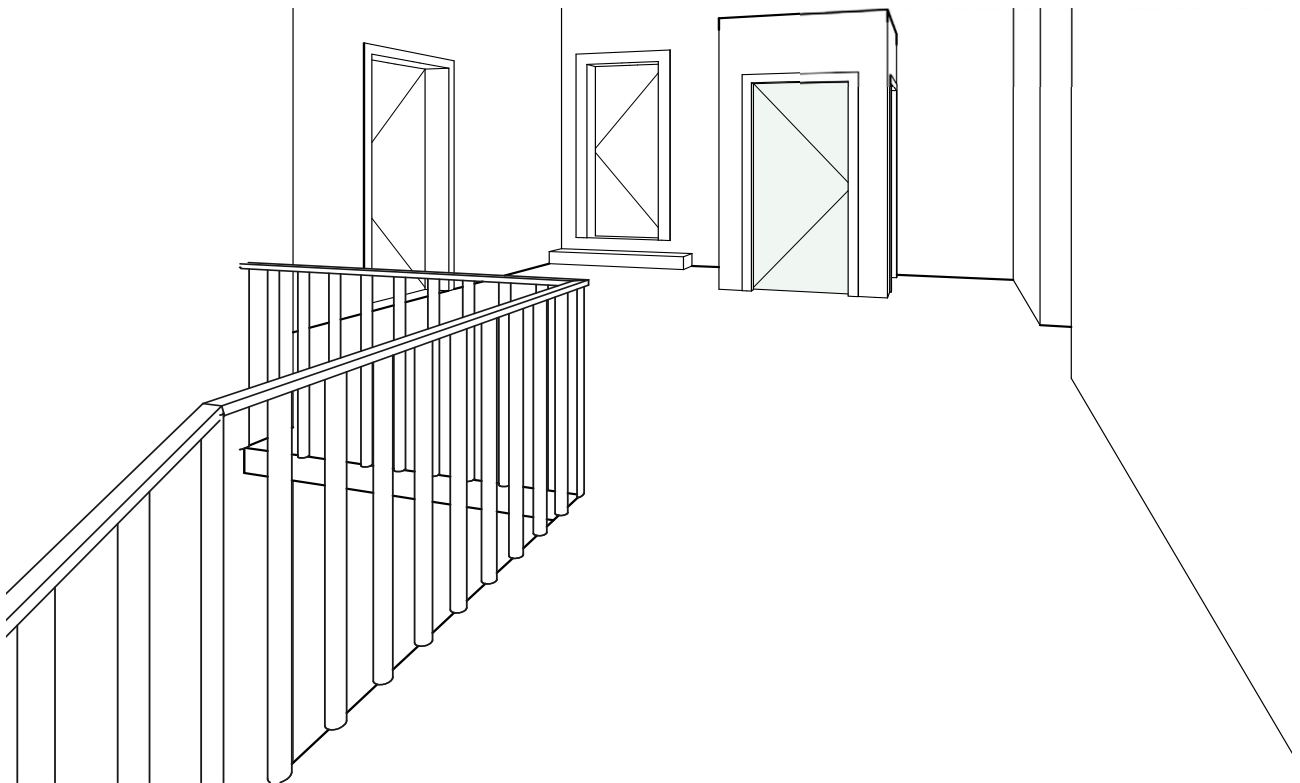

Fig. 2.7.14: 3D Modell, interior view first floor, Doors and handrail

# 5 EVALUATION

Manual surveying, a traditional method in architectural documentation, is a technique that has stood the test of time despite the advent of modern technologies, because it's the fastest method of measuring smaller buildings and details, as windows and doors. This approach involves hands-on measurement and detailed observation of a building or structure, using simple tools such as tape measures, folding rulers, and laser distance meters. While it remains a valuable skill in the field of architecture and preservation, manual surveying presents a nuanced landscape of both strengths and weaknesses that require thorough examination. One of the most significant advantages of manual surveying lies in its ability to provide surveyors with a profound understanding of the structure they are documenting. As professionals physically measure each element of a building, they engage with its form, materials, and construction techniques in a direct and tactile manner. This hands-on process allows surveyors to notice subtle details, irregularities, and unique features that might be overlooked by more automated methods. The act of carefully measuring and recording dimensions fosters a deep connection between project architect and the building, often leading to insights about its history, modifications over time, and architectural significance.

Moreover, this intimate interaction with the structure often results in a more comprehensive documentation process. Surveyors are likely to observe and record details that may not have been part of the original survey plan, simply because they are physically present and actively engaged with every aspect of the building. This level of detail and understanding is particularly valuable in historic preservation projects, where a thorough comprehension of a structure's

nuances can inform sensitive restoration or renovation efforts.

The applicability and effectiveness of manual surveying techniques are heavily dependent on environmental conditions, particularly weather. These external factors can significantly impact both the accuracy of measurements and the overall feasibility of the surveying process.<sup>104</sup> Overcast days typically offer optimal conditions for utilizing laser distance meters, as the diffused light reduces glare and interference with the laser beam. This allows for more precise and reliable readings, especially when measuring longer distances or reflective surfaces. Conversely, strong sunlight can pose substantial challenges to the use of laser distance meters. Intense solar radiation can interfere with the laser beam, making it difficult for the device to accurately measure distances.<sup>105</sup> This interference can lead to inconsistent or incorrect readings, potentially compromising the integrity of the entire survey. In such conditions, surveyors may need to rely more heavily on traditional measuring tools or adjust their working hours to avoid peak sunlight periods.

One of the primary strengths of manual surveying lies in its remarkable adaptability to a wide range of architectural features. This method excels particularly in measuring complex elements that often challenge automated systems. Curved surfaces, for instance, can be meticulously traced and measured by hand, allowing for a more accurate representation of their true form. Intricate architectural details, such as ornate moldings or irregular stonework, benefit from the surveyor's ability to carefully navigate and measure each nuance. Hard-to-reach areas, which might be inacces-

104 cf. Giese, Jürgen. „Im Dschungel der Aufmaßprodukte. Ergebnisformen der Bauvermessung gezielt auswählen, ausschreiben und nutzen“ - „Aufmaßprodukte und Ausschreibung“ (2021). <https://core.ac.uk/download/pdf/196308604.pdf>

105 cf. Streit Datentechnik GmbH. „Aufmaß – Definition, wichtige Infos & Tipps für Handwerker!“. Accessed 12.07.2024. <https://www.streit-software.de/wissen/aufmass>

sible to larger, automated equipment, can often be accessed and measured effectively by a skilled surveyor using handheld tools. This level of adaptability ensures that even the most complex or unique architectural elements are accurately documented. However, it's important to note that this versatility comes with a significant trade-off. Manual surveying of such detailed features is inherently time-consuming, requiring patience and meticulous attention to detail. It also demands considerable physical effort, especially when dealing with large structures or challenging access points. This increased time and labor intensity can impact project timelines and resource allocation, making it crucial to balance the need for detailed manual measurements with overall project efficiency.

Manual surveying is typically a collaborative effort that benefits significantly from the involvement of at least two people<sup>106</sup>, we recommend one person for measuring and one for taking notes. Our team consisted out of 3 project architects. Two of us took the measuring with the folded ruler and laser distance meter and the other one took notes. This team-based approach is for ensuring both accuracy and efficiency throughout the measurement process. In a typical scenario, one team member takes on the role of measuring, utilizing tools such as tape measures, laser distance meters, or folding rulers to obtain precise dimensions of various architectural elements. Simultaneously, their partner focuses on meticulously recording these measurements, often sketching and annotating notes to provide context for the data.

This division of labor serves multiple purposes. Firstly, it substantially reduces the risk of errors that might occur if a single person were

attempting to both measure and record simultaneously. The dedicated recorder can focus entirely on accurately documenting the measurements, while the measurer concentrates on obtaining precise readings. Secondly, this approach significantly accelerates the overall surveying process. The seamless coordination between measuring and recording allows for a continuous flow of work, minimizing delays and maximizing productivity.

Essential tools for manual surveying include tape measures, folding rulers (Zollstocks), laser distance meters, and traditional measuring equipment. Each tool has its strengths and limitations. For instance, tape measures excel at measuring curved surfaces but can be challenging to keep taut over long distances. Laser distance meters offer quick and accurate measurements for longer distances but may struggle with reflective surfaces or in bright sunlight.<sup>107</sup>

One significant limitation of manual surveying becomes apparent when dealing with large structures. As the length of a building increases, maintaining accuracy with traditional tools such as tape measures and folding rulers becomes increasingly challenging. Over extended distances, it is difficult to keep these tools taut and aligned, leading to potential measurement errors. This constraint underscores the necessity for alternative methods or specialized equipment, such as total stations or laser scanning devices, which are better suited for capturing precise measurements over large scales. These advanced tools can provide the accuracy and efficiency required for larger-scale projects, where manual methods might fall short.

---

106 cf. Egger, Martin. „Nutzen und Möglichkeiten mobiler Bauabrechnungssysteme“ (Grin, 2012). <https://www.grin.com/document/274450>

107 cf. Streit Datentechnik GmbH. „Aufmaß – Definition, wichtige Infos & Tipps für Handwerker!“. Accessed 12.07.2024. <https://www.streit-software.de/wissen/aufmass>

As the manual measurement process of the Ohlendorff Villa progressed, an inevitable challenge emerged that is common to large-scale hand surveys: the gradual decline in energy and concentration among the surveying team. This natural phenomenon, while understandable, had notable implications for the accuracy and completeness of the collected data.

With the passing hours, the initial enthusiasm and sharp focus began to wane. The meticulous attention to detail that characterized the early stages of the survey slowly gave way to a more hurried approach. This shift, though subtle at first, manifested in various ways throughout the latter part of the measurement process.

One of the most noticeable effects was the increasing occurrence of oversight errors. Measurements that would have been double-checked earlier in the day were sometimes overlooked or hastily recorded without verification. In some instances, crucial dimensions were entirely forgotten, leaving gaps in the otherwise comprehensive dataset.

Moreover, the accuracy of notation suffered as fatigue set in. Numbers were occasionally transposed or miswritten, introducing potential inaccuracies into the final documentation. These errors, while often small in isolation, could compound to create significant discrepancies if left uncorrected.

It's important to recognize that this gradual decrease in precision is a natural and almost unavoidable aspect of large-scale manual measurements like that of the Ohlendorff Villa. The sheer size and complexity of the building, combined with the physical and mental demands of the survey process, inevitably lead to a decline in performance over time.

This phenomenon underscores the importance of strategies to mitigate such errors. Regular breaks, rotation of tasks among team members, and systematic double-checking procedures can help maintain accuracy throughout

the survey process. Additionally, acknowledging this tendency allows for a more critical review of the collected data in the post-survey phase, ensuring that any errors can be identified and corrected before final documentation is produced.

Perhaps one of the most valuable aspects of manual surveying is the profound understanding of the building it imparts to the surveyors. The process of actively measuring and documenting each element of a structure encourages a level of engagement and observation that can reveal insights about construction techniques, historical modifications, and architectural peculiarities that might be missed by more detached, automated methods.

In conclusion, while manual surveying faces challenges in terms of weather dependency, time consumption, potential for human error and tiredness, it remains a valuable technique in architectural documentation. Its ability to provide a tactile, comprehensive understanding of a structure, coupled with its adaptability to complex architectural features, ensures its continued relevance in the field. However, practitioners must be aware of its limitations, particularly in large-scale projects, and be prepared to complement it with more advanced surveying technologies when necessary. The future of architectural surveying likely lies in a balanced approach, combining the intuitive understanding gained from manual methods with the precision and efficiency of modern technological solutions. As shown in the final Model, the manual measurement still is an indispensable tool (Fig. 2.7.15, 2.7.16).

- not scanned
- systemic weakness - compensable
- systemic weakness - not compensable
- own mistakes
- adopted from other groups (transparent)

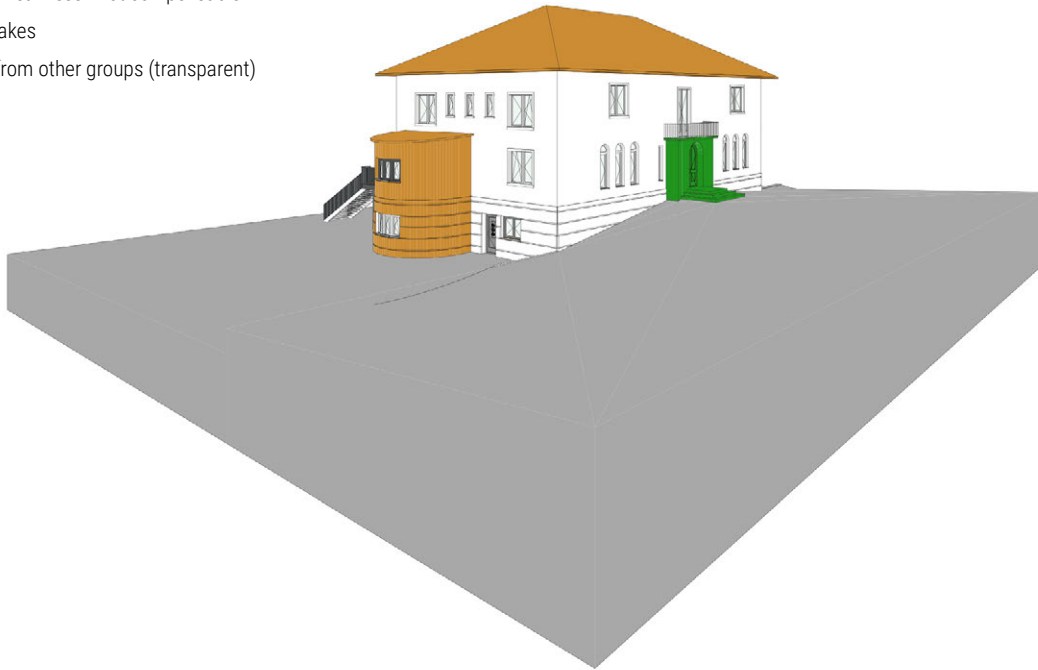

Fig. 2.7.15: 3D Modell, nort-east

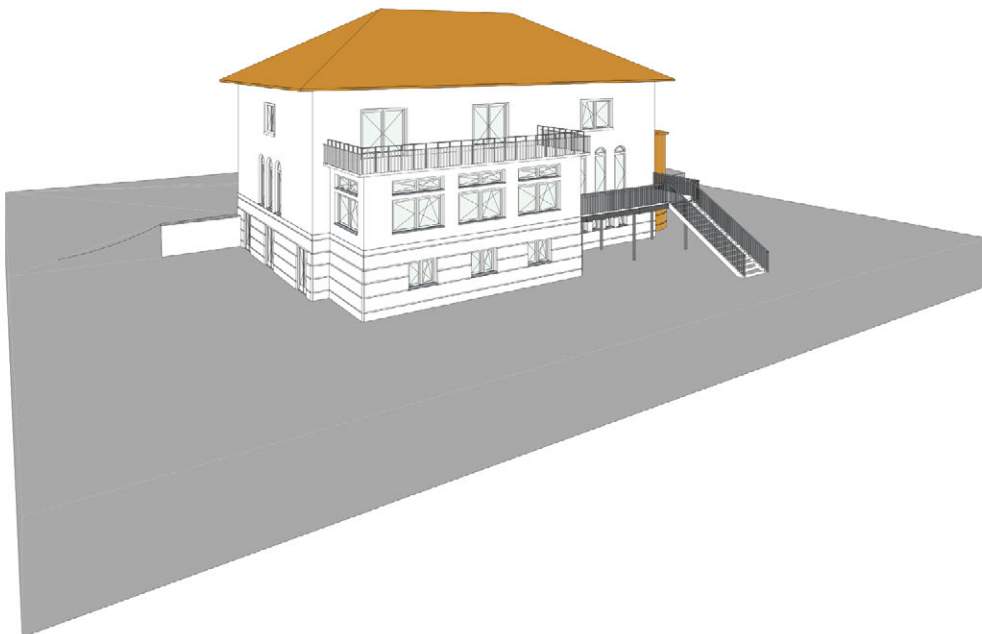
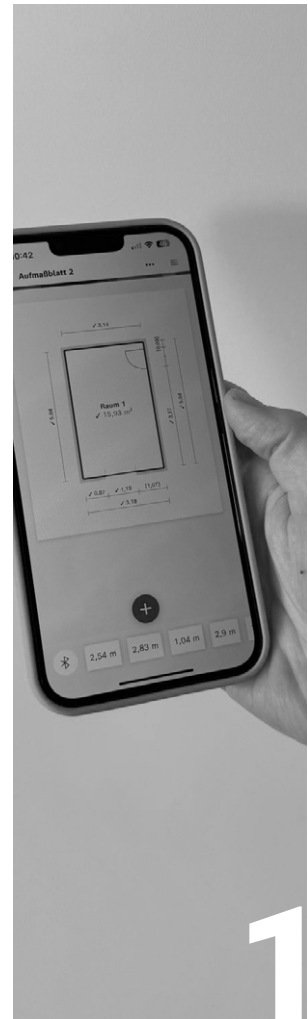

Fig. 2.7.16: 3D Modell, south-west



# MANUAL - DISTO/APPS



## INTRODUCTION

Team	250
Description	250
Requirements	251

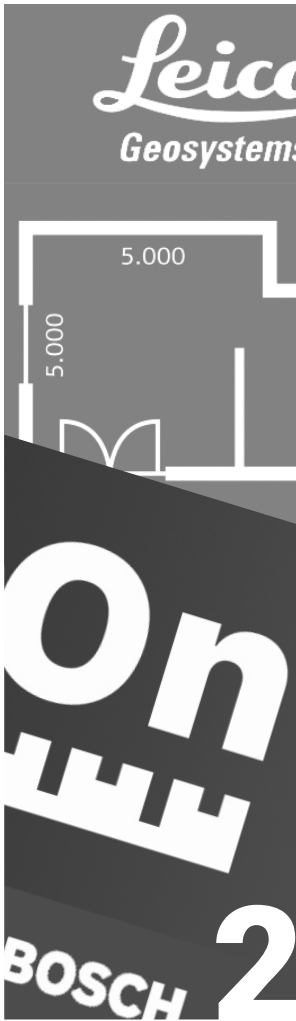

**PREPARATION**

Preparation 254



**SITE MEASUREMENT**

Site Measurement 260

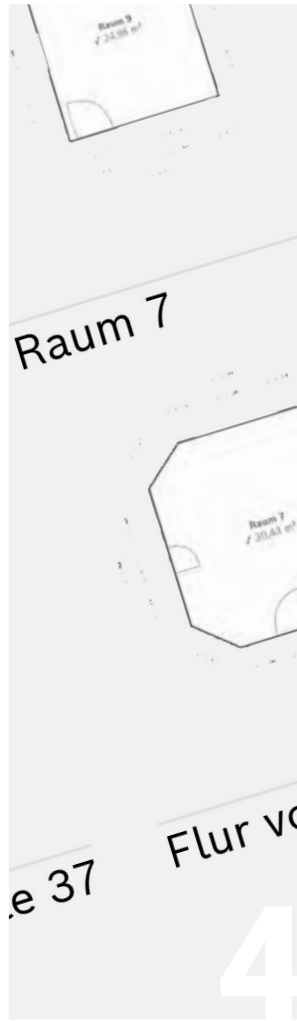

**DATA PROCESSING**

Data Editing 262  
3D Model 264

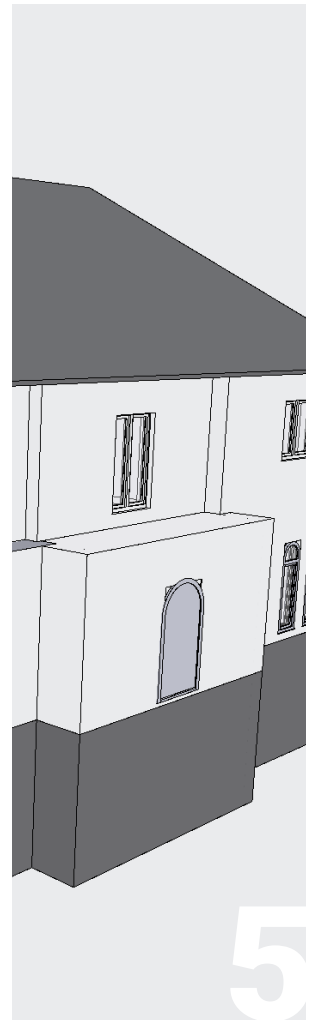

**EVALUATION**

Evaluation 266

# 1 INTRODUCTION

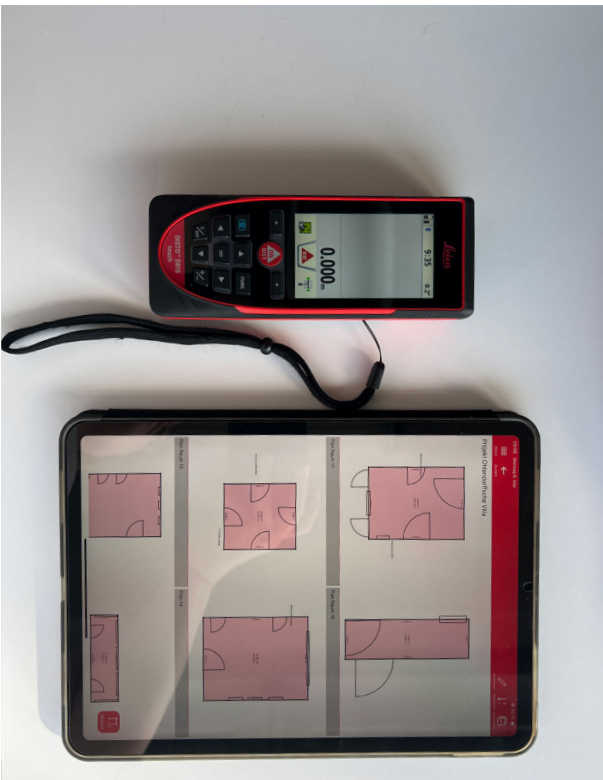

Fig. 2.8.1: Leica D810 Disto with Leica Disto Plan App

## DESCRIPTION

To enable quick, easy, and accurate inventory recording, various companies offer apps and digital products alongside their measuring devices for further processing of measurement data. Due to their availability to students, the systems of Leica and Bosch will be examined in more detail below and compared with other methods of inventory digitisation.

### System presentation Leica

The Swiss company Leica Geosystems<sup>108</sup> offers a solution for inventory recording, which consists of the Disto Plan App<sup>109</sup>, in combination with a range of measuring devices produced by the company. In this particular instance, the Leica Disto D810 measuring device was used. The app serves to complement the D810 (Fig. 2.8.1) by processing, visualising, and exporting the recorded measurement data of the surveyed rooms. Firstly, the devices used, need to be paired via Bluetooth to establish a connection. Then the measured Data is transferred from the Disto D810 to the App, where it can be assembled into floorplans or put into sketches or photos. Finally, the plans can be exported in various formats, as detailed in Chapter 4, Data Editing (p. 262).

The Leica Disto Plan App may be subject to charges depending on its functionality. Some features such as point to point measure can only be used with a subscription. A monthly subscription for 1,99 euros and an annually renewing subscription for 12.99 euros (as of 02.08.2024) is available. The 'Unlimited' product is a one-time purchase for 49.99 euros

108 cf. Leica. „Wer wir sind“. Accessed 02.08.2024. <https://leica-geosystems.com/de-de/about-us/summary>

109 cf. Leica. „Messungen digital dokumentieren“. Accessed 02.08.2024. <https://shop.leica-geosystems.com/de/de-DE/measurement-tools/disto/leica-disto-plan-app>

(as of 02.08.2024)<sup>110</sup>. However, a free trial month allows for the full features to be tested. It is no longer possible to purchase the measuring device D810 from Leica, as newer versions have been developed since. Prices from alternative suppliers range from 844,66 euros (as of 30.05.2024)<sup>111</sup> to 1.104,95 euros (as of 07.07.2024)<sup>112</sup>.

### System presentation Bosch

The German company Bosch offers the Bosch Measuring Master App also in combination with a range of measuring devices produced by the company. The application's objective is to provide an optimal solution for on-site documentation of floor plans, measurements, photographs, and notes. It promises significant time savings for tasks such as measuring, documentation, and quantity calculation. Data storage can be extended via a cloud solution.<sup>113</sup> For the research at hand, the Bosch PLR 50 C was used.

The smartphone or tablet app (Fig. 2.8.2) is paired with the Bluetooth-enabled Bosch PLR 50 C by establishing a connection between the two devices. Once this initial pairing is complete, the user can proceed with setting the basic parameters, such as the unit of measurement and project information. When the data has been collected, the floor plan is created in the app. The plan can then be exported in two file formats (see chapter 4, p. 262) and edited further (Fig. 2.8.3).



Fig. 2.8.2: Bosch PLR 50 C Disto with Measure Master App

Since August 2016, Bosch's App has been available for free in the Apple App Store and Google Play Store.<sup>114</sup> However a monthly subscription of 9,99 or 14,99 euros or a yearly subscription of 149,99 euros (as of 07.06.2024) is necessary to export the project folder, rather than single sheets or sketches. The measuring device costs 110,24 euros (as of 10.07.2024).<sup>115</sup>

110 cf. Apple. „App Store“. Accessed 02.08.2024. <https://apps.apple.com/de/app/leica-disto-plan/id1361178866>

111 cf. 1a Fachhandel. „Leica Entfernungsmesser Disto D810 Touch“. Accessed 30.05.2024. <https://www.1a-vermessung.de/shop/leica-entfernungsmesser-disto-d810-touch/5376/2194/1#>

112 cf. Amazon. „Leica DISTO D810 touch – universeller Laser Entfernungsmesser mit Bluetooth (App-Nutzung), Touch screen und integrierter Kamerafunktion (Innen- und Außenbereich)“. Accessed 07.07.2024. [https://www.amazon.de/Leica-DISTO-D810-touch-Entfernungsmesser/dp/B00GY0LQOE?source=ps-sl-shoppingads-lpcontext&ref\\_=fplfs&smid=A91LOH62ZJ4O5&th=1](https://www.amazon.de/Leica-DISTO-D810-touch-Entfernungsmesser/dp/B00GY0LQOE?source=ps-sl-shoppingads-lpcontext&ref_=fplfs&smid=A91LOH62ZJ4O5&th=1)

113 cf. Bosch. „Die Bosch Gruppe im Überblick“. Accessed 07.06.2024. <https://www.bosch.de/unternehmen/bosch-gruppe-weltweit/>

114 cf. Matthews, Willy. Laser-Entfernungsmesser Test. „Die Measuring Master App von Bosch im Test“ (10.06.2016). Accessed 07.06.2024. <https://www.laserentfernungsmesser-test.de/2016/bosch-kuendigt-die-measuring-master-app-an/>

115 cf. Bosch. „Digitaler Laser-Entfernungsmesser PLR 50C“. Accessed 10.07.2024. <https://www.bosch-diy.com/de/de/p/plr-50-c-0603672200>

## REQUIREMENTS

To ensure successful measurements using the Leica and Bosch systems, several parameters and prerequisites must be met.

Firstly, it is imperative to ensure that all devices are fully charged and calibrated before use. This preparation guarantees that the equipment operates at its highest efficiency and prevents unexpected interruptions due to low battery levels or calibration errors.

Secondly, Bluetooth functionality must be enabled and operational on both the measuring devices and the end devices. For the site measurement, the Leica Disto Plan App was installed on an iPad Pro 11 Zoll, 1st generation, while the Measure On App by Bosch was used on an iPhone 13 Pro Max.

Proper Bluetooth connectivity allows for the seamless transmission of measurement data, ensuring that all information is accurately recorded in real-time. It is also essential to verify that the apps are compatible with the software version on the intended end devices. Ensuring compatibility prevents potential software conflicts and ensures smooth operation.

Environmental conditions at the measurement site also significantly affect the performance of the measuring devices. For instance, bright sunlight can reduce the visibility of the laser point, making it difficult or even impossible for the device to measure distances accurately. Moreover, the absence of obstacles that could interfere with measurements is necessary for achieving accurate results. Obstacles can obstruct the laser path or create reflections.

In addition to these considerations, regular verification of the collected data is crucial for maintaining accuracy. This can be accomplished by measuring distances twice and cross-referencing them with an alternative system to confirm consistency. Once the data has been transferred to the app and a floor plan has been generated, further verification can be performed by switching to a 3D view. This allows for a detailed examination of specific features, such as window sills and door heights, ensuring that all elements are accurately captured and accounted for in the final plan.



# 2 PREPARATION

Prior to conducting on-site measurements, we familiarized ourselves with the applications and measurement devices.

After downloading the two different apps from the available App Store or Play Store, an initial examination of the interface in each app was conducted (Fig. 2.8.3 and 2.8.4). The following questions were of high importance:

How is the app structured? Can the programming be described as understandable? What range of functions is included in the app? Is it possible to create a measurement without a subscription? What subscriptions are available and at what price are they offered?

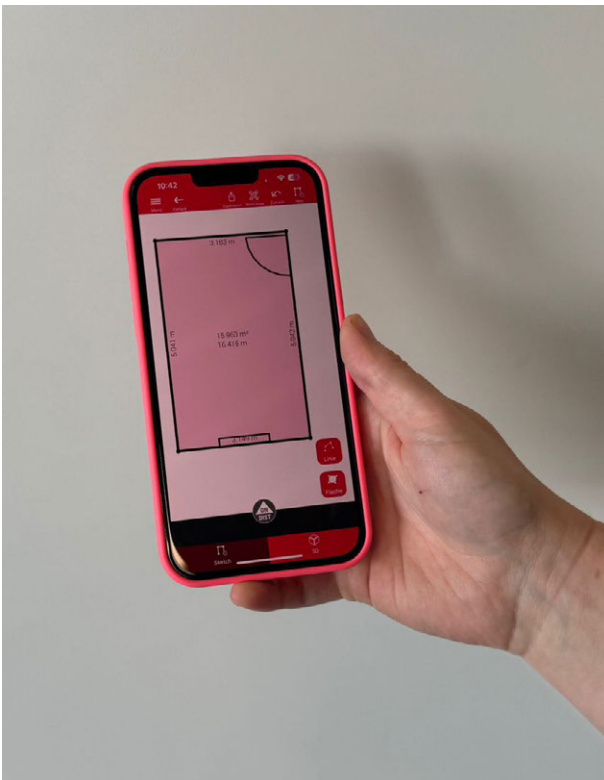

Fig. 2.8.3: Leica Disto Plan App

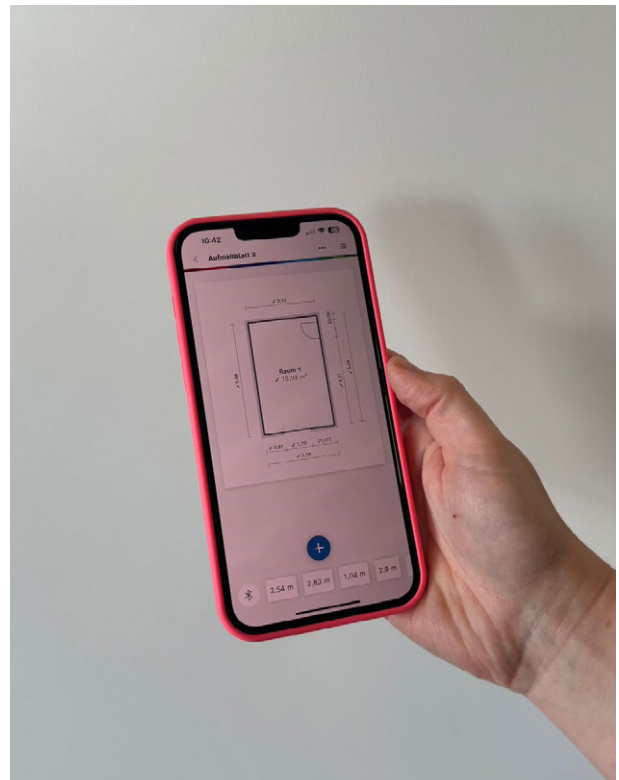

Fig. 2.8.4: Bosch Measure Master App

After a brief review, a sample floor plan was created and an available room was measured (Fig. 2.8.5 and 2.8.6).

During this process, positive and negative experiences were gathered. Additionally, user characteristics were noted and various techniques for measuring were tested. As part of the final review, the battery capacity was evaluated and spare batteries were prepared for use during measurements. A general overview with first impressions was created and listed in Fig. 2.8.7. The comprehensive listing of our findings and first impressions has provided insights on how to use the equipment and how to conduct an on site survey.

In preparation for the on-site measurements, checklists were created to document relevant information. A measuring tape was also taken along, which proved useful in hindsight. The preparation was straightforward as the programs and devices required minimal time. They are characterized by their compact size and can be easily transported.

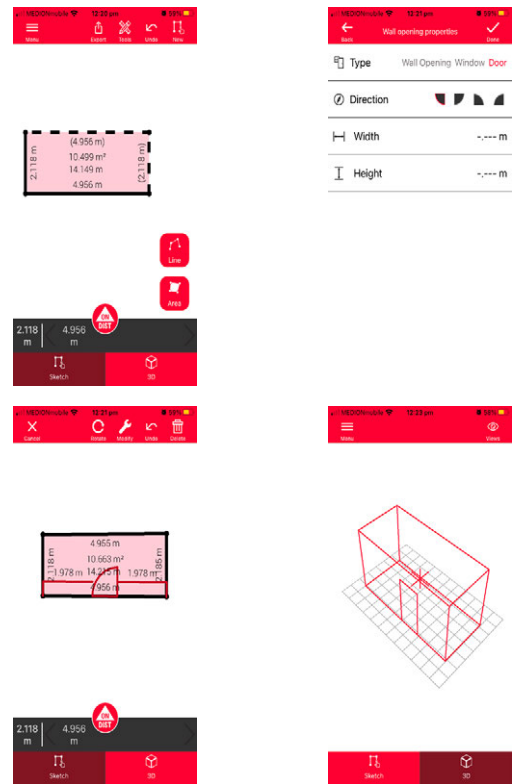

Fig. 2.8.5: Screenshots Leica Disto Plan App

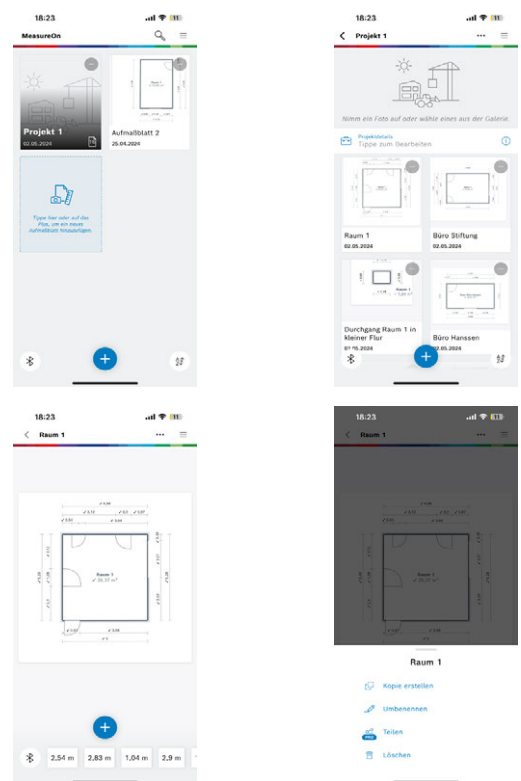

Fig. 2.8.6: Screenshots Bosch Measure Master App



technology criteria	Leica App „Disto Plan“	Leica Disto D810	Bosch App „Measure On“	Bosch Disto PLR 50C
<b>costs</b>	1,99€/ month, 12,99€/ year, 49,99€/ unlimited	varies between 800€/1100€  interchangeable for use with app with all connectible Leica laser distance measurer: Disto D1, D110, D2, D2, X3, D5, X6	9,99 €/ month - for DXF exports and complete PDF reports with com- pany logo - 14,99€/ month PRO version, 5GB cloud storage, unlimited measu- rement sheets and projects synchroni- sed across devices, requires „SingleKey ID“ registration cloud service avail- able only in appro- ved countries	varies between 70€/360€  Interchangeable for use with app with all connecta- ble Bosch laser dis- tance measurers: PLR 30 C, PLR 40 C, and PLR 50 C, as well as GLM 50 C Professional, GLM 100 C Professional, and GLM 120 C Professional.
<b>included for free (without subscrip- tion)</b>	- No P2P measu- rement, not neces- sarily required for creating simple floor plans - Export options available in JPG and PDF Basic	-	- Create projects and measurement sheets - Notes and photos feature - Record distances - Measurement function	-
<b>user-friendliness</b>	Easy to understand during the test - No option to measure ceiling offsets - Simple 3D visu- alization, clear app interface - Various view options - Multiple export options with a sub- scription	- Easy to unders- tand - Bright display, ea- sily readable, even with visual impair- ments - User-friendly with touch display - Easy connection via Bluetooth, ena- bling fast measure- ments - Charged with Mic- ro-USB	- Only 2D visualiza- tion available - Room height can also be measured and recorded - Wall elevation views available - Option to input doors and windows - Photo feature available with the ability to add mea- surements	- Easy handling due to the touch display and device size - Simple Bluetooth connection - Fast measure- ments possible - Perceived longer range between device and app - Battery-powered with 3x AAA batte- ries

Fig. 2.8.7: Comparison of the Leica and Bosch system

<b>technology criteria</b>	<b>Leica app „Disto Plan“</b>	<b>Leica Disto D810</b>	<b>Bosch app „Measure On“</b>	<b>Bosch Disto PLR 50C</b>
<b>user-friendliness (continuation)</b>	<ul style="list-style-type: none"> <li>- Option to input doors, windows, and wall openings</li> <li>- Photo feature available with the ability to add measurements</li> </ul>	<ul style="list-style-type: none"> <li>- The app and laser should always be nearby, otherwise the laser may disconnect</li> </ul>		
<b>accuracy</b>	<ul style="list-style-type: none"> <li>- floor plan representation similar to manual measurements</li> <li>- unsteady base, especially with old, uneven walls</li> </ul>	measured by the laser point (red light spot)	<ul style="list-style-type: none"> <li>- floor plan representation similar to manual measurements</li> <li>- base is slightly more stable, folds out to 90°</li> </ul>	measured by the laser point (red light spot)
<b>process</b>	<ul style="list-style-type: none"> <li>- Sketch room straight lines; angles and irregularities can be included; adjustable after measuring</li> <li>- Digital entry on the device instead of hand-written notes</li> <li>- Accuracy may be low (especially in old buildings).</li> <li>- Very rough measurements; recesses, slopes, and niches may not be represented</li> </ul>	When the base foot is extended on the device, where does the device measure the distance from?	<ul style="list-style-type: none"> <li>- Sketch room straight lines; angles and irregularities can be included; adjustable after measuring</li> <li>- Digital entry on the device instead of hand-written notes</li> <li>- Accuracy may be low (especially in old buildings).</li> <li>- Very rough measurements; recesses, slopes, and niches may not be represented</li> </ul>	When the base foot is extended on the device, where does the device measure the distance from?
<b>e-learning</b>	<ul style="list-style-type: none"> <li>- Numerous webinars, tutorials, and articles are provided by Leica on website/app</li> </ul>	-	<ul style="list-style-type: none"> <li>- Many tutorials on YouTube</li> <li>- No dedicated platform found?</li> </ul>	-

technology criteria	Leica app „Disto Plan“	Leica Disto D810	Bosch app „Measure On“	Bosch Disto PLR 50C
<b>export options</b>	DWG, DXF, PDF, JPEG	-	PDF, JPEG	-
<b>additional features</b>	- Introductions provided before each new project	- direct photo function that requires standing at a distance - self-timer adjustable - built-in calculator - allows adjustment of point of measurement behind, middle, or in front of the laser -measures volume -comes with a level, angle indicator, and memory - inbuilt compass - measure areas of triangles and parallelograms -point to point measurement available	-	- measures volume - includes a level, angle indicator, and adjustable measurement position (behind, middle, or in front of the laser) - measures distance points.
<b>notes</b>	- „Smart Room Function“ not available, as the Disto is not suitable for it - Compatible with iPad (easier with an iPad stylus).	-	Compatible with iPad (easier with an iPad stylus).	-



# 3 SITE MEASUREMENT

After a brief greeting and orientation, we had the opportunity to test our selected systems. Each room was measured sequentially and in parallel using the „MeasureOn App“ from Bosch and the „DISTO Plan App“ from Leica. This approach aimed to directly compare the time required by each system.

During the course of the measurements, a number of obstacles were encountered. Depending on the room being measured, radiator covers and curtains presented challenges. The issue with radiator covers was that they were securely fixed and could not be removed, necessitating adjustments in measuring the room edges accordingly. Radiator covers were also measured and notes were made on the plan. Curtains also obstructed the measurements, necessitating their removal.

The restricted accessibility due to the existing fit out, built in furniture and the built-in elevator also complicated the survey (Fig. 2.8.8). Further complications arose from the architecture itself. Both the Bosch and Leica systems encountered difficulties with the angled walls in Lecture Room 16 (1st floor) and the reception area Room 05 (ground floor). The round shapes of the windows and the cafe area Room 06 (ground floor) were also not measurable in both systems. Additionally, short distances or narrow spaces, such as those behind doors, could not be measured with the laser distance measuring devices. In these cases, we had to resort to using a tape measure for assistance.

Due to the limited range between the Leica Disto and the application on the handheld device, the devices of the Leica System had to be repeatedly reconnected. This unforeseen issue consumed a significant amount of time. Additionally, during the survey, we observed that taking measurements with the Bosch distance measuring device seemed easier than with the Leica Disto. Despite becoming faster over time



Fig. 2.8.8: Using the Bosch Disto for the measurement

and from room to room, our survey proved to be time-consuming. With the Leica Disto Plan App each room took 15,3 minutes to measure (see protocols). The Bosch measurement was slightly faster, however we did not explicitly document the difference. This did not include a detailed inventory of doorframes, windowframes and built in furnitures or stucco detailing.

Moreover, only single-leaf windows and doors could be captured, whereas on-site also multi-leaf doors and windows were present. This information could only be put in later, due to photos and notes taken on site.

Because of time constraints, measurements in the basement, exterior areas, and ground floor kitchen using the systems were not feasible. Subsequently, data collected by the ‚manual measurements‘ group for these areas was utilised during the production of the 3D Model.



# 4 DATA PROCESSING

## DATA EDITING

Following the measurement, the data was exported from the applications. The available export formats included PDF and JPG (Bosch), as well as DWG/DXF and 3D DWG/DXF (Leica). Additionally, the Leica DISTO App provided a report including wall, ceiling, floor and openings areas, as well as a detailed listing of all opening measurements (Fig. 2.8.9). The Bosch system supplied room and wall overviews with area, perimeter, and volume (Fig. 2.8.10). In general, both systems encountered difficulties in exporting window and door data accurately. While these elements could be input and drawn within the applications, their dimensions were no longer visible upon export. Windows and doors measured in the floor plan were not captured in the elevation views (Fig. 2.8.10). The decision was made to explore the possibilities of 3D and 2D DWG/DXF exports from

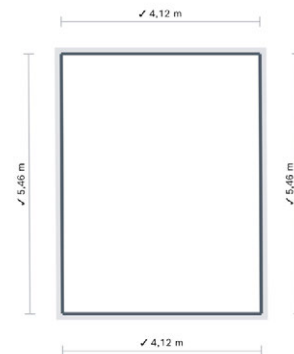

Bodenfläche:	✓ 22,5 m <sup>2</sup>	Bruttowandfläche:	✓ 60,24 m <sup>2</sup>
Umfang:	✓ 19,16 m	Nettowandfläche:	✓ 60,24 m <sup>2</sup>
Höhe:	✓ 3,14 m	Volumen:	✓ 70,72 m <sup>3</sup>



6/55

www.bosch-professional.com/measureon

Fig. 2.8.10: Bosch overview page of the room 2 (entrance hall)

Typ	Name	Wert	Wandfläche	Beschreibung
<b>Zusammenfassung</b>				
	Boden-/ Deckenfläche	22.639 m <sup>2</sup>	-	-
	Wandfläche	60.508 m <sup>2</sup>	-	-
	Öffnungsfläche	16.968 m <sup>2</sup>	-	-
	Netto Wandfläche	43.540 m <sup>2</sup>	-	-
	Volumen	71.289 m <sup>3</sup>	-	-
<b>Distanz</b>				
	a	5.465 m	17.209 m <sup>2</sup>	
	b	4.157 m	13.091 m <sup>2</sup>	
	c	5.465 m	17.208 m <sup>2</sup>	
	d	4.128 m	12.999 m <sup>2</sup>	
	Umfang	19.215 m	60.508 m <sup>2</sup>	-
	Höhe	3.149 m	-	-
<b>Öffnungen</b>				
Türe 1 auf Linie a				
	Breite	-	-	-
	Höhe	-	-	-
Türe 2 auf Linie b				
	Breite	1.733 m	-	-
	Höhe	2.369 m	-	-

Fig. 2.8.9: Leica Report overview page

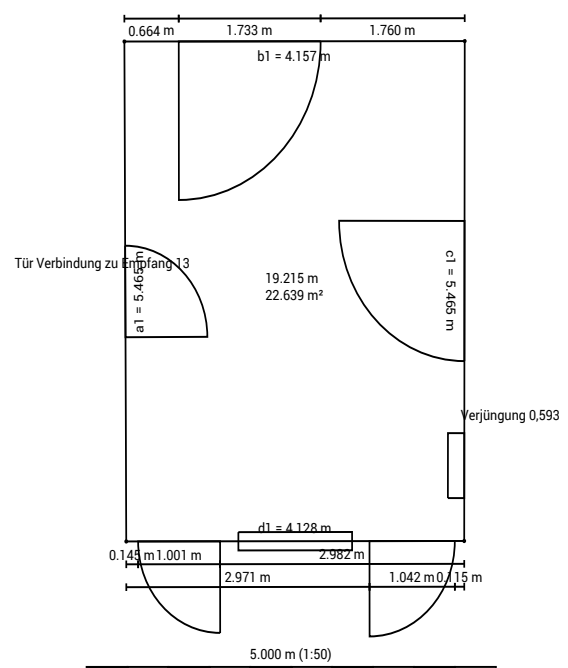

Fig. 2.8.11: Leica overview page of the room 2 (entrance hall)

Leica. This approach was expected to expedite and simplify the production of a 3D Model, leveraging the already digital set of data.

The DWG file formats were imported into various CAD programs to evaluate which program would prove useful for further production. The deciding factors were data usability, visibility and the ability to produce a BIM enabled 3D Model.

ArchiCad 27, Rhino 6 and Vectorworks 2021 were tested.

In both ‚Rhino‘ and ‚Vectorworks‘, importing a 3D DWG resulted in a highly simplified representation composed of lines (Fig. 2.8.11). The annotations made during the survey were not distinctly visible in Vectorworks and were unclear in their association with specific lines or components in Rhino.

In Archicad the 3D export did not appear, solely a 2D line drawing was imported. Here one could not make out the windows or doors that were measured.

Given Archicad’s prominent role in the German BIM software market, it was decided to use this program for the production of the required 3D model.<sup>116</sup> Additionally, the increasing adoption of BIM methodologies in Germany further supports the decision to utilize Archicad.

Due to the difficulties encountered with the usability of the DWG data from Leica, the decision was made to instead use the 2D data from the exported PDF sheets.

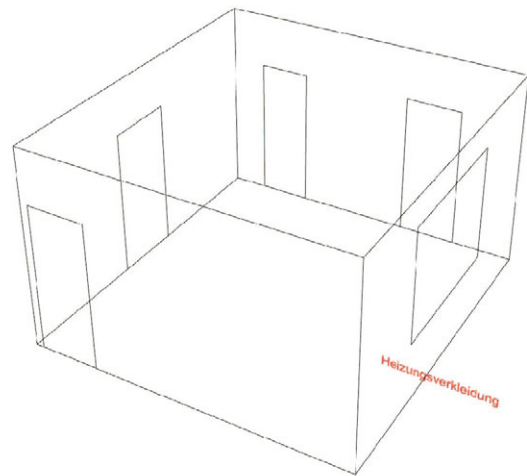

Fig. 2.8.12: Import Rhino 3D representation

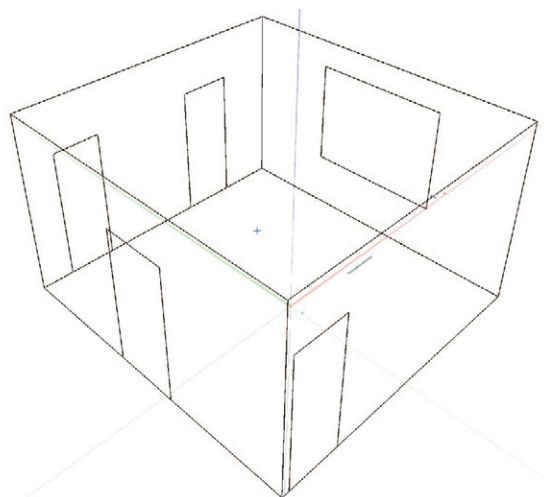

Fig. 2.8.13: Import Vectorworks 3D representation



Fig. 2.8.14: Import Archicad 3D representation

116 cf. Hnin, Thet. „Vectorworks vs Archicad.“ Novatr. Accessed 11.07.2024. <https://www.novatr.com/blog/vectorworks-vs-archicad>



### 3D MODEL

Following the completion of the survey and the export of the acquired data, these were integrated into a BIM-capable 3D model. For this, data sets of Bosch were used, due to the comprehensive layout of the data sheets. Window sills and door heights were then supplemented from the Leica data. During the modelling process, certain challenges, obstacles and deficiencies in the surveying techniques became apparent.

The construction of the three-dimensional model commenced with the library (Room 3) on the ground floor (Fig. 2.8.13). Subsequently, all adjacent rooms were drawn in succession, with each room directly adjoining the previous one. The assembly of these individual rooms resulted in the formation of a complete floor. Once a floor had been established, windows and doors were added, and components were colour-coded according to the legend.

The basement was modelled on the assumption that its exterior walls were identical to those of the ground floor, which were marked in grey due to the absence of measurement data during the survey. Similarly, the design of the roof was based on assumptions, as specific details such as height, structure, and pitch were unknown.

During the course of working with Bosch, a number of discrepancies were identified. There were instances where the overall dimensions did not align with the individual measurements. In the 3D model, inconsistencies and errors were observed to arise from the integration of individual rooms, as seen in figure 2.8.14.

- not scanned
- systemic weakness - compensable
- systemic weakness - not compensable
- own mistakes
- adopted from other groups (transparent)

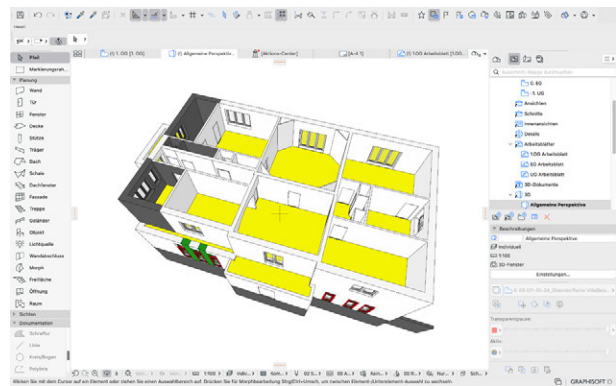
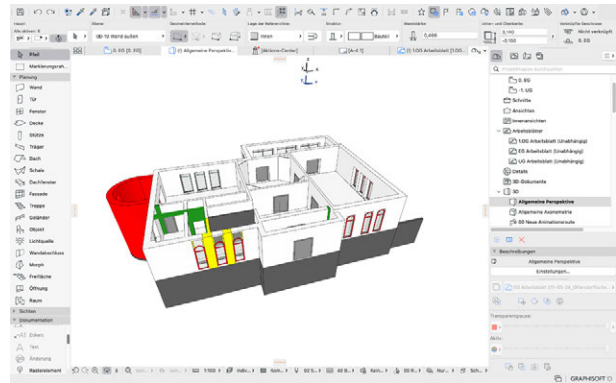

Fig. 2.8.15: 3D modeling process in ArchiCAD

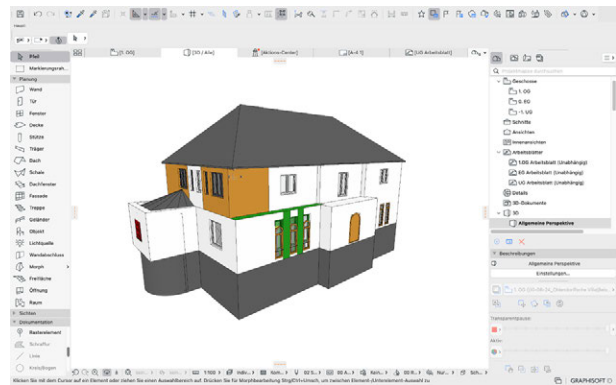
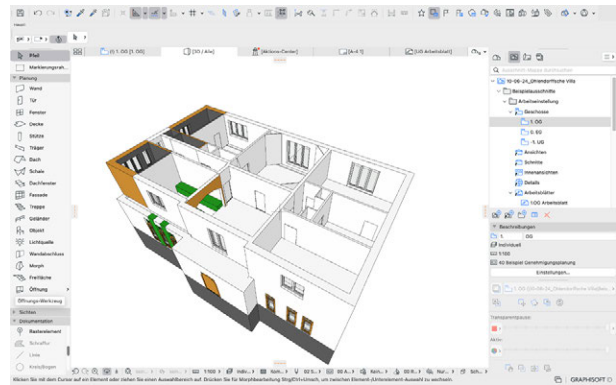

Fig. 2.8.16: 3D modeling process in ArchiCAD



# 5 EVALUATION

The comparative analysis between Leica and Bosch systems provided various insights.

Both systems offer a good price-performance ratio, with each of the Apps being available for little money in the App Store or the Play Store. The Bosch Disto is a little cheaper than the Leica Disto, but has no touchscreen and no integrated camera. They demonstrated similar user-friendly structures, yet differed in their operational nuances. Due to their size, they offer a convenient and efficient device for the use on site. The Leica Disto, with its touchscreen interface aimed at simplifying operations, but faced intermittent challenges with Bluetooth connectivity and hindered a faster survey by its size and weight during operation. In contrast, the Bosch Disto proved more compact and easier to handle, facilitating quicker measurements and had a stronger connectivity to the device with the App.

Furthermore the user interface of both apps and measurement devices are instinctive and both companies offer well accessible online tutorials in case of difficulties. Upon evaluating data handling, Leica's system stood out for its versatile export capabilities, while Bosch excelled in quality and presentation formats.

However, both systems revealed limitations in measuring intricate details such as moldings and door frames and heights as well as window heights and sills.

It is assumed that exterior measurements would have been possible with extra precautions. It is assumed that exterior measurements would have been possible with additional precautions. In such cases, it would have been necessary to have two people present: one person to hold a device to limit the distance of the laser point, and another to operate the measuring device. This teamwork approach would help ensure that the laser point remains stable and clearly visible.

In 3D modeling process, no significant discrepancies were found between the systems, with both offering accessible data integration via mobile applications – a notable advancement in digital workflow efficiency.

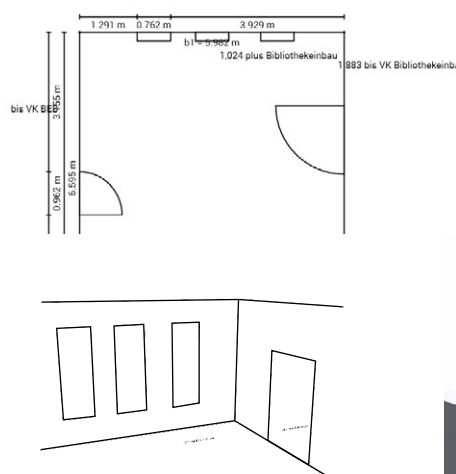

Fig. 2.8.17: Compilation - from site to 3D Model

These observations suggest suitability for simpler space assessments rather than complex architectural elements. It may prove useful for tenant fitouts and measuring a single room rather than a floorplan. The error rate during the assembly of the floorplan in ArchiCad were considered too high. For later use in construction detailing more detailed survey would have been necessary. However, the offered reports of the data collection from both Bosch and Leica might be useful for a quick and initial room book or a bill of quantities. Concluding, both the Leica and Bosch systems are excellent measurement tools. They allow distances to be measured very accurately. However, for a comprehensive building survey, we would recommend a different system, as our tested systems proved to be time-consuming and less precise in detailed aspects.

**OUTCOME**



# ANALYSIS

## COSTS

As part of the system analyses, master's students in spring 2024 conducted a sample-based cost assessment for surveying systems, which includes both the surveying devices and their associated software, as well as the necessary data processing equipment, such as hardware like laptops. Subscription prices for software were also calculated based on a one-year period. This cost analysis was primarily conducted through internet research, making it relatively imprecise, and the values obtained are subject to frequent changes. Nevertheless, it provides a rough overview of the respective system costs and enables an initial comparison of systems.

Two categories were considered: first, the costs for the surveying devices and their software were evaluated. In a second step, the costs for the necessary hardware and software required for digital processing were determined. It is important to note that architecture students have access to free CAD licenses. Even in the first analysis, there are significant price variations for purchase costs. The acquisition cost for a Faro laser scanner, including software, is approximately €43,000, while a Bosch laser pointer can be purchased for as little as €120. Devices like the Faro laser scanner (approximately €43,000) and the Matterport laser scanner (around €8,000) are in a price range that is only economically viable with regular and intensive use. These devices are not suitable for occasional use in architectural offices, as the purchase costs are unlikely to be amortized through sporadic use.

Manual surveying or systems using laser pointers (e.g., Leica, Bosch) are devices and surveying methods with acquisition costs below €1,000. In this case, occasional use would also be economically viable, as these costs can be quickly amortized through project work. Lidar-based systems, such as PolyCam and Scani-

verse examined here, require smartphones equipped with a Lidar scanner. Such devices typically cost more than €1,000. However, since these smartphones are already in use for other purposes, their cost was excluded from the initial assessment. This makes these systems particularly affordable, with free subscriptions or fees of less than €150 per year. Similarly, photogrammetric surveying methods were considered, as they can be carried out with conventional cameras, drones, or 3D cameras, which are also assumed to serve other primary purposes. If their acquisition costs are excluded for this reason, approximately €3,500 still needs to be accounted for to acquire the software (in this case, Agisoft Metashape). Thus, for occasional use, this system would also likely be economically unfeasible at present. The students used the free 30-day trial version for their surveying.



Chapter / System	Preparation	Building Survey	Data Conditioning	Data processing	Modelling	Sum / Ref.- room office, 1st floor
Laserscan 1 - Faro	1	3	0	10	60	74
Laserscan 2 - Matterport	1	3	1	5	10	20
Photogrammetrie exterior	2	3	2	3	-	10
Lidar 1 - Scaniverse	1	10	0	4	10	25
Lidar 1 - Polycam	1	6	0	2	10	19
Photogrammetrie interior	5	7	2	15	-	29
manual survey	6	15	0	6	10	37
Bosch	0	13	2	2	15	32
Theta 360°	5	20	3	15	20	63

**Specific time in minutes in relation to the interior measurement of the office (1st floor\_03)**

Fig. 3.1.1: Time recording of the building survey

## TIME

In addition to the costs, master's students also recorded the time required for the entire process, from preparation for the surveying to the creation of a 3D model. This was documented using a reference room—the office on the first floor of the Ohlendorff Villa. The times mentioned below refer to x minutes per reference room. This analysis goes beyond simply documenting the surveying process, as the time tracking of the entire workflow was of interest, covering all stages up to the final goal: the creation of a BIM-capable 3D model. Throughout this process, the students used standard student hardware and software.

The data collected here is only an approximation, as students naturally work at different speeds and have varying hardware configurations (e.g., computing power).

A striking observation from the time analysis is that while the Faro laser scanner completes the room survey in approximately 3 minutes, it requires an extensive data processing and 3D modeling time of around 70 minutes per reference room. This is due to the large data volumes of the point clouds. Processing these large files on student computers resulted in crashes, significant system slowdowns, and required time-intensive data cleaning. With optimized, higher-quality hardware, this surveying system would likely be much faster.

In comparison, the Matterport system required only a quarter of the time for data processing compared to the Faro laser scanner and worked smoothly on student computers. Unfortunately, the photogrammetric interior survey did not yield fully comparable results in terms of time, as the point cloud of the reference room could not be converted into 3D models, meaning the time for model creation could not be recorded. However, 29 minutes were spent up to the point of data processing. The survey using the Theta 3D camera generated similar

time figures in another, but comparable, room, with approximately 63 minutes spent on the room's digitization.

Lidar-based systems, such as Polycam and Scaniverse, digitized the reference room in 16–20 minutes, with data processing times comparable to the Matterport system. Model creation based on surveying with the Bosch laser pointer took 50% to 100% more time, namely 32 minutes.

A particularly interesting comparison is with manual surveying, which reveals whether the new digital systems are more efficient than traditional manual surveying methods using tape measures and folding rules. Here, 16 minutes were spent on data processing, and the entire process took 37 minutes.

Thus, the Matterport system and the Lidar-based systems Scaniverse and Polycam were significantly faster than manual surveying. The Bosch laser pointer system was only marginally faster, while the Faro laser scanner and Theta 3D camera did not result in any noticeable time savings. The photogrammetric interior survey using standard cameras took 29 minutes up to data processing (excluding model creation). Therefore, there is no indication that this system is faster than manual surveying.

mesures [m]	011 Laserscan Faro	020 Matterport	032 Photogrammetrie exterior	040 Scaniverse	041 Polycam	050 Photogrammetrie interior	053 Photogrammetrie 3D	060 manual survey	070 Bosch-Leica	medium without Laser (011,020)	overall medium
north side GF - length	20,103	-	20,188	20,144	-	-	-	20,345	-	20,226	20,201
east side GF - length	11,604	11,697	11,770	11,609	-	-	-	11,755	-	11,711	11,691
south side GF - length	20,072	-	20,188	20,078	-	-	-	20,345	-	20,204	20,177
west side GF - length	11,604	11,660	11,770	11,566	-	-	-	11,755	-	11,697	11,675
window right - width	0,721	0,761	0,765	0,680	-	-	-	0,710	-	0,718	0,726
window right - arc height	2,198	2,191	2,275	2,187	-	-	-	2,230	-	2,231	2,219
window left - width	0,706	0,747	0,765	0,678	-	-	-	0,710	-	0,718	0,720
window left - arc height	2,180	2,222	2,275	2,196	-	-	-	2,230	-	2,234	2,223
foyer GF - room height	3,071	3,143	-	3,126	3,030	-	3,117	-	3,149	3,105	3,106
foyer GF - floor height	3,553	3,538	-	3,603	-	-	3,247	-	-	3,425	3,473
foyer 1F - room height	2,822	2,900	-	2,884	2,830	-	3,194	3,130	2,890	2,986	2,954
library GF - length	10,074	10,021	-	10,066	10,088	-	-	-	10,713	10,289	10,208
library GF - width	5,477	5,403	-	5,411	5,672	-	-	-	5,982	5,688	5,605
window inside - width	0,940	0,940	-	0,713	0,801	-	-	0,750	0,754	0,755	0,807
window inside - arc height	3,010	3,055	-	2,193	2,048	-	-	2,300	2,182	2,181	2,424
room 1F - length	5,950	5,933	-	5,980	5,858	-	-	5,975	5,958	5,943	5,942
room 1F - width	5,542	5,464	-	5,462	5,322	-	-	5,500	5,475	5,440	5,458

delta [m] to overall medium	011 Laserscan Faro	020 Matterport	032 Photogrammetrie exterior	040 Scaniverse	041 Polycam	050 Photogrammetrie interior	053 Photogrammetrie 3D	060 manual survey	070 Bosch-Leica
north side GF - length	-0,098	-	-0,013	-0,057	-	-	-	+0,144	-
east side GF - length	-0,087	+0,006	+0,079	-0,082	-	-	-	+0,064	-
south side GF - length	-0,105	-	+0,011	-0,099	-	-	-	+0,168	-
west side GF - length	-0,071	-0,015	+0,095	-0,109	-	-	-	+0,080	-
window right - width	-0,005	+0,035	+0,039	-0,046	-	-	-	-0,016	-
window right - arc height	-0,021	-0,028	+0,056	-0,032	-	-	-	+0,011	-
window left - width	-0,015	+0,026	+0,045	-0,042	-	-	-	-0,010	-
window left - arc height	-0,043	-0,001	+0,052	-0,027	-	-	-	+0,007	-
foyer GF - room height	-0,035	+0,037	-	+0,020	-0,076	-	+0,011	-	+0,043
foyer GF - floor height	+0,080	+0,065	-	+0,130	-	-	-0,226	-	-
foyer 1F - room height	-0,133	-0,055	-	-0,071	-0,124	-	+0,240	+0,176	-0,064
library GF - length	-0,135	-0,188	-	-0,143	-0,120	-	-	-	+0,505
library GF - width	-0,129	-0,203	-	-0,195	+0,067	-	-	-	+0,377
window inside - width	+0,132	+0,132	-	-0,094	-0,006	-	-	-0,057	-0,053
window inside - arc height	+0,586	+0,630	-	-0,231	-0,376	-	-	-0,124	-0,242
room 1F - length	+0,007	-0,009	-	+0,038	-0,084	-	-	+0,033	+0,016
room 1F - width	+0,084	+0,006	-	+0,004	-0,136	-	-	+0,042	+0,017

delta [m] to reference (060)	011 Laserscan Faro	020 Matterport	032 Photogrammetrie exterior	040 Scaniverse	041 Polycam	050 Photogrammetrie interior	053 Photogrammetrie 3D	070 Bosch-Leica
north side GF - length	-0,242	-	-0,157	-0,201	-	-	-	-
east side GF - length	-0,151	-0,058	+0,015	-0,147	-	-	-	-
south side GF - length	-0,273	-	-0,157	-0,267	-	-	-	-
west side GF - length	-0,151	-0,095	+0,015	-0,189	-	-	-	-
window right - width	+0,011	+0,051	+0,055	-0,031	-	-	-	-
window right - arc height	-0,032	-0,039	+0,045	-0,043	-	-	-	-
window left - width	-0,004	+0,037	+0,055	-0,032	-	-	-	-
window left - arc height	-0,051	-0,009	+0,045	-0,034	-	-	-	-
foyer GF - room height	-	-	-	-	-	-	-	-
foyer GF - floor height	-	-	-	-	-	-	-	-
foyer 1F - room height	-0,309	-0,231	-	-0,247	-0,300	-	+0,064	-0,240
library GF - length	-	-	-	-	-	-	-	-
library GF - width	-	-	-	-	-	-	-	-
window inside - width	+0,190	+0,190	-	-0,037	+0,051	-	-	+0,004
window inside - arc height	+0,710	+0,755	-	-0,107	-0,252	-	-	-0,118
room 1F - length	-0,025	-0,042	-	+0,005	-0,117	-	-	-0,017
room 1F - width	+0,042	-0,036	-	-0,038	-0,178	-	-	-0,025

Fig. 3.1.2: Comparison of the precision of the different measurement systems

## PRECISION

To assess the precision of various measurement systems, we defined reference components and dimensions, which were derived from the created 3D models, recorded in tables, and compared with each other. This approach allows for the identification of outliers and conclusions about the precision weaknesses of each system. However, the data show a significant variation in measurements, making it difficult to draw reliable conclusions about system accuracy. All the systems studied exhibit measurement tolerances, with interior dimensions varying within a range of +/- single-digit centimeters and exterior dimensions within a range of +/- double-digit centimeters.

A detailed analysis of the individual surveys highlights potential causes for these deviations. The point cloud of the Faro laser scanner shows a spread within the millimeter range, indicating very high measurement accuracy. The measured values typically deviate only within the single-digit centimeter range from the average. An exception, however, is found in the measurements of the library (particularly the bookshelves) and the arched window, where deviations ranging from 13.5 cm to nearly 60 cm were observed. Particularly striking is a deviation of approximately 70 cm when compared to manual measurements of the window.

Similar deviations were observed with the Matterport, Scaniverse, and Polycam systems, especially with the interior dimensions of the arched window and the room dimensions in the library. The point spread for Matterport and Scaniverse is within the single-digit centimeter range, suggesting comparable precision between these two systems. Polycam, which generates 3D models directly without exporting point clouds, was excluded from spread analysis.

Surprisingly precise results were obtained from photogrammetry using standard cameras in exterior measurements. Here, deviations from the reference dimensions were within the single-digit centimeter range compared to the average, and in the double-digit centimeter range when compared to manual measurements. Unfortunately, the photogrammetric interior surveys could not be evaluated, as no usable models could be generated from the photographs.

Another notable finding is that the results from manual measurements were mostly above the average values, with the exception of the interior dimensions of the arched window. This could indicate inaccuracies due to sagging measuring tapes or tolerance errors when using the laser measuring device.

Overall, the measured values show too much variation, both among themselves and compared to manual measurements, to consider any system sufficiently precise. It is therefore recommended that critical dimensions be systematically captured using a second system, and the results verified. This is particularly relevant for components with complex shapes, such as arched windows, cornice moldings, or difficult-to-access interior dimensions, such as those in the bookshelf-lined library.

Finally, it should be noted that this study does not evaluate the precision of the tools themselves, but rather the entire modeling process conducted by master's students in architecture. The observed deviations are likely more attributable to human error in operating the tools and creating the models. This learning process involves identifying systematic errors, analyzing deviations, and deriving measures to improve the surveying and modeling process, such as verification through double measurements.



## **BASIC REQUIREMENTS**

Some systems have failed to produce usable and comparable results when measuring buildings. After the digital measurement, the collected data was found to be incomplete or inaccurate. Nonetheless, these results are insightful as they highlight potential systemic sources of error. These were documented in an error matrix. By considering these in advance of a measurement, it is possible to counteract them and achieve an error-free measurement. Many of the errors recurred in multiple groups and are summarized here once again.

- Strong light contrasts, such as on sunny summer days, should be avoided. Optimal weather conditions occur on cloudy days.
- Reflections (mirrors, polished, shiny surfaces) should be avoided.
- Built-in fixtures (large furniture, wall cabinets, shelves, etc.) are not recognized as such but are interpreted as walls.
- Doors should be opened and secured with wedges.
- No people or animals should appear in the recordings and scans.
- Rooms that are too dark must be illuminated.
- Not all systems are suitable for narrow and tight spaces. Alternative systems should be considered here.
- Do not pause measurement and scanning processes.
- Measured components should be cleared of furniture before measuring.
- Complex room geometries may not be correctly interpreted. In such cases, alternative systems should be considered.
- It is better to perform too many scans and take more pictures than too few during the measurement.
- Incomplete measurements (forgotten areas) should be avoided using the four-eyes principle and thorough checks.

# CONCLUSION

To conclude, we would like to summarize the various systems in terms of their costs, time requirements, and precision, and provide a preliminary outlook on their potential applications. The acquisition of a Faro laser scanner involves significant investment in both hardware and software. Proper operation of this system requires a high level of expertise (e.g., geoinformatics professionals) and powerful computers to generate accurate 3D models within a competitive timeframe. On the other hand, the system produces extremely precise and detailed point clouds. However, the demands in terms of expertise and costs are too high for casual use by construction professionals with the knowledge level of master's architecture students. The precision is almost too exact for common building measurements and could be more effectively applied in heritage conservation.

The acquisition of a Matterport laser scanner costs several thousand euros, making it, like the more expensive Faro scanner, unsuitable for occasional economic use. However, the system is very easy and intuitive to operate, requiring no special expertise. Scans and 3D models are hosted on Matterport's servers, and the company offers various formats for model generation. While this step can be outsourced, it results in a loss of control over the model and its quality. The on-site measurements were completed quickly, much faster than with the reference method of manual measurement, suggesting that this system could be economically viable with regular use. However, when master's students created models, discrepancies and apparent errors occurred with rounded components (e.g., arched windows) and obstructed elements (e.g., bookshelves). Therefore, measurements—especially for such components—should be systematically verified on-site using a secondary system. Overall, this system appears suitable for building surveys and real estate brochures.

For exterior measurements using photogrammetry, the building was photographed extensively from the outside. This approach incurs low acquisition costs, as standard cameras that were already available were used. The data were processed using a free 30-day trial version of the software. The time measurement cannot be compared to other systems in the reference room (interior measurements), as this system was not used there. However, the master's students successfully photographed the building body in one day, generating a usable point cloud and 3D model. This method seems to be an improvement over manual measurement, particularly as it can capture otherwise inaccessible components with accurate scale. If combined with drone images, the entire building can be captured from all angles. In terms of comparable measurements, the photogrammetric model showed deviations of only a few centimeters compared to the reference system, making it surprisingly precise. Combined with other photogrammetric systems for interior measurements, this system can effectively digitize building structures.

The acquisition of the smartphone application Scaniverse is also associated with very low costs. It uses common smartphones that are already available, along with inexpensive software. The measurement was significantly faster than the reference method of manual measurement but slower than the Matterport system due to the longer scanning process. The precision of the LiDAR-supported system appears comparable to Matterport, as both systems showed deviations of only a few centimeters compared to the reference method. Exceptions include critical rounded components (e.g., arched windows, stucco edges) and obstructed components as mentioned earlier. For this reason, measurements should be verified with a secondary system. Overall, this system shows promise for precise digital building measurement and will hopefully continue





to be developed.

With the other smartphone application, Polycam, the acquisition and software costs are similarly low, amounting to less than €150 per year. Like Scaniverse, Polycam can create both point clouds and meshes. However, in this case, the „Room“ mode was tested, which directly generates 3D models. This made the system somewhat faster than Scaniverse, as the 3D models were created directly within the application, rather than exporting a mesh or point cloud for further processing. For this reason, the precision of Polycam is only partially comparable to other systems, as no point cloud spread can be analyzed.

When comparing model dimensions, however, Polycam showed larger deviations from the reference measurements and the average than the point cloud generated by Scaniverse. Similar to the other systems, Polycam still struggles with accurately interpreting curved structures. This issue cannot be corrected when the model is created directly, and in some cases, it may not even be noticeable. Therefore, the „Room“ mode of this system is most suitable for modeling simple, rectangular buildings. As with the previous systems, on-site measurements would need to be verified.

The interior measurement using photogrammetry also involves low costs, as standard cameras or a 3D camera (approximately €300-400) were used. Data were processed using a free 30-day trial version of the software. No conclusions can be drawn about the speed of the system in the reference room because the master's students were unable to digitize the room. The measurement failed due to human error, strong light contrasts, and other factors. However, the students demonstrated the system's functionality in other, only partially comparable rooms, which were digitally modeled within about an hour—twice as long as the manual reference measurement. Thus, this system does not yet seem economically viable for building measu-

rements. The point cloud variation is within the low single-digit centimeter range, indicating surprising precision. It is largely due to the efforts of these working groups that the potential errors of image-based measurement systems, as described in the prerequisites section, became apparent. By adhering to these guidelines, measurements could be less error-prone and perhaps even competitive. Within the realm of photogrammetric interior measurements, the use of a 3D camera could significantly speed up room capture by requiring fewer photos, and a 3D camera-based measurement would likely result in fewer omissions.

In this experiment, manual measurement was used as the reference method. It was not evaluated separately, as it served as a comparison with the other methods. However, it should be noted that manual measurement will likely continue to be used as a verification method in the future.

Laser measurement with handheld devices (e.g., Bosch, Leica) is also relatively inexpensive, as only the devices need to be purchased. However, these systems required almost as much time as manual measurement for the reference room. No significant time savings were observed. In terms of precision, this system encountered similar issues with rounded and obstructed components, resulting in large deviations. On-site verification of measurements would be necessary, but the time investment involved makes this impractical.

# APPENDIX



# BIBLIOGRAPHY

## LASER - FARO

Amazon. „Microsoft Surface Book 2 34,29 cm (13,5 Zoll) Laptop (Intel Core i7 der 8. Generation, 16GB RAM, 512GB SSD, Intel HD Graphics 620, Win 10) silber (Generalüberholt)“ Accessed 09.07.2024.  
[https://www.amazon.de/Microsoft-Surface-Generation-Graphics-Generalüberholt/dp/B088187BMY?source=ps-sl-shoppingads-lpcontext&ref\\_=fplfs&psc=1&smid=A2QBPT2NRCMPLN](https://www.amazon.de/Microsoft-Surface-Generation-Graphics-Generalüberholt/dp/B088187BMY?source=ps-sl-shoppingads-lpcontext&ref_=fplfs&psc=1&smid=A2QBPT2NRCMPLN)

Bunzel Bauvermessungstechnik. „Faro Focus Core 3D-Laserscanner (Komplettpaket)“. Accessed 27.06.2024.  
[https://www.bauvermessungstechnik.info/epages/64219339.mobile/de\\_DE/?ObjectPath=/Shops/64219339/Products/LS9-L-Parcel](https://www.bauvermessungstechnik.info/epages/64219339.mobile/de_DE/?ObjectPath=/Shops/64219339/Products/LS9-L-Parcel)

Faro. „FARO Laser Scanner Focus3D X 30 - The Smart Entry-Level X Series Laser Scanner“. From: Laserscanning Europe. Accessed 08.07.2024.  
[https://www.laserscanning-europe.com/sites/default/files/redakteur\\_images/Datasheet\\_FARO\\_Focus3D\\_X\\_30.pdf](https://www.laserscanning-europe.com/sites/default/files/redakteur_images/Datasheet_FARO_Focus3D_X_30.pdf)

Faro. „Faro Scene Software“. Accessed 30.06.2024.  
[https://de-knowledge.faro.com/Software/FARO\\_SCENE/SCENE/Computer\\_System\\_Requirements\\_for\\_SCENE](https://de-knowledge.faro.com/Software/FARO_SCENE/SCENE/Computer_System_Requirements_for_SCENE)

Faro Knowledge Base. „Firmware Installation für den Focus Laser Scanner“ (14.11.2023). Accessed 10.07.2024.  
[https://de-knowledge.faro.com/Hardware/Focus/Focus/Firmware\\_Installation\\_for\\_the\\_Focus\\_Laser\\_Scanner](https://de-knowledge.faro.com/Hardware/Focus/Focus/Firmware_Installation_for_the_Focus_Laser_Scanner)

Faro Knowledge Base. „Computersystemanforderungen für Scene“ (23.01.2024). Accessed 11.07.2024.  
[https://de-knowledge.faro.com/Software/FARO\\_SCENE/SCENE/Computer\\_System\\_Requirements\\_for\\_SCENE](https://de-knowledge.faro.com/Software/FARO_SCENE/SCENE/Computer_System_Requirements_for_SCENE)

HP. „HP ENVY - TE02-1701ng (2023)“. Accessed 11.07.2024.  
<https://www.hp.com/de-de/shop/product.aspx?id=7N9Q9EA&opt=ABD&sel=DTP>

Laserscanning Europe Shop. „Faro Focus Core“. Accessed 10.07.2024.  
<https://shop.laserscanning-europe.com/FARO-Focus-Core>

Laserscanning Europe Shop. „Faro Focus Premium“. Accessed 10.07.2024.  
<https://shop.laserscanning-europe.com/FARO-Focus-Premium>

utb. „Faro Scene Software“. Accessed 27.06.2024.  
<https://www.utb.at/shop/software/produktdetail/faro-scene-software>

## LASER - MATTERPORT

Matterport. „Available Add-Ons.“ Accessed 08.07.2024.  
[https://support.matterport.com/s/article/Available-Add-Ons?language=en\\_US&catfilter=&parentCategoryLabel=](https://support.matterport.com/s/article/Available-Add-Ons?language=en_US&catfilter=&parentCategoryLabel=)

Matterport. „BIM.“ Accessed 07.07.2024.  
<https://matterport.com/de/bim>

Matterport. „Cameras.“ Accessed 07.07.2024.  
<https://matterport.com/de/cameras>

Matterport. „Digital Twin Features.“ Accessed 07.07.2024.  
<https://matterport.com/de/digital-twin-features>

Matterport. „Exploring Matterport Spaces in VR.“ Accessed 08.07.2024.  
<https://support.matterport.com/s/article/Exploring-Matterport-Spaces-in-VR?language=de>

Matterport. „Getting Started w/Pro3 for Marketing your properties.“ Accessed 08.07.2024.  
<https://www.youtube.com/watch?v=hGRh2TRxcEw>

Matterport. „Introducing Measurement Mode: Now Everyone Can Measure.“ Accessed 08.07.2024.  
[https://support.matterport.com/s/article/Introducing-Measurement-Mode-Now-Everyone-Can-Measure?language=en\\_US&ardId=kA05d000001DWyH](https://support.matterport.com/s/article/Introducing-Measurement-Mode-Now-Everyone-Can-Measure?language=en_US&ardId=kA05d000001DWyH)

Matterport. „Matterport BIM-Datei.“ Accessed 07.07.2024.  
<https://support.matterport.com/s/article/Scan-to-BIM?language=de>

Matterport. „Overview of Matterport E57 File“ (10.05.2024). Accessed 08.07.2024.  
<https://support.matterport.com/s/article/Overview-of-Matterport-E57-File?language=de>

Matterport. „Plans.“ Accessed 07.07.2024.  
<https://buy.matterport.com/de/plans>

Matterport. „Pro3 Technical Specifications.“ Accessed 08.07.2024.  
<https://support.matterport.com/s/article/Pro3-Technical-Specifications?language=de>

Matterport. „Scan a Space: Matterport Pro Camera and Matterport Capture“ (04.04.2023). Accessed 19.06.2024.  
[https://support.matterport.com/s/article/Scan-a-Space-Matterport-Pro-Camera-and-Matterport-Capture?language=en\\_US&categfilter=Get\\_Started\\_Camera\\_Operators&parentCategoryLabel=Get\\_Started\\_Camera\\_Operators](https://support.matterport.com/s/article/Scan-a-Space-Matterport-Pro-Camera-and-Matterport-Capture?language=en_US&categfilter=Get_Started_Camera_Operators&parentCategoryLabel=Get_Started_Camera_Operators)

Matterport. "Scanning for 2D Snapshots While On-Site". Accessed 06.08.2024.  
[https://support.matterport.com/s/article/Scanning-for-2D-Snapshots-While-On-Site?language=en\\_US](https://support.matterport.com/s/article/Scanning-for-2D-Snapshots-While-On-Site?language=en_US)

Thiele, Eike. Scanner 2 GO. „01b So scannen Sie richtig mit der Matterport Pro 3“. Accessed 04.07.2024.  
<https://support.scanner2go.de/hc/de/articles/25920709865489-01b-So-scannen-Sie-richtig-mit-der-Matterport-Pro-3>

## PHOTO - OUTSIDE

Agisoft LLC. „Metashape User Manual: Professional Edition, Version 2.1“. Accessed 12.07.2024.  
[https://www.agisoft.com/pdf/metashape-pro\\_2\\_1\\_en.pdf](https://www.agisoft.com/pdf/metashape-pro_2_1_en.pdf)

Agisoft LLC. „System Requirements“. Accessed 12.07.2024.  
<https://www.agisoft.com/downloads/system-requirements>

DJI. „DJI Phantom 4 Specifications“. Accessed 12.07.2024.  
<https://www.dji.com/de/support/product/phantom-4>

Graphisoft. „Recommended Configuration“. Accessed 12.07.2024.  
<https://graphisoft.com/de/service-support/systemanforderungen>

Lescop, Laurent. ENSA Nantes. Photogrammetry Lecture. 26.04.2024.

Luhman, Thomas; Robson, Stuart; Kyle, Stephen and Boehm, Jan. „Close-Range Photogrammetry and 3D Imaging“ (De Gruyter, 2013), 2.

Nikon USA. „Nikon D5100 Camera User's Manual“. Accessed 12.07.2024.  
[https://cdn-10.nikon-cdn.com/pdf/manuals/dslr/D5100\\_EN.pdf](https://cdn-10.nikon-cdn.com/pdf/manuals/dslr/D5100_EN.pdf)

## PHOTO - INSIDE

3DFLOW. „3DF Zephyr Free - Photogrammetry for everyone“. Accessed 29.06.2024.  
<https://www.3dflow.net/3df-zephyr-free/>

Agisoft. „About“. Accessed 29.06.2024.  
<https://www.agisoft.com/about>

Arnold IT Systems. „Autodesk ReCap Pro“. Accessed 29.06.2024.  
<https://www.arnold-it.com/produkte/3d-bestandserfassungssoftware/autodesk-recap-pro>

Kersten, Thomas. HCU Hamburg. Photogrammetry and Laserscanning Lecture. 22.04.2024.

Lescop, Laurent. ENSA Nantes. Photogrammetry Lecture. 26.04.2024.

Luhman, Thomas. „Nahbereichsphotogrammetrie - Grundlagen, Methoden und Anwendungen“ (Wichmann, 2010), 2/4/8.

Lumalabs. „Dream Machine“. Accessed 29.06.2024.  
<https://lumalabs.ai/dream-machine>

## PHOTO - THETA 360°

Agisoft. „System Requirements“. Accessed 01.07.2024.  
<https://www.agisoft.com/downloads/system-requirements/>

Agisoft LLC. „Agisoft PhotoScan User Manual - Professional Edition, Version 1.3“ (2017)

Konecny, Gootfried. „Mapping from space: The metric camera experiment“. *Science*, 225 (1984). 167-169.

Schindler, Konrad and Förstner, Wolfgang. „Photogrammetry“. In: Ikeuchi, Katsushi (ed.), „Computer Vision - A Reference Guide“ (Springer, 2014). 579-599.

Staschen, Björn. „360 Grad-Rundherum unterwegs“. In: Staschen, Björn (ed.), „Mobiler Journalismus“ (Springer, 2017). 239–257

Teammediadock. Hochschule Luzern - Design Film Kunst. „3D Scan (Photogrammetrie) Metashape“. Accessed 01.07.2024.  
<https://sites.hslu.ch/werkstatt/3d-scan-photogrammetrie/>

## LIDAR - APPS

Askar, Cigdem and Sternberg, Harald. „Use of Smartphone Lidar Technology for Low-Cost 3D Building Documentation with iPhone 13 Pro: A Comparative Analysis of Mobile Scanning Applications“ (Department of Geomatics, HCU, 2023). 3, no. 4, 563-579.  
<https://doi.org/10.3390/geomatics3040030>

Apple Inc. „Apple stellt neues iPad Pro mit fortschrittlichem LiDAR Scanner vor und bringt Trackpad-Unterstützung für iPadOS - Apple (DE)“. Accessed 04.08.2024.  
<https://www.apple.com/de/newsroom/2020/03/apple-unveils-new-ipad-pro-with-lidar-scanner-and-trackpad-support-in-ipados/>

Apple Inc. „App Store - Apple (DE)“ for PolyCam, Scaniverse, 3D Scanner App, Sitescape, Canvas Lite, Magicplan, Metaroom, Metascan. Accessed 04.07.2024.  
<https://www.apple.com/de/app-store/>

Apple Inc. „Metaroom - 3D Raum Scanner im App Store“. Accessed 04.06.2024.  
<https://apps.apple.com/at/app/metaroom-3d-raum-scanner/id163707716>

Blickfeld GmbH. „Blickfeld LiDAR für eine sichere & effiziente digitale Welt“. Accessed 12.07.2024.  
<https://www.blickfeld.com/de/blog/lidar-parameter-verstehen/>

Blickfeld GmbH. „Die Wichtigsten LIDAR-Parameter im Überblick“. Accessed 12.07.2024.  
<https://www.blickfeld.com/de/blog/lidar-parameter-verstehen/>

GRAPHISOFT SE. „Über Hotlink-Module“. Accessed 02.08.2024.  
[https://help.graphisoft.com/AC/18/GER/AC18Help/05\\_Collaboration/05\\_Collaboration-64.htm#:~:text=Mit%20Hotlink%2DModulen%20können%20Sie,Hotlinks%20auf%20eine%20externe%20Quelldatei](https://help.graphisoft.com/AC/18/GER/AC18Help/05_Collaboration/05_Collaboration-64.htm#:~:text=Mit%20Hotlink%2DModulen%20können%20Sie,Hotlinks%20auf%20eine%20externe%20Quelldatei)

Large, Martin. all-electronics. „Lidar: Was es ist, wie es funktioniert und was es kann“. Accessed 27.06.24.  
<https://www.all-electronics.de/automotive-transportation/lidar-sensoren-automotive-575.html>

Medium. „Scaniverse Blog“. Accessed 28.06.24.  
<https://blog.scaniverse.com/>

Niantic Inc. „Support | Scaniverse - 3D Scanner + LiDAR + Gaussian Splatting for iOS and Android“. Accessed 28.06.24.  
<https://scaniverse.com/support>

Polycam Inc. „Getting started with Polycam- User Guide“. Accessed 30.06.24.  
<https://learn.poly.cam/about>

Polycam Inc. „Pricing | Polycam“. Accessed 30.06.2024.  
<https://poly.cam/pricing>

Polycam Inc. „What Devices is polycam available on? - Polycam Help Center“. Accessed 28.06.24.  
<https://learn.poly.cam/product-faqs/what-devices-is-polycam-available-on>

Sketchfab Inc. „Scaniverse - Sketchfab“. Accessed 28.06.24.  
<https://sketchfab.com/scaniverse>

Apps: 3D-Scanner, Canvas Lite, Magicplan, Metaroom, Metascan, PolyCam, Scaniverse and Sitescape. Accessed 04.07.2024.

## MANUAL - DISTOMETER

Bauprofessor-Redaktion. Bauprofessor Lexikon. „Bauabrechnung Aufmaß“ (15.09.2023). Accessed 01.07.2024.  
<https://www.bauprofessor.de/aufmass/>

Donath, Dirk and Thurow, Torsten. „Integrated Architectural Surveying And Planning“. Automation in Construction 16, Nr. 1 (January 2007). 19-27.  
<https://doi.org/10.1016/j.autcon.2005.10.012>

Egger, Martin. „Nutzen und Möglichkeiten mobiler Bauabrechnungssysteme“ (Grin, 2012).  
<https://www.grin.com/document/274450>

Giese, Jürgen. „Im Dschungel der Aufmaßprodukte. Ergebnisformen der Bauvermessung gezielt auswählen, ausschreiben und nutzen“ - „Aufmaßprodukte und Ausschreibung“ (2021).  
<https://core.ac.uk/download/pdf/196308604.pdf>

Gruha Pravesh. „Interior & Exterior Wall Thickness (Residential Standards in 2023)“. Accessed 26.06.2024.  
<https://gruhapraveshinteriors.com/interior-exterior-wall-thickness/>

Heine, Katja; Rheidt, Klaus; Henze, Frank and Riedel, Alexandra. „Erfassen, Modellieren, Visualisieren. Von Handaufmass bis High Tech III. 3D in der historischen Bauforschung“ (Verlag Philipp von Zabern, 2011).  
[https://publik.tuwien.ac.at/files/PubDat\\_204526.pdf](https://publik.tuwien.ac.at/files/PubDat_204526.pdf)



Komzet Bau Bühl. Kompetenzzentrum der Bauwirtschaft. „Aufmaßsysteme“. Accessed 12.07.2024.  
<https://wiki.bubiza.de/lib/exe/fetch.php?media=massivbau:7-checklisten:aufmasssysteme.pdf>

McLine Studios. „What are Architectural Elevation Drawings and Its Importance?“ (24.11.2023). Accessed 12.07.2024.  
<https://mclinestudios.com/architectural-elevation-drawings/>

Streit Datentechnik GmbH. „Aufmaß – Definition, wichtige Infos & Tipps für Handwerker!“. Accessed 12.07.2024.  
<https://www.streit-software.de/wissen/aufmass>

## MANUAL - DISTO/APPS

1a Fachhandel. „Leica Entfernungsmesser Disto D810 Touch“. Accessed 30.05.2024.  
<https://www.1a-vermessung.de/shop/leica-entfernungsmesser-disto-d810-touch/5376/2194/1#>

Amazon. „Leica DISTO D810 touch – universeller Laser Entfernungsmesser mit Bluetooth (App-Nutzung), Touch screen und integrierter Kamerafunktion (Innen- und Außenbereich)“. Accessed 07.07.2024.  
[https://www.amazon.de/Leica-DISTO-D810-touch-Entfernungsmesser/dp/B00GY0LQOE?source=ps-sl-shoppingads-lpcontext&ref\\_=fp\\_lfs&smid=A91LOH-62ZJ405&th=1](https://www.amazon.de/Leica-DISTO-D810-touch-Entfernungsmesser/dp/B00GY0LQOE?source=ps-sl-shoppingads-lpcontext&ref_=fp_lfs&smid=A91LOH-62ZJ405&th=1)

Apple. „App Store“. Accessed 02.08.2024.  
<https://apps.apple.com/de/app/leica-disto-plan/id1361178866>

Bosch. „Die Bosch Gruppe im Überblick“. Accessed 07.06.2024.  
<https://www.bosch.de/unternehmen/bosch-gruppe-weltweit/>

Bosch. „Digitaler Laser-Entfernungsmesser PLR 50C“. Accessed 10.07.2024.  
<https://www.bosch-diy.com/de/de/p/plr-50-c-0603672200>

Hnin, Thet. „Vectorworks vs Archicad.“ Novatr. Accessed 11.07.2024.  
<https://www.novatr.com/blog/vectorworks-vs-archicad>

Leica. „Messungen digital dokumentieren“. Accessed 02.08.2024.  
<https://shop.leica-geosystems.com/de/de-DE/measurement-tools/disto/leica-disto-plan-app>

Leica. „Wer wir sind“. Accessed 02.08.2024.  
<https://leica-geosystems.com/de-de/about-us/summary>

Matthews, Willy. Laser-Entfernungsmesser Test. „Die Measuring Master App von Bosch im Test“ (10.06.2016). Accessed 07.06.2024.  
<https://www.laserentfernungsmesser-test.de/2016/bosch-kuendigt-die-measuring-master-app-an/>

## ANALYSIS

All data regarding the costs, requirements etc. were determined using the relevant websites of the mentioned devices, programs and applications.



# LIST OF FIGURES

## COVER

Close-up of the entrance portal, CAD model of the Ohlendorff Villa (Enver Can Kabaran and Michèle Armbrrecht, 2024)

## PREFACE - LAURENT LESCOP

- Fig. 1.1.1: Metashape interface (© Laurent Lescop, 2024)
- Fig. 1.1.2: Survey process overview (© Laurent Lescop, 2024)
- Fig. 1.1.3: Synoptic view of the data workflow (© Laurent Lescop, 2024)
- Fig. 1.1.4: The photogrammetry principle, finding the third dimension from a couple of images (© Laurent Lescop, 2024)
- Fig. 1.1.5: Photogrammetry: Light point cloud (© Laurent Lescop, 2024)
- Fig. 1.1.6: Photogrammetry: meshing and texturing (© Laurent Lescop, 2024)
- Fig. 1.1.7: Point cloud using NERF technology (© Laurent Lescop, 2024)
- Fig. 1.1.8: Full 3D model using NERF technology (© Laurent Lescop, 2024)
- Fig. 1.1.9: Full 3D model using NERF technology - view from an uncovered side (© Laurent Lescop, 2024)
- Fig. 1.1.10: Full 3D model using NERF technology - top view (© Laurent Lescop, 2024)

## PREFACE - THOMAS P. KERSTEN

- Fig. 1.2.1: Student Group Geodesy and Geoinformatics (own graphic, 2024)
- Fig. 1.2.2: Part of the surveying equipment geodesy (own graphic, 2024)
- Fig. 1.2.3: IMAGER 5010 on tripod (own graphic, 2024)
- Fig. 1.2.4: DJI Phantom 4 Pro (own graphic, 2024)
- Fig. 1.2.5: DJI Mavic 3 (own graphic, 2024)
- Fig. 1.2.6: Matterport Pro 3 (own graphic, 2024)
- Fig. 1.2.7: Segmented point cloud from photogrammetric image data (own graphic, 2024)
- Fig. 1.2.8: Coloured partly segmented point cloud from NavVis VLX 2.0 (own graphic, 2024)
- Fig. 1.2.9: Segmented point cloud from terrestrial laser scanning (own graphic, 2024)
- Fig. 1.2.10: Coloured point cloud from the Matterport System (own graphic, 2024)
- Fig. 1.2.11: Exemplary CAD models of parts of the Ohlendorff'sche Villa (own graphic, 2024)

## PRESENTATION VILLA

- Fig. 1.3.1: Photo Ohlendorff Villa - front (An-d. Wikipedia. Accessed 18.09.2024. Changed to black and white. [https://de.wikipedia.org/wiki/Ohlendorff'sche\\_Villa#/media/Datei:HH-Volksdorf\\_Ohlendorff'sche\\_Villa.jpg](https://de.wikipedia.org/wiki/Ohlendorff'sche_Villa#/media/Datei:HH-Volksdorf_Ohlendorff'sche_Villa.jpg))
- Fig. 1.3.2: Photo Ohlendorff Villa - back (own graphic, 2024)
- Fig. 1.3.3: Ohlendorff Villa floor plan basement (own graphic, 2024)
- Fig. 1.3.4: Ohlendorff Villa floor plan ground floor (own graphic, 2024)
- Fig. 1.3.5: Ohlendorff Villa floor plan upper floor (own graphic, 2024)

## LASER - FARO

- Fig. 2.1.1: Laserscanner Faro Fokus X30 (Elmira Akbarzada, 2024)
- Fig. 2.1.2: Narrow and fully furnished kitchen (Elmira Akbarzada, 2024)
- Fig. 2.1.3: Process in which we place the control points (Elmira Akbarzada, 2024)
- Fig. 2.1.4: FARO 3D laser scanner X30 (3D CAD. „Kaufen oder Dienstleistungsangebot nutzen?“ Accessed 31.07.2024. <http://www.3dcad-gmbh.de/3d-laserscan/laserscanner-kauf-miete/3d-laserscan-system-kaufen.html>)
- Fig. 2.1.5: FARO Focus Core (Laserscanning Europe Shop. „Faro Focus Core“. Accessed 31.07.2024. <https://shop.laserscanning-europe.com/FARO-Focus-Core>)
- Fig. 2.1.6: FARO Focus Premium Core (Laserscanning Europe Shop. „Faro Focus Premium“. Accessed 31.07.2024. <https://shop.laserscanning-europe.com/FARO-Focus-Premium>)
- Fig. 2.1.7: FARO 3D laser scanner X30 (Elmira Akbarzada, 2024)
- Fig. 2.1.8: Library with the unblocked tables and chairs and the FARO X30 (Elmira Akbarzada, 2024)
- Fig. 2.1.9: Touch screen with scan of the corridor-ground floor (Elmira Akbarzada, 2024)
- Fig. 2.1.10: Lecture Room (room 15) (Elmira Akbarzada, 2024)
- Fig. 2.1.11: The 3D laser scanner at the doorway of a narrow passage (Elmira Akbarzada, 2024)
- Fig. 2.1.12: Narrow corridor on the ground floor (Elmira Akbarzada, 2024)
- Fig. 2.1.13: First encounter with the FARO Scene software at the site (Elmira Akbarzada, 2024)
- Fig. 2.1.14: First generated point cloud with all scans (Elmira Akbarzada, 2024)
- Fig. 2.1.15: Point cloud with the exterior area on the computer (Elmira Akbarzada, 2024)
- Fig. 2.1.16: Point cloud of the library with a resolution of 3mm (Sedanur Albustanli, Screenshot Archicad, 2024)
- Fig. 2.1.17: Point cloud 3mm upsite + point cloud without exterior down (Sedanur Albustanli, Screenshot Archicad, 2024)
- Fig. 2.1.18: Point cloud of the library 10mm resolution (Elmira Akbarzada, Screenshot Archicad, 2024)
- Fig. 2.1.19: Scanned person in the outdoor area (Elmira Akbarzada, Screenshot Archicad, 2024)
- Fig. 2.1.20: Point cloud with the model and the model without point cloud (Seda Albustanli, Screenshot Archicad, 2024)

- Fig. 2.1.21: Reconstructed point cloud sections and views (Seda Albustanli, Screenshot Archicad, 2024)  
 Fig. 2.1.22: Reconstructed floor plan with point cloud in the background (Seda Albustanli, Screenshot Archicad, 2024)  
 Fig. 2.1.23: Ground floor (Seda Albustanli, Screenshot Archicad, 2024)  
 Fig. 2.1.24: First floor (Seda Albustanli, Screenshot Archicad, 2024)  
 Fig. 2.1.25: Archicad model with color coding (Elmira Akbarzada, Screenshot Archicad, 2024)

## LASER - MATTERPORT

- Fig. 2.2.1: Matterport Pro 3 (Matterport. „Matterport Pro Camera MC300.“ Accessed 04.07.2024. <https://images.ctfassets.net/icnj41gkyohw/OnPBrHo1qoFBOEMxIIhi/5972169a9f27e937bdcec1b1ae5672be/03cam-mc300-x.webp?h=1200&w=1200&fit=pad&bg=rgb%3Affffff>)  
 Fig. 2.2.2: Example digital twin: Villa - dollhouse mode (Screenshot of „3D Tour of the Villa Volksdorf.“ Matterport. Accessed 06.08.2024. <https://my.matterport.com/show/?m=J3YiMoGAsFh>)  
 Fig. 2.2.3: Example digital twin: Villa - schematic floorplan (Screenshot of „3D Tour of the Villa Volksdorf.“ Matterport. Accessed 06.08.2024. <https://my.matterport.com/show/?m=J3YiMoGAsFh>)  
 Fig. 2.2.4: Example digital twin: Villa - 360 degree tour image (Screenshot of „3D Tour of the Villa Volksdorf.“ Matterport. Accessed 06.08.2024. <https://my.matterport.com/show/?m=J3YiMoGAsFh>)  
 Fig. 2.2.5: Schematic diagram of procedure (own illustration, 2024)  
 Fig. 2.2.6: Matterport subscription options (own illustration based on Matterport. „Plans and Pricing.“ Accessed 02.07.2024. <https://buy.matterport.com/de/plans>)  
 Fig. 2.2.7: Requirements (own illustration, 2024)  
 Fig. 2.2.8: Checklist Preparation (own illustration, 2024)  
 Fig. 2.2.9: Matterport Pro 3 Performance Kit (Lena Böttcher, 2024)  
 Fig. 2.2.10: Resulting 3D Scan and 360° camera image the Matterport app (Lena Böttcher, 2024)  
 Fig. 2.2.11: Selecting Floor 1 in the Storey Selection Tool the Matterport app (Lena Böttcher, 2024)  
 Fig. 2.2.12: Matterport Pro 3 mounted on a tripod (Marisa Martin Pelegrina, 2024)  
 Fig. 2.2.13: Operation from outside the scanning area (Lena Böttcher, 2024)  
 Fig. 2.2.14: Floor plan with m<sup>2</sup> after upload to the Matterport cloud (Screenshot of Matterport. „Villa Volksdorf“. Accessed 04.07.2024. <https://my.matterport.com/show/?m=J3YiMoGAsFh>)  
 Fig. 2.2.15: Original floor plan (StudioD, 2024)  
 Fig. 2.2.16: Autom. generated floor plan with corner instead of rounding (Screenshot of Matterport. „Villa Volksdorf“. Accessed 04.07.2024. <https://my.matterport.com/show/?m=J3YiMoGAsFh>)  
 Fig. 2.2.17: Original floor plan (StudioD, 2024)  
 Fig. 2.2.18: View from library in 360° tour: person on stairs (Screenshot of Matterport. „Villa Volksdorf“. Accessed 11.07.2024. <https://my.matterport.com/show/?m=J3YiMoGAsFh>)  
 Fig. 2.2.19: Next position in 360° tour: person on stairs is gone (Screenshot of Matterport. „Villa Volksdorf“. Accessed 11.07.2024. <https://my.matterport.com/show/?m=J3YiMoGAsFh>)  
 Fig. 2.2.20: View from lecture room in 360° tour: person at table (Screenshot of Matterport. „Villa Volksdorf“. Accessed 11.07.2024. <https://my.matterport.com/show/?m=J3YiMoGAsFh>)  
 Fig. 2.2.21: Next position in 360° tour: person at table is gone (Screenshot of Matterport. „Villa Volksdorf“. Accessed 11.07.2024. <https://my.matterport.com/show/?m=J3YiMoGAsFh>)  
 Fig. 2.2.22: Files offered in the Matterport Cloud (Screenshot by Erdem Balli from the Matterport Cloud, logged in the dhp:i account, 2024)  
 Fig. 2.2.23: Exemplary offer for the BIM file from the Matterport Cloud (Screenshot by Erdem Balli from the Matterport Cloud, logged in the dhp:i account, 2024)  
 Fig. 2.2.24: .XYZ pointcloud with lower point density (Screenshot of own Archicad Project with imported .XYZ file, 2024)  
 Fig. 2.2.25: .E57 pointcloud with higher point density (Screenshot of own Archicad Project with imported .E57 file, 2024)  
 Fig. 2.2.26: Detail comparing the point densities and accuracy of the pointclouds (left .XYZ, right .E57) (Screenshots of own Archicad Projects with imported .E57 file/ .XYZ file, 2024)  
 Fig. 2.2.27: Photogrammetric 3D showcase of Villa Volksdorf (Screenshot of Matterport. „Villa Volksdorf“. Accessed 04.07.2024. <https://my.matterport.com/show/?m=J3YiMoGAsFh>)  
 Fig. 2.2.28: .XYZ pointcloud example (Screenshot of own Archicad Project with imported .XYZ file, 2024)  
 Fig. 2.2.29: .OBJ mesh example (Screenshot of own Archicad Project with imported .OBJ file, 2024)  
 Fig. 2.2.30: Ground floor plan of the .3DM file in Archicad (Screenshot of own Archicad Project with imported .3DM file, 2024)  
 Fig. 2.2.31: Inaccuracies of the wall geometry of the .3dm mesh (Screenshot of own Archicad Project with imported .3DM file, 2024)  
 Fig. 2.2.32: Inaccuracies of the wall thickness of the .3dm mesh (Screenshot of own Archicad Project with imported .3DM file, 2024)  
 Fig. 2.2.33: Missing window sills of the .3dm mesh (Screenshot of own Archicad Project with imported .3DM file, 2024)  
 Fig. 2.2.34: Display of the round wall in the bar area of the .3dm mesh (Screenshot of own Archicad Project with imported .3DM file, 2024)  
 Fig. 2.2.35: Display of the archway above the staircase of the .3dm mesh (Screenshot of own Archicad Project with imported .3DM file, 2024)  
 Fig. 2.2.36: 3D-View of .XYZ pointcloud in Archicad (Screenshot of own Archicad Project with imported .XYZ file, 2024)  
 Fig. 2.2.37: 3D-View of .3dm mesh in Archicad (after original .obj was converted using Rhino) (Screenshot of own Archicad Project with imported .3DM file, 2024)  
 Fig. 2.2.38: Final 3D-Model in Archicad, perspective 1 (Screenshot of own Archicad Project, 2024)  
 Fig. 2.2.39: Final 3D-Model in Archicad, perspective 2 (Screenshot of own Archicad Project, 2024)

## PHOTO - OUTSIDE

- Fig. 2.3.1: Principle of Photogrammetric Measurement (Thomas Luhmann, Stuart Robson, Stephen Kyle and Jan Boehm. „Close-Range Photogrammetry and 3D Imaging“ (De Gruyter, 2013). 2.)  
 Fig. 2.3.2: Fixed lens with masking tape (Katharina Koch, 2024)  
 Fig. 2.3.3: Partially hidden East Facade of the Ohlendorff'sche Villa (Katharina Koch, 2024)

Fig. 2.3.4: Issue of the Camera Angle in Low-Distance Shots (Katharina Koch, 2024)  
 Fig. 2.3.5: Blurred Image of the Staircase to the Basement (Katharina Koch, 2024)  
 Fig. 2.3.6: Shooting Positions in a Room (Katharina Koch, 2024)  
 Fig. 2.3.7: Ohlendorff'sche Villa Basement (Studio D, 2024)  
 Fig. 2.3.8: Ohlendorff'sche Villa Ground Floor (Studio D, 2024)  
 Fig. 2.3.9: Ohlendorff'sche Villa First Floor (Studio D, 2024)  
 Fig. 2.3.10: Top View Photo taken by a Drone (Alina Ivanova, 2024)  
 Fig. 2.3.11: Point Cloud from Agisoft Metashape (Alina Ivanova, Screenshot Metashape, 2024)  
 Fig. 2.3.12: Mesh Model from Agisoft Metashape (Alina Ivanova, Screenshot Metashape, 2024)  
 Fig. 2.3.13: Café Mesh Model from Agisoft Metashape (Alina Ivanova, Screenshot Metashape, 2024)  
 Fig. 2.3.14: Library Mesh Model from Agisoft Metashape (Alina Ivanova, Screenshot Metashape, 2024)  
 Fig. 2.3.15: Tilt of the North Facade in Point Cloud 1 (Tabea Bläse, Screenshot Archicad, 2024)  
 Fig. 2.3.16: 3D Model of the Roof in Point Cloud 2 (Tabea Bläse, Screenshot Archicad, 2024)  
 Fig. 2.3.17: Point Cloud of the small Office (Katharina Koch, Screenshot Archicad, 2024)  
 Fig. 2.3.18: Point Cloud of the Café (Katharina Koch, Screenshot Archicad, 2024)  
 Fig. 2.3.19: Staircase Railing (Katharina Koch, Screenshot Archicad, 2024)  
 Fig. 2.3.20: Upper Floor 3D Model (Katharina Koch, Screenshot Archicad, 2024)  
 Fig. 2.3.21: Ohlendorff'sche Villa Building 3D Model (Katharina Koch, Screenshot Archicad, 2024)  
 Fig. 2.3.22: Close-Up of the Railing in Point Cloud 1 (Tabea Bläse, Screenshot Archicad, 2024)

#### PHOTO - INSIDE

Fig. 2.4.1: Generated mesh in the floor plan (Screenshot Archicad, 2024)  
 Fig. 2.4.2: Model of the pinhole camera (Thomas Luhmann, Nahbereichsphotogrammetrie, 2010, Page 4)  
 Fig. 2.4.3: From Object to result (Thomas Luhmann, Nahbereichsphotogrammetrie, 2010, Page 8)  
 Fig. 2.4.4: Basement floor distance to 30 degree angle (Marianela Lopez, 2024)  
 Fig. 2.4.5: Detailed protocol of the Office Room (Anna Plate, 2024)  
 Fig. 2.4.6: Picture sequence of the Office Room (Benedikt Wigro, 2024)  
 Fig. 2.4.7: Mesh texture of the Office Room (Screenshot 3DF Zephyr, 2024)  
 Fig. 2.4.8: Mesh and Texture with Metashape of the Office Room (Screenshot Metashape, 2024)  
 Fig. 2.4.9: Mesh and Texture with Metashape of the Office Room (Screenshot Metashape, 2024)  
 Fig. 2.4.10: Mesh and Texture with Autodesk Recap of the Office Room (Screenshot Autodesk Recap, 2024)  
 Fig. 2.4.11: Mesh and Texture with Autodesk Recap of the Office Room (Screenshot Autodesk Recap, 2024)  
 Fig. 2.4.12: Mesh and Texture with Luma AI of the Office Room (Screenshot Luma AI, 2024)  
 Fig. 2.4.13: Mesh and Texture with Luma AI of the Office Room (Screenshot Luma AI, 2024)  
 Fig. 2.4.14: Mesh and Texture with 3DF Zephyr of the Office Room (Screenshot 3DF Zephyr, 2024)  
 Fig. 2.4.15: Mesh and Texture with 3DF Zephyr of the Office Room (Screenshot 3DF Zephyr, 2024)  
 Fig. 2.4.16: 3D Meshes with 3DF Zephyr of the Office Room (Moritz Mahr, Screenshot 3DF Zephyr, 2024)  
 Fig. 2.4.17: 3D Meshes in CAD Modell (Screenshot Archicad, 2024)  
 Fig. 2.4.18: 3D Meshes in CAD Modell (Screenshot Archicad, 2024)  
 Fig. 2.4.19: Detailed protocol of the Basement (Benedikt Wigro, 2024)  
 Fig. 2.4.20: Mesh and Texture of the Basement from 3DF Zephyr (Screenshot 3DF Zephyr, 2024)  
 Fig. 2.4.21: Photogrammetry Results of the Basement from 3DF Zephyr (Screenshot 3DF Zephyr, 2024)  
 Fig. 2.4.22: Photogrammetry Results of the Basement from 3DF Zephyr (Screenshot 3DF Zephyr, 2024)  
 Fig. 2.4.23: Blender results of the Office Room (Screenshot Blender, 2024)  
 Fig. 2.4.24: Blender results of the Basement (Screenshot Blender, 2024)  
 Fig. 2.4.25: Plan view of the Office Room (Benedikt Wigro, Screenshot Blender, 2024)  
 Fig. 2.4.26: Section of the Office Room (Benedikt Wigro, Screenshot Blender, 2024)  
 Fig. 2.4.27: Plan view of the Basement (Benedikt Wigro, Screenshot Blender, 2024)  
 Fig. 2.4.28: Section of the Basement (Benedikt Wigro, Screenshot Blender, 2024)  
 Fig. 2.4.29: CAD Floor plan of the Basement (Marianela Lopez, 2024)  
 Fig. 2.4.30: CAD Section plan of the Basement (Marianela Lopez, 2024)  
 Fig. 2.4.31: Diagram time set per Software (own Graphic, 2024)  
 Fig. 2.4.32: Diagram Number of picture shots (own Graphic, 2024)  
 Fig. 2.4.33: Diagram Time Expenditure (own Graphic, 2024)

#### PHOTO - THETA 360°

Fig. 2.5.1: Ricoh Theta V (Theta. „Rico Theta V 360° Kamera“. Accessed 01.07.2024. <https://ricohtheta.eu/de/products/ricoh-theta-v-360-camera>)  
 Fig. 2.5.2: Floorplan groundfloor (own graphic, 2024)  
 Fig. 2.5.3: Camera positioning interior (own graphic, 2024)  
 Fig. 2.5.4: Representation of the vestibule, ground floor in Metashape with 15 images; Attempt 1 (Screenshot Metashape, 2024)  
 Fig. 2.5.5: Representation of the vestibule, ground floor in Metashape with 30 images; Attempt 2 (Screenshot Metashape, 2024)  
 Fig. 2.5.6: Time sheet (own graphic, 2024)  
 Fig. 2.5.7: Protocols, second day of recording, groundfloor (own graphic, 2024)  
 Fig. 2.5.8: Protocols, second day of recording, upperfloor (own graphic, 2024)  
 Fig. 2.5.9: Photoseries vestibule, groundfloor (own graphic, 2024)  
 Fig. 2.5.10: Photoseries anteroom, upper floor (own graphic, 2024)  
 Fig. 2.5.11: Screenshots MetashapePro (Screenshot Metashape, 2024)

Fig. 2.5.12: Screenshots MetashapePro (Screenshot Metashape, 2024)  
 Fig. 2.5.13: Screenshots MetashapePro (Screenshot Metashape, 2024)  
 Fig. 2.5.14: Screenshots MetashapePro (Screenshot Metashape, 2024)  
 Fig. 2.5.15: Gridmodel MetashapePro (Screenshot Metashape, 2024)  
 Fig. 2.5.16: Meshmodel MetashapePro (Screenshot Metashape, 2024)  
 Fig. 2.5.17: Finished model vestibule, MetashapePro (Screenshot Metashape, 2024)  
 Fig. 2.5.18: Finished model anteroom (Screenshot Metashape, 2024)  
 Fig. 2.5.19: Import Model to ArchiCad, 3D Mode (Screenshot Archicad, 2024)  
 Fig. 2.5.20: Import Model to ArchiCad, side view, (Screenshot Archicad, 2024)  
 Fig. 2.5.21: Floorplan, anteroom upper floor (Screenshot Archicad, 2024)  
 Fig. 2.5.22: Floorplan overlapping (own graphic, 2024)  
 Fig. 2.5.23: Import Model to ArchiCad, 3D Mode (Screenshot Archicad, 2024)  
 Fig. 2.5.24: Floorplan vestibule, groundfloor (Screenshot Archicad, 2024)  
 Fig. 2.5.25: Import Model to ArchiCad, side view (Screenshot Archicad, 2024)  
 Fig. 2.5.26: Floorplan, vestibule groundfloor (Screenshot Archicad, 2024)  
 Fig. 2.5.27: Floorplan overlapping (Screenshot Archicad, 2024)

## LIDAR - APPS

Fig. 2.6.1: Systematic of LiDAR measurement technology (Lars Schnell. „LiDAR - Funktionsweise und Anwendungsgebiete in der VFX-Industrie“ (04.06.2016). 8. Accessed 10.07.24. [https://www.hdm-stuttgart.de/vfx/alumni/bamathesis/pdf\\_012/](https://www.hdm-stuttgart.de/vfx/alumni/bamathesis/pdf_012/))  
 Fig. 2.6.2: Site measurement with Scaniverse (Anika Wallbrecher, 2024)  
 Fig. 2.6.3: Workflow LIDAR (Anika Wallbrecher, 2024)  
 Fig. 2.6.4: Comparison of eight different scanner apps (own graphic, sources as referenced, 2024)  
 Fig. 2.6.5: Scaniverse - Apple App Store (Anika Wallbrecher, 2024)  
 Fig. 2.6.6: Polycam Apple - App Store (Anika Wallbrecher, 2024)  
 Fig. 2.6.7: Polycam, types of data processing (Polycam on Youtube. „Announcing Room Mode!“ (14.09.22). Accessed 10.07.24. <https://www.youtube.com/watch?v=0INuYSmhP9s>)  
 Fig. 2.6.8: Scanning process of a room (Anika Wallbrecher, 2024)  
 Fig. 2.6.9: Screenshot Scaniverse, single room with room transitions (Michèle Armbrecht, Screenshot Scaniverse, 2024)  
 Fig. 2.6.10: Screenshot Scaniverse, multiple rooms in one scan (Michèle Armbrecht, Screenshot Scaniverse, 2024)  
 Fig. 2.6.11: Screenshot Scaniverse, illustrated instruction (Michèle Armbrecht, Screenshot Scaniverse, 2024)  
 Fig. 2.6.12: Scanning process (Anika Wallbrecher, 2024)  
 Fig. 2.6.13: Screenshot Scaniverse, scanning process (Michèle Armbrecht, Screenshot Scaniverse, 2024)  
 Fig. 2.6.14: Screenshot Scaniverse, misalignment of the entrance portal (Michèle Armbrecht, Screenshot Scaniverse, 2024)  
 Fig. 2.6.15: Screenshot Scaniverse, misalignment of the heights (Michèle Armbrecht, Screenshot Scaniverse, 2024)  
 Fig. 2.6.16: Screenshot Scaniverse, incorrect angles of the exterior walls (Michèle Armbrecht, Screenshot Scaniverse, 2024)  
 Fig. 2.6.17: Screenshot Scaniverse, crooked hallway (Michèle Armbrecht, Screenshot Scaniverse, 2024)  
 Fig. 2.6.18: Screenshot Scaniverse, processing options for exterior scan (Michèle Armbrecht, Screenshot Scaniverse, 2024)  
 Fig. 2.6.19: Screenshot Scaniverse, processing options for room 13 (Michèle Armbrecht, Screenshot Scaniverse, 2024)  
 Fig. 2.6.20: Screenshot Scaniverse, holes in scan of window (Michèle Armbrecht, Screenshot Scaniverse, 2024)  
 Fig. 2.6.21: Screenshot Scaniverse, round corners and edges (Michèle Armbrecht, Screenshot Scaniverse, 2024)  
 Fig. 2.6.22: Screenshot Scaniverse, misalignment of stucco mouldings (Michèle Armbrecht, Screenshot Scaniverse, 2024)  
 Fig. 2.6.23: Screenshot Scaniverse, contorted rooms (Michèle Armbrecht, Screenshot Scaniverse, 2024)  
 Fig. 2.6.24: Screenshot Scaniverse, detailed scan with high quality (Michèle Armbrecht, Screenshot Scaniverse, 2024)  
 Fig. 2.6.25: Screenshot Archicad, textured scans imported in Archicad (Enver Can Kabaran, Screenshot Archicad, 2024)  
 Fig. 2.6.26: Screenshot Archicad, problem during converting morphs (Enver Can Kabaran, Screenshot Archicad, 2024)  
 Fig. 2.6.27: Screenshot CloudCompare, converting PLY format to DXF format (Enver Can Kabaran, Screenshot CloudCompare, 2024)  
 Fig. 2.6.28: Screenshot Archicad, GF of first scan set with wrong angles (Michèle Armbrecht, Screenshot Archicad, 2024)  
 Fig. 2.6.29: Screenshot Archicad, 1F of first scan set with wrong angles (Michèle Armbrecht, Screenshot Archicad, 2024)  
 Fig. 2.6.30: Screenshot Archicad, assembled first set of scans (Michèle Armbrecht, Screenshot Archicad, 2024)  
 Fig. 2.6.31: Screenshot Archicad, final version of assembled scans (Michèle Armbrecht, Screenshot Archicad, 2024)  
 Fig. 2.6.32: Screenshot Rhino, editing of exterior scan (Michèle Armbrecht, Screenshot Rhino, 2024)  
 Fig. 2.6.33: Screenshot Archicad, vestibules in both scans match (Michèle Armbrecht, Screenshot Archicad, 2024)  
 Fig. 2.6.34: Screenshot Archicad, windows in both scans match (Michèle Armbrecht, Screenshot Archicad, 2024)  
 Fig. 2.6.35: Screenshot Archicad, two overlapping scans (Michèle Armbrecht, Screenshot Archicad, 2024)  
 Fig. 2.6.36: Screenshot Archicad, chosen method with overlapping (Enver Can Kabaran, Screenshot Archicad, 2024)  
 Fig. 2.6.37: Screenshot Archicad, measuring the wall thickness (Enver Can Kabaran, Screenshot Archicad, 2024)  
 Fig. 2.6.38: Screenshot Archicad, measuring the wall height (Enver Can Kabaran, Screenshot Archicad, 2024)  
 Fig. 2.6.39: Screenshot Archicad, drawing walls based on scan (Enver Can Kabaran, Screenshot Archicad, 2024)  
 Fig. 2.6.40: Screenshot Archicad, misalignment of the exterior walls (Enver Can Kabaran, Screenshot Archicad, 2024)  
 Fig. 2.6.41: Screenshot Archicad, measuring the window width (Enver Can Kabaran, Screenshot Archicad, 2024)  
 Fig. 2.6.42: Screenshot Archicad, measuring the window height (Enver Can Kabaran, Screenshot Archicad, 2024)  
 Fig. 2.6.43: Screenshot Archicad, measuring the outdoor entrance (Enver Can Kabaran, Screenshot Archicad, 2024)  
 Fig. 2.6.44: Screenshot Archicad, measuring the entrance facade (Enver Can Kabaran, Screenshot Archicad, 2024)  
 Fig. 2.6.45: Screenshot Archicad, 3D model (Enver Can Kabaran, Screenshot Archicad, 2024)  
 Fig. 2.6.46: Screenshot PolyCam, individual scan of room 15 (Viktoria Probst, Screenshot PolyCam, 2024)  
 Fig. 2.6.47: Screenshot PolyCam, room configuration of rooms 1, 2, 4, 5 (Viktoria Probst, Screenshot PolyCam, 2024)  
 Fig. 2.6.48: Screenshot PolyCam, scanning of room 3 (Viktoria Probst, Screenshot PolyCam, 2024)  
 Fig. 2.6.49: Screenshot PolyCam, scanning of stucco moldings (Viktoria Probst, Screenshot PolyCam, 2024)  
 Fig. 2.6.50: Screenshot PolyCam, scanning of the windows (Viktoria Probst, Screenshot PolyCam, 2024)

Fig. 2.6.51: Screenshot PolyCam, scanning the open and closed doors (Viktoria Probst, Screenshot PolyCam, 2024)  
 Fig. 2.6.52: Screenshot PolyCam, scanning the balcony (Viktoria Probst, Screenshot PolyCam, 2024)  
 Fig. 2.6.53: Screenshot PolyCam, scanning the arched windows (Viktoria Probst, Screenshot PolyCam, 2024)  
 Fig. 2.6.54: Screenshot PolyCam, scanning the entrance door (Viktoria Probst, Screenshot PolyCam, 2024)  
 Fig. 2.6.55: Screenshot PolyCam, round kitchen area (rooms 6,7 and 8) (Viktoria Probst, Screenshot PolyCam, 2024)  
 Fig. 2.6.56: Screenshot PolyCam, scanning of the round vestibule (Viktoria Probst, Screenshot PolyCam, 2024)  
 Fig. 2.6.57: Screenshot PolyCam, tutorial and screen during the usage (Viktoria Probst, Screenshot PolyCam, 2024)  
 Fig. 2.6.58: Screenshot PolyCam, screen during the usage (Viktoria Probst, Screenshot PolyCam, 2024)  
 Fig. 2.6.59: Screenshot PolyCam, output of dimensioned floor plans (Viktoria Probst, Screenshot PolyCam, 2024)  
 Fig. 2.6.60: Screenshot PolyCam, AR mode (Viktoria Probst, Screenshot PolyCam, 2024)  
 Fig. 2.6.61: Screenshot PolyCam, editing mode (Viktoria Probst, Screenshot PolyCam, 2024)  
 Fig. 2.6.62: Screenshot PolyCam, conversion to textured mesh (Viktoria Probst, Screenshot PolyCam, 2024)  
 Fig. 2.6.63: Screenshot Archicad, STL and XYZ-pointcloud (from the left) (Viktoria Probst, Screenshot Archicad, 2024)  
 Fig. 2.6.64: Screenshot Archicad, FBX and DAE (from the left) (Viktoria Probst, Screenshot Archicad, 2024)  
 Fig. 2.6.65: Screenshot Archicad, overlaying scans and floor plans (Viktoria Probst, Screenshot Archicad, 2024)  
 Fig. 2.6.66: Screenshot Archicad, result of the combined rooms (Viktoria Probst, Screenshot Archicad, 2024)  
 Fig. 2.6.67: Screenshot Archicad, result of the combined rooms (Viktoria Probst, Screenshot Archicad, 2024)  
 Fig. 2.6.68: Screenshot Archicad, basement floor (Viktoria Probst, Screenshot Archicad, 2024)  
 Fig. 2.6.69: Screenshot Archicad, ground floor (Viktoria Probst, Screenshot Archicad, 2024)  
 Fig. 2.6.70: Screenshot Archicad, first floor (Viktoria Probst, Screenshot Archicad, 2024)  
 Fig. 2.6.71: Screenshot Archicad, close-up inner corners with transparent layer (Viktoria Probst, Screenshot Archicad, 2024)  
 Fig. 2.6.72: Screenshot Revit, space between the scanned walls (María Albert Enguídanos, Screenshot Revit, 2024)  
 Fig. 2.6.73: Screenshot Archicad, scanned entrance (Viktoria Probst, Screenshot Archicad, 2024)  
 Fig. 2.6.74: Screenshot Revit, modelled entrance (María Albert Enguídanos, Screenshot Revit, 2024)  
 Fig. 2.6.75: Screenshot Archicad, scanned section (Viktoria Probst, Screenshot Archicad, 2024)  
 Fig. 2.6.76: Screenshot Revit, modelled section (María Albert Enguídanos, Screenshot Revit, 2024)  
 Fig. 2.6.77: Screenshot Archicad, window height (Viktoria Probst, Screenshot Archicad, 2024)  
 Fig. 2.6.78: Screenshot Archicad, kitchen rearrangement (Viktoria Probst, Screenshot Archicad, 2024)  
 Fig. 2.6.79: Screenshot Revit, ground floor (María Albert Enguídanos, Screenshot Revit, 2024)  
 Fig. 2.6.80: Screenshot Archicad, scan of the stairs (Viktoria Probst, Screenshot Archicad, 2024)  
 Fig. 2.6.81: Screenshot Revit, first floor (María Albert Enguídanos, Screenshot Revit, 2024)  
 Fig. 2.6.82: Screenshot Revit, BIM-capable 3D model (María Albert Enguídanos, Screenshot Revit, 2024)

#### MANUAL - DISTOMETER

Fig. 2.7.1: Inch rule and laser distance meter (own graphic, 2024)  
 Fig. 2.7.2: Hand sketch (own graphic, 2024)  
 Fig. 2.7.3: Curved wall on eastfacade Ohlenforffsche Villa (own graphic, 2024)  
 Fig. 2.7.4: Curved wall on eastfacade Ohlenforffsche Villa (own graphic, 2024)  
 Fig. 2.7.5: Hand sketch, entrance Northfacade (own graphic, 2024)  
 Fig. 2.7.6: Hand sketch, Westfacade (own graphic, 2024)  
 Fig. 2.7.7: Manual Measurement inside, second floor (own graphic, 2024)  
 Fig. 2.7.8: Documentation window details (own graphic, 2024)  
 Fig. 2.7.9: Manual Measurement inside, interior stairs (own graphic, 2024)  
 Fig. 2.7.10: Photo documentation, entrance (own graphic, 2024)  
 Fig. 2.7.11: Photo documentation, texture and material of the westfacade (own graphic, 2024)  
 Fig. 2.7.12: 3D Modell, facades and interior walls, North-east (Screenshot Archicad, 2024)  
 Fig. 2.7.13: 3D Modell, facades and interior walls, South-west (Screenshot Archicad, 2024)  
 Fig. 2.7.14: 3D Modell, interior view floor, doors and handrail (Screenshot Archicad, 2024)  
 Fig. 2.7.15: 3D Modell, north-east (Screenshot Archicad, 2024)  
 Fig. 2.7.16: 3D Modell, south-west (Screenshot Archicad, 2024)

#### MANUAL - DISTO/APPS

Fig. 2.8.1: Leica D810 Disto with Leica Disto Plan App (Myriam Herder, 2024)  
 Fig. 2.8.2: Bosch PLR 50 C Disto with Measure Master App (Myriam Herder, 2024)  
 Fig. 2.8.3: Leica Disto Plan App (Gina Hommola, 2024)  
 Fig. 2.8.4: Bosch Measure Master App (Gina Hommola, 2024)  
 Fig. 2.8.5: Screenshots Leica Disto Plan App (Screenshots Leica Disto Plan App, 2024)  
 Fig. 2.8.6: Screenshots Bosch Measure Master App (Screenshots Bosch Measure Master App, 2024)  
 Fig. 2.8.7: Comparison of the Leica and Bosch system (own graphic, 2024)  
 Fig. 2.8.8: Using the Bosch Disto for the measurement (Gina Hommola, 2024)  
 Fig. 2.8.9: Leica Report overview page (Screenshot Leica Disto Plan App, 2024)  
 Fig. 2.8.10: Bosch overview page of the room 2 (entrance hall) (Screenshot Bosch Measure Master App, 2024)  
 Fig. 2.8.11: Leica overview page of the room 2 (entrance hall) (Screenshot Leica Disto Plan App, 2024)  
 Fig. 2.8.12: Import Rhino 3D representation (Screenshot Rhino, 2024)  
 Fig. 2.8.13: Import Vectorworks 3D representation (Screenshot Vectorworks, 2024)  
 Fig. 2.8.14: Import Archicad 3D representation (Screenshot Archicad, 2024)  
 Fig. 2.8.15: 3D modeling process in Archicad (Screenshot Archicad, 2024)



Fig. 2.8.16: 3D modeling process in Archicad (Screenshot Archicad, 2024)

Fig. 2.8.17: Compilation - from site to 3D Model (own graphic, screenshots Leica Disto Plan App and Archicad, 2024)

## ANALYSIS

Fig. 3.1.1: Time recording of the building survey (Bernd Dahlgrün, 2024)

Fig. 3.1.2: Comparison of the precision of the different measurement systems (Bernd Dahlgrün, 2024)

All images included in the tables of contents are either image details of the images included in this publication, which are therefore already referenced in the list above, or own photos and illustrations of the authors of this publication.

All portrait photos were taken by the authors of this publication.



# IMPRINT

© HafenCity Universität Hamburg, 2024 - M. Sc. Architecture

Editor:

HafenCity Universität Hamburg,  
Prof. Dr.-Ing. Bernd Dahlgrün  
Building construction  
bernd.dahlgruen@hcu-hamburg.de

Assistant editor:

Till Rudolph  
till.rudolph@hcu-hamburg.de

Layout and design:

Michèle Armbrecht  
michele.armbrecht@hcu-hamburg.de

HafenCity Universität Hamburg  
Henning-Voscherau-Platz 1  
20457 Hamburg  
www.hcu-hamburg.de

<https://nbn-resolving.org/urn:nbn:de:gbv:1373-repos-13883>

This publication is protected by copyright. It must not be reproduced without the prior authorisation of the authors/publishers.

Image rights: The image rights to all photos, with the exception of those labelled otherwise, are held by HCU Hamburg.

All authors are responsible for their texts, contents and illustrations.

