



HAL
open science

Effectiveness of BESS in improving frequency stability of an island grid

Hung Cuong Nguyen, Quoc Tuan Tran, Yvon Besanger

► **To cite this version:**

Hung Cuong Nguyen, Quoc Tuan Tran, Yvon Besanger. Effectiveness of BESS in improving frequency stability of an island grid. *IEEE Transactions on Industry Applications*, 2023, 60 (6), pp.8203-8212. 10.1109/TIA.2024.3443241 . hal-04834964

HAL Id: hal-04834964

<https://hal.science/hal-04834964v1>

Submitted on 12 Dec 2024

HAL is a multi-disciplinary open access archive for the deposit and dissemination of scientific research documents, whether they are published or not. The documents may come from teaching and research institutions in France or abroad, or from public or private research centers.

L'archive ouverte pluridisciplinaire **HAL**, est destinée au dépôt et à la diffusion de documents scientifiques de niveau recherche, publiés ou non, émanant des établissements d'enseignement et de recherche français ou étrangers, des laboratoires publics ou privés.

Effectiveness of BESS in Improving Frequency Stability of an Island Grid

NGUYEN Hung Cuong
Univ. Grenoble Alpes,
CEA LITEN, INES
Le Bourget-du-Lac, France
hung-cuong.NGUYEN@cea.fr

TRAN Quoc Tuan
Univ. Grenoble Alpes,
CEA LITEN, INES
Le Bourget-du-Lac, France
QuocTuan.TRAN@cea.fr

Yvon BESANGER
Univ. Grenoble Alpes
G2Elab – Grenoble INP
38031 Grenoble, France
yvon.besanger@grenoble-inp.fr

Abstract— The integration of Renewable Energy Sources (RES) into the power grid is limited by two inherent characteristics: intermittency and low inertia. These characteristics negatively impact system stability, particularly in terms of frequency stability. If the penetration of RES in a power system exceeds a certain level, the frequency stability of the system is compromised. This paper employs simulations to investigate the impact of high renewable energy integration on the stability of an island microgrid. Various scenarios are considered, involving different ratios of RES and different incidents like short circuits and generator outages. The study proposes and validates the combination of Fault Ride Through (FRT) and battery energy storage systems (BESS) to address these challenges. The results reveal the significant influence of RES penetration levels on the frequency stability of the grid. However, the combination of FRT and BESS proves highly effective in improving system stability, even when RES account for 100% of the system's generation capacity

Keywords— Fault ride through, Frequency droop control, Frequency stability, Micro grid stability, Renewable energy.

I. INTRODUCTION

Global greenhouse gas emissions have become a significant concern, prompting the exploration of renewable energy sources (RES) as a promising solution. However, the conversion of direct current (DC) generated by wind turbines (WTs) and photovoltaic (PV) systems to alternating current (AC) using inverters has disadvantages: it eliminates the inertia of the energy source and weakens the stability of connected systems [1]. Additionally, the intermittent and weather-dependent nature of WTs and PV systems, with their power output influenced by factors such as wind speed, temperature, irradiance, etc. These two inherent characteristics of RES further detract from the stability of connected systems, especially the frequency stability of small and weak grids [2].

Numerous studies have been conducted on this subject, focusing on various aspects. For instance, the challenges concerning the stability of a microgrid were comprehensively discussed in [3]. Similarly, [4] employed a mathematical model to assess the power stability of an isolated microgrid, whereas [5, 6] introduced an assessment approach based on dynamic stability analysis to address this matter.

On the other hand, numerous studies have been undertaken to enhance system stability, employing various approaches. For instance, intelligent fuzzy control [7] and additional nonlinear controllers [8] have been explored as means to improve stability. Additionally, the utilization of batteries as virtual synchronous generators (VSGs), which emulate the beneficial characteristics of traditional rotary generators, has

proven to be an effective solution [9]. Moreover, the implementation of Fault Ride Through (FRT) requirements, as specified in new grid codes [10], and power/frequency droop control [11, 12], have been extensively analyzed and recognized as well-established methods for ensuring power stability, particularly in terms of frequency stabilization in standalone grids. Currently, droop control methods can be classified into four main categories: conventional droop control, virtual impedance loop-based droop control, adaptive droop control, and robust droop control [11]. Conventional power-frequency droop control is widely acknowledged for its simplicity, flexibility, reliability, and effectiveness in improving frequency quality while eliminating the need for complex communication links [11].

The main objective of this research paper is to comprehensively analyze the transient stability of the Guadeloupe grid system. Guadeloupe is an archipelago located in the Caribbean, consisting of seven islands. It forms both a French overseas region and department. The central part of the archipelago, which is shaped like a butterfly, is composed of two major islands: Grande-Terre in the east and Basse-Terre in the west, as illustrated in Fig. 1. This paper specifically concentrates on the examination of the 63kV transmission grid that serves these two major islands.

Similar to numerous other islands, the Guadeloupe archipelago heavily depends on diesel and gas for its electricity generation, resulting in high costs and negative environmental consequences. Nonetheless, Guadeloupe's geographical location provides significant opportunities for exploiting wind and solar energy. Furthermore, the French government has established a target in its Energy Transition for Green Growth (TECV) plan, aiming to derive a minimum of 40% of the island's electricity from RES by 2030 [13]. Consequently, the adoption of renewable energy has become an inevitable and imperative choice for Guadeloupe.

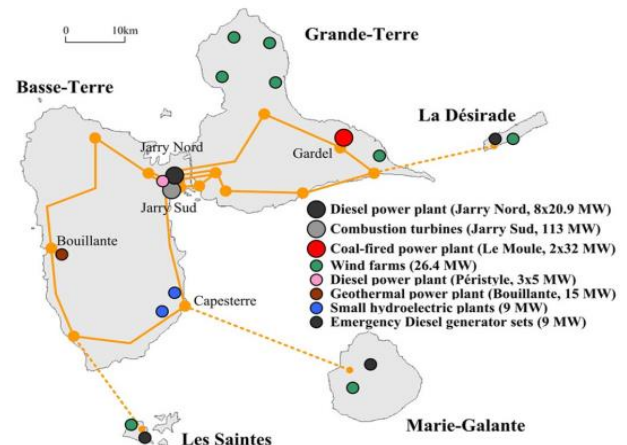

Fig. 1. HV infrastructure in the Guadeloupe archipelago

However, various research studies have highlighted a notable challenge in integrating RES into grids, specifically concerning frequency stability. As the penetration of RES increases, the inertia of the grid decreases. In order to raise the integration of RES into grids, it is crucial to implement measures that enhance frequency stability. This study focuses on assessing the influence of WTs and PV units on the frequency stability of the Guadeloupe grid. Furthermore, the paper also validates the effectiveness of combining the FRT capability with power-frequency (P-f) droop control, which is facilitated by BESS, to support the overall power stability of the grid.

The paper is structured into 5 sections. Section I introduces the topic, while Section II provides an overview of frequency droop control and FRT requirement. Section III offers a detailed description of the Guadeloupe grid, and Section IV outlines different scenarios and presents simulation results for the transient stability of the island microgrid. Lastly, Section V concludes the paper.

II. CONVENTIONAL POWER - FREQUENCY DROOP CONTROL AND FRT REQUIREMENT

A. Principle of P-f droop control

The concept of the technique is visually depicted in Fig. 2a. Essentially, it can be understood that the active power and reactive power output of BESS are determined by the deviation between measured frequency/voltage and as their respective nominal values. The mathematical representation of the power-frequency (P-f) droop property in Fig. 2 is expressed as follows:

$$f = f^* - \frac{m}{\tau S + 1}(P - P^*) \quad (1)$$

Where f^* is nominal frequency of 50Hz; P^* indicate nominal active power of BESS; τ is the time constant of the low-pass filter which filter out the averaged active and reactive power; P stands for real active of BESS; m is the P-f droop coefficients. m can be chosen as (2):

$$m = \frac{f_{max} - f_{min}}{P_{max} - P_{min}} \quad (2)$$

Where f_{max} and f_{min} are the maximum and minimum values of the allowable frequency; P_{max} and P_{min} stand for maximum and minimum capacities of the active power of BESS, respectively.

B. FRT requirement

The Fig. 2b illustrates the voltage requirements for FRT. Without FRT, inverters that connect RES to the grid would automatically disconnect PV systems or WTs from the grid if the voltage at the Point of Common Coupling (PCC) falls outside of the acceptable range (e.g. PCC voltage is below 0.8pu). However, RES will remain connected to the network if the voltage value is above the green curve shown in Fig. 2b in case of applying FRT requirement.

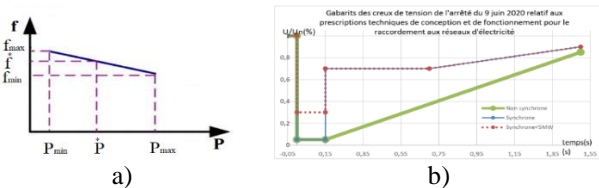

Fig. 2: Principle of conventional power-frequency (P-f) droop characteristic (a) and FRT requirements (b)

III. DESCRIPTION OF GRID AND MODELLING

A. Description of Guadeloupe grid

While the Base-Terre and Grande-Terre transmission grid primarily operates at a voltage level of 63 kV, utilizing overhead lines spanning a total length of 226.2 km, the interconnection of this grid with other islands is at a voltage level of 20 kV, as indicated by the dotted line in Fig. 1.

Fig. 3 presents the single-line diagram of the Base-Terre and Grande-Terre transmission power system. Notably, the system stands out for its meshed structure, a common configuration in transmission networks due to its high reliability in providing power supply. Additionally, Fig. 3 highlights that bus N1 holds significant importance as the most critical and vulnerable node in the system, as it connects to the majority of other nodes within the grid.

B. Loads, Generators and BESS

According to Fig. 3, there are twelve loads located from node N1 to node N13 (excluding node N3) with the total of the active and reactive power of 246.5MW and 60.75MVar, respectively. Additionally, nineteen synchronous generators (SGs) with capacities ranging from 5.00 to 56.35 MVA are connected to the grid at nodes N2, N3, and N12.

It is considered that PV plants are placed at the twelve points where the loads are connected. Additionally, the WTs are connected to the grid specifically at node N3, providing a capacity of 50 MW and operating with a power factor of 0.9.

A BESS is connected at node N1 to regulate the grid frequency as the master if necessary.

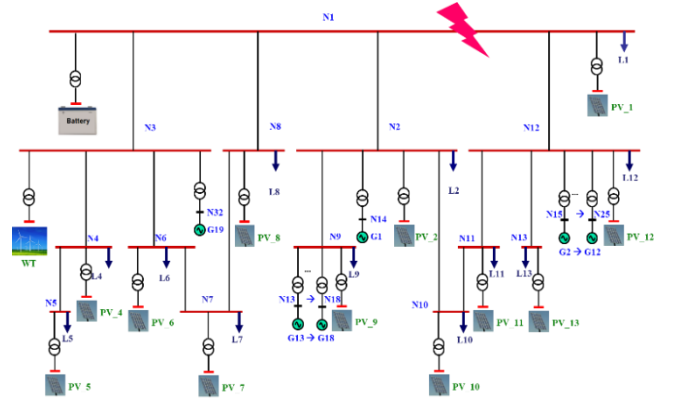

Fig. 3: Single-line diagram of transmission of Guadeloupe grid

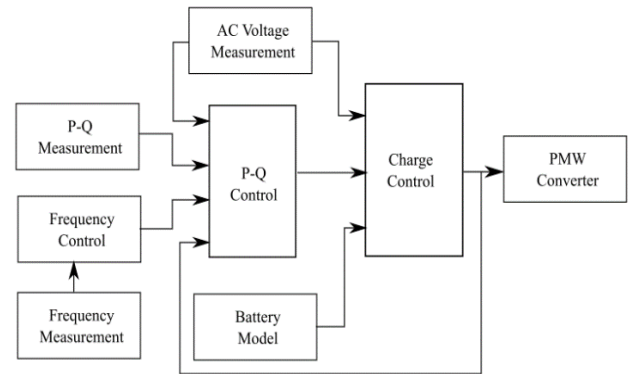

Fig. 4: Blocks diagram controller of battery

C. Modelling network and BESS in Powerfactory

The simulation of the Guadeloupe grid was performed in the Digsilent Powerfactory environment. Components of the network, such as generators, lines, and loads, were modeled based on actual parameters. The FRT requirement according to recommendations in [10] (Fig. 2b) was implemented in the inverters that connect the PV units and wind turbines to the grid. P-f droop with a 0.004 droop coefficient was integrated into the Frequency Control block (Fig. 4) to calculate the deviation and monitor the upper and lower limits of the current frequency. The output from this block was combined with voltage value from AC voltage measurement block and the active and reactive power output of the BESS from P-Q measurement block to form input signals for the P-Q control block, which regulates the active and reactive power that the BESS injects into the grid according to predefined rules (P-f droop and Q-V droop).

IV. SCENARIOS AND SIMULATION RESULTS

A. Scenarios

In order to estimate the maximum level of RES integration that can be accommodated by the Guadeloupe grid while ensuring frequency stability, several scenarios were examined. These scenarios covered PV penetration levels ranging from 67% to 85% of the total grid generation. To simplify the analysis, the WT capacity was held constant at 50 MW. This simplification does not impact the general applicability of the study, as both PV and WT sources connect to the grid using power electronic converters with inherently low inertia characteristics. Additionally, each scenario accounted for two contingencies: three - short-circuit and generator outage incidents.

The ratio of renewable energy sources (RES) is calculated by dividing the total capacity of PV plants and the active power of WTs by the combined rated power of the loads (246.5 MW) and grid losses (approximately 4 MW). It is important to note that in scenario SC_1, the RES proportion starts at 67% due to observed frequency instability after a generator outage when only FRT is employed at this level [14]. As a result, this particular wind and PV energy penetration level was chosen as the starting point to evaluate the effectiveness of combining FRT and BESS in this research. The detailed simulation scenarios are presented in Table I.

Generator G18 serves as the reference generator, with node N_18 being the slack node. A three-phase short circuit event still occurred at the middle of the bus N1, which is the weakest point in the system, as previously discussed. This event took place at 20s and lasted for 150ms with short-circuit resistance being 1 Ohm. This implies that if the system remains stable in terms of frequency during a short circuit at node N1, it will also be stable if a short circuit were to occur anywhere else in the system.

TABLE I: SCENARIOS

Scenarios	SGs	PV (MW)	WT (MW)	RES Rate (%)	H _{sys} (s)
SC_1	G9, G18, G19	117	50	67	1.07
SC_2	G9, G18	139	50	76	0.92
SC_3	G18	162	50	85	0.90

B. Simulation with FRT requirement

Fig. 5 to Fig. 8 present the simulation results of the Guadeloupe grid in scenario SC_1, where the penetration of RES is set at 67% without the application of BESS. The obtained results demonstrate that the frequency of the grid cannot keep stable after generator G18 suddenly stops working at 20s (Fig. 5) if only FRT is utilized. This is because the automatic adjustment of the active power by the remaining generator G19 is unable to compensate for the power loss from generator G18. As a result, the entire system experiences a collapse, as shown in Fig. 6.

From this scenario, the progress carries over to investigate the grid after connecting BESS integrated the P-f droop control to the power system. The two incidents of short circuit and generator outage are simulated again in each scenario to evaluate the effectiveness of using BESS for improving frequency stability.

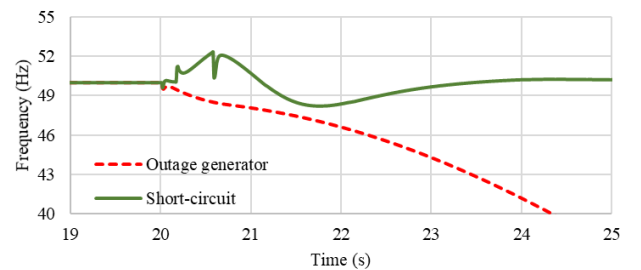

Fig. 5. Frequency variation in scenarios of short-circuit and generator outage at RES rate of 67% with FRT

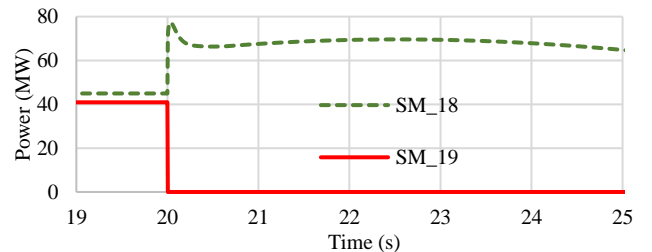

Fig. 6. Power output of SGs in scenario of generator outage at RES rate of 67% with FRT

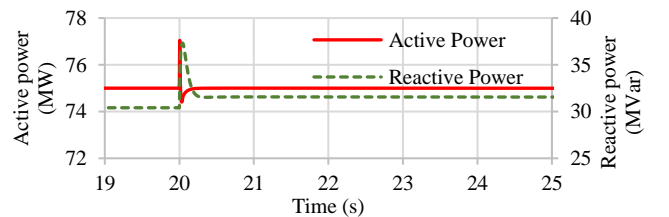

Fig. 7. Active and reactive power output of WTs in scenario of generator outage at RES rate of 67% with FRT

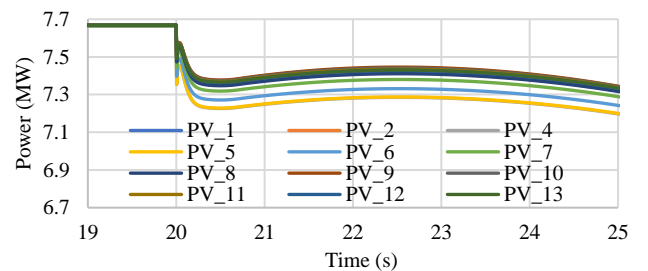

Fig. 8. Power output of PV units in scenario of generator outage at RES rate of 67% with FRT

C. Simulation with FRT and BESS

1) Generator outage

a) Scenarios SC_1

When the G18 generator suddenly stops at 20s, a change in frequency and voltage occurs in the system. The remaining machines' Auto Voltage Regulate (AVR) and Governor (GOV) activate to counteract the loss of power from generator G18. The BESS, through its control blocks, adjusts the active and reactive power injected into the grid to eliminate power system fluctuations, automatically matching the changes.

In this scenario, the simulation results are depicted in Fig. 9 to Fig. 14. By analyzing the results, the following conclusions can be made:

- In case of integration of the BESS, the power stability of the system is maintained after the generator outage event. The system is stable not only in terms of frequency (Fig. 9) but also in voltage (Fig. 10).
- During a generator outage, the power deficit is compensated by increasing power output from generator G19 and the BESS, as shown by the dark-green curve in Fig.13 and Fig. 14. Additionally, the BESS injects extra reactive power into the grid to maintain voltage at its nodes close to I_{pu} , as illustrated in Fig. 10.

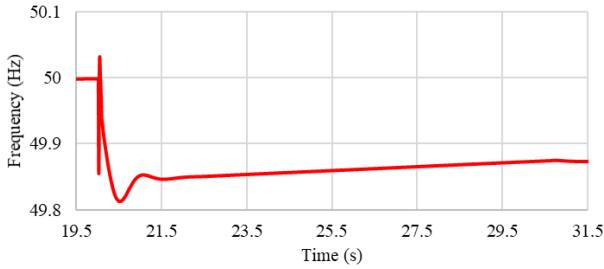

Fig. 9. Frequency variation in scenario of generator outage when applying FRT & BESS at RES rate of 67%

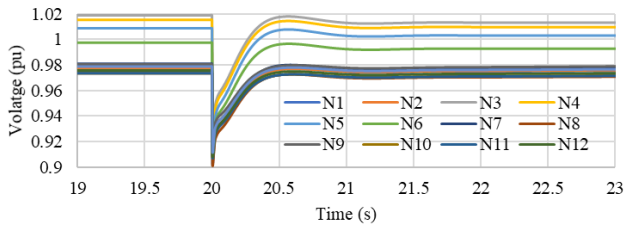

Fig. 10. Voltage variation at the nodes in scenario of generator outage when applying FRT & BESS at RES rate of 67%

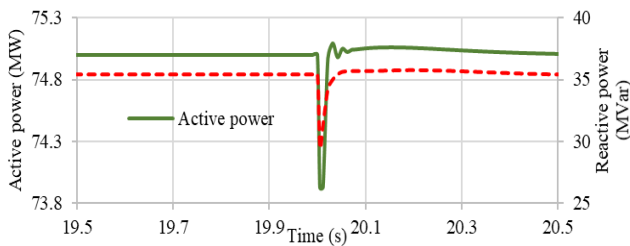

Fig. 11. Active and reactive power of WTs in scenario of generator outage when applying FRT & BESS at RES rate of 67%

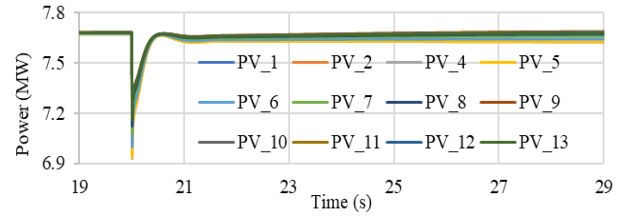

Fig. 12. Power of PV units in scenario of generator outage when applying FRT & BESS at RES rate of 67%

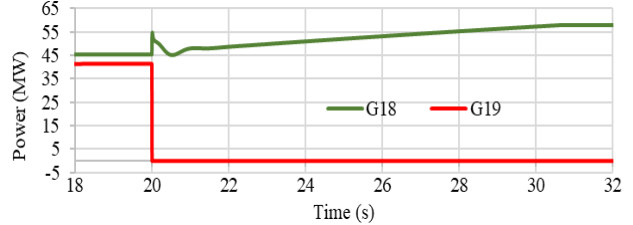

Fig. 13. Power output of SGs in scenario of generator outage when applying FRT & BESS at RES rate of 67%

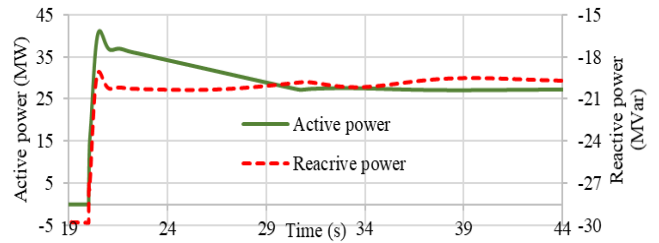

Fig. 14. Active and reactive power of BESS in scenario of generator outage when applying FRT & BESS at RES rate of 67%

- The power output of PV plants and WT remained almost unchanged before and after the incident, as shown in Fig. 11 and Fig. 12 respectively. This is because these nodes are designated as P-Q nodes, as mentioned earlier. Any changes in active and reactive power in the Guadeloupe grid are compensated by generator G19 and the BESS.

b) Scenarios SC_2 and SC_3

The research investigation further proceeds by analyzing the grid under scenarios SC_2, which includes a generator outage disturbance taking place at 20 seconds. The simulation outcomes for these scenarios are presented in Fig. 15, Fig. 16, and Fig. 17.

Especially, in scenario SC_3, where the grid has 100% penetration of renewable energy, generator G18 serves as the only rotating machine. When it stops working at 20s, the BESS acts as a slack bus and grid-forming device to maintain power balance in the grid, as shown in Fig. 16 and Fig. 17.

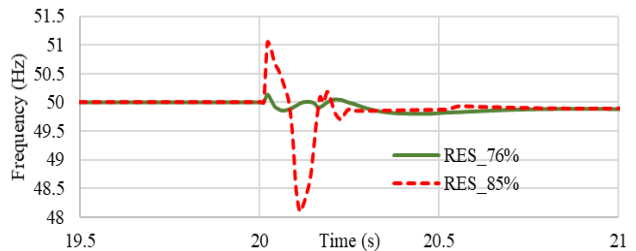

Fig. 15. Frequency variation in scenario of generator outage when applying FRT & BESS

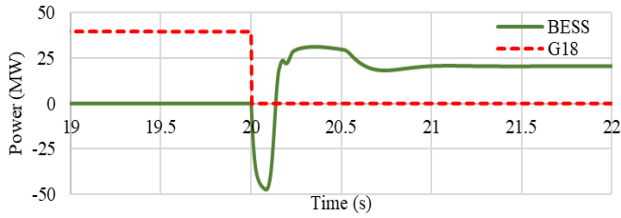

Fig. 16. Active power of BESS and generator G18 in scenario of generator outage when applying FRT & BESS at RES rate of 85%

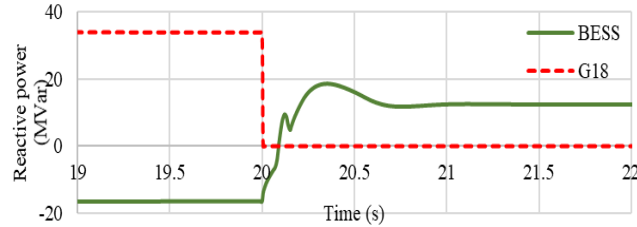

Fig. 17. Reactive power of BESS and generator G18 in scenario of generator outage when applying FRT & BESS at RES rate of 85%

From these two figures it is easy to recognize that the P-F and Q-V droop control characteristics result in unequal increase of power output from the BESS compared to the power loss from generator G18, causing the system frequency to not reach 50Hz as it was prior to the incident. The voltage at nodes in the system also experiences a similar drop (not shown in this paper). Secondary-control will restore the system to its nominal parameters.

Additionally, Fig. 15 also illustrates that an increased proportion of renewable energy sources (RES) in the grid leads to greater frequency fluctuations following an incident, as mentioned in Section I. In the authors' previous studies, this has been proven in both mathematical [2] and simulation terms [14]. If the penetration of RES in the grid exceeds a specific threshold, the frequency becomes unstable following a disturbance [14].

2) Short-circuit

With the assistance of BESS, the system maintains stability in terms of both frequency and voltage, although the voltage stability is not presented in this paper. This stability is sustained even when the percentage of RES reaches 100% during an abrupt generator shutdown. It is crucial to investigate these specific scenarios, particularly when encountering short-circuit disturbances.

The results displayed in Fig. 18 demonstrate that the system consistently preserves frequency stability across all three scenarios (SC_1, SC_2, and SC_3) even after a short-circuit event. This stability is maintained even when the Guadeloupe grid achieves a complete 100% penetration of RES, as indicated by the red dotted curve in the figure.

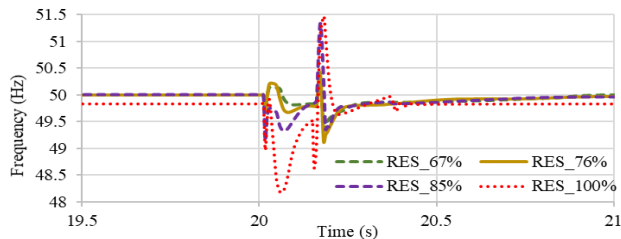

Fig. 18. Variation of frequency in case of short-circuit with FRT & BESS

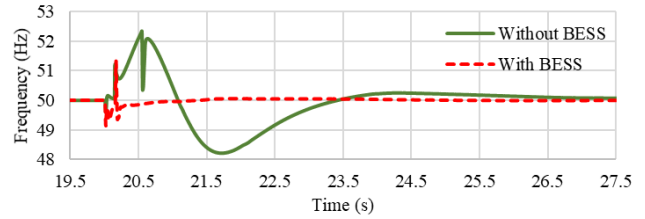

Fig. 19. Frequency variation in scenario of short-circuit before and after applying BESS at RES rate of 85%

The assertion that the frequency variation increases as the ratio of RES in the grid increases has been demonstrated once again in Fig. 18. The minimum frequency in the scenario with 67% RES is approximately 49.3 Hz, while it is around 48 Hz in the scenario SC_3 with 100% WT and PV energy in the system. Furthermore, as shown in Fig. 19, when the system is supported by the BESS, the frequency fluctuation amplitude decreases significantly after a major disturbance. This highlights the crucial role of the BESS in enhancing the frequency quality of the power system.

V. CONCLUSIONS

The frequency stability of power systems is adversely affected by the intermittent nature and low inertia of RES. As the integration of PV systems and WTs into the grid increases, the available system stability reserve diminishes. Depending on the specific characteristics of grids, there exists a limit to how much RES can be integrated while still maintaining frequency stability in the face of major disturbances such as short circuits or generator outages. A promising solution to enhance RES penetration is the combination of FRT capability and BESS. The results obtained in this paper show that with the support of this solution, RES can account for up to 100% while still ensuring stability in both frequency and voltage after large disturbances. In addition, the presence of BESS also leads to significant improvements in the frequency quality of the grid.

For future work, it is suggested to explore areas such as adaptive frequency control, distributed control, optimal reserve allocation, and other methods aimed at improving stability in power systems.

REFERENCES

- [1] P. Tielens, P. Henneaux and S. Cole (Tractebel), "Penetration of renewables and reduction of synchronous inertia in the European power system – Analysis and solutions", Advanced System Studies for Energy Transition (ASSET), November 2008
- [2] C. Nguyen-Hung, T. Tran-Quoc, Y. Basenger, P. Do-Thai, "Impact of renewable energy resources on frequency of a power system based on mathematical approach", 2021 IEEE International Conference on Environment and Electrical Engineering and 2021 IEEE Industrial and Commercial Power Systems Europe.
- [3] R. Majumder, "Some Aspects of Stability in Microgrids," IEEE Transactions on Power Systems, vol. 28, pp. 3243–3252, Aug. 2013.
- [4] N. Beg, A. Armstorfer, A. Rosin, and H. Biechl, "Mathematical Modeling and Stability Analysis of a Microgrid in Island Operation," in 2018 International Conference on Smart Energy Systems and Technologies (SEST), Sep. 2018, pp. 1–6.
- [5] A. Kunwar, F. Shahnia, and R. C. Bansald, "Eigenvalue-Oriented Dynamic Stability Examination to Enhance Designing a Microgrid Hosting Clusters of Inertial and Non-Inertial Distributed Generators," IEEE Transactions on Smart Grid, vol. 11, pp. 1942–1955, May 2020.
- [6] D. Choi, J.-W. Park, and S. H. Lee, "Virtual Multi-Slack Droop Control of Stand-Alone Microgrid With High Renewable Penetration Based on Power Sensitivity Analysis," IEEE Transactions on Power Systems, vol. 33, no. 3, pp. 3408–3417, May 2018.

- [7] R. Khezri, A. Mahmoudi, and S. Golshannavaz, "An Intelligent Fuzzy Control Approach for a Back-Pressure Autonomous Industrial Microgrid," in 2020 IEEE Energy Conversion Congress and Exposition (ECCE), Oct. 2020, pp. 2439–2444.
- [8] A. Mojallal, S. Lotfifard, and S. M. Azimi, "A Nonlinear Supplementary Controller for Transient Response Improvement of Distributed Generations in Micro-Grids," IEEE Transactions on Sustainable Energy, vol. 11, no. 1, pp. 489–499, Jan. 2020.
- [9] A. Moullichon, "Design of a virtual synchronous generator (VSG), a dynamic adaptive system, for Micro Grid stabilization with high penetration of renewable energies", Thesis, 2020.
- [10] ERDF-NOI-RES_13E, "Description et étude des protections de découplage pour le raccordement des Installations de Production raccordées au Réseau Public de Distribution", June 2020
- [11] U. Bashir Tayab, M. –A. –B. Roslan, L. –J. Hwai, M. Kashif, "A review of droop control techniques for microgrid", Renewable and Sustainable Energy Reviews 76 (2017) 717–727.
- [12] X. Hou, Y. Sun, X. Zhang, J. Lu, P. Wang, and J. -M. Guerrero, "Improvement of Frequency Regulation in VSG-Based AC Microgrid Via Adaptive Virtual Inertia", IEEE transactions on power electronics, Vol. 35, no. 2, February 2020.
- [13] Available online at:
<https://www.prefectures-regions.gouv.fr/bourgogne-franche-comte/Region-et-institutions/L-action-de-l-Etat/Environnement-developpement-durable-et-prevention-des-risques/Environnement-developpement-durable-et-prevention-des-risques/La-transition-energetique-pour-la-croissance-verte-TECV/#titre>
- [14] C. Nguyen-Hung, T. Tran-Quoc, Y. Basenger, P. Do-Thai, "Evaluation of photovoltaic penetration effect on frequency stability of Guadeloupe island grid", 2022 IEEE International Conference on Environment and Electrical Engineering and 2022 IEEE Industrial and Commercial Power Systems Europe.