



HAL
open science

Modelling of PDIV evolution over time under multiple ageing factors for insulation of inverter-fed electrical machines

Pawel Pietrzak, David Malec, Antoine Picot, Pascal Maussion, Tahar Hamiti, Loucif Benmamas, Philippe Manfe

► To cite this version:

Pawel Pietrzak, David Malec, Antoine Picot, Pascal Maussion, Tahar Hamiti, et al.. Modelling of PDIV evolution over time under multiple ageing factors for insulation of inverter-fed electrical machines. 2022 IEEE Industry Applications Society Annual Meeting (IAS), Oct 2022, Detroit, France. pp.1-9, 10.1109/IAS54023.2022.9939736 . hal-04833470

HAL Id: hal-04833470

<https://hal.science/hal-04833470v1>

Submitted on 12 Dec 2024

HAL is a multi-disciplinary open access archive for the deposit and dissemination of scientific research documents, whether they are published or not. The documents may come from teaching and research institutions in France or abroad, or from public or private research centers.

L'archive ouverte pluridisciplinaire **HAL**, est destinée au dépôt et à la diffusion de documents scientifiques de niveau recherche, publiés ou non, émanant des établissements d'enseignement et de recherche français ou étrangers, des laboratoires publics ou privés.

Modelling of PDIV evolution over time under multiple ageing factors for insulation of inverter-fed electrical machines

Paweł Pietrzak, David Malec, Antoine Picot, Pascal Maussion
LAPLACE, Université de Toulouse,
CNRS, INPT, UPS
Toulouse, France
pascal.maussion@laplace.univ-tlse.fr

Tahar Hamiti, Loucif Benmamas
Nidec PSA eMotors
Carrières-sous-Poissy, France

Philippe Manfé
Nidec Leroy Somer
Angoulême, France

Abstract— The presented study falls within the scope of research on multi-factor tests and lifetime prediction of insulation systems for electrical machines. It is an attempt to find an indicator of state or remaining life of an insulation system for inverter fed electric motors. Samples of twisted pairs are subjected to high temperature and inverter voltage over long periods of time. Partial Discharge Inception Voltage (PDIV) is measured over the course of their life. The article contains the description of the experimental test bench, method of PDIV measurement and a method of analysis and modeling of the obtained PDIV evolution over time. Changes of PDIV over time are observed. The found evolution of PDIV is modeled with Inverse Power Model with a prediction error of a few percent.

Keywords—insulation, ageing, inverter-fed electrical machine, modeling, PDIV, inverse power model.

I. INTRODUCTION

A. Background

In the process of designing an electrical insulation system designers need feedback about emerging system's capability to perform its envisioned function. Technical standards describe a range of tests and practices for validation of such a system. As the empirical knowledge and understanding of ageing phenomena grow the standards change as well. Advancements in technologies and corresponding research on them also necessitate changes. An example is the introduction of inverters for driving motors which has evolved over the last decades. Low-voltage machines are equipped with Type I insulation systems, which is defined as one containing material that cannot sustain the destructive impacts of long term Partial Discharges (PD). Yet, if confronted with overvoltage from rapidly changing, high dv/dt PWM inverter output, sometimes increased as a result of long cables, the system may experience PD. The effect is even more pronounced when fast-switching new generation SiC components are used [1].

Validation tests can provide theoretical information about the envisioned time a system should survive. They are not aimed at finding a way to evaluate a system in operation, ascertaining how much life it has left and predicting with some uncertainties when it will fail. What is more, the standards put more emphasis on comparative nature of their tests. They compare beginning of life results of a field validated system with those of a new one. This may be problematic in case of systems with largely different design.

One of the ways to predict the remaining life of a system is to find a proper ageing indicator. It may be a measurable

value that monotonously decreases or increases while the system is in operation. Then, beyond a specific value of that indicator, the system could be considered to be at its end of life. If a model, which describes the change over time of that indicator, is found, it is then possible to extrapolate the indicator's value into the future and have some information about when the system may fail.

As of now, the lifetime prediction methods are not well developed. There are numerous tests that can be performed on insulation systems [2]. Yet there is no consensus on which tests are universal and robust indicators of health [3].

B. PDIV as an indicator

Some researchers measure PDIV for the purposes of diagnostics during ageing [4-7]. In [5] one measurement of PDIV for a low-voltage machine was taken at the beginning of life. Then the stators were subjected to a few thermo-electrical ageing periods. After that, the PDIV was measured again in order to check if it had decreased below a certain threshold. The research did not provide many data points, for some the PDIV decreased, while for a few stators it appeared to be rising. Similarly in [6], evolution of PDIV was traced in a thermo-electrical ageing experiment. The study also aimed at evaluating the influence of frequency of sinusoidal voltage on insulation lifetime. The applied electrical stress was above PDIV, the PDs were present, hence the lifetime measured only up to tens of hours. However, the authors were able to observe the decreasing PDIV and modelled it with Inverse Power Model. High-temperature accelerated ageing on twisted-pairs was performed in [7]. PDIV measurements with sine wave voltage were taken multiple times every minute. A decrease in PDIV was observed during the lifetime, having an initial drop over the course of the first hour and then slower linear decrease for a few tens of hours until breakdown.

C. Objectives

In the scope of multi-factor tests, several directions have already been explored. Previous iterations of the research include work done on ageing with influence of PD [8]. The next step was to perform ageing below Partial Discharge Inception Voltage (PDIV). The advantage of test with PD is that they do not take a lot of time; i.e. lifetime ranges from minutes to a couple of hours. On the other hand, it does leave any time to trace evolution of any potential indicators.

The PDIV measurements in this work are performed with square-wave voltage emulating inverter. It was discovered in [9] that the standard test with sinusoidal form may return

different results. Thus, it is better to evaluate the PDIV with the same form of waveform that the samples experience during ageing.

An experiment is set up in this work to follow PDIV while applying multiple ageing factors on the samples. The obtained data could then be utilized for modelling the evolution of PDIV. And afterward, to construct a model which extrapolates the evolution model for different sets of stress factors' levels.

II. METHODOLOGY

A. Samples and experimental set-up

In this particular study, twisted pairs of enameled wires of 0.5 mm in diameter and Temperature Index of 210°C were used. The samples were prepared according to relevant standard [10]. Each experimental batch of samples that was stressed with specific factor level combination consisted of eight twisted pairs.



Fig. 1. Test bench photo, the elements described.

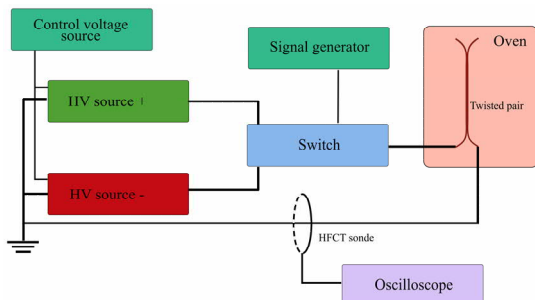

Fig. 2. Test bench schema. System responsible for maintaining the levels of factors as well as one for conducting measurements of PDIV.

The test bench (fig.1) allows emulating voltage form that is experienced by inverter-fed machines. It consists of two high voltage sources, a switch, a function generator and dedicated counters. The sources provide voltage of opposite polarities but equal in value into the switch inputs. The switch, which is gated with signal from function generator, outputs either the positive or the negative voltage values. This output is applied onto the pairs through relays on one side. The other leg of the pair is connected directly to the switch's ground. The test bench simulates square-wave bidirectional voltage and permits to set the values of voltage amplitude and frequency. An additional voltage source allows setting the level of applied voltage in real time. Temperature is also controlled as the samples are kept in an oven during the ageing.

B. PDIV measurement

A High Frequency Current Transformer (HFCT) is inserted on the return wire between the twisted pairs and the sources' mass (Fig. 2). The HFCT is a Pearson Electronic

Current Monitor Model 6585 with a large working bandwidth (400Hz to 250MHz). The signal is observed by an oscilloscope, a Tektronic MSO5204. During each commutation, both current and its FFT are observed. The shape of the current is highly repeatable and characteristic for each pair. During a measurement the level of the applied voltage is increased step by step and the oscilloscope's display is set on the image of the current. This current is the sum of the whole circuit response to pulse voltage (feeding cable, connectors, twisted pair) and, if existing, PD. At some level of the voltage PDs start to appear. PD may be identified by their HF signature. The suddenly change in both temporal and FFT current signature from a critical voltage value has been attributed to PD and has been verified by using an ozone detector put at the top of the twisted pairs. As soon as the recorded signal change (sudden level change in some frequency bands), the sensor are detecting ozone, which allows to validate our method. Fig. 3 displays experimental data with and without PD. The sensitivity of our PD measuring method has been estimated to be about 1pC. This calibration has been performed with another PD measuring test bench using a traditional detection (coupling capacitor and measuring impedance), a sinus applied voltage and a calibration device. Our HFCT has been added into the circuit and the sensitivity could then be estimated by comparing the (calibrated) signal measured by the conventional measuring circuit and our current probe.

The fact of achieving the level over PDIV during the test may be a concern whether an additional destructive factor was introduced. In [7] the PDIV measurements were done automatically with much greater frequency and sinusoidal signal. In this paper, the authors placed one extra sample in the test conditions with intention to not perform the PDIV measurements on it. The lifetime of the control sample was no longer than the lifetime of the one under constant measurements. It inclines to conclude that the measurements were not significantly destructive. The experiments were conducted with only two samples hence hesitation to draw strong conclusions. As for the measurements conducted in this study [7] they are much less frequent (one per day vs. a few per minute) yet the voltage is controlled 'by hand'. The voltage is always decreased as fast as possible as soon as the PDs are spotted but the reaction time would not be as fast as in [7]. The measurements do not seem to be an additional stressor. Moreover, if the impact exists all the samples receive similar 'dose'. A PDIV measurement on a single pair was done only once a day. It was not repeated and only one value was recorded. Preliminary tests of the method with multiple repetitions proved that the spread for one specimen was minimal – no more than one step of voltage resolution of 3.5 V.

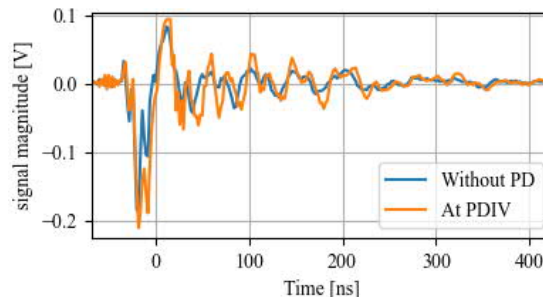

Fig. 3. Temporal view of the measured current at commutation.

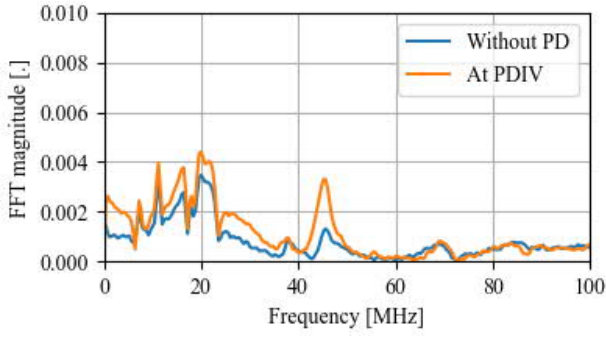

Fig. 4. Spectra of the current signals from Fig.3. Visible change in peak magnitude between 40 and 60 Hz.

What is visualized is an additional charge passing through the insulation – the PD. The value of voltage level of that initial appearance is recorded as the PDIV. The qualitative change of the observed signal appeared much more clearly in its spectrum shown in Fig.4. The spectrum is monitored live during measurements. A rise in frequencies between 40 and 60 MHz can be observed.

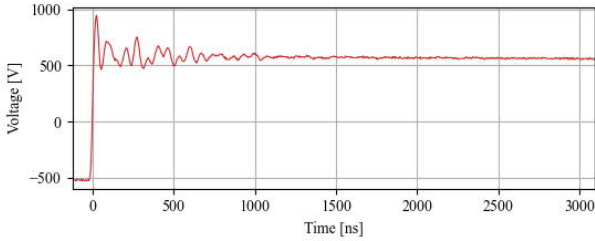

Fig. 5. Voltage applied on the samples. Overshoot at commutation.

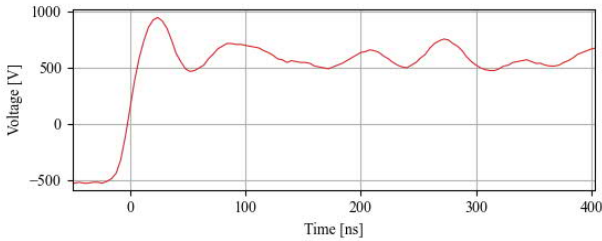

Fig. 6. The commutation of applied voltage, overshoot visible. The voltage rise ramp at 50 V/ns.

The flat portion of voltage is recorded as the PDIV. That works under the assumption that the voltage overshoot (its percentage) is small and constant which is the case here.

C. Design of Experiments

Some of the objectives of the domain called Design of Experiments (DoE) [11] are to minimize the number of experimental runs and to obtain a model of an output as a function of experimental factors. In our case the output being PDIV or rather of PDIV evolution model's parameters.

The method applies to many fields. Notably it was used in the past for insulation lifetime modelling [12]. It is required that the output is linearly dependent on each factor. For this purpose, a model of relation output (Y)-factor (X) needs to be known and then linearized, which can be achieved thanks to non-linear operators. Additionally, the factor levels are normalized so that their influence in the final model can be directly compared. In case of two factors with two levels each, in order to obtain full information four experiments are required (fig.7).

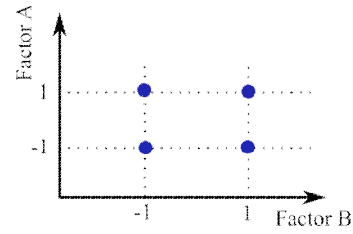

Fig. 7. Example of a full experimental plan for 2 factors and 2 levels.

The four experiments can be described in a matrix form:

$$\begin{bmatrix} Y_1 \\ Y_2 \\ Y_3 \\ Y_4 \end{bmatrix} = \begin{bmatrix} 1 & -1 & -1 & 1 \\ 1 & -1 & 1 & -1 \\ 1 & 1 & -1 & 1 \\ 1 & 1 & 1 & -1 \end{bmatrix} \begin{bmatrix} M \\ E_A \\ E_B \\ I_{AB} \end{bmatrix} \quad (1)$$

Where the vector on the right contains values of results of the experiments, the matrix signifies the levels of the factors and the right vector consists of resulting factor effects. M is the mean value of output Y; E_A, E_B are the main effects of the factors A and B; I_{AB} is the effect of interaction between A and B. Once the effect vector is calculated from (1) it can be used to create a model of output Y for any other combination of the factor levels (2).

$$Y = M + X_A * E_A + X_B * E_B + X_A * X_B * I_{AB} \quad (2)$$

In (2) X_A and X_B are normalized levels of factors. They take values from <-1;1> but the model may be valid for extrapolation beyond that set. Effects of three factors were studied, namely temperature, voltage level and voltage frequency. Values of chosen levels are specified in figure 8. These levels were specifically chosen in order to have some accelerated ageing from thermal ageing and to be just below PDIV which maximizes potential electrical ageing impact.

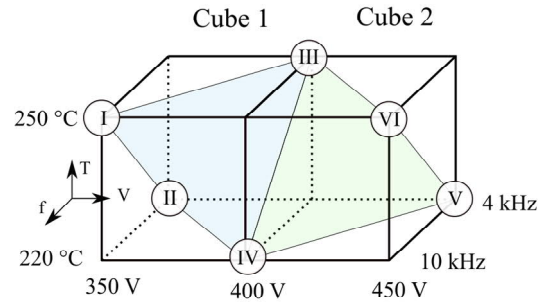

Fig. 8. Two designs of experiment (Cube 1 and Cube 2), both with 3 factors and 2 levels per factor.

Here, only partial designs are considered (4 experiments among the 8 possible configurations) in order to accelerate the experimental process. The main consequence is the inability of modelling the interactions between the different factors which could reduce modeling accuracy.

D. PDIV evolution over time modelling

Each experimental run consisted of eight samples so eight measurements for each combination of the factor's levels. The samples were identical but some variability in the population is inevitable, for this reason the data were treated with Weibull distribution.

In order to apply the distribution the values of PDIV in ascending order were assigned a cumulative probability fraction based on Benard's Approximation. Then those values were transformed into scales corresponding to Weibull graph and modelled with linear regression. Parameters of this model, when retransformed into linear scales are connoted as; scale (α) and shape (β) parameters of Weibull Distribution respectively. The confidence intervals for the values are calculated with methodology presented in the standard [13]. PDIV at each point in time for the purposes of modelling was then considered to be equal the α -Weibull scale parameter. Multiple identical specimens permit to get a better idea of an average value. Weibull distribution is well adapted to describing lifetime or degradation process – weakest specimens have less impact on the average result.

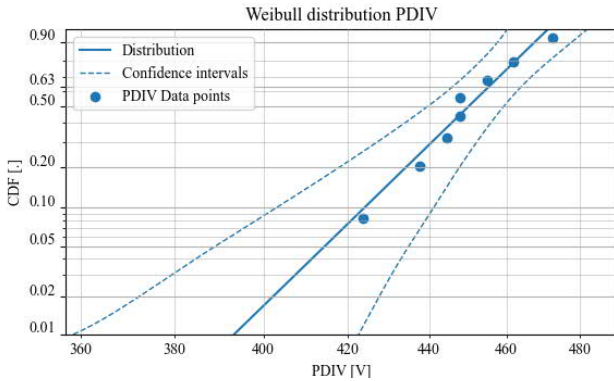

Fig. 9. Example of cumulative distribution function (CDF) of Weibull distribution on Weibull graph. The α -Weibull at 0.63 of CDF, section at that value used as the confidence intervals.

All the reported PDIV are values of the voltage of positive source. The signal is bidirectional; it oscillates between the positive voltage and its opposite value. The resulting series α -Weibull of PDIV in time was modelled with two different models, exponential model and inverse power model. These are presented as:

Assumed form of the Inverse Power Model (model 1):

$$PDIV1(t) = Kt^{-n} \quad (3)$$

And the form of Exponential Model (model 2):

$$PDIV2(t) = Ke^{-n \cdot t} \quad (4)$$

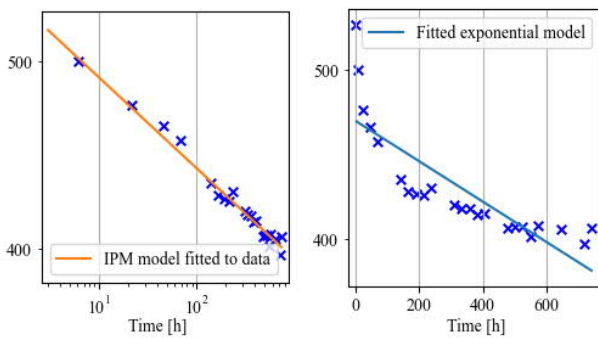

Fig. 10. Comparison IPM (model 1) and EP (model 2) for Point IV.

TABLE I. R^2 VALUES

Point	Model R^2	
	IPM (3)	Exponential (4)
I	0,69	0,16
II	0,91	0,72
III	0,39	0,50
IV	0,99	0,69
V	0,92	0,83
VI	0,81	0,86
Average	0,79	0,63

Both models shown in (3) and (4) are functions of PDIV in time with two constants K and n which were determined by fitting the models to the data. The data are transformed into logarithmic scales and fitted with linear regression. From values of coefficient of determination presented in Table I and visual evaluation of figure 10 the IPM model was chosen as the one that better describes the evolution.

III. RESULTS

A. Dealing with premature end of life in modelling

One of the problems encountered was that a few twisted pairs died prematurely and consequently the spread of the end of life was significant in many cases. Naturally the first pairs to die off were those that manifested lower PDIV from the start. As a consequence, the population in some cases may give impression of rising PDIV. In order to take this effect into account a different approach is proposed. The model was fitted to individual samples (rather than to the scale parameter) and then a weighted average was applied in order to merge the models of all the samples. Results of that original method are presented in fig. 11 for the extreme case of Point I (as in fig. 8, point aged at 250°C, 350 V and 10 kHz).

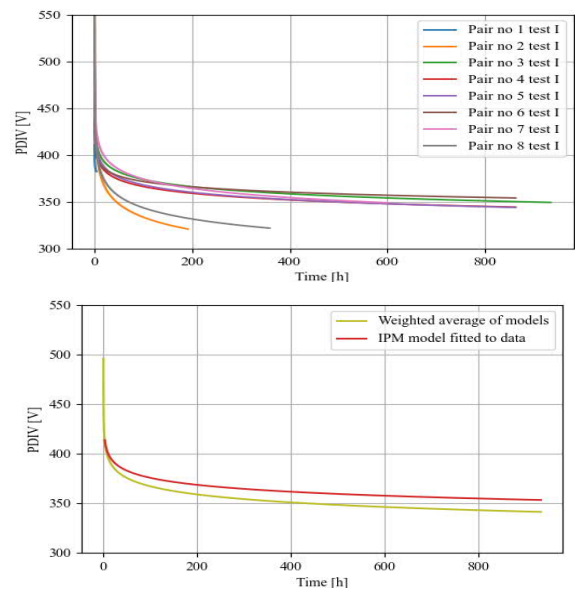

Fig. 11. Models applied to individual twisted pairs (above). Shorter curves indicate shorter life of represented pair. Below comparison of model by taking into account the shorter lifespans.

B. Data and models

Fig. 12 shows the experimental data with fitted IPM model curves obtained from long ageing under PDIV. The measurements were carried out until the last sample of the run broke down (except for points III and VI which were deliberately stopped because the test benches were not available any longer). Table II and III show the levels of factors applied while Table III also shows model parameters as in equation (3).

TABLE II. FACTOR LEVELS

Cube I (II)	Factor levels	
	Minimum level (-I)	Maximum level (+I)
Voltage (below PDIV)	350 V (400 V)	400 V (450 V)
Frequency	4 kHz	10 kHz
Temperature	220°C	250°C

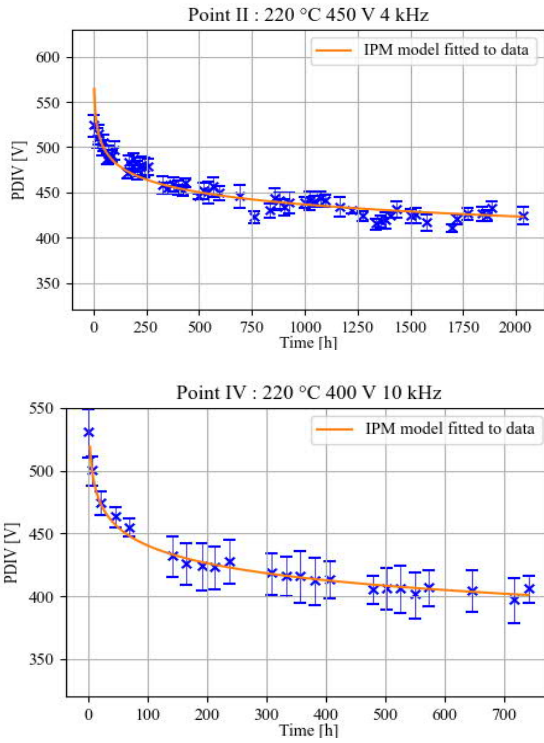

Fig. 12. Data and models of evolution of PDIV at Points II and IV.

TABLE III. MODEL 1 PARAMETERS

Point	Factor values			Parameter	
	V [V]	f [kHz]	T [°C]	K	n
I	350	10	250	426	0.0275
II	350	4	220	592	0.0441
III	400	4	250	475	0.0104
IV	400	10	220	546	0.0468
V	450	4	220	533	0.0303
VI	450	10	250	502	0.0184

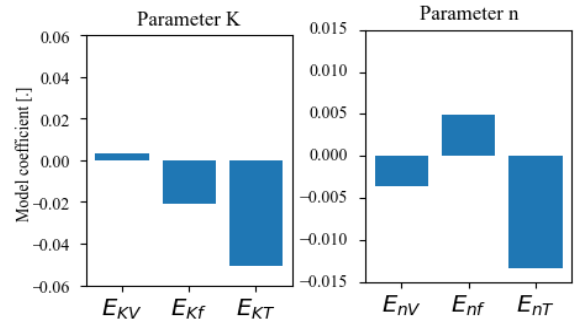

Fig. 13. Main effects of voltage, frequency and Temperature on parameter K (left) and n (right) of equation (3) for models of PDIV evolution.

The two vectors of results for parameter K and n from Table II can be then implanted into equation similar to (1). This equation, when solved provides the main effects of the factors. Since it is not a full experimental design we do not get the interactions between factors.

$$K = M_K + X_V * E_{KV} + X_f * E_{Kf} + X_T * E_{KT} \quad (5)$$

$$n = M_n + X_V * E_{nV} + X_f * E_{nf} + X_T * E_{nT} \quad (6)$$

Each of the parameters have three main effect coefficients, one for every factor (Voltage, frequency, temperature). Xs take values of corresponding factor in normalized form. The models (5) and (6) make it possible to calculate PDIV curve parameters K and n for any combination of factors' levels for values between the minimum and maximum as in Table I.

Fig. 13 presents qualitative impact of the factors on the model of evolution of PDIV. Parameter K, which is responsible for describing the initial value, is most influenced by temperature. The relation is negative, thereby signifying that the higher the temperature, the lower the initial PDIV. Similar case applies to frequency but the impact is comparatively smaller. The ageing voltage set does not influence the initial value of PDIV which is not surprising because it does not influence the first measurements.

Parameter n, which is responsible for the shape of the curve, is again strongly influenced by the temperature and to a smaller degree by frequency and voltage. Temperature over Temperature Index of the material of the enamel is the main ageing factor in this case.

C. PDIV evolution model extrapolation

For one of the experimental points over 2000 h of electro-thermal ageing was conducted. The long lifetime presents an opportunity to check how much data is needed in order to predict accurately the future evolution of PDIV. The modeling was performed with data from the first 200, 400 and 600 hours. Then the models resulting from partial data were extrapolated as far as the actual data and these were compared to that reality. Even longer tests are planned in order to further validate the models.

The errors are calculated from the difference between α -Weibull and modeled value at the point in time. Then that difference is divided by the α -Weibull actual PDIV and converted to percentage.

TABLE IV. ERROR FROM EXTRAPOLATION

Mean % error of model compared to all collected data	Time of data collection [h]	Time considered for the model			
		All	600 h	400 h	200 h
Point I	930	3.17	3.77	4.96	4.32
Point II	2031	1.46	2.32	3.10	4.45
Point III	245	1.45	-	-	1.50
Point IV	740	0.63	0.64	0.65	0.65
Point V	445	0.92	-	0.92	1.06
Point VI	245	0.92	-	-	1.03

Table IV presents relative errors (in %) between the value of α -Weibull and extrapolated model at four points in time.

Point II is the most interesting case as the data were collected for the longest time. Using 200 h of PDIV evolution data (10% of total collected data) provides with model that describes the PDIV with an error of 4.45% on average. Additional 400 h of tests importantly reduces the gap between the model and real values (Table IV), but it still represents only 30% of collected data. Error of model constructed from 600 h of data (2.32%) is comparable to the error of model calculated from all the data at 2031 h (1.46%).

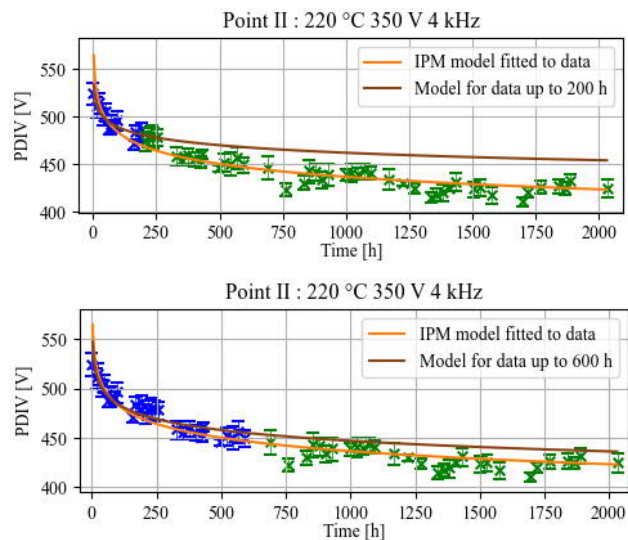

Fig. 14. Comprison of model from limited data and model with all the data. 'Training set' in blue and the remaining data in green.

IV. CONCLUSIONS

The obtained data show some promise as to PDIV's utility as an ageing indicator. In most cases the trend is monotonous (except point I). Inverse power model was identified as the one that best describes the evolution of PDIV. The method of PDIV measurement is not a standard one. Usually the PDIV is measured with an AC voltage not a square-wave form. The new method turned out to be sufficiently robust.

We are currently working on the application of the resulting models obtained thanks to the DoE method to other experimental conditions. The results are promising but not fully correct so far. Presently additional experiments must be

achieved in order to have a full plan that would take into account potential interactions between factors.

The standard way to apply DoE would be to use lifetimes instead of degradation model parameters. It is not possible because at the instant when a PDIV of a sample goes under the level of voltage stress, the main ageing factor changes. The two failure mechanisms act at the same time and there is no way to separate those impacts.

This study made use of twisted pair of round enameled wire. In order to gain more holistic results, one needs to perform tests on different kinds of samples, such as motorettes or complete stators.

REFERENCES

- [1] R. Acheen, C. Abadie, T. Lebey, T. Billard, i S. Duchesne, „Comparison of the Electrical Ageing Under Sinusoidal and Square-Wave Stresses”, w 2018 IEEE Electrical Insulation Conference (EIC), cze. 2018, s. 353–356. doi: 10.1109/EIC.2018.8481024. Acheen, C. Abadie, T. Lebey, and S. Duchesne, 'Electrical stress mapping in a Type II machine supplied by inverters using Si and SiC based components', IET Electr. Power Appl., vol. 14, no. 6, pp. 981–990, Jun. 2020, doi: 10.1049/iet-epa.2019.0345.
- [2] G. C. Stone, Ed., Electrical insulation for rotating machines: design, evaluation, aging, testing, and repair. Piscataway, NJ : Hoboken, NJ: IEEE ; Wiley-Interscience, 2004.
- [3] G. C. Stone and I. Culbert, 'Prediction of stator winding remaining life from diagnostic measurements', in 2010 IEEE International Symposium on Electrical Insulation, San Diego, CA, USA, Jun. 2010, pp. 1–4. doi: 10.1109/ELINSL.2010.5549791.
- [4] P. Yuan et al., 'Deterioration of Stator Winding Insulation in Inverter-Fed Traction Motors', in 2020 IEEE Electrical Insulation Conference (EIC), Jun. 2020, pp. 457–460. doi: 10.1109/EIC47619.2020.9158656.
- [5] J. Richnow, P. Stenzel, A. Renner, D. Gerling, and C. Endisch, 'Influence of different impregnation methods and resins on thermal behavior and lifetime of electrical stators', in 2014 4th International Electric Drives Production Conference (EDPC), Sep. 2014, pp. 1–7. doi: 10.1109/EDPC.2014.6984406.
- [6] L. Briano, F. Gallesì, F. Guastavino, and E. Torello, 'Variation Over Time of Partial Discharge Inception Voltage Due to Combined Electrical and Thermal Stress on Twisted Pairs', in 2021 IEEE Conference on Electrical Insulation and Dielectric Phenomena (CEIDP), Dec. 2021, pp. 543–546. doi: 10.1109/CEIDP50766.2021.9705328.
- [7] M. Szczepanski, L. Fetouhi, M. Sabatou, S. Pin, and G. Belijar, 'PD energy as a marker of low-voltage insulation aging', in 2021 IEEE Electrical Insulation Conference (EIC), Jun. 2021, pp. 377–380. doi: 10.1109/EIC49891.2021.9612374.
- [8] P. Pietrzak et al., 'Effect of voltage and frequency cycling on the lifetime of enameled wires for low voltage inverter-fed motors', in 2021 IEEE Conference on Electrical Insulation and Dielectric Phenomena (CEIDP), Dec. 2021, pp. 163–166. doi: 10.1109/CEIDP50766.2021.9705459.
- [9] P. Wang, A. Cavallini, and G. C. Montanari, 'Endurance testing of rotating machines insulation systems: Do sinusoidal and square voltage waveforms provide comparable results?', in 2013 IEEE International Conference on Solid Dielectrics (ICSD), Jun. 2013, pp. 310–313. doi: 10.1109/ICSD.2013.6619823.
- [10] IEC 60851-5:2008 'Winding wires Test methods-Part 5: Electrical properties', 2008.
- [11] D. C. Montgomery, Design and analysis of experiments, Eighth edition. Hoboken, NJ: John Wiley & Sons, Inc, 2013.
- [12] M. Szczepanski, D. Malec, P. Maussion, B. Petitgas, and P. Manfé, 'Use of Design of Experiments (DoE) predictive models as a method of comparison of enameled wires used in low voltage inverter-fed motors', in 2018 IEEE Industry Applications Society Annual Meeting (IAS), Sep. 2018, pp. 1–8. doi: 10.1109/IAS.2018.8544548.
- [12] IEC 60216-1, 'Electrical insulating materials Thermal endurance properties Part 1: Ageing procedures and evaluation of test results'-2013.

[13] „IEC/IEEE Guide for the Statistical Analysis of Electrical Insulation Breakdown Data (Adoption of IEEE Std 930-2004)”. IEC 62539 First Ed. 2007-07 IEEE 930, s. 1-53, 2007, doi: 10.1109/IEEESTD.2007.4288250. M. Szezepanski, D. Malec, P. Maussion, B. Petitgas, and P. Manfó, ‘Use of Design of Experiments

(DoE) predictive models as a method of comparison of enameled wires used in low voltage inverter fed motors’, in 2018 IEEE Industry Applications Society Annual Meeting (IAS), Sep. 2018, pp. 1-8. doi: 10.1109/IAS.2018.8544548.